

# FINAL REPORT

## ELECTRICAL ENGINEERING SUPPORT FOR TELEMETERED TRAFFIC MONITORING SYSTEMS

**FDOT Contract No. BD-543-3**

**Period of Performance: 11/26/2003 - 3/30/2009**

**SUBMITTED BY:**



**FAMU-FSU College of Engineering  
Florida State University  
2525 Pottsdamer Street  
Tallahassee, FL 32310-6046**



**PRINCIPAL INVESTIGATOR:**

**Bruce A. Harvey, Ph. D.  
Assistant Professor  
Department of Electrical and Computer Engineering  
Phone: (850) 410-6451  
Fax: (850) 410-6479  
Email: [bharvey@eng.fsu.edu](mailto:bharvey@eng.fsu.edu)**

**March 2009**

## **DISCLAIMER**

The opinions, findings and conclusions expressed in this publication are those of the authors and not necessarily those of the State of Florida Department of Transportation.

## **METRIC CONVERSION FACTORS**

1 ft = 0.3048 m

1 mph = 1.609 km/hr

1. Report No.		2. Government Accession No.		3. Recipient's Catalog No.	
4. Title and Subtitle  Electrical Engineering Support of Telemetered Traffic Monitoring Sites				5. Report Date March 2009	
				6. Performing Organization Code	
7. Author(s) Bruce A. Harvey				8. Performing Organization Report No.	
9. Performing Organization Name and Address Department of Electrical and Computer Engineering FAMU-FSU College of Engineering 2525 Pottsdamer Street Tallahassee, FL 32310-6046				10. Work Unit No. (TRAIS)	
				11. Contract or Grant No. BD-543-3 November 2003 – March 2009	
12. Sponsoring Agency Name and Address Florida Department of Transportation 605 Suwannee Street, MS 30 Tallahassee, FL 32399				13. Type of Report and Period Covered Final Report November 2003 – December 2008	
				14. Sponsoring Agency Code	
15. Supplementary Notes					
16. Abstract <p>The aim of this project was to provide electrical engineering support for the telemetered traffic monitoring sites (TTMS) operated by the Statistics Office of the Florida Department of Transportation. This project was a companion to project BD-543-12, which provided civil engineering support for the same sites. The project consisted of three main efforts that are detailed in this report. The first task was to conduct efforts to improve modem communication with the TTMS sites. The second task was to conduct field and laboratory testing to specify and identify lightning surge suppression devices to protect the TTMS's electronics (communications and classification) from lightning surges. The third task was to develop interface electronics for and support field testing of a segmented sensor design to identify dual versus single tires. This identification can lead to improve vehicle classification accuracy.</p> <p>The results of the first task were verification of communication equipments used and development of refined modem strings. This increased the reliability of the communication with the TTMS sites reducing the need for manual collection of traffic data. The second task resulted in an initial characterization of the lightning surges, specification of surge suppressor requirements and identification of appropriate surge suppressors to protect the TTMS equipment. The third task resulted in the development of a prototype electronics interface and a successful field test demonstrating the feasibility of the segmented sensor to improve classification. This project has resulted in lower maintenance costs for the TTMS sites and potentially improved classification performance.</p>					
17. Key Word Modem communication, lightning, surge suppression, vehicle classification			18. Distribution Statement No restrictions.		
19. Security Classif. (of this report) Unclassified		20. Security Classif. (of this page) Unclassified		21. No. of Pages 231	22. Price

## **Acknowledgements**

The author wishes to acknowledge the support and assistance of the Project Manager, Mr. Richard Reel of the FDOT Statistics Office.

The author also wishes to acknowledge the efforts of the multiple graduate and undergraduate research assistants on this project:

Graduate Research Assistants: Salman Siddiqui  
Onyekachi Acholem  
Michael Akali

Undergraduate Research Assistants: Ajay Subramanian  
Arthur Boote  
Bryce Barbato  
Christian Wahiwe

## Executive Summary

The Florida Department of Transportation (FDOT) currently monitors about 7,000 traffic count sites including over 300 permanent telemetered traffic monitoring sites (TTMSs). The monitoring equipment generally consists of traffic-actuated sensing devices imbedded in the pavement and classification equipment that captures the traffic volumes, vehicle classifications, and truck weights. The information captured by the field monitoring devices is thereafter downloaded and processed to get information on Annual Average Daily Traffic (ADT), K-factor, T-factor, truck weight, and other pertinent information. This information is used in various forms by different FDOT departments for planning, designing, operations, and maintenance activities relating to both highway pavements and bridges.

The FAMU-FSU College of Engineering (COE) was contracted to provide electrical engineering support to the Transportation Statistics Office of the FDOT in improving the accuracy and reliability of the TTMS sensors and communication equipment. The Principal Investigator for the project was Dr. Bruce A. Harvey of the Department of Electrical and Computer Engineering. The project was conducted from November 26, 2003 to March 30, 2009. The major efforts conducted under this project were

1. Modem Communication Reliability,
2. Lightning Protection for TTMS, and
3. Electronic Interface Design for and Field Tests of a Segmented Axle Sensor.

In addition to the major efforts, the COE also provided technical support for the SO as needed throughout the project.

### *Modem Communication Reliability*

On a nightly basis the FDOT Statistics Office automatically polls each of the over 300 telemetered traffic monitoring sites to retrieve the vehicle count, classification and weigh-in-motion data acquired during the previous day. There are a variety of modems used in the monitoring sites and a modem bank at the FDOT Statistics Office. Reliable communication has been a need of the FDOT in order to reduce the manual labor required to acquire the data from sites that do not connect and download data during the automated process. This effort's objectives were to identify problems with the modem communication system and identify improvements that will reduce the number of times data cannot be automatically acquired from the TTMS sites.

There were four specific tasks that were conducted to support this effort. The first task was to analyze the modem string used to set up the modems for communication in order to identify and correct problems. The goal of the effort was to develop modem strings for the different modems used in the TTMS sites. The second task was to test the Digi International's AccelePort RAS 8-modem PCI board ( or Digiboard) that the FDOT was using in its automated polling system to determine the performance characteristics of the

modem bank. The third task was to analyze the performance of the local and long distance telephone connections. The fourth task was to evaluate the reliability of communication with weigh-in-motion (WIM) sites. The tasks under these efforts are described in greater detail in the following sections.

The efforts to improve modem communication between the FDOT automated polling system at the Burns Building in Tallahassee, Florida and the individual TTMS sites were very successful. Modem initialization strings were developed for the TTMS site modems that significantly improved the operation of a number of the TTMS modems. The modem strings and phone lines used in the Burns Building were found to work well for modem communications. Long distance telephone communication was found to have intermittent period of very poor modem performance and recommendations for improving the automated re-dialing of TTMS sites when errors occur were provided. The reliability of communications with WIM sites was evaluated and it was found that the primary causes of polling errors can be directly attributed to large file sizes and the modem initialization strings.

The benefits to the FDOT resulting from this effort include improved communication with the TTMS sites to collect count, classification and weight statistics. The reduced errors in the automatic polling reduced the cost of manually downloading the data or sending someone to locally download the data.

#### *Lightning Protection for TTMS*

Protection of the over 300 permanent TTMS installations from the damaging effects of lightning is of critical importance to the FDOT. Sites damaged by lightning result in the reduction of statistical information collected of the number classification and weight of vehicles operating on Florida's highways. Also, the cost of repairing the sites damaged by lightning is considerable. Florida is known as the lightning capital of North America and thus much of the state (particularly central Florida) is subject to more lightning than the rest of the United States.

To address the problem of lightning protection for TTMSs this research project continued the efforts of a previous research project (Project No. BC-596, "Improving Operation of FDOT Telemetered Traffic Monitoring Sites"). The efforts under this research effort consist of two tasks. The first task is the continuation of lightning field tests to characterize the lightning environment for which protection is needed. The second task is to conduct laboratory testing of existing low-voltage surge suppressors to identify surge suppressors appropriate for the protection of electronics that interface with the in-pavement sensors. These two tasks are described in the following sections.

The results of the efforts to count and measure the lightning surges through TTMS phone lines and in-pavement sensors has improved the understanding of the specifications needed for surge suppressors. The research indicated that surge suppressors for both telephone and sensors needs to be rated to endure 1,000s of lightning surges in order to ensure the reliability of the TTMS sites. Through the laboratory testing efforts, surge

suppressors have been recommended for telephone line and in-pavement sensors that have been tested to endure at least 10,000 surges without failure. Further testing is needed to determine the maximum rated surge current for surge suppressors and to provide a more complete characterization of the lightning surges experienced by the TTMS equipments.

The benefits to the FDOT of lightning field testing and laboratory surge suppressor testing was the specification and recommendation of reliable surge suppressors to protect the sensitive electronics in the TTMSs. This has improved the reliability of the TTMS sites and reduced the cost of repairs to the TTMS equipment due to failures caused by lightning surges.

#### *Electronic Interface Design for and Field Tests of a Segmented Axle Sensor*

The Florida Department of Transportation currently maintains over 300 telemetered traffic monitoring sites (TTMS) throughout the state to monitor traffic operations on the state highway system. Most of these TTMS stations employ inductive loop detectors and piezoelectric axle sensors to determine the number of axles, axle spacing and length of individual vehicles. This information is used to attempt to determine the classification of the vehicles. Vehicle classification statistics are used to estimate pavement wear and traffic patterns, and to plan maintenance and improvements of the roads. Thus accurate classification of vehicles is critical to the FDOT.

Classification of vehicles using number of axles, axle spacing and length alone can result in a significant number of classification errors. For example, a long-bed pickup truck with all single tires (Class 3) can easily have the length and axle spacing of some smaller trucks with 2 axles and 6 tires (Class 5). Class 5 vehicles are generally heavier and carry larger loads than a Class 3 pickup truck. Such misclassifications lead to inaccurate pavement loading statistics.

Classification algorithms can be improved if the axle sensor had the ability detect single versus dual tires on each axle. This information would greatly reduce misclassifications of vehicles such as the Class 3 –Class 5 errors. John Reed of PET Corporation proposed a design for a segmented axle sensor that can provide an estimate of the tire width and thus discriminate between single and dual tire axles. This effort was designed to determine if the segmented axle sensor is feasible and if the identification of single and dual tire axles can improve vehicle classification accuracy.

The design and implementation of the electronics interface for, and the field testing of the prototype metallic segmented sensor demonstrated that tire width estimation resulting in single versus dual tire discrimination can significantly improve the vehicle classification accuracy. The implementation of an interface for and testing of the prototype extruded segmented sensor demonstrated the feasibility of the design and interfacing of an extruded segmented sensor. Future efforts are required to fully implement the interface electronics for the segmented sensor.

The benefits to the FDOT of the design and implementation of interface electronics, and the field testing of the segmented axle sensors is the demonstrated the feasibility of improved vehicle classification. By using the tire width estimate from the segmented sensors the accuracy of the vehicle classification can be improved. Improved vehicle classification statistics will improve the efficiency of highway maintenance and improvement planning.

All of the tasks conducted under this project were successfully completed by the faculty, staff and students of the Department of Electrical and Computer Engineering at the FAMU-FSU College of Engineering.



## Table of Contents

Acknowledgements.....	iv
Executive Summary .....	v
Table of Contents.....	ix
1. Introduction.....	1
2. Modem Communication Reliability .....	2
2.1. Analysis of Modem Initialization Strings.....	2
2.2. Performance Study of the Digi AccelePort RAS 8-Modem PCI Board.....	3
2.3. Burns Building Phone Line Assessment.....	5
2.4. Modem Connection Reliability of Weigh-In-Motion (WIM) Sites.....	7
3. Lightning Protection for TTMS .....	10
3.1. Field Testing of Lightning Surges .....	10
3.2. Low-Voltage Surge Suppression for TTMS Sensors.....	11
4. Electronic Interface Design for and Field Tests of a Segmented Axle Sensor.....	14
5. Conclusions.....	16
6. Benefits to the FDOT .....	17
Appendix A. Interim Report “Analysis of Modem Initialization Strings” .....	A-1
Appendix B. Interim Report “Performance Study of the Digi AccelePort RAS 8-Modem PCI Board” .....	B-1
Appendix C. Interim Report “Burns Building Phone Line Assessment” .....	C-1
Appendix D. Table Summarizing 2003 Polling Errors Form Automated Polling of TTMS Data .....	D-1
Appendix E. Interim Report “Field Testing of TTMS Lightning Surges” .....	E-1
Appendix F. Interim Report “Low-Voltage Surge Suppression for TTMS Sensors” .....	F-1
Appendix G. Interim Report “Electronic Interface Design for and Field Tests of a Segmented Axle Sensor” .....	G-1

## **List of Tables**

Table 1. Summary of Results of First Five Phases .....	6
Table 2. Listing of Error Codes in the Data Provided by FDOT .....	8

## 1. Introduction

The Florida Department of Transportation (FDOT) currently monitors about 7,000 traffic count sites including over 300 permanent telemetered traffic monitoring sites (TTMSs). The monitoring equipment generally consists of traffic-actuated sensing devices imbedded in the pavement and classification equipment that captures the traffic volumes, vehicle classifications, and truck weights. The information captured by the field monitoring devices is thereafter downloaded and processed to get information on Annual Average Daily Traffic (ADT), K-factor, T-factor, truck weight, and other pertinent information. This information is used in various forms by different FDOT departments for planning, designing, operations, and maintenance activities relating to both highway pavements and bridges.

The Department of Electrical and Computer Engineering at the FAMU-FSU College of Engineering (COE) was contracted to provide support to the Statistics Office (SO) of the FDOT in improving the accuracy and reliability of the TTMS sensors and communication equipment. The major efforts conducted under this project were

1. Modem Communication Reliability,
2. Lightning Protection for TTMS, and
3. Electronic Interface Design for and Field Tests of a Segmented Axle Sensor.

In addition to the major efforts, the COE also provided technical support for the SO as needed throughout the project.

## **2. Modem Communication Reliability**

On a nightly basis the FDOT Statistics Office automatically polls each of the over 300 telemetered traffic monitoring sites to retrieve the vehicle count, classification and weigh-in-motion data acquired during the previous day. There are a variety of modems used in the monitoring sites and a modem bank at the FDOT Statistics Office. Reliable communication has been a need of the FDOT in order to reduce the manual labor required to acquire the data from sites that do not connect and download data during the automated process. This effort's objectives were to identify problems with the modem communication system and identify improvements that will reduce the number of time data cannot be automatically acquired from the TTMS sites.

There were four specific tasks that were conducted to support this effort. The first task was to analyze the modem string used to set up the modems for communication in order to identify and correct problems. The goal of the effort was to develop modem strings for the different modems used in the TTMS sites. The second task was to test the Digi International's AccelePort RAS 8-modem PCI board (or Digiboard) that the FDOT was using in its automated polling system to determine the performance characteristics of the modem bank. The third task was to analyze the performance of the local and long distance telephone connections. The fourth task was to evaluate the reliability of communication with weigh-in-motion (WIM) sites. The tasks under these efforts are described in greater detail in the following sections.

### **2.1. Analysis of Modem Initialization Strings**

One of the biggest concerns for the Florida Department of Transportation (FDOT) Transportation Statistics Office (TSO) has been the task of configuring modem strings with different data collection equipments at its 300+ telemetered traffic monitoring sites (TTMSs). These modem strings are dependent on the make and model of the modems along with the make and model of the TTMS equipment, and the modem strings provided by the TTMS equipment vendors required tweaking. The purpose of this study was to study, design, and recommend modem strings for use at the TTMS sites and data collection modems.

#### *Activities Conducted*

An in-depth study was conducted to study the issue of modem initialization strings. The study was divided into three phases. Phase I involved collection of the modem strings used by the FDOT for their field modems with respect to the data collection equipments. In Phase II, the modem initialization strings used by FDOT were studied along with the default settings of the modem to study the issue of optimal performance of the modems and a thorough analysis was performed. In Phase III, the modem initialization strings covered in Phase I and II were used, and new modem strings were generated by tweaking the existing modem initialization strings to provide the optimum modem strings for each modem discussed in the study relative to the data collection equipment used. Also, new

modem initialization strings were provided for newer modems that FDOT was planning to use.

### *Results and Conclusions*

Based on the research done on initialization string it was observed that the data collection equipments had a certain desired format to communicate with the modem attached to it and therefore it had to be used accordingly. Unfortunately these specifications were not always given by the vendors and thus cause a problem of trial and error. At present FDOT has the document from PEEK (*Tech Notes for Configuring a Modem for an ADR*) to make modem strings for the PEEK data collection equipment and that also only for ADR units 1000, 1000 plus, 2000, 2000 plus, 3000, and 3000 plus. The instructions provided by the PEEK document do not apply to the ADR-4000 and ADR-6000 unit as mentioned in the Tech Notes. Such documents were not available for the PAT and Diamond data collection software and their presence would help understand the requirements that particular data equipment has regarding the modem settings, and those particular settings could be added to the initialization strings. Also, for future purposes, the modem manual should be checked to verify that the default values are given after the factory setting. This was not very clear for the cascade modem as they mainly list the basic AT command set and then print a list of settings after execution of AT&F command rather than mentioning if it is default in the command set presentation itself.

### *Benefits to the FDOT*

The benefit of this research was the generation of modem strings for newer modems that FDOT was planning to use, optimization of existing initialization strings based on TTMS vendor requirements, discussion of methodology on generating the initialization strings efficiently; all leading to an increase in modem reliability from the Burns Building to the TTMS sites, a reduction in manual downloads of data files from the TTMS sites, and thus reduction in maintenance cost.

The details of the study and the resulting generalized modem strings resulting from this effort are provided in the interim report “Analysis of Modem Initialization Strings,” which is included in Appendix A of this report.

## **2.2. Performance Study of the Digi AccelePort RAS 8-Modem PCI Board**

One of the main items of interest to the Transportation Statistic Office at the Florida Department of Transportation is the analysis of the data collected from over 300 plus of its telemetered traffic monitoring sites (TTMSs) distributed over the State of Florida. This data collection is initiated at the headquarters of the FDOT by using 8-polling lines in the communication room of the Burns Building to collect the data from all the 300+ TTMSs. All the polling lines have a modem that calls the modem at the TTMSs and once connected, it downloads the data collected that particular day. At the time FDOT started using the Digi International’s AccelePort RAS 8-modem PCI board (a bank of calling modems) to collect the data from the TTMS equipment, the reliability of the connections

between the Digiboard modems and the modems at the TTMSs became a concern for the FDOT.

The Florida A&M University-Florida State University College of Engineering (FAMU-FSU COE) Department of Electrical and Computer Engineering was tasked to test the performance of Digiboard modems when connecting to typical field modems used by the FDOT. These tests were to assess the reliability of the modem connection as a function of noise level and attenuation on the telephone line.

#### *Activities Conducted*

The testing of the Digiboard modems was conducted in four phases. In Phase I, compatibility of the Digiboard modem to a variety of modems was assessed under ideal line conditions. A Teltone Telephone Line Emulator (TLE) was used to connect the Digiboard modems to the other modems tested. In Phase II, the Teltone TLE was used to introduce random (white) noise to the telephone line and the maximum noise level at which the modems could reliably connect was determined. In Phase III, the noise was removed and attenuation was added to the lines (sending and receiving) to assess the sensitivity of the modem connections to signal level. Finally, in Phase IV, the effects of combinations of noise and attenuation were assessed.

#### *Results and Conclusions*

The performance of the Digi International's AccelePort RAS 8-Modem PCI card used by the FDOT for collection of data from the TTMS systems was very similar to that of other 56K modems tested. It was observed that the Digiboard modems were more sensitive to noise when connecting to lower speed (14.4K) modems and thus may have more difficulty connecting to the modems used in TTMS installations. The Digiboard performed as well as or slightly better than other 56K modems when connecting to 14.4K modems over attenuated lines. When a combination of line attenuation (fixed at 24 dB) and noise are present, the Digiboard modems demonstrate weaker performance when connecting with 14.4K modems. And as FDOT changes the old modems at the TTMS sites that operate at less than 14.4kbps, the operation of the Digiboard modems would only improve with those upgrades.

#### *Benefits to the FDOT*

The benefit of this study was that it was verified that the investment of the FDOT in the Digiboard modem was justified as it was reliable and performed better with modems connecting at 14.4K and higher. Therefore, no changes were recommended in that aspect.

#### *Further Details*

The details of the study including tests conducted, test results and conclusions are provided in the interim report "Performance Study of the Digi AccelePort RAS 8-Modem PCI Board," which is included in Appendix B of this report.

### **2.3. Burns Building Phone Line Assessment**

The Florida Department of Transportation (FDOT) Transportation Statistics Office currently collects traffic data from over 300 permanent telemetered traffic monitoring sites (TTMSs) distributed over the State of Florida. By and large the gathering of the data from the TTMSs is accomplished using telephone modems to dial up each site. This process of dial up is initiated by 8-polling lines in the communication room of the Burns Building at midnight to collect the data from all the 300+ TTMSs. Due to the problems with the drop connections, and unsuccessful connections between the Burns Building phone lines and the TTMSs, the FDOT tasked the FAMU-FSU College of Engineering (COE) to assess the performance of the phone lines in the Burns Building communication room. The task of analyzing the performance of the phone lines was distributed into six phases.

#### *Activities Conducted*

During Phase I to Phase V of the study, the quality of local calls was assessed on the phone lines of the Burns Building. To this effect, the initial tests included day and night time measurements of each of the 8 polling lines in the communication room. The line quality was measured between the communication room and the COE using the Modem line Quality Tester (MLQT) units provided by the FDOT. Then, to isolate the source of line degradations at the Burns Building, the MLQT tests were conducted between Burns Building and a residence line (Phase II), between the COE and the residence line (Phase III), between two residence lines (Phase IV), and between the COE and the Springhill Road facility of the FDOT (Phase V).

The later tests, Phase VI, included using the long distance service at the Burns Building to dial to the College of Engineering instead of using the local service, as the local service was through sprint whereas the long distance service was via Suncomm. Also, tests were performed between the Burns Building and the site 320-2, site 204, site 343 and site 96. Site 320-2 is located at SR-93/I-75, between I-10 AND US-90, Columbia County (southbound side), Site 204 at SR-528/Beeline Expwy, 1.4 MI W of SR-15, Orange County (SE of Orlando), Site 343 at SR-400/I-4, 1.6 MI E OF SR-434, Seminole County (Orlando), and Site 96 at SR-9, 0.4 MI SW OF Biscayne Canal Bridge, Dade County (near Miami). These sites were selected for long distance line quality tests when they were visited for data collection of the lightning surges. These later tests were grouped together as the last phase of the data collection and analysis for the Burns Building phone line assessments.

#### *Results and Conclusions*

In the initial tests all the 8 polling lines in the Burns Building Communication Room were tested at daytime and nighttime. A total of 20 runs were performed on each line during daytime and 10 runs at nighttime. The results indicated that the performance of the

phone lines was not affected by the time of the day the tests were conducted. All tests were then conducted during the daytime.

Phases II to V were then conducted to compare the performance of the Burns Building Phone lines with that of the College of Engineering (COE) and residential phone lines. The summary of the results from the first five phases of the phone line assessments of the Burns Building are provided in Table 1.

**Table 1. Summary of Results of First Five Phases**

Phase	Test Sites	Ave BER	Ave Speed
I	Burns Building to College Of Engineering (COE) Daytime (20 runs)	1.25E-04	24510
	Burns Building to COE Nighttime (10 runs)	1.06E-04	24668
II	Burns Building to Residence Phone Line	2.34E-04	23580
III	COE to Residence Phone Line	0	28880
IV	Between two Residence Phone Lines	9.42E-06	27360
V	Springhill Rd Facility of FDOT to COE	1.57E-03	24933

In Table 1, ‘Ave BER’ stands for Average Bit Error Rate, and it is (the number of bits received in error during the test/total number of bits transmitted); and ‘Ave Speed’ stands for Average Connection Speed at which the connection was established and its units are bits per second (bps).

Table 1 shows that there is some degradation in the phone lines at the Burns Building based on the average BER and the average connection speed, although these degradations do not affect the voice communication, they do affect data communication due to the errors or noise on the phone line.

In Phase VI, long distance communication (via Suncomm service at the Burns Building) was established with several different TTMS sites, which were chosen mainly out of convenience as those sites were visited for data collection of lightning surges. A total of four different TTMS sites were used for this purpose: namely Site 320-2 near Lake City, Site 204, Site 343 and Site 96 (The locations of these sites are mentioned earlier for exact reference). A total of 25 connections were established with Site 320-2 (on one day), a total of 40 connections established with Site 204 (on three different days), a total of 40 connections established with Site 343 (on three different days), and a total of 20 connections established with Site 96. From the results of all the tests it was concluded that the presence of surge suppressor on the phone line at the TTMS site does not degrade the performance of the phone line. Also the number of errors on long distance connections was much more than those in the local tests conducted in the first five phases of the tests. There were also some dropped calls during the long distance connections from the Burns Building to the TTMS sites. These dropped calls tended to occur in bursts indicating that there was some sort of time dependence to the problems.



Since these period of poor performance are due to bursts of errors on the telephone line, the solution to increase efficiency of the polling system, along with reduced errors was to implement a delay in reconnecting to that particular site and to download after certain delay, causing the bursts of errors to pass.

#### *Benefits to the FDOT*

The benefit of this research was to discover that the long distance calls from the Burns Building to TTMS sites tend to have periods of poor performance; therefore the failure of connection does not imply failure of the modem. Further a method to maneuver across this problem was suggested, which in essence improves the efficiency of the current polling system, as it is not bogged down trying to reconnect to a site, and also reduces the time and effort required with manual downloads of data from TTMS sites, by reconnecting after certain time and doing this process automatically, hence reducing cost of operations for the FDOT.

#### *Further Details*

The details of the tests conducted, test results and conclusions are provided in the interim report “Burns Building Phone Line Assessment” which is included in Appendix C of this report.

### **2.4. Modem Connection Reliability of Weigh-In-Motion (WIM) Sites**

One of the concerns FDOT had was the lack of reliable connections to download data of the Weigh-in-Motion (WIM) Sites. The Florida A&M University-Florida State University College of Engineering (FAMU-FSU COE) Department of Electrical and Computer Engineering was tasked to determine the causes and, if possible, corrections that can be made to improve the performance of the communication connections.

#### *Activities Conducted*

FDOT provided FAMU-FSU College of Engineering the data about the problems experienced in the year 2003 with downloading data from all TTMS sites. The first task associated with this data was to extract the relevant information so that the analysis could be performed. To do this, the data was organized by the TTMS Site Number along with the kind of error that occurred at that site. There were ten different kinds of errors that were observed in the data, and are referred as Error Code Numbers. The descriptions of these ten error codes are listed in Table 2.

**Table 2. Listing of Error Codes in the Data Provided by FDOT**

Error Code	Description of Error Codes Numbers
0	Software problem with Polling System
1	Error while initializing modem.
2	Poll4Modem.exe is not responding.
3	Counter phone answered but modems did not connect.
4	Phone on counter did not answer.
5	Phone on the counter was busy.
6	Counter's phone answered and modems connected but unable to login.
7	An error was detected during a file download.
8	The specified file was not found on the counter.
9	Upload to the TTMS Server failed.
10	Unknown error.
99	Software of the polling system crashed

From the data it was observed that the total number of sites that had some kind of problem were 292, of which 32 problem sites were WIM sites. (TTMS sites numbered 99xx are the WIM sites.) Then the data was sorted based on the number of errors per site to analyze the performance of WIM sites relative to other sites listed. It was observed that while not all of the worst sites were WIM sites, about half of the 40 worst sites were WIM sites.

Also the number of errors by error code was calculated. From these calculations it was observed that the WIM sites were 11.3% of the total sites, but accounted for 24.8% of the data download errors. The purpose of this was to see where the WIM sites performed worse than other sites in general. It was found that the top three error codes where the WIM sites performed worse than the other sites were error codes 6, 7 and 3. Error codes 3 and 6 were likely due to modem string problems as they had to do with connection and login, where as Error code 7 was an error detected during download. Statistically, the longer files from WIM sites would likely have more errors during downloads.

### *Results and Conclusions*

From the data analysis, it was observed that from the total errors that were found at different TTMS sites, 7% of the errors were during data download, and were mainly found in WIM sites. This was most likely because of the size of data downloaded from the WIM sites is much larger than the data downloaded from other sites. It was also noted that over 50% of the errors causing unreliable connections were likely due to modem initialization strings. Therefore the best approach to reduce the data collection errors was to improve and/or optimize the modem initialization strings. Also, one method that could be employed to improve the reliability of the data downloads from the WIM sites is to break the large daily data files into smaller files. Statistically, there would be less chance of download failure in a smaller file, and if there is an error in downloading a smaller file,

the time to re-transmit the smaller file would be less than repeating the entire daily file. The overall result would be an improved and efficient polling system and reduced errors.

*Benefits to the FDOT*

The benefit of this study is the potential to improve the performance of WIM sites by nearly 50% by incorporating the study of modem initialization strings. It was also noted that increase in error code 7 are expected due to the larger files being downloaded (with respect to the count/classify sites) as mentioned above. By breaking the files into smaller files, the likelihood of file error will be smaller and the cost of retransmitting due to an error is greatly reduced.

A table summarizing the download errors recorded in is included in Appendix D of this report.

### **3. Lightning Protection for TTMS**

Protection of the over 300 permanent TTMS installations from the damaging effects of lightning is of critical importance to the FDOT. Sites damaged by lightning result in the reduction of statistical information collected of the number classification and weight of vehicles operating on Florida's highways. Also, the cost of repairing the sites damaged by lightning is considerable. Florida is known as the lightning capital of North America and thus much of the state (particularly central Florida) is subject to more lightning than the rest of the United States.

To address the problem of lightning protection for TTMSs this research project continued the efforts of a previous research project (Project No. BC-596, "Improving Operation of FDOT Telemetered Traffic Monitoring Sites"). The efforts under this research effort consist of two tasks. The first task is the continuation of lightning field tests to characterize the lightning environment for which protection is needed. The second task is to conduct laboratory testing of existing low-voltage surge suppressors to identify surge suppressors appropriate for the protection of electronics that interface with the in-pavement sensors. These two tasks are described in the following sections.

#### **3.1. Field Testing of Lightning Surges**

The Florida Department of Transportation (FDOT) Transportation Statistics Office currently collects traffic data from over 300 permanent telemetered traffic monitoring sites (TTMSs) distributed over the State of Florida. The State of Florida, known as the lightning capital of North America, is a harsh environment for electronic equipment such as TTMS telecommunication and traffic monitoring equipment. The goal of this effort was to characterize the number and magnitude of lightning surges experienced through the telephone lines and in-pavements sensors at the TTMS sites. The objective was to aid the FDOT in specifying and selecting appropriate surge suppressors to protect the sensitive electronic equipment in the TTMS cabinets.

##### *Activities Conducted and Results*

In the initial phases of this effort surge counters were installed to count the number of lightning surges incurred through the telephone lines connected to the TTMS cabinets. This effort was a continuation of the effort from a previous project. The combined results of the telephone line surge counting efforts were a total of 4,897 surges recorded over 192 days of testing. This is an average of 25.5 surges per day with up to 461 surges in a single day. The surge suppressors needed to protect the telecommunications equipment at the TTMS sites needs to be able to endure 1,000s of lightning surges in order to prevent excessive repairs at the over 300 TTMS sites in Florida.

The second phase of the effort was to count and quantify the lightning surges incident through the in-pavement sensors (loops and piezoelectric sensors) at the TTMS sites. The first part of this effort was to count the number of surges using an over-voltage detector and event logger. The results of these counts were 206 surges counted over 785

test days for an average of 0.26 surges per day on loop detectors and 199 over 471 days for an average of 0.44 surges per day for piezoelectric sensors. However, in the last summer of this effort a surge measurement system was developed that could record the magnitude of the currents produced by the lightning surges. The surge current measurement system recorded more detailed information and had a higher bandwidth than the in-pavement surge counting system. The results from the surge current measurement system revealed a more complex surge environment than was indicated by the surge count system. The results indicated that a single lightning stroke can result in multiple surge peaks, each equivalent to a surge produced in laboratory testing. The surge current measurement system recorded a total of 2953 surge peaks on the 3 loop sensors tested over a combined 380 test days for an average of 7.77 surge peaks per day. Also recorded were 4155 surge peaks on the single piezoelectric sensor tested for 127 days for an average of 32.7 surge peaks per day. The peak surge current measured was 2,679 Amps.

### *Conclusion*

The results of this research indicated that surge suppressors for both telephone and sensors needs to be rated to endure 1,000s of lightning surges in order to ensure the reliability of the TTMS sites. Suppressors have been recommended that have been tested to endure at least 10,000 surges without failure. Further testing is needed to determine the maximum rated surge current for surge suppressors and to provide a more complete characterization of the lightning surges experienced by the TTMS equipments.

### *Benefits of the FDOT*

The benefits to the FDOT from this research are improved surge suppressor specifications and recommended suppressors for implementation. The implementation of appropriate surge suppressors can potentially save in the cost of the suppressors installed through proper selection, and also save significantly in the cost of repairing sites damaged by lightning surges.

Further information on the field test conducted, the test equipment used, the results of the field tests and the conclusions can be found in the interim report "Lightning Protection for TTMS," which is included in Appendix E of this report.

## **3.2. Low-Voltage Surge Suppression for TTMS Sensors**

Lightning surge suppression is one of the major concerns of the FDOT Transportation Statistics Office. The 300+ TTMS sites maintained throughout the State of Florida are continually stressed and damaged by the high number of lightning strikes commonly found in Florida. Previous analyses performed by the FAMU-FSU College of Engineering focused primarily on lightning surges experienced through the telephone lines. Telephone line surge suppressors protect the modem and other equipment in the TTMSs from current surges on the telephone lines generated by lightning in the immediate area. Since the telephone line is characterized by voltages up to approximately

140V, the surge suppressors used in it have a higher clamping voltage ( $< 25V$ ). These telephone line surge suppressors are ineffective in shielding the in-pavement piezoelectric and loop sensor modules that operate at much lower voltages (typically 10V or less) than the clamping voltage of the telephone line surge suppressors. Since these sensors record specific data on vehicles passing through, such as: the number of axles, speed (per lane), volume of traffic, and weight in motion (WIM), the damage to them leads to inaccurate data and loss of data in high lightning strike regions, not to mention the cost attributed to repair the sensors. The solution to this problem was to use surge suppressors with a lower clamping voltage than the telephone line surge suppressors. The FAMU-FSU COE was tasked to identify and test lightning surge suppressors designed for the low voltage operation of the in-pavement sensors used at the TTMS sites, and to develop appropriate specifications for future surge suppressor purchases that would protect the in-pavement sensors from the lightning surges, and would be resilient to surge suppressor failures.

### *Activities Conducted*

The effort included identifying several low voltage surge suppressors, and testing them for maximum surge capacity, and the let-through voltage permitted by the suppressors during a current surge. To this effect, the parameters measured were the maximum current, peak output and recovery time. These parameters were used to obtain the operational assessment of the low voltage surge suppressors. Then to measure the durability of the surge suppressors, the surge current (produced by the impulse generator) was set to the rated capacity (up to 6 KA) and tested for resilience to repeated surges. Each suppressor was subjected to up to 10,000 surges. The low voltage surge suppressors tested were those from EDCO (SRA6CA-916, SRA6CA-716), CITEL (BP1-24, BP1-12, BP1-06, and DS210-12) and Atlantic Scientific (Device: 24516, 24528, 24538 and 90489).

### *Results and Conclusions*

The testing and results gathered from this study produced results, which for the most part, were expected. Each device was tested for durability, operating characteristics, and assessed for use in conjunction with in-pavement sensors. It was determined that the EDCO SRA series produced the shortest time of decline after the initial impulse and handled endurance tests sufficiently enough to operate for low voltage sensor protection. The CITEL BP1 series also produced favorable result in terms of characteristics and durability. The reaction time of the surge arresting gas tube is longer when compared to CMOS type suppressors, but that time difference is only in a matter of a few microseconds. The electronics in the BP1 series suppressors proved to be very reliable for high current surges and durable for multiple surges, but the electrical contacts need to be re-designed to reduce failures. The CITEL DS series suppressor produced the longest time of decline after impulse, but did not pass the endurance test adequately for this application. Lastly, the Atlantic Scientific devices had a low maximum let through voltage, fast response time to return to nominal voltage. It was resilient at 2000A surges, but at 6000A, its traces disintegrated in less than 100 hits. The results of the lightning surge measurements in summer 2008 illustrated that there were few surges over 2000

Amps during the four-months of testing. This result gave a positive sign that the resilience of the Atlantic Scientific devices would be good at the TTMS sites.

As a result of this study, the FDOT decided to install some low-voltage Atlantic Scientific devices in about 14 TTMS sites to protect the loop and piezoelectric sensor circuits from lightning surges. Recommendations of models to use were made to the FDOT based on the results of this research.

#### *Benefits to the FDOT*

The results of this research have improved the reliability of the TTMS sites by reducing the number of failures due to lightning surges. Continued field and laboratory testing can potentially result in specifications and recommendations for surge suppressors that will significantly reduce failures in communication and classification equipments at the TTMS sites. This will improve the traffic data collection and reduce the maintenance costs of the TTMSs.

The details of the surge counting and measurement field tests and results are provided in the interim report “Field Testing of TTMS Lightning Surges,” which is included in Appendix F of this report.

#### 4. Electronic Interface Design for and Field Tests of a Segmented Axle Sensor

The Florida Department of Transportation currently maintains over 300 telemetered traffic monitoring sites (TTMS) throughout the state to monitor traffic operations on the state highway system. Most of these TTMS stations employ inductive loop detectors and piezoelectric axle sensors to determine the number of axles, axle spacing and length of individual vehicles. This information is used to attempt to determine the classification of the vehicles. Vehicle classification statistics are used to estimate pavement wear and traffic patterns, and to plan maintenance and improvements of the roads. Thus accurate classification of vehicles is critical to the FDOT.

Classification of vehicles using number of axles, axle spacing and length alone can result in a significant number of classification errors. For example, a long-bed pickup truck with all single tires (Class 3) can easily have the length and axle spacing of some smaller trucks with 2 axles and 6 tires (Class 5). Class 5 vehicles are generally heavier and carry larger loads than a Class 3 pickup truck. Such misclassifications lead to inaccurate pavement loading statistics.

Classification algorithms can be improved if the axle sensor had the ability detect single versus dual tires on each axle. This information would greatly reduce misclassifications of vehicles such as the Class 3 –Class 5 errors. John Reed of PET Corporation proposed a design for a segmented axle sensor that can provide an estimate of the tire width and thus discriminate between single and dual tire axles. This effort was designed to determine if the segmented axle sensor is feasible and if the identification of single and dual tire axles can improve vehicle classification accuracy.

##### *Activities Conducted*

An in-depth study was conducted to study and implement the segmented sensor electronic interface for classification of vehicles using the algorithm developed by Dr Ren Moses of the Department of Civil and Environmental Engineering at the FAMU-FSU College of Engineering.

This effort was conducted in two phases. First, PET Corporation produced a prototype sensor using metallic conductors. The segment lengths were designed with the aid of a study of tire footprints conducted on a separate research project by Dr. Ren Moses. An electronics interface was designed and constructed to sense the segment closures and transmit the closure information via a serial port to a classification algorithm running on a laptop computer. Field tests were conducted to demonstrate the operation of the sensor and interface, and to demonstrate the improved classification accuracy using the tire width information.

The metallic sensor was implemented to provide a proof of concept before proceeding to the second phase of the project. In the second phase of the project PET Corporation constructed a prototype of a segmented sensor made entirely of conductive and non-conductive extruded polymers. The extruded polymers are expected to be much more



durable than the metallic conductors and eventual automatic extrusion of a sensor is far more cost-effective and flexible than the manual construction required for the metallic sensors.

A new electronics interface was designed and constructed for use with the extruded sensors. The extruded polymer conductors used in the new prototype have a very high resistance that complicates the interface design. The design team modified a design originated by Dr. David Bourner of the University of Maryland in Baltimore County. Several modifications were made to Dr. Bourner's design to improve the speed and accuracy of the electronics interface. The extruded sensor and interface electronics were field tested along with the classification algorithm to demonstrate the feasibility and benefits of the extruded sensor.

### *Results and Conclusions*

The implementation of the electronics interface and the field testing of the prototype metallic segmented sensor demonstrated that tire width estimation resulting in single versus dual tire discrimination can significantly improve the vehicle classification accuracy. The implementation of an interface for and testing of the prototype extruded segmented sensor demonstrated the feasibility of the design and interfacing of an extruded segmented sensor. Future efforts are required to fully implement the interface electronics for the segmented sensor.

### *Benefits to the FDOT*

This project demonstrated that the potential for improve vehicle classification can be attained using segmented sensors. The feasibility of the extruded segmented sensor was also demonstrated. When implemented, the FDOT will benefit from more accurate vehicle classification at the TTMS sites.

The details of the electronics interface designs, field tests conducted and results are provided in the interim report "Electronic Interface Design for and Field Tests of a Segmented Axle Sensor," which is included in Appendix G of this report.

## 5. Conclusions

This project has included several efforts to support and improve the operation of the FDOT Telemetered Traffic Monitoring Systems. The major areas of support included:

1. Modem Communications Reliability
2. Lightning Surge Protection
3. Improved Vehicle Classification Using Segmented Axle Sensors

The efforts to improve modem communication between the FDOT automated polling system at the Burns Building in Tallahassee, Florida and the individual TTMS sites were very successful. Modem initialization strings were developed for the TTMS site modems that significantly improved the operation of a number of the TTMS modems. The modem strings and phone lines used in the Burns Building were found to work well for modem communications. Long distance telephone communication was found to have intermittent period of very poor modem performance and recommendations for improving the automated re-dialing of TTMS sites when errors occur were provided. The reliability of communications with WIM sites was evaluated and it was found that the primary causes of polling errors can be directly attributed to large file sizes and possibly the modem initialization strings.

The results of the efforts to count and measure the lightning surges through TTMS phone lines and in-pavement sensors has improved the understanding of the specifications needed for surge suppressors. The research indicated that surge suppressors for both telephone and sensors needs to be rated to endure 1,000s of lightning surges in order to ensure the reliability of the TTMS sites. Through the laboratory testing efforts, surge suppressors have been recommended for telephone line and in-pavement suppressors that have been tested to endure at least 10,000 surges without failure. Further testing is needed to determine the maximum rated surge current for surge suppressors and to provide a more complete characterization of the lightning surges experienced by the TTMS equipments.

The design and implementation of the electronics interface for, and the field testing of the prototype metallic segmented sensor demonstrated that tire width estimation resulting in single versus dual tire discrimination can significantly improve the vehicle classification accuracy. The implementation of an interface for and testing of the prototype extruded segmented sensor demonstrated the feasibility of the design and interfacing of an extruded segmented sensor. Future efforts are required to fully implement the interface electronics for the segmented sensor.

## **6. Benefits to the FDOT**

The results of this project have provided three specific benefits to the FDOT.

- a. Improved communication with the TTMS sites to collect count, classification and weight statistics. The reduced errors in the automatic polling reduced the cost of manually downloading the data or sending someone to locally download the data.
- b. The lightning field testing and laboratory surge suppressor testing has led to the specification and recommendation of reliable surge suppressors to protect the sensitive electronics in the TTMSs. This has improved the reliability of the TTMS sites and reduced the cost of repairs to the TTMS equipment due to failures caused by lightning surges.
- c. The design and implementation of interface electronics, and the field testing of the segmented axle sensors has demonstrated the feasibility of improved vehicle classification. By using the tire width estimate from the segmented sensors the accuracy of the vehicle classification can be improved. Improved vehicle classification statistics will improve the efficiency of highway maintenance and improvement planning.

## **Appendix A**

### **Interim Report**

#### **“Analysis of Modem Initialization Strings”**

**Interim Technical Report**

**Analysis of Modem Initialization Strings**

**Project:**

**Electrical Engineering Support for Telemetered Traffic Monitoring Sites  
(FDOT Contract No. BD543 RPWO 3, FSU OMNI No. 010295)**

**Submitted by:**

**FAMU-FSU College of Engineering  
2525 Pottsdamer Street  
Tallahassee, FL 32310-6046**

**Principal Investigator:**

**Bruce A. Harvey, Ph. D., Associate Professor  
Department of Electrical and Computer Engineering  
Phone: (850) 410-6451  
Fax: (850) 410-6479  
Email: [bharvey@eng.fsu.edu](mailto:bharvey@eng.fsu.edu)**

## Executive summary

One of the biggest concerns for the Florida Department of Transportation (FDOT) Transportation Statistics Office (TSO) has been the task of configuring modem strings with different data collection equipments at its 300+ telemetered traffic monitoring sites (TTMSs). These modem strings are dependent on the make and model of the modems along with the make and model of the TTMS equipment, and the modem strings provided by the TTMS equipment vendors required tweaking. The purpose of this study was to study, design, and recommend modem strings for use at the TTMS sites and data collection modems.

An in-depth study was conducted to study the issue of modem initialization strings. The study was divided into three phases. Phase I involved collection of the modem strings used by the FDOT for their field modems with respect to the data collection equipments. In Phase II, the modem initialization strings used by FDOT were studied along with the default settings of the modem to study the issue of optimal performance of the modems and a thorough analysis was performed. In Phase III, the modem initialization strings covered in Phase I and II were used, and new modem strings were generated by tweaking the existing modem initialization strings to provide the optimum modem strings for each modem discussed in the study relative to the data collection equipment used. Also, new modem initialization strings were provided for newer modems that FDOT was planning to use.

Based on the research done on initialization string it was observed that the data collection equipments had a certain desired format to communicate with the modem attached to it and therefore it had to be used accordingly. Unfortunately these specifications were not always given by the vendors and thus cause a problem of trial and error. At present FDOT has the document from PEEK (*Tech Notes for Configuring a Modem for an ADR*) to make modem strings for the PEEK data collection equipment and that also only for ADR units 1000, 1000 plus, 2000, 2000 plus, 3000, and 3000 plus. The instructions provided by the PEEK document do not apply to the ADR-4000 and ADR-6000 unit as mentioned in the Tech Notes. Such documents were not available for the PAT and Diamond data collection software and their presence would help understand the requirements that particular data equipment has regarding the modem settings, and those particular settings could be added to the initialization strings. Also, for future purposes, the modem manual should be checked to verify that the default values are given after the factory setting. This was not very clear for the cascade modem as they mainly list the basic AT command set and then print a list of settings after execution of AT&F command rather than mentioning if it is default in the command set presentation itself.

The benefit of this research was the generation of modem strings for newer modems that FDOT was planning to use, optimization of existing initialization strings based on TTMS vendor requirements, discussion of methodology on generating the initialization strings efficiently; all leading to an increase in modem reliability from the Burns Building to the TTMS sites, a reduction in manual downloads of data files from the TTMS sites, and thus reduction in maintenance cost.

## Table of Contents

Executive summary.....	A-3
Table of Contents.....	A-4
List of Tables .....	A-5
1. Introduction.....	A-6
2. Study of Initialization Strings .....	A-6
2.1 Phase I – Collection of Modem Strings in the Field.....	A-6
2.2 Phase II – Analysis of Modem String Functionality.....	A-7
2.2.1 Peek Modem Strings .....	A-7
2.2.2 PAT Modem Strings .....	A-10
2.2.3 Diamond Modem Strings.....	A-12
2.3 Phase III – Creating & Tweaking (Generalizing) Modem Strings .....	A-13
2.3.1 Generalizing Modem Strings for Peek Equipment .....	A-13
2.3.2 Generalizing Modem Strings for PAT Equipment .....	A-15
2.3.3 Generalizing Modem Strings for Diamond Equipment .....	A-16
2.4 Phase IV – Future Research.....	A-17
3. Conclusions.....	A-18
4. References.....	A-19
4.1. AT Modem Commands.....	A-19
4.2 Common Terminology.....	A-21
4.3 Recommendations for Common Modem Problems.....	A-22

## List of Tables

Table 1. Modem Strings for Peek Equipment.....	6
Table 2. Modem Strings for PAT Equipment.....	7
Table 3. Modem Strings for Diamond Equipment.....	7
Table 4. Analysis of Modem Strings for Peek Equipment .....	7
Table 5. Summary of Modem Commands for Peek Modem Strings.....	8
Table 6. Analysis of Modem Strings for PAT Equipment.....	10
Table 7. Summary of Modem Commands for PAT Modem Strings.....	11
Table 8. Analysis of Modem Strings for Diamond Equipment .....	12
Table 9. Summary of Modem Commands for Diamond Modem Strings.....	12
Table 10. Minimizing Starcomm Modem Strings for Peek Equipment .....	13
Table 11. Minimizing LPM-14-E Modem Strings for Peek Equipment .....	14
Table 12. Minimizing LPM-33 Modem Strings for Peek Equipment .....	14
Table 13. Generalized Cascade Modem Strings for Peek Equipment.....	15
Table 14. Generalized Starcomm Modem Strings for PAT Equipment .....	16
Table 15. Generalized LPM-33 Modem Strings for PAT Equipment.....	16
Table 16. Generalized Starcomm Modem Strings for Diamond Equipment.....	16
Table 17. Generalized LPM Modem Strings for Diamond Equipment.....	17
Table 18. Generalized Cascade Modem Strings for Diamond Equipment.....	17



## 1. Introduction

One of the biggest concerns for the Florida Department of Transport (FDOT) has been the task of configuring modem strings with different data collection equipments. The purpose of this study was to demystify the mystery behind the modem initialization strings by analyzing the need of the various initialization strings given by the data collection equipment vendors. The three vendors for the data collection equipment are Peek, Diamond, and PAT; and the main modems in the field at present include Starcomm 14.4, Starcomm 33.6, LPM-14E, LPM-33, and Cascade 33.6.

## 2. Study of Initialization Strings

The study of the initialization strings was divided into four phases. The first phase was the collection of the initialization string used by the modems in the field with respect to the data collection equipment they were connected to. The second phase involved studying the modem strings collected, to analyze their functionality based on their manuals, and to study the requirements of the data collection equipment for the modems. The third phase involved tweaking the modem strings obtained in phase I to achieve a generalized modem string; it also involved designing an initialization string for the cascade modem for peek equipment and initialization string for the LPM-33 equipment for the PAT data collection equipment. The fourth phase would be the focus of the future studies and it involves the in field testing of the modem strings that were theoretically analyzed based on the notes from the manufactures of the modem and the data collection equipment.

### 2.1 Phase I – Collection of Modem Strings in the Field

Phase I involved collection of the modem strings used by the FDOT for their field modems with respect to the data collection equipment. Tables 1 – 3 contain the strings obtained from the FDOT.

**Table 1. Modem Strings for Peek Equipment**

<b>Starcomm 14.4</b>	<b>LPM-14-E</b>	<b>LPM-33</b>
ATQ0	ATQ0	AT&FE0
ATV1E0F0L0N1W2M1	ATV1E0	ATDLY2
AT&C1&D2&K0&Q5&R1	ATB1F0W1X0	ATQ0V1B1W2X0
ATA3\G0\N3	AT&C1&D2&K0&Y0	AT&C1&D2&K0&Y0
AT%C3%E1	AT%C3%E2	AT%C3%E2\N3
ATS0=1S24=120S7=90	ATA3\G0\N3	ATS24=0
AT&W0&W1	AT)M0*H0	ATS7=90S0=1
	ATS7=90S0=1	AT&W0
	AT&W0	

Note: Cascade initialization strings were not configured and were requested to be designed for the Peek equipment.

**Table 2. Modem Strings for PAT Equipment**

Starcomm	LPM-14-E	CASCADE 33.6
AT&F	AT&F	AT&F
AT&D3&S0	AT&C1&D2&k3	ATE0V0Q1
AT)M1S24=120	AT&Y0\N3 S0=1	AT&C1&d2&K0\N3&Y0
ATS0=1E0V0Q1	ATE0V0Q1	ATS0=1
AT&W0	AT&W0	AT&W
AT&W1	AT&W1	

**Table 3. Modem Strings for Diamond Equipment**

Starcomm	LPM-14-E/LPM-33	CASCADE 33.6
ATE0Q0V0X1S0=1	AT&E0Q0V0S0=2	ATE0Q0V0S0=2
AT&C1&D2S24=120&W0	ATX1&C1&D2&W0	ATX1&C1&D2&W0

Note: FDOT had concern with the cascade modem not functioning properly with the Peek data collection equipment and this was looked into in phase II and III.

## 2.2 Phase II – Analysis of Modem String Functionality

Phase II of the initialization string research involved studying the strings currently used along with the default settings of the modems. The study of the initialization string is also done based on the data collection equipment basis as some of the settings in the initialization string are required by the data collection equipment.

### 2.2.1 Peek Modem Strings

**Table 4. Analysis of Modem Strings for Peek Equipment**

Starcomm 14.4	LPM-14-E	LPM-33
ATQ0	ATQ0	AT&FE0
ATV1 <b>E0F0</b> L0N1W2M1	ATV1 <b>E0</b>	ATDLY2
AT&C1&D2&K0&Q5&R1	ATB1F0W1X0	ATQ0V1B1W2X0
AT\A3\G0\N3	AT&C1&D2&K0&Y0	AT&C1&D2&K0&Y0
AT%C3%E1	AT%C3%E2	AT%C3%E2\N3
ATS0=1S24=120S7=90	AT\A3\G0\N3	ATS24=0
AT&W0&W1	AT)M0*H0	ATS7=90S0=1
	ATS7=90S0=1	AT&W0
	AT&W0	

Table 4 contains the modems strings for the Peek equipment with added highlighting for analysis. The initialization strings that are in bold are not default commands and would

be required. The rest of the commands are in the default setting of the modem and can be retrieved by AT&F or AT&F0 commands used to restore factory configuration. *An interesting thing to note is that some commands that are default in the Starcomm modem are not default in the LPM modem and would therefore need to be specified.*

*Analysis*

As can be observed from the table above, the commands that are not in bold do not make a difference if they are present or not as far as the command AT&F0 is executed on the top of the list. This would indeed reduce the initialization string for a specific modem, but if a generic modem string is needed then it would be necessary to reinforce the strings incase they are not the default type for a specific modem.

The *Tech Notes* document provided by PEEK to the FDOT to help configure any modems with ADR system of PEEK provided some useful insight as to what the ADR data collection equipment requires of the modem to function properly. It should be noted that this document does not list instructions that apply to ADR-4000 and ADR-6000 units. The specifications listed are summarized in Table 5 with very minor modifications. The original table can be obtained from PEEKS “*Tech Notes for Configuring a Modem for an ADR*”.

**Table 5. Summary of Modem Commands for Peek Modem Strings**

<b>Purpose of the Command</b>	<b>Typical Command</b>	<b>Notes</b>
Factory Reset	&F0	Should be the first command
Delay	DLY2	Reset followed with a delay of 2 secs. Required by ADR Modem Configurer utility
Enable Result Codes	Q0	ADR expects these response
Verbose Result codes	V1	Turn on verbose version of result code
Disable local echo	E0	Required by ADR
Connect at any baud rate	N1 or F0	Should not use both (N1 is standard)
Minimum result codes	X0	
Hang-up on loss of DTR	&D2	Required
Program flow control	&K0	Flow control not needed for ADR
Auto-reliable mode	\N3 or \N6 check manual	Modem attempts error correction with ability to fall back to normal connection
Fixed serial port baud rate	Refer manual	
Enable data compression	Usually %C3	
Enable auto retrain	Usually %E2	
Auto answer on first ring	S0=1	
Time to answer	S7=90	Modem attempts to answer for 90 secs after ring detected
Save the configuration	&W0	

*Analysis of Starcomm Initialization String for Peek Equipment*

Based on table 5, summarized by PEEK, and table 4 (the initialization string for Starcomm) the following things can be observed and concluded:

- 1) The string AT&F should be added at the very beginning followed by the DLY2 command to give 2 second of delay (as mentioned in Table 5).
- 2) The strings that are not in bold letters can be removed without any problems, although there presence would not affect anything as such.
- 3) Among the letters that are in bold, L0 and W2, even though they are not default, there absence would not make much of a difference as they are not required by the ADR system. Also X0 should be added as it is required by the PEEK data collection equipment as mentioned in Table 5.
- 4) One important observation in the Starcomm initialization, in table 4, is that it could have a potential problem as it uses F0 command and the N1 command together, whereas only one should be used.
- 5) For the auto-retrain the command %E1 is used although %E2 is more commonly used now and is the command usually used by PEEK for its own LPM modem.
- 6) The S registers that are important are mentioned. S0=1 for answering after first ring is required. S24=120 gives the modem 120 seconds before it goes into sleep mode if no activity take place of sending or receiving data during that time. S7=90 is explained in table 5.

#### *Analysis of LPM-14-E Initialization String for Peek Equipment*

From Table 4 and Table 5, the following observations and analysis were deduced:

- 1) The string AT&F should be added at the very beginning to reset modem to factory defaults followed by the DLY2 command to give 2 second of delay (as mentioned in Table 5).
- 2) The strings that are not in bold letters can be removed without any problems, although there presence would not affect anything as such.
- 3) The strings &C1, &D2 are not default in the PEEK modem and need to be added for proper functionality with the peek data collection equipment. It is also noted that W1 command is used but its presence is not required by the PEEK equipment, and that W2 is used for the LPM-33 modem.
- 4) Also the functionality of \N3 command is different from that of Starcomm command \N3. So one should not set string for one modem to another without verifying its functionality. For instance the \N6 command in Starcomm modem is equivalent to \N3 command in Peek modem.
- 5) The S registers are set as per the requirements in Table 5.

#### *Analysis of LPM-33 Initialization String for Peek Equipment*

From Table 4 and Table 5, the following observations and analysis were deduced:

- 1) The E0 command should come after the DLY2 command as per the suggestion in Table 5 from PEEK.
- 2) The strings that are not in bold letters can be removed without any problems, although there presence would not affect anything as such.
- 3) The strings &C1, &D2 are not default in the PEEK modem and need to be added for proper functionality with the peek data collection equipment. It is also noted that W2 command is used but the PEEK equipment does not require its presence.

- 4) Also the functionality of \N3 command is different from that of Starcomm command \N3. So one should not set string for one modem to another without verifying its functionality. For instance the \N6 command in Starcomm modem is equivalent to \N3 command in Peek modem.
- 5) With the S-registers it is noted that S24=0 is set as the default value. This shows that the LPM-33 modem works well probably when it does not go into sleep mode. This part of the modem analysis needs to be verified practically to ensure if the modem going into sleep mode affects its performance when the next connection is established or not. The rest of the S registers are set as per the requirements in Table 5.

### 2.2.2 PAT Modem Strings

**Table 6. Analysis of Modem Strings for PAT Equipment**

Starcomm	LPM-14-E	CASCADE 33.6
AT&F	AT&F	AT&F
AT&D3&S0	AT&C1&D2&K3	ATE0V0Q1
AT)M1S24=120	AT&Y0\N3 S0=1	AT&C1&D2&K0\N3&Y0
AT&S0=1E0V0Q1	ATE0V0Q1	AT&S0=1
AT&W0	AT&W0	AT&W
AT&W1	AT&W1	

The initialization string for the modems shows that all the commands for the PAT data collection equipment are in bold; these commands are not default commands and would be required. As mentioned earlier, some commands that might be default for the LPM modem might not be for Cascade modem and for Starcomm modem. One thing observed in Table 6 is the color of some of the strings in Red while some in Blue and a few in Black. The color in Red is the commands that are common amongst the three modems. The one in Blue color are commands that are common in two of the three modems listed in Table 6, and the Black color illustrates that nothing is in common between the three modems on this initialization string.

Unfortunately there were no notes on the PAT data collection equipment to give insight into what was desired by that particular brand of data collection equipment for the purpose of modem initialization. Therefore this part of the study involved comparing the initialization strings given by PAT for all three modems and deducing the requirements of the data collection equipment. This is partly done by the color scheme mentioned above.

#### *Analysis of Starcomm Initialization String for PAT Equipment*

- 1) The modem is set to factory default value by AT&F.
- 2) The string &D3 is used to do soft reset of the modem although &D2 could have been also used. The reason for using the &D3 command may be because of the use of the S24 register that sets the modem to sleep mode after 120 seconds. Since

- the modem goes into sleep mode, the soft reset is used, &D3. It might be true that if &D2 is used then the S24=0 must be set, which is its default value! This can be tested practically unless verified by some reliable source.
- 3) The )M1 command is used to enable transmit power level adjustment during MNP 10 link negotiation. At this moment it is not clear as to why PAT suggested this string only for Starcomm modem and not for the LPM and cascade modems.
  - 4) With regards to the &W1 string it is just precautionary to save the current profile in both registers although saving it in &W0 would be sufficient as AT&F would upload the &W0 profile.

*Analysis of LPM-14-E/LPM-33 Initialization String for PAT Equipment*

- 1) The modem is set to factory default value by AT&F.
- 2) The string &D2 is standard and as observed with this command the S24 register is not set, and &W1 command is just precautionary and can be done without.
- 3) The &K3 command is the one set in the Starcomm modem by default and is also set in the LPM modem as observed in Table 6. This suggests that the PAT data collection equipment has no problem with the RTS/CTS flow control enabled.

*Analysis of Cascade Modem Initialization String for PAT Equipment*

- 1) The modem is set to factory default value by AT&F.
- 2) The only instruction that stands out in Table 6 for this modem is the &K0 command, which is used to disable DTE/DCE (Terminal/modem) flow control. It is again a mystery why PAT equipment manufacturers enable this command for Starcomm and LPM modem by setting &K3 and thus enabling RTS/CTS flow control but switches it off for the cascade modem.

Based on the analysis above, it can be deduced that the method of modem initialization by PAT data collection manufacturer is also somewhat standard and can be summarized as in Table 7.

**Table 7. Summary of Modem Commands for PAT Modem Strings**

Purpose of the Command	Typical Command	Notes
Factory Reset	&F0	Should be the first command
Disable local echo	E0	Required by ADR
Terse Result codes	V0	Turn on short version of result code to the DTE
Disable Result Codes	Q1	Disable result code to the DTE
RLSD output	&C1	RLSD follows the state of the carrier
Hang-up on loss of DTR	&D2	Required
Program flow control	&K3 or &K0	Enable Xon/Xoff flow control or disable flow control
Auto-reliable mode	\N3 or \N6 check manual	Modem attempts error correction with ability to fall back to normal connection
Auto answer on first ring	S0=1	
Designate a default profile	&Y0	Selects users profile used after reset
Save the configuration	&W0	Stores current configuration in profile 0

The only concerns from the PAT data collection equipment initialization string is the disabling off the flow control in the cascade modem and the enabling of the transmit power level negotiation during MNP 10 link for the Starcomm modem. One explanation of the phenomenon of the flow control could be that the data collection equipment is smart to realize that if the flow control is off it does not need to do its own flow control, and thus it does not matter if it is on or not. For the transmit power level negotiation it might be worth testing it practically to check which option is better i.e. having it on or off.

### 2.2.3 Diamond Modem Strings

**Table 8. Analysis of Modem Strings for Diamond Equipment**

Starcomm	LPM-14-E/LPM-33	CASCADE 33.6
ATE0Q0V0X1S0=1	ATE0Q0V0X1S0=2	ATE0Q0V0X1S0=2
AT&C1&D2S24=120&W0	AT&C1&D2&W0	AT&C1&D2&W0

Note: According to FDOT the Diamond data collection equipment worked perfectly with all the three modems with the initialization string given in Table 8. It is interesting to note that the modems are not reset to Factory defaults but should be done just as a safety measure.

Based on the Table 8, it can be observed that all the initialization strings are pretty much standard with the exception of the S24 register in the Starcomm modem. A summary of the Diamond data collection equipment modem initialization string commands is given in Table 9.

**Table 9. Summary of Modem Commands for Diamond Modem Strings**

Purpose of the Command	Typical Command	Notes
Factory Reset	&F0	Should be the first command
Disable local echo	E0	Required by ADR
Terse Result codes	V0	Turn on short version of result code to the DTE
Enable Result Codes	Q0	Enable result code to the DTE
RLSD output	&C1	RLSD follows the state of the carrier
Hang-up on loss of DTR	&D2	Required
Extended Result Codes	X1	Disables monitoring of busy tones and sends only OK, CONNECT, RING, NO CARRIER, ERROR, NO ANSWER, and CONNECT xxxx. Blind dialing on.
Auto answer	S0=1 or S0=2	Answer on first or second ring respectively
Save the configuration	&W0	Stores current configuration in profile 0

Although &K3 is the default value setting for the serial port (DTE/DCE) flow control in all the three modems, it would be a good idea to put &K3 in the Cascade modem as it is pre-initialized to &K0 by Diamond Traffic Products as per their statement in the manual for the cascade modem, page 25.

## 2.3 Phase III – Creating & Tweaking (Generalizing) Modem Strings

The third phase of the research involved tweaking the current modem strings used by the FDOT so as to find a generalized modem string that would work with most of the modems or to state a specific way that would simplify the design of the initialization string for any new modem that could be used by the FDOT in the future. This phase of the research heavily depends on the analysis of Phase II. In this phase, the initialization string for the cascade modem for the Peek data collection equipment and the initialization string for LPM-33 modem for the PAT data collection equipment were also created.

### 2.3.1 Generalizing Modem Strings for Peek Equipment

*Tweaking Starcomm Modem Initialization String*

**Table 10. Minimizing Starcomm Modem Strings for Peek Equipment**

Starcomm 14.4	Starcomm (Table 5)	Starcomm (Minimum)
ATQ0	<b>AT&amp;F0</b>	<b>AT&amp;F0</b>
ATV1 <b>E0F0</b> L0N1W2M1	<b>ATDLY2</b>	<b>ATDLY2</b>
AT&C1&D2& <b>K0</b> &Q5&R1	ATE0Q0V1N1X0	ATE0X0
ATV <b>A3</b> \G0 <b>N3</b>	AT&C1&D2&K0&Q5& <b>Y0</b>	AT&K0& <b>Y0</b>
AT%C3% <b>E1</b>	ATV <b>A3</b> \N <b>6</b>	ATV <b>A3</b>
ATS <b>0=1S24=120S7=90</b>	AT%C3% <b>E2</b>	ATS0=1S7=90 <b>S30=120</b>
AT&W0&W1	ATS0=1S7=90 <b>S30=120</b>	AT&W0
	AT&W0	

In Table 10 it can be observed that the column on the left side is the initialization string that is currently in use by the FDOT. The bolded letters (commands) in the leftmost column are the commands that are not default for that modem. The column in the middle illustrates the strings as required by PEEK data collection equipment specifications for ADR units. The last column gives the minimum necessary commands for full functionality. It can be noted that the column in the middle and the left has some bolded letters (commands). These are the ones that have been added or modified to improve the initialization string.

In terms of improvement, first the modem are reset to factory defaults and a delay of 2 seconds is added as required by the ADR configure utility (as per the specification by PEEK for the ADR units). Also the &Y0 command is added to select profile 0 after it is reset. Also, the command \N6 and %E2 are used instead of \N3 and %E1 respectively. The former represents the better choice and is closer to the recommendations of PEEK too. Finally S30=120 has been added to set the disconnect timer. It disconnects the modem connection after 120 seconds (2 minutes) if there is no data-communication taking place. This is a precautionary measure to make sure that the modem hangs up in case somebody forgets to close the connection after completing the checking of the site.



*Tweaking LPM-14-E Modem Initialization String*

In Table 11, similar methodology is used as in the Starcomm modem described above i.e. the middle column gives the strings as per suggestion of PEEK document and the rightmost column gives the minimum initialization string needed for desired functionality. Again, the bolded letters (commands) in the middle and rightmost column illustrate the commands that are added or modified from the current version of the commands used (illustrated in the leftmost column). The bolded letters (commands) in the leftmost column are the commands that are not default for that modem.

**Table 11. Minimizing LPM-14-E Modem Strings for Peek Equipment**

LPM-14-E (Current)	LPM-14-E (Table 5)	LPM-14-E (Minimum)
ATQ0	AT& <b>F0</b>	<b>AT&amp;F0</b>
ATV1 <b>E0</b>	ATDLY <b>2</b>	<b>ATDLY2</b>
ATB1F0 <b>W1X0</b>	ATE0Q0V1N1X0	ATE0X0
AT& <b>C1&amp;D2&amp;K0&amp;Y0</b>	AT&C1&D2&K0&Q5&Y0	AT&C1&D2&Q5&K0 <b>&amp;Y0</b>
AT%C3%E2	AT%C3%E2	AT\A3
AT\A <b>3</b> \G0 <b>N3</b>	AT\A3\N3	ATS0=1S7=90 <b>S30=120</b>
AT)M0*H0	ATS0=1S7=90 <b>S30=120</b>	AT&W0
AT <b>S7=90S0=1</b>	AT&W0	
AT& <b>W0</b>		

It can be observed from the middle column that the only modification to the current modem string was to add the factory default followed by the delay of 2 seconds. Also the precautionary measure of setting a timer of 2 minutes is set by the S30 register to make sure that the modem hangs up after 2 minute of idle time.

*Tweaking LPM-33 modem initialization string*

**Table 12. Minimizing LPM-33 Modem Strings for Peek Equipment**

LPM-33 (current)	LPM-33 (Table 5)	LPM-33 (Minimum)
AT& <b>FE0</b>	AT&F0	AT&F0
ATDLY <b>2</b>	ATDLY2	ATDLY2
ATQ0V1B1 <b>W2X0</b>	ATE0Q0V1N1X0	ATE0X0
AT& <b>C1&amp;D2&amp;K0&amp;Y0</b>	AT&C1&D2&K0&Q5&Y0	AT&C1&D2&K0&Q5&Y0
AT%C3%E2 <b>N3</b>	AT%C3%E2	AT\A <b>3</b> \N3
ATS24=0	AT\A <b>3</b> \N3	ATS0=1S7=90 <b>S30=120</b>
AT <b>S7=90S0=1</b>	ATS0=1S7=90 <b>S30=120</b>	AT&W0
AT& <b>W0</b>	AT&W0	

The leftmost column gives the current modem string used and the bolded letters (commands) illustrates commands that are not default to the modem. The middle column gives the modem initialization string based on Table 5 (recommendations of PEEK for setting up Modem with the ADR Data collection unit), and the bolded letters illustrates

commands that have been added or modified. Lastly, the rightmost column gives the minimum initialization string required for correct functionality of the modem.

From the additions to the LPM-33 modem is the \A3 command, which increases the maximum MNP block size to 256 characters from the default 128 characters used, when operating an MNP error corrected link. The S30 register is just a precautionary step to disconnect the modem after 2 minute of idle time.

*Generating modem initialization string for Cascade modem*

Table 13 gives the suggested initialization string for the Cascade modem to work with the LPM data collection units. The column on the left side gives the initialization string as per Table 5 recommendations, whereas the rightmost column gives an alternative initialization string, which also closely follows the recommendations in Table 5. The issue with the cascade modem is that it does not clearly state what the default values are of the modem and therefore it is safe to initialize them.

**Table 13. Generalized Cascade Modem Strings for Peek Equipment**

<b>CASCADE (Table 5)</b>	<b>CASCADE (Alternative)</b>
AT&F0	AT&F0
ATDLY2	ATDLY2
ATE0Q0V1X0	ATE0Q0V1X0
AT&C1&D2&K0&Q5&Y0	AT&C1&D2&K0&Y0
AT%C3%E2	AT\N3
ATVA3\N3	ATS0=1S7=90S30=120
ATS0=1S7=90S30=120	AT&W0
AT&W0	

The main difference between the two columns in Table 13 is the missing of the data compression and line monitoring capability commands. These were removed from the right column, as the manufacturer does not initialize them before sending their modems. A practical test could be performed with both the modem strings to check their functionality. Also missing is the &Q5 command as it is not listed in the modem manual although it is referenced under the &D2 command.

**2.3.2 Generalizing Modem Strings for PAT Equipment**

*Alternative Suggestion to Starcomm Modem String*

If at all the current Starcomm modem string with the PAT equipment gives problem in connecting to the modems in the field it would be advised to change the field string to the suggested string. The string would most probably be changed if there are problems in establishing connection with the Starcomm modems in the field with the PAT data collection equipment. Otherwise it would be fine to go with the current modem strings. Table 14 provides the alternative Starcomm modem string.

**Table 14. Generalized Starcomm Modem Strings for PAT Equipment**

Starcomm (current)	Starcomm (suggestion)
AT&F	AT&F
AT&D3&S0	ATE0V0Q1
<b>AT)M1S24=120</b>	AT&S0
ATS0=1E0V0Q1	ATS0=1
AT&W0	AT&W0
AT&W1	

*Comment about LPM-14-E and Cascade Modem String*

With respect to the LPM-14-E and the cascade modem, the current modem strings are ideal and can be left unchanged.

*Comment about LPM-33 Modem String*

The LPM-14-E modem string would also be suitable for the LPM-33 modem also since the commands provided are not suppose to change in an upgrade of the modem. The LPM-33 Reference manual was not available to cross-verify the instruction sets of the two. Therefore the modem initialization string for the LPM-33 can be given as in Table 15.

**Table 15. Generalized LPM-33 Modem Strings for PAT Equipment**

LPM-33
AT&F
ATE0V0Q1
AT&C1&D2&K3&Y0
ATN3
ATS0=1
AT&W0

**2.3.3 Generalizing Modem Strings for Diamond Equipment**

For the diamond data collection equipment it is recommended that if there are no problems with the initialization string they should not be changed. Table 16, 17 and 18 gives the recommended modem string for Starcomm, LPM and cascade modem respectively.

**Table 16. Generalized Starcomm Modem Strings for Diamond Equipment**

Starcomm (current)	Starcomm (if needed)
ATE0Q0V0X1S0=1	AT&FE0Q0V0X1S0=2

AT&C1&D2S24=120&W0	AT&C1&D2& <b>Y0</b> &W0
--------------------	-------------------------

**Table 17. Generalized LPM Modem Strings for Diamond Equipment**

LPM (current)	LPM (if needed)
ATE0Q0V0X1S0=2	AT&FE0Q0V0X1S0=2
AT&C1&D2&W0	AT&C1&D2& <b>K3\N3&amp;Y0</b> &W0

**Table 18. Generalized Cascade Modem Strings for Diamond Equipment**

CASCADE 33.6 (current)	Cascade 33.6 (if needed)
ATE0Q0V0X1S0=2	AT&FE0Q0V0X1S0=2
AT&C1&D2&W0	AT&C1&D2& <b>K0\N3&amp;Y0</b> &W0

The main changes or rather additions to the modem strings are made in bold letters for quick observation. It can be seen that the additions are mainly as a safety measure. The AT&F command is usually used to make sure the factory defaults are set; the defaults are usually the ideal conditions for the modem to operate. The other commands that are added are mainly because they are not default but are desired by the modem to work more efficiently.

## 2.4 Phase IV – Future Research

In Phase IV it was proposed to go to the field sites and test the modem string with the data collection equipment attached and verify the performance of the modems as analyzed in phase III. Also, certain other aspect of the data collection would be looked into for optimal performance of the remote data collection system to help FDOT cut cost on the monthly communication bill for downloading the data using long-distance calls.

### 3. Conclusions

Based on the research done on initialization string it was observed that the data collection equipments had a certain desired format to communicate with the modem attached to it and therefore it had to be used accordingly. Unfortunately these specifications were not always given by the vendors and thus cause a problem of trial and error. At present FDOT has the document from PEEK (*Tech Notes for Configuring a Modem for an ADR*) to make modem strings for the PEEK data collection equipment and that also only for ADR units 1000, 1000 plus, 2000, 2000 plus, 3000, and 3000 plus. The instructions provided by the PEEK document do not apply to the ADR-4000 and ADR-6000 unit as mentioned in the Tech Notes. Such documents were not available for the PAT and Diamond data collection software and their presence would help understand the requirements that particular data equipment has regarding the modem settings, and those particular settings could be added to the initialization strings. Also, for future purposes, the modem manual should be checked to verify that the default values are given after the factory setting. This was not very clear for the cascade modem as they mainly list the basic AT command set and then print a list of settings after execution of AT&F command rather than mentioning if it is default in the command set presentation itself.

The benefit of this research was the generation of modem strings for newer modems that FDOT was planning to use, optimization of existing initialization strings based on TTMS vendor requirements, discussion of methodology on generating the initialization strings efficiently; all leading to an increase in modem reliability from the Burns Building to the TTMS sites, a reduction in manual downloads of data files from the TTMS sites, and thus reduction in maintenance cost.

## 4. References

This chapter contains certain references that might be useful to understand the modem commands, the commonly used terminology, and some common questions regarding the modem strings.

### 4.1. AT Modem Commands

Many users ask for optimal initialization strings for their particular modem. If one takes the time to learn some of the basic features available in most modems, one can see that these strings are merely a series of commands that enable, disable, or specify parameters for these features. Most modem manufacturers chose reasonable default values for these features in hopes that the modem will be usable with little or no configuration. Unfortunately these defaults vary from one brand (or model) of modem to another, and settings will depend on the features of the computer and communications software, as well as those of the system one wishes to call.

AT strings is a set of commands that control the modem. The initial strings come as part of the modem's factory settings. There are two ways to configure a modem: storing the configuration in the modem or storing initialization strings in one's communications software. The former is generally simpler, but not a feature of all modems. The latter can be more cumbersome, but allows for greater flexibility in allowing different configurations for calling different services.

#### Common AT modem commands

- A** Answer incoming call
- A/** Repeat last command. (Don't preface with AT. Enter usually aborts.)
- D** Dial the following number and then handshake in originate mode.  
Dial Modifiers (These are common but most modems will have more.)
- P** Pulse dial
- T** Touch Tone dial
- W** Wait for second dial tone
  - , Pause for time specified in register S8 (usually 2 seconds)
  - ; Remain in command mode after dialing
  - ! Flash switch-hook (Hang up for a half second as in transferring a call)
- E** Will not echo commands to the computer (also **E0**)
- E1** Will echo commands to the computer (so one can see what one types)
- H** On Hook (hang up, also **H0**)
- H1** Off Hook (phone picked up)
- I** Inquiry, Information, or Interrogation  
(This command is very model specific. I0 usually returns a number or code, while higher numbers often provide much more useful information.)
- L** Speaker Loudness (**L0** off or low volume)
- L1** Low volume
- L2** Medium volume (usual default)

**L3** Loud or high volume  
**M** Speaker off (**M0**) (**M3** is also common, but different on many brands)  
**M1** Speaker on until remote carrier detected (until the other modem is heard)  
**M2** Speaker is always on (data sounds are heard after CONNECT)  
**O** Return Online (**O0** see also **X1** as dial tone detection may be active)  
**O1** Return Online after an equalizer retrain sequence  
**Q** Quiet mode **Q0** displays result codes, user sees command responses (e.g. OK)  
**Q1** Quiet mode, result codes are suppressed, user does not see responses  
**Sn?** Query the contents of S-register n  
**Sn=r** Store the value r in S-register n  
**V** non-Verbal (Numeric result codes **V0**)  
**V1** Verbal English result codes (e.g. CONNECT, BUSY, NO CARRIER etc.)  
**X** Hayes Smartmodem 300 compatible result codes (**X0**) (Many have more than 4)  
**X1** Usually adds connection speed to basic result codes (e.g. CONNECT 1200)  
**X2** Usually adds dial tone detection (preventing blind dial and sometimes **ATO**)  
**X3** Usually adds busy signal detection  
**X4** Usually adds both busy signal and dial tone detection  
**Z** Reset modem to stored configuration (**Z0**, **Z1** etc. for multiple profiles)  
 (Same as &F (factory default) on modems with out NVRAM (non volatile memory))

**&C0** Carrier detect (CD) signal always on  
**&C1** Carrier detect indicates remote carrier (usual preferred default)  
**&D0** Data Terminal Ready (DTR) signal ignored (**See your manual** on this one!)  
**&D1** If DTR goes from On to Off the modem goes into command mode (**some** modems)  
**&D2** Some modems hang upon DTR On to Off transition. (usual preferred default)  
**&F** Factory defaults (Most modems have several defaults **&F1**, **&F2**, etc.)  
**&P** (**&P0**) U.S./Canada pulse dialing 39% make/ 61% break ratio  
**&P1** U.K./Hong Kong pulse dialing 33% make/ 67% break ratio  
**&T** Model specific self tests on some modems  
**&V** View active (and often stored) configuration profile settings (or **ATI4**)  
**&W** Store profile in NVRAM (&W0, &W1 etc. for multiple profiles)  
 Some settings cannot be stored. These often don't show on **&V** or **ATI4**  
**&Zn=x** Store number x in location n for AT DS on some modems

## S-registers

Register	Range	Default	Function
<b>S0</b>	0-255 rings	1-2	Answer on ring number. <u>Don't answer if 0</u>
<b>S1</b>	0-255 rings	0	If S0>0 this register counts incoming rings
<b>S2</b>	0-127 ASCII	43 +	Escape to command mode character S2>127 no ESC
<b>S3</b>	0-127 ASCII	13 CR	Carriage return character
<b>S4</b>	0-127 ASCII	10 LF	Line feed character
<b>S5</b>	0-32,127 ASCII	8 BS	Backspace character
<b>S6</b>	2-255 seconds	2	Dial tone wait time (blind dialing, see <b>Xn</b> )
<b>S7</b>	1-255 seconds	30-60	Wait time for remote carrier

<b>S8</b>	0-255 seconds 2	Comma pause time used in dialing
<b>S9</b>	1-255 1/10 sec. 6	Carrier detect time required for recognition
<b>S10</b>	1-255 1/10 sec. 7-14	Time between loss of carrier and hang up
<b>S11</b>	50-255 msec. 70-95	Duration and spacing of tones when tone dialing
<b>S12</b>	0-255 1/50 sec. 50	Guard time for pause around +++ command sequence

Many modems have dozens, even hundreds, of S registers, but only the first dozen or so are fairly standard. They are changed with a command like ATSn=N, and examined with ATSn?

## 4.2 Common Terminology

When discussing about modems, some information is critical to understand in order to have discussion of the modem issues. This section covers some basic terminology commonly used when communicating about modems.

### Initialization string

The initialization string is probably the most common cause of data speed problems. A browser's dialer program sends commands to the modem before dialing the required telephone numbers. These commands setup the modem for different types of connections. Incorrect modem settings in the dialer program can cause very slow connections or other unpredictable problems. Sometimes it is possible to improve performance by adding to or changing the initialization string.

### DTE rate and compression

DTE rate is the rate at which your computer sends and receives data to and from your modem. If data compression is used, the DTE should be set as high as possible. The ITU V.42bis compression standard can achieve 4-to-1 compression and automatically switch off if data cannot be compressed. The MNP 5 compression standard can achieve 2-to-1 compression, but does not switch off if data cannot be compressed, and slows down data transfer as a result.

Note the compression is most effective on text files like HTML files and has little effect on files that are already compressed such as ZIP files and JPG graphic files.

### Error Control & Data Compression

There are two common types of error control, LAPM and MNP. LAPM is an error control protocol specified in ITU-T Recommendation V.42. MNP has different levels with levels 2-4 being included in ITU-T Recommendation V.42. MNP 10 and MNP 10EC are protocols for error correction in wireless channels. Most modems use LAPM error control by default and it is better than MNP5 error control. Error control found in modems is V.42/MNP class 2 to 4

Data compression includes the standards V.42bis/MNP class 5. V.42bis is the standard for the BTLZ data compression protocol, which is better than MNP 5.



Note: V.42 is the standard that uses either LAPM (Link Access Procedures for Modems) error correction protocol or MNP 4, 3, or 2.

### **Line Quality**

The telephone line quality is very important when it comes to connecting modems at a good connection speed. Sometimes the noise in the line might be to such an amount that the modems have to negotiate at a very low speed or sometimes even lose the connection. Some modems have better noise cancellation chips and can perform better.

### **Port speed and line speed**

This is one of the most confusing aspects of modem terminology. The port speed (**Data Terminal Equipment speed**) is the speed between your computer's serial port and your modem. It can be set to 110, 300, 1200, 2400, 4800, 9600, 19200, 38400, 57600, 115200 and recently 230400 and above. The line speed (**Data Communication Equipment speed**) is the speed between your modem and the modem at the other end of the telephone line. Depending on the modem, the line speed can be 2400, 4800, 7200, 9600, 12000, 14400, 16800, 19200, 214000, 24000, 288000, 31200 and 336000 bps. The 56 kbps modems can have higher line speed based on telephone line quality.

*It is very important to use the right '.inf' file for the modem.*

## **4.3 Recommendations for Common Modem Problems**

There are a number of issues when dealing with modems that can be configured with the help of software. Some of these issues are discussed in this section.

### *Software Configuration*

Generally no parity, eight data bits, one stop bit, and hardware flow control are the most common software settings. Probably the most complicated values to pick can be the DTE rate or serial port speed. This is most easily accomplished by starting at the link rate of the modem and trying successively higher speeds and observing the impact on performance.

#### **Problem:** Modem won't dial:

- Try a regular phone on the modem line and listen for dial tone. If there is no dial tone the
- Problem is the phone line and not the modem.
- Try X1 to disable dial tone detection.
- Try pulse dialing ATDP instead of ATDT.
- Try dialing manually with a phone and then use AT X1 O

**Problem:** Modem dials but won't connect:

- Try adding commas after the phone number to increase the time the originating modem waits for carrier, or increase the value of S7. (e.g. AT S7=100 DT 1234567 or ATDT , , 1234567)
- Try X1 for simple result codes esp. if VOICE result appears after modem tone is heard.
- Try configuring for a slower link rate (set a lower port speed in your software or modem).
- Try disabling MNP 4,5, V.42, and V.42*bis* protocols each.

**Problem:** Modem hangs up for no reason during a connection:

- Try \A0 for a 64 character maximum MNP block instead of the default 256-character block.
- Disconnect all other phones and answering machines on the same line to see if any of them are interfering.
- Call your phone company if you can hear static on your lines.
- It is possible your modem may have a bug in its ROM, call your support line to check on the version of your ROM or for other problems unique to your modem.

**Problem:** Zmodem file transfers don't work:

- Check parity. X, Y, and Zmodem require none (No Parity).
- Check flow control. Are the modem and software set the same, preferably RTS/CTS?

## **Appendix B**

### **Interim Report**

#### **“Performance Study of the Digi AccelePort RAS 8-Modem PCI Board”**

**Interim Technical Report**

**Performance Study of the  
Digi AccelePort RAS 8-Modem PCI Board**

**PROJECT:**

**Electrical Engineering Support for Telemetered Traffic Monitoring Sites  
(FDOT Contract No. BC-543 RPWO 3, FSU OMNI No. 010295)**

**Submitted by:**

**FAMU-FSU College of Engineering  
2525 Pottsdamer Street  
Tallahassee, FL 32310-6046**

**Principal Investigator:**

**Bruce A. Harvey, Ph. D., Associate Professor  
Department of Electrical and Computer Engineering  
Phone: (850) 410-6451  
Fax: (850) 410-6479  
Email: [bharvey@eng.fsu.edu](mailto:bharvey@eng.fsu.edu)**

## Executive Summary

One of the main items of interest to the Transportation Statistic Office at the Florida Department of Transportation (FDOT) is the analysis of the data collected from over 300 plus of its telemetered traffic monitoring sites (TTMSs) distributed over the State of Florida. This data collection is initiated at the headquarters of the FDOT by using 8-polling lines in the communication room of the Burns Building to collect the data from all the 300+ TTMSs. All the polling lines have a modem which calls the modem at the TTMSs and once connected, it downloads the data collected that particular day. At the time FDOT started using the Digi International's AccelePort RAS 8-modem PCI board Digiboard (a bank of calling modems) to collect the data from the TTMS equipment, the reliability of the connections between the Digiboard modems and the modems at the TTMSs became a concern for the FDOT.

The Florida A&M University-Florida State University College of Engineering (FAMU-FSU COE) Department of Electrical and Computer Engineering was tasked to test the performance of Digiboard modems when connecting to typical field modems used by the FDOT. These tests were to assess the reliability of the modem connection as a function of noise level and attenuation on the telephone line.

The testing of the Digiboard modems was conducted in four phases. In Phase I, compatibility of the Digiboard modem to a variety of modems was assessed under ideal line conditions. A Teltone Telephone Line Emulator (TLE) was used to connect the Digiboard modems to the other modems tested. In Phase II, the Teltone TLE was used to introduce random (white) noise to the telephone line and the maximum noise level at which the modems could reliably connect was determined. In Phase III, the noise was removed and attenuation was added to the lines (sending and receiving) to assess the sensitivity of the modem connections to signal level. Finally, in Phase IV, the effects of combinations of noise and attenuation were assessed.

The performance of the Digi International's AccelePort RAS 8-Modem PCI card used by the FDOT for collection of data from the TTMS systems was very similar to that of other 56K modems tested. It was observed that the Digiboard modems were more sensitive to noise when connecting to lower speed (14.4K) modems and thus may have more difficulty connecting to the modems used in TTMS installations. The Digiboard performed as well as or slightly better than other 56K modems when connecting to 14.4K modems over attenuated lines. When a combination of line attenuation (fixed at 24 dB) and noise are present, the Digiboard modems demonstrate weaker performance when connecting with 14.4K modems. And as FDOT changes the old modems at the TTMS sites that operate at less than 14.4kbps, the operation of the Digiboard modems would only improve with those upgrades.

The benefit of this study was that it was verified that the investment of the FDOT in the Digiboard modem was justified as it was reliable and performed better with modems connecting at 14.4K and higher. Therefore, no changes were recommended in that aspect.

## Table of Contents

Executive Summary .....	B-3
Table of Contents .....	B-4
List of Figures and Tables.....	B-5
1. Introduction .....	B-6
2. The Digi International AccelePort RAS 8-Modem PCI Board .....	B-6
3. Testing of the Digiboard Modems .....	B-7
3.1. Phase I – Ideal Line Conditions .....	B-7
3.2. Phase II - Noisy Line Performance Tests.....	B-7
3.3. Phase III – Attenuated Line Tests .....	B-10
3.4. Phase IV – Focused Tests, Combinations of Impairments.....	B-12
4. Conclusions on Digi AccelePort RAS 8-Modem Performance.....	B-13
References.....	B-14

## List of Figures and Tables

Figure 1. The Digi AccelePort RAS PCI Board .....	B-6
Table 1. Maximum Operating Noise Level (in dBrn).....	B-8
Table 2. Constant Noise of 55 dBrn on Calling Modems.....	B-9
Table 3. Maximum Operating Line Attenuation.....	B-11
Table 4. Maximum Receiving Modem Line Attenuation with a Constant Attenuation of 28 dB on Calling Modems.....	B-12
Table 5. Maximum Operating Noise Level (in dBrn) with a Line Attenuation of 24 dB: Connections Between 56K and Lower-Speed Modems .....	B-13

## 1. Introduction

The Florida Department of Transportation (FDOT) Transportation Statistics Office currently collects traffic data from over 300 permanent telemetered traffic monitoring sites (TTMSs) distributed over the State of Florida. By and large the gathering of the data from the TTMSs is accomplished using telephone modems to dial up each site. For roughly the past year, the FDOT has used Digi International's AccelePort RAS 8-modem PCI board (Digiboard) as a bank of calling modems to collect the data from the TTMS equipment. The reliability of the connections between the Digiboard modems and the modems at the TTMSs has been a concern for the FDOT.

The Florida A&M University-Florida State University College of Engineering (FAMU-FSU COE) Department of Electrical and Computer Engineering was tasked to test the performance of Digiboard modems when connecting to typical field modems used by the FDOT. These tests were to assess the reliability of the modem connection as a function of noise level and attenuation on the telephone line. The procedures defined from previous modem testing [1] were followed for these tests.

## 2. The Digi International AccelePort RAS 8-Modem PCI Board

The Digi AccelePort RAS 8-modem PCI board (see Figure 1) is an internal computer card intended for personal computers or workstations based on Windows, Linux or UNIX operating systems. The card allows the computer to establish 8 simultaneous modem connections. The modems are capable of up to 56K rates using the V.90 or K56Flex standards. It is compatible with the modem speeds and standards used by the FDOT for TTMS installations. A data sheet for the Digiboard is included in Appendix A.



**Figure 1. The Digi AccelePort RAS PCI Board**



### 3. Testing of the Digiboard Modems

The testing of the Digiboard modems was conducted in four phases. In Phase I, compatibility of the Digiboard modem to a variety of modems was assessed under ideal line conditions. A Teltone Telephone Line Emulator (TLE) was used to connect the Digiboard modems to the other modems tested. In Phase II, the Teltone TLE was used to introduce random (white) noise to the telephone line and the maximum noise level at which the modems could reliably connect was determined. In Phase III, the noise was removed and attenuation was added to the lines (sending and receiving) to assess the sensitivity of the modem connections to signal level. Finally, in Phase IV, the effects of combinations of noise and attenuation were assessed.

The modems used in combination with the Digiboard modems during testing were:

DC Modems:                      Starcomm Modem – 14.4 (Rockwell/Conexant Chipset)  
   Starcomm Modem – 33.6 (Rockwell/Conexant Chipset)  
   Cascade 14.4 Data Modem (Rockwell/Conexant Chipset)  
   Cascade 33.6 Data Modem (Rockwell/Conexant Chipset)  
   Motorola V.3600 Modem (Motorola Chipset)  
   Telenetics MIU14.4-LV (Rockwell/Conexant Chipset)  
   Micro-Aide LPM 14.4 (Rockwell/Conexant Chipset)  
   Micro-Aide LPM 33.6 (Rockwell/Conexant Chipset)

Desktop (AC) Modems:        Win Lucent Modem (Internal Laptop – Chipset Lucent)  
   US Robotics 56k (Chipset US Robotics)  
   Zoom 56K (Chipset Lucent ‘Oscera’)  
   Best Data 56k (Rockwell/Conexant Chipset)

For comparison, the results from the testing conducted in the previous effort [1] are tabulated along with the results of the Digiboard tests.

#### 3.1. Phase I – Ideal Line Conditions

In the first phase, the digiboard modems were connected to various modems under ideal conditions to evaluate the compatibility and performance of modems under test. As expected, under ideal conditions, all modems connected at the desired optimum specs. This test indicated that regardless of the chipsets and protocols, the modems were compatible under ideal conditions.

#### 3.2. Phase II - Noisy Line Performance Tests

The second phase of the tests involved researching the threshold level of the white noise the modem could withstand and communicate. Thus a number of tests were performed under increasing noise levels to check the failing point of the modem. The end result of this phase was to observe, in general, the tolerance of the Digiboard modem to line noise when connecting with different modems.

Table 1 summarizes the results of the tests under equal noise conditions in both communication directions (the most likely condition on telephone lines). The noise produced by the Teltone TLE is white noise and the units are dBrn. The unit dBrn is noise level in decibels relative to a reference level of -90 dBm (decibels relative to a milliwatt; -90 dBm = 10<sup>-9</sup> milliwatt = 10<sup>-12</sup> Watts).

**Table 1. Maximum Operating Noise Level (in dBrn)**

CALLING MODEMS	RECEIVING MODEMS											
	A	B	C	D	E	F	G	H	I	J	K	L
A	60	60	55	60	55	60	65	60	60	60	NP	NP
B	60	NA	60	60	60	60	60	50	60	60	60	60
C	60	60	NA	60	60	60	60	55	60	60	NP	NP
D	60	60	60	60	55	60	60	55	60	60	55	50
E	60	60	60	55	NA	60	60	60	55	NA	NP	NP
F	60	60	60	60	60	60	60	60	60	60	55	60
G	55	50	60	60	60	60	NA	60	60	60	60	55
H	60	60	50	55	60	60	60	NA	60	60	55	65
I	60	60	55	60	50	60	60	60	NA	60	60	65
J	60	60	60	60	NA	60	60	60	60	NA	NP	NP
M	50	50	50	60	55	NA	60	60	60	NA	65	60

NA = Combination of modems not available  
 NP = Test of this combination of modem not performed

Modem Key

- A - Starcomm 14.4 (Rockwell)
- B - LPM 14.4 (Rockwell)
- C - Cascade 14.4 (Rockwell)
- D - Starcomm 33.6 (Rockwell)
- E - Cascade 33.6 (Rockwell)
- F - Micro-Aide 33.6
- G - Best Data 56 k (Rockwell)
- H - US Robotics (USR)
- I - Zoom 56 k (Lucent)
- J - Laptop 56 k (Lucent)
- K - Motorola V.3600 (Motorola)
- L - Telenetics MIU 14.4 LV
- M - Digiboard 56 k modem

The results summarized in Table 1 demonstrate that the digiboard 56k modem performed with all the modems to the noise levels up to 50 dBrn (-40 dBm). The combination of tests that were the least resilient (shaded yellow) in case of the digiboard modem was the connection to the 14.4k modems.

A variation of the above test was then performed to test the compatibility of 56K modems with lower-rate DC modems. In this test, the white noise on the calling modem was fixed at a level of 55 dBrn, and the noise on the receiving modem was varied. Table 2 summarizes the results of the test indicating the maximum noise tolerated at the receiver modem. From the results it was observed that the digiboard 56K modem did not perform at all with the 14.4 k modems when the constant white noise of 55dBrn was fixed on it. Therefore, if the lines at the calling sites are noisy (at the 55dBrn level or above) it would cause a lot of errors as the modems would not be able to communicate to 14.4 K modems and lower.

**Table 2. Constant Noise of 55 dBrn on Calling Modems**

CALLING MODEMS	RECEIVING MODEMS						
	A	B	C	D	E	F	G
A	65	60	60	65	60	60	65
B	55	NA	60	65	60	60	65
C	60	60	NA	60	60	60	NC
D	55	60	55	NA	65	65	65
E	60	NC	60	60	NA	65	60
F	60	55	NC	60	60	NA	65
G	60	60	NC	60	60	65	NA
H	NC	NC	55	60	60	65	NA

NC = No connection could be achieved  
 NA = Not available combination

Modem Key

- A - Starcomm 14.4 (Rockwell)
- B - Cascade 14.4 (Rockwell)
- C - Cascade 33.6 (Rockwell)
- D - Best Data 56 k (Rockwell)
- E - US Robotics (USR)
- F - Zoom 56 k (Lucent)
- G - Laptop 56 k (Lucent)
- H - Digiboard 56 k modem

From the tests, it was concluded that the Digiboard modems' performance was very similar to other 56K modems tested in the previous effort. [1] The Digiboard modems are somewhat more sensitive to noise when connecting with low-speed (14.4K) modems.

### **3.3. Phase III – Attenuated Line Tests**

In the third phase of testing, the attenuation of the signal levels was varied and the ability of the modems to compensate for line attenuation was studied. These tests evaluate the ability of the modems to adjust to the attenuated line conditions such as those experienced by remote sites. The test involved only attenuation without any white noise added to the telephone lines. The summary of the results using equal line attenuation in each direction is given in Table 3.

With the Digiboard modem it was observed that all the modem were able to communicate with an attenuation up to 26 – 30 dB. The 26 dB connection was established with the 56k Zoom modem whereas the 30 dB connection was made with the 33.6 k Motorola modem. These test results thus indicate that the affects of line attenuation alone are relatively independent of the speed of the modem connected to the Digiboard modem.

Again, a variation of these tests was conducted using a fixed attenuation of 28 dB on the calling modems. Then the maximum attenuation on the received modem was varied in order to determine the maximum attenuation where connection was possible. The results are illustrated in Table 4. It can be observed from the results that the Zoom modem was not able to establish connection even though it was a 56K modem, whereas the Starcomm and Cascade modem established the connections at 32 dB and 30 dB respectively. Thus the line attenuation does not seem to impact the performance between the 56K modems and the 14.4K modems.

The results of the tests demonstrate that when experiencing phone line attenuation, the Digiboard modems' performance was nearly identical to the other modem combinations tested in the previous effort. [1]

**Table 3. Maximum Operating Line Attenuation**

CALLING MODEMS	RECEIVING MODEMS											
	A	B	C	D	E	F	G	H	I	J	K	L
A	30	28	32	30	28	32	34	24	28	28	NP	NP
B	28	NA	30	28	30	30	30	30	26	28	32	28
C	30	30	NA	26	28	30	32	26	30	28	NP	NP
D	30	28	30	30	26	32	30	30	32	30	32	28
E	32	30	28	26	NA	30	30	28	28	NA	NP	NP
F	32	30	30	32	30	30	30	30	30	32	32	30
G	30	30	30	30	30	30	NA	30	28	28	30	30
H	28	30	24	30	32	30	30	NA	28	28	30	32
I	28	26	28	32	26	30	28	30	NA	30	28	30
J	30	28	28	30	NA	32	30	30	30	NA	NP	NP
M	28	28	28	28	28	NA	28	28	26	NA	30	28

NA = Combination of modems not available

NP = Test of this combination of modem not performed

Modem Key

A - Starcomm 14.4 (Rockwell)

B - LPM 14.4 (Rockwell)

C - Cascade 14.4 (Rockwell)

D - Starcomm 33.6 (Rockwell)

E - Cascade 33.6 (Rockwell)

F - Micro-Aide 33.6

G - Best Data 56 k (Rockwell)

H - US Robotics (USR)

I - Zoom 56 k (Lucent)

J - Laptop 56 k (Lucent)

K - Motorola V.3600 (Motorola)

L - Telenetics MIU 14.4 LV

M - Digiboard 56 k modem

**Table 4. Maximum Receiving Modem Line Attenuation with a Constant Attenuation of 28 dB on Calling Modems**

CALLING MODEMS	RECEIVING MODEMS						
	A	B	C	D	E	F	G
A	32	32	32	30	NC	32	36
B	30	NA	28	32	NC	30	30
C	32	28	NA	32	30	30	NC
D	30	30	30	NA	32	30	32
E	28	NC	30	32	NA	32	32
F	26	28	NC	30	30	NA	30
G	28	28	NC	32	30	30	NA
H	32	30	32	34	32	NC	NA

NC = No connection could be made  
 NA = Not available combination

Modem Key

- A - Starcomm 14.4 (Rockwell)
- B - Cascade 14.4 (Rockwell)
- C - Cascade 33.6 (Rockwell)
- D - Best Data 56 k (Rockwell)
- E - US Robotics (USR)
- F - Zoom 56 k (Lucent)
- G - Laptop 56 k (Lucent)
- H - Digiboard 56 k modem

**3.4. Phase IV – Focused Tests, Combinations of Impairments**

Based on the test plan from the previous effort [1], the Phase I - III tests were conducted to evaluate the performance of the modems. The results from Phases I – III indicated that generally the modems performed similarly with few exceptions regardless of chipset or manufacturer. Therefore Phase IV was reduced somewhat and the tests focused more on the performance of connections between 56K modems and lower-speed modems. Table 5 illustrates the combination of noise and attenuation parameters that affect the performance of the 56K modems with the 14.4K modems. This test also compares the performance of the Digiboard 56K modems with other 56K modems used previously in the tests. For this test, the attenuation in both directions was fixed at 24 dB (the lowest successful connection speed in Phase III). The noise in both directions was then varied to determine the maximum noise level at which the modems can establish a connection.

**Table 5. Maximum Operating Noise Level (in dBrn) with a Line Attenuation of 24 dB: Connections Between 56K and Lower-Speed Modems**

Desktop modems	DC MODEMS							
	A	B	C	D	E	F	G	H
BestData 56k	42	42	42	42	44	44	42	44
US Robotics 56k	42	30	30	40	38	44	40	40
Zoom 56k	40	42	40	42	40	44	40	40
Digiboard 56k	32	32	34	44	40	48	44	NA

NA = Not Available

- A - Starcomm 14.4
- B - Cascade 14.4
- C - LPM-14-E
- D - Cascade 33.6
- E - Telenetics 14.4 MIU-LV
- F - Motorola V.3600
- G - Starcomm 33.6
- H - LPM - 33

The results of the test for most combinations of modems indicated that the connections could be established with noise levels between 32 and 48 dBrn. It was observed that the Digiboard modem did not perform as well with the 14.4 K modems when there was substantial noise on the telephone lines, whereas the BestData 56k modem and Zoom performed much better with 14.4 modems in those instances. And as FDOT changes the old modems at the TTMS sites that operate at less than 14.4kbps, the operation of the Digiboard modems would only improve with those upgrades.

#### 4. Conclusions on Digi AccelePort RAS 8-Modem Performance

The performance of the Digi International's AccelePort RAS 8-Modem PCI card used by the FDOT for collection of data from the TTMS systems was very similar to that of other 56K modems tested. It was observed that the Digiboard modems were more sensitive to noise when connecting to lower speed (14.4K) modems and thus may have more difficulty connecting to the modems used in TTMS installations. The Digiboard performed as well as or slightly better than other 56K modems when connecting to 14.4K modems over attenuated lines. When a combination of line attenuation (fixed at 24 dB) and noise are present, the Digiboard modems demonstrate weaker performance when connecting with 14.4K modems. And as FDOT changes the old modems at the TTMS sites that operate at less than 14.4kbps, the operation of the Digiboard modems would only improve with those upgrades.

The benefit of this study was that it was verified that the investment of the FDOT in the Digiboard modem was justified as it was reliable and performed better with modems connecting at 14.4K and higher. Therefore, no changes were recommended in that aspect.

## References

[1] FDOT Contract Number BC-596 (FSU Project No. 613054139), “Improving Operation of FDOT Telemetered Traffic Monitoring Sites.”



**Appendix C**

**Interim Report**

**“Burns Building Phone Line Assessment”**

**Interim Technical Report**

**Burns Building Phone Line Assessment**

**PROJECT:**

**Electrical Engineering Support for Telemetered Traffic Monitoring Sites  
(FDOT Contract No. BC-543 RPWO 3, FSU OMNI No. 010295)**

**Submitted by:**

**FAMU-FSU College of Engineering  
2525 Pottsdamer Street  
Tallahassee, FL 32310-6046**

**Principal Investigator:**

**Bruce A. Harvey, Ph. D., Associate Professor  
Department of Electrical and Computer Engineering  
Phone: (850) 410-6451  
Fax: (850) 410-6479  
Email: [bharvey@eng.fsu.edu](mailto:bharvey@eng.fsu.edu)**

## Executive Summary

The Florida Department of Transportation (FDOT) Transportation Statistics Office currently collects traffic data from over 300 permanent telemetered traffic monitoring sites (TTMSs) distributed over the State of Florida. By and large the gathering of the data from the TTMSs is accomplished using telephone modems to dial up each site. This process of dial up is initiated by 8-polling lines in the communication room of the Burns Building at midnight to collect the data from all the 300+ TTMSs. Due to the problems with the drop connections, and unsuccessful connections between the Burns Building phone lines and the TTMSs, the FDOT tasked the FAMU-FSU College of Engineering (COE) to assess the performance of the phone lines in the Burns Building communication room. The task of analyzing the performance of the phone lines was distributed into six phases.

During Phase I to Phase V of the study, the quality of local calls was assessed on the phone lines of the Burns Building. To this effect, the initial tests included day and night time measurements of each of the 8 polling lines in the communication room. The line quality was measured between the communication room and the COE using the Modem line Quality Tester (MLQT) units provided by the FDOT. Then, to isolate the source of line degradations at the Burns Building, the MLQT tests were conducted between Burns Building and a residence line (Phase II), between the COE and the residence line (Phase III), between two residence lines (Phase IV), and between the COE and the Springhill Road facility of the FDOT (Phase V).

The later tests, Phase VI, included using the long distance service at the Burns Building to dial to the College of Engineering instead of using the local service, as the local service was through sprint whereas the long distance service was via Suncomm. Also, tests were performed between the Burns Building and the site 320-2, site 204, site 343 and site 96. Site 320-2 is located at SR-93/I-75, between I-10 AND US-90, Columbia County (southbound side), Site 204 at SR-528/Beeline Expwy, 1.4 MI W of SR-15, Orange County (SE of Orlando), Site 343 at SR-400/I-4, 1.6 MI E OF SR-434, Seminole County (Orlando), and Site 96 at SR-9, 0.4 MI SW OF Biscayne Canal Bridge, Dade County (near Miami). These sites were selected for long distance line quality tests when they were visited for data collection of the lightning surges. These later tests were grouped together as the last phase of the data collection and analysis for the Burns Building phone line assessments.

In the initial tests all the 8 polling lines in the Burns Building Communication Room were tested at daytime and nighttime. A total of 20 runs were performed on each line during daytime and 10 runs at nighttime. The results indicated that the performance of the phone lines was not affected by the time of the day the tests were conducted. All tests were then conducted during the daytime.

Phases II to V were then conducted to compare the performance of the Burns Building Phone lines with that of the College of Engineering (COE) and residential phone lines.

The summary of the results from the first five phases of the phone line assessments of the Burns Building are provided in Table 1.

**Table 1. – Summary of Results of First Five Phases**

Phase	Test Sites	Ave BER	Ave Speed
I	Burns Building to College Of Engineering (COE) Daytime (20 runs)	1.25E-04	24510
	Burns Building to COE Nighttime (10 runs)	1.06E-04	24668
II	Burns Building to Residence Phone Line	2.34E-04	23580
III	COE to Residence Phone Line	0	28880
IV	Between two Residence Phone Lines	9.42E-06	27360
V	Springhill Rd Facility of FDOT to COE	1.57E-03	24933

In Table 1, ‘Ave BER’ stands for Average Bit Error Rate, and it is (the number of bits received in error during the test/total number of bits transmitted); and ‘Ave Speed’ stands for Average Connection Speed at which the connection was established and its units are bits per second (bps).

Table 1 shows that there is some degradation in the phone lines at the Burns Building based on the average BER and the average connection speed, although these degradations do not affect the voice communication, they do affect data communication due to the errors or noise on the phone line.

In Phase VI, long distance communication (via Suncomm service at the Burns Building) was established with several different TTMS sites, which were chosen mainly out of convenience as those sites were visited for data collection of lightning surges. A total of four different TTMS sites were used for this purpose: namely Site 320-2 near Lake City, Site 204, Site 343 and Site 96 (The locations of these sites are mentioned earlier for exact reference). A total of 25 connections were established with Site 320-2 (on one day), a total of 40 connections established with Site 204 (on three different days), a total of 40 connections established with Site 343 (on three different days), and a total of 20 connections established with Site 96. From the results of all the tests it was concluded that the presence of surge suppressor on the phone line at the TTMS site does not degrade the performance of the phone line. Also the number of errors on long distance connections was much more than those in the local tests conducted in the first five phases of the tests. There were also some dropped calls during the long distance connections from the Burns Building to the TTMS sites. These dropped calls tended to occur in bursts indicating that there was some sort of time dependence to the problems. Since these period of poor performance are due to bursts of errors on the telephone line, the solution to increase efficiency of the polling system, along with reduced errors was to implement a delay in reconnecting to that particular site and to download after certain delay, causing the bursts of errors to pass.

The benefit of this research was to discover that the long distance calls from the Burns Building to TTMS sites tend to have periods of poor performance; therefore the failure of

connection does not imply failure of the modem. Further a method to maneuver across this problem was suggested, which in essence improves the efficiency of the current polling system, as it is not bogged down trying to reconnect to a site, and also reduces the time and effort required with manual downloads of data from TTMS sites, by reconnecting after certain time and doing this process automatically, hence reducing cost of operations for the FDOT.

## Table of Contents

Executive Summary .....	C-3
Table of Contents .....	C-6
List of Tables .....	C-7
1. Introduction.....	C-8
2. Modem Line Quality Tests of Phone Lines .....	C-8
2.1. Phase I – Burns Building & COE .....	C-9
2.2. Phase II – Burns Building & Residence Phone Line .....	C-10
2.3. Phase III – COE & Residence Phone Line .....	C-10
2.4. Phase IV – Between Two Residential Phone Lines.....	C-11
2.5. Phase V – COE & Springhill Rd Facility of FDOT.....	C-11
2.6. Phase VI – Burns Building and TTMS Sites .....	C-12
3. Conclusions on Performance Analysis of Burns Building Phone Lines.....	C-16
4. Detailed Data .....	C-17
4.1. Phase I – Burns Building & COE .....	C-17
4.2. Phase II – Burns Building & Residence Phone Line .....	C-34
4.3. Phase III – COE & Residence Phone Line .....	C-36
4.4. Phase IV – Between Two Residential Phone Lines.....	C-36
4.5. Phase V – COE & Springhill Rd Facility of FDOT.....	C-37
4.6. Phase VI – Burns Building and TTMS sites.....	C-38

## **List of Tables**

Table 1. – Summary of Results of First Five Phases .....	C-4
Table 2. Daytime Run (20 runs per line, total 8 lines).....	C-9
Table 3. Midnight runs (10 runs per line, total 8 lines) .....	C-9
Table 4. Summary of Test Results between Burns Building & Residential phone lines .....	C-10
Table 5. Summary of Test Results between COE & Residential Phone Lines.....	C-11
Table 6. Summary of Test Results between Two Residential Phone Lines .....	C-11
Table 7. Summary of Test Results between COE & Springhill Rd Facility of FDOT .....	C-12
Table 8. Summary of Test Results between Burns Building and Site 320-2.....	C-13
Table 9. Summary of Test Results between Burns Building and Site 204 .....	C-13
Table 10. Summary of Test Results between Burns Building and Site 343 .....	C-14
Table 11. Summary of Test Results between Burns Building and Site 96 .....	C-14

## **1. Introduction**

The Florida Department of Transportation (FDOT) Transportation Statistics Office currently collects traffic data from over 300 permanent telemetered traffic monitoring sites (TTMSs) distributed over the State of Florida. By and large the gathering of the data from the TTMSs is accomplished using telephone modems to dial up each site. This process of dial up is initiated by 8-polling lines in the communication room of the Burns Building at midnight to collect the data from all the 300+ TTMSs. Due to the problems with the drop connections, and unsuccessful connections between the Burns Building phone lines and the TTMSs, the FDOT tasked the FAMU-FSU College of Engineering (COE) to assess the performance of the phone lines in the Burns Building communication room.

The initial tests included day and night time measurements of each of the 8 polling lines in the communication room. The line quality was measured between the communication room and the COE using the Modem line Quality Tester (MLQT) units provided by the FDOT. Then, to isolate the source of line degradations at the Burns Building, the MLQT tests were conducted between Burns Building and a residence line, between the COE and the residence line, between two residence lines, and between the COE and the Springhill Road facility of the FDOT.

The later tests included using the long distance service at the Burns Building to dial to the College of Engineering instead of using the local service, as the local service was through sprint whereas the long distance service was via Suncomm. Also, tests were performed between the Burns Building and the site 320-2 near Lake City, site 204, site 343 and site 96. Site 320-2 is located at SR-93/I-75, between I-10 AND US-90, Columbia County (southbound side), Site 204 at SR-528/Beeline Expwy, 1.4 MI W of SR-15, Orange County (SE of Orlando), Site 343 at SR-400/I-4, 1.6 MI E OF SR-434, Seminole County (Orlando), and Site 96 at SR-9, 0.4 MI SW OF Biscayne Canal Bridge, Dade County (near Miami). These sites were selected for long distance line quality tests when they were visited for data collection of the lightning surges.

## **2. Modem Line Quality Tests of Phone Lines**

The Modem line quality tests for the Burns Building phone lines were conducted in six phases using the modem line quality tester (MLQT) units provided by the FDOT. The purpose of the six phases was to eventually isolate the performance of the phone lines at the Burns Building. Several different test phases were designed to use different local exchange centers to isolate the problem areas in the phone lines. In each phase, all lines were tested at least 10 times and an average was taken. In Phase I, the phone line quality was tested between the Burns Building and the COE. In Phase II, line quality was tested between Burns Building and a residential telephone line. In Phase III, the line quality was tested between the COE and the same residential telephone line as in Phase II. In Phase IV, the line quality was tested between two residential telephone lines. In Phase V, line quality tests were performed between COE and the Springhill Rd facility of the FDOT. In



the last phase, actual long distance line quality was tested between the Burns Building and a number of the TTMS sites of FDOT.

### 2.1. Phase I – Burns Building & COE

In Phase I, the line quality tests were conducted from each of the 8 polling lines in the Burns Building communication room at daytime and at nighttime to the COE. There were two set of tests conducted in the daytime, each test performing 10 runs per line, making a total of 20 runs on each line (for the two sets together). The midnight runs had a set of test (10 runs per line) conducted over all the lines (eight in total). These results were then averaged to perform an analysis of the performance of the phone lines. The data and its averages for the daytime and midnight runs are given in Tables 2 and 3, where BER stands for Bit Error Rate, which is the <total number of errors on the line>/<total number of bits transmitted>. The speed of the data connections is measured in bits per second (bps).

**Table 2. Daytime Run (20 runs per line, total 8 lines)**

Line	Send		Receive		Overall	
	Ave BER	Ave Speed	Ave BER	Ave Speed	Ave BER	Ave Speed
2701	1.11E-04	23880	1.41E-04	24360	1.26E-04	24120
2702	5.99E-05	24120	4.20E-05	25080	5.09E-05	24600
2703	8.33E-05	23520	1.22E-04	25560	1.02E-04	24540
2704	1.27E-04	24120	1.08E-04	25560	1.17E-04	24840
2705	1.35E-04	23160	2.01E-04	25440	1.68E-04	24300
2706	1.91E-04	23040	1.61E-04	25200	1.76E-04	24120
2707	1.58E-04	24120	1.15E-04	25320	1.36E-04	24720
2708	9.01E-05	23520	1.52E-04	26160	1.21E-04	24840
<b>Overall</b>	1.19E-04	23685	1.30E-04	25335	1.25E-04	24510

**Table 3. Midnight runs (10 runs per line, total 8 lines)**

Line	Send		Receive		Overall	
	Ave BER	Ave Speed	Ave BER	Ave Speed	Ave BER	Ave Speed
2701	1.42E-04	24480	8.18E-05	25000	1.12E-04	24740
2702	4.62E-05	23520	4.84E-05	24800	4.73E-05	24160
2703	1.50E-04	23520	1.62E-04	25920	1.56E-04	24720
2704	8.87E-05	24000	7.28E-05	26160	8.07E-05	25080
2705	1.56E-04	24960	4.32E-05	24720	9.96E-05	24840
2706	1.26E-04	24240	9.89E-05	25000	1.12E-04	24620
2707	1.51E-04	23280	2.07E-04	25600	1.79E-04	24440
2708	9.85E-05	24480	3.07E-05	25000	6.46E-05	24740
<b>Overall</b>	1.20E-04	24060	9.31E-05	25275	1.06E-04	24668

As expected, all the lines connected without any drop connections. The test indicated that there were no problems between the connections between the Burns Building and the COE. There were no significant performance differences between the daytime and the midnight tests. Also, the results of the tests demonstrate the phone lines performed efficiently for the speed of the MLQT of 28000 bps.

## 2.2. Phase II – Burns Building & Residence Phone Line

The Phase II of the test involved using a secondary phone line to evaluate the performance of the Burns Building phone line through a different exchange center to evaluate if it causes a difference in performance of the phone lines. For this purpose, two of the phone lines of the Burns Building communication room were used to call the residential site, and for each line, 10 runs were performed. The details of the tests are included in Chapter 4, under Phase II. A summary of the results is provided in Table 4. These tests were conducted in the daytime.

**Table 4. Summary of Test Results between Burns Building & Residential phone lines**

Line	Send		Receive		Overall	
	Ave BER	Ave Speed	Ave BER	Ave Speed	Ave BER	Ave Speed
2704	1.76E-04	22800	1.74E-04	24480	1.75E-04	23640
2706	2.72E-04	23040	3.15E-04	24000	2.93E-04	23520
<b>Overall</b>	2.24E-04	22920	2.45E-04	24240	2.34E-04	23580

From the results in Table 4 it was observed that there were no problems with the phone lines making and maintaining connections, and that quality (average BER and transmission speed) was comparable to those measured in Phase I. To further test the problem areas, other tests were conducted on different phone lines to detect the possible problems.

## 2.3. Phase III – COE & Residence Phone Line

In Phase III of testing, the phone lines were tested between the COE and the residential telephone line used with the Burns Building line test in Phase II. This test had two purposes: First to check the relative performance between the residential phone line & COE in Phase III, to the performance of residential phone line with the Burns Building, and second to find out the possible reasons behind the relative performance of the COE & Burns Building to the Residence phone line. The summary of the ten test runs between COE and the residential phone line are given in Table 5. These tests were performed during the daytime hours as the tests in Phase II.

**Table 5. Summary of Test Results between COE & Residential Phone Lines**

Send		Receive		Overall	
Ave BER	Ave Speed	Ave BER	Ave Speed	Ave BER	Ave Speed
0.00E+00	28800	0.00E+00	28800	0.00E+00	28800

The details of each of the runs are recorded in Chapter 4 under Phase III. As can be observed from the results in Table 5, the tests indicated a perfect connection between the two phone lines. There were no errors recorded during the test. This test indicates that there appears to be some slight performance degradation using the Burns Building telephone lines.

#### **2.4. Phase IV – Between Two Residential Phone Lines**

In Phase IV, the phone line quality was tested between two residential sites. There were 10 connections established between the two residential sites, all during the daytime hours. The details of the time and the actual test results are recorded in Chapter 4 under Phase IV. The summary of the 10 runs is given in Table 6.

**Table 6. Summary of Test Results between Two Residential Phone Lines**

Send		Receive		Overall	
Ave BER	Ave Speed	Ave BER	Ave Speed	Ave BER	Ave Speed
8.59E-06	27600	1.03E-05	27120	9.42E-06	27360

It was observed that all the connections were established with out the connection being disconnected. The Average speed was also efficient indicating that the performance of the phone lines under the test was normal. With comparison to the data from the Burns Building, the average data transfer speed was usually more for the connections outside the Burns Building than the one performed from the Burns Building. Further tests were conducted to verify the analysis and to deduce the possible causes of problems experienced by the FDOT.

#### **2.5. Phase V – COE & Springhill Rd Facility of FDOT**

In Phase V of the tests, the phone line quality tests were performed between the COE and the Springhill road facility of the FDOT. Again, 10 connections were established between the two lines and the performance of the lines was observed by analysis of the data connection speed and the errors on the line when sending the data. The detailed results of the test are presented in Chapter 4 under Phase V. The summary of the test result is provided in Table 7.

**Table 7. Summary of Test Results between COE & Springhill Rd Facility of FDOT**

Line	Send		Receive		Overall	
	Ave BER	Ave Speed	Ave BER	Ave Speed	Ave BER	Ave Speed
414-2813	8.01E-03	25440	1.04E-03	24480	4.53E-03	24960

Note: One of the runs had a very high BER and disconnected after a short time.

In this test, the third run performed between the two lines had a remote disconnect after establishing the connection. In the third run, the connection was disconnected after 36 seconds, where as the test duration was set to 120 seconds. The cause of this disconnect was the large number of errors on the phone line compared to the total bits sent in just 36 seconds. The rest of the other 9 runs performed properly with an average connection speed of 24933. The connection speed was less than those between the COE and the residential site indicating that there might be some disturbances on the phone lines near the Springhill facility. In general, a comparison of results from Table 7 (summary of results between COE & Springhill Rd facility), and Tables 2 and 3 (summary of results between COE & Burns Building) illustrate that both the FDOT facilities (Burns Building and Springhill Rd facility) may have the same switching center as the data speeds and the average BER is very close.

## **2.6. Phase VI – Burns Building and TTMS Sites**

After completion of the first five phases, the progress of the tests was shared with the FDOT and it was mentioned that the local service of the FDOT was through sprint, whereas the long distance was through Suncomm. Therefore, further tests were planned and executed using the Suncomm service to see the effects of its performance.

As in previous tests, the Modem Line Quality Testers (MLQT) supplied by the FDOT was used to analyze the performance of the telephone connections. The first test set was a series of 10 calls dialed as long distance (dialed 6-1< area code>< phone number>) from the Burns Building to the College of Engineering (COE). These calls performed very nearly the same as the local calls tested previously. Since there was no easy way to determine if the Suncomm system actually routed these lines through the long distance switching system, actual long distance tests were planned.

A number of TTMS sites were tested using the long distance service at the Burns Building. The sites tested included site 320-2 near Lake City, site 204, site 343 and site 96. These sites were selected for long distance line quality tests when they were visited for data collection of the lightning surges.

### *Long Distance Connection from Burns Building to Site 320-2*

To test the phone line at the Site 320-2 from the Burns Building via Suncomm network, a total of 25 calls were made and the results recorded. The details of the results can be observed in Chapter 4 under Phase VI. The summary of the results is provided in Table 8.

**Table 8. Summary of Test Results between Burns Building and Site 320-2**

Date	Comment	Total Runs	Good runs	Avg Bytes	Errors	BER	Avg Speed
6/17/2004	w/o EDCO	25	15	3316970	3444	0.0010383	21600

In Table 8, 'w/o EDCO' means that the tests connections were established without the presence of the EDCO surge suppressor on the phone line. Other tests in this phase did include the surge suppressor on the phone line, at the TTMS site, to analyze if its presence affected the quality of phone line connection.

For 15 of the 25 calls, the performance appeared to be very much the same as the local calls made from the Burns Building. However, for attempts 2 through 11, the MLQTs failed to properly connect and returned the message "No MLQT Detected" at the receiving end. This was an interesting outcome as it was not obvious from this one test if it was a problem with the Suncomm system, or a problem with this particular line, or some other factor between the two lines. To further probe in to this problem, other long distance tests were scheduled.

*Long Distance Connection from Burns Building to Site 204*

The next step was to conduct the long distance test between the Burns Building and the Site 204. The tests were conducted at least three different days, as illustrated in Table 9, to check the performance of the lines on different days and to check for consistency.

**Table 9. Summary of Test Results between Burns Building and Site 204**

Date	Comment	Total Runs	Good runs	Avg Bytes	Errors	BER	Avg Speed
7/2/2004	w/o EDCO	10	9	180362.2	953	0.0005284	23520
7/8/2004	w/o EDCO	10	2	104577.5	6734	0.0321962	22800
8/4/2004	w/ EDCO	10	9	170042.2	828	0.0004869	22080
8/4/2004	w/o EDCO	10	9	182811.4	2374	0.0012986	22800

As observed from Table 9, one of the tests conducted was with the EDCO surge suppressor connected to the phone line, while the other three tests were conducted without the surge suppressor connected. There was not much of a difference noted with or without the presence of the surge suppressor. On one of the days, a number of disconnects happened, where as on the other days, 9 out of 10 test runs were successful. This illustrated that the problem was not a consistent one but random, and those random factors could include the amount of noise on the phone line at particular times (at times occurring in bursts) causing a failure in making a connection with the field site. Also the

tests were conducted on different sites to check if this problem was on a particular site on that day or on both sites. The other long distance test was established with Site 343.

*Long Distance Connection from Burns Building to Site 343*

Similar to Site 204, Site 343 had tests conducted on three different days, and similar results were observed based on the days that the tests were conducted. Similar to Site 204, one of the tests was conducted with the EDCO surge suppressor, while the other three were performed without the surge suppressor. The summary of the results is presented in Table 10.

**Table 10. Summary of Test Results between Burns Building and Site 343**

Date	Comment	Total Runs	Good runs	Avg Bytes	Errors	BER	Avg Speed
7/2/2004	w/o EDCO	10	8	177482.7	49243	0.0277452	20160
7/8/2004	w/o EDCO	10	6	196385.1	27397	0.0199295	22628.5714
8/4/2004	w/ EDCO	10	10	237169.1	166	7.00E-05	22800
8/4/2004	w/o EDCO	10	10	237595.3	220	9.26E-05	22800

It was observed that the day when 4 out of 10 connections failed, it was the same day when 8 out of 10 connections failed on site 204. This could indicate the there were some errors even on the Suncomm lines as both site had problem connecting on that day and the number of errors on that day were high on both sites. Also it was observed that the presence of the surge suppressor did not make a significant impact, positive or negative.

*Long Distance Connection from Burns Building to Site 96*

One more site that was tested with long distance phone line quality test was Site 96. This site was tested on only one day with the EDCO surge suppressor and without the surge suppressor. The summary of the results is presented in Table 11.

**Table 11. Summary of Test Results between Burns Building and Site 96**

Date	Comment	Total Runs	Good runs	Avg Bytes	Errors	BER	Avg Speed
8/6/2004	w/ EDCO	10	10	209030	4497	0.0021514	21840
8/6/2004	w/o EDCO	10	10	213946.6	272	0.0001271	21600

It was observed that all connections were established successfully and that the number of errors in the connection with the surge suppressor was more than the errors with out the

surge suppressor by a factor of 16. This was interesting, but since only one test was conducted on this site, it does not give a conclusive result, although the other Sites 204 and 343 indicate that the surge suppressor does not cause much difference on the quality of the phone line.

### **3. Conclusions on Performance Analysis of Burns Building Phone Lines**

There were two kinds of tests that were conducted from the Burns Building. One was using the local sprint lines and the other was in which the field sites were called and long distance line quality was measured. The first kind of tests indicated that in general the quality of line in the Burns Building communication room had slightly lower average speed connections than the connections done from the COE. This indicated a slight degradation of the phone line quality at the Burns Building for data transfer, although the voice would not be affected with this minor degradation. The second kind of test, i.e. the long distance test to the field sites, indicated that the long distance communications of telephone lines had a significant increased probability of errors and dropped connections. It was also observed that most of the dropped calls tended to occur in bursts indicating that there was some sort of time dependence to the problems. Since these period of poor performance are due to bursts of errors on the telephone line, the solution to increase efficiency of the polling system, along with reduced errors was to implement a delay in reconnecting to that particular site and to download after certain delay, causing the bursts of errors to pass.

The benefit of this research was to discover that the long distance calls from the Burns Building to TTMS sites tend to have periods of poor performance; therefore the failure of connection does not imply failure of the modem. Further a method to maneuver around this problem was suggested, which in essence improves the efficiency of the current polling system, as it is not bogged down trying to reconnect to a site, and also reduces the time and effort required with manual downloads of data from TTMS sites, by reconnecting after certain time and doing this process automatically, hence reducing cost of operations for the FDOT.



## 4. Detailed Data

This chapter contains the details of all the data that was collected for all six phases discussed earlier in the report. This data is analyzed in section 2 of the report. In Phase I, data was collected during daytime hours and during midnight hours to see if there was a difference in performance of the phone lines. The data collected illustrated that the change in the hours of data collection (daytime or nighttime) did not affect the performance of the phone lines. Therefore all the other Phases had the tests conducted during the daytime.

### 4.1. Phase I –Burns Building & COE

In Phase I, data was collected between the Burns Building & the COE using the Modem Line Quality Tester (MLQT). The calls were initiated from the Burns Building and received by the COE, and the data illustrates this accordingly, providing the Burns Building sender data first and then the corresponding COE receiver data.

The tests were conducted in three different sets. The first two sets of data were collected during daytime hours, and the last set of data was collected at nighttime. The total bytes are in bits per second (bps), Errors are in bits, duration in seconds, EFS stands for Error Free Seconds, illustrating the amount of time during the 2 minute test in which there were no errors. The Connect speed is in bps, and the signal levels in dB.

#### *Daytime Data Collection - Set # 1:*

A total of 10 tests were conducted on each phone line. There were eight phone lines in the Burns Building: 2701, 2702, 2703, 2704, 2705, 2706, 2707, and 2708. The data collected is illustrated below with the sender data on line 2701 first and then receiver data on line 2701 next.

#### **Line 2701 Burns**

No	Time	Total Bytes	Errors	Duration	EFS	Connect Speed	Signal Level	Signal Quality
1	1:20 PM	285828	17	120	119	24000	22	25
2	1:25 PM	227794	46	120	117	21600	22	12
3	1:30 PM	284602	0	120	120	24000	24	23
4	1:35 PM	284498	0	120	120	24000	22	18
5	1:40 PM	273918	0	120	120	24000	22	22
6	1:47 PM	272407	19	120	118	24000	24	22
7	1:51 PM	286020	16	120	119	24000	24	24
8	1:56 PM	286214	60	120	119	24000	24	25
9	2:02 PM	225676	56	120	117	21600	24	13
10	2:06 PM	273512	106	120	114	24000	22	19

**Line 2701 COE**

No	Time	Total Bytes	Errors	Duration	EFS	Connect Speed	Signal Level	Signal Quality
1	1:21 PM	285996	0	125	125	24000	24	19
2	1:27 PM	228145	124	117	114	26400	24	28
3	1:32 PM	284772	0	126	125	24000	22	19
4	1:37 PM	285169	0	125	125	26400	24	28
5	1:43 PM	274084	17	120	119	26400	22	26
6	1:49 PM	272575	34	119	116	26400	24	34
7	1:54 PM	286188	16	126	125	26400	24	31
8	1:58 PM	286380	0	126	126	2400	24	19
9	2:04 PM	226031	146	116	111	26400	24	29
10	2:09 PM	273681	103	120	114	26400	24	31

**Line 2702 Burns**

No	Time	Total Bytes	Errors	Duration	EFS	Connect Speed	Signal Level	Signal Quality
1	2:11 PM	274356	14	120	119	24000	24	21
2	2:17 PM	285853	94	120	114	26400	22	30
3	2:22 PM	285202	0	120	120	24000	25	23
4	2:28 PM	270348	45	120	118	24000	21	18
5	2:32 PM	284376	20	120	119	24000	22	20
6	2:38 PM	285516	0	120	120	24000	22	22
7	2:42 PM	285656	9	120	119	24000	24	21
8	2:48 PM	285012	0	120	120	24000	22	19
9	2:55 PM	236798	0	120	120	21600	22	16
10	3:00 PM	285298	0	120	120	24000	22	23

**Line 2702 COE**

No	Time	Total Bytes	Errors	Duration	EFS	Connect Speed	Signal Level	Signal Quality
1	2:15 PM	274525	32	120	118	26400	24	31
2	2:21 PM	286008	0	125	125	24000	22	18
3	2:25 PM	285372	0	125	125	24000	22	19
4	2:30 PM	270516	63	118	115	26400	22	29
5	2:34 PM	284546	20	125	124	26400	24	27
6	2:40 PM	285684	0	125	125	24000	24	20
7	2:45 PM	285828	9	126	125	24000	24	27
8	2:51 PM	285180	0	125	125	24000	24	21
9	2:57 PM	236940	0	122	122	26400	24	28
10	3:02 PM	285468	0	125	125	24000	24	19

**Line 2703 Burns**

No	Time	Total Bytes	Errors	Duration	EFS	Connect Speed	Signal Level	Signal Quality
1	3:07 PM	284765	43	120	117	24000	22	23
2	3:11 PM	226467	56	120	117	21600	24	14
3	3:16 PM	284820	0	120	120	24000	22	24
4	3:25 PM	285343	63	120	116	26400	24	28
5	3:32 PM	284413	0	120	120	24000	24	17
6	3:37 PM	227089	0	120	120	21600	24	17
7	3:41 PM	226860	33	120	119	21600	22	15
8	3:46 PM	272476	32	120	118	24000	22	19
9	3:50 PM	273258	0	120	120	24000	22	23
10	3:55 PM	286044	0	120	120	24000	22	23

**Line 2703 COE**

No	Time	Total Bytes	Errors	Duration	EFS	Connect Speed	Signal Level	Signal Quality
1	3:09 PM	284933	43	125	122	26400	22	30
2	3:13 PM	226822	143	117	113	26400	22	25
3	3:18 PM	284988	0	125	125	24000	24	18
4	3:28 PM	285504	0	125	125	24000	25	18
5	3:34 PM	284580	0	125	125	24000	24	17
6	3:39 PM	227231	17	117	116	26400	22	24
7	3:44 PM	227212	123	117	114	26400	22	24
8	3:48 PM	272645	50	119	116	26400	22	31
9	3:53 PM	273430	18	119	118	26400	22	28
10	3:58 PM	286212	0	126	126	24000	24	17

**Line 2704 Burns**

No	Time	Total Bytes	Errors	Duration	EFS	Connect Speed	Signal Level	Signal Quality
1	1:45 PM	272635	18	120	118	24000	22	24
2	1:49 PM	273425	50	120	116	24000	24	20
3	2:00 PM	284960	0	120	120	24000	22	19
4	2:05 PM	237423	14	120	119	21600	22	15
5	2:09 PM	271837	12	120	119	24000	22	24
6	2:14 PM	308580	37	120	117	26400	22	31
7	2:20 PM	284671	85	120	114	26400	22	27
8	2:24 PM	284839	39	120	117	24000	24	23
9	2:30 PM	284869	0	120	120	24000	22	21
10	2:34 PM	273325	34	120	118	24000	22	19

**Line 2704 COE**

No	Time	Total Bytes	Errors	Duration	EFS	Connect Speed	Signal Level	Signal Quality
1	1:46 PM	272807	36	119	116	26400	24	28
2	1:51 PM	284748	0	125	125	24000	22	18
3	2:02 PM	285132	0	126	126	24000	22	20
4	2:07 PM	237565	14	123	122	26400	22	221
5	2:12 PM	272009	28	119	117	26400	22	24
6	2:16 PM	308764	28	126	124	26400	25	32
7	2:22 PM	284832	9	125	124	24000	24	22
8	2:28 PM	285009	39	125	122	26400	24	27
9	2:32 PM	285036	0	125	125	24000	24	19
10	2:37 PM	272495	49	119	116	26400	24	25

**Line 2705 Burns**

No	Time	Total Bytes	Errors	Duration	EFS	Connect Speed	Signal Level	Signal Quality
1	2:36 PM	271762	47	120	116	24000	24	22
2	2:44 PM	285466	43	120	117	24000	25	22
3	2:48 PM	268854	59	120	116	24000	24	20
4	2:53 PM	272191	33	120	119	24000	24	22
5	2:57 PM	270617	32	120	118	24000	24	21
6	3:03 PM	283884	0	120	120	24000	24	19
7	3:08 PM	225336	47	120	119	21600	24	15
8	3:13 PM	285636	32	120	117	24000	22	20
9	3:17 PM	308303	131	120	113	26400	22	28
10	3:23 PM	226044	10	120	119	21600	25	16

**Line 2705 COE**

No	Time	Total Bytes	Errors	Duration	EFS	Connect Speed	Signal Level	Signal Quality
1	2:42 PM	271932	63	119	114	26400	24	28
2	2:47 PM	285635	43	125	122	26400	22	29
3	2:51 PM	271580	77	119	114	26400	24	29
4	2:57 PM	272359	51	119	117	26400	22	36
5	3:00 PM	270784	50	118	115	26400	24	34
6	3:06 PM	284052	0	125	125	24000	24	19
7	3:11 PM	225687	139	116	114	24000	24	19
8	3:16 PM	285805	10	125	124	24000	24	19
9	3:20 PM	308481	49	125	123	26400	24	31
10	3:26 PM	226186	28	116	114	26400	24	29

**Line 2706 Burns**

No	Time	Total Bytes	Errors	Duration	EFS	Connect Speed	Signal Level	Signal Quality
1	11:20 AM	273860	8	120	119	24000	24	20
2	11:22 AM	227109	0	120	120	21600	24	20
3	11:25 AM	284246	29	120	118	24000	22	23
4	11:29 AM	286210	0	120	120	24000	24	25
5	11:32 AM	238164	61	120	119	21600	22	13
6	11:36 AM	227880	0	120	120	21600	24	18
7	11:39 AM	286188	0	120	120	24000	24	22
8	11:43 AM	285010	75	120	115	26400	24	26
9	11:47 AM	236979	0	120	120	21600	24	15
10	11:50 AM	237141	15	120	119	21600	25	15

**Line 2706 COE**

No	Time	Total Bytes	Errors	Duration	EFS	Connect Speed	Signal Level	Signal Quality
1	11:18 AM	274028	27	120	118	26400	22	29
2	11:22 AM	227254	17	117	116	24000	22	19
3	11:26 AM	284415	29	124	122	26400	22	27
4	11:30 AM	286380	0	126	126	24000	24	23
5	11:34 AM	238513	131	123	122	24000	24	20
6	11:37 AM	228023	16	117	116	26400	24	25
7	11:40 AM	286356	0	126	126	24000	24	18
8	11:44 AM	285170	12	125	124	24000	24	18
9	11:48 AM	237121	0	122	122	26400	24	24
10	11:53 AM	237284	15	122	121	24000	24	16

**Line 2707 Burns**

No	Time	Total Bytes	Errors	Duration	EFS	Connect Speed	Signal Level	Signal Quality
1	11:56 AM	283951	244	120	104	26400	22	35
2	11:59 AM	284292	0	120	120	24000	24	20
3	12:02 PM	273011	13	120	119	24000	24	19
4	12:05 PM	237682	13	120	119	21600	24	12
5	12:09 PM	284836	0	120	120	24000	22	21
6	12:12 PM	285492	0	120	120	24000	24	22
7	12:16 PM	285312	0	120	120	24000	24	23
8	12:19 PM	309058	134	120	113	26400	24	29
9	12:23 PM	237648	98	120	115	21600	24	14
10	12:26 PM	272092	59	120	116	24000	24	21

**Line 2707 COE**

No	Time	Total Bytes	Errors	Duration	EFS	Connect Speed	Signal Level	Signal Quality
1	11:56 AM	284088	0	125	125	24000	22	20
2	12:00 PM	284460	0	125	125	24000	22	19
3	12:04 PM	273179	45	119	117	26400	22	28
4	12:08 PM	238036	90	122	121	24000	25	20
5	12:12 PM	285002	0	125	125	26400	24	32
6	12:16 PM	285660	0	125	125	24000	24	17
7	12:19 PM	285480	0	125	125	26400	24	23
8	12:22 PM	309234	28	126	124	26400	24	36
9	12:26 PM	238000	174	123	118	26400	24	27
10	12:29 PM	272262	77	119	114	26400	24	23

**Line 2708 Burns**

No	Time	Total Bytes	Errors	Duration	EFS	Connect Speed	Signal Level	Signal Quality
1	12:31 PM	272935	13	120	119	24000	24	19
2	12:35 PM	228140	34	120	119	21600	24	12
3	12:38 PM	308220	45	120	117	26400	24	32
4	12:42 PM	273632	0	120	120	24000	24	24
5	12:45 PM	272078	13	120	119	24000	24	24
6	12:49 PM	286023	35	120	118	24000	25	21
7	12:52 PM	285080	42	120	118	24000	22	18
8	12:56 PM	284381	36	120	118	26400	24	30
9	12:59 PM	226408	20	120	119	21600	24	15
10	1:03 PM	228854	0	120	120	21600	25	15

**Line 2708 COE**

No	Time	Total Bytes	Errors	Duration	EFS	Connect Speed	Signal Level	Signal Quality
1	12:34 PM	273105	31	119	117	26400	25	32
2	12:37 PM	228494	120	117	114	26400	22	25
3	12:41 PM	308399	36	125	123	26400	24	30
4	12:44 PM	273802	18	120	119	26400	24	26
5	12:48 PM	272249	30	119	117	26400	24	30
6	12:52 PM	286190	19	126	125	26400	24	39
7	12:55 PM	285245	42	125	123	26400	24	30
8	12:59 PM	284544	0	124	124	24000	24	18
9	1:03 PM	226760	108	117	115	24000	22	21
10	1:06 PM	228996	16	118	117	26400	24	29

*Daytime Data Collection - Set # 2:*

The second set of data collected between the Burns Building and COE was also collected during daytime hours, similar to data collected in set 1 earlier, with a total of 10 runs per line, and data from sender (Burns Building) provided first, followed by data collected at the receiver end (COE).

**Line 2701 Burns**

<b>No</b>	<b>Time</b>	<b>Total Bytes</b>	<b>Errors</b>	<b>Duration</b>	<b>EFS</b>	<b>Connect Speed</b>	<b>Signal Level</b>	<b>Signal Quality</b>
1	3:06 PM	268866	74	120	115	24000	22	21
2	3:09 PM	237308	22	120	118	21600	24	14
3	3:13 PM	284674	0	120	120	24000	22	22
4	3:16 PM	284049	0	120	120	24000	22	24
5	3:32 PM	308791	31	120	18	26400	24	30
6	3:34 PM	284504	67	120	116	24000	24	21
7	3:38 PM	285152	78	120	115	26400	24	33
8	3:41 PM	286184	10	120	119	24000	24	20
9	3:45 PM	270834	10	120	119	24000	24	23
10	3:48 PM	285589	0	120	120	24000	24	18

**Line 2701 COE**

<b>No</b>	<b>Time</b>	<b>Total Bytes</b>	<b>Errors</b>	<b>Duration</b>	<b>EFS</b>	<b>Connect Speed</b>	<b>Signal Level</b>	<b>Signal Quality</b>
1	3:08 PM	271534	96	119	113	26400	24	30
2	3:12 PM	237659	104	123	121	24000	24	22
3	3:16 PM	284844	0	125	125	24000	24	21
4	3:30 PM	284220	0	125	125	24000	24	19
5	3:33 PM	308973	31	126	124	26400	24	37
6	3:37 PM	284673	67	125	121	26400	24	30
7	3:41 PM	285312	0	126	126	24000	24	19
8	3:44 PM	286354	10	126	125	26400	22	33
9	3:48 PM	271004	26	118	116	26400	22	27
10	3:51 PM	285756	0	125	125	24000	24	19

**Line 2702 Burns**

No	Time	Total Bytes	Errors	Duration	EFS	Connect Speed	Signal Level	Signal Quality
1	3:53 PM	285240	14	120	119	24000	24	19
2	3:56 PM	285996	66	120	116	26400	24	29
3	4:00 PM	285176	0	120	120	24000	24	22
4	4:03 PM	285661	0	120	120	24000	22	17
5	4:07 PM	284389	0	120	120	24000	24	18
6	4:10 PM	285037	18	120	119	24000	22	18
7	4:13 PM	273282	18	120	119	24000	24	21
8	4:17 PM	271746	0	120	120	24000	24	24
9	4:20 PM	286010	11	120	119	24000	24	17
10	4:24 PM	273818	26	120	119	24000	22	23

**Line 2702 COE**

No	Time	Total Bytes	Errors	Duration	EFS	Connect Speed	Signal Level	Signal Quality
1	3:56 PM	285410	14	126	125	26400	24	30
2	3:59 PM	286152	0	126	126	24000	24	18
3	4:03 PM	285348	0	125	125	24000	22	19
4	4:07 PM	285828	0	126	126	24000	24	20
5	4:10 PM	284556	0	125	125	24000	22	19
6	4:14 PM	285204	18	125	124	24000	24	22
7	4:17 PM	273448	35	119	117	26400	24	31
8	4:21 PM	271915	16	119	118	26400	22	29
9	4:24 PM	286178	11	125	124	26400	25	34
10	4:24 PM	273981	17	120	119	26400	24	26

**Line 2703 Burns**

No	Time	Total Bytes	Errors	Duration	EFS	Connect Speed	Signal Level	Signal Quality
1	4:30 PM	272287	0	120	120	24000	24	19
2	4:33 PM	236707	0	120	120	21600	24	17
3	4:37 PM	236884	63	120	117	21600	24	12
4	4:40 PM	237538	0	120	120	21600	24	15
5	4:44 PM	308325	87	120	114	26400	24	25
6	4:47 PM	284080	44	120	117	24000	24	23
7	4:51 PM	284987	0	120	120	24000	24	24
8	4:54 PM	283955	0	120	120	24000	25	23
9	4:58 PM	273887	25	120	118	24000	24	21
10	5:01 PM	284674	0	120	120	24000	22	22



**Line 2703 COE**

No	Time	Total Bytes	Errors	Duration	EFS	Connect Speed	Signal Level	Signal Quality
1	4:32 PM	272455	16	119	118	26400	24	27
2	4:36 PM	236850	0	122	122	26400	24	27
3	4:40 PM	237231	136	122	119	26400	24	31
4	4:43 PM	237680	0	123	123	26400	24	28
5	4:47 PM	308504	9	125	124	26400	25	33
6	4:50 PM	284248	44	124	121	26400	25	35
7	4:54 PM	285156	0	125	125	24000	22	19
8	4:57 PM	284124	0	124	124	24000	24	18
9	5:00 PM	274053	53	120	116	26400	24	30
10	5:04 PM	284844	0	125	125	24000	24	18

**Line 2704 Burns**

No	Time	Total Bytes	Errors	Duration	EFS	Connect Speed	Signal Level	Signal Quality
1	5:06 PM	285745	21	120	118	24000	24	21
2	5:09 PM	285825	0	120	120	24000	24	20
3	5:13 PM	273729	11	120	119	24000	22	21
4	5:17 PM	286068	0	120	120	24000	24	20
5	5:20 PM	271173	13	120	119	24000	24	23
6	5:24 PM	226697	17	120	119	21600	24	16
7	5:27 PM	309368	145	120	108	26400	25	29
8	5:30 PM	226504	86	120	116	21600	24	13
9	5:34 PM	272081	0	120	120	24000	22	20
10	5:38 PM	307547	118	120	111	26400	24	31

**Line 2704 COE**

No	Time	Total Bytes	Errors	Duration	EFS	Connect Speed	Signal Level	Signal Quality
1	5:09 PM	285914	21	126	124	26400	25	31
2	5:12 PM	285996	0	125	125	24000	25	20
3	5:16 PM	273900	28	120	118	26400	22	27
4	5:20 PM	286236	0	125	125	24000	24	18
5	5:24 PM	271342	31	119	117	26400	24	25
6	5:27 PM	226842	34	117	115	24000	22	22
7	5:30 PM	309543	56	126	121	26400	25	30
8	5:33 PM	226854	176	117	112	26400	22	33
9	5:37 PM	272247	18	119	118	26400	24	32
10	5:40 PM	307725	29	125	122	26400	24	32

**Line 2705 Burns**

No	Time	Total Bytes	Errors	Duration	EFS	Connect Speed	Signal Level	Signal Quality
1	10:50 AM	236771	37	120	118	21600	24	16
2	10:53 AM	285444	19	120	119	24000	24	25
3	10:56 AM	238390	56	120	118	21600	24	14
4	11:00 AM	225521	105	120	115	21600	25	17
5	11:03 AM	227548	40	120	119	21600	22	14
6	11:06 AM	237076	0	120	120	21600	22	15
7	11:10 AM	237176	0	120	120	21600	25	19
8	11:13 AM	284340	0	120	120	24000	24	22
9	11:16 AM	286044	0	120	120	24000	22	22
10	11:20 AM	273253	16	120	119	24000	24	20

**Line 2705 COE**

No	Time	Total Bytes	Errors	Duration	EFS	Connect Speed	Signal Level	Signal Quality
1	10:52 AM	236913	37	122	120	26400	24	29
2	10:56 AM	285614	19	125	124	24000	24	20
3	10:59 AM	238745	134	123	121	26400	22	32
4	11:02 AM	225871	192	116	110	26400	22	33
5	11:06 AM	227894	129	117	114	24000	24	18
6	11:09 AM	237220	0	122	122	26400	24	27
7	11:13 AM	237320	0	123	123	24000	22	17
8	11:16 AM	284508	0	125	125	24000	24	18
9	11:20 AM	286212	0	126	126	24000	22	20
10	11:23 AM	273419	33	119	117	26400	22	27

**Line 2706 Burns**

No	Time	Total Bytes	Errors	Duration	EFS	Connect Speed	Signal Level	Signal Quality
1	11:25 AM	228569	22	120	118	21600	24	17
2	11:28 AM	284633	45	120	116	24000	24	17
3	11:32 AM	237189	48	120	118	21600	24	14
4	11:36 AM	237872	21	120	119	21600	24	18
5	11:39 AM	227389	313	120	104	21600	24	18
6	11:42 AM	285470	0	120	120	24000	22	18
7	11:46 AM	228817	191	120	114	21600	24	13
8	11:49 AM	285883	114	120	112	26400	22	30
9	11:53 AM	281712	0	120	120	24000	22	18
10	11:56 AM	284674	42	120	118	24000	24	18

**Line 2706 COE**

No	Time	Total Bytes	Errors	Duration	EFS	Connect Speed	Signal Level	Signal Quality
1	11:27 AM	228711	37	118	115	26400	24	25
2	11:31 AM	284799	45	125	121	26400	24	32
3	11:34 AM	237532	104	122	121	26400	24	30
4	11:38 AM	238015	21	123	122	26400	24	23
5	11:41 AM	22711	132	117	114	26400	22	25
6	11:45 AM	285636	0	126	126	24000	24	23
7	11:48 AM	229168	192	118	112	26400	24	35
8	11:52 AM	286032	0	125	125	24000	22	22
9	11:55 AM	284340	0	125	125	24000	24	16
10	11:59 AM	284844	20	125	124	24000	24	19

**Line 2707 Burns**

No	Time	Total Bytes	Errors	Duration	EFS	Connect Speed	Signal Level	Signal Quality
1	12:02 PM	308271	61	120	115	26400	21	27
2	12:05 PM	284559	11	120	119	24000	25	21
3	12:08 PM	285153	0	120	120	24000	25	22
4	12:12 PM	308195	119	120	114	26400	21	33
5	12:15 PM	238076	63	120	116	21600	24	13
6	12:19 PM	284526	19	120	118	26400	22	33
7	12:22 PM	238140	0	120	120	21600	24	15
8	12:25 PM	284532	10	120	119	24000	24	18
9	12:29 PM	284530	34	120	118	24000	24	18
10	12:33 PM	285614	0	120	120	24000	24	22

**Line 2707 COE**

No	Time	Total Bytes	Errors	Duration	EFS	Connect Speed	Signal Level	Signal Quality
1	12:04 PM	308451	22	125	123	26400	24	39
2	12:08 PM	284725	11	125	124	24000	25	18
3	12:12 PM	285324	0	125	125	24000	24	20
4	12:15 PM	308374	13	125	124	26400	24	28
5	12:18 PM	238426	134	123	119	26400	24	28
6	12:21 PM	284688	0	125	125	24000	22	19
7	12:25 PM	238283	0	123	123	26400	24	27
8	12:29 PM	284701	10	125	124	24000	24	19
9	12:32 PM	284697	34	125	123	26400	24	28
10	12:36 PM	285780	0	126	126	24000	24	18

**Line 2708 Burns**

No	Time	Total Bytes	Errors	Duration	EFS	Connect Speed	Signal Level	Signal Quality
1	12:38 PM	237746	0	120	120	21600	24	15
2	12:41 PM	227250	29	120	119	21600	24	12
3	12:45 PM	237458	0	120	120	21600	24	14
4	12:49 PM	273089	0	120	120	24000	24	24
5	12:52 PM	307759	84	120	113	26400	24	34
6	12:56 PM	285827	23	120	118	24000	24	22
7	1:00 PM	272255	0	120	120	24000	24	19
8	1:03 PM	273092	65	120	117	24000	24	21
9	1:07 PM	285707	0	120	120	24000	24	24
10	1:10 PM	237571	39	120	119	21600	24	14

**Line 2708 COE**

No	Time	Total Bytes	Errors	Duration	EFS	Connect Speed	Signal Level	Signal Quality
1	12:41 PM	237888	0	123	123	26400	24	25
2	12:44 PM	227597	119	117	114	26400	24	29
3	12:48 PM	237600	0	123	123	26400	24	29
4	12:51 PM	273257	14	119	118	26400	25	26
5	12:55 PM	307933	24	125	123	26400	24	30
6	12:59 PM	285998	23	126	124	26400	24	24
7	1:03 PM	272425	17	119	118	26400	24	27
8	1:06 PM	273257	80	119	115	26400	24	31
9	1:10 PM	285876	0	126	126	26400	22	21
10	1:14 PM	237922	111	123	121	26400	24	23

*Nighttime Data Collection Set # 1:*

The third set of data collected between the Burns Building and COE was collected during nighttime hours, and similar to data collected in set 1 & 2, a total of 10 runs per line were performed on a total of eight phone lines, and the data from sender (Burns Building) is provided first, followed by data collected at the receiver end (COE).

From the tests it was observed that performing the tests during the daytime and nighttime did not vary the performance of the phone lines significantly, and therefore concluded that it would be sufficient to perform the tests at any time of the day.

**Line 2701 Burns**

No	Time	Total Bytes	Errors	Duration	EFS	Connect Speed	Signal Level	Signal Quality
1	12:19 AM	285974	0	120	120	24000	25	20
2	12:23 AM	284036	71	120	115	24000	22	33
3	12:26 AM	271410	15	120	119	24000	22	34
4	12:30 AM	285047	92	120	115	24000	22	33
5	12:33 AM	284123	0	120	120	24000	24	20
6	12:37 AM	285973	0	120	120	24000	22	20
7	12:40 AM	271503	0	120	120	24000	22	32
8	12:43 AM	307814	95	120	115	26400	22	37
9	12:48 AM	285305	132	120	112	26400	22	20
10	12:51 AM	284293	0	120	120	24000	24	23

**Line 2701 COE**

No	Time	Total Bytes	Errors	Duration	EFS	Connect Speed	Signal Level	Signal Quality
1	12:19 AM	286140	0	126	126	24000	25	20
2	12:23 AM	282041	71	124	119	26000	22	33
3	12:27 AM	274138	32	120	118	26000	22	34
4	12:31 AM	285214	92	125	120	26000	22	33
5	12:35 AM	284292	0	125	125	24000	24	20
6	12:39 AM	286140	0	125	125	24000	22	20
7	12:43 AM	271668	17	119	118	26000	22	32
8	12:47 AM	307985	21	126	125	26000	22	37
9	12:51 AM	285456	0	125	125	24000	22	20
10	12:54 AM	284460	0	125	125	24000	24	23

**Line 2702 Burns**

No	Time	Total Bytes	Errors	Duration	EFS	Connect Speed	Signal Level	Signal Quality
1	12:57 AM	285660	0	120	120	24000	24	21
2	1:00 AM	285063	24	120	119	24000	24	21
3	1:04 AM	284844	0	120	120	24000	24	26
4	1:08 AM	285372	0	120	120	24000	24	24
5	1:11 AM	285701	0	120	120	24000	22	23
6	1:15 AM	285650	14	120	119	24000	24	21
7	1:19 AM	227019	0	120	120	21600	24	17
8	1:22 AM	227326	45	120	116	21600	25	15
9	1:26 AM	285443	16	120	119	24000	24	22
10	1:30 AM	273991	27	120	117	24000	24	19

**Line 2702 COE**

No	Time	Total Bytes	Errors	Duration	EFS	Connect Speed	Signal Level	Signal Quality
1	12:59 AM	285828	0	125	125	24000	24	18
2	1:03 AM	285228	0	126	126	24000	24	19
3	1:07 AM	285012	0	125	125	24000	22	19
4	1:10 AM	285540	0	126	126	24000	24	21
5	1:14 AM	285870	0	125	125	26000	22	27
6	1:18 AM	285816	0	126	126	26000	24	23
7	1:22 AM	227166	18	117	116	24000	22	28
8	1:26 AM	227468	62	117	112	26000	24	37
9	1:29 AM	285612	16	125	124	24000	24	21
10	1:32 AM	274156	36	120	117	26000	24	32

**Line 2703 Burns**

No	Time	Total Bytes	Errors	Duration	EFS	Connect Speed	Signal Level	Signal Quality
1	12:25 AM	285755	0	120	120	24000	24	20
2	12:29 AM	283993	222	120	105	26400	24	30
3	12:32 AM	273589	70	120	114	24000	24	17
4	12:37 AM	226825	0	120	120	21600	25	13
5	12:40 AM	226685	51	120	117	21600	24	13
6	12:45 AM	272121	0	120	120	24000	24	25
7	12:48 AM	227425	52	120	119	21600	24	13
8	12:52 AM	273110	0	120	120	24000	24	23
9	12:55 AM	271480	0	120	120	24000	24	21
10	12:59 AM	284980	0	120	120	24000	24	24

**Line 2703 COE**

No	Time	Total Bytes	Errors	Duration	EFS	Connect Speed	Signal Level	Signal Quality
1	12:25 PM	285924	0	126	126	24000	22	20
2	12:29 PM	284136	0	124	124	24000	24	19
3	12:33 PM	273757	88	120	113	26400	24	31
4	12:37 PM	226970	17	117	116	26400	24	25
5	12:41 PM	227035	132	117	113	26400	24	25
6	12:45 PM	272290	16	119	118	26400	24	27
7	12:49 PM	227776	140	117	114	26400	24	26
8	12:52 PM	273279	17	119	118	26400	24	22
9	12:56 PM	271651	16	119	118	26400	24	27
10	1:00 AM	285150	0	125	125	26400	24	27

**Line 2704 Burns**

No	Time	Total Bytes	Errors	Duration	EFS	Connect Speed	Signal Level	Signal Quality
1	1:05 AM	271169	0	120	120	24000	22	24
2	1:08 AM	236670	15	120	119	21600	25	18
3	1:12 AM	284897	35	120	118	24000	24	20
4	1:15 AM	285513	0	120	120	24000	22	20
5	1:20 AM	271773	63	120	116	24000	25	19
6	1:23 AM	272597	0	120	120	24000	22	24
7	1:27 AM	273412	14	120	119	24000	24	20
8	1:30 AM	284404	0	120	120	24000	22	22
9	1:35 AM	308253	119	120	113	26400	24	29
10	1:38 AM	284702	0	120	120	24000	22	19

**Line 2704 COE**

No	Time	Total Bytes	Errors	Duration	EFS	Connect Speed	Signal Level	Signal Quality
1	1:04 AM	271341	16	119	118	26400	22	24
2	1:09 AM	236813	15	123	122	26400	24	23
3	1:13 AM	285065	35	125	123	26400	24	34
4	1:17 AM	285684	0	125	125	26400	22	30
5	1:20 AM	271939	81	119	114	26400	25	30
6	1:24 AM	272775	23	120	118	26400	22	30
7	1:28 AM	273581	32	120	118	26400	24	23
8	1:32 AM	284574	0	125	125	26400	22	35
9	1:35 AM	308425	0	125	125	26400	24	29
10	1:39 AM	284868	0	125	125	24000	22	21

**Line 2705 Burns**

No	Time	Total Bytes	Errors	Duration	EFS	Connect Speed	Signal Level	Signal Quality
1	1:43 AM	286088	81	120	115	26400	22	28
2	1:46 AM	284245	8	120	119	24000	22	23
3	1:50 AM	273861	21	120	118	24000	24	21
4	1:53 AM	285121	67	120	115	26400	22	29
5	1:57 AM	285398	50	120	116	24000	24	18
6	2:01 AM	283863	158	120	108	26400	22	26
7	2:05 AM	284860	32	120	118	26400	22	28
8	2:08 AM	271857	24	120	118	24000	22	24
9	2:12 AM	286165	0	120	120	24000	24	23
10	2:15 AM	283933	0	120	120	24000	24	23

**Line 2705 COE**

No	Time	Total Bytes	Errors	Duration	EFS	Connect Speed	Signal Level	Signal Quality
1	1:43 AM	286248	0	126	126	24000	24	19
2	1:47 AM	284412	0	125	125	24000	24	18
3	1:50 AM	274026	38	120	117	26400	24	32
4	1:55 AM	285288	0	125	125	24000	24	21
5	1:59 AM	285564	43	126	123	26400	22	31
6	2:02 AM	284016	0	124	124	24000	24	19
7	2:06 AM	285024	0	125	125	24000	24	18
8	2:10 AM	272022	41	119	116	26400	24	31
9	2:14 AM	286332	0	125	125	24000	24	18
10	2:18 AM	284100	0	125	125	24000	24	19

**Line 2706 Burns**

No	Time	Total Bytes	Errors	Duration	EFS	Connect Speed	Signal Level	Signal Quality
1	12:20 AM	284509	0	120	120	24000	22	19
2	12:25 AM	285395	0	120	120	24000	22	17
3	12:29 AM	286147	147	120	111	26400	22	30
4	12:32 AM	281934	41	120	117	24000	22	19
5	12:40 AM	283896	63	120	116	26400	22	28
6	12:43 AM	271177	8	120	119	24000	24	22
7	12:48 AM	285110	19	120	119	24000	25	24
8	12:52 AM	238446	33	120	118	21600	24	14
9	12:56 AM	273035	38	120	118	24000	24	21
10	1:00 AM	285058	0	120	120	24000	24	25

**Line 2706 COE**

No	Time	Total Bytes	Errors	Duration	EFS	Connect Speed	Signal Level	Signal Quality
1	12:21 AM	284676	0	125	125	24000	24	17
2	12:24 AM	285564	0	125	125	24000	22	18
3	12:27 AM	285816	19	126	125	24000	24	20
4	12:31 AM	286313	41	125	122	26000	22	31
5	12:35 AM	284362	85	125	121	26000	24	28
6	12:41 AM	285228	0	125	125	24000	24	18
7	12:44 AM	271345	25	119	117	26000	24	29
8	12:48 AM	285278	19	125	124	24000	22	19
9	12:52 AM	238586	33	123	121	26000	24	34
10	12:56 AM	273202	53	119	115	26000	24	31



**Line 2707 Burns**

No	Time	Total Bytes	Errors	Duration	EFS	Connect Speed	Signal Level	Signal Quality
1	1:05 AM	284029	10	120	119	24000	22	23
2	1:08 AM	271585	0	120	120	24000	22	22
3	1:12 AM	274795	53	120	119	24000	24	25
4	1:16 AM	284067	0	120	120	24000	22	24
5	1:20 AM	238420	21	120	118	21600	25	19
6	1:24 AM	226643	45	120	117	21600	24	14
7	1:26 AM	309480	161	120	110	26400	22	25
8	1:31 AM	237470	20	120	119	21600	24	16
9	1:35 AM	226778	43	120	118	21600	24	14
10	1:38 AM	274892	44	120	119	24000	24	22

**Line 2707 COE**

No	Time	Total Bytes	Errors	Duration	EFS	Connect Speed	Signal Level	Signal Quality
1	1:05 AM	281936	0	124	124	24000	24	17
2	1:09 AM	271752	18	119	118	26000	24	38
3	1:13 AM	274961	16	120	119	26000	24	25
4	1:17 AM	284236	0	125	125	26000	24	29
5	1:21 AM	238564	21	123	121	26000	22	32
6	1:24 AM	226992	133	117	113	26000	22	32
7	1:28 AM	309656	117	125	118	26000	24	33
8	1:32 AM	237826	94	123	121	24000	22	19
9	1:34 AM	227125	126	117	113	26000	22	26
10	1:38 AM	275059	18	120	119	26000	22	33

**Line 2708 Burns**

No	Time	Total Bytes	Errors	Duration	EFS	Connect Speed	Signal Level	Signal Quality
1	1:47 AM	284891	0	120	120	24000	24	24
2	1:50 AM	286133	21	120	119	24000	22	19
3	1:54 AM	285410	10	120	119	26400	21	31
4	1:57 AM	285002	0	120	120	24000	22	21
5	2:00 AM	225294	0	120	120	21600	24	17
6	2:04 AM	285418	21	120	119	24000	24	22
7	2:07 AM	272051	18	120	119	24000	22	22
8	2:11 AM	284914	0	120	120	24000	24	24
9	2:14 AM	307754	99	120	114	26400	24	36
10	2:18 AM	284344	107	120	112	26400	22	30

**Line 2708 COE**

No	Time	Total Bytes	Errors	Duration	EFS	Connect Speed	Signal Level	Signal Quality
1	1:46 AM	285060	0	125	125	24000	24	17
2	1:50 AM	286300	10	125	124	26000	22	32
3	1:54 AM	285576	0	126	126	24000	24	17
4	1:58 AM	285171	0	125	125	26000	22	25
5	2:01 AM	227997	17	117	116	26000	24	22
6	2:04 AM	285588	0	126	126	24000	22	20
7	2:08 AM	272221	35	119	117	26000	24	34
8	2:11 AM	285084	0	125	125	24000	24	19
9	2:15 AM	307932	24	125	123	26000	24	29
10	2:19 AM	284496	0	125	125	24000	24	22

**4.2. Phase II – Burns Building & Residence Phone Line**

In Phase II, two out of the eight phone lines of the Burns Building were used to perform the line quality tests with a residential phone line. The two lines used from the Burns Building were 2704 and 2706. These lines were selected as they had a high connection speed with the tests in Phase I. All the tests were conducted during daytime hours. The time is given in the second column from the left. The calls were initiated at the Burns Building and received at the residential phone line. The data is given in the same order i.e. first the data from the sender side, then from the receiver side.

<b>Burns</b>				<b>Line 2704</b>				
No	Time	Total Bytes	Errors	Duration	EFS	Connect Speed	Signal Level	Signal Quality
1	4:00 PM	227063	48	120	118	21600	25	19
2	4:03 PM	285879	24	120	118	24000	24	20
3	4:07 PM	237963	38	120	118	21600	24	15
4	4:10 PM	236986	40	120	118	21600	25	20
5	4:14 PM	284366	0	120	120	24000	24	21
6	4:17 PM	284471	161	120	118	24000	25	21
7	4:21 PM	286214	31	120	119	24000	25	25
8	4:24 PM	237322	116	120	114	21600	25	19
9	4:28 PM	237817	0	120	120	21600	25	25
10	4:31 PM	284967	0	120	120	24000	22	21

**Residence****Line 2704**

No	Time	Total Bytes	Errors	Duration	EFS	Connect Speed	Signal Level	Signal Quality
1	4:04 PM	227202	44	117	114	26400	27	29
2	4:07 PM	286044	0	125	125	24000	27	23
3	4:10 PM	238316	110	123	121	24000	27	20
4	4:14 PM	237128	40	123	121	24000	27	21
5	4:17 PM	284532	0	125	125	24000	27	20
6	4:21 PM	284633	95	125	123	24000	28	24
7	4:24 PM	286382	31	126	125	24000	27	19
8	4:28 PM	237480	133	122	116	26400	27	30
9	4:32 PM	237962	0	123	123	24000	27	27
10	4:35 PM	285132	0	125	125	24000	27	21

**Burns****Line 2706**

No	Time	Total Bytes	Errors	Duration	EFS	Connect Speed	Signal Level	Signal Quality
1	3:23 PM	285367	516	120	119	24000	24	23
2	3:27 PM	227554	10	120	119	21600	24	16
3	3:30 PM	285062	43	120	118	24000	22	18
4	3:34 PM	228585	0	120	120	21600	24	15
5	3:37 PM	237341	0	120	120	21600	24	18
6	3:41 PM	238507	0	120	120	21600	25	32
7	3:44 PM	284628	0	120	120	24000	24	21
8	3:48 PM	281716	23	120	119	24000	25	25
9	3:52 PM	285091	55	120	118	24000	25	21
10	3:55 PM	284871	70	120	118	24000	25	24

**Residence****Line 2706**

No	Time	Total Bytes	Errors	Duration	EFS	Connect Speed	Signal Level	Signal Quality
1	3:27 PM	285525	454	125	124	24000	27	21
2	3:30 PM	227694	47	117	114	24000	27	24
3	3:34 PM	285397	203	126	123	24000	27	21
4	3:37 PM	228725	40	117	116	24000	27	26
5	3:41 PM	237485	0	123	123	24000	27	24
6	3:44 PM	238650	0	124	124	24000	27	19
7	3:48 PM	284796	0	125	125	24000	28	23
8	3:52 PM	284342	23	125	124	24000	27	23
9	3:55 PM	285256	45	125	123	24000	28	20
10	3:58 PM	285036	21	125	124	24000	27	22

### 4.3. Phase III – COE & Residence Phone Line

In Phase III, the modem line quality tests were performed between the COE and the residence phone line. The phone line tests were initiated from the COE and received at the residence phone line. The data provided is in the same format, i.e. the sender data is provided first with the header COE, followed by the receiver data.

<b>COE</b>		<b>Line 410-6686</b>						
<b>No</b>	<b>Time</b>	<b>Total Bytes</b>	<b>Errors</b>	<b>Duration</b>	<b>EFS</b>	<b>Connect Speed</b>	<b>Signal Level</b>	<b>Signal Quality</b>
1	11:47 AM	331877	0	120	120	28800	21	16
2	11:51 AM	333445	0	120	120	28800	22	17
3	11:54 AM	332490	0	120	120	28800	22	17
4	11:58 AM	331319	0	120	120	28800	22	17
5	12:01 PM	331231	0	120	120	28800	22	16
6	12:05 PM	333161	0	120	120	28800	21	16
7	12:08 PM	331879	0	120	120	28800	22	15
8	12:12 PM	331511	0	120	120	28800	22	16
9	12:16 PM	331206	0	120	120	28800	21	16
10	12:19 PM	332550	0	120	120	28800	21	16

### Residence line – Residence 1

<b>No</b>	<b>Time</b>	<b>Total Bytes</b>	<b>Errors</b>	<b>Duration</b>	<b>EFS</b>	<b>Connect Speed</b>	<b>Signal Level</b>	<b>Signal Quality</b>
1	11:51 AM	332066	0	126	126	28800	24	17
2	11:55 AM	333634	0	126	126	28800	24	18
3	11:58 AM	332682	0	126	126	28800	22	17
4	12:02 PM	331506	0	126	126	28800	22	17
5	12:05 PM	331422	0	126	126	28800	24	22
6	12:08 PM	333354	0	126	126	28800	22	20
7	12:12 PM	332066	0	126	126	28800	22	19
8	12:15 PM	331702	0	126	126	28800	24	17
9	12:19 PM	331394	0	125	125	28800	24	20
10	12:22 PM	332738	0	126	126	28800	22	18

### 4.4. Phase IV – Between Two Residential Phone Lines

In Phase IV, Modem line Quality Tests were performed between two residential phone lines. The tests were conducted during daytime. The data indicates that the phone line initiating the test was Residence 1 and the phone line receiving the data for the tests was Residence 2. This is indicated in the headers of the table, thus clarifying the sender and the receiver respectively.

**Residence line – Residence 1**

No	Time	Total Bytes	Errors	Duration	EFS	Connect Speed	Signal Level	Signal Quality
1	4:58 PM	283999	0	120	120	28800	27	30
2	5:01 PM	309991	0	120	120	26400	27	24
3	5:05 PM	307641	0	120	120	28800	27	26
4	5:08 PM	284076	0	120	120	24000	30	17
5	5:12 PM	309836	0	120	120	28800	28	34
6	5:15 PM	307770	13	120	119	28800	30	27
7	5:19 PM	308193	0	120	120	26400	30	25
8	5:23 PM	309639	0	120	120	28800	28	25
9	5:27 PM	295809	0	120	120	26400	30	23
10	5:31 PM	309464	13	120	119	28800	28	27

**Residence line – Residence 2**

No	Time	Total Bytes	Errors	Duration	EFS	Connect Speed	Signal Level	Signal Quality
1	5:00 PM	282044	0	124	124	26400	28	28
2	5:04 PM	310167	0	126	126	26400	28	25
3	5:08 PM	307814	0	125	125	26400	30	28
4	5:12 PM	284237	0	125	125	28800	28	26
5	5:15 PM	310011	0	126	126	26400	30	21
6	5:19 PM	307944	0	125	125	26400	30	24
7	5:22 PM	308367	0	125	125	28800	30	31
8	5:26 PM	307756	0	126	126	26400	31	29
9	5:30 PM	295979	18	120	119	28800	30	29
10	5:34 PM	309635	13	125	125	26400	31	26

**4.5. Phase V – COE & Springhill Rd Facility of FDOT**

In Phase V, the same tests were conducted between the COE and the Springhill Rd facility of FDOT. In this part of the test, the calls were initiated from the Springhill Rd facility of FDOT and received at the COE. The data provided in the tables first shows the data collected on the sender side i.e. at Springhill (as indicated in the header of the table provided), followed by the data at the receiver side in the next table after the Springhill data.

In the data collected it was observed that in one of the connections (connection # 3) the test got disconnected. The actual test duration was 120 seconds (2 minutes), but it got disconnected after 35 seconds. Out of the 36 seconds, half of the time the data had errors. These errors seem to be a random burst of noise on the line and when the test was conducted, the burst of noise had passed away and the connections were established successfully for the remainder of the tests.

**Springhill****Line 414-2813**

No	Time	Total Bytes	Errors	Duration	EFS	Connect Speed	Signal Level	Signal Quality
1	12:43 PM	284105	0	120	120	24000	33	26
2	12:47 PM	238281	4998	120	94	28800	30	35
3	<b>12:51 PM</b>	<b>65038</b>	<b>13732</b>	<b>36</b>	<b>17</b>	<b>26400</b>	<b>30</b>	<b>22</b>
4	12:54 PM	228585	1000	120	115	21600	30	42
5	12:58 PM	283926	0	120	120	24000	31	19
6	1:01 PM	285704	0	120	120	26400	30	28
7	1:06 PM	285005	0	120	120	24000	31	21
8	1:11 PM	235349	109	120	118	26400	30	20
9	1:14 PM	284812	0	120	120	26400	30	19
10	1:17 PM	284871	0	120	120	26400	31	28

**COE****Line 414-2813**

No	Time	Total Bytes	Errors	Duration	EFS	Connect Speed	Signal Level	Signal Quality
1	12:47 PM	284268	0	125	125	24000	33	22
2	12:51 PM	237050	1142	123	100	21600	33	16
3	<b>12:54 PM</b>	<b>63215</b>	<b>1128</b>	<b>30</b>	<b>17</b>	<b>24000</b>	<b>33</b>	<b>22</b>
4	12:58 PM	238397	340	123	120	26400	30	39
5	1:01 PM	284088	0	124	124	26400	31	31
6	1:04 PM	285864	0	126	126	24000	30	18
7	1:09 PM	285167	0	125	125	26400	30	28
8	1:14 PM	235389	2	122	121	21600	33	19
9	1:17 PM	284976	0	125	125	24000	31	20
10	1:21 PM	309257	0	126	126	26400	31	33

**4.6. Phase VI – Burns Building and TTMS sites**

In Phase VI, tests were conducted using the long-distance service at the Burns Building, as it was mentioned by FDOT that the local service and the long distance service was provided through different carriers. These tests were conducted in two parts. First the local tests were conducted using the long distance service by dialing a 6-1-  
(850 for local tests)-<phone number>. Then to test the phone line quality at the TTMS sites via the long-distance service at Burns building, tests were planned at sites that were visited for lightning data collection (another part of the same project of FDOT). The TTMS sites used for the phone line assessment tests were: Site 320-2, site 204, site 343, and site 96.

The first part of the test was done using the long-distance service (Suncomm) of the Burns buildings where the tests were initiated from and received at the COE. The tests were initiated from line 2704 and 2706 of the Burns Building. These tests performed very nearly the same as the local calls tested in the previous phases.

*Using Suncomm & Dialing COE (5/20/2004)*

**COE received from Line 2704**

**Suncomm Line Test to COE**

No	Time	Total Bytes	Errors	Duration	EFS	Connect Speed	Signal Level	Signal Quality
1	9:23 AM	237470	0	122	122	24000	24	18
2	9:27 AM	284484	0	125	125	24000	24	17
3	9:31 AM	272716	61	119	115	26400	24	31
4	9:35 AM	238113	36	123	120	26400	24	29
5	9:38 AM	227893	127	118	115	24000	22	19
6	9:42 AM	285708	0	126	126	24000	24	22
7	9:46 AM	272506	125	119	111	26400	22	32
8	9:50 AM	227920	16	117	116	24000	24	18
9	9:54 AM	286189	21	126	125	24000	24	18
10	9:57 AM	284460	0	125	125	24000	24	22

**COE received from Line 2706**

**Suncomm Line Test to COE**

No	Time	Total Bytes	Errors	Duration	EFS	Connect Speed	Signal Level	Signal Quality
1	10:02 AM	285588	0	126	126	24000	22	18
2	10:06 AM	272482	76	119	114	26400	25	29
3	10:10 AM	237086	20	122	120	26400	24	30
4	10:14 AM	284028	0	125	125	24000	24	17
5	10:18 AM	271987	29	119	117	26400	24	31
6	10:22 AM	272784	40	119	116	26400	22	32
7	10:26 AM	285684	0	126	126	24000	24	19
8	10:30 AM	284916	0	125	125	24000	24	22
9	10:34 AM	271236	84	119	113	26400	22	28
10	10:38 AM	286013	58	125	122	26400	24	34

The second part of the long distance phone line assessment was performed by initiating the calls from the Burns Building in the daytime to Site 320-2 near Lake City. A total of 25 tests were run on line 2702 of the Burns Building, of which test number 2 to 11 did not establish a connection at the receiver end. The other 15 connections were established successfully although at a lower connection speed than observed in the local tests.

Further it was observed that the failure in establishing connection was in sequence from test run 2 to 11. This indicates that a burst of random noise was on the line that caused a bad connection, and once it passed, the connections were established successfully. To isolate the cause of this random noise, further study is required, and at the moment it is recommended to retry to establish the connection after a certain time delay. The results of the phone line assessments for site 320-2 near Lake City are provided in the following table.

*Burns Building (Suncomm) Calling Site 320-2*

Burns Building line 2702 called Site 320-2					SunComm Line Test			
No	Time	Total Bytes	Errors	Duration	EFS	Connect Speed	Signal Level	Signal Quality
1	11:02 AM	214451	19	120	119	21600	22	21
2	11:05 AM		No MLQT Detected			14400		
3	11:06 AM		No MLQT Detected			14400		
4	11:07 AM		No MLQT Detected			14400		
5	11:08 AM		No MLQT Detected			14400		
6	11:10 AM		No MLQT Detected			14400		
7	11:11 AM		No MLQT Detected			14400		
8	11:12 AM		No MLQT Detected			14400		
9	11:13 AM		No MLQT Detected			14400		
10	11:13 AM		No MLQT Detected			14400		
11	11:14 AM		No MLQT Detected			14400		
12	11:15 AM	238401	114	120	116	21600	24	24
13	11:19 AM	238575	837	120	107	21600	22	19
14	11:22 AM	237434	137	120	116	21600	22	20
15	11:26 AM	238256	388	120	106	21600	22	21
16	11:30 AM	213781	15	120	119	21600	22	29
17	11:33 AM	237388	54	120	118	21600	22	22
18	11:36 AM	236616	85	120	115	21600	22	22
19	11:40 AM	213920	0	120	120	21600	22	22
20	11:44 AM	213655	0	120	120	21600	22	21
21	11:48 AM	213407	74	120	117	21600	22	17
22	11:53 AM	179750	526	120	118	21600	22	22
23	11:56 AM	213161	1195	120	113	21600	22	24
24	12:00 PM	213710	0	120	120	21600	21	22
25	12:03 PM	214465	0	120	120	21600	22	18

*Burns Building (Suncomm) Calling Site 204*

Another TTMS site that was used to perform Burns Building phone line assessment was the Site 204. This site was visited at three different times. It was visited on July 02, 2004, on July 08, 2004, and on August 04, 2004. On the first visit to the site 10 runs were established to check the line quality. All the connections were established from the Burns Building and the results are provided in the next table.



Burns Building

**SENDER** Dialed Site: 204, Line No: 407-251-2387

Jul 02, 04

No	Time	Total Bytes	Errors	Duration	EFS	Connect Speed	Signal Level	Signal Quality
1	11:45	190242	14	120	119	24000	22	31
2	11:49	189831	44	120	117	24000	22	26
3	11:53	186896	15	120	119	24000	22	28
4	11:56	0	0	0	0	21600	0	0
5	11:57	214115	20	120	118	24000	22	31
6	12:01	214104	302	120	100	24000	22	30
7	12:05	213763	263	120	106	24000	21	29
8	12:09	190305	35	120	117	24000	21	34
9	12:12	190488	249	120	104	24000	21	29
10	12:16	213878	11	120	119	21600	22	21

Avg. Bytes	Errors	BER	Avg. connection Speed
180362.2	953	0.00052838	23520

The next table gives the data collected at the Site 204, which received the calls from the Burns Building.

Site 204, Line No: 407-251-2387

**RECEIVER**

Jul 02, 04

No	Time	Total Bytes	Errors	Duration	EFS	Connect Speed	Signal Level	Signal Quality
1	11:47	190416	0	126	126	16800	33	39
2	11:52	189970	26	126	124	16800	33	40
3	11:56	189600	15	125	124	16800	33	33
4	11:58	0	0	0	0	16800	0	0
5	12:01	214275	20	125	123	19200	33	41
6	12:04	214264	289	126	109	19200	33	61
7	12:08	213919	251	125	111	19200	33	63
8	12:12	190449	26	126	124	16800	33	43
9	12:16	190625	223	126	113	16800	33	72
10	12:19	214038	11	125	124	19200	33	34

Avg. Bytes	Errors	BER	Avg. connection Speed
180755.6	861	0.00047633	17760

The data had some connection problems in the fourth run, as it did not detect the MLQT on the receiver side.

On the second visit to the site, on July 08, 2004, the first connection between Burns Building and Site 204 was established successfully, the second connection got disconnected after 40 seconds due to a burst of errors on the line. All the other

connections were unsuccessful as the random errors on the line had increased and were present while the connection was trying to be established. Therefore, Site 204 was schedule for another visit to perform another set of data collection. The results from the second visit are given in the following table.

**Burns Building**      **SENDER** Dialed Site: 204, Line No: 407-251-2387      **Jul 08, 04**

No	Time	Total Bytes	Errors	Duration	EFS	Connect Speed	Signal Level	Signal Quality
1	11:05	190402	0	120	120	21600	22	18
2	11:08	18753	6734	44	36	24000	21	28
3	11:10	0	0	0	0	0	0	0
4	0:00	0	0	0	0	0	0	0
5	0:00	0	0	0	0	0	0	0
6	0:00	0	0	0	0	0	0	0
7	0:00	0	0	0	0	0	0	0
8	0:00	0	0	0	0	0	0	0
9	0:00	0	0	0	0	0	0	0
10	0:00	0	0	0	0	0	0	0

Avg. Bytes	Errors	BER	Avg. connection Speed
104577.5	6734	0.03219622	22800

The following table presents the data on the receiver side (Site 204) on the second visit to Site 204 (on July 08, 2004).

**Site 204, Line No: 407-251-2387**      **RECEIVER**      **Jul 08, 04**

No	Time	Total Bytes	Errors	Duration	EFS	Connect Speed	Signal Level	Signal Quality
1	11:06	190576	0	126	126	16800	33	36
2	11:08	18702	6682	14	6	16800	33	47
3	11:10	0	0	0	0	0	0	0
4	0:00	0	0	0	0	0	0	0
5	0:00	0	0	0	0	0	0	0
6	0:00	0	0	0	0	0	0	0
7	0:00	0	0	0	0	0	0	0
8	0:00	0	0	0	0	0	0	0
9	0:00	0	0	0	0	0	0	0
10	0:00	0	0	0	0	0	0	0

Avg. Bytes	Errors	BER	Avg. connection Speed
104639	6682	0.03192882	16800

On the third visit to Site 204, on August 04, 2004, there were two types of phone line assessments tests performed between the Burns Building and Site 204. The first type of test had the EDCO surge suppressor connected to the phone line at the Site 204, while the second type of test did not have the EDCO surge suppressor connected to the phone line at the Site 204. The purpose of the surge suppressor was to see if it affected the quality of the phone lines used for data collection. The following two tables give the results of the transmitting side (Burns Building) and the receiving side (site 204) when the EDCO surge suppressor is connected.

**Burns Building**      **SENDER**      Dialed Site: 204, Line No: 407-251-2387      Aug 04,04      **W EDCO**

No	Time	Total Bytes	Errors	Duration	EFS	Connect Speed	Signal Level	Signal Quality
1	9:51	189223	100	120	114	21600	22	16
2	9:55	190098	13	120	119	21600	22	21
3	9:58	189329	12	120	119	24000	22	31
4	10:02	165729	17	120	118	21600	21	23
5	10:06	190400	0	120	120	21600	22	22
6	10:10	190037	62	120	116	21600	22	21
7	10:14	190294	76	120	115	21600	21	23
8	10:18	0	0	0	0	21600	22	18
9	10:19	189698	0	120	120	21600	22	23
10	10:23	205614	548	120	101	24000	22	29

Avg. Bytes	Errors	BER	Avg. connection Speed
170042.2	828	0.00048694	22080

The following is the data collected from Site 204 with the EDCO surge suppressor connected to the phone line.

**Site 204, Line No: 407-251-2387**      **RECEIVER**      Aug 04,04      **W EDCO**

No	Time	Total Bytes	Errors	Duration	EFS	Connect Speed	Signal Level	Signal Quality
1	9:54	189398	100	125	119	16800	33	48
2	9:58	190241	13	125	124	16800	33	37
3	10:02	189505	12	125	124	16800	31	48
4	10:06	165901	17	124	122	14400	33	31
5	10:10	190544	0	126	126	16800	33	40
6	10:13	190179	62	126	121	16800	33	35
7	10:17	190470	76	126	121	16800	33	39
8	10:18	0	0	0	0	16800	0	0
9	10:22	189840	0	125	125	16800	33	34
10	10:27	205877	460	120	99	19200	33	70

Avg. Bytes	Errors	BER	Avg. connection Speed
170195.5	740	0.00043479	16800

The second type of test did not have the EDCO surge suppressor connected on the phone line. The results from the transmitter side (Burns Building) and the receiver side (Site 204) is given in the following two tables respectively.

**W/O**

**Burns Building      SENDER      Dialed Site: 204, Line No: 407-251-2387      Aug 04,04      EDCO**

No	Time	Total Bytes	Errors	Duration	EFS	Connect Speed	Signal Level	Signal Quality
1	10:28	189842	70	120	116	21600	21	22
2	10:32	0	0	0	0	21600	22	22
3	10:33	190533	53	120	117	21600	21	21
4	10:36	213824	221	120	107	21600	22	21
5	10:40	190423	30	120	118	24000	21	30
6	10:44	212932	55	120	118	24000	19	29
7	10:48	190064	1375	120	55	24000	21	31
8	10:52	213279	151	120	113	21600	24	25
9	10:55	237456	397	120	94	24000	22	28
10	10:59	189761	22	120	118	24000	22	27

Avg. Bytes	Errors	BER	Avg. connection Speed
182811.4	2374	0.00129861	22800

The following is the data on the receiver side (Site 204) without the EDCO surges suppressor.

**W/O**

**Site 204, Line No: 407-251-2387      RECEIVER      Aug 04,04      EDCO**

No	Time	Total Bytes	Errors	Duration	EFS	Connect Speed	Signal Level	Signal Quality
1	10:31	189986	70	125	121	16800	33	32
2	10:33	0	0	0	0	19200	33	127
3	10:36	190675	53	126	123	16800	33	45
4	10:39	214019	221	126	111	19200	33	50
5	10:43	190648	15	126	125	16800	33	35
6	10:47	213090	55	125	123	19200	31	56
7	10:50	190260	1396	127	61	16800	34	65
8	10:54	213439	137	125	119	19200	33	71
9	10:59	237673	397	122	97	21600	33	48
10	11:03	189937	22	125	124	16800	33	35

Avg. Bytes	Errors	BER	Avg. connection Speed
182972.7	2366	0.00129309	18240

From the data collected from Site 204 it was concluded that there was not much of a difference from the presence of the EDCO surge suppressor on the performance of the phone line.

*Burns Building (Suncomm) Calling Site 343*

Another TTMS site that was used to perform Burns Building phone line assessment was the Site 343. This site was also visited at three different times just like Site 204. It was visited on July 02, 2004, on July 08, 2004, and on August 04, 2004. On the first visit to the site 10 runs were established to check the line quality. All the connections were established from the Burns Building and the results are provided in the next table.

**Burns Building      SENDER      Dialed Site: 343, Line No: 407-262-7664      Jul 02,04**

No	Time	Total Bytes	Errors	Duration	EFS	Connect Speed	Signal Level	Signal Quality
1	13:16	0	0	0	0	0	0	0
2	13:17	95027	1543	120	99	21600	21	20
3	13:20	236741	2626	120	97	21600	22	15
4	13:23	239399	13227	120	57	21600	22	14
5	13:27	237497	174	120	117	24000	22	24
6	13:31	237207	51	120	118	24000	24	26
7	13:34	237683	126	120	116	24000	22	22
8	13:38	13461	13324	38	32	21600	22	15
9	13:40	239580	18151	120	63	21600	22	16
10	13:44	238232	21	120	119	21600	22	21

Avg. Bytes	Errors	BER	Avg. connection Speed
177482.7	49243	0.02774524	20160

Data below is from the receiver side (site 343).

**Site 343, Line No: 407-262-7664      RECEIVER      Jul 02,04**

No	Time	Total Bytes	Errors	Duration	EFS	Connect Speed	Signal Level	Signal Quality
1	13:16	0	0	0	0	0	0	0
2	13:19	94853	1087	121	102	9600	31	22
3	13:23	237008	2281	123	102	21600	33	25
4	13:27	239411	10484	124	64	21600	33	24
5	13:30	237805	155	123	120	21600	33	25
6	13:34	237594	28	123	122	21600	33	22
7	13:38	238034	63	124	122	21600	33	28
8	13:39	13274	13127	9	4	21600	33	26
9	13:43	239810	14324	124	65	21600	33	23
10	13:47	238532	21	123	122	21600	33	31

Avg. Bytes	Errors	BER	Avg. connection Speed
177632.1	41570	0.0234023	18240

It was observed from the above two tables that the first run did not connect, as there was no carrier detected (most probably a resetting issue with MLQT). Also there was a remote disconnect during the eighth run. This was due to the random burst of noise that occurred on the phone line.

On the second visit to the Site 343, on July 08, 2004, the first connection between Burns Building and Site 204 was not established, as the MLQT could not be detected. The results from the second visit are given in the following table.

**Burns Building**      **SENDER** Dialed Site: 343, Line No: 407-262-7664      **Jul 08, 04**

No	Time	Total Bytes	Errors	Duration	EFS	Connect Speed	Signal Level	Signal Quality
1	12:20	0	0	0	0	21600	0	0
2	12:22	213601	3172	120	79	24000	22	24
3	12:25	237398	3154	120	93	24000	21	25
4	12:29	237721	10014	120	94	21600	22	17
5	12:33	237212	0	120	120	21600	22	16
6	12:36	235439	1051	120	105	21600	22	15
7	12:40	213325	10006	120	23	24000	22	28
8	12:44	0	0	0	0	0	0	0
9	0:00	0	0	0	0	0	0	0
10	0:00	0	0	0	0	0	0	0

Avg. Bytes	Errors	BER	Avg. connection Speed
196385.1	27397	0.0199295	22628.57143

The test runs 2 to 6 were successful and the rest of the connections failed due to the number of errors on the line. This phenomenon of random burst was observed the same day on Site 204 and requires further study, as it could be dependent on a number of issues.

The receiver side data (collected from Site 343) is given in the following table.

**Site 343, Line No: 407-262-7664**                      **RECEIVER**                      **Jul 08, 04**

No	Time	Total Bytes	Errors	Duration	EFS	Connect Speed	Signal Level	Signal Quality
1	12:21	0	0	0	0	21600	0	0
2	12:24	213820	2924	124	83	19200	33	25
3	12:28	237871	3036	123	94	21600	31	27
4	12:31	237962	9403	123	96	21600	33	24
5	12:35	237510	0	123	123	21600	33	24
6	12:38	235887	977	126	108	21600	33	24
7	12:43	214279	9996	128	29	19200	33	66
8	0:00	0	0	0	0	0	0	0
9	0:00	0	0	0	0	0	0	0
10	0:00	0	0	0	0	0	0	0

Avg. Bytes	Errors	BER	Avg. connection Speed
196761.3	26336	0.01912107	20914.28571

On the third visit to Site 343, on August 04, 2004, there were two types of phone line assessments tests performed between the Burns Building and Site 343, similar to the one done for Site 343. The first type of test had the EDCO surge suppressor connected to the phone line at the Site 343, while the second type of test did not have the EDCO surge suppressor connected to the phone line at the Site 204. The purpose of the surge suppressor was to see if it affected the quality of the phone lines used for data collection. The following two tables give the results of the transmitting side (Burns Building) and the receiving side (site 343) when the EDCO surge suppressor is connected.

**Burns Building**                      **SENDER**                      **Dialed Site: 343, Line No: 407-262-7664**                      **Aug 04,04**                      **W EDCO**

No	Time	Total Bytes	Errors	Duration	EFS	Connect Speed	Signal Level	Signal Quality
1	12:05	237838	0	120	120	24000	22	23
2	12:08	237738	0	120	120	24000	22	24
3	12:12	236546	0	120	120	21600	21	17
4	12:16	238114	25	120	119	21600	22	16
5	12:19	236631	15	120	119	21600	24	19
6	12:23	236436	25	120	119	24000	22	20
7	12:26	237485	36	120	118	24000	21	26
8	12:30	236822	0	120	120	21600	22	14
9	12:34	237664	14	120	119	21600	21	16
10	12:38	236417	51	120	117	24000	21	29

Avg. Bytes	Errors	BER	Avg. connection Speed
237169.1	166	6.9992E-05	22800

The following is data from the receiver side (Site 343) with the EDCO surge suppressor connected to the phone line at the Site 343.

Site 343, Line No: 407-262-7664 **RECEIVER** Aug 04,04 **W EDCO**

No	Time	Total Bytes	Errors	Duration	EFS	Connect Speed	Signal Level	Signal Quality
1	12:07	238150	0	123	123	21600	33	21
2	12:11	238150	0	124	124	21600	33	20
3	12:14	236940	0	123	123	21600	33	22
4	12:18	238412	25	123	122	21600	31	21
5	12:22	236961	15	122	121	21600	33	20
6	12:25	236793	25	123	122	21600	33	20
7	12:29	237813	36	123	121	21600	31	24
8	12:33	237120	0	123	123	21600	31	21
9	12:36	237961	14	123	122	21600	31	20
10	12:40	236772	29	123	122	21600	31	23

Avg. Bytes	Errors	BER	Avg. connection Speed
237169.1	166	6.9992E-05	22800

The second type of test did not have the EDCO surge suppressor connected on the phone line. The results from the transmitter side (Burns Building) and the receiver side (Site 343) are given in the following two tables respectively.

Burns Building **SENDER** Dialed Site: 343, Line No: 407-262-7664 Aug 04,04 **W/O EDCO**

No	Time	Total Bytes	Errors	Duration	EFS	Connect Speed	Signal Level	Signal Quality
1	12:45	237720	20	120	119	24000	21	22
2	12:48	237866	0	120	120	24000	22	25
3	12:51	237789	22	120	118	24000	22	27
4	12:55	237733	32	120	118	21600	22	19
5	12:58	236822	0	120	120	24000	22	24
6	13:01	237574	16	120	119	21600	22	17
7	13:05	237558	37	120	119	21600	22	13
8	13:08	237419	51	120	117	21600	22	16
9	13:11	238186	27	120	118	24000	21	23
10	13:15	237286	15	120	119	21600	21	16

Avg. Bytes	Errors	BER	Avg. connection Speed
237595.3	220	9.2594E-05	22800



The following is the data on the receiver side (Site 204) without the EDCO surges suppressor.

Site 343, Line No: 407-262-7664			RECEIVER			Aug 04,04		W/O EDCO
No	Time	Total Bytes	Errors	Duration	EFS	Connect Speed	Signal Level	Signal Quality
1	12:47	238140	0	123	123	21600	33	26
2	12:50	238230	0	123	123	21600	31	20
3	12:54	235532	13	123	122	21600	33	22
4	12:57	238031	32	124	122	21600	33	30
5	13:01	237170	0	123	123	21600	33	22
6	13:04	237962	16	123	122	21600	33	22
7	13:07	238354	106	123	121	21600	31	30
8	13:10	238180	121	124	121	21600	31	25
9	13:14	238591	16	124	123	21600	33	24
10	13:17	237702	15	123	122	21600	33	23

Avg. Bytes	Errors	BER	Avg. connection Speed
237789.2	319	0.00013415	21600

*Burns Building (Suncomm) Calling Site 96*

The last TTMS site that was used to perform Burns Building phone line assessment was Site 96. This site was visited once on August 06, 2004, but a total of ten runs were performed with the EDCO surge suppressor on the phone line at Site 96, and without the surge suppressor on the phone line. The data with the EDCO surge suppressor is provided first.

Burns Building			SENDER Dialed Site: 96, Line No: 305-681-5442			Aug 06,04		W EDCO
No	Time	Total Bytes	Errors	Duration	EFS	Connect Speed	Signal Level	Signal Quality
1	11:30	190310	0	120	120	21600	24	17
2	11:34	213491	41	120	118	21600	24	22
3	11:37	213939	0	120	120	21600	21	16
4	11:40	214224	0	120	120	21600	25	22
5	11:44	213096	70	120	117	21600	24	21
6	11:48	213345	0	120	120	21600	22	17
7	11:51	213399	0	120	120	21600	25	23
8	11:55	190200	0	120	120	21600	24	20
9	11:58	213757	4351	120	108	24000	21	28
10	12:02	214539	35	120	118	21600	24	20

Avg. Bytes	Errors	BER	Avg. connection Speed
209030	4497	0.00215137	21840

The data from the receiver side (Site 96) with the EDCO surge suppressor:

Site 96, Line No: 305-681-5442 **RECEIVER** Aug 06,04 **W EDCO**

No	Time	Total Bytes	Errors	Duration	EFS	Connect Speed	Signal Level	Signal Quality
1	11:33	190480	0	126	126	16800	34	22
2	11:37	213646	41	125	123	19200	33	65
3	11:41	214092	0	125	125	19200	33	25
4	11:44	214380	0	126	126	19200	33	35
5	11:47	213251	70	125	122	19200	33	65
6	11:51	213498	0	125	125	19200	33	33
7	11:55	213552	0	124	124	19200	33	25
8	11:58	190336	0	125	125	16800	36	30
9	12:02	213915	4309	125	115	19200	33	43
10	12:05	214690	35	125	123	19200	34	55

Avg. Bytes	Errors	BER	Avg. connection Speed
209184	4455	0.0021297	18720

The second set of tests done at Site 96 was designed to test the connection between the Burns Building and the Site without the presence of the EDCO surge suppressor on the phone line. The tables provided first present the data collected at the transmitter side (Burns Building) and then at the receiver side (Site 96)

Burns Building **SENDER** Dialed Site: 96, Line No: 305-681-5442 Aug 06,04 **W/O EDCO**

No	Time	Total Bytes	Errors	Duration	EFS	Connect Speed	Signal Level	Signal Quality
1	12:06	214279	0	120	120	21600	24	20
2	12:09	214321	66	120	116	21600	24	29
3	12:13	214516	30	120	118	21600	24	15
4	12:16	213254	26	120	119	21600	24	20
5	12:20	213920	0	120	120	21600	24	22
6	12:23	213936	0	120	120	21600	22	20
7	12:27	213671	29	120	118	21600	22	17
8	12:30	213724	29	120	118	21600	22	20
9	12:34	214590	49	120	118	21600	24	16
10	12:37	213255	43	120	118	21600	22	22

Avg. Bytes	Errors	BER	Avg. connection Speed
213946.6	272	0.00012713	21600

The data from the receiver side (Site 96) without the EDCO surge suppressor:

Site 96, Line No: 305-681-5442			RECEIVER			Aug 06,04		W/O EDCO
No	Time	Total Bytes	Errors	Duration	EFS	Connect Speed	Signal Level	Signal Quality
1	12:09	214434	0	125	125	19200	33	31
2	12:13	214473	44	126	124	19200	33	35
3	12:16	214669	19	125	124	19200	34	28
4	12:19	213409	26	124	123	19200	33	36
5	12:23	214074	0	125	125	19200	34	29
6	12:26	214092	0	125	125	19200	33	33
7	12:30	213824	29	125	123	19200	33	44
8	12:33	213878	29	125	124	19200	34	34
9	12:36	214744	49	125	123	19200	34	37
10	12:40	213410	14	125	124	19200	33	39

Avg. Bytes	Errors	BER	Avg. connection Speed
214100.7	210	9.8085E-05	19200

It was observed from the last collection of data from Site 96 that the surge suppressors' presence did not affect the performance of the lines as the connect speed were about the same and so were the errors on the line.

## Appendix D

### Table Summarizing 2003 Polling Errors Form Automated Polling of TTMS Data

The errors recorded in 2003 by the automatic polling systems used by the FDOT to collect data from telemetered traffic monitoring sites (TTMS) sites was provided. This data was processed and summarized in Table 1. The grayed colored rows in Table 1 indicate the errors from Weigh-in-Motion (WIM) sites. The left column indicates the TTMS site number. The Error codes indicate the type of error that occurred when downloading the data from a particular TTMS site. The descriptions of these codes are listed in Table 2. At the bottom of Table 1 the sums of errors by type are calculated for TTMS sites as a whole and for WIM sites only.

**Table 1 – Summary of TTMS Download Errors Recorded by the FDOT in 2003**

Site Number	Error Codes													Total Errors
	0	1	2	3	4	5	6	7	8	9	10	12	99	
0010 1	2		2	6	19		2			1				32
0013 1	1			2		2	2		1		1			9
0014 1			2	4										6
0018 1	1			3	13		2				1			20
0031 1			1	6	1		13	6	1		2			30
0037 1	3		15	21	1	2	3		7	2	3			57
0038 1	3		7	5		3		2			1			21
0039 1			6											6
0043 1	4		2	7	1		11	9			1			35
0044 1	1			2	5	1								9
0047 1	2		31	1										34
0048 1	4			27	17	3	7	7	19	2	1			87
0050 1	2		1	9	6		2							20
0051 1	1		1	5			2	1	1	1				12
0054 1				2			2							4
0060 1	4													4
0062 1	2		1	23	8	1	3	9	6		1			54
0065 1	2		10	14		8	2	6	5					47
0066 1	4			1	1	3	23	1						33
0068 1							1							1
0073 1	2			2	3		1			1				9

0079 1	2			15	2		9	14		1	3			46
0080 1	4			2	1	3	26							36
0086 1	2			3	24	12	6	1	1		3			52
0087 1	1			2	16	4	2				1			26
0094 1	3		4	15	10		3	4	11		2			52
0096 1				8	29		7		4		1			49
0099 1							7				1			8
0101 1			16	1										17
0102 1	33		9	18	14	5	2	4	3	2	1			91
0104 1	16		1	20	1	3	3			7				51
0105 1				6	20	15	2	1	4					48
0106 1	2			1	7	14	36	1	3		3			67
0108 1			15	10	20	12	2	18	1		1			79
0109 1				7	10		2	2	2					23
0110 1				6		1	4	1	1					13
0110 2	1			9		2	3		1		1			17
0112 1			1	7	37	1	2	1						49
0113 1	7		3	13	26	5	15	7	30	9				115
0114 1	3		33	31		2	10	4			2			85
0117 1	2		1	2	1	1								7
0118 1	3		2	11	36	23	5	8			1			89
0122 1	11		14	17	1	5	13				1			62
0123 1				2		1	2	1			1			7
0123 2				2	16	9	2			2	5			36
0128 1	12		4	8	65	6	12	19			7			133
0130 1					17		17							34
0132 1	4		4	13	8			1	4		2			36
0133 1	5			7	46		24			7	4			93
0134 1	9		12	51	30	11	15	1	1	10	3			143
0136 1	4			26	7	5	30	5		1				78
0137 1	1		1	6	12		6		13		2			41
0137 2	1			2		7	2	2	1	1	1			17
0139 1				1			2		1					4

0140 1			3	1	14		12							30
0143 1	2			11			3		1					17
0144 1				3	2	17	6							28
0145 1	2		8	16	27			31	23					107
0146 1				56	17	1	5		7					86
0149 1				1			2		24	1				28
0150 1				1		1	2		1					5
0151 1	2			18						1				21
0152 1	5			5		2	1	1						14
0154 1	6		2	7	8	1	5	2		8				39
0156 1	5		1	12			3	8	8	2				39
0161 1	1			8		1	3	4	4					21
0161 2	1			14			4	3	4	1	1			28
0162 1	1					1	3		11					16
0163 1	1			2		1	2	3			1			10
0163 2	1			19	10	8	13		5		1			57
0164 1	2			6			2		5		2			17
0165 1				2	32	1	2				3			40
0166 1	5			3			18	2			2			30
0167 1	3			2	6		1	1			1			14
0168 1	2			5	16						1			24
0171 1			2	41	5	5	3		3	1	1			61
0172 1											2			2
0173 1	5			2	1	5				1				14
0174 1	2			2	9		7	2	1					23
0175 1	10		4	22	1	4	5	7		3				56
0176 1				3	22		9		1					35
0177 1	7		2	9	1	1	34	21		1	2			78
0180 1				4		1	2		2					9
0181 1			10	9	15	1	3	3	2					43
0182 1				4	13	1	4		4					26
0183 1	1		1	4	43	4	2		10					65
0184 1	3			12	26	1		1	1					44

0185 1	18			5	26	3	22	7	2	5	1			89
0186 1				1			24							25
0186 2	2			2			2							6
0187 1	1		38	4	39	39	2	1	13		3			140
0188 1	2			1		2	2	2	3		1			13
0189 1	5		5	7	10	2	3	2	3		2			39
0190 1	4		1	3	14	17	2	1						42
0191 1	6		1	15	47	8	16	7	12					112
0192 1	1		10	16	43	1	3	15	1		5			95
0193 1	1		2	3	20									26
0194 1	1			2	21	2	2		8		1	1		38
0195 1	1		37	1	16		2		4		1			62
0196 1	3		5	10		3	8	7	13					49
0196 2	4		14	17	6	1	3	5	3	3				56
0197 1	25		9	2	46			1			1			84
0199 1				1			2		2					5
0201 1				1	1	8	9							19
0202 1				1	1	4	2		6					14
0203 1				1	4	4	2		1	1				13
0204 1	2				3	24	30				1			60
0206 1	4		26	34	69	8	37				4			182
0207 1	7			1	4					1				13
0209 1	18		25	36	21	2	20							122
0210 1	5		7	22	32		13	1		1	4			85
0211 1	5		6	1	16	24		1		1	2			56
0212 1	4		2	20	61	18	1				1			107
0213 1	5		1	1	10	2	2			1	2			24
0214 1				4			2			1	1			8
0215 1				1		27	2	25			1			56
0216 1			1	1	7			4	1	1				15
0217 1			1	4	1	9								15
0218 1	3		5	9	8		10	1	6		1			43
0219 1	3			6	17	4	3	2		1				36



0220 1	2		2	1	6	25	2		4	1				43
0222 1	1			1			2							4
0223 1	12	7	20	40	103	10	61	3	21		5			282
0224 1	46	8		157	67	3	2	25	30		5			343
0225 1	1			4	39	1	2	1	2		1			51
0226 1	5			2	6	54					2			69
0227 1				3			2	1	2					8
0228 1				26		4	5	1	14					50
0229 1				13	68	2	3		12		1			99
0230 1	11			24	1		6	4						46
0231 1	9			12	1		6	5		2	3			38
0232 1				2	11	9	2				1			25
0233 1	2			4			4	2			1			13
0234 1	1		1	29	1	1	3	3		5	7			51
0235 1				15	14	11	1	4	5		3			53
0236 1	7		2	17	5	12	27							70
0237 1					23	3	2		2		1			31
0238 1	4		1	1			11	1	3		1			22
0239 1	6		1	35	1	2	9	4		6				64
0240 1	2		1	17	9	5	15	1			2			52
0241 1	4			2			2	9						17
0242 1	4			8	23	10	2	1						48
0243 1	1		1	2			2							6
0244 1	2		1	32	12		47	1		1				96
0245 1	10			1				1		1	1			14
0246 1	3			146	7		6	4	2		3	1		172
0247 1	10		2	2		3	4	1		3	1			26
0248 1	13		1	5	6	4	7			1	2			39
0249 1	2			11	16		21	2			3			55
0250 1				1			2	1	1		1			6
0251 1	1		8	23	27	13	9	7	20	1				109
0252 1	2				11	6		2		1	1			23
0253 1	2		1	6			2				1			12

0254 1	1		2	119	11	1	1			1	2			138
0256 1					11		2				2			15
0257 1	3			9	34	1	5		18					70
0258 1	1		2	4		1	2							10
0259 1	2			18	15		4		4		3			46
0261 1	7		8	17	11	16	5	10	19					93
0262 1	10			14	2	5	7	4		1	1			44
0263 1	14		1	7	7	3	2	1		8				43
0264 1	4			12	1		5	8			1			31
0265 1	10			6		1	1	1						19
0268 1			11	8	20	2	9	2	1		1			54
0269 1	10		15	32	3	11	5	11	1	2				90
0270 1	1		14	33	1		3		8		1			61
0271 1	3			29	21	1	6		8		3			71
0272 1	5			6	23	1	4	1	26		2			68
0273 1	1		1	4	45		3		2					56
0274 1	3			14	22	5	1	1	23	1	2			72
0275 1	2		7	18	85	1	1							114
0276 1	3		1	9	5		1	1			2			22
0277 1	2			8	1	2	1	1			2			17
0278 1	1			3	4	1	1	2			1			13
0279 1	8				7									15
0280 1	7		30	1	1		3	4						46
0281 1				4	18		2		56					80
0282 1	10		7	18	30	4	3	4	22	10				108
0283 1	2		41	30	15	2	3	4	9					106
0284 1	2		1	15	6		6	5		3				38
0285 1	1		12	32	2	2	3	3	5	4	1			65
0286 1	24		19	20	10	5	16	6		3	5			108
0287 1	3			6	31	35			6		1			82
0289 1			2	2			22	2	1					29
0291 1	19		20	4	8	2	3							56
0292 1	2		2	14	21	2	5		4	6	1			57

0293 1					28		2				1			31
0294 1	1		1	34	9	1	10	4		3	1			64
0295 1	1			4	7		2				1			15
0296 1	5			1			2		4					12
0297 1				3	29		2		1		1			36
0298 1				1	43	1	2		9		3			59
0299 1	5		5	40	6		11	2	4	1				74
0301 1			2	37	2	7	2		3		1			54
0302 1	1		10	4	1	5	8	4	2	1				36
0303 1	3		7	15	48		6		4		1			84
0304 1	3			1		5	1	2			3			15
0306 1	2			1		1	2	2	1		1			10
0308 1					1	2	2				3			8
0310 1				7		12	2		1					22
0311 1	1			4		3	2		1					11
0311 2	1			14	1	3	2	1	3					25
0312 1							2			1				3
0313 1	3		1	4		12	1				2			23
0314 1							1	2						3
0315 1				7	90	1	2		1		1			102
0316 1	2			5	58	28	2				1			96
0317 1	3		23	23	6	2	9		6					72
0318 1					4		1							5
0319 1	2		20	16		1		1	1					41
0320 1	3		2	29	11	2	4		10	4	1			66
0320 2	5		9	30	3		4	6	18	2	1			78
0321 1	1			4	7	2		8	47					69
0322 1	4		1	13	20	1	9	1	10	8	1			68
0323 1	2		37	7	7		10	2	8		1			74
0324 1	3		1	6	1		28	13		1	1			54
0325 1	2		2	17	2		3		8	2		1		37
0326 1	1				9	2	5		5	1				23
0327 1	4		10	15	12	16	16	21	19	1	2			116

0328 1	28		1	1		1	4	9	23					67
0329 1	2		1	26	25	17	5	1			3			80
0330 1	8		1	24	13	1	40	4		5	1			97
0331 1				2	33		2	1	2		2			42
0331 2	2			4	2		29	5	13		1			56
0332 1				1			2							3
0333 1				2	12		9		2		1			26
0334 1				1	25		7	1						34
0335 1	8		3	15	22	3	1	1		2	1			56
0336 1			1	13	9		2		5	12				42
0337 1	3		1	1	32	5	1	1		1	2			47
0343 1				2	23	55		1	5		3			89
0344 1	2			5						1	1			9
0345 1	13		4	10	19	2	10	4	1	7	3			73
0346 1				2		14	1				1			18
0348 1				1			2	2			1			6
0349 1			3				3				2			8
0350 1	4		1	14	1	1	3	24	4					52
0351 1	5		11	23	11	3	4	2	3		1			63
0354 1			2	48	19	2	4	1	4					80
0354 2			9	29	2		8	1	13					62
0355 1	47							7	15					69
0355 2	2			17	118	6	7	1	4		2			157
0357 1	2		1	1	21	1	64	2	2		3			97
0359 1											2			2
0403 1			20	4	7	19	1		2					53
0403 2	1		3	11	20	2	15	1	5		2			60
0406 1	5		2	22	34	1	4	4	34	12	1			119
0407 1	1			4	11		8		25					49
0410 1			21	14	3	1								39
0413 1	4		24	2	23	1	2	1						57
0416 1	4			1	9	1		5	3					23
0416 2	1			2	18	5	2	3	3					34

0417 1	1			2	6		2	1			2			14
0417 2			1	8	18	1	18	2	15		1			64
0421 1				11	67				2		3			83
0428 1	1		2	4	1		4		3		3			18
0429 1	3			1	13	1	7	5	3		2			35
0430 1	1			8	39		9	1	2	1	3			64
9901 1	2		17	3			5	23	4		1			55
9904 1	18		7	33	17	2	59	27		9	2		1	175
9905 1	7		4	67	124	2		6	6	3	4			223
9907 1	1		20	99	47	6	79	15	2		5			274
9908 1				7	12		9	62	5	1	6			102
9909 1	10		9	44	2	4	24	33	8	7	4		1	146
9913 1	7		5	22	9	5	83	7	2	1	8			149
9916 1	5		6	38	16	6	30	20	4	10	1			136
9917 1	8		3	39	19	16	62	12	1		4			164
9918 1	3		5	41	16	17	110	8	2		2			204
9919 1				2	7	1	11			1	4			26
9920 1	5				2		11	19						37
9921 1	2			9	15		7	4	22		2			61
9922 1	1			7		1	1	4			1			15
9925 1	13		15	15		12	28	6	9	1	9			108
9926 1	7			12	33	7	48	61	10	7	3			188
9927 1	8		39	21	12	1	61	12	5	1	6			166
9928 1	5		15	24	54	25	57	19			3			202
9929 1	2		9	18	113	1	17	4	10	3	2		3	182
9930 1	8		15	4		13	38	8	1		2		1	90
9930 2	1		15	1		10	10	1		1				39
9931 1	3		4	41	12	5	115	9	1		4			194
9932 1			20	43	26	2				1				92
9934 1	6		6	1	28	40	5	7	13		2			108
9935 1	1		2	24	17	11		5	29					89
9936 1	5		32	40	3	19	58	12			1			170
9937 1	2		5	62	1	3	57	11	1	6	4		4	156

9939 1	10			3	28		21	41	1					104
9940 1	15			3		14	76	60	1		6			175
9942 1	9			1		9	27	55	1		3		1	106
9943 1	1				14		15	38	1		1		1	71
9944 1	1			5		4	15	48	1		1			75
9946 1	1			1			16	50	1		5			74
Grand Total	1058	15	1162	3565	3958	1208	2724	1307	1147	261	353	3	12	16773
Error #	0	1	2	3	4	5	6	7	8	9	10	12	99	
% of Total	6.3%	0.1%	6.9%	21.3%	23.6%	7.2%	16.2%	7.8%	6.8%	1.6%	2.1%	0.0%	0.1%	
WIM Total	167	0	253	730	627	236	1155	687	141	52	96	0	12	4156
Percent	4.0%	0.0%	6.1%	17.6%	15.1%	5.7%	27.8%	16.5%	3.4%	1.3%	2.3%	0.0%	0.3%	

**Table 2 – Description of Error Codes**

<b>Error Code</b>	Description of Error Codes Numbers
0	Software problem with Polling System
1	Error while initializing modem.
2	Poll4Modem.exe is not responding.
3	Counter phone answered but modems did not connect.
4	Phone on counter did not answer.
5	Phone on the counter was busy.
6	Counter's phone answered and modems connected but unable to login.
7	An error was detected during a file download.
8	The specified file was not found on the counter.
9	Upload to the TTMS Server failed.
10	Unknown error.
99	Software of the polling system crashed

**Appendix E**

**Interim Report**

**“Field Testing of TTMS Lightning Surges”**



**Interim Technical Report**

**Field Testing of Telemetered Traffic Monitoring Site  
Lightning Surges**

**PROJECT:**

**Electrical Engineering Support for TTMS  
(FDOT Contract No. BC-543 RPWO 3, FSU Project No. 613056039)**

**Submitted by:**

**FAMU-FSU College of Engineering  
2525 Pottsdamer Street  
Tallahassee, FL 32310-6046**

**Principal Investigator:**

**Bruce A. Harvey, Ph. D., Associate Professor  
Department of Electrical and Computer Engineering  
Phone: (850) 410-6451  
Fax: (850) 410-6479  
Email: [bharvey@eng.fsu.edu](mailto:bharvey@eng.fsu.edu)**

## Executive Summary

The Florida Department of Transportation (FDOT) Transportation Statistics Office currently collects traffic data from over 300 permanent telemetered traffic monitoring sites (TTMSs) distributed over the State of Florida. The State of Florida, known as the lightning capital of North America, is a harsh environment for electronic equipment such as TTMS telecommunication and traffic monitoring equipment. The goal of this effort was to characterize the number and magnitude of lightning surges experienced through the telephone lines and in-pavements sensors at the TTMS sites. The objective was to aid the FDOT in specifying and selecting appropriate surge suppressors to protect the sensitive electronic equipment in the TTMS cabinets.

In the initial phases of this effort surge counters were installed to count the number of lightning surges incurred through the telephone lines connected to the TTMS cabinets. This effort was a continuation of the effort from a previous project. The combined results of the telephone line surge counting efforts were a total of 4,897 surges recorded over 192 days of testing. This is an average of 25.5 surges per day with up to 461 surges in a single day. The surge suppressors needed to protect the telecommunications equipment at the TTMS sites needs to be able to endure 1,000s of lightning surges in order to prevent excessive repairs at the over 300 TTMS sites in Florida.

The second phase of the effort was to count and quantify the lightning surges incident through the in-pavement sensors (loops and piezoelectric sensors) at the TTMS sites. The first part of this effort was to count the number of surges using an over-voltage detector and event logger. The results of these counts were 206 surges counted over 785 test days for an average of 0.26 surges per day on loop detectors and 199 over 471 days for an average of 0.44 surges per day for piezoelectric sensors. However, in the last summer of this effort a surge measurement system was developed that could record the magnitude of the currents produced by the lightning surges. The surge current measurement system recorded more detailed information and had a higher bandwidth than the in-pavement surge counting system. The results from the surge current measurement system revealed a more complex surge environment than was indicated by the surge count system. The results indicated that a single lightning stroke can result in multiple surge peaks, each equivalent to a surge produced in laboratory testing. The surge current measurement system recorded a total of 2953 surge peaks on the 3 loop sensors tested over a combined 380 test days for an average of 7.77 surge peaks per day. Also recorded were 4155 surge peaks on the single piezoelectric sensor tested for 127 days for an average of 32.7 surge peaks per day. The peak surge current measured was 2,679 Amps.

The results of this research indicated that surge suppressors for both telephone and sensors needs to be rated to endure 1,000s of lightning surges in order to ensure the reliability of the TTMS sites. Suppressors have been recommended that have been tested to endure at least 10,000 surges without failure. Further testing is needed to determine the maximum rated surge current for surge suppressors and to provide a more complete characterization of the lightning surges experienced by the TTMS equipments.

The benefits to the FDOT from this research are improved surge suppressor specifications and recommended suppressors for implementation. The implementation of appropriate surge suppressors can potentially save in the cost of the suppressors installed through proper selection, and also save significantly in the cost of repairing sites damaged by lightning surges.

## Table of Contents

Executive Summary .....	E-3
Table of Contents.....	E-5
List of Figures and Tables .....	E-6
1. Introduction.....	E-7
2. Field Tests to Count Lightning Surges through Telephone Lines .....	E-8
2.1. Telephone Line Lightning Surge Count Equipment.....	E-8
2.2. Telephone Line Field Tests.....	E-10
2.3. Results of Telephone Line Surge Counts.....	E-11
3. Field Test to Count Lightning Surges through In-Pavement Sensor .....	E-12
3.1. In-Pavement (Low-Voltage) Sensor Lightning Surge Count Equipment.....	E-13
3.2. In-Pavement Sensor Lightning Surge Count Field Tests.....	E-14
3.3. Results of In-Pavement (Low-Voltage) Surge Counts .....	E-17
4. Field Tests to Measure the Magnitude of the Current of In-Pavement Sensor Lightning Surges.....	E-20
4.1. Lightning Surge Current Measurement Equipment.....	E-20
4.2. 2007 Surge Current Measurement System Design and Field Testing .....	E-20
4.3. 2008 Surge Current Measurement System Design and Field Testing .....	E-23
5. Conclusions and Recommendations .....	E-33
6. Benefits to the FDOT.....	E-34

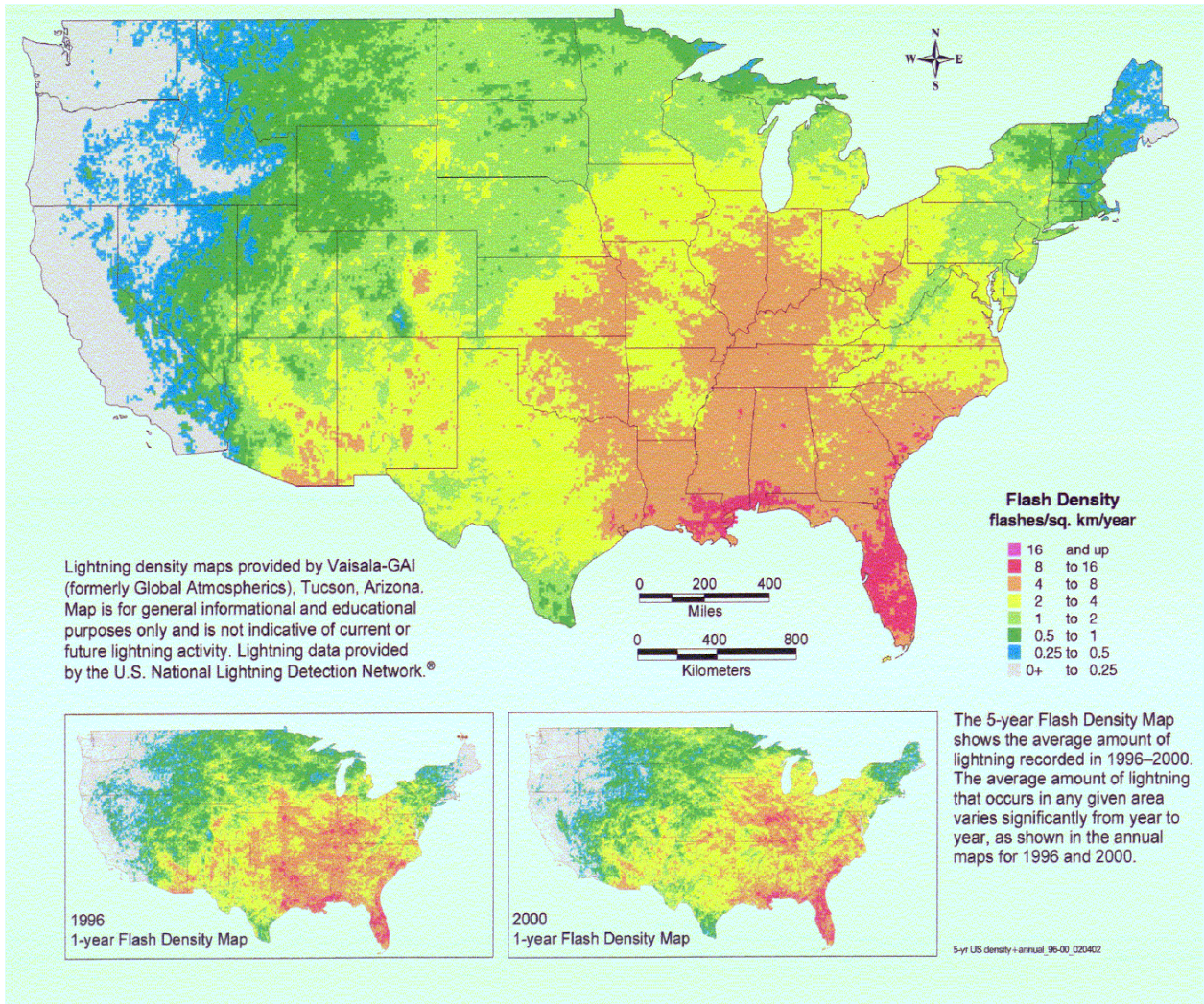
## List of Figures and Tables

Figure 1. Lightning Density Map for the United States.....	E-8
Figure 2. MetraHit Multimeter .....	E-9
Figure 3. MetraHit Multimeter and Software .....	E-9
Figure 4. Typical MetraHit Meter Setup.....	E-10
Figure 5. HOBO H07 Event Logger .....	E-13
Figure 6. Interface Electronics for Low-Voltage Surge Counter.....	E-13
Figure 7. Surge Current Measurement System used in 2007.....	E-22
Figure 8. Pearson Model 101 Current Sensor .....	E-23
Figure 9. Surge Current Measurement System used in 2008.....	E-25
Figure 10. Example of 3 Lightning Surges Recorded.....	E-26
Figure 11. Example of a Surge Cluster .....	E-27
Figure 12. 2008 Surge Data and Peak Surges for Piezoelectric Sensor at Site 86 .....	E-28
Figure 13. 2008 Surge Counts and Surge Peaks for Site 86 Piezoelectric Sensor.....	E-29
Figure 14. Comparison of Surge Peaks and Surge Counts during an Active Thunderstorm .....	E-29
Figure 15. Comparison of Surge Peaks and Surge Counts during a Small or Distant Thunderstorm.....	E-30
Figure 16. Comparison of Surge Peaks and Surge Counts for an Intense or Close Lightning Strike .....	E-30
Figure 17. Surge Cluster for the Largest Surge Peak Recorded in 2008 .....	E-33
Table 1. 2004 Telephone Line Surge Count Field Tests .....	E-11
Table 2. 2005 Telephone Line Surge Count Field Tests .....	E-11
Table 3. Telephone Line Surge Count Results .....	E-12
Table 4. 2005 In-Pavement Sensor Surge Count Field Tests .....	E-15
Table 5. 2006 In-Pavement Sensor Surge Count Field Tests .....	E-15
Table 6. 2007 In-Pavement Sensor Surge Count Field Tests .....	E-16
Table 7. 2008 In-Pavement Sensor Surge Count Field Tests .....	E-17
Table 8. Loop Detector Lightning Surge Count Results.....	E-18
Table 9. Piezoelectric Sensor Lightning Surge Count Results .....	E-19
Table 10. 2008 In-Pavement Sensor Surge Count Field Tests .....	E-24
Table 11. Summary of 2008 Sensor Surge Count Field Test Results.....	E-32

## 1. Introduction

The Florida Department of Transportation (FDOT) Transportation Statistics Office currently collects traffic data from over 300 permanent telemetered traffic monitoring sites (TTMSs) distributed over the State of Florida. The task of maintaining the TTMSs is complicated by lightning surges that can damage the communication and sensor equipment installed in these sites. The state of Florida often referred to as the lightning capital of North America (see Figure 1 for a lightning flash density map for the 48 contiguous states). Telephone lines and in-pavement sensor are vulnerable to currents induced by nearby lightning strikes in addition to the less frequent direct strikes. Thus the equipment in this state needs to be well protected by surge suppressors to reduce the risk of equipment damage and subsequent data loss. These suppressors take the most, if not all, of the large currents and shunt them to ground, in effect protecting the equipment from unwarranted currents. Sometimes the suppressors are damaged by the large currents and must be replaced. The goal of this effort was to quantify the frequency and magnitude of lightning surges experienced by the telephone lines and in-pavement sensors. This effort and the associated task of testing surge suppressors will aid the FDOT in selecting appropriate surge suppressors for use in the TTMS equipment cabinets.

This research effort included three (3) different types of field testing over 5 years. The first type of test was intended to count the lightning surges experienced through the telephone lines used to communicate with the TTMS count and classification equipment. The second type of test was designed to count the number of lightning surges induced in the loops and piezoelectric sensors installed in the pavement. These first two (2) types of tests recorded incidents where the magnitude of the input voltage exceeded normal ranges. The third type of test expanded the effort to attempt to record the magnitude of the surge currents arriving from the in-pavement sensors. The results of these tests are then used to define parameters and requirements for surge suppressors needed to protect the electronic equipment installed in the TTMS cabinets. Proper selection of the surge suppressors will reduce the number of failures at TTMS sites and thus reduce the cost of maintenance of the TTMS equipment.



**Figure 1. Lightning Density Map for the United States**

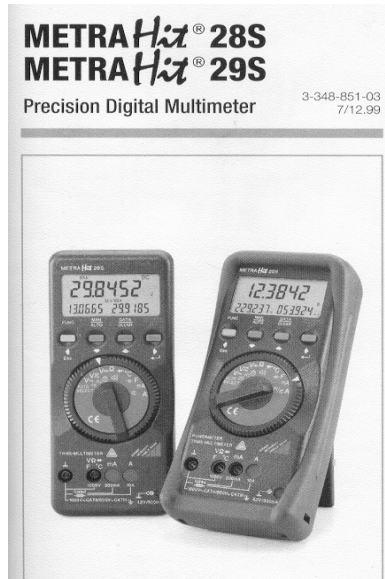
## **2. Field Tests to Count Lightning Surges through Telephone Lines**

The field tests to count the lightning surges entering the TTMS cabinets through the telephone lines were a continuation of the efforts begun under the previous project funded by the FDOT (FDOT Contract No. BC-596, FSU OMNI No. 010295).

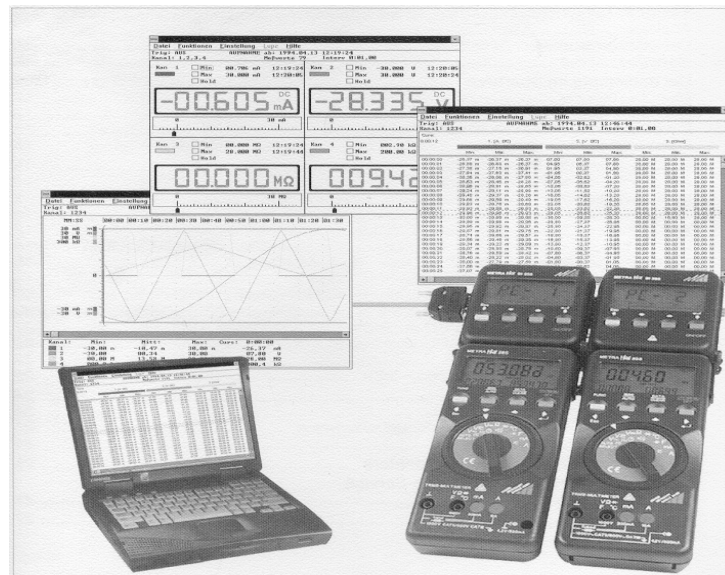
### **2.1. Telephone Line Lightning Surge Count Equipment**

Two MetraHit 29S hand-held data-logging meters (see Figures 2 and 3) were purchased. These meters were designed to be used to measure and record over and under voltage events on electrical power systems. By adjusting their trigger thresholds these meters were able to detect surges on a telephone line. The units were installed at the TTMS sites detected voltages above the normal required voltages (50 Vdc + 90 Vac). The unit setup involved connecting one probe to the gas tube of the surge suppressor and the other end

of the probe to ground (see Figure 4). The MetraHit 29S can record pulses  $\geq 5 \mu\text{Sec}$  and  $> 200\text{V}$ , the minimum threshold setting. Not only can the meter store pulses with magnitude, but also records the date and time. Collecting this data can provide a clearer picture of the lightning environment at the TTMS sites, particularly whether the sites are experiencing an occasional extremely large current surge or a large number of smaller surges.

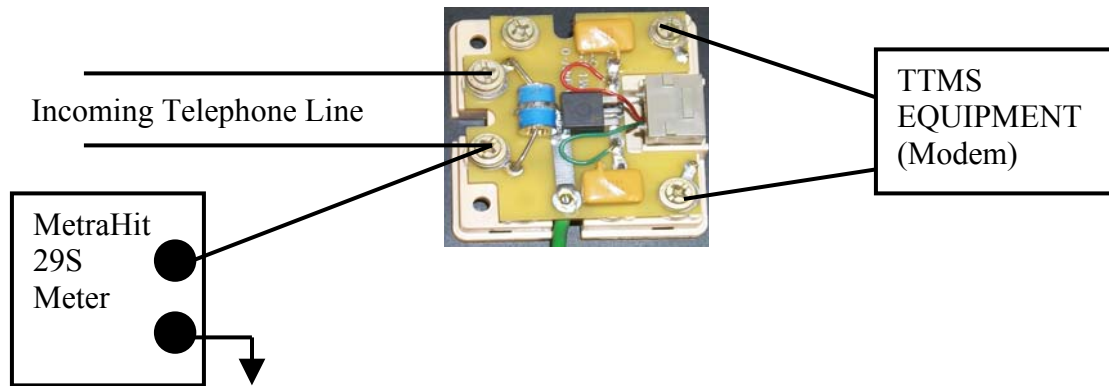


**Figure 2. MetraHit Multimeter**



**Figure 3. MetraHit Multimeter and Software**





**Figure 4. Typical MetraHit Meter Setup**

The internal batteries of MetraHit meters did not have sufficient capacity to operate the meters for the length of time necessary for a meaningful test (hours instead of days). Therefore an external 4.5 Volt power supply was needed to supply the meters. Voltage regulators were purchased to obtain 4.5 Volts from a 12 Volt battery supplied by the FDOT. A separate 12 Volt battery was installed to power the meters during testing to avoid excessive loading of the TTMS site battery. A typical 12 Volt battery used by the FDOT was found to supply a MetraHit 29S for over 1 month.

## **2.2. Telephone Line Field Tests**

The lightning count field tests were conducted during the peak lightning months in the summer (June – September). Sites for installation were selected from TTMS sites indicated by the FDOT as having a high incidence of lightning-related problems.

### *Summer 2004 Field Tests*

The FDOT provided five TTMS sites for surge counting in the summer of 2004. The sites are:

- Site 320-2: I-75 near Lake City;
- Site 204: SR528 (Beeline) Orlando;
- Site 343: I-4 near Longwood;
- Site 292: I-95 near Bunnell; and
- Site 96: SR9 near North Miami Beach

The field tests conducted in the summer of 2004 are summarized in Table 1. Data collection was hampered by some unexpected problems. During the testing at site 320-2 the meter was programmed incorrectly. This was resolved prior to tests at the other sites. During the tests at sites 292 and 96 the meters discontinued operation unexpectedly without collecting any meaningful data. The cause of the meter shut downs is suspected to be due to excessive temperature. The meters are only rated for operation up to 50°C (122°F) and have been used for over 3 years for these field tests.

**Table 1. 2004 Telephone Line Surge Count Field Tests**

Site #	Installation Dates	Dates of Data Collection	Comments
320-2	6/17 – 7/1/ 2004	None	Programming error.
204	7/2 – 8/4/2004	7/2 – 8/4/2004	
343	7/8 – 8/4/2004	7/8 – 8/4/2004	
292	8/4/2004 – 10/8/04	None	MetraHit Meter shut down for unknown reason.
96	8/4/2004 – 10/8/04	None	MetraHit Meter shut down for unknown reason.

*Summer 2005 Field Tests*

The sites selected for installation of the telephone line surge counters were

- Site 130: I-4 near Orlando; and
- Site 194: I-75 near Tampa.

The field tests conducted in the summer of 2005 are summarized in Table 2. Again, the MetraHit meters shut down before the end of the testing periods. At site 130, the meter operated properly for 15 days and then stopped collecting data. At site 194, the meter shut down shortly after installation without collecting any meaningful data.

When the telephone line surge counter was retrieved from site 194 on September 25, 2005 it was discovered that the telephone line and modem had been replaced with wireless modem. Discussions with the FDOT personnel revealed that many of the sites would transition from traditional wired telephone to wireless modems over the next several years. Therefore it was decided to end the field tests to count the surges on telephone lines.

**Table 2. 2005 Telephone Line Surge Count Field Tests**

Site #	Installation Dates	Dates of Data Collection	Comments
130	7/26 – 9/26/2005	7/26 – 8/10/2005	MetraHit Meter shut down for unknown reason on 8/10/05.
194	8/19 – 9/26/2004	None	MetraHit Meter shut down for unknown reason after less than 1 day.

**2.3. Results of Telephone Line Surge Counts**

The MetraHit meters in the telephone line surge counters recorded instances with voltage magnitudes greater than 200V. The meters were capable of detecting the pulses as close as 0.5 microseconds apart. Typically the meters record a single voltage when a surge occurs. Occasionally a lightning surge produces a series voltage spikes with alternating

sign. A series of alternating recordings separated by 0.5 microseconds are referred to as a ring surge. Note that ring surges are not entirely unexpected. In the field of power systems this effect is well documented and explained in terms of impedance mismatches (see “Electrical Transients in Power Systems” by Allan Greenwood, John Wiley & Sons, Inc., 1991).

The results for the field tests conducted in 2004 and 2005 are summarized in Table 3.

**Table 3. Telephone Line Surge Count Results**

Year	Site #	Results
2004	204	Total Surges: 14 Ring Surges: 4 Recorded Days: 31 Average Surges per Day: 0.52 Peak Surges in a Day: 8 on 7/2/04 Note: All surges occurred between 7/2 - 7/9/2004.
2004	343	Total Surges: 141 Ring Surges: 14 Recorded Days: 27 Average Surges per Day: 10.07 Peak Surges in a Day: 93 on 7/8/04 Note: All surges occurred between 7/8 - 7/13/2004.
2005	130	Total Surges: 166 Ring Surges: 13 Recorded Days: 15 Average Surges per Day: 11.07 Peak Surges in a Day: 102 on 7/28/05 Note: All surges occurred between 7/26 - 7/30/2005.

The results and recommendations from the previous project funded by the FDOT (FDOT Contract No. BC-596, FSU OMNI No. 010295) and the telephone line surge counts completed during this project led to the use of the EDCO FASTEL DOT telephone line surge suppressor. This suppressor was used in all TTMS sites where telephone line surge counts were obtained. A total of 4,897 surges were counted over 192 days of testing (an average of 25.5 surges per day with up to 461 surges in a single day) were recorded without a single failure of the lightning surge suppressor. Also, the trend in the FDOT was to replace the wired telephone lines with wireless modems. Therefore the emphasis of the lightning surge field tests was placed on the characterization of the lightning surges from the in-pavement sensors used at the TTMS sites.

### **3. Field Test to Count Lightning Surges through In-Pavement Sensor**

The in-pavement sensors used with the TTMS sites also experience failures associated with lightning surges. The in-pavement sensors (e.g. loop detectors and piezoelectric

sensors) operate at much lower voltages than the telephone lines and modems. Therefore the counter used for the telephone lines cannot be used for counting the surges from in-pavement devices. A new lightning surge counter was developed for use with loop detectors and piezoelectric axle sensors.

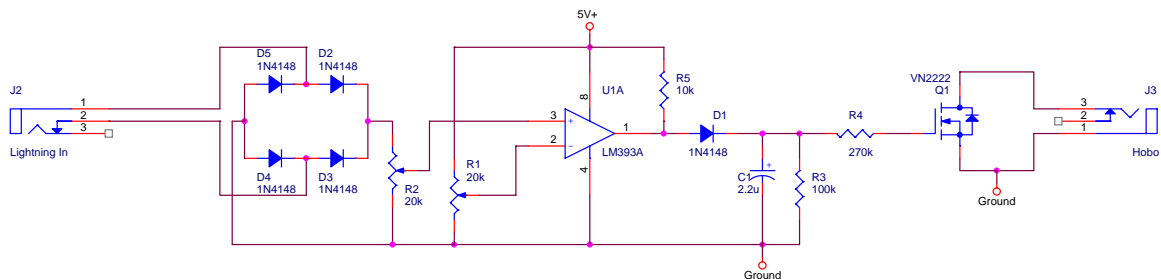
### 3.1. In-Pavement (Low-Voltage) Sensor Lightning Surge Count Equipment

A HOBO H07 Event Logger (Figure 5) from Onset Computer Corporation was used to record the lightning surges from the in-pavement sensors. The HOBO H07 is designed to log the time and date of a contact closure. It is capable of recording contact closures separated by as little as 1/2 second.



**Figure 5. HOBO H07 Event Logger**

An interface circuit (Figure 7) was designed to simulate a contact closure whenever the input voltage exceeds a given threshold. The circuit uses a full-wave rectifier to ensure a positive voltage is applied to a threshold detector. The threshold detector is followed by a peak hold circuit that holds the detection long enough for the event to be recorded. The time constant for the peak hold is 0.22 seconds. The output of the peak hold triggers a transistor that acts as an electronic switch to simulate the contact closure for the H07 event logger.



**Figure 6. Interface Electronics for Low-Voltage Surge Counter**

The HOBO H07 is powered by an internal battery and the interface electronics are powered by a 12V battery with a 5V regulator. This low-voltage counter can operate for

over 90 days between battery charges. The threshold voltage chosen for this counter was 15V. This voltage is higher than the expected voltages from the in-pavement sensors, but lower than the clamping voltages of the lightning surge suppressors used at the TTMS sites tested.

The limitation of this design is the speed at which the counter can record lightning surges. The telephone line surge counter detected surges less than ½ second apart and ring surges with peaks around 0.5 microseconds apart. The low-voltage surge count system used for this test will not distinguish between surges less than 0.5 seconds apart and will not be able to detect the ring surges. Further analysis of the circuit indicates that surges generating larger voltages can increase the delay between measurable surges to as much as nearly 6 seconds. Therefore, the count data recorded with this system will tend to undercount the total number of lightning surges. However the system is still useful in determining how often the in-pavement sensor are experiencing 1 or more lightning surges in a short amount of time. Analysis of the data from the field tests indicates that this counter was able to detect some surges separated by only 0.5 seconds; however some surges separated by 0.5 -6 seconds may still have been missed.

### **3.2. In-Pavement Sensor Lightning Surge Count Field Tests**

A total of 4 low-voltage surge counters were assembled for counting surges from in-pavement loop detectors and piezoelectric sensors. These counters were installed during the peak lightning months of the summer starting in 2005 and continuing through 2008. In each TTMS site a counter was installed on one piezoelectric sensor and one loop detector. The sites were chosen from sites recommended by the FDOT as sites where lightning problems are frequent.

#### *Summer 2005*

The sites selected for installation of the low-voltage surge counters were chosen to correspond with the installation of the telephone line surge counters. These sites were

- Site 130: I-4 near Orlando; and
- Site 194: I-75 near Tampa.

The field tests conducted in the summer of 2005 are summarized in Table 4. The low-voltage surge counters operated the full 62 days at Site 130 and the full 38 days at Site 194.

**Table 4. 2005 In-Pavement Sensor Surge Count Field Tests**

Site #	Installation Dates	Dates of Data Collection	Comments
130	7/26 – 9/26/2005	7/26 – 9/26/2005	Installed on: Loop: WB Lane 3 Lag Piezo: P5
194	8/19 – 9/26/2005	8/19 – 9/26/2005	Installed on: Loop: L1A Piezo: Lane 1

*Summer 2006*

The sites selected for installation of the low-voltage surge counters were

- Site 162: SR-60 near Tampa; and
- Site 407: SR-570 near Lakeland.

The field tests conducted in the summer of 2006 are summarized in Table 5. The low-voltage surge counters operated the full 91 days at Site 162 and the full 40 days at Site 407.

**Table 5. 2006 In-Pavement Sensor Surge Count Field Tests**

Site #	Installation Dates	Dates of Data Collection	Comments
162	6/3 – 9/2/2006	6/3 – 9/2/2006	Installed on: Loop: #4 (4 red bands) Piezo: #4 (4 black bands)
407	7/24 – 9/2/2006	7/24 – 9/2/2006	Installed on: Loop: 4B Piezo: 4

*Summer 2007*

The sites selected for installation of the low-voltage surge counters were

- Site 162: SR-60 near Tampa;
- Site 407: SR-570 near Lakeland; and
- Site 343: I-4 near Longwood.

The field tests conducted in the summer of 2007 are summarized in Table 6. The low-voltage surge counters operated the full 111 days at Site 162. The pavement was being replaced at Site 407 during the test period. No classification equipment was installed during the test and it was uncertain if the in-pavement sensor were intact. No surges were recorded and this test site was ignored in the analysis. On August 1, 2007 the low-voltage counters were removed from Site 407 and installed in Site 343 in conjunction with the newly developed surge current system (see Section 4). The low-voltage surge counters operated the full 64 days at Site 343.

**Table 6. 2007 In-Pavement Sensor Surge Count Field Tests**

Site #	Installation Dates	Dates of Data Collection	Comments
162	6/15 – 10/4/2007	6/15 – 10/4/2007	Installed on: Loop: #4 (4 red bands) Piezo: #4 (4 black bands)
407	6/16 – 8/1/2007	None	Installed on: Loop: 4B Piezo: 4 Note: No count/classify equipment, but sensors appear to be intact. Re-paving conducted during tests.
343	8/1 – 10/4/2007	8/1 – 10/4/2007	Installed on: Loop: 1A Piezo: 1+ Note: Installed in conjunction with surge current measurement system.

*Summer 2008*

The sites selected for installation of the low-voltage surge counters were chosen to correspond with the sites selected for the current measurement systems (see Section 4). The sites chosen were

- Site 162: SR-60 near Tampa; and
- Site 86: SR-600/US-92 near Saint Petersburg (west end of Gandy Bridge).

The field tests conducted in the summer of 2008 are summarized in Table 7. The low-voltage surge counters operated the full 126 days at Sites 162 and the full 127 days at Site 86. On August 11, 2008 the clocks on the in-pavement surge counters and the surge measurement systems (Section 4) were synchronized for easier comparison.

**Table 7. 2008 In-Pavement Sensor Surge Count Field Tests**

Site #	Installation Dates	Dates of Data Collection	Comments
162	6/1 – 10/5/2008	6/1 – 10/5/2008	Installed on: Loop: #3 (3 yellow bands) Loop: #4 (4 red bands) Note: Difficult to install current measurement probe on piezo sensors.
86	6/1 – 10/6/2008	6/1 – 10/6/2008	Installed on: Loop: lane 4 Piezo: lane 3

### **3.3. Results of In-Pavement (Low-Voltage) Surge Counts**

The low voltage surge counters detected when voltages on the input of the in-pavement sensor exceeded 15V. The results for the counters installed on the loop detectors are summarized in Table 8. The results for the counter installed on the piezoelectric sensors are summarized in Table 9.

The number surges recorded on the loop detector inputs was 206 over 785 test days for an average of 0.26 surges per day. The most surges recorded in any one day were 21.

The number of surges recorded on piezoelectric sensor inputs was 199 over 471 days for an average of 0.44 surges per day. This does not include the surge counts on the piezoelectric sensor in Site 130 during the summer of 2005 when the counter recorded 673 surges over 62 days. Only one (1) surge was counted on the loop detector at Site 130 over the same time period.

The number of surges induced through the piezoelectric sensors appears to be almost 70% higher than the number of surges induced through the loop detectors. However, the average number of daily surges counted for the in-pavement sensors is over an order of magnitude less than the average daily surges recorded for the telephone lines.



**Table 8. Loop Detector Lightning Surge Count Results**

Year	Site	Sensor	Results
2005	130	WB Lane 3 Lag	Total Surges: 1 Recorded Days: 62 Average Surges per Day: 0.02 Peak Surges in a Day: 1 on 8/4/05
2005	194	L1A	Total Surges: 14 Recorded Days: 38 Average Surges per Day: 0.37 Peak Surges in a Day: 7 on 8/28/05
2006	162	#4 (4 red bands)	Total Surges: 2 Recorded Days: 91 Average Surges per Day: 0.02 Peak Surges in a Day: 1 on 7/22/06 & 8/19/06
2006	407	4B	Total Surges: 28 Recorded Days: 40 Average Surges per Day: 0.70 Peak Surges in a Day: 21 on 7/24/06
2007	162	#4 (4 red bands)	Total Surges: 43 Recorded Days: 111 Average Surges per Day: 0.39 Peak Surges in a Day: 12 on 7/19/07
2007	343	1A	Total Surges: 8 Recorded Days: 64 Average Surges per Day: 0.13 Peak Surges in a Day: 3 on 8/24/07
2008	162	#3 (3 yellow bands)	Total Surges: 34 Recorded Days: 126 Average Surges per Day: 0.27 Peak Surges in a Day: 8 on 7/17/08
2008	162	#4 (4 red bands)	Total Surges: 30 Recorded Days: 126 Average Surges per Day: 0.24 Peak Surges in a Day: 6 on 7/17/08 & 8/5/08
2008	86	Lane 4	Total Surges: 46 Recorded Days: 127 Average Surges per Day: 0.36 Peak Surges in a Day: 7 on 6/24/08 & 7/7/08
		<b>TOTAL</b>	<b>Total Surges: 206</b> <b>Recorded Days: 785</b> <b>Average Surges per Day: 0.26</b> <b>Peak Surges in a Day: 21</b>

**Table 9. Piezoelectric Sensor Lightning Surge Count Results**

Year	Site	Sensor	Results
2005	130	P5	Total Surges: 673 ** Recorded Days: 62 Average Surges per Day: 10.85 Peak Surges in a Day: 138 on 8/20/05
2005	194	Lane 1	Total Surges: 40 Recorded Days: 38 Average Surges per Day: 1.05 Peak Surges in a Day: 16 on 8/21/08
2006	162	#4 (4 black bands)	Total Surges: 2 Recorded Days: 91 Average Surges per Day: 0.02 Peak Surges in a Day: 2 on 7/22/06
2006	407	4	Total Surges: 54 Recorded Days: 40 Average Surges per Day: 1.35 Peak Surges in a Day: 44 on 7/24/06
2007	162	#4 (4 black bands)	Total Surges: 33 Recorded Days: 111 Average Surges per Day: 0.30 Peak Surges in a Day: 8 on 7/19/07
2007	343	1+	Total Surges: 10 Recorded Days: 64 Average Surges per Day: 0.16 Peak Surges in a Day: 3 on 8/24/07
2008	86	Lane 3	Total Surges: 60 Recorded Days: 127 Average Surges per Day: 0.47 Peak Surges in a Day: 15 on 6/24/08
		<b>TOTAL</b>	<b>Total Surges: 872 (199) ***</b> <b>Recorded Days: 533 (471)</b> <b>Average Surges per Day: 1.64 (0.43)</b> <b>Peak Surges in a Day: 138 (44)</b>

\*\* - Data from Site 130 in summer 2005 seems

\*\*\* - Data in parenthesis does not include the surge count from Site 130 in the summer of 2005.

#### **4. Field Tests to Measure the Magnitude of the Current of In-Pavement Sensor Lightning Surges**

The in-pavement sensors used in typical TTMS installations operate at a much lower voltage (< 15V) than the telephone line. Thus the surge protectors needed to protect the lower-voltage electronics associated with these sensors needs to have lower break-over and clamping voltages. These low-voltage suppressors are often rated for lower surge currents (2,000 Amps typ.) than are the higher-voltage suppressors for the telephone lines (10 – 20 kA typ.). The field tests counting the number of lightning surges that occur through the in-pavement sensors (see Section 3) do not provide any information on the magnitude of the current surges. Also, the relatively low speed of the low-voltage surge counters used (see Section 3.1) may result in missing surges from rapid lightning strikes.

To better characterize the lightning surges occurring through in-pavement sensors and to aid in the specification of surge suppressors for the in-pavement sensors, a new lightning sensor was developed. The new sensor that was developed can measure the magnitude of the current of a lightning surge, and operated at a faster bandwidth than the previous surge counter.

##### **4.1. Lightning Surge Current Measurement Equipment**

The lightning surge measurement system consists of a programmable data logger, a current sensing device and interface electronics. The programmable data logger selected for this system was the CR800 datalogger from Campbell Scientific, Inc. The CR800 is low-power logger able to operate on a 12V battery. The logger can collect data at a rate of 100 samples per second (10 milliseconds between samples), has six 13-bit analog-to-digital converters for accurate measurements and can store data in 2 Mbytes of battery-backed memory.

The initial surge current measurement system was designed for use in the summer of 2007. It used a sensing resistor to measure the surge current. The system was redesigned for use in the summer of 2008 by changing the sensor to an inductive current monitor, and redesigning the electronics for lower noise and a wider current sensing range.

##### **4.2. 2007 Surge Current Measurement System Design and Field Testing**

The initial surge current measurement system was designed and two systems were constructed in 2007. Each system was capable of monitoring the surge currents on two separate in-pavement sensors.

One current measurement system was installed in Site 343 (I-4 near Longwood) on August 1, 2007. For comparison and verification the current measurement system was installed to monitor the same in-pavement sensors that the surge counters were monitoring (see Table 6).

The second current measurement system was installed in Site130 (I-4 near Orlando) on August 4, 2007. No surge counters were installed at this location.

### *Design of the 2007 Current Measurement System*

The initial current sensing device was a precision 1 milliohm resistor placed in series with the in-pavement sensor wire. The voltage across the sensing resistor was used to determine the input current. Large lightning current can result in the voltage at the resistor relative to absolute ground to be very large so an isolation amplifier was used to protect the data logger and the interface electronics. The interface electronics consisted of a precision rectifier, a scaling amplifier and a precision peak hold (200 millisecond time constant for  $\leq 5\%$  error in 0.01 seconds) circuit. Due to the isolation requirements, this system required two separate +/- 12V power supplies. The circuit diagram for the interface electronics is shown in Figure 7.

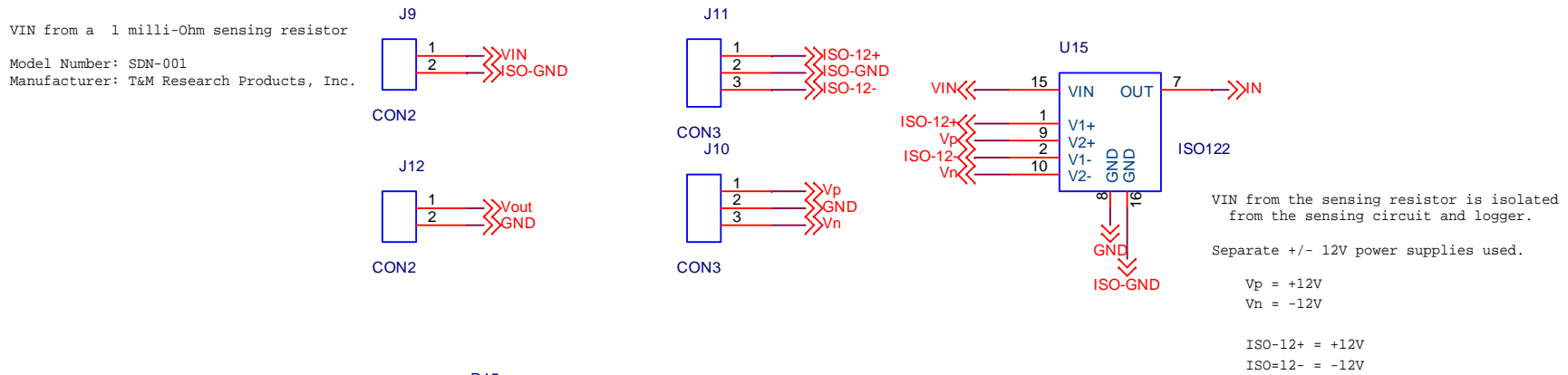
The magnitude of the surge currents expected was unknown. Therefore the system was calibrated to measure surge currents up to 10,000 Amps. The noise floor of the interface electronics limited the minimum current that could be recorded on the datalogger. To avoid recording the noise on the input, the datalogger recording threshold was set such that the minimum current recorded was 400 Amps.

### *2007 Current Measurement Field Test Results*

The current measurement systems were installed in Sites 343 and 130 on August 1 and 4, 2007, respectively. The initial power analysis indicated that this system could operate for approximately 2 months on the batteries used. On October 4, 2007 the current measurement systems were retrieved from both sites. During the process of collecting the systems it was noticed that the main battery powering the datalogger was dead. The batteries installed did not last as long as predicted. Data shows at least one battery used in site 343 died on September 15, 2007, 45 days into the data collection. Also, it appears that a battery died in site 130 on September 25, 2007, 52 days into the data collection.

The surge current measurement systems recorded no surge events at either site 343 or 130 during this field test. This indicates that the surges experienced at the sites (site 343 counted 17 surges between the 2 sensors) were of magnitude  $\leq 400$  Amps (the threshold for the surge current measurement systems), or the current measurement systems did not operate as expected.

Laboratory testing of the current measurement systems used in these field tests were conducted and it was determine that the results were sometimes inconsistent. The apparent cause was the rapid change in voltage at the sensing resistor relative to ground. It was determined that a new current sensor was needed and that this sensor needed to be isolated from the surge current.



**Figure 7. Surge Current Measurement System used in 2007**

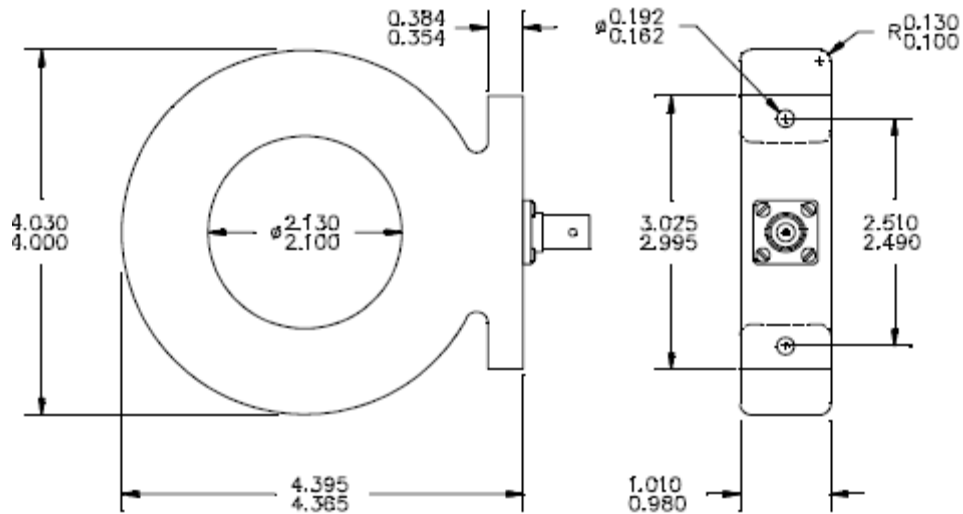
### 4.3. 2008 Surge Current Measurement System Design and Field Testing

In 2008 the current measurement systems were redesigned to correct the problems and limitations of the initial design. In the summer of 2008 the two current measurement systems were installed at two TTMS sites along with the surge counters for validation and comparison.

#### *Design of the 2008 Current Measurement Systems*

The two problems apparent in the 2007 design of the current measurement systems were the direct connection current sensor (resistor) to the in-pavement sensor inputs, and the electronics noise generated by the interface electronics. Also the complexity and size of the 4 batteries required to power the systems made installation difficult. To address these problems and simplify the systems a new current sensor was selected and the interface electronics were modified.

The new current sensor selected for the current measurement system was the Model 101 current sensor from Pearson Electronics, Inc (see Figure 8). This sensor has the useable rise time (100 ns) and the maximum peak current (50,000 Amps) necessary to measure the expected current waveform of a lightning surge. The Model 101 is an inductive sensor that is installed around the input wire from the in-pavement sensor and thus remains electrically isolated from the rapid voltage changes anticipated during a lightning surge. The output sensitivity of the sensor is 0.01 Volts/Amp.



**Figure 8. Pearson Model 101 Current Sensor**

The use of an isolated current sensor allowed for the simplification of the interface electronics and operation of the system on a single +/- 12 Volt power supply (2 batteries). The output of the sensor is passed through a precision rectifier followed by a precision high-speed peak hold circuit before being output to the data logger. The removal of the isolation amplifier and a slight modification of the electronics reduced the noise in the

interface electronics. The system was calibrated to monitor surge currents in the range of 70 to 4,000 Amps. The redesigned measurement systems were tested using the MIG0606 surge generator and found to be very stable and more accurate than the previous design. The circuit schematic for the interface electronics used in the 2008 surge current measurement system is given in Figure 9.

*2008 Current Measurement Field Tests*

The sites selected for installation of the low-voltage surge counters and the current measurement systems were

Site 162: SR-60 near Tampa; and

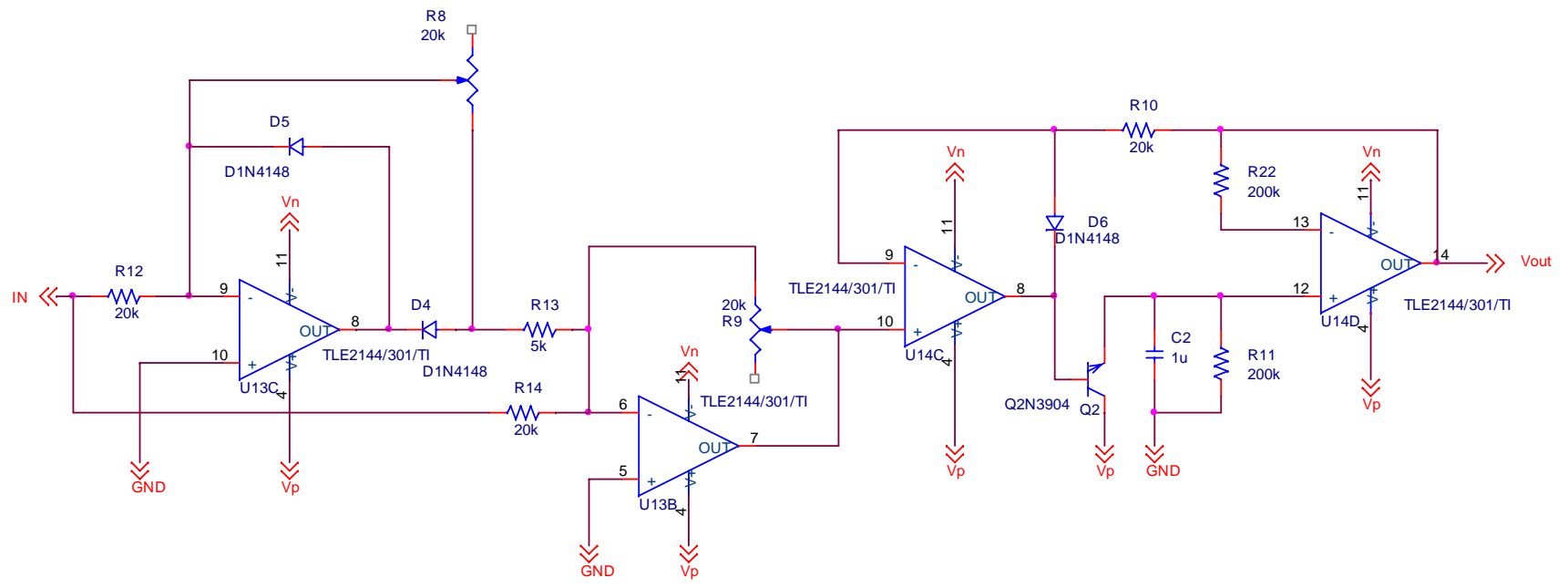
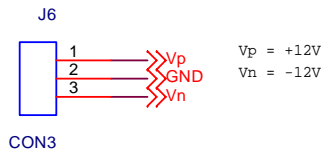
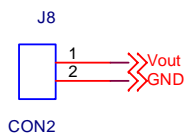
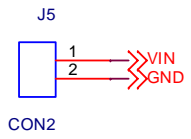
Site 86: SR-600/US-92 near Saint Petersburg (west end of Gandy Bridge).

The current measurement field tests conducted in the summer of 2008 are summarized in Table 10. The low-voltage surge counters operated the full 126 days at Sites 162 and the full 127 days at Site 86. The current measurements systems operated for 123 days at Site 162 and 120 days at Site 86. The difference in days operating between the counters and current measurement systems was due to the time needed to recharge the measurement system batteries. On August 11, 2008 the clocks on the in-pavement surge counters and the surge measurement systems (Section 4) were synchronized for easier comparison.

**Table 10. 2008 In-Pavement Sensor Surge Count Field Tests**

Site #	Installation Dates	Dates of Data Collection	Comments
162	6/1 – 10/5/2008	6/1 – 7/3/2008 7/5 – 8/10/2008 8/11 – 10/5/2008  Time gaps due to recharging of batteries.	Installed on: Loop: #3 (3 yellow bands) Loop: #4 (4 red bands) Note: The current sensor could not be installed on the piezo sensors at this site due to space and wiring constraints.
86	6/1 – 10/6/2008	6/1 – 7/3/2008 7/5 – 8/10/2008 8/11 – 10/5/2008  Time gaps due to recharging of batteries.	Installed on: Loop: lane 4 Piezo: lane 3

VIN from an inductive current monitor  
 Model Number: 101  
 Pearson Electronics, Inc.  
 Sensitivity: 0.01 Volts / Ampere

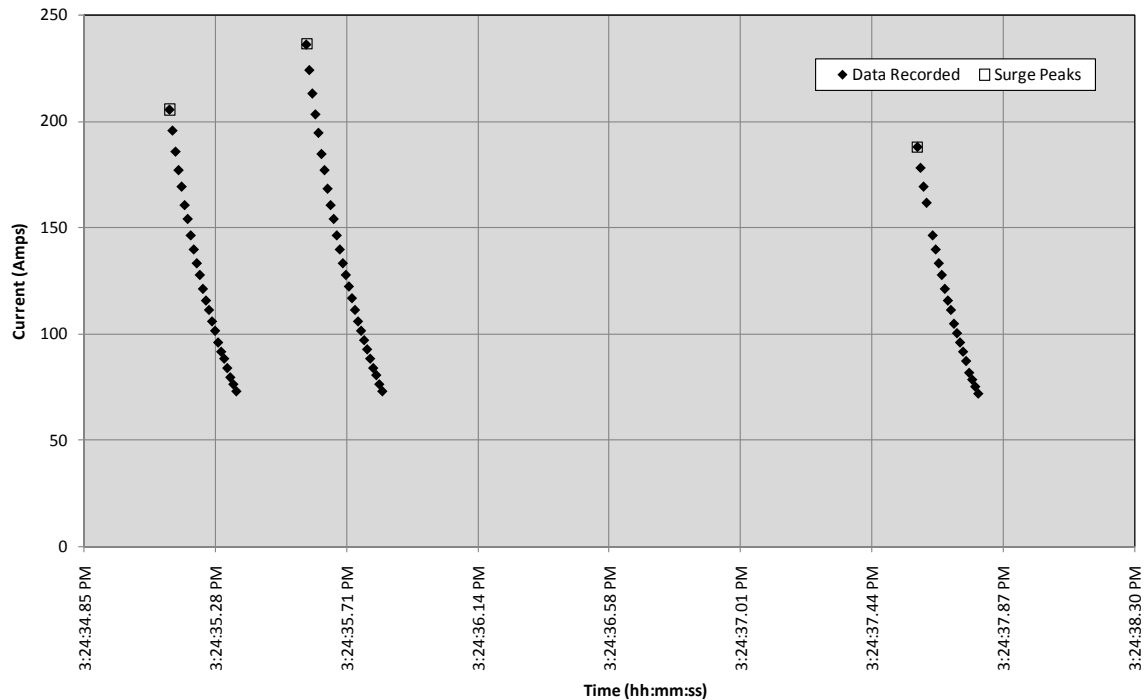


**Figure 9. Surge Current Measurement System used in 2008**



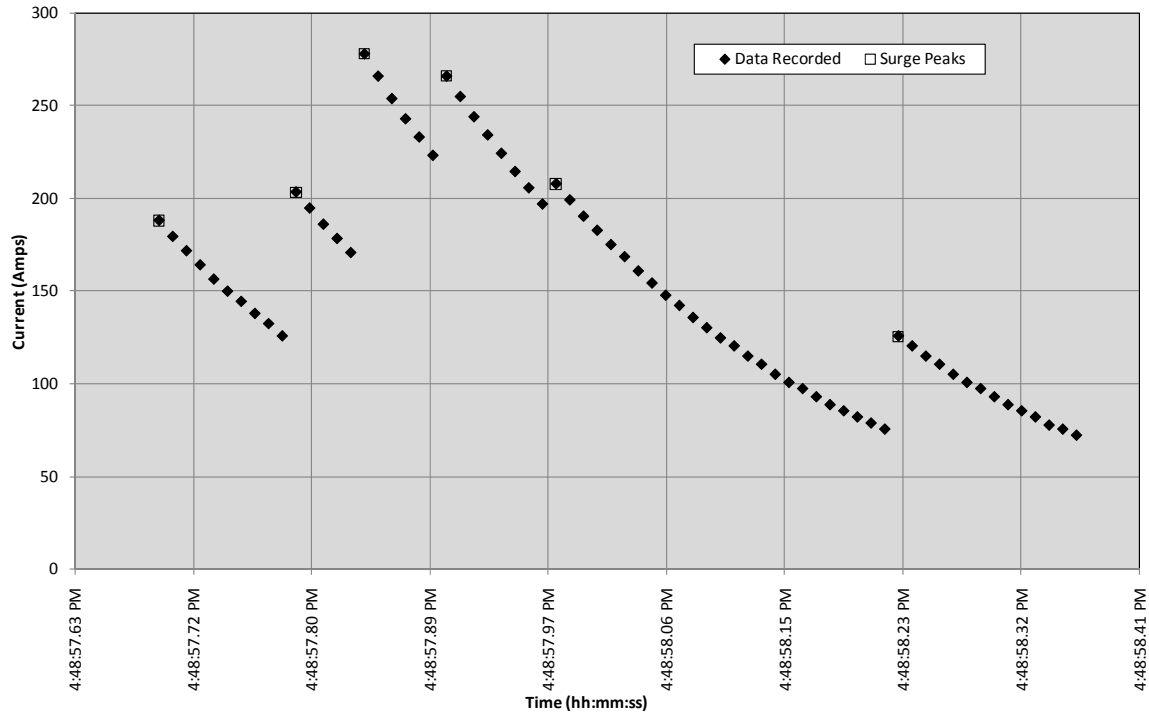
## Results and Analyses of the 2008 Field Tests

The quantity of data collected using the surge current measurement system was considerably greater than the data collected from any of the previous surge counting field tests. The ability to store the magnitudes of the surge currents at a 100 Hz sample rate provided a lot of information not previously afforded by the surge counters. Some of the data collected reflected artifacts of the peak hold circuitry used in the interface electronics. Figure 10 depicts an example of three lightning surges recorded by the surge current measurement system. Each individual sample point stored ( $> 70$  Amps detected) is identified with a solid diamond. For analysis purposes the peaks of each surge pattern recorded are highlighted with a square. The sequence of samples following each of the surge peaks is an artifact of the exponential decay in the peak hold circuitry. Time gaps in the plot indicate periods where no surge was recorded.



**Figure 10. Example of 3 Lightning Surges Recorded**

One of the more interesting discoveries from the data analysis was that some of the surges produce a cluster of surge peaks. These are likely due to the same effects that were noted in the telephone line surge counts (see Section 2.3). An example of the surge cluster is shown in Figure 11. Note that the datalogger recorded a continuous stream of samples. The first 5 peak occur with about 0.4 seconds and all six occur in less than 1 second. The first 5 peaks and possibly the 6<sup>th</sup> peak as well are likely produced by a single lightning stroke. Simply counting the peaks may over-estimate the number of lightning strokes; however, each peak represents a distinct surge. Thus counting and analyzing the surge peaks will provide a measure of the number and size of surges against which a surge suppressor must provide protection.



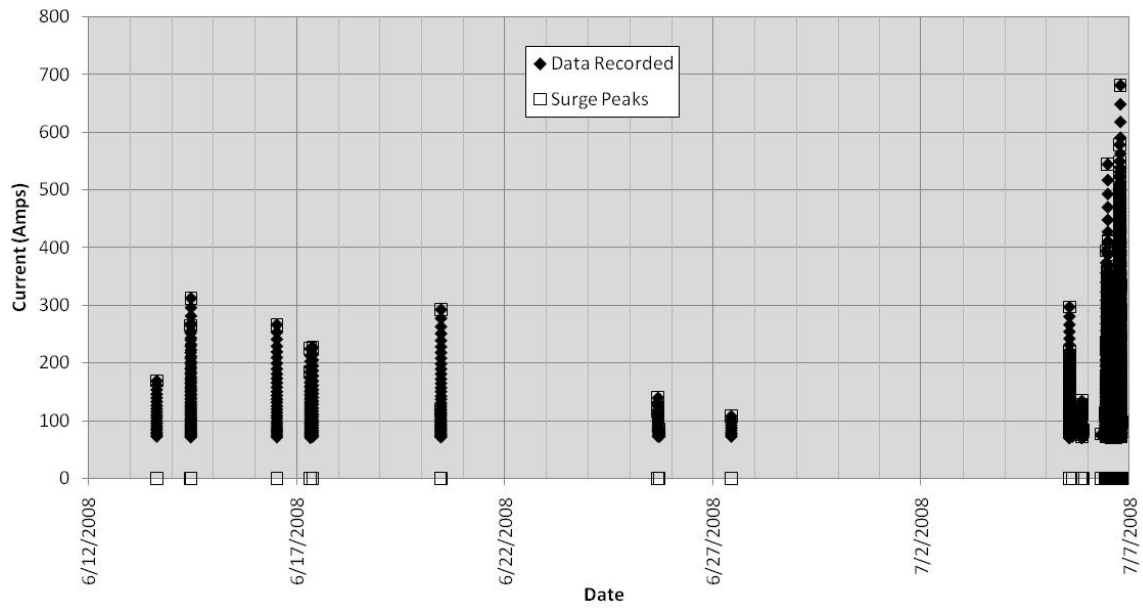
**Figure 11. Example of a Surge Cluster**

Figure 12 is a plot of the surge currents recorded and peak surges for the piezoelectric sensor in Site 86 recorded during the summer of 2008. Note that the Surge Peaks plotted with a current of 0 Amps is simply an artifact of the program generating the plot and not actual peaks recorded. This current sensor monitored the current of the surges on the active lead to the piezoelectric sensor from June 1 to August 10, 2008 and then monitored the current on the grounded lead from August 11 to October 6, 2008. Larger but less frequent surges were recorded on the grounded lead, but it is impossible to determine from this one test if the differences are due to lead monitored or the weather.

Figure 13 plots the surge peaks recorded by the current measurement system monitoring the piezoelectric sensor in Site 86 along with indicators when the corresponding surge counter recorded a lightning surge. The surge counter (see Section 3) monitoring this sensor over the same time period recorded a total of 60 surges. The total number of surge peaks recorded by the current measurement system for this same field test was 4155 with current peaks ranging from 71.05 to 2564 Amps. The surge counter appeared to count surges during the same time intervals where significant lightning surge current peaks were measured by the current measurement system.

In Figures 14, 15 and 16 the surges recorded by the surge counters (with the HOBO event logger) are compared against the surge peaks for a few cases recorded. In Figure 14 there are a large number of surge peaks were recorded by the current measurement system during a particular thunderstorm, but only 7 surges were recorded by the surge counter (HOBO). It appears from this example that the surge counter seemed to only record surges with peaks above about 500 Amps.

Surge Data and Peak Surges  
Site 86, Piezo Sensor, 6/1 - 7/6/2008



Surge Data and Peak Surges  
Site 86, Piezo Sensor, 7/7 - 10/6/2008

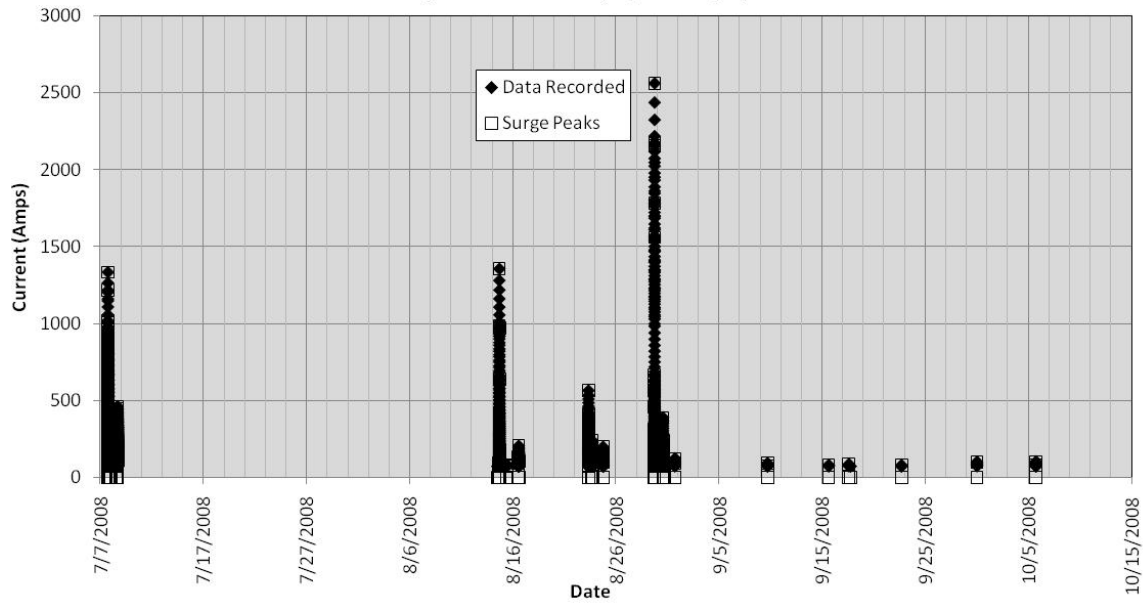
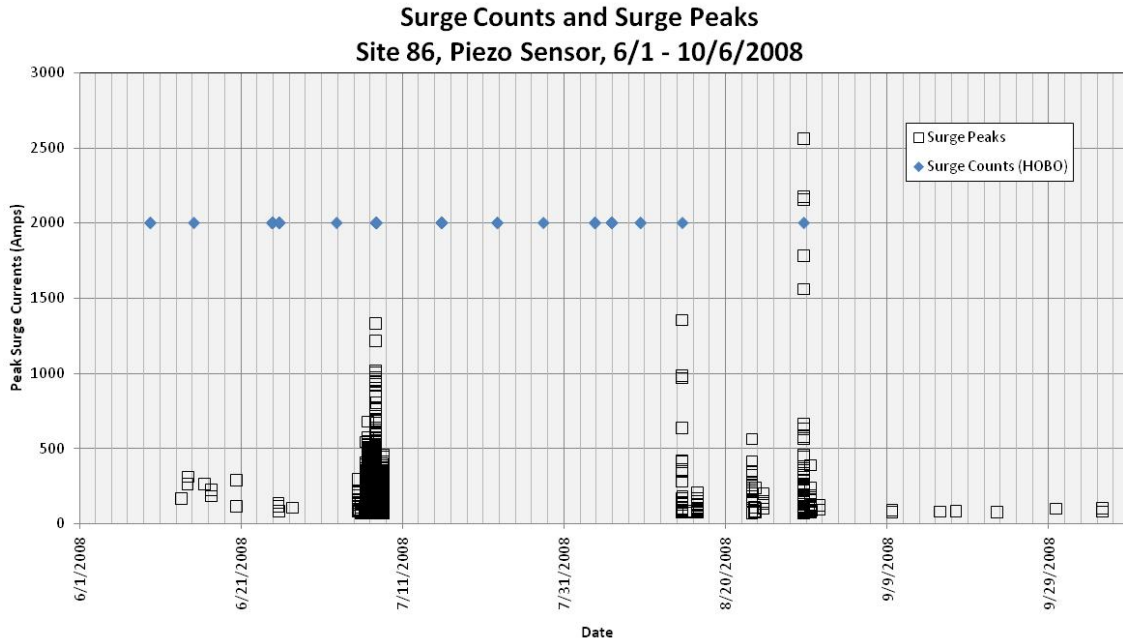
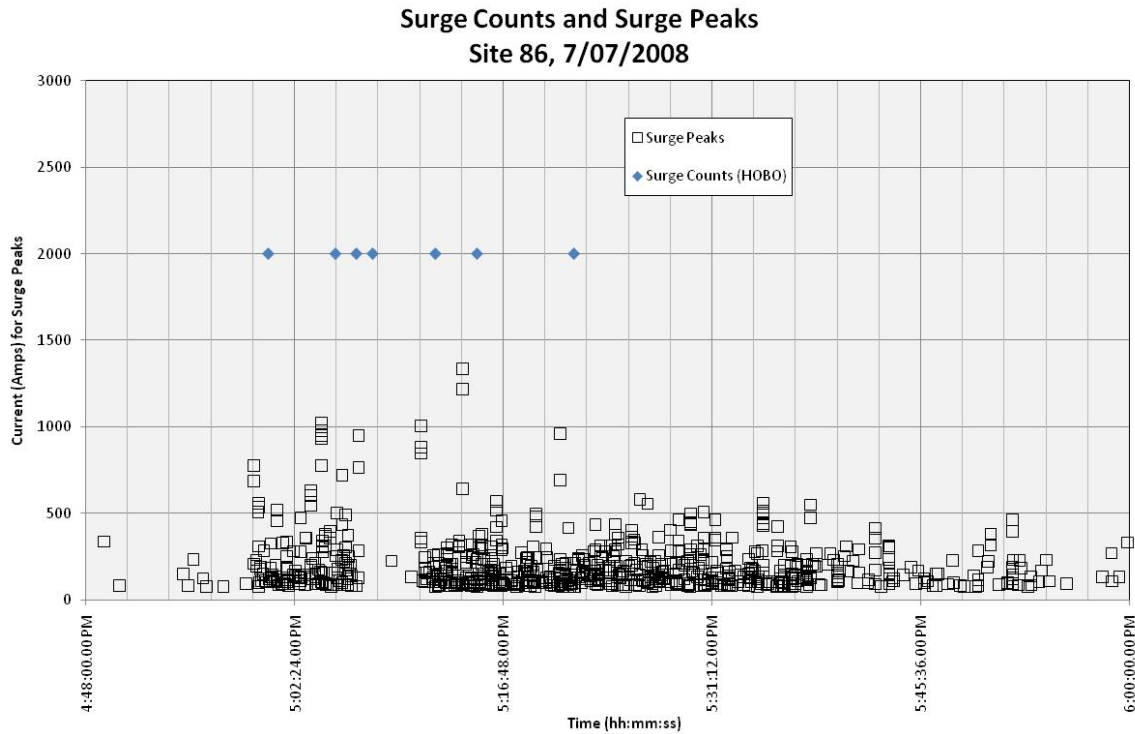


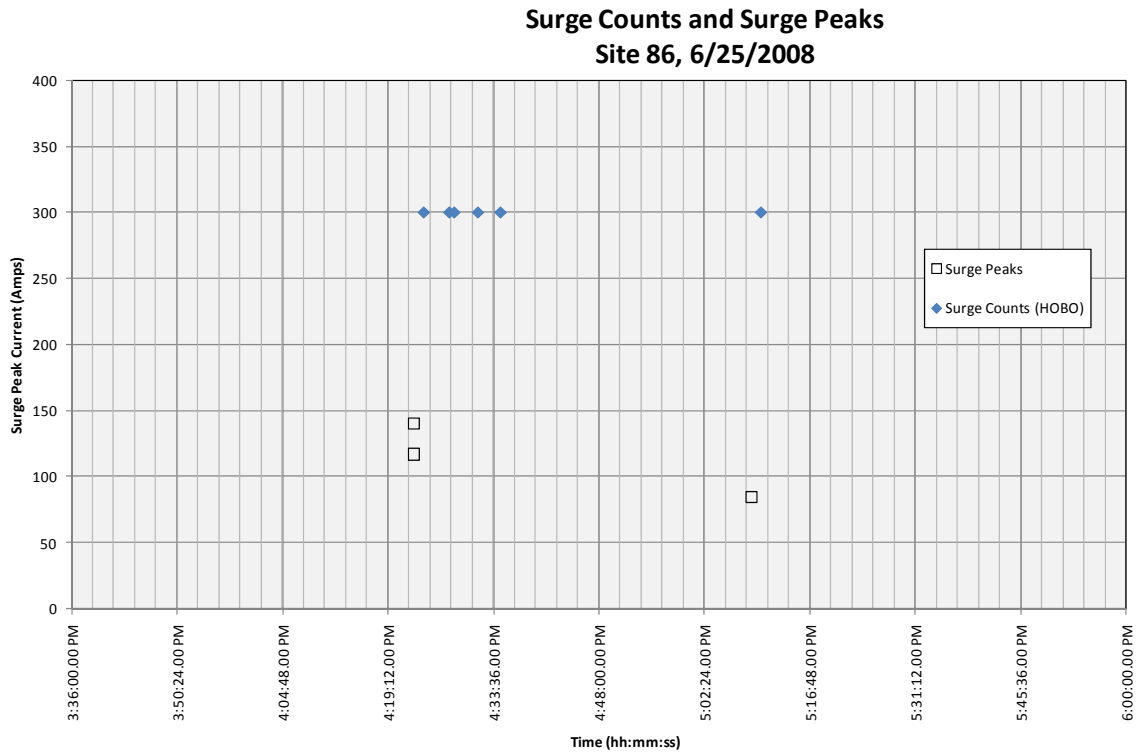
Figure 12. 2008 Surge Data and Peak Surges for Piezoelectric Sensor at Site 86



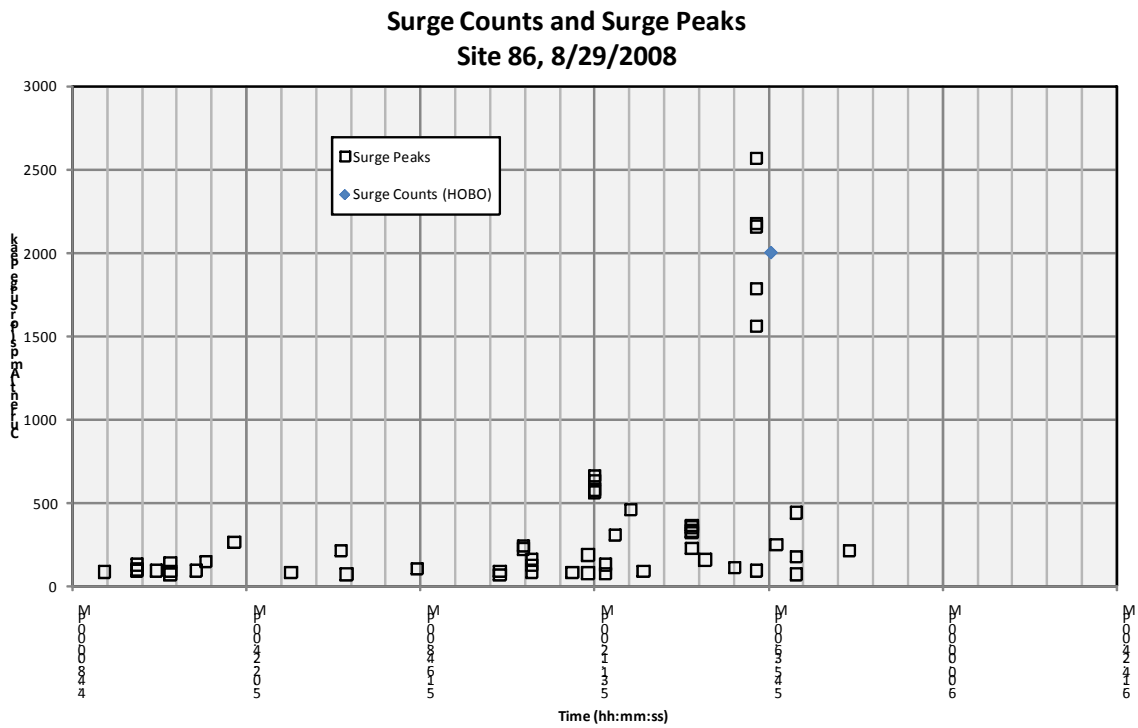
**Figure 13. 2008 Surge Counts and Surge Peaks for Site 86 Piezoelectric Sensor**



**Figure 14. Comparison of Surge Peaks and Surge Counts during an Active Thunderstorm**



**Figure 15. Comparison of Surge Peaks and Surge Counts during a Small or Distant Thunderstorm**



**Figure 16. Comparison of Surge Peaks and Surge Counts for an Intense or Close Lightning Strike**

In Figure 15 there appears to be a small or distant thunderstorm producing only a 3 relatively low-current surges (< 150 Amps). In this case the surge counter recorded a total of 7 surges during the same time period. This result seems to indicate that there may have been more low-current surges (< 70 Amps) that were not recorded by the surge current measurement system.

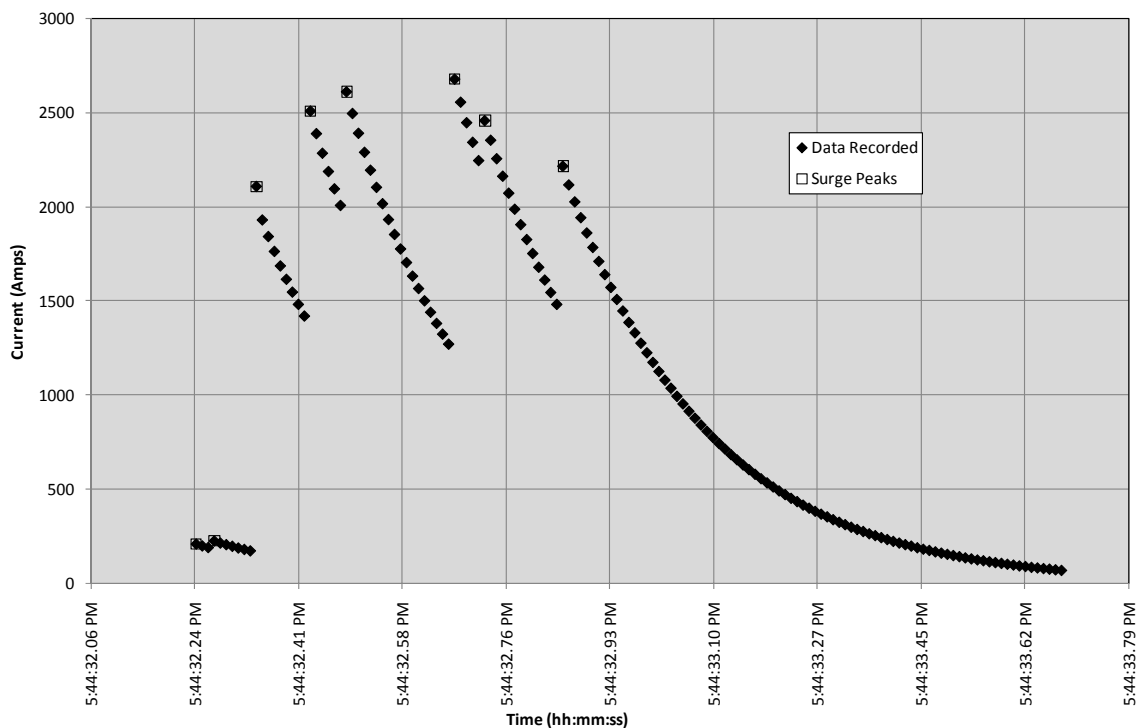
Figure 16 is an example of a moderate thunderstorm including one very intense (> 2,500 Amps) lightning surge. The counter recorded the intense surge, but did not record separately at least one other surge greater than 500 Amps.

The surge counter can at best only count lightning surges separated by at least 0.5 seconds. However, a closer examination of the peak hold circuit for the surge counter revealed that this counter may miss some single surges due to current limitations charging the hold capacitor. Also, the surge counter's peak hold circuit may be saturated for several second after a large magnitude surge or multiple closely spaced surges. The interface circuit for the surge counter needs to be re-examined and likely redesigned to improve the surge counter's accuracy. However, the basic limitation of the HOBO event logger used in the counter is the ½ second sampling interval. The results of the field tests using the surge current measurement system revealed that multiple surge peaks can occur in less than ½ second (see Figure 11).

A summary of the surge peaks recorded by the surge current measurement system during the field tests in the summer of 2008 are summarized in Table 11. The peaks correspond directly to the magnitudes of the surge current resulting from lightning strikes and a single lightning strike apparently can produce multiple surges. For example, the summary of the surge peaks recorded for loop in lane 4 of Site 86 indicates that there are 7 surge peaks greater than 2000 Amps and 3 of these surges are greater than 2500 Amps. However, a single surge cluster (shown in Figure 17, recorded on 8/29/08) contains 6 out of the 7 surge peaks over 2000 Amps and all 3 of the surge peaks over 2500 Amps. The surge current measurement system more accurately counts the magnitude and quantity of surge currents against which the surge suppressor must protect the electronics; the current measurement system will likely over count the number of lightning strikes causing the surges.

**Table 11. Summary of 2008 Sensor Surge Count Field Test Results**

Site #	Installation Dates	Summary of Results
162	6/1 – 10/5/2008 <u>Collection Periods:</u> 6/1 – 7/3/2008 7/5 – 8/10/2008 8/11 – 10/5/2008	<p>Loop: #3 (3 yellow bands)</p> Max. Recorded Surge Peak: 846.0 Amps Min. Recorded Surge Peak: 71.12 Amps Total # Surge Peaks Recorded: 318 # Surge Peaks > 100 Amps: 184 # Surge Peaks > 250 Amps: 23 # Surge Peaks > 500 Amps: 10 # Surge Peaks > 1000 Amps: 0
		<p>Loop: #4 (4 red bands)</p> Max. Recorded Surge Peak: 1099.0 Amps Min. Recorded Surge Peak: 76.58 Amps Total # Surge Peaks Recorded: 564 # Surge Peaks > 100 Amps: 558 # Surge Peaks > 250 Amps: 474 # Surge Peaks > 500 Amps: 201 # Surge Peaks > 1000 Amps: 6 # Surge Peaks > 1500 Amps: 0
86	6/1 – 10/6/2008 <u>Collection Periods:</u> 6/1 – 7/3/2008 7/5 – 8/10/2008 8/11 – 10/5/2008	<p>Loop: lane 4</p> Max. Recorded Surge Peak: 2679.0 Amps Min. Recorded Surge Peak: 72.12 Amps Total # Surge Peaks Recorded: 2070 # Surge Peaks > 100 Amps: 1414 # Surge Peaks > 250 Amps: 317 # Surge Peaks > 500 Amps: 75 # Surge Peaks > 1000 Amps: 13 # Surge Peaks > 1500 Amps: 10 # Surge Peaks > 2000 Amps: 7 # Surge Peaks > 2500 Amps: 3
		<p>Piezo: lane 3</p> Max. Recorded Surge Peak: 2564.0 Amps Min. Recorded Surge Peak: 71.05 Amps Total # Surge Peaks Recorded: 4155 # Surge Peaks > 100 Amps: 2922 # Surge Peaks > 250 Amps: 627 # Surge Peaks > 500 Amps: 58 # Surge Peaks > 1000 Amps: 10 # Surge Peaks > 1500 Amps: 5 # Surge Peaks > 2000 Amps: 3 # Surge Peaks > 2500 Amps: 1



**Figure 17. Surge Cluster for the Largest Surge Peak Recorded in 2008**

## 5. Conclusions and Recommendations

The research and testing conducted under this project has demonstrated that there are a large number of lightning surges impacting the FDOT TTMS equipments through both the telephone lines and the in-pavement sensors. Through the field testing conducted in this task and the related laboratory testing of surge suppressors, surge suppressors have been identified that are suitable for the protection of the telephone modems and the count/classification equipment. The EDCO FASTEL DOT surge suppressor has been identified as an appropriate surge suppressor for telephone line protection. A series of low-voltage suppressors from Atlantic Scientific were identified as being a potential replacement for the existing sensor surge suppressors and are being deployed in TTMS sites for evaluation.

The in-pavement lightning surge field testing has improved from simple counts to measuring the magnitude of the surge currents. The 2008 summer lightning season produced the first successful measurements of the magnitude of surge currents coming through the in-pavement sensors. The surge magnitudes measured were between 70 Amps (the sensitivity limit of the equipment) and over 2,600 Amps. The higher bandwidth of the current measurement system also revealed a more detailed characterization of the lightning surges experienced in a typical thunderstorm and even in a single lightning stroke. The surge current measurement system recorded a total of 2953 surge peaks on the 3 loop sensors tested over a combined 380 test days for an average of



7.77 surge peaks per day. Also recorded were 4155 surge peaks on the single piezoelectric sensor tested for 127 days for an average of 32.7 surge peaks per day.

More testing is needed to be able to develop complete specifications for the surge suppressors needed to protect the count and classification equipment using the in-pavement surge suppressors.

## **6. Benefits to the FDOT**

This research has provided the information necessary to specify and identify appropriate surge suppressors to protect the telecommunication and traffic monitoring equipment in the TTMS from most lightning surges. The improved lightning protection has reduced the number of TTMS sites damaged by lightning and thus reduced the cost of repairs of the TTMS sites.

**Interim Technical Report**

**Low-Voltage Surge Suppression  
for Telemetered Traffic Monitoring Site Sensors**

**PROJECT:**

**Electrical Engineering Support for TTMS  
(FDOT Contract No. BC-543 RPWO 3, FSU OMNI No. 010295)**

**Submitted by:**

**FAMU-FSU College of Engineering  
2525 Pottsdamer Street  
Tallahassee, FL 32310-6046**

**Principal Investigator:**

**Bruce A. Harvey, Ph. D., Associate Professor  
Department of Electrical and Computer Engineering  
Phone: (850) 410-6451  
Fax: (850) 410-6479  
Email: [bharvey@eng.fsu.edu](mailto:bharvey@eng.fsu.edu)**

## Executive Summary

Lightning surge suppression is one of the major concerns of the Florida Department of Transportation (FDOT) Transportation Statistics Office. The 300+ telemetered traffic monitoring sites (TTMS) maintained throughout the State of Florida are continually stressed and damaged by the high number of lightning strikes commonly found in Florida. Previous analyses performed by the FAMU-FSU College of Engineering focused primarily on lightning surges experienced through the telephone lines. Telephone line surge suppressors protect the modem and other equipment in the TTMSs from current surges on the telephone lines generated by lightning in the immediate area. Since the telephone line is characterized by voltages up to approximately 140V, the surge suppressors used in it have a higher clamping voltage (< 25V). These telephone line surge suppressors are ineffective in shielding the in-pavement piezo and loop sensor modules that operate at much lower voltages (typically 10V or less) than the clamping voltage of the telephone line surge suppressors. Since these sensors record specific data on vehicles passing through, such as: the number of axles, speed (per lane), volume of traffic, and weight in motion (WIM), the damage to them leads to inaccurate data and lost of data in high lightning strike regions, not to mention the cost attributed to repair the sensors. The solution to this problem was to use surge suppressors with a lower clamping voltage than the telephone line surge suppressors. The FAMU-FSU COE was tasked to identify and test lightning surge suppressors designed for the low voltage operation of the in-pavement sensors used at the TTMS sites, and to develop appropriate specifications for future surge suppressor purchases that would protect the in-pavement sensors from the lightning surges, and would be resilient to surge suppressor failures.

The effort included identifying several low voltage surge suppressors, and testing them for maximum surge capacity, and the let-through voltage permitted by the suppressors during a current surge. To this effect, the parameters measured were the maximum current, peak output and recovery time. These parameters were used to obtain the operational assessment of the low voltage surge suppressors. Then to measure the durability of the surge suppressors, the surge current (produced by the impulse generator) was set to the rated capacity (up to 6 KA) and tested for resilience to repeated surges. Each suppressor was subjected to up to 10,000 surges. The low voltage surge suppressors tested were those from EDCO (SRA6CA-916, SRA6CA-716), CITEL (BP1-24, BP1-12, BP1-06, DS210-12) and Atlantic Scientific (Device: 24516, 24528, 24538 and 90489).

The testing and results gathered from this study produced results, which for the most part, were expected. Each device was tested for durability, operating characteristics, and assessed for use in conjunction with in-pavement sensors. It was determined that the EDCO SRA series produced the shortest time of decline after the initial impulse and handled endurance tests sufficiently enough to operate for low voltage sensor protection. The CITEL BP1 series also produced favorable result in terms of characteristics and durability. The reaction time of the surge arresting gas tube is longer when compared to CMOS type suppressors, but that time difference is only in a matter of a few

microseconds. The electronics in the BP1 series suppressors proved to be very reliable for high current surges and durable for multiple surges, but the electrical contacts need to be re-designed to reduce failures. The CITEL DS series suppressor produced the longest time of decline after impulse, but did not pass the endurance test adequately for this application. Lastly, the Atlantic Scientific devices had a low maximum let through voltage, fast response time to return to nominal voltage. It was resilient at 2000A surges, but at 6000A, its traces disintegrated in less than 100 hits. The results of the lightning surge measurements in summer 2008 illustrated that there were few surges over 2000 Amps during the four-months of testing. This result gave a positive sign that the resilience of the Atlantic Scientific devices would be good at the TTMS sites.

As a result of this study, the FDOT decided to install some low-voltage Atlantic Scientific devices in about 14 TTMS sites to protect the loop and piezo sensor circuits from lightning surges. Recommendations of models to use were made to the FDOT based on the results of this research.

## Table of Contents

Executive Summary .....	F-3
Table of Contents .....	F-5
1. Introduction.....	F-7
2. Experimental setup.....	F-7
2.1. EDCO Suppression Capabilities .....	F-9
2.2. EDCO Impulse Generator Results .....	F-9
2.3. CITEL BP1 Suppression Capabilities.....	F-11
2.4. CITEL BP1 Impulse Generator Results.....	F-12
2.5. CITEL DS Suppression Capabilities .....	F-14
2.6. CITEL DS Impulse Generator Results .....	F-15
2.7. Atlantic Scientific Suppression Capabilities.....	F-17
2.8. Atlantic Scientific Impulse Generator Results.....	F-17
3. Recommendations for Suppressor Specifications.....	F-18
4. Conclusions and Future Considerations.....	F-20
5. Detailed Data .....	F-21
5.1 Surge Suppressor outputs.....	F-21
5.1.1. EDCO SRA Series Surge Suppressor Output.....	F-21
5.1.2. CITEL BP1 Series Surge Suppressor Output .....	F-25
5.1.3. CITEL DS Series Surge Suppressor Output .....	F-32
5.1.4. Atlantic Scientific Series Surge Suppressor Output .....	F-35
5.2 Specifications .....	F-39
5.1.5. EDCO SRA Series Manufacturer Specifications.....	F-39
5.1.6. CITEL BP1 Series Manufacturer Specifications .....	F-39
5.1.7. CITEL DS Series Manufacturer Specifications.....	F-40
5.1.8. Atlantic Scientific Series Manufacturer Specifications .....	F-40

## List of Figures and Tables

Figure 1. Test Station.....	F-8
Figure 2. Suppressor Connection.....	F-8
Figure 3. EDCO SRA6LCA-916 .....	F-9
Figure 4. EDCO SRA6LCA-916 at 250A .....	F-10
Figure 5: EDCO SRA6CLA-916 at 500A .....	F-11
Figure 6. CITEL BP1-06 at 1000A.....	F-12
Figure 7. CITEL BP1-06 at 4000A.....	F-13
Figure 8. CITEL BP1-06 Endurance .....	F-14
Figure 9. CITEL BP1-06 Endurance .....	F-14
Figure 10. CITEL DS210-12VDC at 300A .....	F-15
Figure 11. CITEL DS210-12VDC at 300A .....	F-16
Figure 12. Damage to CITEL DS210-12VDC Suppressor.....	F-16
Figure 13. Atlantic Scientific 24516 output for 2000A input current.....	F-17
Table 1. Endurance Test Results for Atlantic Scientific Device 24516 .....	F-18
Table 2. Recommended Low Voltage Suppressor Specifications .....	19

## **1. Introduction**

Lightning surge suppression is one of the major concerns of the Florida Department of Transportation (FDOT) Transportation Statistics Office. The 300+ telemetered traffic monitoring sites (TTMS) maintained throughout the State of Florida are continually stressed and damaged by the high number of lightning strikes commonly found in Florida. Previous analyses performed by the FAMU-FSU College of Engineering focused primarily on lightning surges experienced through the telephone lines.

Telephone line surge suppressors protect the modem and other equipment in the TTMSs from current surges on the telephone lines generated by lightning in the immediate area. Since the telephone line is characterized by voltages up to approximately 140V, the surge suppressors used in it have a higher clamping voltage (<25V). These telephone line surge suppressors are ineffective in shielding the in-pavement piezo and loop sensor modules that operate at much lower voltages (~10V or less) than the clamping voltage of the telephone line surge suppressors. Since these sensors record specific data on vehicles passing through, such as: the number of axles, speed (per lane), volume of traffic, and weight in motion (WIM), the damage to them leads to inaccurate data and lost of data in high lightning strike regions, not to mention the cost attributed to repair the sensors. The solution to this problem was to use surge suppressors with a lower clamping voltage than the telephone line surge suppressors. The FAMU-FSU COE was tasked to identify and test lightning surge suppressors designed for the low voltage operation of the in-pavement sensors used at the TTMS sites, and to develop appropriate specifications for future surge suppressor purchases that would protect the in-pavement sensors from the lightning surges, and would be resilient to surge suppressor failures.

At the time this study was conducted, FDOT had conveyed their concerns regarding the EDCO SRA6LCA-916 and EDCO SRA6LCA-716 surge suppressors they were using. Initial testing of the EDCO SRA6CA-916 and EDCO SRA6CA-716 showed that the rated break over voltage (150V) and the clamping voltage (<25V) were too high to prevent damage to the circuitry. The typical operating voltage of sensors was 5V-6V and a lightning surge after passing through the surge suppressor could generate pulses up to 20-80 Volts or more causing severe damages to the in-pavement sensors. Therefore a number of low voltage surge suppressors were identified, acquired, tested and compared to the EDCO surge suppressors. The focus of the tests was to find surge suppressors that could operate at a lower breakdown voltage, quickly suppress voltage spikes, and be resilient to the number of lightning hits expected in the field at the TTMS sites. The surge suppressors from EDCO and CITEL were initially investigated, as their primary focus was surge suppression. Later, Atlantic Scientific surge suppressors were also included as they had surge suppressors designed for data purposes operating at low voltages.

## **2. Experimental setup**

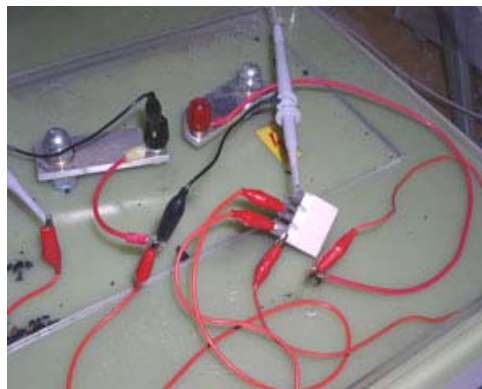
In order to test the necessary components an EMC-Partner modular impulse generator and an Agilent mixed signal oscilloscope were utilized. The modular impulse generator has the capability to produce up to 6 KA of surge current. The test setup, as shown in

Figure 1, feeds two oscilloscope probes into the generator chamber to measure the output voltage and the input voltage (only on low current tests).



**Figure 1. Test Station**

Figure 2 illustrates how the positive bar of the generator is attached to the positive lead of the suppressor and the ground bar is connected to the ground lead of the suppressor. Once that is connected the output probe is set on the output of the suppressor and grounded with the ground bar. Once the case is closed the generator sends a short test pulse through the device to ensure that a closed circuit is formed.



**Figure 2. Suppressor Connection**

Two phases of tests were conducted using this experimental setup. The first phase measured the magnitude of the output spike of the suppressor and illustrated the waveform at which the voltage rouse and fell. The magnitude would indicate how much voltage the suppressor would alleviate and the waveform would indicate the amount of time passed until the suppressor returned to nominal voltage. This phase would result in analyzing the operational assessment of the surge suppressors. The second phase tested the endurance of each device when put under massive trauma. To this effect, the surge current (produced by the modular impulse generator) was set to the rated capacity (up to 6 KA) and tested for resilience to repeated surges. Each suppressor was subjected to up to 10,000 surges. The intent of the tests was to determine how durable each design was and



to see specifically what component of the suppressor was the most vulnerable to lightning surges. Each device had different vulnerabilities and therefore had various drawbacks. The low voltage surge suppressors tested were those from EDCO (SRA6CA-916, SRA6CA-716), CITEL (BP1-24, BP1-12, BP1-06, DS210-12) and Atlantic Scientific (Device: 24516, 24528, 24538 and 90489).

### **2.1. EDCO Suppression Capabilities**

The EDCO SRA 6LCA-916 and EDCO SRA 6LCA-716 are three-pronged devices that are built to work in parallel with sensor/low voltage devices. The device characteristics include having the capability to provide differential and common-mode protection for low voltage vehicle loop detectors. The device is basically made up of a single transistor, as shown in Figure 3, commonly known as a Sidactor. Sidactors tend to be popular for low voltage application because they are based on a CMOS technology, which leads to a much faster response time and suppression of lower voltages. Issues that arise from sidactors tend to be with durability over an extended period of time and under heavy load conditions. Technical Specifications for the EDCO SRA Series from the manufacturer can be found in Section 5.2.1.

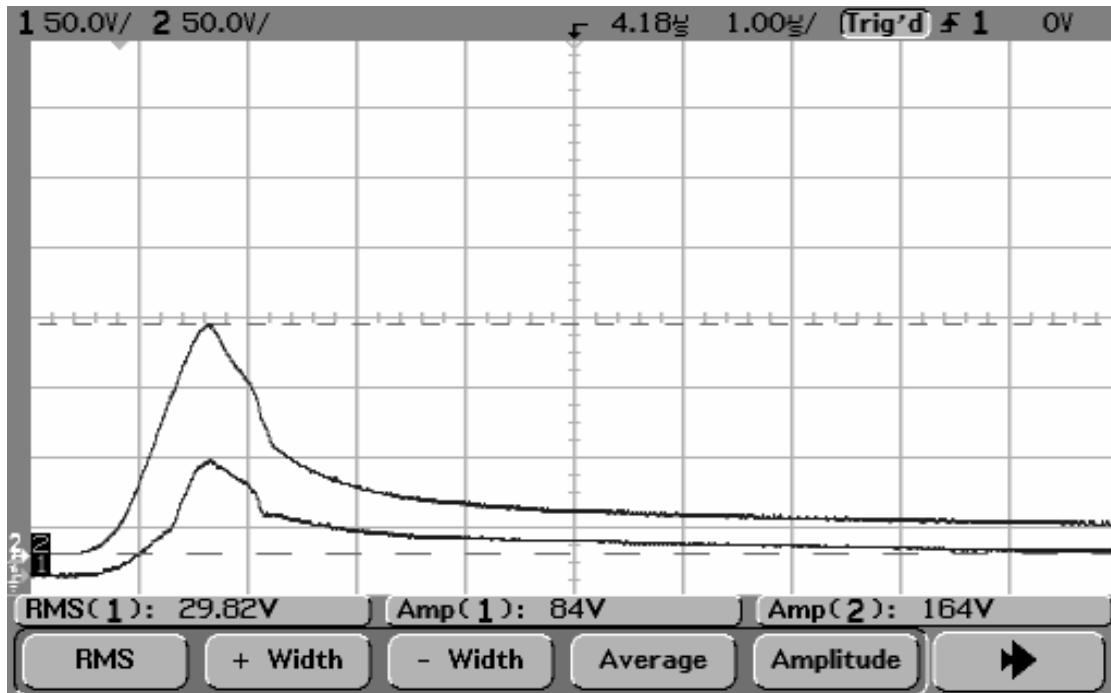


**Figure 3. EDCO SRA6LCA-916**

### **2.2. EDCO Impulse Generator Results**

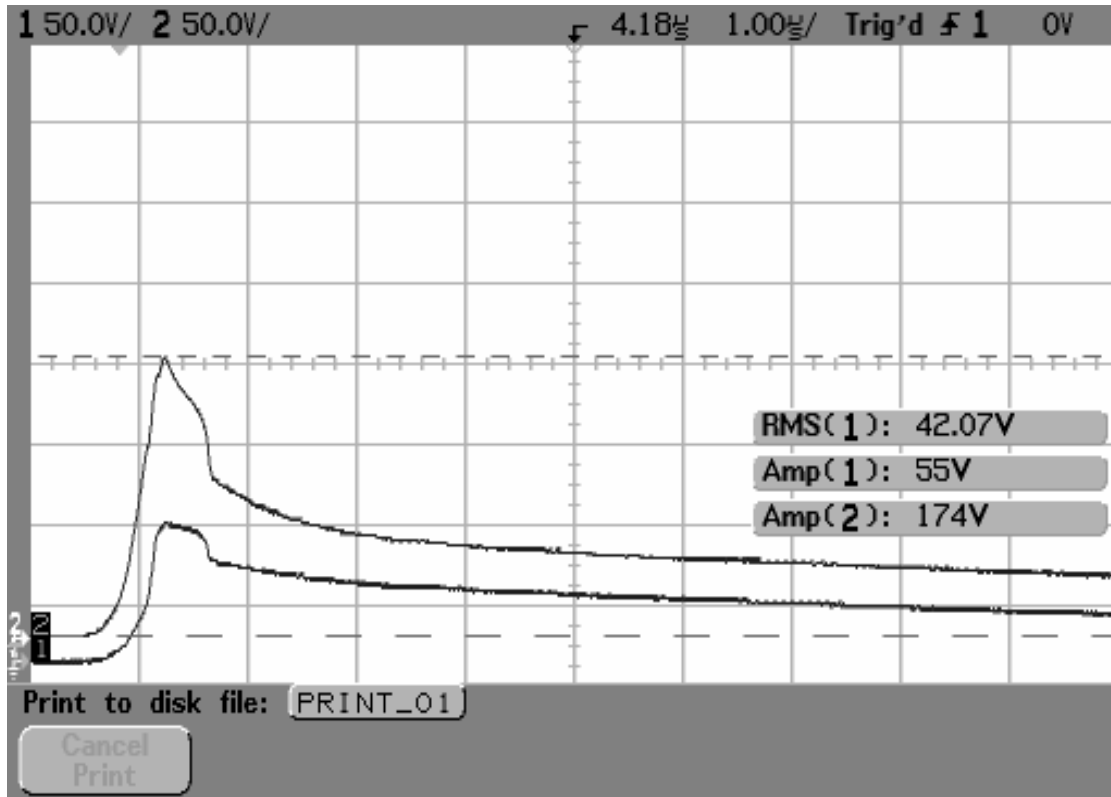
*Phase 1:*

The EDCO SRA6LCA-916 was first tested at 250A as shown in Figure 4. The lower line indicates the output of the suppressor and the upper line indicates the input voltage to the suppressor.



**Figure 4. EDCO SRA6LCA-916 at 250A**

The graph in Figure 4 shows an initial rise in voltage from the impulse and approximately 3 to 4 microseconds to return to the normal operating voltage. Figure 5 shows the same suppressor at 500A of input current. This graph illustrates a sharper incline in the initial pulse but a slower time of decline (about 7 to 8 microseconds) to nominal voltage. Therefore, it can be seen that as the surge magnitude increases so also did the time required to return to normal operating voltage. The time it takes for the suppressor output to return to acceptable voltages is significant. The longer it takes for the voltage to return to safe levels, the greater the amount of energy delivered to the sensor boards and the greater the potential for damage. Similar tests were done with the EDCO SRA6LA-716 and can be seen in Section 5.1.1.



**Figure 5: EDCO SRA6CLA-916 at 500A**

*Phase 2:*

The EDCO SRA6LCA-916 failed at a surge current of 1000 A. The sidactor failed and would not absorb the current, thus causing arcing at the input leads from the generator. The result for this scenario can be found under Section 5.1.1.

**2.3. CITEL BP1 Suppression Capabilities**

The BP1 series of devices, manufactured by CITEL, are designed to be implemented in a linear/series formation with whatever device it is protecting. However, the BP1 devices selected operate at low voltages and have low breakover voltages, which allows for safe protection for low voltage devices. In addition to the low breakover, it uses a three element surge arrester gas discharge tube as its primary surge suppressing element, which adds to the overall robustness of the device. It should be able to withstand a much harsher environment than the sidactor variety. Other components used in the design involve the use of power resistors used as voltage dividers to suppress remaining voltage that leaks from the surge arrester. The initial driving force behind testing this device was if testing were to be successful, a parallel orientation of components would be suggested to the manufacturer so as to fit the standard requirements for implementation on the piezo sensor array.

An initial drawback noted in this design suggests that response time within the device may be slower than the CMOS variety due to the use of the surge arrester gas tube. The slower response time results in more energy transferred to the protected device and correspondingly higher chance of device failure. However, the effects of a slower shunting of the surge current may be mitigated by the lower break over voltage of the suppressors. Technical specifications for the CITEL BP1 Series from the manufacturer can be found in Section 5.2.2.

## 2.4. CITEL BP1 Impulse Generator Results

### Phase 1:

The CITEL BP1-24, BP1-12, and BP1-06 were chosen for this study. Each suppressor was rated at breakover voltages less than 40V, thereby being ideal for this application. These particular suppressors were tested under higher current levels than other types so to better illustrate the rise and decline of the suppressor, specifically the surge arrester gas tube. This was necessary due to the slow response of the gas tube. Low voltages would get a small response from the gas tube and would produce a small waveform.

Since each suppressor yielded similar results, the BP1-06 will be taken into consideration for this analysis. Figure 6 depicts the response of the BP1-06 suppressor at 1000A.

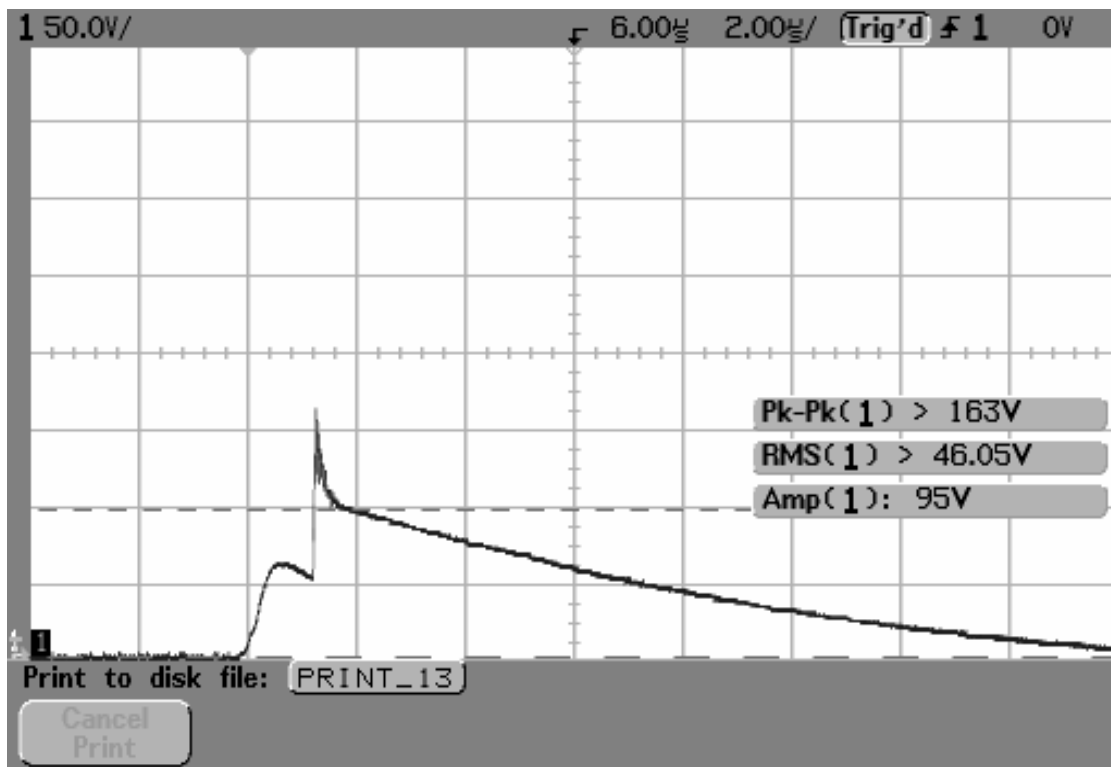
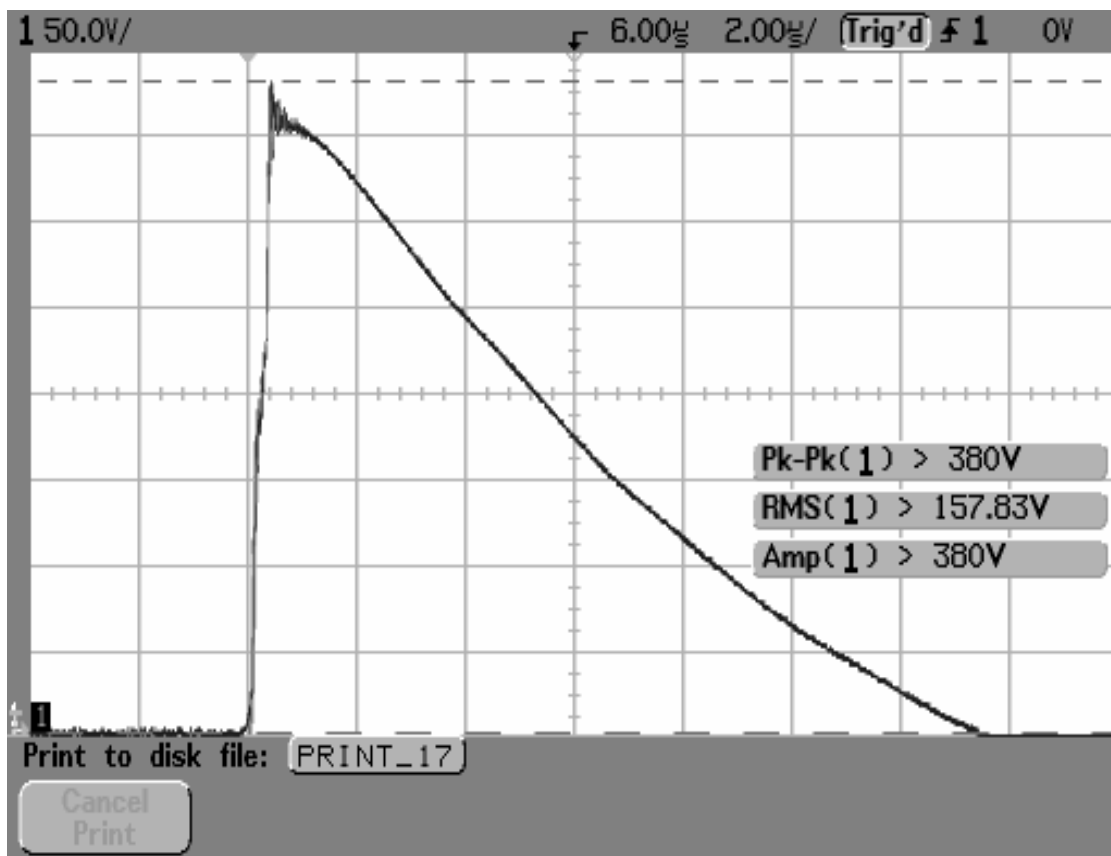


Figure 6. CITEL BP1-06 at 1000A

The initial spike is interesting in that there is about a 1-microsecond region where the voltage drops before the voltage spikes to its full magnitude. This is attributed to the slow response of the gas tube. Another expected attribute that occurred was the relatively slow voltage decay, which in this case was of the magnitude of roughly 13 microseconds. Figure 7 depicts the same suppressor at 4000A and illustrates an interesting, but not totally unexpected result. The peak output voltage was higher, but occurred much faster than at the lower surge current. Evidently, the higher resulting voltages caused the gas tube to activate faster. However, the device was again slow (>10 us) to bring the output voltages back down to below 50 V.

Full tests results of this suppressor along with the BP1-12 and BP1-24 test results can be viewed in Section 5.1.2.



**Figure 7. CITELE BP1-06 at 4000A**

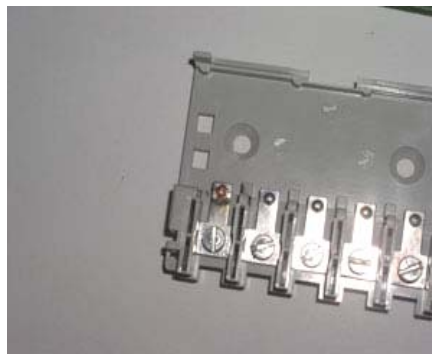
*Phase 2:*

Endurance tests were conducted with each surge suppressor to determine problem areas within the infrastructure of the device. In the case of the CITELE BP1 series, the problem was the contact between the terminal and the circuit board. The contact was a metal bar pressing on an etched contact on the circuit card. The large surge currents through this relatively small contact area result in the deterioration of the pad on the circuit card.

Eventually, there was no direct contact remaining and the surges arced between the metal bar and the circuit card causing even more damage. The damage from the endurance testing is illustrated in Figures 8 and 9. The damage was obvious after roughly 1100 to 1500 surges (at 6 KA), as the current began to arc.



**Figure 8. CITELE BP1-06 Endurance**



**Figure 9. CITELE BP1-06 Endurance**

To further test the actual components of the suppressor, wires were soldered directly to the positive input and ground of the suppressor and testing resumed. It was determined from these tests that the components showed no further evidence of degradation throughout the 10,000 surges tested.

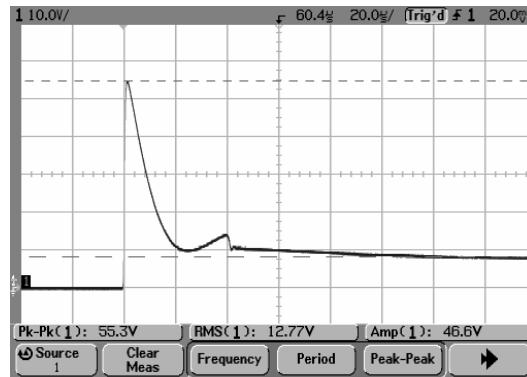
## **2.5. CITELE DS Suppression Capabilities**

The CITELE DS Series was constructed to be implemented in parallel with devices via a DIN rail. The DS series uses varistors to match the desired operating voltage of the input from 12 V to 110V, and thermal fuses to help quickly react to surge impulses. This particular surge suppressor has a breakover voltage at 12 V. If successful the DS series could be manufactured to fit the size requirements for the piezo sensors. The suppressor itself includes its own housing for easy implementation in any device. Technical specifications for the CITELE DS Series from the manufacturer can be found in Section 5.2.2.

## 2.6. CITEL DS Impulse Generator Results

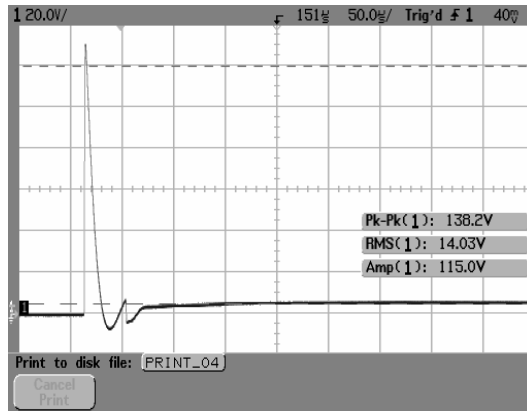
### *Phase 1:*

The CITEL DS210-12DC is a unique design, which incorporates the use of varistors to suppress rapid surges and thermal fuses to protect against longer-term over-current conditions. Figure 10 illustrates operation of the DS210-12DC at 300 A.



**Figure 10. CITEL DS210-12VDC at 300A**

The actual test surge test revealed that voltage decay was relatively long. From the peak voltage to roughly 10V over nominal, the voltage decay time exceeded 20 microseconds. Subsequently from 10V to nominal the time exceeded over 120 microseconds. The energy build up from the peak to the 10V is quite substantial and could potentially result in more damage to the protected circuitry. Figure 11 illustrates the same suppressor at 800A. Similar results occurred with this test; however, the full time of decline can be realized at roughly 50 microseconds after the impulse. The variation in signal from the tail end of the impulse indicates the varistor trying to adapt back to nominal voltage. The overall major draw backs from this device from an operational standpoint suggest that voltage decay from the initial pulse takes much too long to return to nominal voltage and the decline from the peak voltage to 10V over nominal can cause serious concerns with the integrity of the device over an extended period of time. Full tests results of this suppressor can be seen in Section 5.1.3.



**Figure 11. CITEL DS210-12VDC at 300A**

*Phase 2:*

Endurance testing was conducted on the CITEL DS210-12VDC suppressor. The suppressor was tested at 2000A (maximum discharge current allowance) for an extended period of time. After roughly 155 hits at 15-second intervals, the impulse started to arc at the input and eventually the suppressor buckled under pressure. Figure 12 illustrates the outcome of the endurance test.



**Figure 12. Damage to CITEL DS210-12VDC Suppressor**

Upon further inspection the component that suffered the most damaged was the coupling device between two varistors. The top of this coupling completely blew off the connection and caused the outer casing to break off. It was determined from these tests that the vulnerability that encompassed these suppressors predominately dealt with the coupling between the varistors.



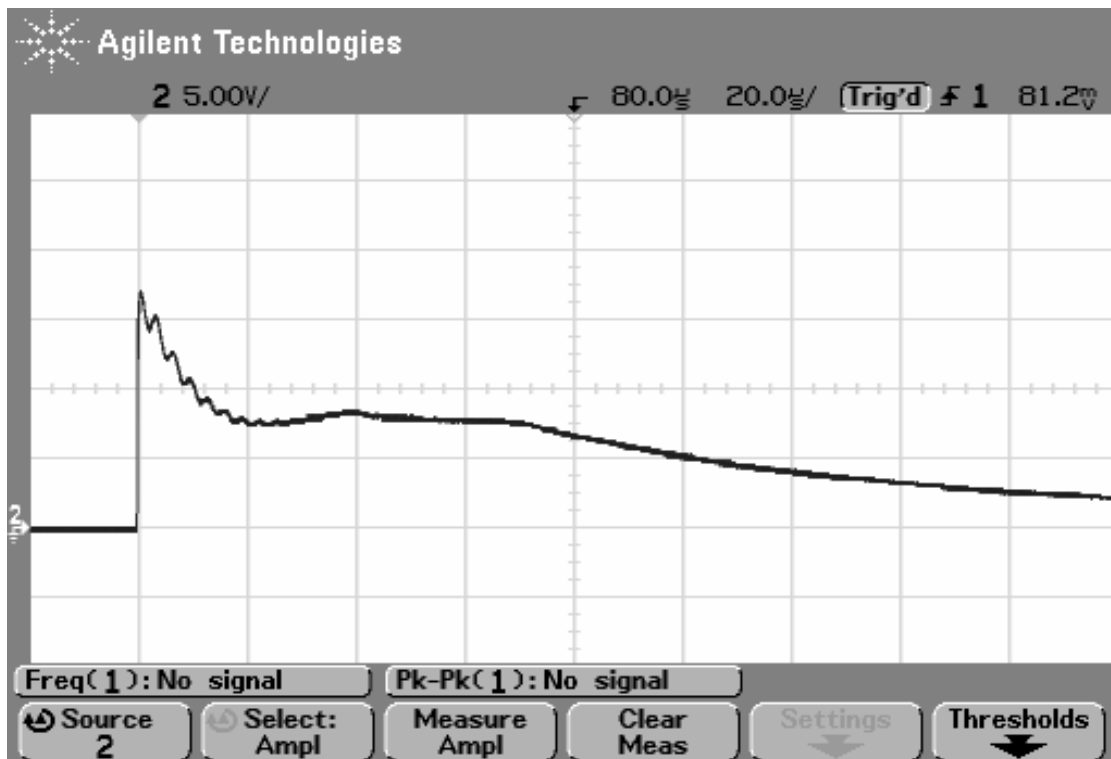
## 2.7. Atlantic Scientific Suppression Capabilities

The Atlantic Scientific low-voltage surge suppressor devices have a sophisticated hybrid circuitry including a combination of high energy Metal Oxide Varistors (MOVs) or Gas Discharge Tubes (GDTs) with ultra fast diodes and Silicon Avalanche Diodes (SADs). This gives the surge suppressors its characteristic low let-through voltage and a high surge current capacity to provide excellent protection. Technical specifications for the Atlantic Scientific suppressors from the manufacturer can be found in Section 5.2.3.

## 2.8. Atlantic Scientific Impulse Generator Results

### Phase 1:

There were four different devices from Atlantic Scientific that were used for this study. The device model numbers were 24516, 24528, 24538, and 90489. The device 24516 was rated for maximum let through voltage of 12V at 2000A, device 24528 rated for 12V at 5000A, device 24538 rated for 25V at 5000A, and device 90489 rated for 10V at 5000A. Since the surge suppressor devices from Atlantic Scientific had lower voltages, they were ideal for the application of the in-pavement sensors. Figure 13 illustrates the output of the device 24516 for a surge current of 2000A.



**Figure 13. Atlantic Scientific 24516 output for 2000A input current**

From the specifications mentioned earlier, the maximum let through voltage for device 24516 was 12V at 2000A. It can be observed from Figure 13, that after the initial spike of

the 2000A, the voltage reached the nominal voltage in less than 20us. This device illustrated very good results for the application of FDOT for the in-pavement sensors with low voltages and surge currents of up to 2000A. Similar tests were performed on all the devices obtained from Atlantic Scientific and the results are recorded in Section 5.1.4.

*Phase 2:*

Endurance tests were conducted with each surge suppressor model received from Atlantic Scientific. There were two tests performed on the devices. The first one was to test the devices with up to 10000 surges at 6000A to see if the device could survive. It was observed that after a few surges of 6000A (less than 100surges), the circuit traces in the devices disintegrated. Since the devices were rated for 2000A, the second tests used a surge current of 2000A. All the device models survived over 10,000 hits with a surge current of 2000A. The results for the device 24516 are given in Table 1, while the details of other device results are mentioned in Section 5.1.4.

**Table 1. Endurance Test Results for Atlantic Scientific Device 24516**

Time scale of 20us per division and 5v per vertical division		
Endurance Tests	Input Current	Test 1: 6000A Test 2: 2000A
	Number of Tests	Test 1: The traces disintegrated after 87 tests at 6000A Test 2: Greater than 10,000 Tests
	Result	Test 2: Device survived the endurance tests with minimal deviation in input response. 267V 1733A input response initial test 281V 1732A input response final test.

It was concluded that the Atlantic Scientific devices were durable for surges up to 2000A and can withstand a few surges up to 6000A. From the lightning current measurements in the field, the results in summer 2008 recorded only one lightning surge of approximately 2000A, while the rest of the surges had lower peak currents. This result showed a promising sign that the Atlantic Scientific devices would be successful if implemented at FDOT's TTMS sites.

**3. Recommendations for Suppressor Specifications**

The results and assessments from the low voltage sensor suppressor tests are summarized in Table 2. These assessments are based on successful implementation for use on a low voltage piezo sensor array for various models of counter/classifiers. There are three categories of assessment done on these devices that are outlined below. The operational assessment compares the initial rise of impulse and time of decline to nominal voltage as seen in all studies. The endurance assessment discusses the vulnerabilities of each

suppressor. Finally the application assessment discusses possible methods of integrating suppressor with the piezo sensor array.

**Table 2. Recommended Low Voltage Suppressor Specifications**

SUPPRESSOR	OPERATIONAL ASSESSMENT	ENDURANCE ASSESSMENT	APPLICATION
EDCO SRA Series	Typically initial voltage peak would be reached uninterrupted and time of decline tends to range between 3 to 8 microseconds. Relatively fast response.	Could withstand up to 1000 A of Current. The Internal Transistor has distinct limitations of operation.	Break over voltage is much too high to protect piezo sensor so fabrication of similar suppressor with breakover voltages ranging from 10 to 20V is suggested.
CITEL BP1 Series	Demonstrated an unusual initial rise to impulse, but returned to nominal voltage fairly fast. Slightly slower response due to surge arresting gas tube.	Actual component on suppressor withstood current over 5000 A relatively well. Only vulnerability to be cited was weak metal contacts for grounding suppressor.	Re-engineering suppressor to work for parallel components would allow this suppressor to be implemented in piezo sensor array.
CITEL DS210-12	Produced smooth waveforms for initial pulse and decline. Recorded slowest time of decline and produced unusual fluxuations due to varistor.	Vulnerabilities to be cited dealt with the coupling between varistors buckling under peak voltages pulses.	Is manufactured as a parallel device so could be easily implemented to fit the three-prong architecture of suppressors presently being used. Not particularly suggested for this application.
ATLANTIC SCIENTIFIC Series	The device has a fast response time in returning back to nominal voltage, about less than 10 microseconds. Also had the lowest peak let-through voltage.	Could stand 2000A surges over 10,000 times, but at 6000A, it failed within 100 hits as the traces disintegrated.	Break over voltage is ideal for in-pavement sensor protection, and response-time is fast too. Since hits at the TTMS sites have current typ. 2000A or less, this device is a good match for FDOT's application.

#### **4. Conclusions and Future Considerations**

The testing and results gathered from this study produced results, which for the most part, were expected. Each device was tested for durability and operating characteristics, and assessed for use in conjunction with piezo sensors. It was determined that the EDCO SRA series produced the shortest time of decline after the initial impulse and handled endurance tests sufficiently enough to operate for low voltage sensor protection. The CITEL BP1 series also produced favorable result in terms of output characteristics and durability (if the electrical contacts are re-designed to reduce damage). The reaction time of the surge arresting gas tube is longer when compared to CMOS type suppressors, but that the time difference was only a few microseconds. The CITEL DS series suppressor produced the longest output voltage decay time after surge, but did not pass the endurance test adequately for this application. Lastly, the Atlantic Scientific devices had a low maximum let through voltage and a fast response time to return to nominal voltage. It was durable for up to 2000A surges, but could only withstand a few surges (<100) at 6000A before suffering damage. The lightning surge measurements field tests in summer 2008 recorded only a few surge currents greater than 2000A during a four-month test at 2 sites. These results indicate that the Atlantic Scientific devices are good choices for low-voltage sensor circuit protection at the TTMS sites.

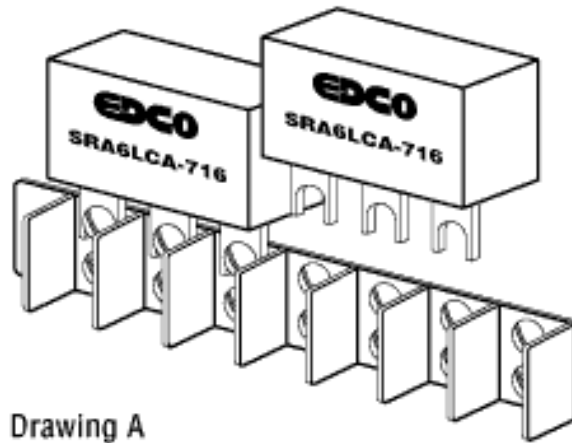
During the course of this study, the FDOT installed Atlantic Scientific surge suppressors in about 14 TTMS sites to protect the loop and piezo sensor circuits from lightning surges. Recommendations of models to use were made to the FDOT based on the results of this research.

Specifications and detailed results from study are included in Section 5.

## 5. Detailed Data

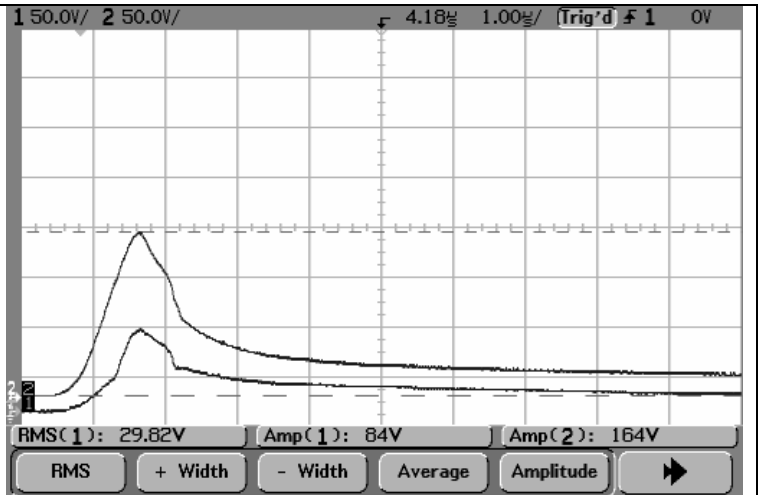
### 5.1 Surge Suppressor outputs

#### 5.1.1. EDCO SRA Series Surge Suppressor Output



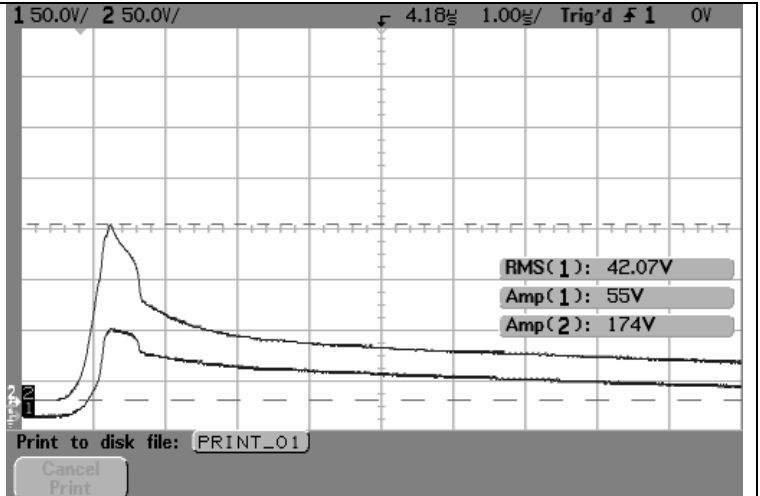
#### EDCO SRA6LCA-916 250 A Current

250 A	
Oscilloscope	Imp. (Impulse generator output)
84 Vpk-pk	157 V
	197 A



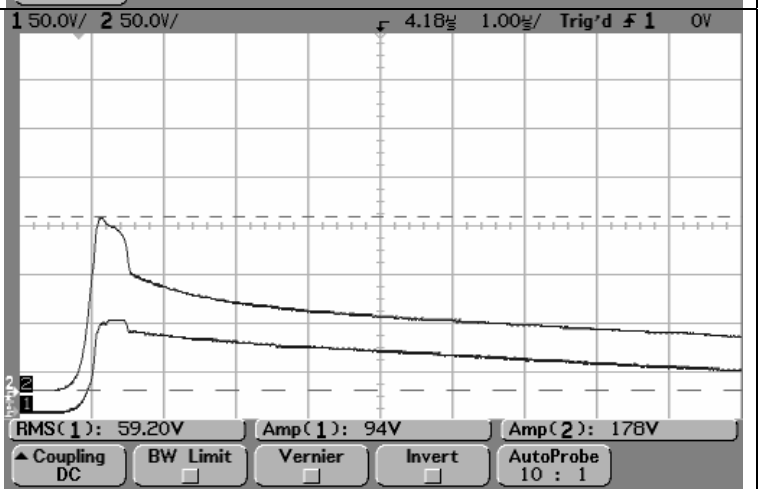
EDCO SRA6LCA-916 500 A Current

500 A	
<b>Oscilloscope</b>	<b>Imp. (Impulse generator output)</b>
55 Vpk-pk	192 V
	400 A



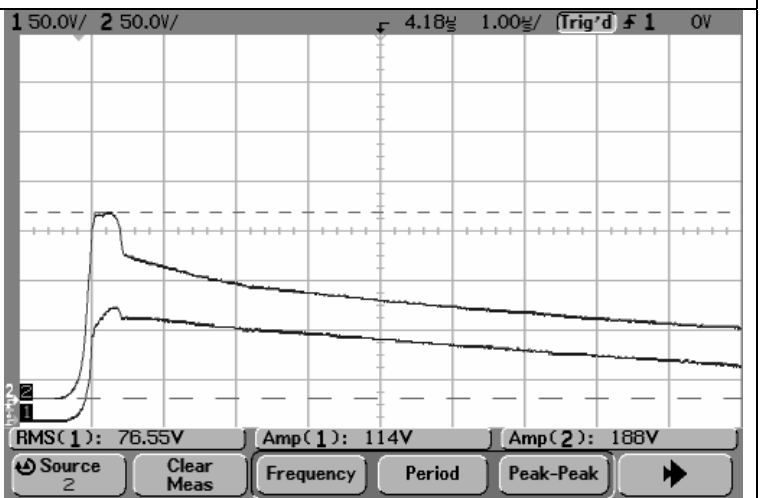
EDCO SRA6LCA-916 750 A Current

750 A	
<b>Oscilloscope</b>	<b>Imp. (Impulse generator output)</b>
94 Vpk-pk	192 V
	750 A



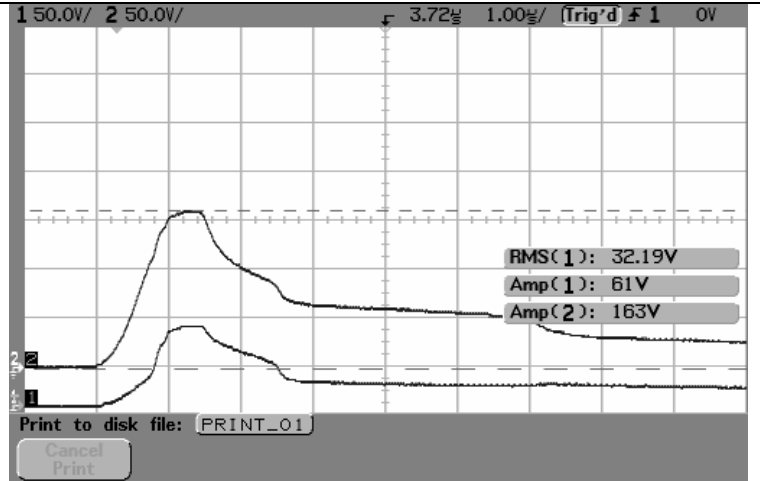
EDCO SRA6LCA-916 1000 A Current

1000 A	
<b>Oscilloscope</b>	<b>Imp. (Impulse generator output)</b>
114 Vpk-pk	227 V
	817 A



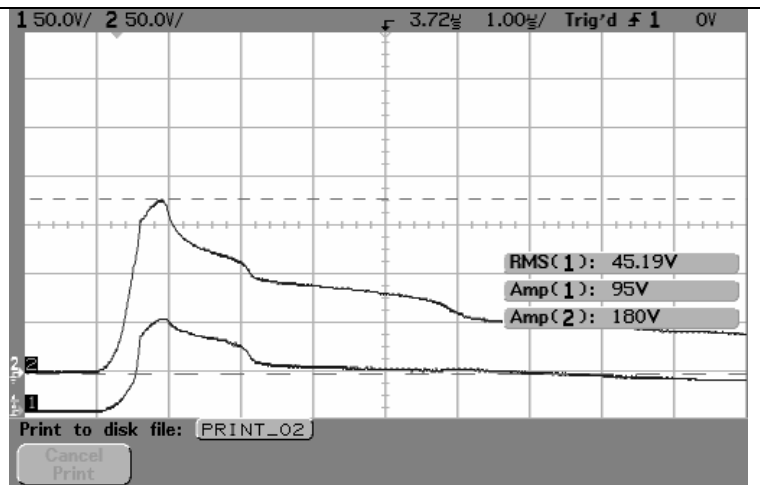
**EDCO SRA6LCA-716 250 A Current**

250 A	
<b>Oscilloscope</b>	<b>Imp. (Impulse generator output)</b>
61 Vpk-pk	164 V
	192 A



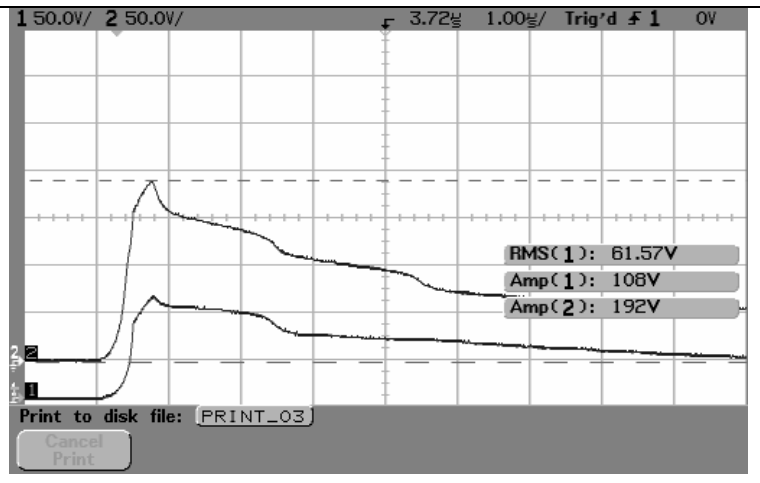
**EDCO SRA6LCA-716 500 A Current**

500 A	
<b>Oscilloscope</b>	<b>Imp. (Impulse generator output)</b>
95 Vpk-pk	203 V
	400 A



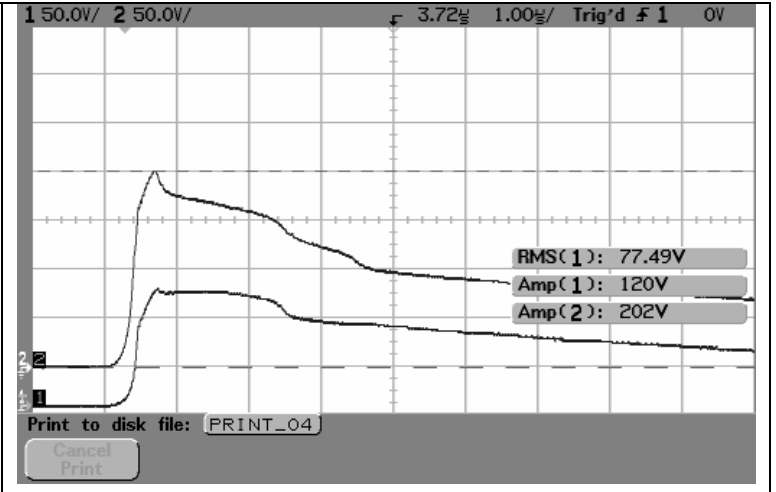
**EDCO SRA6LCA-716 750 A Current**

750 A	
<b>Oscilloscope</b>	<b>Imp. (Impulse generator output)</b>
108 Vpk-pk	264 V
	605 A



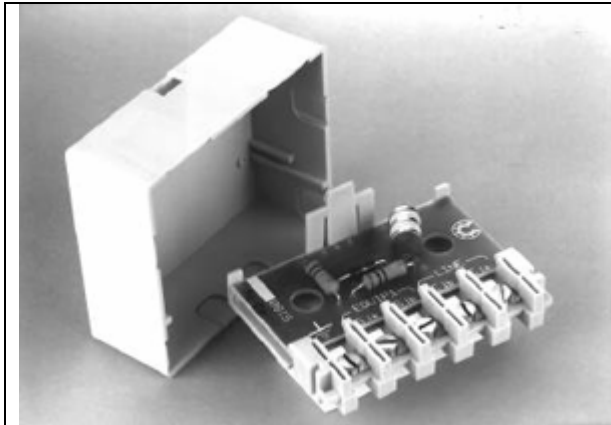
EDCO SRA6LCA-716 1000 A Current

1000 A	
<b>Oscilloscope</b>	<b>Imp. (Impulse generator output)</b>
120 Vpk-pk	330 V
	811 A

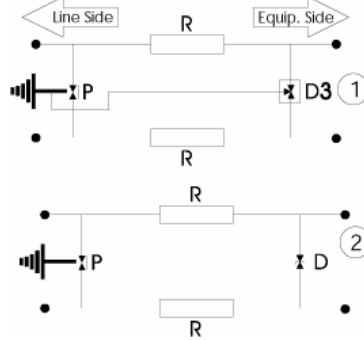




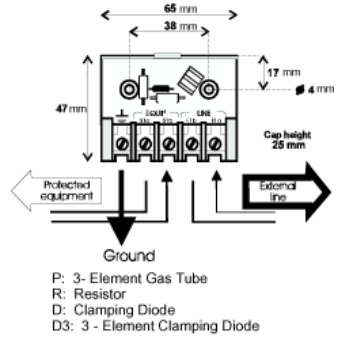
## 5.1.2. CITELE BP1 Series Surge Suppressor Output



### Electrical Diagrams

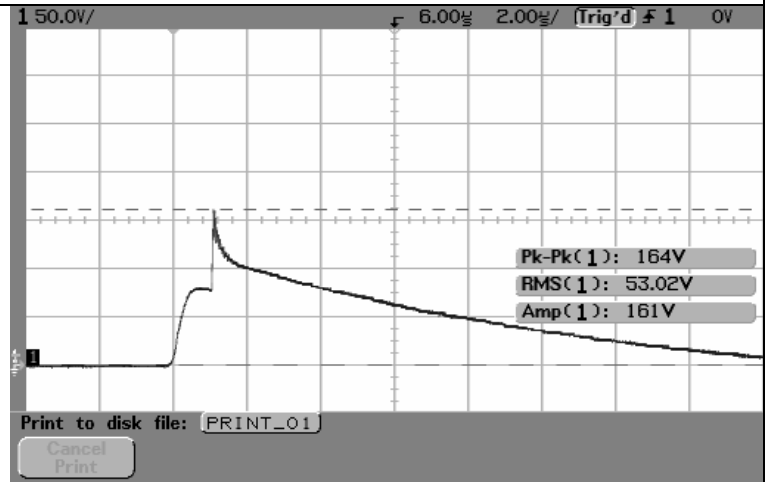


### Mechanical Diagram



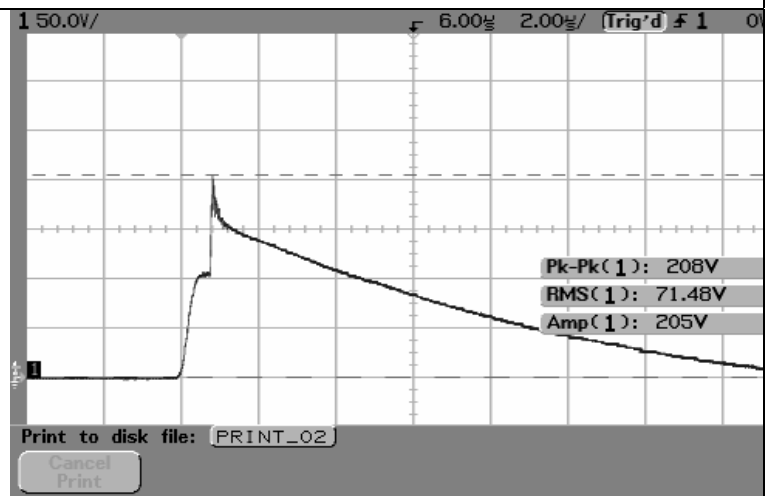
### BP1-24 1000 A Current

1000 A	10/11/04 4:50 pm
<b>Oscilloscope</b>	<b>Imp. (Impulse generator output)</b>
161 Vpk-pk	374 V
164 V peak	928 A



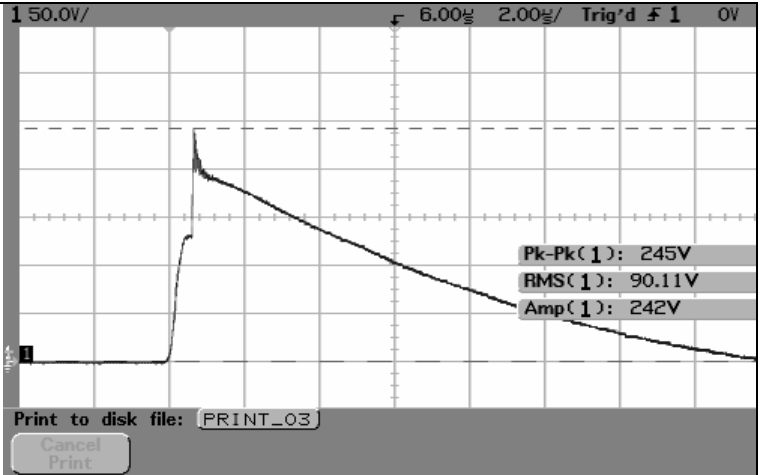
### BP1-24 1500 A Current

1500 A	10/11/04 4:53 pm
<b>Oscilloscope</b>	<b>Imp. (Impulse generator output)</b>
208 Vpk-pk	409 V
205 V peak	1404 A



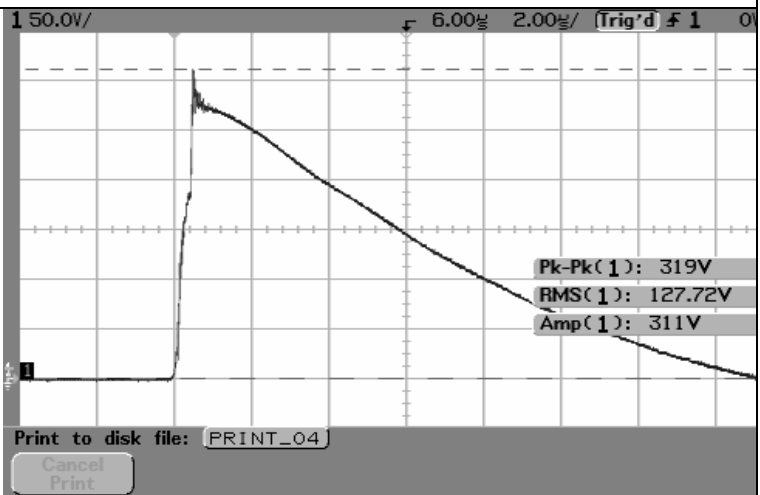
BP1-24 2000 A Current

2000 A	10/11/04 4:54 pm
<b>Oscilloscope</b>	<b>Imp. (Impulse generator output)</b>
245 Vpk-pk	440 V
242 V peak	1867 A



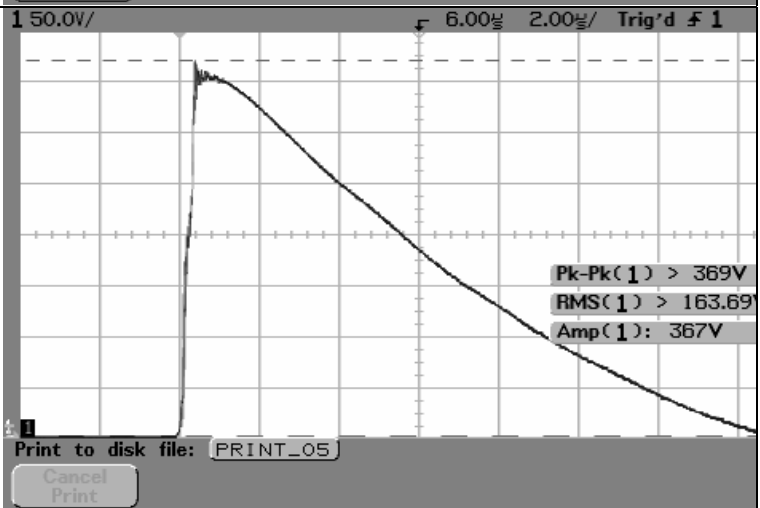
BP1-24 3000 A Current

3000 A	10/11/04 4:55 pm
<b>Oscilloscope</b>	<b>Imp. (Impulse generator output)</b>
319 Vpk-pk	474 V
311 V peak	2834 A



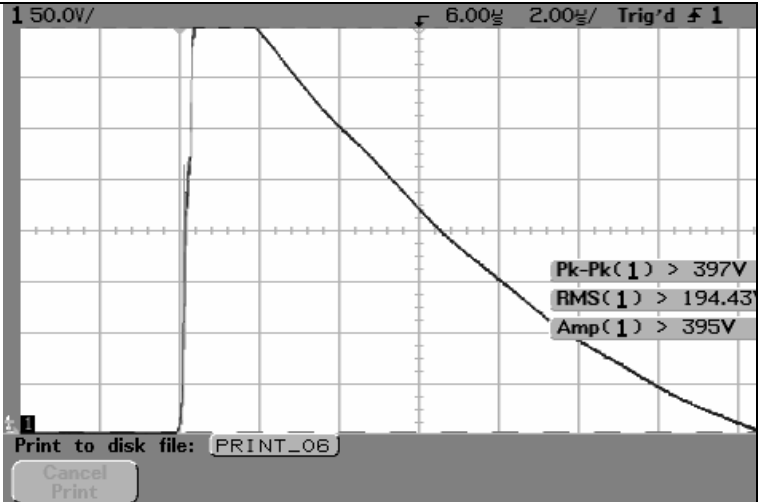
BP1-24 4000 A Current

4000 A	10/11/04 4:56 pm
<b>Oscilloscope</b>	<b>Imp. (Impulse generator output)</b>
369 Vpk-pk	534 V
367 V peak	3779 A



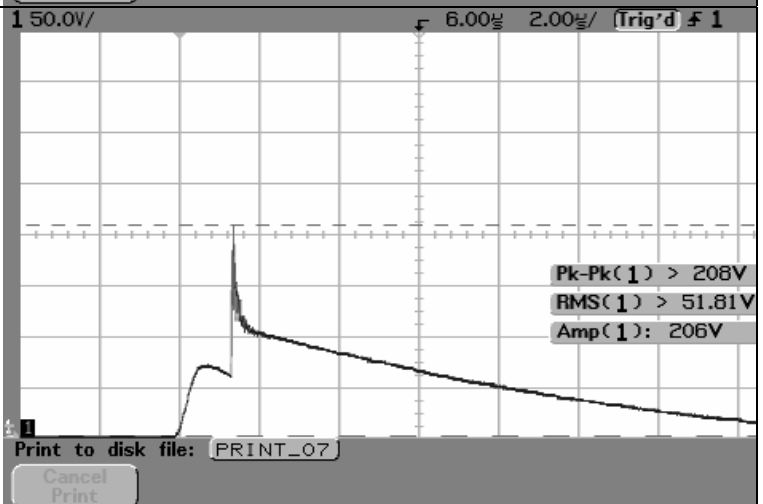
BP1-24 5000 A Current

5000 A	10/11/04 4:58 pm
<b>Oscilloscope</b>	<b>Imp. (Impulse generator output)</b>
Clipped Vpk-pk	660 V
Clipped V Amp.	4710 A



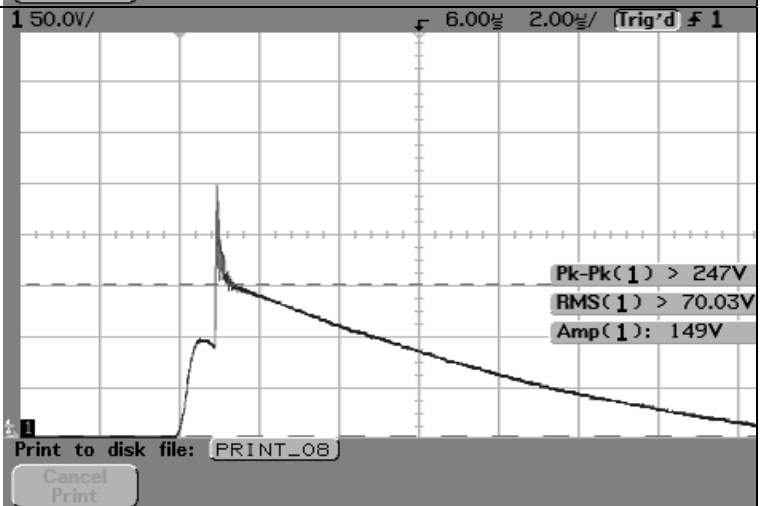
BP1-12 1000 A Current

1000 A	10/11/04 5:03 pm
<b>Oscilloscope</b>	<b>Imp. (Impulse generator output)</b>
208 Vpk-pk	440 V
206 V peak	920 A



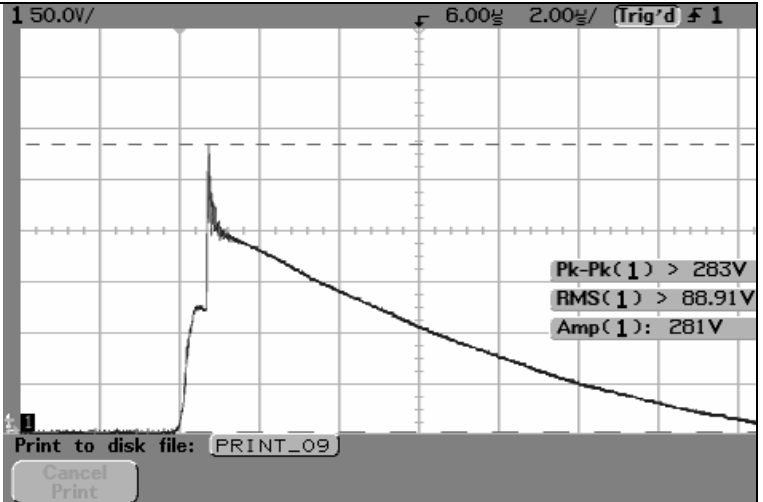
BP1-12 1500 A Current

1500 A	10/11/04 5:06 pm
<b>Oscilloscope</b>	<b>Imp. (Impulse generator output)</b>
249 Vpk-pk	471 V
149 V peak	1391 A



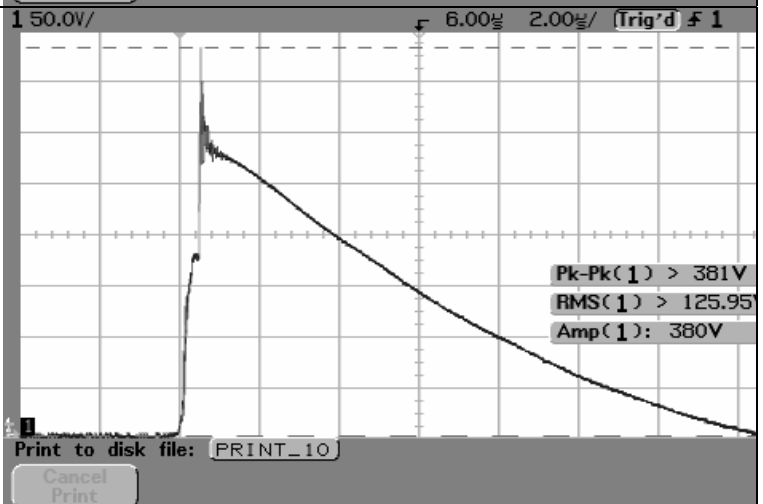
BP1-12 2000 A Current

2000 A	10/11/04 5:08 pm
<b>Oscilloscope</b>	<b>Imp. (Impulse generator output)</b>
283 Vpk-pk	501 V
281 V peak	1880 A



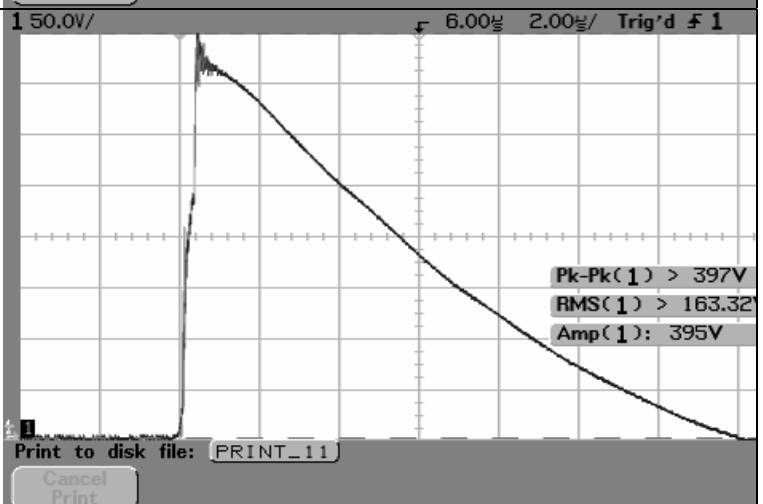
BP1-12 3000 A Current

3000 A	10/11/04 5:10 pm
<b>Oscilloscope</b>	<b>Imp. (Impulse generator output)</b>
381 Vpk-pk	550 V
380 V peak	2817 A



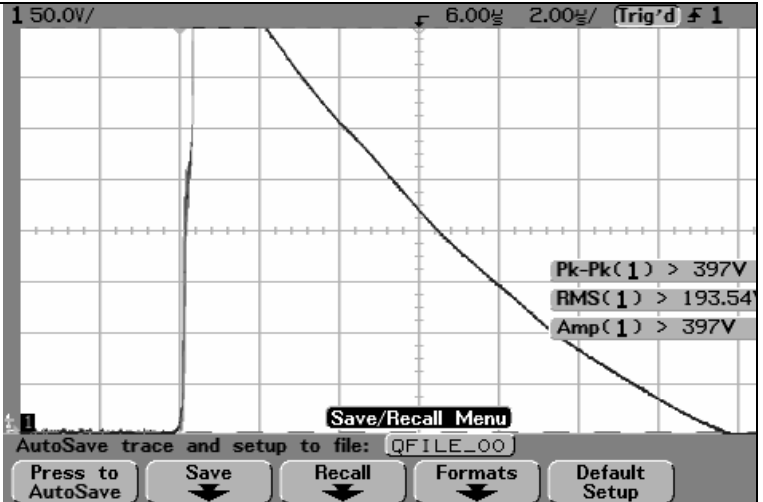
BP1-12 4000 A Current

4000 A	10/11/04 5:12 pm
<b>Oscilloscope</b>	<b>Imp. (Impulse generator output)</b>
397 Vpk-pk	583 V
395 V peak	3778 A



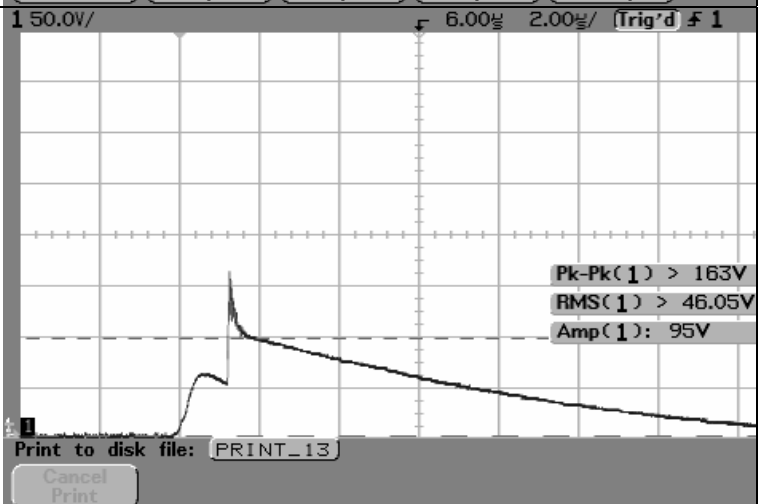
BP1-12 5000 A Current

5000 A	10/11/04 5:15 pm
<b>Oscilloscope</b>	<b>Imp. (Impulse generator output)</b>
Clipped Vpk-pk	659 V
Clipped V Amp.	4720 A



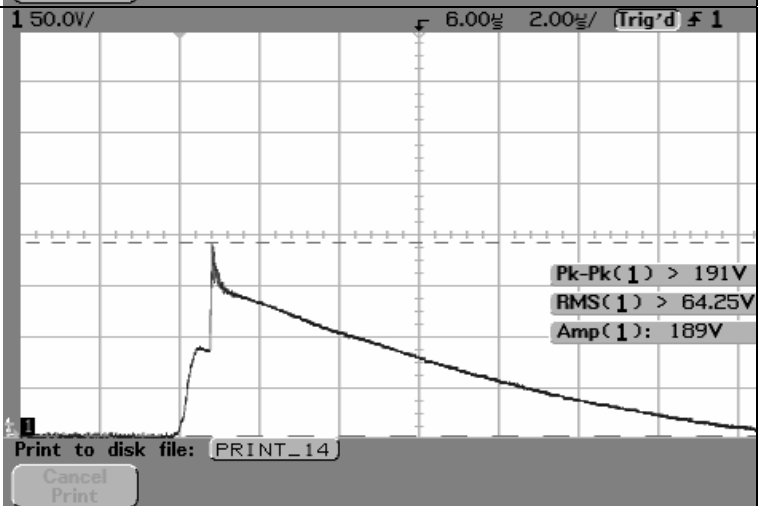
BP1-06 1000 A Current

1000 A	10/11/04 5:17 pm
<b>Oscilloscope</b>	<b>Imp. (Impulse generator output)</b>
163 Vpk-pk	414 V
95 V peak	972 A



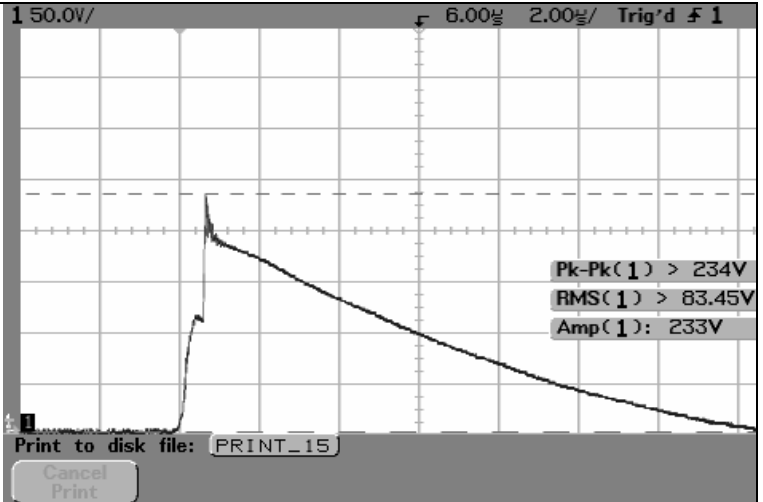
BP1-06 1500 A Current

1500 A	10/11/04 5:18 pm
<b>Oscilloscope</b>	<b>Imp. (Impulse generator output)</b>
191 Vpk-pk	482 V
189 V peak	1388 A



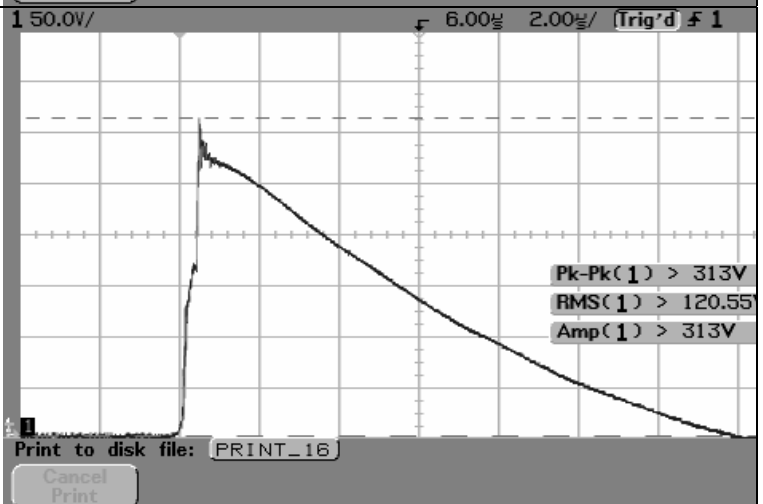
BP1-06 2000 A Current

2000 A	10/11/04 5:19 pm
<b>Oscilloscope</b>	<b>Imp. (Impulse generator output)</b>
234 Vpk-pk	440 V
233 V peak	1875 A



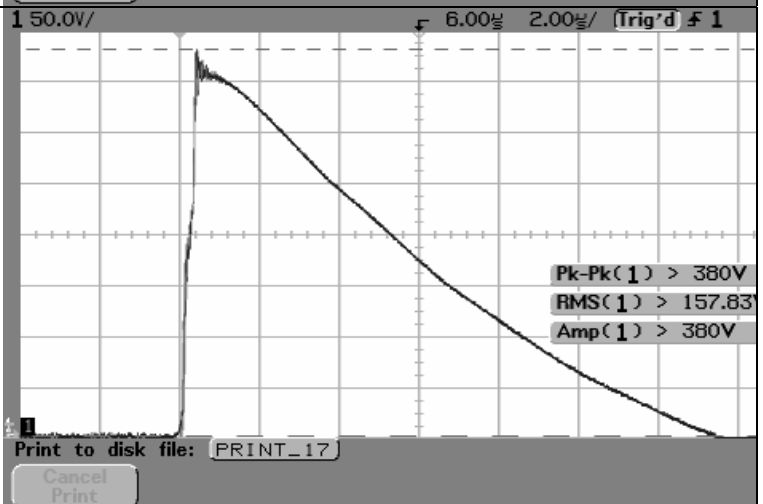
BP1-06 3000 A Current

3000 A	10/11/04 5:20 pm
<b>Oscilloscope</b>	<b>Imp. (Impulse generator output)</b>
313 Vpk-pk	486 V
313 V peak	2816 A



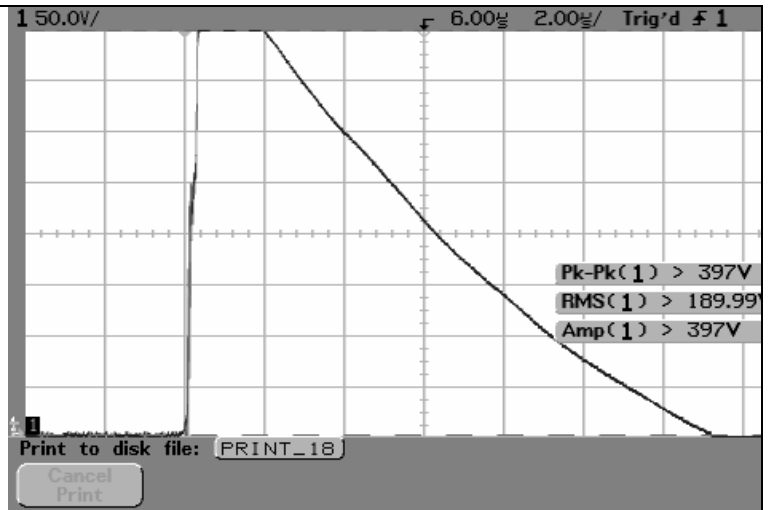
BP1-06 4000 A Current

4000 A	10/11/04 5:21 pm
<b>Oscilloscope</b>	<b>Imp. (Impulse generator output)</b>
380 Vpk-pk	539 V
380 V peak	3769 A


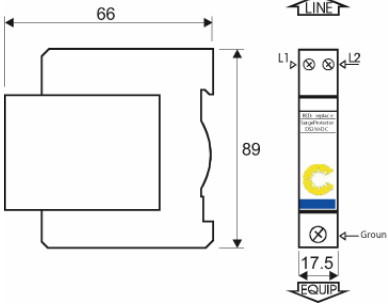
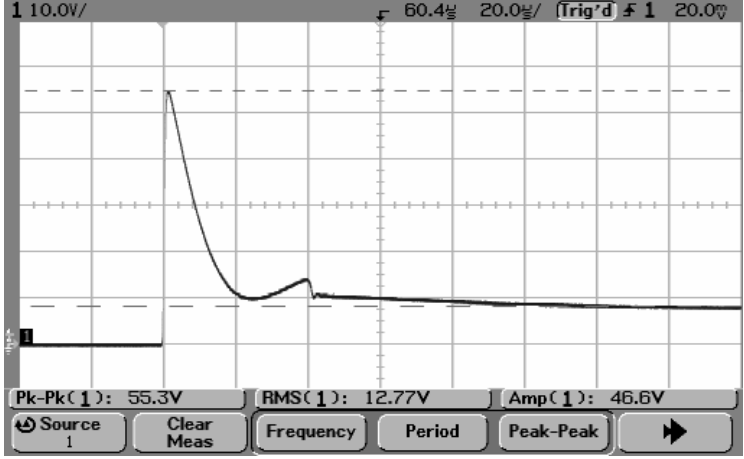
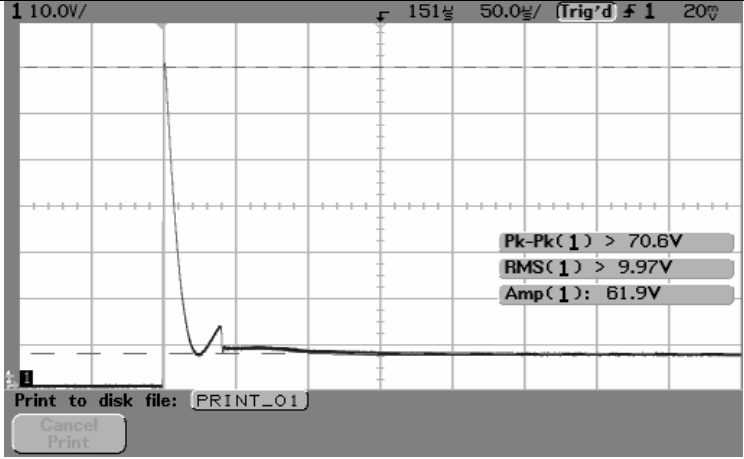


BP1-06 5000 A Current

5000 A	5:22 pm
<b>Oscilloscope</b>	<b>Imp. (Impulse generator output)</b>
Clipped Vpk-pk	654 V
Clipped V Amp.	4720 A



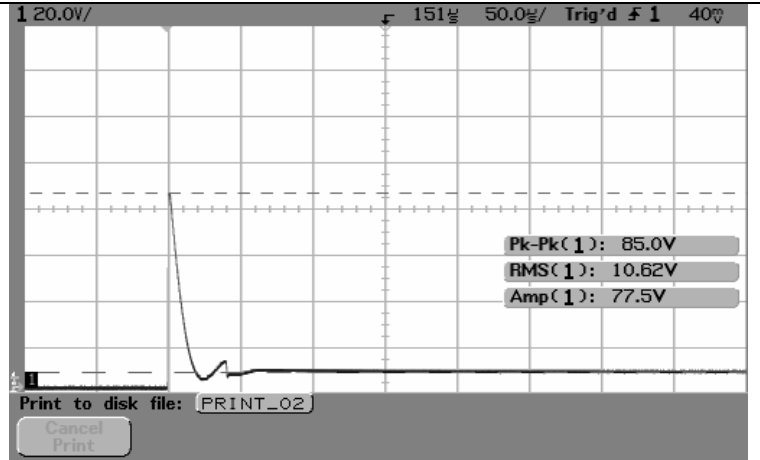
### 5.1.3. CITELE DS Series Surge Suppressor Output

	<h4>Mechanical Specifications</h4>  <p>Dimensions: 89 X 66 X 17.5 (H X D X W)</p> <p>Mounting: Device is mounted in parallel on a DIN Rail 50022 rail.</p> <p>I/O Connections: Screw terminals</p> <p>*All dimensions are in millimeters.</p>								
<p>DS210-12DC 300 A Current</p> <table border="1" data-bbox="133 802 724 989"> <tr> <td>300 A</td> <td>11/09/04 3:58pm</td> </tr> <tr> <td><b>Oscilloscope</b></td> <td><b>Imp. (Impulse generator output)</b></td> </tr> <tr> <td>46.6 V Amp.</td> <td>98 V</td> </tr> <tr> <td></td> <td>232 A</td> </tr> </table>	300 A	11/09/04 3:58pm	<b>Oscilloscope</b>	<b>Imp. (Impulse generator output)</b>	46.6 V Amp.	98 V		232 A	
300 A	11/09/04 3:58pm								
<b>Oscilloscope</b>	<b>Imp. (Impulse generator output)</b>								
46.6 V Amp.	98 V								
	232 A								
<p>DS210-12DC 400 A Current</p> <table border="1" data-bbox="133 1289 673 1451"> <tr> <td>400 A</td> <td>11/09/04 3:59 pm</td> </tr> <tr> <td><b>Oscilloscope</b></td> <td><b>Imp. (Impulse generator output)</b></td> </tr> <tr> <td>61.9 V Amp.</td> <td>123 V</td> </tr> <tr> <td></td> <td>314 A</td> </tr> </table>	400 A	11/09/04 3:59 pm	<b>Oscilloscope</b>	<b>Imp. (Impulse generator output)</b>	61.9 V Amp.	123 V		314 A	
400 A	11/09/04 3:59 pm								
<b>Oscilloscope</b>	<b>Imp. (Impulse generator output)</b>								
61.9 V Amp.	123 V								
	314 A								



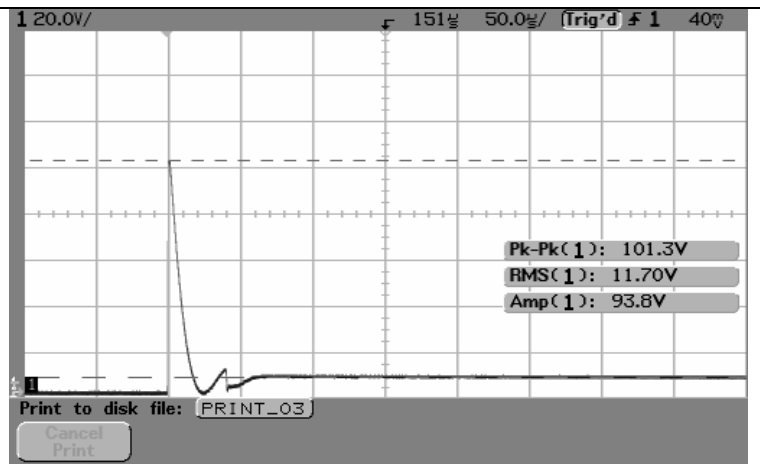
DS210-12DC 500 A Current

500 A	11/09/04 4:03 pm
<b>Oscilloscope</b>	<b>Imp. (Impulse generator output)</b>
77.5 V Amp.	146 V
	392 A



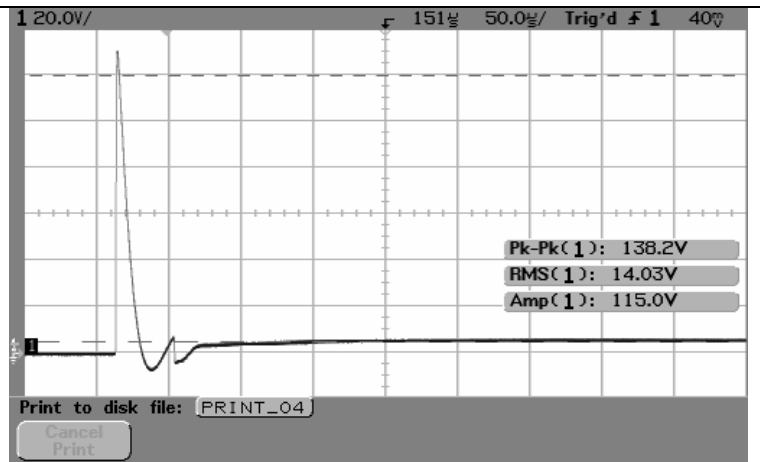
DS210-12DC 600 A Current

600 A	11/09/04 4:05 pm
<b>Oscilloscope</b>	<b>Imp. (Impulse generator output)</b>
93.06 V Amp.	172 V
	484 A



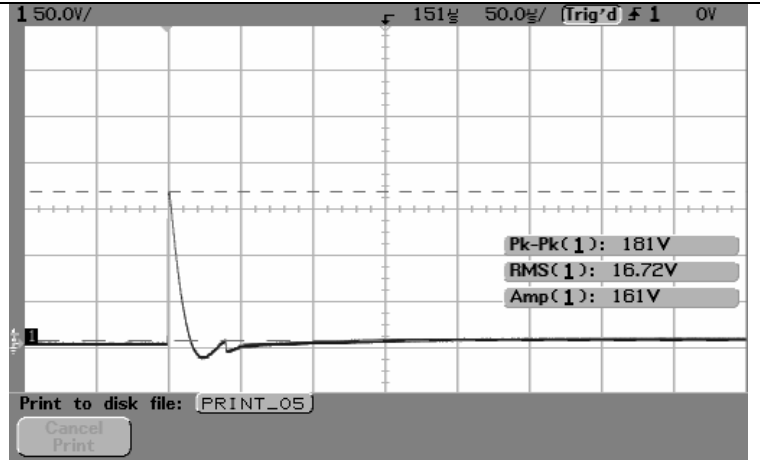
DS210-12DC 800 A Current

800 A	11/09/04 4:07 pm
<b>Oscilloscope</b>	<b>Imp. (Impulse generator output)</b>
115 V peak	221 V
	657 A



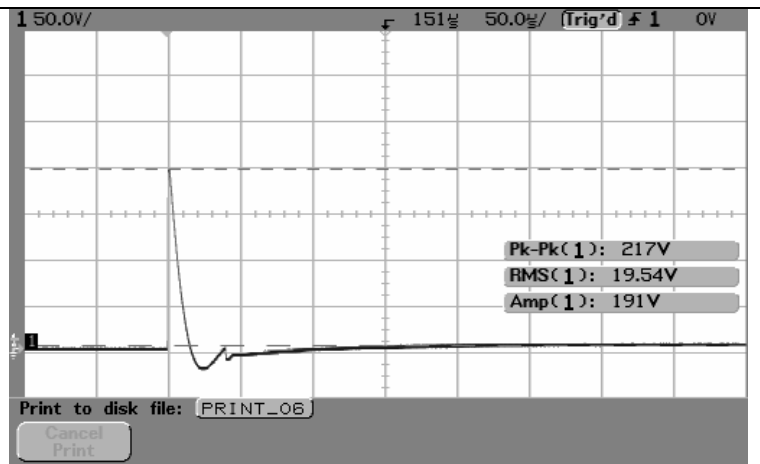
DS210-12DC 1000 A Current

1000 A	11/09/04 4:10 pm
<b>Oscilloscope</b>	<b>Imp. (Impulse generator output)</b>
161 V peak	274 V
	840 A



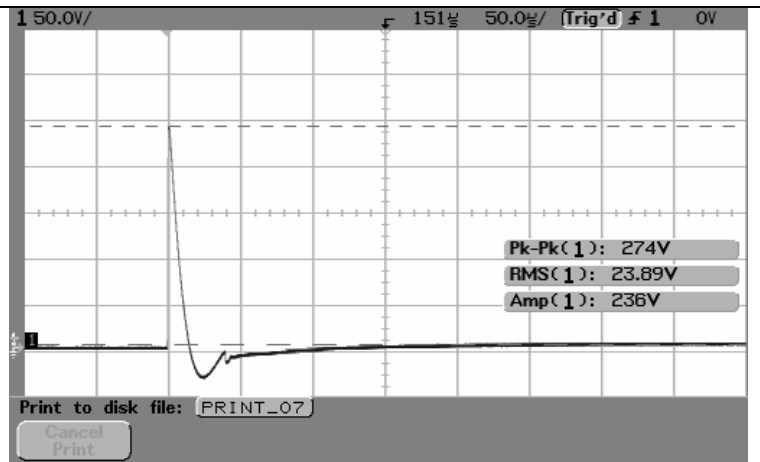
DS210-12DC 1200 A Current

1200 A	11/09/04 4:11 pm
<b>Oscilloscope</b>	<b>Imp. (Impulse generator output)</b>
191 V peak	323 V
	1014 A



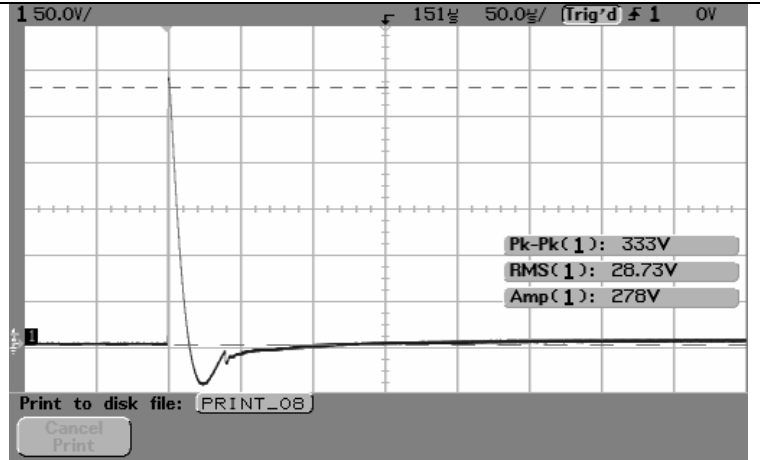
DS210-12DC 1500 A Current

1500 A	11/09/04 4:12 pm
<b>Oscilloscope</b>	<b>Imp. (Impulse generator output)</b>
236 V peak	396 V
	1274 A



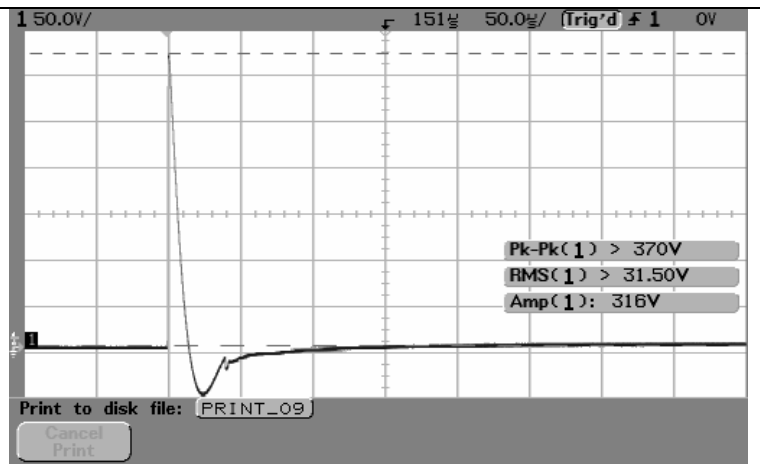
**DS210-12DC 1800 A Current**

1800 A	11/09/04 4:13 pm
<b>Oscilloscope</b>	<b>Imp. (Impulse generator output)</b>
278 V peak	476 V
	1555 A



**DS210-12DC 2000 A Current**

2000 A	11/09/04 4:15 pm
<b>Oscilloscope</b>	<b>Imp. (Impulse generator output)</b>
316 V peak	524 V
	1722 A

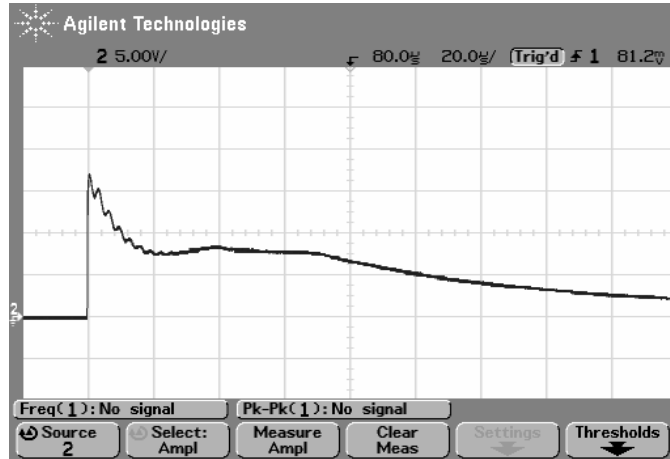


**5.1.4. Atlantic Scientific Series Surge Suppressor Output**



Atlantic Scientific Series Surge Suppressors

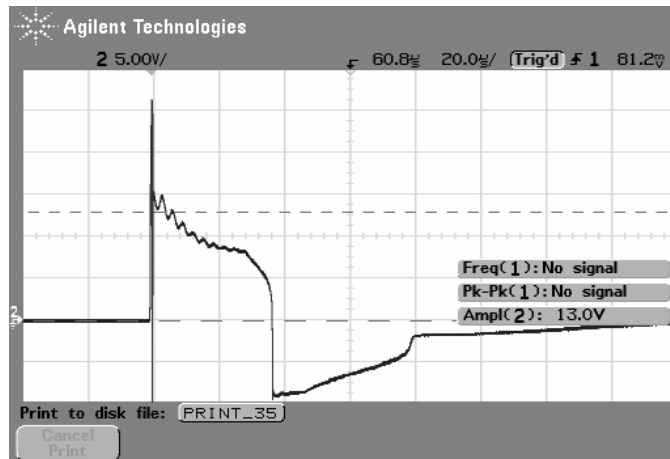
**Endurance test on Atlantic Scientific Device # No: 24516**



Atlantic Scientific 24516 Output for 2000A input current

Time scale of 20us per division and 5v per vertical division		
<b>Endurance Tests</b>	Input Current	Test 1: 6000A Test 2: 2000A
	Number of Tests	Test 1: The traces disintegrated after 87 tests at 6000A Test 2: Greater than 10,000 Tests
	Result	Test 2: Device survived the endurance tests with minimal deviation in input response. 267V 1733A input response initial test 281V 1732A input response final test.

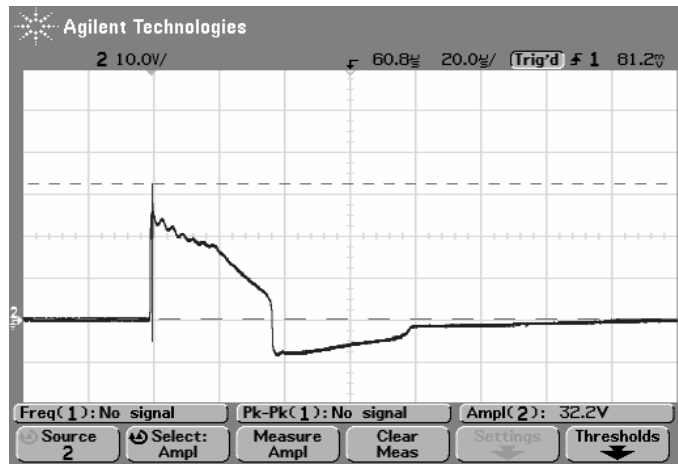
**Endurance test on Atlantic Scientific Device # No: 24528**



Atlantic Scientific 24528 Output for 2000A input current

Time scale of 20us per division and 5v per vertical division		
Endurance Tests	Input Current	2000A
	Number of Tests	Greater than 10,000 Tests
	Result	Device survived the endurance tests with minimal deviation in input response.  502V 1941A input response initial test 502V 1939A input response final test.

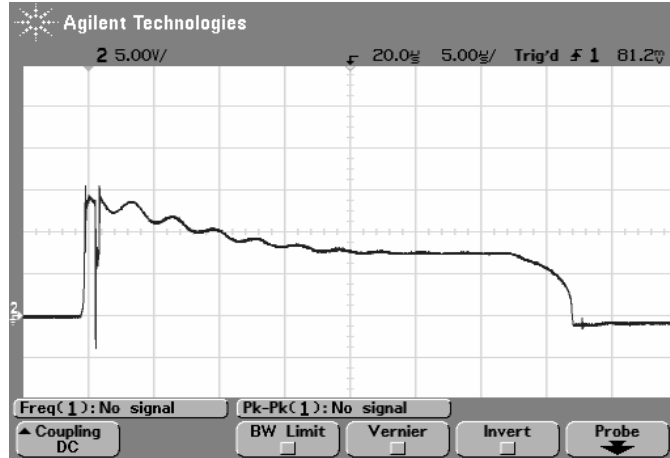
**Endurance test on Atlantic Scientific Device # No: 24538**



Atlantic Scientific 24538 Output for 2000A input current

Time scale of 20us per division and 5v per vertical division		
Endurance Tests	Input Current	2000A
	Number of Tests	Greater than 10,000 Tests
	Result	Device survived the endurance tests with minimal deviation in input response.  491V 1929A input response initial test 501V 1929A input response final test.

**Endurance test on Atlantic Scientific Device # No: 90489**



Atlantic Scientific 90489 Output for 2000A input current

Time scale of 5us per division and 5v per vertical division		
Endurance Tests	Input Current	Test 1: 6000A Test 2: 3000A
	Number of Tests	Test 1: Test 1: The traces disintegrated after 4 tests at 6000A Test 2: Greater than 10,000 Tests
	Result	Test 2: Device survived the endurance tests with minimal deviation in input response. 281V 2917A input response initial test 287V 2910A input response final test.

## 5.2 Specifications

### 5.1.5. EDCO SRA Series Manufacturer Specifications

TABLE 1: EDCO SRA Series SPECIFICATIONS	
Peak Surge Current:	
8x20μs (Differential Mode)	400 Amps
8x20μs (Common Mode)	1000 Amps
Life Expectancy (Occurrences):	
8x20μs (200A)	500 (Typ)
10x700μs (100A)	100 (Typ)t
Response Time	< 5 ns
Input Capacitance	35pf
Clamping Voltage (After Breakover)	< 25V
Breakover Voltage	150V (typ.)
Operating Temperature	-40°C to +85°C
Weight	3 oz.
Dimensions:	
SRA6LC	1.2" Square cube
SRA6LC W/LEADS	1.2" Square cube
Mounting:	
SRA6LCA-716	7/16" Terminal Strip Spacing
SRA6LCA-916	9/16" Terminal Strip Spacing
SRA6LCB	9/16" Terminal Strip Spacing
SRA6LCBLL	9/16" Terminal Strip Spacing

### 5.1.6. CITEL BP1 Series Manufacturer Specifications

	BP1-24	BP1-12	BP1-06
Series Resistance	4.7 ohm	4.7 ohm	4.7 ohm
Capacitance	300 pF	400 pF	900 pF
Max. Line Current	200 mA	200 mA	200 mA
Max. Line Voltage	24 V	15 V	6V
Clamping Voltage	30 V	20 V	10 V
Residual Voltage	35 V	30 V	20 V
Power Handling	10 kA	10 kA	10 kA
End of Life Char.	Short Circuit	Short Circuit	Short Circuit

## **Appendix F**

### **Interim Report**

#### **“Low-Voltage Surge Suppression for TTMS Sensors”**



### 5.1.7. CITELE DS Series Manufacturer Specifications

	<b>DS210-12DC</b>
Nominal DC Voltage	12 V
Nominal AC Voltage	10 V
Maximum DC Voltage	15 V
Nominal Discharge Current	1 kA
Maximum Discharge Current	2 kA
Protection Level	85 V

### 5.1.8. Atlantic Scientific Series Manufacturer Specifications

<b>Specifications of Atlantic Scientific Devices</b>	<b>Device 24516</b>	<b>Device 24528</b>	<b>Device 24538</b>	<b>Device 90489</b>
Max. Input Current	10,000A	10,000A	10,000A	10,000A
Max let thru Voltage	12V @ 2000A	12V @ 5000A	25V @ 5000A	10V @ 5000A
Serial Device Interface	RS423	RS422	RS232	RS485

## **Appendix G**

### **Interim Report**

**“Electronic Interface Design for and Field Tests of a Segmented Axle Sensor”**

**Interim Technical Report**

**Electronic Interface Design for and Field Tests of  
a Segmented Axle Sensor**

**PROJECT:**

**Electrical Engineering Support for Telemetered Traffic Monitoring Sites  
(FDOT Contract No. BC-543 RPWO 3, FSU OMNI 010295)**

**Submitted by:**

**FAMU-FSU College of Engineering  
2525 Pottsdamer Street  
Tallahassee, FL 32310-6046**

**Principal Investigator:**

**Bruce A. Harvey, Ph. D., Associate Professor  
Department of Electrical and Computer Engineering  
Phone: (850) 410-6451  
Fax: (850) 410-6479  
Email: [bharvey@eng.fsu.edu](mailto:bharvey@eng.fsu.edu)**

**December 2008.**

## Executive Summary

The Florida Department of Transportation currently maintains over 300 Telemetered Traffic Monitoring Sites (TTMS) throughout the state to monitor traffic operations on the state highway system. Most of these TTMS stations employ inductive loop detectors and piezoelectric axle sensors to determine the number of axles, axle spacing and length of individual vehicles. This information is used to attempt to determine the classification of the vehicles. Vehicle classification statistics are used to estimate pavement wear and traffic patterns, and to plan maintenance and improvements of the roads. Thus accurate classification of vehicles is critical to the FDOT.

Classification of vehicles using number of axles, axle spacing and length alone can result in a significant number of classification errors. For example, a long-bed pickup truck with all single tires (Class 3) can easily have the length and axle spacing of some smaller trucks with 2 axles and 6 tires (Class 5). Class 5 vehicles are generally heavier and carry larger loads than a Class 3 pickup truck. Such misclassifications lead to inaccurate pavement loading statistics.

Classification algorithms can be improved if the axle sensor had the ability to detect single versus dual tires on each axle. This information would greatly reduce misclassifications of vehicles such as the Class 3 –Class 5 errors. John Reed of PET Corporation proposed a design for a segmented axle sensor that can provide an estimate of the tire width and thus discriminate between single and dual tire axles. This effort was designed to determine if the segmented axle sensor is feasible and if the identification of single and dual tire axles can improve vehicle classification accuracy.

### *Activities Conducted*

An in-depth study was conducted to study and implement the segmented sensor electronic interface for classification of vehicles using the algorithm developed by Dr. Ren Moses of the Department of Civil and Environmental Engineering at the FAMU-FSU College of Engineering.

This effort was conducted in two phases. First, PET Corporation produced a prototype sensor using metallic conductors. The segment lengths were designed with the aid of a study of tire footprints conducted on a separate research project by Dr. Ren Moses. An electronics interface was designed and constructed to sense the segment closures and transmit the closure information via a serial port to a classification algorithm running on a laptop computer. Field tests were conducted to demonstrate the operation of the sensor and interface, and to demonstrate the improved classification accuracy using the tire width information.

The metallic sensor was implemented to provide a proof of concept before proceeding to the second phase of the project. In the second phase of the project PET Corporation constructed a prototype of a segmented sensor made entirely of conductive and non-

conductive extruded polymers. The extruded polymers are expected to be much more durable than the metallic conductors and eventual automatic extrusion of a sensor is far more cost-effective and flexible than the manual construction required for the metallic sensors.

A new electronics interface was designed and constructed for use with the extruded sensors. The extruded polymer conductors used in the new prototype have a very high resistance that complicates the interface design. The design team modified a design originated by Dr. David Bourner of the University of Maryland in Baltimore County. Several modifications were made to Dr. Bourner's design to improve the speed and accuracy of the electronics interface. The extruded sensor and interface electronics were field tested along with the classification algorithm to demonstrate the feasibility and benefits of the extruded sensor.

### *Results and Conclusions*

The implementation of the electronics interface and the field testing of the prototype metallic segmented sensor demonstrated that tire width estimation resulting in single versus dual tire discrimination can significantly improve the vehicle classification accuracy. The implementation of an interface for and testing of the prototype extruded segmented sensor demonstrated the feasibility of the design and interfacing of an extruded segmented sensor. Future efforts are required to fully implement the interface electronics for the segmented sensor.

### *Benefits to the FDOT*

This project demonstrated that the potential for improve vehicle classification can be attained using segmented sensors. The feasibility of the extruded segmented sensor was also demonstrated. When implemented, the FDOT will benefit from more accurate vehicle classification at the TTMS sites.

## Table of Contents

Executive Summary .....	G-3
Table of Contents .....	G-5
List of Figures and Tables.....	G-6
1 Introduction.....	G-7
2 Interface Design and Field Tests for the Metallic Segmented Sensor .....	G-9
2.1 Introduction.....	G-9
2.2 The Metallic Sensor .....	G-9
2.3 Initial Interface Design .....	G-11
2.3.1 Determination of Sampling Speed .....	G-11
2.3.2 Sensor Pulse Tests.....	G-11
2.3.3 Electronics Design .....	G-13
2.3.4 Microprocessor Software Implementation.....	G-14
2.3.5 Field Tests of Initial Design.....	G-15
2.3.6 Shadow Closure Problem.....	G-16
2.4 Final Electronic Interface Design for the Metallic Sensor.....	G-17
2.5 Field Testing .....	G-19
3 Interface Design and Field Testing of Extruded Segmented Sensor .....	G-22
3.1 Design of the Interface Electronics for the Extruded Segmented Sensor .....	G-23
3.1.1 Modifications to the UMBC Electronics .....	G-23
3.1.2 Final Design of the Extruded Sensor Electronic Interface.....	G-25
3.2 Field Testing of the Extruded Segmented Sensor and Electronic Interface .....	G-29
4 Conclusions and Future Work .....	G-30

## List of Figures and Tables

Figure 1. Segment Numbering of the Metallic Sensor .....	G-10
Figure 2. Wiring Model of the Metallic Sensor.....	G-10
Figure 3. Internal view of segment 6. ....	G-10
Figure 4. Circuit Model for Capacitance Testing. ....	G-12
Figure 5. Output Recorded for Open Segment .....	G-12
Figure 6. Output Recorded for a Closed Segment .....	G-13
Figure 7. Circuit Model for Threshold Calculation. ....	G-14
Figure 8. Format of Interface Electronics Output.....	G-15
Figure 9. Snapshot of the Classification Software.....	G-16
Figure 10. Example of the Shadow Closure Problem.....	G-17
Figure 11. Current Sensing Circuit to Detect True Segment Closures .....	G-18
Figure 12. Set-up of the Interface Electronics for the Metallic Segmented Sensor.....	G-18
Figure 13. Sample Output Form the Software and the Matching Image of the Vehicle .....	G-21
Figure 14. Block Diagram of the circuit .....	G-22
Figure 15. Clock Signal Generator .....	G-26
Figure 16. Output Latches.....	G-27
Figure 17. Pull-Down Circuit (B circuit).....	G-28
Figure 18. Closure Sensing Circuit.....	G-28
Table 1. Scheme F Vehicle Classification .....	G-8

## 1 Introduction

The Florida Department of Transportation currently maintains over 300 Telemetered Traffic Monitoring Sites (TTMS) throughout the state to monitor traffic operations on the state highway system. These TTMS stations employ inductive loop detectors and piezoelectric sensor arrays (configured as loop-piezo-loop) to determine axle counts and axle spacing of individual vehicles. The axle count, axle spacing and vehicle length is used to estimate the vehicle's classification according to the Federal Highway Administration's (FHWA) Scheme F shown in Table 1. Vehicle count and classification statistics are used to estimate the load on highway pavement and plan pavement maintenance. The accuracy of the vehicle count and classification from the TTMSs is critical in accurately planning pavement wear.

Using a combination of loop detectors and piezoelectric axle sensors can provide the classification system with axle counts, axle spacing and vehicle length with some degree of accuracy. However, this information is not always sufficient to accurately classify the vehicles. For example, a long-bed pickup truck with all single tires (Class 3) can easily have the length and axle spacing of some smaller trucks with 2 axles and 6 tires (Class 5). Class 5 vehicles are generally heavier and carry larger loads than a Class 3 pickup truck. Such misclassifications lead to inaccurate pavement loading statistics.

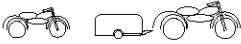
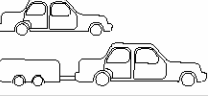
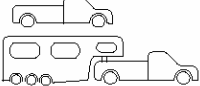
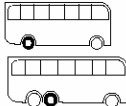
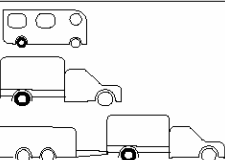
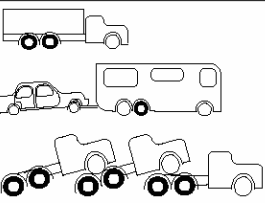
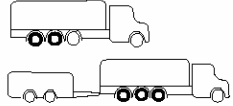
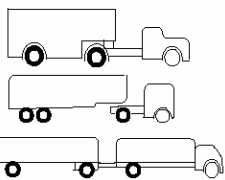
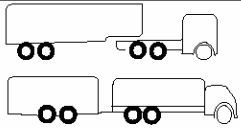

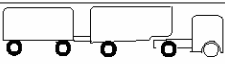

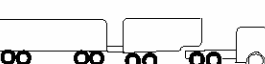
In order to minimize the vehicle classification errors an additional variable was proposed: single / dual tire discrimination. A segmented axle sensor-based system capable of distinguishing the number of tires (single versus dual tires or 2-tire versus 4-tire axles) on a vehicle's axle was proposed and evaluated in the several field tests.

John Reed of PET Corporation proposed a segmented sensor design capable of distinguishing dual-tire axles by effectively estimating vehicle tire width information by the number of segments closed. Fairly definitive identification of dual-tire truck axles can be assured if the widths of dual tire and single tires are exclusive and the estimated tire width is accurate. Development of the system being proposed would provide FDOT a level of identification resolution surpassing that of current TTMS stations.

The entire project was in two phases. In the first phase a metallic pilot prototype of the segmented sensor was designed and constructed by PET Corporation. This sensor was constructed using metallic conductors and conductive polymer contacts. This metallic prototype was a first prototype designed only to validate the concept of single/dual tire discrimination and improved vehicle classification. The tasks of the FAMU-FSU College of Engineering research team was to design and construct an electronics interface for the segmented sensor that would output reports of segment closures via a serial port, and to conduct field tests to verify the performance of the sensor and improved vehicle classification.



**Table 1. Scheme F Vehicle Classification**

Class	Sketch	Description	Axles	Dual tired axles
1		Motorcycle	2 to 4	0
2		Passenger cars with or without light trailer	2 to 4	0
3		Pickups, vans, SUVs with or without light trailer	2 to 5	0
4		Buses	2 or 3	1
5		2 axle 6 tire truck or motorhome with or without light trailer	2 to 5	1
6		3 axle truck or motorhome with or without light trailer	3 to 7	At least 1
7		Truck with at least 4 axles with or without light trailer	At least 4	At least 2
8		3 or 4 axle tractor-semi-trailer or truck-trailer	3 or 4	2 or 3
9		5 axle tractor-semi-trailer or truck-trailer	5	3 or 4
10		Tractor semi trailer or truck-trailer with 6 or more axles	At least 6	At least 4
11		5 axle tractor-multi-trailer	5	4
12		6 axle tractor-multi-trailer	6	5
13		7 or more axle tractor-multi-trailer	At least 7	At least 6

The second phase of this effort was for PET Corporation to design and construct a segmented sensor completely out of extruded conductive polymers. This sensor would be more durable than the sensor with the metallic conductors (metallic conductors tend to wear and fail) and a completely tooled process could make segmented sensor of virtually any segment size and count without manual construction. Again the goal for this research team was to construct an electronics interface for the extruded segmented sensor and conduct field tests to demonstrate the sensor's operation.

Initially the design of the metallic and extruded sensor electronics interfaces were to be conducted in parallel with a design team led by Dr. David Bourner of the University of Maryland, Baltimore County (UMBC). However, the initial interface design for the metallic sensor was completed by the FAMU-FSU design team (with input from Dr. Bourner), while Dr. Bourner proceeded with the extruded sensor interface designs. Later, Dr. Bourner left UMBC and the design work was sent to the FAMU-FSU design team.

The following sections describe the designs for the electronics interfaces and the field testing of the metallic and extruded prototype sensors.

## **2 Interface Design and Field Tests for the Metallic Segmented Sensor**

### **2.1 Introduction**

The FDOT tasked this research team to design and build electronic interface circuit capable of interfacing two sixteen-channel segmented axle metallic segmented sensors to accomplish classification in one lane of traffic. Progressive Engineering Technologies (PET) Corporation constructed the sensors. The sensor's ability to operate in an actual highway environment was then tested.

### **2.2 The Metallic Sensor**

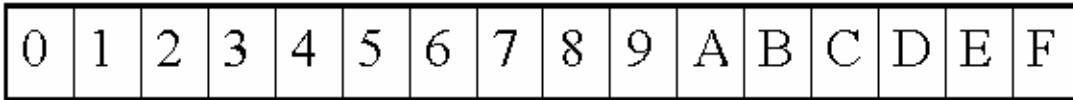
The metallic sensor built by PET Corporation consisted of 16 segments that were numbered from '0' (closest segment) to 'F' using hexadecimal notation (see Figure 1). As shown in Figure 2, the sensor had 8 connections labeled  $t_0 - t_3$  and  $b_0 - b_3$ . The connectors  $b_0 - b_3$  each provided a connection to one of 4 consecutive segments (a quartet) on one side of the sensor. The connectors  $t_0 - t_3$  provide connections to each of the individual segments within each quartet. Therefore, a closure of a single segment will provide a unique connection between one  $t_0 - t_3$  connector and a single  $b_0 - b_3$  connector. For example, if segment 7 is closed, then there is an electronic connection between connector  $t_2$  and connector  $b_1$ .

An internal view depicting the construction of the metallic sensor is shown in Figure 3. The bare wire running through the conductive polymer sensor contacts provides electronic connection to the segment switch contact. The insulated wires pass through the conductive polymer without making electrical connections. The bare wire is cut in the gaps between segments and connected to the appropriate conductors ( $t_0 - t_3$  or  $b_0 - b_3$ ) to generate the wiring pattern depicted in Figure 2.

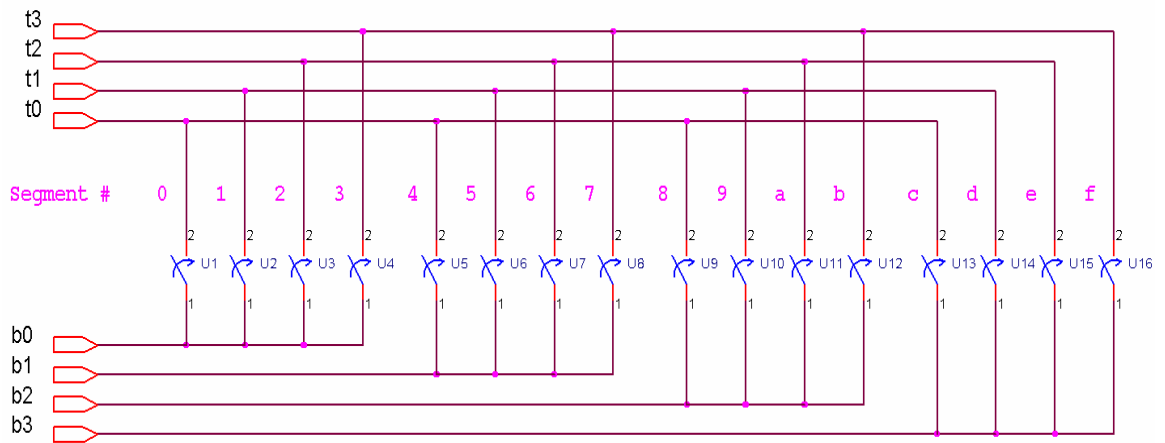
The metallic sensor is characterized by:

- Very low resistance conductors and
- Moderate resistance contacts.

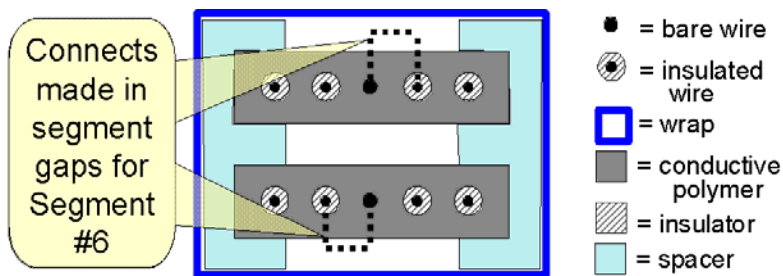
Segmented Sensor



**Figure 1. Segment Numbering of the Metallic Sensor**



**Figure 2. Wiring Model of the Metallic Sensor.**



**Figure 3. Internal view of segment 6.**

## 2.3 Initial Interface Design

### 2.3.1 Determination of Sampling Speed

One of the requirements for the electronic interface is the need to sample all 16 of the segments fast enough to ensure detection of every sensor closure. It was determined that each quartet of segments can be sampled at one time. Therefore, an appropriate speed for sampling each quartet was calculated to ensure the detection of the tires on a vehicle traveling at a maximum speed of 100 miles/hr. The assumptions used in the calculations are as follows:

- Maximum allowable speed of vehicles: 100miles/hr
- Minimum tire longitudinal (direction of travel) contact with the road: 4 inches.

Based on these assumptions, the tire's minimum time of contact with the sensor is:

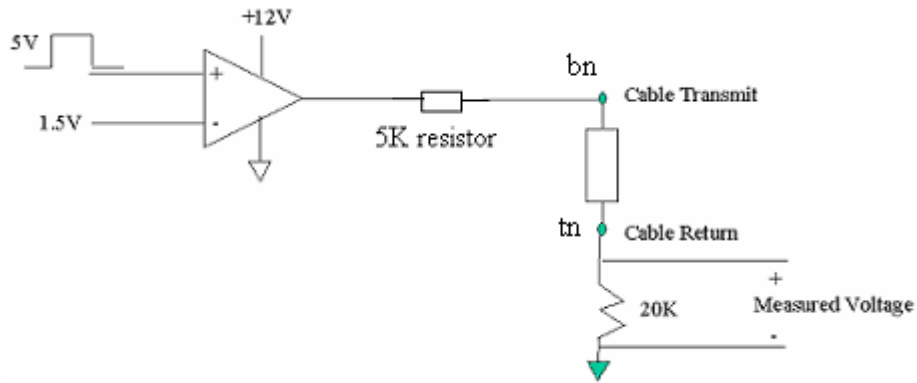
$$\frac{4 \text{ " hr}}{100 \text{ miles}} * \frac{\text{miles}}{5280 \text{ feet}} * \frac{\text{feet}}{12 \text{ "}} * \frac{3600 \text{ seconds}}{\text{hr}} = 2.27 \text{ milli seconds} \quad (1)$$

Therefore 2.27 milliseconds is the maximum time that can be used to sample the entire segmented sensor. Since the sampling mechanism required that each quartet (group of four segments) be sampled sequentially, a time of 0.57 milliseconds was determined to be the maximum time available to sample each quartet. To allow for the possibility of contact bounce (multiple closures of a segment upon a single tire passing) it was decided that 10 samples of the entire sensor was needed to ensure detection of a tire. To accomplish this it was decided that each quartet would be sampled at a rate of one quartet every 50 microseconds.

### 2.3.2 Sensor Pulse Tests

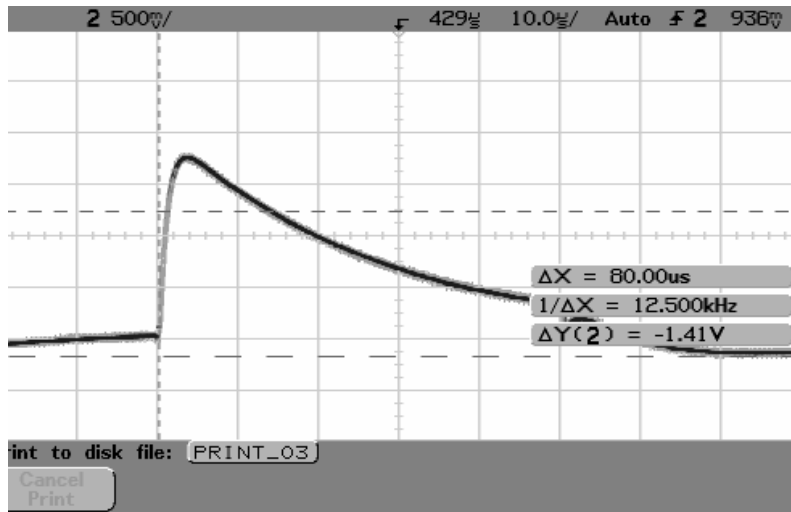
The sensor was tested to determine if a 50 microsecond pulse can successfully be transmitted through the sensor and detected at the output. Additionally, it was necessary to determine if a 50 microsecond pulse would be transmitted capacitively through the sensor even when the segment was not closed.

The segmented sensor was connected to a test circuit via a 25-foot Cat5E Ethernet cable (chosen for its high bandwidth). The Ethernet cable consists of 4 twisted pairs of wire. The wires in each twisted pair were connected to t0 and b0, t1 and b1, t2 and b2, or t3 and b3. A 12-volt, 50 microsecond pulse was transmitted through a 5 kΩ resistor to one of the base connectors (b0 – b3). The individual segment connectors (t0 – t3) were connected through a 20 kΩ resistor to ground (see Figure 4). The output voltage across the 20 kΩ was measured and used to determine either the pass-through capacitance (open segment) or the shunt capacitance (closed segment) for the sensor.



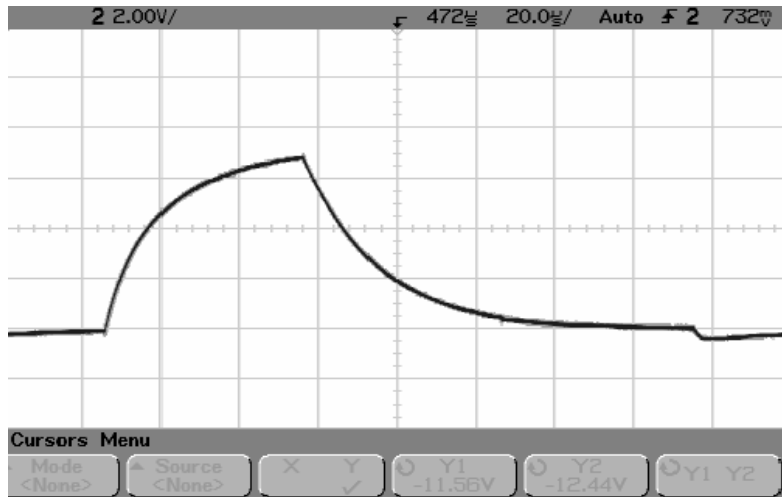
**Figure 4. Circuit Model for Capacitance Testing.**

Each input/output combination (i.e. each segment) was tested with the corresponding segment closed and opened. Figure 5 shows an example of the output waveform measured across the 20 kΩ resistor when the corresponding segment was open. The capacitances of the Ethernet cables, the internal conductors of the sensor and the segment contact act as a high-pass filter causing the output to go high at the start of the 50 microsecond pulse. However, the voltage drops to less than 0.5 V by the end of the 50 microsecond pulse.



**Figure 5. Output Recorded for Open Segment**

Figure 6 depicts an example of the output waveform when the segment corresponding to an input/output pair was closed. For this case the capacitances between the wires and conductors have a low-pass filter effect. The output rises in an exponential pattern towards the maximum voltage. From this example it can be seen that the output reaches over 6.5 V by the end of the 50 microsecond pulse.



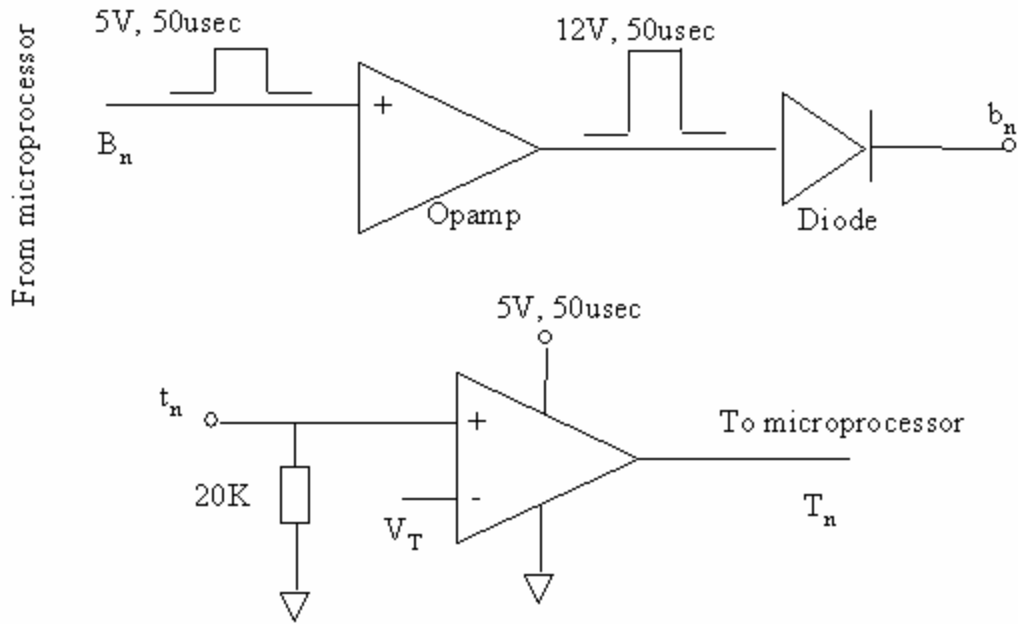
**Figure 6. Output Recorded for a Closed Segment**

From the above tests, it can be concluded that the capacitances within the connecting cables and sensor are not large enough to prevent the sampling of each quartet within a 50 microsecond time period. Therefore, a 50-microsecond pulse will be transmitted to each base connector sequentially. The 4 individual segment connectors will be tested to determine which segments within the tested quartet are closed.

### 2.3.3 Electronics Design

The initial circuit schematic design is shown in Figure 7. The circuit is basically a test of continuity to detect segment closure. For the transmit part of the circuit, 5V, 50-microsecond pulses from the microprocessor are first amplified to 12v pulses using TLE 2144 operational amplifiers. The 12V pulses are then passes through diodes to the input of the metallic sensors designated as  $b_n$  (i.e.  $b_0$ --- $b_3$  as shown in Figure 2). The diodes were used to isolate the operational amplifier outputs for cases where multiple segments are closed.

A detection circuit is connected to each of the individual segment connectors (i.e.  $t_0$ --- $t_3$  as shown in Figure 2). The detection circuit consists of a 20 k $\Omega$  test resistor and a comparator with threshold. If the output at the end of the 50 microsecond pulse is greater than the threshold, the microprocessor would sample a '1' (5V) and interpret it as a segment closure. The threshold range used was between 2.4 – 2.5V.



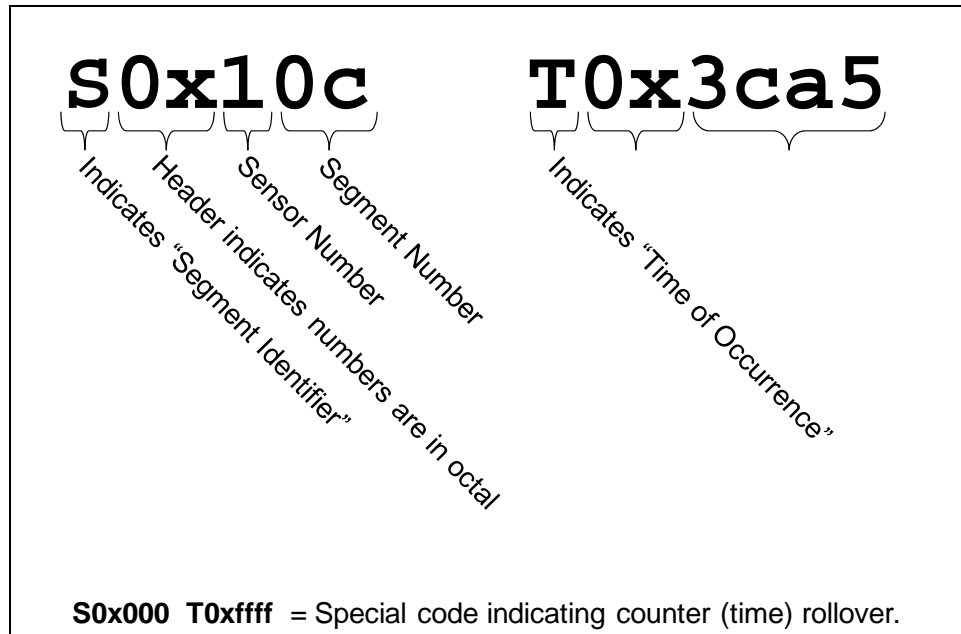
**Figure 7. Circuit Model for Threshold Calculation.**

### 2.3.4 Microprocessor Software Implementation

Software was written in Assembly language on a Freescale HC12 microprocessor to generate the 50 microsecond pulses (amplified and transmitted on the base connectors,  $b_0 - b_3$ ), sample the returning signals from the individual segment connections ( $t_0 - t_3$  after the threshold detector), handle debouncing of the segment contacts, and transmit a closure result on a serial output whenever a segment closes.

Upon detecting a segment closure, the microprocessor produces a serial output (in ASCII) for each segment closure in the format shown in Figure 8.

The example output in Figure 8 is a report of a closure on segment C of sensor 2 at a time of 3ca5 milliseconds in hex (15,525 milliseconds). Whenever the millisecond clock rolls over to zero, a special code is transmitted with the maximum clock count.



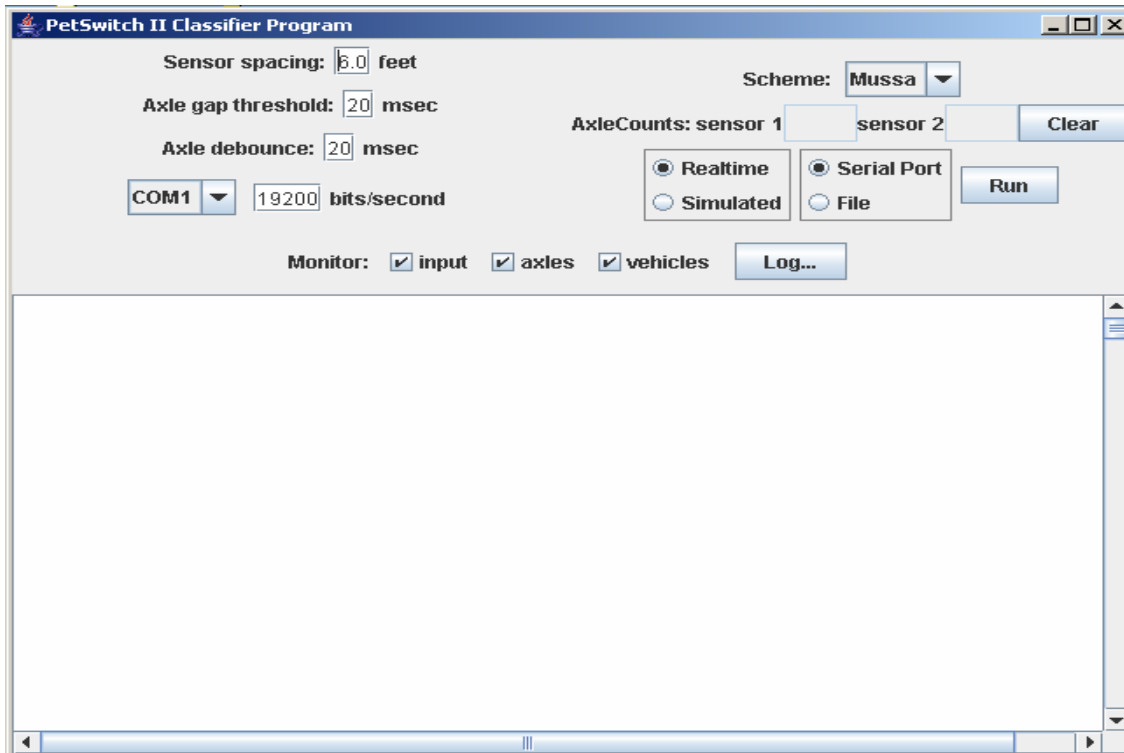
**Figure 8. Format of Interface Electronics Output**

### 2.3.5 Field Tests of Initial Design

The initial design of the electronics interface capable of operating 2 metallic segmented sensors was implemented and tested in the laboratory. At the direction of John Reed of PET, George Dinwiddie of iDIA Computing, LLC developed software designed to run on a laptop computer to receive and process the sensor closures reported by the interface electronics. The software implemented a classification algorithm based on a decision model by Dr Ren Moses of the department of Civil and Environmental Engineering. The algorithm implemented the single/dual tire detection capability of the segmented sensor to attempt to improve the classification accuracy of the system. A screen capture of the software is shown in Figure 9.

Field tests were completed on surface streets near the FAMU-FSU College of Engineering, on US27 north of Tallahassee (near the Gadsden county line), and on I-10 west of Tallahassee at CR268. During these tests, descriptions of the vehicles were manually recorded for comparison with the data recorded from the interface electronics. An initial review of the data collected indicated that the sensor system and interface electronics appeared to perform as intended. However, a more detailed analysis of the results revealed a problem with the interface electronics design.





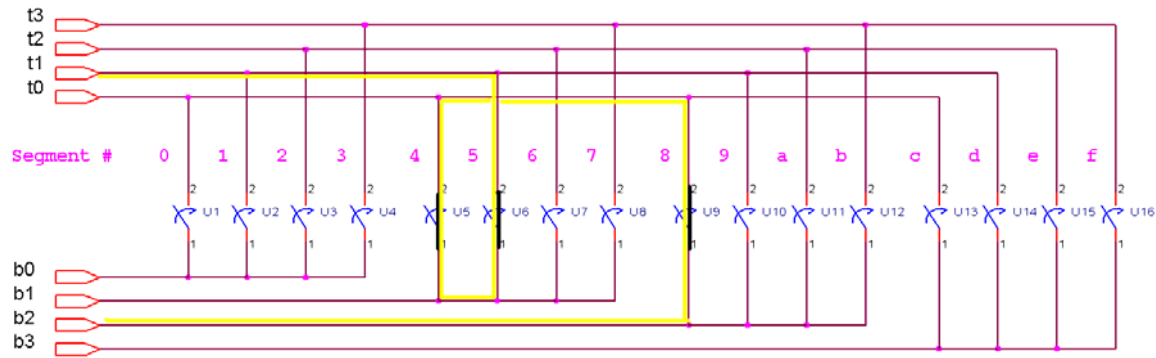
**Figure 9. Snapshot of the Classification Software**

### **2.3.6 Shadow Closure Problem**

Examining the data from the field tests revealed that the recorded width of some tires (as measured by the number of segment closures) was far larger than expected. Some single tires were recorded to be the width of a double tire and some double tire were recorded as extremely wide (some wider than 4 feet). Laboratory testing and simulation revealed that due to the internal construction of the segmented sensor false closures (called shadow closures) can be detected.

A simple example of how a shadow closure can be detected is depicted in Figure 10. In this example, segments 4, 5 and 8 are closed. When the electronic interface tests for continuity between t1 and b2 (testing for closure on segment 9), the closures for segments 4, 5 and 8 create a connection from t1 to b2 as shown in the yellow line. The electronics will detect a shadow closure on segment 9.

The shadow closure problem caused the electronic interface to sometime report an exaggerated tire width and thus falsely indicate that some single tires were double tires. This then caused the classification algorithm to erroneously classify the vehicles. The electronic interface needed to be re-designed to allow for the discrimination between shadow closures and actual closures within the sensor.



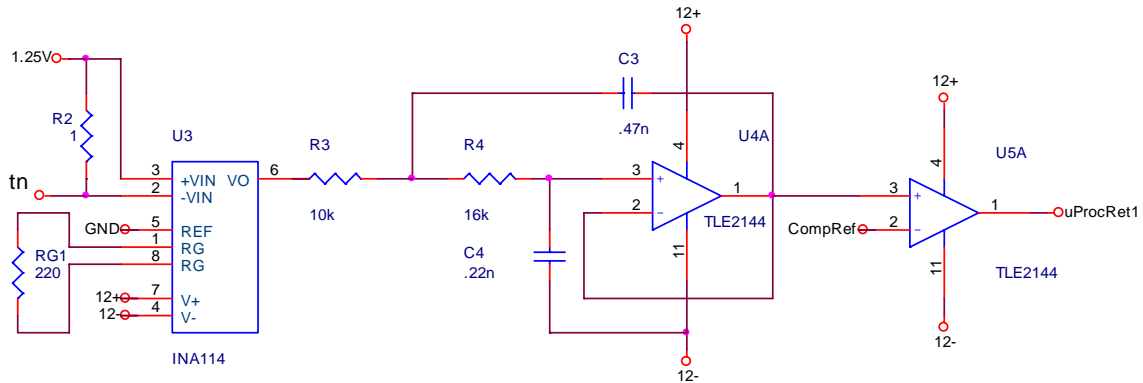
**Figure 10. Example of the Shadow Closure Problem**

## 2.4 Final Electronic Interface Design for the Metallic Sensor

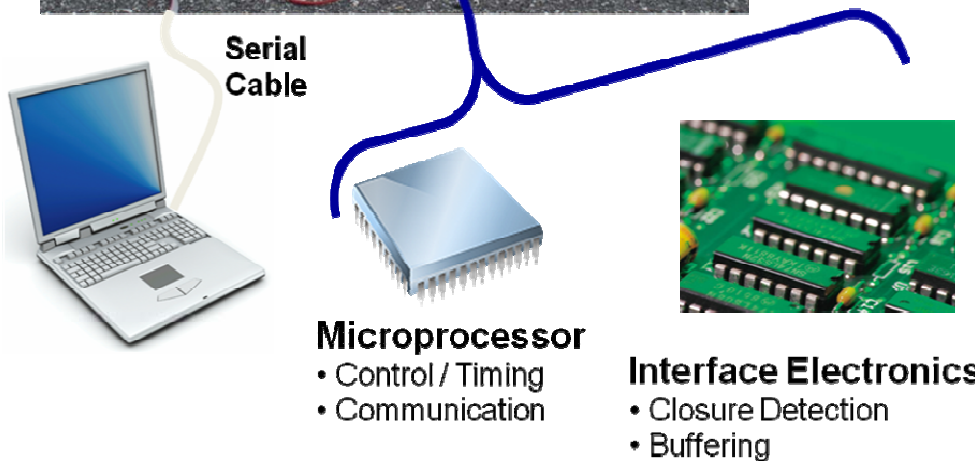
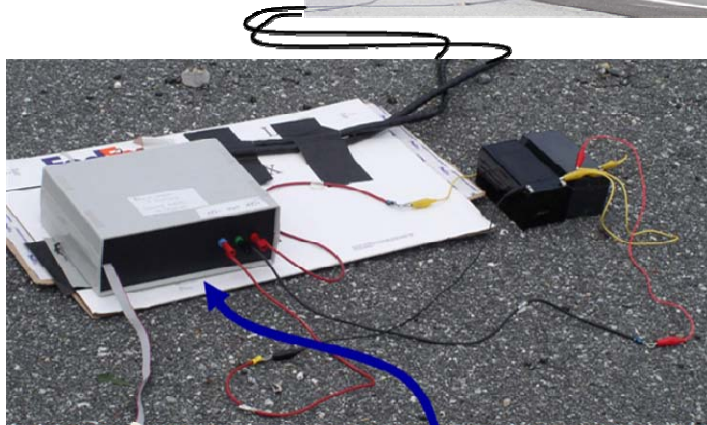
Dr. David Bourner provided the suggested modification that allowed the electronic interface to discriminate between shadow and true segment closures. The metallic segmented sensor was measured to have closure resistance of between  $12.8$  and  $21\Omega$ . The metallic conductors (wires) in the sensor had negligible effect on the measured resistance of a closure. Therefore, a shadow closure would have the resistance of 3 closures in series or between  $37.4$  and  $63\Omega$ . Dr. Bourner's suggestion was to use a precision voltage source and a precision  $1\Omega$  resistor to measure the resistance of the closure. If the resistance was less than around  $30\Omega$ , then a true closure was detected. If the resistance measured was higher than  $30\Omega$ , then either no closure or a shadow closure occurred, and therefore no closure is reported.

The microprocessor program and timing of the initial electronic interface remained the same for the final design, but the control and sensing circuitry was modified. In the final design the 50 microsecond pulses from the microprocessor sequentially connected each base input (b0 – b3) to ground using a MAX4620 CMOS analog switch. Using a 1 Ohm resistor, the current flowing into the individual segment inputs of the sensor (t0 – t3) was measured to determine which segments were closed as shown in Figure 11. The voltage across the precision  $1\Omega$  sensing resistor (R2) was amplified using an INA 114 instrumentation amplifier, low-pass filtered to reduce noise and compared against a threshold. If a true closure was detected, the voltage would exceed the threshold and a closure was indicated to the microprocessor (uProcRet1).

The redesigned electronic interface was tested in the laboratory and on surface streets near the FAMU-FSU College of Engineering and found to work well. Shadow closures were no longer detected and the correct closures were transmitted via the serial port to a laptop where the software developed by George Dinwiddie provided vehicle classification. The interconnection of the sensors to the electronics and the laptop computer (used for classification and data recording) is depicted in Figure 12.



**Figure 11. Current Sensing Circuit to Detect True Segment Closures**



**Figure 12. Set-up of the Interface Electronics for the Metallic Segmented Sensor**

## 2.5 Field Testing

On March 22, 2007 a field test was conducted on Springhill Road in front of the FDOT facility. This site had a high traffic volume with a fair number of double-tired vehicles. After the tests, some anomalies in the data were noted. The circuitry was reviewed and some repairs and modifications were made to correct problems and improve performance.

A second field test was conducted on March 29, 2007 on US27 north of Tallahassee. This test included video ground truth information from 2 angles. Early in the tests it became apparent that one quartet of segments on sensor 1 was not operating properly. The problem was found to be a wiring problem that was easily repairable and the testing continued. The system appeared to operate properly for the latter half of the field test and the resulting data was forwarded to George Dinwiddie and John Reed

The data recorded by the segmented sensor electronics during the field test conducted on March 29, 2007 on US27 north of Tallahassee was reviewed. The data showed some anomalies including some apparent random closures of entire quartets of segments. Considerable effort was undertaken to determine the cause of the erroneous segment closures. Eventually it was determined that there were some electronic device failures. These were repaired and the interface electronics were calibrated. A brief field test was conducted on June 13, 2007 on Levi Street verified that the interface electronics were operating properly.

While the repairs to the interface electronics were being accomplished, the data sent to George Dinwiddie and John Reed was analyzed and cleaned to remove (comment out) the false closures caused by the electronic interface problems. George Dinwiddie enhanced the classification software he was developing to provide real-time vehicle classification.

The enhanced software was received from George Dinwiddie in early June and tested in the laboratory. The software was again tested during the June 13, 2007 field test. The results of the field test were relayed to George and recommendations for software improvements were made. A new version of the classification software was received, and a field test and live demonstration was scheduled for July 2, 2007 on US27 north of Tallahassee.

A field test of the segmented sensor and demonstration of live vehicle classification was conducted on July 2, 2007 on US27 north of Tallahassee. The goal was to demonstrate that the segmented sensor, interface electronics and classification software could provide real-time vehicle classification. The sensor and interface electronics performed as designed for the metallic segmented sensors used. The real-time vehicle classification provided by George Dinwiddie's software performed reasonably well (minor problem to be expected for prototype software). The interface for the metallic sensor is complete and appears to work as expected. The results demonstrated that the identification of dual tire axles can improve the overall accuracy of vehicle classification.

An example, from the July 2, 2007 field test, of the demonstrated benefit of using tire widths (dual tire detection) in classifying vehicles is shown in Figure 13. The pictures are frame captures from video cameras used to provide ground truth during the field test. The first vehicle is a 2-axle standard van (class 3) with all single tires. The second vehicle is a class 5 truck with dual tires on the rear axle. The text is the sensor data transmitted by the interface electronics and the recorded output of the classification algorithm in George Dinwiddie's software (indicated by lines preceded by '#'). The blue text and brackets are comments provided to aid the reader in identifying the axles hitting each sensor. As can be seen in the data from the electronic interface, the dual tires closed more segments than did the single tires. The software was able to detect the dual tire and correctly classify the vehicles.

The metallic prototype of the segmented sensor and electronic interface designed under this effort worked well in the final field test. The field test successfully demonstrated that single and double dual tires could be detected. The real-time vehicle classification software performed reasonably well and provided good classification accuracy. The results demonstrated that the identification of dual tire axles can improve the overall accuracy of vehicle classification using scheme F.



S0x109 T0xbcae } Axle 1. Sensor 1  
 S0x108 T0xbcae }  
 S0x109 T0xbd4e } Axle 2. Sensor 1  
 S0x108 T0xbd4e }  
 S0x207 T0xbd8e } Axle 1. Sensor 2  
 S0x206 T0xbd8e }  
 S0x207 T0xbe2e } Axle 2. Sensor 2  
 S0x206 T0xbe2e }

**Class 3**  
**Example**

# Axle{48.70 MPH,2321.45 feet,2 elements wide}  
 # Axle{48.70 MPH,11.43 feet,2 elements wide}  
 # (Mussa) Vehicle{class 3: OTHER (LIMO, VAN, RV) [-/2  
 11.4/2] 48.7 MPH}



S0x10a T0x136e } Axle 1. Sensor 1  
 S0x109 T0x136e }  
 S0x209 T0x141e } Axle 1. Sensor 2  
 S0x208 T0x141e }  
 S0x10c T0x1466 } Axle 2. Sensor 1  
 S0x10a T0x1466 }  
 S0x109 T0x1466 }  
 S0x20b T0x1516 } Axle 2. Sensor 2  
 S0x208 T0x1516 }  
 S0x20a T0x151e }  
 S0x209 T0x151e }

**Class 5**  
**Example**

# Axle{61.98 MPH,269.73 feet,2 elements wide}  
 # Axle{61.98 MPH,22.55 feet,4 elements wide}  
 # (Mussa) Vehicle{class 5: 2D [-/2 22.5/4] 62.0 MPH}

Figure 13. Sample Output Form the Software and the Matching Image of the Vehicle

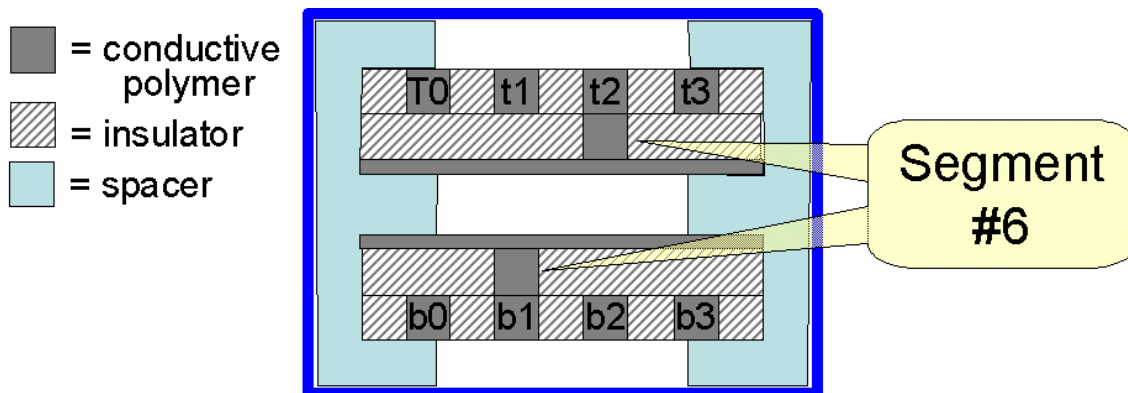
### 3 Interface Design and Field Testing of Extruded Segmented Sensor

Following the successful implementation and testing of the metallic segmented sensor and interface, the efforts of the research team at the FAMU-FSU College of Engineering were focused on the design and implementation of the extruded sensor's electronic interface. By this point in time the engineers at PET Corporation had completed the assembly of the first prototypes of the segmented sensors constructed from extruded conductive polymers. The final design of the segmented sensor is intended to be a completely extruded sensor that can be produced with a minimum of manual labor.

Among the benefits of using the extruded sensor were the following:

- Extruded sensors are made of polymers therefore more durable than the metallic counterparts.
- The assembly of the metallic sensors required an intensive manual labor process whereas the extruded sensors were manufacture through an automated extraction process.
- Extruded sensors are more reliable than the metallic sensors in which the wirings are susceptible to wear and break.

Figure 14 depicts a cross-section of the extruded segmented sensor that illustrates the internal configuration of the sensor. Conductive polymers provide the conductors for the base (b0 – b3) connections to the quartets of segments and the conductors for the individual segment connections (t0 – t3). A conductive polymer is also used for the segment's contact surfaces, and to make connections between the contact surfaces and the conductors. The depicted cross-section is an example of the view through segment 6 of the segmented sensor.



**Figure 14. Block Diagram of the circuit**

The internal connections for the extruded segmented sensor and the metallic segmented sensor were identical. However the conductive polymers used for the conductors in the extruded sensor have a very high resistance compared to the metallic conductors of the earlier prototype. Measurements of the resistance of a closure in the extruded sensor made at UMBC demonstrated that the closure resistance for segment 0 (nearest segment)

was 2 – 13 k $\Omega$ , and for segment F (farthest segment) was 618 – 689 k $\Omega$ . The resistance in the conductors clearly is the most significant contributor to the measured closure resistance in the sensor.

### **3.1 Design of the Interface Electronics for the Extruded Segmented Sensor**

Dr. David Bourner at UMBC began the design of the interface electronics for the extruded segmented sensor while the research team at the FAMU-FSU College of Engineering was completing the field tests for the metallic segmented sensor. Dr. Bourner left his position at UMBC and was unable to complete the design and implementation of the interface. Therefore the designs and the partially-completed electronics from UMBC were transferred to the design team at the FAMU-FSU College of Engineering. The FAMU-FSU team then completed the design and implementation of the interface electronics for the extruded segmented sensor.

The concept behind the interface electronics developed at UMBC was similar to implemented design of the interface for the metallic sensor. However, in the interface for the extruded sensor the maximum resistance for detection of a closure was approximately 700 k $\Omega$ . Due to the high and length-dependent resistance of the conductor, the interface design did not allow for the discrimination between true segment closures and shadow closures as was done in the metallic interface design.

The design of the microprocessor software was not conducted by the UMBC research team. The interface between the electronics and the microprocessor was also different that the interface used in the metallic design discussed previously. Initial tests of the closure sensing circuitry on a prototype extruded sensor also revealed that some modifications of the UMBC's design were needed for proper operation. The following sections summarize the modifications made to the UMBC electronics and final design of the interface electronics for the extruded segmented sensor

#### **3.1.1 Modifications to the UMBC Electronics**

The original circuitry by Dr. Bourner was simulated in Orcad and Quartus. Based on the simulation results obtained, the original circuitry was modified to eliminate multiple and false closures in the quartets (group of four consecutive segments).

##### *Closure Sensing Electronics*

The UMBC closure sensing circuitry used a transistor to amplify the current through the sensor to detect closure. This approach allowed for the sensing of currents down to approximately 1 micro Amp (1  $\mu$ A). The original UMBC sensing circuit was design to sample each segment sequentially rather than sample all 4 segments of a quartet simultaneously. This approach did not work as intended and the electronics were modified to provide a clear function that increased the operation speed of the system.

##### *Clock Signal Generation and Output Latching*



The UMBC interface design relied on an internal clock and control signal generation to control the sampling of the sensor segment. The microprocessor did not provide the sampling control signals as had been done in the metallic sensor interface. The UMBC electronics provided an interrupt signal to alert the microprocessor whenever any segment was closed. Also, the control signal generation was designed to sample each individual segment of the sensor sequentially.

The control signal generation and latching circuits implemented in the UMBC interface boards were replaced with a programmable logic board (Altera UP2 development board). The control signals were modified to provide a clear signal to dissipate charges on the individual segment conductors ( $t_0 - t_3$ ). Following a delay, the control signals would latch the results of the closure detections for the quartet being sampled. When the entire sensor (all 4 quartets) had been sampled, the results of the closures were latched into output buffers connected to the microprocessor. If any segments were closed, the logic provided an active-low interrupt signal to the microprocessor. Upon receiving the interrupt the microprocessor will acquire the closure results from the output latches, process the closures, and generate the closure messages that are transmitted out the serial port.

### *Sampling Speed*

Several of the modifications to the interface electronics and logic were intended to improve the sampling speed of the electronic interface. The high resistance of the extruded conductors and the inherent capacitance within the sensor and connecting cable make it difficult to rapidly sample the closures on the sensor. The clear function in the electronics was designed to help dissipate charges on the sensor's conductors. Without this function, the charges on the individual segment conductors often caused false closure detections (referred to as phantom closures) to occur on corresponding segments of quartets sampled after a true closure.

Based on the analysis of tire longitudinal contact area and vehicle speed (see Equation (1) in Section 2.3.1), a tire will be in contact with the sensor for a minimum of 3.2 milliseconds assuming a maximum speed of 70 MPH. The control signal generator causes the interface to sample the entire segmented sensor every 16 clock cycles. Therefore, the ideal clock speed required to ensure detection of a closure (at least one time) is 5 kHz. Unfortunately, despite the circuit and logic changes made, the interface was only able to operate at clock speeds of 2 – 2.5 kHz without detecting excessive phantom closures. Therefore the system was operated with a 2 – 2.5 kHz clock speed during testing.

### *Static Electricity and Grounding*

The high resistance of the sensor's internal conductors also made the sensor and interface electronics sensitive to static electricity. During preliminary field testing in the parking lot of the FAMU-FSU College of Engineering the interface reported a large number of

random closures. Attaching a ground wire between the electronics and the sensor resulted in much less sensitivity to static charges. Therefore, a ground wire was added to the connecting cables between the interface and the sensors.

### **3.1.2 Final Design of the Extruded Sensor Electronic Interface**

The final designs for the interface electronics including the logic implemented on the programmable logic board are provided in Figures 15 to 18. The clocking logic in Figure 15 provided the control signals for the quartet (Figure 17), the clear signal for the closure sensing circuit (Figure 18), and the latching signals for the output result buffer latches (Figure 16). The output latches (Figure 16) latch the results for each quartet into a buffer until the results for all the segments in sensor are latched in an output buffer. If a closure has been detected in the sensor, an active-low interrupt signal is generated to alert the microprocessor. The pull-down circuits (Figure 17) are used to sequentially connect each quartet's base (b0 – b3) to ground and thus activate the quartet for sensing closures. The closure sensing circuit (Figure 18) first clears the charges in the individual segment conductors (t0 – t3) and then senses if the resistance to ground is less than about 1 M $\Omega$ . If so, then output goes high to indicate a segment closure is detected.

The HC12 microprocessor used in the metallic sensor interface was also used for the extruded sensor interface. The microprocessor's software modified to adapt to the operation of the extruded sensor interface electronics. The 50 microsecond output pulses were removed. The IRQ interrupt was enabled to detect when the output latches contained a segment closure. Then results of the closure detection for all 16 segments were retrieved from the output buffers. Finally, debouncing of the segment closures and identification of new closures was determined. New segment closures were indicated using the serial port in the same format used for the metallic sensor interface.

Clock Signal Generator  
(div by 16 synchronous counter)

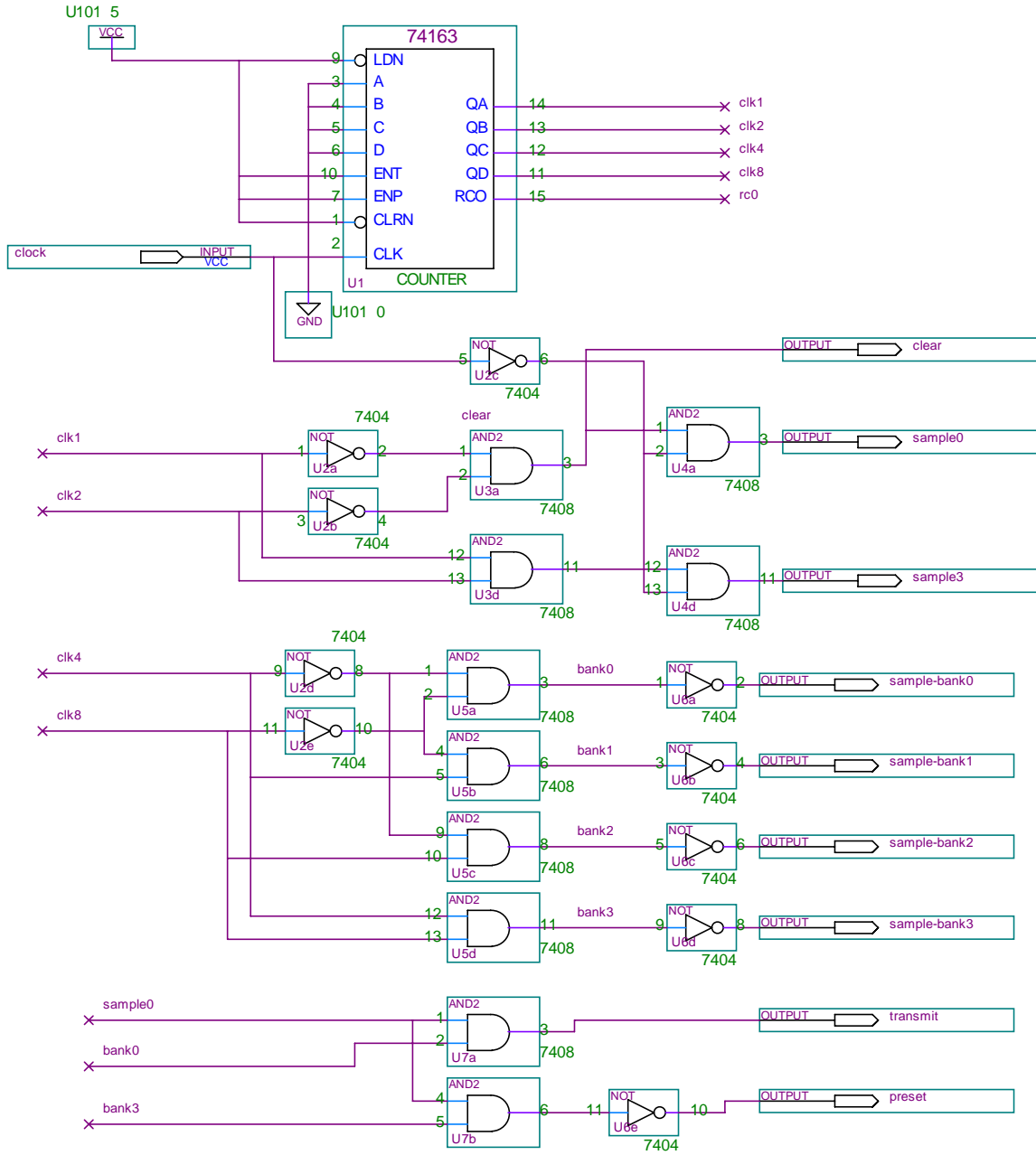


Figure 15. Clock Signal Generator

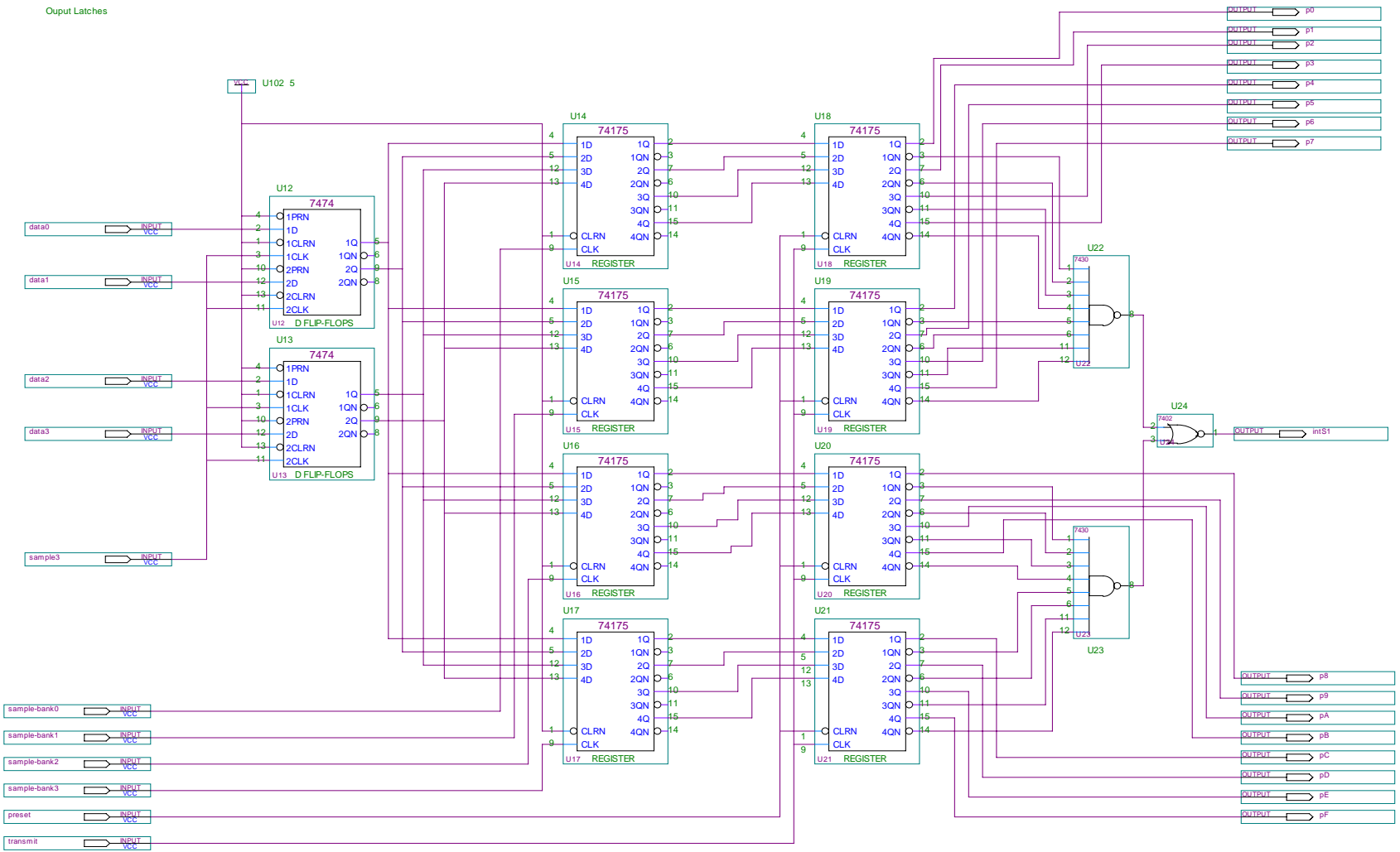
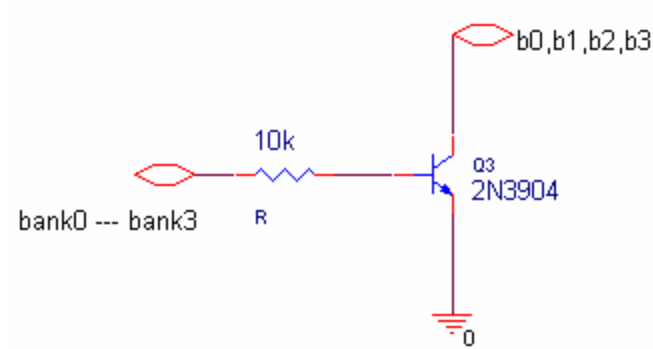
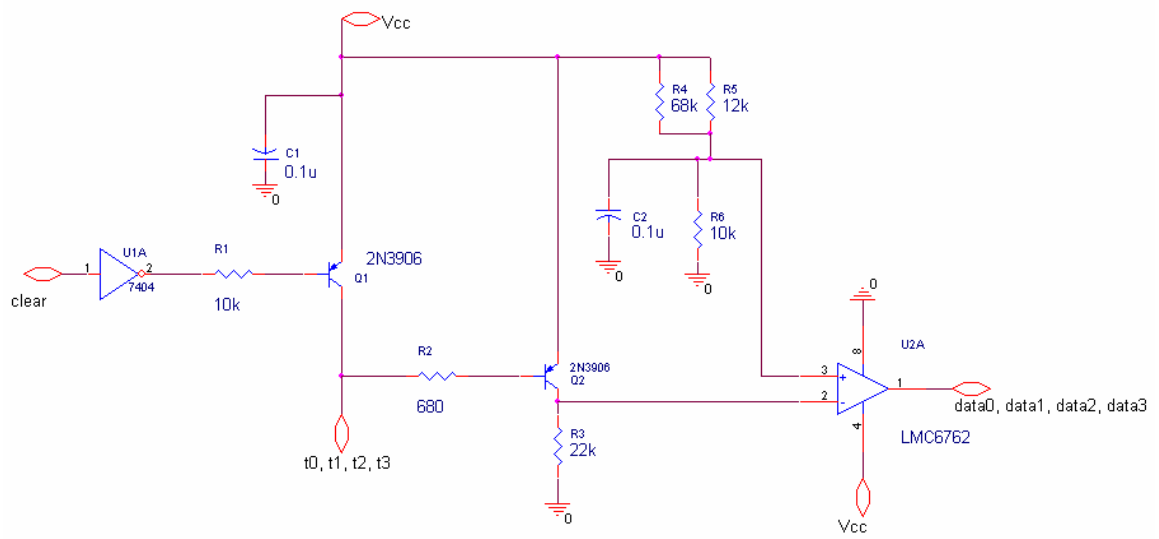


Figure 16. Output Latches



**Figure 17. Pull-Down Circuit (B circuit)**



**Figure 18. Closure Sensing Circuit**

### **3.2 Field Testing of the Extruded Segmented Sensor and Electronic Interface**

On April 28, 2008, an attempt was made to demonstrate the operation of the extruded segmented sensors and modified electronic interface. The field test was conducted on US27N north of Tallahassee. The goal of the demonstration was to verify the ability of the interface electronics to detect segment closures and to attempt to classify the vehicles using the classification algorithm (developed by Dr. Ren Moses) implemented in software (by George Dinwiddie). In addition, the tests will determine if the current grounding was sufficient for operation on an open roadway.

Almost immediately upon placing the sensors in the roadway, the electronics began producing erroneous closure indications. Vehicles passing over the sensor caused the number of errors to increase rapidly. Finally, the demonstration was halted and the sensors removed from the road. Analysis after the field test revealed that the errors were the result of 2 problems. First, the extruded sensors had multiple structural failures that caused some segments to intermittently close. As a result, both extruded sensors were sent back to John Reed (of PET Corporation) to be completely rebuilt. Secondly, noise (from static electricity and within the electronics) caused random closures to occur during the test. The electronics interface circuitry was modified to reduce noise in the power supply, and the detection thresholds were raised to reduce the chance of induced noise from causing false closure detections.

On June 24, 2008, John Reed delivered the rebuilt extruded sensor to the FAMU-FSU College of Engineering. The sensors and electronics were tested in the laboratory and found to be performing well. A controlled field test was conducted in a parking lot to test the system's ability to detect closures and classify vehicles. This test was also successful.

On June 25, 2008, a second field demonstration was conducted on US27N north of Tallahassee. This demonstration was much more successful than the previous test in April. During the field test the sensor and interface appeared to operate as intended for the most part. The interface electronics was found to be susceptible to heat and had to be shaded to operate well. As expected, if the interface's clock speed was raised above 2 kHz the interface produced a large number of phantom closures. The prototype extruded sensors worked well for about 2 hours before one of the segments began to fail from wear. The classification software was able to detect dual tires and correctly classify a significant number of vehicles. The slow clock speed of the interface resulted in a number of missed axles during the test. Overall this field test demonstrated that the extruded segmented sensor is a viable sensor for detecting dual tires and that an electronics interface for this type of sensor is feasible.

#### **4 Conclusions and Future Work**

The results from this effort indicate that the use of single/dual tire discrimination can improve the classification of vehicles. The extruded sensor prototype was not durable enough for long-term use, but the sensor worked as intended. Durability of the sensor can be improved for the final design of the sensor. Also, the interface electronics successfully demonstrate the operation of the segmented sensors and provided segment closure information to the classification algorithms.

The design of the interface electronics used for the extruded segmented sensor had some significant limitations. The sample rate of the interface was too slow to ensure detection of every segment closure for vehicles at highway speeds. Also, the interface was not able to differentiate true segment closures from shadow closures. The approach use in the interface to detect segment closures needs to be completely redesigned to improve its performance. This will require a complete electrical characterization of the extruded segmented sensor and the consideration of approaches other than simple current detection.

This project demonstrated that the potential for improve vehicle classification can be attained using segmented sensors. The feasibility of the extruded segmented sensor was also demonstrated. When implemented, the FDOT will benefit from more accurate vehicle classification at the TTMS sites.