

CORROSION INHIBITORS FOR CONCRETE BRIDGES

HWY-2003-14

FINAL REPORT

FHWA/NC/2006-25

**Prepared for
North Carolina Department of Transportation**

**Prepared by
Amir Mirmiran, Ph.D., P.E., Professor and Chair
Dept of Civil and Environmental Engineering
Florida International University
Miami, FL 33174**

**Sami Rizkalla, Ph.D., Distinguished Professor
Department of Civil Engineering
North Carolina State University
Raleigh, NC 27695**

**and
Anna Cook, Engineer
HDR Engineering, Inc.
3733 National Dr., Suite 207
Raleigh, NC 27612**

December 2004

Technical Report Documentation Page

1. Report No. FHWA/NC/2006-25	2. Government Accession No.	3. Recipient's Catalog No.	
4. Title and Subtitle Corrosion Inhibitors for Concrete Bridges		5. Report Date December 2004	
		6. Performing Organization Code	
7. Author(s) Amir Mirmiran, Principal Investigator Sami Rizkalla, Co-Principal Investigator Anna Cook, Engineer (former Graduate Student)		8. Performing Organization Report No.	
9. Performing Organization Name and Address Constructed Facilities Laboratory Department of Civil, Construction, & Environmental Engineering 2414 Campus Shore Drive, Centennial Campus, Box 7533 NC State University, Raleigh, NC 27695-7533		10. Work Unit No. (TRAIS)	
		11. Contract or Grant No.	
12. Sponsoring Agency Name and Address North Carolina Department of Transportation Research and Development Unit P.O. Box 25201 Raleigh, NC 27611		13. Type of Report & Period Covered Final Report July 2002 - December 2004	
		14. Sponsoring Agency Code 2003-14	
15. Supplementary Notes			
<p>16. Abstract</p> <p>Deicing salts and salt-water spray can cause serious corrosion problems for reinforced concrete bridge structures. These problems can lead to costly and labor-intensive repair and even replacement of the structure. Surface applied corrosion inhibitors are potentially a useful and cost effective way to prolong the life of existing structures. The purpose of this research project was to evaluate the effectiveness of commercially available corrosion inhibitors for surface treatments of existing reinforced concrete bridges.</p> <p>Reinforced concrete specimens were cast with different levels of initial chloride contents, coated with one of six products tested, and placed in accelerated corrosion environments. Each manufacturer donated their corresponding products for use in the experiment. The manufacturers were also given the test matrix and parameters in advance of the product application and invited to participate in the application process. Environmental conditions, voltmeter, and half cell potential readings were taken on a weekly basis in accordance with ASTM standards. Intermittently, some of these specimens were removed from their environments and evaluated on a visual, mass loss, strength loss, and chloride content basis. This data was then compiled and compared to each other and to control specimens located in a non-corrosive environment.</p> <p>It was found that surface applied corrosion inhibitors delay the onset of corrosion and the speed of the corrosion process. It was also found that a maximum chloride content of 0.5% by cement weight exists beyond which none of the inhibitor products were useful. Suggestions for further research in this area of study are also included.</p>			
17. Key Words Bridge, Concrete, Corrosion, Inhibitors.		18. Distribution Statement	
19. Security Classif. (of this report) Unclassified	20. Security Classif. (of this page) Unclassified	21. No. of Pages 284	22. Price

Form DOT F 1700.7 (8-72)

Reproduction of completed page authorized

DISCLAIMER

The contents of this report reflect the views of the authors and not necessarily the views of the sponsoring agency or the University. The authors are responsible for the facts and the accuracy of the data presented herein. The contents do not necessarily reflect the official views or policies of either the North Carolina Department of Transportation or the Federal Highway Administration at the time of publication. This report does not constitute a standard, specification, or regulation.

ACKNOWLEDGEMENTS

Financial support for this research was provided by the North Carolina Department of Transportation and the Federal Highway Administration. The authors are grateful to the NCDOT Technical Advisory Panel (Mr. Cecil Jones-Chair, Mr. Rodger Rochelle, Mr. Shannon Lasater, Mr. Greg Perfetti, Mr. Dan Holderman, Mr. Ron Hancock, the Late Mr. Lin Wiggins, Mr. Tom Koch, Mr. Rick Nelson, and Mr. Chris Peoples of NCDOT, and the now retired Mr. Paul Simon and Mr. Ernesto Villalba of FHWA) for their continuous oversight and valuable suggestions during the course of the project. The authors would like to also thank the personnel of the NCDOT- Materials and Test Unit, especially Mr. Christopher Peoples and his staff for allowing the use of their test facilities for the chloride diffusion tests. The authors further extend their sincere thanks to Mr. Jerry Atkinson, laboratory technician at the Constructed Facilities Laboratory, and Dr. Raafat El-Hacha of the University of Calgary, formerly a post-doctoral fellow at the NC State University. The extensive number of specimens and the extended period of tests required tremendous participation from a number of students, including undergraduate students; Ms. Heather Hess, Ms. Stephanie Kruep, and Mr. Jahmaal Tillman; and graduate students; Mr. Marcio Araujo, Mr. Won Chang Choi, Mr. Cenan Mertol, Mr. Nuttapone Paoinchantara, Mr. Engin Reis, and Mr. Zhenhua Wu.

SUMMARY

Deicing salts and salt-water spray can cause serious corrosion problems for reinforced concrete bridge structures. These problems can lead to costly and labor-intensive repair and even replacement of the structure. Surface applied corrosion inhibitors are potentially a useful and cost effective way to prolong the life of existing structures. The purpose of this research project was to evaluate the effectiveness of commercially available corrosion inhibitors for surface treatments of existing reinforced concrete bridges.

Reinforced concrete specimens were cast with different levels of initial chloride contents, coated with one of six products tested, and placed in accelerated corrosion environments. Each manufacturer donated their corresponding products for use in the experiment. The manufacturers were also given the test matrix and parameters in advance of the product application and invited to participate in the application process. Environmental conditions, voltmeter, and half cell potential readings were taken on a weekly basis in accordance with ASTM standards. Intermittently, some of these specimens were removed from their environments and evaluated on a visual, mass loss, strength loss, and chloride content basis. This data was then compiled and compared to each other and to control specimens located in a non-corrosive environment.

It was found that surface applied corrosion inhibitors delay the onset of corrosion and the speed of the corrosion process. It was also found that a maximum chloride content of 0.5% by cement weight exists beyond which none of the inhibitor products were useful. Suggestions for further research in this area of study are also included.

TABLE OF CONTENTS

	Page
Title Page	i
Technical Report Documentation Page	ii
Disclaimer	iii
Acknowledgments	iv
Summary	v
Table of Contents	vi
List of Tables	viii
List of Figures	ix
Chapter 1. Introduction	1
1.1 Background and Problem Statement	1
1.2 Need for research	1
1.3 Objectives	1
1.4 Scope and Contents	2
Chapter 2. Literature Review	4
2.1 Introduction	4
2.2 Causes of Corrosion	4
2.3 Mechanism of Corrosion	4
2.4 Corrosion Prevention Methods	7
2.4.1 New Construction	7
2.4.2 Existing Structures	7
2.4.3 Surface Applied Corrosion Inhibitors	7
Chapter 3. Experimental Procedure	11
3.1 Introduction	11
3.2 Test Preparation	11
3.2.1 Specimen Geometry	11
3.2.2 Slab Geometry	12
3.2.3 Formwork and Casting	13
3.2.4 Test Assembly	14
3.2.5 Chloride Analysis Cubes	16
3.3 Pilot Tests	17
3.4 Test Setup	19
3.4.1 Test Parameters	19
3.4.2 Test Procedure	19
3.4.3 Application of Corrosion Inhibitors	21
3.4.4 Epoxy Coating	22
3.5 Exposure Environments	23
3.5.1 Submersion Baths	23
3.5.2 Environmental Chamber	24
3.5.3 Control Environment	26

3.6	Data Collection During Exposure	27
3.6.1	Corrosion Current Measurements	27
3.6.2	Half Cell Potential Measurements	28
3.6.3	Environmental Condition Measurements	29
3.6.4	Chloride Content Measurements	30
3.7	Post-Exposure Measurements	32
3.7.1	Visual Corrosion Evaluations	33
3.7.2	Mass Loss Measurements	33
3.7.3	Tension Tests	35
Chapter 4.	Analysis and Discussion	37
4.1	Introduction	37
4.2	Measurements and Results During Accelerated Testing	37
4.2.1	Corrosion Current Measurement and Results	37
4.2.2	Half Cell Readings and Results	42
4.2.3	Environmental Readings and Results	45
4.3	Post-Exposure Measurements and Results	48
4.3.1	Chloride Content Analysis and Results	48
4.3.2	Visual Ratings: Analysis and Results	52
4.3.3	Mass Loss Measurements and Results	64
4.3.4	Tension Tests and Results	67
4.4	Cross Comparison for Post-Exposure Data	69
Chapter 5.	Findings and Conclusions	72
5.1	Summary	72
5.2	Conclusions	72
5.3	Suggestions for Further Research	74
Chapter 6.	Recommendations and Technology Implementations	75
	References	76
	Appendices	78
	Appendix A. Corrosion Rate Graphs	78
	Appendix B. Cumulative Corrosion Graphs	103
	Appendix C. Half Cell Potential Graphs	128
	Appendix D. Chloride Content Graphs	153
	Appendix E. Surface Corrosion and Rib Loss Graphs	159
	Appendix F. Cumulative Mass Loss Graphs	185
	Appendix G. Visual Ratings and Mass and Strength Loss Graphs	210

LIST OF TABLES

		Page
2.1	Manufacturers and Their Corresponding Products Tested	8
3.1	Chloride Analysis Cube Matrix	17
3.2	Test Matrix	20
3.3	Product Application Chart	21

LIST OF FIGURES

		Page
2.1	Effects of Corrosion on Reinforced Concrete as Displayed During This Research	5
2.2	Mechanism of Corrosion in Macrocell and Microcell	6
2.3	Chloride Attack on Steel Bars	6
3.1	Specimen Geometry	12
3.2	Formwork for the Specimens	13
3.3	Formwork for the Cubes	13
3.4	Chloride Addition During Specimen and Cube Casting	14
3.5	Casting of the Specimens and the Cubes	14
3.6	Casting of the Slabs	14
3.7	Test Setup	15
3.8	Resistor and Clip Connection	16
3.9	Pilot Test Setup	17
3.10	Failed Specimen	17
3.11	Pilot Test 2: Setup with Strain Indicator Box	18
3.12	Pilot Test 2: Using DEMEC Points and Dial Gauge	18
3.13	Pilot Test 2: Spotting Cracks	19
3.14	Epoxy Coating of the Slabs and Specimens	22
3.15	Epoxy Coating of the Cubes	23
3.16	Loaded Bath in Wet Cycle	24
3.17	Loaded Bath in Dry Cycle	24
3.18	Original Environmental Chamber	25
3.19	Assembled Environmental Chamber	26
3.20	Control Environment Specimens	27
3.21	Typical Voltmeter Reading Procedure	28
3.22	Typical Half Cell Potential Reading Procedure	29
3.23	Typical Salinity Measurement Procedure	30
3.24	pH Measurement Reading	30
3.25	Temperature Monitoring	30
3.26	Cubes and Powder Ready for Chloride Analysis Testing	31
3.27	Weighing the Dried Powder Samples	31
3.28	Filtering Chloride Samples	32
3.29	Titrating a Prepared Chloride Sample	32
3.30	Visual Evaluation Procedure	33
3.31	Bars Submerged in Chemical Cleaning Solution	34
3.32	Brushing Bars After Chemical Bath	34
3.33	Drying the Bars After Chemical Bath	35
3.34	Weighing a Bar After the Cleaning Process	35
3.35	Tension Test Setup	36

3.36	Extensometer Setup	36
3.37	Bar After Failure in Tension	37
4.1	Corrosion Rate for Control Specimens (Set #2)	38
4.2	Corrosion Rate for Bath 2, 0.0% Chloride, Pre-Cracked	38
4.3	Corrosion Rate for Chamber Shelf 3, 2.0% Chloride, Post-Cracked	39
4.4	Cumulative Corrosion over Time for Control Specimens (Set #2)	39
4.5	Cumulative Corrosion over Time for Bath 2, 0.0% Chloride, Pre-Cracked	40
4.6	Cumulative Corrosion over Time for Chamber Shelf 3, 2.0% Chloride, Post-Cracked	40
4.7	Half Cell Readings for Control Specimens (Set #2)	43
4.8	Half Cell Readings for Bath 2, 0.0% Chloride, Pre-Cracked	43
4.9	Half Cell Readings for Chamber Shelf 3, 2.0% Chloride, Post-Cracked	44
4.10	Salinity Over Time for Bath and Chamber Environments	46
4.11	pH over Time for Bath and Chamber Environments	46
4.12	Temperature over Time for Bath and Chamber Environments	47
4.13	Humidity and Temperature Over Time for Control Environment	48
4.14	Chloride Content for Control Specimens	49
4.15	Chloride Content for Bath Specimens – 1.5% Chloride	50
4.16	Chloride Content for Chamber Specimens – 0.0% Chloride	51
4.17	% Chloride Surface Corrosion at End Sections for 1.0% Chloride (Set #1)	53
4.18	% Chloride Surface Corrosion at End Sections for 1.0% Chloride (Set #2)	53
4.19	% Chloride Rib Loss at End Sections for 1.0% Chloride (Set #1)	54
4.20	% Chloride Rib Loss at End Sections for 1.0% Chloride (Set #2)	54
4.21	% Chloride Surface Corrosion at Midsection for 0.0% Chloride (Set #1)	55
4.22	% Chloride Surface Corrosion at Midsection for 1.5% Chloride (Set #1)	55
4.23	% Chloride Surface Corrosion at Midsection for 3.0% Chloride (Set #1)	56
4.24	% Chloride Surface Corrosion at Midsection for 0.0% Chloride (Set #2)	56
4.25	% Chloride Surface Corrosion at Midsection for	

	1.5% Chloride (Set #2)	57
4.26	% Chloride Surface Corrosion at Midsection for 3.0% Chloride (Set #2)	57
4.27	Time Step of Surface Corrosion for 0.0% Chloride, Pre-Cracked Specimens	59
4.28	% Chloride Rib Loss in Midsections for 0.0% Chloride (Set #1)	60
4.29	% Chloride Rib Loss in Midsections for 1.5% Chloride (Set #1)	60
4.30	% Chloride Rib Loss in Midsections for 3.0% Chloride (Set #1)	61
4.31	% Chloride Rib Loss in Midsections for 0.0% Chloride (Set #2)	61
4.32	% Chloride Rib Loss in Midsections for 1.5% Chloride (Set #2)	62
4.33	% Chloride Rib Loss in Midsections for 3.0% Chloride (Set #2)	62
4.34	Time Step of Rib Loss for 0.0% Chloride, Pre-Cracked Specimens	63
4.35	Cumulative Mass Loss/Length for Control Specimens	64
4.36	Cumulative Mass Loss/Length for Bath 4, 0.0% Chloride, Post-Cracked Specimens	66
4.37	Cumulative Mass Loss/Length for Chamber 0.0% Chloride, Shelf 3, Post-Cracked Specimens	66
4.38	Typical Load Deflection Curve for Bath 4, 0.0% Chloride, NO CI Specimen, Post-Cracked	67
4.39	Percent Strength Loss Based on Tension Tests for Bath 3, 0.0% Chloride, Post-Cracked	68
4.40	Percent Strength Loss Based on Tension Tests for Chamber 0.5% Chloride, Shelf 4, Pre-Cracked	68
4.41	Visual Ratings for Bath 2, 0.0% Chloride, Pre-Cracked Specimens	69
4.42	Mass Loss and Strength Loss for Bath 2, 0.0% Chloride, Pre-Cracked Specimens	70
4.43	Visual Ratings for Chamber 0.5% Chloride, Shelf 2, Pre-Cracked Specimens	71
4.44	Mass Loss and Strength Loss for Chamber 0.5% Chloride, Shelf 2, Pre-Cracked Specimens	71
A.1	Corrosion Rate for Control Set #1	78
A.2	Corrosion Rate for Control Set #2	78
A.3	Corrosion Rate for Bath 1, 0.0% Chloride, Pre-Cracked	79
A.4	Corrosion Rate for Bath 1, 0.5% Chloride, Pre-Cracked	79
A.5	Corrosion Rate for Bath 1, 1.0% Chloride, Pre-Cracked	80
A.6	Corrosion Rate for Bath 1, 1.5% Chloride, Pre-Cracked	80

A.7	Corrosion Rate for Bath 1, 2.0% Chloride, Pre-Cracked	81
A.8	Corrosion Rate for Bath 1, 3.0% Chloride, Pre-Cracked	81
A.9	Corrosion Rate for Bath 2, 0.0% Chloride, Pre-Cracked	82
A.10	Corrosion Rate for Bath 2, 0.5% Chloride, Pre-Cracked	82
A.11	Corrosion Rate for Bath 2, 1.0% Chloride, Pre-Cracked	83
A.12	Corrosion Rate for Bath 2, 1.5% Chloride, Pre-Cracked	83
A.13	Corrosion Rate for Bath 2, 2.0% Chloride, Pre-Cracked	84
A.14	Corrosion Rate for Bath 2, 3.0% Chloride, Pre-Cracked	84
A.15	Corrosion Rate for Bath 3, 0.0% Chloride, Post-Cracked	85
A.16	Corrosion Rate for Bath 3, 0.5% Chloride, Post-Cracked	85
A.17	Corrosion Rate for Bath 3, 1.0% Chloride, Post-Cracked	86
A.18	Corrosion Rate for Bath 3, 1.5% Chloride, Post-Cracked	86
A.19	Corrosion Rate for Bath 3, 2.0% Chloride, Post-Cracked	87
A.20	Corrosion Rate for Bath 3, 3.0% Chloride, Post-Cracked	87
A.21	Corrosion Rate for Bath 4, 0.0% Chloride, Post-Cracked	88
A.22	Corrosion Rate for Bath 4, 0.5% Chloride, Post-Cracked	88
A.23	Corrosion Rate for Bath 4, 1.0% Chloride, Post-Cracked	89
A.24	Corrosion Rate for Bath 4, 1.5% Chloride, Post-Cracked	89
A.25	Corrosion Rate for Bath 4, 2.0% Chloride, Post-Cracked	90
A.26	Corrosion Rate for Bath 4, 3.0% Chloride, Post-Cracked	90
A.27	Corrosion Rate for Chamber Shelf 1, 0.0% Chloride, Post-Cracked	91
A.28	Corrosion Rate for Chamber Shelf 1, 0.5% Chloride, Post-Cracked	91
A.29	Corrosion Rate for Chamber Shelf 1, 1.0% Chloride, Post-Cracked	92
A.30	Corrosion Rate for Chamber Shelf 1, 1.5% Chloride, Post-Cracked	92
A.31	Corrosion Rate for Chamber Shelf 1, 2.0% Chloride, Post-Cracked	93
A.32	Corrosion Rate for Chamber Shelf 1, 3.0% Chloride, Post-Cracked	93
A.33	Corrosion Rate for Chamber Shelf 2, 0.0% Chloride, Pre-Cracked	94
A.34	Corrosion Rate for Chamber Shelf 2, 0.5% Chloride, Pre-Cracked	94
A.35	Corrosion Rate for Chamber Shelf 2, 1.0% Chloride, Pre-Cracked	95
A.36	Corrosion Rate for Chamber Shelf 2, 1.5% Chloride, Pre-Cracked	95
A.37	Corrosion Rate for Chamber Shelf 2, 2.0% Chloride, Pre-Cracked	96
A.38	Corrosion Rate for Chamber Shelf 2, 3.0% Chloride, Pre-Cracked	96
A.39	Corrosion Rate for Chamber Shelf 3, 0.0% Chloride,	

	Post-Cracked	97
A.40	Corrosion Rate for Chamber Shelf 3, 0.5% Chloride, Post-Cracked	97
A.41	Corrosion Rate for Chamber Shelf 3, 1.0% Chloride, Post-Cracked	98
A.42	Corrosion Rate for Chamber Shelf 3, 1.5% Chloride, Post-Cracked	98
A.43	Corrosion Rate for Chamber Shelf 3, 2.0% Chloride, Post-Cracked	99
A.44	Corrosion Rate for Chamber Shelf 3, 3.0% Chloride, Post-Cracked	99
A.45	Corrosion Rate for Chamber Shelf 4, 0.0% Chloride, Pre-Cracked	100
A.46	Corrosion Rate for Chamber Shelf 4, 0.5% Chloride, Pre-Cracked	100
A.47	Corrosion Rate for Chamber Shelf 4, 1.0% Chloride, Pre-Cracked	101
A.48	Corrosion Rate for Chamber Shelf 4, 1.5% Chloride, Pre-Cracked	101
A.49	Corrosion Rate for Chamber Shelf 4, 2.0% Chloride, Pre-Cracked	102
A.50	Corrosion Rate for Chamber Shelf 4, 3.0% Chloride, Pre-Cracked	102
B.1	Cumulative Corrosion over Time for Control Set #1	103
B.2	Cumulative Corrosion over Time for Control Set #2	103
B.3	Cumulative Corrosion over Time for Bath 1, 0.0% Chloride, Pre-Cracked	104
B.4	Cumulative Corrosion over Time for Bath 1, 0.5% Chloride, Pre-Cracked	104
B.5	Cumulative Corrosion over Time for Bath 1, 1.0% Chloride, Pre-Cracked	105
B.6	Cumulative Corrosion over Time for Bath 1, 1.5% Chloride, Pre-Cracked	105
B.7	Cumulative Corrosion over Time for Bath 1, 2.0% Chloride, Pre-Cracked	106
B.8	Cumulative Corrosion over Time for Bath 1, 3.0% Chloride, Pre-Cracked	106
B.9	Cumulative Corrosion over Time for Bath 2, 0.0% Chloride, Pre-Cracked	107
B.10	Cumulative Corrosion over Time for Bath 2, 0.5% Chloride, Pre-Cracked	107
B.11	Cumulative Corrosion over Time for Bath 2, 1.0% Chloride, Pre-Cracked	108
B.12	Cumulative Corrosion over Time for Bath 2, 1.5%	

	Chloride, Pre-Cracked	108
B.13	Cumulative Corrosion over Time for Bath 2, 2.0% Chloride, Pre-Cracked	109
B.14	Cumulative Corrosion over Time for Bath 2, 3.0% Chloride, Pre-Cracked	109
B.15	Cumulative Corrosion over Time for Bath 3, 0.0% Chloride, Post-Cracked	110
B.16	Cumulative Corrosion over Time for Bath 3, 0.5% Chloride, Post-Cracked	110
B.17	Cumulative Corrosion over Time for Bath 3, 1.0% Chloride, Post-Cracked	111
B.18	Cumulative Corrosion over Time for Bath 3, 1.5% Chloride, Post-Cracked	111
B.19	Cumulative Corrosion over Time for Bath 3, 2.0% Chloride, Post-Cracked	112
B.20	Cumulative Corrosion over Time for Bath 3, 3.0% Chloride, Post-Cracked	112
B.21	Cumulative Corrosion over Time for Bath 4, 0.0% Chloride, Post-Cracked	113
B.22	Cumulative Corrosion over Time for Bath 4, 0.5% Chloride, Post-Cracked	113
B.23	Cumulative Corrosion over Time for Bath 4, 1.0% Chloride, Post-Cracked	114
B.24	Cumulative Corrosion over Time for Bath 4, 1.5% Chloride, Post-Cracked	114
B.25	Cumulative Corrosion over Time for Bath 4, 2.0% Chloride, Post-Cracked	115
B.26	Cumulative Corrosion over Time for Bath 4, 3.0% Chloride, Post-Cracked	115
B.27	Cumulative Corrosion over Time for Chamber Shelf 1, 0.0% Chloride, Post-Cracked	116
B.28	Cumulative Corrosion over Time for Chamber Shelf 1, 0.5% Chloride, Post-Cracked	116
B.29	Cumulative Corrosion over Time for Chamber Shelf 1, 1.0% Chloride, Post-Cracked	117
B.30	Cumulative Corrosion over Time for Chamber Shelf 1, 1.5% Chloride, Post-Cracked	117
B.31	Cumulative Corrosion over Time for Chamber Shelf 1, 2.0% Chloride, Post-Cracked	118
B.32	Cumulative Corrosion over Time for Chamber Shelf 1, 3.0% Chloride, Post-Cracked	118
B.33	Cumulative Corrosion over Time for Chamber Shelf 2, 0.0% Chloride, Pre-Cracked	119
B.34	Cumulative Corrosion over Time for Chamber Shelf 2, 0.5% Chloride, Pre-Cracked	119

B.35	Cumulative Corrosion over Time for Chamber Shelf 2, 1.0% Chloride, Pre-Cracked	120
B.36	Cumulative Corrosion over Time for Chamber Shelf 2, 1.5% Chloride, Pre-Cracked	120
B.37	Cumulative Corrosion over Time for Chamber Shelf 2, 2.0% Chloride, Pre-Cracked	121
B.38	Cumulative Corrosion over Time for Chamber Shelf 2, 3.0% Chloride, Pre-Cracked	121
B.39	Cumulative Corrosion over Time for Chamber Shelf 3, 0.0% Chloride, Post-Cracked	122
B.40	Cumulative Corrosion over Time for Chamber Shelf 3, 0.5% Chloride, Post-Cracked	122
B.41	Cumulative Corrosion over Time for Chamber Shelf 3, 1.0% Chloride, Post-Cracked	123
B.42	Cumulative Corrosion over Time for Chamber Shelf 3, 1.5% Chloride, Post-Cracked	123
B.43	Cumulative Corrosion over Time for Chamber Shelf 3, 2.0% Chloride, Post-Cracked	124
B.44	Cumulative Corrosion over Time for Chamber Shelf 3, 3.0% Chloride, Post-Cracked	124
B.45	Cumulative Corrosion over Time for Chamber Shelf 4, 0.0% Chloride, Pre-Cracked	125
B.46	Cumulative Corrosion over Time for Chamber Shelf 4, 0.5% Chloride, Pre-Cracked	125
B.47	Cumulative Corrosion over Time for Chamber Shelf 4, 1.0% Chloride, Pre-Cracked	126
B.48	Cumulative Corrosion over Time for Chamber Shelf 4, 1.5% Chloride, Pre-Cracked	126
B.49	Cumulative Corrosion over Time for Chamber Shelf 4, 2.0% Chloride, Pre-Cracked	127
B.50	Cumulative Corrosion over Time for Chamber Shelf 4, 3.0% Chloride, Pre-Cracked	127
C.1	Half Cell Potential Readings for Control Set #1	128
C.2	Half Cell Potential Readings for Control Set #2	128
C.3	Half Cell Potential Readings for Bath 1, 0.0% Chloride, Pre-Cracked	129
C.4	Half Cell Potential Readings for Bath 1, 0.5% Chloride, Pre-Cracked	129
C.5	Half Cell Potential Readings for Bath 1, 1.0% Chloride, Pre-Cracked	130
C.6	Half Cell Potential Readings for Bath 1, 1.5% Chloride, Pre-Cracked	130
C.7	Half Cell Potential Readings for Bath 1, 2.0% Chloride, Pre-Cracked	131

C.8	Half Cell Potential Readings for Bath 1, 3.0% Chloride, Pre-Cracked	131
C.9	Half Cell Potential Readings for Bath 2, 0.0% Chloride, Pre-Cracked	132
C.10	Half Cell Potential Readings for Bath 2, 0.5% Chloride, Pre-Cracked	132
C.11	Half Cell Potential Readings for Bath 2, 1.0% Chloride, Pre-Cracked	133
C.12	Half Cell Potential Readings for Bath 2, 1.5% Chloride, Pre-Cracked	133
C.13	Half Cell Potential Readings for Bath 2, 2.0% Chloride, Pre-Cracked	134
C.14	Half Cell Potential Readings for Bath 2, 3.0% Chloride, Pre-Cracked	134
C.15	Half Cell Potential Readings for Bath 3, 0.0% Chloride, Post-Cracked	135
C.16	Half Cell Potential Readings for Bath 3, 0.5% Chloride, Post-Cracked	135
C.17	Half Cell Potential Readings for Bath 3, 1.0% Chloride, Post-Cracked	136
C.18	Half Cell Potential Readings for Bath 3, 1.5% Chloride, Post-Cracked	136
C.19	Half Cell Potential Readings for Bath 3, 2.0% Chloride, Post-Cracked	137
C.20	Half Cell Potential Readings for Bath 3, 3.0% Chloride, Post-Cracked	137
C.21	Half Cell Potential Readings for Bath 4, 0.0% Chloride, Post-Cracked	138
C.22	Half Cell Potential Readings for Bath 4, 0.5% Chloride, Post-Cracked	138
C.23	Half Cell Potential Readings for Bath 4, 1.0% Chloride, Post-Cracked	139
C.24	Half Cell Potential Readings for Bath 4, 1.5% Chloride, Post-Cracked	139
C.25	Half Cell Potential Readings for Bath 4, 2.0% Chloride, Post-Cracked	140
C.26	Half Cell Potential Readings for Bath 4, 3.0% Chloride, Post-Cracked	140
C.27	Half Cell Potential Readings for Chamber Shelf 1, 0.0% Chloride, Post-Cracked	141
C.28	Half Cell Potential Readings for Chamber Shelf 1, 0.5% Chloride, Post-Cracked	141
C.29	Half Cell Potential Readings for Chamber Shelf 1, 1.0% Chloride, Post-Cracked	142
C.30	Half Cell Potential Readings for Chamber Shelf 1,	

	1.5% Chloride, Post-Cracked	142
C.31	Half Cell Potential Readings for Chamber Shelf 1, 2.0% Chloride, Post-Cracked	143
C.32	Half Cell Potential Readings for Chamber Shelf 1, 3.0% Chloride, Post-Cracked	143
C.33	Half Cell Potential Readings for Chamber Shelf 2, 0.0% Chloride, Pre-Cracked	144
C.34	Half Cell Potential Readings for Chamber Shelf 2, 0.5% Chloride, Pre-Cracked	144
C.35	Half Cell Potential Readings for Chamber Shelf 2, 1.0% Chloride, Pre-Cracked	145
C.36	Half Cell Potential Readings for Chamber Shelf 2, 1.5% Chloride, Pre-Cracked	145
C.37	Half Cell Potential Readings for Chamber Shelf 2, 2.0% Chloride, Pre-Cracked	146
C.38	Half Cell Potential Readings for Chamber Shelf 2, 3.0% Chloride, Pre-Cracked	146
C.39	Half Cell Potential Readings for Chamber Shelf 3, 0.0% Chloride, Post-Cracked	147
C.40	Half Cell Potential Readings for Chamber Shelf 3, 0.5% Chloride, Post-Cracked	147
C.41	Half Cell Potential Readings for Chamber Shelf 3, 1.0% Chloride, Post-Cracked	148
C.42	Half Cell Potential Readings for Chamber Shelf 3, 1.5% Chloride, Post-Cracked	148
C.43	Half Cell Potential Readings for Chamber Shelf 3, 2.0% Chloride, Post-Cracked	149
C.44	Half Cell Potential Readings for Chamber Shelf 3, 3.0% Chloride, Post-Cracked	149
C.45	Half Cell Potential Readings for Chamber Shelf 4, 0.0% Chloride, Pre-Cracked	150
C.46	Half Cell Potential Readings for Chamber Shelf 4, 0.5% Chloride, Pre-Cracked	150
C.47	Half Cell Potential Readings for Chamber Shelf 4, 1.0% Chloride, Pre-Cracked	151
C.48	Half Cell Potential Readings for Chamber Shelf 4, 1.5% Chloride, Pre-Cracked	151
C.49	Half Cell Potential Readings for Chamber Shelf 4, 2.0% Chloride, Pre-Cracked	152
C.50	Half Cell Potential Readings for Chamber Shelf 4, 3.0% Chloride, Pre-Cracked	152
D.1	Chloride Content for Control Specimens	153
D.2	Chloride Content for Bath Specimens – 0.0% Chloride	153
D.3	Chloride Content for Bath Specimens – 0.5% Chloride	154

D.4	Figure D.4 – Chloride Content for Bath Specimens – 1.0% Chloride	154
D.5	Chloride Content for Bath Specimens – 1.5% Chloride	155
D.6	Chloride Content for Bath Specimens – 2.0% Chloride	155
D.7	Chloride Content for Bath Specimens – 3.0% Chloride	156
D.8	Chloride Content for Chamber Specimens – 0.0% Chloride	156
D.9	Chloride Content for Chamber Specimens – 0.5% Chloride	157
D.10	Chloride Content for Chamber Specimens – 1.0% Chloride	157
D.11	Chloride Content for Chamber Specimens - 2.0% Chloride	158
D.12	Chloride Content for Chamber Specimens – 3.0% Chloride	158
E.1	Surface Corrosion at Mid Section for 0.0% Chloride (Set#1)	159
E.2	Rib Loss at Mid Section for 0.0% Chloride (Set #1)	159
E.3	Surface Corrosion at Mid Section for 0.5% Chloride (Set#1)	160
E.4	Rib Loss at Mid Section for 0.5% Chloride (Set #1)	160
E.5	Surface Corrosion at Mid Section for 1.0% Chloride (Set#1)	161
E.6	Rib Loss at Mid Section for 1.0% Chloride (Set #1)	161
E.7	Surface Corrosion at Mid Section for 1.5% Chloride (Set#1)	162
E.8	Rib Loss at Mid Section for 1.5% Chloride (Set #1)	162
E.9	Surface Corrosion at Mid Section for 2.0% Chloride (Set#1)	163
E.10	Rib Loss at Mid Section for 2.0% Chloride (Set #1)	163
E.11	Surface Corrosion at Mid Section for 3.0% Chloride (Set#1)	164
E.12	Rib Loss at Mid Section for 3.0% Chloride (Set #1)	164
E.13	Surface Corrosion at Mid Section for Average of all Chloride Contaminants (Set #1)	165
E.14	Rib Loss at Mid Section for Average of all Chloride Contaminants (Set #1)	165
E.15	Surface Corrosion at Mid Section for 0.0% Chloride (Set#2)	166
E.16	Rib Loss at Mid Section for 0.0% Chloride (Set #2)	166
E.17	Surface Corrosion at Mid Section for 0.5% Chloride (Set#2)	167
E.18	Rib Loss at Mid Section for 0.5% Chloride (Set #2)	167
E.19	Surface Corrosion at Mid Section for 1.0% Chloride	

	(Set#2)	168
E.20	Rib Loss at Mid Section for 1.0% Chloride (Set #2)	168
E.21	Surface Corrosion at Mid Section for 1.5% Chloride (Set#2)	169
E.22	Rib Loss at Mid Section for 1.5% Chloride (Set #2)	169
E.23	Surface Corrosion at Mid Section for 2.0% Chloride (Set#2)	170
E.24	Rib Loss at Mid Section for 2.0% Chloride (Set #2)	170
E.25	Surface Corrosion at Mid Section for 3.0% Chloride (Set#2)	171
E.26	Rib Loss at Mid Section for 3.0% Chloride (Set #2)	171
E.27	Surface Corrosion at Mid Section for Average of all Chloride Contaminants (Set #2)	172
E.28	Rib Loss at Mid Section for Average of all Chloride Contaminants (Set #2)	172
E.29	Time Step of Surface Corrosion for 0.0% Chloride Pre-Cracked Specimens	173
E.30	Time Step of Rib Loss for 0.0% Chloride Pre-Cracked Specimens	173
E.31	Time Step of Surface Corrosion for 0.5% Chloride Pre-Cracked Specimens	174
E.32	Time Step of Rib Loss for 0.5% Chloride Pre-Cracked Specimens	174
E.33	Time Step of Surface Corrosion for 1.0% Chloride Pre-Cracked Specimens	175
E.34	Time Step of Rib Loss for 1.0% Chloride Pre-Cracked Specimens	175
E.35	Time Step of Surface Corrosion for 1.5% Chloride Pre-Cracked Specimens	176
E.36	Time Step of Rib Loss for 1.5% Chloride Pre-Cracked Specimens	176
E.37	Time Step of Surface Corrosion for 2.0% Chloride Pre-Cracked Specimens	177
E.38	Time Step of Rib Loss for 2.0% Chloride Pre-Cracked Specimens	177
E.39	Time Step of Surface Corrosion for 3.0% Chloride Pre-Cracked Specimens	178
E.40	Time Step of Rib Loss for 3.0% Chloride Pre-Cracked Specimens	178
E.41	Time Step of Surface Corrosion for 0.0% Chloride Post-Cracked Specimens	179
E.42	Time Step of Rib Loss for 0.0% Chloride Post-Cracked Specimens	179
E.43	Time Step of Surface Corrosion for 0.5% Chloride Post-Cracked Specimens	180

E.44	Time Step of Rib Loss for 0.5% Chloride Post-Cracked Specimens	180
E.45	Time Step of Surface Corrosion for 1.0% Chloride Post-Cracked Specimens	181
E.46	Time Step of Rib Loss for 1.0% Chloride Post-Cracked Specimens	181
E.47	Time Step of Surface Corrosion for 1.5% Chloride Post-Cracked Specimens	182
E.48	Time Step of Rib Loss for 1.5% Chloride Post-Cracked Specimens	182
E.49	Time Step of Surface Corrosion for 2.0% Chloride Post-Cracked Specimens	183
E.50	Time Step of Rib Loss for 2.0% Chloride Post-Cracked Specimens	183
E.51	Time Step of Surface Corrosion for 3.0% Chloride Post-Cracked Specimens	184
E.52	Time Step of Rib Loss for 3.0% Chloride Post-Cracked Specimens	184
F.1	Cumulative Mass Loss/Length for Control Specimens	185
F.2	Cumulative Mass Loss/Length for Bath 1, 0.0% Chloride Pre-Cracked Specimens	185
F.3	Cumulative Mass Loss/Length for Bath 1, 0.5% Chloride Pre-Cracked Specimens	186
F.4	Cumulative Mass Loss/Length for Bath 1, 1.0% Chloride Pre-Cracked Specimens	186
F.5	Cumulative Mass Loss/Length for Bath 1, 1.5% Chloride Pre-Cracked Specimens	187
F.6	Cumulative Mass Loss/Length for Bath 1, 2.0% Chloride Pre-Cracked Specimens	187
F.7	Cumulative Mass Loss/Length for Bath 1, 3.0% Chloride Pre-Cracked Specimens	188
F.8	Cumulative Mass Loss/Length for Bath 2, 0.0% Chloride Pre-Cracked Specimens	188
F.9	Cumulative Mass Loss/Length for Bath 2, 0.5% Chloride Pre-Cracked Specimens	189
F.10	Cumulative Mass Loss/Length for Bath 2, 1.0% Chloride Pre-Cracked Specimens	189
F.11	Cumulative Mass Loss/Length for Bath 2, 1.5% Chloride Pre-Cracked Specimens	190
F.12	Cumulative Mass Loss/Length for Bath 2, 2.0% Chloride Pre-Cracked Specimens	190
F.13	Cumulative Mass Loss/Length for Bath 2, 3.0% Chloride Pre-Cracked Specimens	191
F.14	Cumulative Mass Loss/Length for Bath 3, 0.0% Chloride	

	Post-Cracked Specimens	191
F.15	Cumulative Mass Loss/Length for Bath 3, 0.5% Chloride Post-Cracked Specimens	192
F.16	Cumulative Mass Loss/Length for Bath 3, 1.0% Chloride Post-Cracked Specimens	192
F.17	Cumulative Mass Loss/Length for Bath 3, 1.5% Chloride Post-Cracked Specimens	193
F.18	Cumulative Mass Loss/Length for Bath 3, 2.0% Chloride Post-Cracked Specimens	193
F.19	Cumulative Mass Loss/Length for Bath 3, 3.0% Chloride Post-Cracked Specimens	194
F.20	Cumulative Mass Loss/Length for Bath 4, 0.0% Chloride Post-Cracked Specimens	194
F.21	Cumulative Mass Loss/Length for Bath 4, 0.5% Chloride Post-Cracked Specimens	195
F.22	Cumulative Mass Loss/Length for Bath 4, 1.0% Chloride Post-Cracked Specimens	195
F.23	Cumulative Mass Loss/Length for Bath 4, 1.5% Chloride Post-Cracked Specimens	196
F.24	Cumulative Mass Loss/Length for Bath 4, 2.0% Chloride Post-Cracked Specimens	196
F.25	Cumulative Mass Loss/Length for Bath 4, 3.0% Chloride Post-Cracked Specimens	197
F.26	Cumulative Mass Loss/Length for Chamber Shelf 1 0.0% Chloride, Post-Cracked Specimens	197
F.27	Cumulative Mass Loss/Length for Chamber Shelf 1 0.5% Chloride, Post-Cracked Specimens	198
F.28	Cumulative Mass Loss/Length for Chamber Shelf 1 1.0% Chloride, Post-Cracked Specimens	198
F.29	Cumulative Mass Loss/Length for Chamber Shelf 1 1.5% Chloride, Post-Cracked Specimens	199
F.30	Cumulative Mass Loss/Length for Chamber Shelf 1 2.0% Chloride, Post-Cracked Specimens	199
F.31	Cumulative Mass Loss/Length for Chamber Shelf 1 3.0% Chloride, Post-Cracked Specimens	200
F.32	Cumulative Mass Loss/Length for Chamber Shelf 2 0.0% Chloride, Pre-Cracked Specimens	200
F.33	Cumulative Mass Loss/Length for Chamber Shelf 2 0.5% Chloride, Pre-Cracked Specimens	201
F.34	Cumulative Mass Loss/Length for Chamber Shelf 2 1.0% Chloride, Pre-Cracked Specimens	201
F.35	Cumulative Mass Loss/Length for Chamber Shelf 2 1.5% Chloride, Pre-Cracked Specimens	202
F.36	Cumulative Mass Loss/Length for Chamber Shelf 2 2.0% Chloride, Pre-Cracked Specimens	202

F.37	Cumulative Mass Loss/Length for Chamber Shelf 2 3.0% Chloride, Pre-Cracked Specimens	203
F.38	Cumulative Mass Loss/Length for Chamber Shelf 3 0.0% Chloride, Post-Cracked Specimens	203
F.39	Cumulative Mass Loss/Length for Chamber Shelf 3 0.5% Chloride, Post-Cracked Specimens	204
F.40	Cumulative Mass Loss/Length for Chamber Shelf 3 1.0% Chloride, Post-Cracked Specimens	204
F.41	Cumulative Mass Loss/Length for Chamber Shelf 3 1.5% Chloride, Post-Cracked Specimens	205
F.42	Cumulative Mass Loss/Length for Chamber Shelf 3 2.0% Chloride, Post-Cracked Specimens	205
F.43	Cumulative Mass Loss/Length for Chamber Shelf 3 3.0% Chloride, Post-Cracked Specimens	206
F.44	Cumulative Mass Loss/Length for Chamber Shelf 4 0.0% Chloride, Pre-Cracked Specimens	206
F.45	Cumulative Mass Loss/Length for Chamber Shelf 4 0.5% Chloride, Pre-Cracked Specimens	207
F.46	Cumulative Mass Loss/Length for Chamber Shelf 4 1.0% Chloride Pre-Cracked Specimens	207
F.47	Cumulative Mass Loss/Length for Chamber Shelf 4 1.5% Chloride, Pre-Cracked Specimens	208
F.48	Cumulative Mass Loss/Length for Chamber Shelf 4 2.0% Chloride, Pre-Cracked Specimens	208
F.49	Cumulative Mass Loss/Length for Chamber Shelf 4 3.0% Chloride, Pre-Cracked Specimens	209
G.1	Visual Rating for Bath 1, 0.0% Chloride, Pre-Cracked	210
G.2	Mass Loss and Strength Loss for Bath 1, 0.0% Chloride, Pre-Cracked	210
G.3	Visual Rating for Bath 1, 0.5% Chloride, Pre-Cracked	211
G.4	Mass Loss and Strength Loss for Bath 1, 0.5% Chloride, Pre-Cracked	211
G.5	Visual Rating for Bath 1, 1.0% Chloride, Pre-Cracked	212
G.6	Mass Loss and Strength Loss for Bath 1, 1.0% Chloride, Pre-Cracked	212
G.7	Visual Rating for Bath 1, 1.5% Chloride, Pre-Cracked	213
G.8	Mass Loss and Strength Loss for Bath 1, 1.5% Chloride, Pre-Cracked	213
G.9	Visual Rating for Bath 1, 2.0% Chloride, Pre-Cracked	214
G.10	Mass Loss and Strength Loss for Bath 1, 2.0% Chloride, Pre-Cracked	214
G.11	Visual Rating for Bath 1, 3.0% Chloride, Pre-Cracked	215
G.12	Mass Loss and Strength Loss for Bath 1, 3.0% Chloride,	

	Pre-Cracked	215
G.13	Visual Rating for Bath 2, 0.0% Chloride, Pre-Cracked	216
G.14	Mass Loss and Strength Loss for Bath 2, 0.0% Chloride, Pre-Cracked	216
G.15	Visual Rating for Bath 2, 0.5% Chloride, Pre-Cracked	217
G.16	Mass Loss and Strength Loss for Bath 2, 0.5% Chloride, Pre-Cracked	217
G.17	Visual Rating for Bath 2, 1.0% Chloride, Pre-Cracked	218
G.18	Mass Loss and Strength Loss for Bath 2, 1.0% Chloride, Pre-Cracked	218
G.19	Visual Rating for Bath 2, 1.5% Chloride, Pre-Cracked	219
G.20	Mass Loss and Strength Loss for Bath 2, 1.5% Chloride, Pre-Cracked	219
G.21	Visual Rating for Bath 2, 2.0% Chloride, Pre-Cracked	220
G.22	Mass Loss and Strength Loss for Bath 2, 2.0% Chloride, Pre-Cracked	220
G.23	Visual Rating for Bath 2, 3.0% Chloride, Pre-Cracked	221
G.24	Mass Loss and Strength Loss for Bath 2, 3.0% Chloride, Pre-Cracked	221
G.25	Visual Rating for Bath 3, 0.0% Chloride, Post-Cracked	222
G.26	Mass Loss and Strength Loss for Bath 3, 0.0% Chloride, Post-Cracked	222
G.27	Visual Rating for Bath 3, 0.5% Chloride, Post-Cracked	223
G.28	Mass Loss and Strength Loss for Bath 3, 0.5% Chloride, Post-Cracked	223
G.29	Visual Rating for Bath 3, 1.0% Chloride, Post-Cracked	224
G.30	Mass Loss and Strength Loss for Bath 3, 1.0% Chloride, Post-Cracked	224
G.31	Visual Rating for Bath 3, 1.5% Chloride, Post-Cracked	225
G.32	Mass Loss and Strength Loss for Bath 3, 1.5% Chloride, Post-Cracked	225
G.33	Visual Rating for Bath 3, 2.0% Chloride, Post-Cracked	226
G.34	Mass Loss and Strength Loss for Bath 3, 2.0% Chloride, Post-Cracked	226
G.35	Visual Rating for Bath 3, 3.0% Chloride, Post-Cracked	227
G.36	Mass Loss and Strength Loss for Bath 3, 3.0% Chloride, Post-Cracked	227
G.37	Visual Rating for Bath 4, 0.0% Chloride, Post-Cracked	228
G.38	Mass Loss and Strength Loss for Bath 4, 0.0% Chloride, Post-Cracked	228
G.39	Visual Rating for Bath 4, 0.5% Chloride, Post-Cracked	229
G.40	Mass Loss and Strength Loss for Bath 4, 0.5% Chloride, Post-Cracked	229
G.41	Visual Rating for Bath 4, 1.0% Chloride, Post-Cracked	230
G.42	Mass Loss and Strength Loss for Bath 4, 1.0% Chloride,	

	Post-Cracked	230
G.43	Visual Rating for Bath 4, 1.5% Chloride, Post-Cracked	231
G.44	Mass Loss and Strength Loss for Bath 4, 1.5% Chloride, Post-Cracked	231
G.45	Visual Rating for Bath 4, 2.0% Chloride, Post-Cracked	232
G.46	Mass Loss and Strength Loss for Bath 4, 2.0% Chloride, Post-Cracked	232
G.47	Visual Rating for Bath 4, 3.0% Chloride, Post-Cracked	233
G.48	Mass Loss and Strength Loss for Bath 4, 3.0% Chloride, Post-Cracked	233
G.49	Visual Rating for Chamber Shelf 1, 0.0% Chloride, Post-Cracked	234
G.50	Mass Loss and Strength Loss for Chamber Shelf 1, 0.0% Chloride, Post-Cracked	234
G.51	Visual Rating for Chamber Shelf 1, 0.5% Chloride, Post-Cracked	235
G.52	Mass Loss and Strength Loss for Chamber Shelf 1, 0.5% Chloride, Post-Cracked	235
G.53	Visual Rating for Chamber Shelf 1, 1.0% Chloride, Post-Cracked	236
G.54	Mass Loss and Strength Loss for Chamber Shelf 1, 1.0% Chloride, Post-Cracked	236
G.55	Visual Rating for Chamber Shelf 1, 1.5% Chloride, Post-Cracked	237
G.56	Mass Loss and Strength Loss for Chamber Shelf 1, 1.5% Chloride, Post-Cracked	237
G.57	Visual Rating for Chamber Shelf 1, 2.0% Chloride, Post-Cracked	238
G.58	Mass Loss and Strength Loss for Chamber Shelf 1, 2.0% Chloride, Post-Cracked	238
G.59	Visual Rating for Chamber Shelf 1, 3.0% Chloride, Post-Cracked	239
G.60	Mass Loss and Strength Loss for Chamber Shelf 1, 3.0% Chloride, Post-Cracked	239
G.61	Visual Rating for Chamber Shelf 2, 0.0% Chloride, Pre-Cracked	240
G.62	Mass Loss and Strength Loss for Chamber Shelf 2, 0.0% Chloride, Pre-Cracked	240
G.63	Visual Rating for Chamber Shelf 2, 0.5% Chloride, Pre-Cracked	241
G.64	Mass Loss and Strength Loss for Chamber Shelf 2, 0.5% Chloride, Pre-Cracked	241
G.65	Visual Rating for Chamber Shelf 2, 1.0% Chloride, Pre-Cracked	242
G.66	Mass Loss and Strength Loss for Chamber Shelf 2,	

	1.0% Chloride, Pre-Cracked	242
G.67	Visual Rating for Chamber Shelf 2, 1.5% Chloride, Pre-Cracked	243
G.68	Mass Loss and Strength Loss for Chamber Shelf 2, 1.5% Chloride, Pre-Cracked	243
G.69	Visual Rating for Chamber Shelf 2, 2.0% Chloride, Pre-Cracked	244
G.70	Mass Loss and Strength Loss for Chamber Shelf 2, 2.0% Chloride, Pre-Cracked	244
G.71	Visual Rating for Chamber Shelf 2, 3.0% Chloride, Pre-Cracked	245
G.72	Mass Loss and Strength Loss for Chamber Shelf 2, 3.0% Chloride, Pre-Cracked	245
G.73	Visual Rating for Chamber Shelf 3, 0.0% Chloride, Post-Cracked	246
G.74	Mass Loss and Strength Loss for Chamber Shelf 3, 0.0% Chloride, Post-Cracked	246
G.75	Visual Rating for Chamber Shelf 3, 0.5% Chloride, Post-Cracked	247
G.76	Mass Loss and Strength Loss for Chamber Shelf 3, 0.5% Chloride, Post-Cracked	247
G.77	Visual Rating for Chamber Shelf 3, 1.0% Chloride, Post-Cracked	248
G.78	Mass Loss and Strength Loss for Chamber Shelf 3, 1.0% Chloride, Post-Cracked	248
G.79	Visual Rating for Chamber Shelf 3, 1.5% Chloride, Post-Cracked	249
G.80	Mass Loss and Strength Loss for Chamber Shelf 3, 1.5% Chloride, Post-Cracked	249
G.81	Visual Rating for Chamber Shelf 3, 2.0% Chloride, Post-Cracked	250
G.82	Mass Loss and Strength Loss for Chamber Shelf 3, 2.0% Chloride, Post-Cracked	250
G.83	Visual Rating for Chamber Shelf 3, 3.0% Chloride, Post-Cracked	251
G.84	Mass Loss and Strength Loss for Chamber Shelf 3, 3.0% Chloride, Post-Cracked	251
G.85	Visual Rating for Chamber Shelf 4, 0.0% Chloride, Pre-Cracked	252
G.86	Mass Loss and Strength Loss for Chamber Shelf 4, 0.0% Chloride, Pre-Cracked	252
G.87	Visual Rating for Chamber Shelf 4, 0.5% Chloride, Pre-Cracked	253
G.88	Mass Loss and Strength Loss for Chamber Shelf 4,	

	0.5% Chloride, Pre-Cracked	253
G.89	Visual Rating for Chamber Shelf 4, 1.0% Chloride, Pre-Cracked	254
G.90	Mass Loss and Strength Loss for Chamber Shelf 4, 1.0% Chloride, Pre-Cracked	254
G.91	Visual Rating for Chamber Shelf 4, 1.5% Chloride, Pre-Cracked	255
G.92	Mass Loss and Strength Loss for Chamber Shelf 4, 1.5% Chloride, Pre-Cracked	255
G.93	Visual Rating for Chamber Shelf 4, 2.0% Chloride, Pre-Cracked	256
G.94	Mass Loss and Strength Loss for Chamber Shelf 4, 2.0% Chloride, Pre-Cracked	256
G.95	Visual Rating for Chamber Shelf 4, 3.0% Chloride, Pre-Cracked	257
G.96	Mass Loss and Strength Loss for Chamber Shelf 4, 3.0% Chloride, Pre-Cracked	257

CHAPTER 1. INTRODUCTION

1.1 Background and Problem Statement

Deterioration of concrete bridges due to exposure to chloride attack is a major problem facing a number of state departments of transportation (DOT), including the North Carolina DOT (NCDOT). Use of deicing salts on roadways and bridges across the state, along with exposure to salt laden air and sea spray along the coastlines creates harsh environmental conditions and accelerates the corrosion process of concrete structures. This creates a greater need each year for the repair or replacement of corroding bridge structures across North Carolina, and is a very costly and labor-intensive venture for the NCDOT. Aside from the direct costs of repair or replacement, negative psychological effects on drivers, extended traffic delays during repair or replacement, possible safety hazards for workers and drivers, and reduced service life for bridges are all related to the deterioration of affected structures.

Since the early observations of corrosion damage to highway structures in the 1960's, the need for cost effective corrosion protection has been more and more apparent (Weindgroff 1996). Since then, many corrosion protection methods have been developed in order to delay, slow, or stop the corrosion process. These include sealants for the exposed surface of the concrete, placing protective coatings on the reinforcement, using electrochemical means to protect the reinforcement and extract chlorides, and the use of corrosion inhibiting admixtures in the mix design.

1.2 Need for Research

Although the use of corrosion inhibiting admixtures have been implemented and their effectiveness for new concrete structures have been documented for quite some time, there has been little research conducted on the use of their sister products, surface applied corrosion inhibitors on existing concrete structures. Many companies that produce these surface applied corrosion inhibitors claim that their products can delay, slow, stop, or even reverse the corrosion process in existing reinforced concrete structures. Due to the lack of independent research on these products, these claims have not been fully verified, especially to address the specific problems and conditions facing the NCDOT. The NCDOT has had experience with corrosion inhibiting admixtures such as calcium nitrite (NCHRP 10-45 2000) but has not implemented the use of surface treatments.

1.3 Objectives

This study was launched to address the major concerns of the NCDOT bridge maintenance regarding surface applied corrosion inhibitors, and the following objectives were identified:

1. Determine the effectiveness of commercially available corrosion inhibitors for remediation purposes in delaying, slowing, or stopping corrosion in existing reinforced concrete.
2. The assessment is to be conducted under controlled laboratory conditions of wet-dry submersion cycles and periodic salt-water spray in order to simulate severe corrosion environments encountered in the field over time.
3. Compare the effectiveness of different corrosion inhibitor products at varying levels of chloride contamination representing the various stages of corrosion in reinforced concrete.
4. Establish a threshold chloride content for the corrosion inhibitors, beyond which they are no longer useful to apply.
5. Determine if the products have any detrimental effect on the concrete itself.
6. Determine any potential application problems that may occur with the products that would make them difficult for the NCDOT to use. These may include ponding, extended time for absorption, or a change in texture of the surface characteristics such as slickness.
7. Develop guidelines and specifications for use of surface applied corrosion inhibitors and impart this knowledge to the NCDOT for implementation.

1.4 Scope and Contents

Accelerated corrosion testing was conducted on 348 small-scale representations of bridge deck sections. Six different commercially available surface applied corrosion inhibitor products were tested in two separate harsh environments, wet/dry submersion cycles in a 15% chloride solution at 130°F, and periodic salt-water spray with 15% concentration at 130°F. Voltmeter, half cell potential, and environmental condition readings were taken during the accelerated environmental testing. Specimens were removed from the environment at timed intervals and autopsies were performed on the reinforcement in order for visual ratings, mass loss measurements, and tension tests to be conducted. Chloride content analysis tests were also performed at timed intervals throughout the tests.

This report consists of six chapters, including this introductory chapter. There is also an appendix with additional data on the accelerated corrosion tests.

Chapter 2 discusses the causes of corrosion and the chemical process that takes place. It also reviews the methods for corrosion protection that have been used successfully, and briefly discusses the limited research on surface applied corrosion inhibitors. The particular manufactures and products used in this research program are discussed, along with their product composition and perceived benefits.

Chapter 3 provides a detailed summary of the experimental setup and processes for this project. It discusses the methods of assessment used throughout the research and their relevance to the project.

Chapter 4 presents the data that was collected during the project as a graphical representation in order to uncover patterns and trends that would lead to possible conclusions.

Chapter 5 summarizes the findings and conclusions developed from this research and outlines the direction for possible further research.

Chapter 6 summarizes recommendations and technology implementations.

CHAPTER 2. LITERATURE REVIEW

2.1 Introduction

The most common durability problem in reinforced concrete structures today is the corrosion of the embedded steel (Bentur et al. 1997). Corrosion of reinforcement in concrete can produce cosmetic flaws such as staining or cracking. Much more severe, however, is the structural damage it can produce. Delamination, spalling, exposure of the steel, and reduction of the reinforcement cross-section can lead to serious safety hazards (Bentur et al. 1997). Repair and/or replacement of these seriously damaged structures can be very costly. It is estimated that the cost to repair bridge decks in the US alone are somewhere between \$50 and \$200 million each year (Bentur et al. 1997). It is therefore apparent that any method of delaying or stopping the corrosion process would be greatly beneficial to the owners (departments of transportation) and civil engineering industry.

2.2 Causes of Corrosion

Although corrosion can occur in the absence of chlorides, chloride ions are the main cause for the corrosion of reinforcing steel in concrete (ACI 222R-96). It would seem obvious that to prevent corrosion, one could just produce concrete with no chlorides. Unfortunately, preventing corrosion is not as simple as eliminating all chlorides from the concrete mix. Although ACI 318-02 does specify maximum acceptable chloride contents under different conditions, it is often times impossible to fully eliminate chlorides altogether even in new construction. These ions can be found throughout nature. Even mix ingredients such as water and aggregate generally contain small amounts of chloride. Sometimes, chloride ions are intentionally added to the mix as a form of accelerant (ACI 222R-96). After casting, reinforced concrete can be further subjected to many forms of chloride invasion. Bridges and marine structures are especially vulnerable to chloride attack due to the use of deicing salts and salt laden air along the coastlines. When the chlorides are dissolved, they can migrate into the unprotected concrete just as pore water.

2.3 Mechanism of Corrosion

“The corrosion of steel in concrete is an electrochemical process in which both chemical reactions and flow of electrical current are involved” (Bentur et al. 1997). Four things must be present for corrosion to take place: an anode, a cathode, an electrical conductor, and an aqueous medium (ACI 222R-96). Electrons are produced at the anode by the anodic reaction and flow to the cathode where they are used in the cathodic reaction. This flow of electrons, along with the counter flow of ions in the external concrete pore solution make up the corrosion current (Bentur et al. 1997). Iron is oxidized to ferrous ions at the anode, i.e., the negative pole, as below:



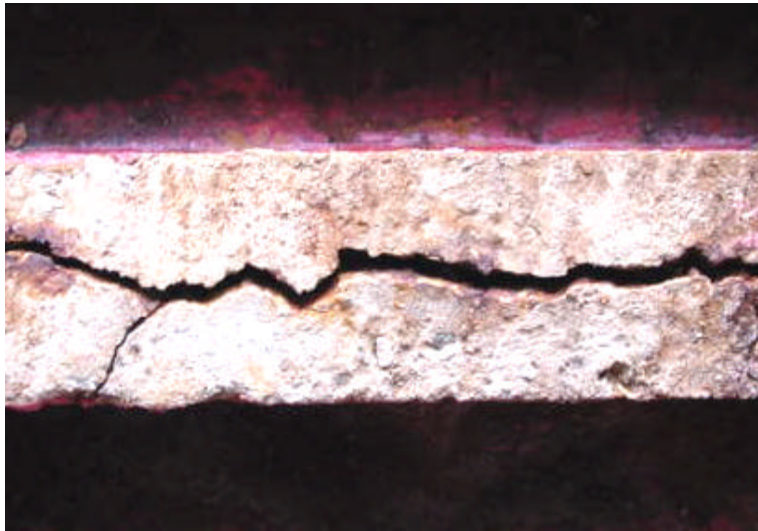

A serious problem occurs at the anode. When the anode loses electrons, there is a reduction in the area of the original steel. This reduced cross-section can lead to higher stress concentrations on the reinforcement and possibly failure. This is especially severe in prestressing tendons. The corrosion products are deposited onto the cathode. When this chemical reaction takes place, the corrosion products created have a volume that is several times greater than that of the original iron. This can also be a very serious problem, if the metal is embedded in concrete, as with reinforcing steel. The larger volume of the corrosion products can generate stresses on the surrounding concrete sufficient to cause severe cracking and spalling of the concrete. This is illustrated in Figure 2.1.

Figure 2.1 – Effects of Corrosion on Reinforced Concrete as Displayed During this Research

The cathode is where the reduction occurs. The following is the cathodic reaction that takes place in concrete:



These reactions can occur as macrocell corrosion or microcell corrosion. The difference between these two types of corrosion lies in the distance between the anode and the cathode. In a macrocell reaction, some distance separates the anode and cathode such that one section of reinforcement is losing mass while the other section is gaining the corrosion products. This is common in welded wire fabric or tied rebar mesh. When macrocell corrosion exists, with a known resistance, it is possible to measure the rate of corrosion (macrocell corrosion current) as will be discussed in the next chapter. In a microcell reaction, the anode and cathode are extremely close such that the mass is lost and corrosion products are deposited in essentially the same area of the reinforcement. Figure 2.2 shows both the macrocell and microcell corrosion.

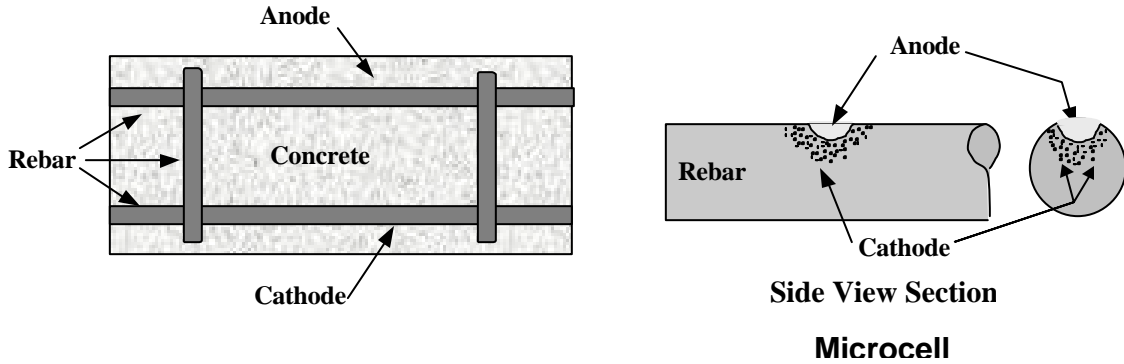

Figure 2.2 - Mechanism of Corrosion in Macrocell and Microcell

Chloride ions facilitate the reactions at the anode and cathode by breaking down the passivating film around the rebar. Concrete naturally provides a protective environment for reinforcement. It creates a very strong alkaline environment ($\text{pH} > 10$) in which a thin film of ferric oxide forms on the surface of the rebar and helps prevent the reinforcement from corroding (Pullar-Strecker 2002). This passive layer can be broken down by carbonation or by sufficient levels of chlorides. Figure 2.3 shows a diagram of the passive layer breakdown by chloride attack.

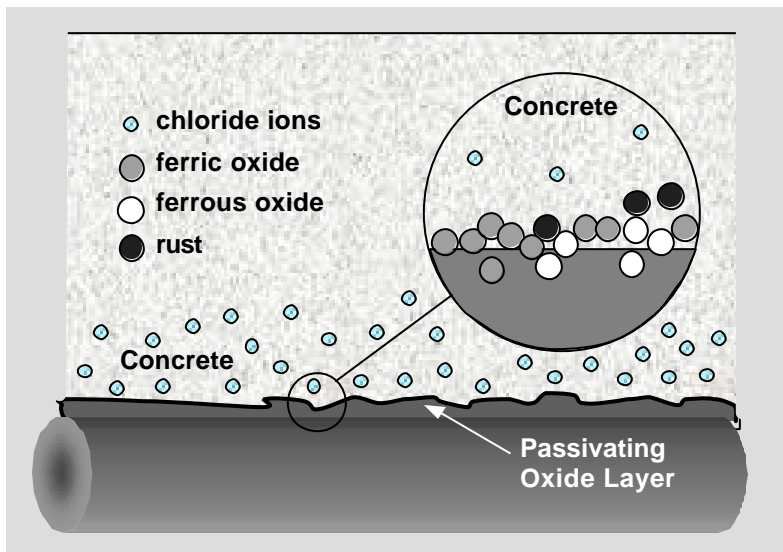

Figure 2.3 - Chloride Attack on Steel Bars

Investigations have shown that if this passive layer is broken down, conditions are ripe for corrosion in the reinforced concrete structure that is exposed to intermittent wetting and drying (ACI 222R-96). However, if the sections are fully saturated on a continuous basis, the rate of corrosion may be very slow. This is due to the lack of available oxygen

to initiate the corrosion reaction. Research has shown that corrosion increases as the sodium chloride concentration increases until a threshold of concentration is reached. Beyond this threshold, the rate of corrosion decreases even with increased chloride ion concentration (ACI 222R-96).

2.4 Corrosion Prevention Methods

2.4.1 New Construction

There are many methods presently available that have been proven to slow or prevent corrosion. Through the years, practices have been developed for new construction that greatly increases the service life of structures. These include establishing a minimum concrete cover over the rebar, developing initial chloride limits in mixes (as discussed previously), and lowering the permeability of the mixes.

Along with these general practices, more advanced corrosion protection methods have been developed for new construction. Corrosion inhibiting admixtures, such as calcium nitrite, have been proven to be a cost effective way to protect reinforcement when added to the initial concrete mix (El-Jazairi and Berke 1990). Sealants for concrete have also been developed and implemented in recent decades. These include waterproof membranes, Polymer impregnation, and various types of overlays (ACI 222R-96). Other methods of corrosion prevention for new construction have included coatings on rebar and different types of corrosion resistant rebar.

2.4.2 Existing Structures

For existing structures that were built before these preventative technologies could be implemented, corrosion protection is much more challenging. However, there is a continuously rising demand for rehabilitation techniques and protection methods for older, existing structures. Some structures are so severely damaged that topical treatments would be useless. In these severe cases, sections of the concrete can be removed and replaced with treated concrete, new reinforcement, and possibly a topcoat of sealer. In cases that are not as severe, electrochemical protection can be implemented. This is where chloride is actually extracted from the reinforced concrete by electrochemical means (Bentur et al. 1997). Another method of protection that has been successfully implemented in existing structures is cathodic protection. If applied properly, this method can prevent corrosion and stop corrosion that is already in progress (Bentur et al. 1997). This method utilizes an external sacrificial anode that gives up electrons and in turn protects the internal reinforcement by forcing it to act as the cathode.

2.4.3 Surface Applied Corrosion Inhibitors

All of the previously discussed methods have been tested and have proven themselves effective to slow or even stop the effects of corrosion. However, some of these methods

can be costly and difficult to implement in existing construction. The construction and maintenance industries are always looking for more cost effective and easily implemented ways to prevent corrosion for existing structures exposed to harsh environments. One possible method is the use of chemical corrosion inhibitors applied to the exposed surface of the affected reinforced concrete. These products use much of the same technologies and chemicals developed for corrosion inhibiting admixtures. If proven effective in preventing or stopping the corrosion process, these surface applied chemicals could be a cost effective solution to prolonging the lifespan of affected structures.

Six companies and their latest surface applied corrosion inhibiting products were chosen to be the focus of this research project. These manufactures were Aquaron, Axim, Cortec, Grace, Master Builders, and Sika. These companies were chosen because their familiarity to the NCDOT and their reputations in the concrete industry. Table 2.1 shows these manufacturers and their products used in this project.

Manufacturer	Product
Aquron	AQURON-7000/CPT 2000
Axim	AXIM Post III
Cortec	MCI 2020M/MCI 2022
Grace	Postrite
Master Builders/Chemrex	Sonocrete-Corrosion Inhibitor
Sika	FerroGard 903

Table 2.1 – Manufacturers and Their Corresponding Products Tested

The research team requested information on each of the products listed above. Specific chemical compositions of all products were not provided although requested. The following information was provided by the manufacturers in the product literature:

Aquron

- The Aquaron 7000 System consists of two coats of a penetrant (Aquaron 7000), and one coat of sealant (Aquaron CPT 2000).
- Aquaron 7000 is not a sodium silicate product.
- Aquaron CPT 2000 is a colloidal silicate concrete treatment.
- The two products together form a homogeneous gel matrix that neutralizes and purges the chlorides to the surface by chemical attraction.
- The gel that is formed prevents further chloride contamination.
- It can be used as a remedial treatment or a preventative treatment for reinforced concrete structures (Aquaron 2002).

Axim

- One coat of Axim Post III for a full treatment.
- Surface applied migrating corrosion inhibitor with a multi-component silane sealer.
- Silane sealer delays the ingress of chlorides.
- Axim Post III is suitable for existing and new (fully cured) reinforced concrete (Axim 1999).

Cortec

- One coat of MCI 2020M, and one coat of sealant MCI 2022.
- MCI 2020M is a water-based surface treatment migrating corrosion inhibitor.
- MCI 2022 is a penetrating, waterborne, vapor-permeable, water-repelling sealer for concrete and masonry.
- MCI 2022 is made of a low VOC blend of silane/siloxane emulsions and migrating corrosion inhibitors.
- For use on existing reinforced concrete structures (Cortec 2001).

Grace

- Three applications of Postrite.
- Postrite penetrates the concrete and protects the reinforcement by surrounding it with a corrosion inhibitor.
- Calcium nitrite based.
- Intended for the repair of concrete that has experienced damage due to chloride induced corrosion (Grace 1999).

Master Builders/ChemRex

- Sonocrete – Corrosion Inhibitor applied in two applications.
- Surface applied, water-based, migrating corrosion inhibitor containing no calcium nitrite
- Forms a protective layer around the reinforcement that inhibits corrosion.
- For use on existing reinforced concrete structures (ChemRex 2002).

Sika

- FerroGard 903 requires two applications.
- It is a corrosion inhibiting impregnation coating for hardened concrete designed to penetrate the surface and then to diffuse in vapor or liquid form to the reinforcement.
- Forms a protective layer on the surface of the reinforcement.
- FerroGard 903 is a combination of amino alcohols and organic and inorganic corrosion inhibitors.
- Does not contain calcium nitrite.
- Maximum chloride content of structures intended for treatment is 6 lbs/yd³.
- For use on existing reinforced concrete structures (Sika 2001).

It is obvious that there are many different methods that surface applied corrosion inhibitors use to prevent corrosion. Surface applied corrosion inhibitors can reduce the penetration of chlorides and carbon dioxide. With proper application, including monitoring and recoating, these corrosion inhibitors can contribute to the long-term good health of a structure exposed to corrosive environments (Pullar-Strecker 2002). It is difficult to compare different corrosion inhibitors due to the lack of accepted standard evaluation tests that can be applied to all types of inhibitors. It is necessary that a system of acceptable tests be developed for use in comparing corrosion inhibitors (Vermani and Clemena1998). Pullar-Strecker (2002) suggested that long-term studies must be conducted to evaluate surface applied corrosion inhibitors since most studies to date have been relatively short-term, and there is little long-term proof of their effectiveness.

CHAPTER 3. EXPERIMENTAL PROCEDURE

3.1 Introduction

The main objective of this research project was to determine the effectiveness of six commercially available surface applied corrosion inhibitors. Reinforced concrete specimens were cast and then coated with one of the six corrosion inhibitor products tested. These products were donated by the corresponding manufacturers who were informed of the test matrix and parameters for approval prior to product application. Each product manufacturer was also invited to participate in the application process. Two sets of specimens, pre-cracked and post-cracked, were prepared, wherein controlled cracking was induced before or after the corrosion inhibitor products were applied, respectively. Each specimen was duplicated once to ensure repeatability of the test results. These specimens were then placed in one of three testing environments. Two of the test environments were designed to accelerate corrosion using 15% salt-water solutions and a temperature of 130°F in either submersion wet/dry cycles or spray cycles. The general lab environment was considered the control environment and was kept at approximately 70°F temperature and 50% relative humidity. The data collected throughout the experiment included corrosion current (voltmeter) readings, half cell potential readings, environmental condition readings, and chloride content analysis. Duplicate specimens were removed halfway through the testing and evaluated by visual assessments of corrosion, mass loss measurements, and strength reduction (tension) tests. At the end of the test, the remaining specimens were removed and evaluated in the same manner.

3.2 Test Preparation

3.2.1 Specimen Geometry

The reinforced concrete specimens used in the pilot test and in this research project were cast with identical dimensions: 2.5 in width, 2.0 in depth, and 14 in length. All specimens were reinforced with one ½ in diameter No. 4 Grade 60 steel bar (deformed bar) with ½ in concrete cover from the top surface, and 1.0 in cover from the sides, as shown in Figure 3.1. The steel rebar extended from the concrete at both ends by 1.0 in. Stainless steel screws were drilled into one end of the rebar to allow for the necessary wiring for the corrosion assessment, i.e., voltmeter and half cell readings, during the test program. The bar ends were coated for a length of 2 in on either end using high temperature resistant epoxy paint to eliminate end corrosion effects.

The specimen geometry was chosen to aid in the acceleration of the corrosion process, to simulate the approximate rebar cover in the existing concrete bridge decks in North Carolina, and to simplify the casting and handling of the specimens.

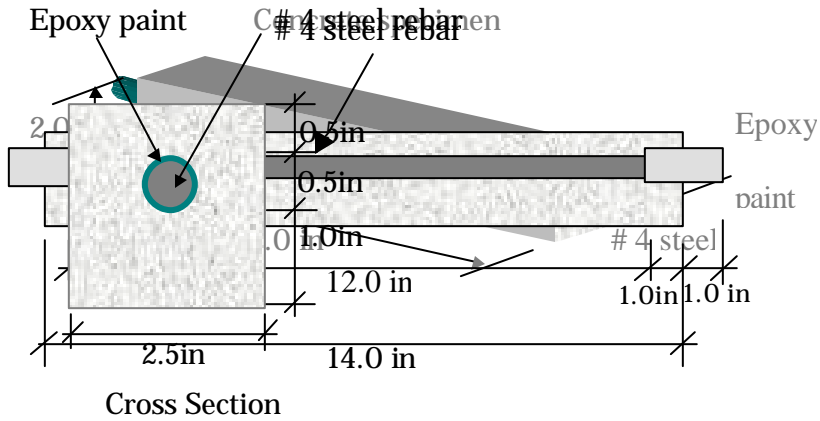

Epoxy Paint

Figure 3.1 - Specimen Geometry

3.2.2 Slab Geometry

In order to produce the necessary crack patterns in the specimens, concrete slabs were designed and cast as support for the specimens. Each concrete slab was designed to hold seven specimens of the same chloride content, except for the slab for the control specimens, which held twelve specimens, i.e., two of each chloride content. The dimensions of each regular slab were as follows: 15 in width, 4 in depth, and 37.5 in length. The slabs contained a tied mesh of No. 3 deformed bars, vertical stainless steel threaded rods, and seven No. 8 bars to correspond with the seven specimens per slab. The

vertical threaded rods were used in addition to the epoxy-coated plates to load each end of the specimen in order to induce the initial cracks. The No. 8 bars were necessary for monitoring of the corrosion current density. Each end of the No. 8 bars extended $\frac{1}{2}$ in out of either side of the slab. These bars, similar to the No. 4 bars in the specimens, were also coated with the same epoxy for a length of 2 in on either side. Also, similar to the specimens, one end of each No. 8 bar was equipped with a stainless steel screw.

3.2.3 Formwork and Casting

The formwork for the specimens and cubes are shown in Figures 3.2 and 3.3. For the specimens and the cubes, six batches of concrete were cast, one for each chloride content. The appropriate amount of Sodium Chloride (NaCl) to achieve the correct initial chloride content by cement weight was added for each batch. Figure 3.4 shows the addition of the chloride during the mixing. The concrete was mixed in the laboratory, following a standard NCDOT mix. Figure 3.5 shows the casting of the specimens and the cubes. The concrete for the slabs was ready mixed delivered to the laboratory, but followed the same mix proportions described earlier. Figure 3.6 shows the casting procedure for the slabs.



Figure 3.2 – Formwork for the Specimens

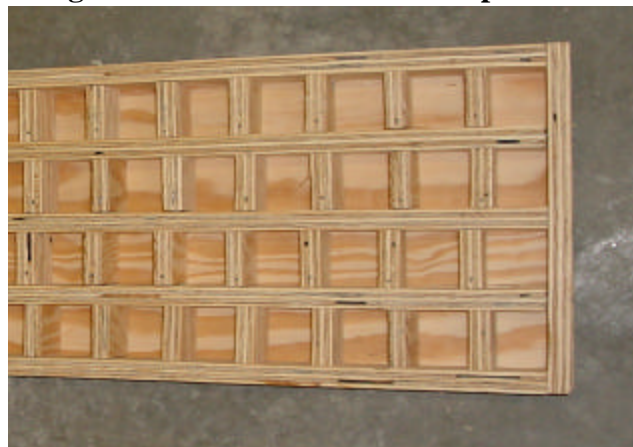

Figure 3.3 - Formwork for the Cubes



Figure 3.4 – Chloride Addition During Specimen and Cube Casting



Figure 3.5 - Casting of the Specimens and the Cubes



Figure 3.6 – Casting of the Slabs

3.2.4 Test Assembly

Small strips of approximately 1/8 in thick pre-cured carbon fiber reinforced polymer (FRP) were used as spacers under each specimen to create a height difference between the ends and the middle of the specimen. This allowed for tightening of the plates on each end to induce cracking with similar pattern in the specimens. The choice of carbon FRP was to avoid corrosion of the spacer. Once the appropriate cracking was induced and the

proper corrosion inhibitor products applied to each specimen, ½ in of grout was added on the top of each slab. The purpose for the grout was to provide continuity in the concrete between the specimens and the slabs so that an electrochemical current could freely pass between the two mediums. The grout was made of the same mix as the specimens, except that it did not contain any aggregates. Figure 3.7 shows the test setup.

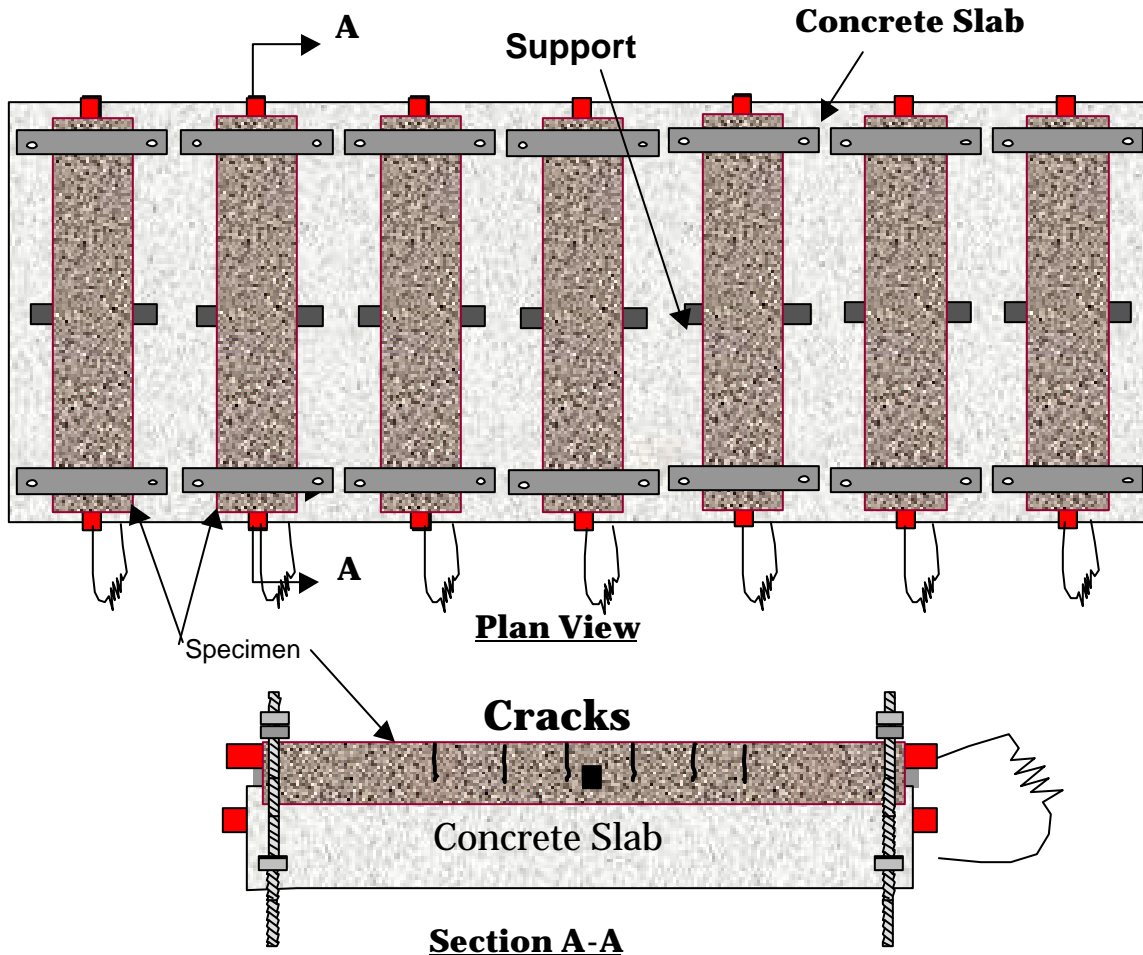

Figure 3.7 – Test Setup

A 100-ohm resistor was connected between the screws of each bar located in the slab to the screw in the corresponding bar in the specimen. Metal clips were used to connect the wire from the resistor on the bottom bar to the screw in the top bar. These resistors and the connecting wires were also coated with the same high temperature-resistant epoxy paint as the ends of the bars to protect them from the harsh environments. The resistors in conjunction with the grout provided the necessary connections for the macro-cell corrosion loop. The clips allowed disconnecting the resistors for half-cell measurements. A picture of the resistor connection can be seen in Figure 3.8.

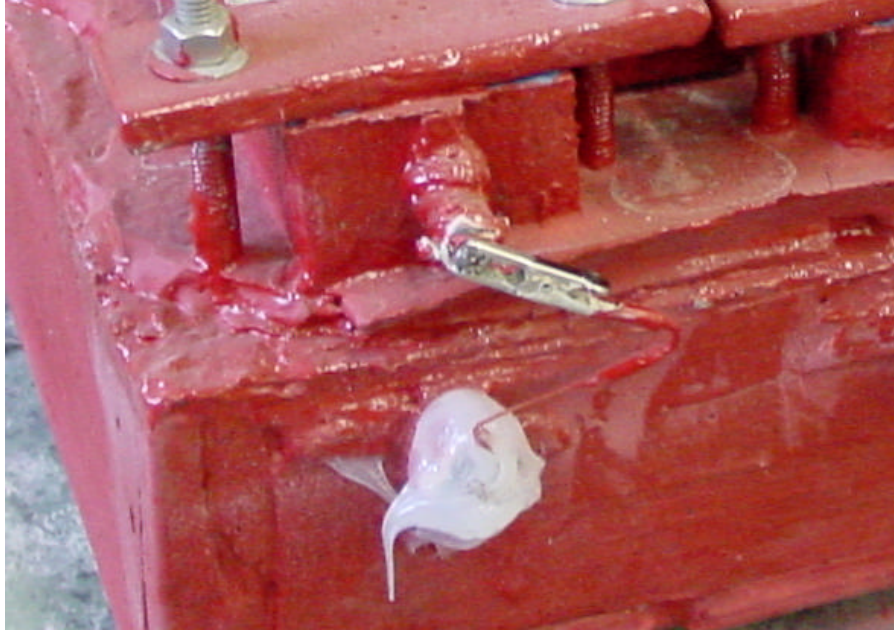

Figure 3.8 – Resistor and Clip Connection

3.2.5 Chloride Analysis Cubes

In addition to the slabs and the specimens, 456 two-inch cubes were cast in preparation for this project. 210 cubes were placed in the bath environment, 210 were placed in the environmental chamber, 30 were placed in the control environment, and six initial cubes were tested immediately after casting and curing. The purpose of the cubes was to provide a sample of concrete to test for chloride content at timed intervals. These cubes were cast with the same chloride contents as the specimens ranging from 0.0% to 3.0%, coated with the same corrosion inhibitor products, and placed in the same environments as the specimens. They were also coated with the epoxy paint on all sides except the top and bottom to mimic the specimens. At the end of each timed interval, one set of cubes was removed from its environment. Powder was then collected from the cubes by removing the epoxy paint and drilling at $\frac{1}{2}$ in from the top surface of each cube. The powder was placed in a sealed container until chloride analysis could be performed. The purpose for drilling at the $\frac{1}{2}$ in depth was to simulate the concrete conditions at the surface of the bar in the specimen. Each sealed powder sample was then taken to the Materials and Test Unit of the NCDOT, properly prepared using DOT standards, and titrated to determine the chloride content of each cube at the $\frac{1}{2}$ in level. This procedure was done at scheduled timed intervals of 1 month, 3 months, 6 months, 12 months, and 18 months of environmental exposure, along with six initial control cubes. Table 3.1 shows the cube test matrix. Note that the limit of 3.0% chloride contamination by weight of cement corresponds to approximately 0.3% by weight of concrete, or approximately 12 lb/yd³ of concrete. The range was adopted from an FHWA corrosion study (Clemena and Virmani 1988), although it was expected that surface applied corrosion inhibitors may be less effective at such high levels of chloride content.

Table 3.1 – Chloride Analysis Cube Matrix

Number of Cubes for Chloride Diffusion Test								
	CI Product	NO CI	Aquron	Axim	Cortec	Grace	Master Builders	Sika
Chloride Content	0.0%	16	10	10	10	10	10	10
	0.5%	16	10	10	10	10	10	10
	1.0%	16	10	10	10	10	10	10
	1.5%	16	10	10	10	10	10	10
	2.0%	16	10	10	10	10	10	10
	3.0%	16	10	10	10	10	10	10

3.3 Pilot Tests

Two sets of pilot tests were carried out before preparing the specimens for the actual test program. These pilot tests were done on specimens with the same dimensions as the proposed test specimens. The first pilot test was carried out to determine the flexural response of the specimens. Strain gauges were placed on the top and bottom surfaces of the concrete specimens at their mid-span. Each specimen was then tested in three-point bending using the 220-kip MTS closed-loop universal testing machine. As expected, the specimens were over-reinforced and failed by crushing of concrete rather than yielding of steel bars. Figures 3.9 and 3.10 show the first pilot test setup and the failed specimen.

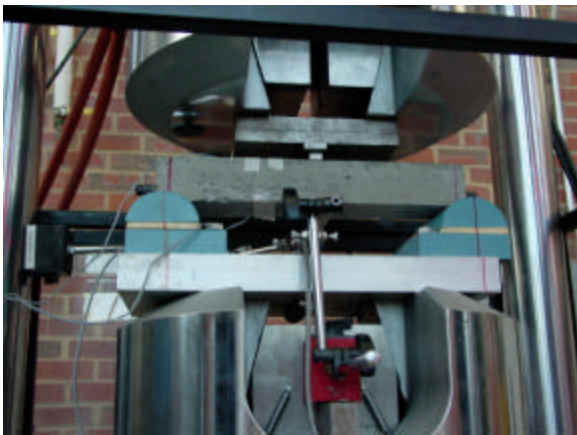

Figure 3.9 – Pilot Test Setup

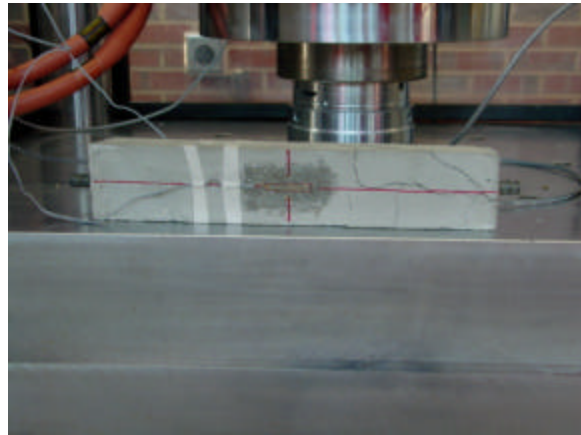

Figure 3.10 – Failed Specimen

The purpose of the second pilot test was to determine a simple, yet reliable and consistent method to induce similar crack patterns and similar strain levels in the specimens. Several specimens were equipped with strain gauges on the rebar before casting. The strain

gauges were then connected to a strain indicator box. Additionally, DEMEC (Demountable Mechanical Strain Gauge) points were placed on the top surface of the concrete. Using these methods of measurement, each specimen was loaded by hand tightening the end plates. The cracks on the surface of the concrete specimens were monitored using magnifying glass and sufficient light. The first crack was observed at a strain of about 0.0007 in the embedded re-bar. The second crack was observed at a strain of about 0.0011 in the embedded re-bar. Repeatability of the data was confirmed on the various specimens. Therefore, it was decided that the appropriate and consistent strain level in the concrete was achieved when two cracks perpendicular to the length of the specimen and spanning the width of the specimen became visible. Figures 3.11, 3.12, and 3.13 show the second pilot test.



Figure 3.11 – Pilot Test 2: Setup with Strain Indicator Box

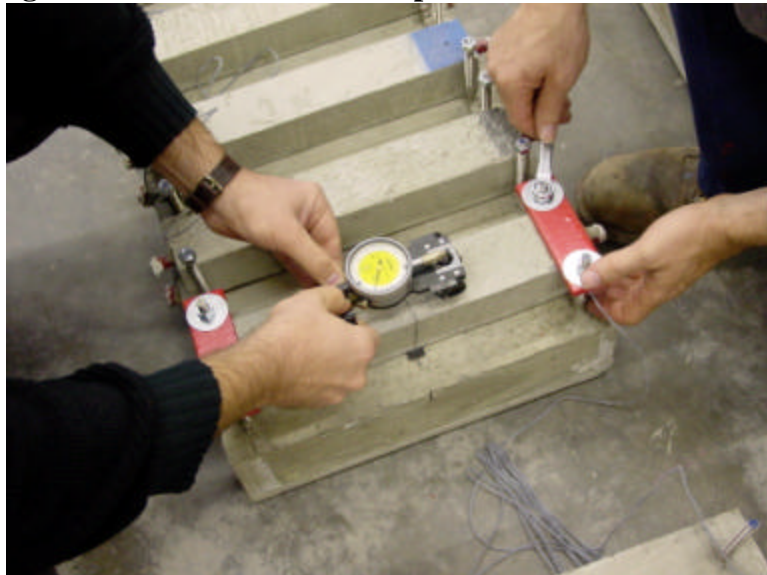

Figure 3.12 – Pilot Test 2: Using DEMEC Points and Dial Gauge



Figure 3.13 – Pilot Test 2: Spotting Cracks

3.4 Test Setup

3.4.1 Test Parameters

The parameters of the final test matrix included six different levels of initial chloride contents (0.0%, 0.5%, 1.0%, 1.5%, 2.0%, and 3.0% of the weight of the cement in the mix), six different corrosion inhibitor products from six different manufacturers, pre-cracked and post-cracked conditions, duplicate specimens, and three environmental conditions. A total of 348 specimens were cast and used in the actual test program: 168 of these were located in four wet/dry baths, 168 specimens were placed in the environmental chamber, and 12 others in the control environment. Table 3.2 shows the overall test matrix and the selected corrosion inhibitor products. The limit of 3.0% chloride contamination by weight of cement corresponds to approximately 0.3% by weight of concrete, or approximately 12 lb/yd³ of concrete. The range was adopted from an FHWA corrosion study (Clemena and Virmani 1988), although it was expected that surface applied corrosion inhibitors may be less effective at such high levels of chloride content.

3.4.2 Test Procedure

Of the seven specimens placed on each slab, the first served as the control specimen, and thus was not coated with any corrosion inhibitor. The remaining six were coated with one of the six products identified in Table 3.2 above. Each slab held only specimens of one particular percentage of initial chloride content. The ends of the specimens were color coded to identify the initial chloride content. Half of the specimens of each color code were cracked first. Then, the corrosion inhibitor products were applied on all specimens. Subsequently, the remaining specimens were cracked.

Table 3.2 – Test Matrix

Corrosion Inhibitor (Manufacturer)	Environment	Number of Specimens						Total Number of Specimens
		Chloride Content (by weight of cement)						
		0.0%	0.5%	1.0%	1.5%	2.0%	3.0%	
No Corrosion Inhibitor	Control Environment	2	2	2	2	2	2	12
	Wet/Dry Cycles	4	4	4	4	4	4	48
	Salt-Water Spray	4	4	4	4	4	4	
AQURON-7000/CPT-2000 (Aquron Protectants)	Wet/Dry Cycles	4	4	4	4	4	4	48
	Salt-Water Spray	4	4	4	4	4	4	
AXIM Post III (Axim Concrete Technologies)	Wet/Dry Cycles	4	4	4	4	4	4	48
	Salt-Water Spray	4	4	4	4	4	4	
MCI 2020M/MCI2022 (Cortec Corporation)	Wet/Dry Cycles	4	4	4	4	4	4	48
	Salt-Water Spray	4	4	4	4	4	4	
Postrite (W.R. Grace and Company)	Wet/Dry Cycles	4	4	4	4	4	4	48
	Salt-Water Spray	4	4	4	4	4	4	
Sonocrete - Corrosion Inhibitor (Chemrex/Master Builders)	Wet/Dry Cycles	4	4	4	4	4	4	48
	Salt-Water Spray	4	4	4	4	4	4	
FerroGard-903 (Sika Corporation)	Wet/Dry Cycles	4	4	4	4	4	4	48
	Salt-Water Spray	4	4	4	4	4	4	
Total Number of Specimens		58	58	58	58	58	58	348

3.4.3 Application of Corrosion Inhibitors

Each corrosion inhibitor product was applied based on the recommended dosage rates in the vendor’s literature. If the rate was given as a range, the average value was chosen for this study. Most application rates were given in gallons per square foot of surface area. These values were converted to the surface area for each specimen and the exact amount of product was used for each application, using a syringe to administer the product and a brush to distribute the product evenly on the surface. For each product, the instructions for the number of coats, drying time between coats, and the amount of each coat varied. During the application, observations were made for each product on the odor, color, drying time of the product on the concrete surface, and the apparent slickness or change in the texture of the concrete surface. A list of the products, their application dosages, and the observations are provided in Table 3.3. Also listed in the table are the cost per gallon and the total cost per square foot for each product. The costs per gallon were obtained from each manufacturer based on the purchase of 100 gallons of each product.

Table 3.3 –Product Application Chart

Manufacturer		Aquron	Axim	Cortec	Grace	Master Builders (Chemrex)	Sika
Product		Aquron 7000 CPT 2000	Axim Post III	MCI 2020 MCI 2022	Postrite	Sonocrete Corrosion Inhibitor	Ferrogard - 903
Applied Dosage	Primer	2 coats 200 ft ² /Gal	1 coat 200 ft ² /Gal	1 coat 150 ft ² /Gal	3 coats 125 ft ² /Gal	2 coats 150 ft ² /Gal	2 coats 100 ft ² /Gal
	Sealer	1 coat 200 ft ² /Gal	None	1 coat 150 ft ² /Gal	None	None	None
Cost (\$/Gal)*	Primer	37.00	75.00	40.04	75.00	119.85	36.94
	Sealer	37.00	None	16.19	None	None	None
Cost (\$/ft ²)		0.555	0.375	0.375	1.800	1.598	0.739
Odor		None	Very strong ammonia smell with noxious fumes	Mild ammonia smell	None	Ammonia smell	Very slight ammonia smell
Drying Time		15-30 minutes last coat - 1hr	1 hour	15-30 minutes	30 minutes each	Last coat 1-2 hours	Last coat 1 hour
Slickness		Slightly for sealer until dried	None	None	None	None	None

*Based on purchase of 100 gallons of each product.

3.4.4 Epoxy Coating

Once the slabs and specimens were assembled and prepared with the corrosion inhibitors, one final step was needed before they could be exposed to the different environments. This step was applying the high temperature resistant epoxy coating to all of the sides of the slabs, specimens, and cubes, and to the top of the grouted slabs. The purpose for this coating was to prevent any influx of chlorides from entering the specimens or the cubes from the sides, and to force any such entry only from the top of the specimens and cubes. This was meant to simulate real life conditions of a typical section of a reinforced concrete bridge deck. The tops of the slab were coated also to prevent the penetration of chlorides to preserve the non-corroded condition of the reference bars located in the slabs. Figures 3.14 and 3.15 show the epoxy coating process.



Figure 3.14 - Epoxy Coating of the Slabs and Specimens



Figure 3.15 – Epoxy Coating of the Cubes

3.5 Exposure Environments

As stated earlier, three different environments were used in this research project; two to introduce an accelerated corrosion process, and the third as a control environment. The next section explains these different environments in detail.

3.5.1 Submersion Baths

Four watertight submersion baths were fabricated using timber, plywood, rubber pond liner, fiberglass insulation, and insulating foam. Each bath was designed to hold six slabs with seven specimens each, for a total of 42 specimens per bath. The baths were approximately 10 feet long by 4.5 feet wide and 1 foot deep. The experiment called for one week of submersion in 15% salt-water solution at 130°F-sustained temperature followed by one week of dry heat at the same temperature to further accelerate the corrosion. To achieve these temperature requirements, a water heater, thermostat, and circulating pump were installed in each bath for use during the submerged cycles. An industrial space heater was used for the dry cycles. Cubes were placed in one of the baths along with the slabs, five for each specimen for a total of 210 cubes. Once the slabs were loaded into the baths, water and salt was added to reach a 15% solution in two of the baths. The other two baths were exposed to dry heat. At the end of each week of exposure, the water was pumped from the wet baths to the dry baths, and the dry heat was introduced to the once-wet baths. Half of the specimens in the baths were removed at the end of six months. The duplicate set of specimens was removed at the end of the one-year exposure period. Figures 3.15 and 3.16 show the baths in wet and dry cycles.



Figures 3.16 – Loaded Bath in Wet Cycle



Figure 3.17 – Loaded Bath in Dry Cycle

3.5.2 Environmental Chamber

The project first made use of the lab's environmental chamber, which has the ability to range in temperature from -105° to $+180^{\circ}$ F, control humidity, and spray either salt water or potable water to simulate rain, or wet conditions. The slabs and 210 cubes were loaded into the chamber on aluminum shelves stacked four high with all specimens of the same

chloride content on top of each other to prevent any chloride diffusion from one slab to the other. The chamber was then programmed to run 15% salt-water spray cycles for four minutes at 130°F, and then run a dry cycle for 11 minutes at the same temperature, for a total cycle of 15 minutes. This cycle continued for five days out of the week, giving two days of shut down time to cool down the chamber and take the appropriate readings from week to week. Figure 3.17 shows the original environmental chamber.

This chamber ran the accelerated corrosion test for 18 days. At this time, severe leakage around the chamber base caused a halt in the test program. After much deliberation, it was decided to build a new chamber for immediate use. The new chamber was built within about a month, much in the same way as the baths. The base dimensions and materials used were the same, except for the height. The chamber was made higher to accommodate four slabs high and allow for a person to enter in order to take readings. The chamber was built with a holding pool at the bottom for the 15% salt-water solution. A pump was placed in this holding pool and attached to a piping system that carried the water to spray pipes at the top of the chamber. Again, a water heater was used to reach the desired temperature. The slabs along with the cubes were loaded into the new chamber for continued testing. At the end of three months, the first set of specimens was removed from the chamber for evaluation. The remaining specimens were removed after six months of exposure. Figure 3.19 shows the assembled environmental chamber with the loaded specimens.



Figure 3.18 – Original Environmental Chamber



Figure 3.19 – Assembled Environmental Chamber

3.5.3 Control Environment

The control environment was inside in the lab, held at approximately 70°F and 50% relative humidity. Twelve specimens were located in this environment, two of each chloride content, all loaded on one slab. These specimens did not have any corrosion inhibitor products applied to them. The reason for this was to provide a reference of how the different chloride content specimens performed under no external extreme environmental conditions. Thirty cubes were also placed in this control environment, five for each chloride content. These cubes were tested at scheduled time intervals discussed earlier. At the end of one year, six specimens were removed from the control environment for evaluation. Figure 3.20 shows the control environment specimens.

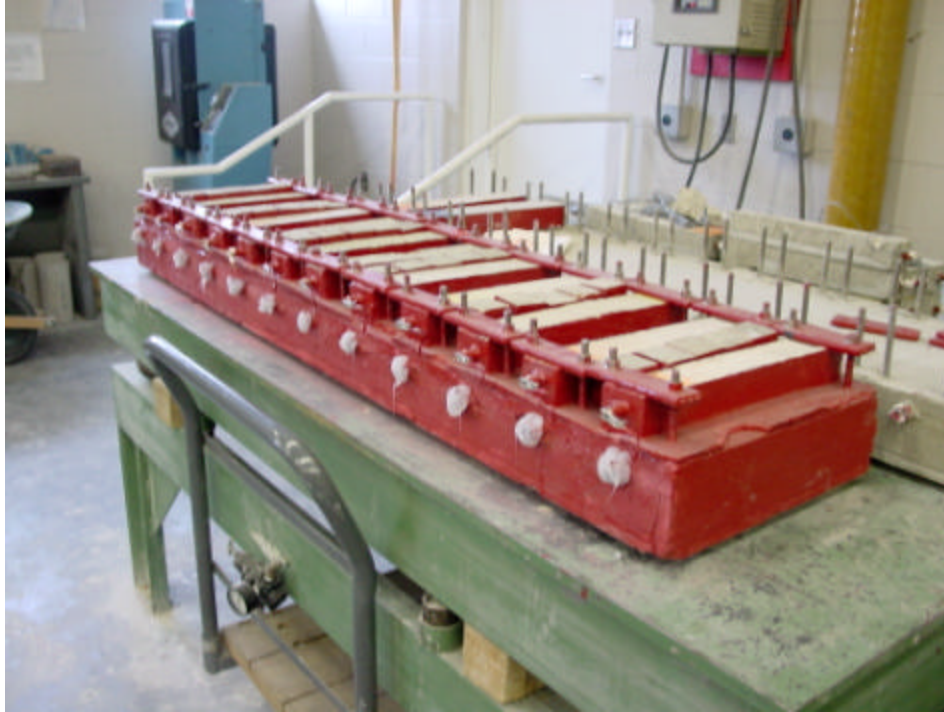

Figure 3.20 – Control Environment Specimens

3.6 Data Collection During Exposure

A number of methods were utilized during the duration of this study to collect data for evaluation of the different corrosion inhibitor products. These methods are discussed in detail below.

3.6.1 Corrosion Current Measurements

The test specimens were set up so that a method of measurement using a known resistance in accordance with voltmeter readings could be used to determine the corrosion current density. This method, commonly referred to as voltmeter readings or corrosion current density data, has been utilized by other investigators as well and follows ASTM G 109 - 99 (West et al. 2002). For this method of measurement to work, a current has to develop between the corroding bar and a reference bar. There must also be a known resistance connecting these two bars. With a known resistance and the voltmeter readings, the simple equation $V = IR$ (Voltage = Current x Resistance) can be solved for current, $I = V/R$. The current can then be divided by the nominal area of the bar to provide a useful measurement known as the corrosion current density. The voltmeter readings were taken once each week for every specimen in all the environments. The data was collected and recorded in a spreadsheet for further analysis. Figure 3.21 shows the typical voltmeter reading procedure.

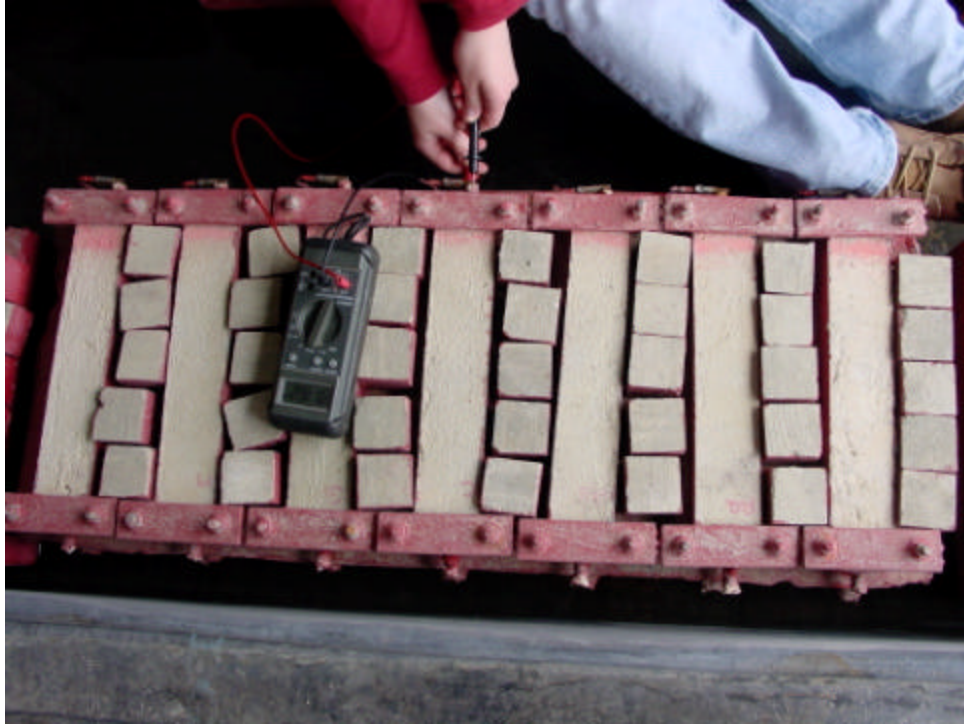

Figure 3.21 – Typical Voltmeter Reading Procedure

3.6.2 Half Cell Potential Measurements

Half cell potential measurements were also taken weekly for each specimen, following ASTM standard C-876. The reading device consists of essentially a voltmeter box connected to two leads, one being a simple connector wire, and the other, a copper-copper sulfate half cell electrode. The electrode consists of a copper rod submerged in an airtight sulfate/water solution. The surface of each concrete specimen was first wetted and then the moist electrode tip was placed on the wet surface for readings. The other lead wire was connected to the end of the corroded bar, after having detached it from the reference bar. The half cell data was collected in the same manner as the voltmeter readings and then recorded in a spreadsheet for further analysis. Figure 3.22 shows the typical half cell potential reading procedure.

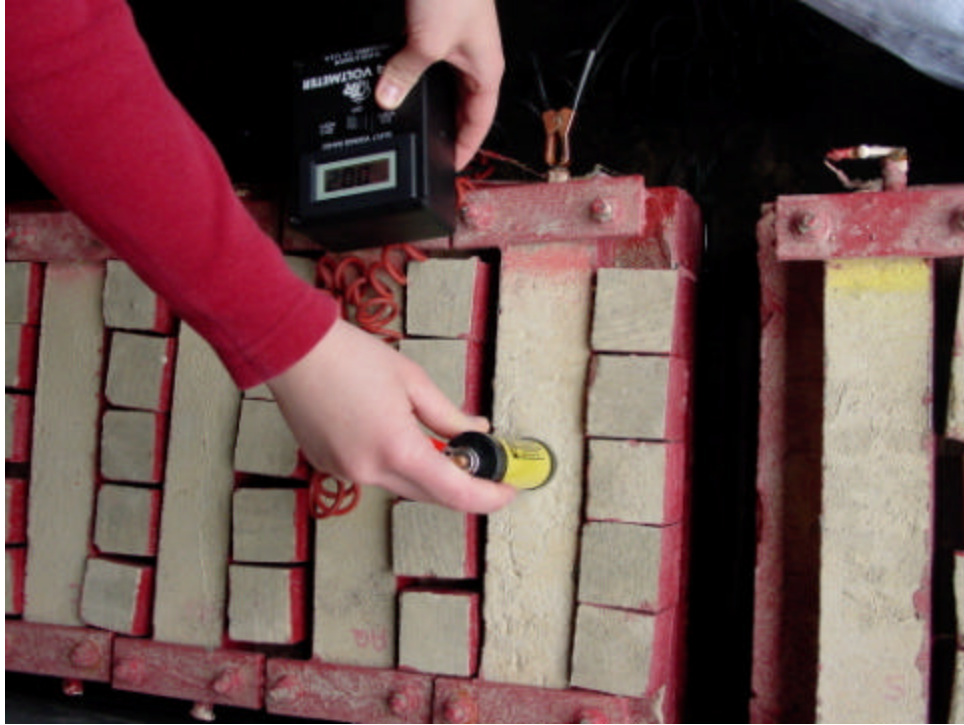

Figure 3.22 – Typical Half Cell Potential Reading Procedure

3.6.3 Environmental Condition Measurements

Four different environmental condition measurements were taken on a weekly basis: salt-water concentration, pH, temperature, and humidity. The salt-water concentration was measured by taking a sample of each water reservoir from the baths and the chamber. The samples were then weighed and compared with a previously calibrated scale to measure chloride content. The purpose for this measurement was to maintain an approximate 15% salt-water solution at all times. If the solutions were not 15% at the time of measurement, the solution was either diluted or concentrated accordingly until a 15% solution was achieved. Figure 3.23 shows the typical salinity measurement procedure.

Each water reservoir was also subjected to pH measurements. Strips of pH indicator paper were submerged in each water reservoir and the color of the paper was then compared to a given pH scale. Figure 3.24 shows the pH measurements. This was monitored to give any warning of a chemical change in the salt-water solution.

Temperature measurements were taken during both the wet and dry cycles of corrosion testing, along with the control environment. The temperature was regulated to be approximately 130°F at all times in order to accelerate corrosion. Figure 3.25 shows the temperature measurements. The final environmental condition that was monitored was the humidity in the control environment. A digital thermometer/humidity gauge was used to measure the relative humidity of the control environment. The control environment was kept at approximately 50% relative humidity.

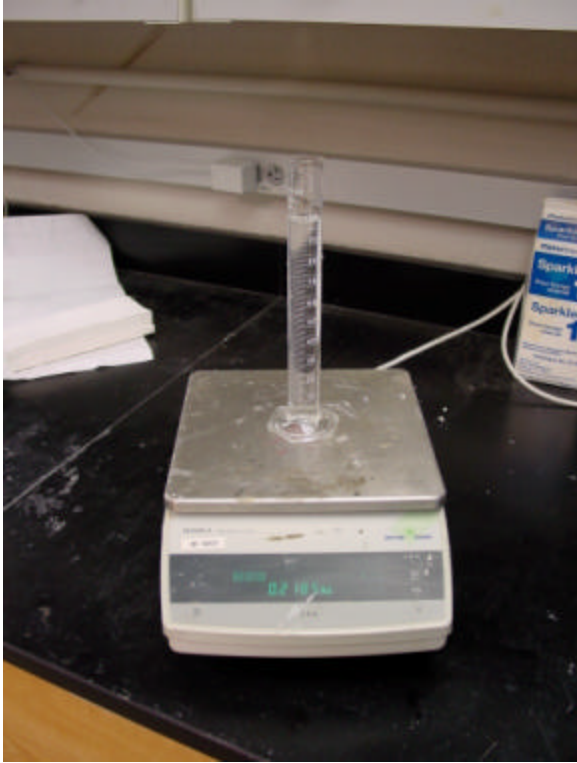

Figure 3.23 – Typical Salinity Measurement Procedure



Figure 3.24 – pH Measurement Reading



Figure 3.25 – Temperature Monitoring

3.6.4 Chloride Content Measurements

One important method to determine the effectiveness of the corrosion inhibitors is the chloride content analysis. As discussed earlier, drilled concrete powder samples were

collected from the cubes at scheduled time intervals. These samples were tested at the NCDOT Materials and Test Unit following their standard test procedure which is a modification of ASTM C 1152. Under this procedure, samples were dried, prepared into a liquid solution, filtered, and then titrated. After calculations were performed using the titration data, the chloride content of each sample could be determined. Figures 3.26, 3.27, 3.28, and 3.29 show the various steps in the chloride analysis procedure.



Figure 3.26 – Cubes and Powder Ready for Chloride Analysis Testing

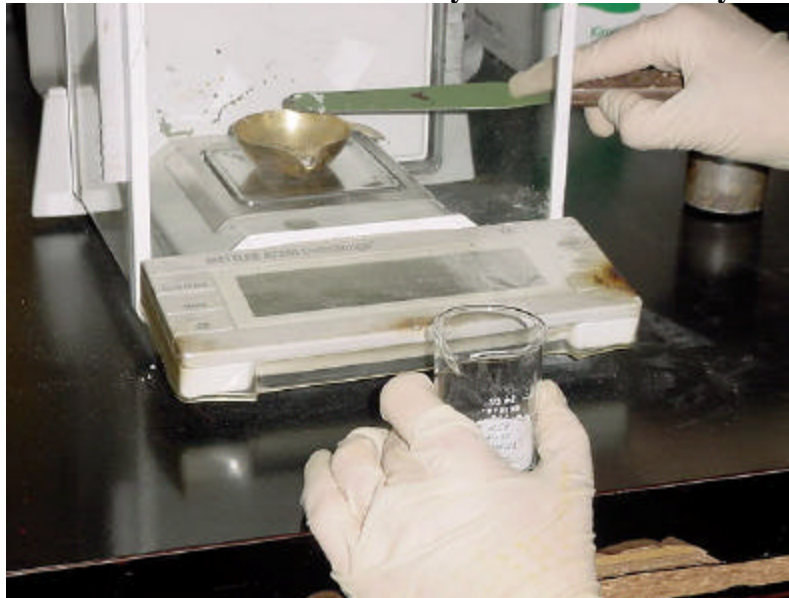

Figure 3.27 – Weighing the Dried Powder Samples



Figure 3.28 – Filtering Chloride Samples



Figure 3.29 – Titrating a Prepared Chloride Sample

3.7 Post-Exposure Measurements

As mentioned earlier, the duration of the accelerated corrosion testing was scheduled for 18 months for both the submersion baths and the spray chamber. As the tests progressed, it became clear to the research team that severe corrosion was occurring much earlier than expected. Therefore, it was decided to end the exposure of the specimens at different intervals. This was possible due to the duplicate specimens. The order the specimens were retrieved from their harsh environments were as follows: the first batch of the chamber was retrieved at the end of three months of exposure, the rest from the chamber

at the end of six months, the first batch from the baths at the end of six months, and the remainder at the end of one year of accelerated corrosion testing. Each removed specimen was subjected to three post-exposure measurements: visual analysis, mass loss measurements, and tension tests, as discussed below.

3.7.1 Visual Corrosion Evaluations

Once the slabs were removed from the corrosive environments, the tested bars were recovered from each concrete specimen and evaluated visually using two quantifiable scales: percentage of surface area covered by corrosion and percentage of rib volume lost to corrosion. These percentages, although estimated only visually, provided a good basis of comparison. These evaluations were conducted by the same person for all bars. Randomly selected bars were assessed multiple times to ensure repeatability of the evaluations. Each bar was graphically divided into five different sections, two end sections and three middle sections. The purpose was to separate the amount of corrosion in the end sections of the bar from the corrosion in the middle sections, to ensure that various corrosion inhibitor products were not penalized for end effects that may have resulted from improper sealing. After surface rust evaluation, the bars were cleaned by light brushing using a non-wire brush, to evaluate rib loss in each section. Figure 3.30 shows the visual analysis procedure.

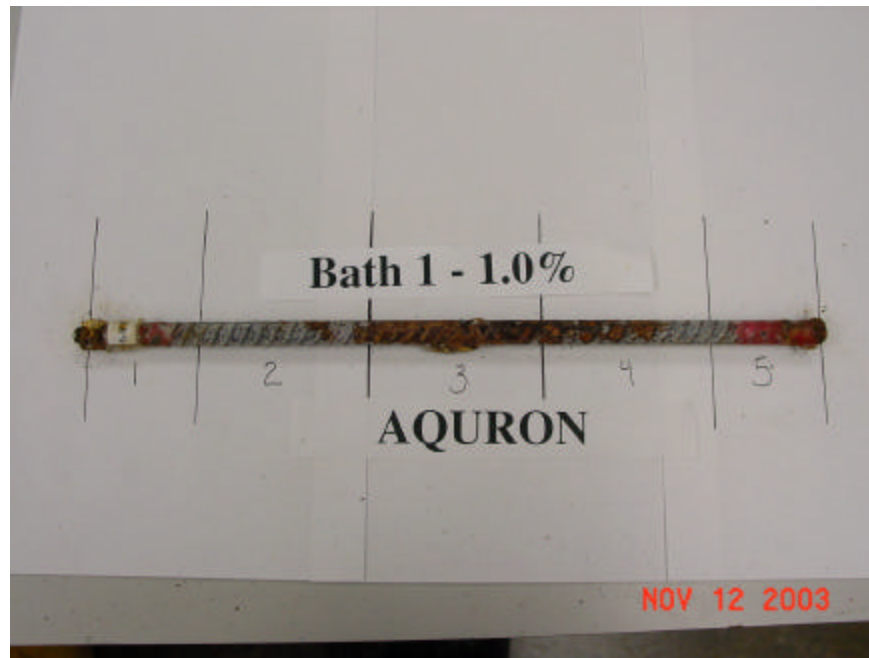

Figure 3.30 – Visual Evaluation Procedure

3.7.2 Mass Loss Measurements

The mass loss measurements in this study followed the ASTM standard G1 – 03. This standard provides a number of options for chemical cleaning of the rusted bars. After

consulting several chemical experts, the standard using a mixture of 500ml-hydrochloric acid (HCl), 3.5g-hexamethylene tetramine ($C_6H_{12}N_4$), and 500ml-reagent water was chosen as the best option for this study. When soaked in this solution mixture, the bars would actually lose the majority of corrosion product to a chemical reaction with the liquid. Before this method could be utilized, the epoxied ends of the bars were cut off. The bars were soaked in the solution for 10-minute cycles, while weighing after each cycle until no significant mass loss could be recorded. For this study, four cycles provided the desired accuracy, as changes after 4 cycles were very negligible. Figures 3.31, 3.32, 3.33, and 3.34 show the various steps in the mass loss measurement process.

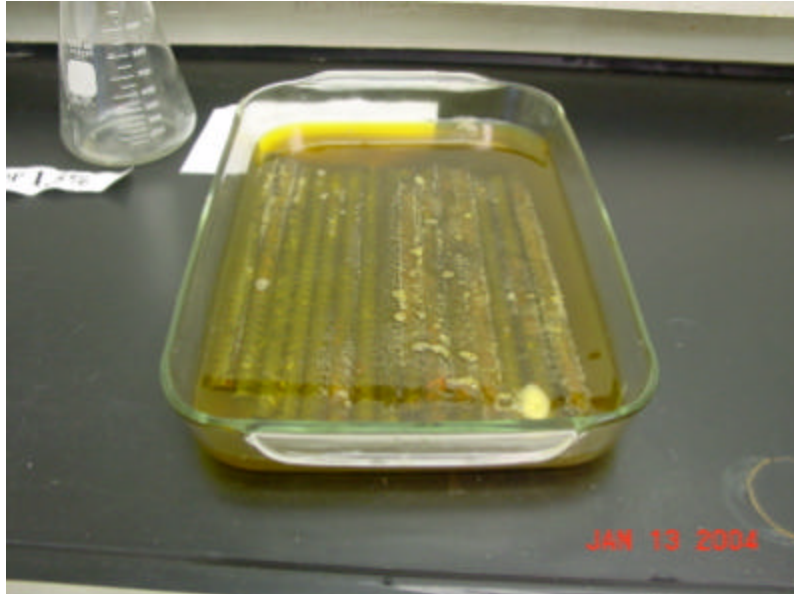

Figure 3.31 – Bars Submerged in Chemical Cleaning Solution



Figure 3.32 – Brushing Bars After the Chemical Bath



Figure 3.33 – Drying the Bars After the Chemical Bath

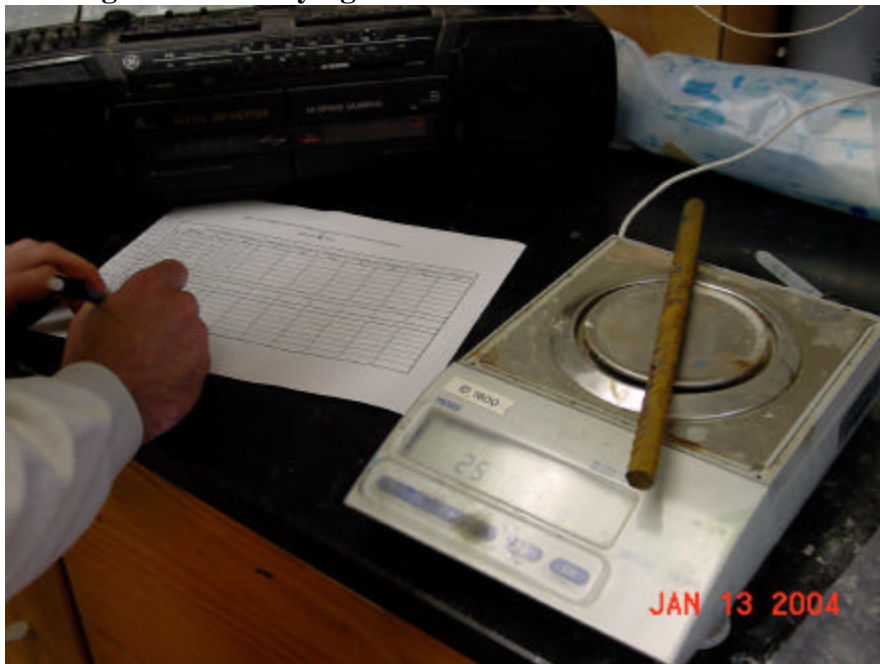

Figure 3.34 – Weighing a Bar After the Cleaning Process

3.7.3 Tension Tests

The last test to be performed on each individual bar was the tension test. The tension tests were performed in accordance with ASTM standard A 370 – 03a. Each bar was placed in the lab's 220-kip MTS closed-loop universal testing machine under tension forces until failure. An extensometer was used for each test to measure the change in the length of the bar. The load-deflection graphs were generated for each specimen, and the loss of

strength was measured in comparison with a control non-corroded bar. Figures 3.35, 3.36, and 3.37 show the various steps in the tension test.



Figures 3.35 – Tension Test Setup



Figure 3.36 – Extensometer Setup



Figure 3.37 – Bar After Failure in Tension

CHAPTER 4. ANALYSIS AND DISCUSSION

4.1 Introduction

As discussed in Chapter 3, a number of data sets were collected over the duration of this project. Measurements were taken before, during, and after the environmental exposure. The following sections will discuss the measurements and the findings based on this data.

4.2 Measurements and Results During Accelerated Testing

4.2.1 Corrosion Current Measurements and Results

Corrosion Current measurements were taken for each of the 348 specimens on a weekly basis using a voltmeter. The method for using the voltmeter to collect these measurements was discussed previously in Section 3.6.1, and generally followed ASTM G 109-99. These readings were collected and entered into a spreadsheet so that graphs could be developed and trends could be observed. The voltmeter readings, along with the known resistance of 100 Ohms, were used in accordance with ASTM G 102-89 (R 99) to determine corrosion rates for the specimens. This corrosion rate is calculated using Faraday's Law as per ASTM G 102-89 (R99):

$$CR = K_1 \left(\frac{i_{Cor}}{r} \right) \left(\frac{W}{n} \right) \quad (4.1)$$

where CR = corrosion rate given in mm/year, $K_1 = 3.27 \times 10^{-3}$, mm g/ μ A cm yr, i_{cor} = corrosion current density (μ A/cm²) = (I_{cor}/A), where I_{cor} = total anodic current (μ A), and A = exposed specimen area (cm²), ρ = density in g/cm³, W = the atomic weight of the element, and n = the number of electrons required to oxidize an atom of the element in the corrosion process, that is, the valence of the element. Figures 4.1, 4.2, and 4.3 show typical graphs of the corrosion rate over time for specimens from the three environments; control, bath and chamber. Each of the graphs generated from this experiment for corrosion rate vs. time can be found in Appendix A. The gap in the chamber data was due to the shut down of the original chamber after some problems as discussed in Section 3.5.2 and for the time it took to complete the construction of the new chamber. The corrosion rate data can be interpreted as the instantaneous rate of corrosion at the particular time of voltage measurement. From the figures, it is obvious that the corrosion rate changes frequently over time for each specimen and a useful product comparison is not practical with these graphs. Fluctuations seen throughout for all three environments may indicate the start and end of each corrosion event. It was necessary to convert the corrosion rates for each specimen to a total corrosion measurement following ASTM G 109-99. This was done by integrating the corrosion rate data over time. Figures 4.4, 4.5, and 4.6 show the cumulative corrosion over time for the same specimens as the previous graphs. Graphs for other specimens are shown in Appendix B.

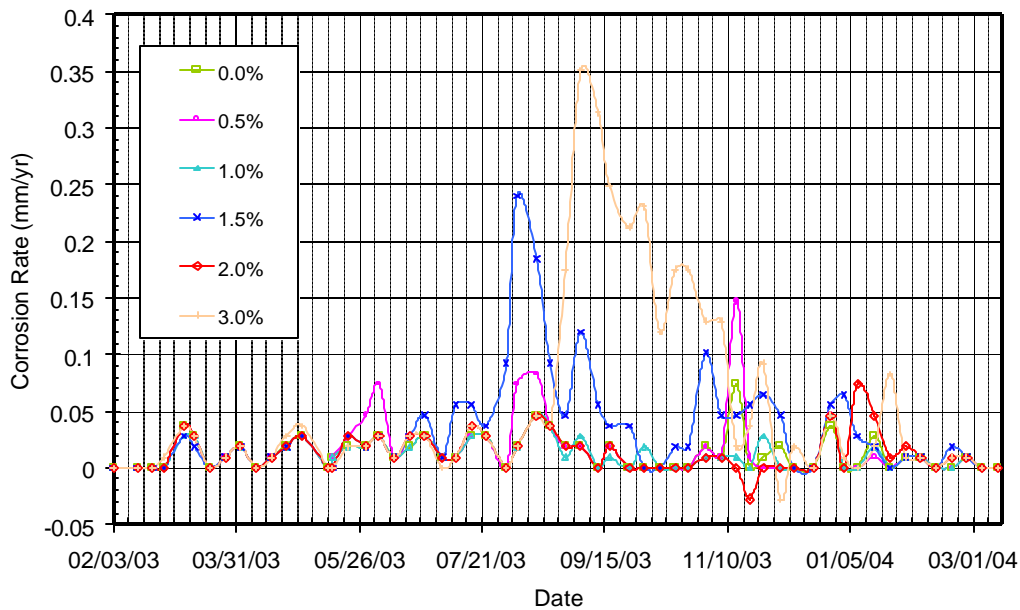

Figure 4.1 - Corrosion Rate for Control Specimens (Set #2)

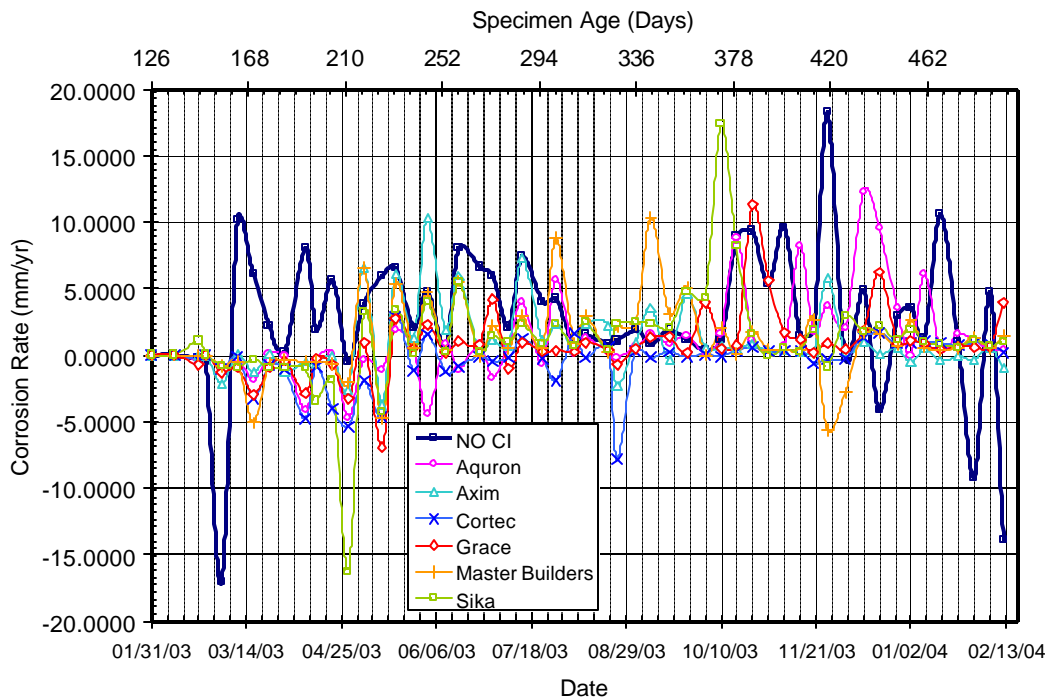

Figure 4.2 - Corrosion Rate for Bath 2, 0.0% Chloride, Pre-Cracked

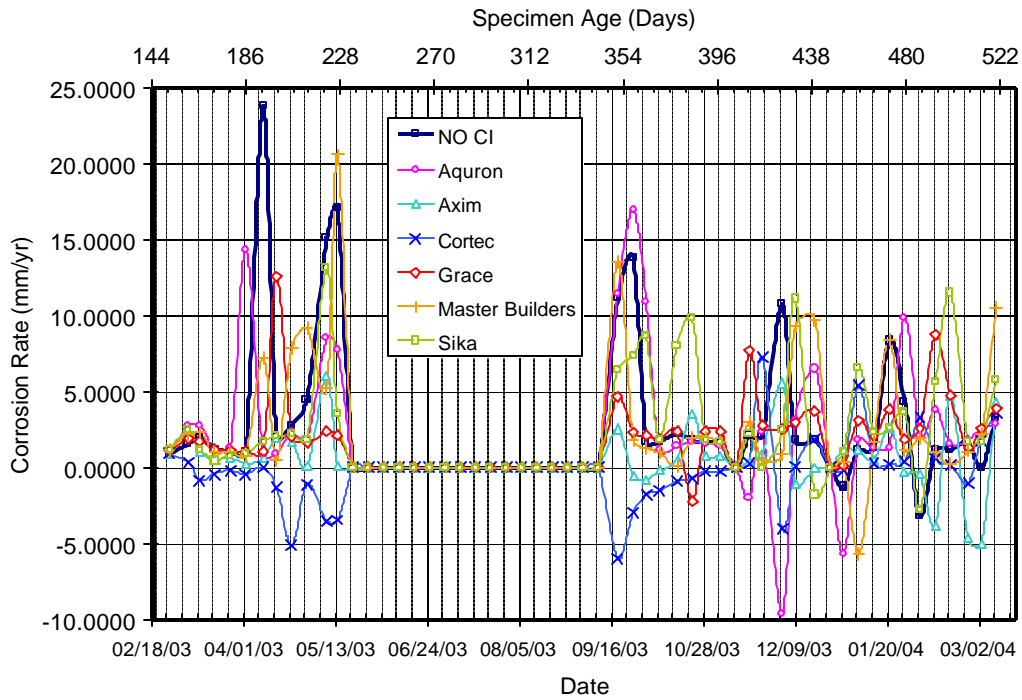

Figure 4.3 - Corrosion Rate for Chamber Shelf 3, 2.0% Chloride, Post-Cracked

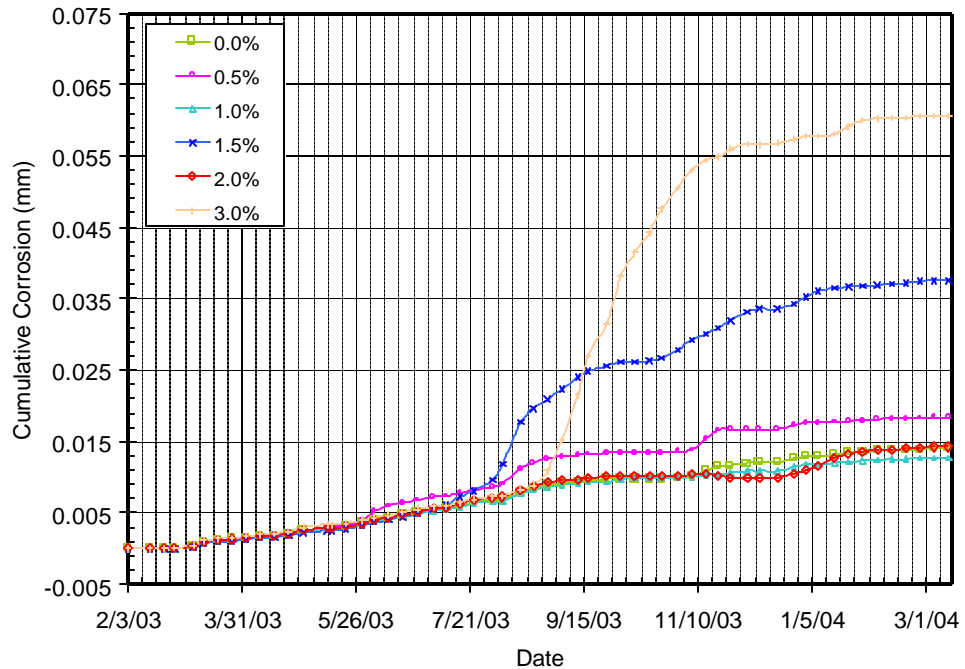

Figure 4.4 - Cumulative Corrosion Over Time for Control Specimens (Set #2)

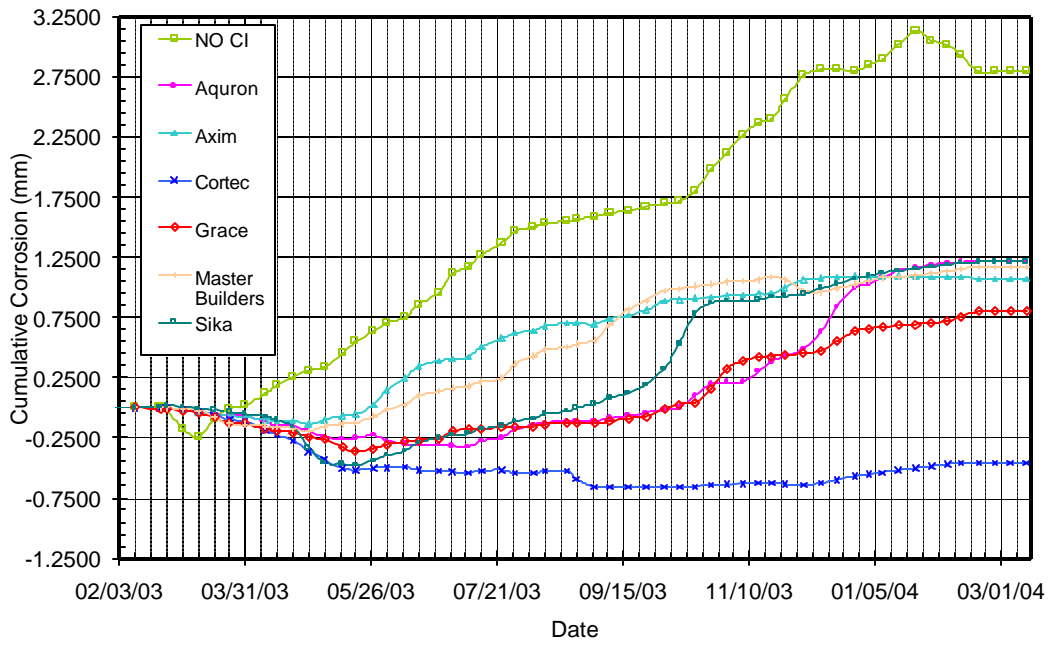

Figure 4.5 - Cumulative Corrosion Over Time for Bath 2, 0.0% Chloride, Pre-Cracked

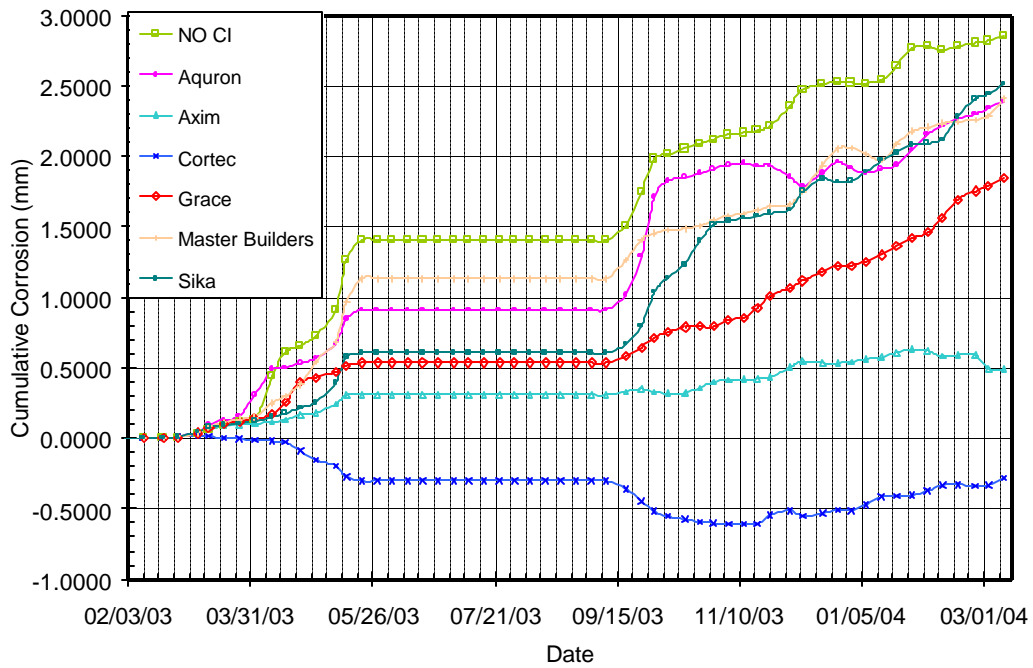

Figure 4.6 - Cumulative Corrosion Over Time for Chamber Shelf 3, 2.0% Chloride, Post-Cracked

For the control specimens, it is evident that the onset of corrosion is much later than in the bath and chamber environments. It is also clear that even at the end of the test program the amount of total corrosion of the control specimens was very little in comparison with the other environments, as was expected. All specimens display small amounts of corrosion, however there are several with initial chloride contents that display significantly more accumulated corrosion as compared to the others: these are 0.5%, 1.5%, and 3.0%. It is not clear why the 1.0% and 2.0% specimens display almost the same cumulative corrosion as the 0.0% specimens. In Set #1 of the control specimens (see Appendix B), on the other hand, the 0.0%, 0.5%, and 1.0% specimens follow the same pattern of cumulative corrosion, while the 1.5%, 2.0%, and 3.0% specimens have significantly higher cumulative corrosion. The difference in the effect of the initial chloride content may be explained as follows:

- The levels of corrosion may be too low for non-accelerated corrosion, and therefore no real pattern of behavior for various chloride contents may exist after about one year.
- The resolution for this method of measurement may not be detailed enough to accurately detect corrosion at lower levels.
- Continued testing on these bars may be necessary to show any trends if they do exist.

It can, however, be concluded that different chloride levels do affect the onset of corrosion and can speed up the corrosion process based on these two sets of specimens.

The cumulative corrosion graphs for both the bath and the chamber specimens, on the other hand, exhibit significant levels of corrosion in comparison with the control specimens. This was expected due to the severe nature of the accelerated testing environments. The graphs shown above indicate that the corrosion inhibitor products are more effective in slowing the corrosion process than if no corrosion inhibitor was used. Graphs for every specimen for total corrosion over time can be found in Appendix B. For many of these graphs, it may not be differentiable as to which product(s) performed the best. Furthermore, there are anomalies where it is unclear whether the products even outperformed the control specimens. Furthermore, some of the graphs, especially those of the bath specimens, display negative cumulative corrosion. These negative values may be explained as follows:

- The reference bar is corroding more severely than the test bar, thus reversing the corrosion current and displaying a negative value (West et al. 2002).
- There is no macrocell developed between the reference bar and the test bar.
- The test bar is corroding, but the macrocell has developed only within the test bar itself.
- The test bar is corroding, but a microcell of corrosion has developed on the test bar.

To determine if the reference bars were corroding, a sampling of reference bars were excavated at the conclusion of the test and examined for corrosion. Little or no corrosion was found on the reference bars examined. This leaves the explanation that there was either a macrocell or microcell developed on the test bar itself. This can be verified by the graphs of the half cell readings that will be discussed later. The standard for the half cell graphs specify values more negative than -0.35V to be indicative of a 90% probability of corrosion. By comparing the graphs for the half cell readings with the cumulative corrosion graphs, it can be determined if the test bar is corroding at the time of negative cumulative corrosion readings. If the test bar is corroding, then the data for corrosion current and cumulative corrosion for that particular specimen is rendered spurious. Furthermore, the scatter in data for this method may be due to the deviation from the set specifications in the ASTM standard that was used. ASTM G 109-99 states “this test method may not properly rank the performance of different corrosion inhibitors, especially at concrete covers over the steel of less than 40mm (1.5 in)”. The concrete cover used in this experiment was 0.5 in. This was chosen based on the data supplied by the NCDOT to represent the shallower concrete cover in existing bridge decks in North Carolina. It is also a possibility that, although the voltmeter data may be useful in determining whether the specimens are corroding or not, it may not have the precision that is necessary to compare different corrosion inhibitor products with one another. Based on these findings, it is clear that the corrosion current method alone does not provide adequate information in distinguishing the performances of different products.

4.2.2 Half Cell Readings and Results

As with the voltmeter readings, half cell readings were taken each week for every specimen tested. This data collection was based on ASTM C 876 – 91 (R 99), as discussed in detail in Section 3.6.2. All of these readings were collected and entered into a spreadsheet so that useful graphs could be developed and any trends in the data would be found. Figures 4.7, 4.8, and 4.9 show typical half cell data over time for the control, bath, and chamber environments, respectively. The full set of graphs of half cell potentials over time for all specimens can be seen in Appendix C.

As mentioned earlier, the gap in the chamber data was due to the switch from the original chamber to the new chamber. ASTM standard C 876 –91 (R 99) provides the following limits as guidance for half cell potential data:

- Measured Potential $> -0.20\text{ V}$: Greater than 90% probability that no corrosion is occurring in that area at the time of measurement
- $-0.20\text{ V} \geq$ Measured Potential $\geq -0.35\text{ V}$: Corrosion activity in the area of measurement is uncertain
- Measured Potential $< -0.35\text{ V}$: Greater than 90% probability that corrosion is occurring in that area at the time of measurement

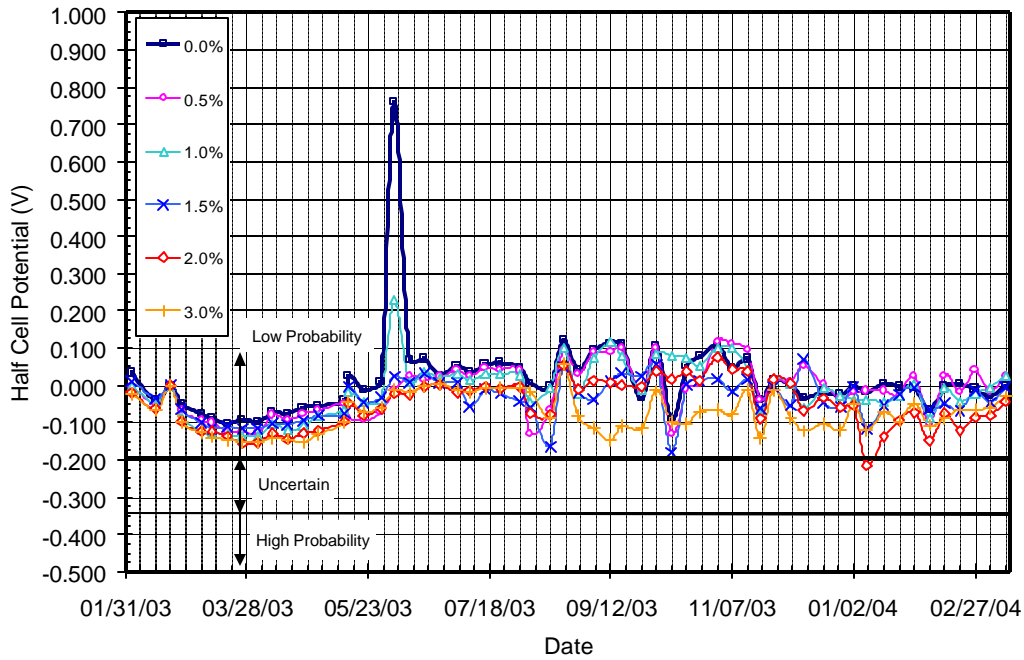

Figure 4.7 - Half Cell Readings for Control Specimens (Set #2)

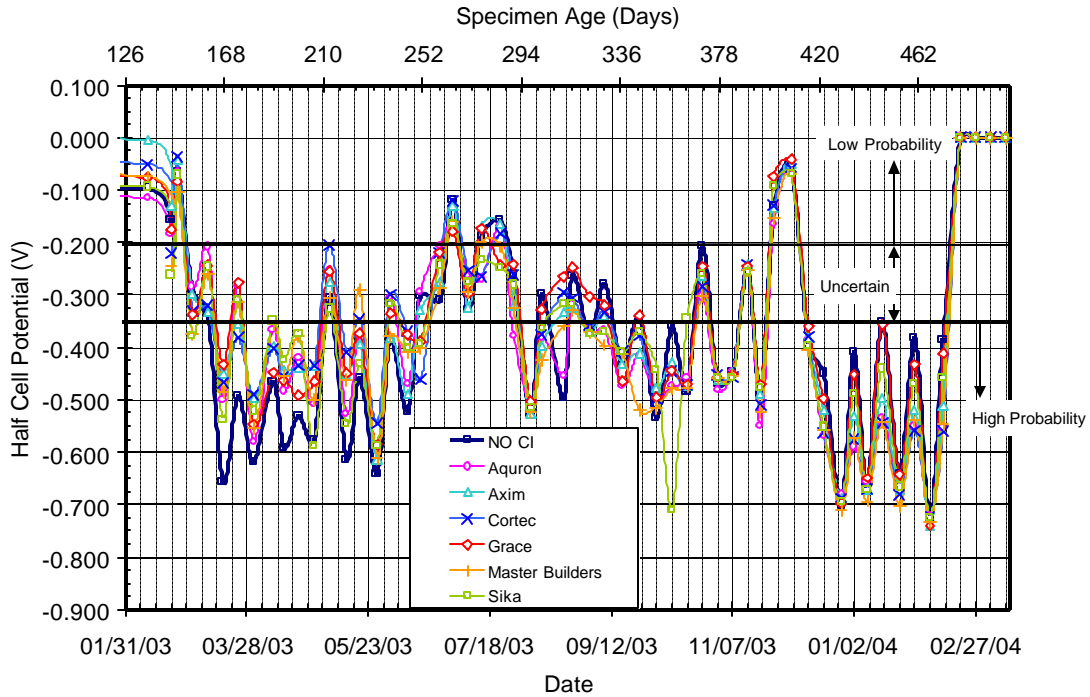

Figure 4.8 - Half Cell Readings for Bath 2, 0.0% Chloride, Pre-Cracked

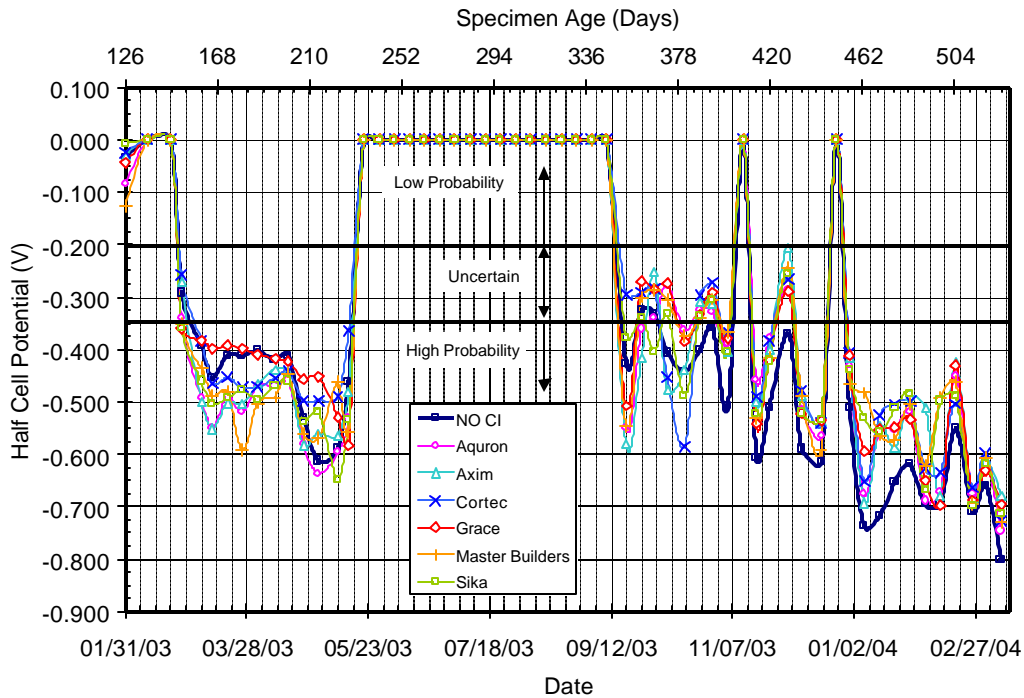

Figure 4.9 - Half Cell Readings for Chamber Shelf 3, 2.0% Chloride, Post-Cracked

As expected, no corrosion was measured for the control environment specimens by the half cell method.

Based on the above stated limits, the bath specimens began to exhibit a high probability of corrosion after approximately one month of accelerated testing. The bath specimens for the most part stay within this region for the remainder of the accelerated test program except to fluctuate into the uncertain range on occasion and very rarely into the range of low probability of corrosion. The cyclic fluctuations that are exhibited by the half cell graphs for the bath specimens were observed to occur due to the one-week wet and one week dry cycles. Much higher potentials were generally observed directly after the wet cycles. Conversely, lower potentials were observed following a week in the dry cycle for the same specimen. This phenomenon occurred even with proper wetting of the concrete surface prior to taking measurements after each cycle. This may be attributed to the fact that the electrical current being measured could travel through the saturated concrete with more ease than it could through the dry concrete, despite a fully wetted surface.

The chamber specimens display many of the same trends as those in the baths. Similar to the specimens in the baths, there was a high probability of corrosion observed after just about one month of accelerated environmental exposure for most specimens. Most specimens fluctuated in and out of the high probability and uncertain regions, and occasionally into the low probability range. There were more occurrences of chamber

specimens in the uncertain range than in the bath specimens. This was most likely due to the severity of the bath environment, as compared with the chamber. Unlike the baths, there is no real cyclic trend observed because readings were taken in the chamber under similar saturation conditions each week.

While a number of trends were observed with the half cell data, there is no clear indication as to which corrosion inhibitor products performed the best. This is primarily due to the nature of this data. The data provides the probability that corrosion is or is not occurring, but it does not provide to what extent the corrosion occurs. For example, two specimens may have very different potentials both more negative than -0.35 V and therefore both have a 90% probability that corrosion is occurring. The standard does not state that the more negative, the more probable corrosion, but rather gives only the limits listed above. This leads to the conclusion that no comparison may be directly drawn between the performances of different corrosion inhibitors based solely on the half cell potential data. The half cell potential data can be used to determine the probability of corrosion only.

It is important to note that there are many factors that affect the accuracy of half cell potential readings, including temperature, light, and cleanliness of the electrode (Ansuini & Dimond 1994). These factors, along with the precision of the half cell readings make it impractical to determine the performance of the corrosion inhibitor products from this measurement alone. The full set of graphs of half cell potentials over time for all specimens can be seen in Appendix C.

4.2.3 Environmental Readings and Results

The environmental readings taken during this testing program included salt-water concentration, pH, temperature, and humidity. These readings, similar to the voltmeter and half cell readings, were taken on a weekly basis. The details for collecting the environmental data were described in Section 3.6.3. Figure 4.10 shows the change in salinity over time for the baths and the chamber.

Although slight changes in salinity occur periodically, it is evident that the average remains relatively close to the target 15% NaCl concentration. Furthermore, adjustments were made every time a change was observed.

The target pH for the water used in this project was a neutral range from 6-8. Figure 4.11 shows the change in pH over time for the baths and the chamber.

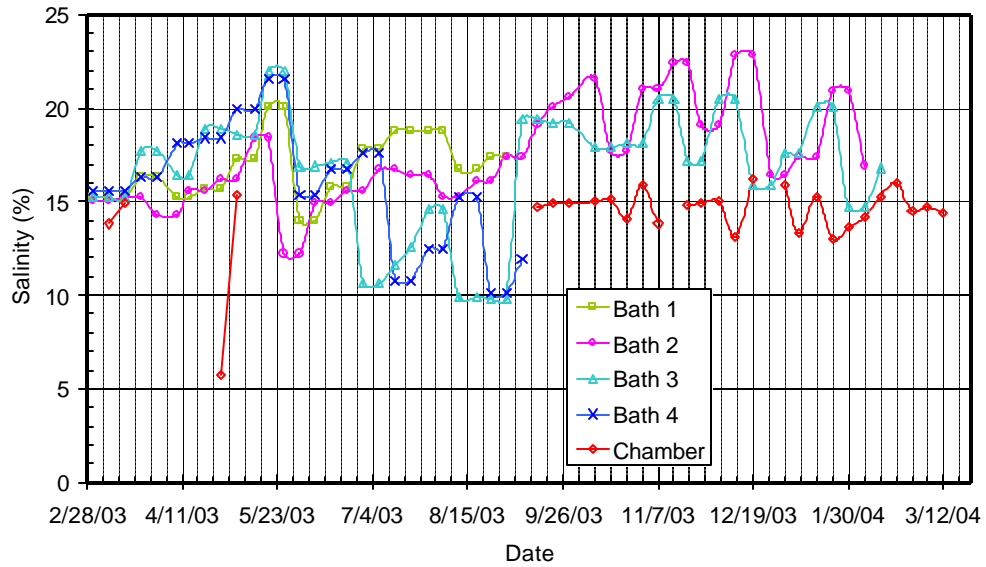

Figure 4.10 - Salinity Over Time for Bath and Chamber Environments

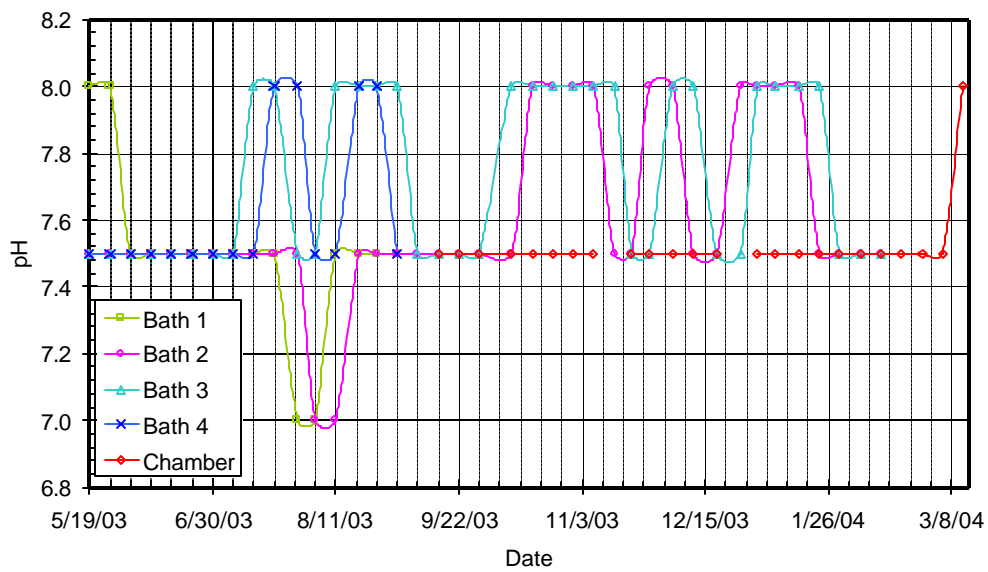

Figure 4.11 - pH Over Time for Bath and Chamber Environments

It is clear from Figure 4.11 that the pH of the salt-water solutions had no significant fluctuations over time. This means that the alkalinity of the solution did not change over time, which in turn indicates that the pH of the solution itself should not affect the accelerated corrosion test results. ACI 222R-96 states that the alkalinity of concrete actually protects the reinforcing steel from low levels of chloride attack by forming a protective barrier on the surface of the steel. The range for this protection is considered a pH value between 8 and 13. At pH levels above or below this, the layer of protection around the steel can be more readily broken down and corrosion is more likely to occur. As shown in Figure 4.11, at no time during the experiments, the pH level in any of the environments entered into the range between 8 and 13.

The target temperature for the specimens in the baths and chamber was 130°F for both the wet and dry cycles of the tests in order to further accelerate the corrosion process. Figure 4.12 shows temperature vs. time for the baths and chamber environment.

It can be observed that fluctuations in temperature occurred frequently over time, but the average temperature was kept relatively close to the target of 130°F.

The only environment for which the humidity was measured was the control environment. The target humidity for this environment was set at 50% RH. Figure 4.13 shows the humidity and temperature changes over time for the control environment.

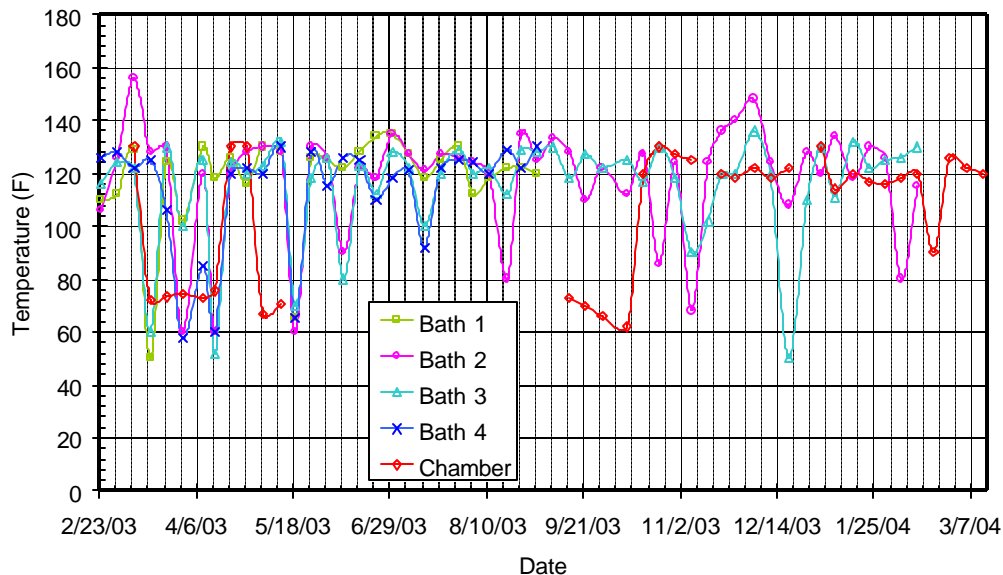

Figure 4.12 - Temperature Over Time for Bath and Chamber Environments

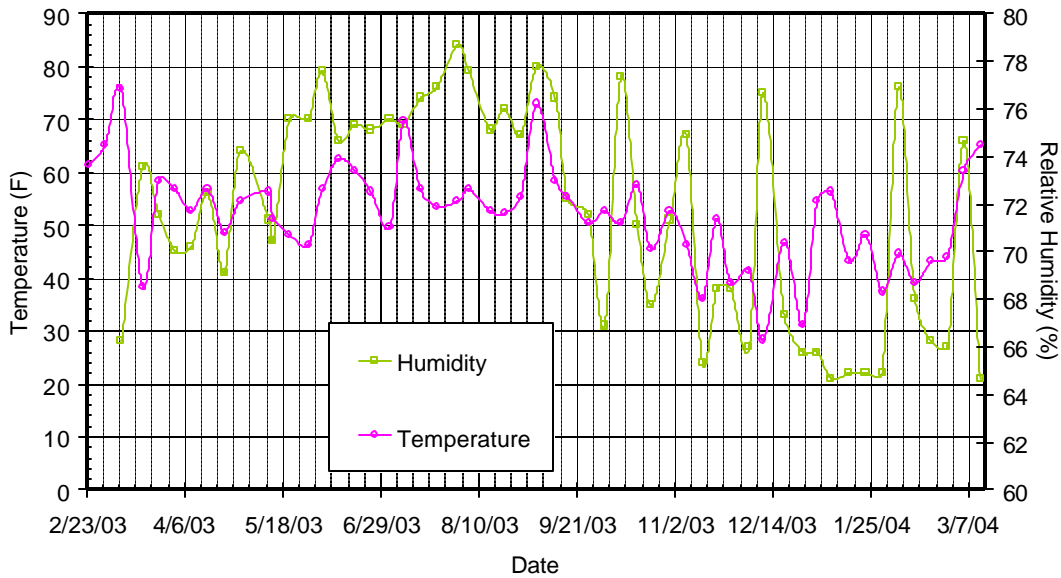

Figure 4.13 - Humidity and Temperature Over Time for Control Environment

Air conditioning in the laboratory, where the control specimens were kept, was not as effective in controlling the humidity as it was for the temperature. From Figure 4.13, it is clear that humidity fluctuated considerably over time, while the average remained at about 50%. On the other hand, temperature was kept very close to the target of 70°F.

4.3 Post-Exposure Measurements and Results

4.3.1 Chloride Content Analysis and Results

Chloride content analysis tests were performed on 324 – 2” cubes: 6 initial cubes, 90 after one month of exposure, 90 after 3 months of exposure, another 90 after 6 months of exposure, and finally 48 after 12 months of exposure, the latter for baths and control only. The method of testing for chloride content was discussed in detail in Section 3.6.4. The purpose of these tests was to measure the chloride ion concentration at the level of the rebar (1/2 in below the concrete surface) based on the weight of the concrete. Based on titration results, calculations were performed to determine the percent Chloride ion by weight of concrete in the sample. These calculations were based on the NCDOT Materials and Test Unit Procedure C-4.0, “Chloride Analysis on Bridge Concrete (Potentiometric Titration Method)”. As mentioned in Chapter 3, this test method was based on ASTM standard C 1152. It is very important that these calculations are not confused with the initial chloride contamination percentages. As mentioned in Chapter 3, the initial chloride contamination levels were based on the weight of dry cement in the

mix only. The percent chloride ion concentration found by titration methods identifies the percent concentration based upon the weight of the cured concrete. The difference between these two percentages is roughly a factor of 10, obviously the percentage based on weight of dry cement being the higher. Figure 4.14 shows the change in chloride ion percentages over time for the control environment.

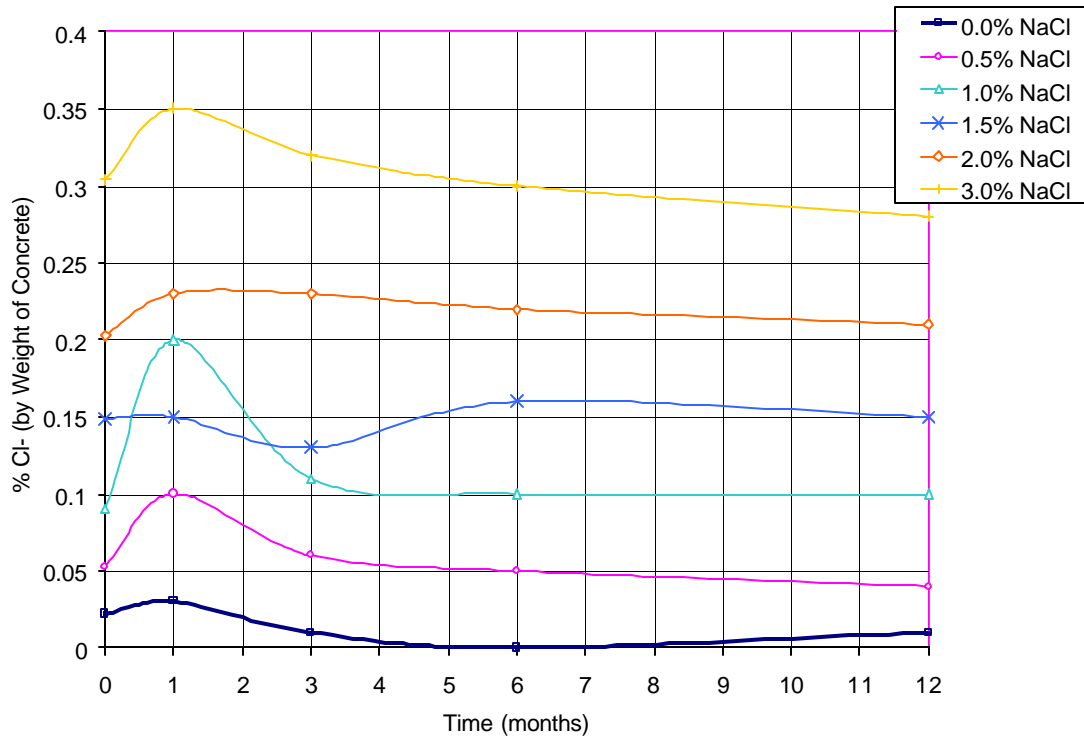

Figure 4.14 - Chloride Content for Control Specimens

The control specimens display the behavior that would be expected. The higher the initial chloride content, the higher the chloride ion percentage tested. There is slight overlap between the 1.0% and 1.5% at one month, but that may be attributed to the collection of the sample of powder, which may or may not include part of the aggregates. Figure 4.15 shows the chloride content for several bath specimens.

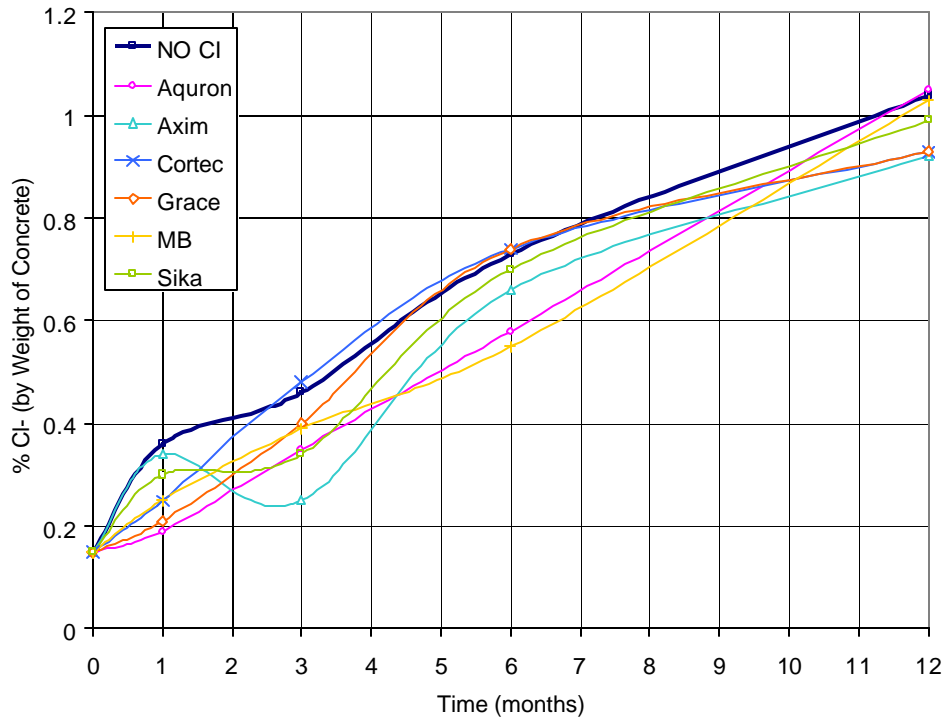

Figure 4.15 - Chloride Content for Bath Specimens – 1.5% Chloride

It was observed that most of the 1.5% bath samples tested returned results with lower chloride contents than that of the control specimen, i.e., with no corrosion inhibitor. This indicates that those with lower tested chloride contents performed better at preventing additional chloride influx over the course of the accelerated testing program. The graph for the 1.5% bath specimens displays closely clustered chloride analysis results. This clustered phenomenon occurs more predominately with higher initial chloride contaminations. The bath specimens at 0.0% and 0.5% initial chloride contamination, on the other hand, display more scattered data with only a few products performing better than the control specimen. The high spread between the no corrosion inhibitor and those products that display lower chloride contents indicate a better product performance over the control. However, as the initial chloride contents increase beyond 0.5%, the data spread decreases significantly indicating a drop from 50% improved performance to 30% for the 1.0% initial chloride specimens. This increased performance reduces even further to a range of 10-15% for the 1.5%-3.0% initial chloride specimens. From this data, it is obvious that as the level of chloride contamination increases, the effectiveness of the corrosion inhibitors decreases.

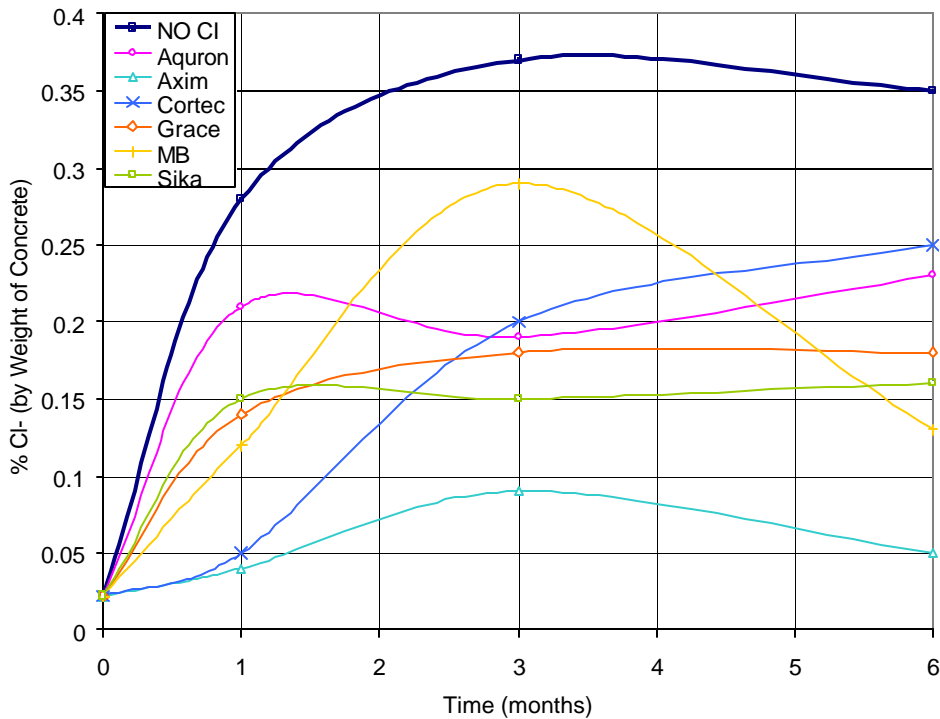

Figure 4.16 - Chloride Content for Chamber Specimens – 0.0% Chloride

Based on the 0.0% specimens of the chamber, it is clear that corrosion inhibitor products are generally successful in preventing further chloride contamination. However, the graph shown here displays highly scattered results, making it difficult to make general conclusions. Similar to the baths, when the initial chloride contamination is increased, the less scattered the data becomes. This leads to the same conclusion that the corrosion inhibitors become less effective at higher levels of initial chloride contamination. Unlike the baths, however, the chloride contamination seems to stabilize over time. In the baths, this trend was not observed, but rather there was a consistent increase in the level of chloride of the specimens over the course of the testing program. This may be attributed to the harsher nature of the bath environment. Due to the frequent wet/dry cycles in the baths, higher corrosion results were observed along with higher overall chloride contaminations. It is believed that if the specimens were tested for a longer period of time, eventually the same level of corrosion and chloride contamination as the baths could have been reached in the chamber. All products displayed chloride contaminations below that of the control specimen for most data points, especially at the lower initial chloride contamination levels. As the level of initial chloride increased, it was evident that every corrosion inhibitor became less effective. As time progressed and as the initial chloride contamination levels increased, most products became less effective to the point that no significant difference was noticed compared to the control specimen. All of the chloride content graphs can be found in Appendix D.

4.3.2 Visual Ratings: Analysis and Results

After the accelerated environmental testing was concluded, the specimens were removed from their respective environments and each piece of test rebar was extracted from the concrete. A visual rating system was used to collect data from each bar regarding percent surface corrosion and percent rib loss. This visual rating system was explained in Section 3.7.1. Once this data was compiled, graphs were made comparing the different corrosion inhibitor products at all stages of removal. There were two methods of data collection for the visual evaluations: surface rust assessment and rib loss assessment. These evaluations were performed for both the mid-sections and the end-sections of each test bar. As discussed in Chapter 3, the bars were divided into five segments – two end-sections, and three mid-sections. The data was collected and grouped as end-sections and mid-sections for comparison. The purpose of this distinction was to determine if end effects for the bars were significant. A sampling of these graphs for surface rust percentage in the end-sections can be seen in Figures 4.17 and 4.18.

Figure 4.17 shows the first set of specimens taken from the chamber at the end of three months, and from the baths at the end of six months. Figure 4.18 shows the second set of specimens taken from the chamber and bath at the end of six months and one year, respectively. From these graphs, it is obvious that although corrosion did occur in the end sections of the specimens, the same amount of surface rust occurred for nearly all specimens regardless of which corrosion inhibitor, if any, was applied. There is no significant difference in the amount of surface rust for any specimen in the same data set. This same trend was observed in the rib loss graphs for the end-sections, as well. A sampling of the end-section rib loss graphs are shown in Figures 4.19 and 4.20.

Once again, Figure 4.19 displays the first set of specimens removed from the chamber at the end of three months, and from the baths at the end of six months. Figure 4.18 shows the second set of specimens removed from the chamber and bath at the end of six months and one year, respectively. These two sets of data, both for surface rust and rib loss show the same trends: there is no significant difference in the performance of any corrosion inhibitor products at the end sections as compared to the control specimen. This is a very important observation because from this observation it can be concluded that the end section surface rust and rib loss can be disregarded as a factor possibly affecting the performance of the corrosion inhibitors. This conclusion also validates the next steps in the test procedure, which focuses only on the mid-section of test bars for further analysis of the corrosion inhibitors.

For the analysis of the corrosion inhibitor products, only the data for the mid-sections was used. The visual evaluation for the midsection of the bars gave data that was much more distinct and functional in comparing different corrosion inhibitor products. Figures 4.21-26 show a sampling of the surface rust comparison graphs for the mid-sections of the bars.

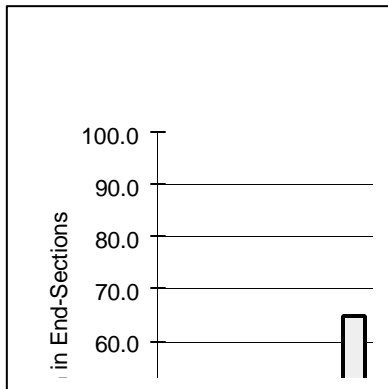
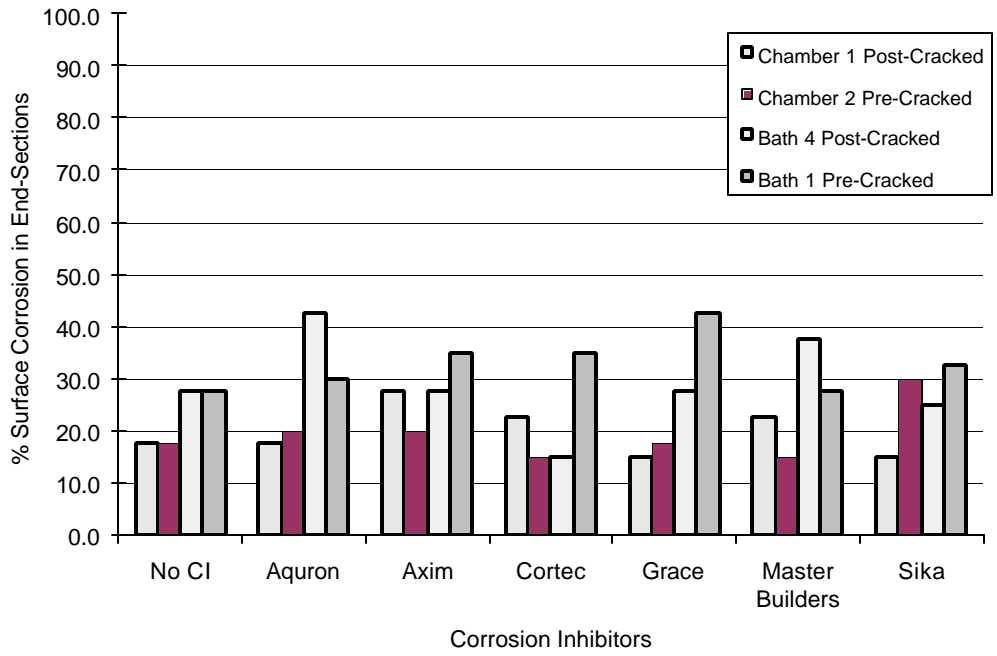

Figure 4.17 - % Surface Corrosion at End Sections for 1.0% Chloride (Set #1)

Figure 4.18 - % Surface Corrosion at End Sections for 1.0% Chloride (Set #2)

Pre-Cracked

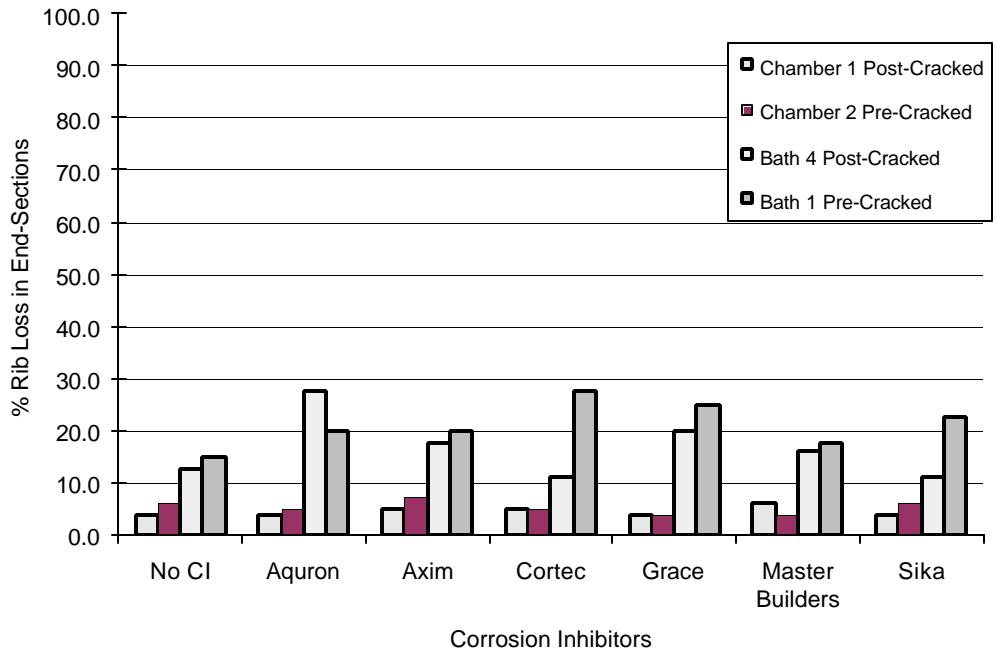

Figure 4.19 - % Rib Loss at End Sections for 1.0% Chloride (Set #1)

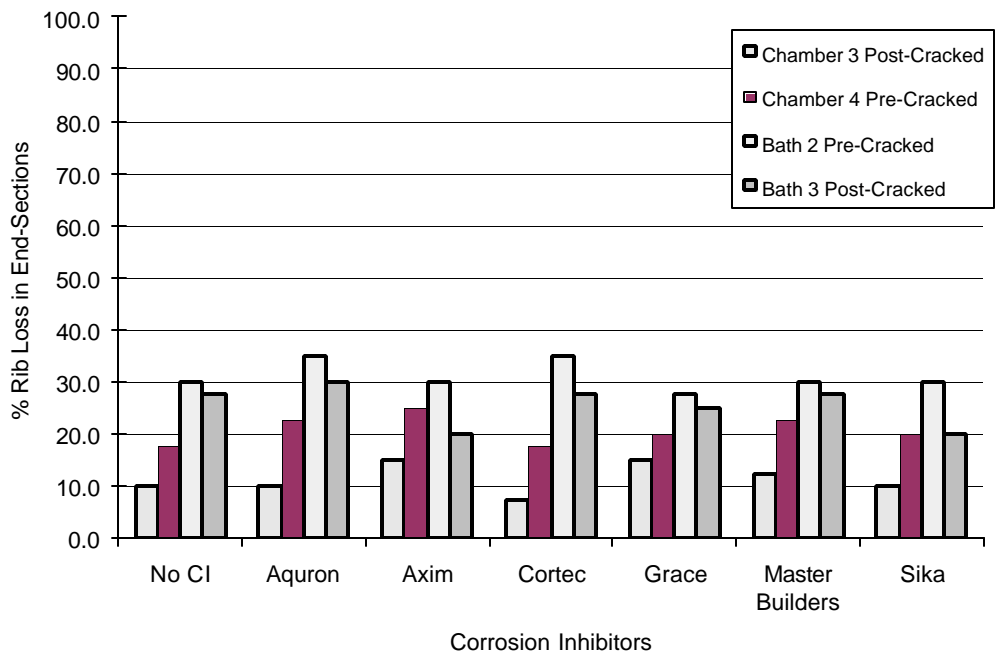

Figure 4.20 - % Rib Loss at End Sections for 1.0% Chloride (Set #2)

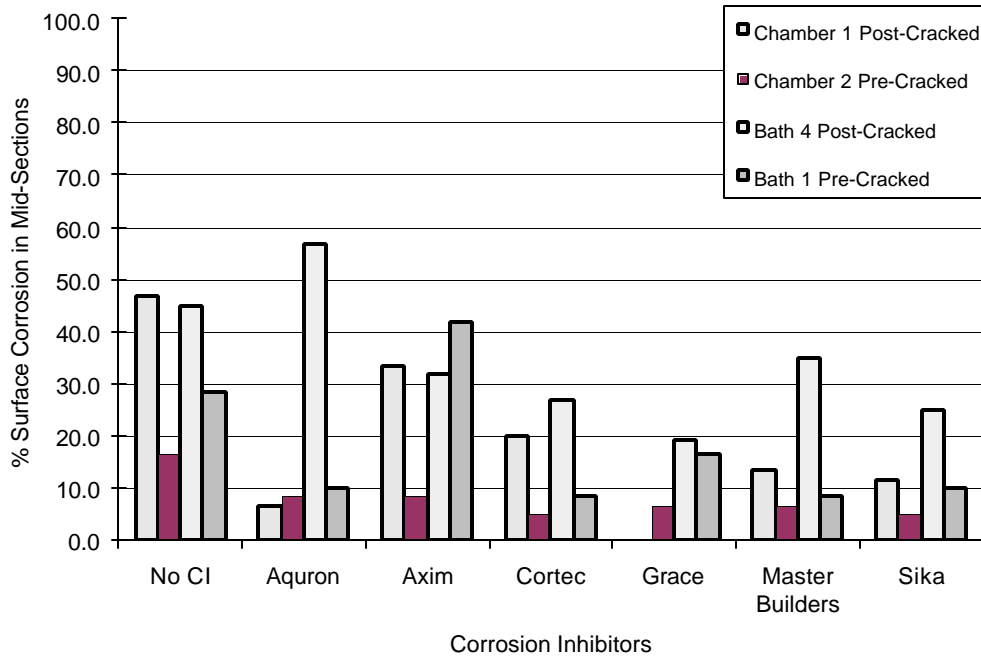

Figure 4.21 - % Surface Corrosion at Midsection for 0.0% Chloride (Set #1)

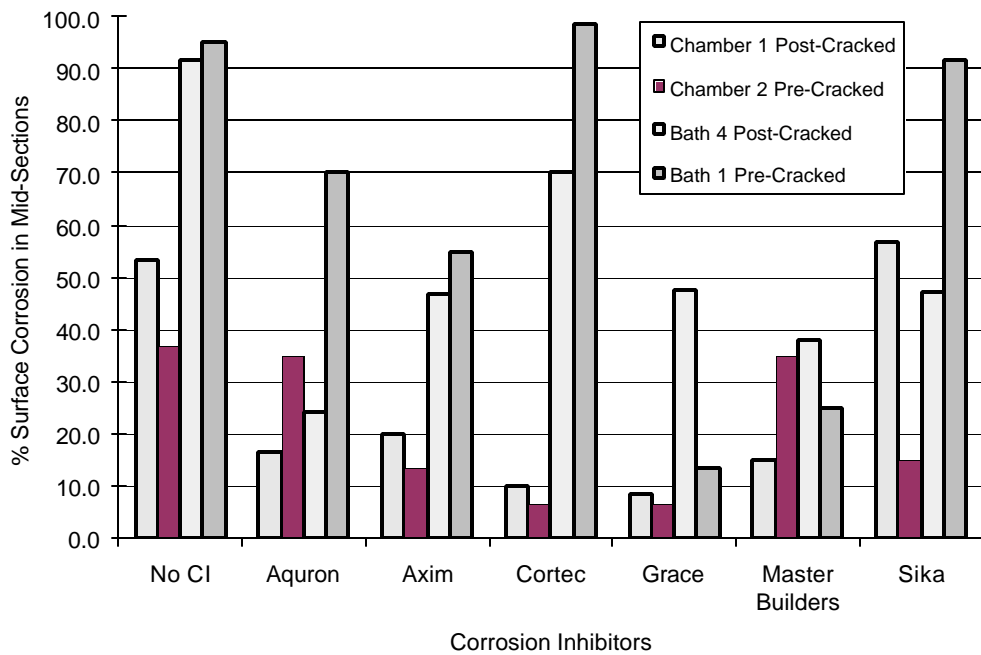

Figure 4.22 - % Surface Corrosion at Midsection for 1.5% Chloride (Set #1)

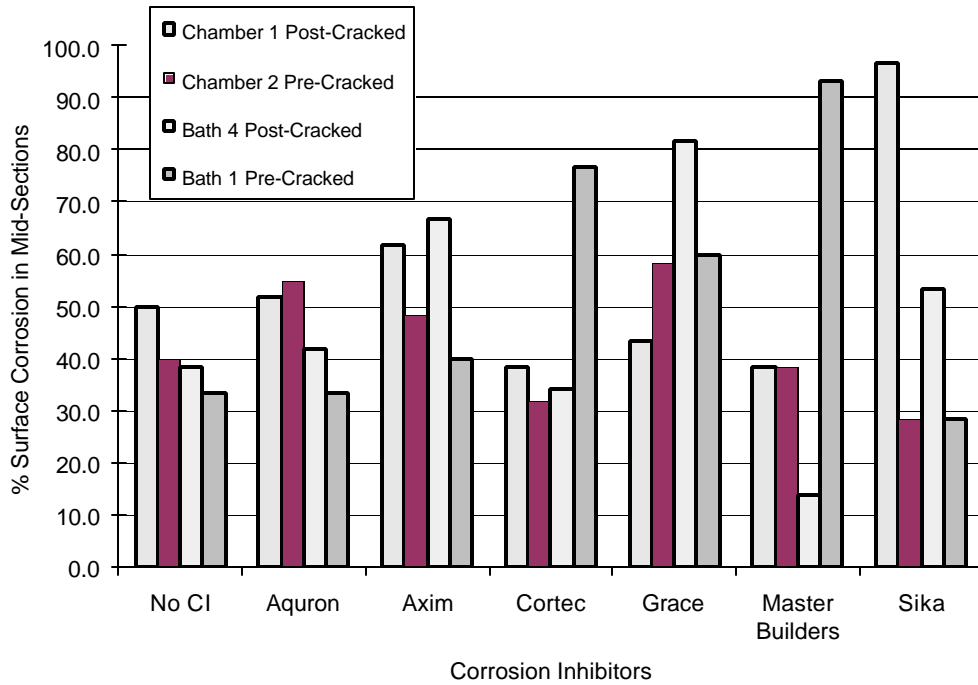

Figure 4.23 - % Surface Corrosion at Midsection for 3.0% Chloride (Set #1)

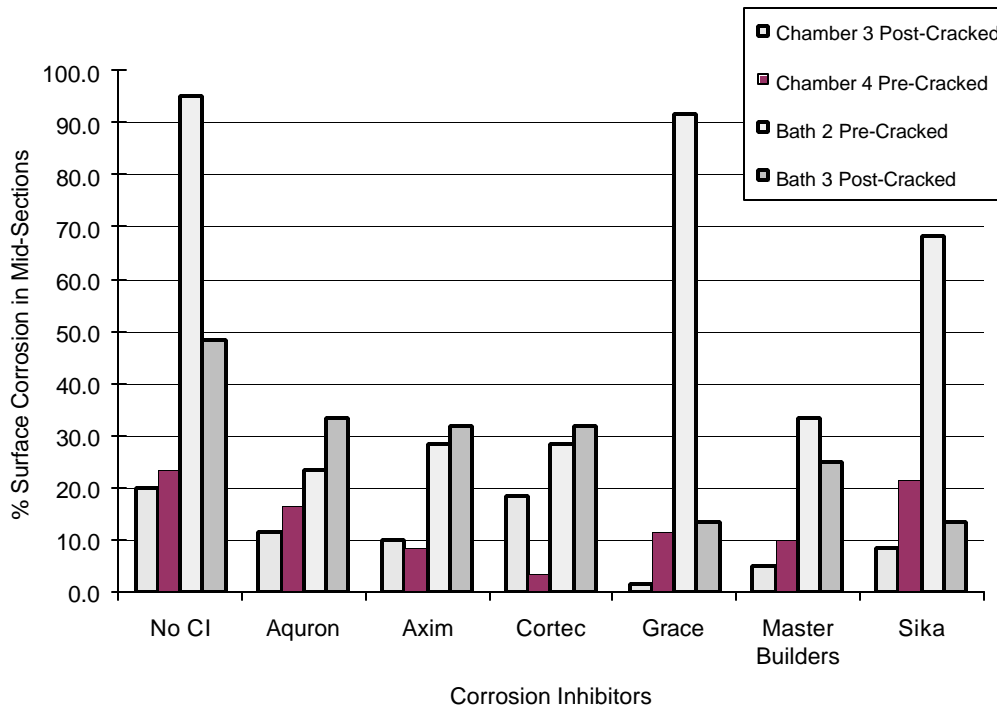

Figure 4.24 - % Surface Corrosion at Midsection for 0.0% Chloride (Set #2)

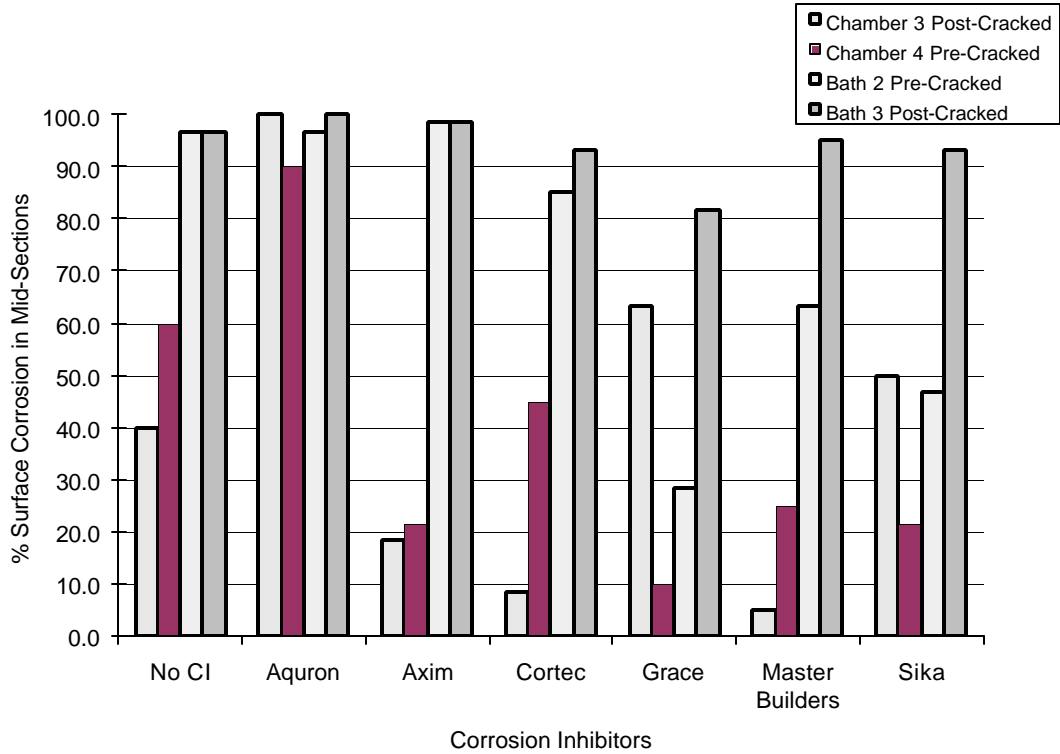

Figure 4.25 - % Surface Corrosion at Midsection for 1.5% Chloride (Set #2)

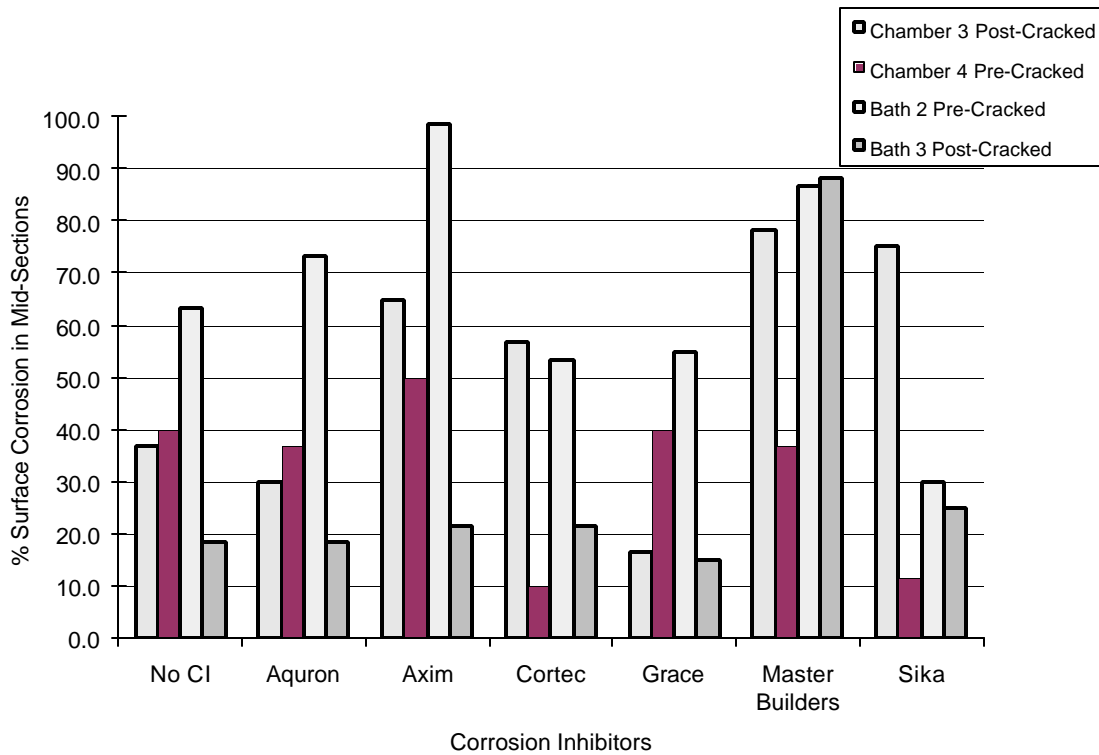

Figure 4.26 - % Surface Corrosion at Midsection for 3.0% Chloride (Set #2)

Figures 4.21, 4.22, and 4.23 are all of the first set of specimens removed from the chamber and baths at three and six months, respectively, as discussed earlier. The following figures, 4.24, 4.25, and 4.26, are graphs of the second set of specimens removed from the chamber and baths at six months and one year, respectively.

From these graphs, several trends can be observed. One trend that is quite clear is that at 0.0% initial chloride content, there is a very distinct difference in the performance of the corrosion inhibitors. Also, at this level of chloride contamination, it can be said that almost all corrosion inhibitor products perform better than the control specimens. As the level of chloride contamination is increased to 1.5%, there is an increase in the percentage of surface rust, as would be expected. At this level, however, there is less of a difference between the performance of the specimens with and without corrosion inhibitor products. However, several products appear to continue working well even at this high level of chloride contamination. As the level of initial chloride contamination increases from 1.5% to 3.0%, it is observed that the surface rust percentage actually decreases in some cases. At first thought, this is a very peculiar phenomenon. This may be due to the solution reaching an optimum chloride contamination level, beyond which there is little or no difference in the advance of the corrosion process. In some cases, the corrosion activity documented is less at higher levels of chloride contamination beyond the optimum chloride level (Smith et al. 1992). It is also clear that the performance of the corrosion inhibitors average out and appear to be close to the same level or below the performance of the specimens with no corrosion inhibitor applied. There are a few exceptions as would be expected. Based on these graphs, it can be determined that at this level of initial chloride contamination (3.0%), no corrosion inhibitor products are effective. The surface corrosion graphs for the mid-sections can be found in Appendix E.

Another useful comparison for the visual evaluations is the performance of the same products at the same level of chloride contamination over the course of the accelerated testing program. Because of the timed removal of specimens at four different stages in the corrosion program, it is possible to compare these different stages to see how the products performed over time. Figure 4.27 shows the mid-section surface rust evaluations over the four stages of accelerated testing for the 0.0% specimens.

This graph represents corrosion at different stages of exposure for each specimen. It is believed that the wet/dry cycles in the baths provided a much more aggressive environment than the periodic salt water spray in the chamber, and therefore, the specimens that were removed from the chamber after six months did not show as much corrosion as those in the baths. These graphs provide the important data over time of continued exposure for each corrosion inhibitor. It can be observed that most specimens at the 0.0% initial chloride contamination level do exhibit an increase in the percent surface rust over the time of exposure, as was expected. As with all data in this project, there are exceptions. These may be attributed to natural variations due to sample size. If the sample size was large enough, it is expected that average surface corrosion would exhibit an increase over time for most all specimens. At the earliest stage of exposure, all of the specimens with corrosion inhibitors perform better than the control specimen for

the 0.0% specimens for both pre-cracked and post-cracked specimens. This is also true at the second stage (removal from chamber at six months) for the 0.0% specimens. At the third stage, there only two outliers to this trend. Finally, at the fourth stage (removal from the bath after 12 months), all specimens with corrosion inhibitors display less surface rust than their control counterparts at 0.0% initial chloride contamination.

These same observations also hold true at the 0.5% initial chloride contamination level. However, at the 1.0% initial chloride level and above, the difference between the performance of the corrosion inhibitors and no corrosion inhibitor specimens greatly decreases. Therefore, it can be concluded from this data that the effectiveness of the corrosion inhibitors decreases after the initial chloride contamination level of 0.5%, regardless of the time of environmental exposure.

The second method of visual evaluation involved estimating a percent rib loss in the mid-section for each specimen. This was carried out after the surface rust evaluations and a light cleaning with a non-wire bristle brush had taken place. The following figures 4.28, 4.29, and 4.30 show a sampling of the rib loss graphs for the first set of specimens removed from their environments.

Figures 4.31, 4.32, and 4.33 show the percent rib loss for a sampling of the second set of specimens removed from their testing environments.

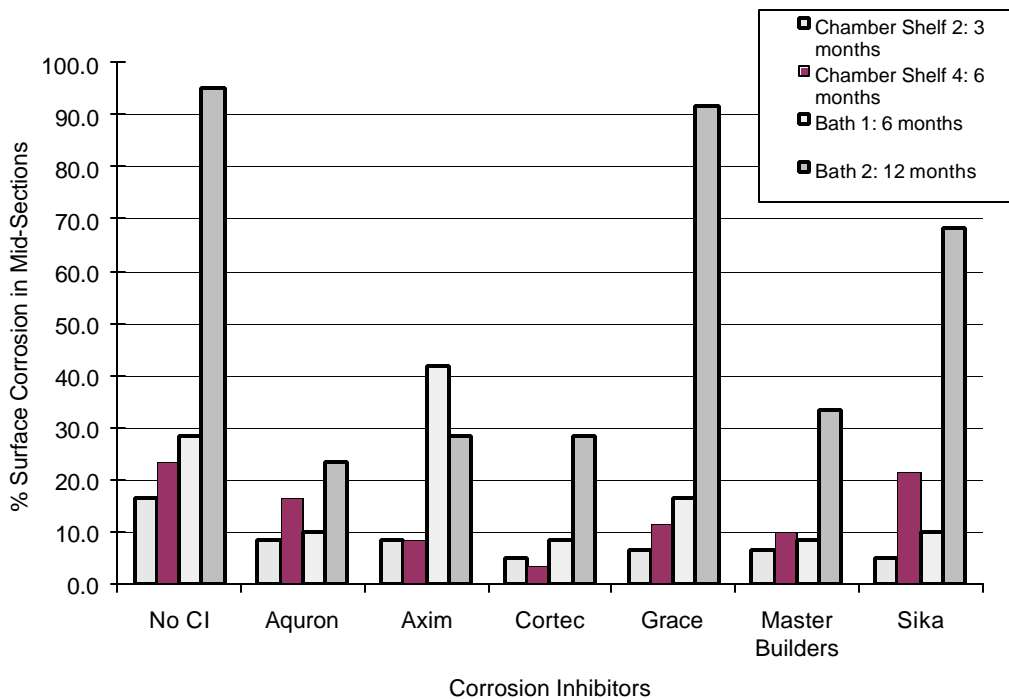

Figure 4.27 – Time Step of Surface Corrosion for 0.0% Chloride, Pre-Cracked Specimens

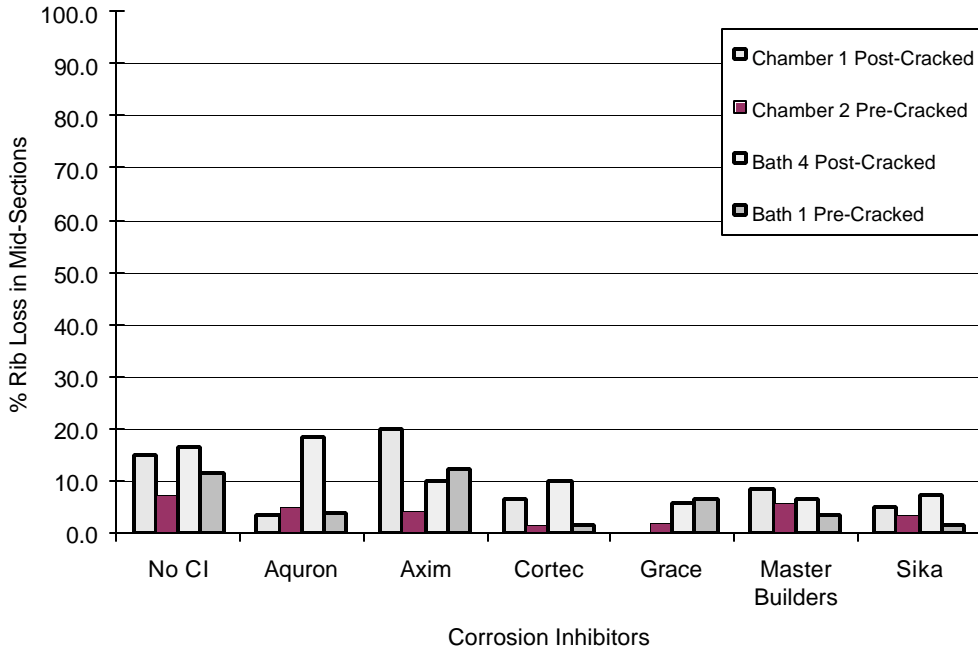

Figure 4.28 - % Rib Loss in Midsections for 0.0% Chloride (Set #1)

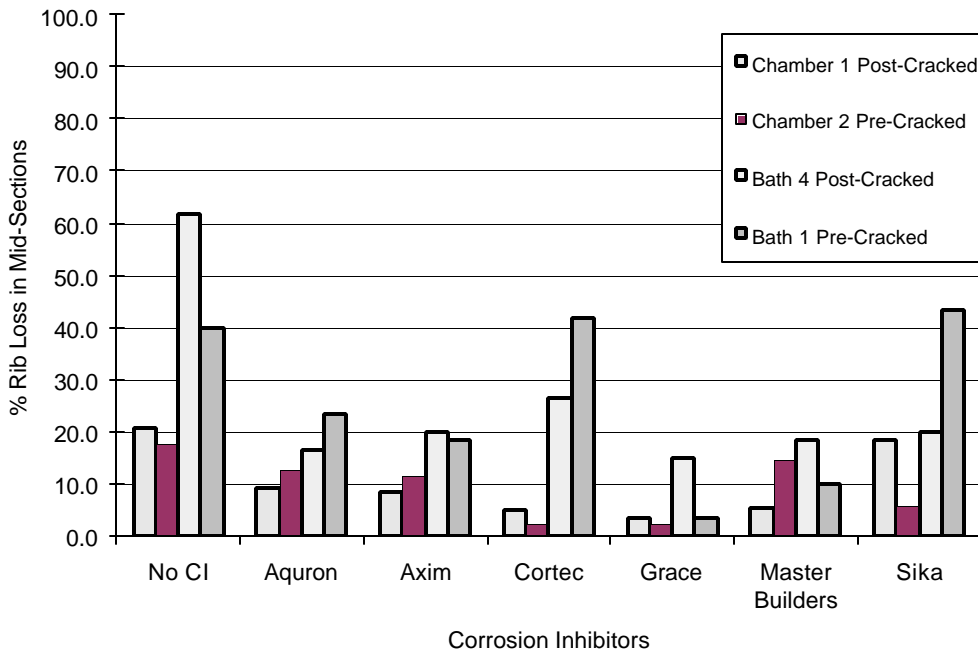

Figure 4.29 - % Rib Loss in Midsections for 1.5% Chloride (Set #1)

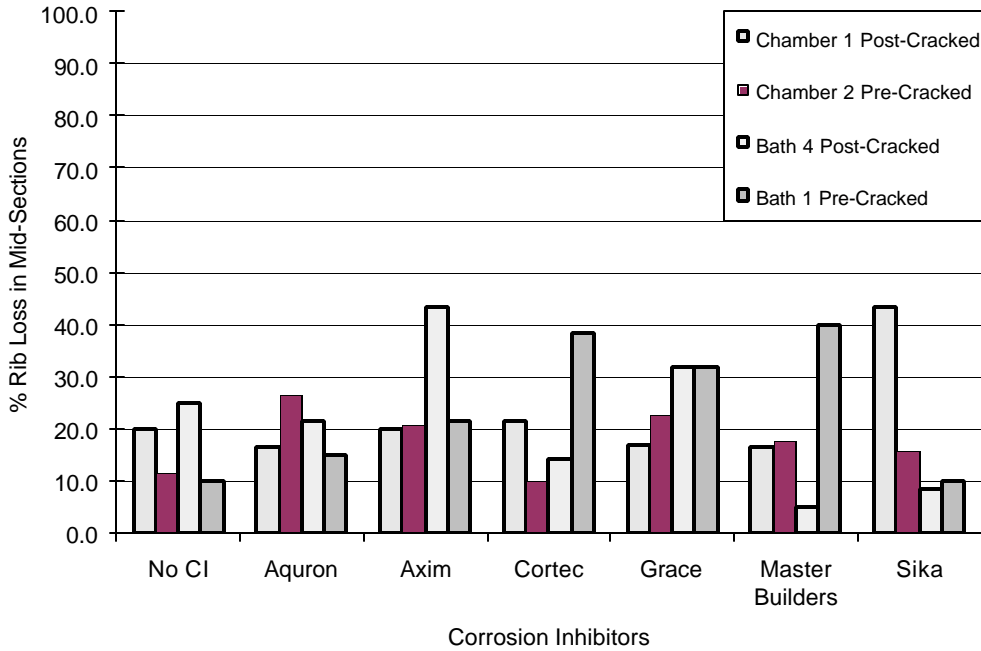

Figure 4.30 - % Rib Loss in Midsections for 3.0% Chloride (Set #1)

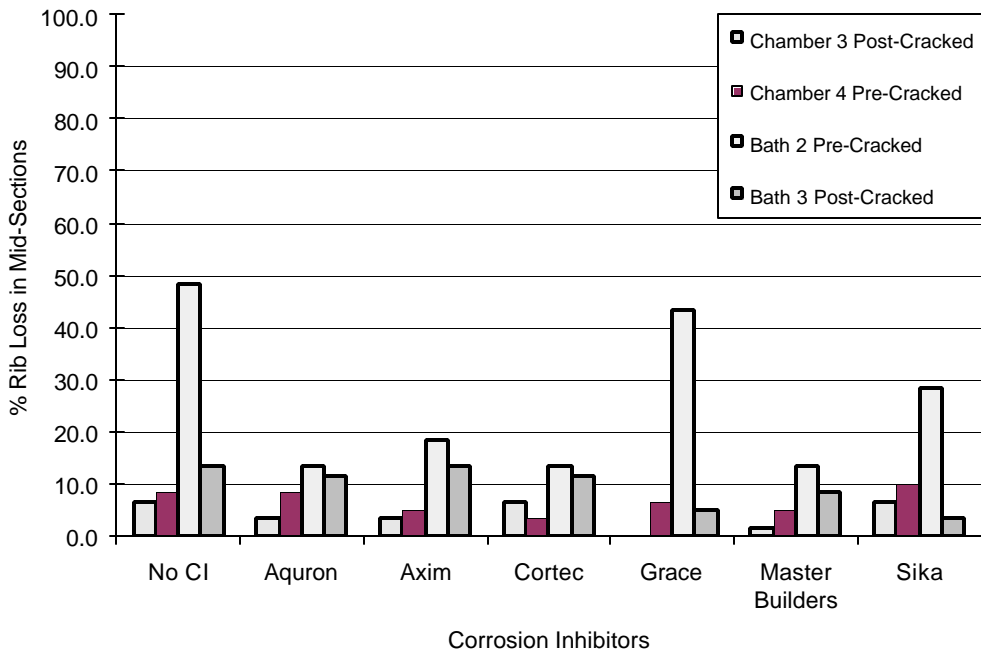

Figure 4.31 - % Rib Loss in Midsections for 0.0% Chloride (Set #2)

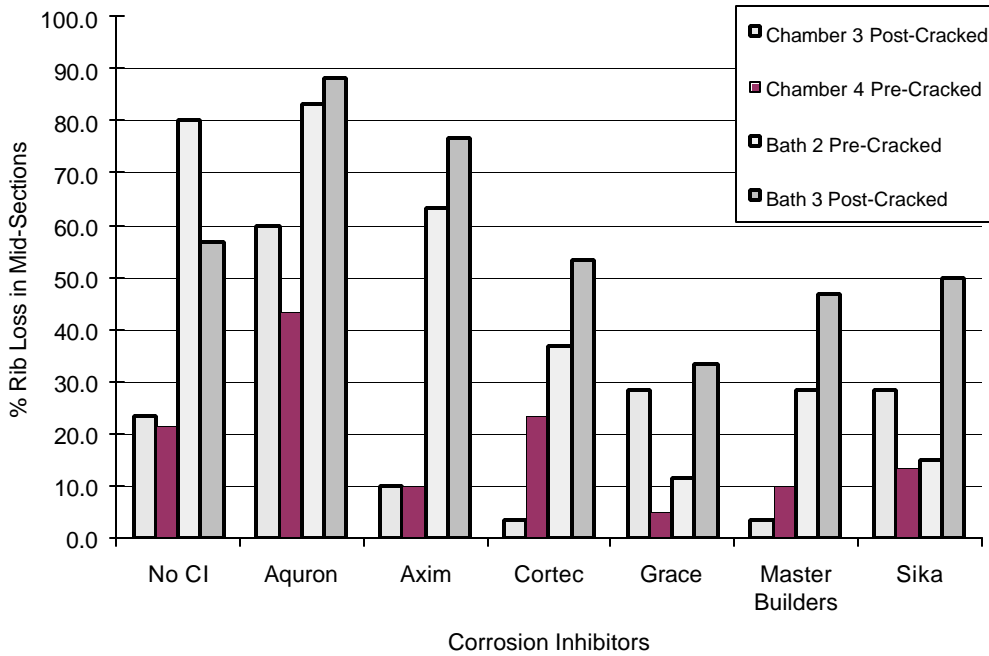

Figure 4.32 - % Rib Loss in Midsections for 1.5% Chloride (Set #2)

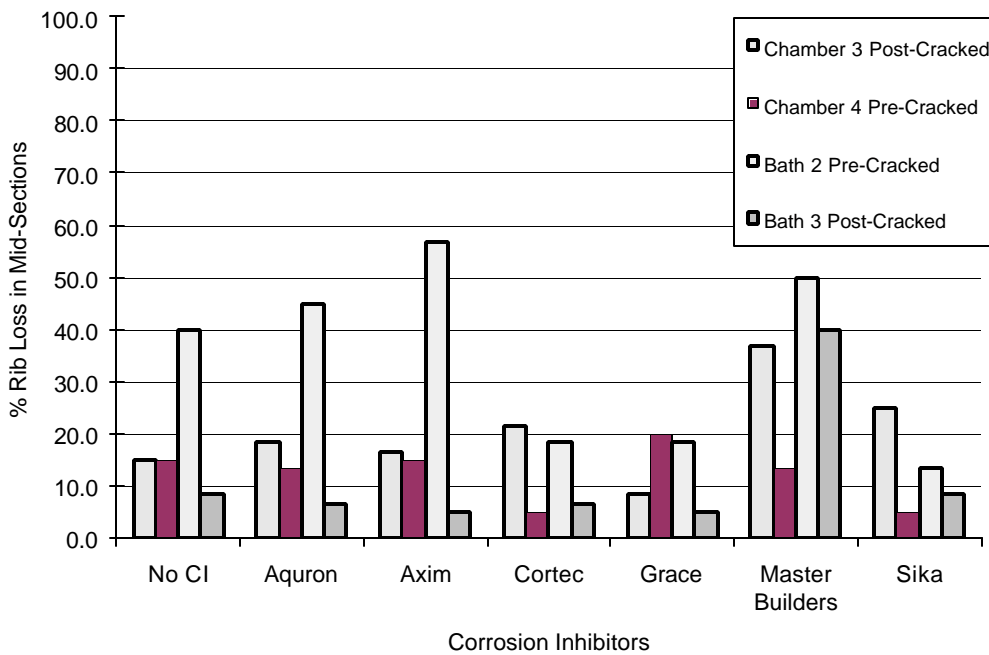

Figure 4.33 - % Rib Loss in Midsections for 3.0% Chloride (Set #2)

Although the numbers are lower, the rib loss graphs show the same trend as the surface rust graphs. These lower numbers were expected since it requires more corrosion activity to remove ribs than it does for the rust to appear only on the surface. Many of the same trends observed for the surface rust graphs are seen in the rib loss graphs. For instance, at 0.0% initial chloride, many of the specimens with the corrosion inhibitor products seem to exhibit less rib loss than the specimens without the corrosion inhibitors. Again, as this rises to 1.5%, the effectiveness of the corrosion inhibitor products diminishes. As the initial chloride level moves up to 3.0%, the rib loss again tends to decrease just as surface rust did at this point. These graphs also exhibit a similar averaging effect for the values of all specimens. Again, this peculiar phenomenon may be due to the realization of threshold chloride content level prior to the 3.0% level, as discussed previously. Once again it can be determined that at this level of initial chloride contamination, no corrosion inhibitor products are effective.

As with the surface rust assessment, it is useful to compare the mid-section rib loss graphs for the same specimens over time stepped intervals. Figure 4.34 shows the time step data for rib loss of the 0.0% specimens.

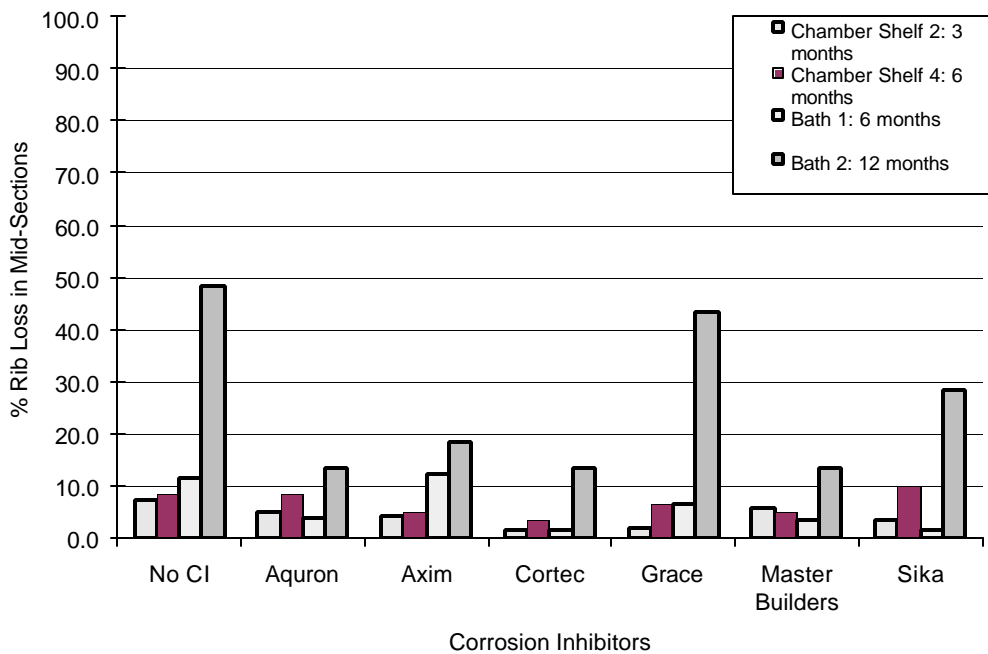

Figure 4.34 – Time Step of Rib Loss for 0.0% Chloride, Pre-Cracked Specimens

The time step rib loss graphs show similar trends to those of the time step surface corrosion graphs. Most specimens show an increase in rib loss as the time steps progress at the lower levels of initial chloride contamination. However, some differences do exist. Unlike the surface corrosion graphs, there are few products that exhibit an increase in rib

loss at the 0.0% and 0.5% chloride levels than do the specimens with no inhibitor products. Similar to the surface corrosion graphs, the rib loss time step data shows little effectiveness beyond 0.5% for the corrosion inhibitor products.

4.3.3 Mass Loss Measurements and Results

After visual evaluations were concluded for each of the specimens, chemical mass loss measurements were conducted. This method followed the standards set forth in ASTM G1-03, as described in detail in Section 3.7.2. The data from these tests were recorded in a spreadsheet, and graphs were developed for each specimen based on the overall mass loss per length after the chemical cleanings. These were compared to the overall mass loss per length for the control specimens to determine the significance of the amount of metal lost. Figures 4.35, 4.36, and 4.37 show a sampling of the mass loss data for the control, bath, and chamber specimens.

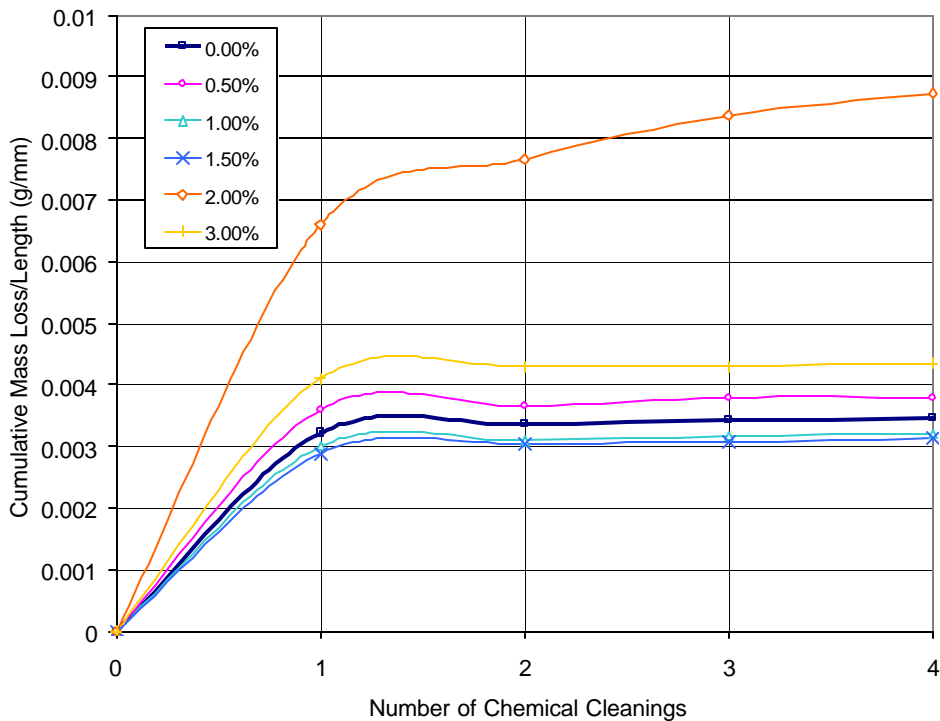

Figure 4.35 – Cumulative Mass Loss/Length for Control Specimens

For the control specimens, the cumulative mass losses per unit length were very little as would be expected. The 2.0% specimen was the only specimen that displayed comparable mass losses to the accelerated environmental testing. But even this specimen displayed low mass losses in comparison. As with all specimens in the chemical cleaning process, there is a very high difference after the first cleaning, beyond which the mass losses level out and little changes can be detected.

Figure 4.36 shows that the most mass losses occurred on the specimen with no corrosion inhibitor applied, with the other specimens displaying less mass losses. Therefore, it can be concluded that all corrosion inhibitors are preventing corrosion to some extent. This trend is true for almost every specimen at the 0.0% and 0.5% initial chloride contamination levels. As the initial chloride contamination level increases beyond 0.5%, this trend starts to dissipate, just as noted in visual evaluations. Between 1.0% and 1.5% initial chloride contamination, the corrosion inhibitor products still appear to be useful to some extent, but to a lesser degree. When the initial chloride contamination increases to 2.0% and 3.0%, the performance of the corrosion inhibitors are much more sporadic. However, at the 3.0% level some products still perform better than the no corrosion inhibitor specimens, but it is not consistent enough to draw any solid conclusions.

Figure 4.37 shows that the most mass losses occurred on the specimen with no corrosion inhibitor applied, with the other specimens displaying less mass losses. Also similar to the bath specimens, this trend is true for almost every specimen at the 0.0% and 0.5% initial chloride contamination levels. As the initial chloride contamination level increases beyond 0.5%, it is more difficult to determine which products, if any perform consistently well. At the 1.0% initial chloride contamination levels, several products perform sporadically better than the no corrosion inhibitor specimen. At both the 1.0% and 1.5% initial chloride contamination, the corrosion inhibitor products still appear to be useful to some extent, but to a lesser degree. At the 1.5% initial chloride level, there were no corrosion inhibitors that performed consistently well. When the initial chloride contamination increases to 2.0% and 3.0%, the performance of the corrosion inhibitors are increasingly arbitrary. All of the mass loss graphs can be found in Appendix F. Also, mass loss results are compared with other measures in Appendix G.

It is important to note that the chemical cleaning process to measure mass loss does not give a good indication of the damage incurred by pitting corrosion. The chemical cleaning is not able to fully remove pitting corrosion in some cases according to ASTM G1-03. In order for the effects of pitting corrosion to be determined, and to corroborate the visual analysis and mass loss conclusions, it was deemed necessary to conduct tension tests on all of the specimens.

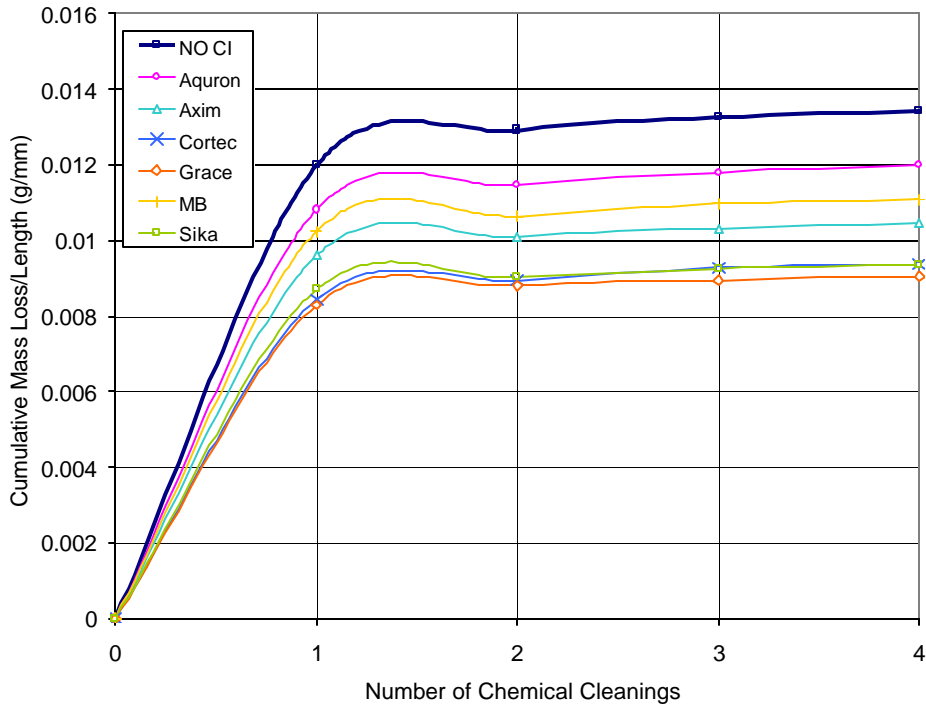

Figure 4.36 – Cumulative Mass Loss/Length for Bath 4, 0.0% Chloride, Post-Cracked Specimens

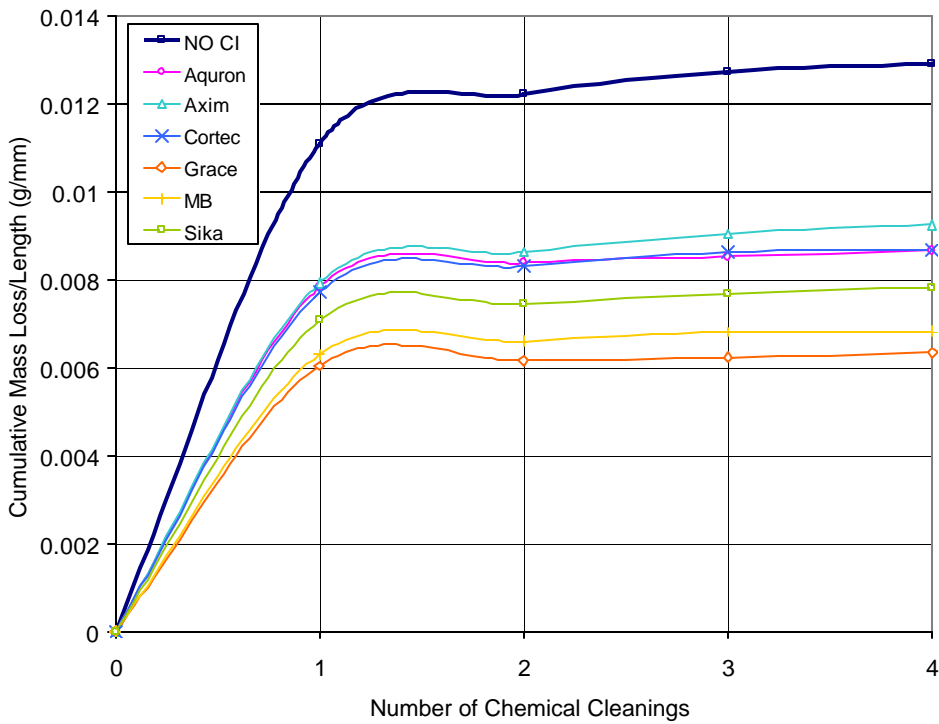

Figure 4.37 – Cumulative Mass Loss/Length for Chamber 0.0% Chloride, Shelf 3, Post-Cracked Specimens

4.3.4 Tension Tests and Results

The last set of data collected for this experiment was the tension tests. These tests were conducted in accordance with ASTM A370-03a. The purpose of these tests was to determine the extent of corrosion in general, and pitting corrosion in particular. The tension test procedure was discussed in detail in Section 3.7.3. The data from the tension tests were collected and entered into a spreadsheet so that graphs could be developed for comparison purposes. A typical load deflection curve of the tension test data is shown in Figure 4.38. The most significant value on the graph is the peak load, which was used to compare the loss of cross section in various rebars. From these tension tests, a percent strength loss was calculated based upon the tension test data from a control bar. These graphs can be seen in Figures 4.39 and 4.40.

It should be stated that “strength loss” in this section actually refers to a reduction in peak load of the rebar caused by metal loss due to corrosion effects, not a strength loss based on material properties. The term “strength loss” is used in this section to differentiate between the tension tests and the chemical mass loss tests. Figure 4.39 shows that the specimen with no corrosion inhibitor product demonstrates the highest strength loss. This indicates that the specimens with corrosion inhibitors were more effective in preventing corrosion. However, this trend is not observed for many of the bath specimens. Despite this anomaly, several products do consistently show better results than that of the specimen with no corrosion inhibitor. There is however no apparent pattern to the usefulness of the products for the bath specimens.

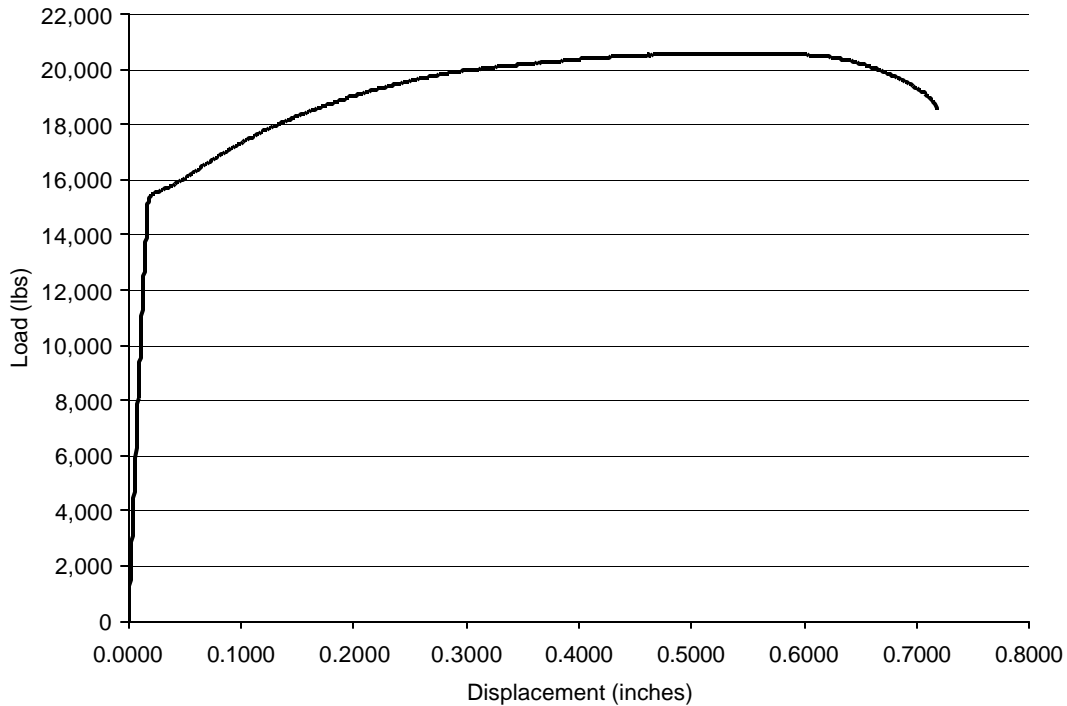

Figure 4.38 – Typical Load Deflection Curve for Bath 4, 0.0% Chloride, NO CI Specimen, Post-Cracked

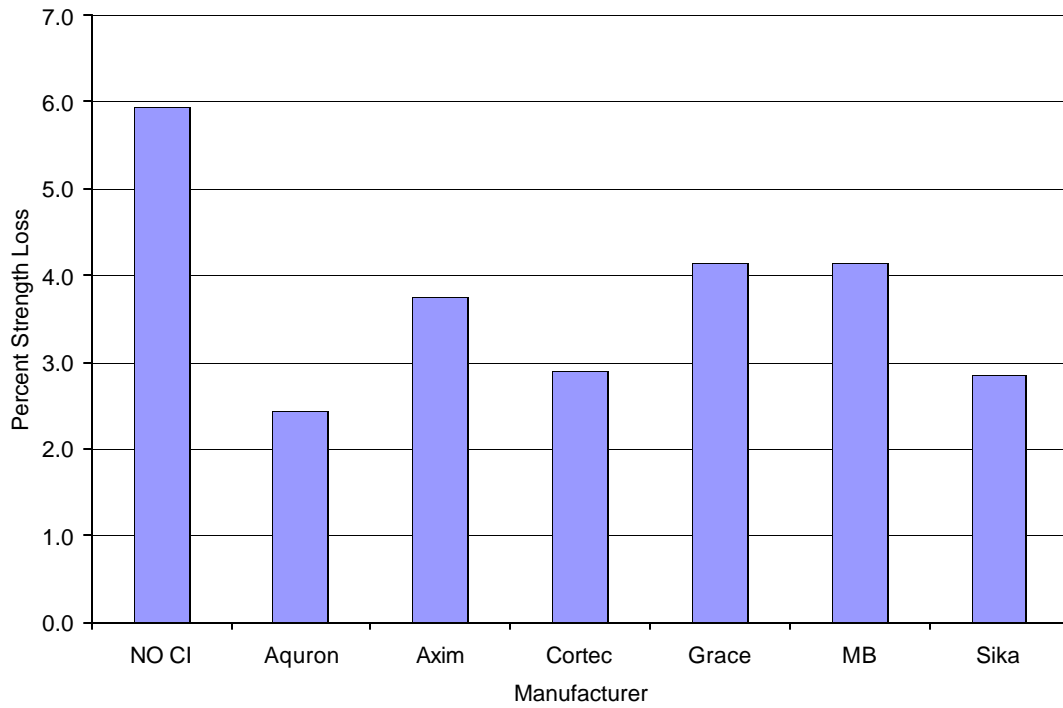

Figure 4.39 – Percent Strength Loss Based on Tension Tests for Bath 3, 0.0% Chloride, Post-Cracked

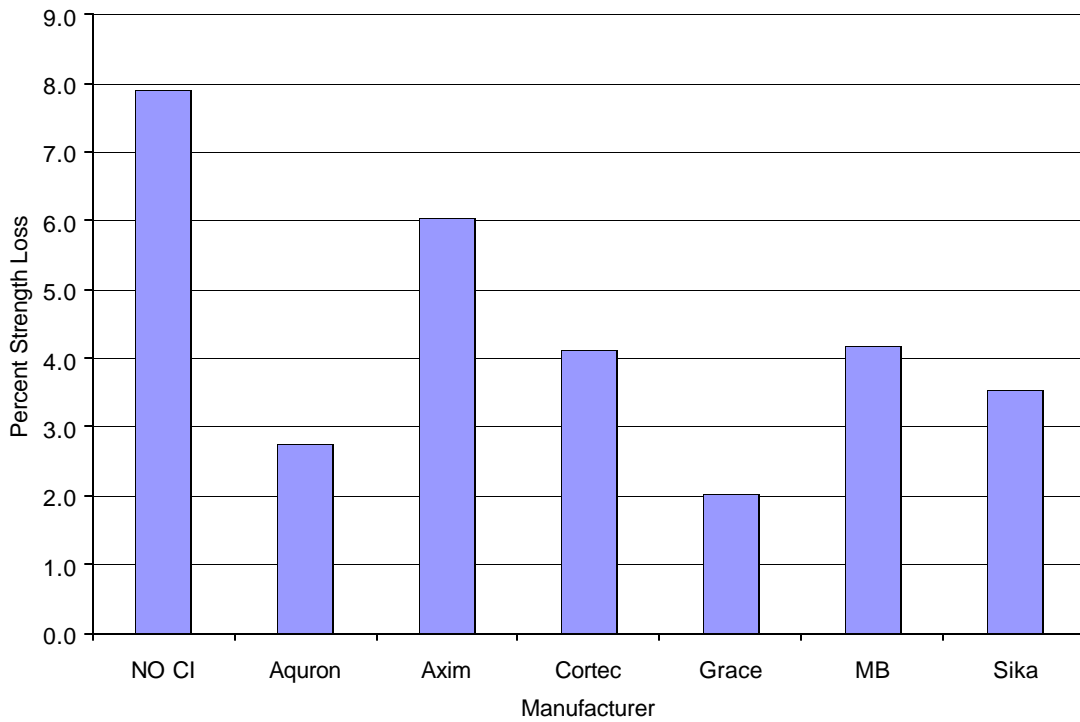

Figure 4.40 – Percent Strength Loss Based on Tension Tests for Chamber 0.5% Chloride, Shelf 4, Pre-Cracked

Figure 4.40 shows the percent strength loss for a set of chamber specimens. The no corrosion inhibitor specimen displays higher percent strength loss than other specimens in this figure. As with the bath specimens this trend does not hold true for most data sets. The specimens at 0.0% and 0.5% initial chloride contamination have a higher occurrence of this trend, as expected. Some products still appear to be effective at levels above 0.5% initial chloride content. Additional tension test results are shown in Appendix G.

4.4 Cross Comparison for Post-Exposure Data

The most useful data collected for this project was done after the accelerated environmental testing was concluded. These analysis tools included the visual ratings (both surface corrosion and rib loss), chemical mass loss measurements, and tension testing. By conducting all four analyses and comparing the results, it was possible to verify the performance of the corrosion inhibitors. This was a necessary and very useful step in this research project since the data collected during the accelerated environmental exposure could only confirm if the bars were corroding but not to what extent with any degree of accuracy. Figures 4.41 through 4.44 show a comparison of the visual rating graphs with the mass loss/strength loss graphs for one set of specimens from both the bath and chamber environments.

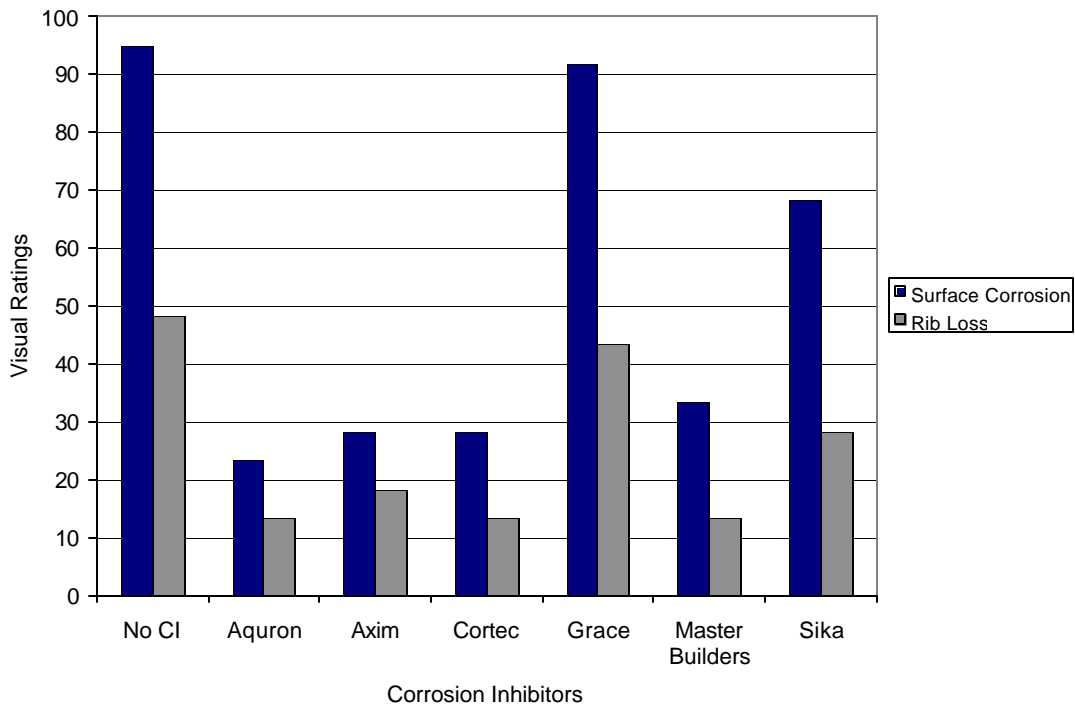

Figure 4.41 – Visual Ratings for Bath 2, 0.0% Chloride, Pre-Cracked Specimens

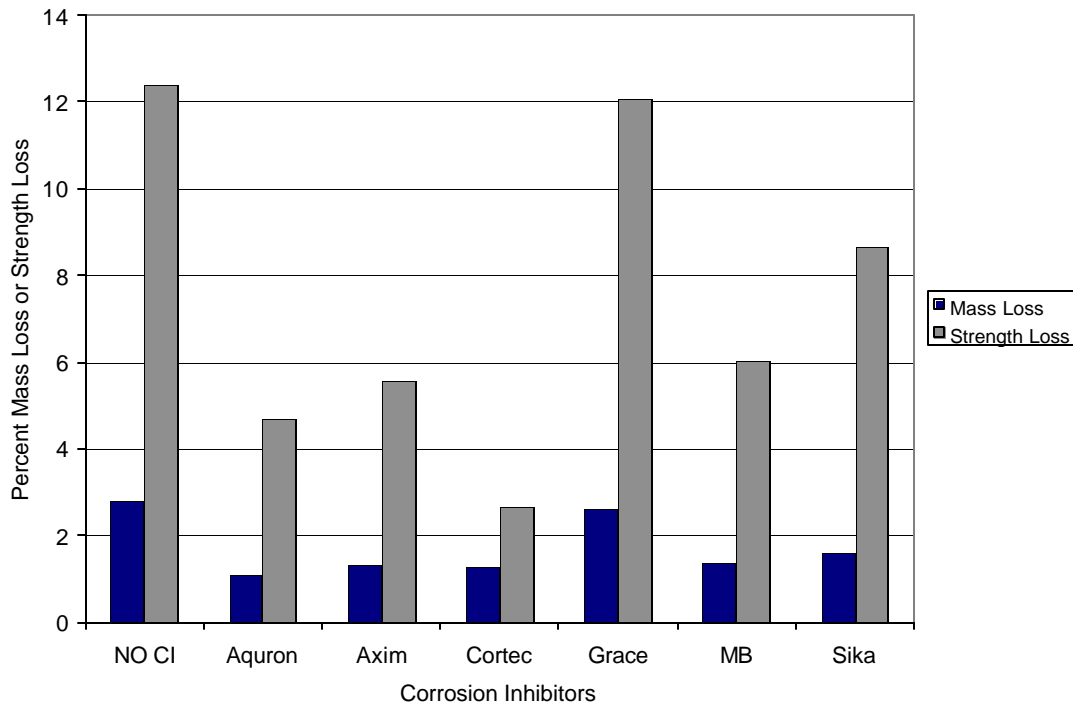

Figure 4.42 – Mass Loss and Strength Loss for Bath 2, 0.0% Chloride, Pre-Cracked Specimens

Although each graph is on a very different scale, it is evident that the same pattern of behavior exists for the corrosion inhibitors in both graphs. The specimen with no corrosion inhibitor performs worst in both visual rating analysis as well as mass loss/strength loss analysis. Most graphs for the bath data exhibit the same pattern of behavior for both visual ratings and mass loss/strength loss graphs when compared side by side. There are, of course, a few exceptions to this pattern. The next two figures show similar graphs for the chamber specimens.

The same pattern of behavior is exhibited by these two graphs as was for the bath specimens. The mass loss and strength loss data confirm the visual rating data. This is very significant because it verifies the methods of data collection and analysis that was used for this project. For both these graphs, the specimen with no corrosion inhibitor product exhibits the worst performance.

Some of the same results were found with these comparative data sets as the earlier analyses. As the initial chloride contamination level increased, the effectiveness of all corrosion inhibitor products decreased. Along with this, the difference between the performance of the specimens with no corrosion inhibitor products and those with the products also diminished. Although all products show improvement over the control specimens in the lower levels of chloride contamination and earlier stages of exposure, some products seem to show more consistent results than others. All comparisons between the visual ratings and the mass/strength loss can be found in Appendix G.

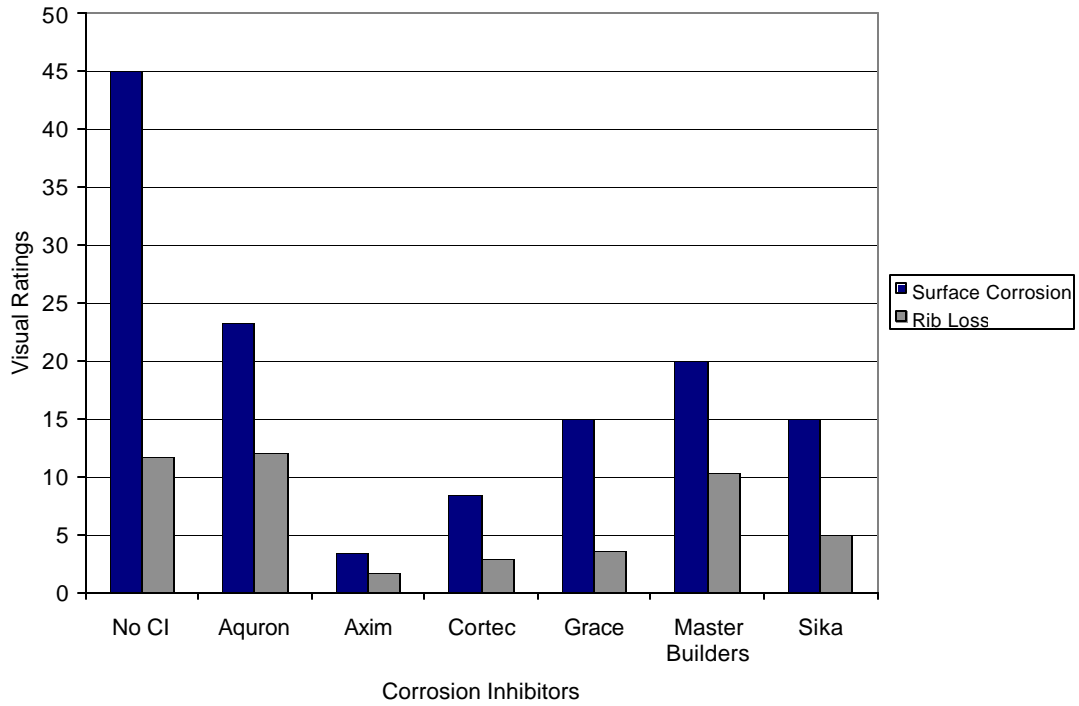

Figure 4.43 – Visual Ratings for Chamber 0.5% Chloride, Shelf 2, Pre-Cracked Specimens

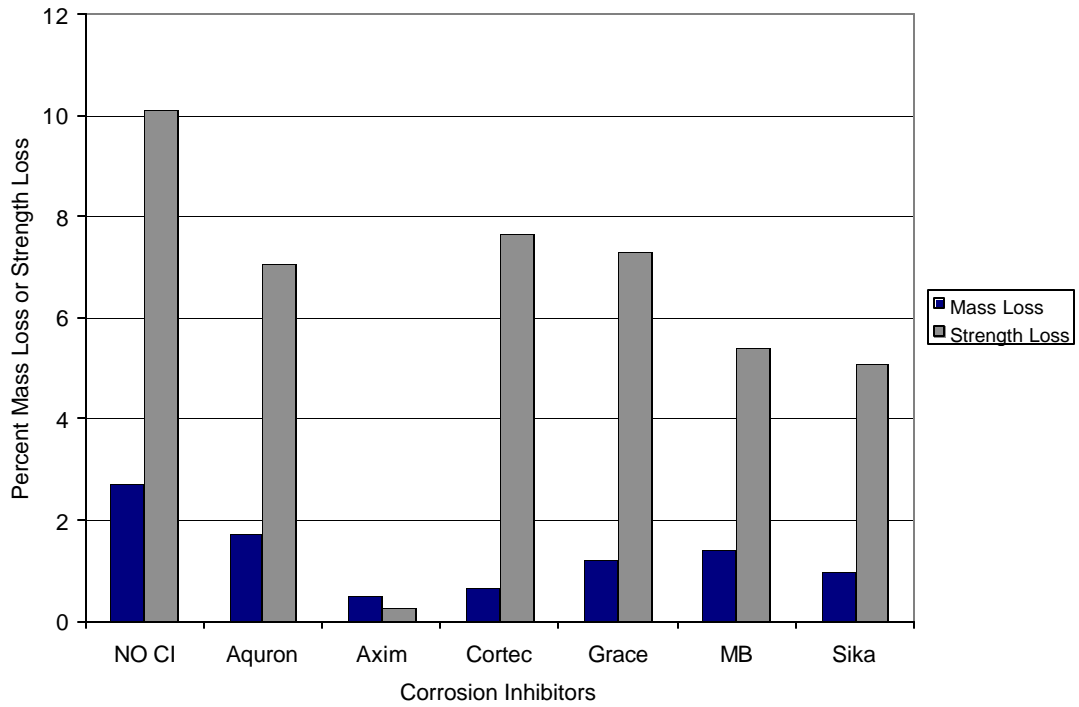

Figure 4.44 – Mass Loss and Strength Loss for Chamber 0.5% Chloride, Shelf 2, Pre-Cracked Specimens

CHAPTER 5. SUMMARY AND CONCLUSIONS

5.1 Summary

Corrosion of reinforced concrete structures is a serious problem facing most state DOTs today. Many methods of corrosion protection have been proven effective over the years, but can be costly and difficult to implement. If the manufacturers' claims were substantiated that surface applied corrosion inhibitors could delay, slow, stop, or reverse the corrosion process in existing reinforced concrete structures, there could be a cost effective and simple solution to the corrosion problem in the inventory of the state DOTs. This research project tested six commercially available surface applied corrosion inhibitor products under accelerated corrosion environments, simulating field conditions, to determine the extent of their effectiveness. Each manufacturer of the products tested was made aware of the test matrix and parameters prior to the test and was invited to participate in the product application process. The products tested were donated by their respective manufacturers, and each was applied exactly as specified by its respective manufacturer. Two sets of specimens, pre-cracked and post-cracked, were prepared, wherein controlled cracking was induced before or after the corrosion inhibitor products were applied, respectively. Specimens were prepared in duplicates to ensure repeatability of the test results. Two test environments were designed to accelerate corrosion using 15% salt-water solutions and a temperature of 130°F in either submersion wet/dry cycles or spray cycles. A number of specimens were left in the general lab environment as control specimens, and were kept at approximately 70°F temperature and 50% relative humidity. A number of measurements were made during and after the exposure, including corrosion current (voltmeter) readings, half cell potential readings, environmental condition readings, chloride content analysis, visual assessment of corrosion (surface rust and rib loss), mass loss, and strength reduction (tension).

5.2 Conclusions

Given the test matrix, test parameters, test environments, and measurement techniques used in this study; as described in this report, following findings were established in three different categories; test parameters, measurement techniques, and product effectiveness:

Test Parameters:

- The effects of pre-cracking and post-cracking in this study appeared to be negligible due to several issues; the small size of the cracks (two hairline cracks), the lack of sufficient concrete cover (1/2 in as opposed to 2 in), the severity of the corrosive environment, and the rapid onset of the corrosion process. Therefore, it could not be determined from this experiment whether cracked or un-cracked decks would be more suitable for the corrosion inhibitor application.
- A threshold chloride content appears to exist between 1.5% and 3.0% initial chloride contamination (by weight of cement), beyond which the addition of chloride does not increase the severity of corrosion. This was observed by the averaging effect displayed from the visual ratings.

Measurement Techniques:

- It appeared that neither the macrocell corrosion current nor the half cell potential data provided adequate distinction in determining the extent of corrosion in various test specimens, and therefore, could not be used to compare the effectiveness of the corrosion

- inhibitor products. The macrocell corrosion current data can be useful if a macrocell has developed between the reference bar and the test bar. Even then, the resolution of this method appeared to be too low to generate a good comparison between the various products. The half cell potential data may be useful in relaying the probability of corrosion, but not the extent of corrosion. Therefore, it could not provide with any degree of certainty a comparison of the corrosion inhibitor products. As a result, further steps were deemed necessary to evaluate the effectiveness of the corrosion inhibitor products.
- On the other hand, the combination of visual ratings (surface rust and rib loss), mass loss measurements and tension tests seemed to provide conclusive evidence as to the extent of corrosion in each test bar. Unlike mass loss measurements that do not indicate severity of the pitting corrosion, tension tests can provide a better assessment of the extent of corrosion within the test bar.
 - Visual ratings of the test bars further indicated that specimen preparations were effective in that end effects of the bars were found negligible. Therefore, only the mid-sections of the bars, which were fully embedded inside the concrete, were needed for further analysis.

Product Effectiveness:

- It was determined that overall; corrosion inhibitor products that were tested did initially help delay and slow the corrosion process. However, none of the products appeared to have totally stopped or reversed the corrosion process. Moreover, no product was found to purge the chloride from the specimens, based on the cube analysis data.
- All products tested seemed more effective at lower levels of chloride contamination. It is therefore safe to say that each product would be most effective as a preventive measure, if applied on a fully hardened new “virgin” concrete with initial chloride content below those specified by ACI to induce corrosion. In all cases, further exposure to the accelerated corrosion environment resulted in a more severe corrosion, although not at the same rate for all products.
- Each product tested was effective to a certain extent both in terms of exposure time and the initial chloride content. Some products performed better under the specific test conditions (i.e., spray and submersion) than did others. Therefore, further parameters should be considered when determining which product(s) should be implemented into the NCDOT’s rehabilitation program. These may include: cost of the product in a single application (including materials, labor, traffic control, and alternative traffic routing) and time to subsequent applications. An optimization of these parameters may indicate that the most cost effective product is not the most effective or vice versa. The benefit of the product applied should be weighed against the financial investment to apply and reapply the product, and an optimization of these parameters should be reached before choosing which product to apply.
- A threshold chloride content appears to exist at about 0.5% initial chloride contamination (by weight of cement), beyond which almost all corrosion inhibitor products become less effective. Table 5.1 shows the chloride content limits of the ACI 222 for new construction. NCDOT has established 2 lbs per cubic yard of concrete as the threshold for the rehabilitation of concrete decks. If more than 4 out of 10 deck samples taken diagonally across the deck exceed this threshold, then the bridge deck is replaced. Assuming a normal weight concrete with a unit weight of 145 lbs/yd³, this threshold corresponds to 0.050% by weight of concrete, or 0.5% by weight of cement, which is the same as the threshold established in the present study. However, depending on the preventive routines adopted by the Bridge Maintenance Division, it may be possible to

choose one of the tested products to delay replacement of a concrete deck with higher chloride contamination, as long as proper monitoring and inspection are adhered to.

Table 5.1 – Comparison of Chloride Content Thresholds

	Description	By Cement Weight	By Concrete Weight	Lbs/Yd ³ of Concrete*
ACI 222	Prestressed Concrete	0.08%	0.008%	0.3
	Reinforced Concrete in Wet Conditions	0.15%	0.015%	0.6
	Reinforced Concrete in Dry Conditions	0.20%	0.020%	0.8
NCDOT	Threshold for deck rehab, replace deck if 4/10 sample over threshold	0.50%	0.050%	2.0
This study	Threshold for CI effectiveness	0.50%	0.050%	2.0

* 2 lbs / (27 cf/cy * 145 lbs/cf)*100 = 0.050%

5.3 Suggestions for Further Research

Although this research effort provided several conclusions for the products tested and for the testing procedures and measurement techniques, there are a number of issues that may need further investigation:

- Determine the active ingredients and the composition of the products, and focus on the effectiveness of the components rather than the entire products. This may require chemical analysis of the corrosion inhibitor products to obtain their composition signature. The ultimate goal should be to develop guidelines, specifications, and acceptance test methods and criteria for the active ingredients.
- Investigate means to establish the effect of crack extent and severity on the effectiveness of surface applied corrosion inhibitors.
- Correlate the exposure time in the accelerated testing environments to the actual field condition and real time deterioration, primarily based on the rate of increase of chloride contamination. While a number of research projects have attempted to address this issue, it remains unclear as to how many years of real time exposure could be simulated by a limited number of accelerated corrosion testing in the laboratory. This issue could also affect the re-application regime of corrosion inhibitor products on concrete surface.
- Finally, it is recommended that DOTs begin using these products on a trial basis and take detailed accounts of their performance in order to determine the effectiveness in actual field conditions. It is suggested that candidates for these field trials be chosen based on chloride analysis testing and the likelihood of exposure to corrosive environments. Those structures with results from chloride analysis testing of 0.5% chloride contamination (by cement weight) or below would be considered good candidates for use of these products on a trial basis. The more severe the environment of the trial basis, the faster corrosion would occur and data could be collected.

CHAPTER 6. RECOMMENDATIONS AND TECHNOLOGY IMPLEMENTATIONS

Based on an extensive experimental investigation on six commercially available surface applied corrosion inhibitor products in two different accelerated corrosion environments simulating field conditions, it was determined that (a) these products did initially help delay and slow the corrosion process, (b) none of these products totally stopped or reversed the corrosion process, and none seemed to purge chloride content of concrete, (c) these products were more effective at lower levels of initial chloride contamination, and (d) the threshold chloride content for effectiveness of the products tested was in the range of about 0.5% by weight of cement or approximately 0.05% by weight of concrete, or 2 lbs/yd³ of concrete. On the other hand, depending on the preventive routines adopted by the Bridge Maintenance Division, it may be feasible to choose one of the tested products to delay replacement of a concrete deck with higher chloride contamination, as long as proper monitoring and inspection are adhered to.

With the completion of the project, the research team is willing to participate in any workshop within NCDOT to inform bridge maintenance engineers of the outcome of the study.

Also, based on the encouraging findings of the project, it is recommended that NCDOT begins using these products on a trial basis and take detailed accounts of their performance in order to determine the effectiveness in actual field conditions. It is suggested that candidates for these field trials be chosen based on chloride analysis testing and the likelihood of exposure to corrosive environments. Those structures with results from chloride analysis testing of 0.05% chloride contamination (by weight of concrete) or below would be considered good candidates for use of these products on a trial basis. Such effort will answer the real time that it would take for each product to lose its effectiveness, requiring re-application.

REFERENCES

ACI 222R-96, “Corrosion of Metals in Concrete”, *ACI Manual of Concrete*, Farmington Hills, MI, American Concrete Institute, (CD-Rom) 2000.

ACI 318-02, “Building Code Requirements for Structural Concrete”, *ACI Manual of Concrete*, Farmington Hills, MI, American Concrete Institute, 2002.

ASTM A370-03a, “Standard Test Methods and Definitions for Mechanical Testing of Steel Products”, West Conshohocken, PA, American Society for Testing and Materials, 2003.

ASTM C-876 – 91 (R99), “Standard Test Method for Half-Cell Potentials for Uncoated Reinforcing Steel in Concrete”, West Conshohocken, PA, American Society for Testing and Materials, 1999.

ASTM C-1152 – 03, “Standard Test Method for Acid-Soluble Chloride in Mortar and Concrete”, West Conshohocken, PA, American Society for Testing and Materials, 2003.

ASTM G1-03, “Standard Practice for Preparing, Cleaning, and Evaluating Corrosion Test Specimens”, West Conshohocken, PA, American Society for Testing and Materials, 2003.

ASTM G102 - 89 (R99), “Standard Practice for Calculation of Corrosion Rates and Related Information from Electrochemical Measurements”, West Conshohocken, PA, American Society for Testing and Materials, 1999.

ASTM G109-99, “Standard Test Method for Determining the Effects of Chemical Admixtures on the Corrosion of Embedded Steel Reinforcement in Concrete Exposed to Chloride Environments”, West Conshohocken, PA, American Society for Testing and Materials, 1999.

Ansuini, F.J., Dimond, J.R., “Factors Affecting The Accuracy of Reference Electrodes”, *Corrosion/94*, Paper #323, Houston, TX, NACE, 1994.

Aquron, “Aquron 7000™ System”, Technical Sheet, Aquron Corporation, Rockwall, TX, 2002.

Axim, “Axim Post III: Post Treatment corrosion Inhibitor and Penetrating Sealing Compound for Concrete”, Axim Italcementi Group – Corrosion Inhibitor Products, Axim, Middlebranch, OH, 1999.

Bentur, A., Berke, N.S., Diamond, S., *Steel Corrosion in Concrete: Fundamentals and Civil Engineering Practice*, New York, NY, E & FN Spon, 1997.

Berke, N.S., El-Jazairi, B., “The use of Calcium Nitrite as a Corrosion Inhibiting Admixture to Steel Reinforcement in Concrete”, *Corrosion of Reinforcement in Concrete*, Third International Symposium on ‘Corrosion of Reinforcement in Concrete Construction’, New York, NY, Elsevier Science Publishing Co., Inc., 1990.

Breen, J.E., Vignos, R.P., West, J.S., “Evaluation of Corrosion Protection for Internal Prestressing Tendons in Precast Segmental Bridges”, *PCI Journal*, September-October 2002: 76-91.

Buittke, B., Landgren, J.R., McDonald, D., Pheifer, D.W., Smith, R.J., “Laboratory and Field Corrosion Test Methods for Highway Metals Exposed to Inhibited Rock Salt”, *Transportation Research Record No. 1347*, Transportation Research Board – National Research Council, Washington, D.C., National Academy Press, 1992.

ChemRex, “Sonocrete Corrosion Inhibitor: Surface Applied Migrating Corrosion Inhibitor”, Sonneborn Concrete Repair Systems, ChemRex, Shakopee, MN, 2002.

“Chloride Analysis on Bridge Concrete – (Potentiometric Titration Method)”, M&T Procedure C-4.0, Revised 06/1999 by G.D. Roberts, 1999.

Clemena, G.G., Virmani, P., “Corrosion Protection – Concrete Bridges”, Federal Highway Administration, US Department of Transportation, FHWA-RD-98-088, McLean, VA, 1998.

Cortec, “MCI: Migrating Corrosion Inhibitors for Concrete Structures”, Buyers Guide, Cortec Corporation, St. Paul, MN, 2001.

Grace, “Postrite: A Revolution in the Battle Against Corrosion”, Application Guide, W.R. Grace & Co.-Conn., Cambridge, MA, 1999.

Lankard, D.R., Thompson, N.G., Yunovich, M., “Procedures for Evaluating Corrosion-Inhibiting Admixtures for Structural Concrete”, NCHRP 10-45 2000, National Cooperative Highway Research Program, Transportation Research Board, Washington D.C., 2000.

Pullar-Strecker, Peter, “ICE Design and Practice Guides”, *Concrete Reinforcement Corrosion, from Assessment to Repair Decisions*, London, England, Thomas Telford Publishing, 2002.

Sika, “Sika FerroGard[®] 903: Penetrating Corrosion Inhibiting, Impregnation Coating for Hardened Concrete”, Product Information, Sika Corporation, Lyndhurst, NJ, 2001.

Weingroff, R.F., “FHWA By Day, A look at the History of the Federal Highway Administration” 1996.

APPENDIX A. CORROSION RATE GRAPHS

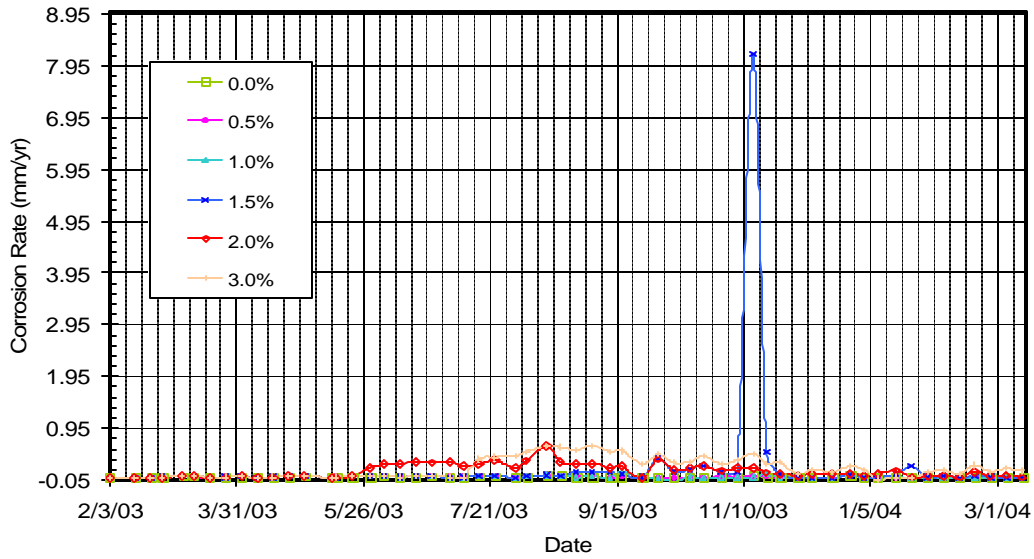

Figure A.1 – Corrosion Rate for Control Set #1

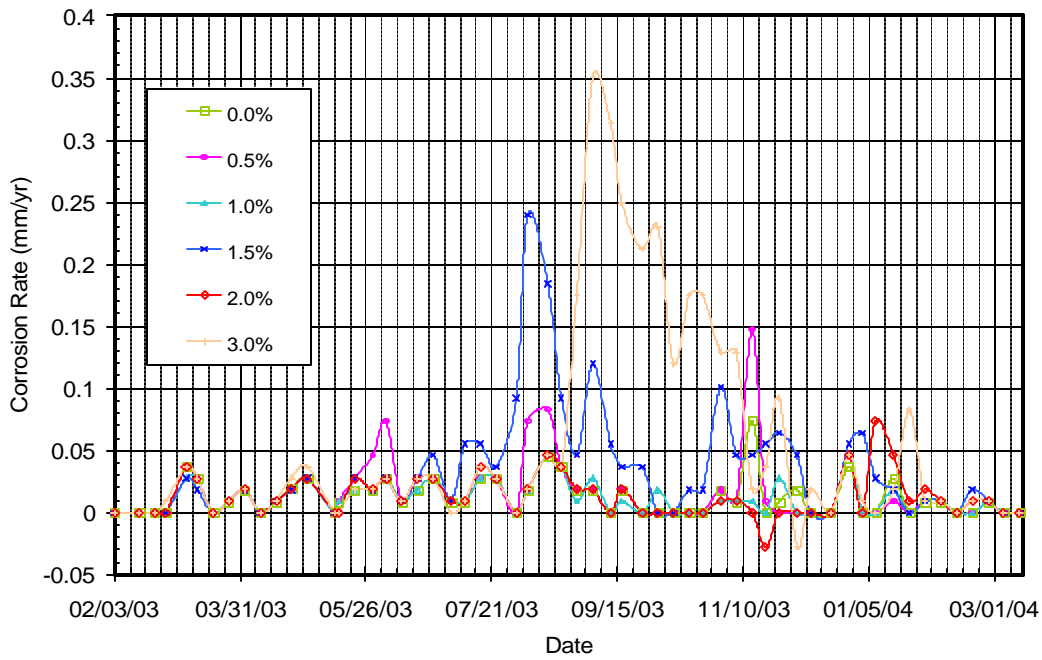

Figure A.2 – Corrosion Rate for Control Set #2

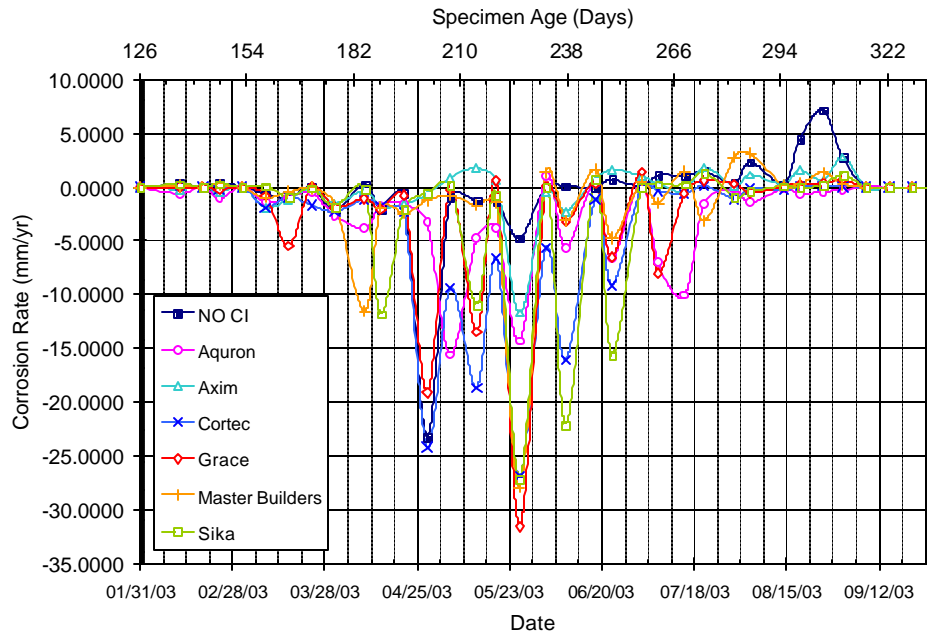

Figure A.3 – Corrosion Rate for Bath 1, 0.0% Chloride, Pre-Cracked

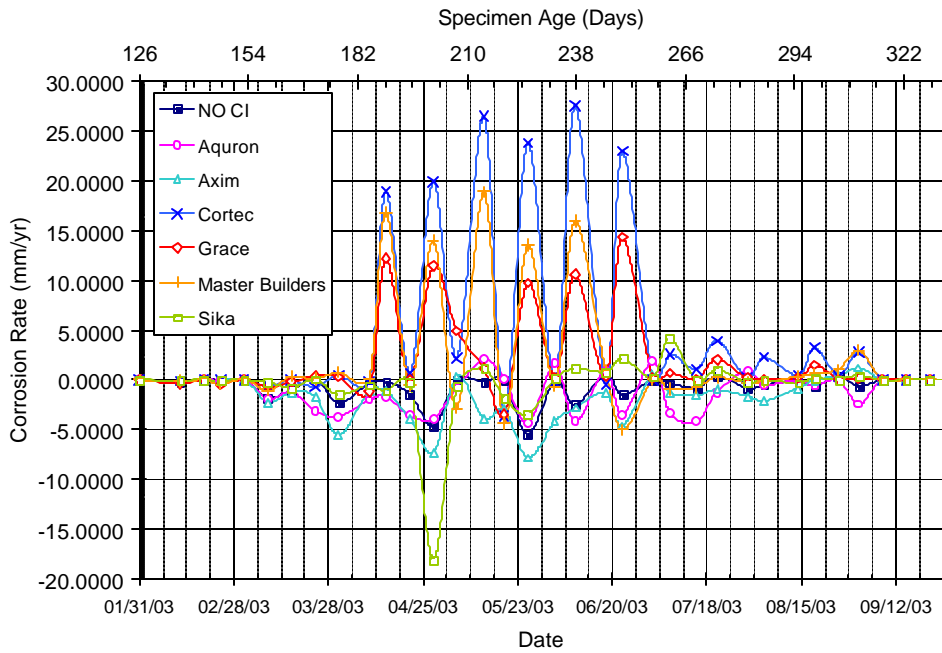

Figure A.4 – Corrosion Rate for Bath 1, 0.5% Chloride, Pre-Cracked

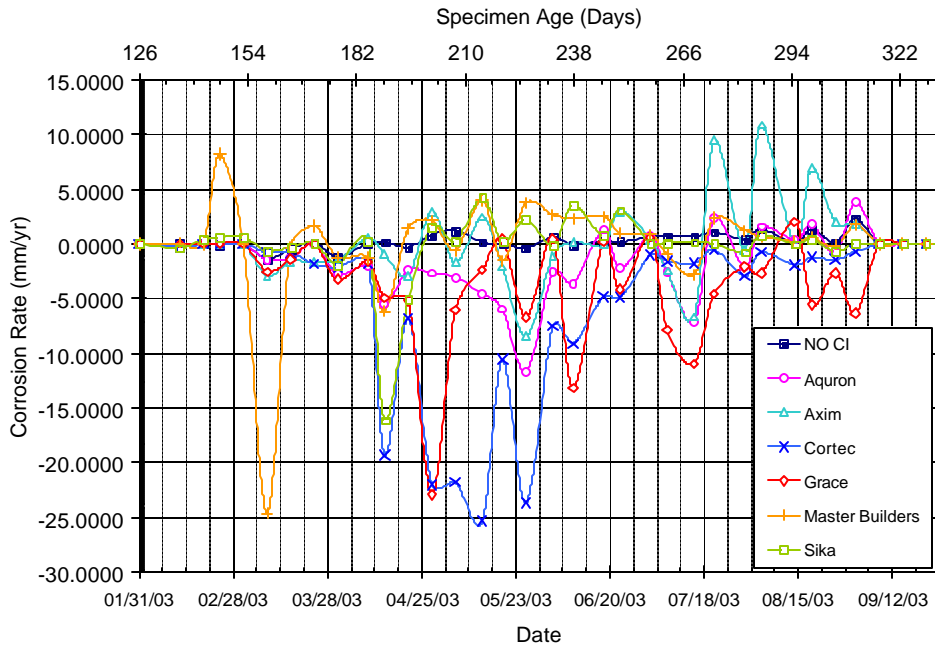

Figure A.5 – Corrosion Rate for Bath 1, 1.0% Chloride, Pre-Cracked

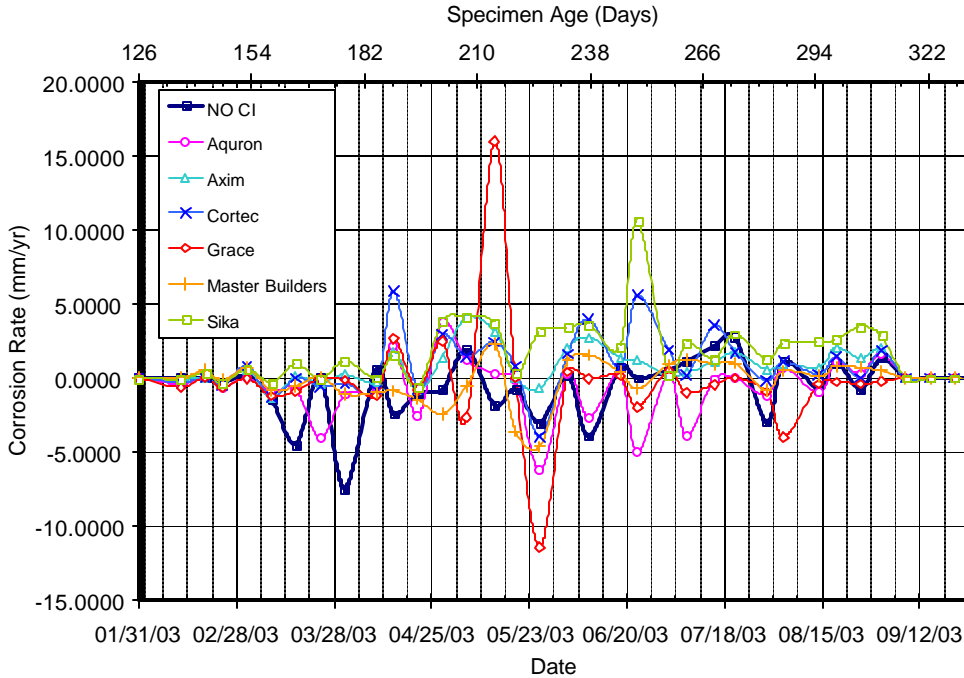

Figure A.6 – Corrosion Rate for Bath 1, 1.5% Chloride, Pre-Cracked

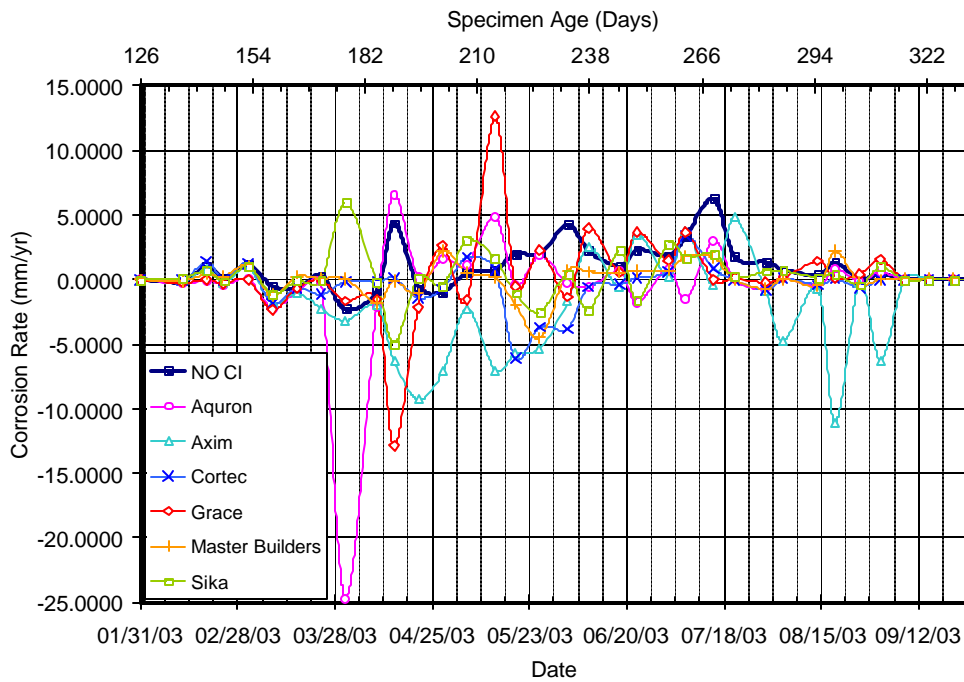

Figure A.7 – Corrosion Rate for Bath 1, 2.0% Chloride, Pre-Cracked

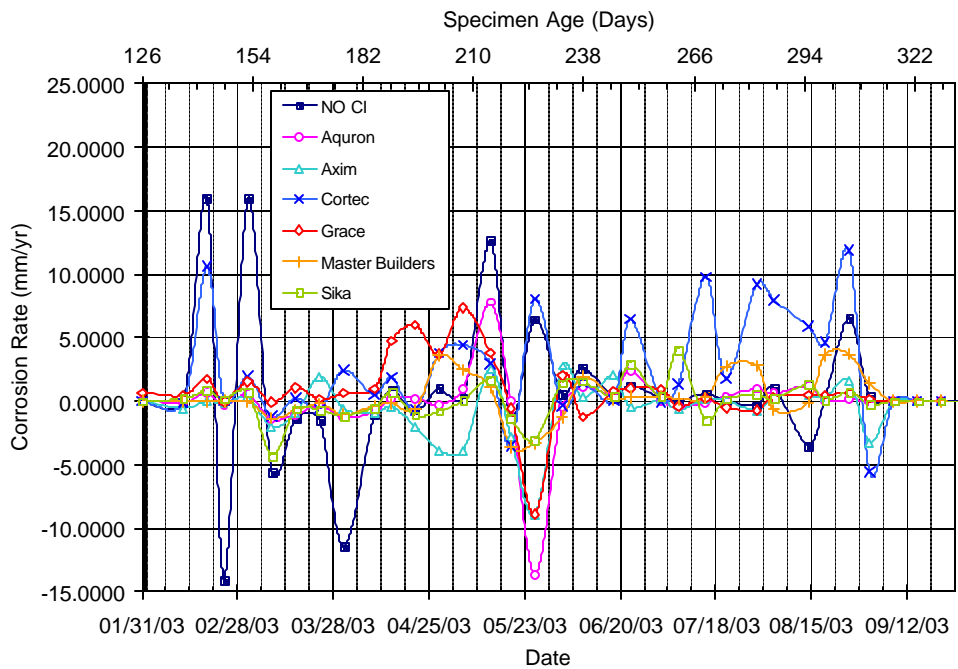

Figure A.8 – Corrosion Rate for Bath 1, 3.0% Chloride, Pre-Cracked

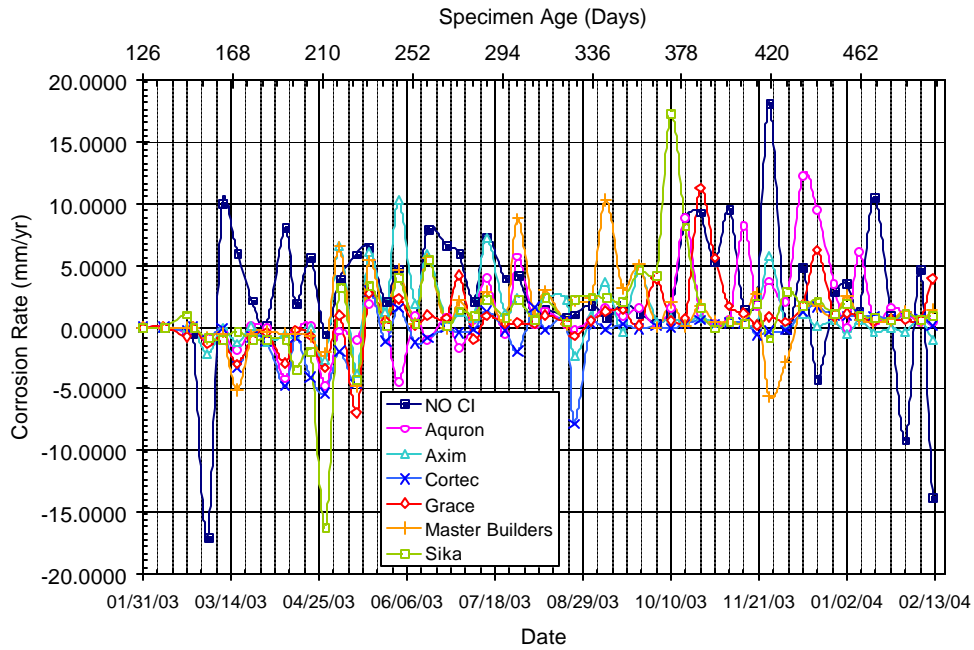

Figure A.9 – Corrosion Rate for Bath 2, 0.0% Chloride, Pre-Cracked

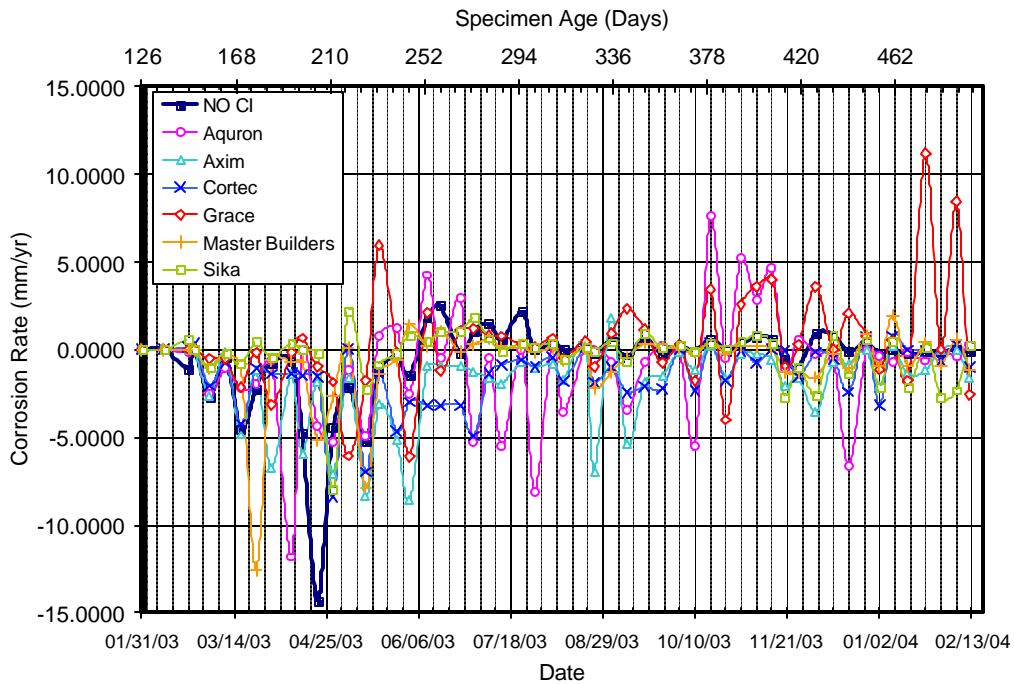

Figure A.10 – Corrosion Rate for Bath 2, 0.5% Chloride, Pre-Cracked

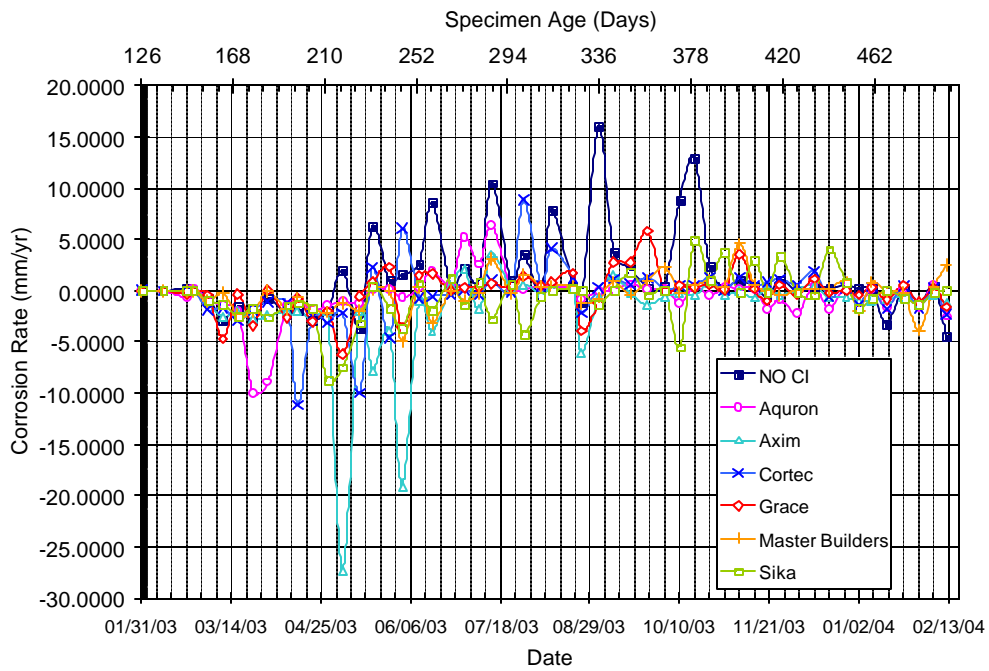

Figure A.11 – Corrosion Rate for Bath 2, 1.0% Chloride, Pre-Cracked

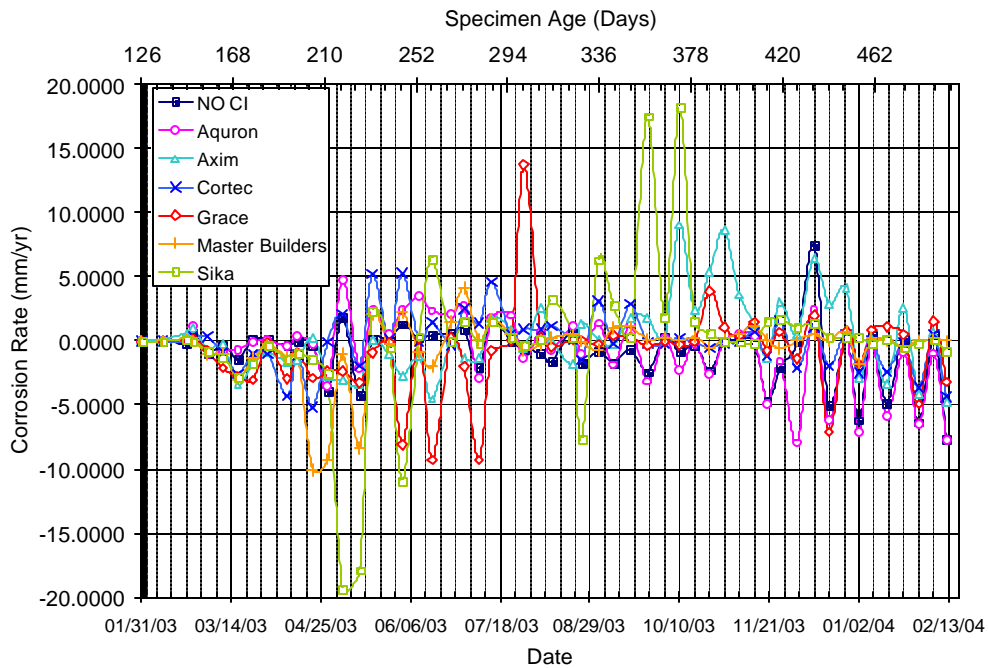

Figure A.12 – Corrosion Rate for Bath 2, 1.5% Chloride, Pre-Cracked

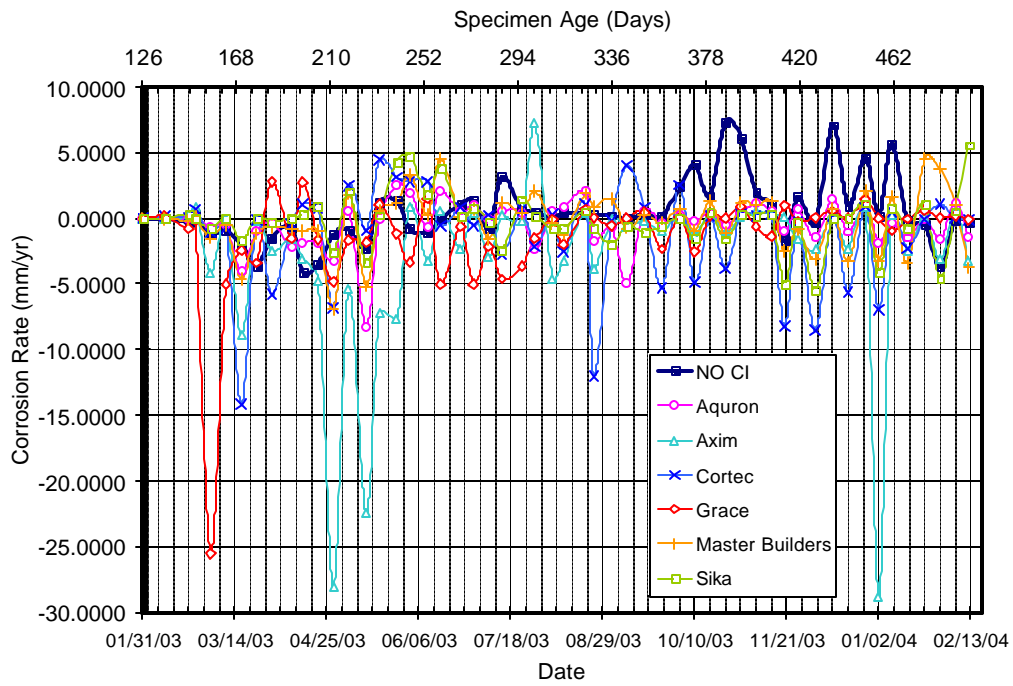

Figure A.13 – Corrosion Rate for Bath 2, 2.0% Chloride, Pre-Cracked

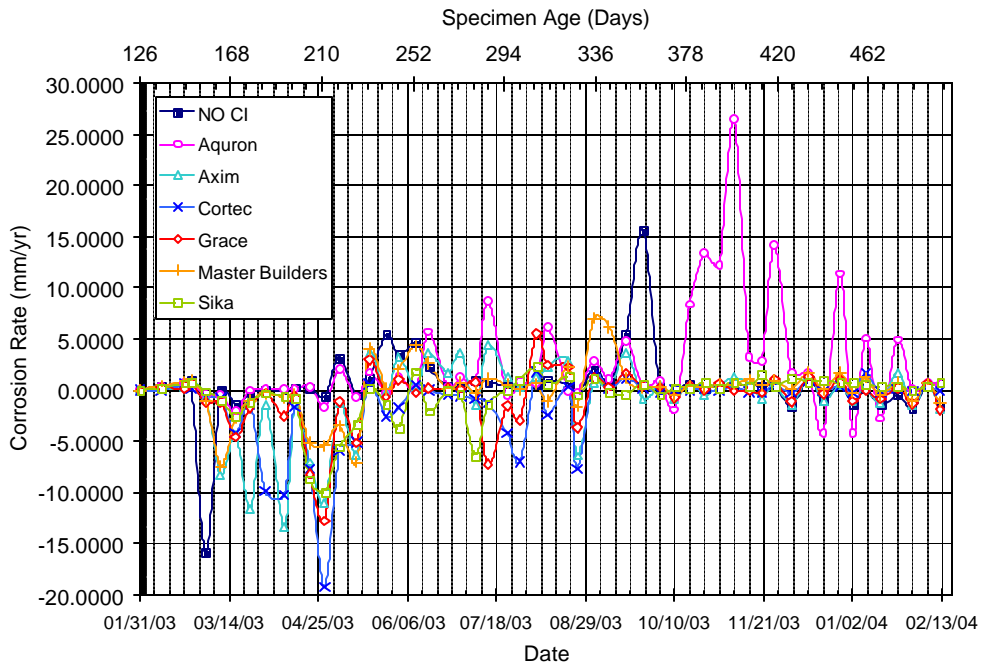

Figure A.14 – Corrosion Rate for Bath 2, 3.0% Chloride, Pre-Cracked

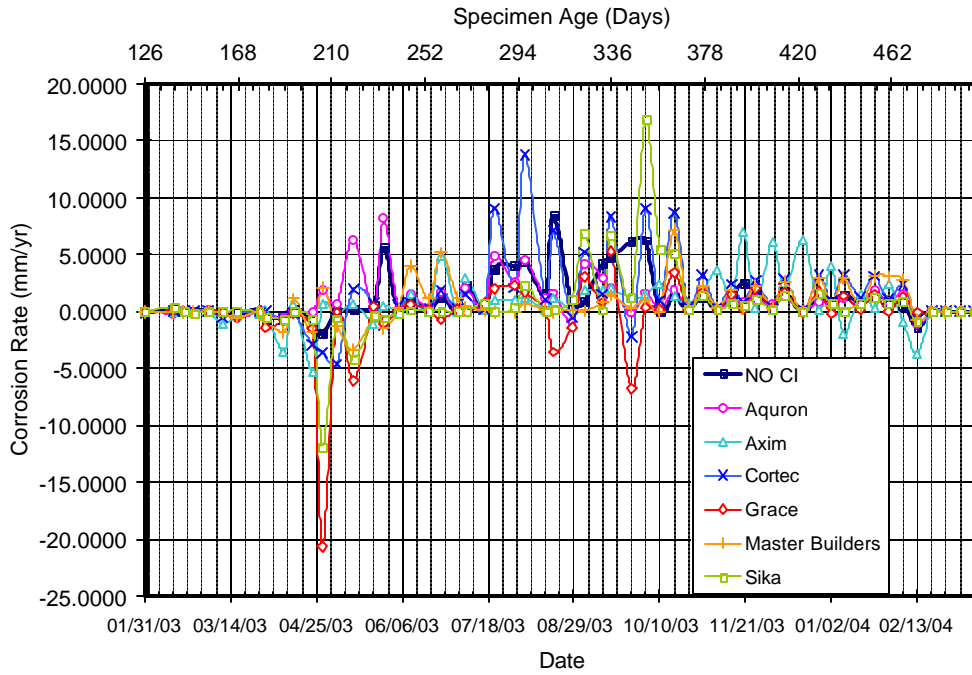

Figure A.15 – Corrosion Rate for Bath 3, 0.0% Chloride, Post-Cracked

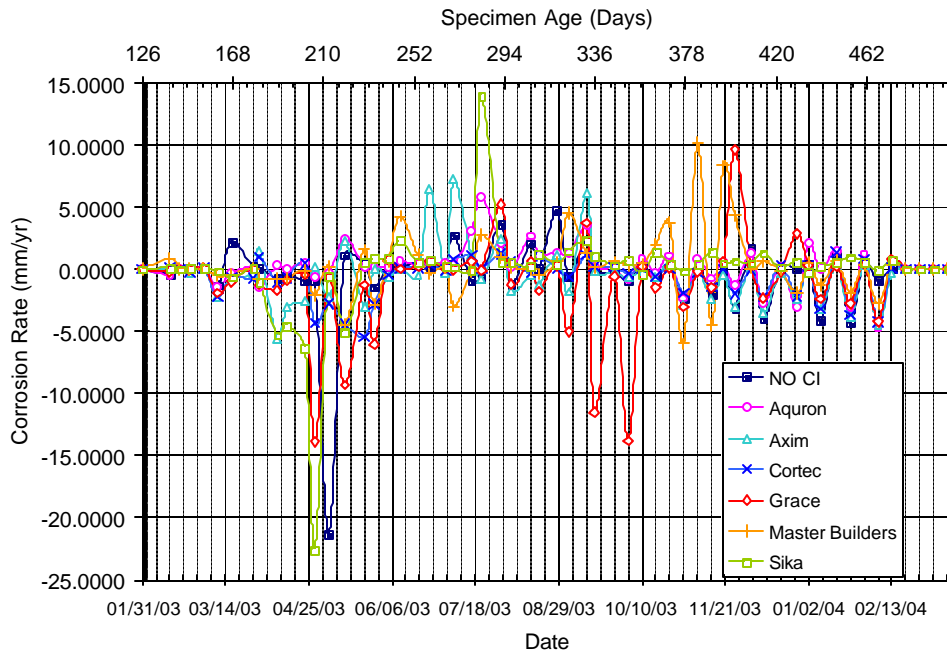

Figure A.16 – Corrosion Rate for Bath 3, 0.5% Chloride, Post-Cracked

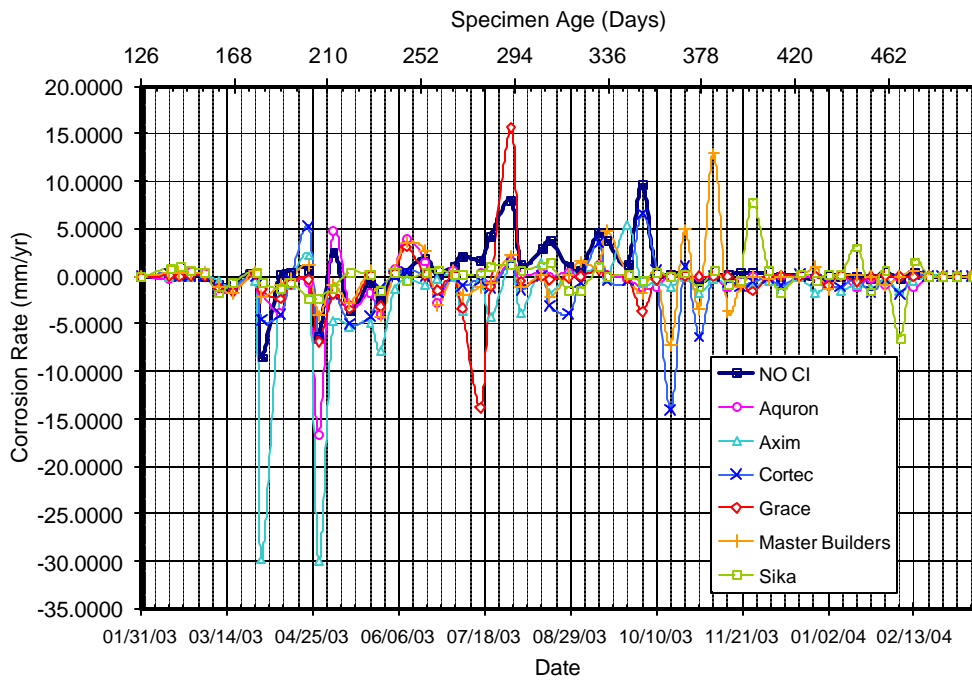

Figure A.17 – Corrosion Rate for Bath 3, 1.0% Chloride, Post-Cracked

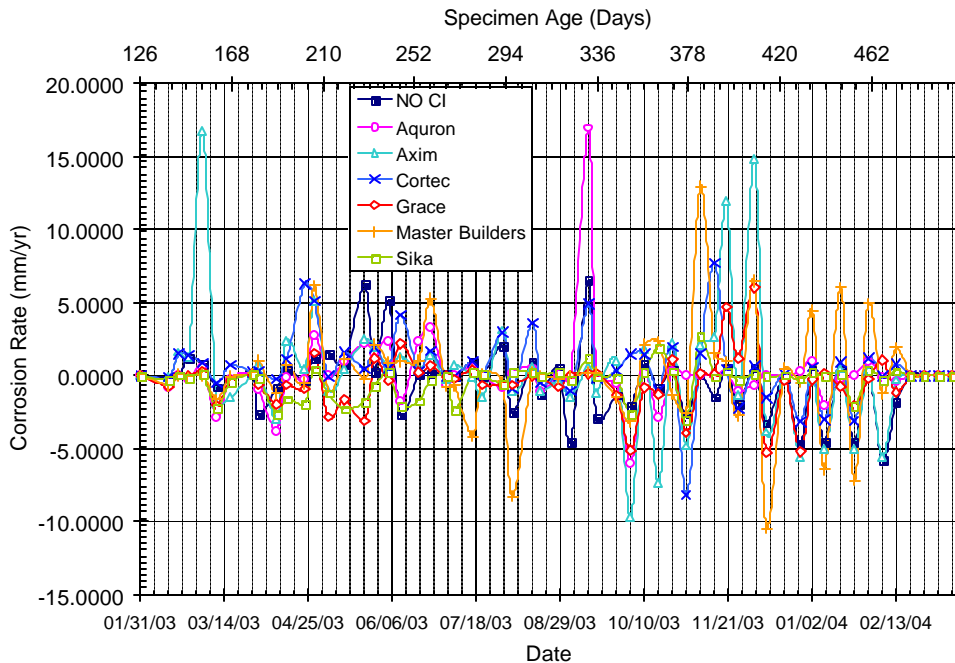

Figure A.18 – Corrosion Rate for Bath 3, 1.5% Chloride, Post-Cracked

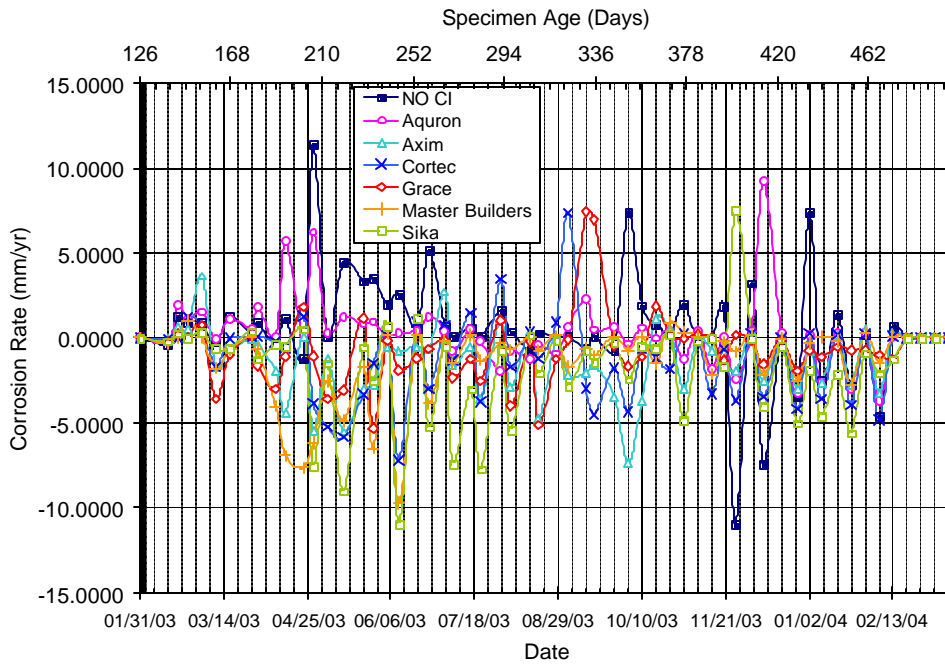

Figure A.19 – Corrosion Rate for Bath 3, 2.0% Chloride, Post-Cracked

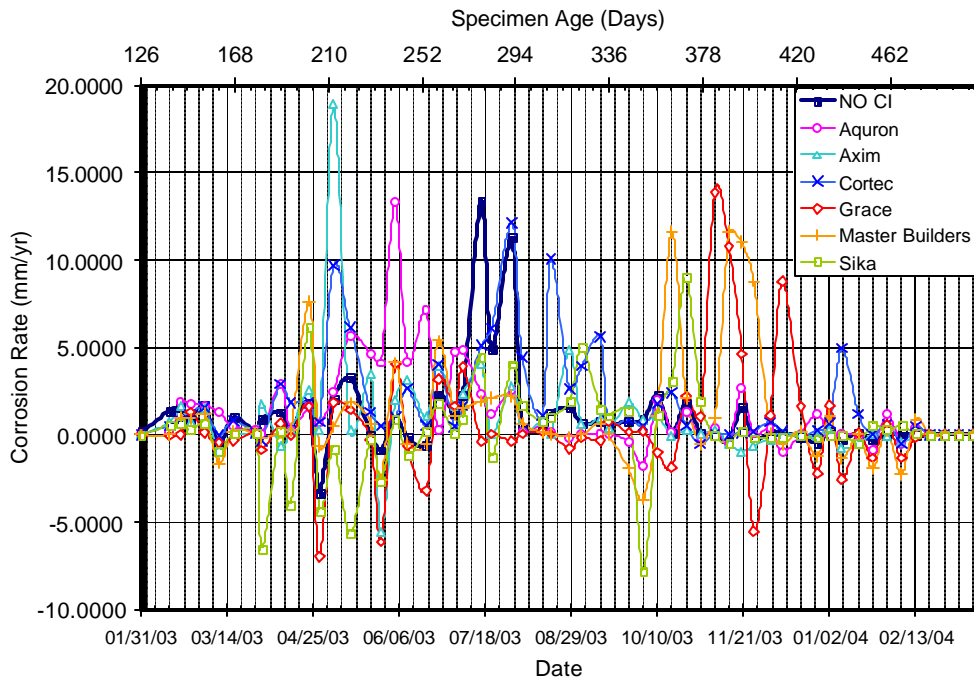

Figure A.20 – Corrosion Rate for Bath 3, 3.0% Chloride, Post-Cracked

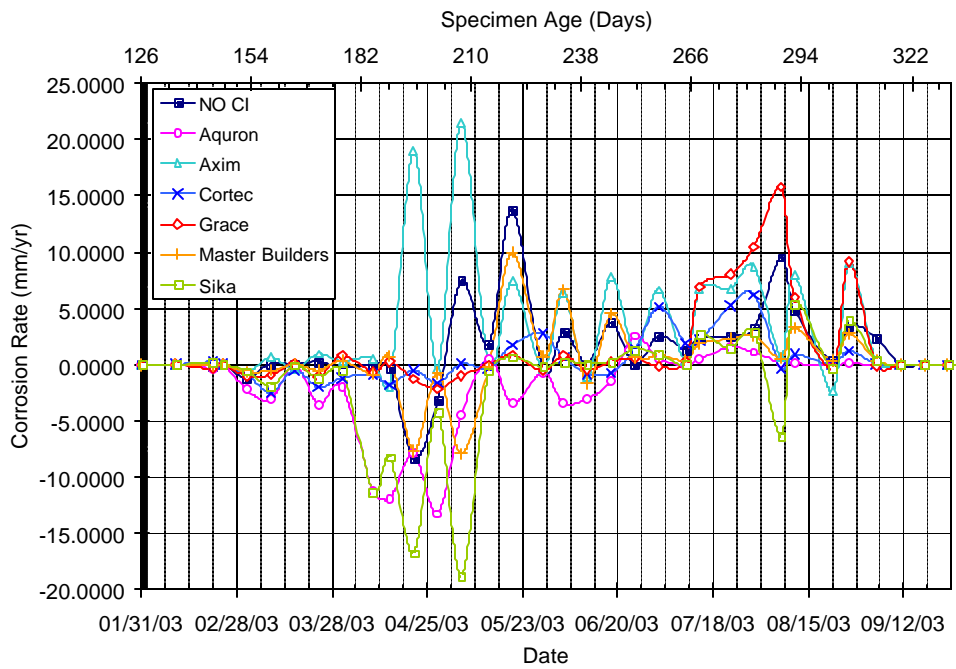

Figure A.21 – Corrosion Rate for Bath 4, 0.0% Chloride, Post-Cracked

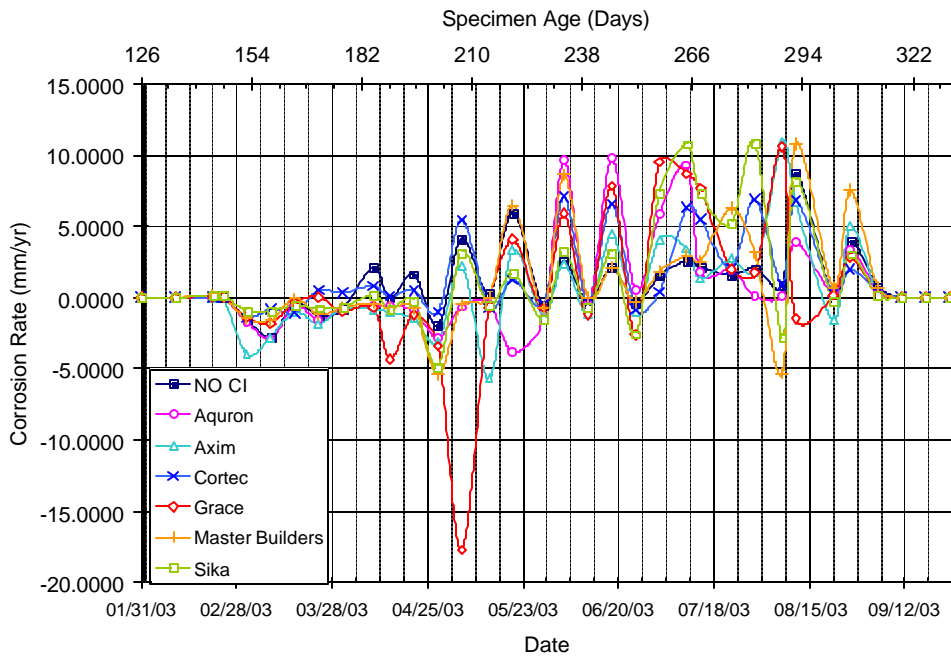

Figure A.22 – Corrosion Rate for Bath 4, 0.5% Chloride, Post-Cracked

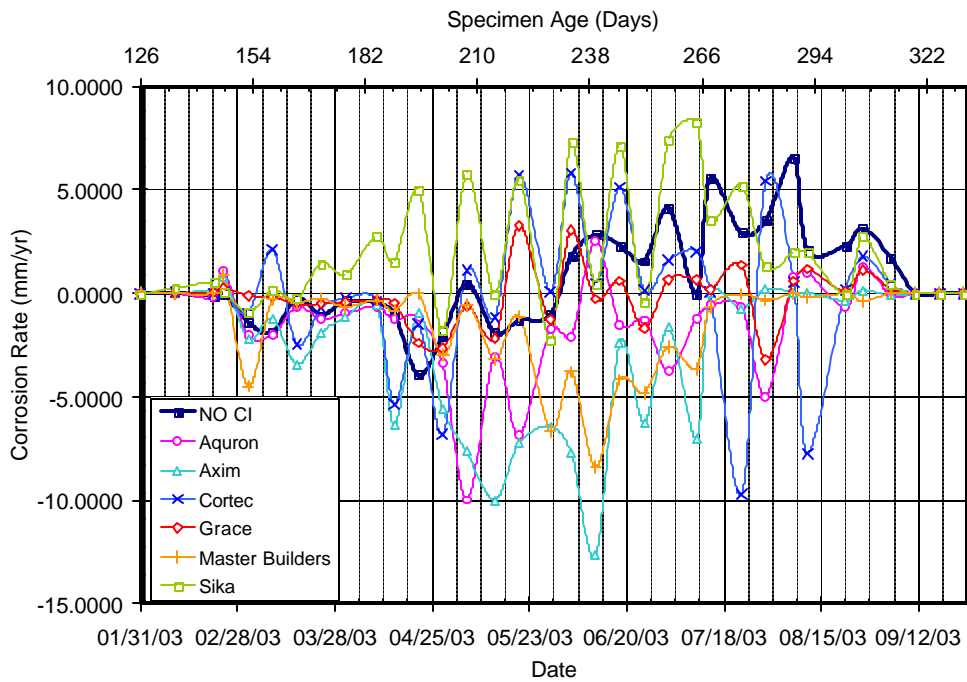

Figure A.23 – Corrosion Rate for Bath 4, 1.0% Chloride, Post-Cracked

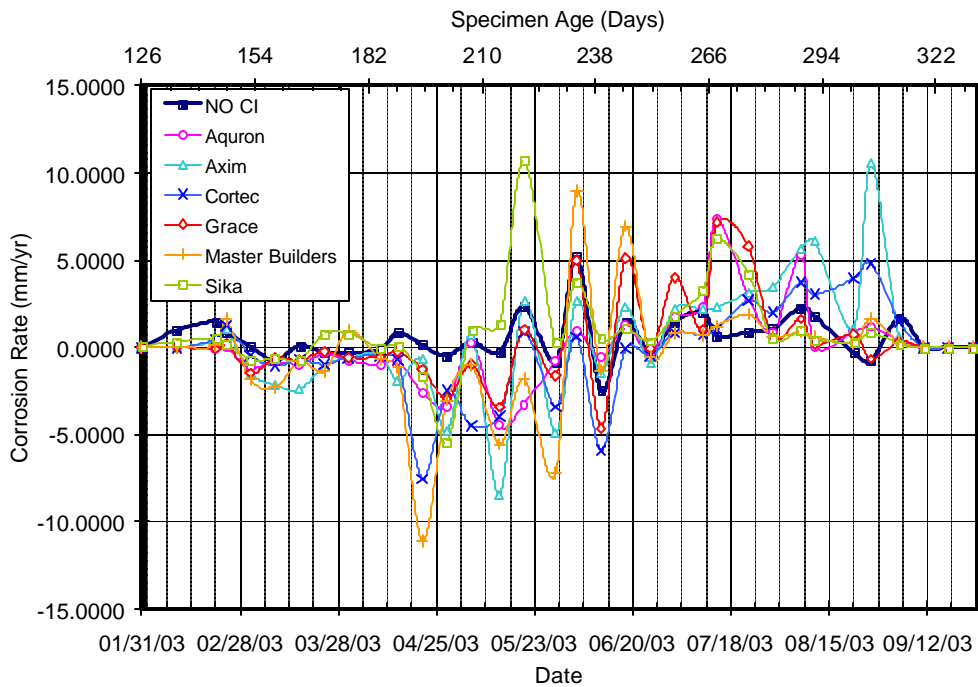

Figure A.24 – Corrosion Rate for Bath 4, 1.5% Chloride, Post-Cracked

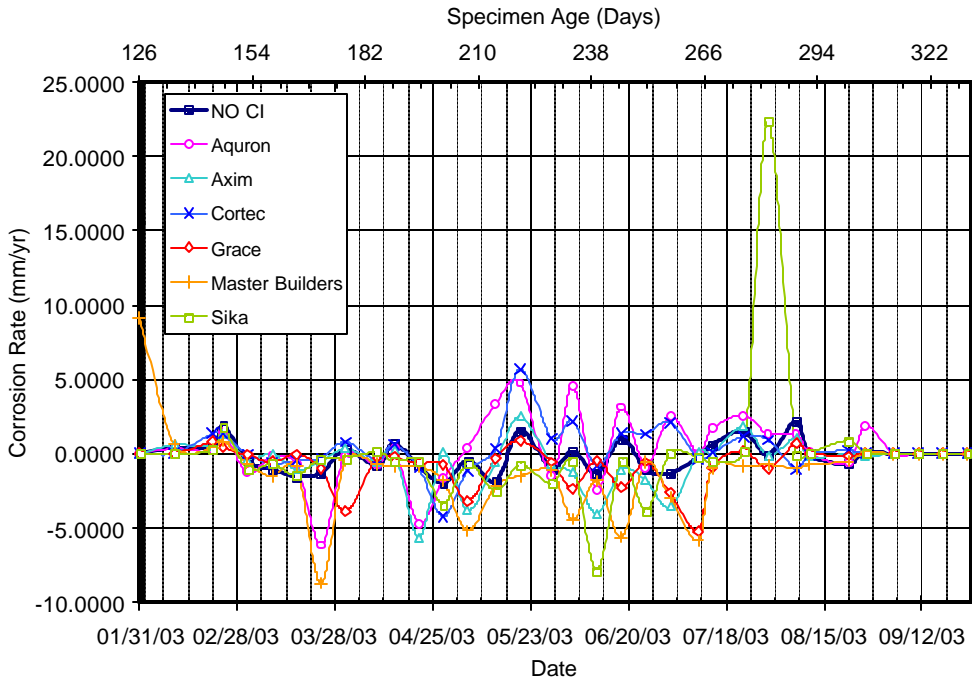

Figure A.25 – Corrosion Rate for Bath 4, 2.0% Chloride, Post-Cracked

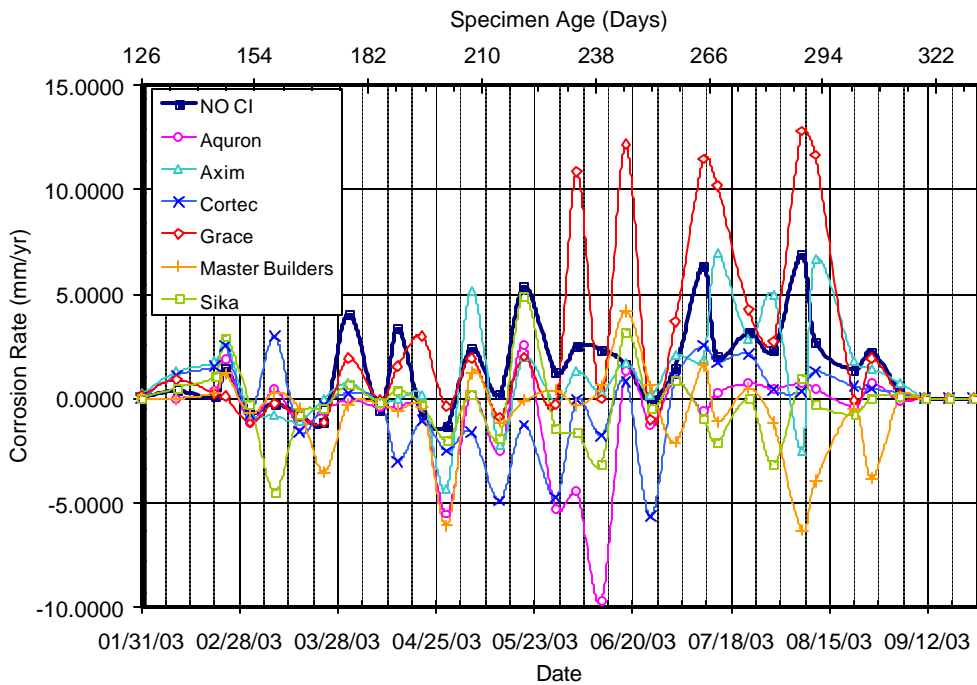

Figure A.26 – Corrosion Rate for Bath 4, 3.0% Chloride, Post-Cracked

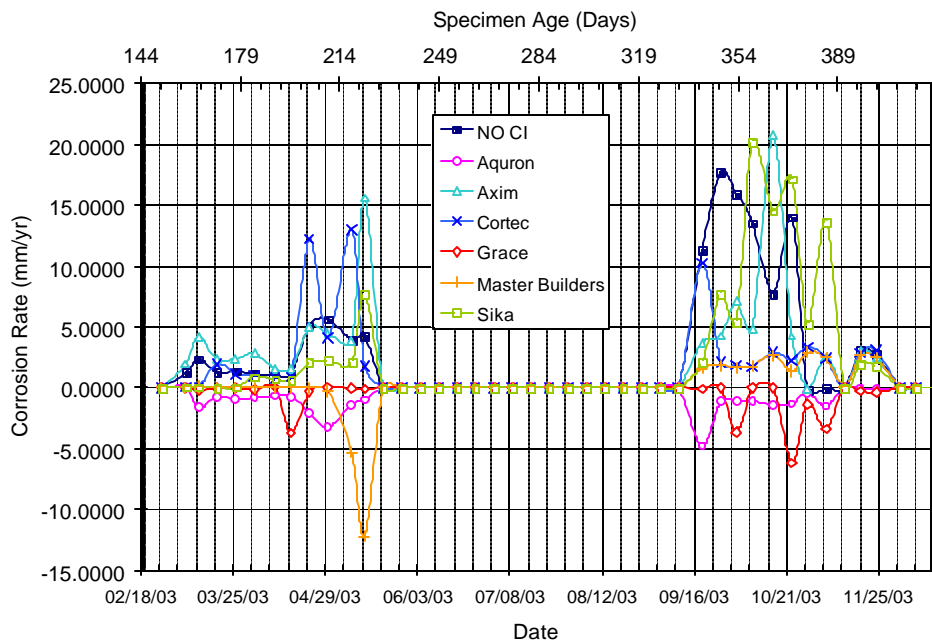

Figure A.27 – Corrosion Rate for Chamber Shelf 1, 0.0% Chloride, Post-Cracked

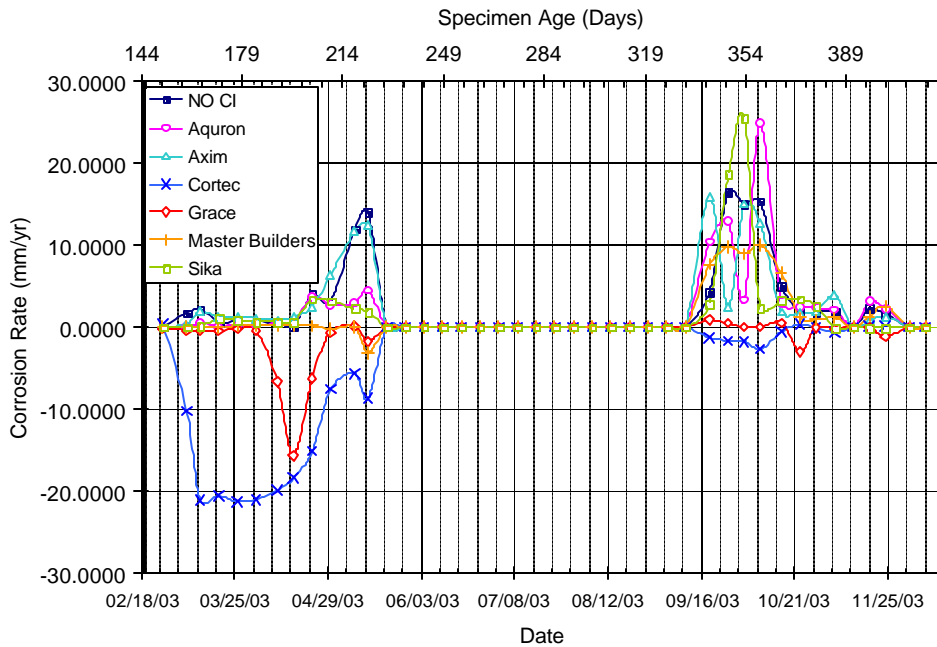

Figure A.28 – Corrosion Rate for Chamber Shelf 1, 0.5% Chloride, Post-Cracked

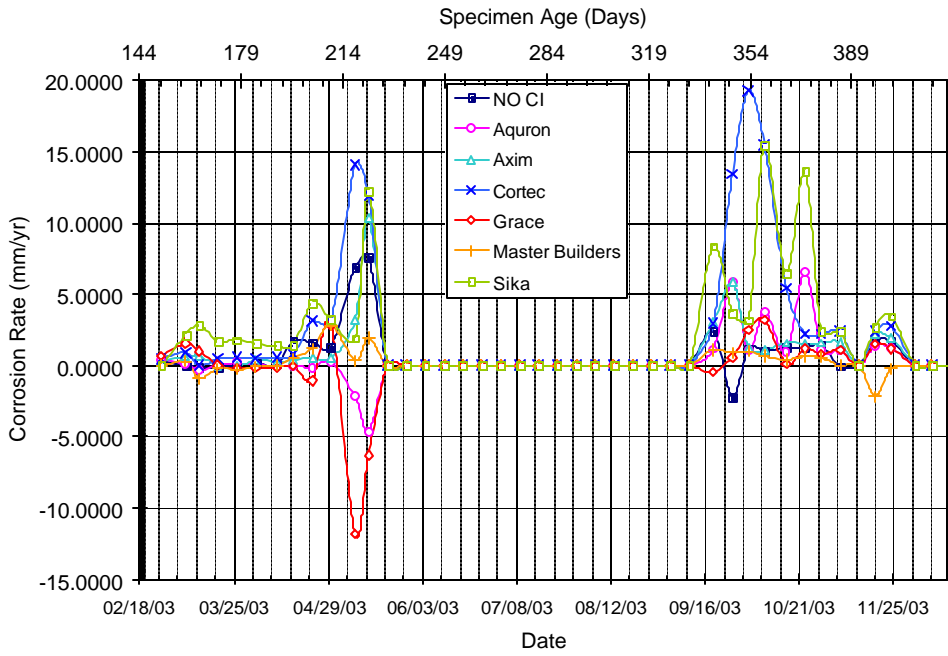

Figure A.29 – Corrosion Rate for Chamber Shelf 1, 1.0% Chloride, Post-Cracked

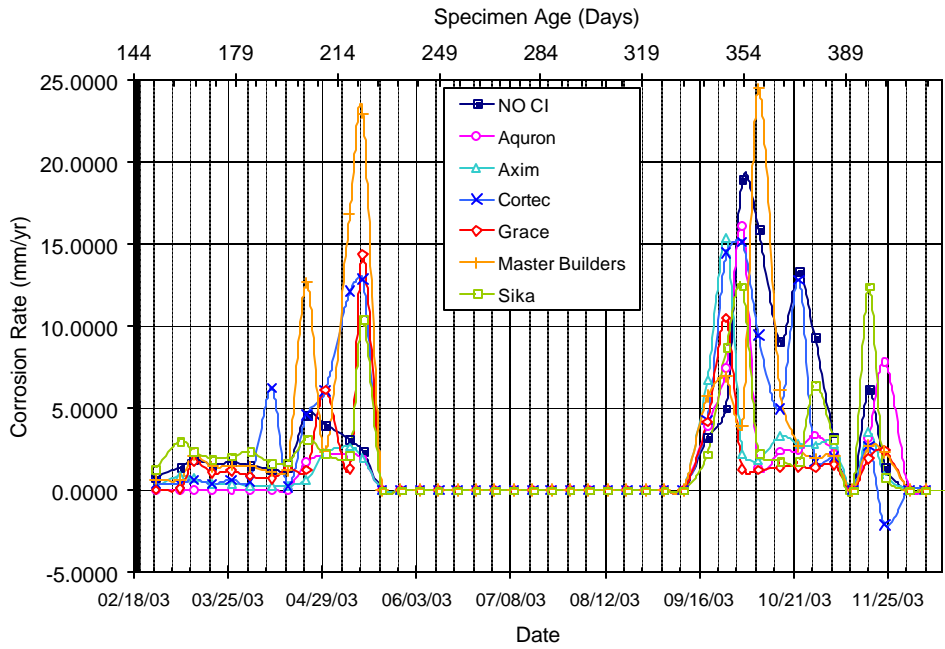

Figure A.30 – Corrosion Rate for Chamber Shelf 1, 1.5% Chloride, Post-Cracked

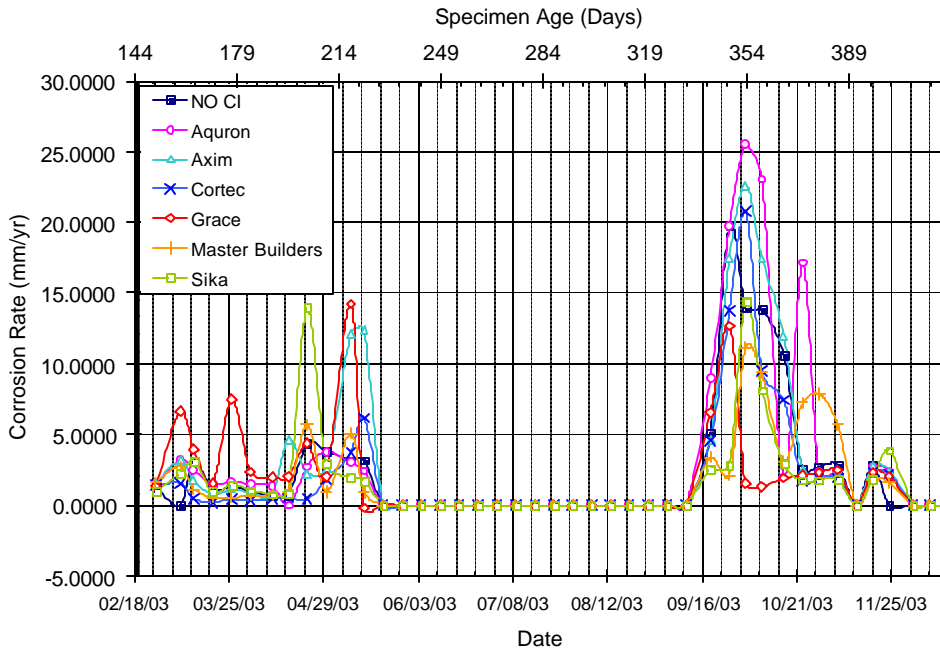

Figure A.31 – Corrosion Rate for Chamber Shelf 1, 2.0% Chloride, Post-Cracked

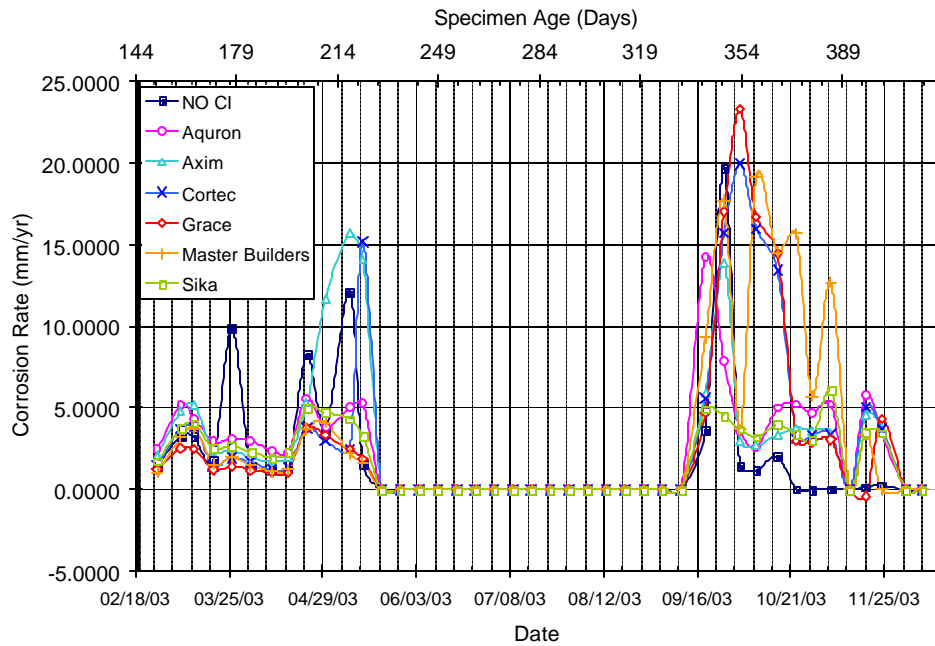

Figure A.32 – Corrosion Rate for Chamber Shelf 1, 3.0% Chloride, Post-Cracked

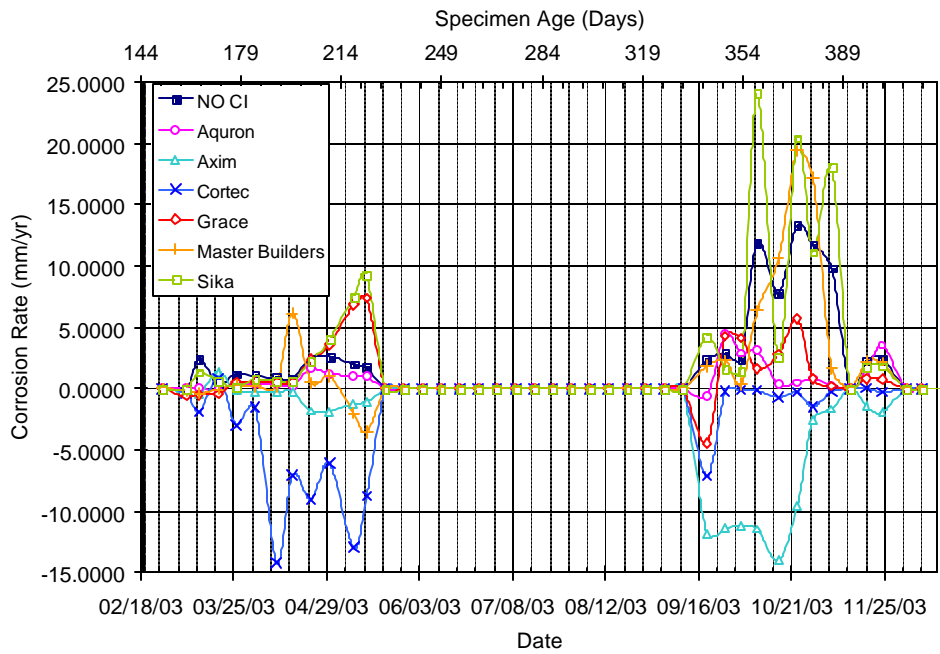

Figure A.33 – Corrosion Rate for Chamber Shelf 2, 0.0% Chloride, Pre-Cracked

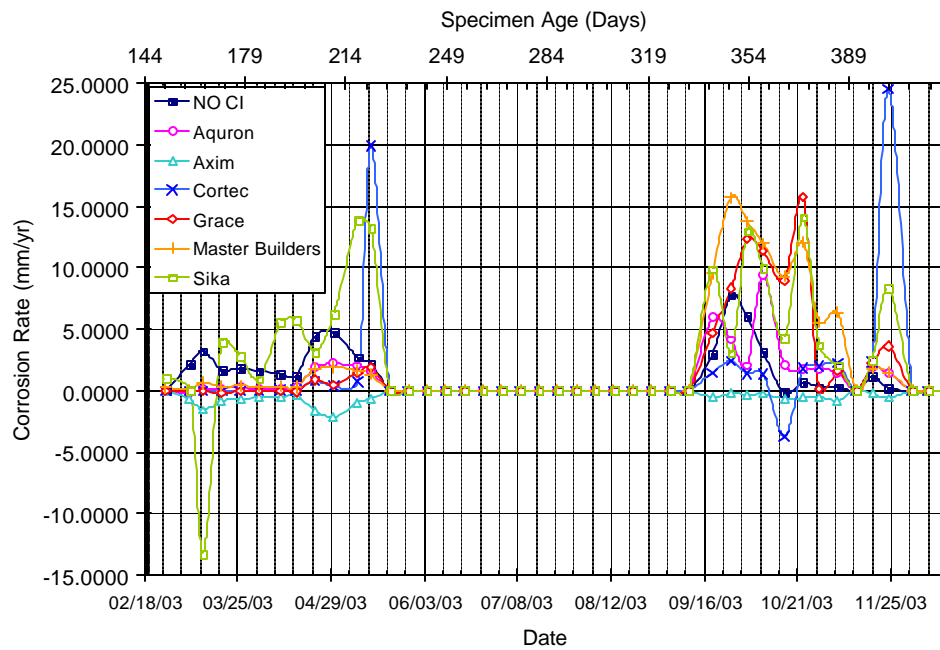

Figure A.34 – Corrosion Rate for Chamber Shelf 2, 0.5% Chloride, Pre-Cracked

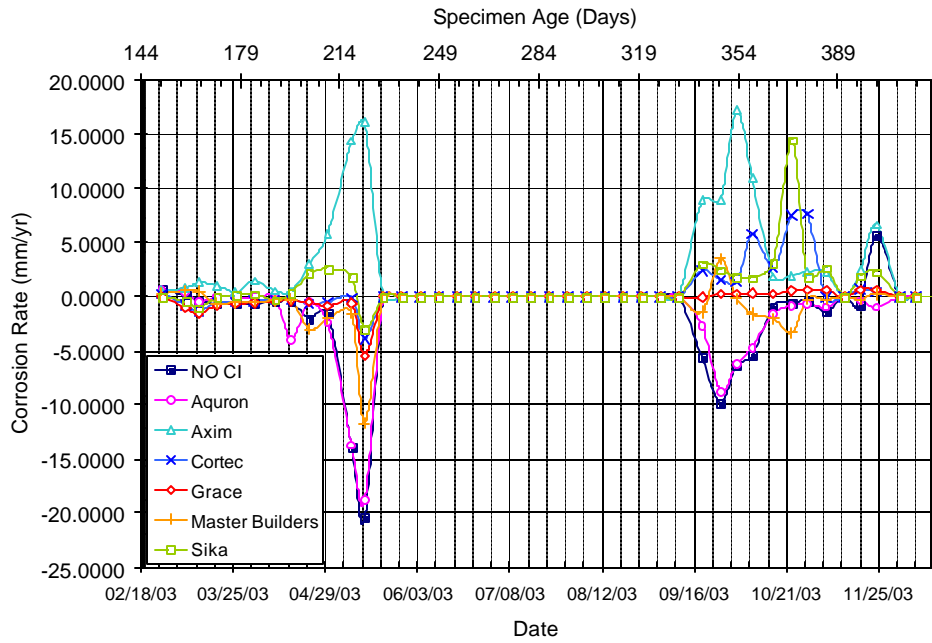

Figure A.35 – Corrosion Rate for Chamber Shelf 2, 1.0% Chloride, Pre-Cracked

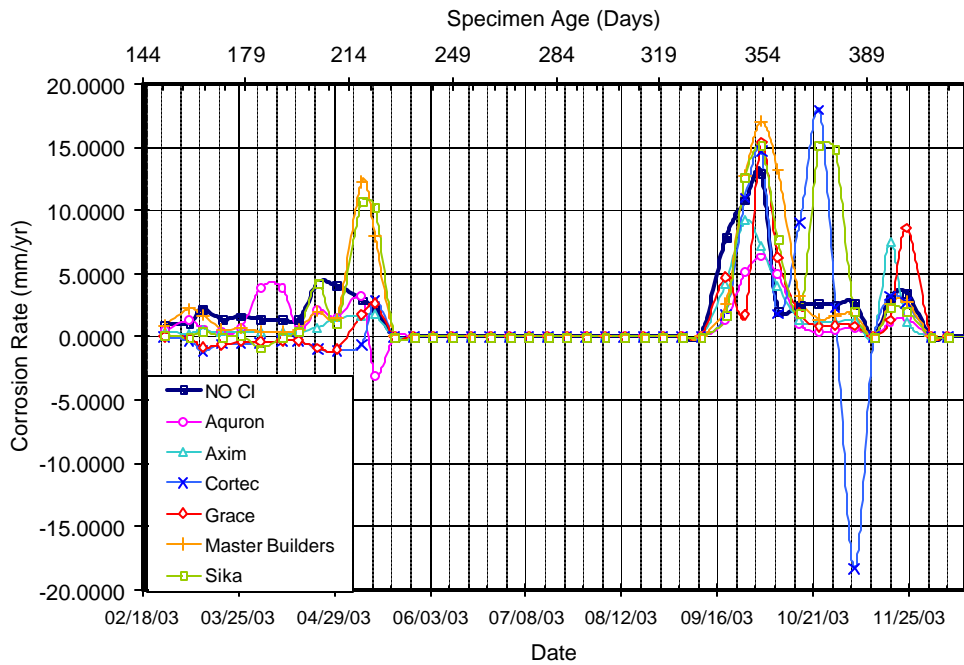

Figure A.36 – Corrosion Rate for Chamber Shelf 2, 1.5% Chloride, Pre-Cracked

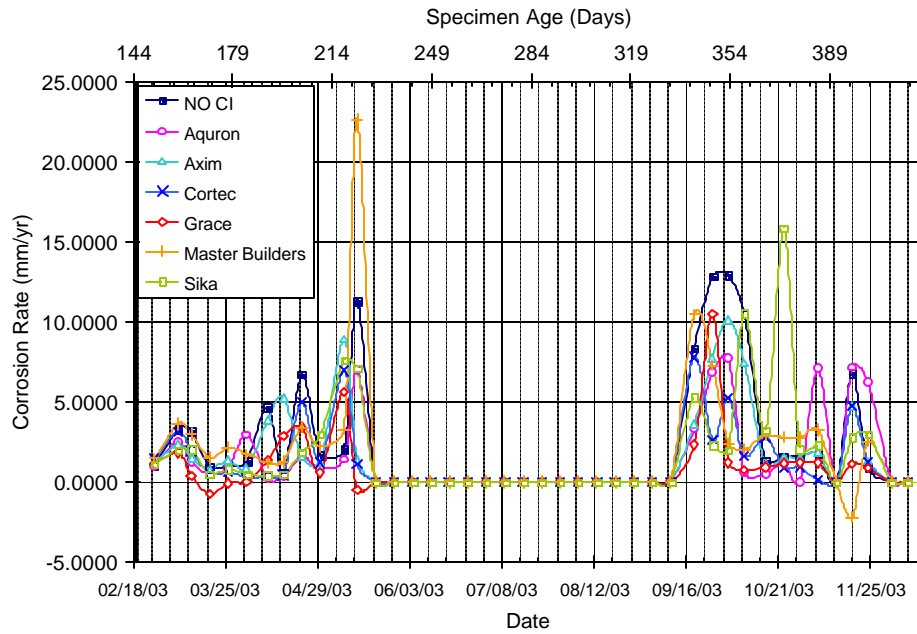

Figure A.37 – Corrosion Rate for Chamber Shelf 2, 2.0% Chloride, Pre-Cracked

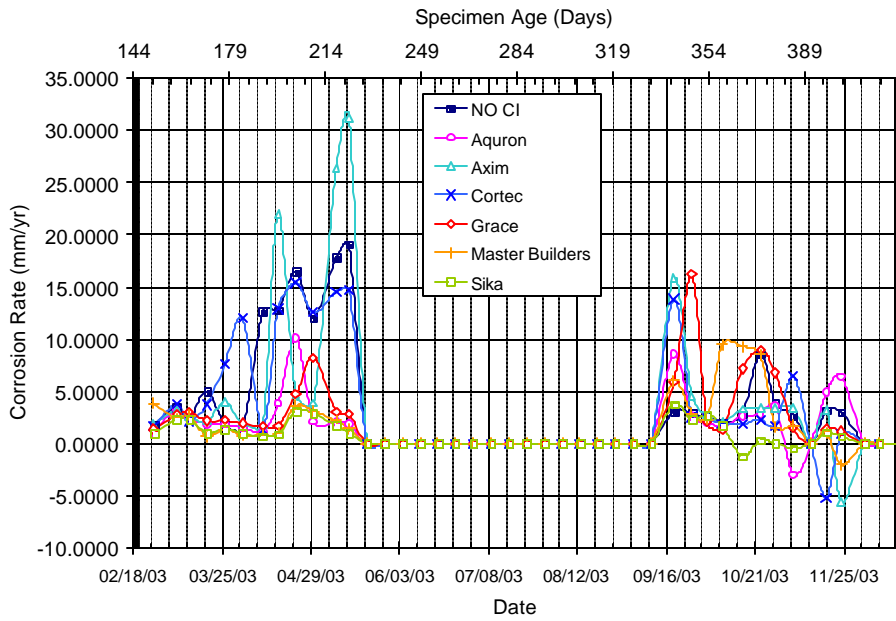

Figure A.38 – Corrosion Rate for Chamber Shelf 2, 3.0% Chloride, Pre-Cracked

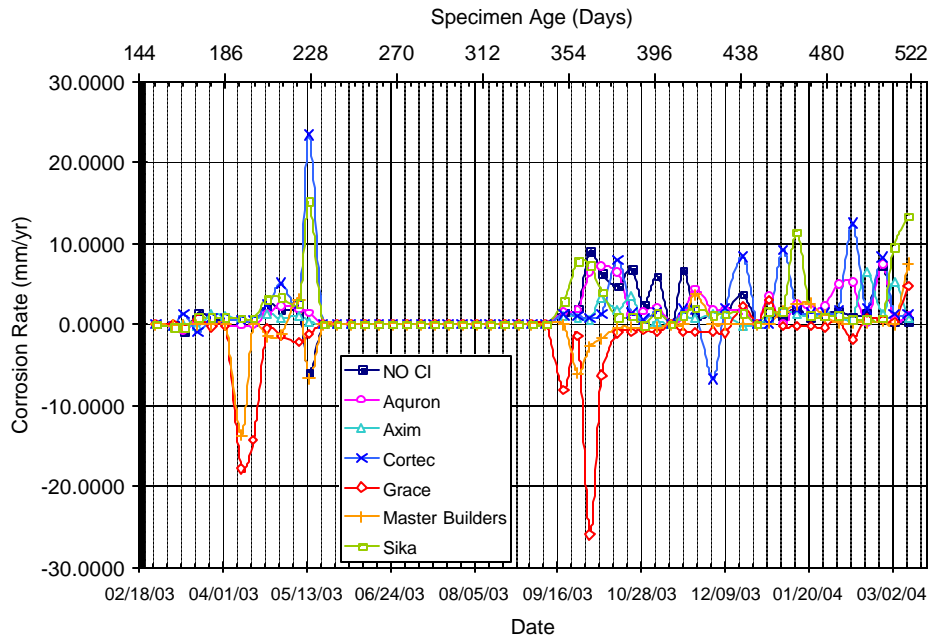

Figure A.39 – Corrosion Rate for Chamber Shelf 3, 0.0% Chloride, Post-Cracked

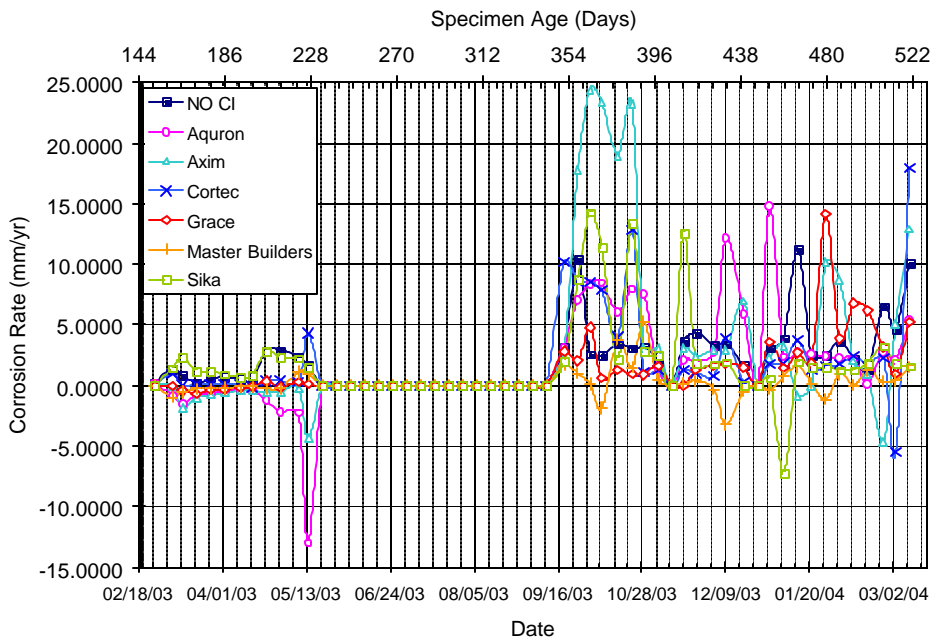

Figure A.40 – Corrosion Rate for Chamber Shelf 3, 0.5% Chloride, Post-Cracked

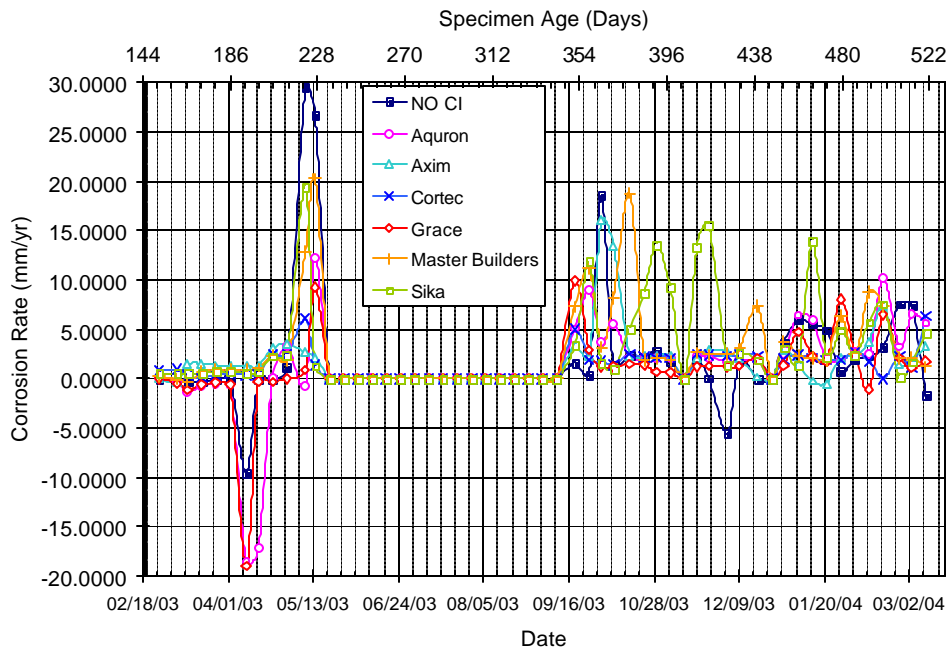

Figure A.41 – Corrosion Rate for Chamber Shelf 3, 1.0% Chloride, Post-Cracked

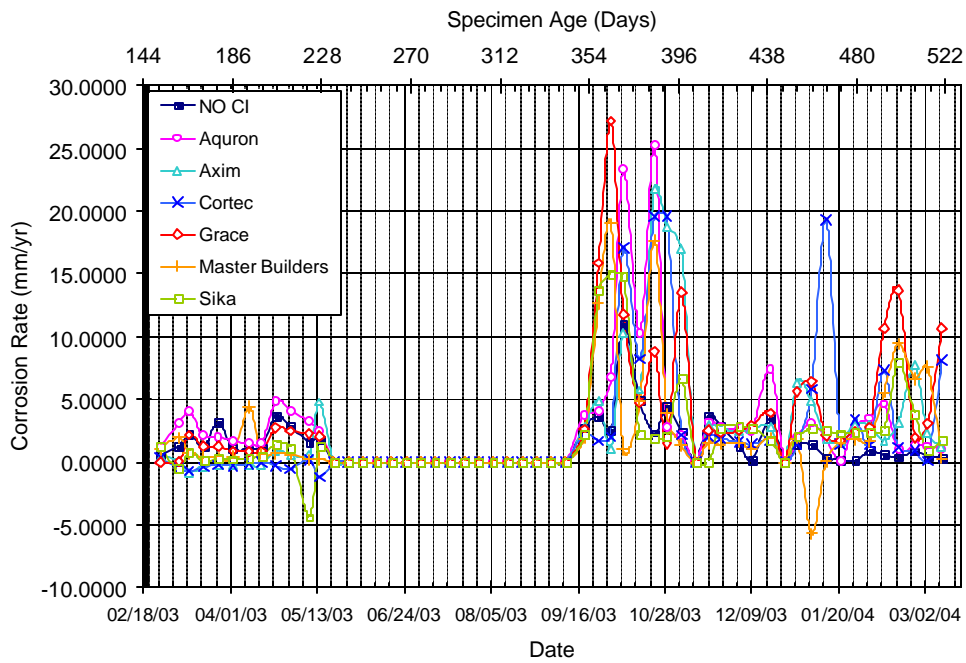

Figure A.42 – Corrosion Rate for Chamber Shelf 3, 1.5% Chloride, Post-Cracked

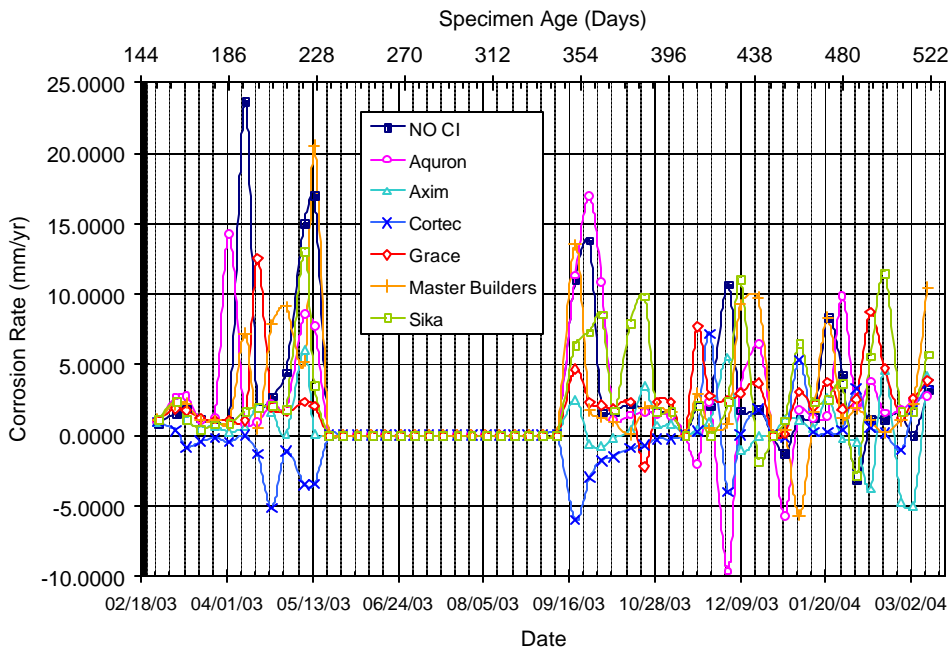

Figure A.43 – Corrosion Rate for Chamber Shelf 3, 2.0% Chloride, Post-Cracked

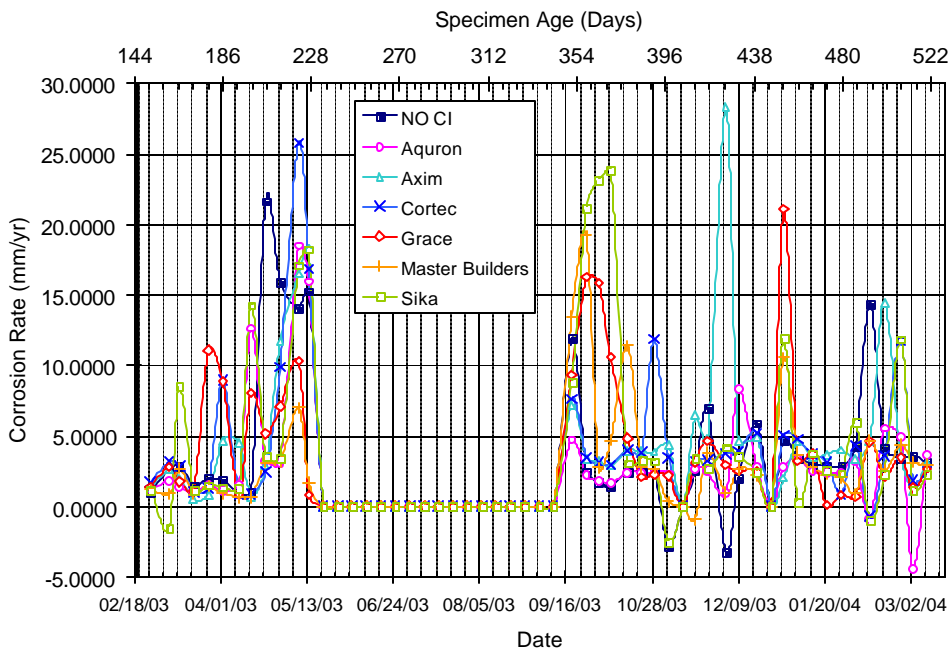

Figure A.44 – Corrosion Rate for Chamber Shelf 3, 3.0% Chloride, Post-Cracked

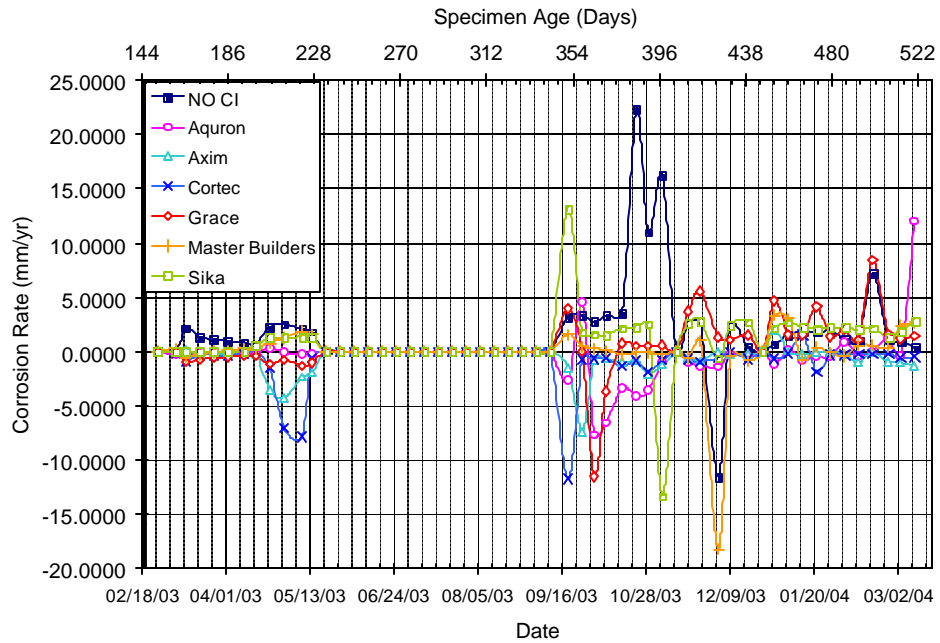

Figure A.45 – Corrosion Rate for Chamber Shelf 4, 0.0% Chloride, Pre-Cracked

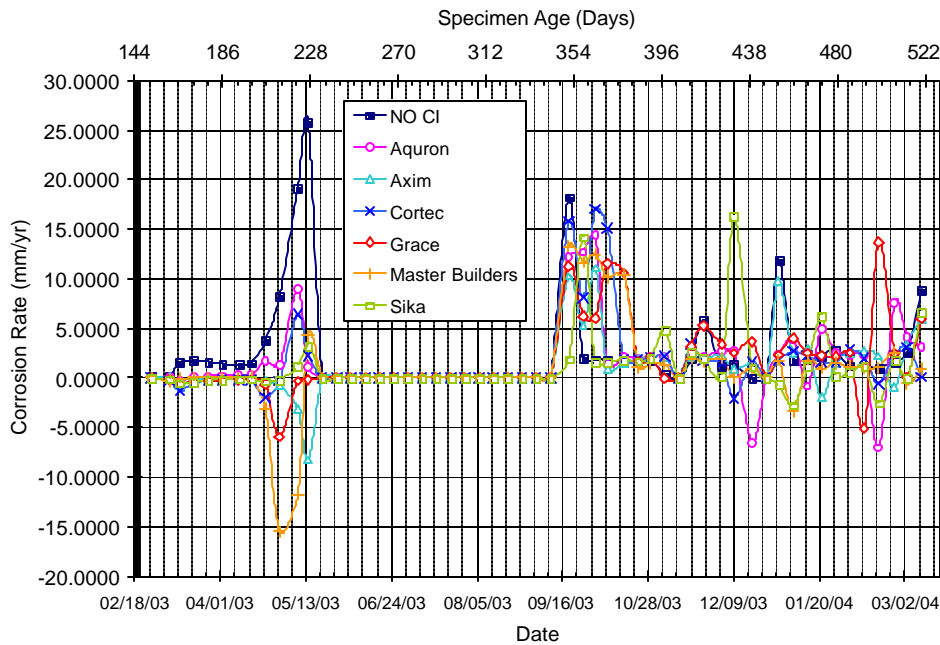

Figure A.46 – Corrosion Rate for Chamber Shelf 4, 0.5% Chloride, Pre-Cracked

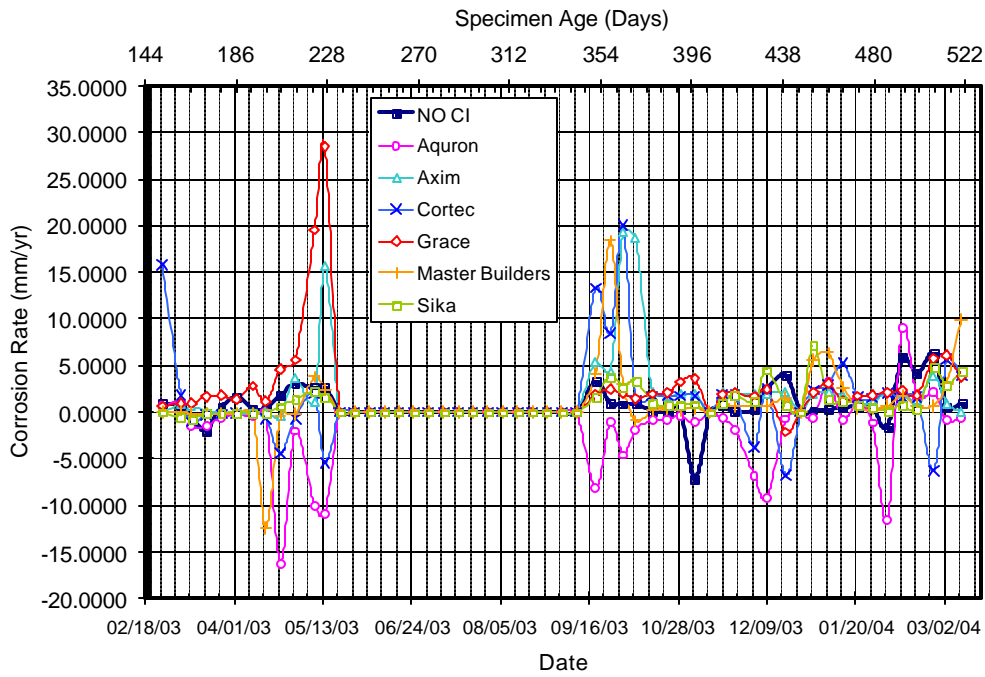

Figure A.47 – Corrosion Rate for Chamber Shelf 4, 1.0% Chloride, Pre-Cracked

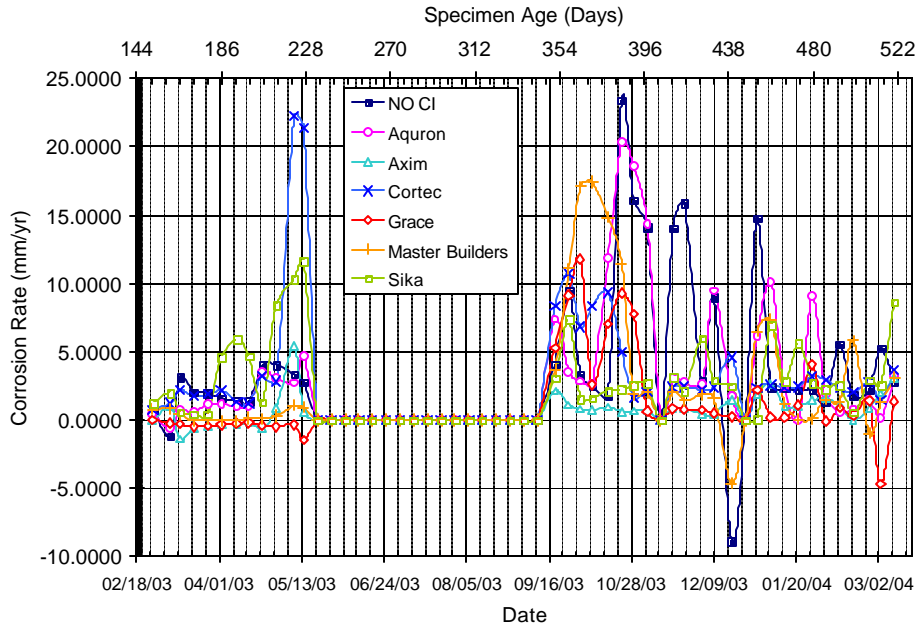

Figure A.48 – Corrosion Rate for Chamber Shelf 4, 1.5% Chloride, Pre-Cracked

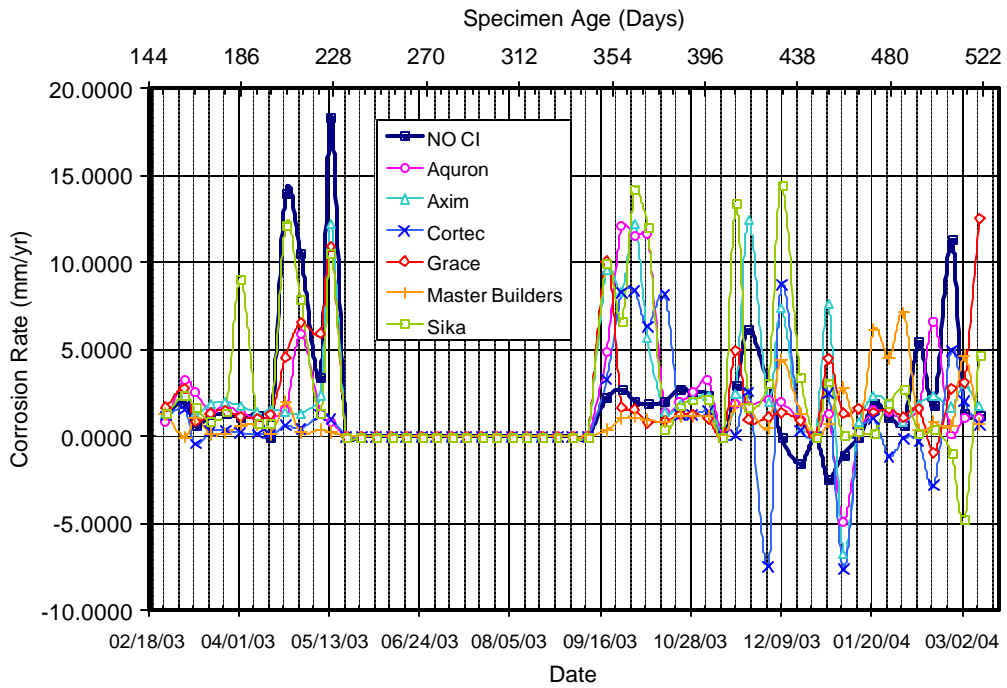

Figure A.49 – Corrosion Rate for Chamber Shelf 4, 2.0% Chloride, Pre-Cracked

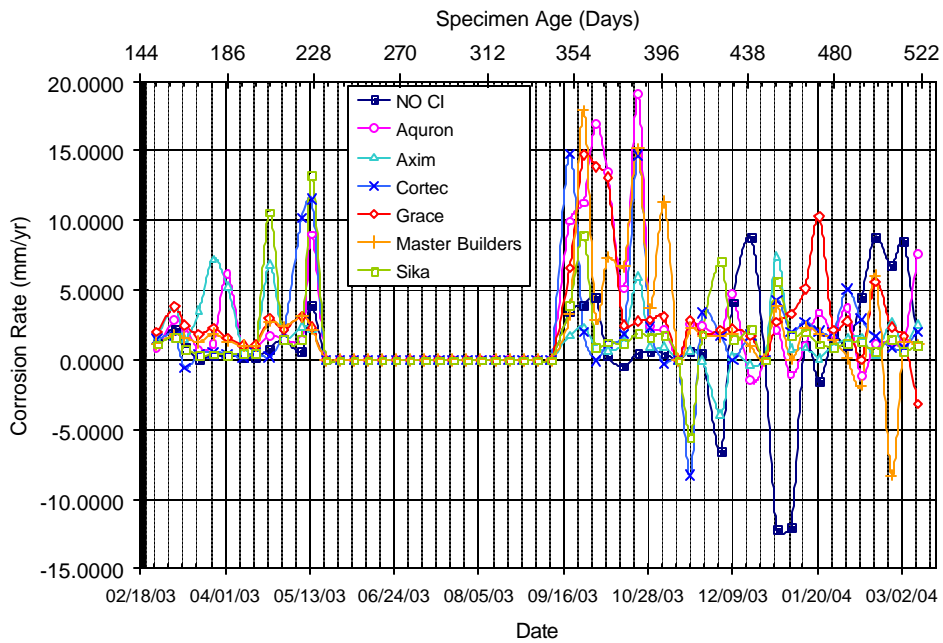

Figure A.50 – Corrosion Rate for Chamber Shelf 4, 3.0% Chloride, Pre-Cracked

APPENDIX B. CUMULATIVE CORROSION GRAPHS

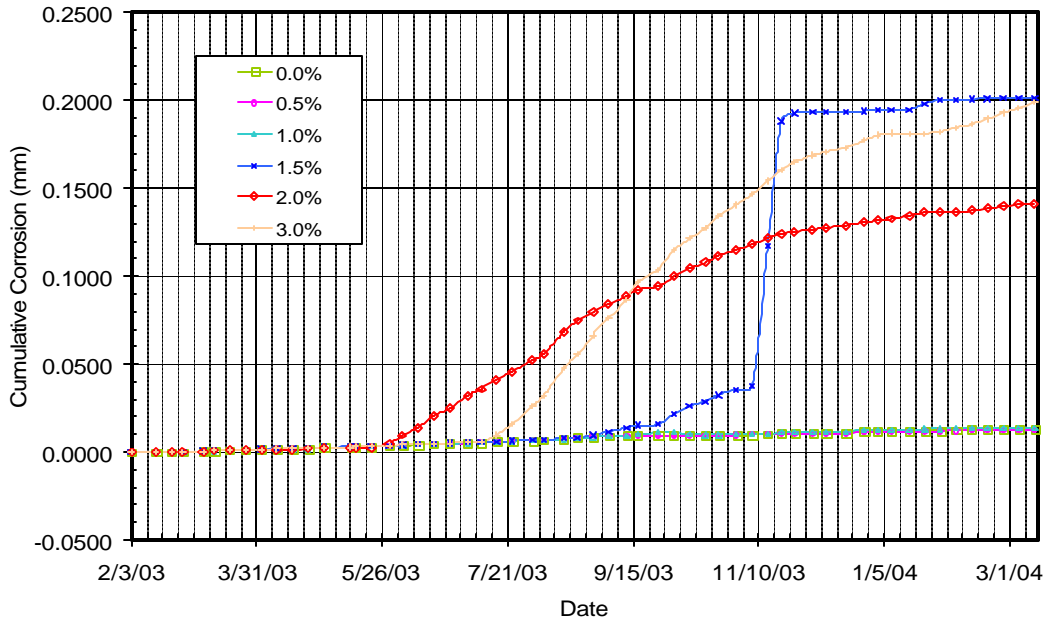

Figure B.1 – Cumulative Corrosion Over Time for Control Set #1

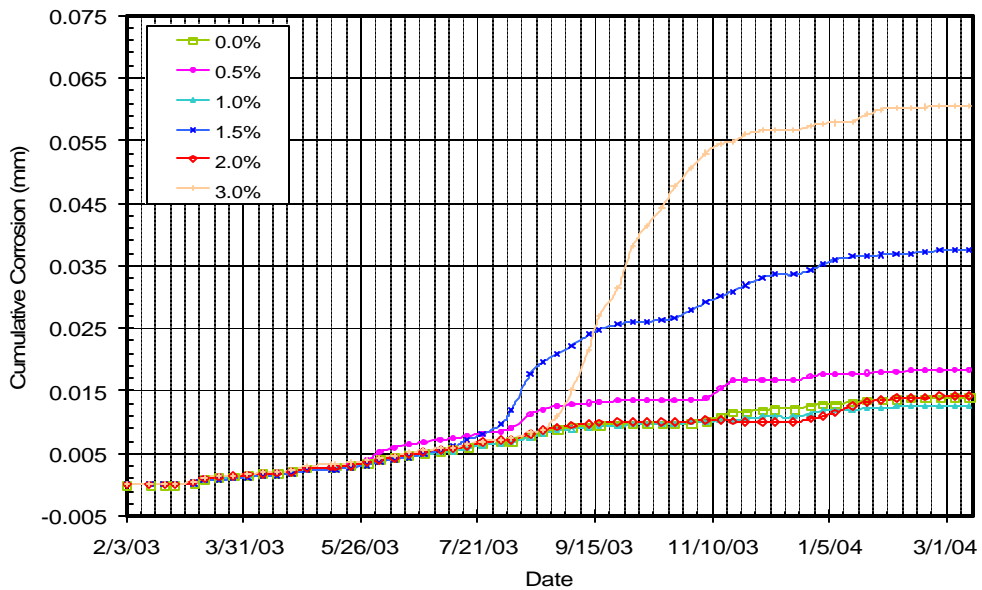

Figure B.2 – Cumulative Corrosion Over Time for Control Set #2

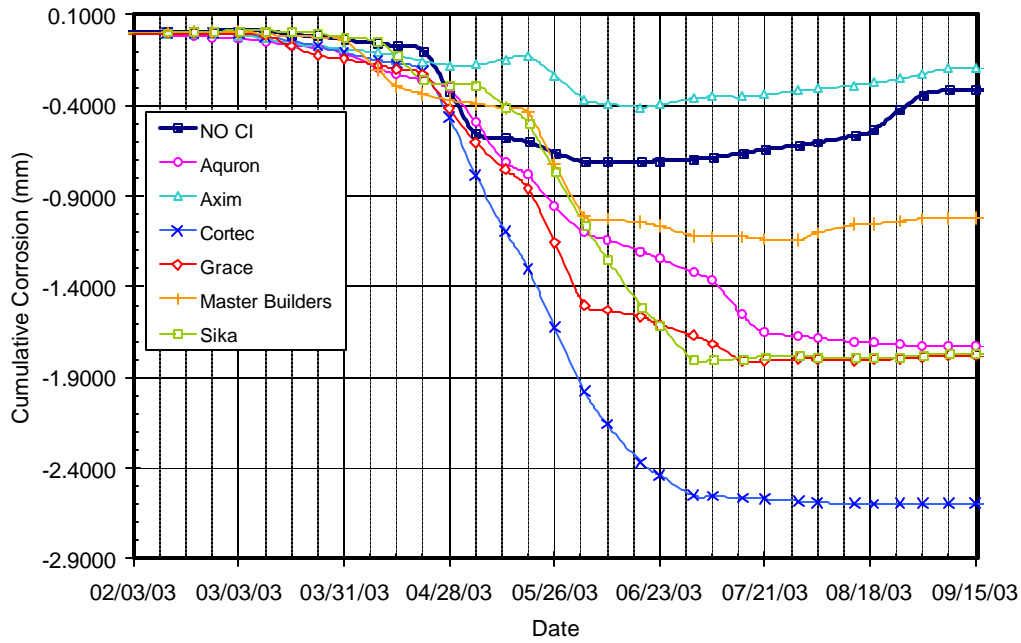

Figure B.3 – Cumulative Corrosion Over Time for Bath 1, 0.0% Chloride, Pre-Cracked

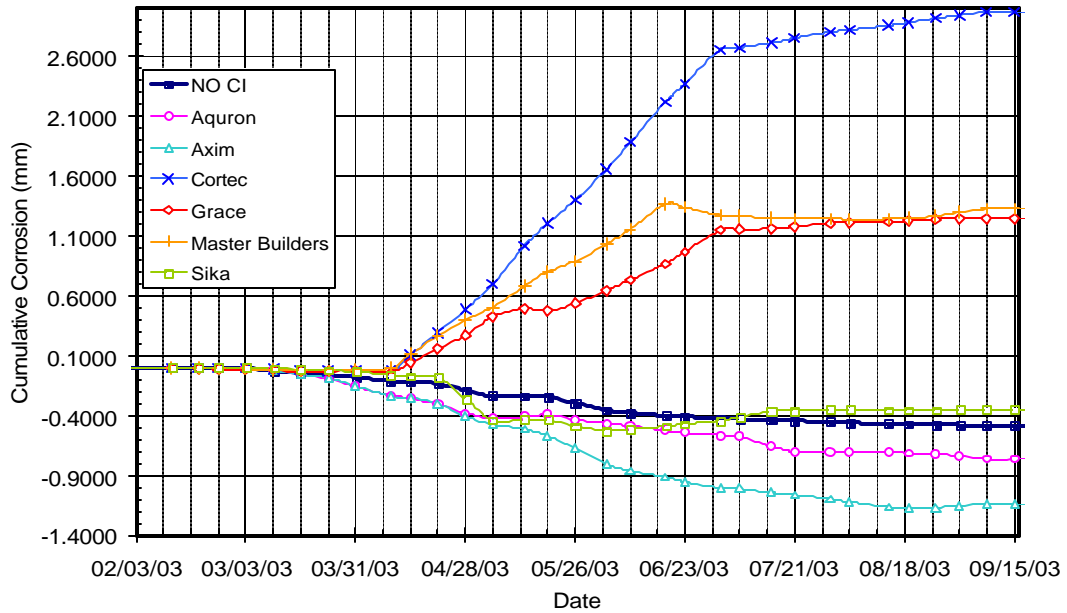

Figure B.4 – Cumulative Corrosion Over Time for Bath 1, 0.5% Chloride, Pre-Cracked

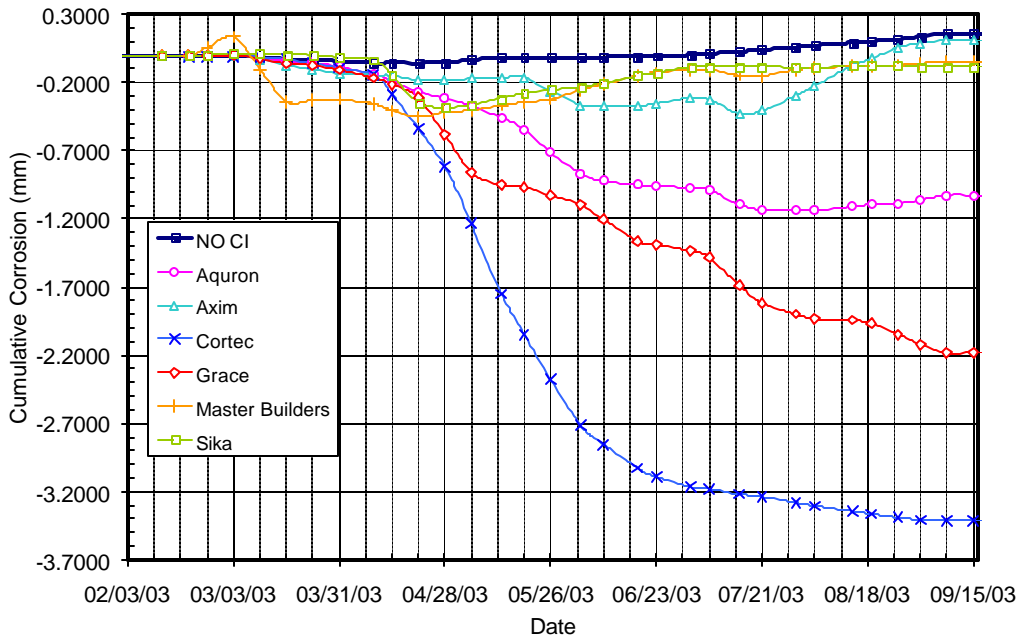

Figure B.5 – Cumulative Corrosion Over Time for Bath 1, 1.0% Chloride, Pre-Cracked

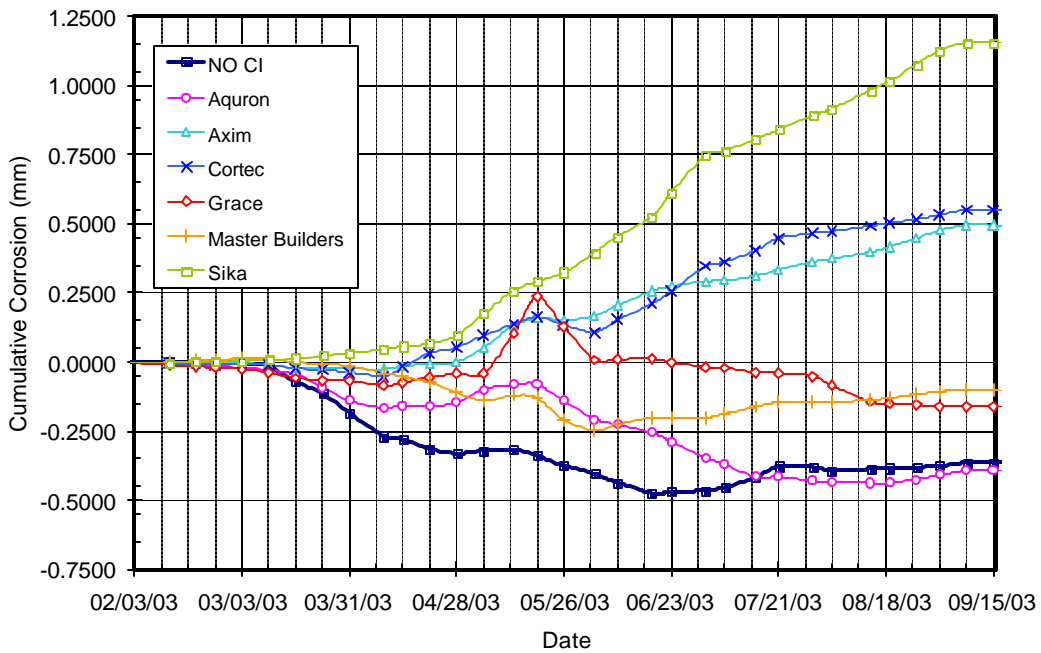

Figure B.6 – Cumulative Corrosion Over Time for Bath 1, 1.5% Chloride, Pre-Cracked

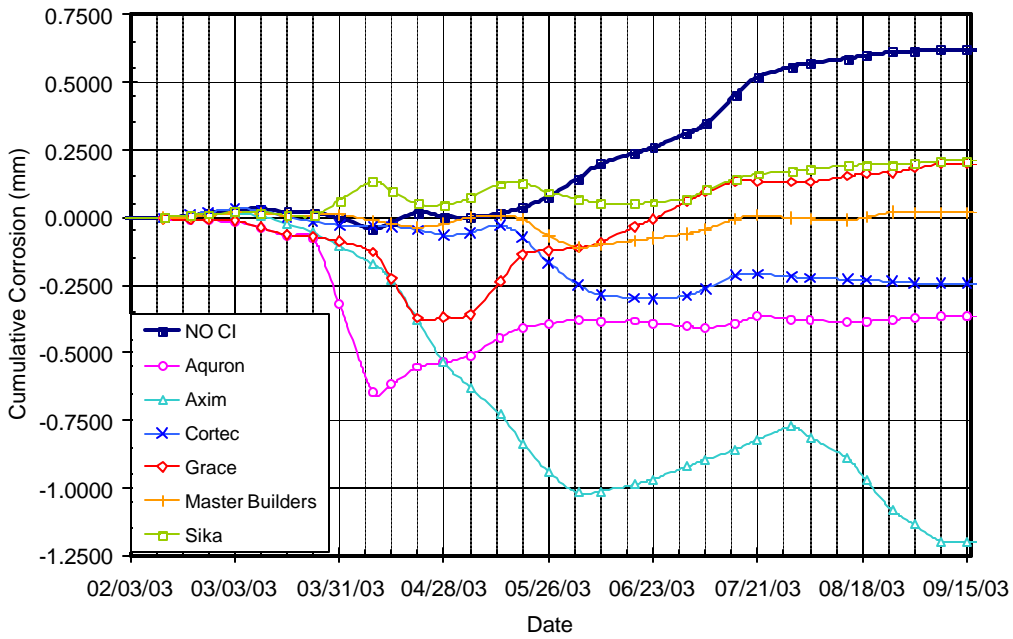

Figure B.7 – Cumulative Corrosion Over Time for Bath 1, 2.0% Chloride, Pre-Cracked

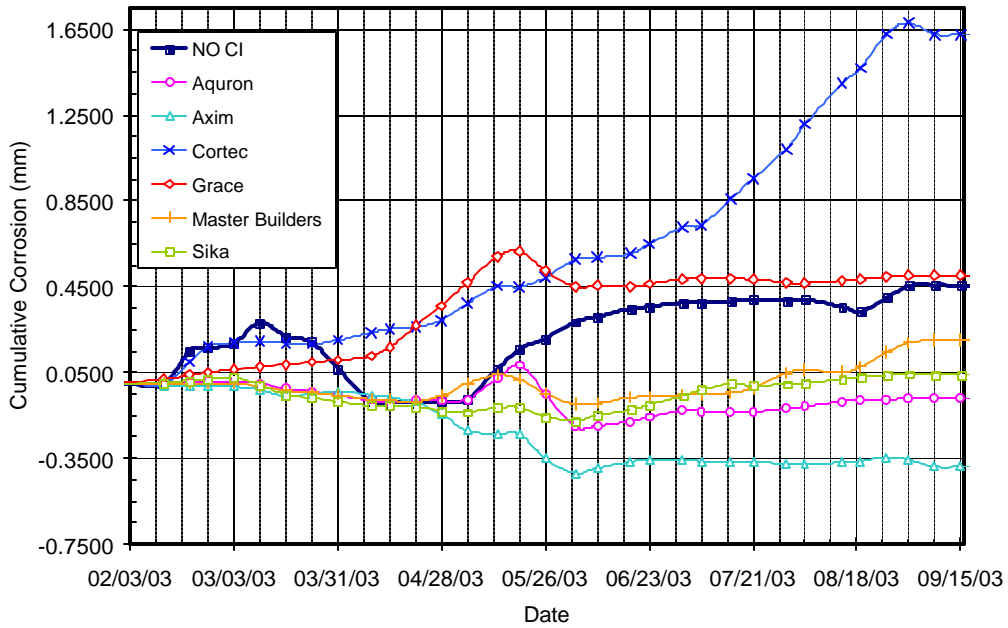

Figure B.8 – Cumulative Corrosion Over Time for Bath 1, 3.0% Chloride, Pre-Cracked

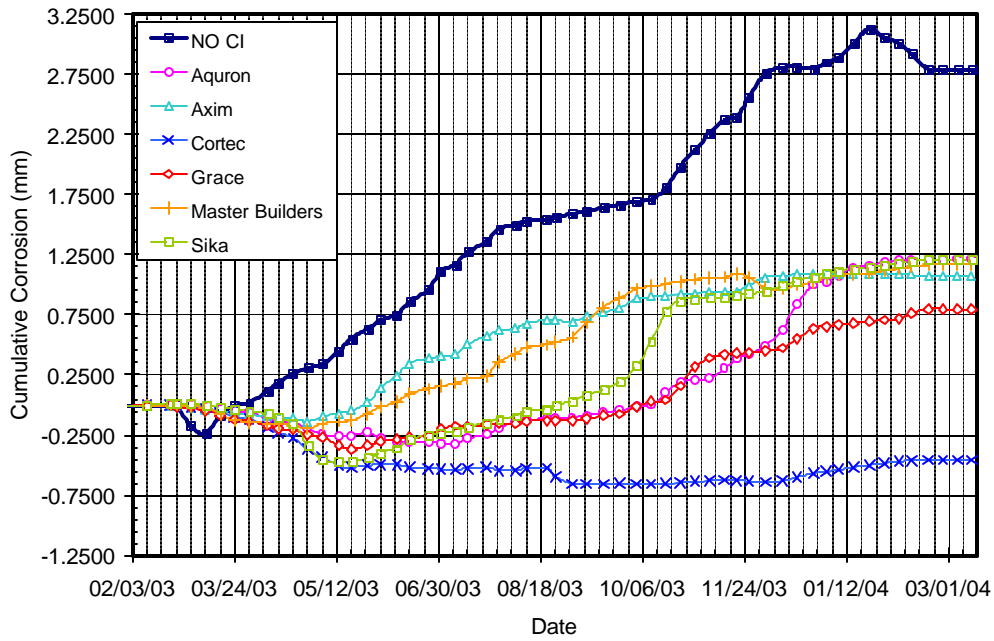

Figure B.9 – Cumulative Corrosion Over Time for Bath 2, 0.0% Chloride, Pre-Cracked

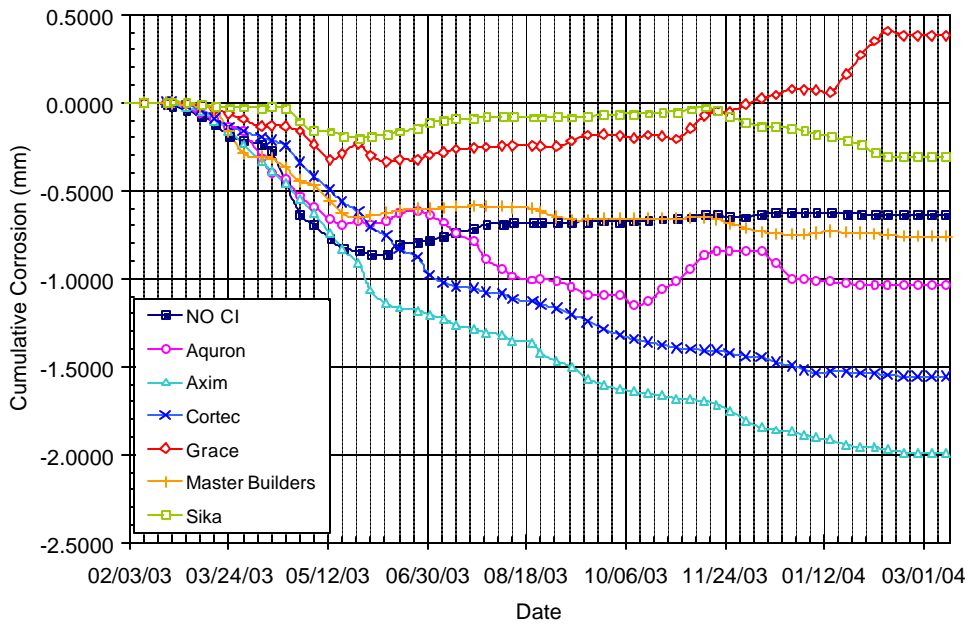

Figure B.10 – Cumulative Corrosion Over Time for Bath 2, 0.5% Chloride, Pre-Cracked

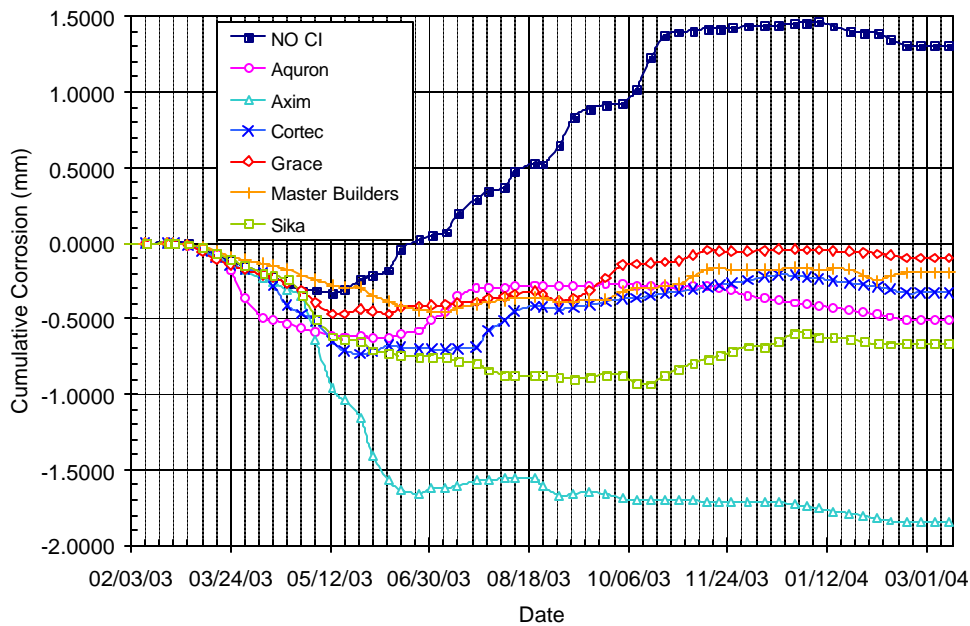

Figure B.11 – Cumulative Corrosion Over Time for Bath 2, 1.0% Chloride, Pre-Cracked

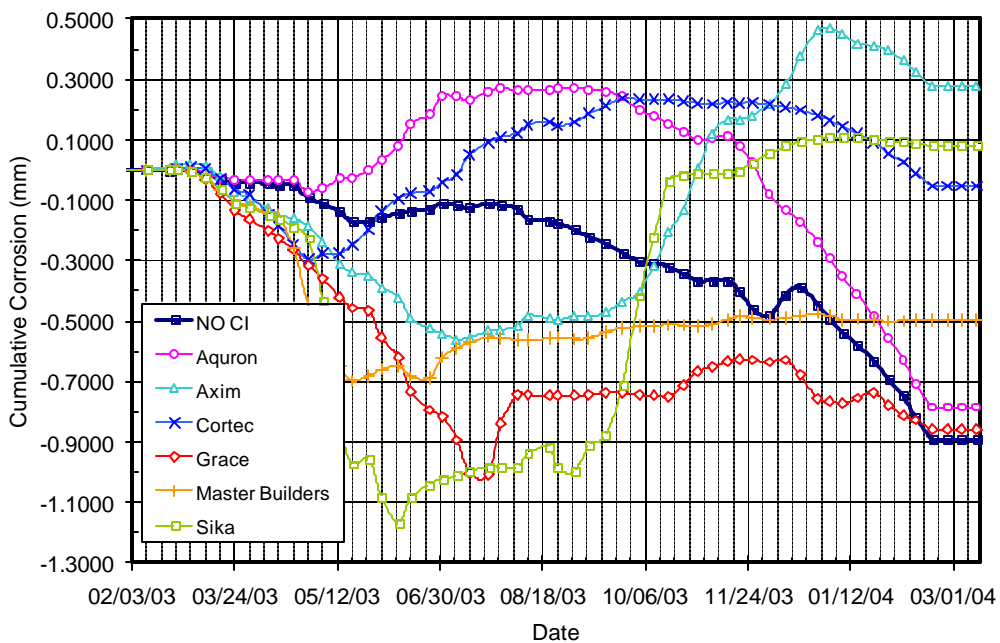

Figure B.12 – Cumulative Corrosion Over Time for Bath 2, 1.5% Chloride, Pre-Cracked

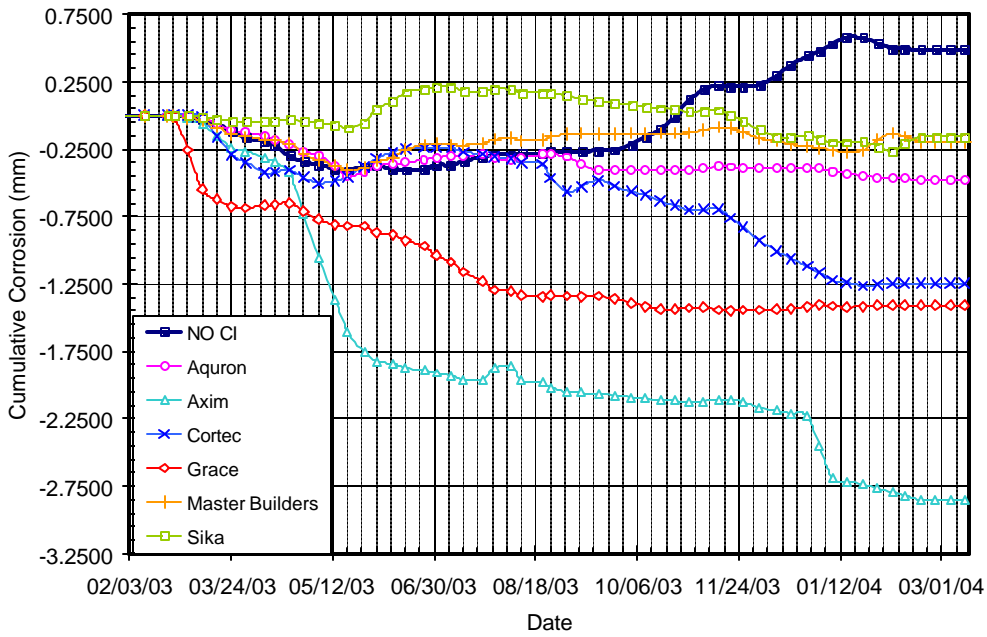

Figure B.13 – Cumulative Corrosion Over Time for Bath 2, 2.0% Chloride, Pre-Cracked

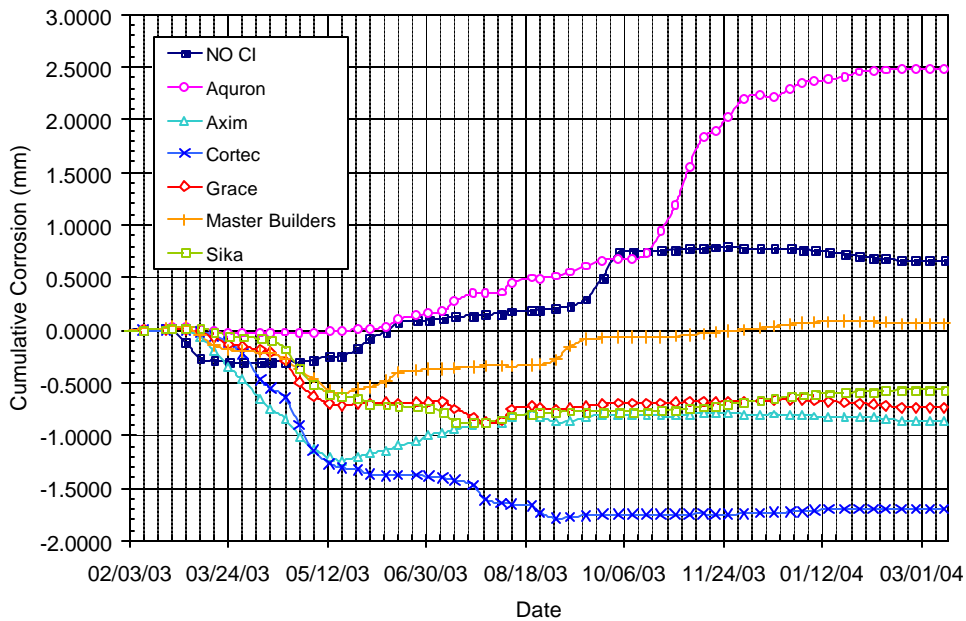

Figure B.14 – Cumulative Corrosion Over Time for Bath 2, 3.0% Chloride, Pre-Cracked

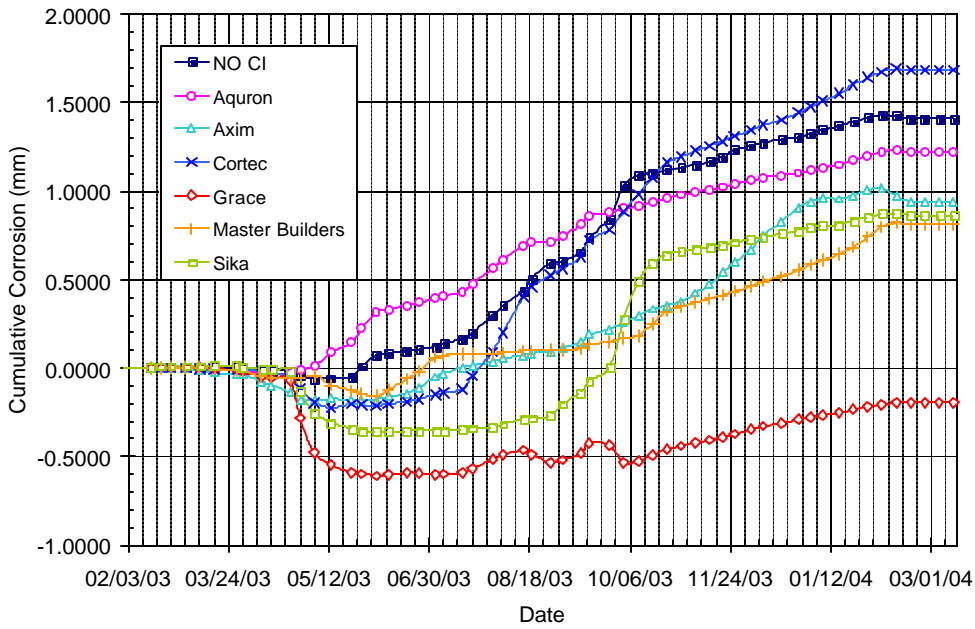

Figure B.15 – Cumulative Corrosion Over Time for Bath 3, 0.0% Chloride, Post-Cracked

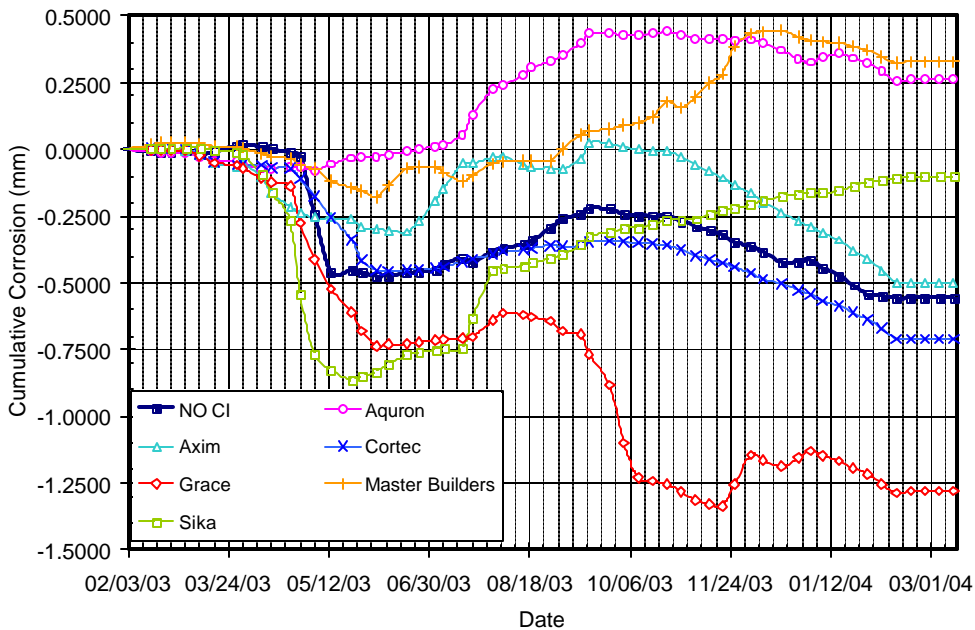

Figure B.16 – Cumulative Corrosion Over Time for Bath 3, 0.5% Chloride, Post-Cracked

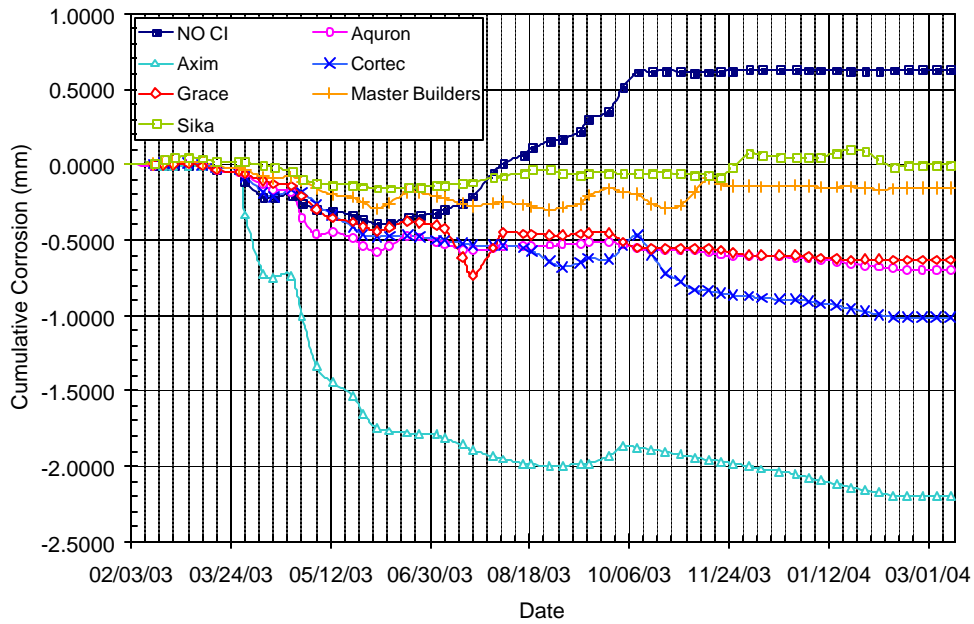

Figure B.17 – Cumulative Corrosion Over Time for Bath 3, 1.0% Chloride, Post-Cracked

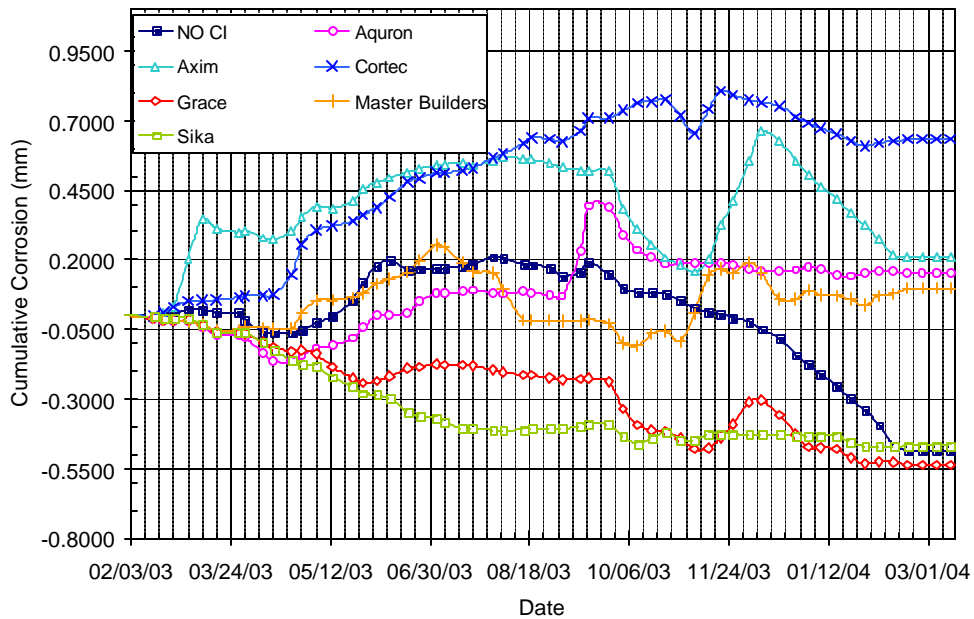

Figure B.18 – Cumulative Corrosion Over Time for Bath 3, 1.5% Chloride, Post-Cracked

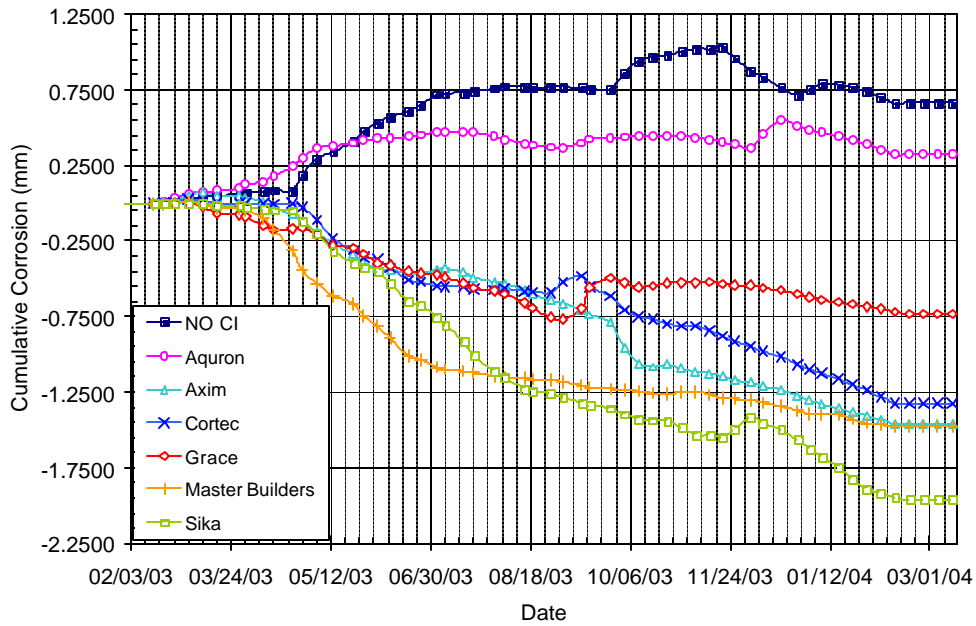

Figure B.19 – Cumulative Corrosion Over Time for Bath 3, 2.0% Chloride, Post-Cracked

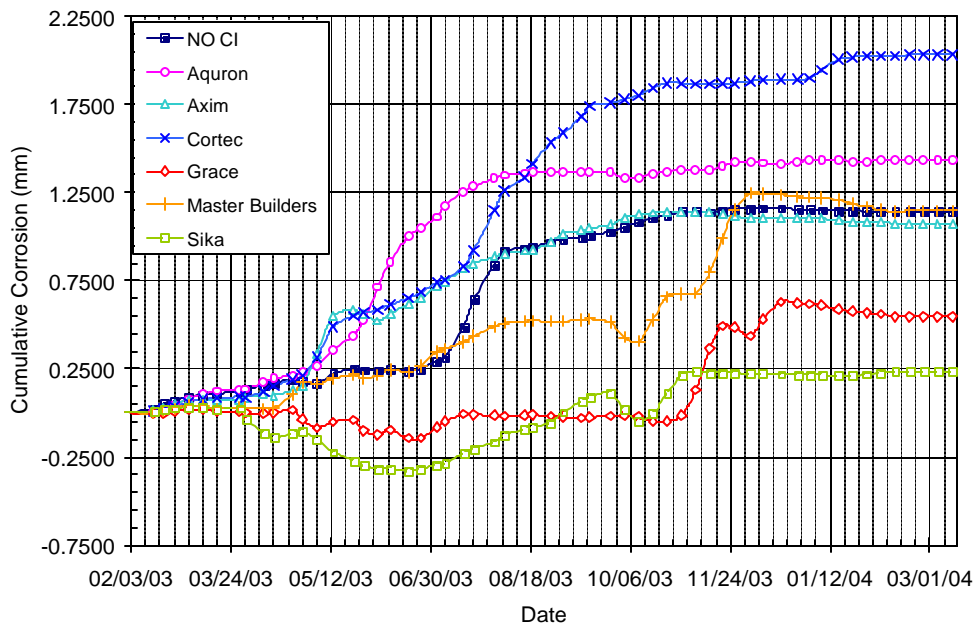

Figure B.20 – Cumulative Corrosion Over Time for Bath 3, 3.0% Chloride, Post-Cracked

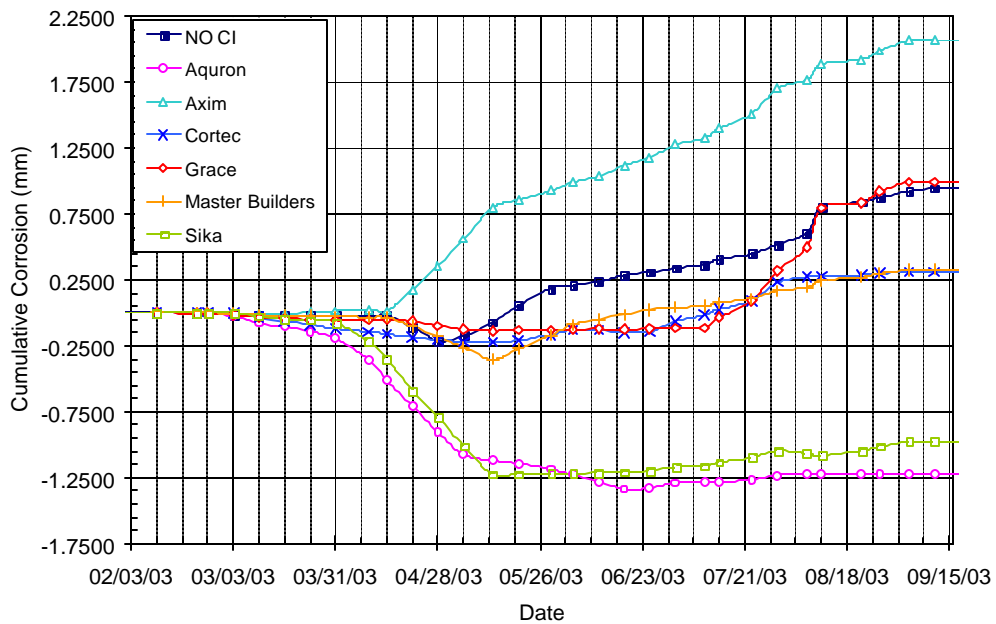

Figure B.21 – Cumulative Corrosion Over Time for Bath 4, 0.0% Chloride, Post-Cracked

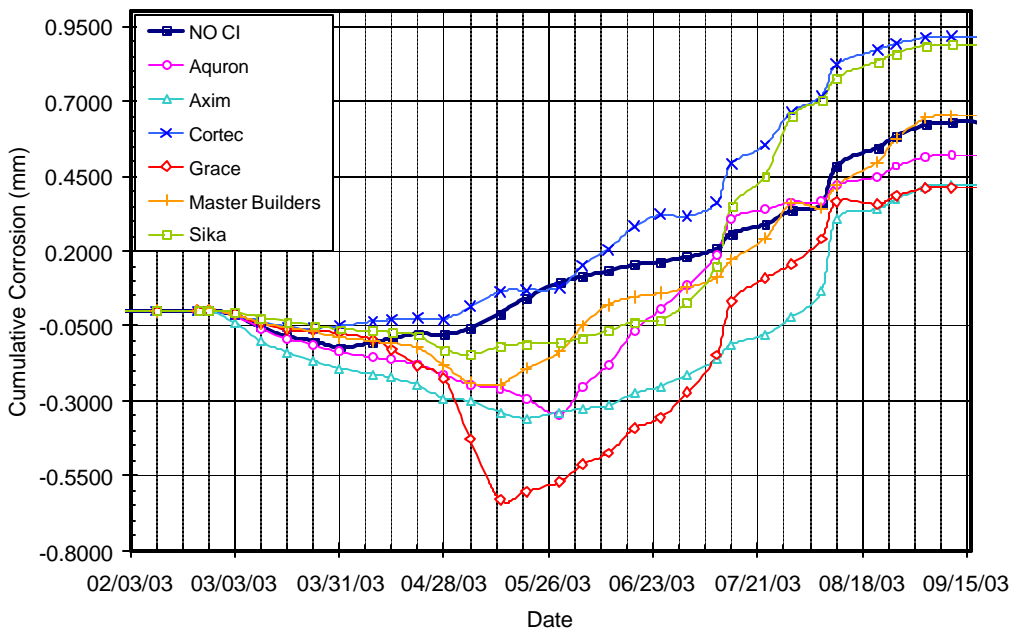

Figure B.22 – Cumulative Corrosion Over Time for Bath 4, 0.5% Chloride, Post-Cracked

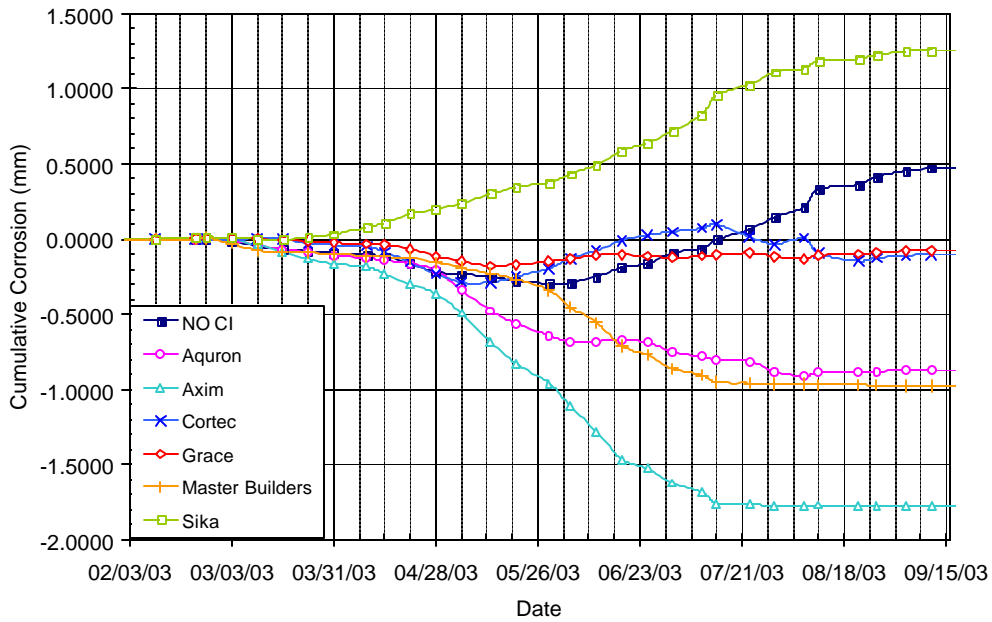

Figure B.23 – Cumulative Corrosion Over Time for Bath 4, 1.0% Chloride, Post-Cracked

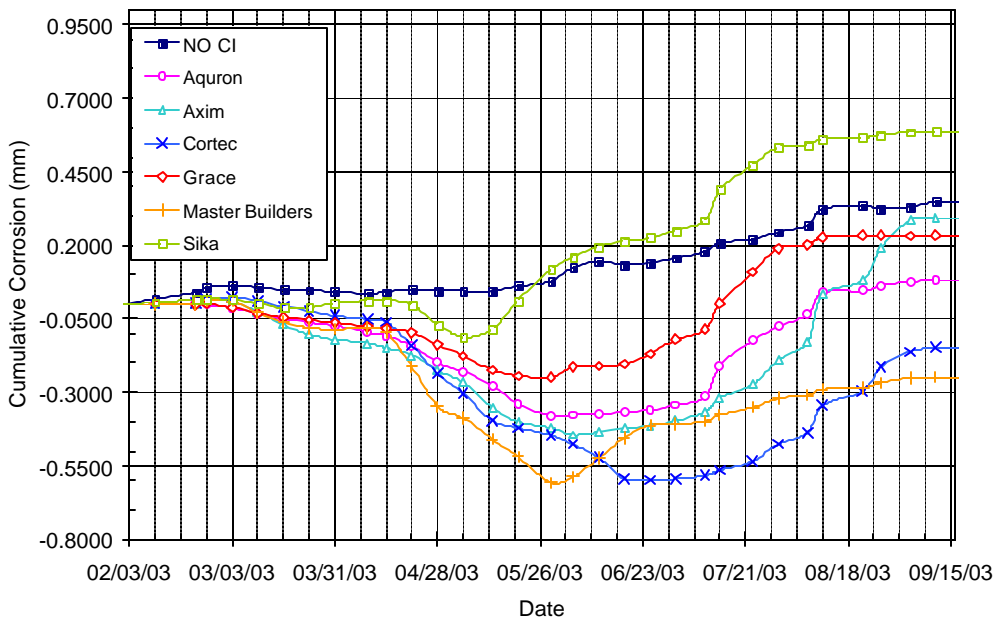

Figure B.24 – Cumulative Corrosion Over Time for Bath 4, 1.5% Chloride, Post-Cracked

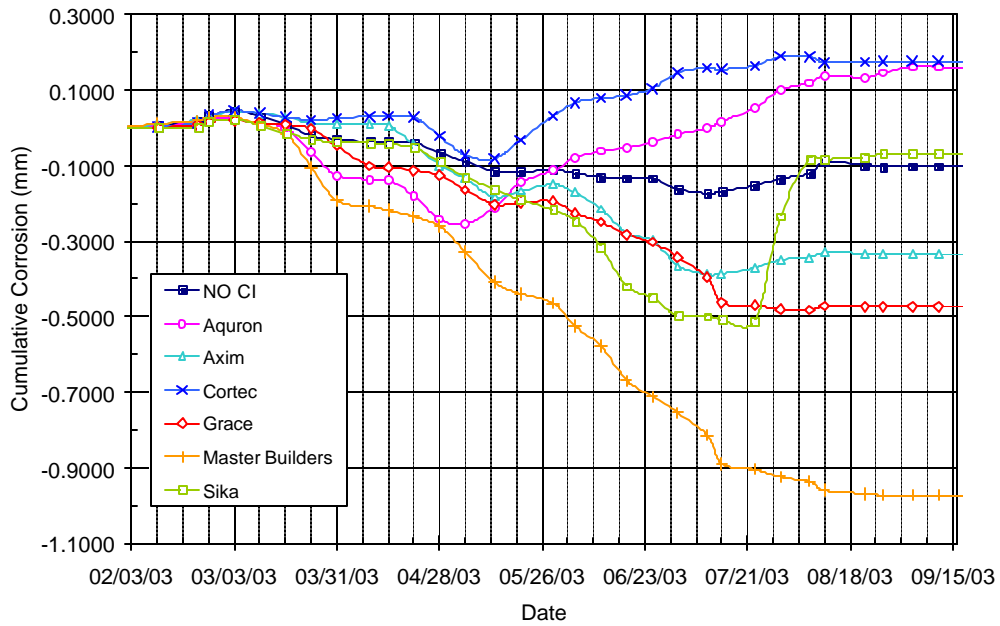

Figure B.25 – Cumulative Corrosion Over Time for Bath 4, 2.0% Chloride, Post-Cracked

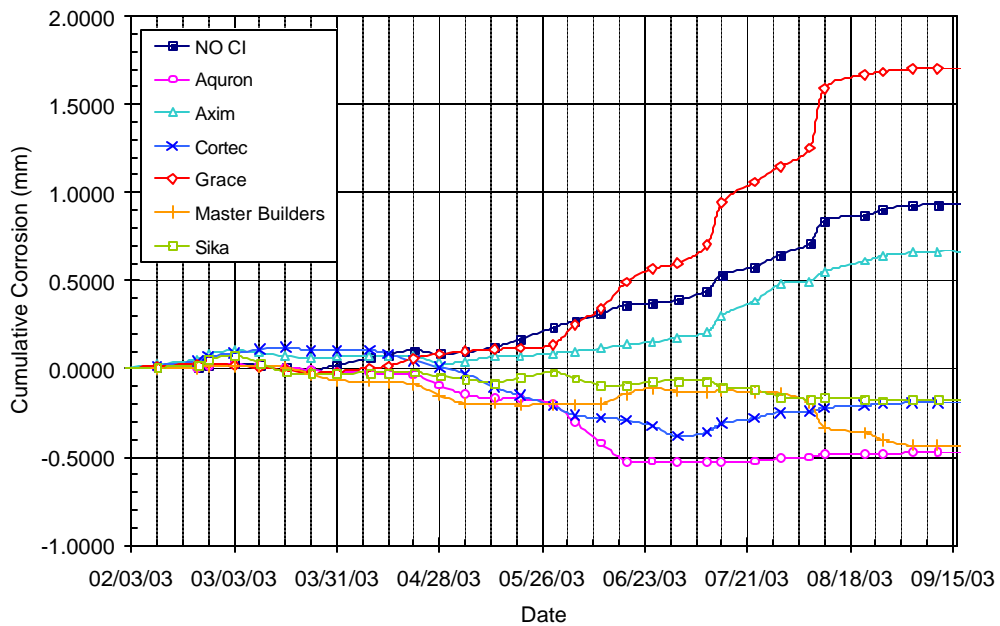

Figure B.26 – Cumulative Corrosion Over Time for Bath 4, 3.0% Chloride, Post-Cracked

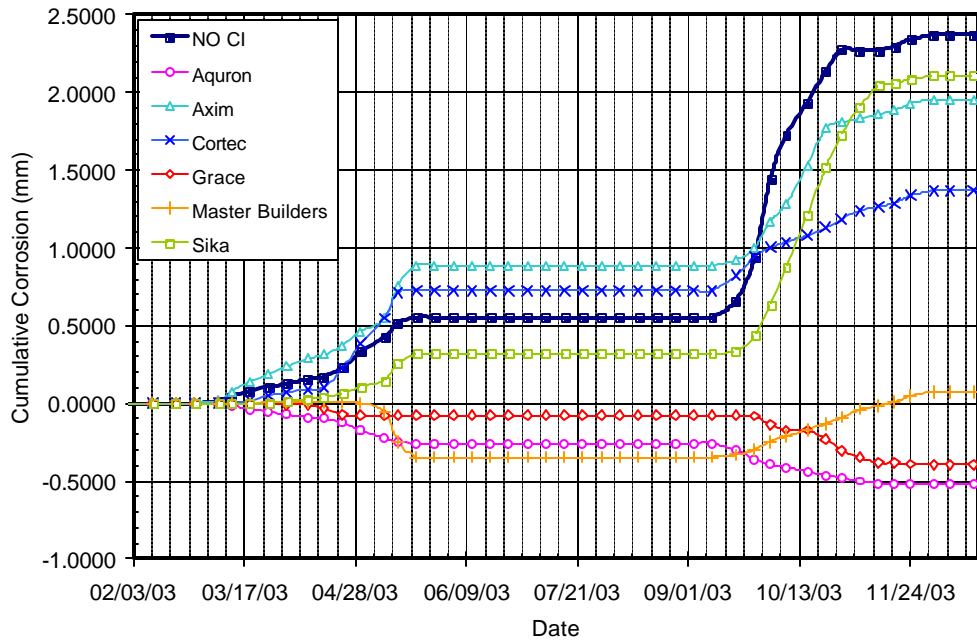

Figure B.27 – Cumulative Corrosion Over Time for Chamber Shelf 1, 0.0% Chloride, Post-Cracked

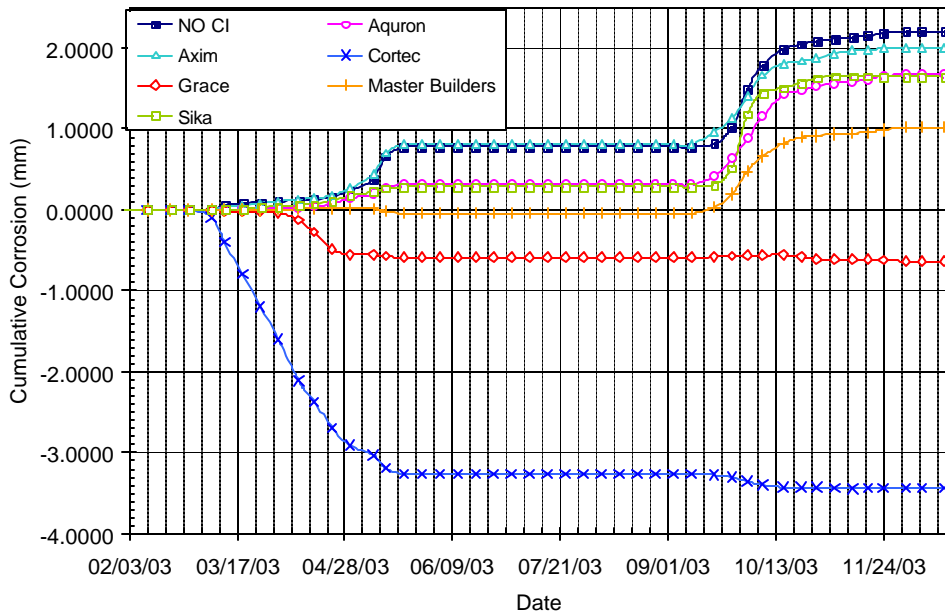

Figure B.28 – Cumulative Corrosion Over Time for Chamber Shelf 1, 0.5% Chloride, Post-Cracked

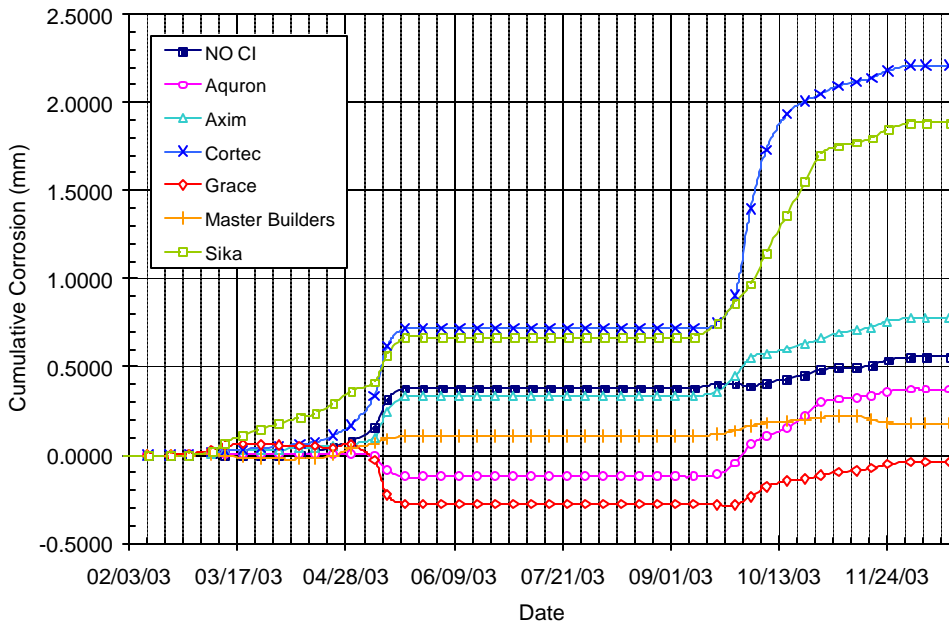

Figure B.29 – Cumulative Corrosion Over Time for Chamber Shelf 1, 1.0% Chloride, Post-Cracked

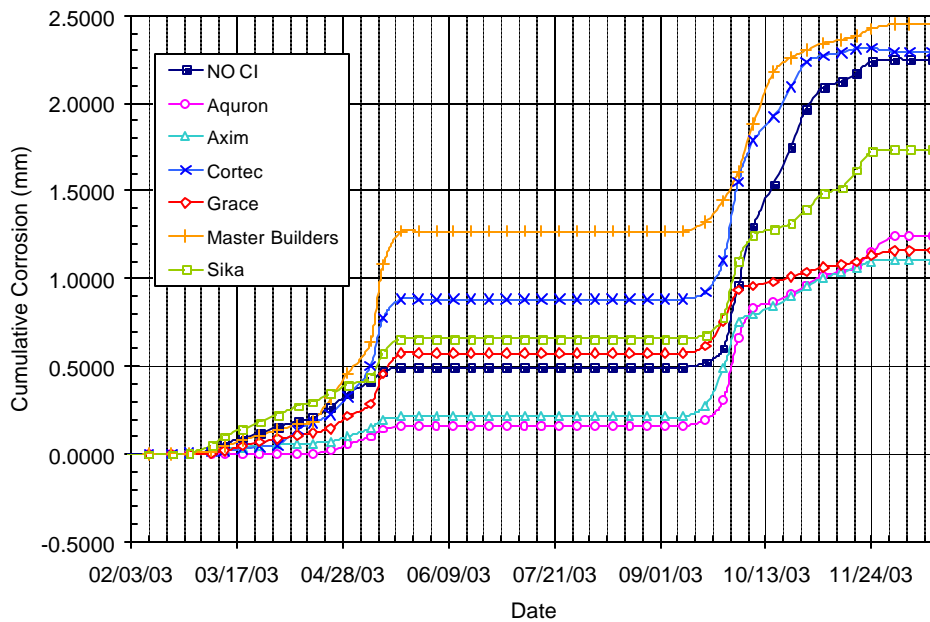

Figure B.30 – Cumulative Corrosion Over Time for Chamber Shelf 1, 1.5% Chloride, Post-Cracked

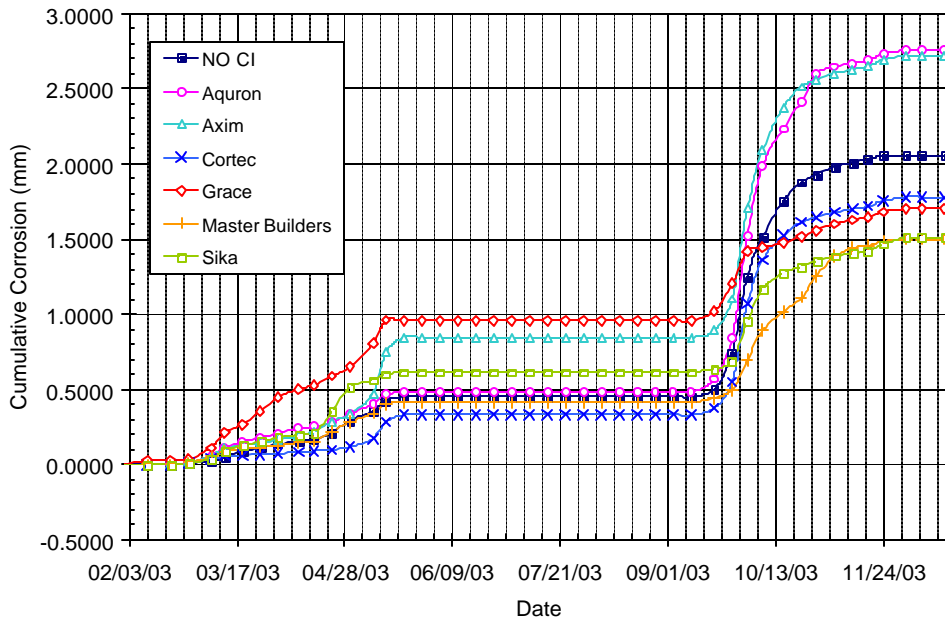

Figure B.31 – Cumulative Corrosion Over Time for Chamber Shelf 1, 2.0% Chloride, Post-Cracked

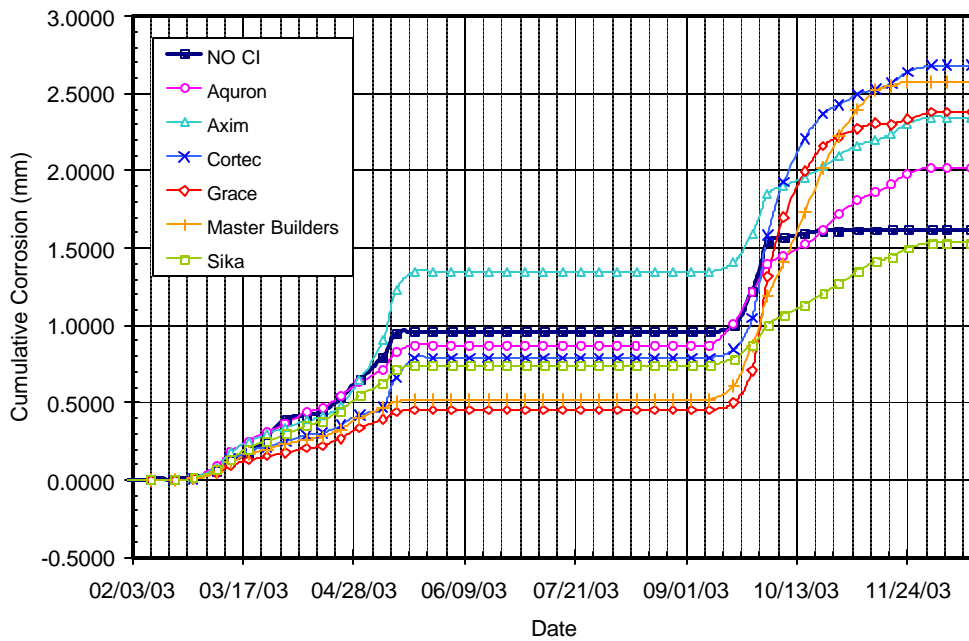

Figure B.32 – Cumulative Corrosion Over Time for Chamber Shelf 1, 3.0% Chloride, Post-Cracked

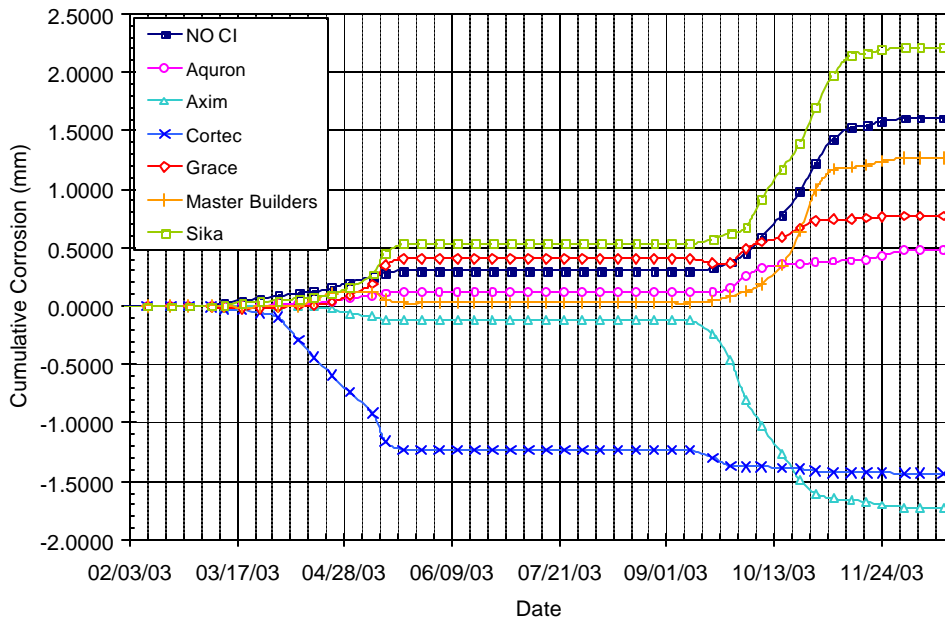

Figure B.33 – Cumulative Corrosion Over Time for Chamber Shelf 2, 0.0% Chloride, Pre-Cracked

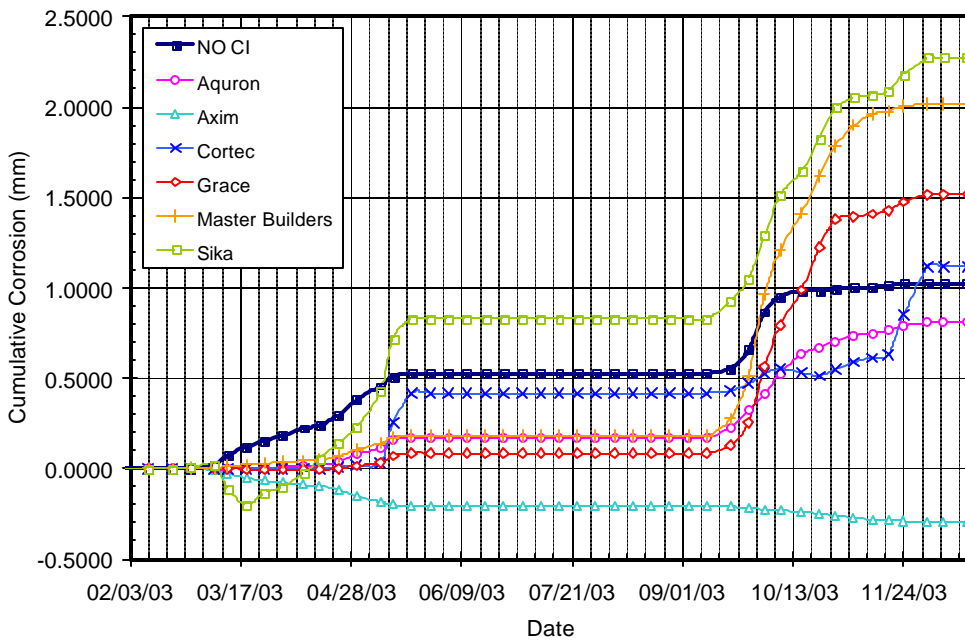

Figure B.34 – Cumulative Corrosion Over Time for Chamber Shelf 2, 0.5% Chloride, Pre-Cracked

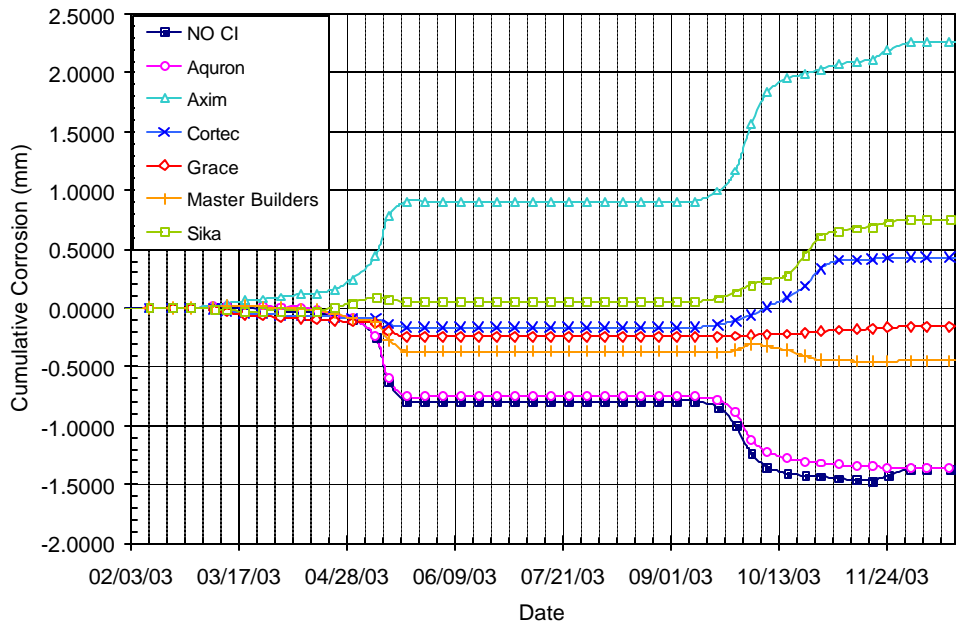

Figure B.35 – Cumulative Corrosion Over Time for Chamber Shelf 2, 1.0% Chloride, Pre-Cracked

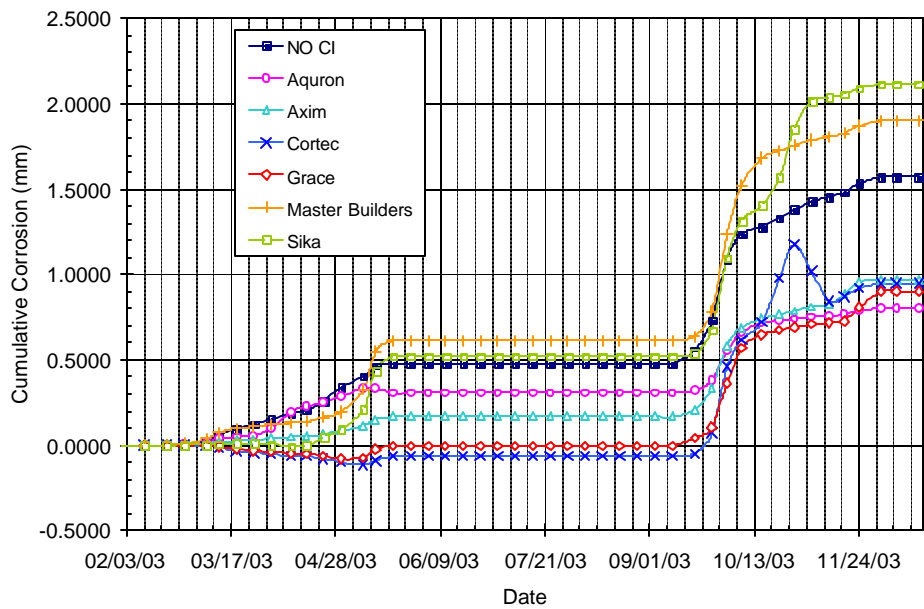

Figure B.36 – Cumulative Corrosion Over Time for Chamber Shelf 2, 1.5% Chloride, Pre-Cracked

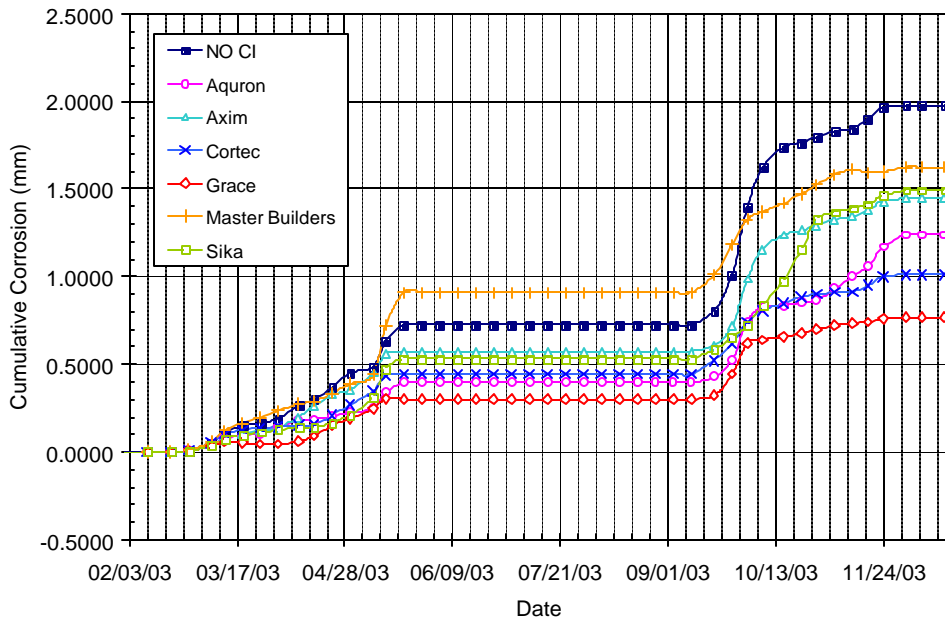

Figure B.37 – Cumulative Corrosion Over Time for Chamber Shelf 2, 2.0% Chloride, Pre-Cracked

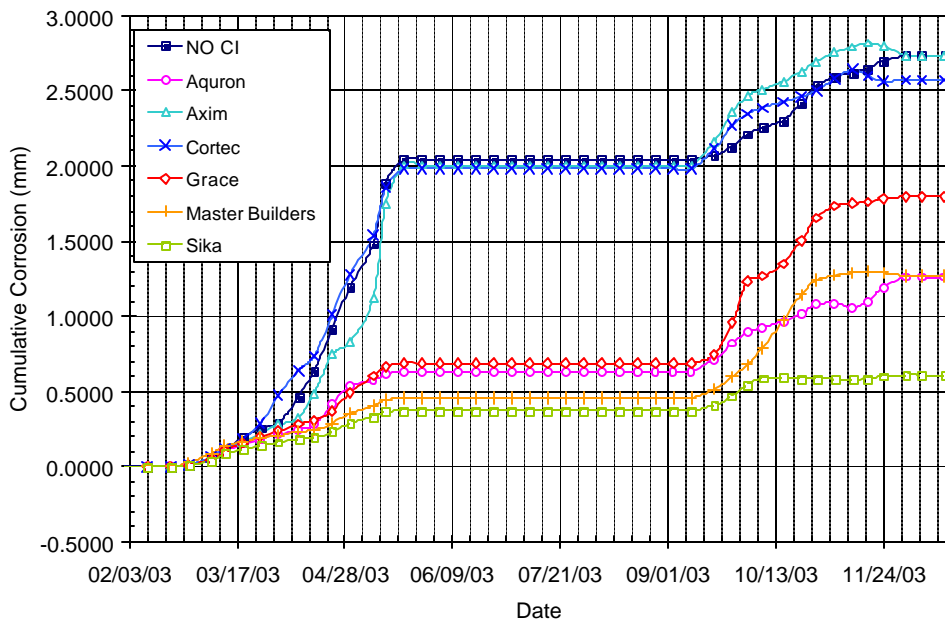

Figure B.38 – Cumulative Corrosion Over Time for Chamber Shelf 2, 3.0% Chloride, Pre-Cracked

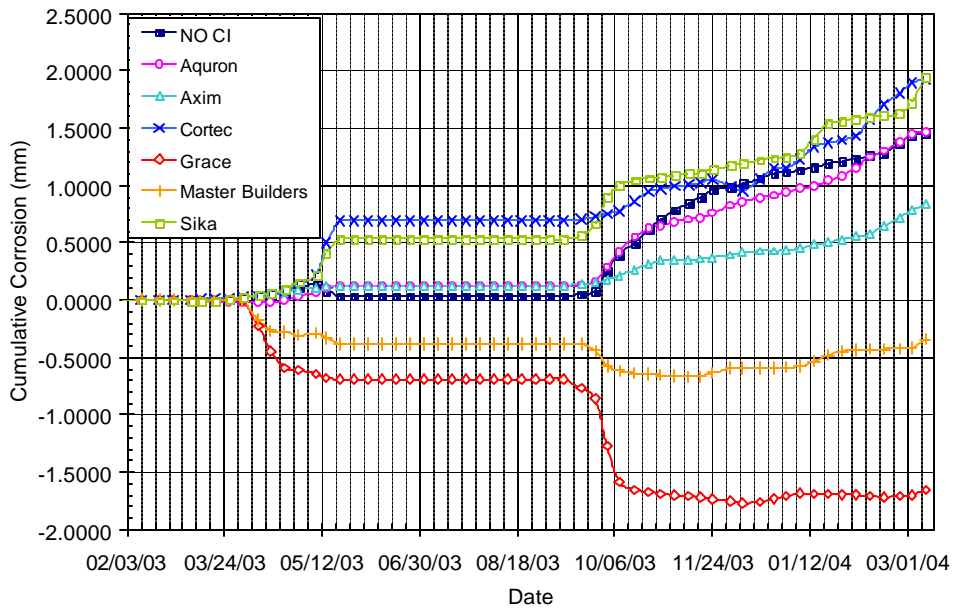

Figure B.39 – Cumulative Corrosion Over Time for Chamber Shelf 3, 0.0% Chloride, Post-Cracked

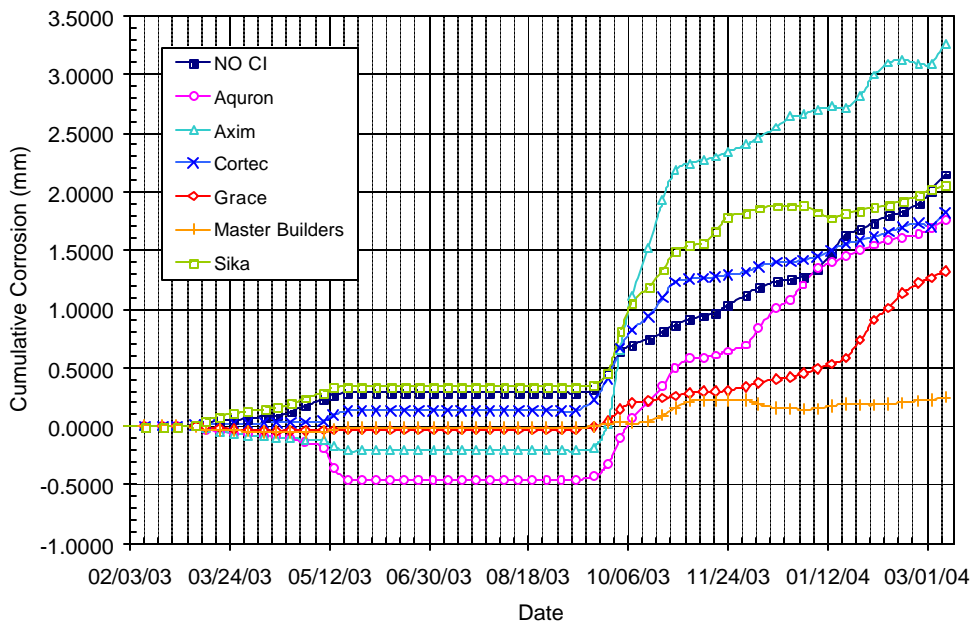

Figure B.40 – Cumulative Corrosion Over Time for Chamber Shelf 3, 0.5% Chloride, Post-Cracked

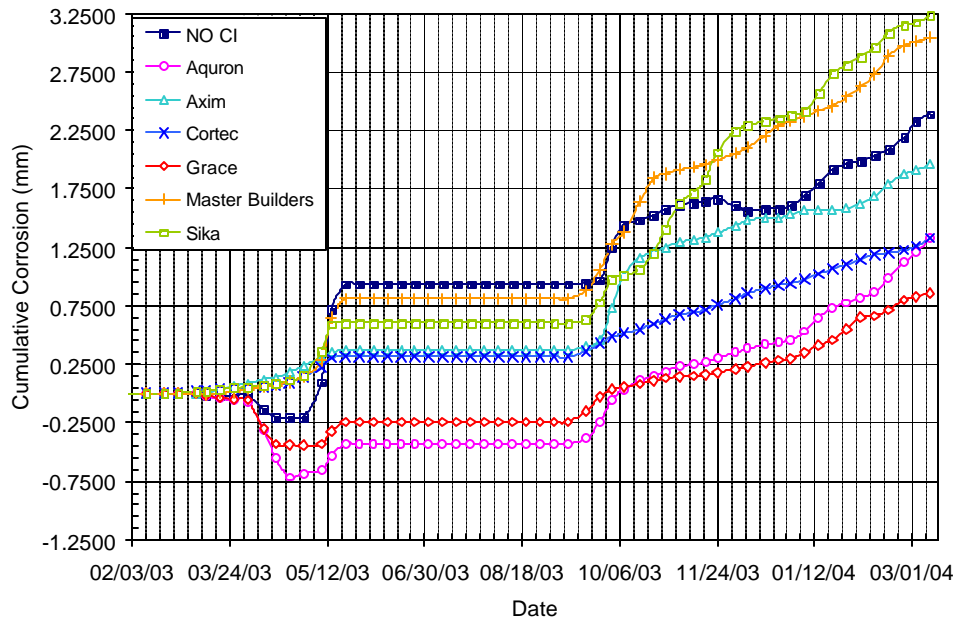

Figure B.41 – Cumulative Corrosion Over Time for Chamber Shelf 3, 1.0% Chloride, Post-Cracked

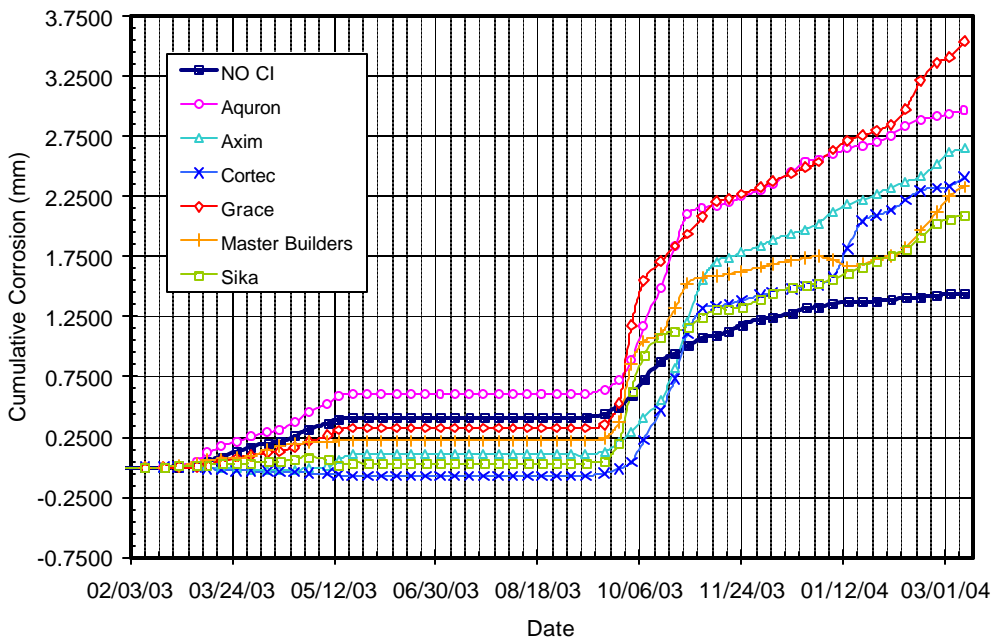

Figure B.42 – Cumulative Corrosion Over Time for Chamber Shelf 3, 1.5% Chloride, Post-Cracked

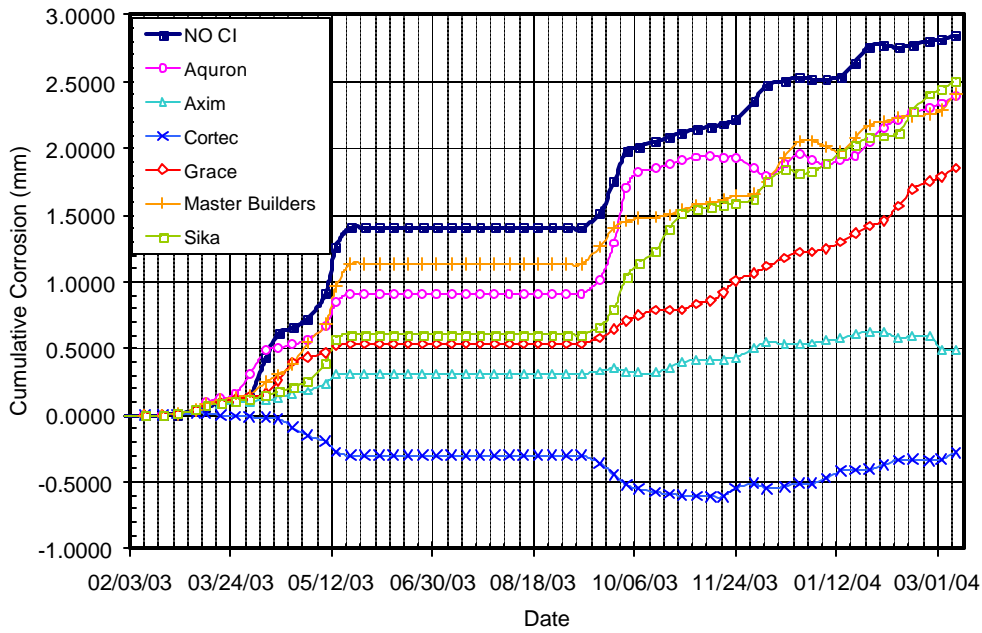

Figure B.43 – Cumulative Corrosion Over Time for Chamber Shelf 3, 2.0% Chloride, Post-Cracked

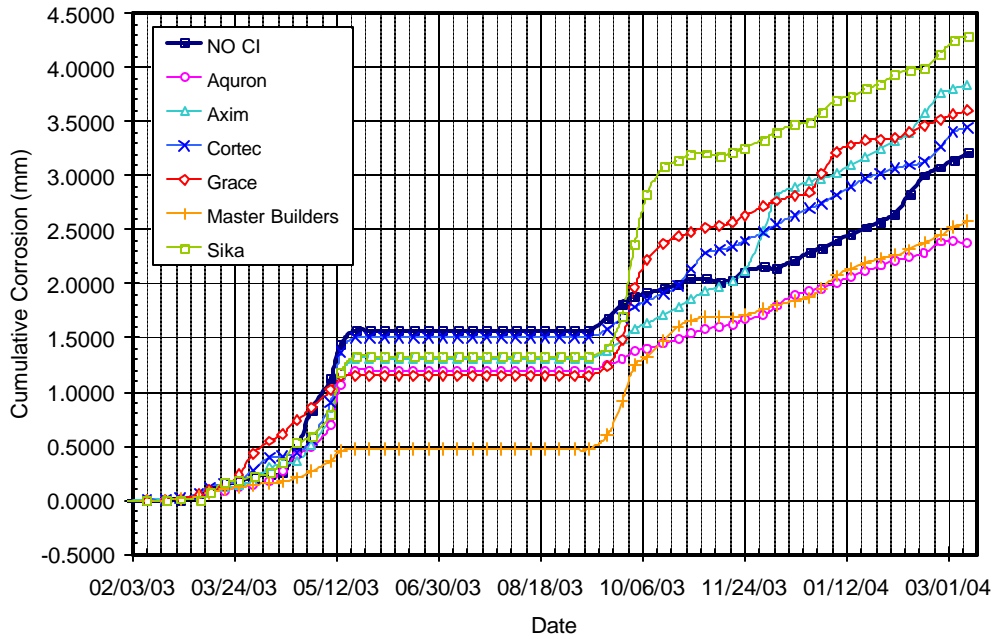

Figure B.44 – Cumulative Corrosion Over Time for Chamber Shelf 3, 3.0% Chloride, Post-Cracked

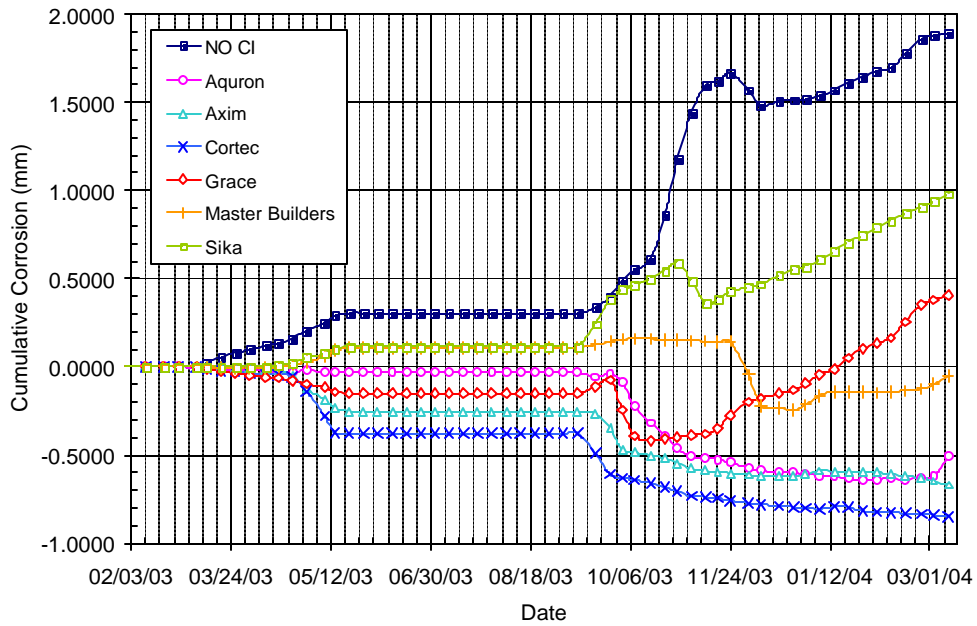

Figure B.45 – Cumulative Corrosion Over Time for Chamber Shelf 4, 0.0% Chloride, Pre-Cracked

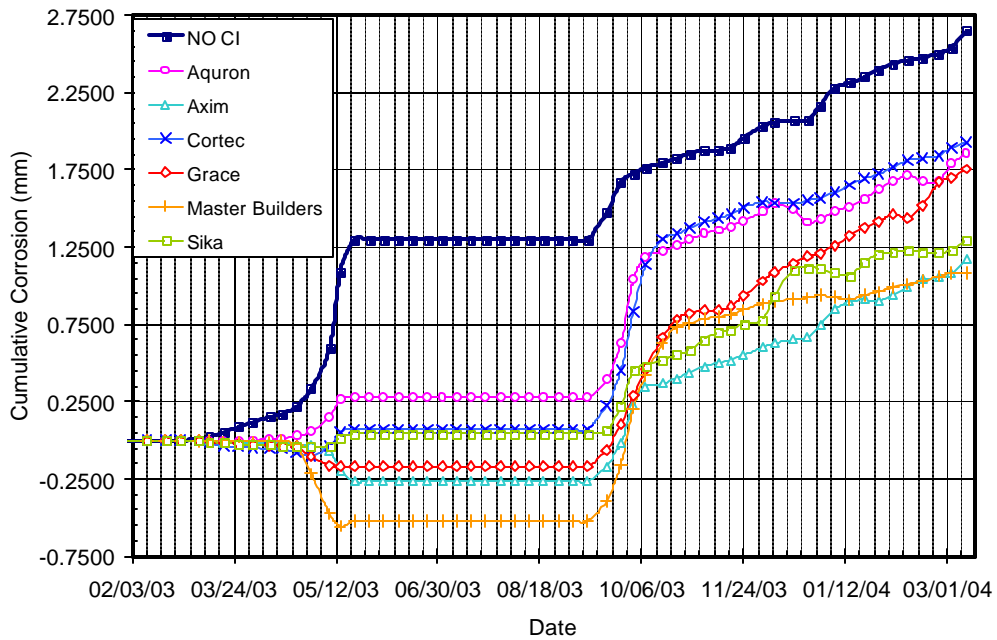

Figure B.46 – Cumulative Corrosion Over Time for Chamber Shelf 4, 0.5% Chloride, Pre-Cracked

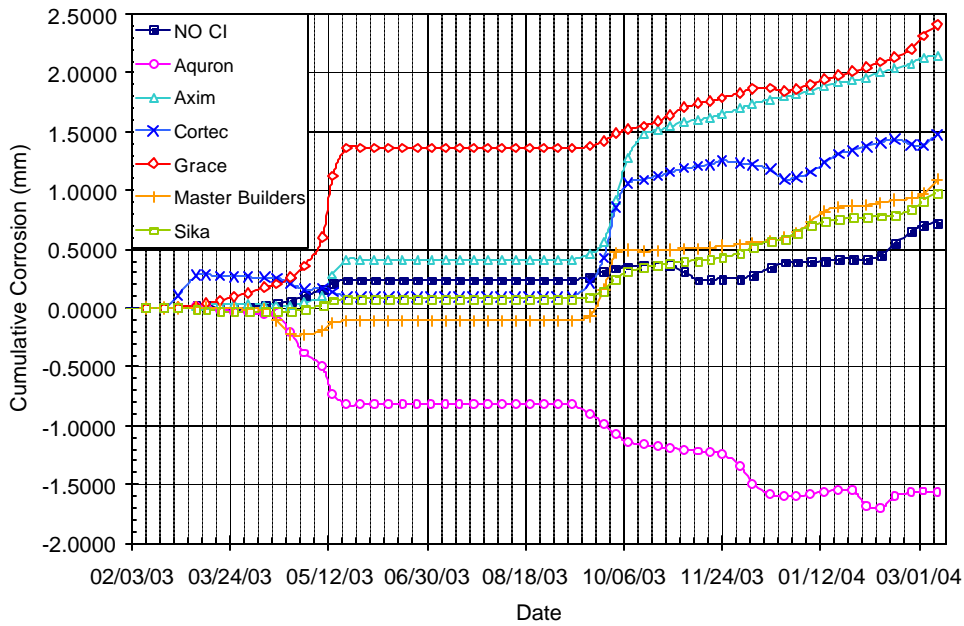

Figure B.47 – Cumulative Corrosion Over Time for Chamber Shelf 4, 1.0% Chloride, Pre-Cracked

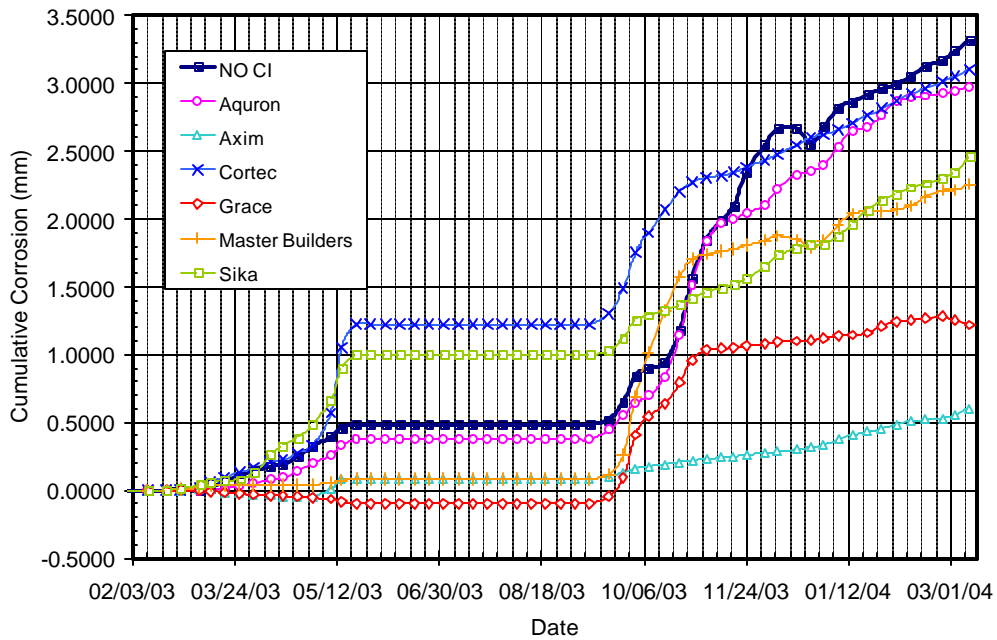

Figure B.48 – Cumulative Corrosion Over Time for Chamber Shelf 4, 1.5% Chloride, Pre-Cracked

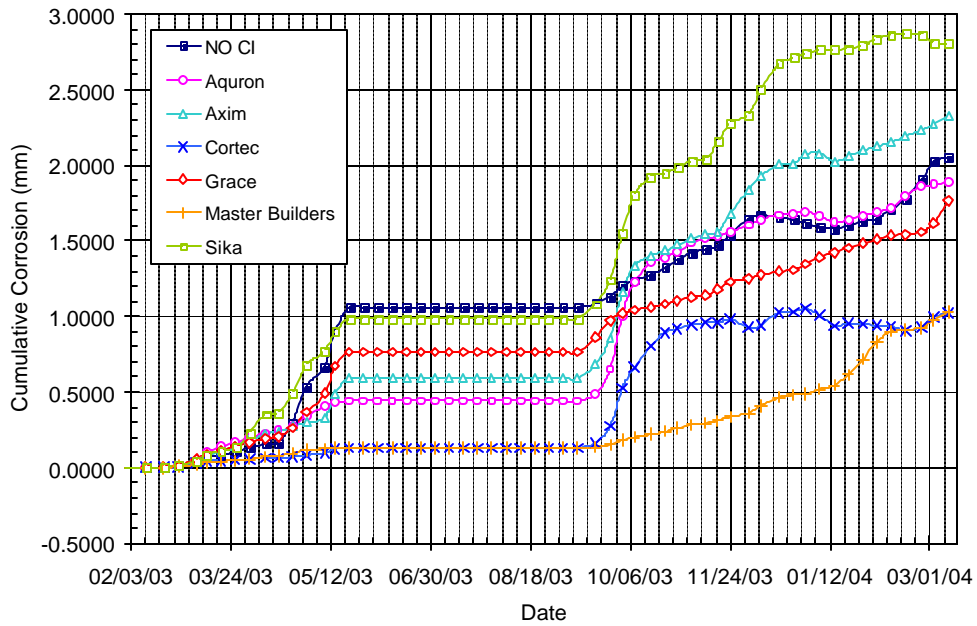

Figure B.49 – Cumulative Corrosion Over Time for Chamber Shelf 4, 2.0% Chloride, Pre-Cracked

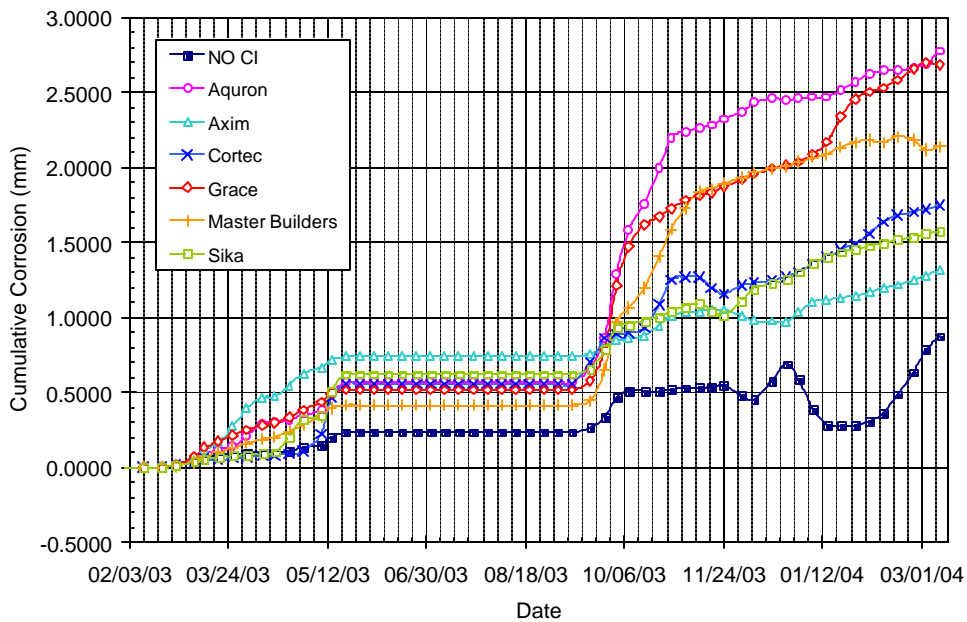

Figure B.50 – Cumulative Corrosion Over Time for Chamber Shelf 4, 3.0% Chloride, Pre-Cracked

APPENDIX C. HALF CELL POTENTIAL GRAPHS

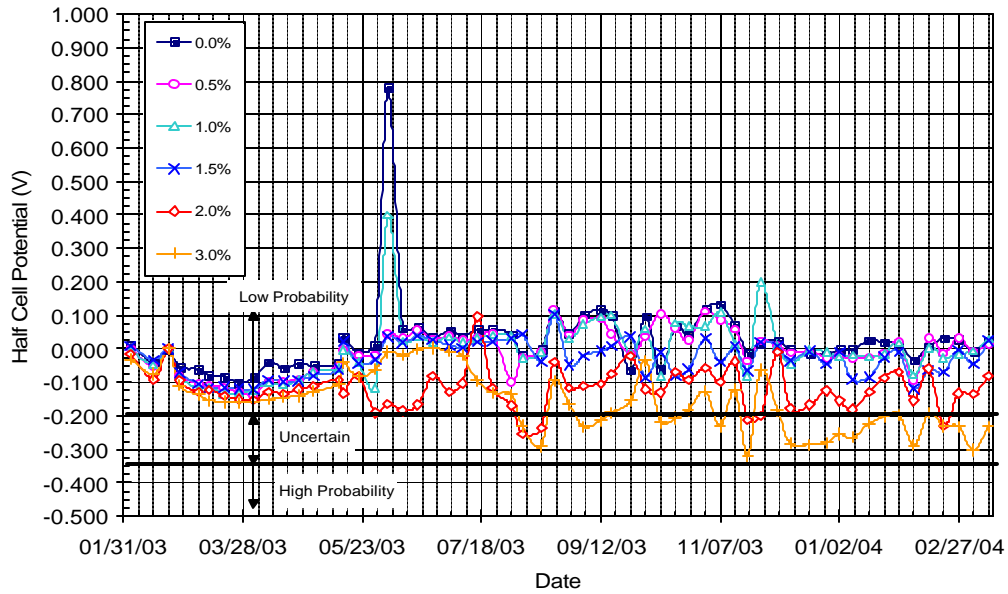

Figure C.1 – Half Cell Potential Readings for Control Set #1

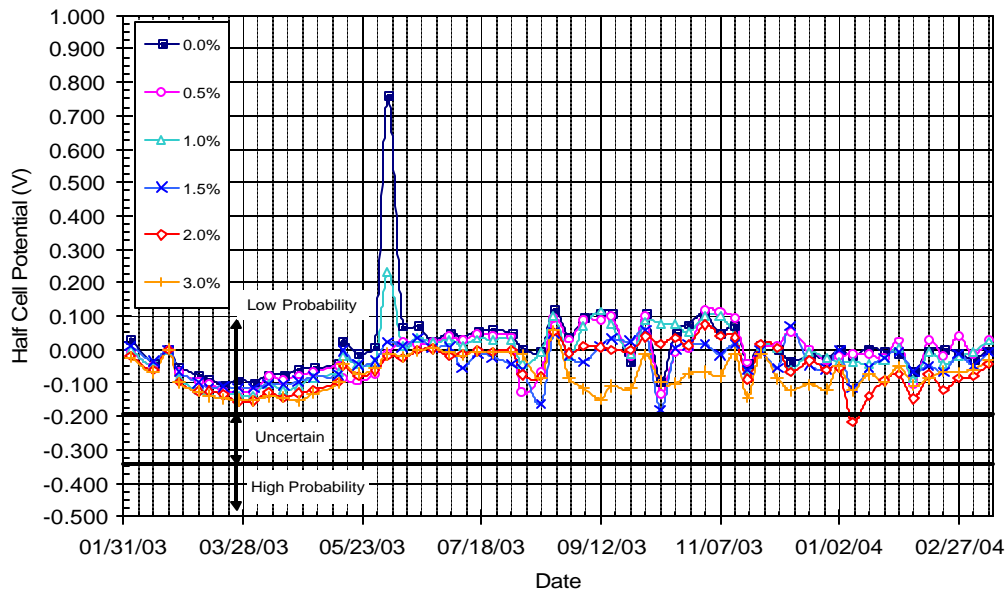

Figure C.2 – Half Cell Potential Readings for Control Set #2

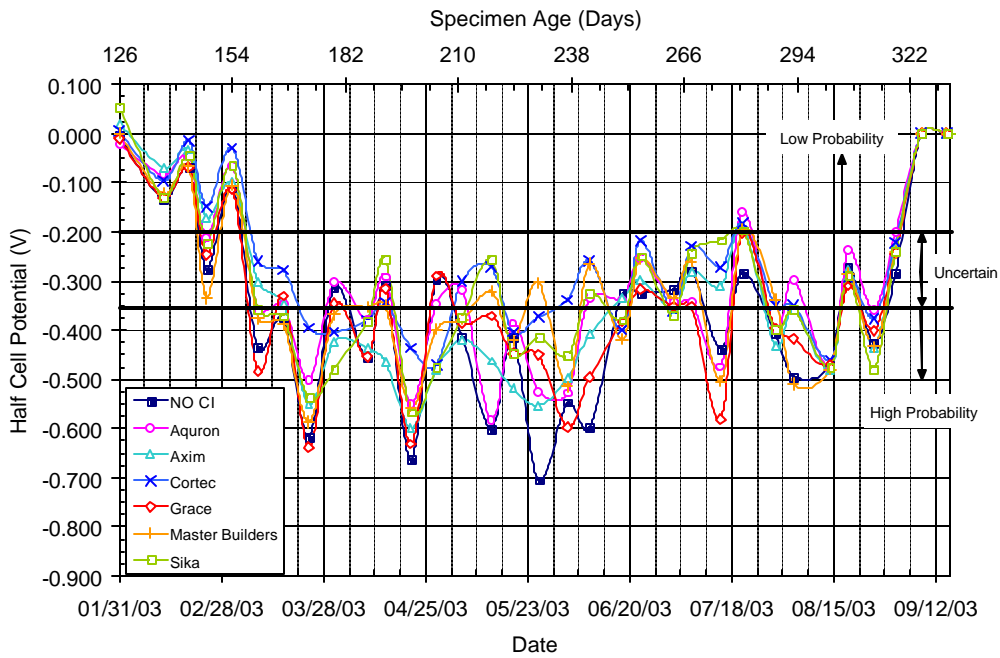

Figure C.3 – Half Cell Potential Readings for Bath 1, 0.0% Chloride, Pre-Cracked

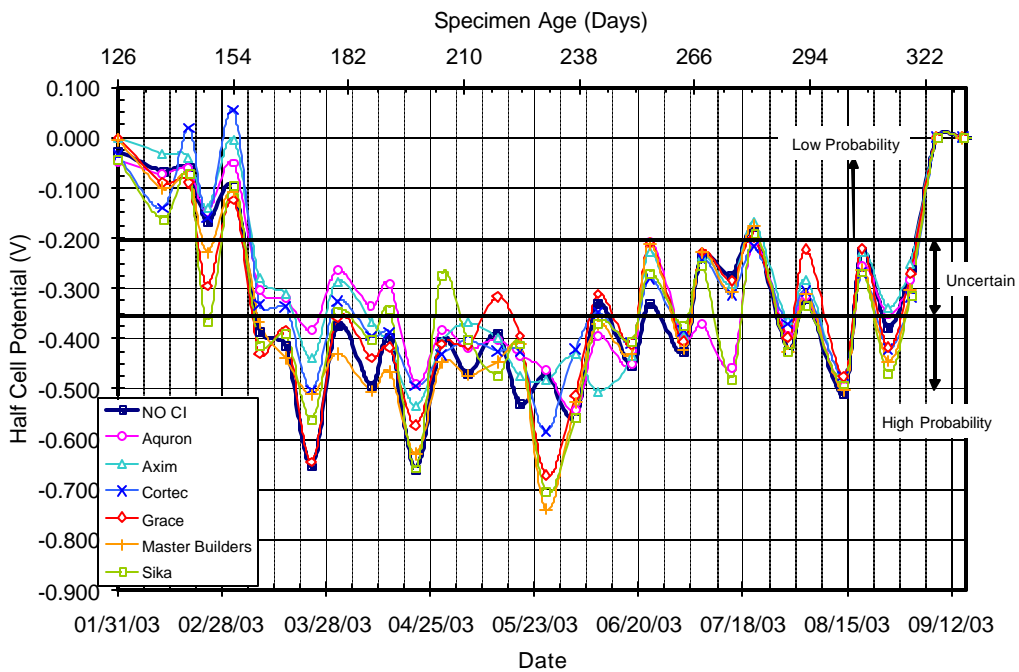

Figure C.4 – Half Cell Potential Readings for Bath 1, 0.5% Chloride, Pre-Cracked

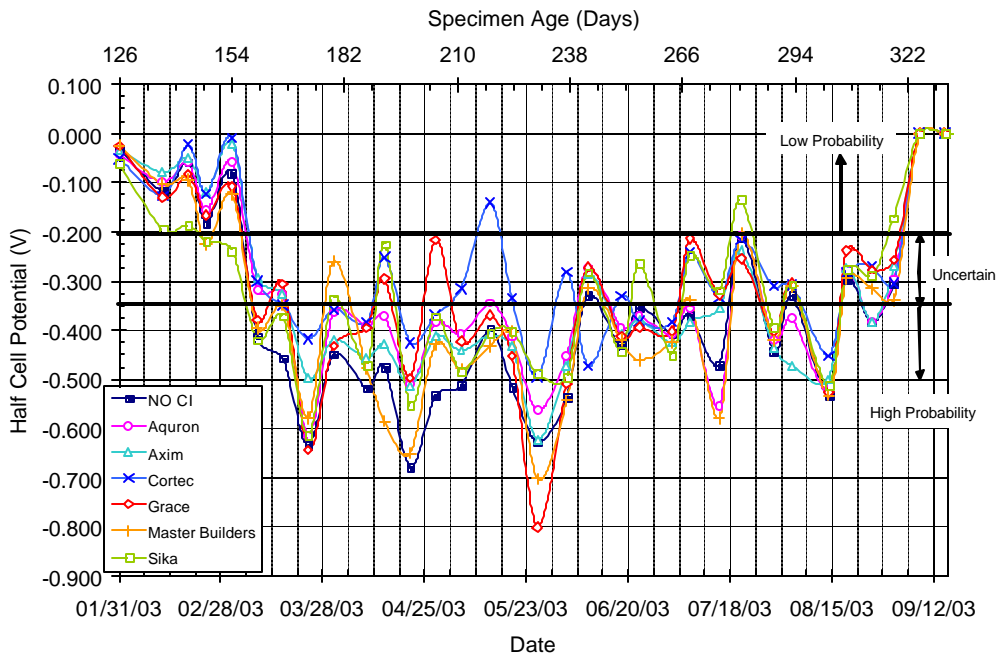

Figure C.5 – Half Cell Potential Readings for Bath 1, 1.0% Chloride, Pre-Cracked

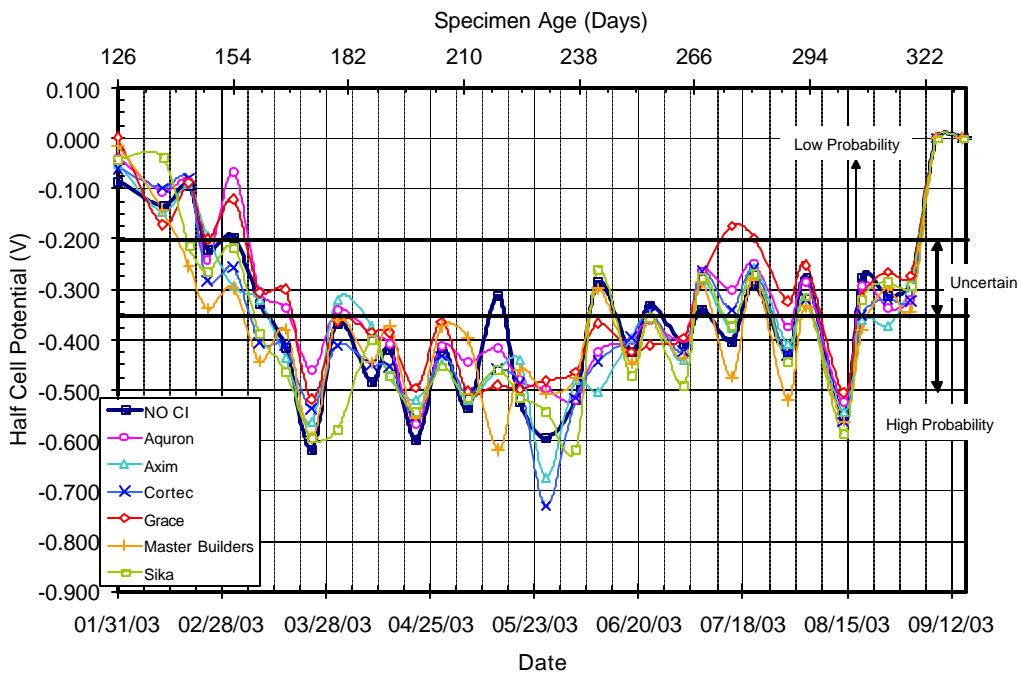

Figure C.6 – Half Cell Potential Readings for Bath 1, 1.5% Chloride, Pre-Cracked

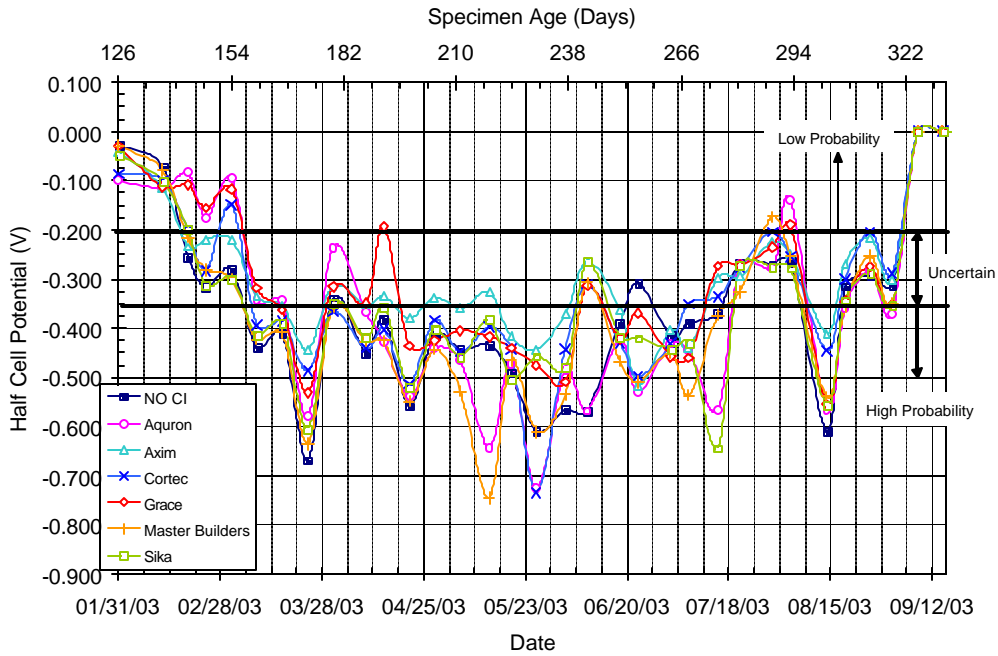

Figure C.7 – Half Cell Potential Readings for Bath 1, 2.0% Chloride, Pre-Cracked

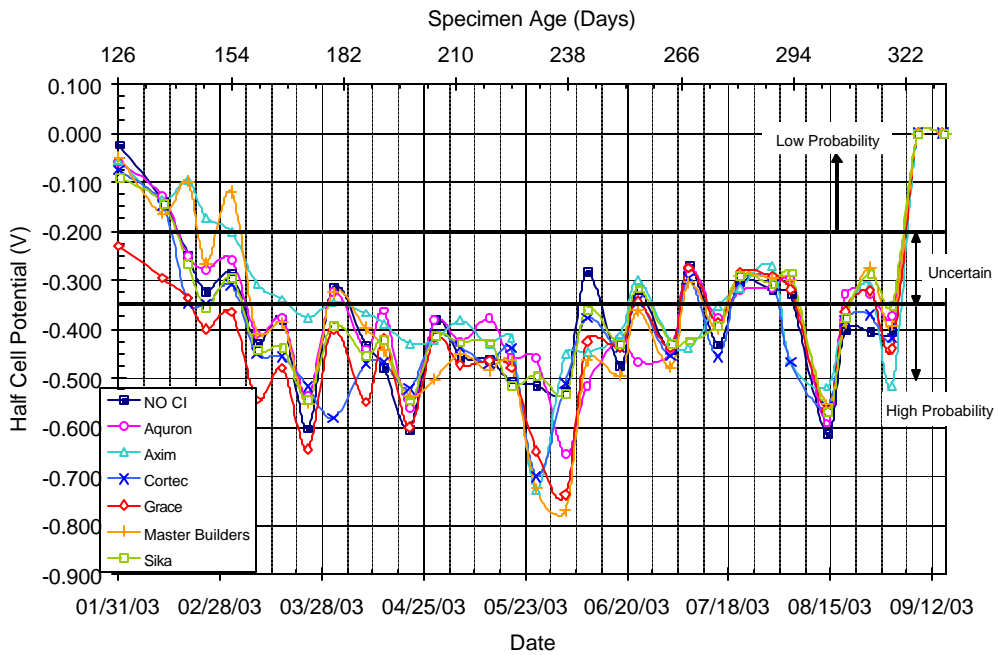

Figure C.8 – Half Cell Potential Readings for Bath 1, 3.0% Chloride, Pre-Cracked

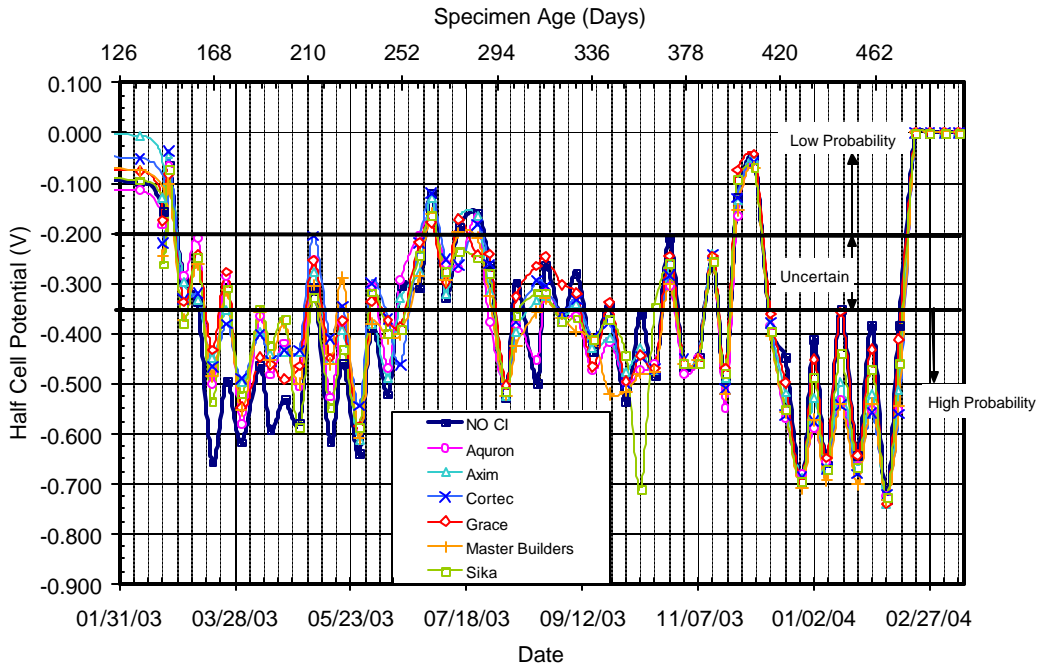

Figure C.9 – Half Cell Potential Readings for Bath 2, 0.0% Chloride, Pre-Cracked

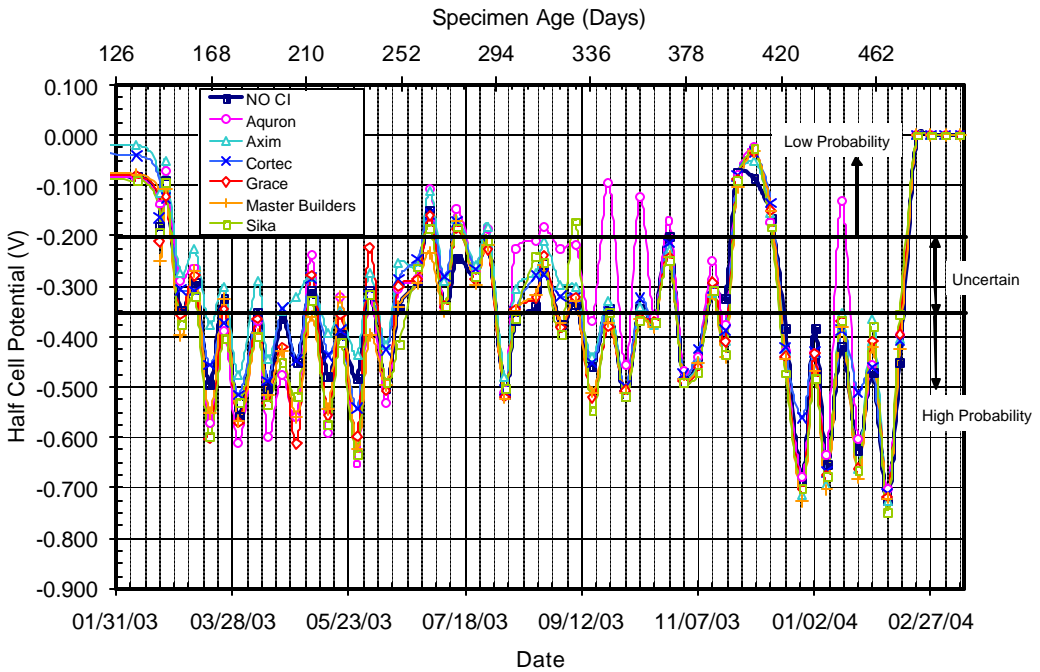

Figure C.10 – Half Cell Potential Readings for Bath 2, 0.5% Chloride, Pre-Cracked

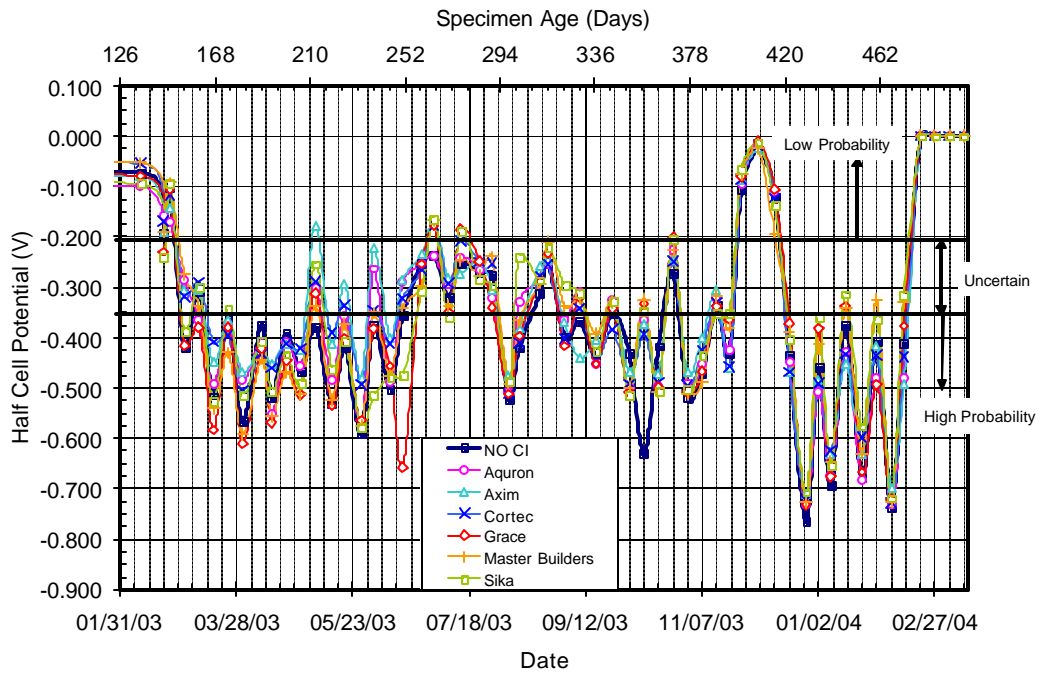

Figure C.11 – Half Cell Potential Readings for Bath 2, 1.0% Chloride, Pre-Cracked

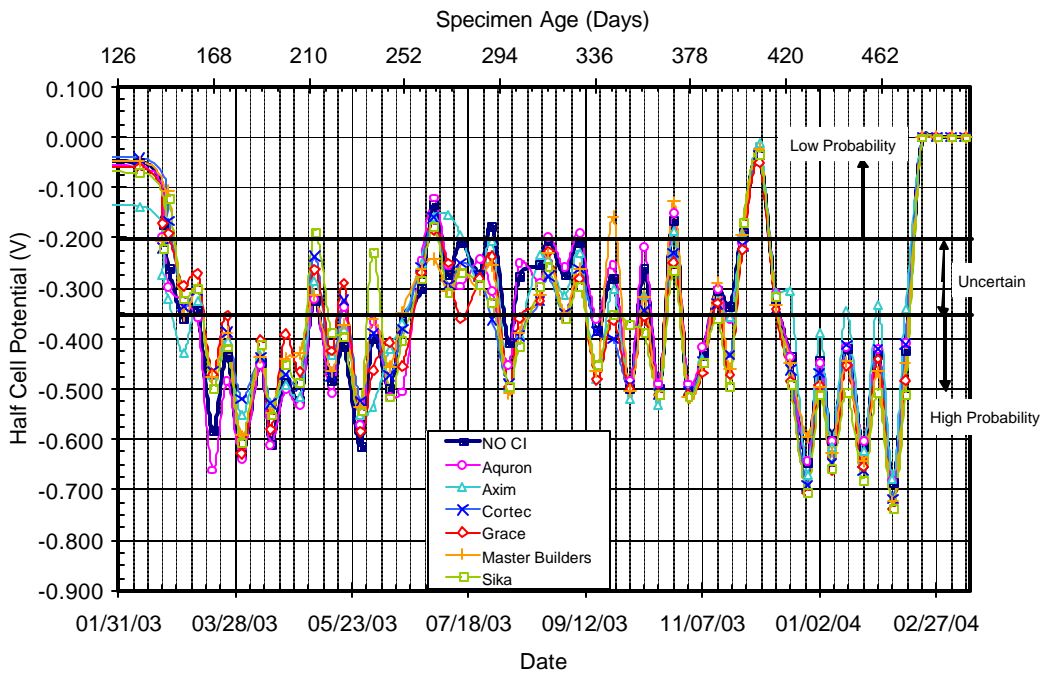

Figure C.12 – Half Cell Potential Readings for Bath 2, 1.5% Chloride, Pre-Cracked

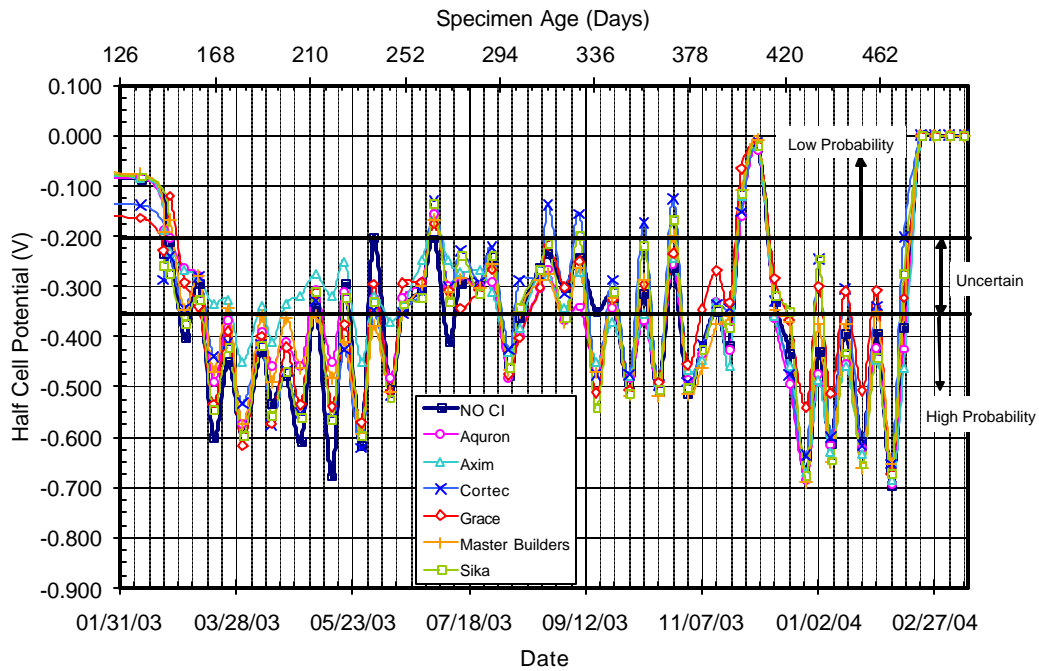

Figure C.13 – Half Cell Potential Readings for Bath 2, 2.0% Chloride, Pre-Cracked

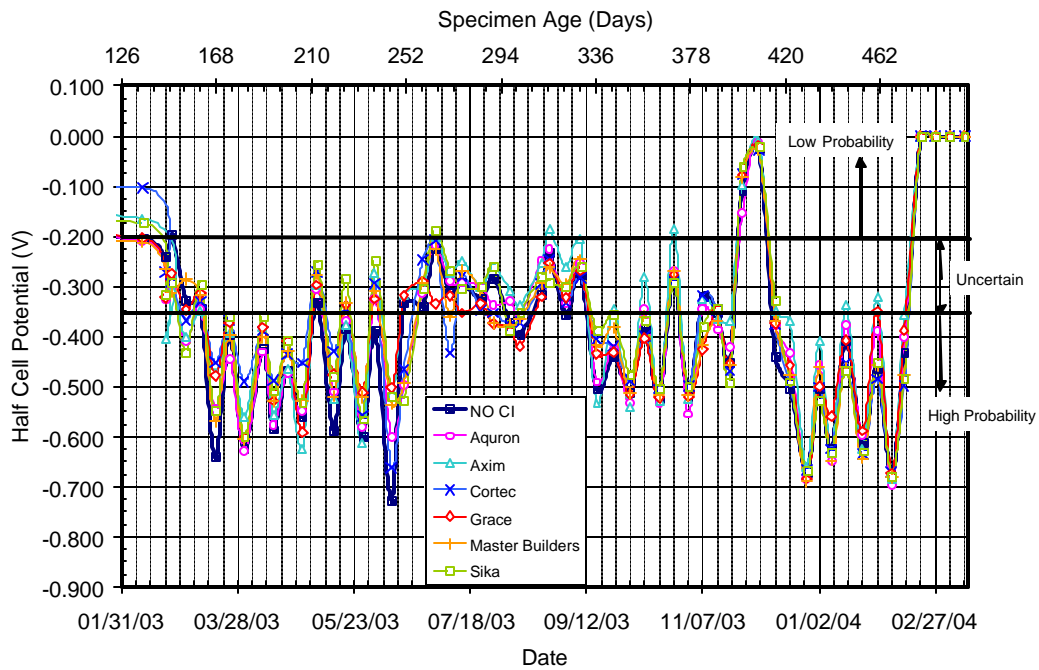

Figure C.14 – Half Cell Potential Readings for Bath 2, 3.0% Chloride, Pre-Cracked

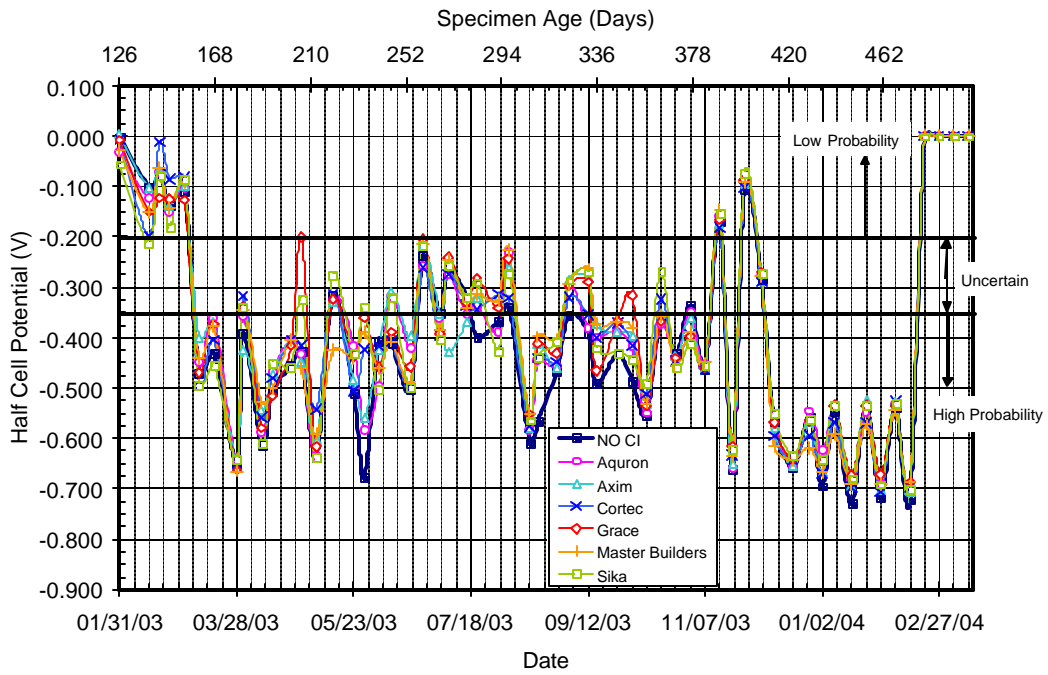

Figure C.15 – Half Cell Potential Readings for Bath 3, 0.0% Chloride, Post-Cracked

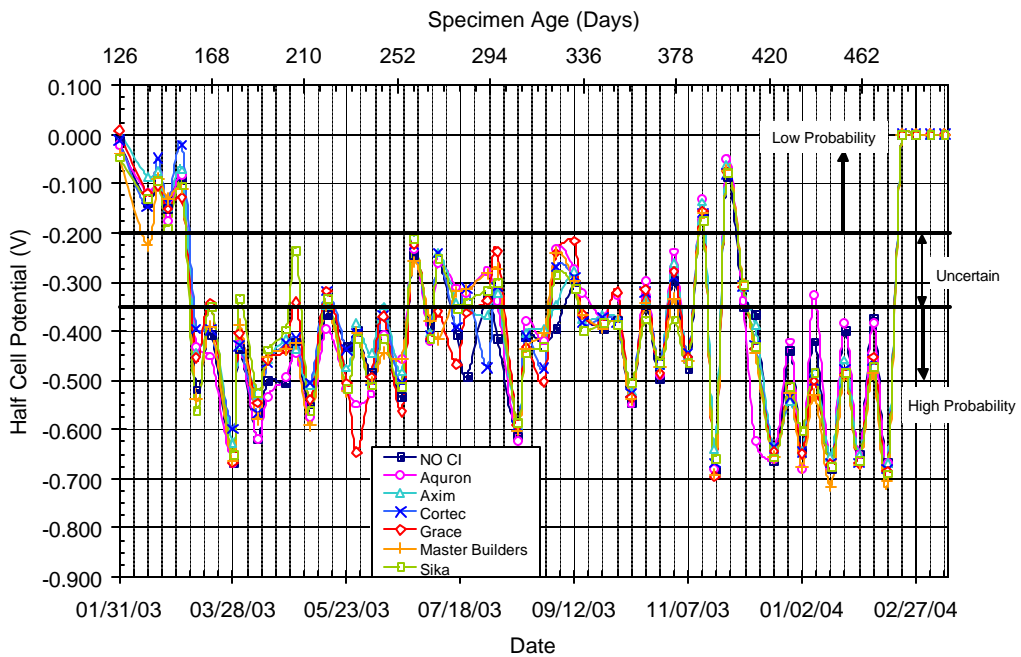

Figure C.16 – Half Cell Potential Readings for Bath 3, 0.5% Chloride, Post-Cracked

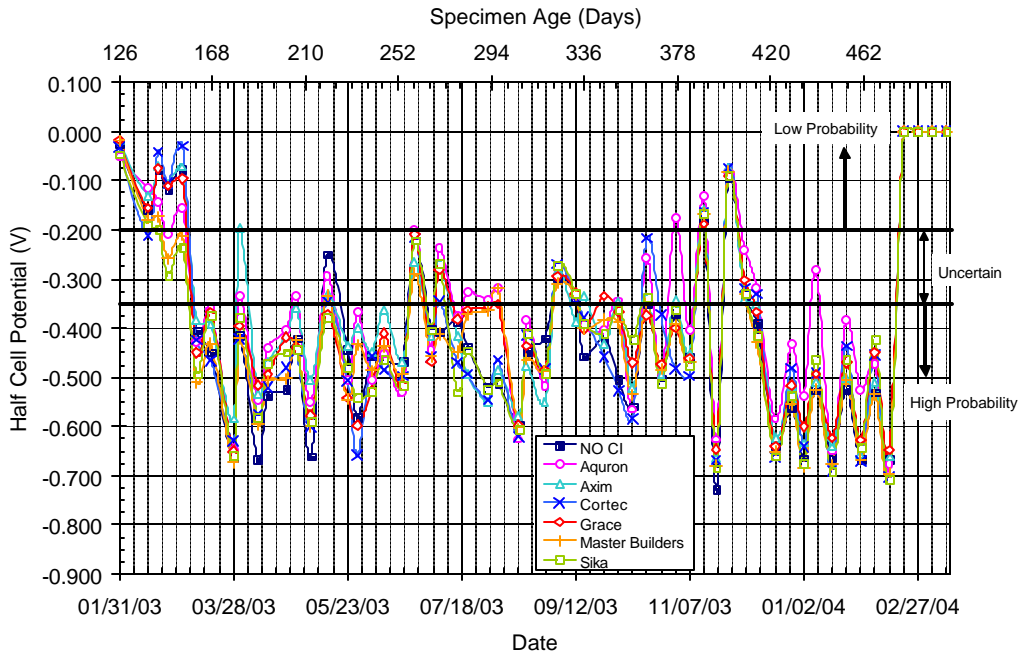

Figure C.17 – Half Cell Potential Readings for Bath 3, 1.5% Chloride, Post-Cracked

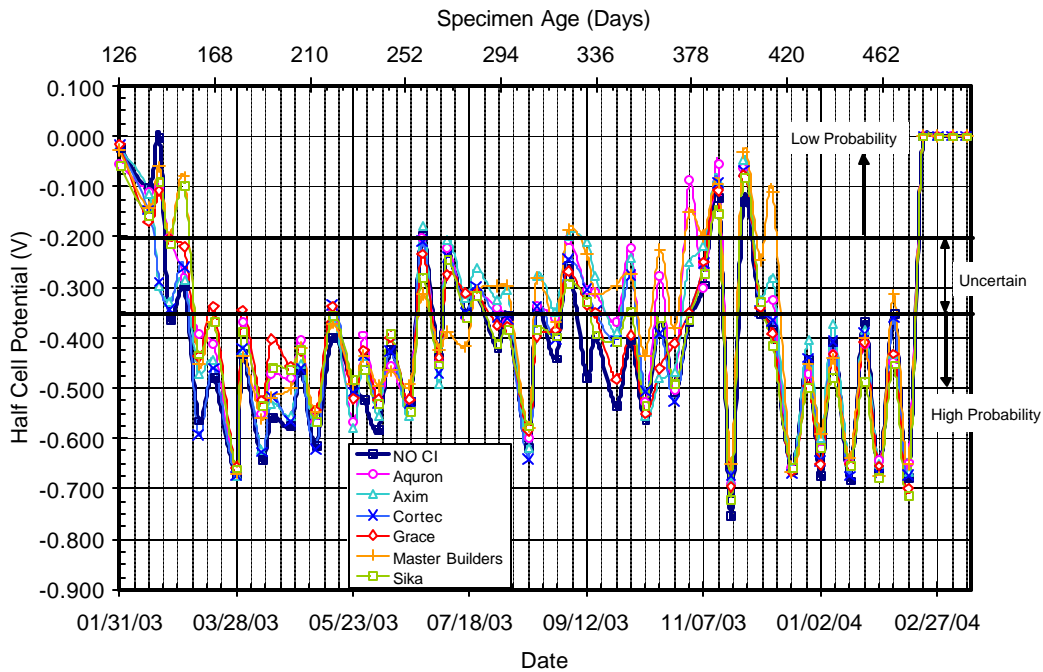

Figure C.18 – Half Cell Potential Readings for Bath 3, 1.5% Chloride, Post-Cracked

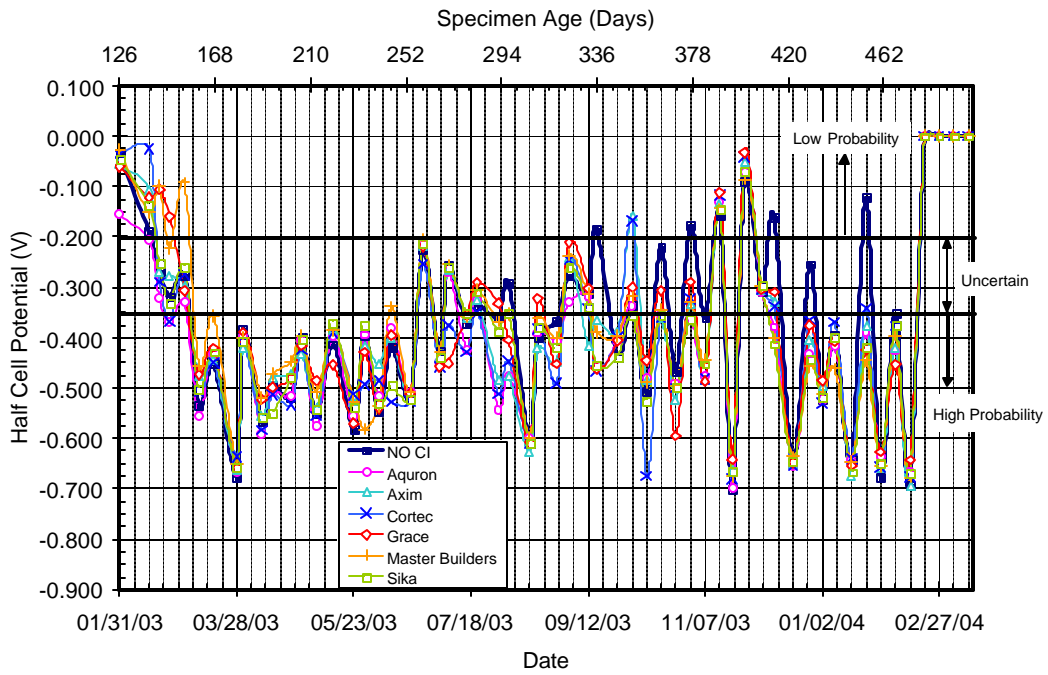

Figure C.19 – Half Cell Potential Readings for Bath 3, 2.0% Chloride, Post-Cracked

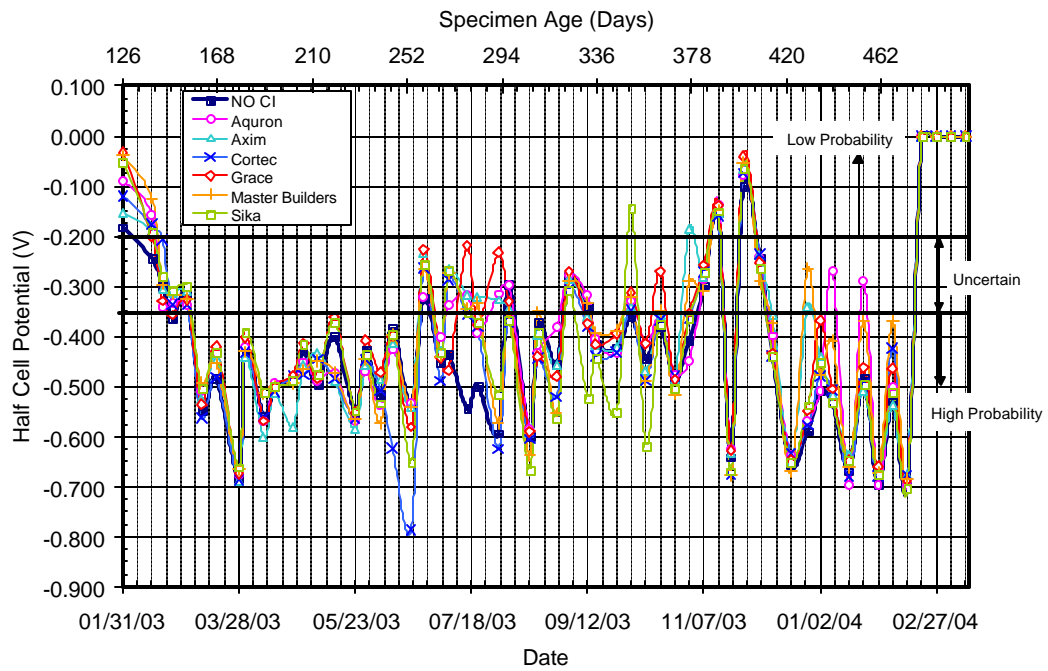

Figure C.20 – Half Cell Potential Readings for Bath 3, 3.0% Chloride, Post-Cracked

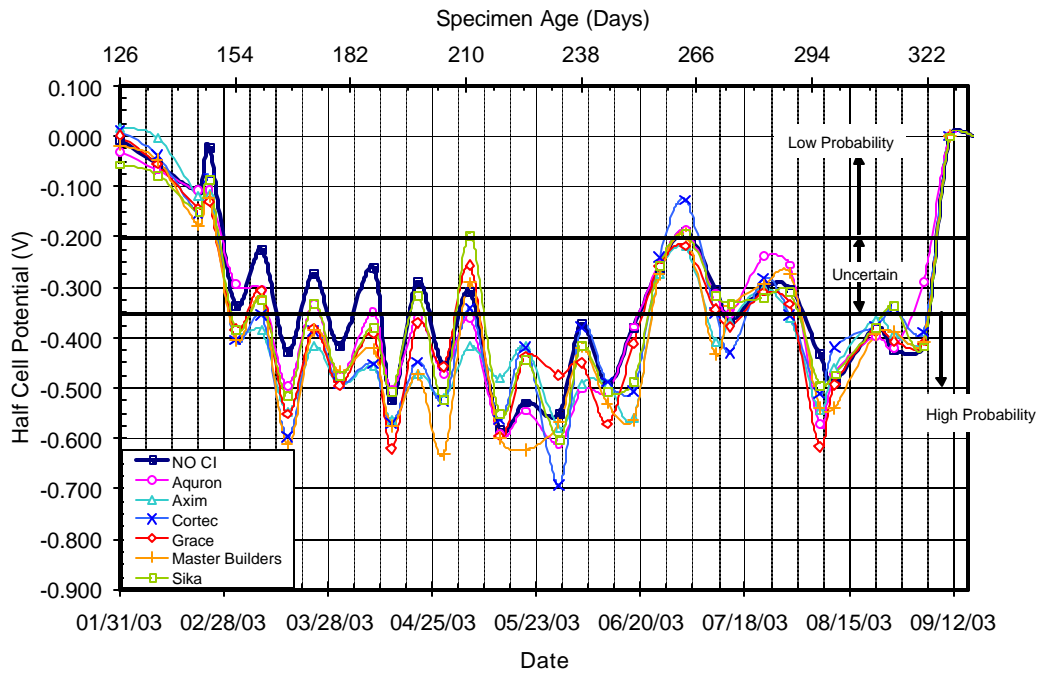

Figure C.21 – Half Cell Potential Readings for Bath 4, 0.0% Chloride, Post-Cracked

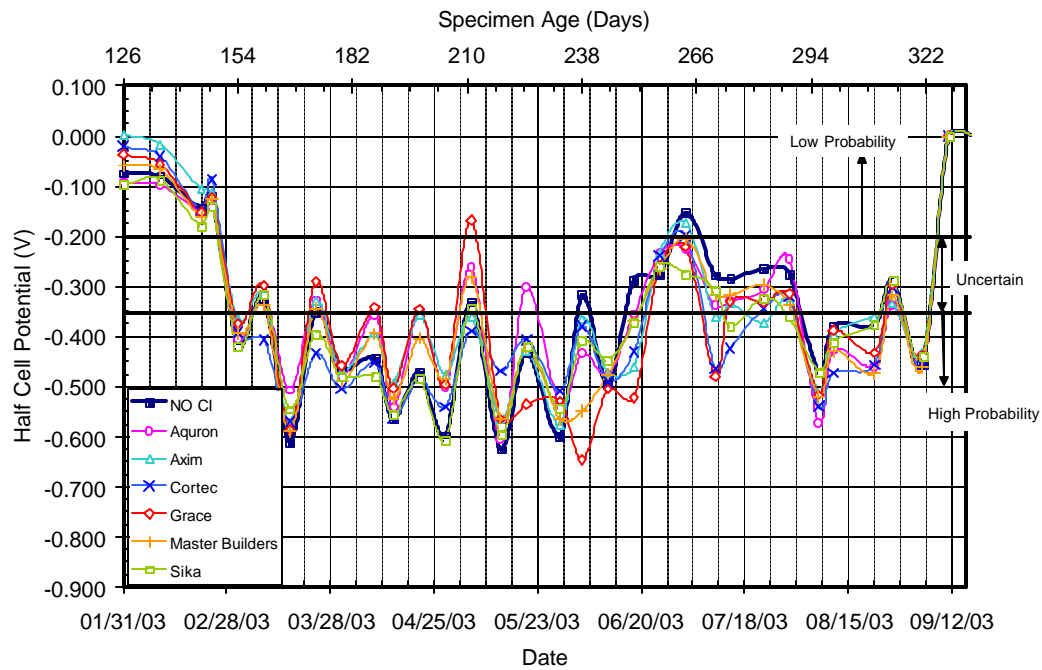

Figure C.22 – Half Cell Potential Readings for Bath 4, 0.5% Chloride, Post-Cracked

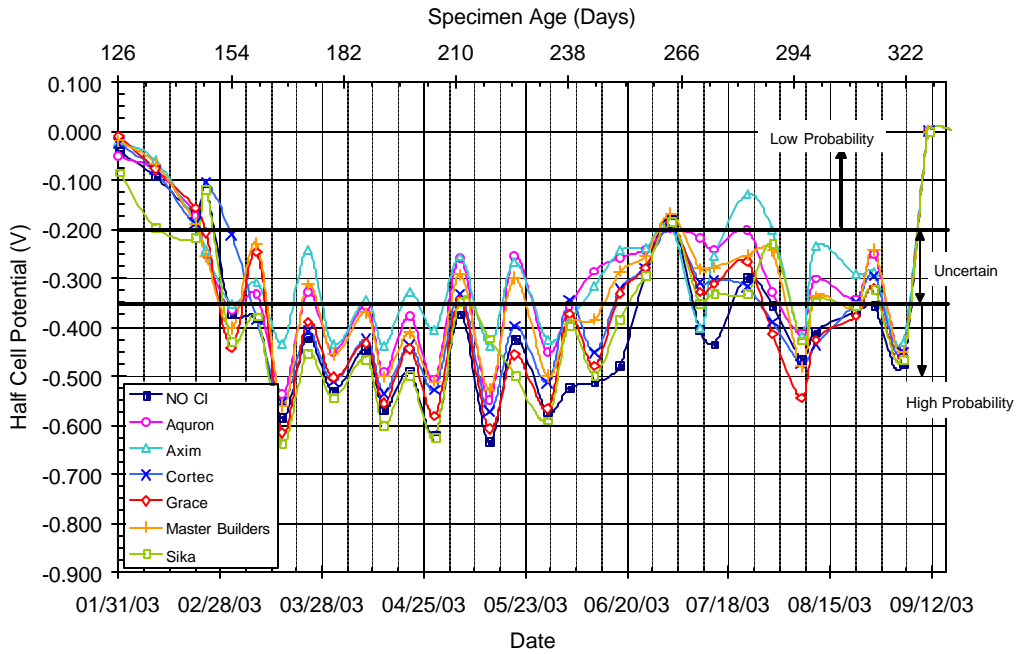

Figure C.23 – Half Cell Potential Readings for Bath 4, 1.0% Chloride, Post-Cracked

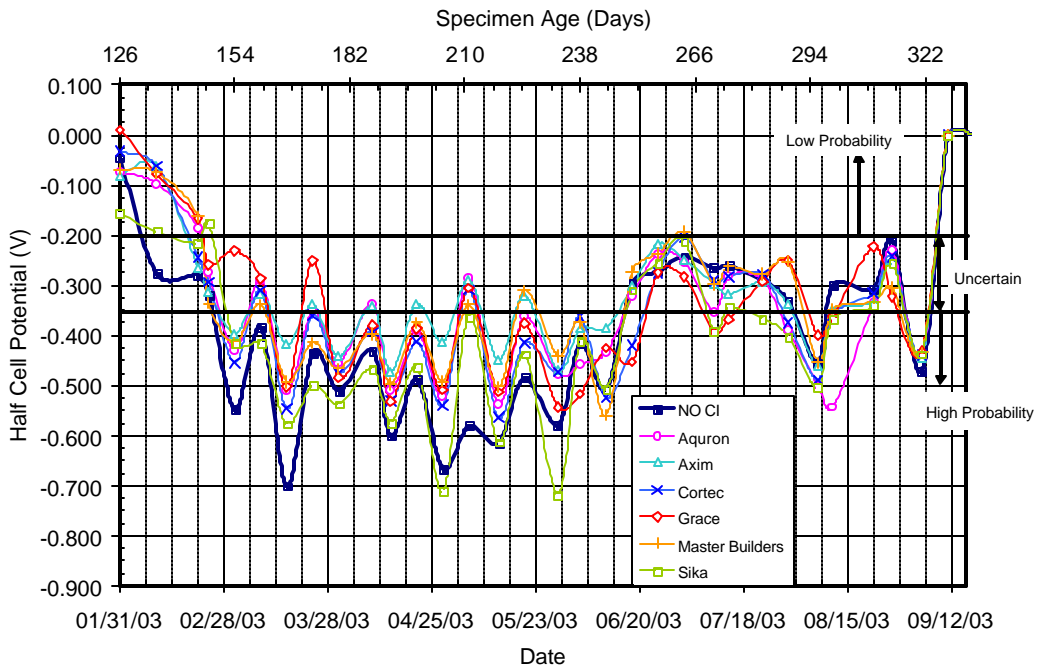

Figure C.24 – Half Cell Potential Readings for Bath 4, 1.5% Chloride, Post-Cracked

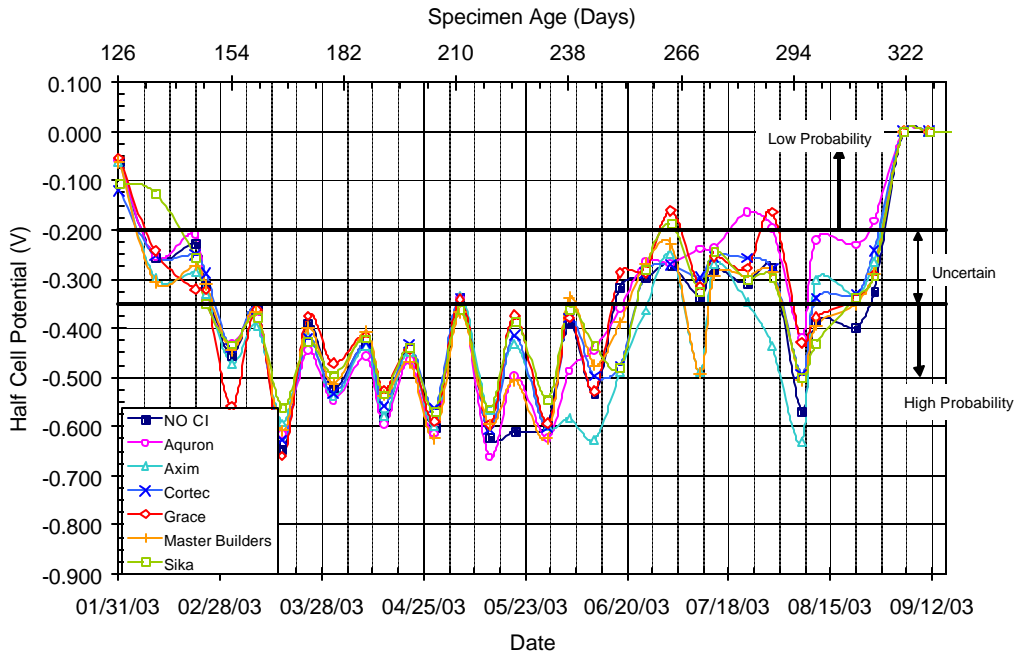

Figure C.25 – Half Cell Potential Readings for Bath 4, 2.0% Chloride, Post-Cracked

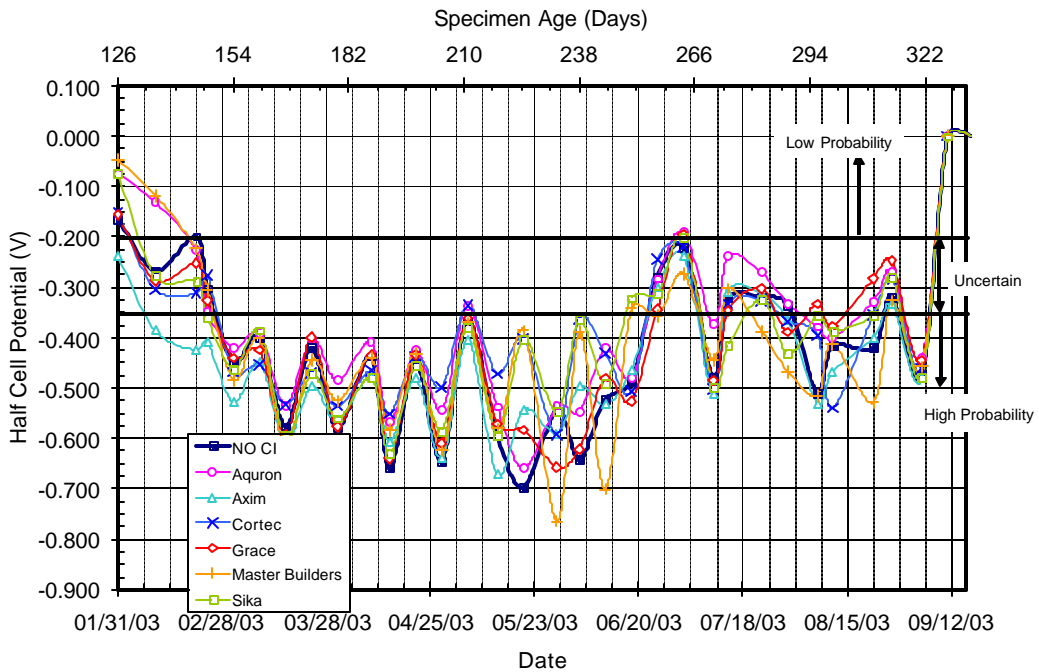

Figure C.26 – Half Cell Potential Readings for Bath 4, 3.0% Chloride, Post-Cracked

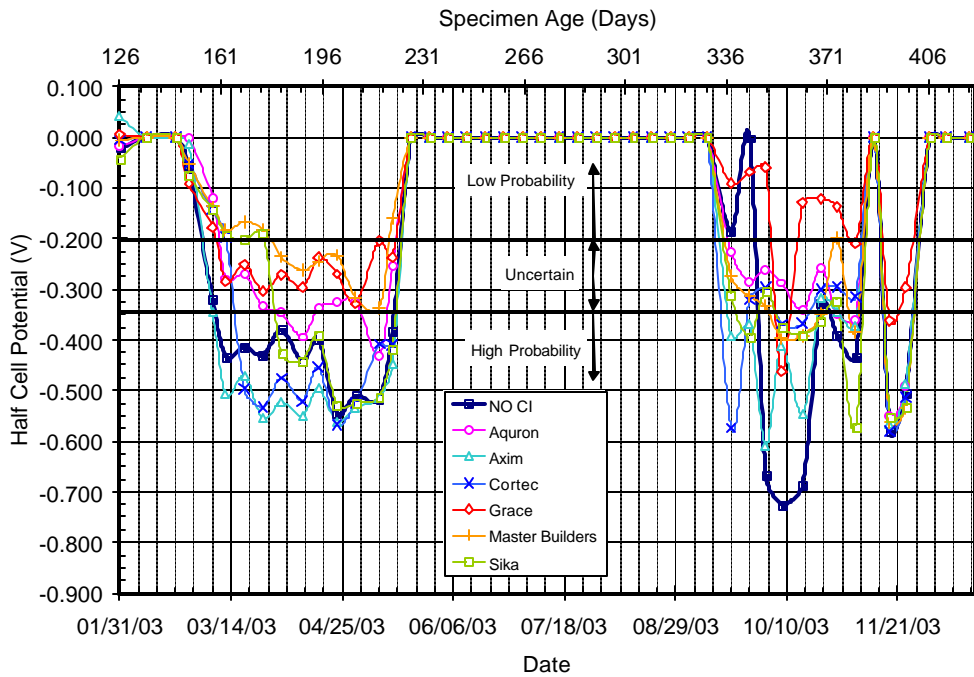

Figure C.27 – Half Cell Potential Readings for Chamber Shelf 1, 0.0% Chloride, Post-Cracked

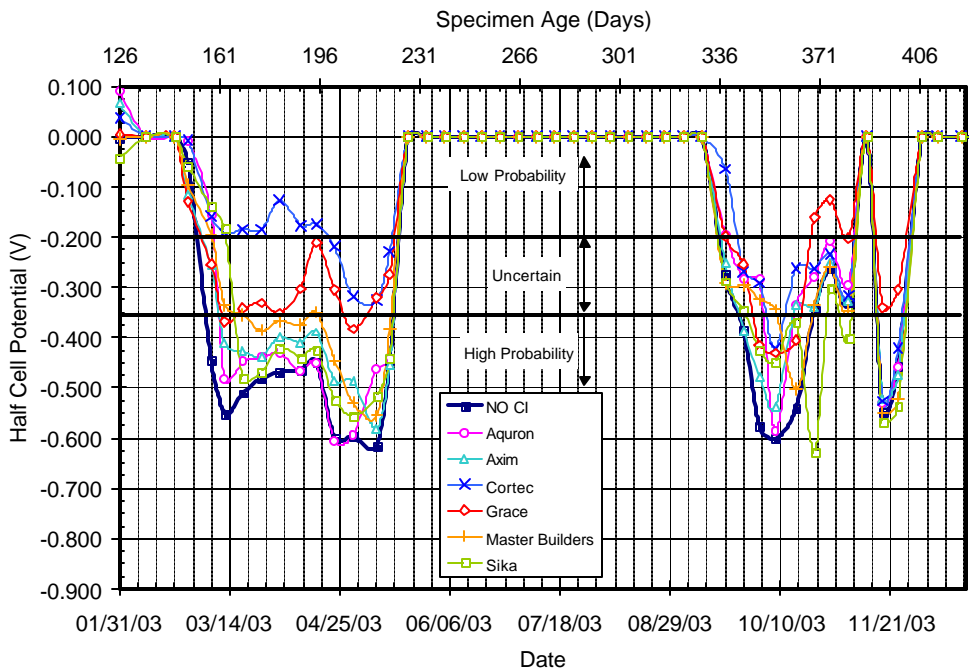

Figure C.28 – Half Cell Potential Readings for Chamber Shelf 1, 0.5% Chloride, Post-Cracked

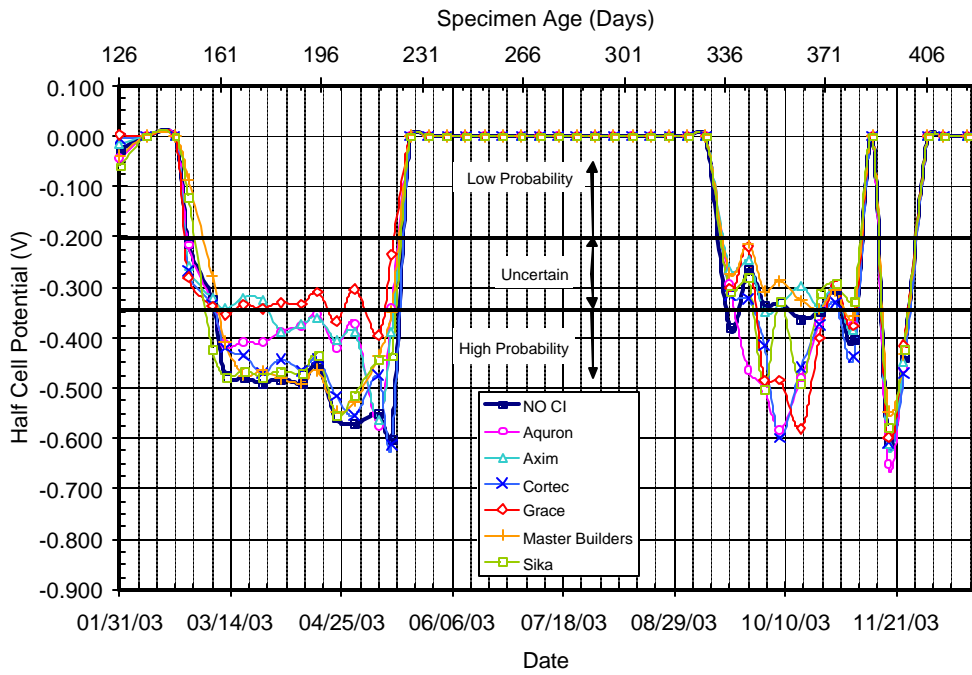

Figure C.29 – Half Cell Potential Readings for Chamber Shelf 1, 1.0% Chloride, Post-Cracked

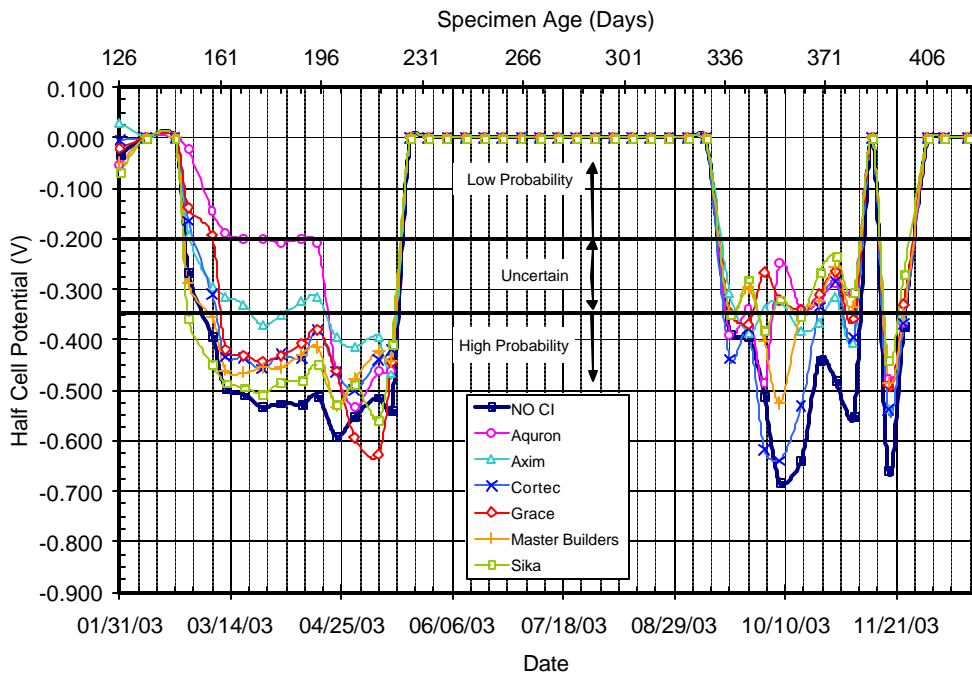

Figure C.30 – Half Cell Potential Readings for Chamber Shelf 1, 1.5% Chloride, Post-Cracked

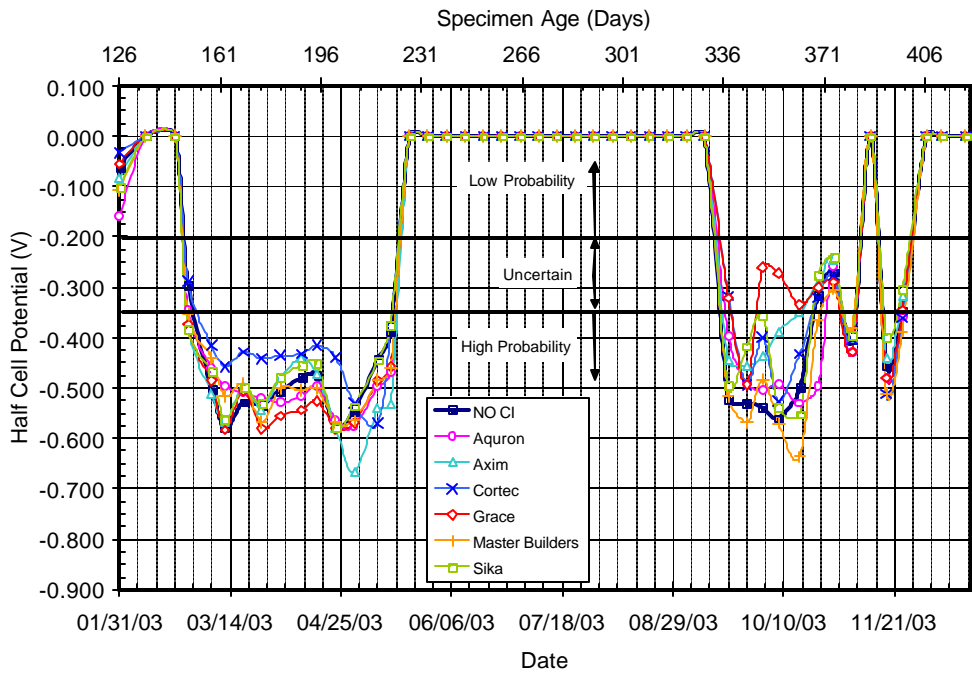

Figure C.31 – Half Cell Potential Readings for Chamber Shelf 1, 2.0% Chloride, Post-Cracked

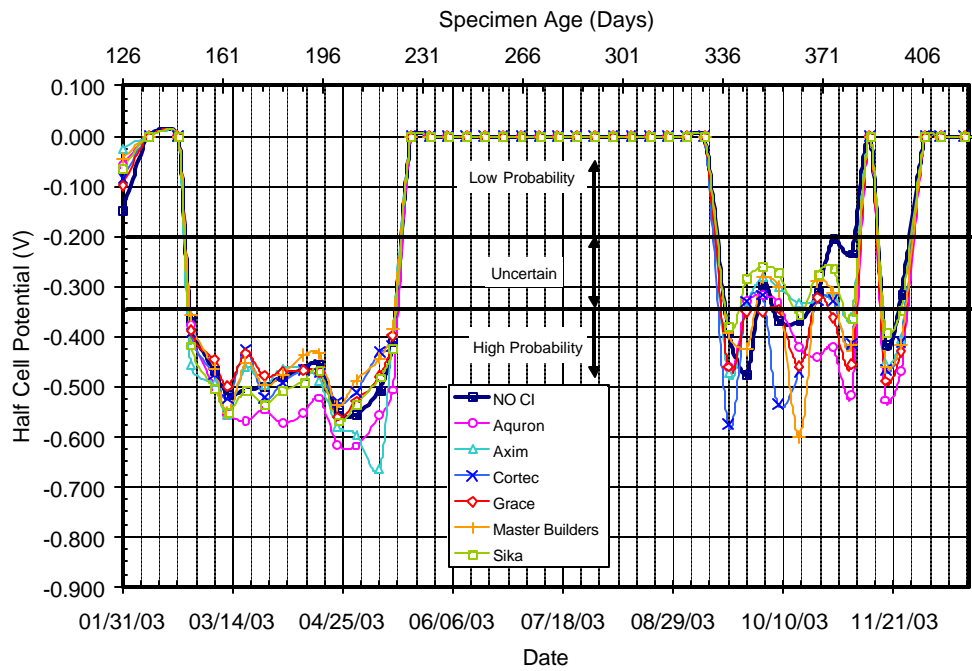

Figure C.32 – Half Cell Potential Readings for Chamber Shelf 1, 3.0% Chloride, Post-Cracked

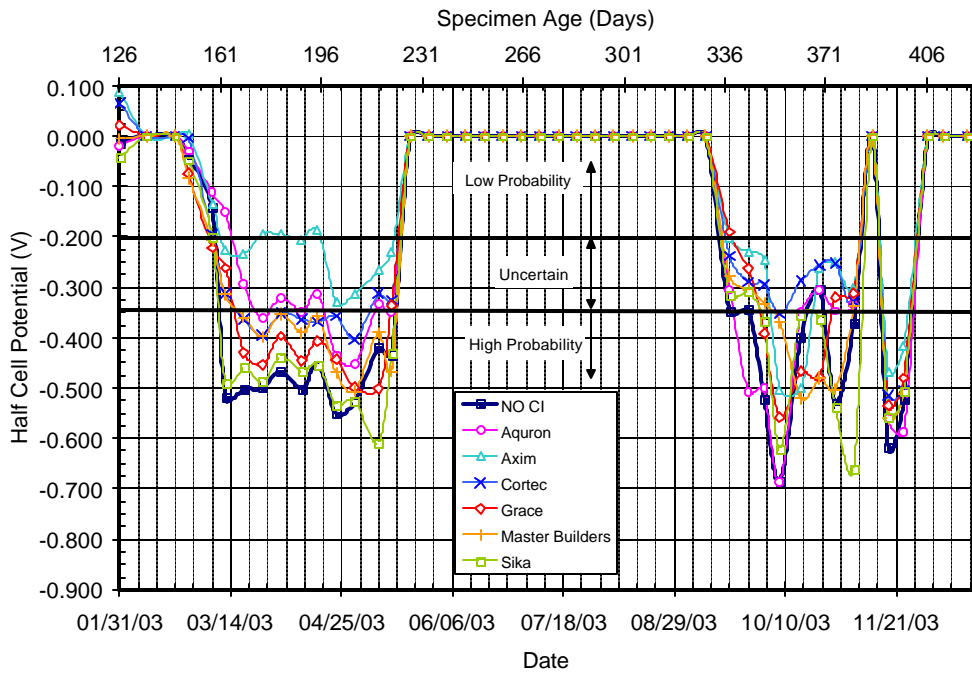

Figure C.33 – Half Cell Potential Readings for Chamber Shelf 2, 0.0% Chloride, Pre-Cracked

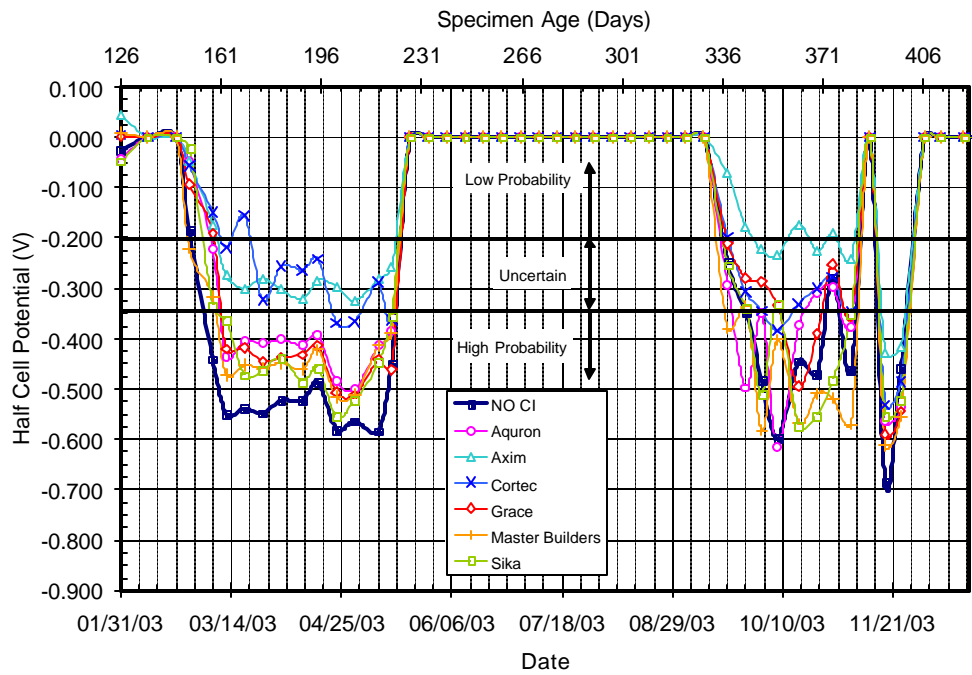

Figure C.34 – Half Cell Potential Readings for Chamber Shelf 2, 0.5% Chloride, Pre-Cracked

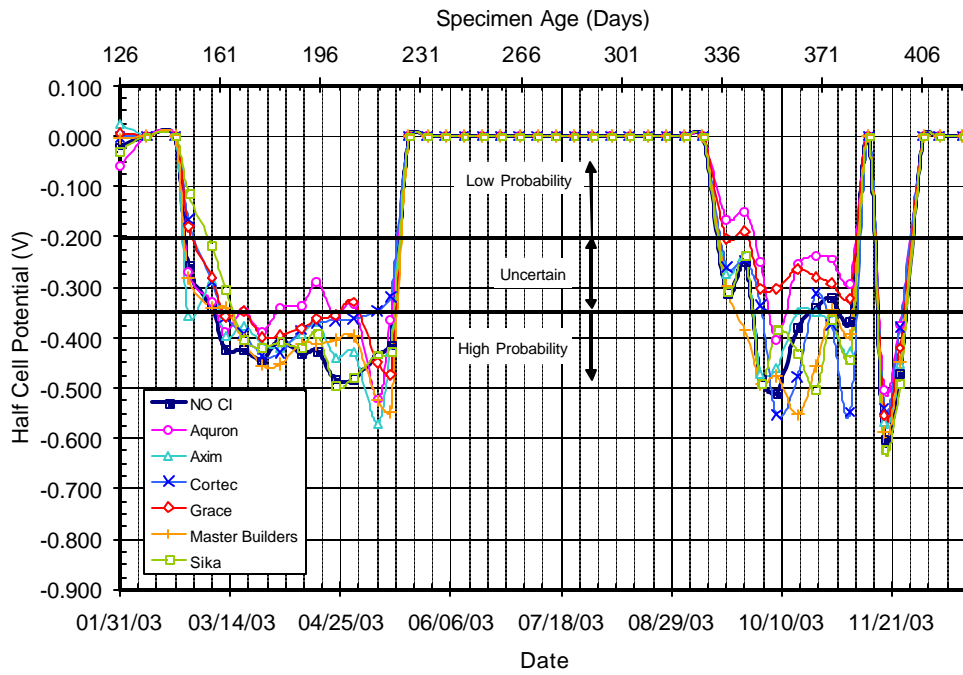

Figure C.35 – Half Cell Potential Readings for Chamber Shelf 2, 1.0% Chloride, Pre-Cracked

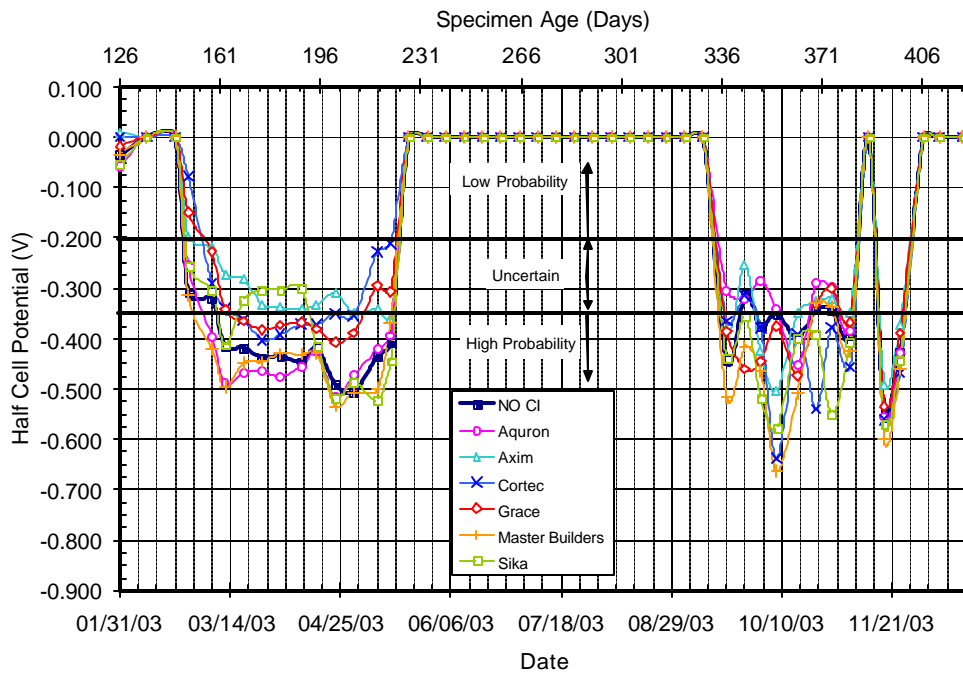

Figure C.36 – Half Cell Potential Readings for Chamber Shelf 2, 1.5% Chloride, Pre-Cracked

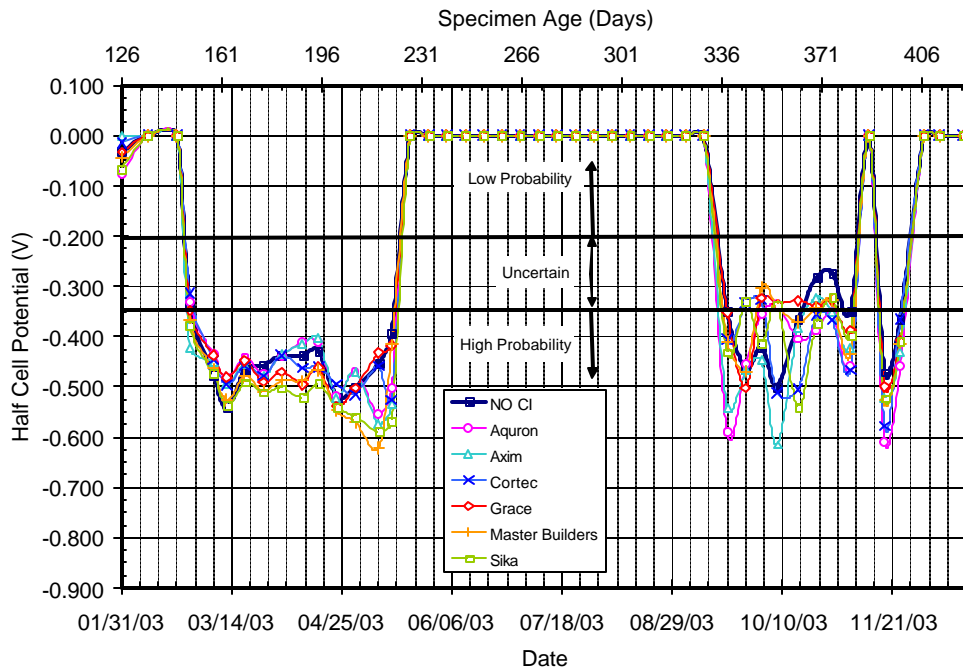

Figure C.37 – Half Cell Potential Readings for Chamber Shelf 2, 2.0% Chloride, Pre-Cracked

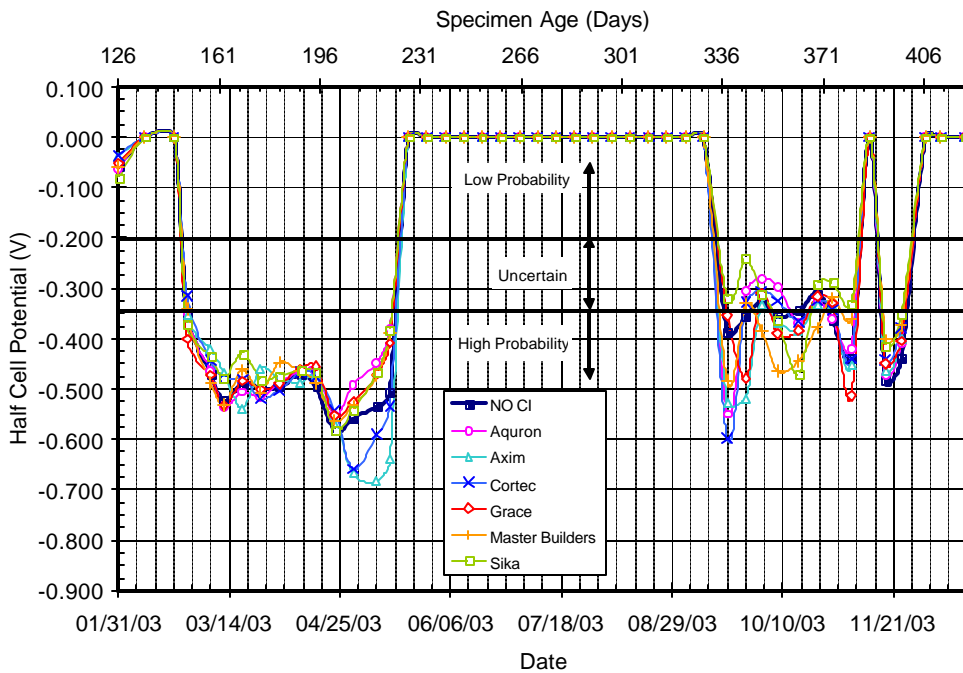

Figure C.38 – Half Cell Potential Readings for Chamber Shelf 2, 3.0% Pre-Cracked

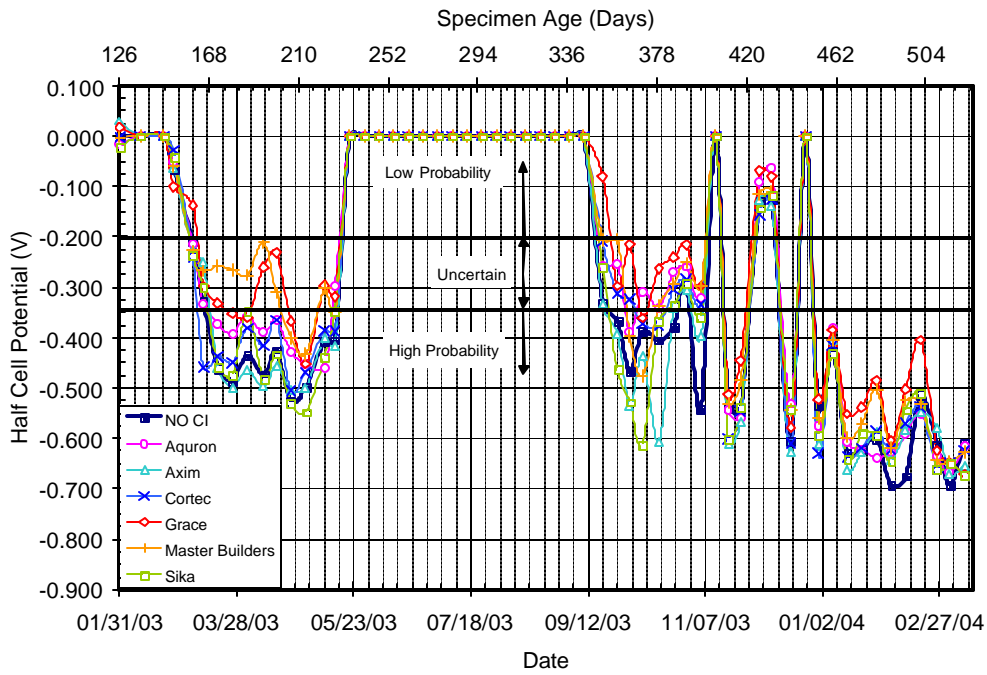

Figure C.39 – Half Cell Potential Readings for Chamber Shelf 3, 0.0% Chloride, Post-Cracked

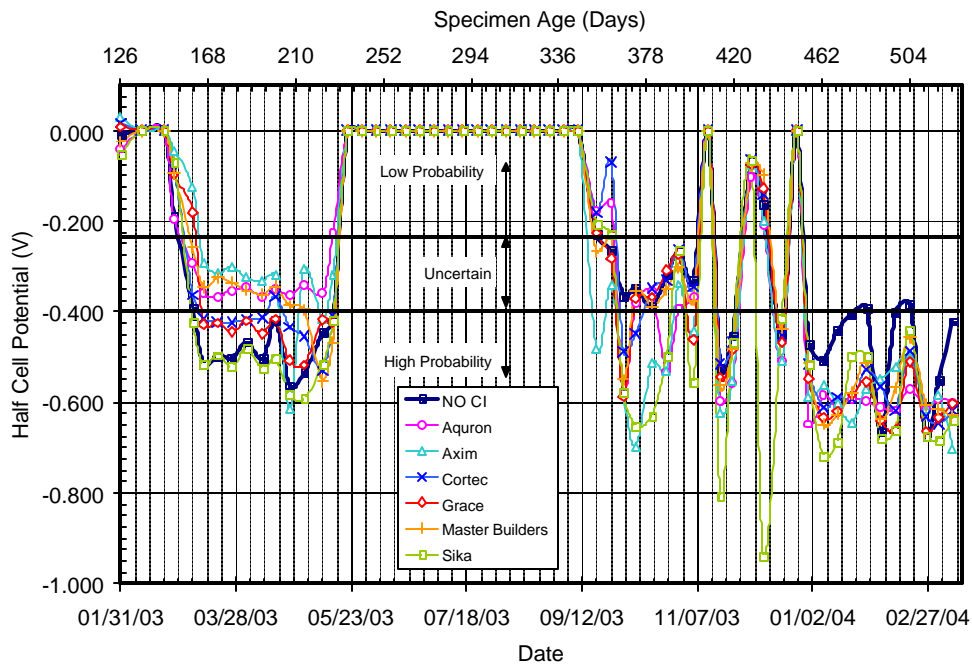

Figure C.40 – Half Cell Potential Readings for Chamber Shelf 3, 0.5% Chloride, Post-Cracked

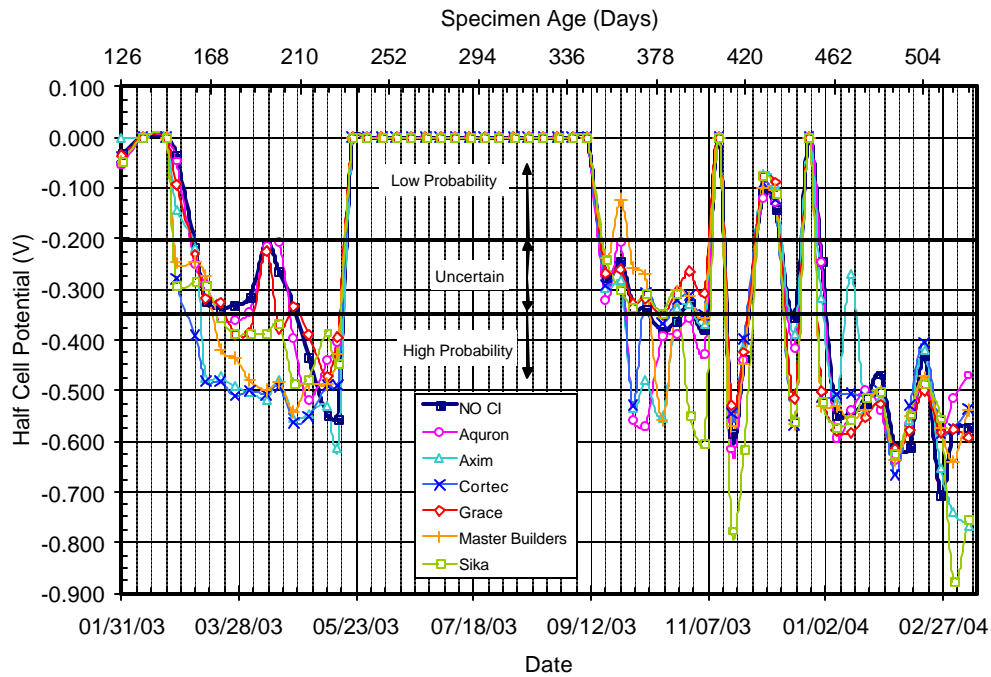

Figure C.41 – Half Cell Potential Readings for Chamber Shelf 3, 1.0% Chloride, Post-Cracked

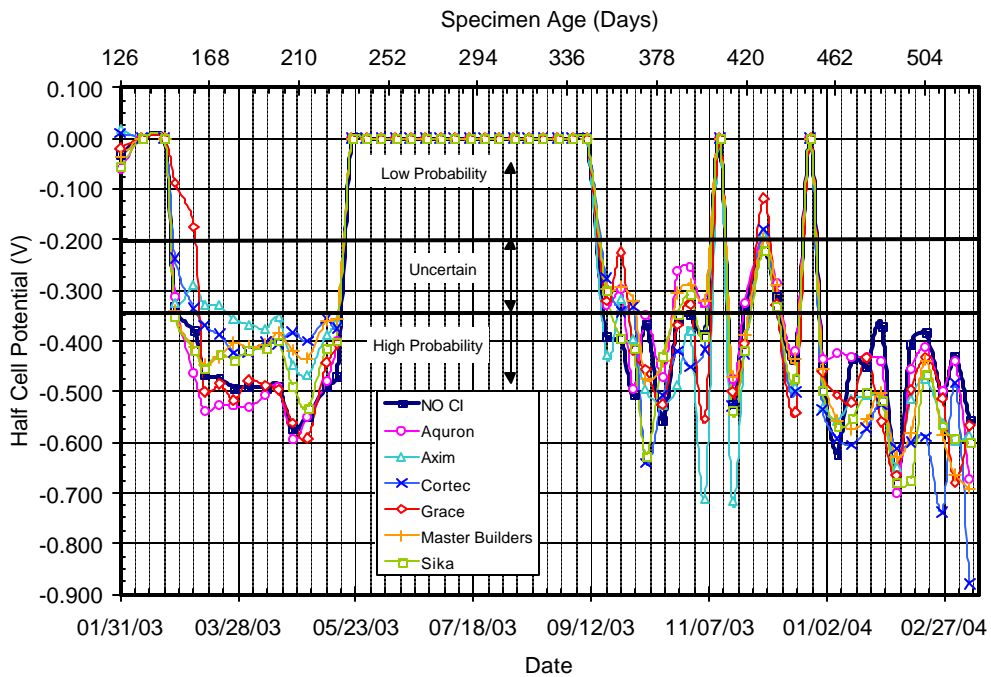

Figure C.42 – Half Cell Potential Readings for Chamber Shelf 3, 1.5% Chloride, Post-Cracked

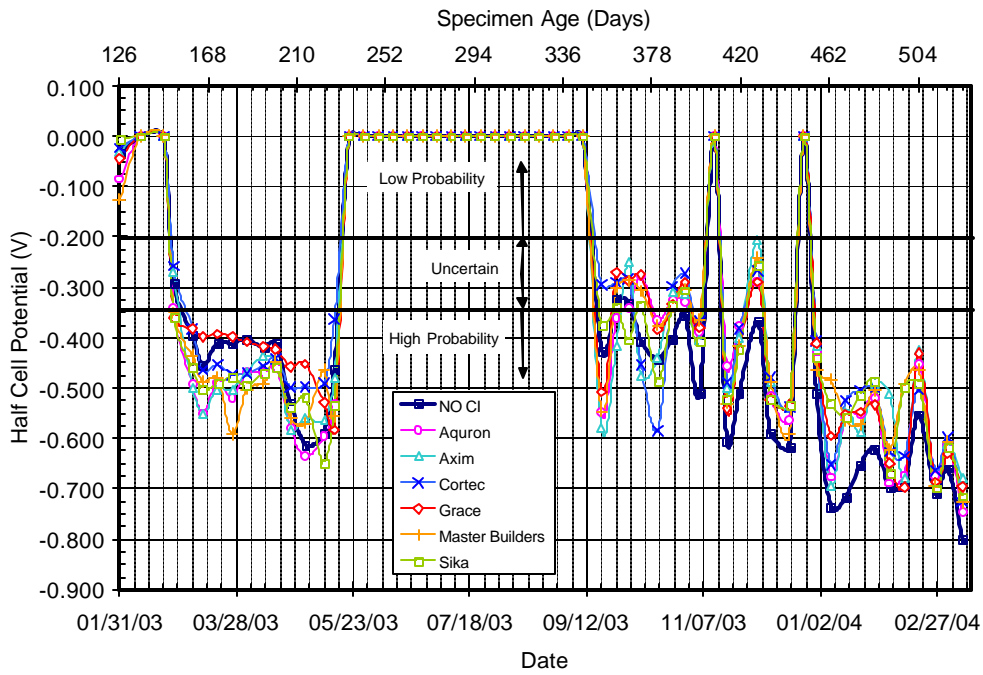

Figure C.43 – Half Cell Potential Readings for Chamber Shelf 3, 2.0% Chloride, Post-Cracked

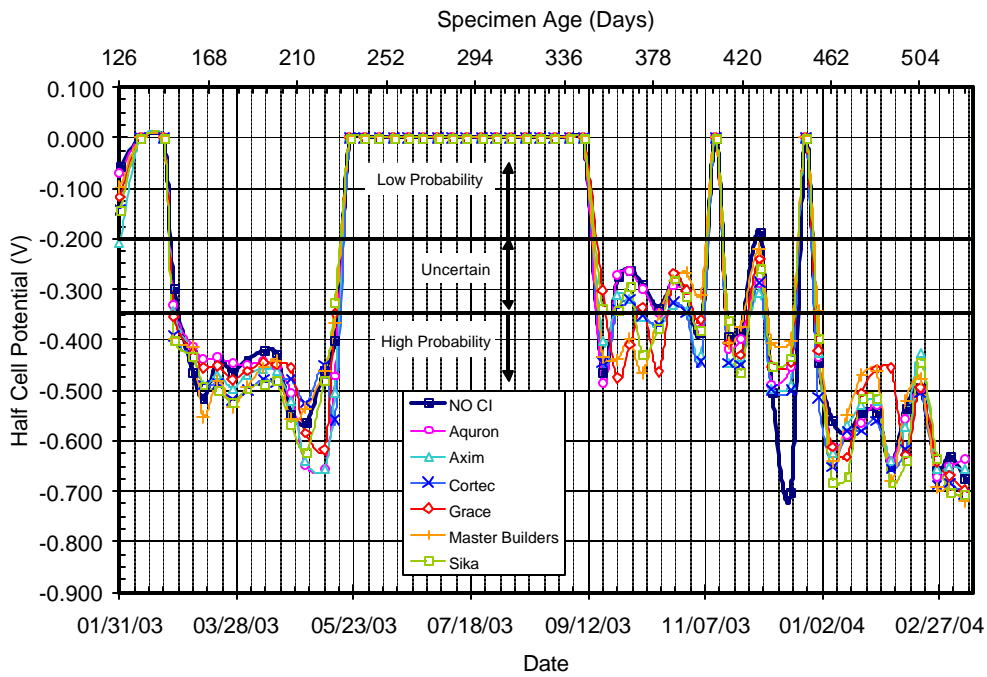

Figure C.44 – Half Cell Potential Readings for Chamber Shelf 3, 3.0% Chloride, Post-Cracked

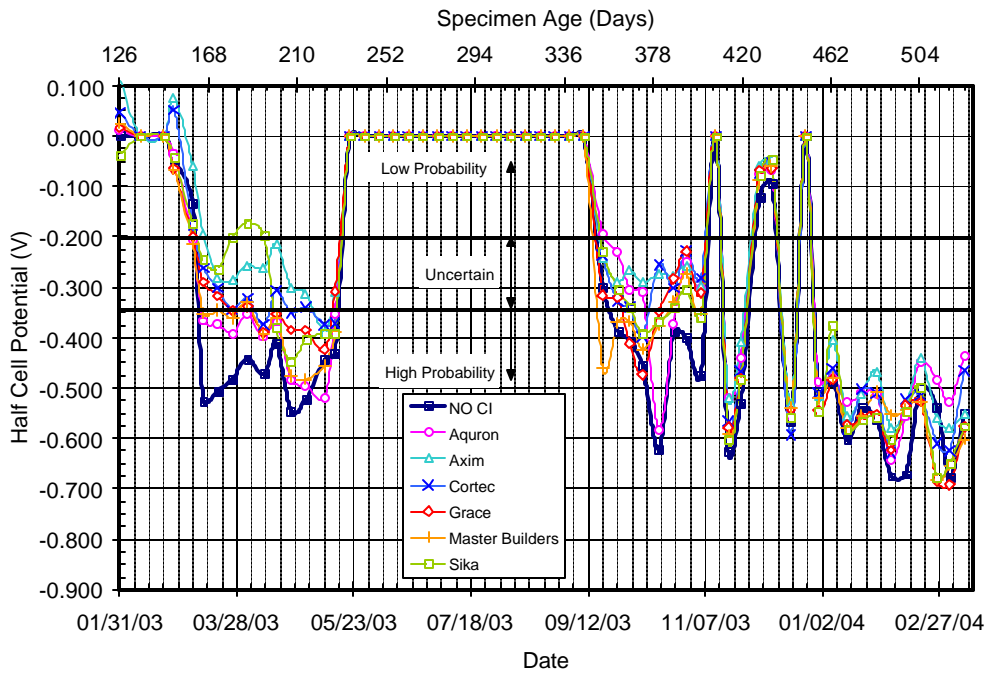

Figure C.45 – Half Cell Potential Readings for Chamber Shelf 4, 0.0% Chloride, Pre-Cracked

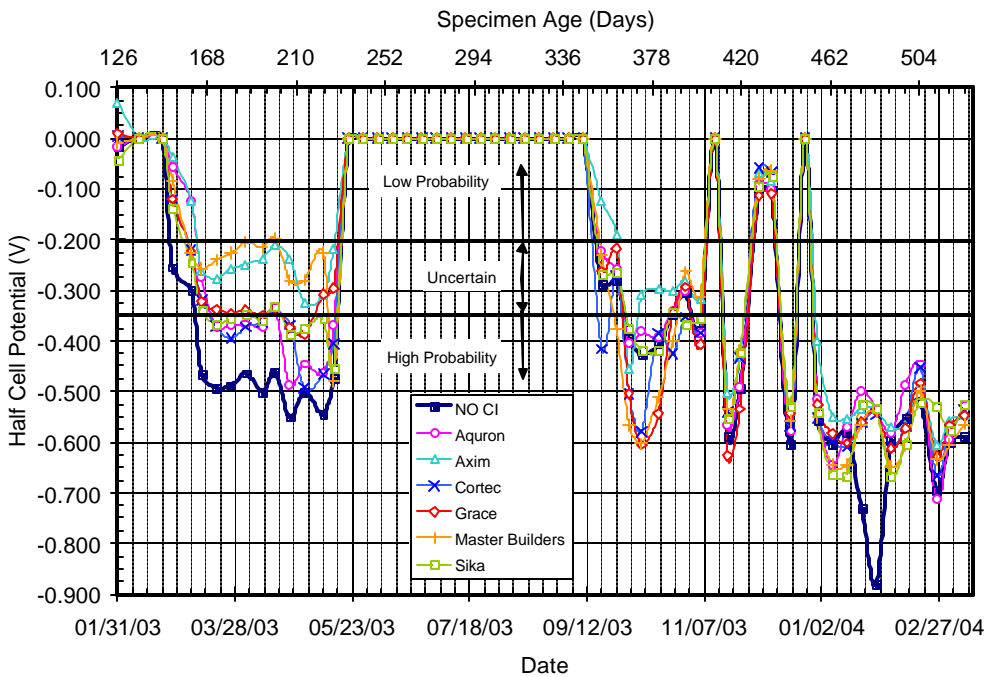

Figure C.46 – Half Cell Potential Readings for Chamber Shelf 4, 0.5% Chloride, Pre-Cracked

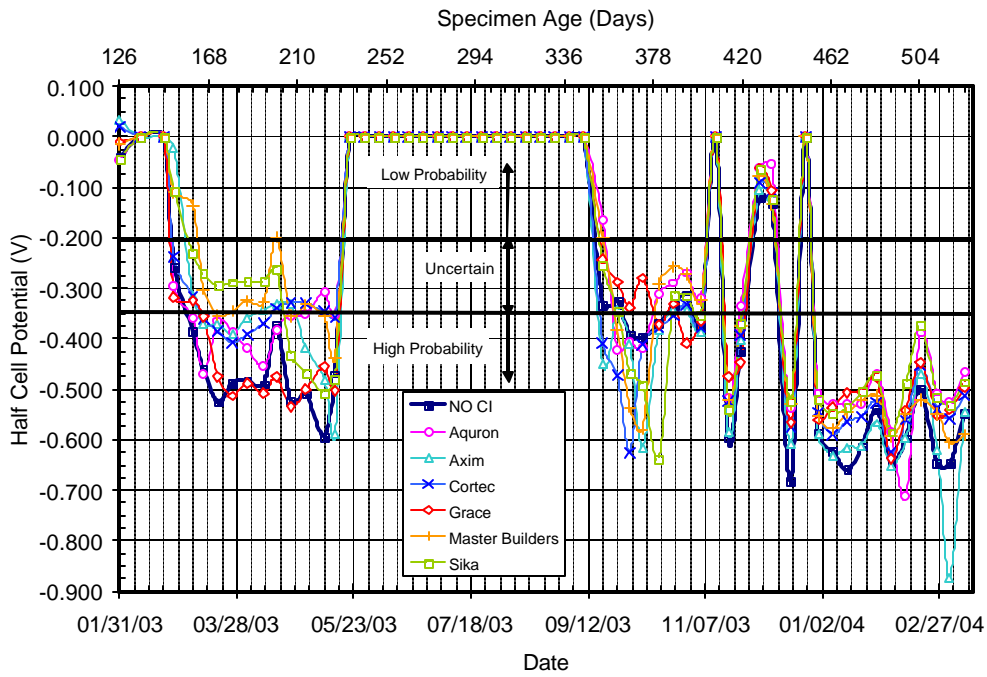

Figure C.47 – Half Cell Potential Readings for Chamber Shelf 4, 1.0% Chloride, Pre-Cracked

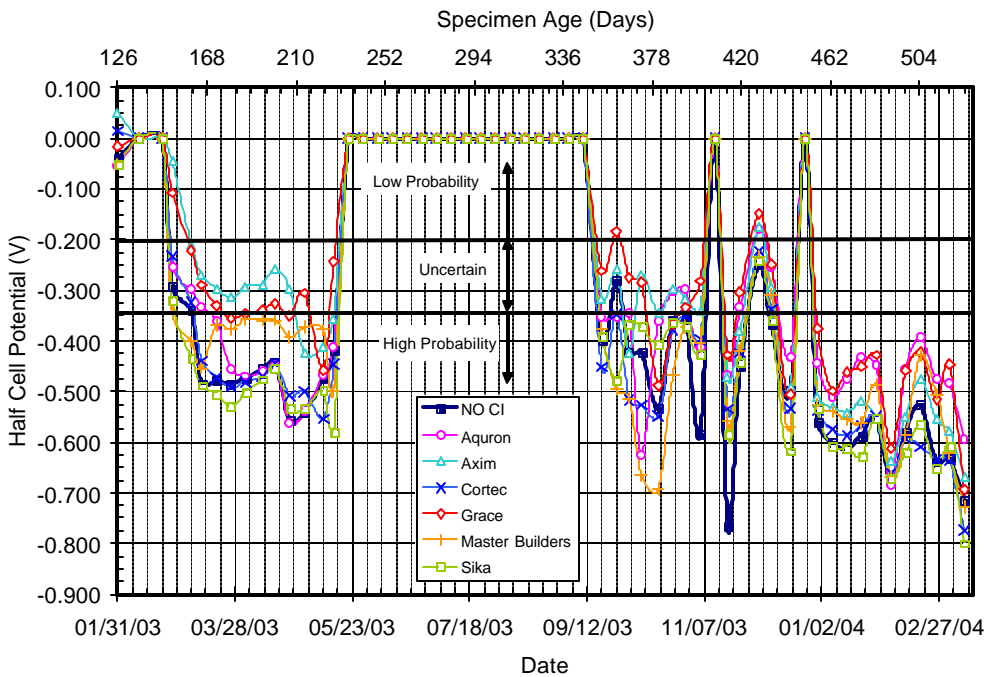

Figure C.48 – Half Cell Potential Readings for Chamber Shelf 4, 1.5% Chloride, Pre-Cracked

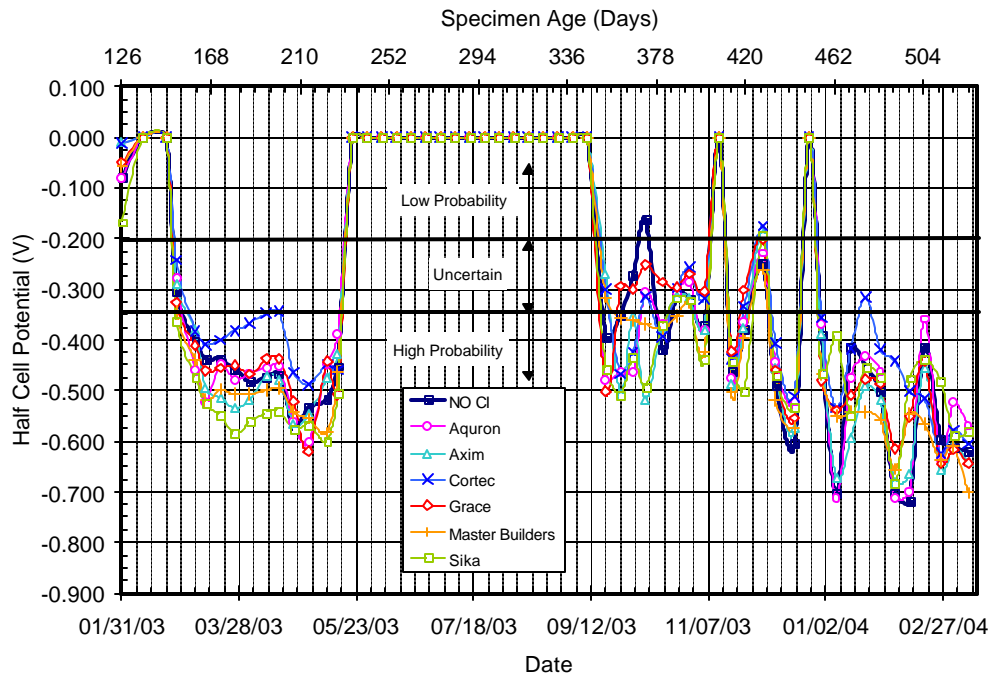

Figure C.49 – Half Cell Potential Readings for Chamber Shelf 4, 2.0% Chloride, Pre-Cracked

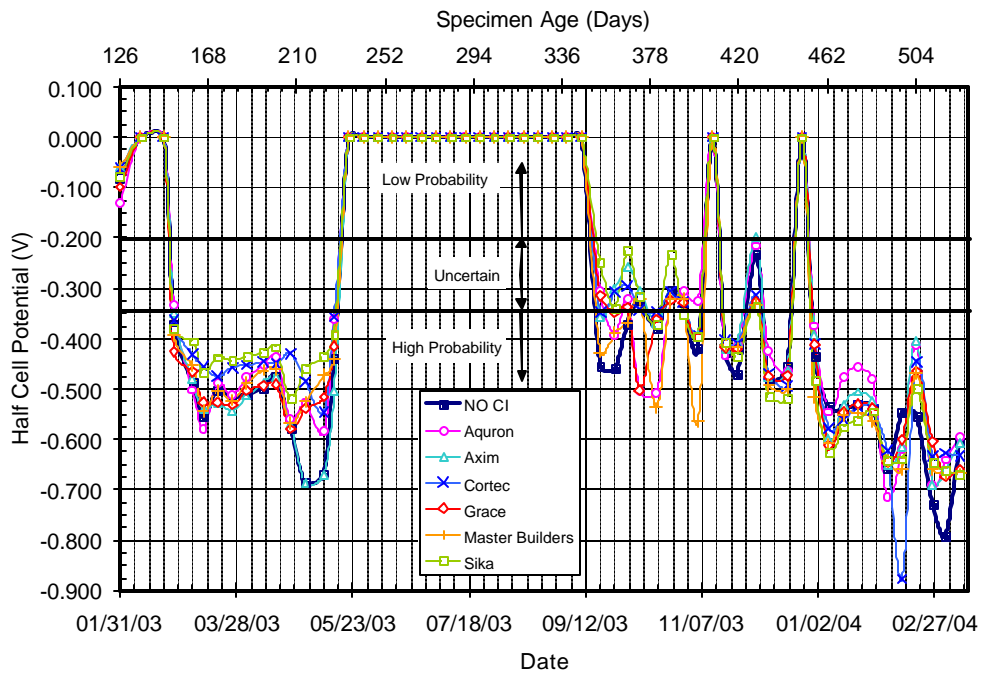

Figure C.50 – Half Cell Potential Readings for Chamber Shelf 4, 3.0% Chloride, Pre-Cracked

APPENDIX D. CHLORIDE CONTENT GRAPHS

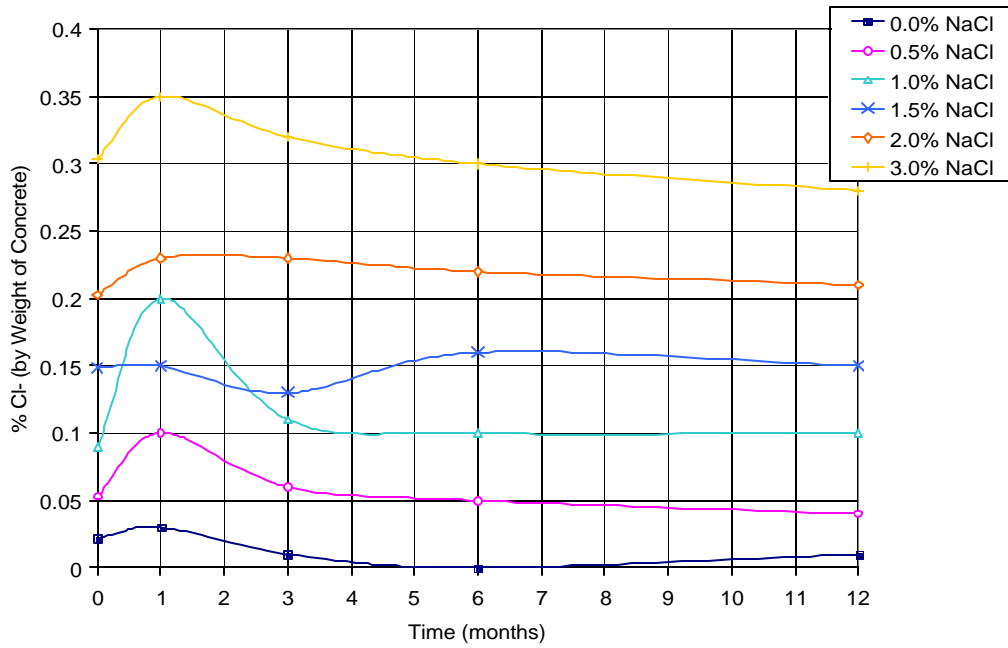

Figure D.1 – Chloride Content for Control Specimens

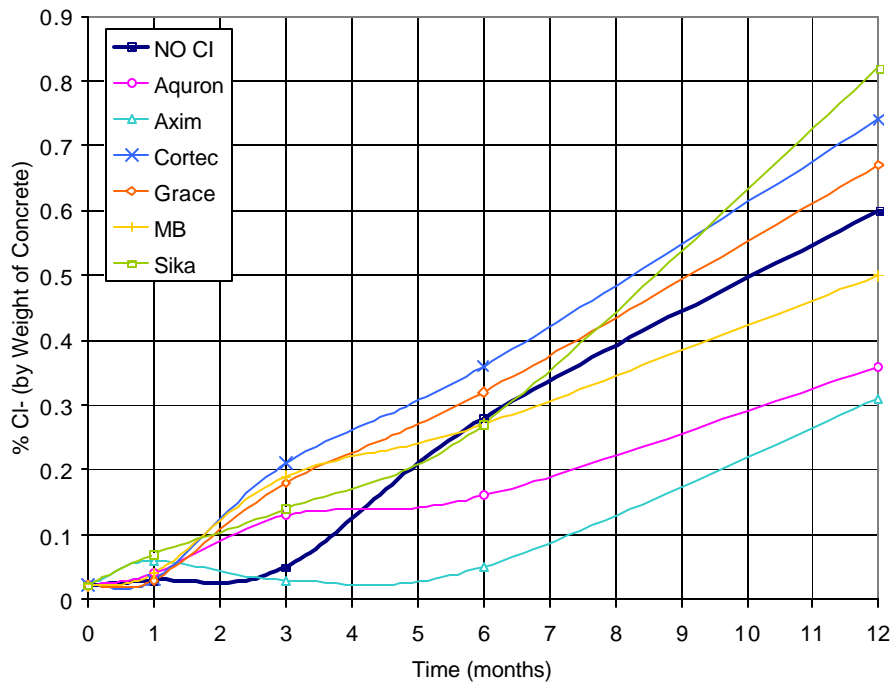

Figure D.2 – Chloride Content for Bath Specimens – 0.0% Chloride

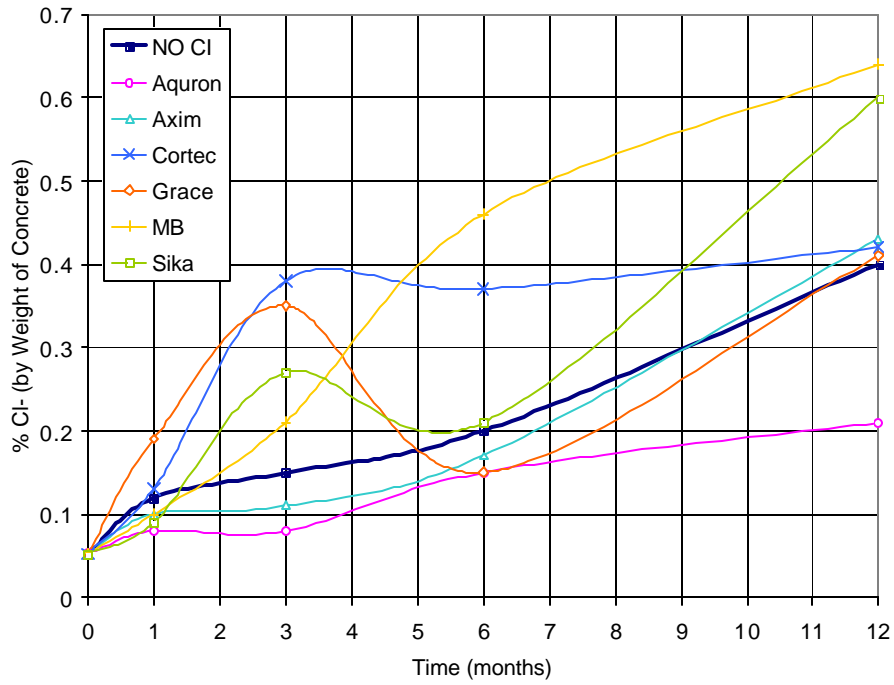

Figure D.3 – Chloride Content for Bath Specimens – 0.5% Chloride

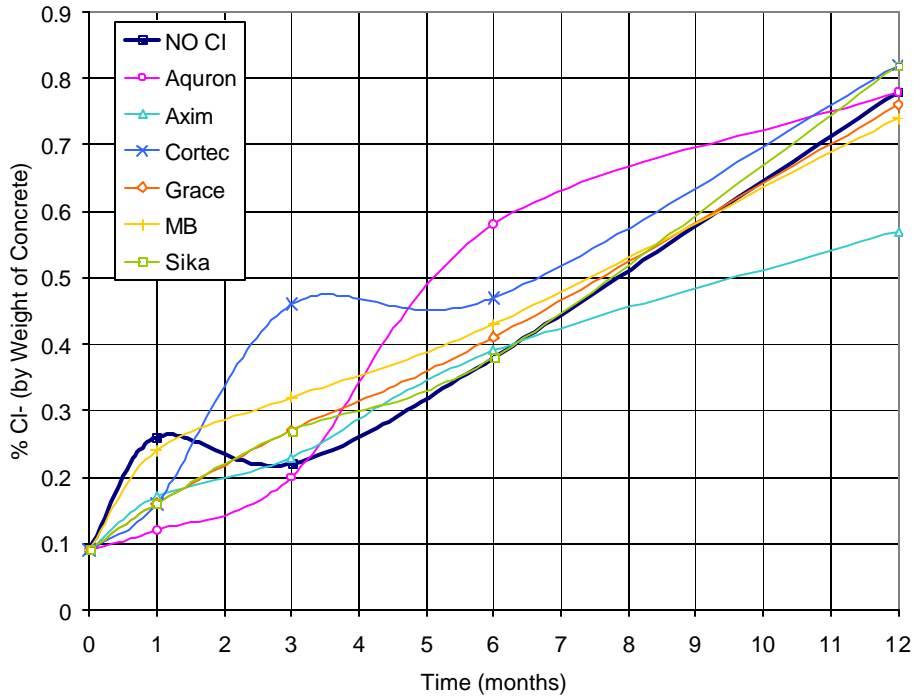

Figure D.4 – Chloride Content for Bath Specimens – 1.0% Chloride

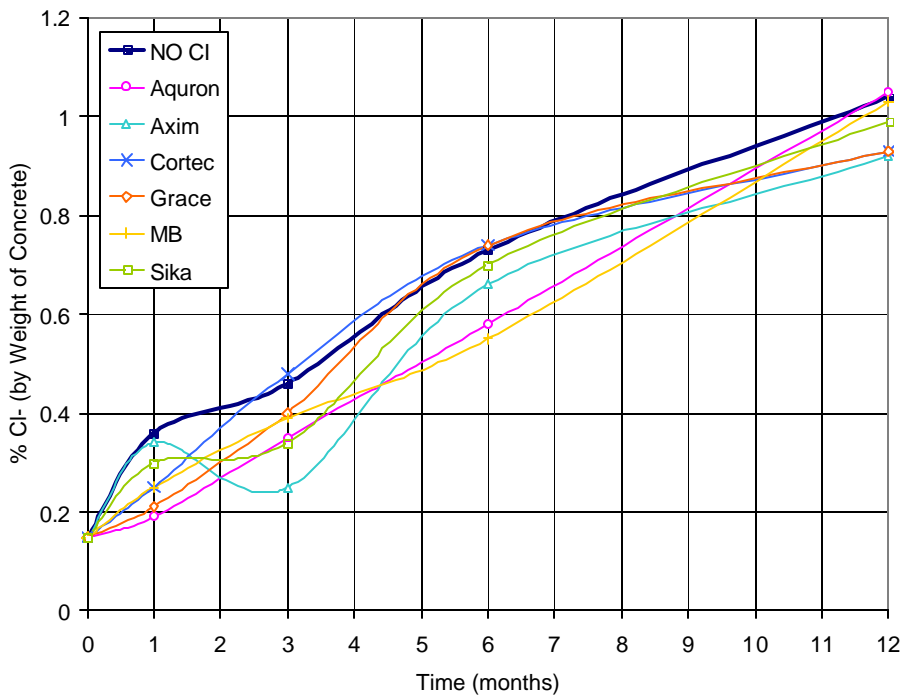

Figure D.5 – Chloride Content for Bath Specimens – 1.5% Chloride

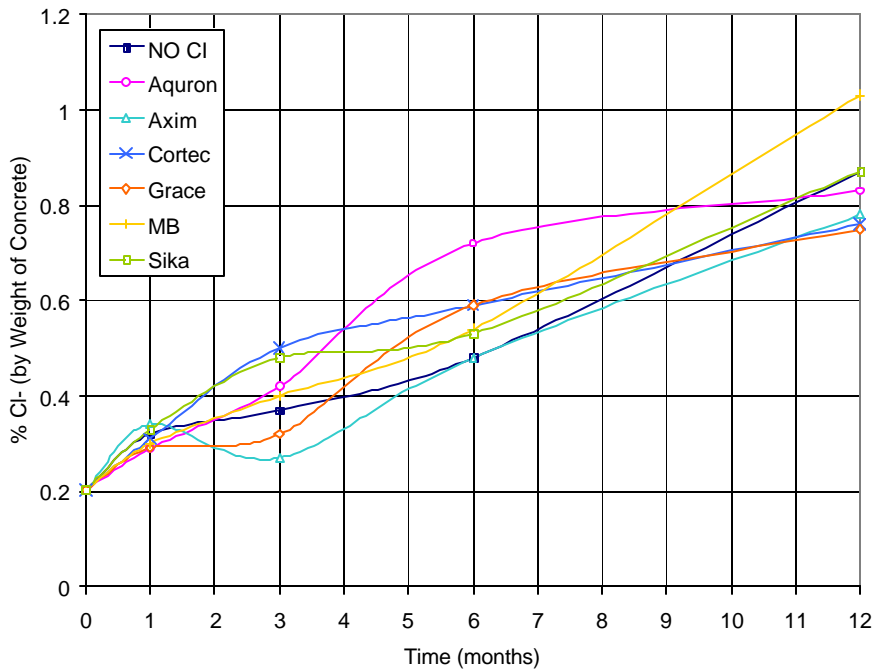

Figure D.6 – Chloride Content for Bath Specimens – 2.0% Chloride

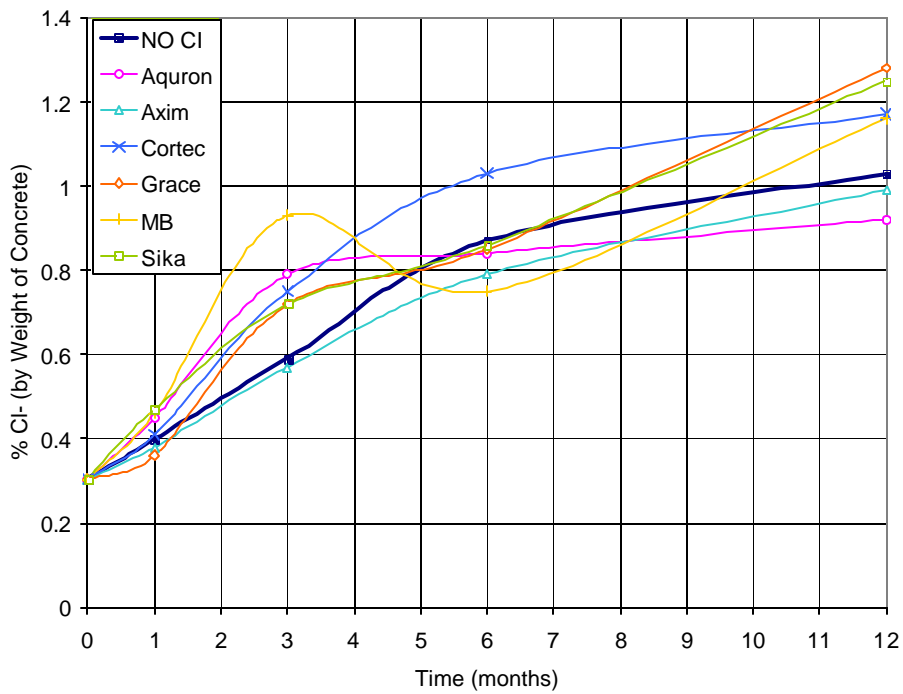

Figure D.7 – Chloride Content for Bath Specimens – 3.0% Chloride

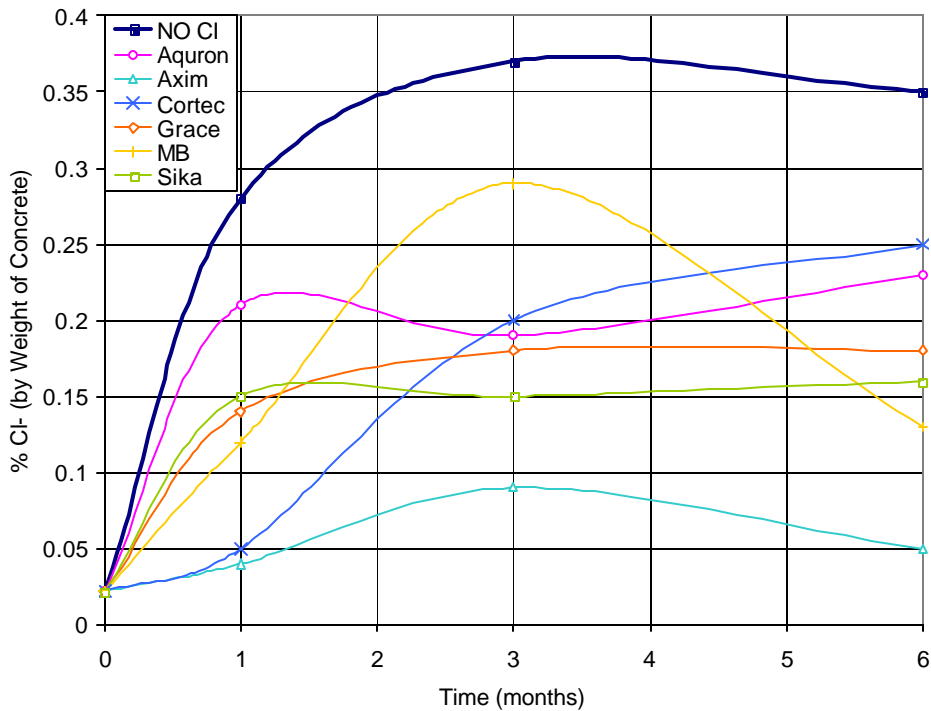

Figure D.8 – Chloride Content for Chamber Specimens – 0.0% Chloride

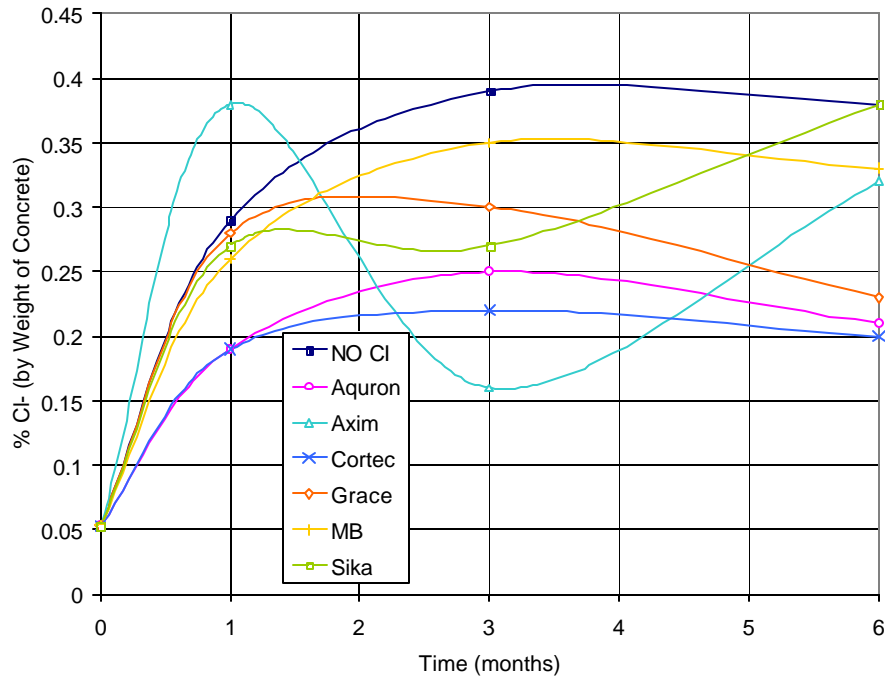

Figure D.9 – Chloride Content for Chamber Specimens – 0.5% Chloride

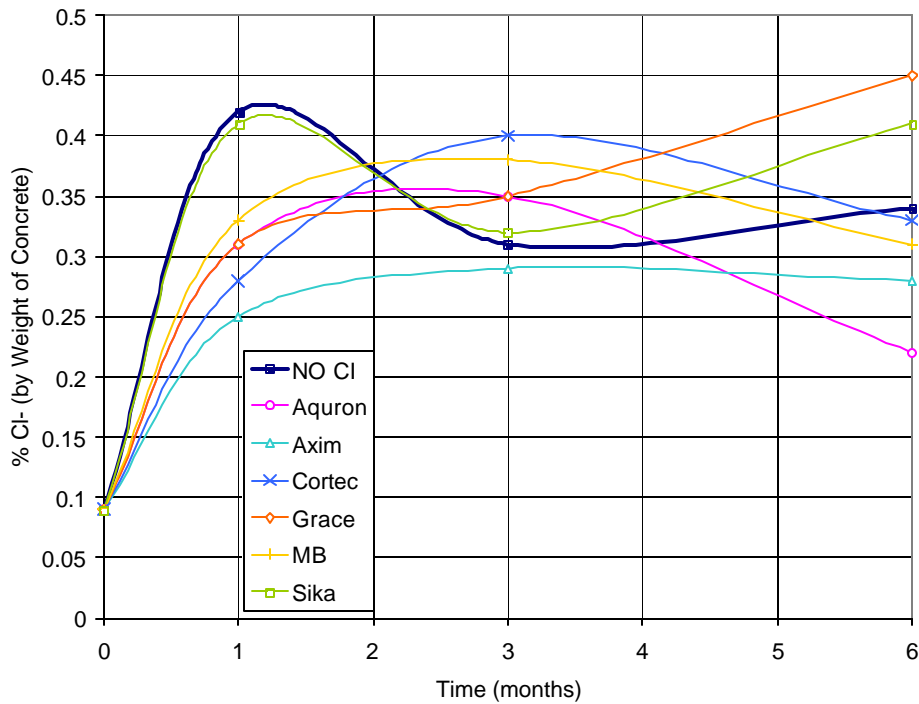

Figure D.10 – Chloride Content for Chamber Specimens – 1.0% Chloride

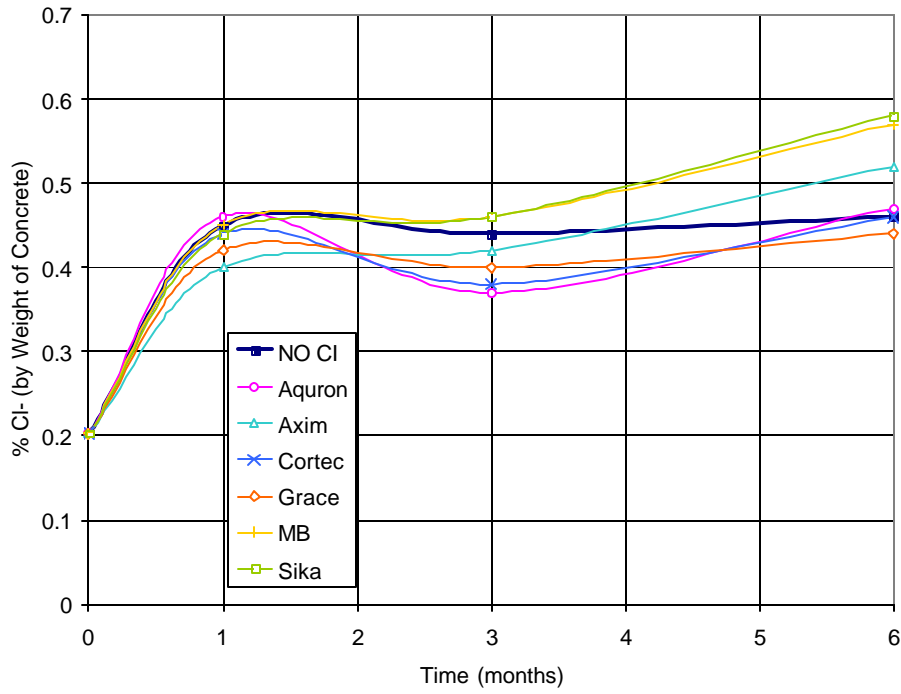

Figure D.11 – Chloride Content for Chamber Specimens 2.0% Chloride

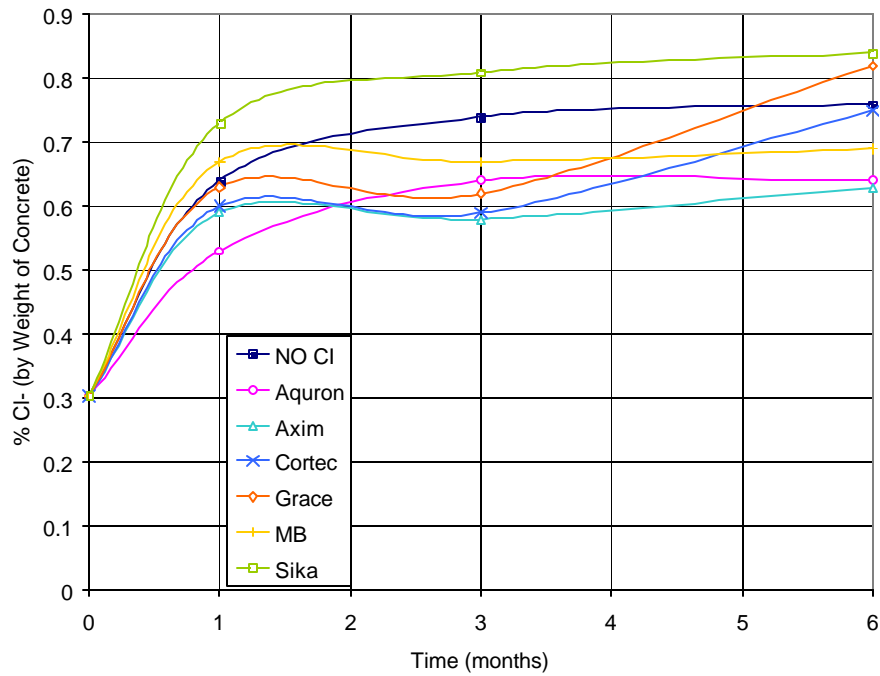

Figure D.12 – Chloride Content for Chamber Specimens – 3.0% Chloride

APPENDIX E. SURFACE CORROSION AND RIB LOSS GRAPHS

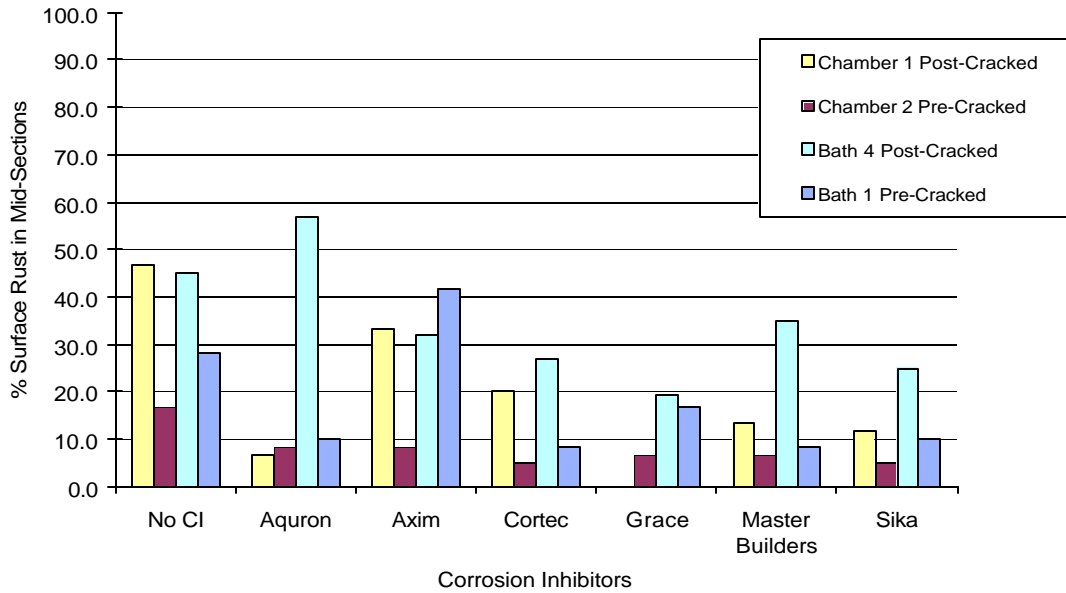

Figure E.1 Surface Corrosion at Mid Section for 0.0% Chloride (Set#1)

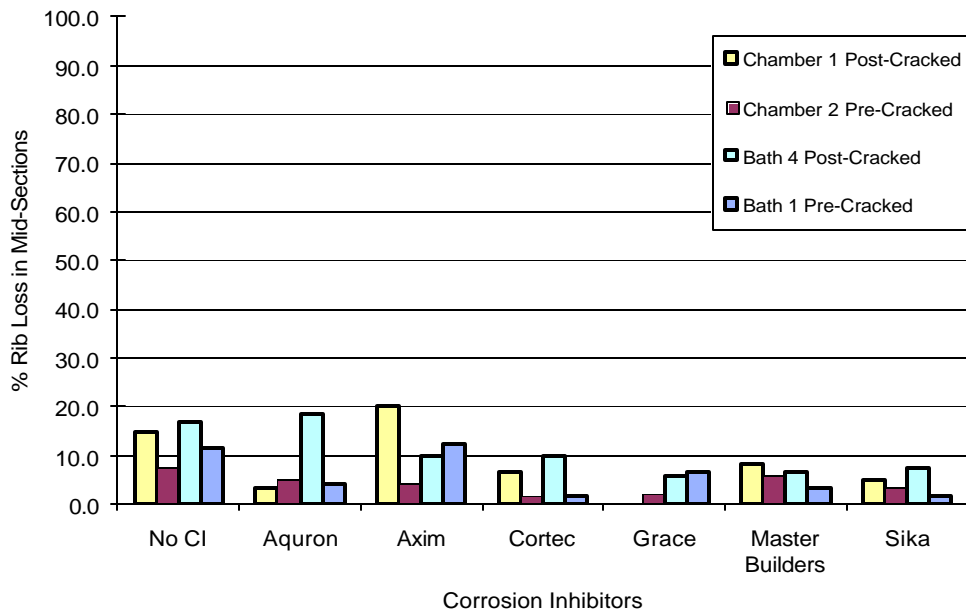

Figure E.2 Rib Loss at Mid Section for 0.0% Chloride (Set #1)

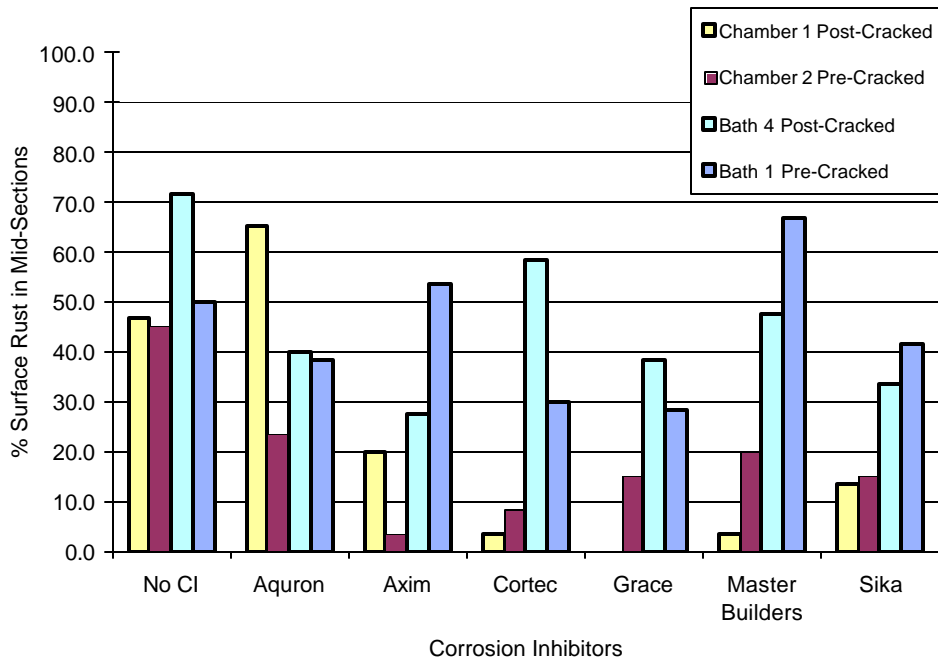

Figure E.3 Surface Corrosion at Mid Section for 0.5% Chloride (Set#1)

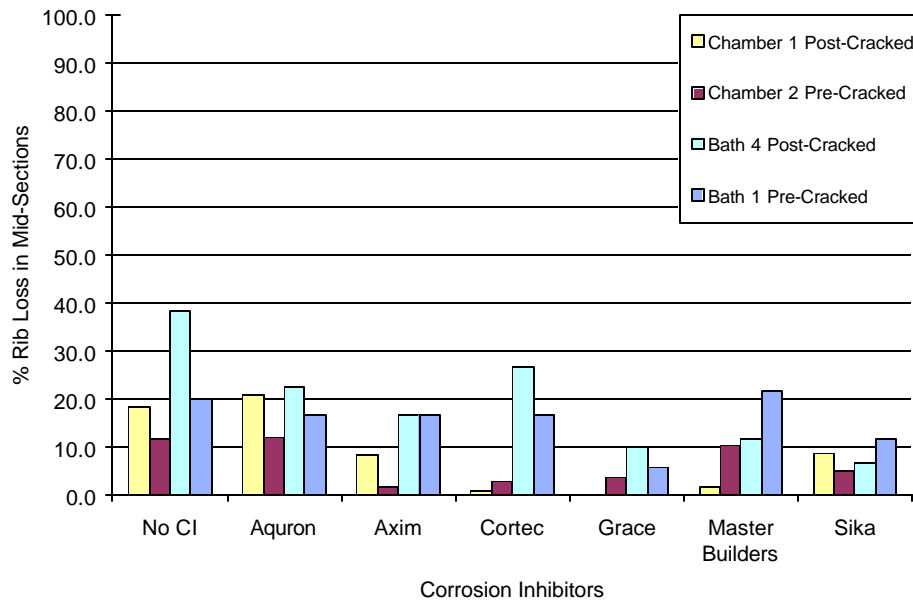

Figure E.4 Rib Loss at Mid Section for 0.5% Chloride (Set #1)

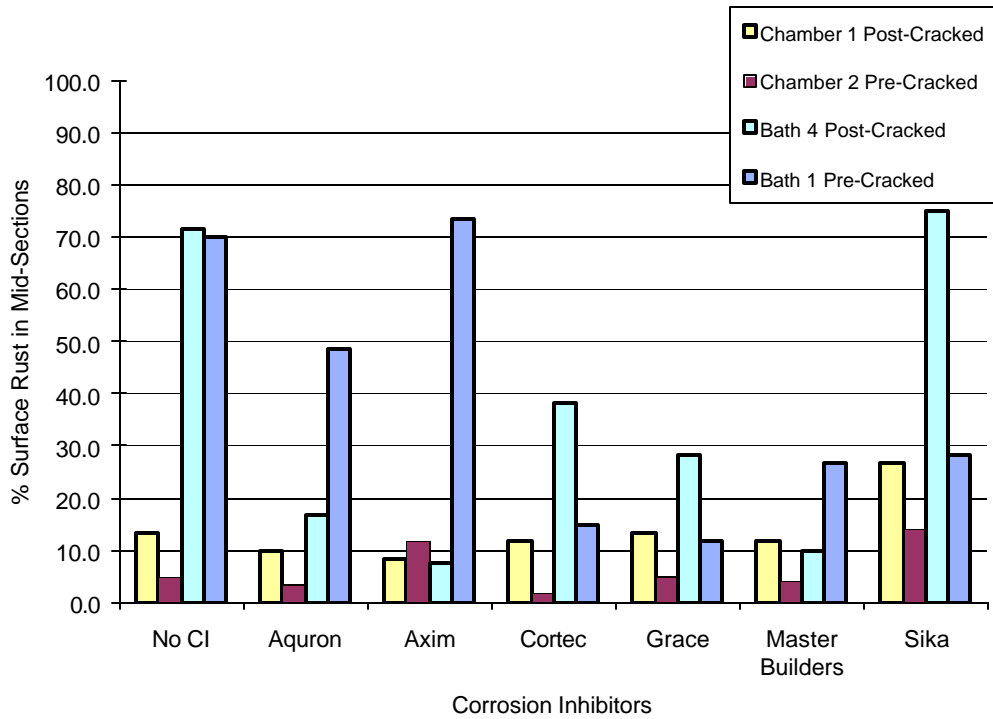

Figure E.5 Surface Corrosion at Mid Section for 1.0% Chloride (Set#1)

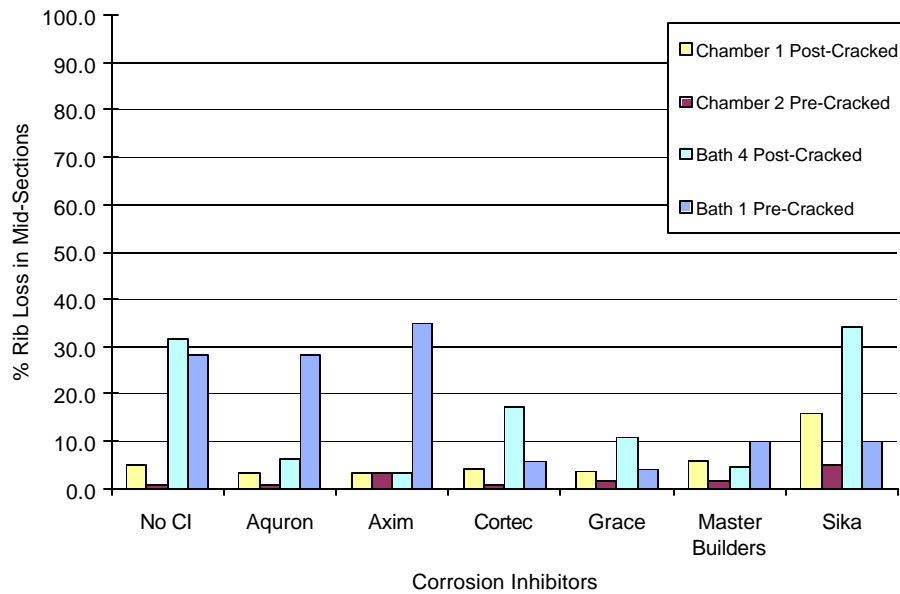

Figure E.6 Rib Loss at Mid Section for 1.0% Chloride (Set #1)

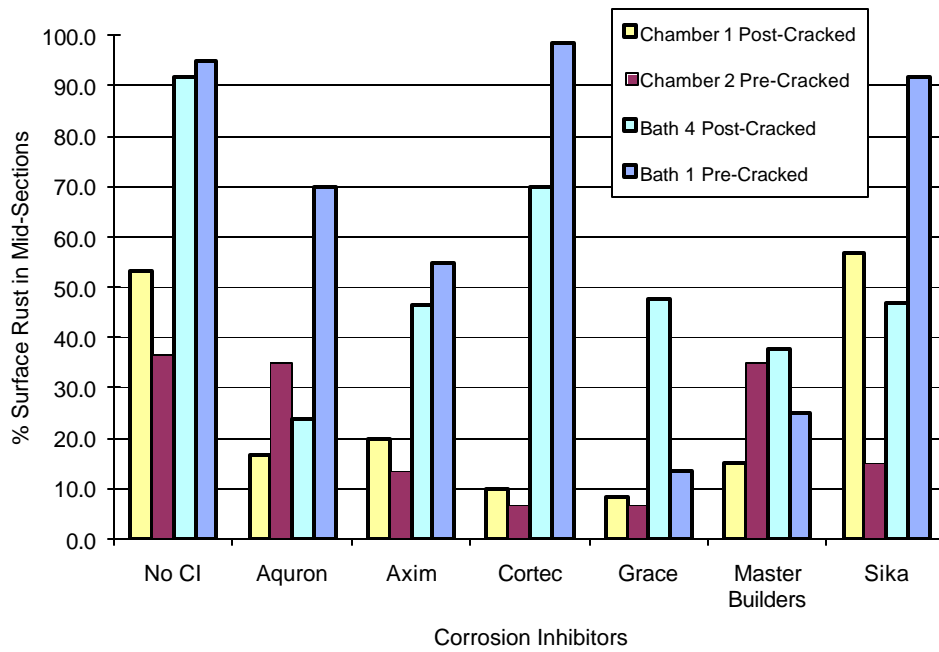

Figure E.7 Surface Corrosion at Mid Section for 1.5% Chloride (Set#1)

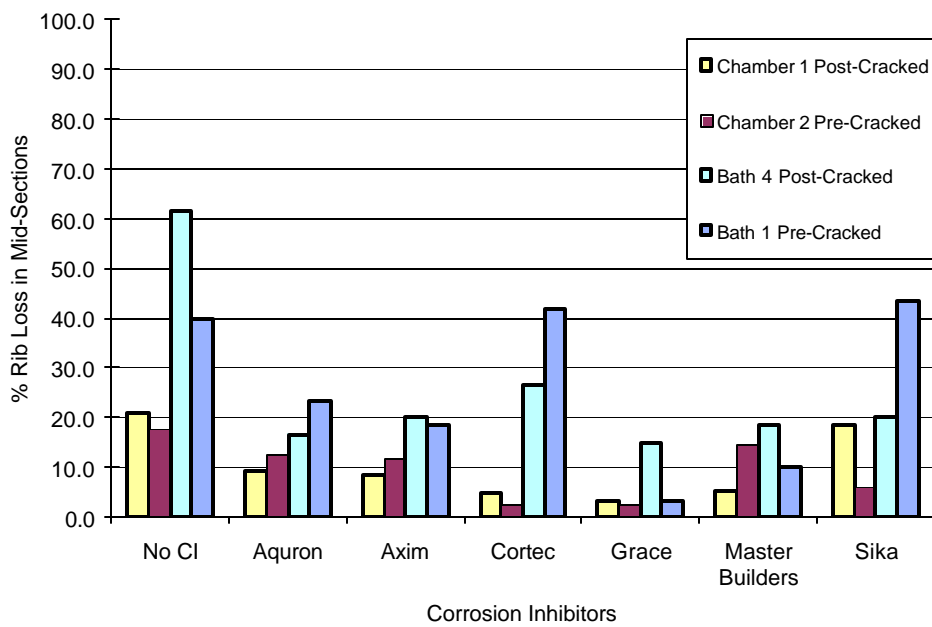

Figure E.8 Rib Loss at Mid Section for 1.5% Chloride (Set #1)

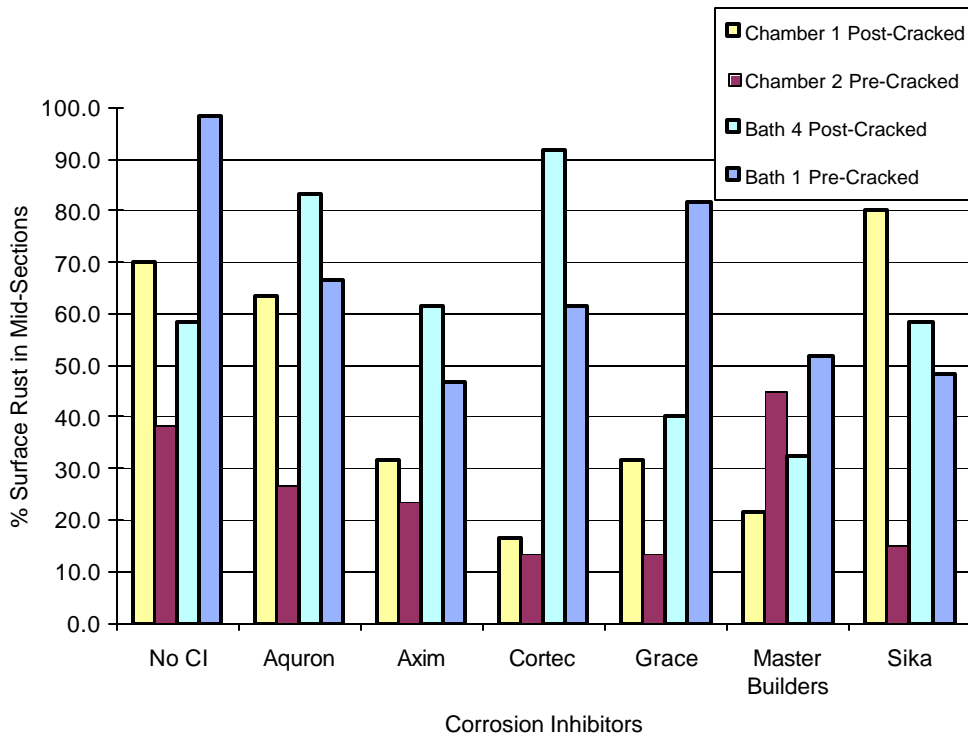

Figure E.9 Surface Corrosion at Mid Section for 2.0% Chloride (Set#1)

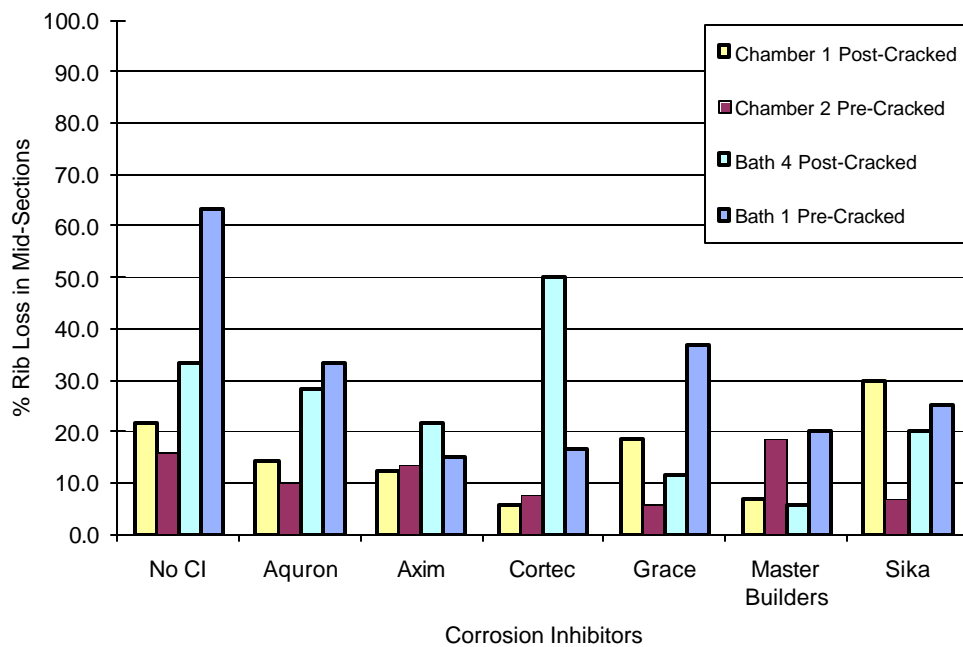

Figure E.10 Rib Loss at Mid Section for 2.0% Chloride (Set #1)

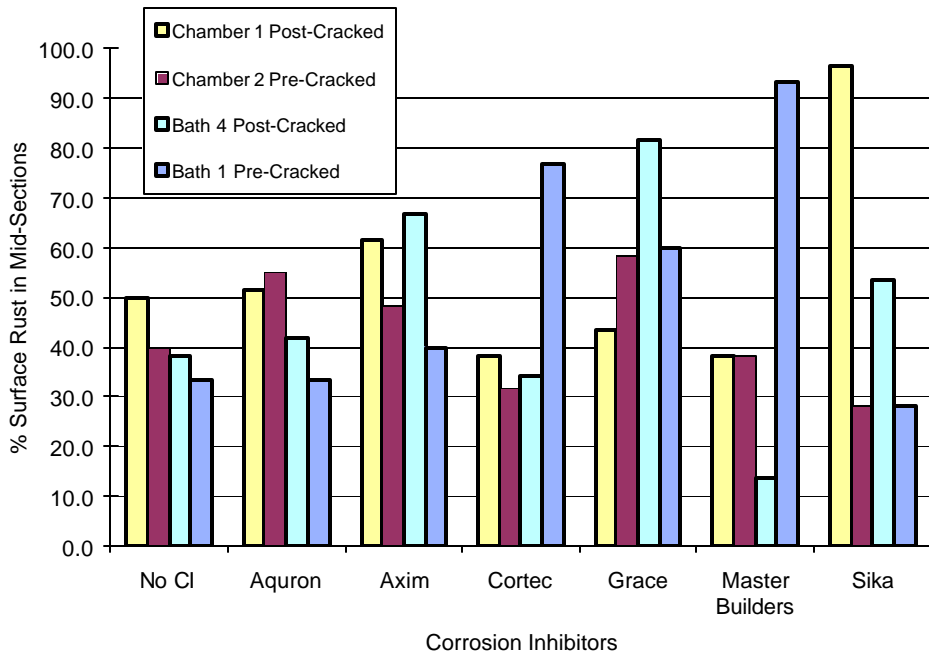

Figure E.11 Surface Corrosion at Mid Section for 3.0% Chloride (Set#1)

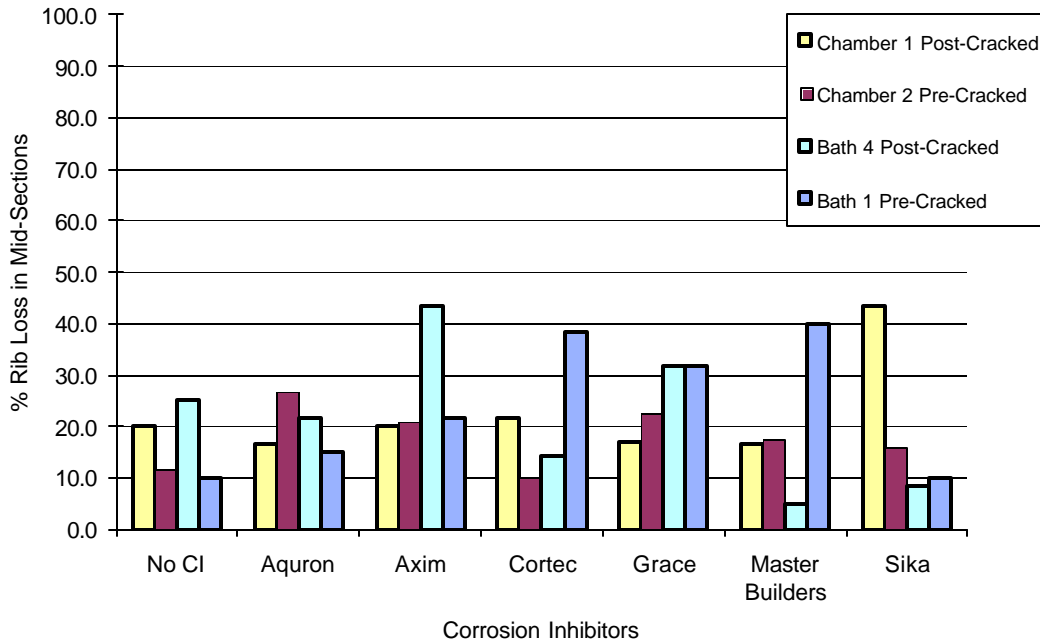

Figure E.12 Rib Loss at Mid Section for 3.0% Chloride (Set #1)

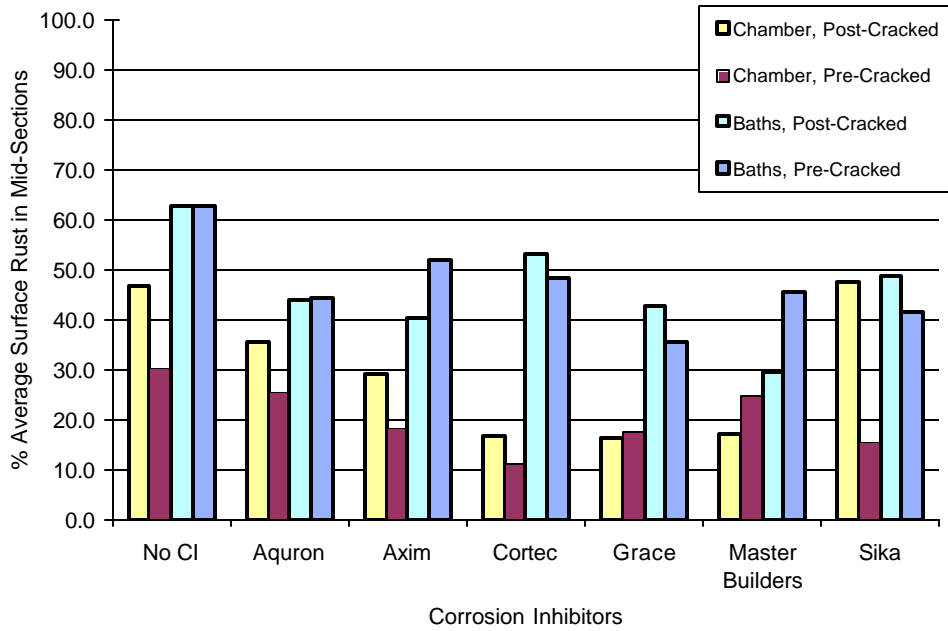

Figure E.13 Surface Corrosion at Mid Section for Average of all Chloride Contaminants (Set#1)

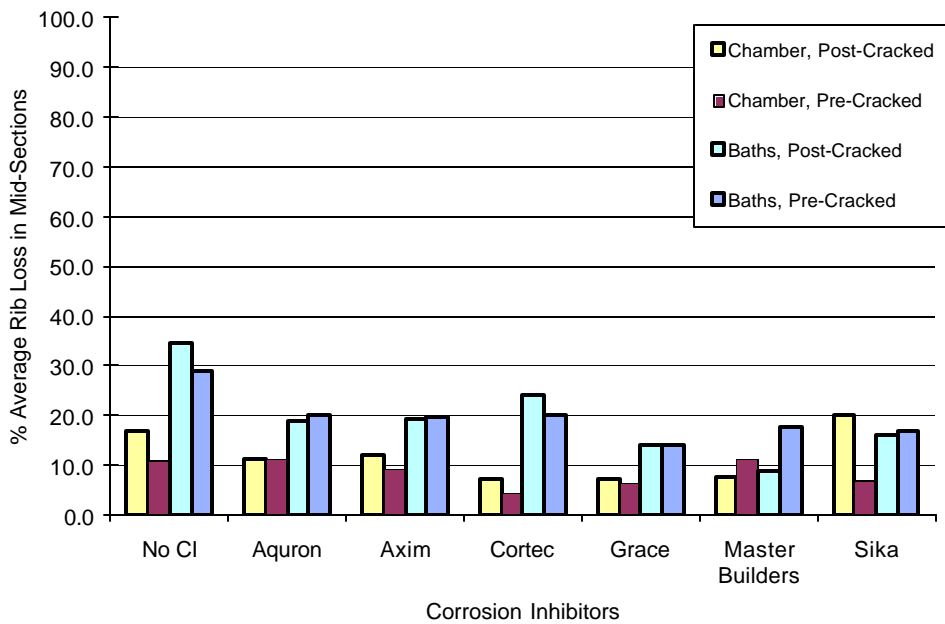

Figure E.14 Rib Loss at Mid Section for Average of all Chloride Contaminants (Set#1)

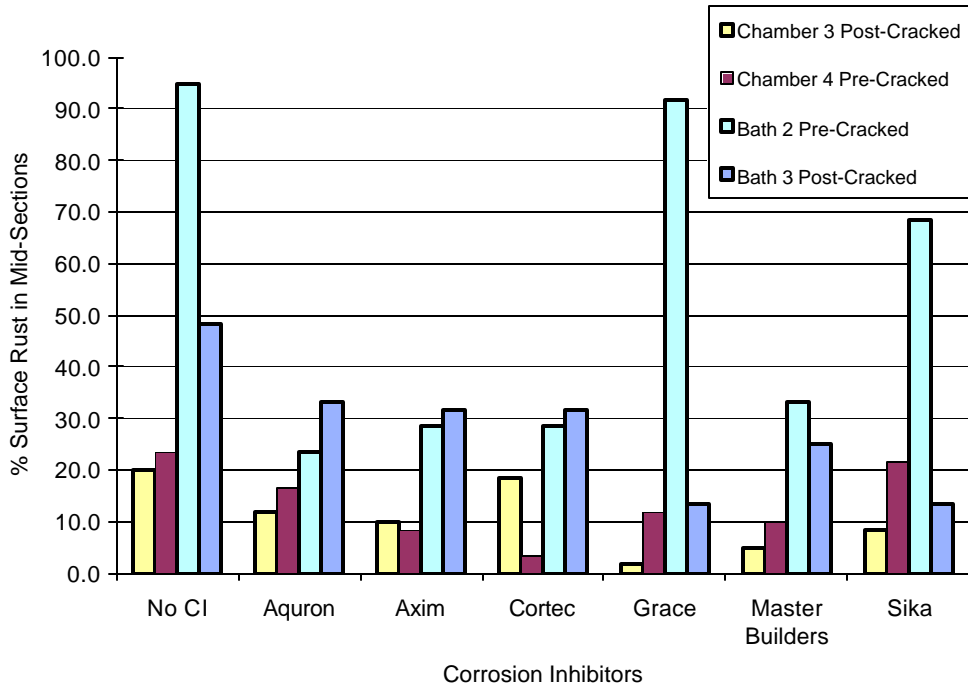

Figure E.15 Surface Corrosion at Mid Section for 0.0% Chloride (Set#2)

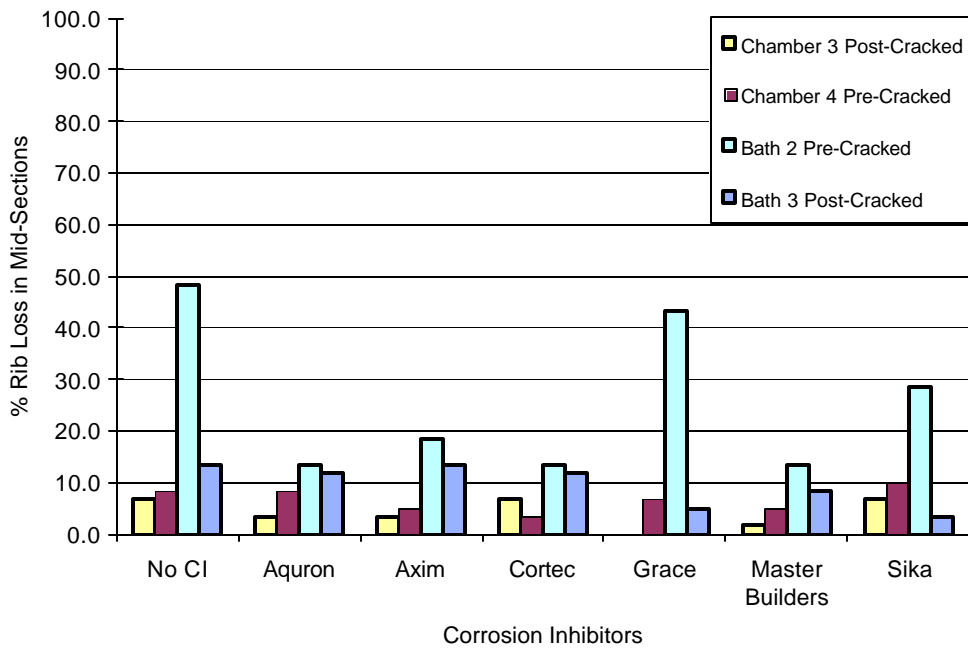

Figure E.16 Rib Loss at Mid Section for 0.0% Chloride (Set #2)

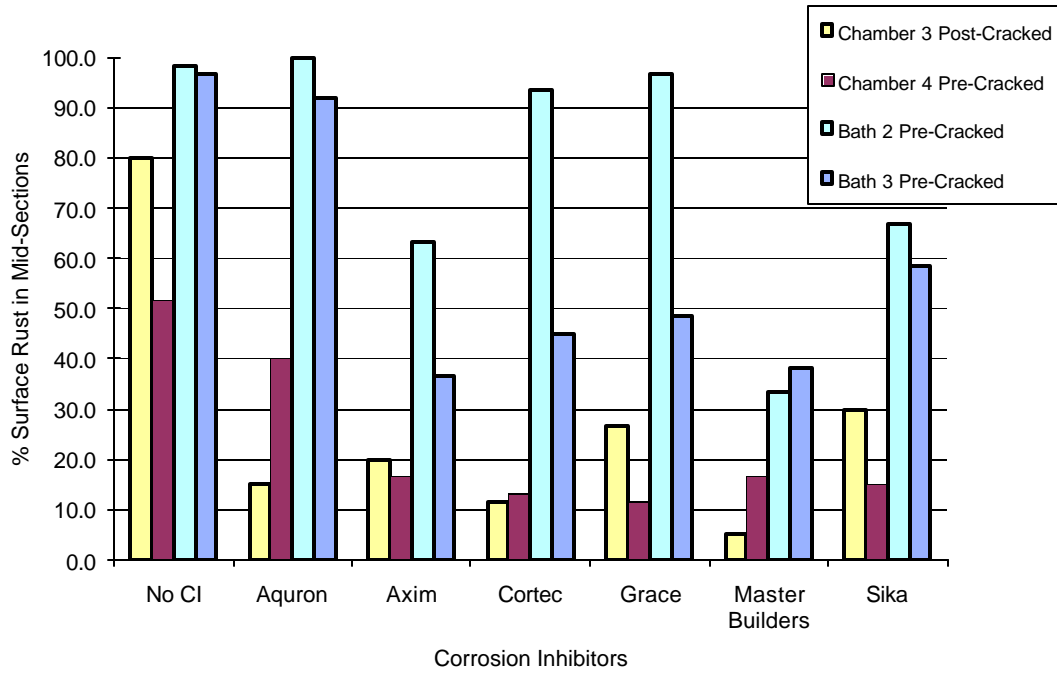

Figure E.17 Surface Corrosion at Mid Section for 0.5% Chloride (Set#2)

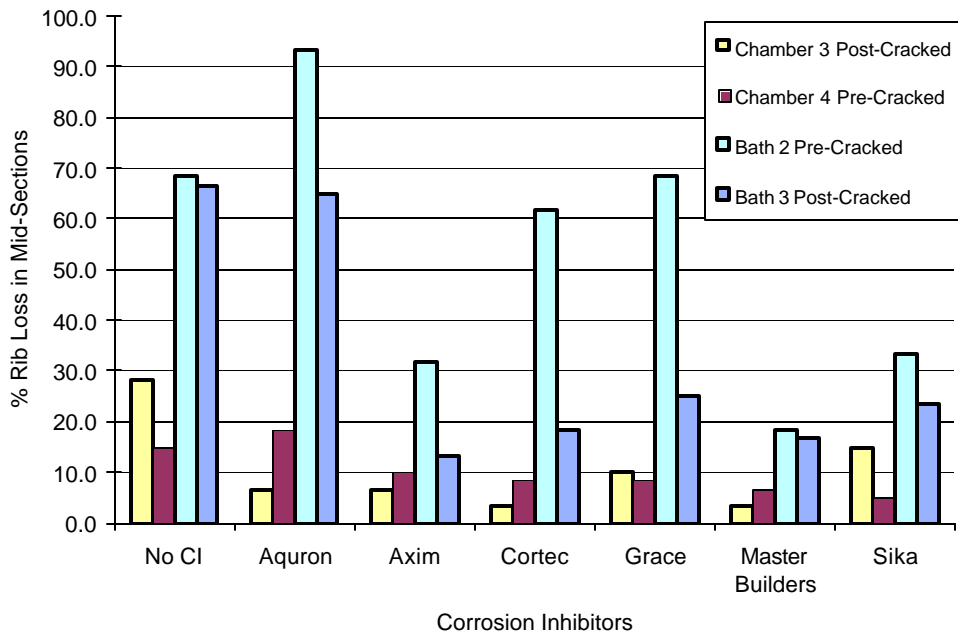

Figure E.18 Rib Loss at Mid Section for 0.5% Chloride (Set #2)

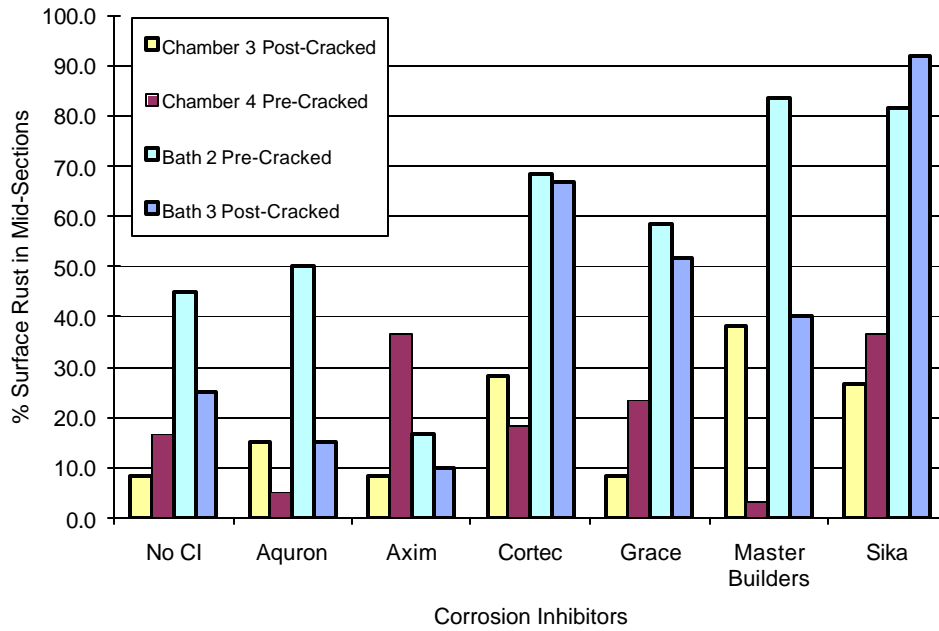

Figure E.19 Surface Corrosion at Mid Section for 1.0% Chloride (Set#2)

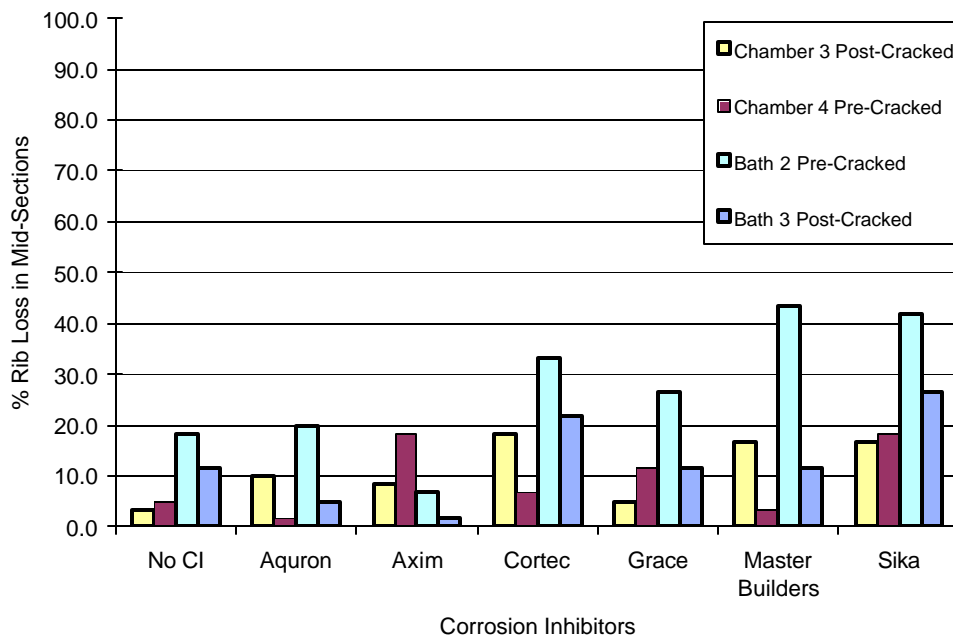

Figure E.20 Rib Loss at Mid Section for 1.0% Chloride (Set #2)

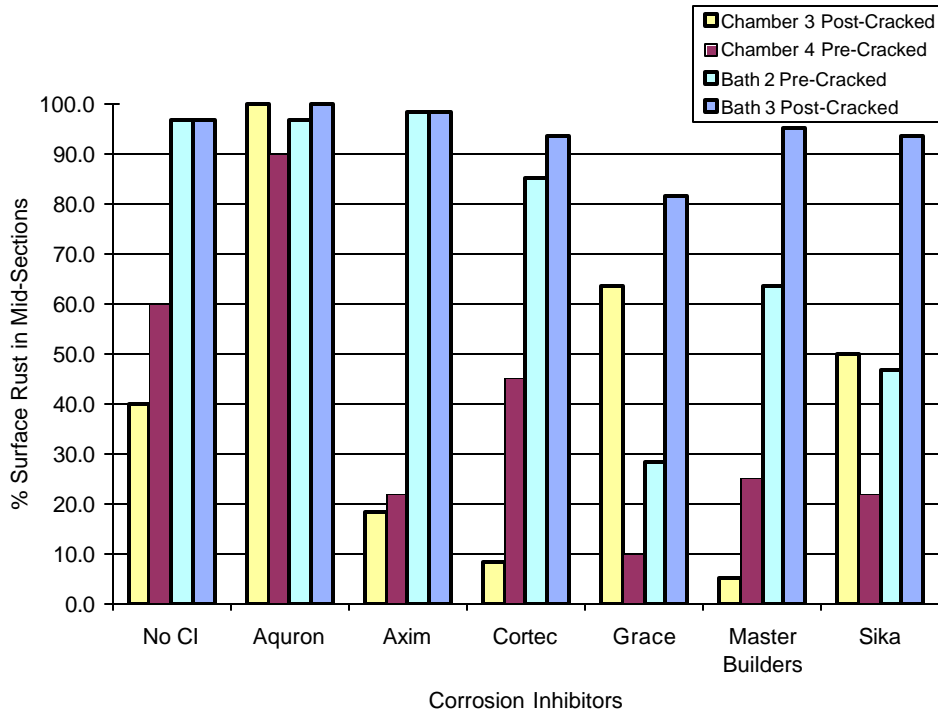

Figure E.21 Surface Corrosion at Mid Section for 1.5% Chloride (Set#2)

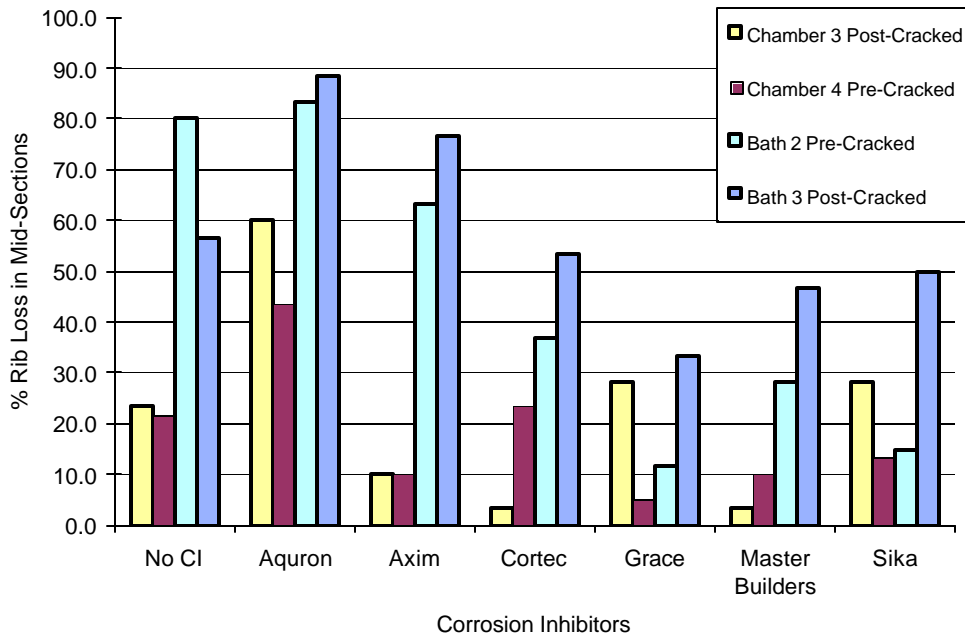

Figure E.22 Rib Loss at Mid Section for 1.5% Chloride (Set #2)

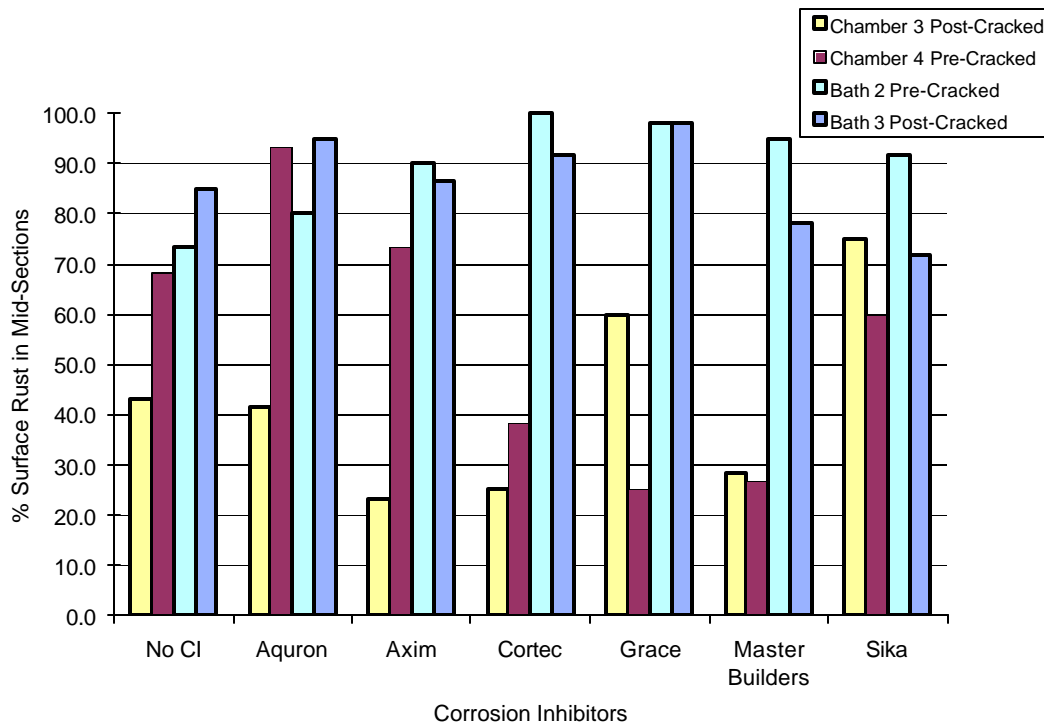

Figure E.23 Surface Corrosion at Mid Section for 2.0% Chloride (Set#2)

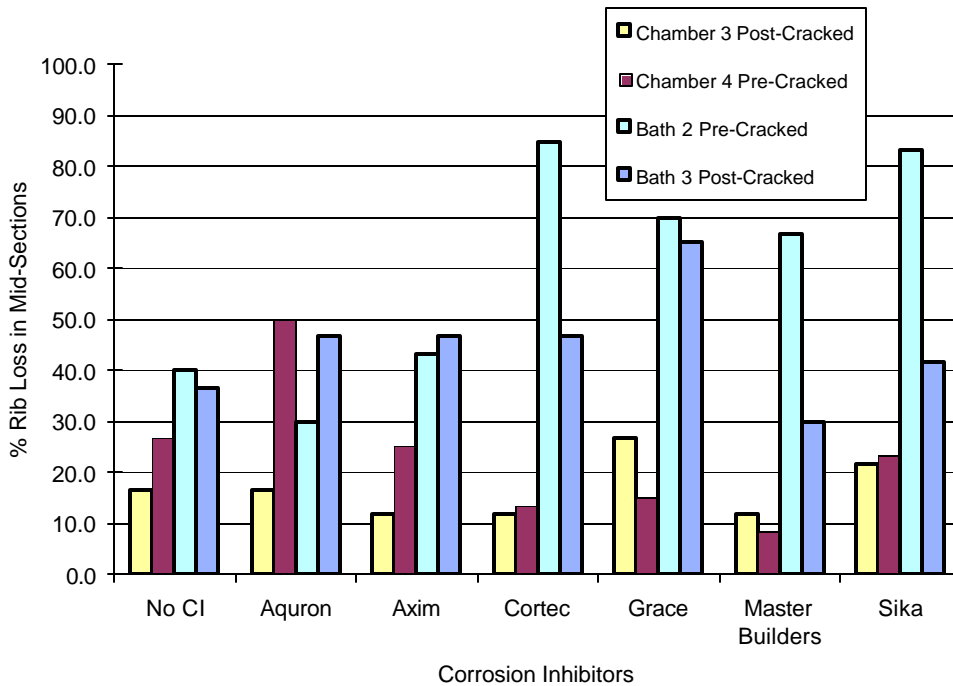

Figure E.24 Rib Loss at Mid Section for 2.0% Chloride (Set #2)

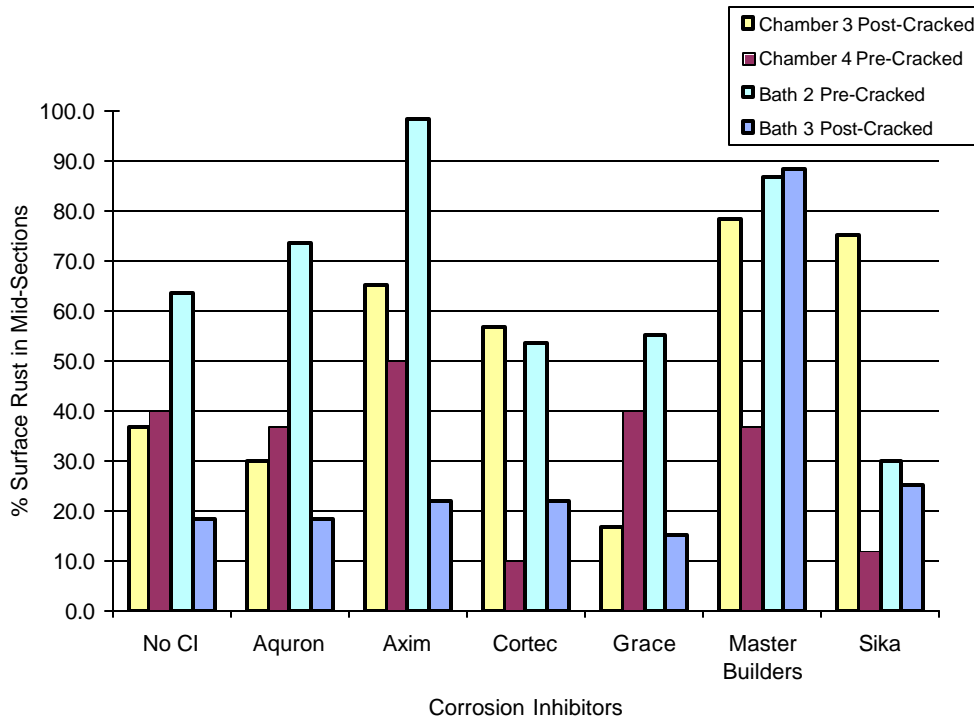

Figure E.25 Surface Corrosion at Mid Section for 3.0% Chloride (Set#2)

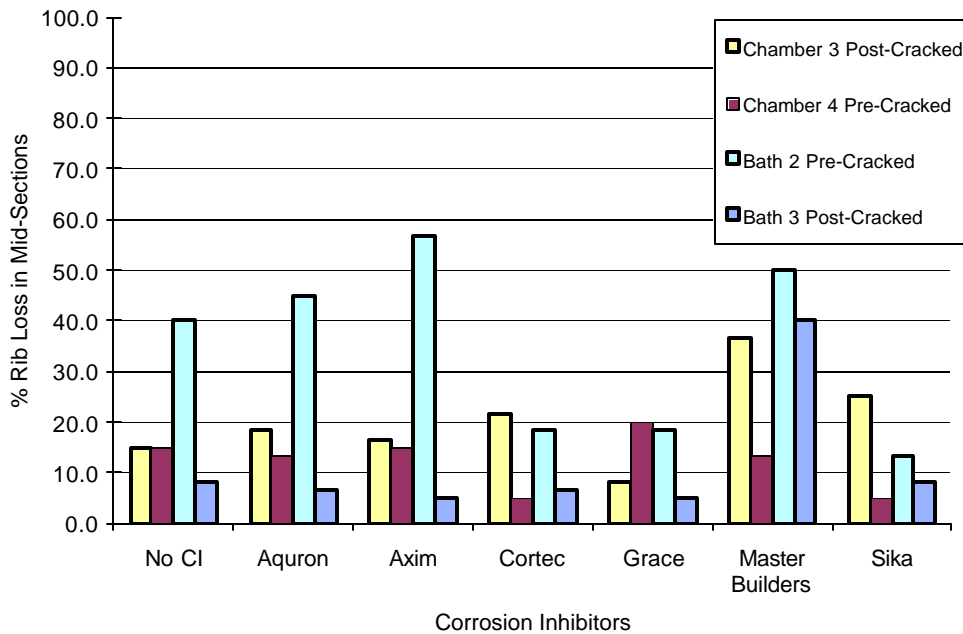

Figure E.26 Rib Loss at Mid Section for 3.0% Chloride (Set #2)

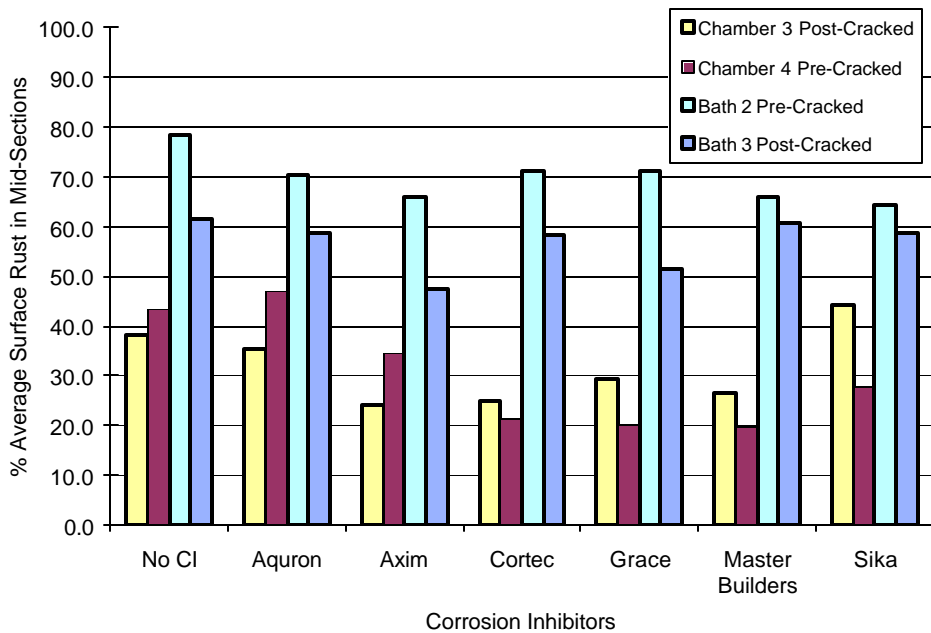

Figure E.27 Surface Corrosion at Mid Section for Average of all Chloride Contaminants (Set#2)

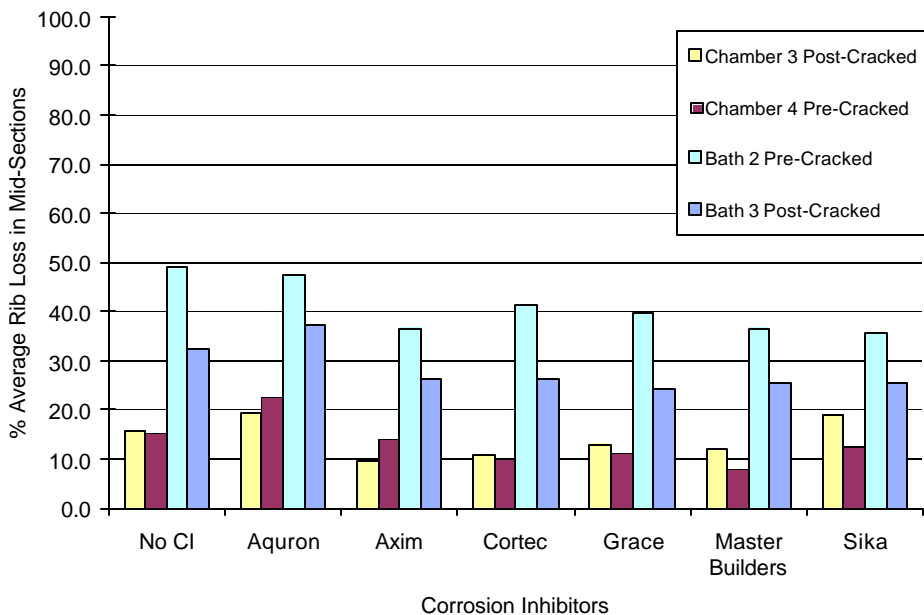

Figure E.28 Rib Loss at Mid Section for Average of all Chloride Contaminants (Set#2)

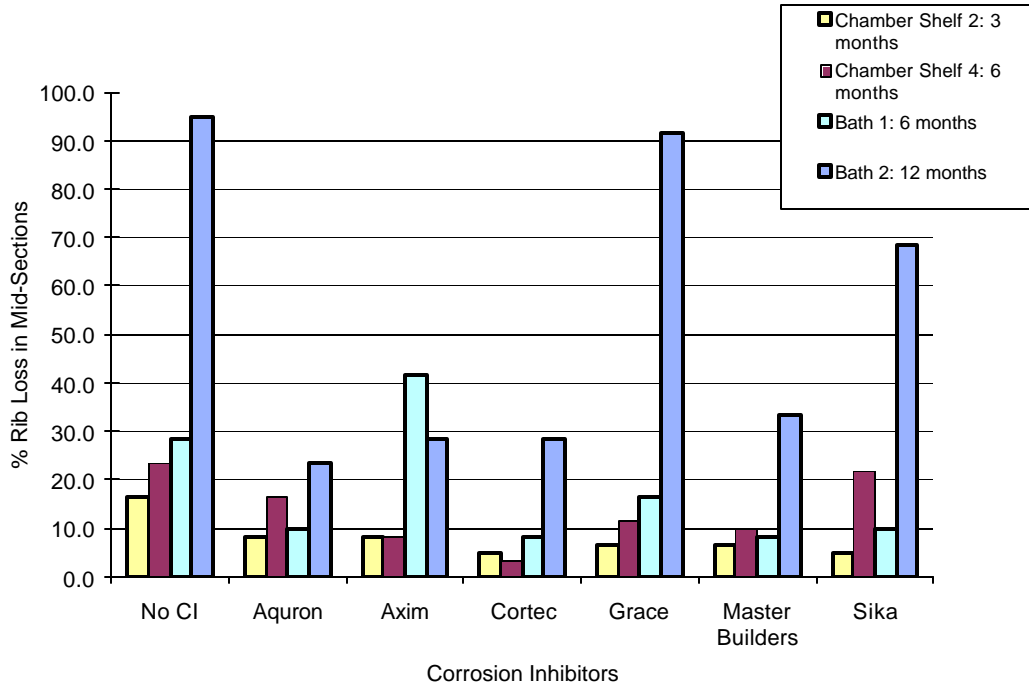

Figure E.29 Time Step of Surface Corrosion for 0.0% Chloride Pre-Cracked Specimens

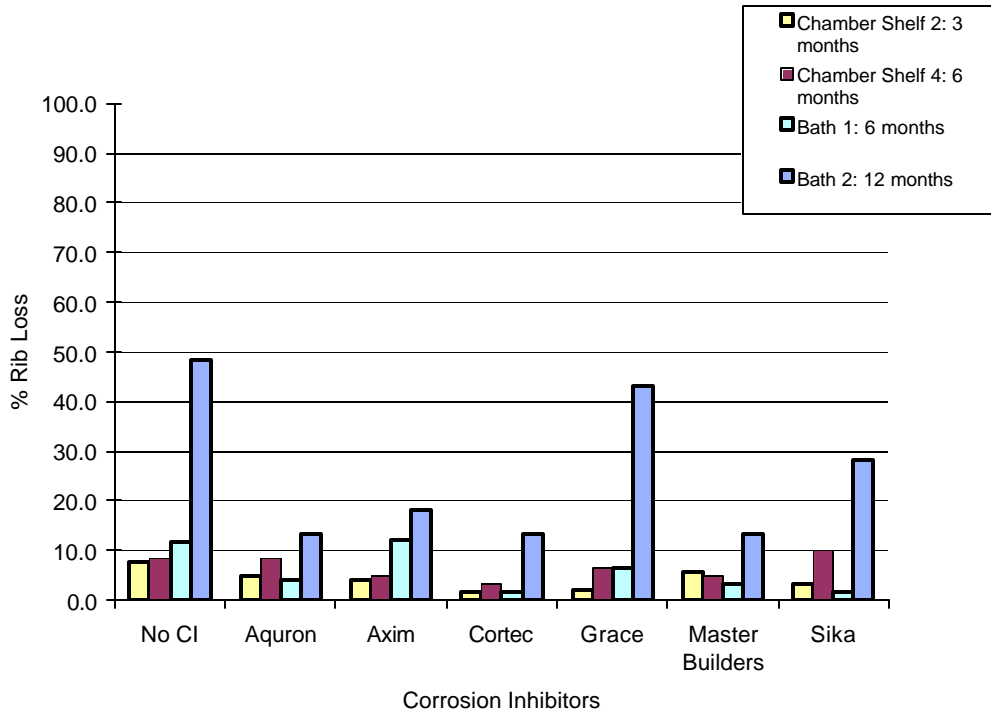

Figure E.30 Time Step of Rib Loss for 0.0% Chloride Pre-Cracked Specimens

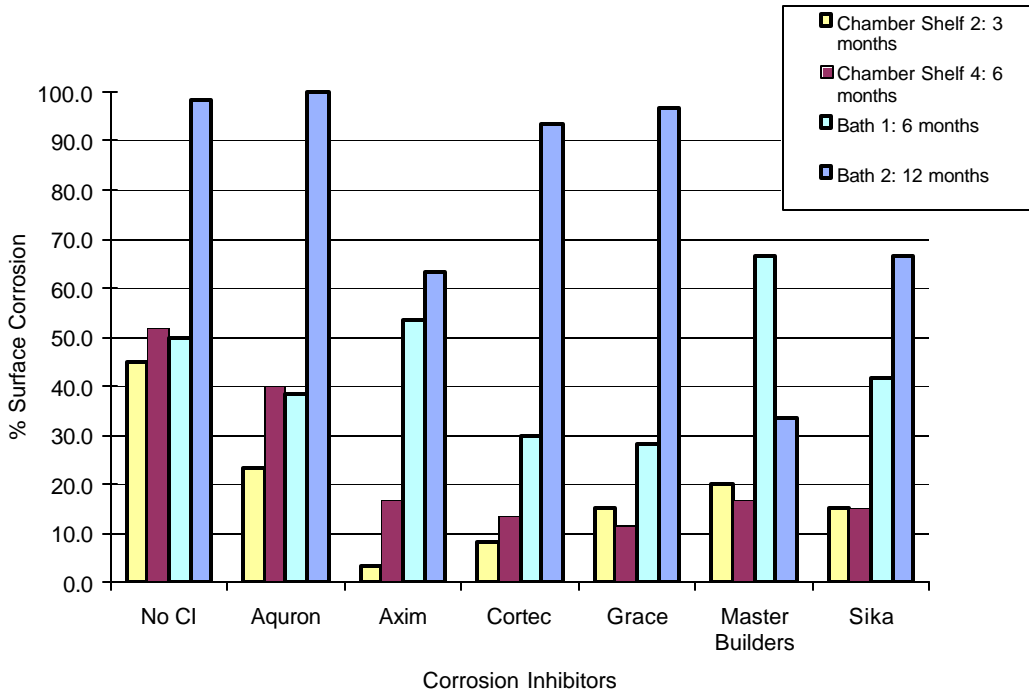

Figure E.31 Time Step of Surface Corrosion for 0.5% Chloride Pre-Cracked Specimens

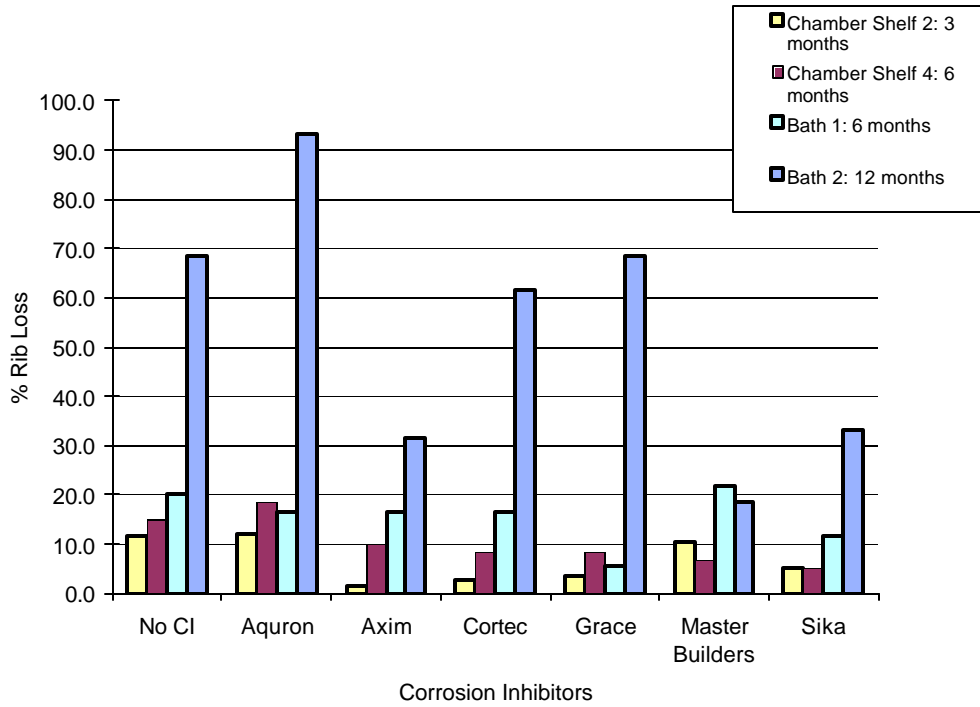

Figure E.32 Time Step of Rib Loss for 0.5% Chloride Pre-Cracked Specimens

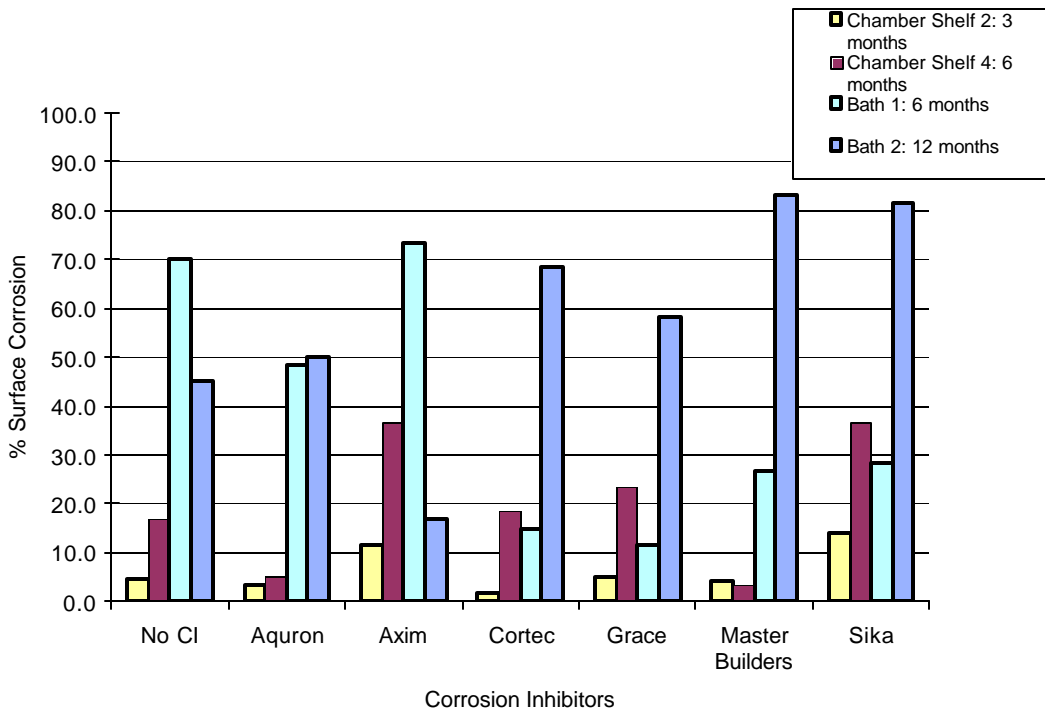

Figure E.33 Time Step of Surface Corrosion for 1.0% Chloride Pre-Cracked Specimens

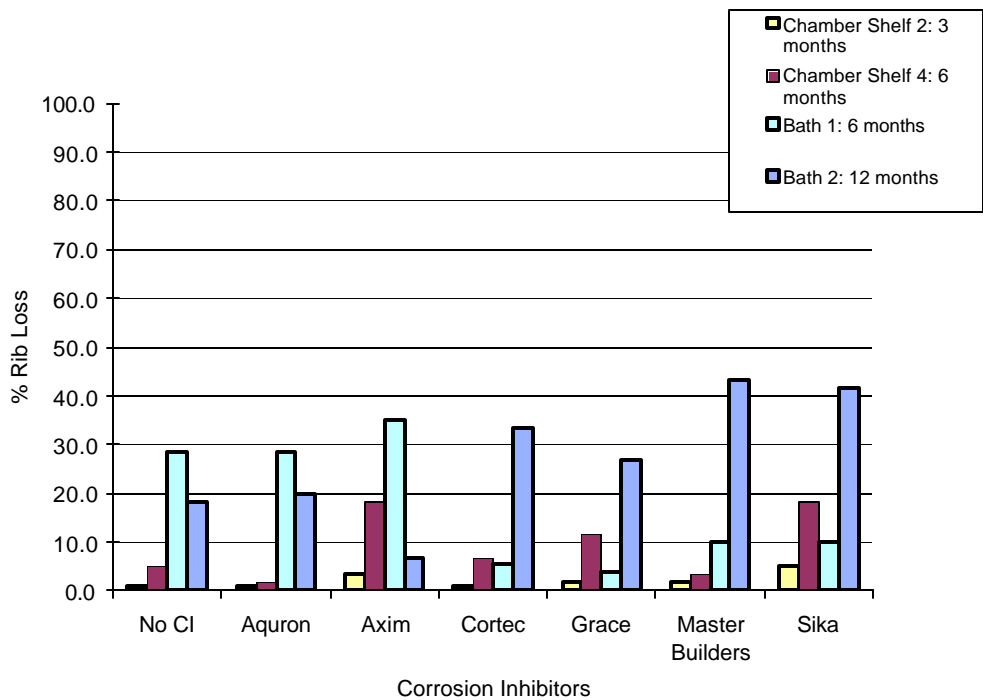

Figure E.34 Time Step of Rib Loss for 1.0% Chloride Pre-Cracked Specimens

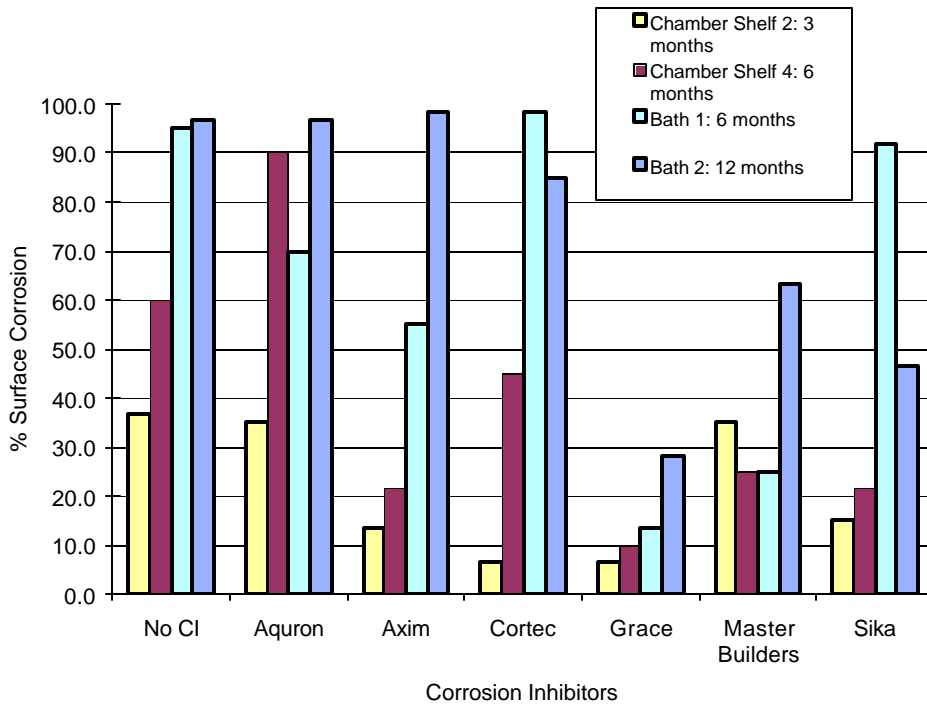

Figure E.35 Time Step of Surface Corrosion for 1.5% Chloride Pre-Cracked Specimens

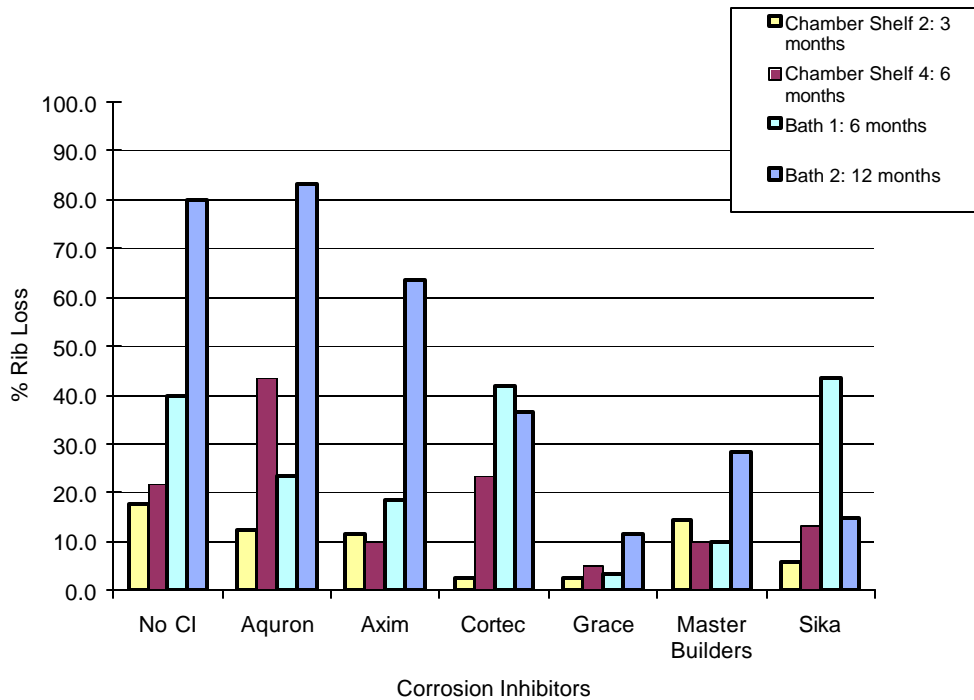

Figure E.36 Time Step of Rib Loss for 1.5% Chloride Pre-Cracked Specimens

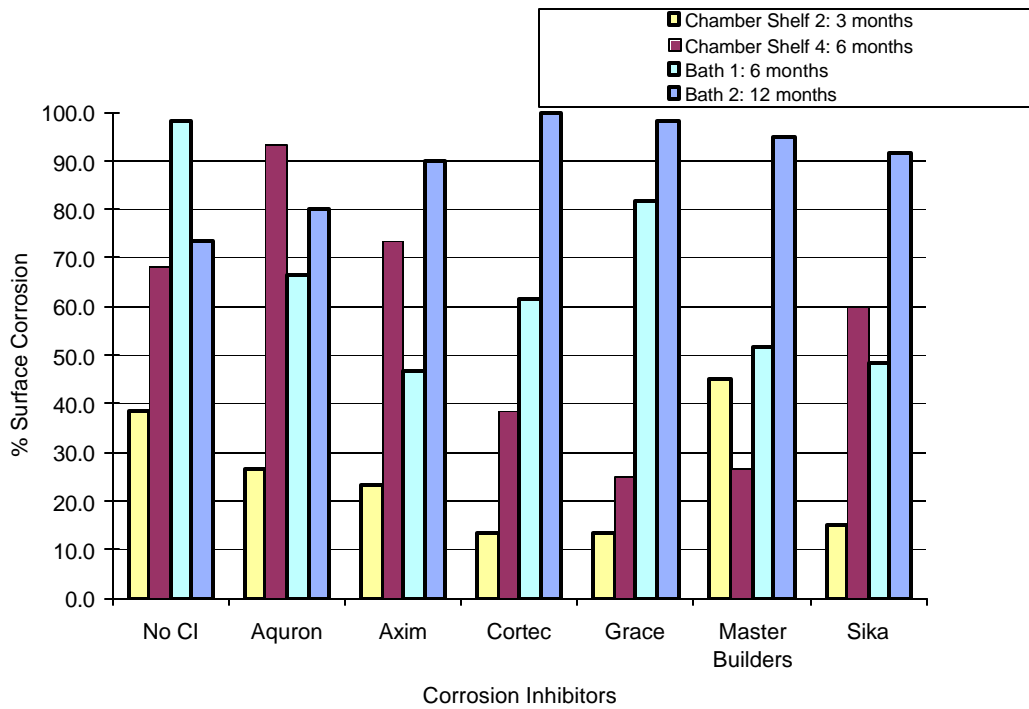

Figure E.37 Time Step of Surface Corrosion for 2.0% Chloride Pre-Cracked Specimens

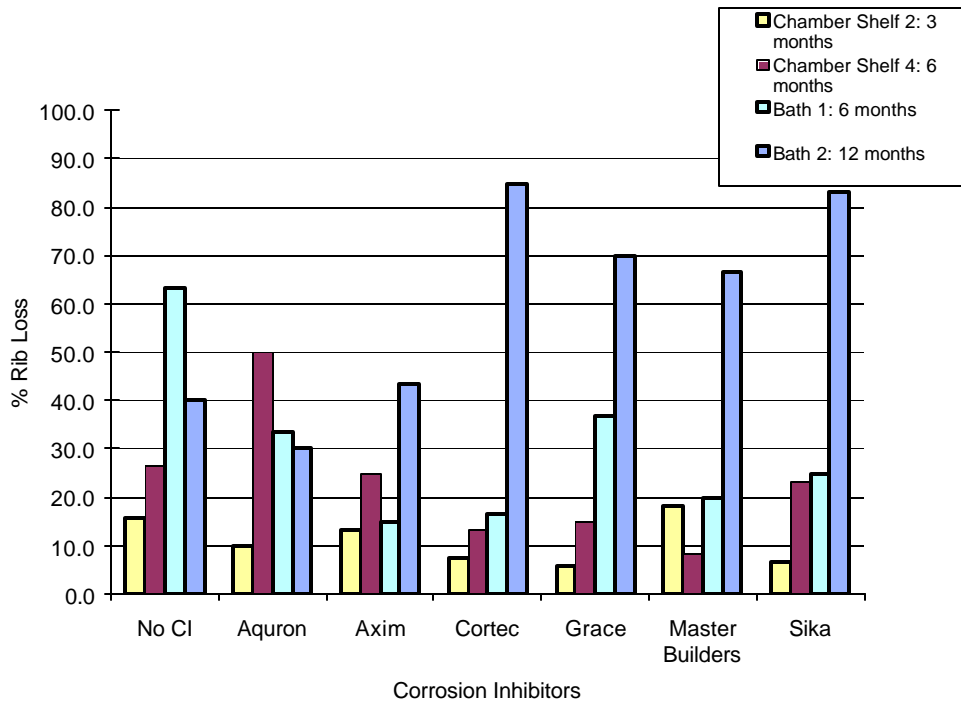

Figure E.38 Time Step of Rib Loss for 2.0% Chloride Pre-Cracked Specimens

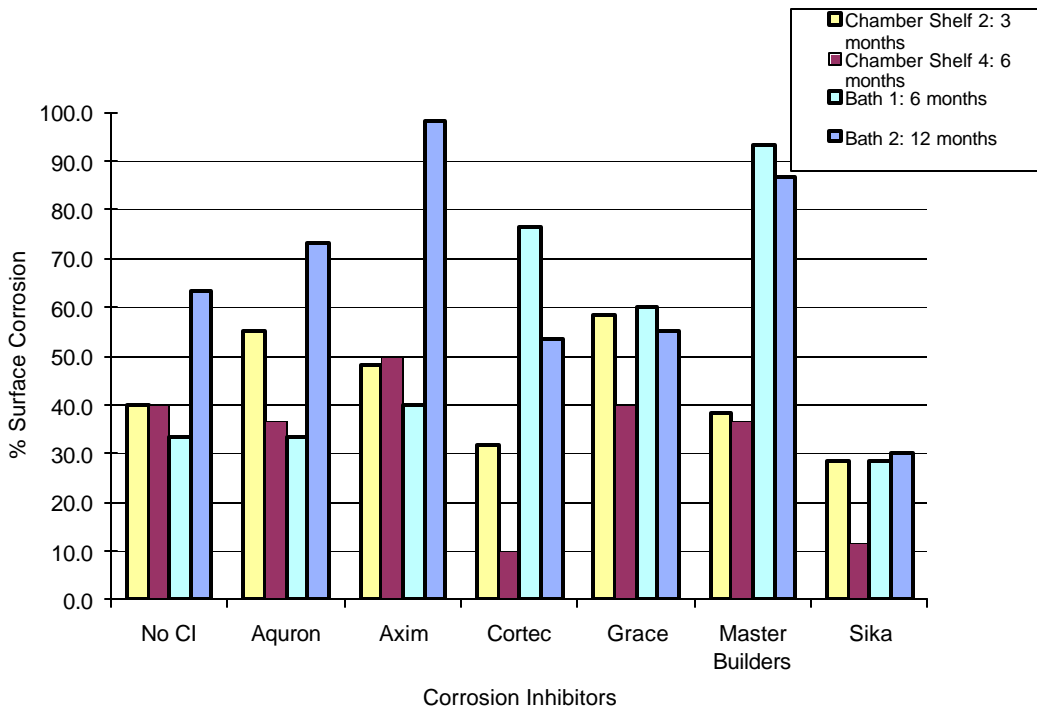

Figure E.39 Time Step of Surface Corrosion for 3.0% Chloride Pre-Cracked Specimens

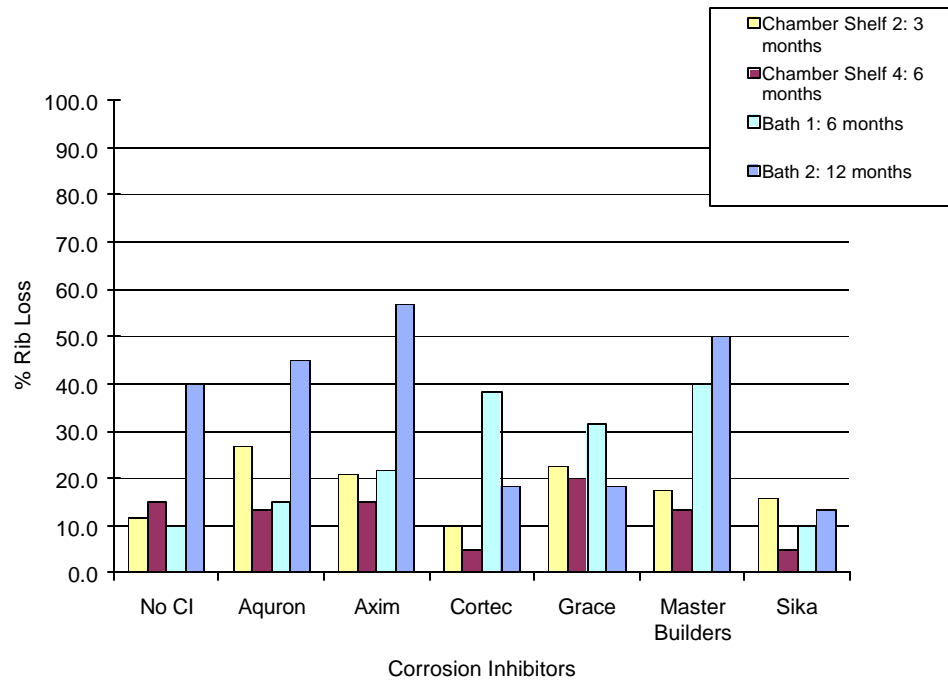

Figure E.40 Time Step of Rib Loss for 3.0% Chloride Pre-Cracked Specimens

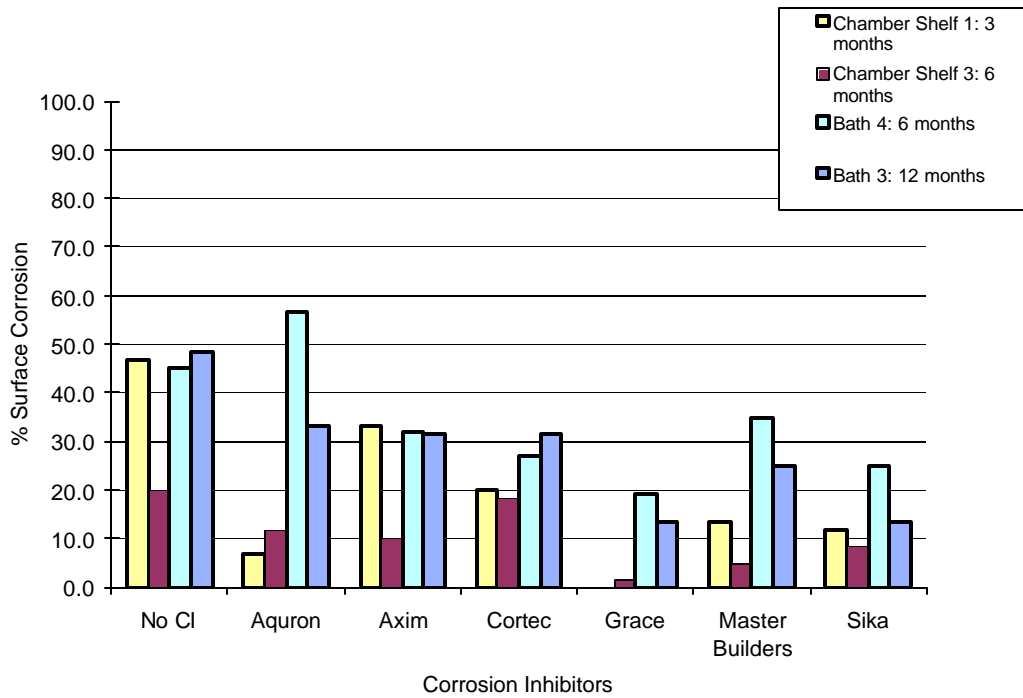

Figure E.41 Time Step of Surface Corrosion for 0.0% Chloride Post-Cracked Specimens

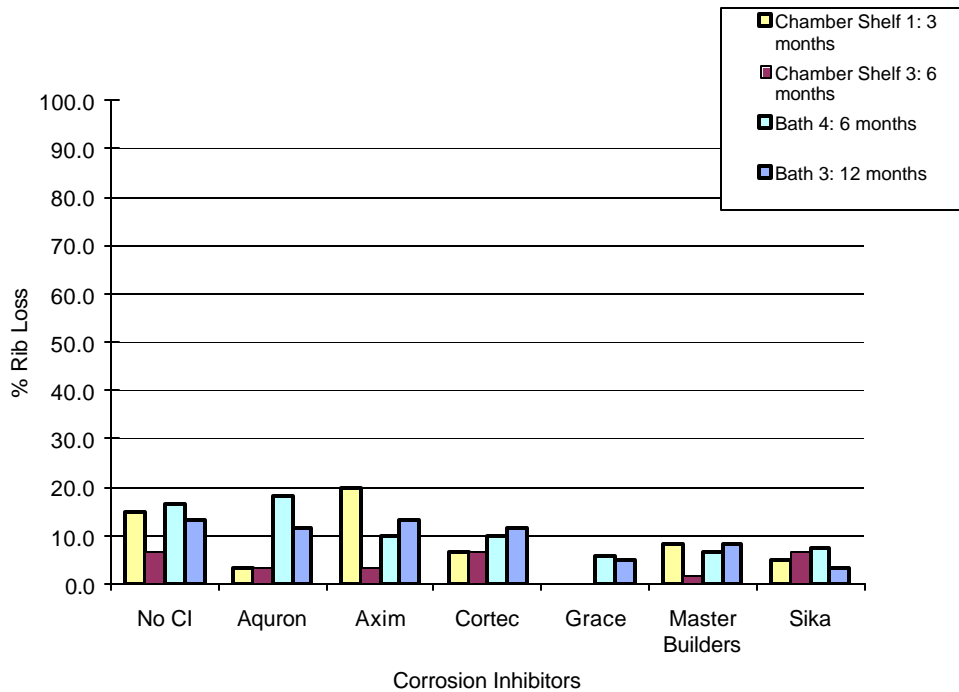

Figure E.42 Time Step of Rib Loss for 0.0% Chloride Post-Cracked Specimens

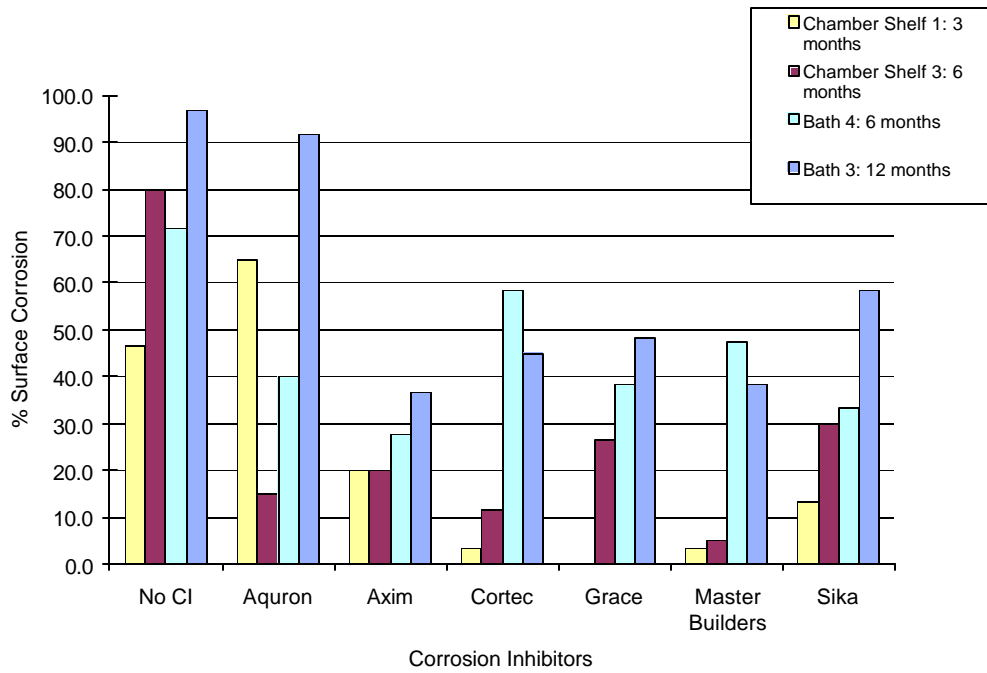

Figure E.43 Time Step of Surface Corrosion for 0.5% Chloride Post-Cracked Specimens

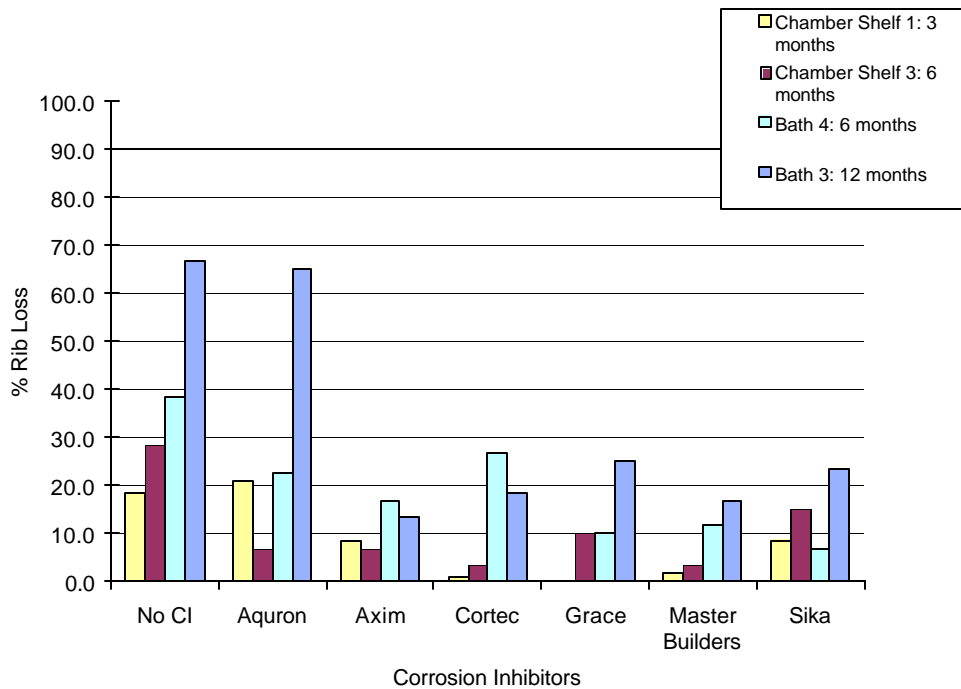

Figure E.44 Time Step of Rib Loss for 0.5% Chloride Post-Cracked Specimens

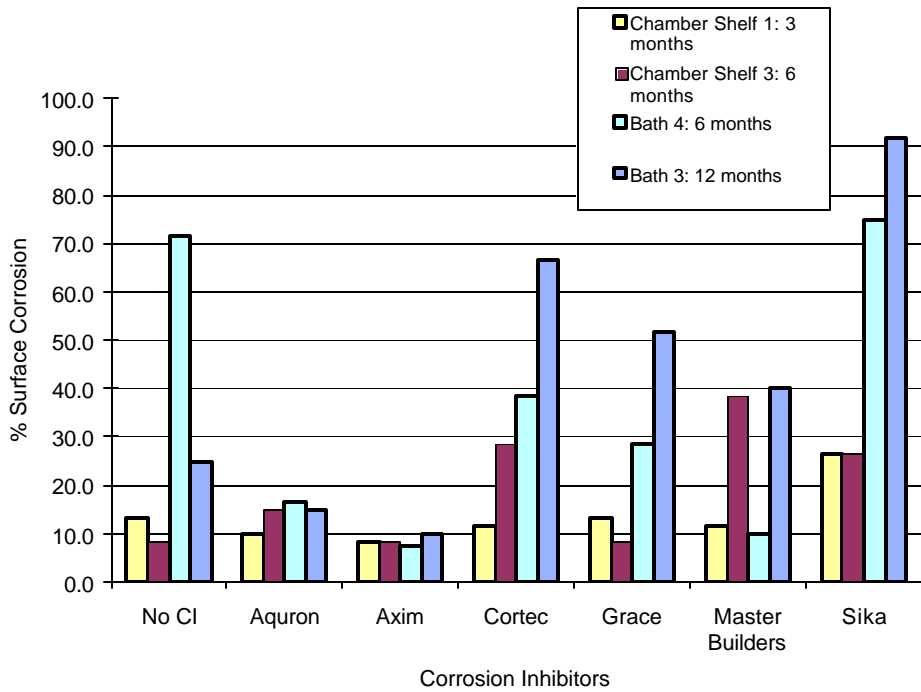

Figure E.45 Time Step of Surface Corrosion for 1.0% Chloride Post-Cracked Specimens

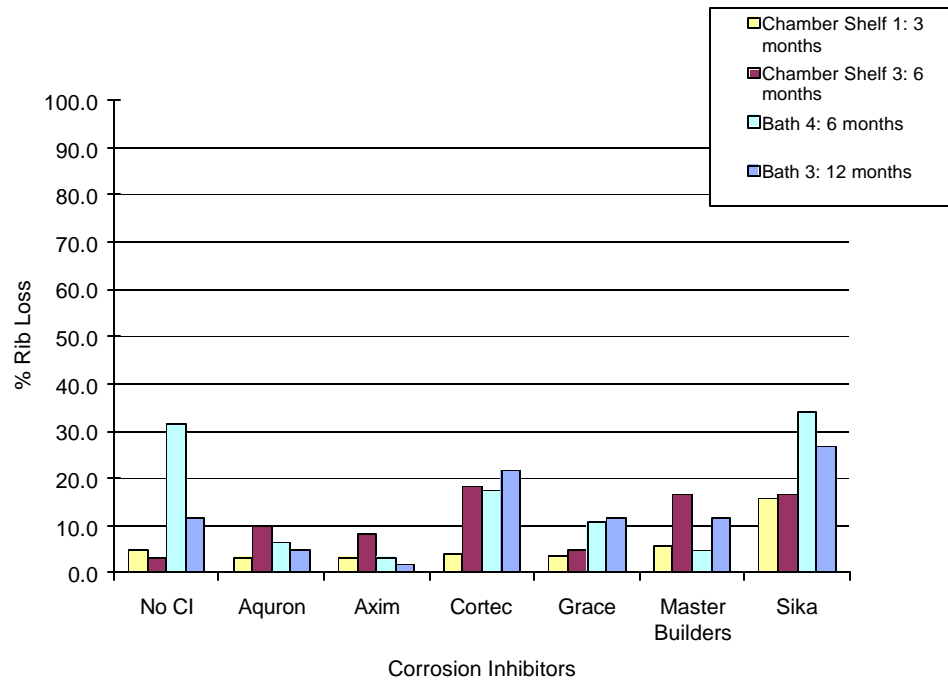

Figure E.46 Time Step of Rib Loss for 1.0% Chloride Post-Cracked Specimens

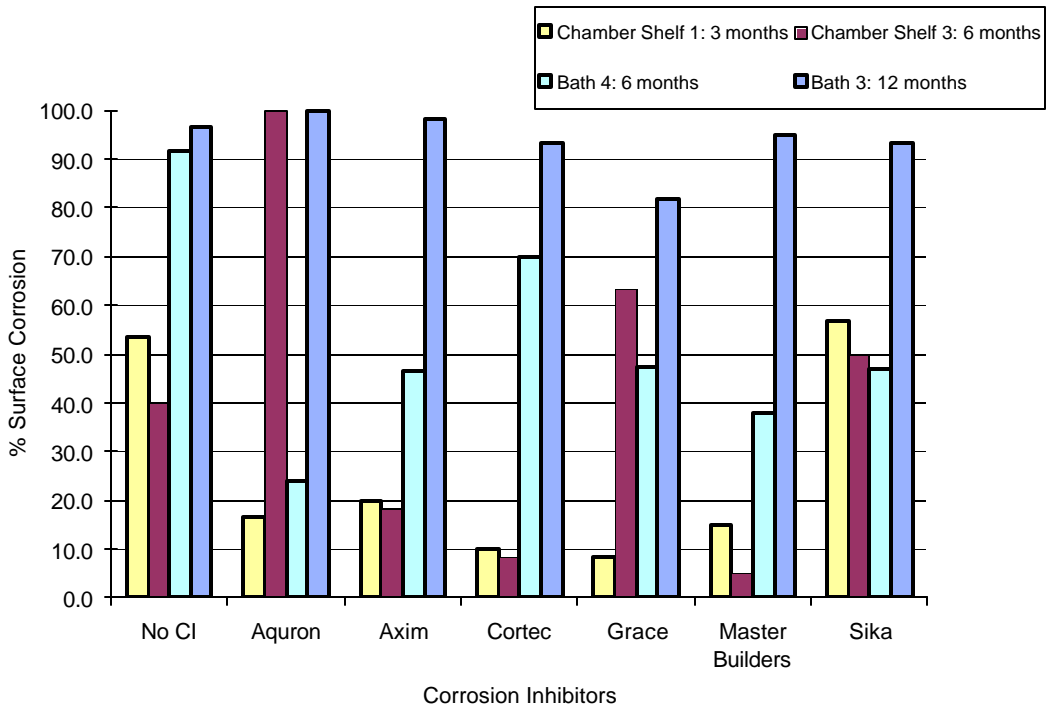

Figure E.47 Time Step of Surface Corrosion for 1.5% Chloride Post-Cracked Specimens

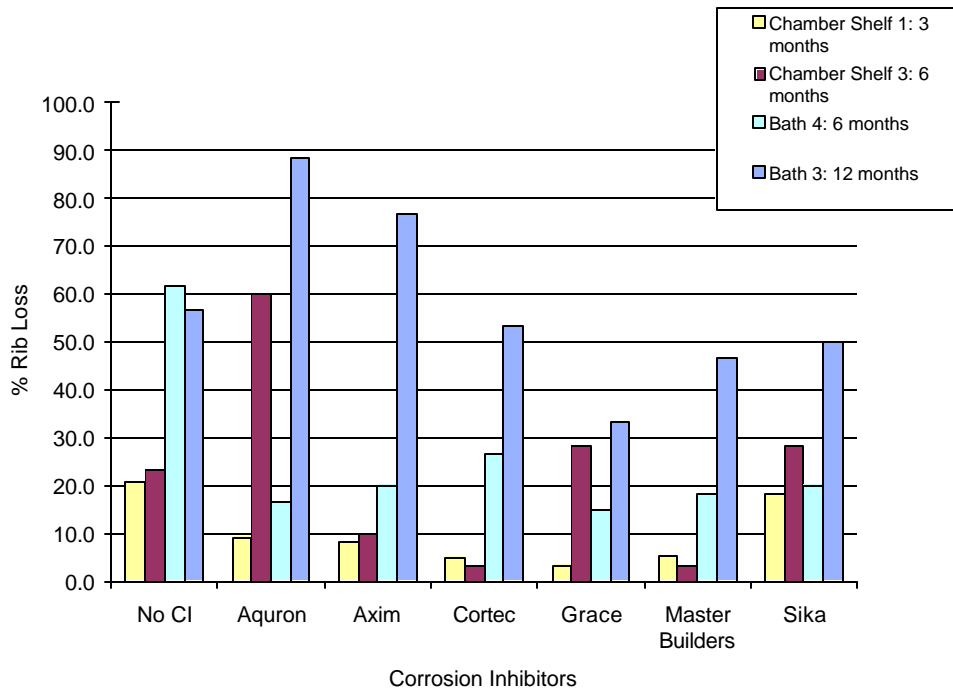

Figure E.48 Time Step of Rib Loss for 1.5% Chloride Post-Cracked Specimens

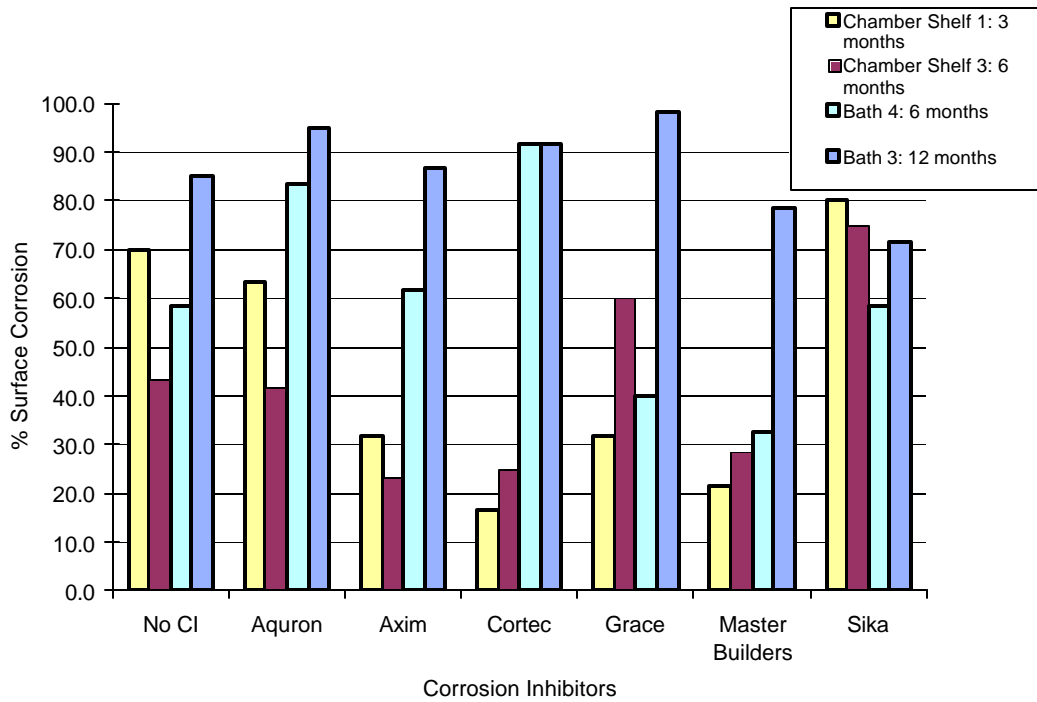

Figure E.49 Time Step of Surface Corrosion for 2.0% Chloride Post-Cracked Specimens

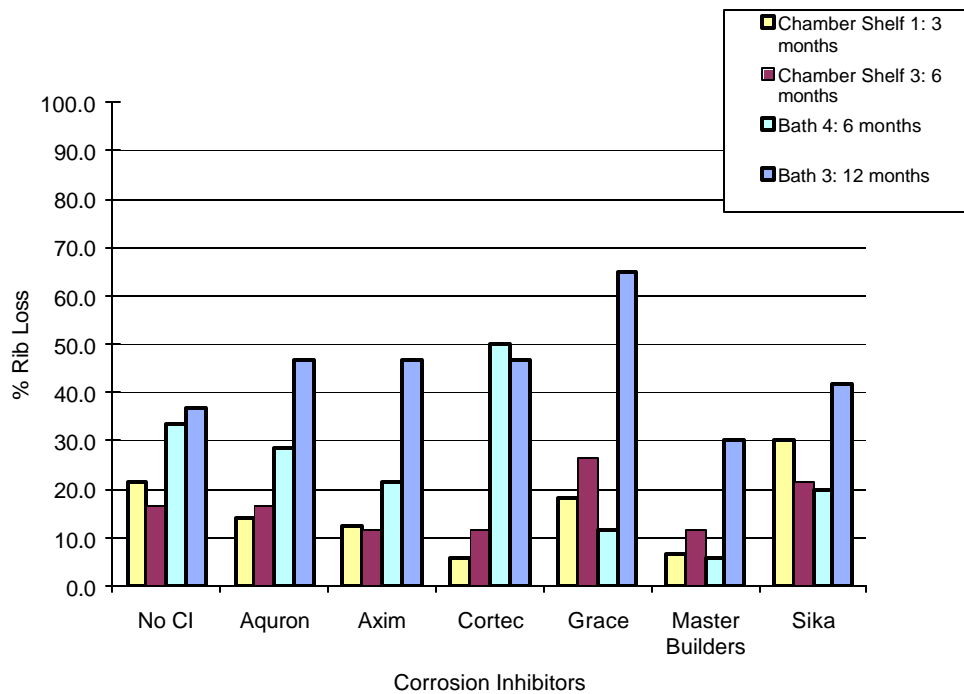

Figure E.50 Time Step of Rib Loss for 2.0% Chloride Post-Cracked Specimens

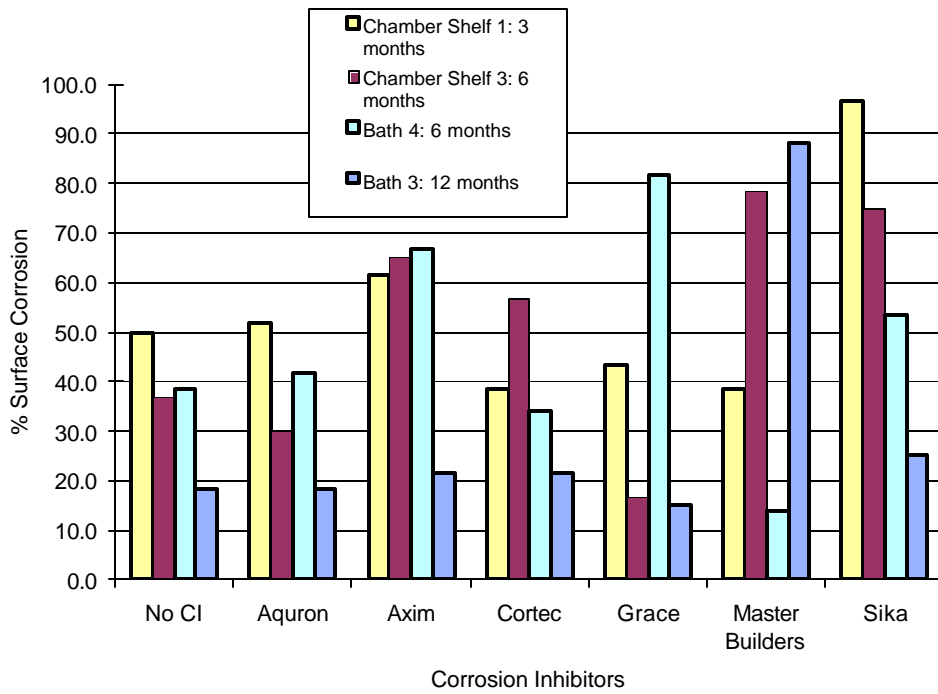

Figure E.51 Time Step of Surface Corrosion for 3.0% Chloride Post-Cracked Specimens

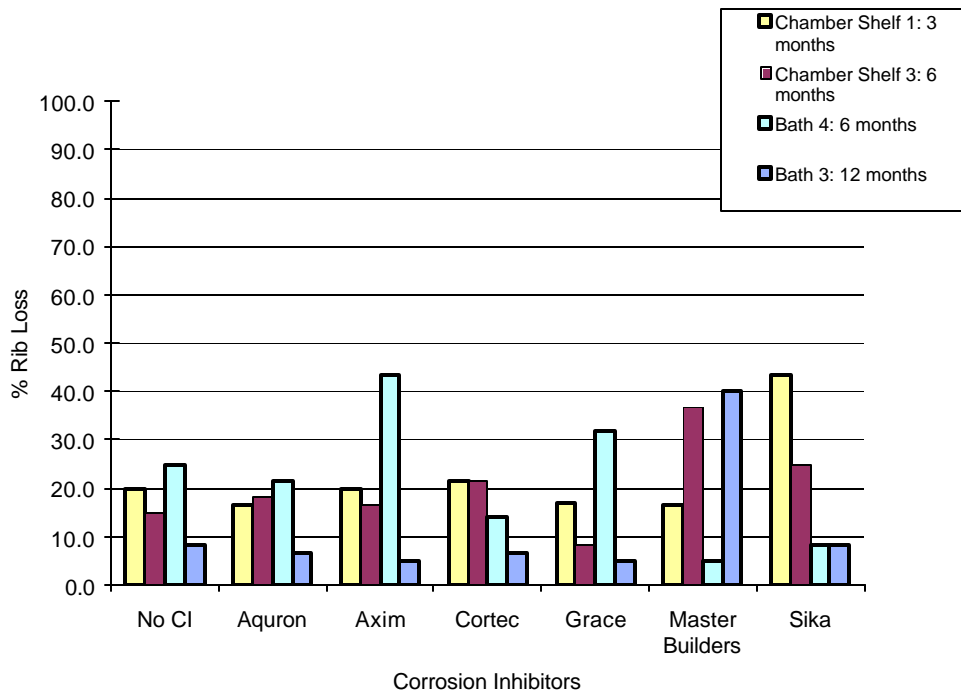

Figure E.52 Time Step of Rib Loss for 3.0% Chloride Post-Cracked Specimens

APPENDIX F. CUMULATIVE MASS LOSS GRAPHS

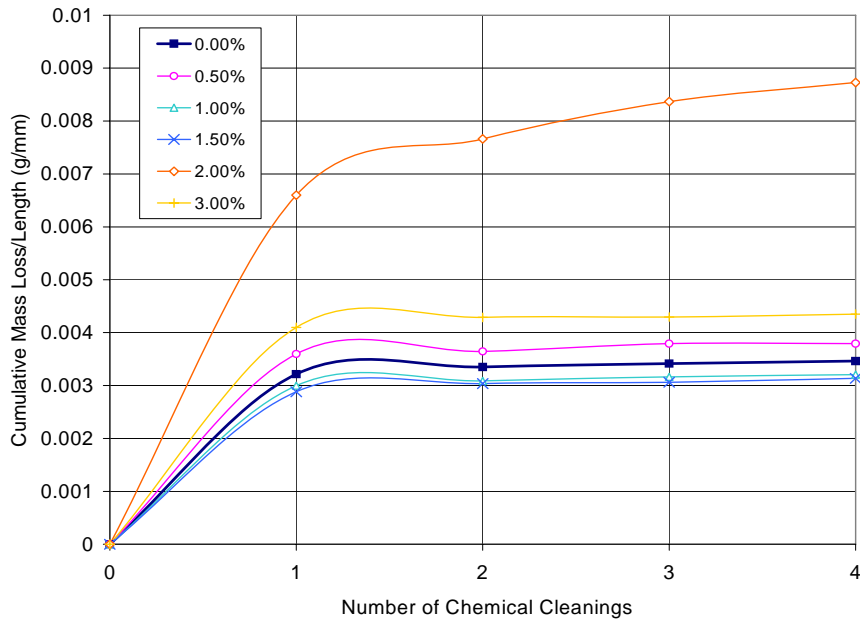

Figure F.1 – Cumulative Mass Loss/Length for Control Specimens

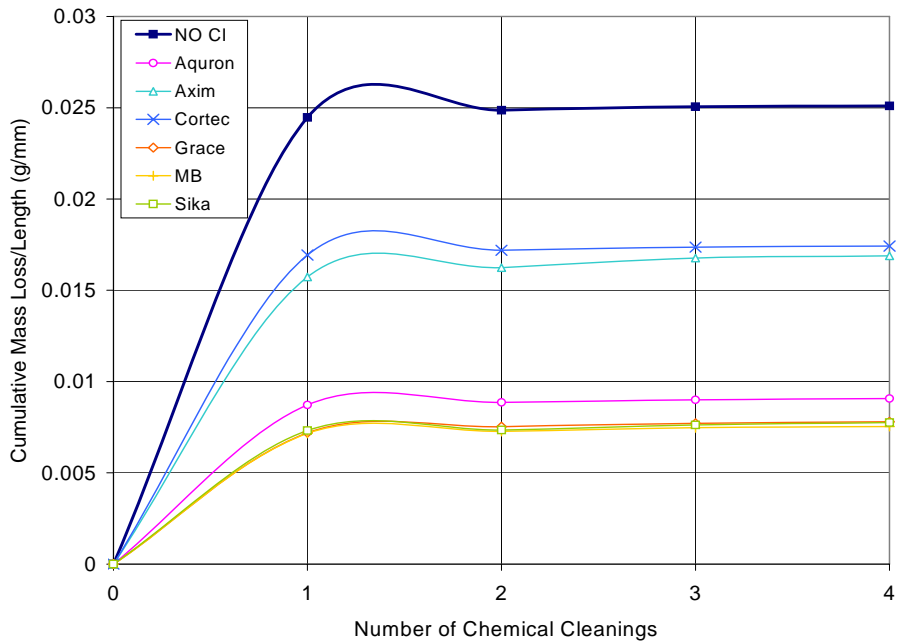

Figure F.2 – Cumulative Mass Loss/Length for Bath 1, 0.0% Chloride Pre-Cracked Specimens

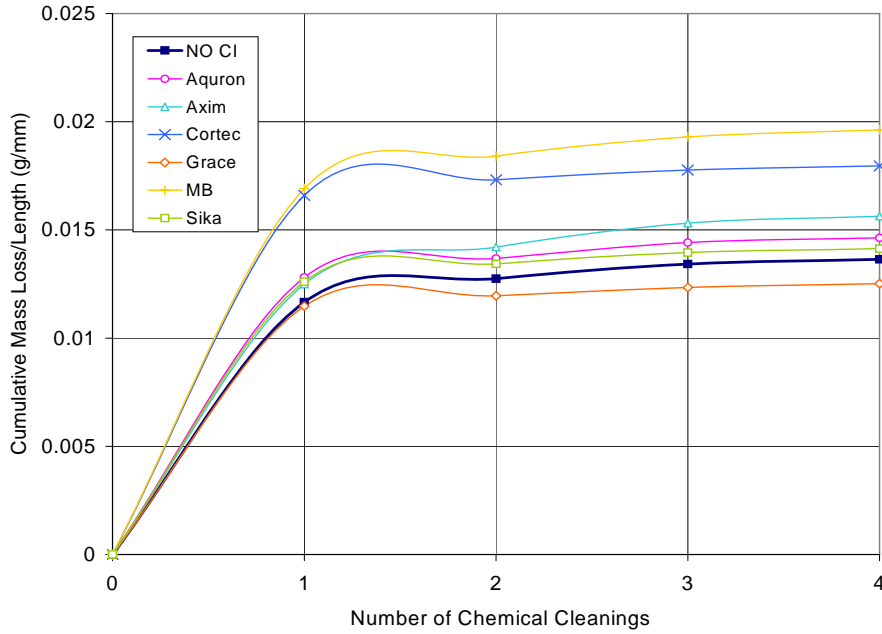

Figure F.3 – Cumulative Mass Loss/Length for Bath 1, 0.5% Chloride Pre-Cracked Specimens

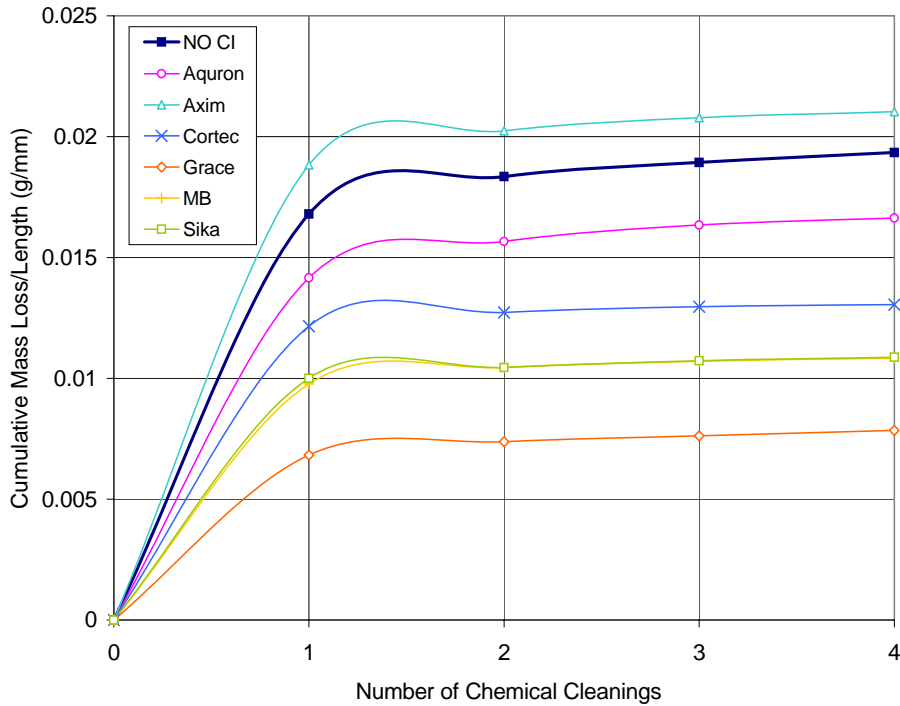

Figure F.4 – Cumulative Mass Loss/Length for Bath 1, 1.0% Chloride Pre-Cracked Specimens

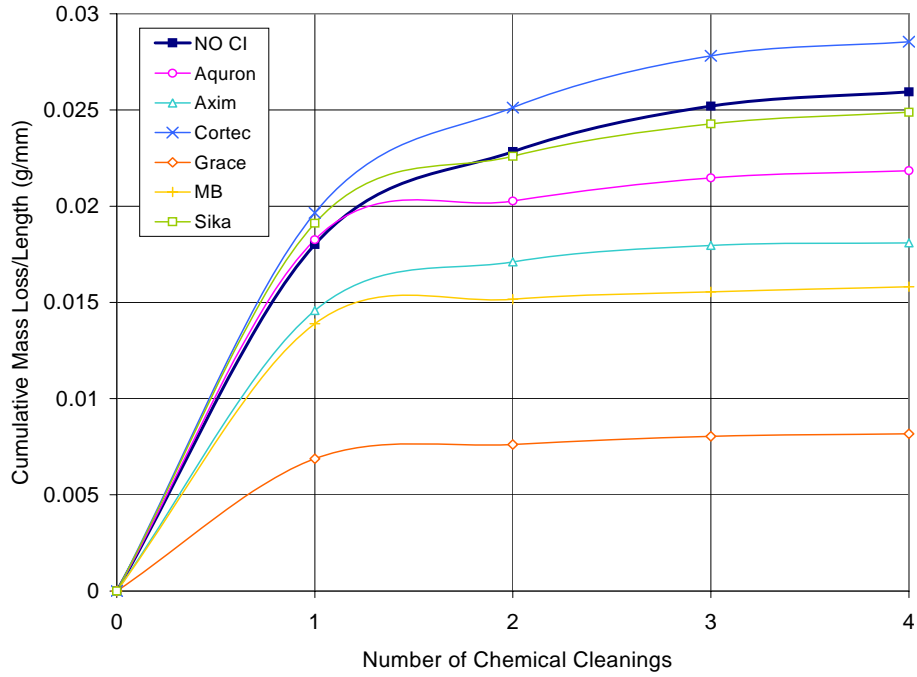

Figure F.5 – Cumulative Mass Loss/Length for Bath 1, 1.5% Chloride Pre-Cracked Specimens

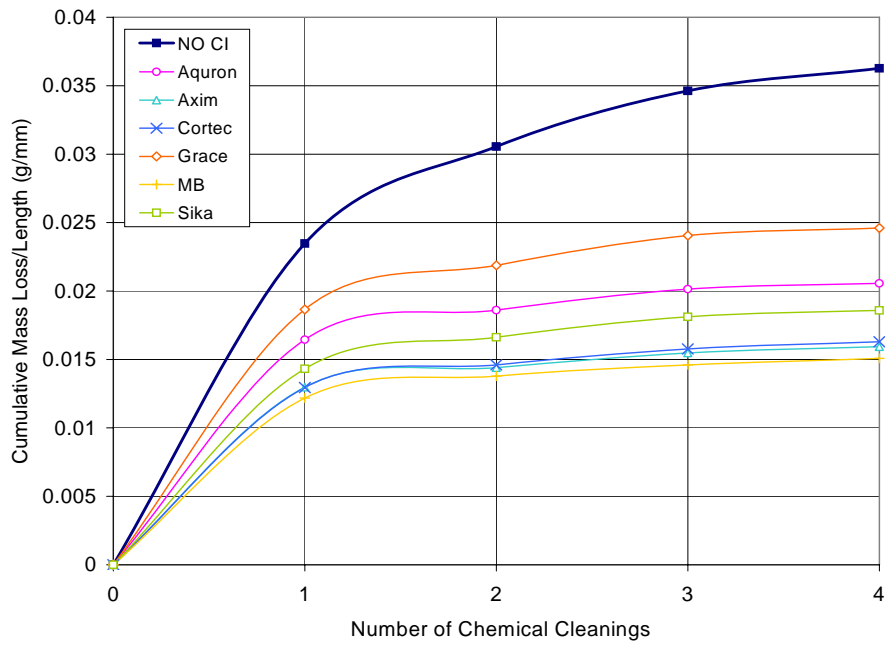

Figure F.6 – Cumulative Mass Loss/Length for Bath 1, 2.0% Chloride Pre-Cracked Specimens

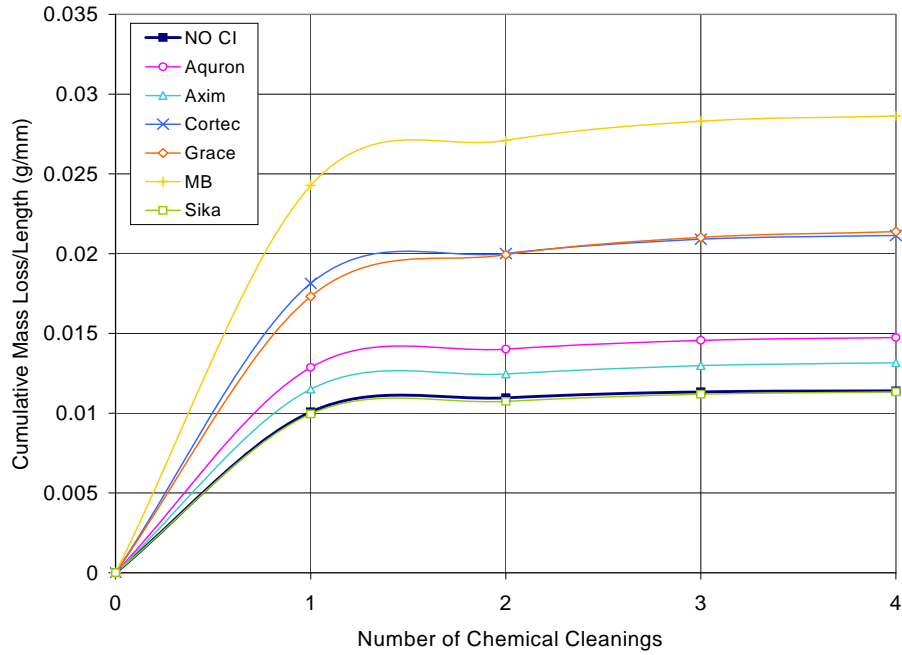

Figure F.7 – Cumulative Mass Loss/Length for Bath 1, 3.0% Chloride Pre-Cracked Specimens

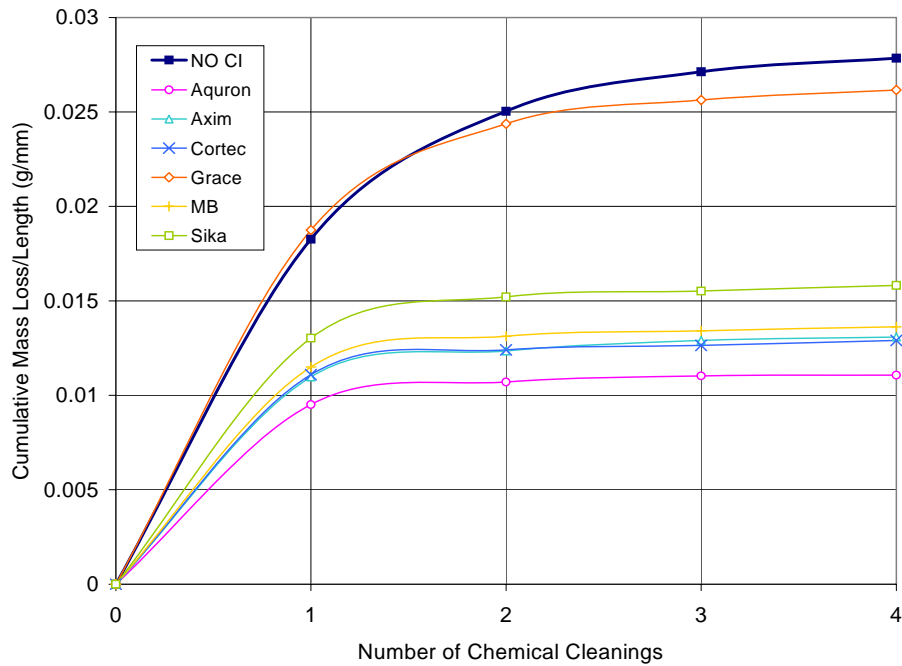

Figure F.8 – Cumulative Mass Loss/Length for Bath 2, 0.0% Chloride Pre-Cracked Specimens

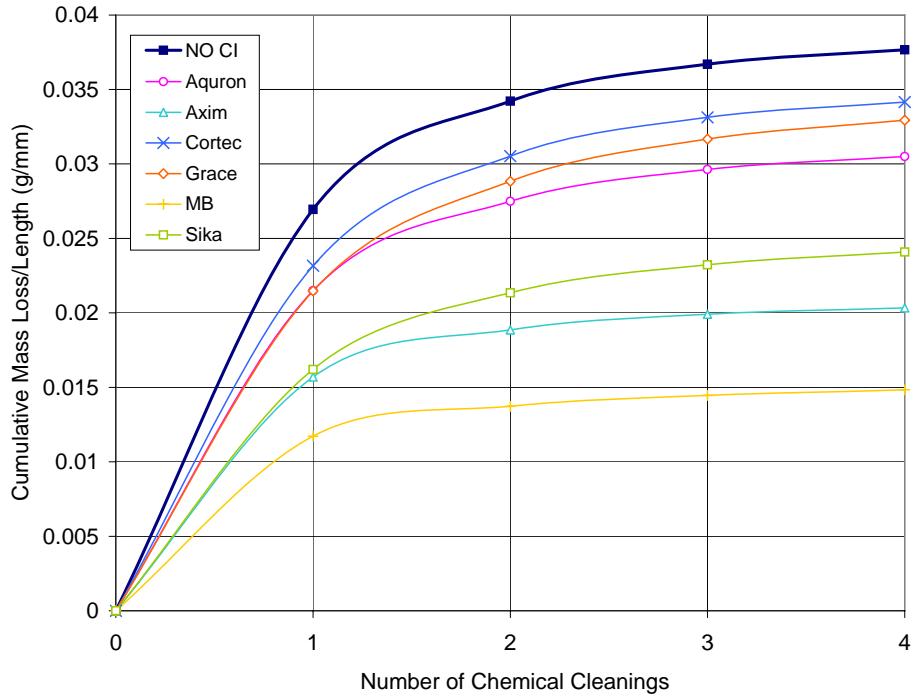

Figure F.9 – Cumulative Mass Loss/Length for Bath 2, 0.5% Chloride Pre-Cracked Specimens

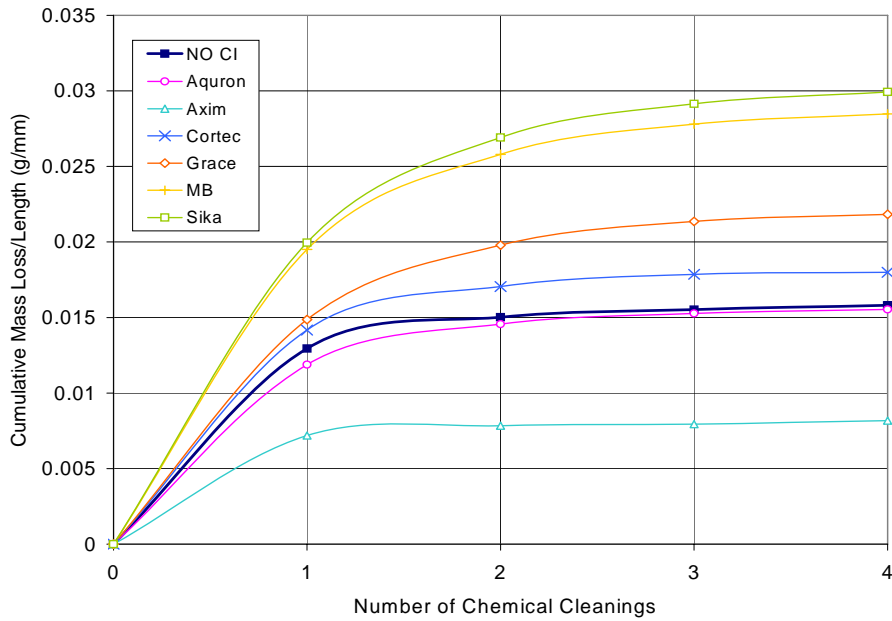

Figure F.10 – Cumulative Mass Loss/Length for Bath 2, 1.0% Chloride Pre-Cracked Specimens

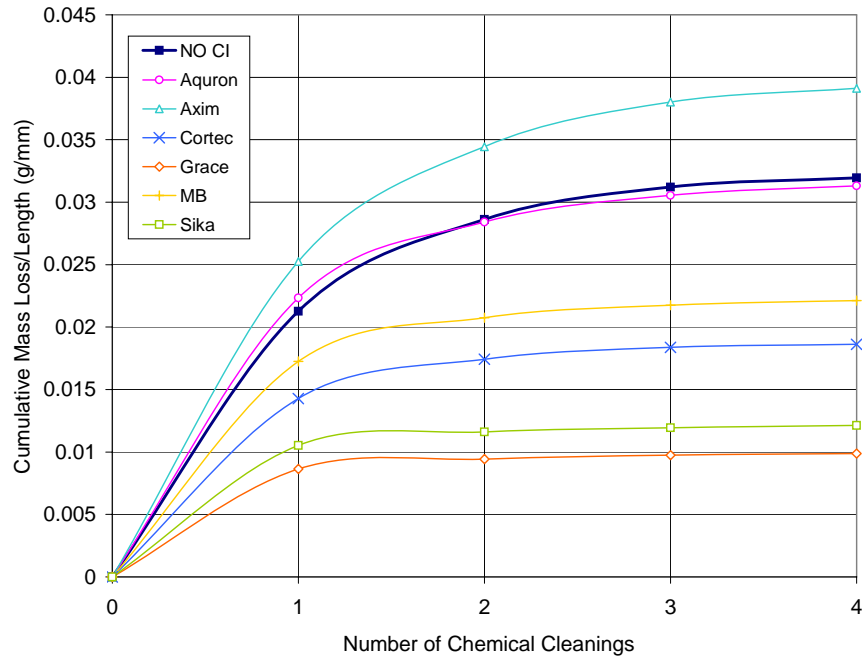

Figure F.11 – Cumulative Mass Loss/Length for Bath 2, 1.5% Chloride Pre-Cracked Specimens

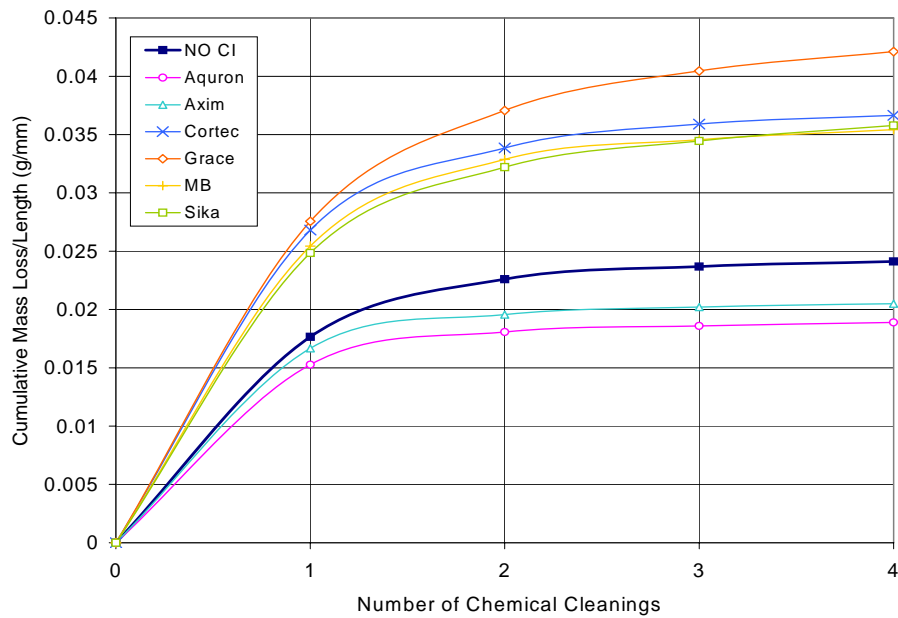

Figure F.12 – Cumulative Mass Loss/Length for Bath 2, 2.0% Chloride Pre-Cracked Specimens

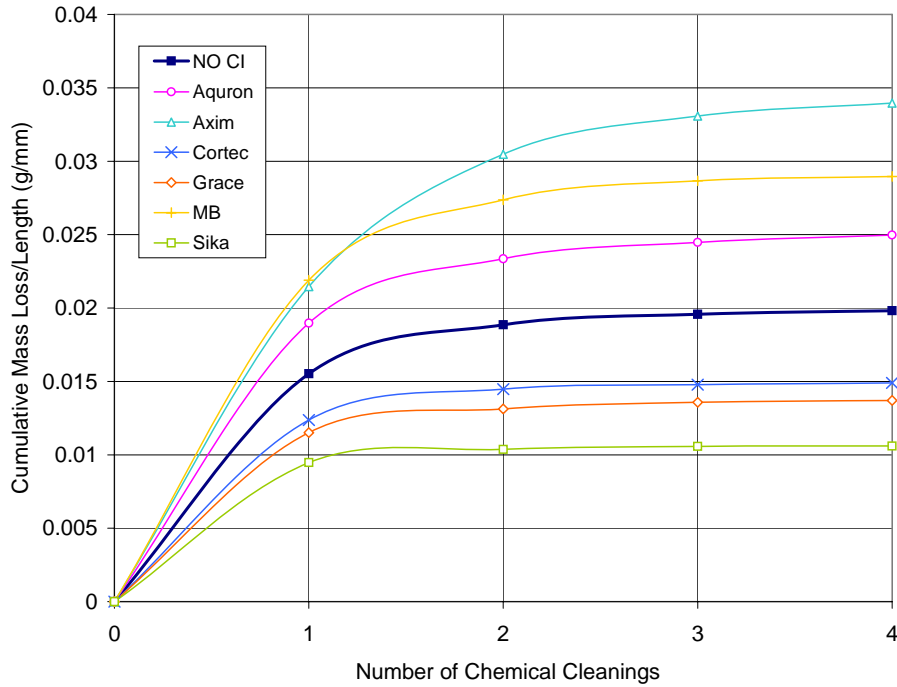

Figure F.13 – Cumulative Mass Loss/Length for Bath 2, 3.0% Chloride Pre-Cracked Specimens

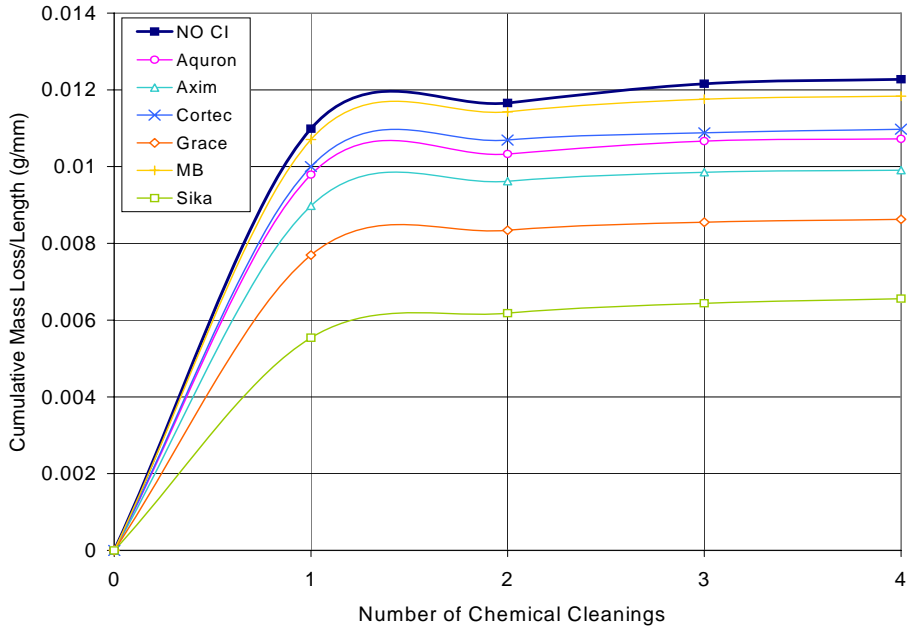

Figure F.14 – Cumulative Mass Loss/Length for Bath 3, 0.0% Chloride Post-Cracked Specimens

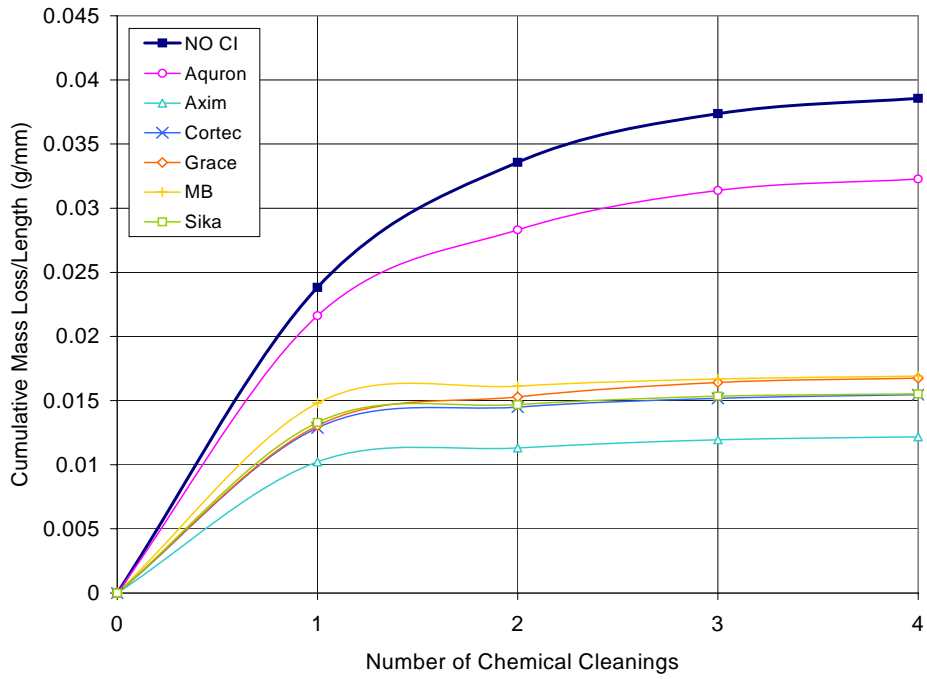

Figure F.15 – Cumulative Mass Loss/Length for Bath 3, 0.5% Chloride Post-Cracked Specimens

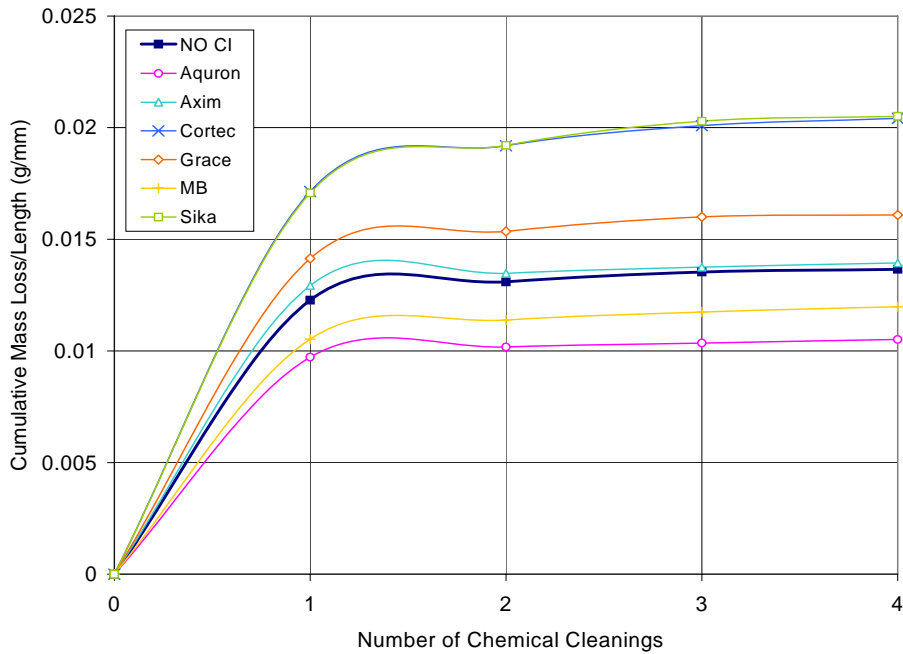

Figure F.16 – Cumulative Mass Loss/Length for Bath 3, 1.0% Chloride Post-Cracked Specimens

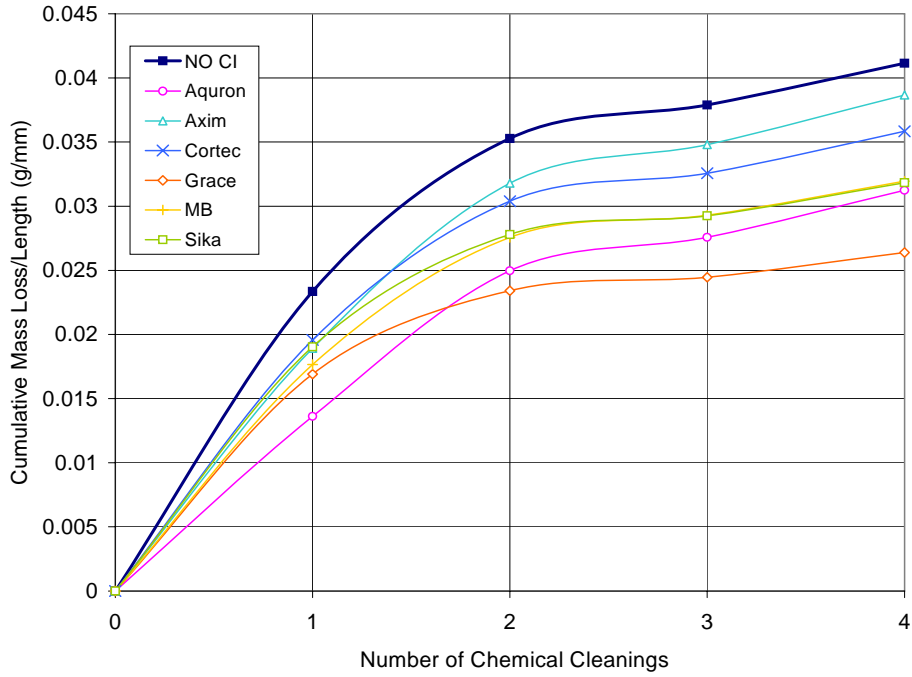

Figure F.17 – Cumulative Mass Loss/Length for Bath 3, 1.5% Chloride Post-Cracked Specimens

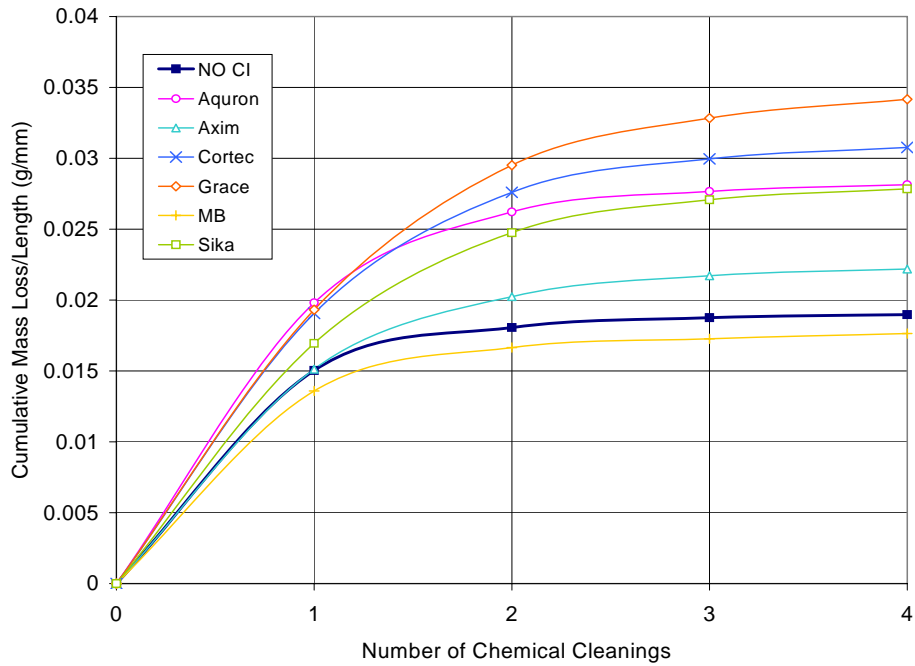

Figure F.18 – Cumulative Mass Loss/Length for Bath 3, 2.0% Chloride Post-Cracked Specimens

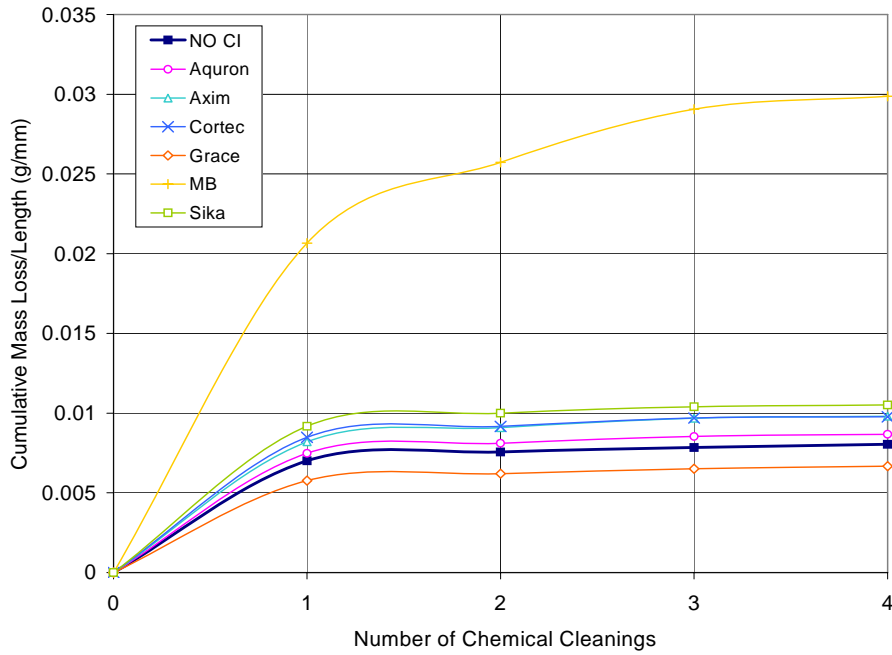

Figure F.19 – Cumulative Mass Loss/Length for Bath 3, 3.0% Chloride Post-Cracked Specimens

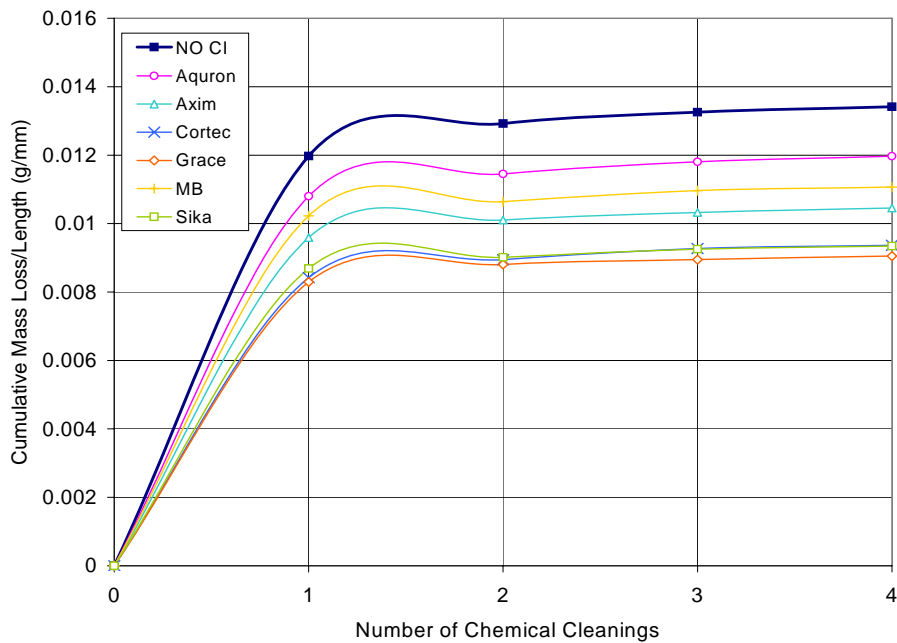

Figure F.20 – Cumulative Mass Loss/Length for Bath 4, 0.0% Chloride Post-Cracked Specimens

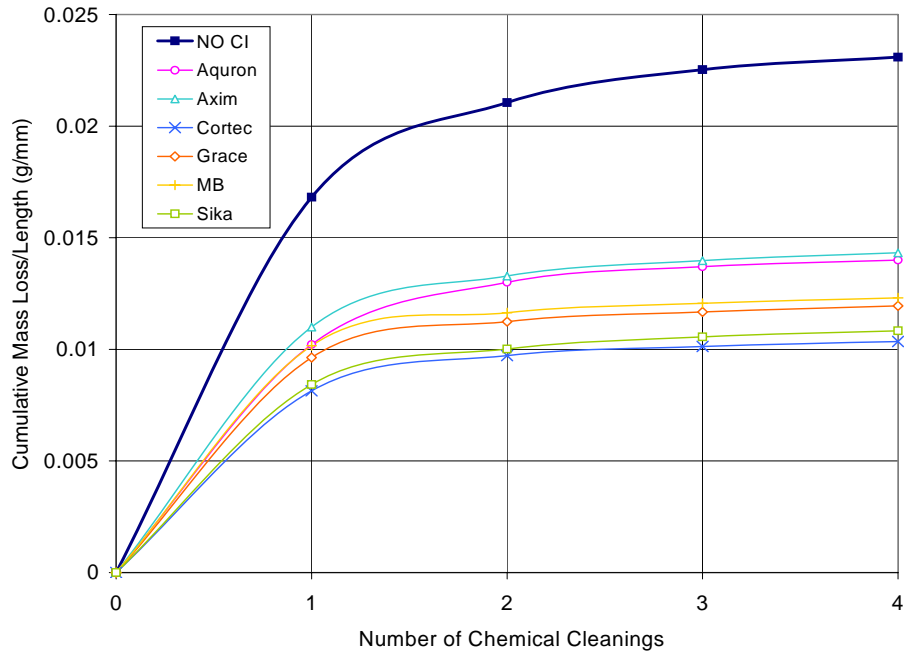

Figure F.21 – Cumulative Mass Loss/Length for Bath 4, 0.5% Chloride Post-Cracked Specimens

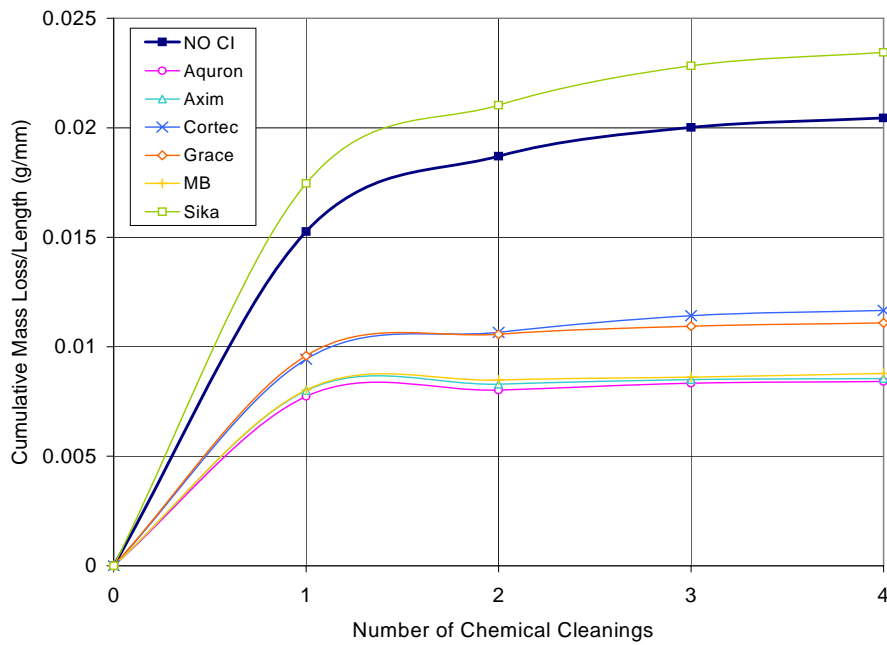

Figure F.22 – Cumulative Mass Loss/Length for Bath 4, 1.0% Chloride Post-Cracked Specimens

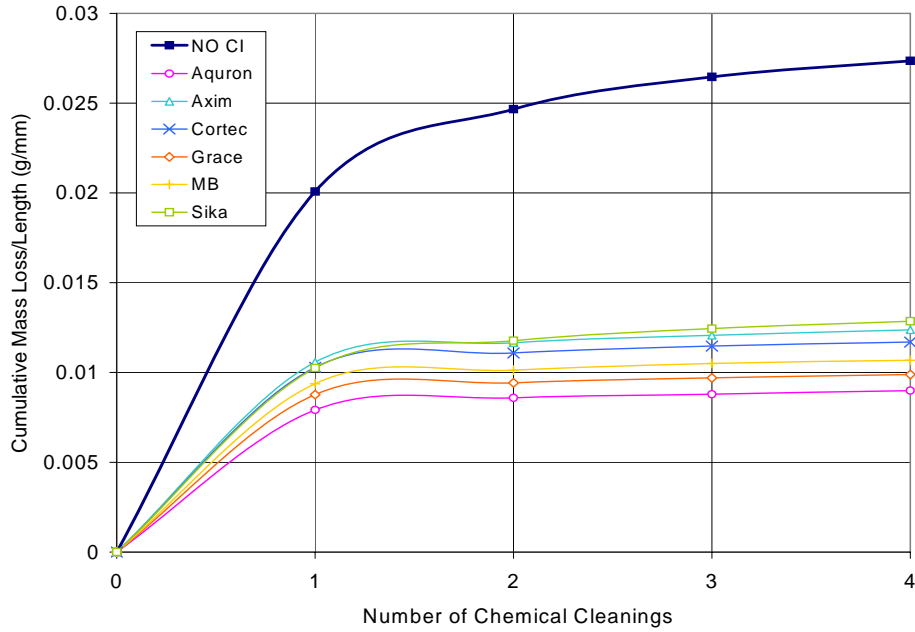

Figure F.23 – Cumulative Mass Loss/Length for Bath 4, 1.5% Chloride Post-Cracked Specimens

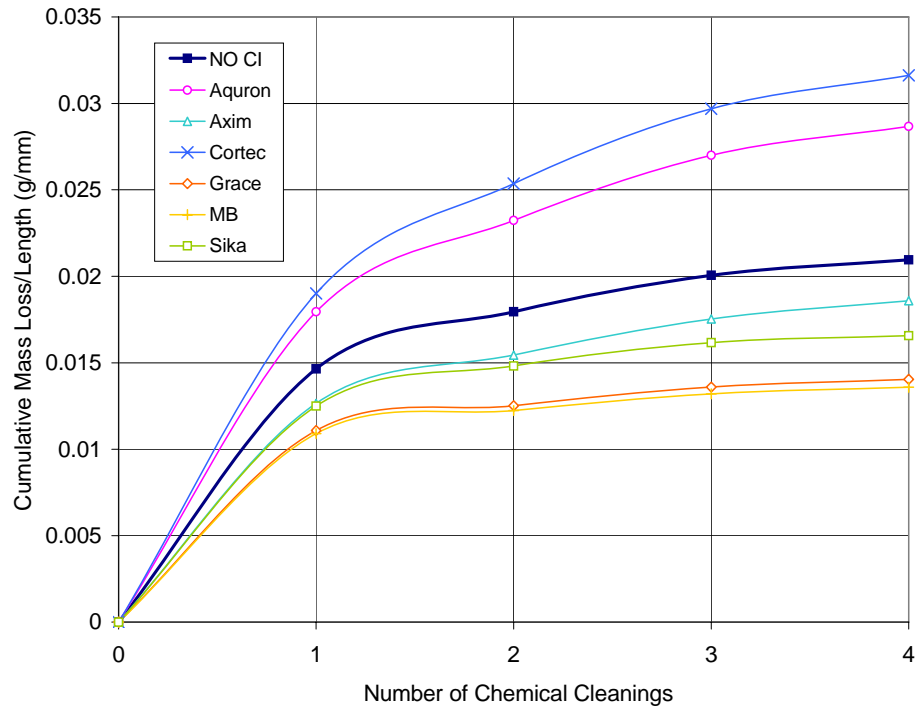

Figure F.24 – Cumulative Mass Loss/Length for Bath 4, 2.0% Chloride Post-Cracked Specimens

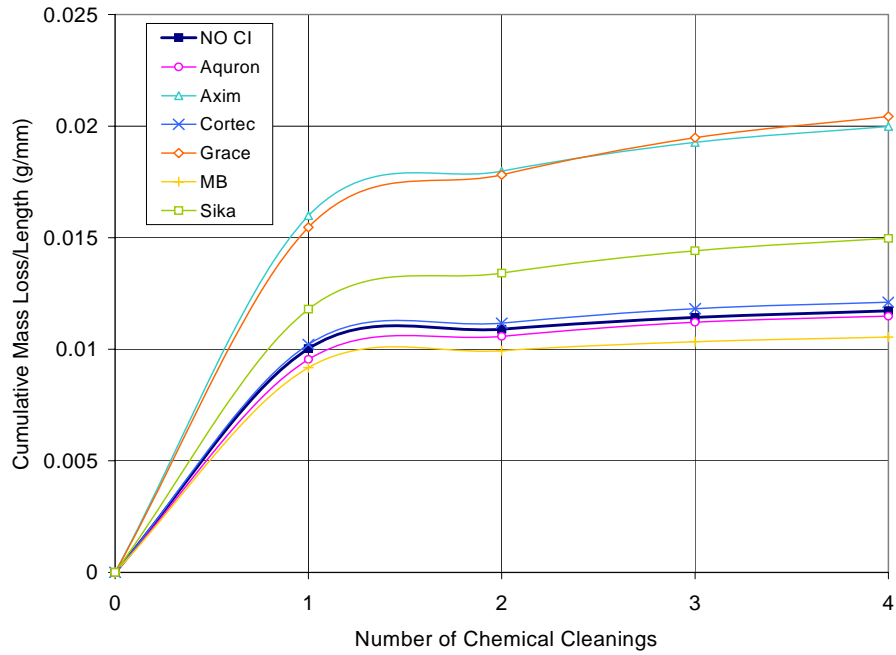

Figure F.25 – Cumulative Mass Loss/Length for Bath 4, 3.0% Chloride Post-Cracked Specimens

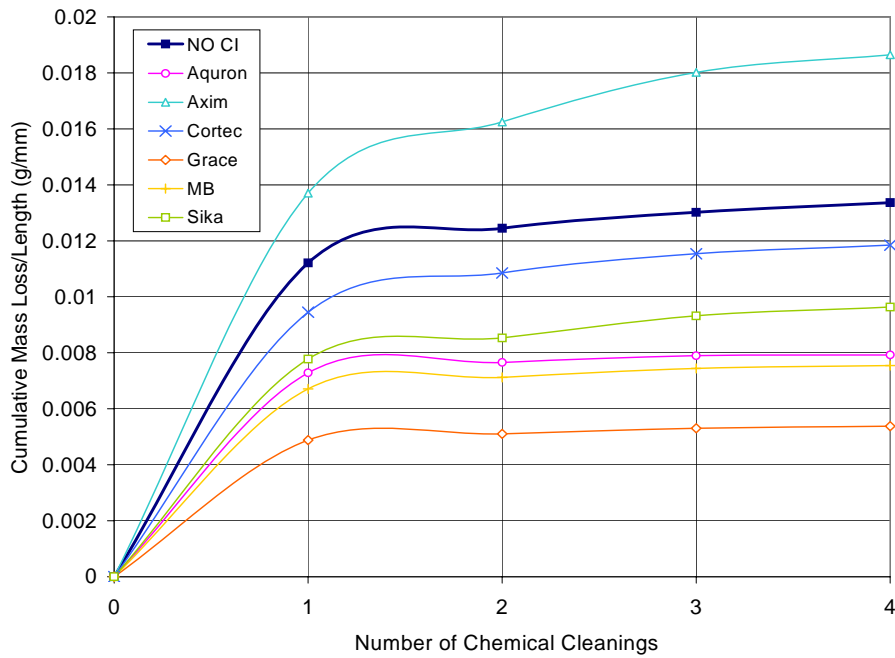

Figure F.26 – Cumulative Mass Loss/Length for Chamber Shelf 1 0.0% Chloride, Post-Cracked Specimens

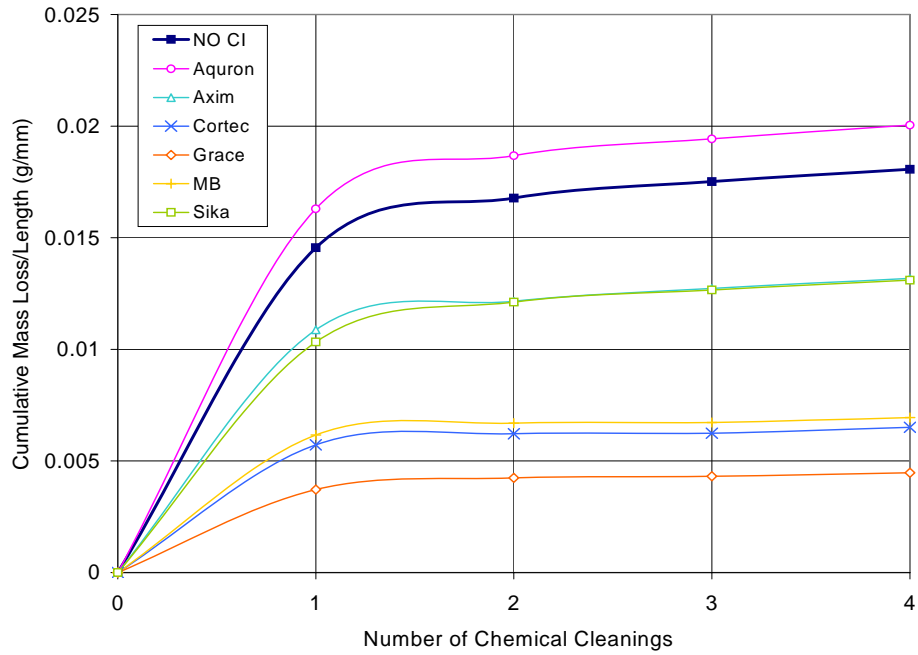

Figure F.27 – Cumulative Mass Loss/Length for Chamber Shelf 1 0.5% Chloride, Post-Cracked Specimens

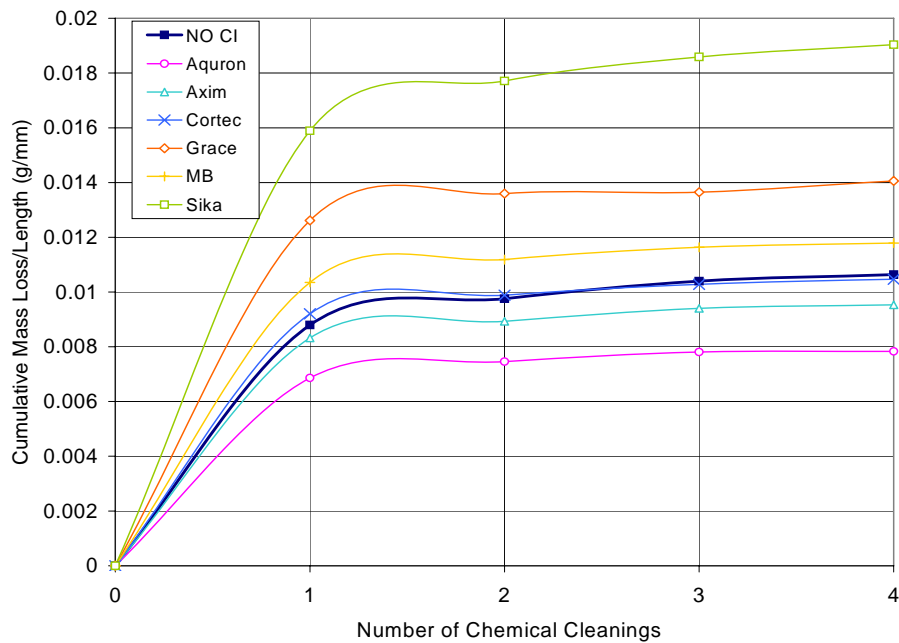
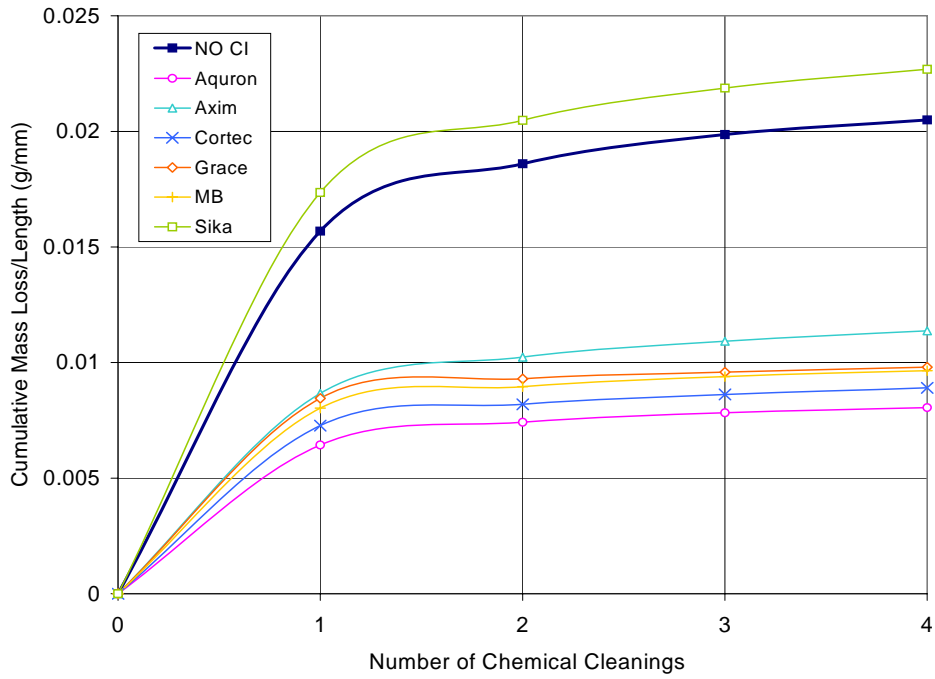
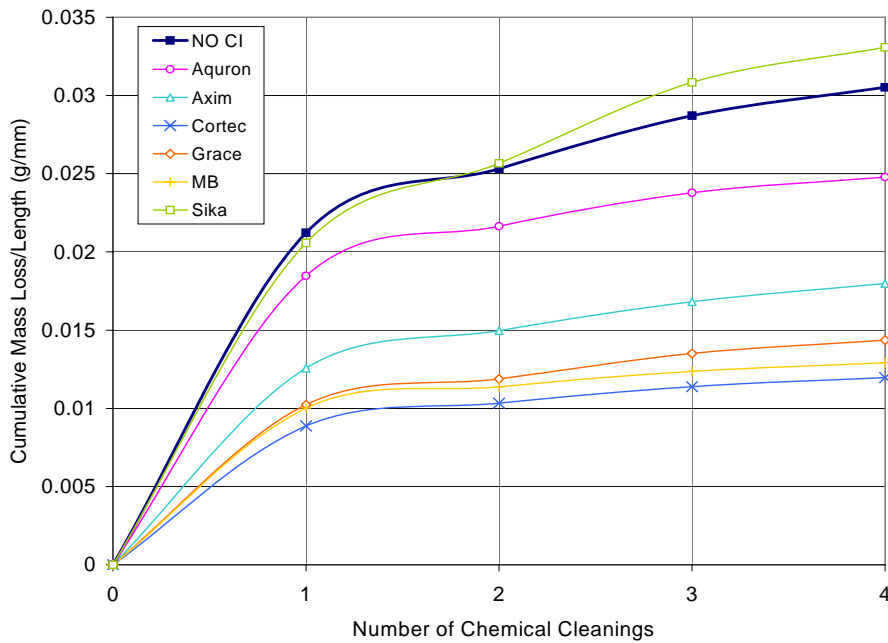

Figure F.28 – Cumulative Mass Loss/Length for Chamber Shelf 1 1.0% Chloride, Post-Cracked Specimens



**Figure F.29 – Cumulative Mass Loss/Length for Chamber Shelf 1
1.5% Chloride, Post-Cracked Specimens**



**Figure F.30 – Cumulative Mass Loss/Length for Chamber Shelf 1 2.0% Chloride,
Post-Cracked Specimens**

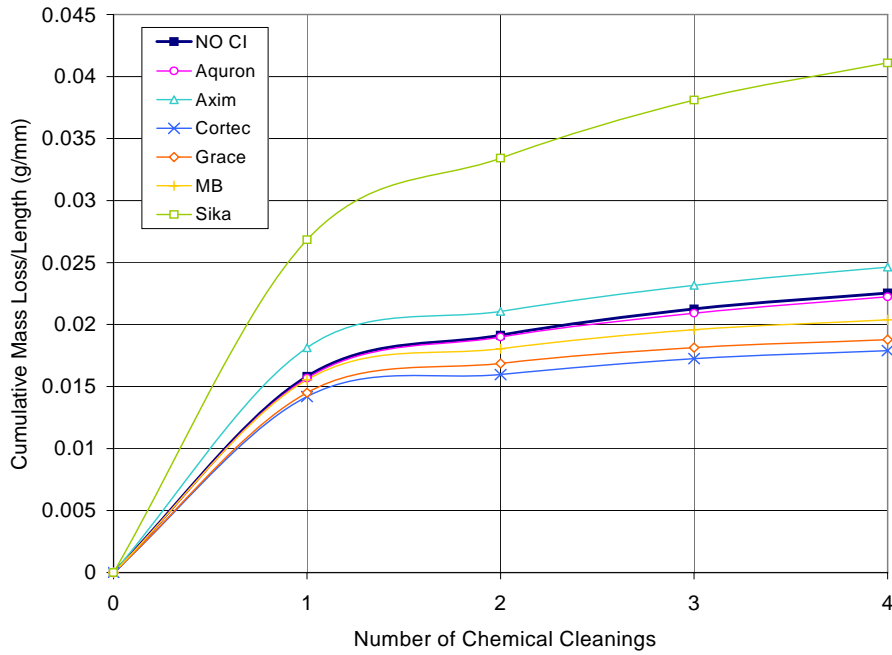

**Figure F.31 – Cumulative Mass Loss/Length for Chamber Shelf 1
3.0% Chloride, Post-Cracked Specimens**

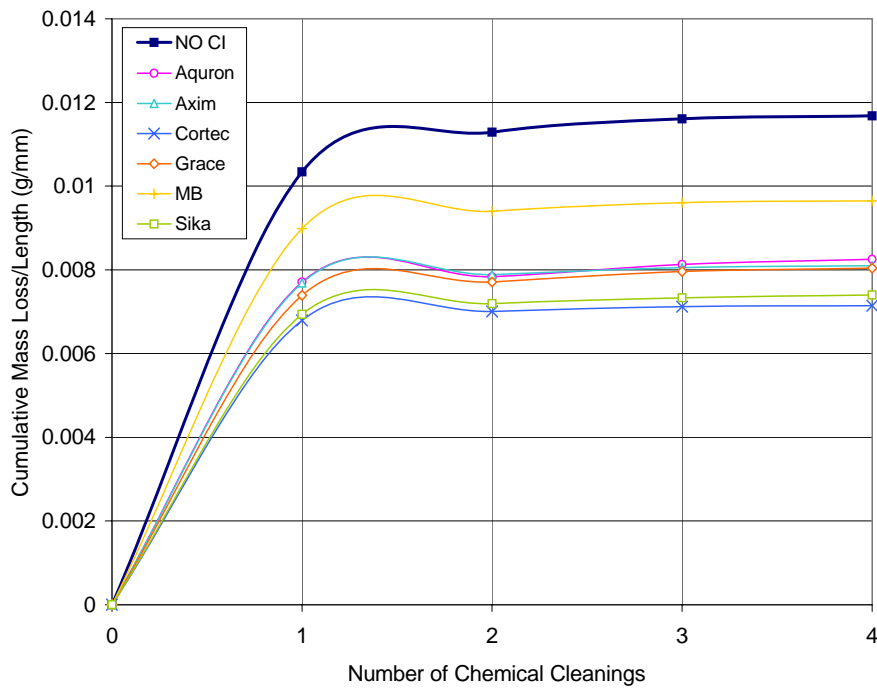

**Figure F.32 – Cumulative Mass Loss/Length for Chamber Shelf 2
0.0% Chloride, Pre-Cracked Specimens**

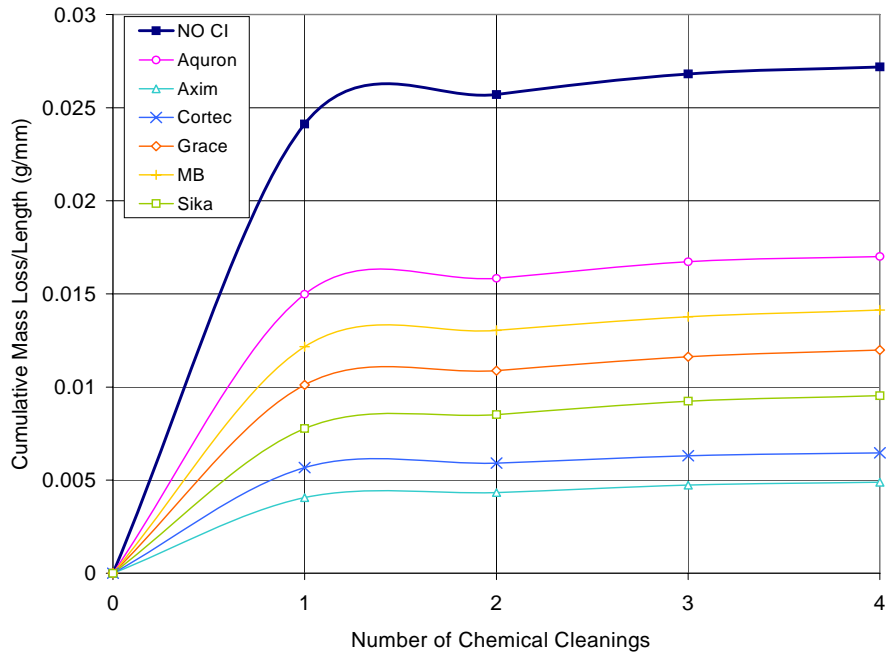

**Figure F.33 – Cumulative Mass Loss/Length for Chamber Shelf 2
0.5% Chloride, Pre-Cracked Specimens**

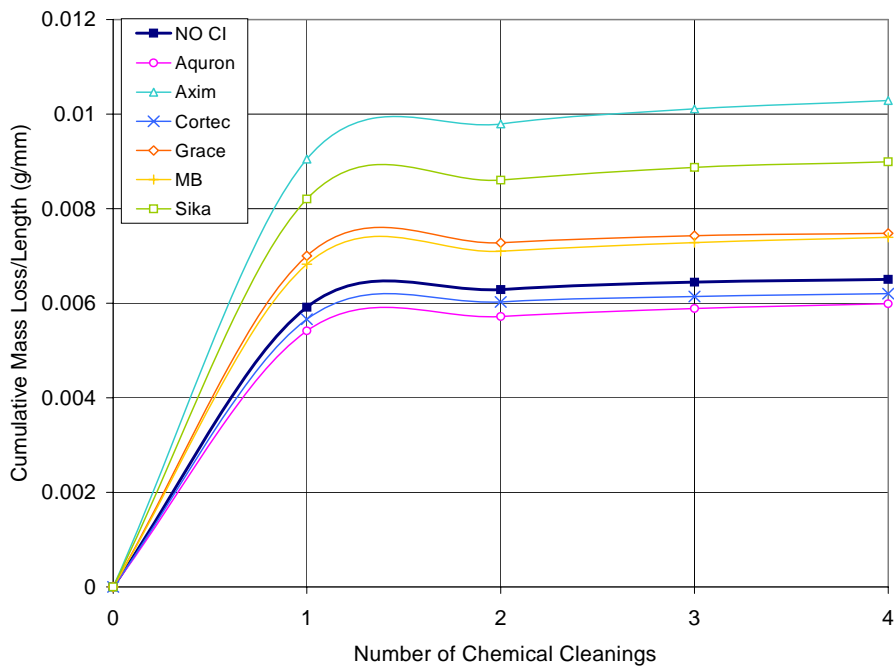

**Figure F.34 – Cumulative Mass Loss/Length for Chamber Shelf 2
1.0% Chloride, Pre-Cracked Specimens**

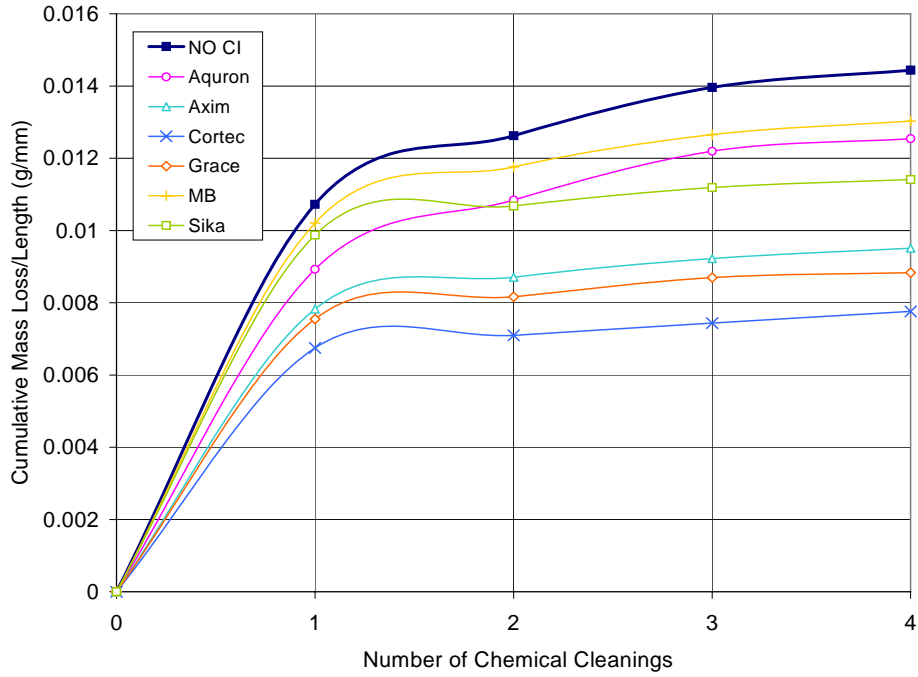

**Figure F.35 – Cumulative Mass Loss/Length for Chamber Shelf 2
1.5% Chloride, Pre-Cracked Specimens**

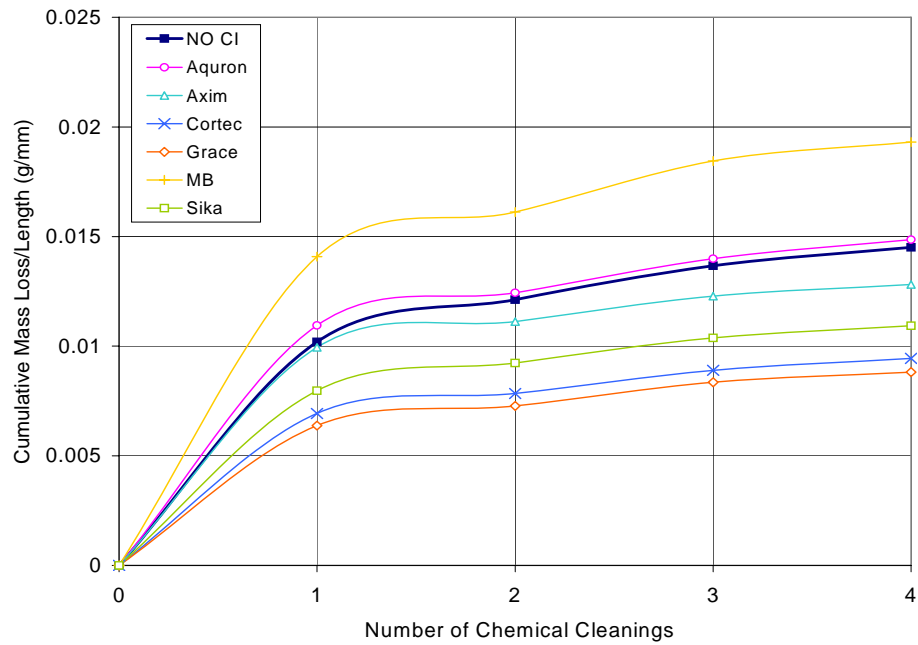

**Figure F.36 – Cumulative Mass Loss/Length for Chamber Shelf 2
2.0% Chloride, Pre-Cracked Specimens**

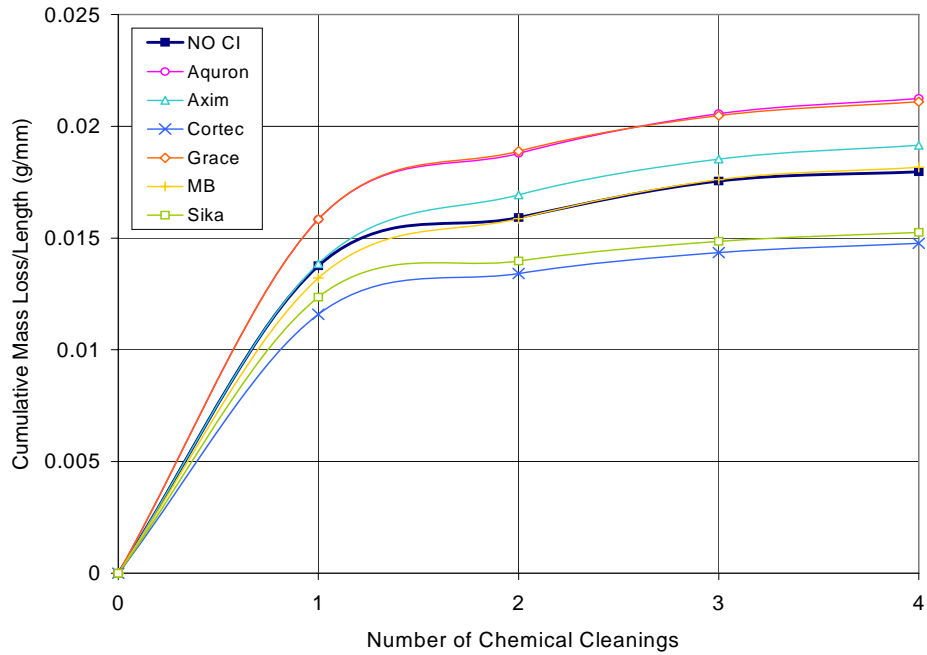

**Figure F.37 – Cumulative Mass Loss/Length for Chamber Shelf 2
3.0% Chloride, Pre-Cracked Specimens**

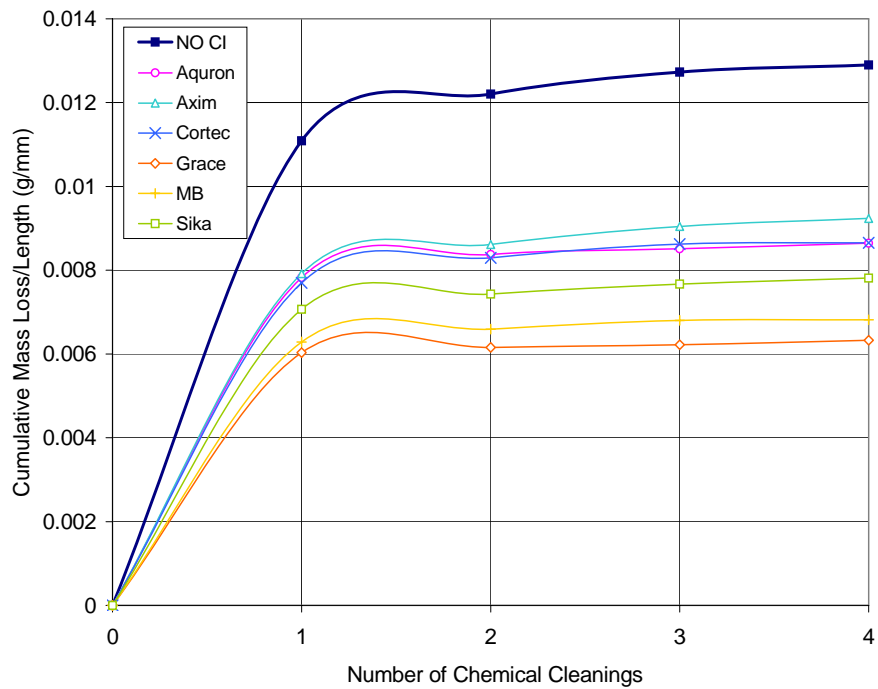

**Figure F.38 – Cumulative Mass Loss/Length for Chamber Shelf 3
0.0% Chloride, Post-Cracked Specimens**

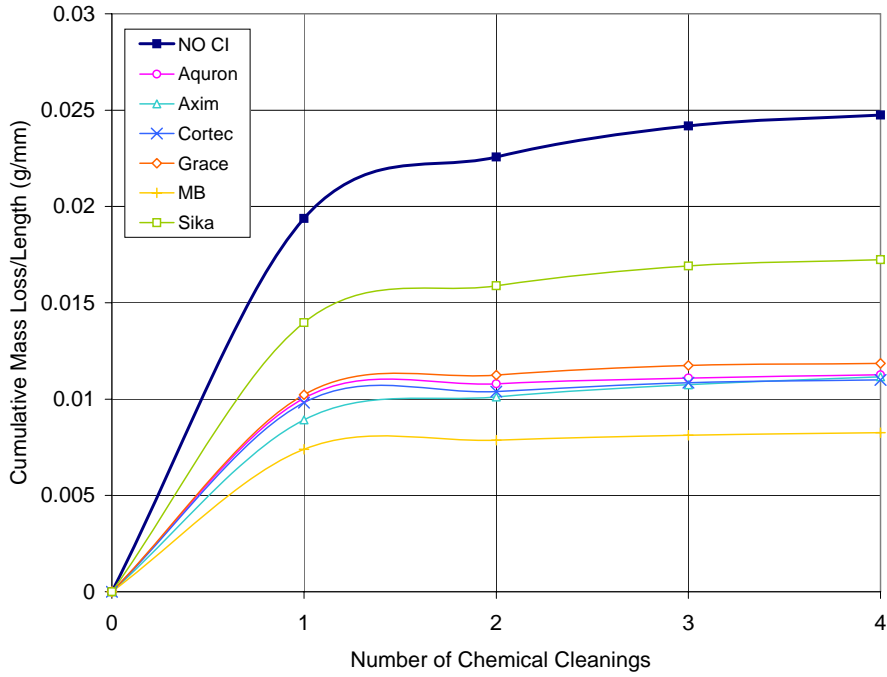

**Figure F.39 – Cumulative Mass Loss/Length for Chamber Shelf 3
0.5% Chloride, Post-Cracked Specimens**

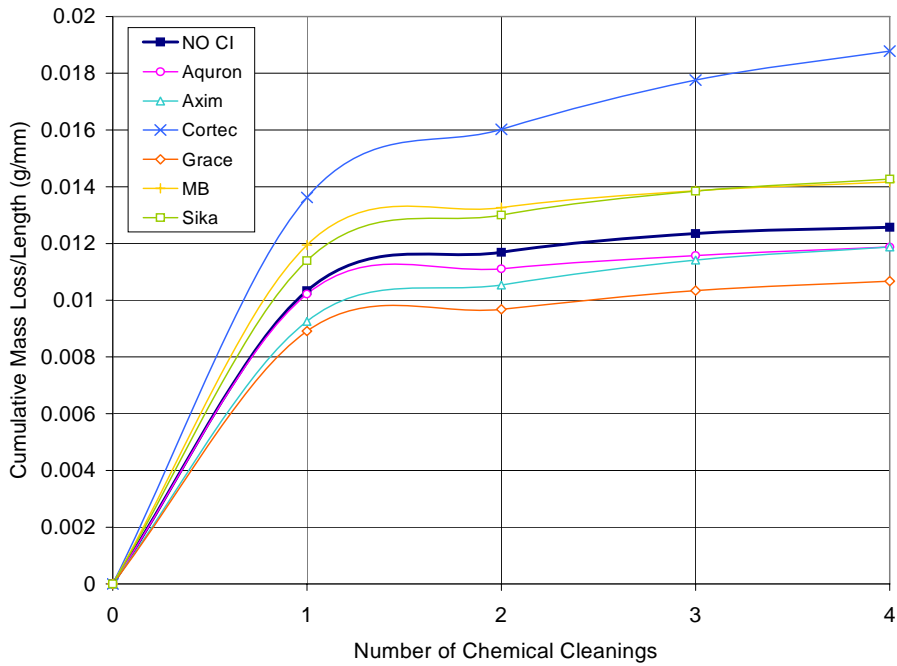

**Figure F.40 – Cumulative Mass Loss/Length for Chamber Shelf 3
1.0% Chloride, Post-Cracked Specimens**

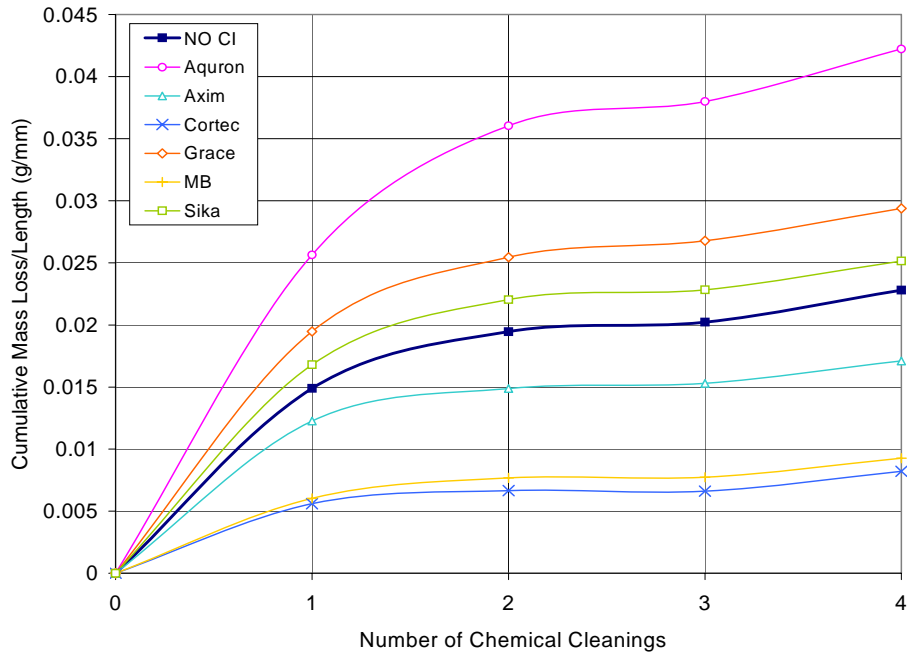

**Figure F.41 – Cumulative Mass Loss/Length for Chamber Shelf 3
1.5% Chloride, Post-Cracked Specimens**

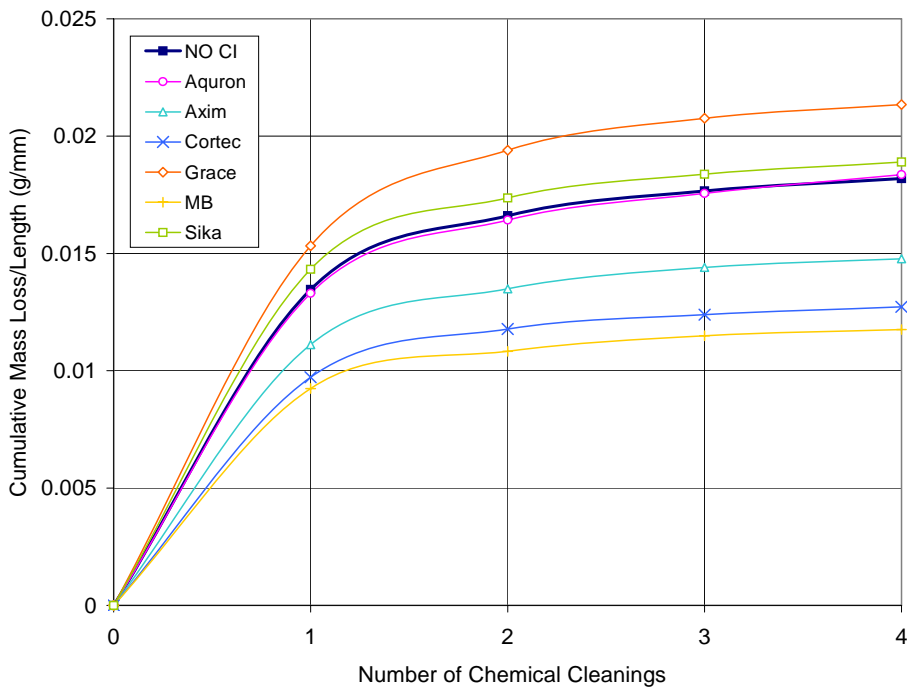

**Figure F.42 – Cumulative Mass Loss/Length for Chamber Shelf 3
2.0% Chloride, Post-Cracked Specimens**

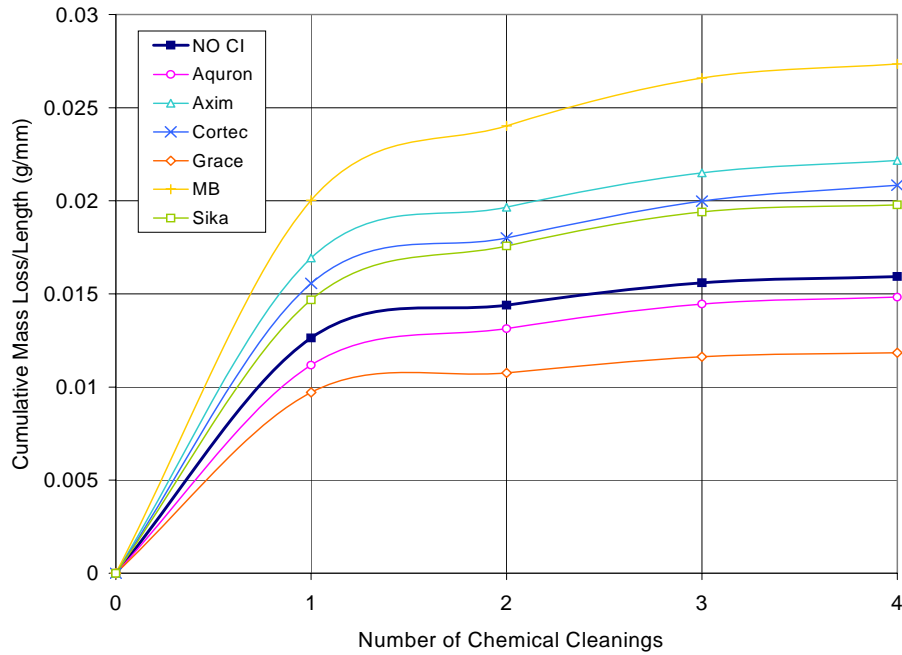

**Figure F.43 – Cumulative Mass Loss/Length for Chamber Shelf 3
3.0% Chloride, Post-Cracked Specimens**

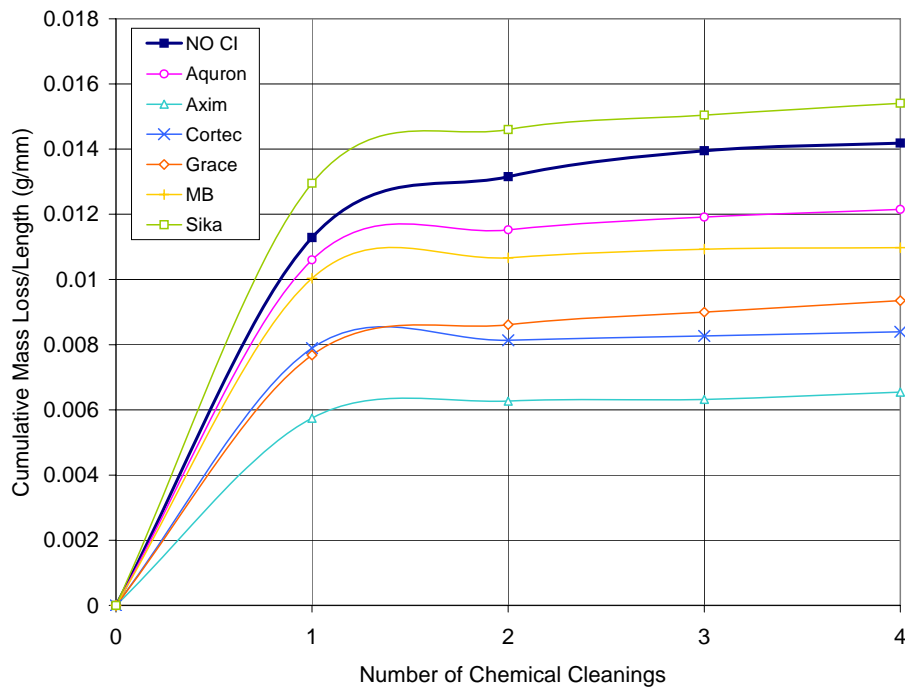

**Figure F.44 – Cumulative Mass Loss/Length for Chamber Shelf 4
0.0% Chloride, Pre-Cracked Specimens**

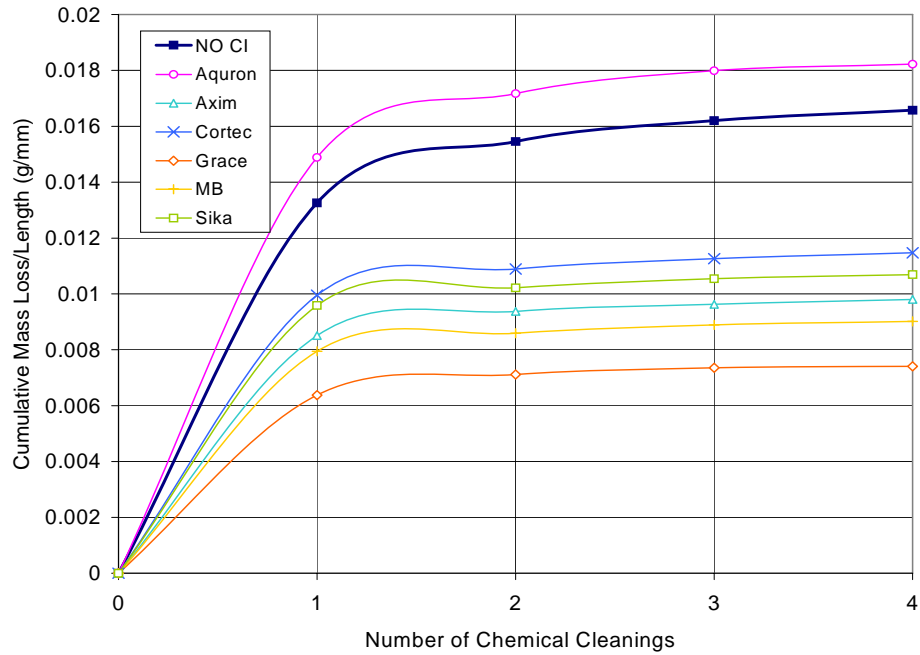

**Figure F.45 – Cumulative Mass Loss/Length for Chamber Shelf 4
0.5% Chloride, Pre-Cracked Specimens**

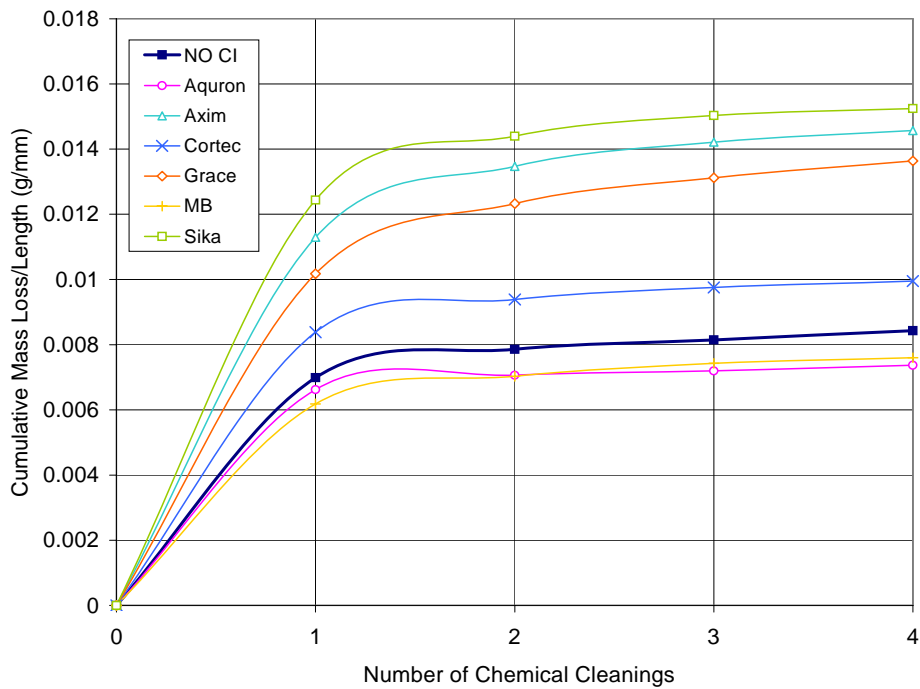

**Figure F.46 – Cumulative Mass Loss/Length for Chamber Shelf 4
1.0% Chloride, Pre-Cracked Specimens**

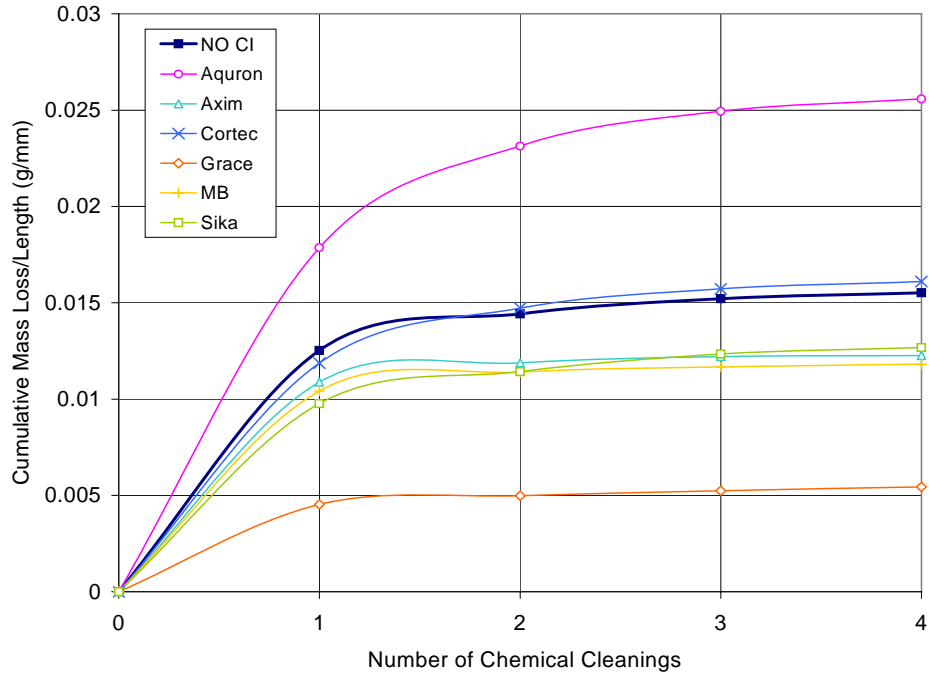

**Figure F.47 – Cumulative Mass Loss/Length for Chamber Shelf 4
1.5% Chloride, Pre-Cracked Specimens**

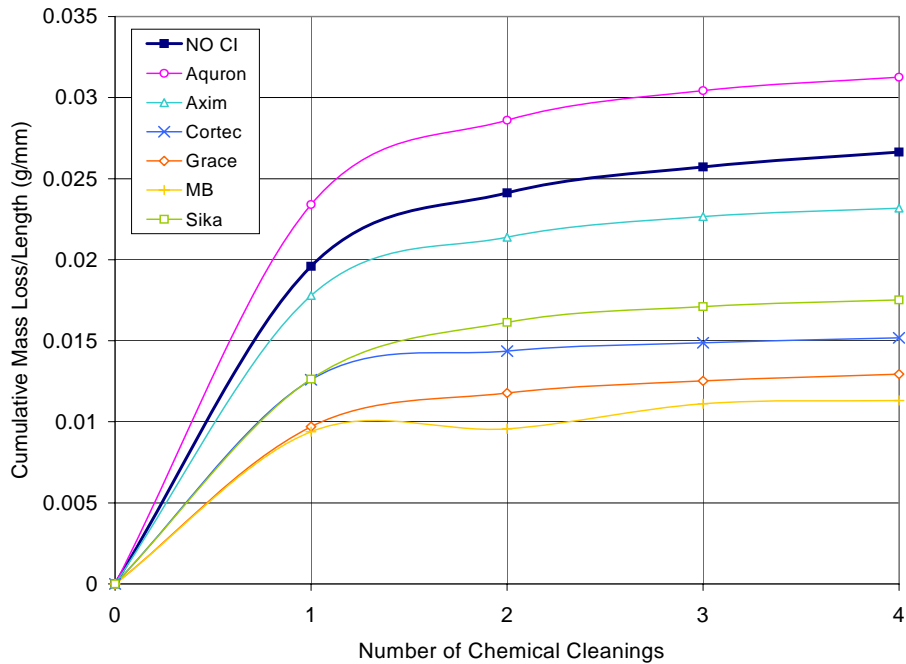

**Figure F.48 – Cumulative Mass Loss/Length for Chamber Shelf 4
2.0% Chloride, Pre-Cracked Specimens**

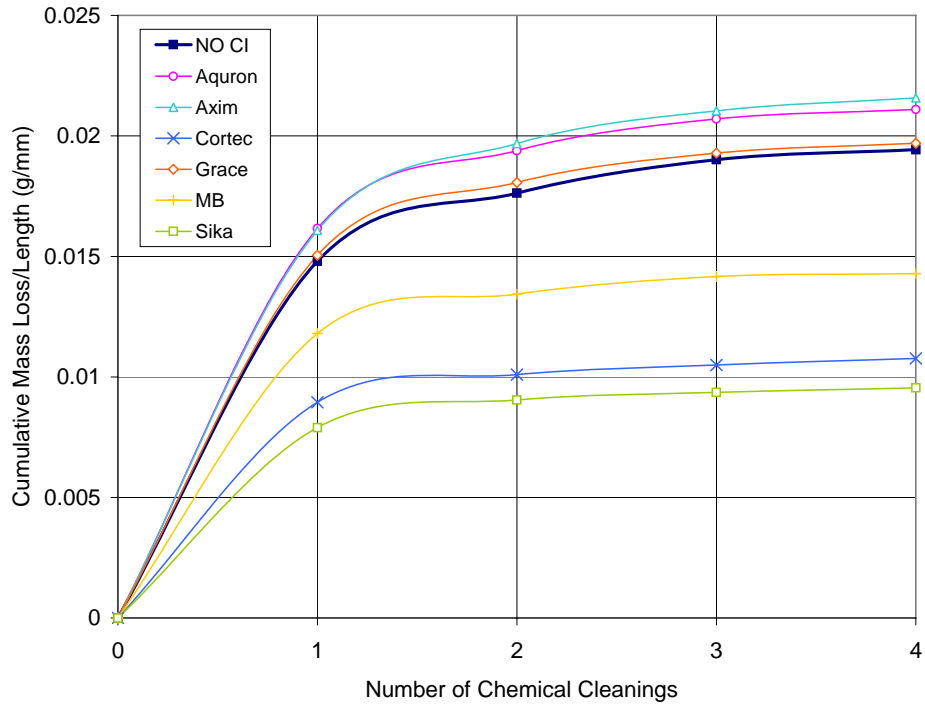

**Figure F.49 – Cumulative Mass Loss/Length for Chamber Shelf 4
3.0% Chloride, Pre-Cracked Specimens**

APPENDIX G. VISUAL RATINGS AND MASS AND STRENGTH LOSS GRAPHS

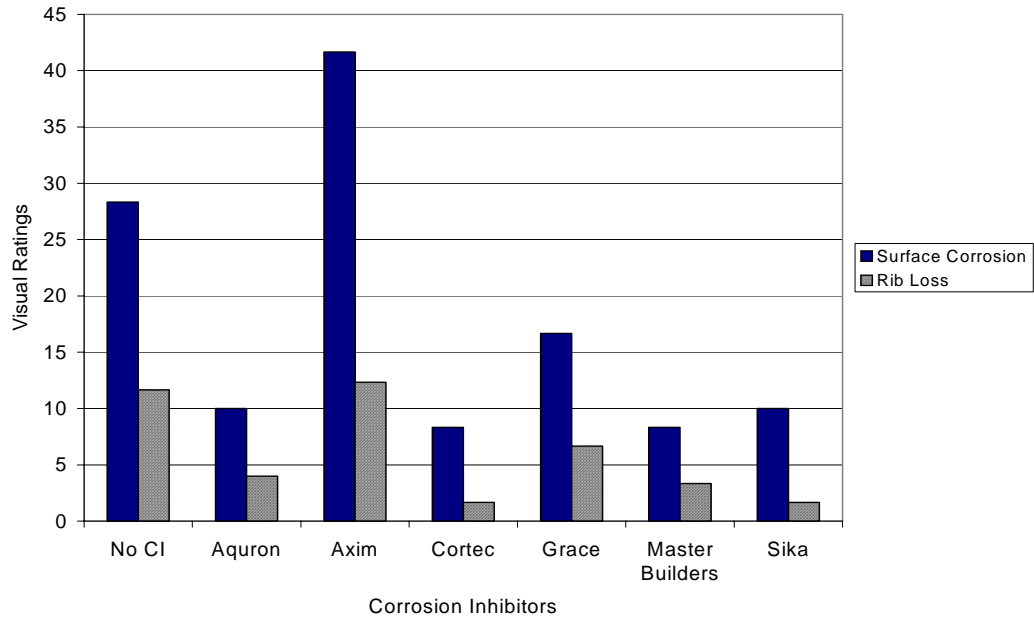

Figure G.1 – Visual Ratings for Bath 1, 0.0% Chloride, Pre-Cracked

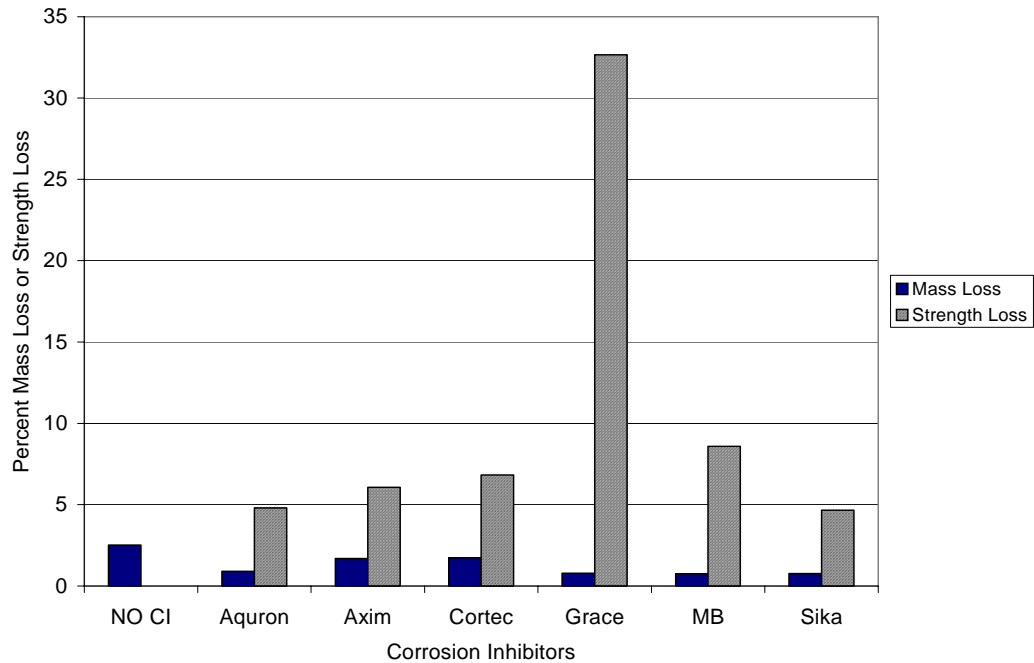

Figure G.2 – Mass Loss and Strength Loss for Bath 1, 0.0% Chloride, Pre-Cracked

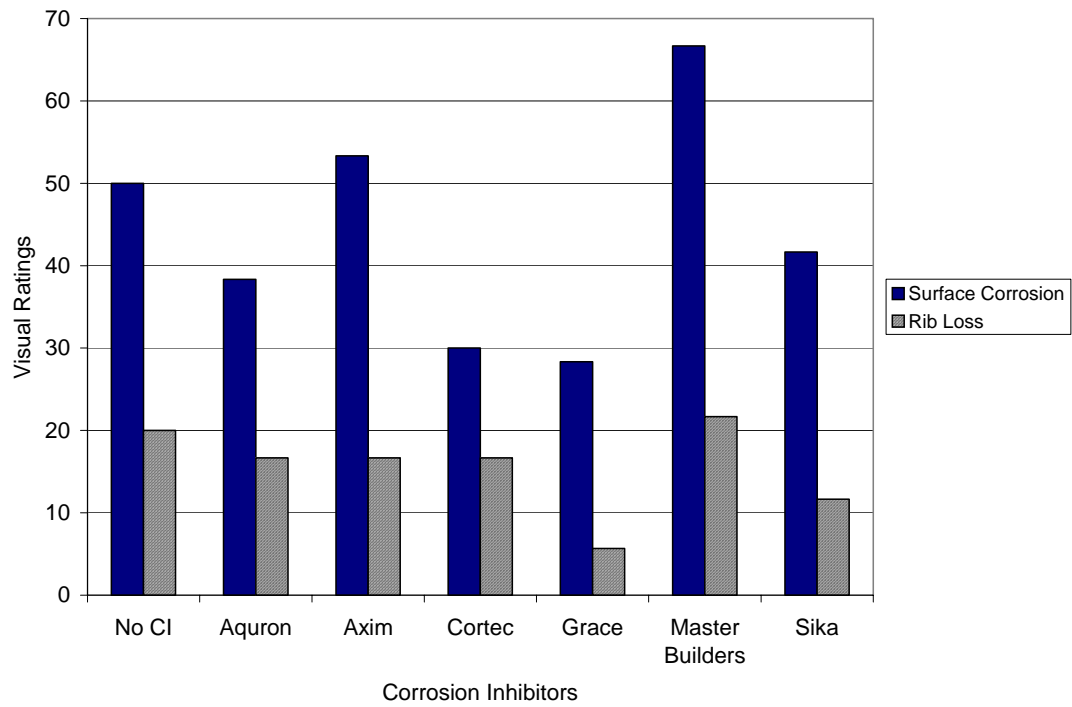

Figure G.3 – Visual Ratings for Bath 1, 0.5% Chloride, Pre-Cracked

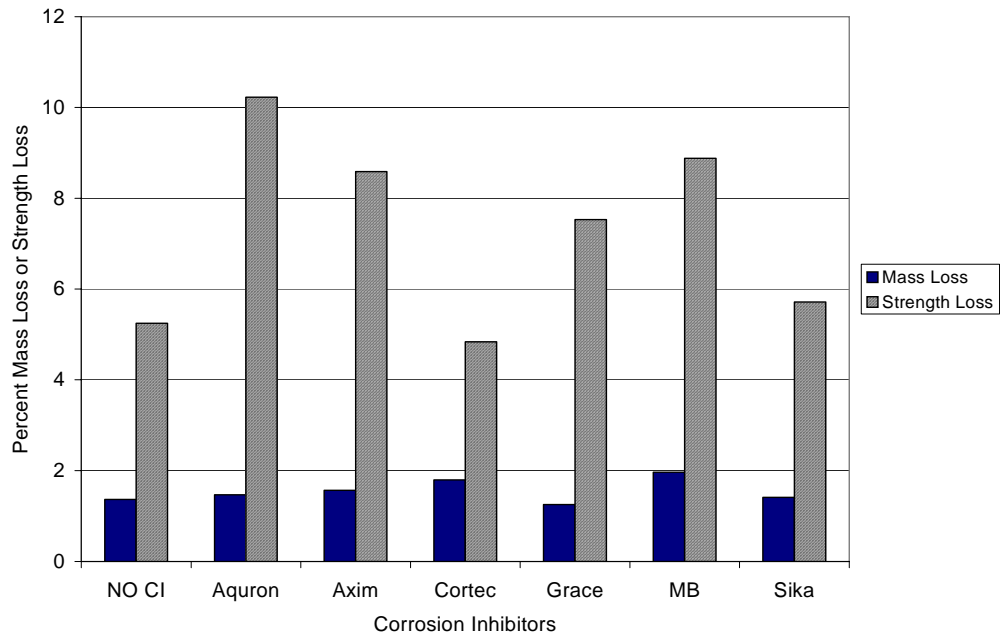

Figure G.4 – Mass Loss and Strength Loss for Bath 1, 0.5% Chloride, Pre-Cracked

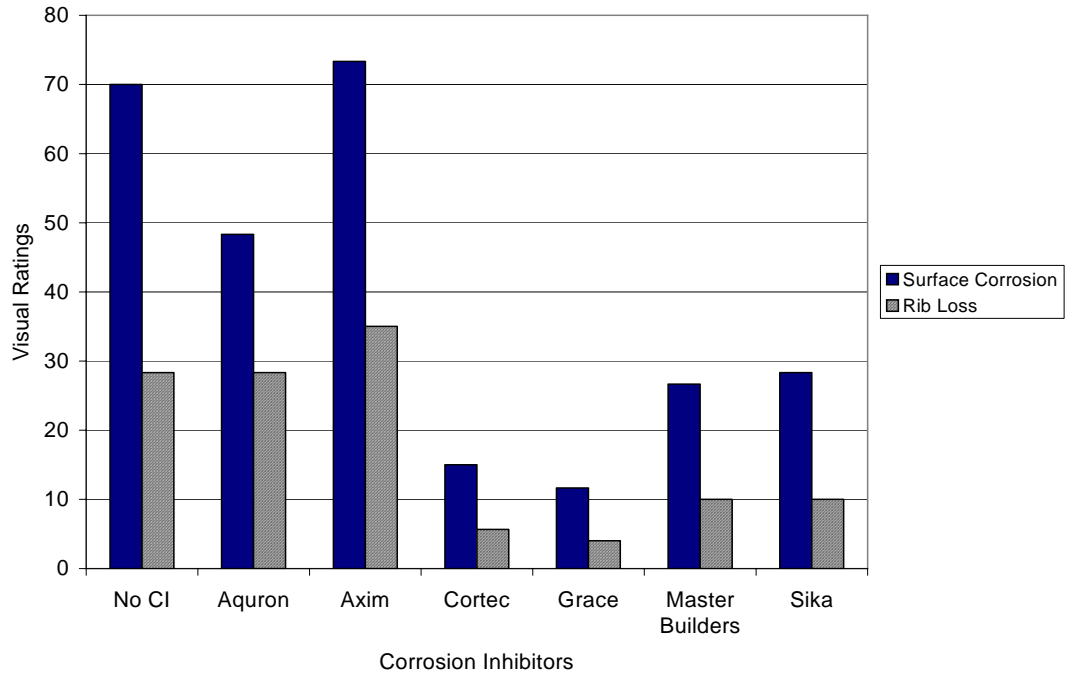

Figure G.5 – Visual Ratings for Bath 1, 1.0% Chloride, Pre-Cracked

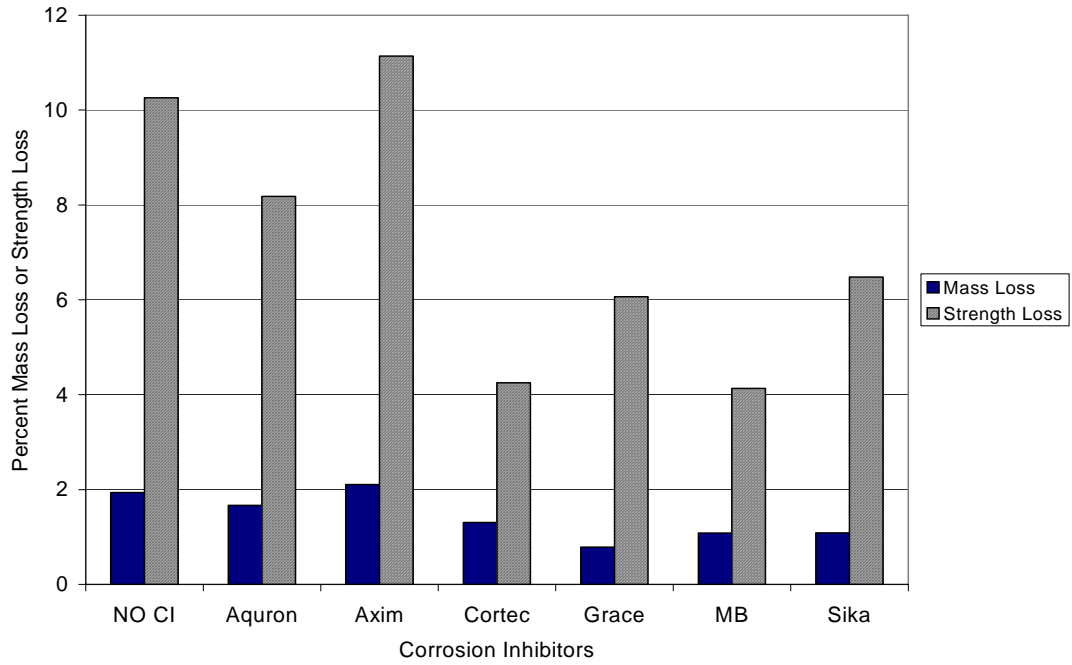

Figure G.6 – Mass Loss and Strength Loss for Bath 1, 1.0% Chloride, Pre-Cracked

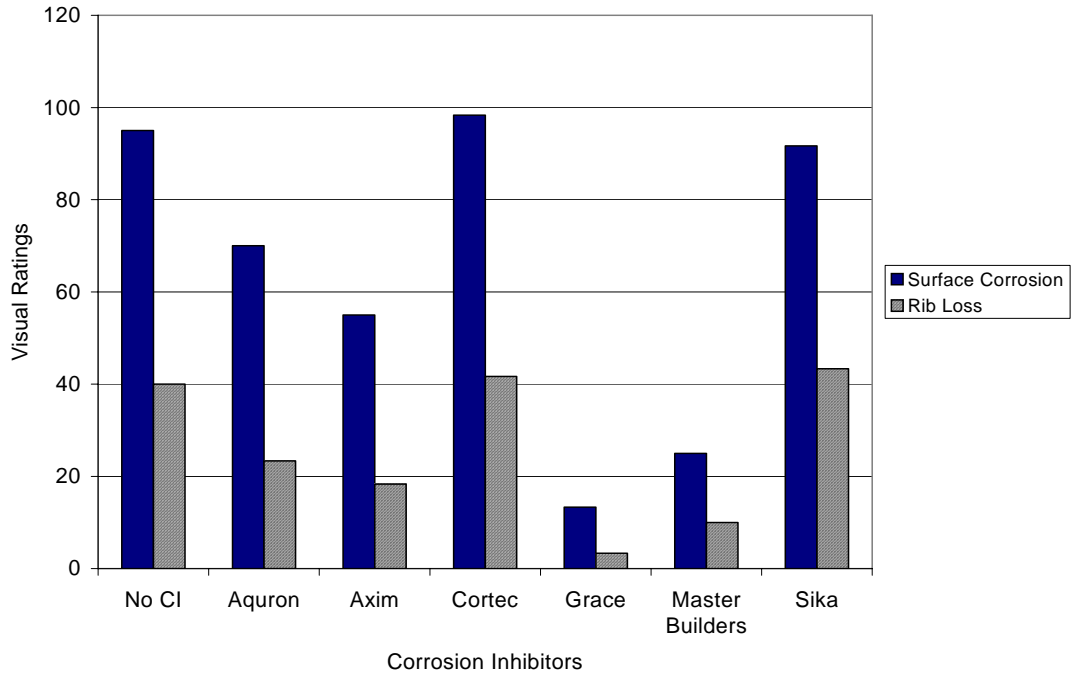

Figure G.7 – Visual Ratings for Bath 1, 1.5% Chloride, Pre-Cracked

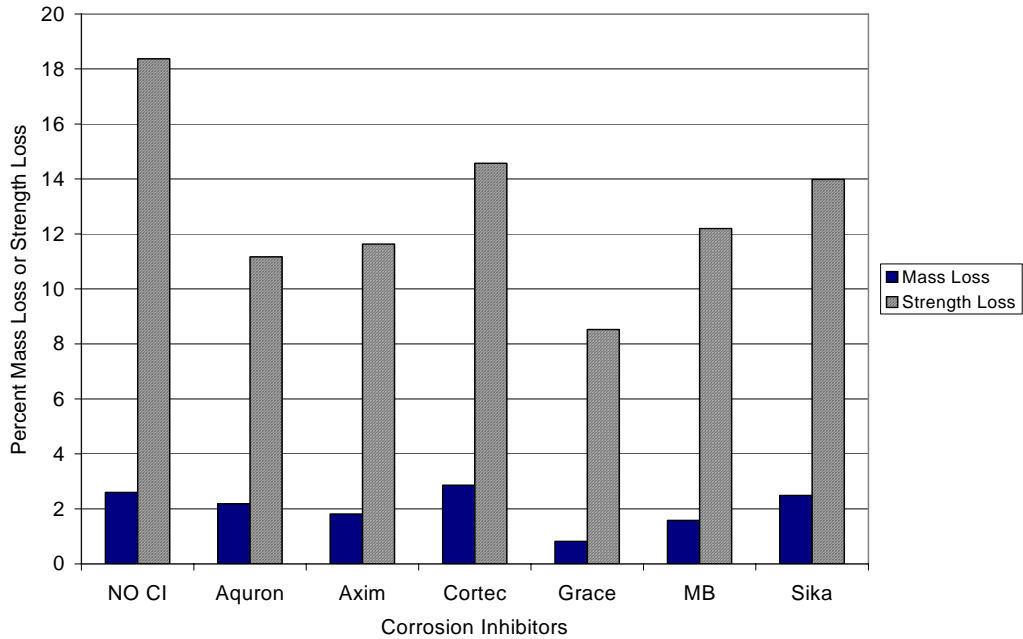

Figure G.8 – Mass Loss and Strength Loss for Bath 1, 1.5% Chloride, Pre-Cracked

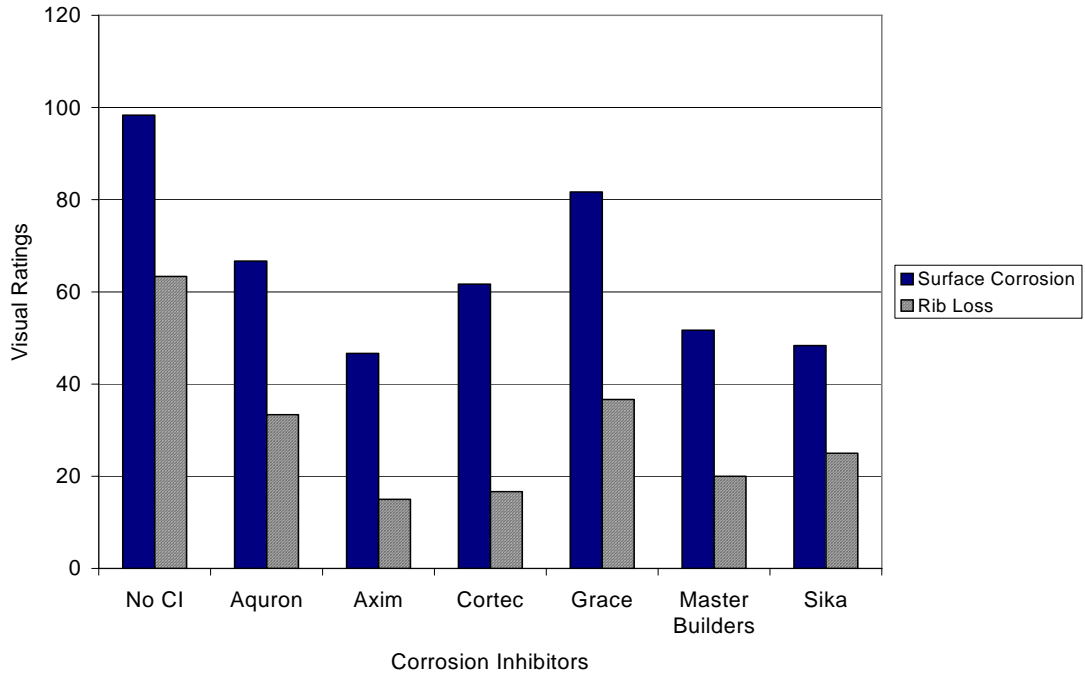

Figure G.9 – Visual Ratings for Bath 1, 2.0% Chloride, Pre-Cracked

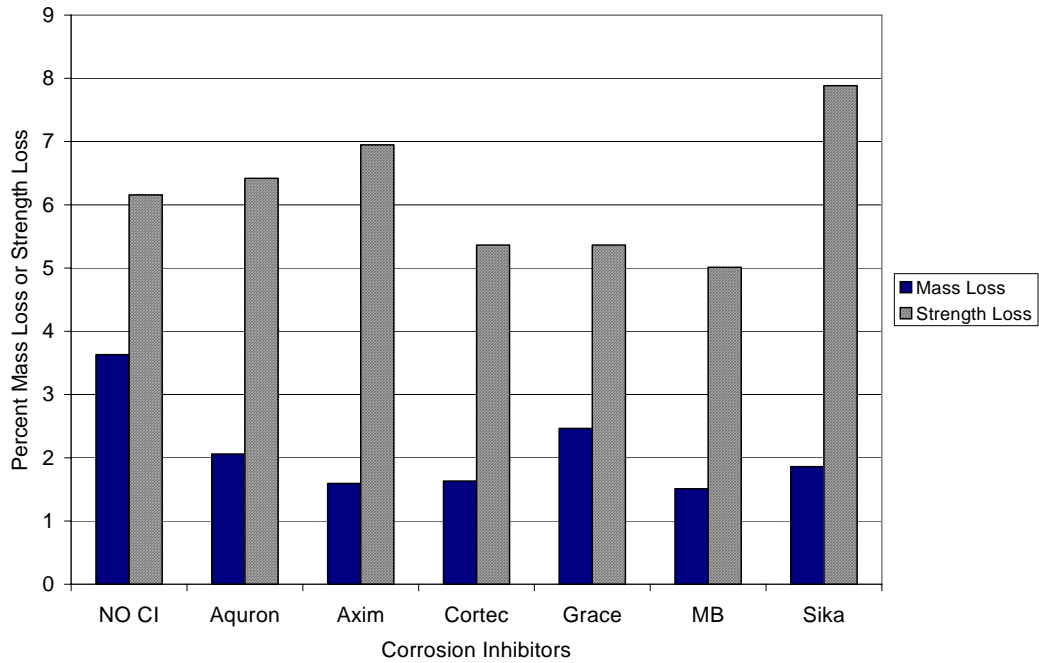

Figure G.10 – Mass Loss and Strength Loss for Bath 1, 2.0% Chloride, Pre-Cracked

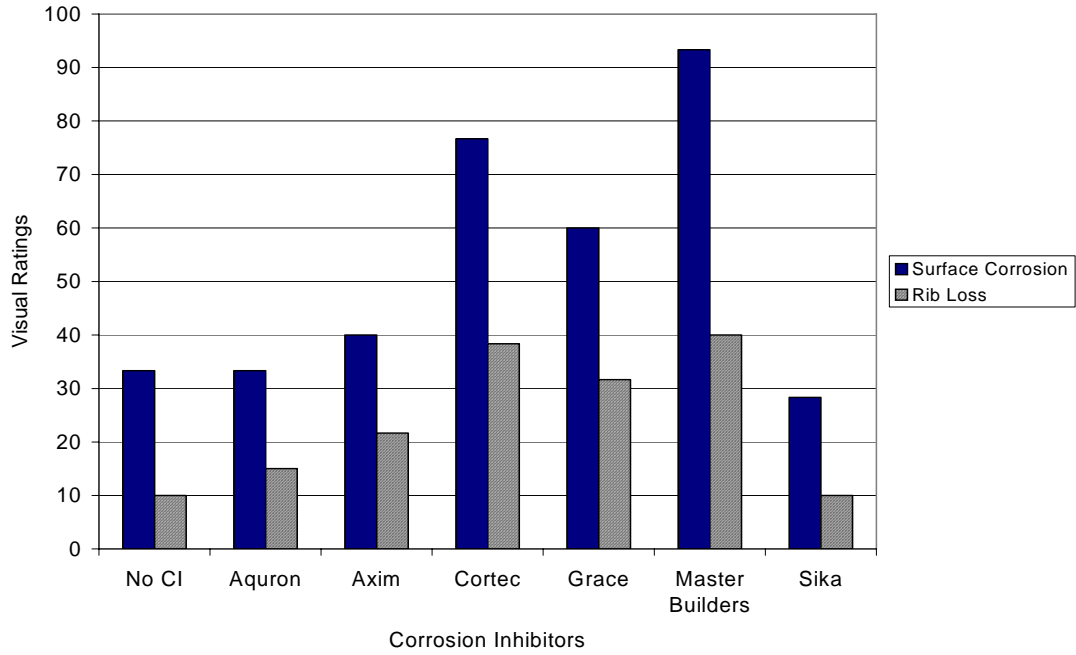

Figure G.11 – Visual Ratings for Bath 1, 3.0% Chloride, Pre-Cracked

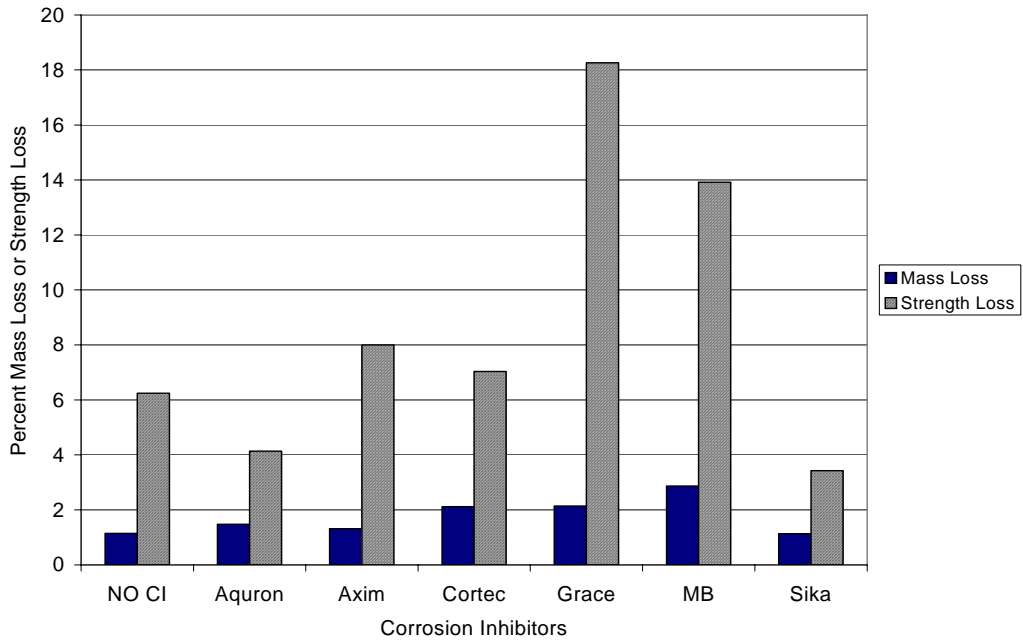

Figure G.12 – Mass Loss and Strength Loss for Bath 1, 3.0% Chloride, Pre-Cracked

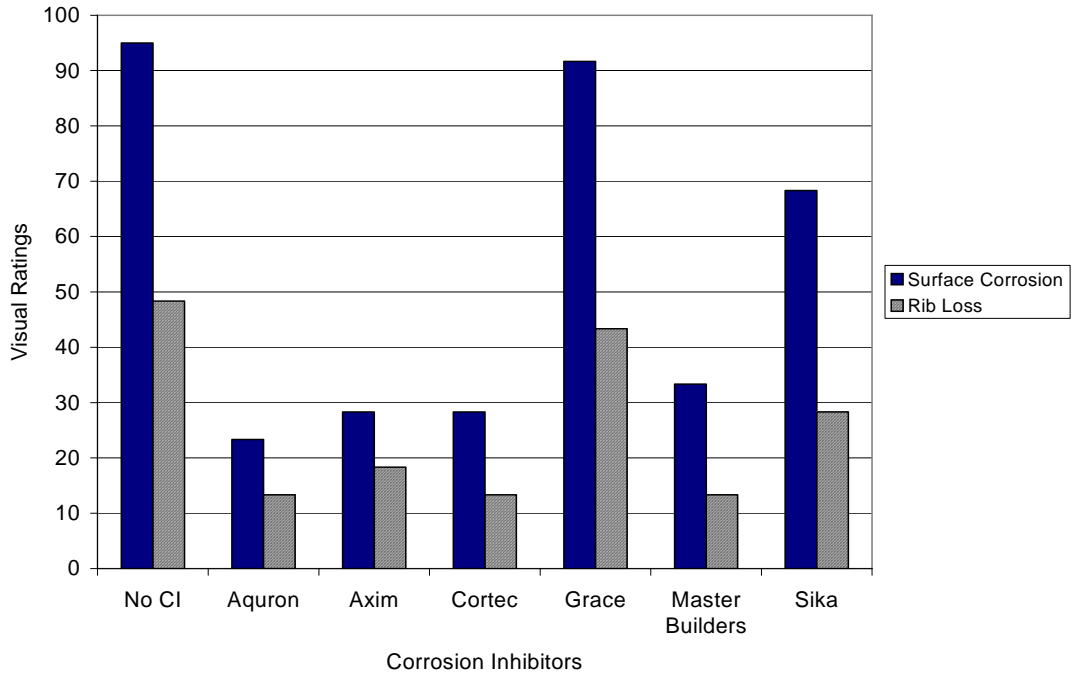

Figure G.13 – Visual Ratings for Bath 2, 0.0% Chloride, Pre-Cracked

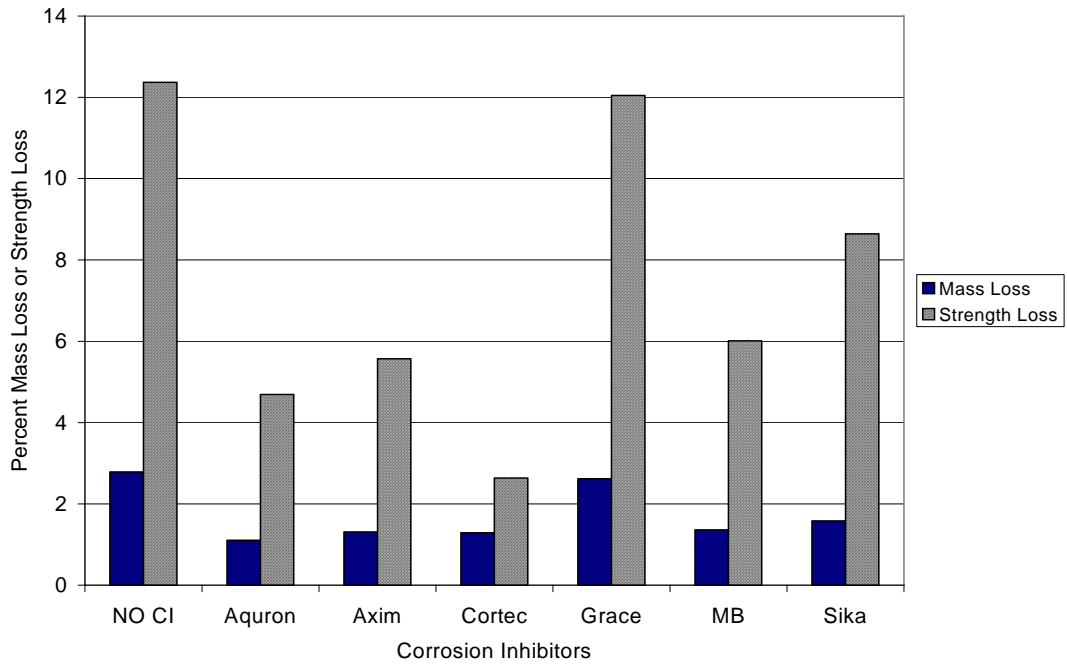

Figure G.14 – Mass Loss and Strength Loss for Bath 2, 0.0% Chloride, Pre-Cracked

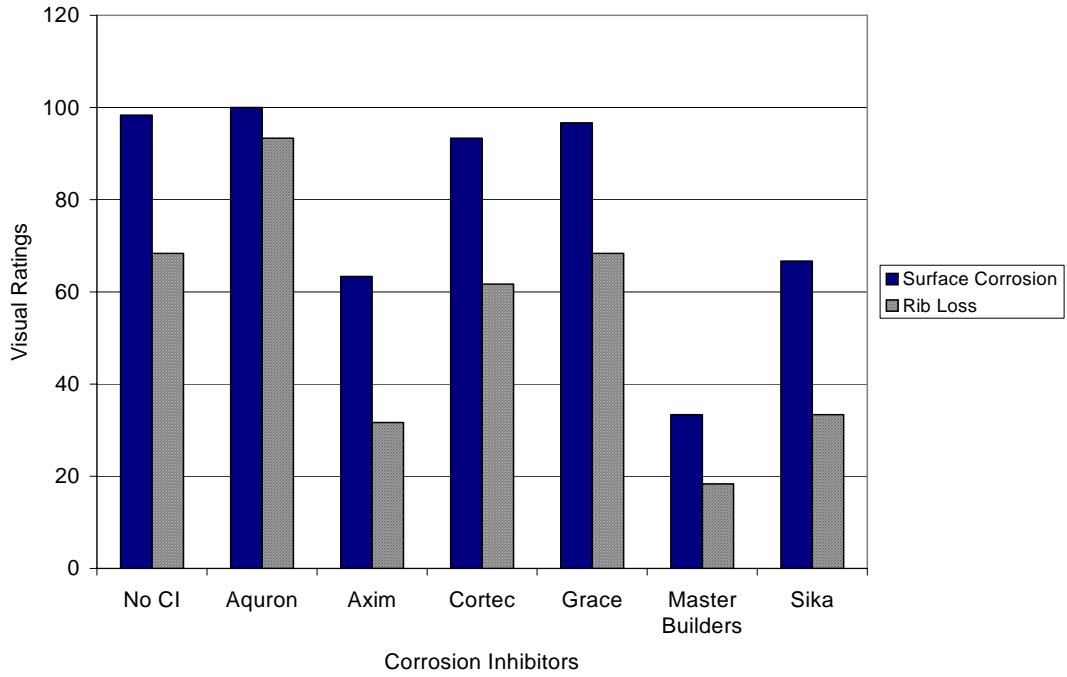

Figure G.15 – Visual Ratings for Bath 2, 0.5% Chloride, Pre-Cracked

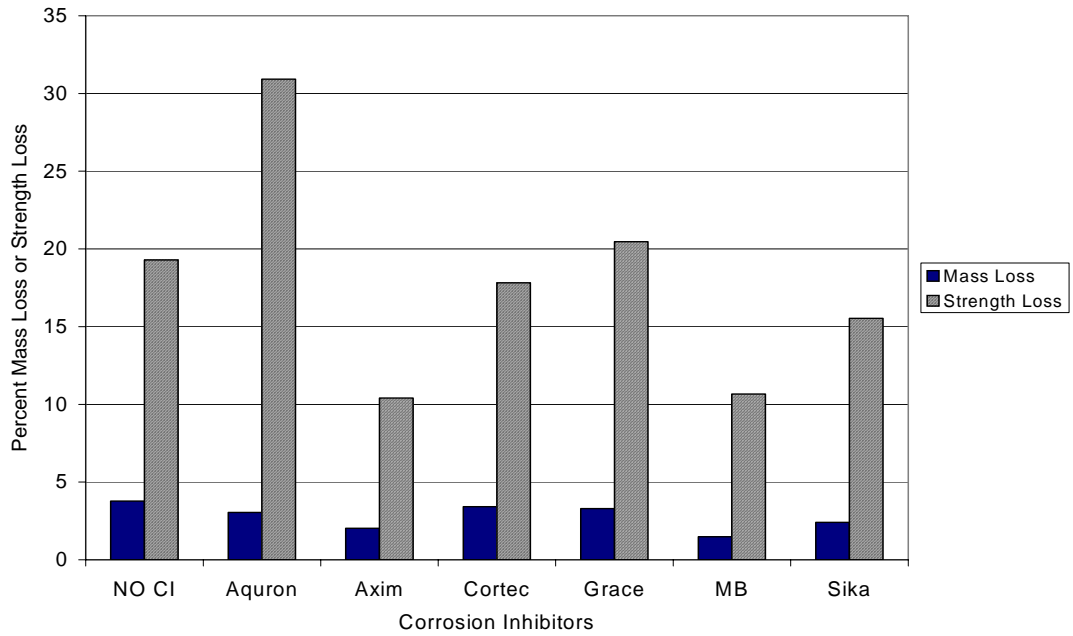

Figure G.16 – Mass Loss and Strength Loss for Bath 2, 0.5% Chloride, Pre-Cracked

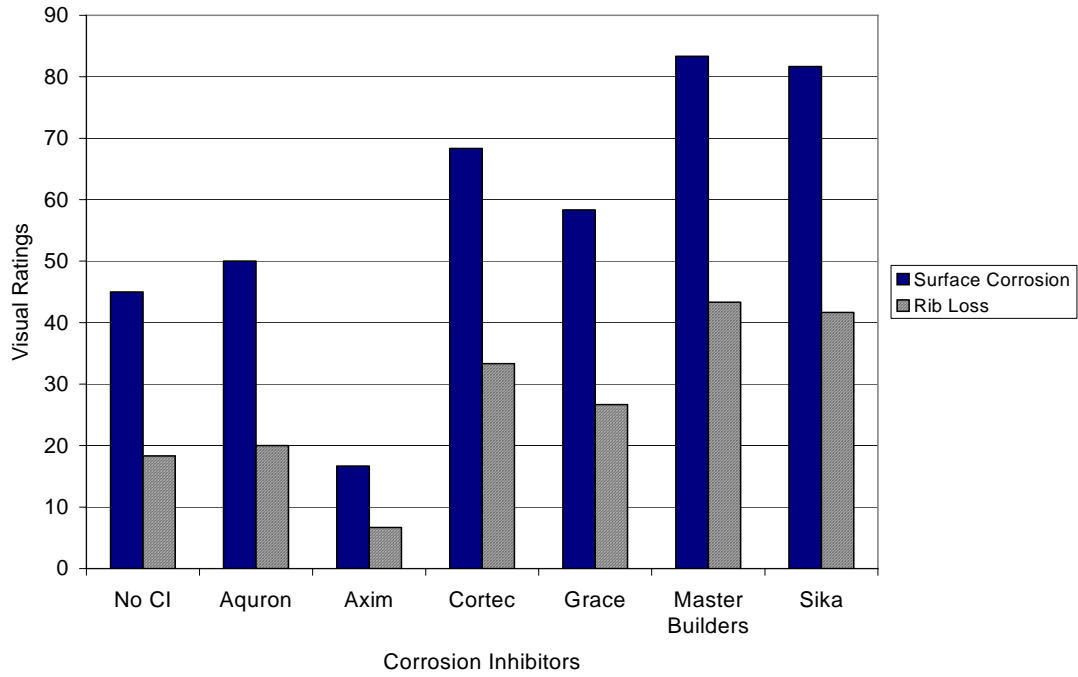

Figure G.17 – Visual Ratings for Bath 2, 1.0% Chloride, Pre-Cracked

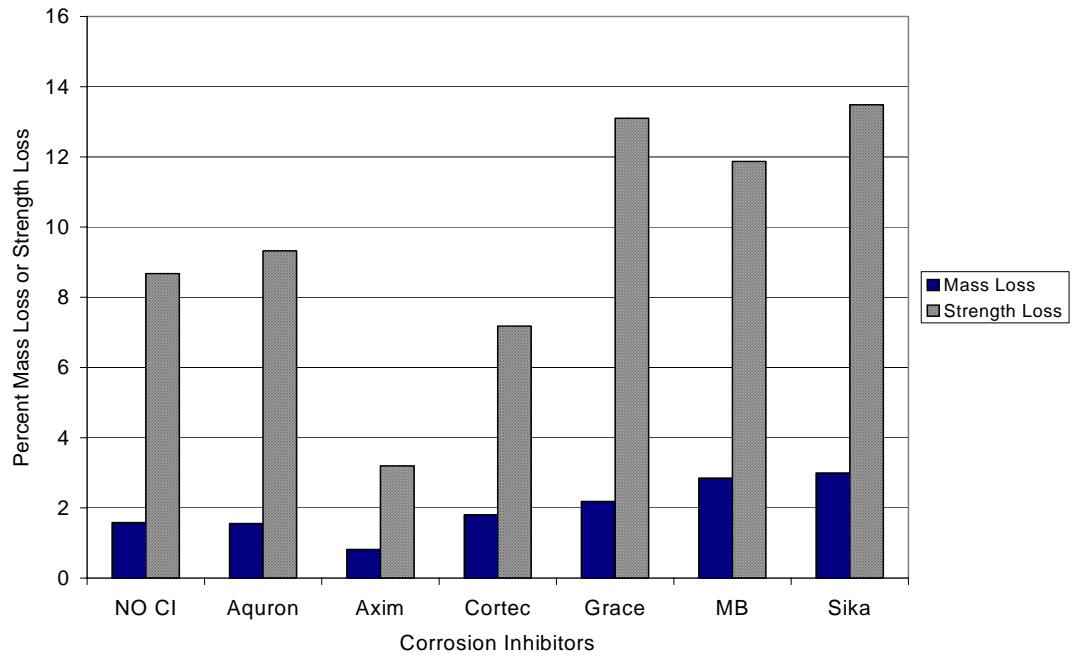

Figure G.18 – Mass Loss and Strength Loss for Bath 2, 1.0% Chloride, Pre-Cracked

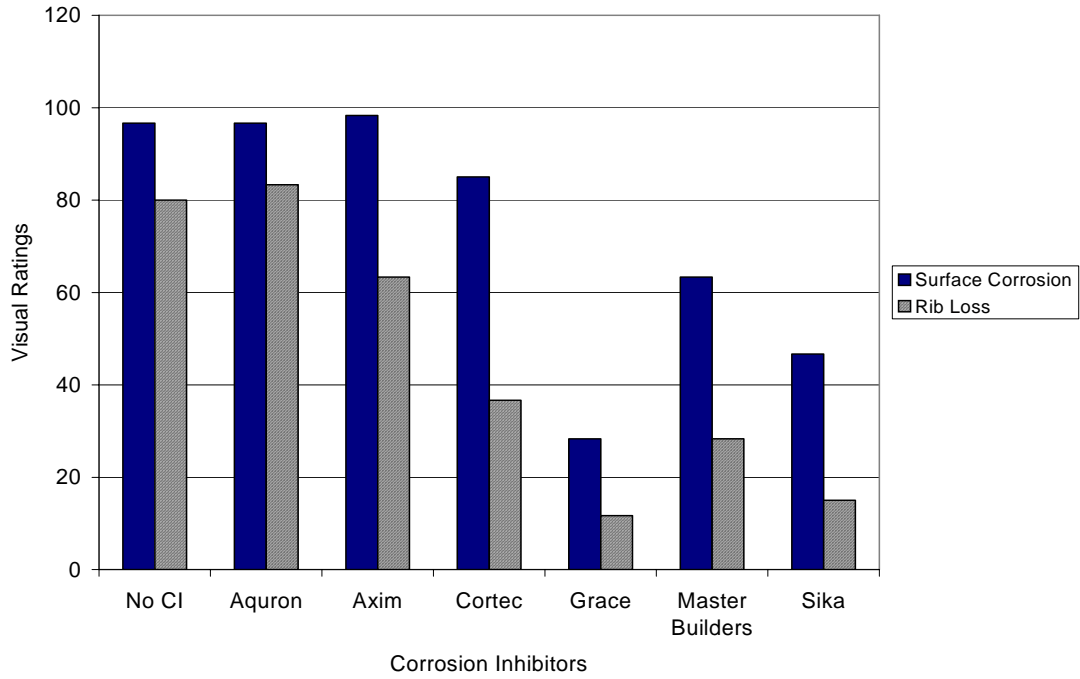

Figure G.19 – Visual Ratings for Bath 2, 1.5% Chloride, Pre-Cracked

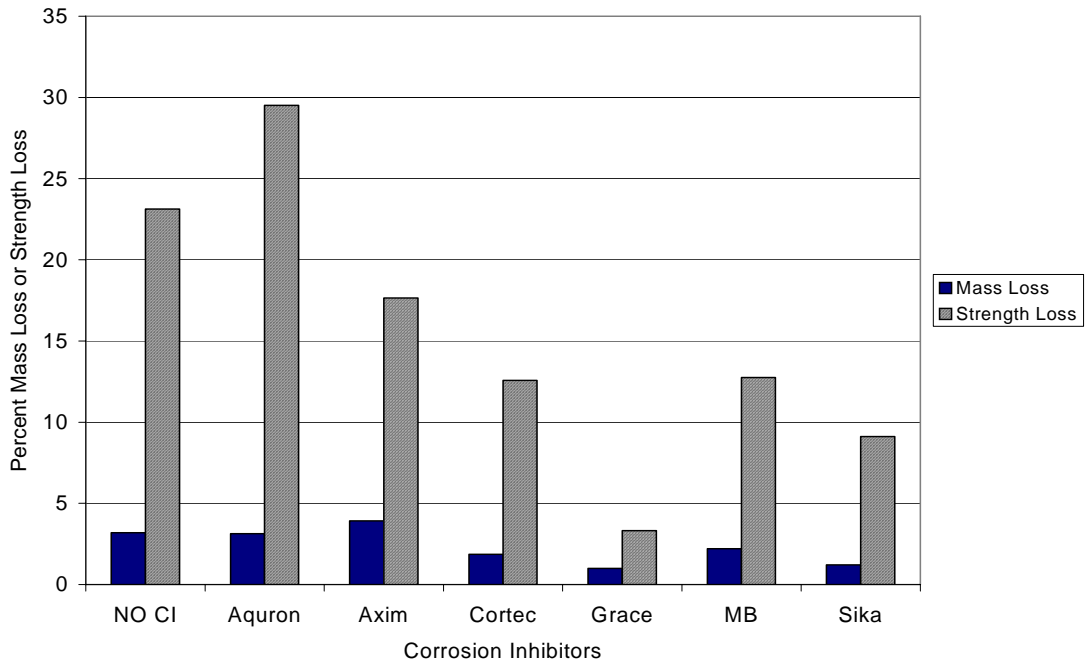

Figure G.20 – Mass Loss and Strength Loss for Bath 2, 1.5% Chloride, Pre-Cracked

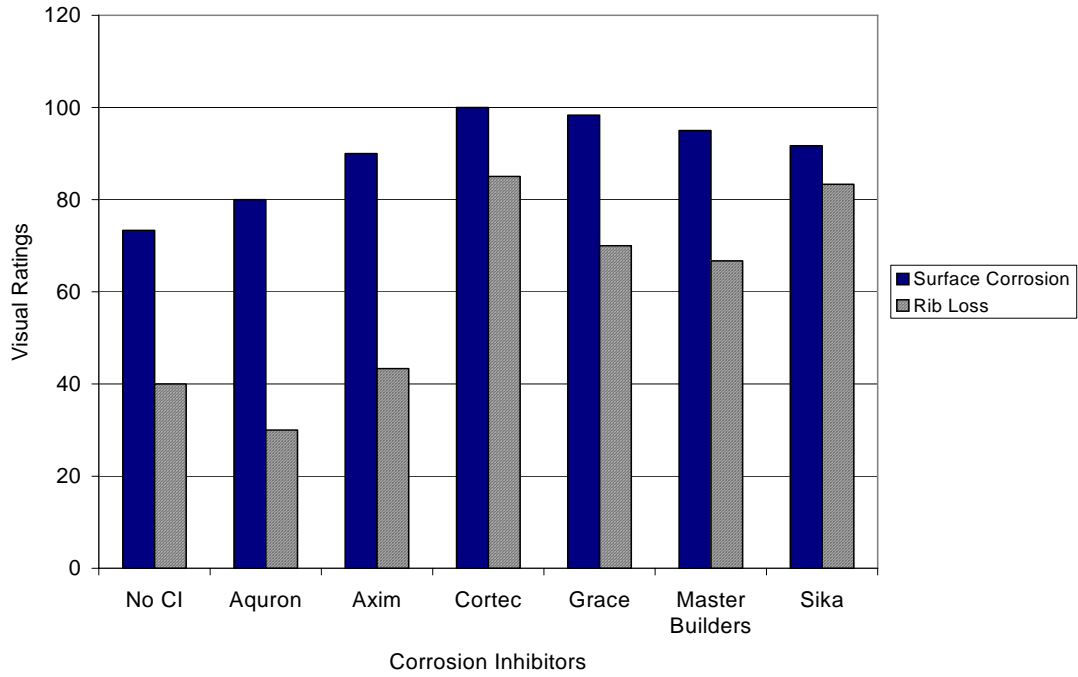

Figure G.21 – Visual Ratings for Bath 2, 2.0% Chloride, Pre-Cracked

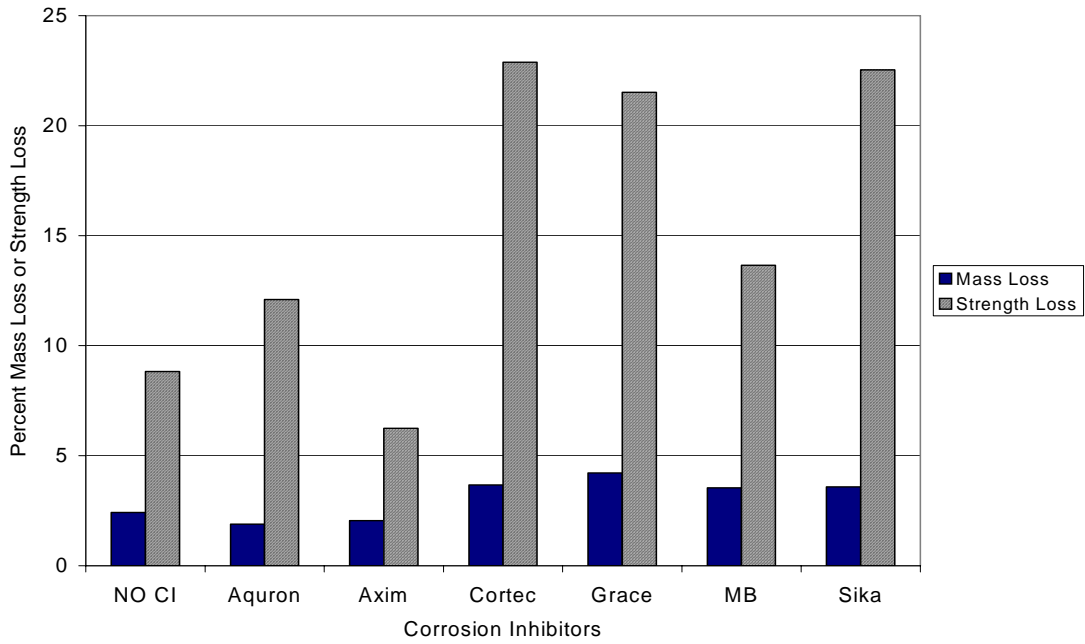

Figure G.22 – Mass Loss and Strength Loss for Bath 2, 2.0% Chloride, Pre-Cracked

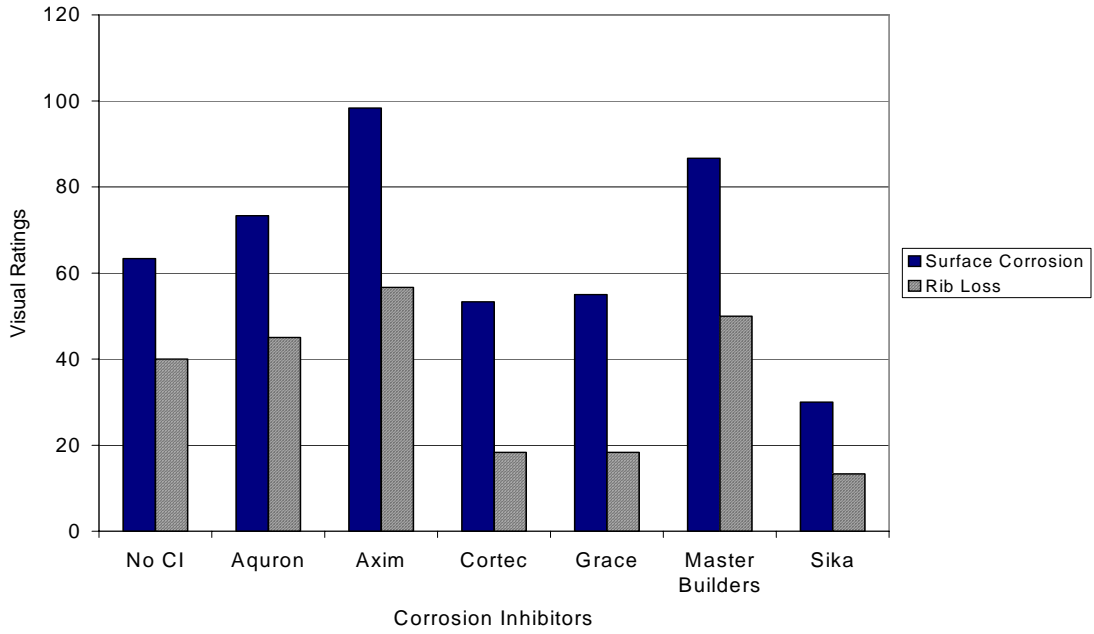

Figure G.23 – Visual Ratings for Bath 2, 3.0% Chloride, Pre-Cracked

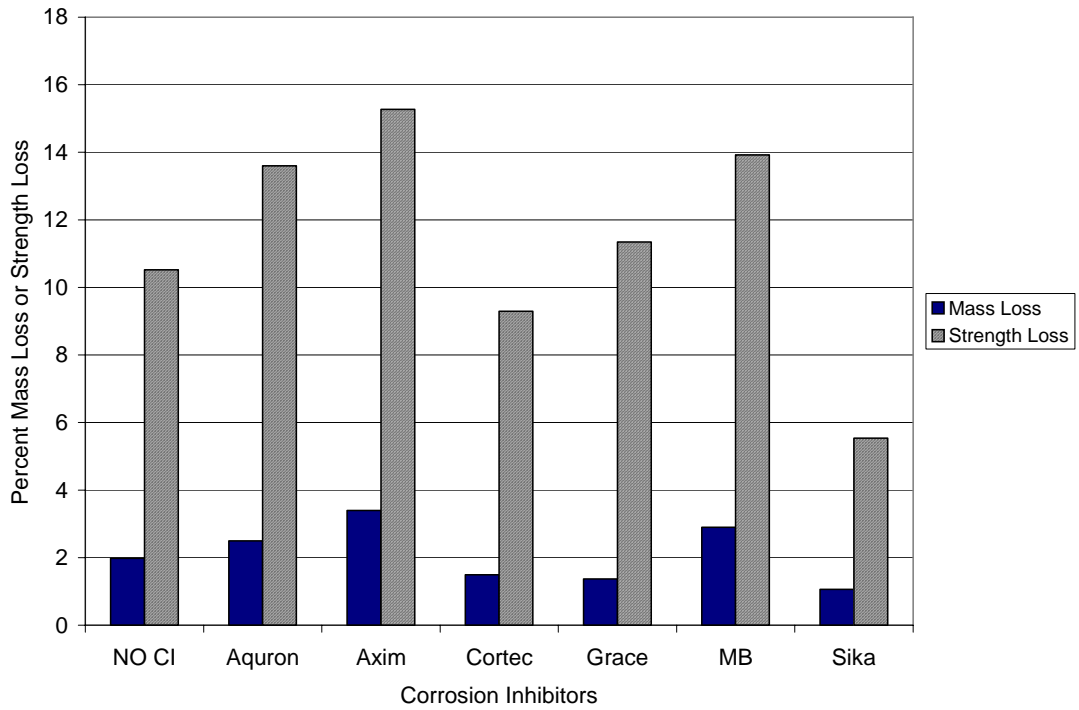

Figure G.24 – Mass Loss and Strength Loss for Bath 2, 3.0% Chloride, Pre-Cracked

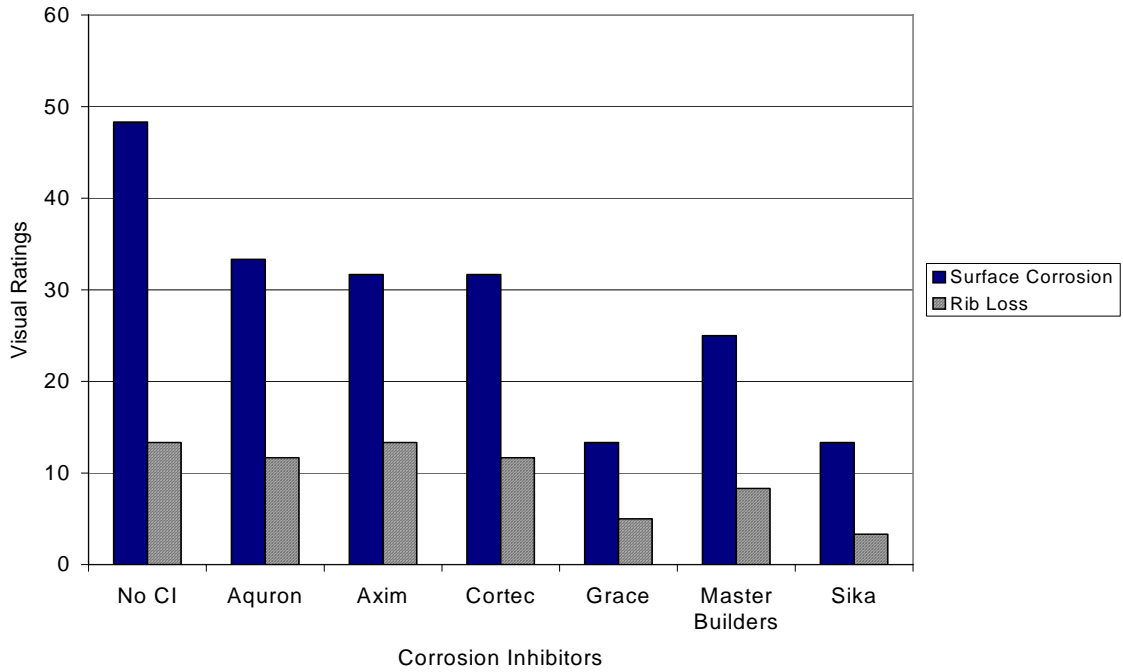

Figure G.25 – Visual Ratings for Bath 3, 0.0% Chloride, Post-Cracked

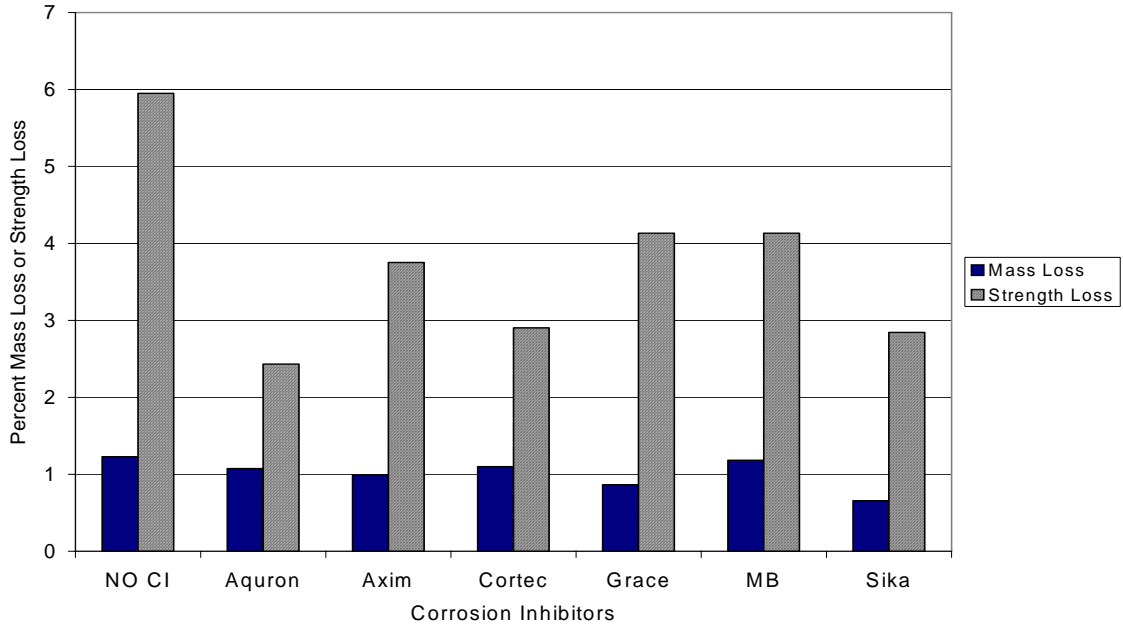

Figure G.26 – Mass Loss and Strength Loss for Bath 3, 0.0% Chloride, Post-Cracked

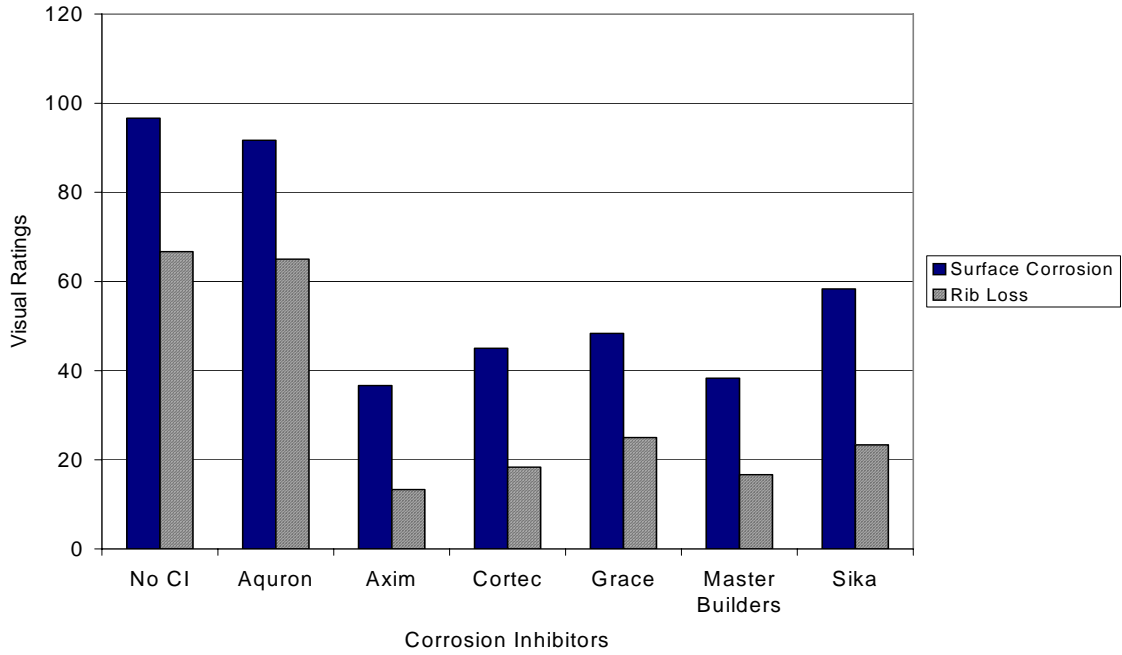

Figure G.27 – Visual Ratings for Bath 3, 0.5% Chloride, Post-Cracked

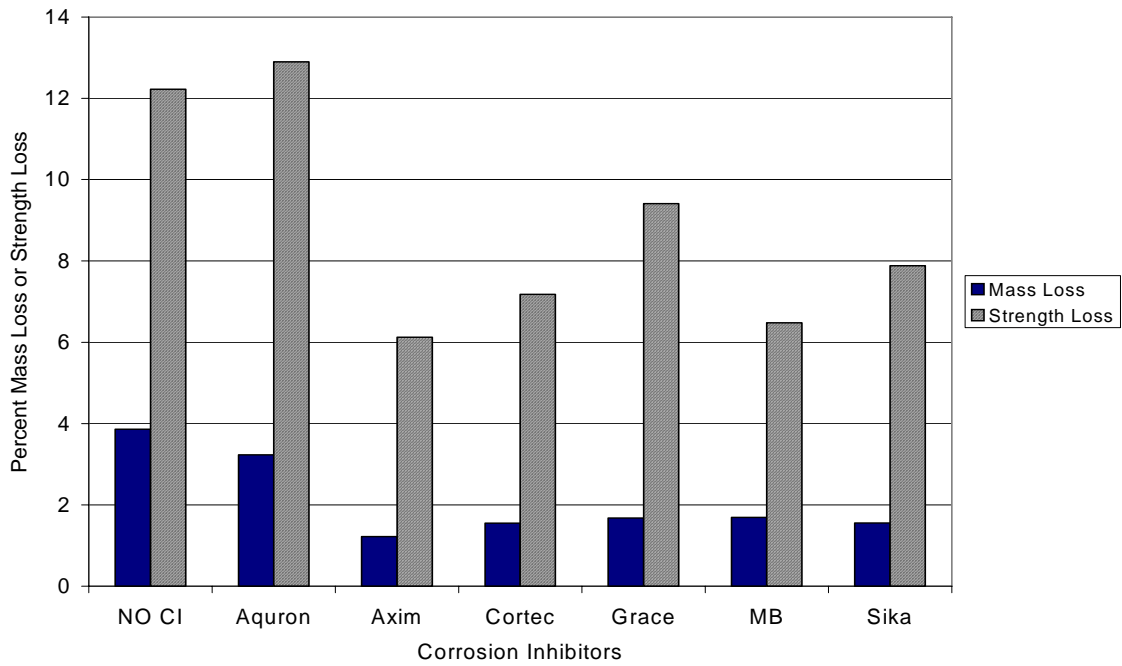

Figure G.28 – Mass Loss and Strength Loss for Bath 3, 0.5% Chloride, Post-Cracked

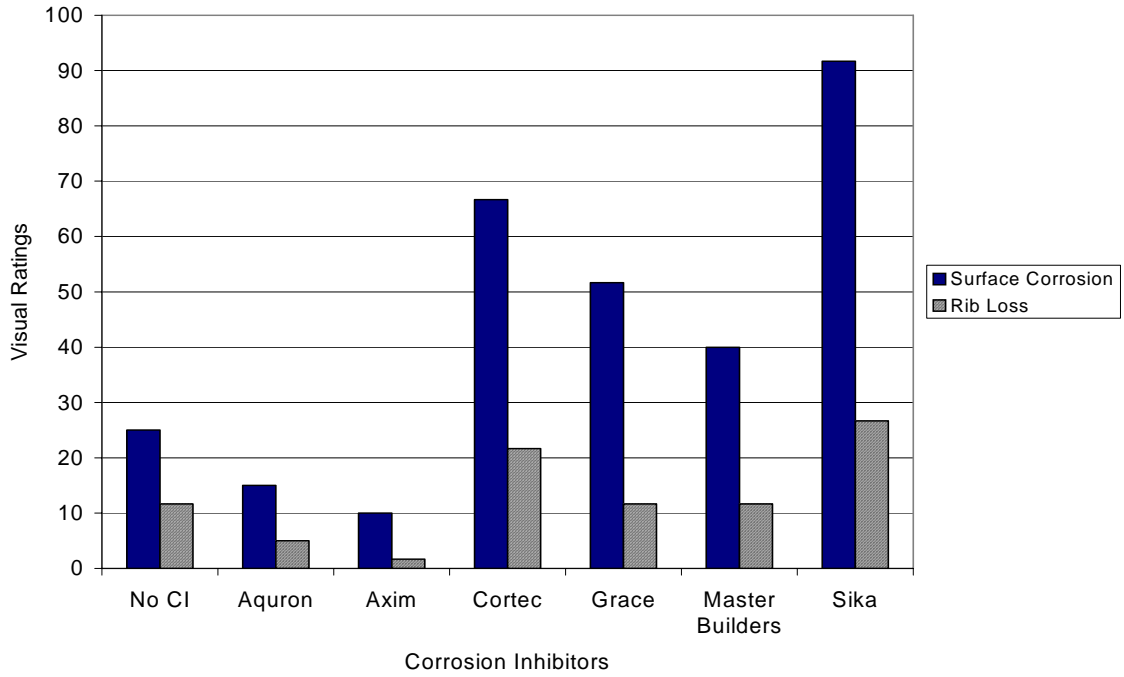

Figure G.29 – Visual Ratings for Bath 3, 1.0% Chloride, Post-Cracked

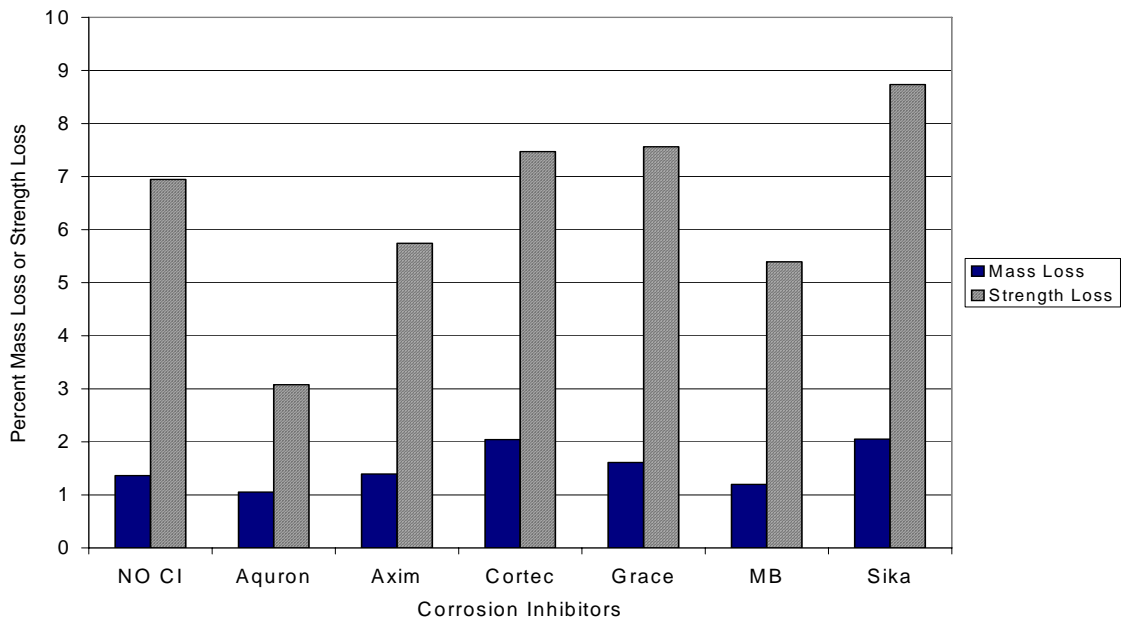

Figure G.30 – Mass Loss and Strength Loss for Bath 3, 1.0% Chloride, Post-Cracked

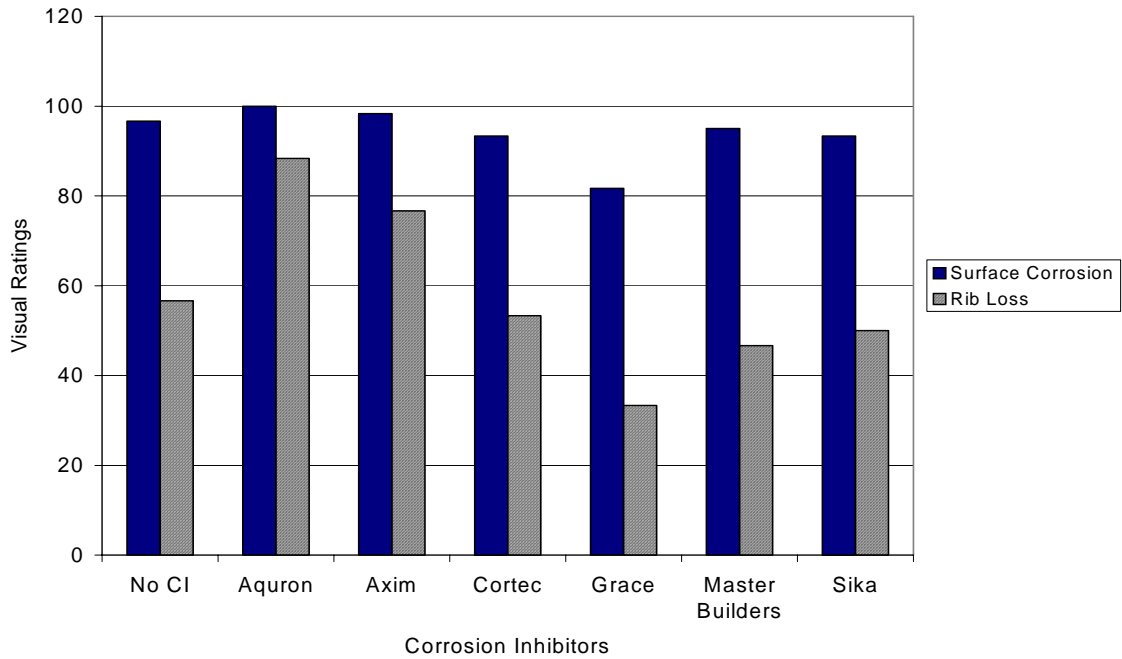

Figure G.31 – Visual Ratings for Bath 3, 1.5% Chloride, Post-Cracked

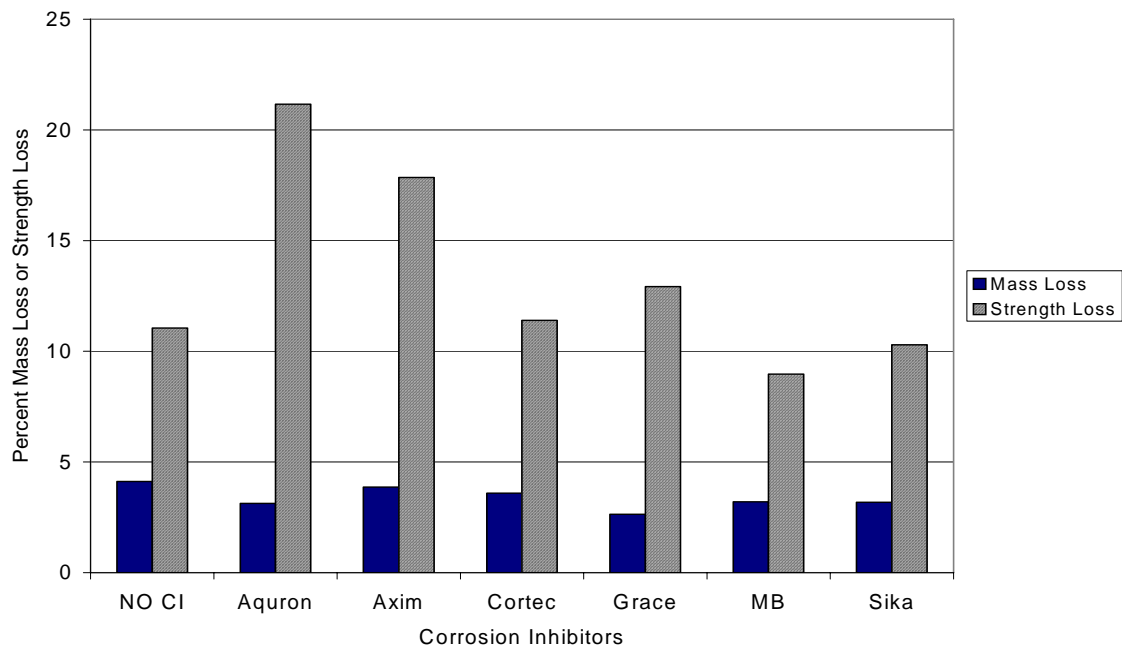

Figure G.32 – Mass Loss and Strength Loss for Bath 3, 1.5% Chloride, Post-Cracked

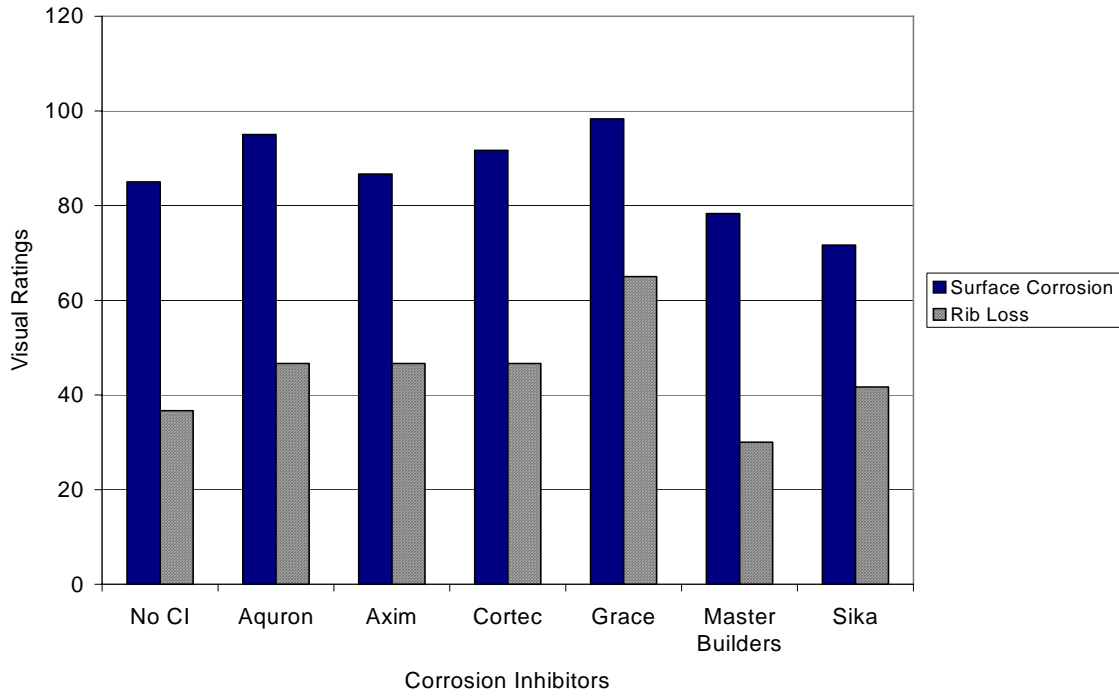

Figure G.33 – Visual Ratings for Bath 3, 2.0% Chloride, Post-Cracked

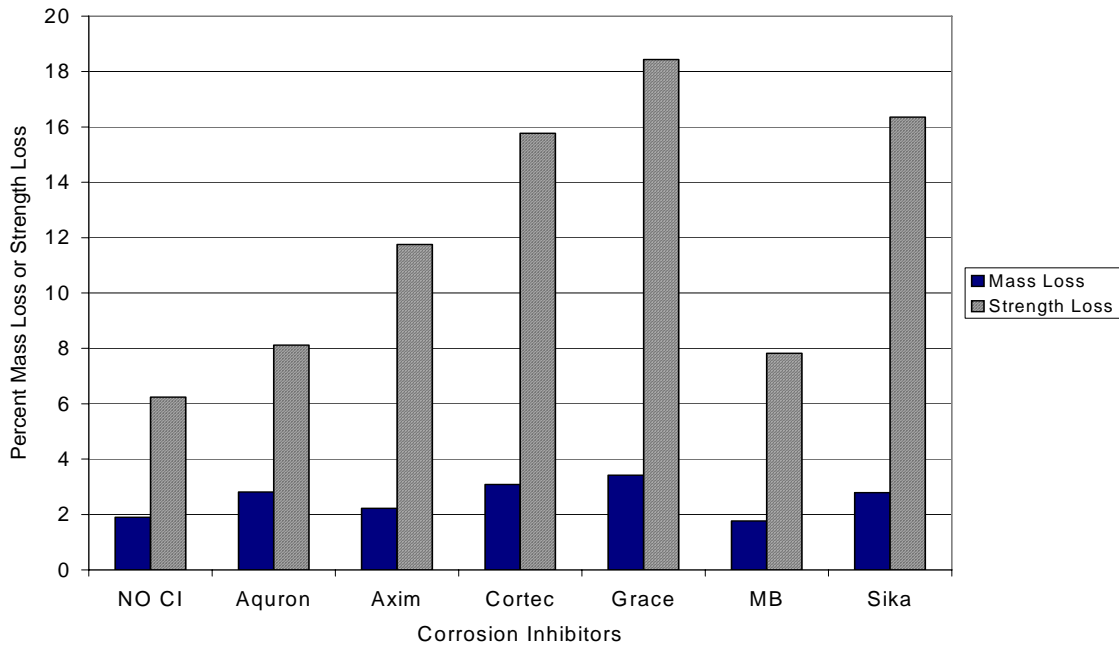

Figure G.34 – Mass Loss and Strength Loss for Bath 3, 2.0% Chloride, Post-Cracked

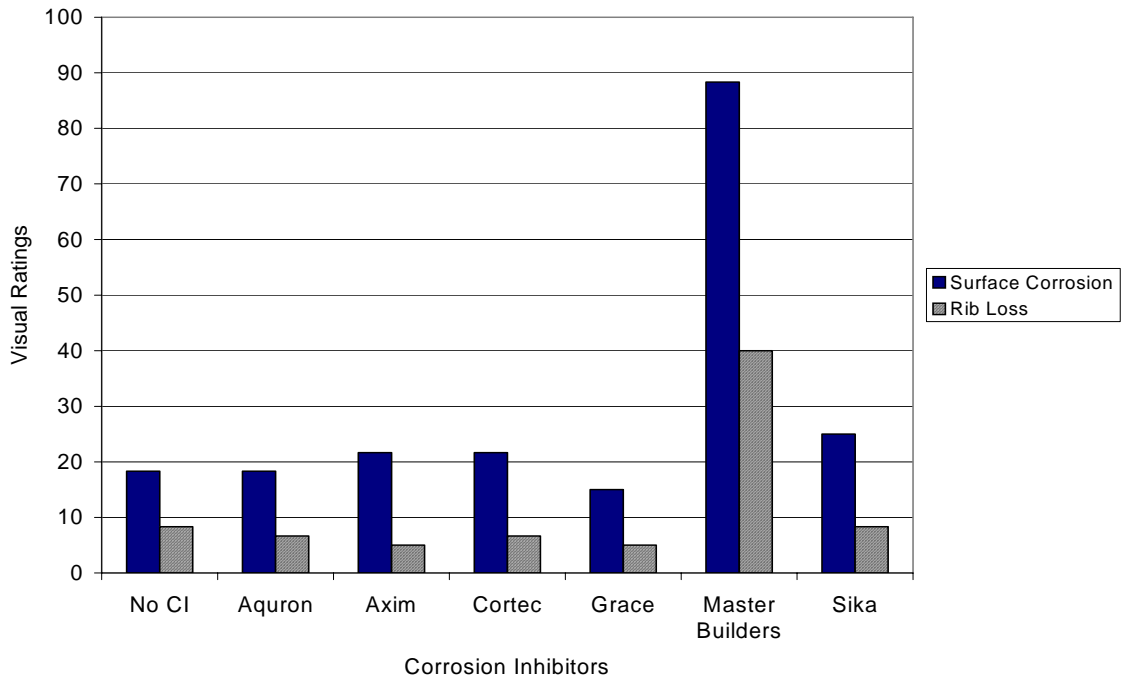

Figure G.35 – Visual Ratings for Bath 3, 3.0% Chloride, Post-Cracked

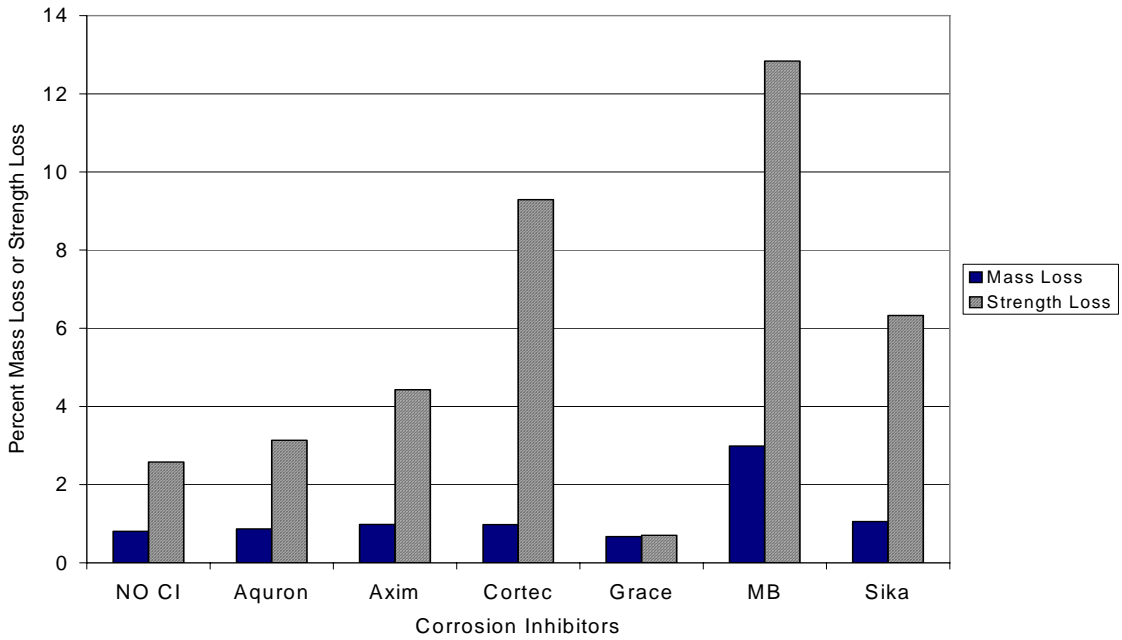

Figure G.36 – Mass Loss and Strength Loss for Bath 3, 3.0% Chloride, Post-Cracked

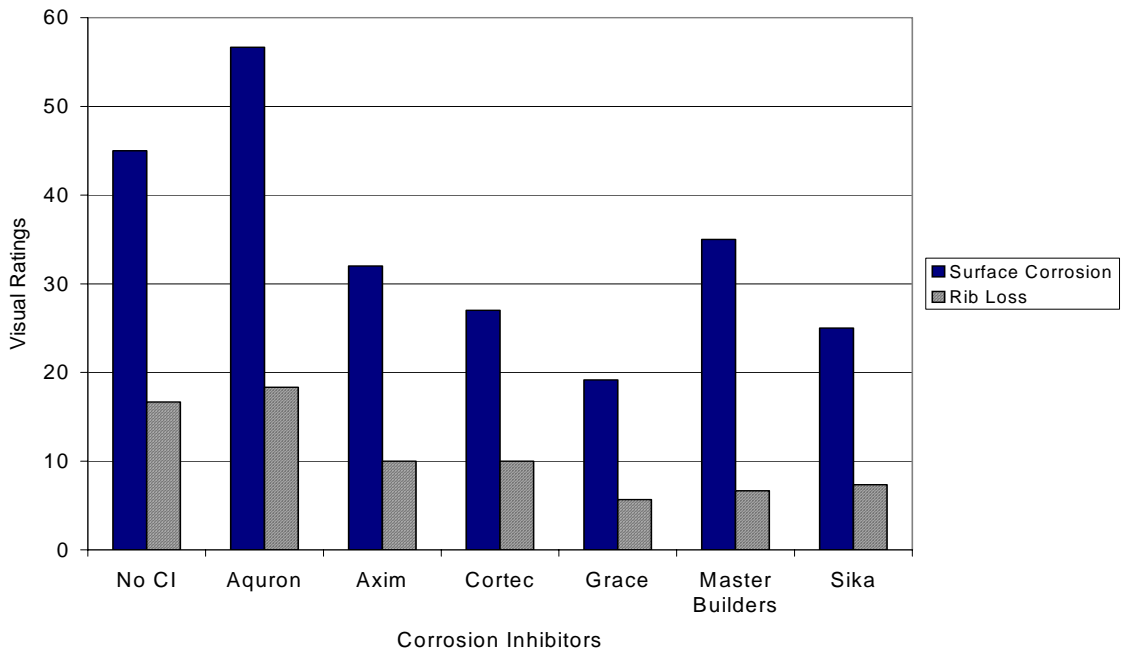

Figure G.37 – Visual Ratings for Bath 4, 0.0% Chloride, Post-Cracked

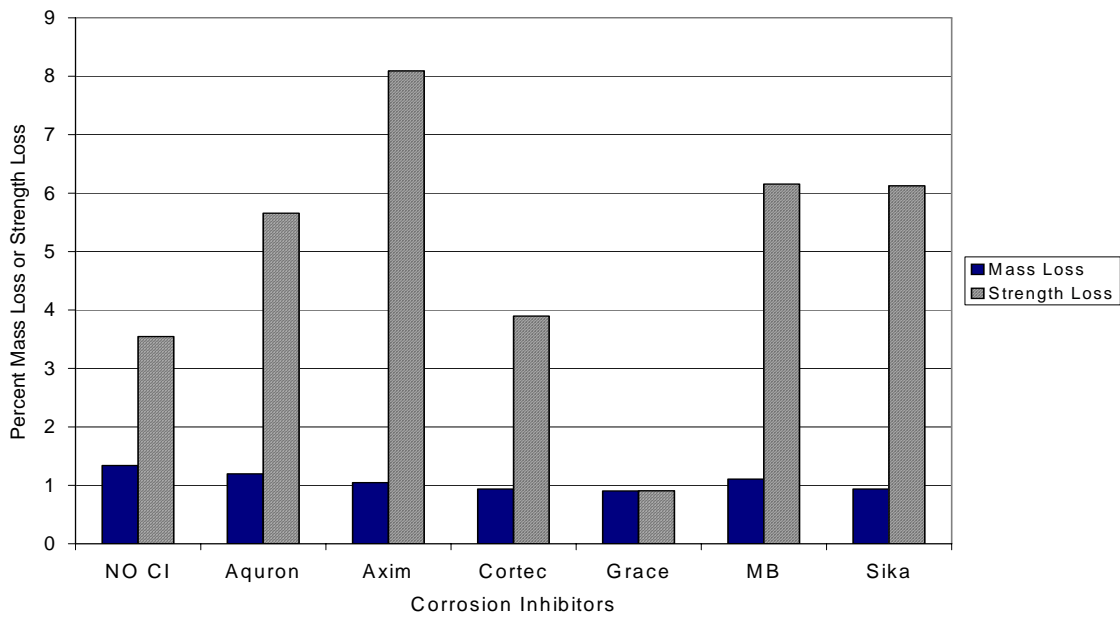

Figure G.38 – Mass Loss and Strength Loss for Bath 4, 0.0% Chloride, Post-Cracked

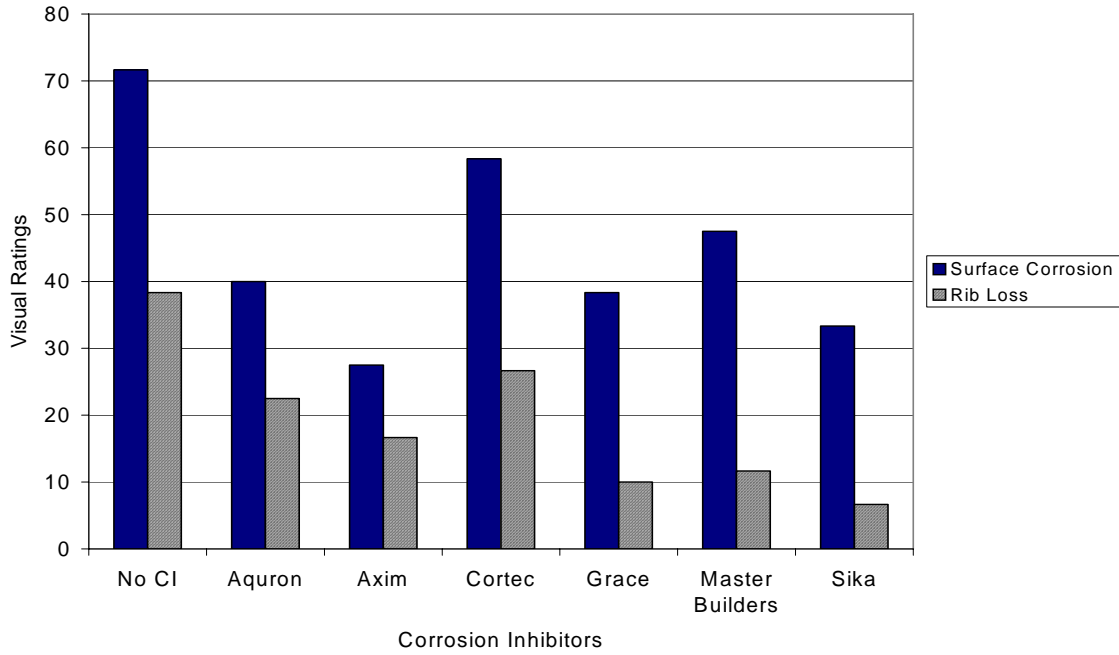

Figure G.39 – Visual Ratings for Bath 4, 0.5% Chloride, Post-Cracked

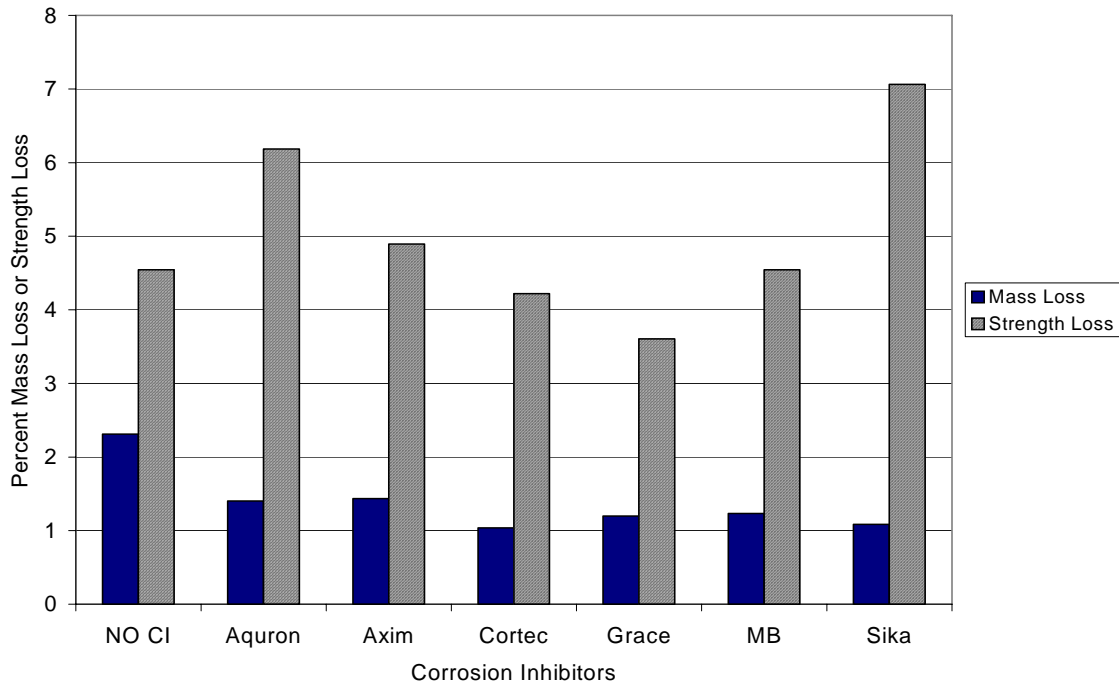

Figure G.40 – Mass Loss and Strength Loss for Bath 4, 0.5% Chloride, Post-Cracked

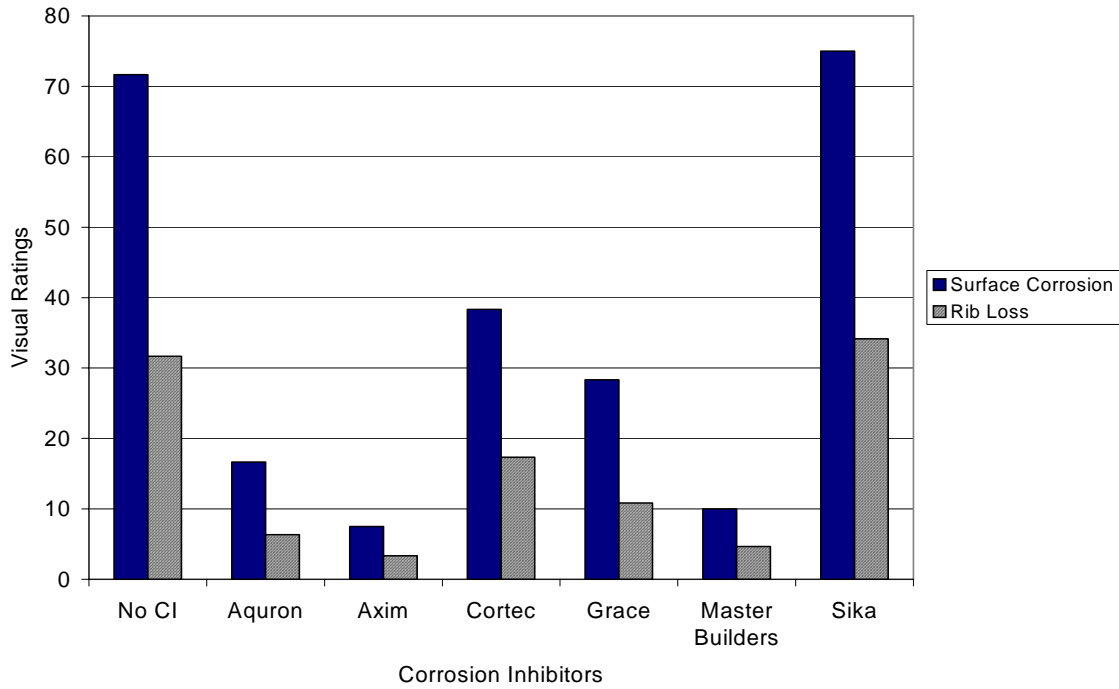

Figure G.41 – Visual Ratings for Bath 4, 1.0% Chloride, Post-Cracked

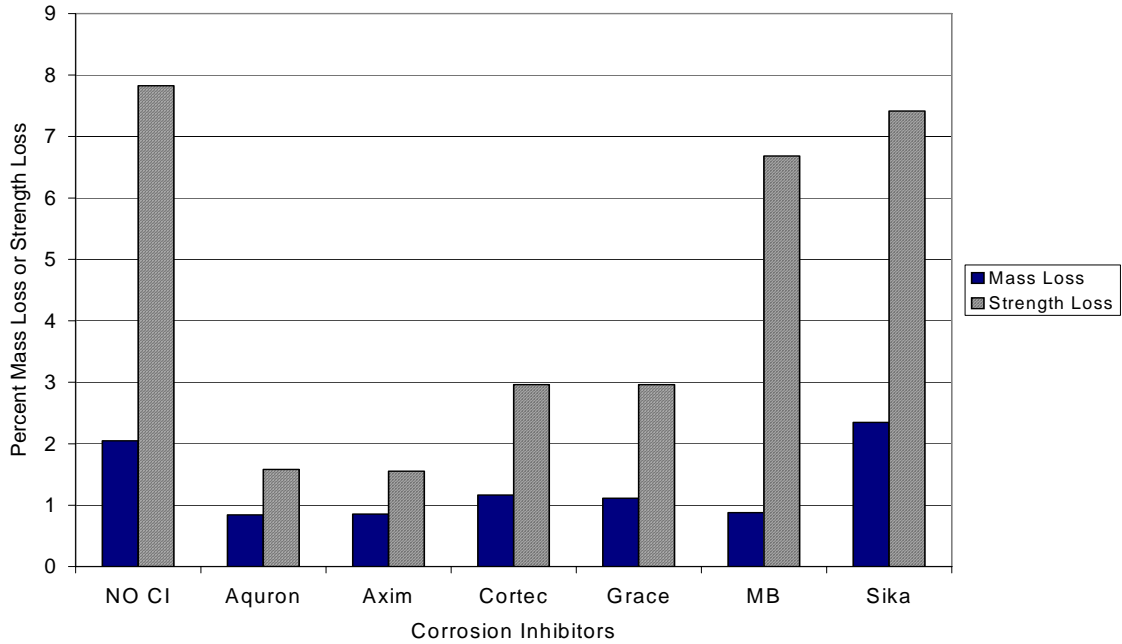

Figure G.42 – Mass Loss and Strength Loss for Bath 4, 1.0% Chloride, Post-Cracked

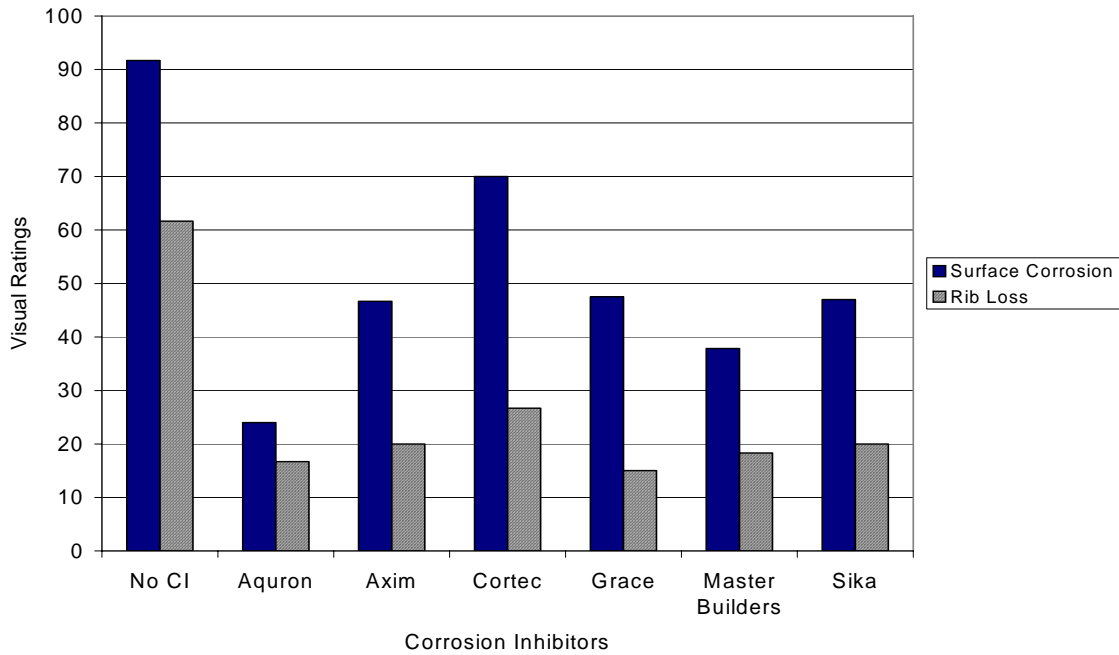

Figure G.43 – Visual Ratings for Bath 4, 1.5% Chloride, Post-Cracked

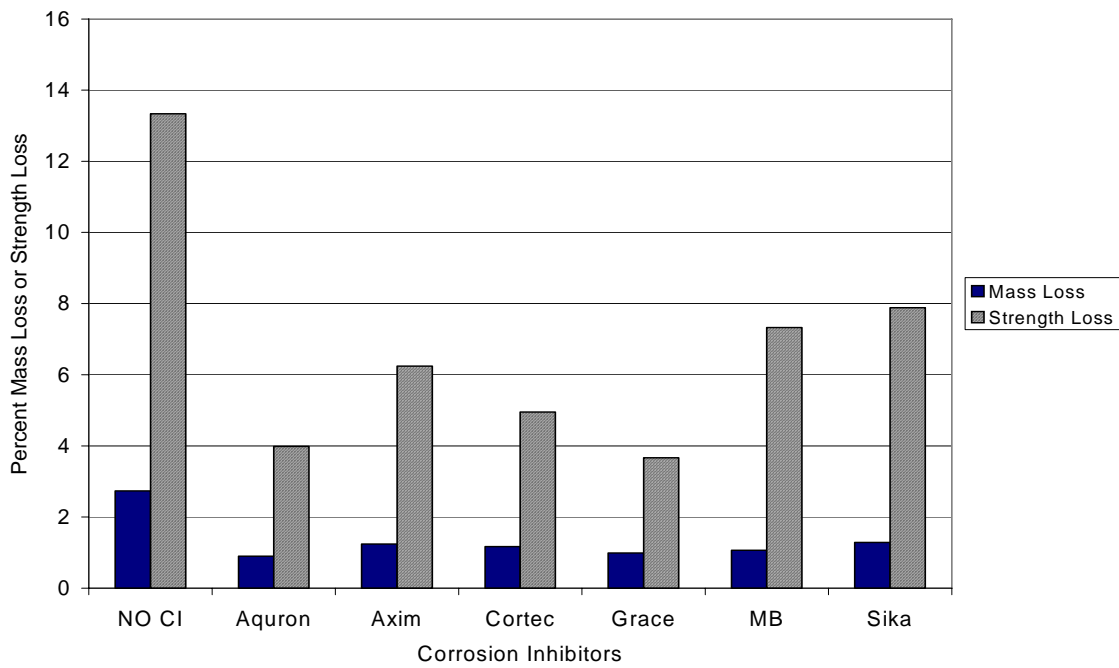

Figure G.44 – Mass Loss and Strength Loss for Bath 4, 1.5% Chloride, Post-Cracked

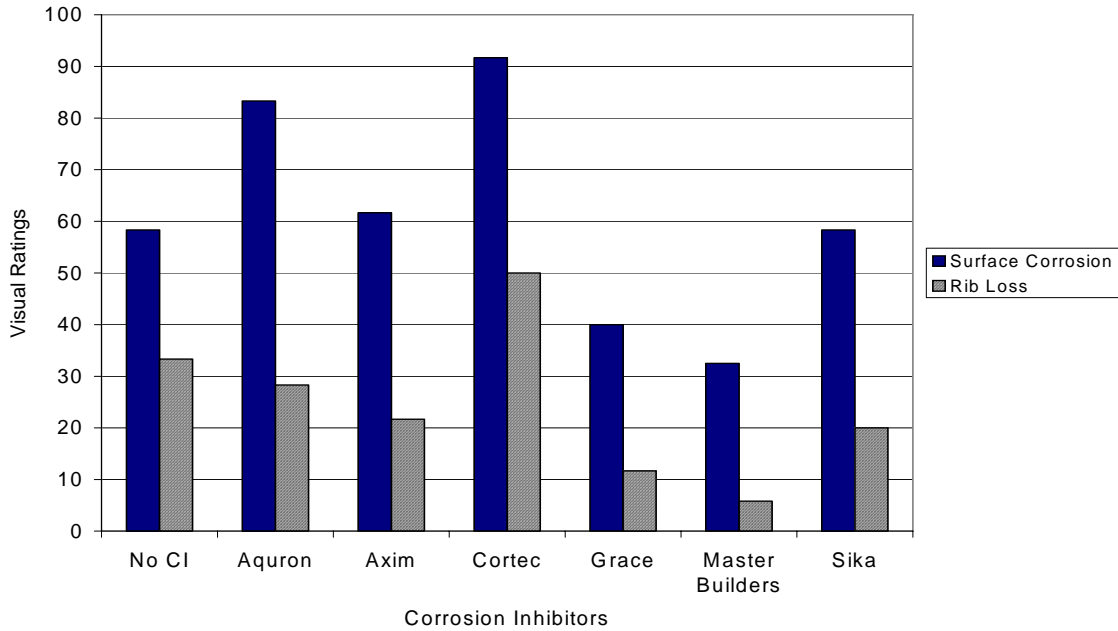

Figure G.45 – Visual Ratings for Bath 4, 2.0% Chloride, Post-Cracked

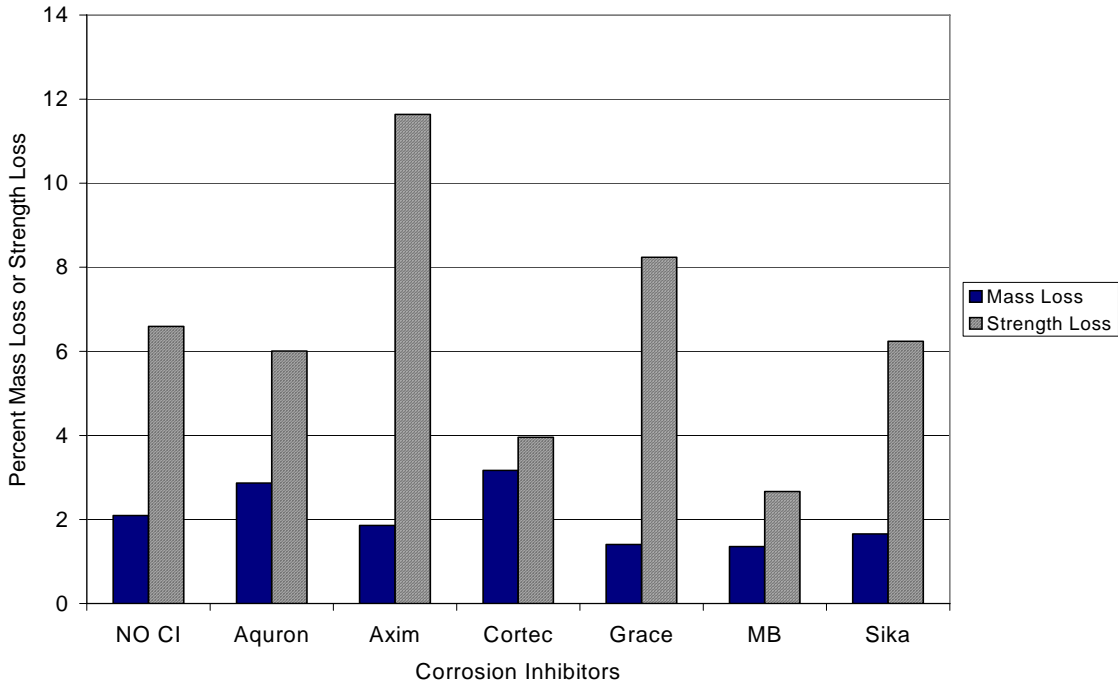

Figure G.46 – Mass Loss and Strength Loss for Bath 4, 2.0% Chloride, Post-Cracked

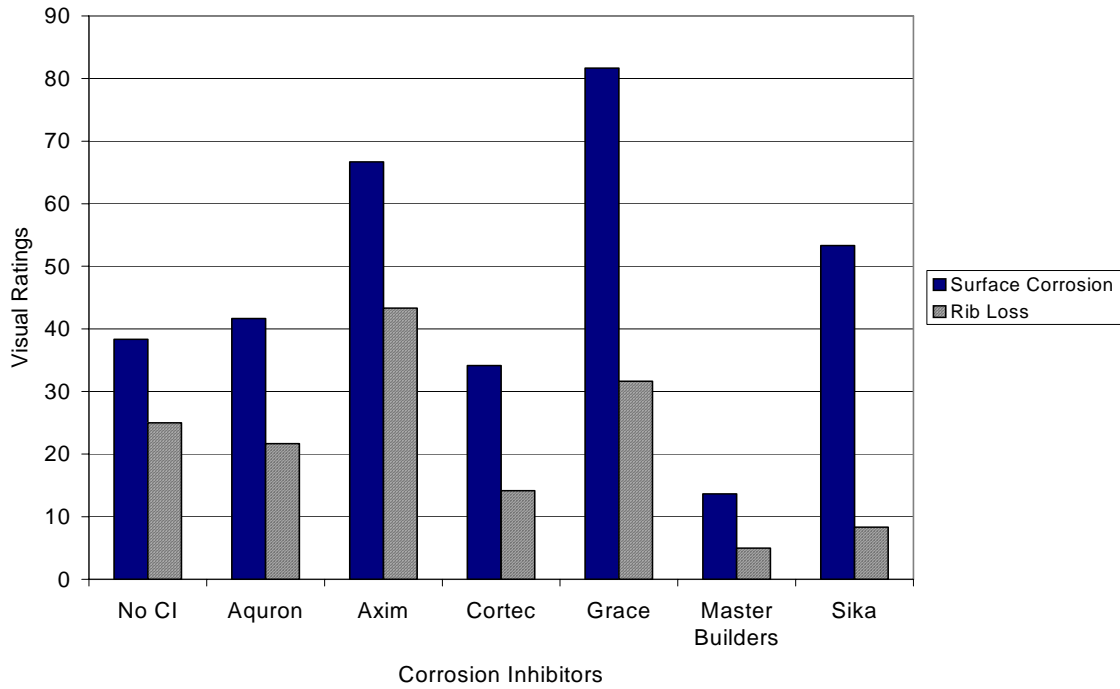

Figure G.47 – Visual Ratings for Bath 4, 3.0% Chloride, Post-Cracked

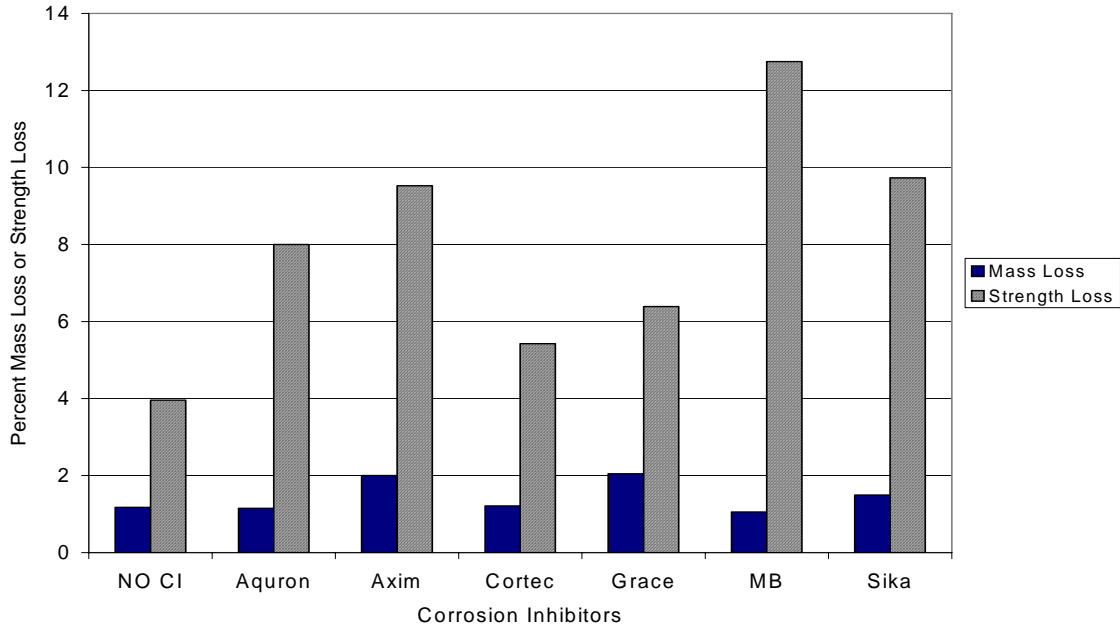

Figure G.48 – Mass Loss and Strength Loss for Bath 4, 3.0% Chloride, Post-Cracked

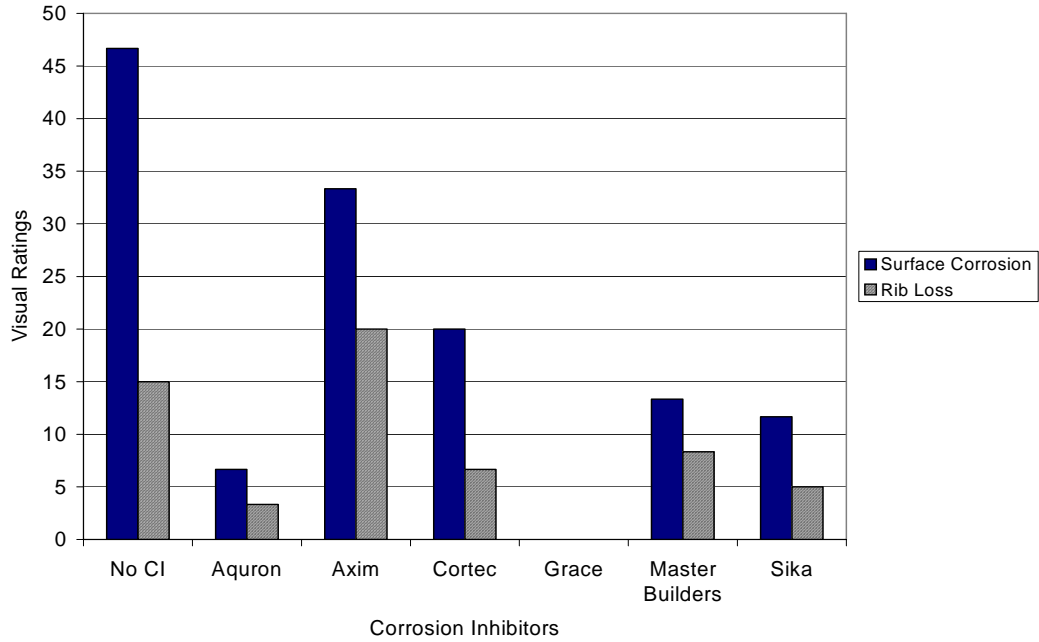

Figure G.49 – Visual Ratings for Chamber Shelf 1, 0.0% Chloride, Post-Cracked

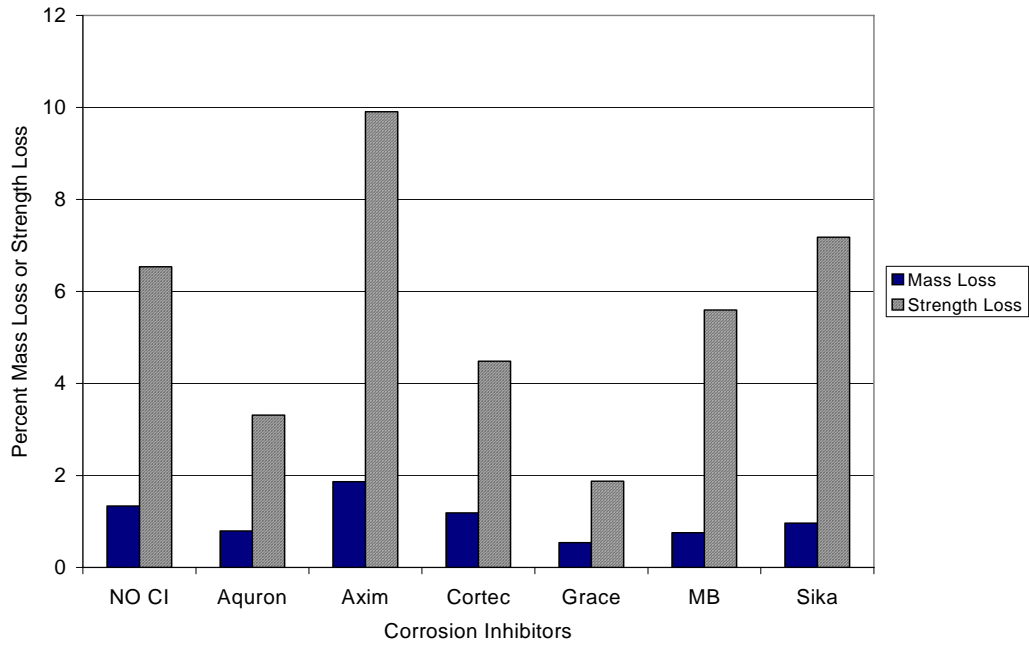

Figure G.50 – Mass Loss and Strength Loss for Chamber Shelf 1, 0.0% Chloride, Post-Cracked

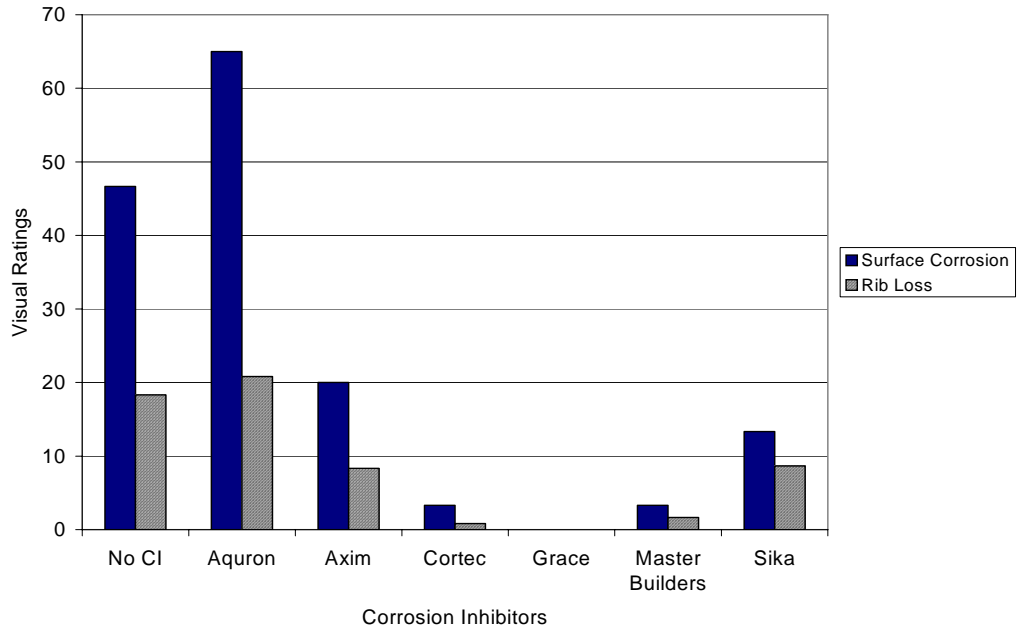

Figure G.51 – Visual Ratings for Chamber Shelf 1, 0.5% Chloride, Post-Cracked

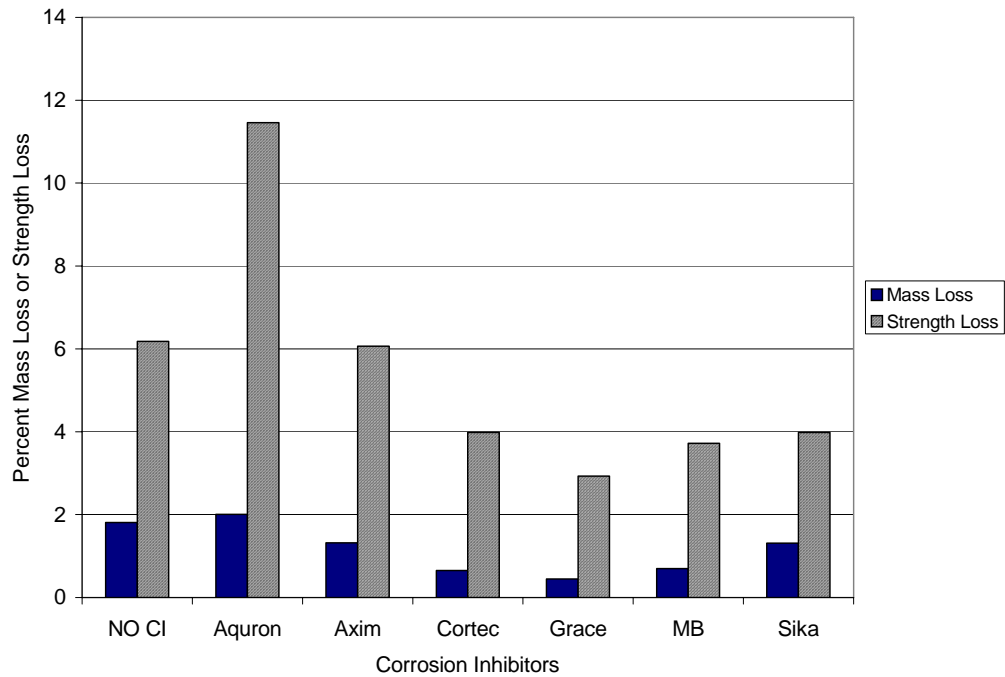

Figure G.52 – Mass Loss and Strength Loss for Chamber Shelf 1, 0.5% Chloride, Post-Cracked

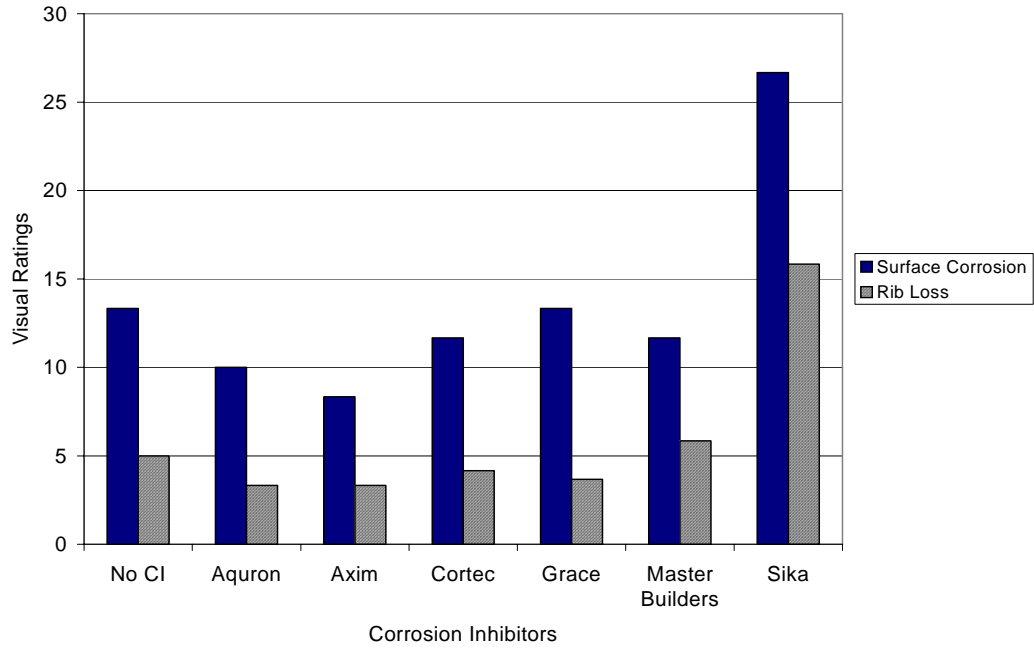

Figure G.53 – Visual Ratings for Chamber Shelf 1, 1.0% Chloride, Post-Cracked

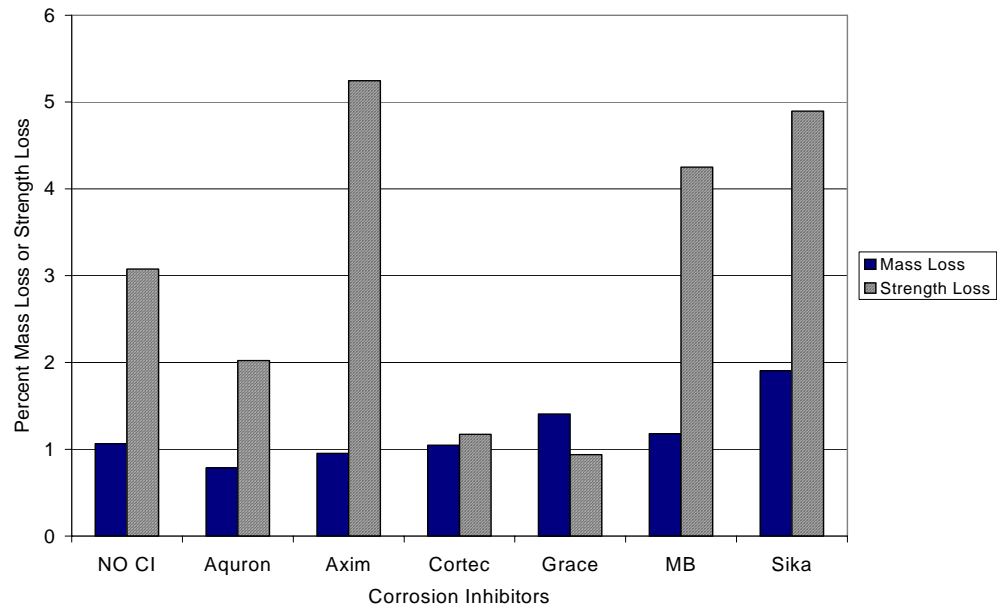

Figure G.54 – Mass Loss and Strength Loss for Chamber Shelf 1, 1.0% Chloride, Post-Cracked

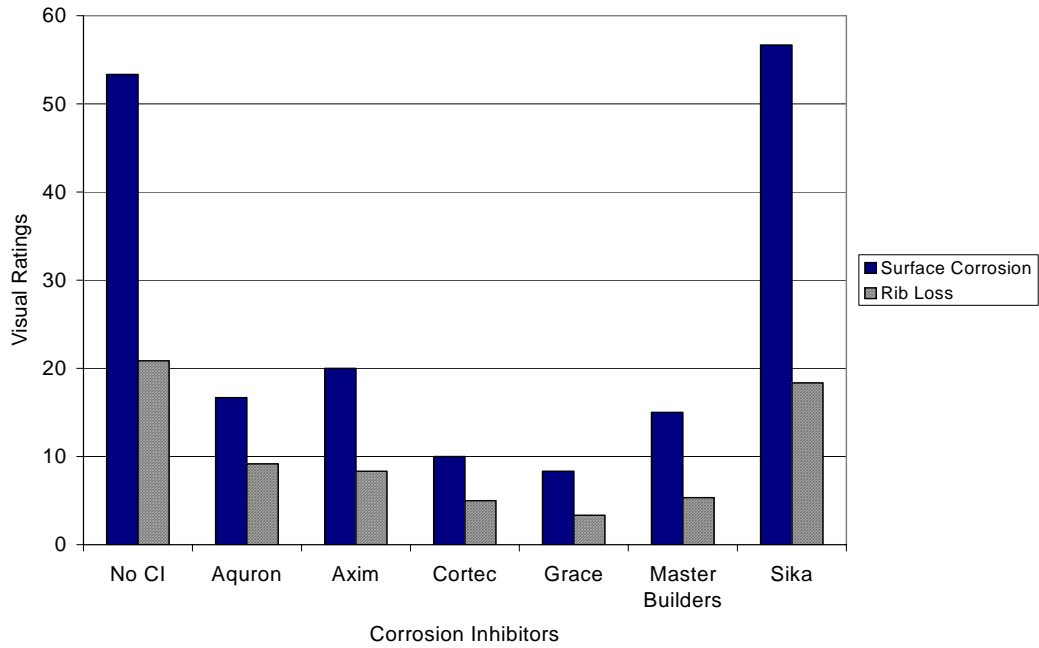

Figure G.55 – Visual Ratings for Chamber Shelf 1, 1.5% Chloride, Post-Cracked

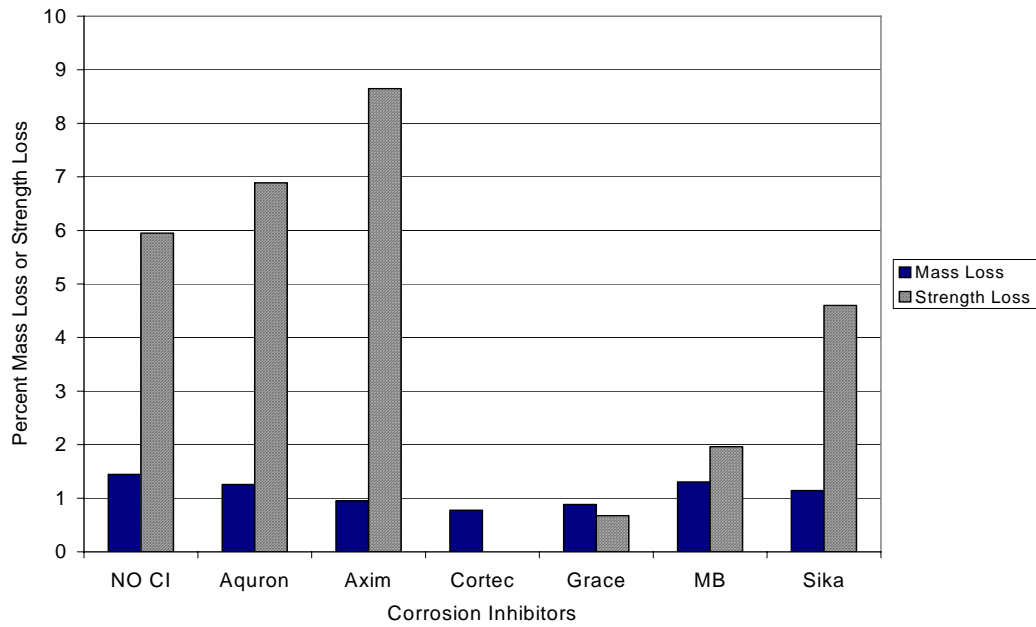

Figure G.56 – Mass Loss and Strength Loss for Chamber Shelf 1, 1.5% Chloride, Post-Cracked

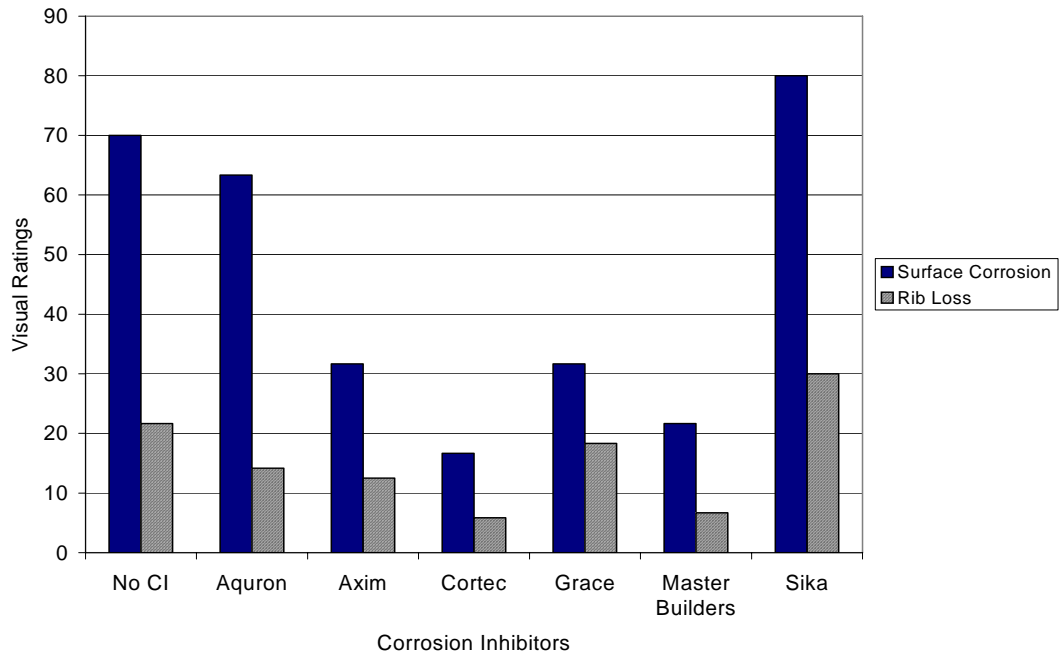

Figure G.57 – Visual Ratings for Chamber Shelf 1, 2.0% Chloride, Post-Cracked

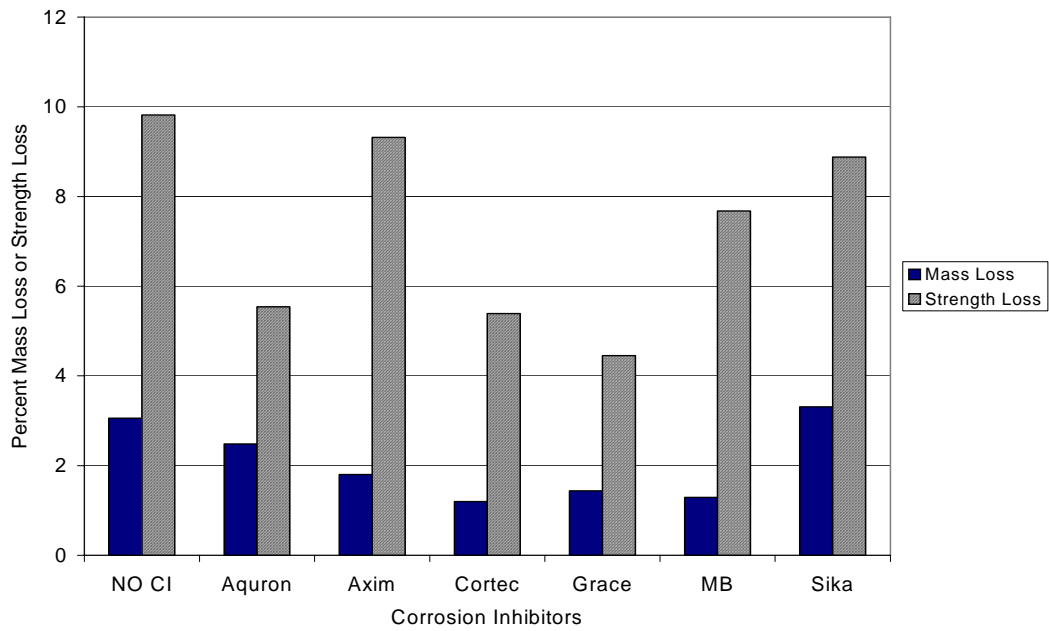

Figure G.58 – Mass Loss and Strength Loss for Chamber Shelf 1, 2.0% Chloride, Post-Cracked

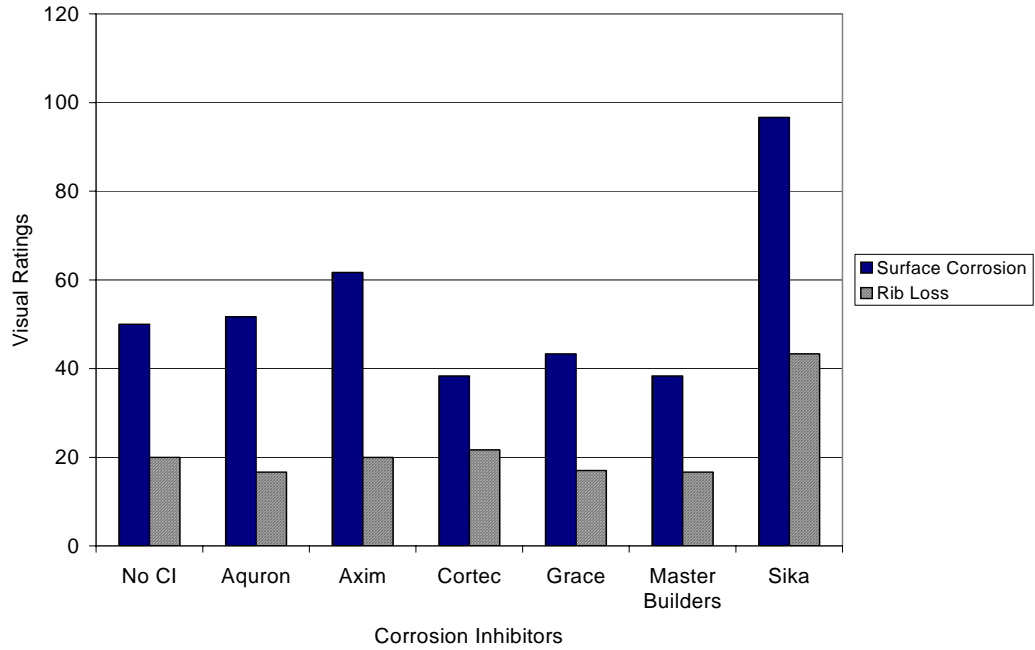

Figure G.59 – Visual Ratings for Chamber Shelf 1, 3.0% Chloride, Post-Cracked

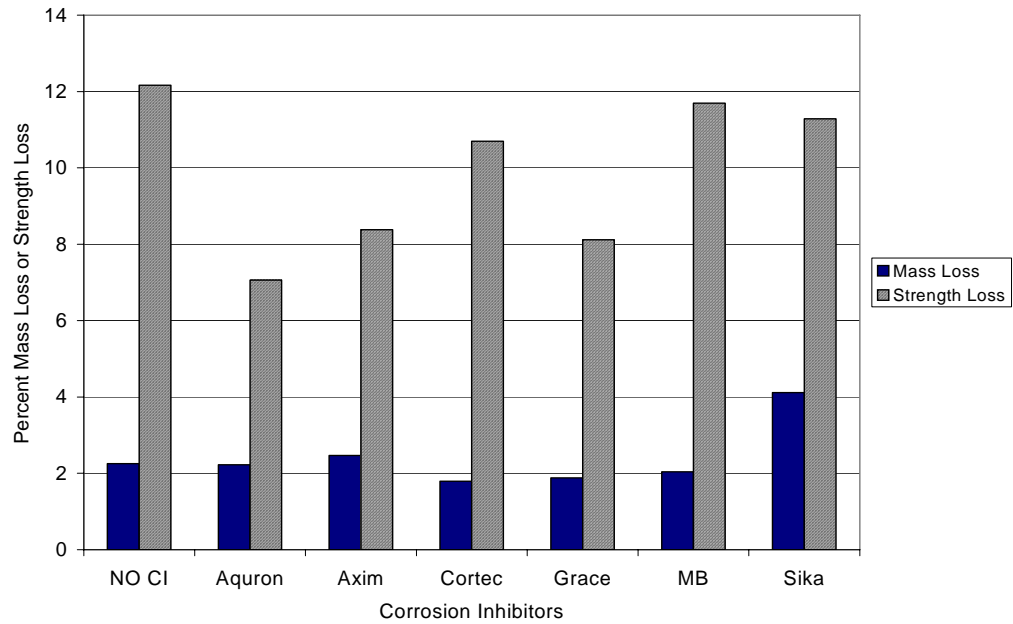

Figure G.60 – Mass Loss and Strength Loss for Chamber Shelf 1, 3.0% Chloride, Post-Cracked

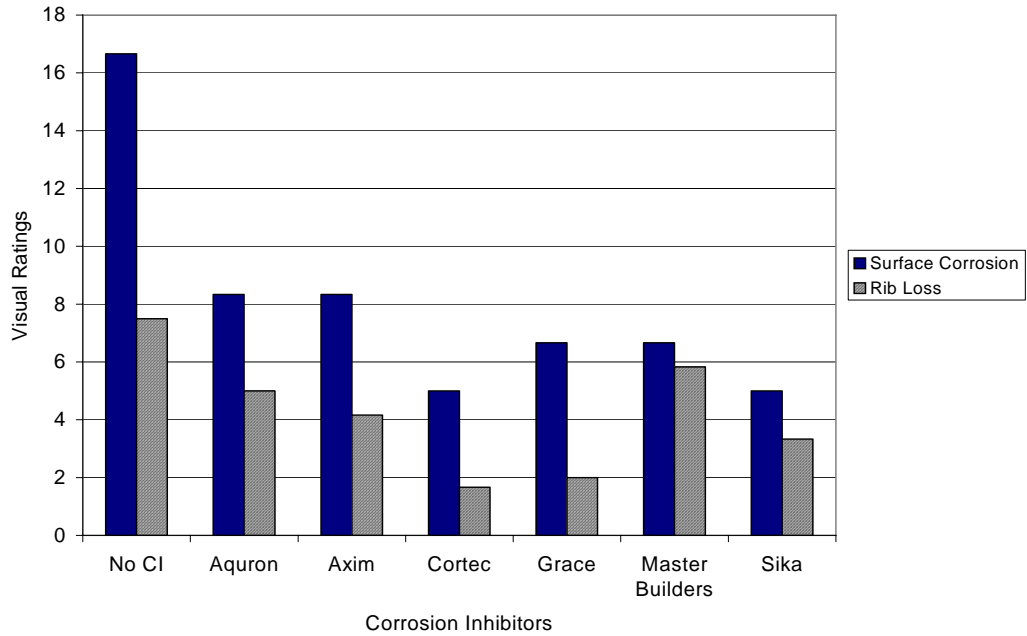

Figure G.61 – Visual Ratings for Chamber Shelf 2, 0.0% Chloride, Pre-Cracked

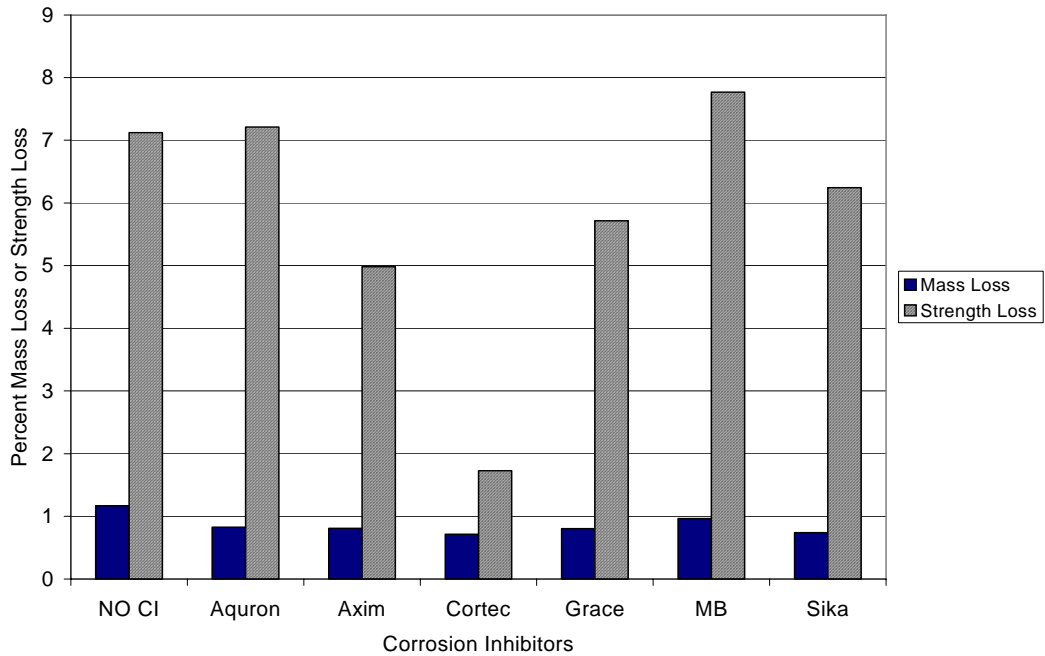

Figure G.62 – Mass Loss and Strength Loss for Chamber Shelf 2, 0.0% Chloride, Pre-Cracked

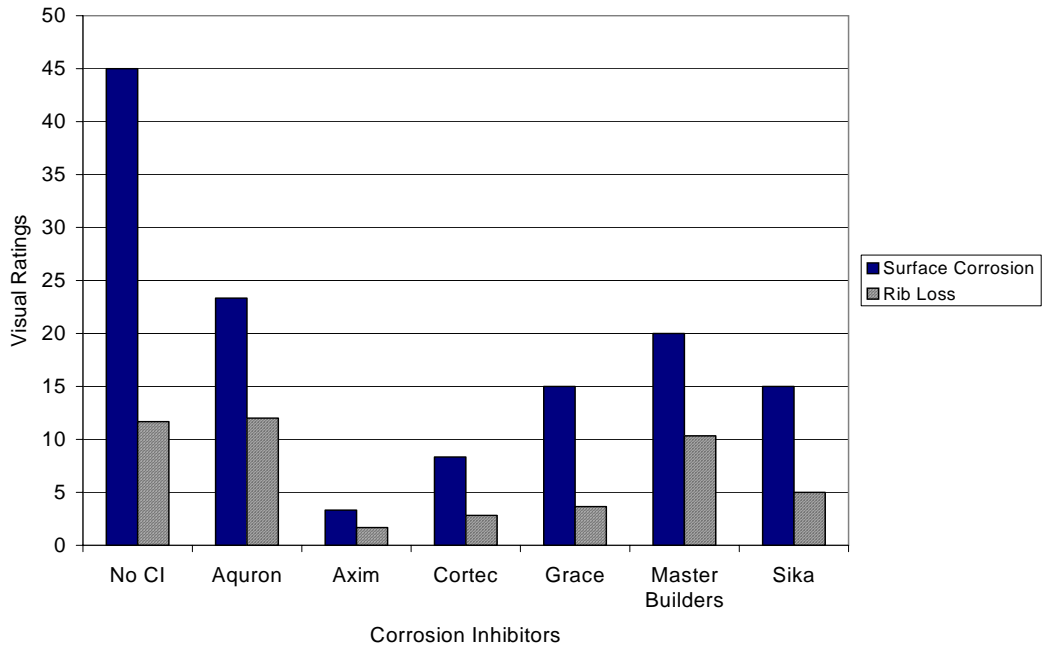

Figure G.63 – Visual Ratings for Chamber Shelf 2, 0.5% Chloride, Pre-Cracked

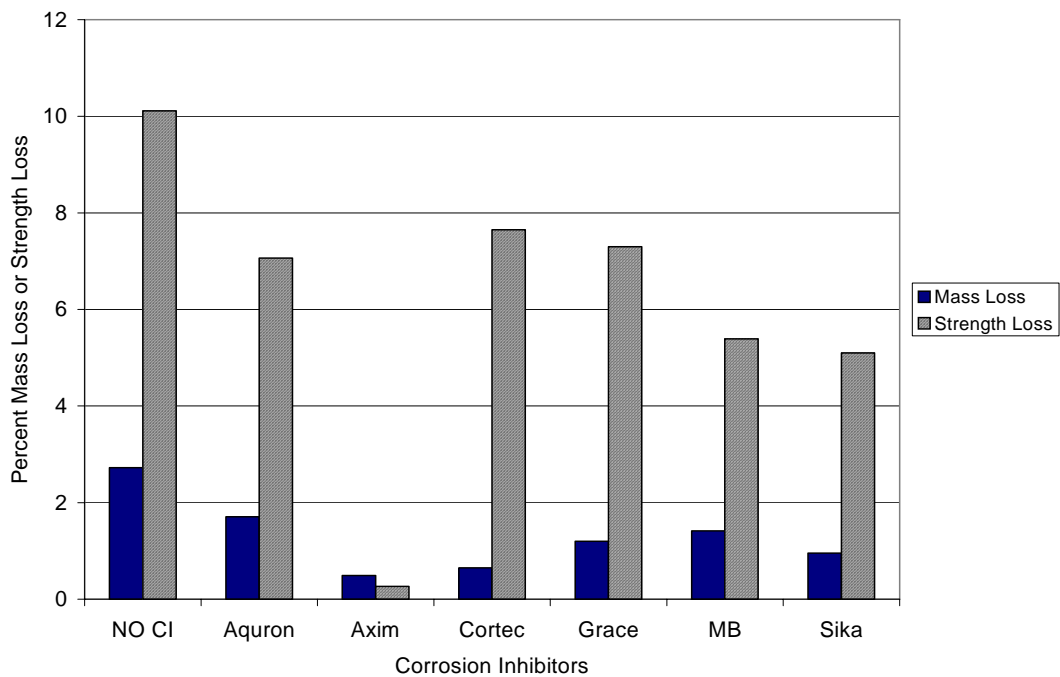

Figure G.64 – Mass Loss and Strength Loss for Chamber Shelf 2, 0.5% Chloride, Pre-Cracked

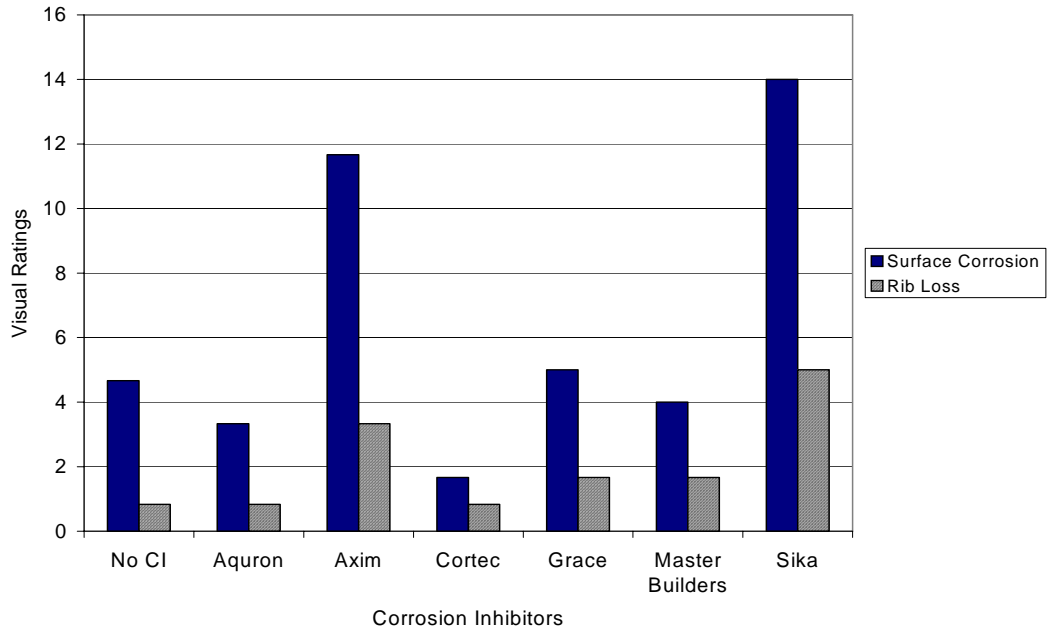

Figure G.65– Visual Ratings for Chamber Shelf 2, 1.0% Chloride, Pre-Cracked

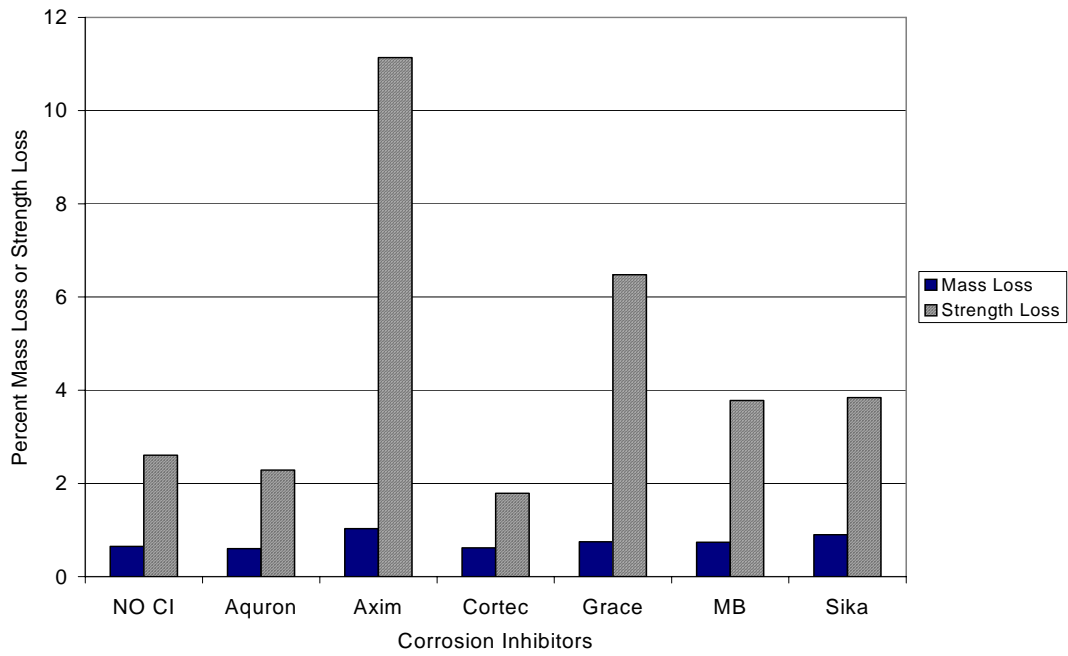

Figure G.66 – Mass Loss and Strength Loss for Chamber Shelf 2, 1.0% Chloride, Pre-Cracked

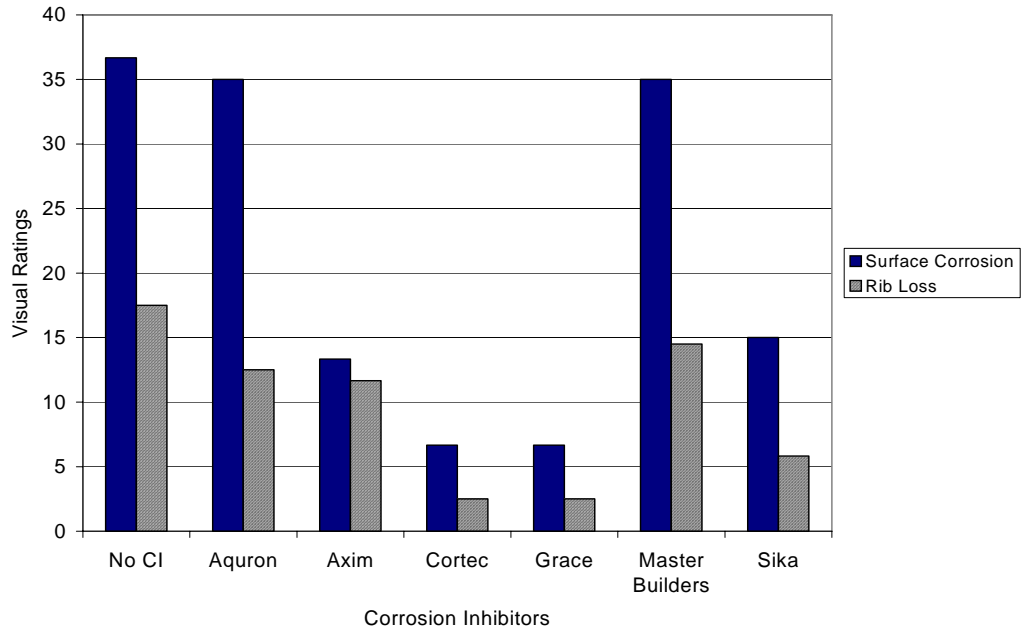

Figure G.67 – Visual Ratings for Chamber Shelf 2, 1.5% Chloride, Pre-Cracked

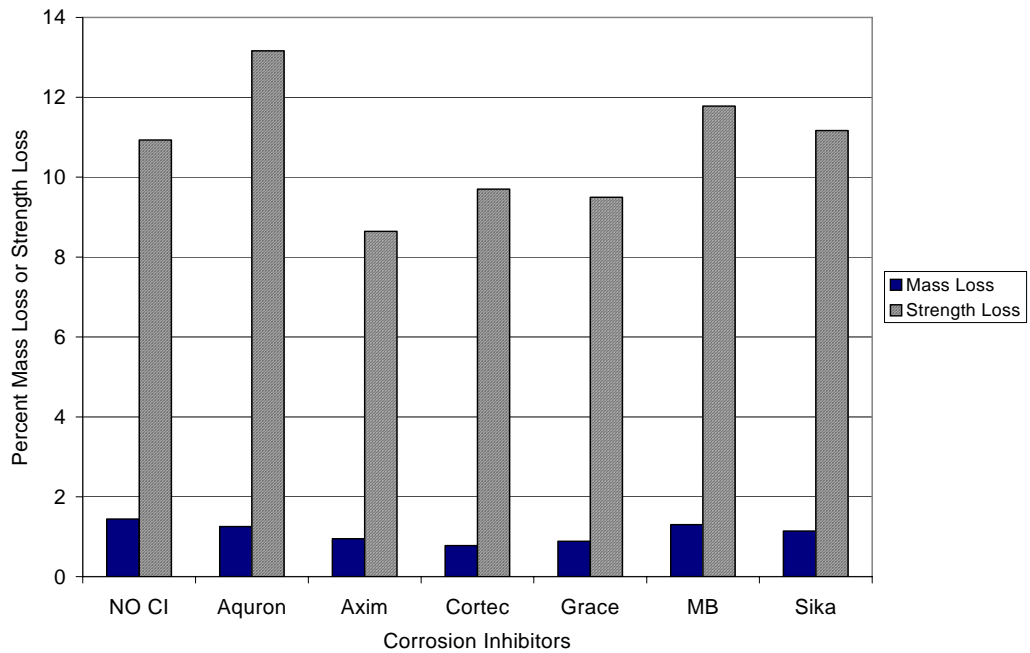

Figure G.68 – Mass Loss and Strength Loss for Chamber Shelf 2, 1.5% Chloride, Pre-Cracked

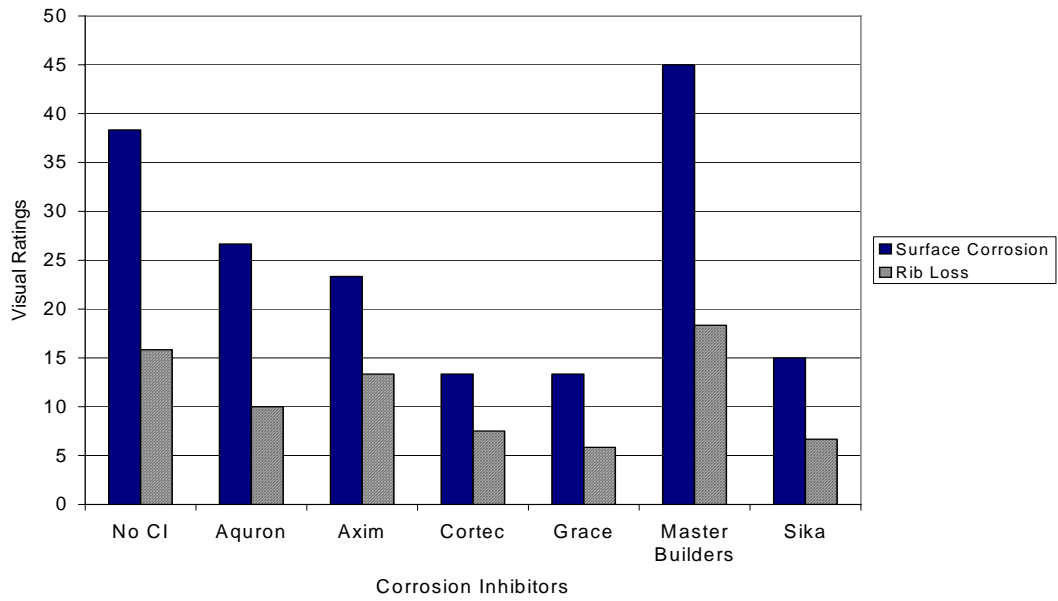

Figure G.69– Visual Ratings for Chamber Shelf 2, 2.0% Chloride, Pre-Cracked

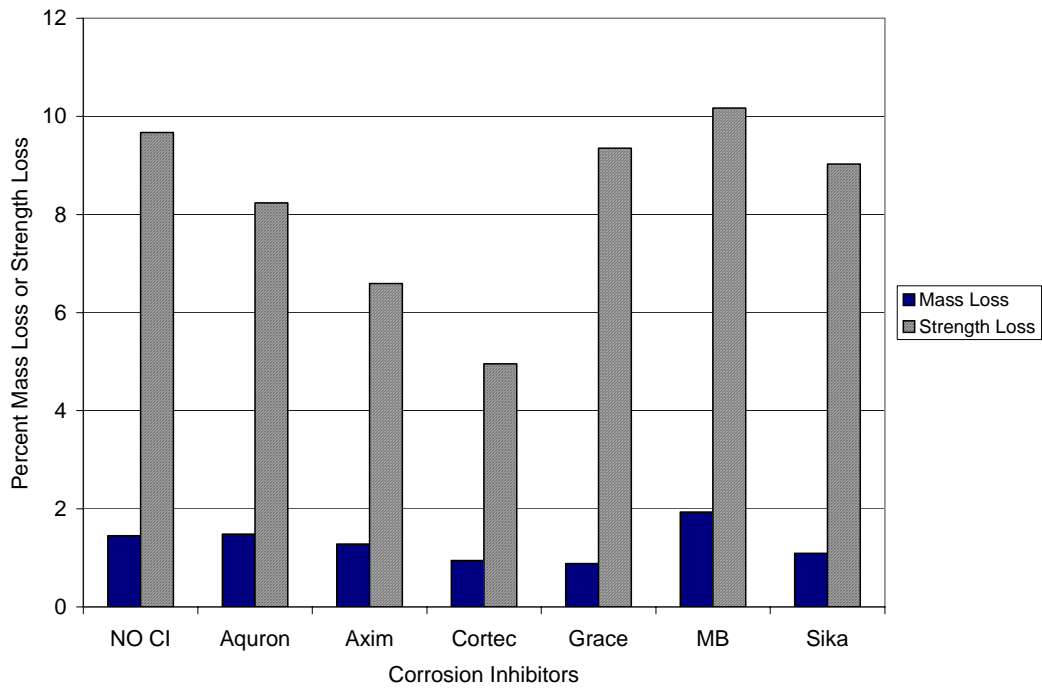

Figure G.70 – Mass Loss and Strength Loss for Chamber Shelf 2, 2.0% Chloride, Pre-Cracked

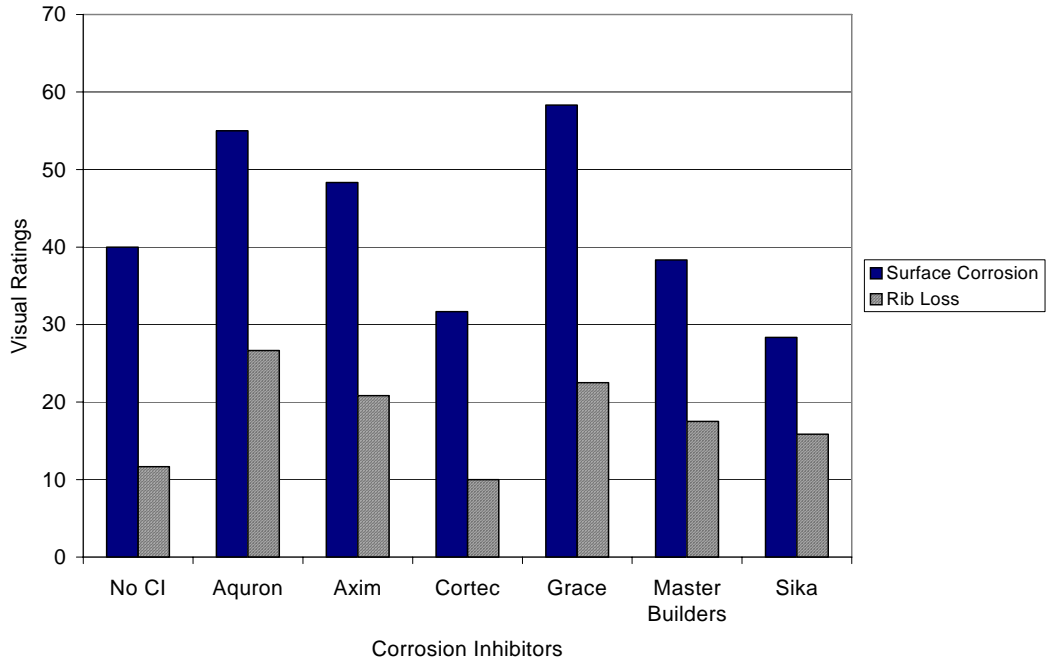

Figure G.71 – Visual Ratings for Chamber Shelf 2, 3.0% Chloride, Pre-Cracked

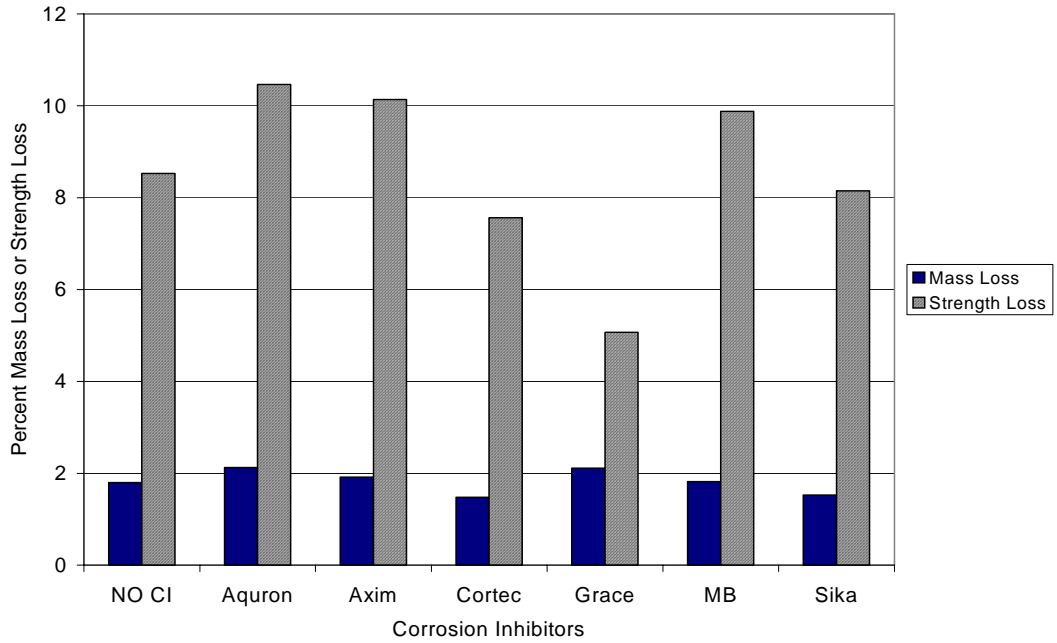

Figure G.72 – Mass Loss and Strength Loss for Chamber Shelf 2, 3.0% Chloride, Pre-Cracked

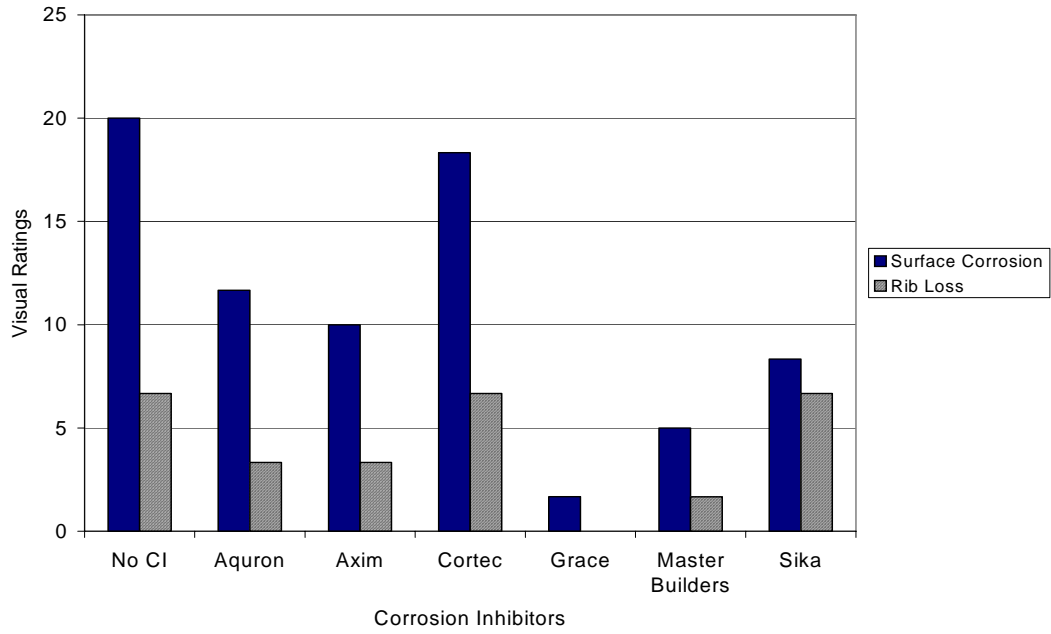

Figure G.73 – Visual Ratings for Chamber Shelf 3, 0.0% Chloride, Post-Cracked

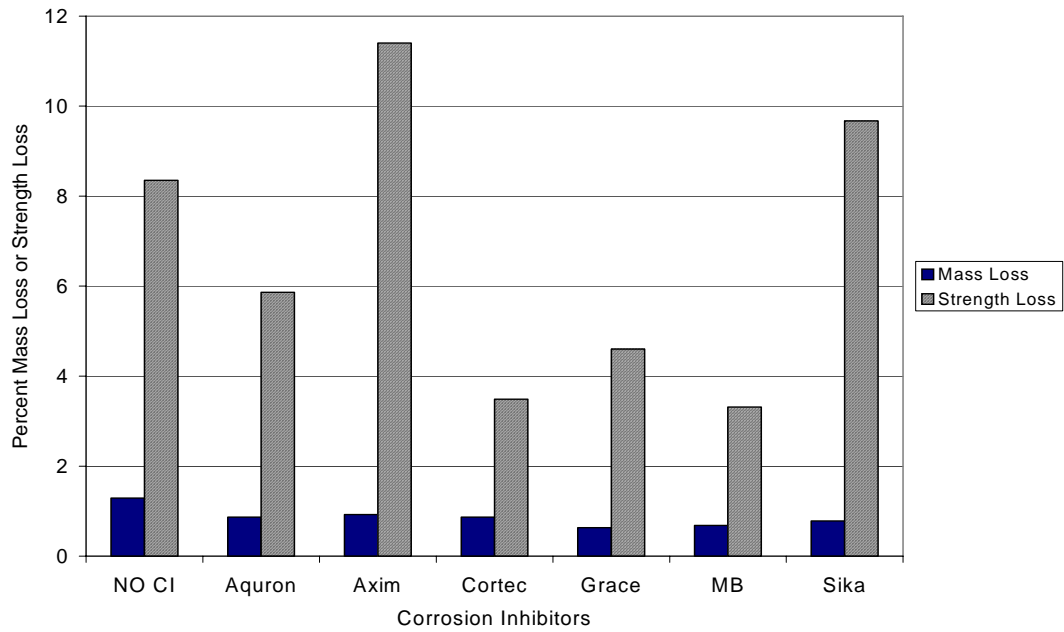

Figure G.74 – Mass Loss and Strength Loss for Chamber Shelf 3, 0.0% Chloride, Post-Cracked

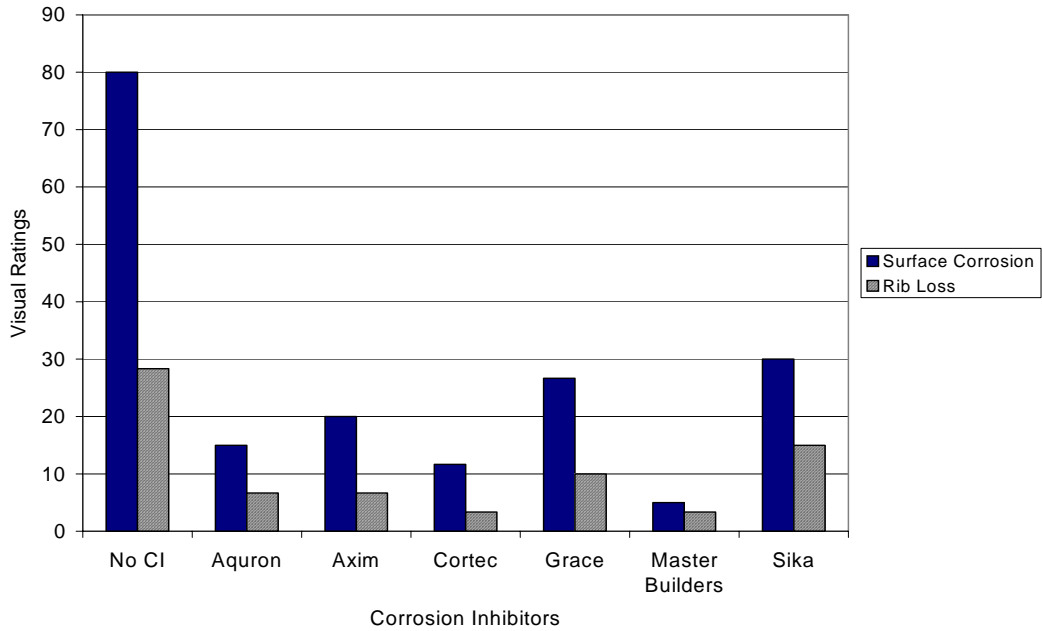

Figure G.75 – Visual Ratings for Chamber Shelf 3, 0.5% Chloride, Post-Cracked

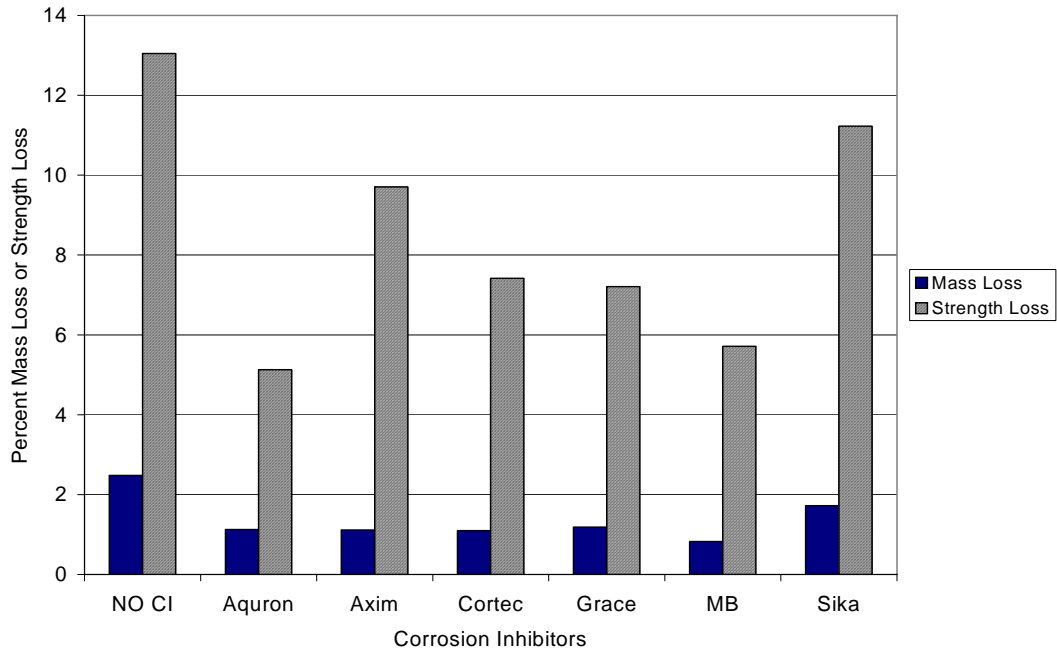

Figure G.76 – Mass Loss and Strength Loss for Chamber Shelf 3, 0.5% Chloride, Post-Cracked

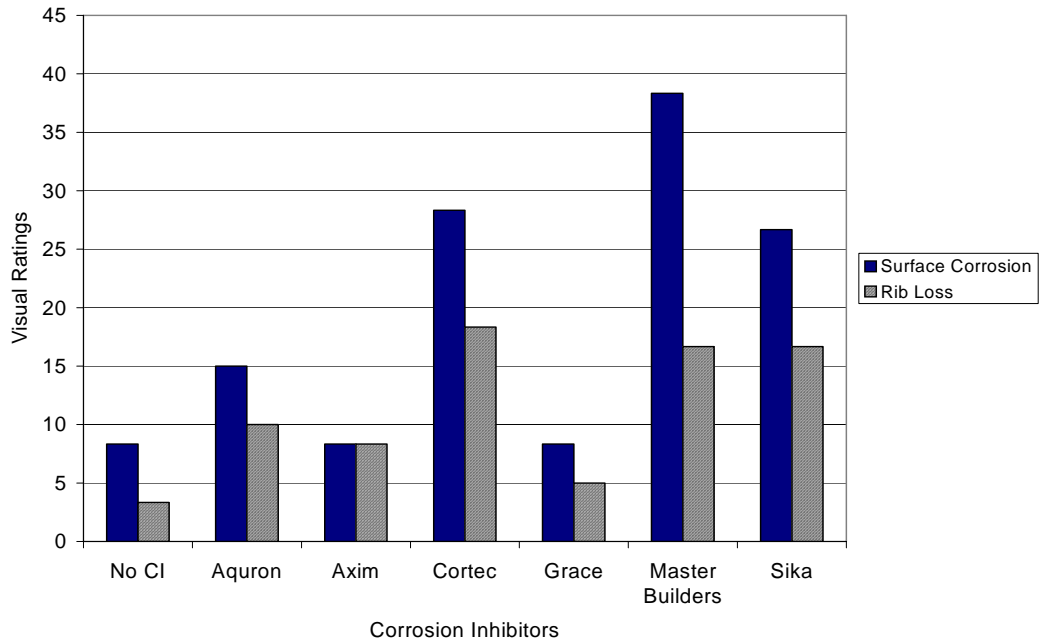

Figure G.77 – Visual Ratings for Chamber Shelf 3, 1.0% Chloride, Post-Cracked

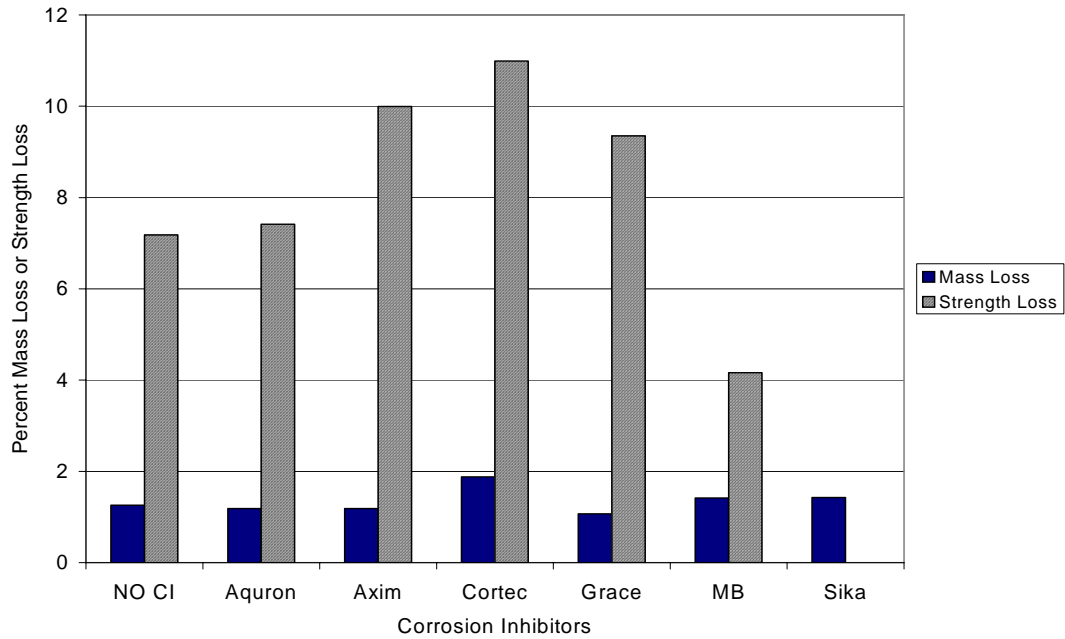

Figure G.78 – Mass Loss and Strength Loss for Chamber Shelf 3, 1.0% Chloride, Post-Cracked

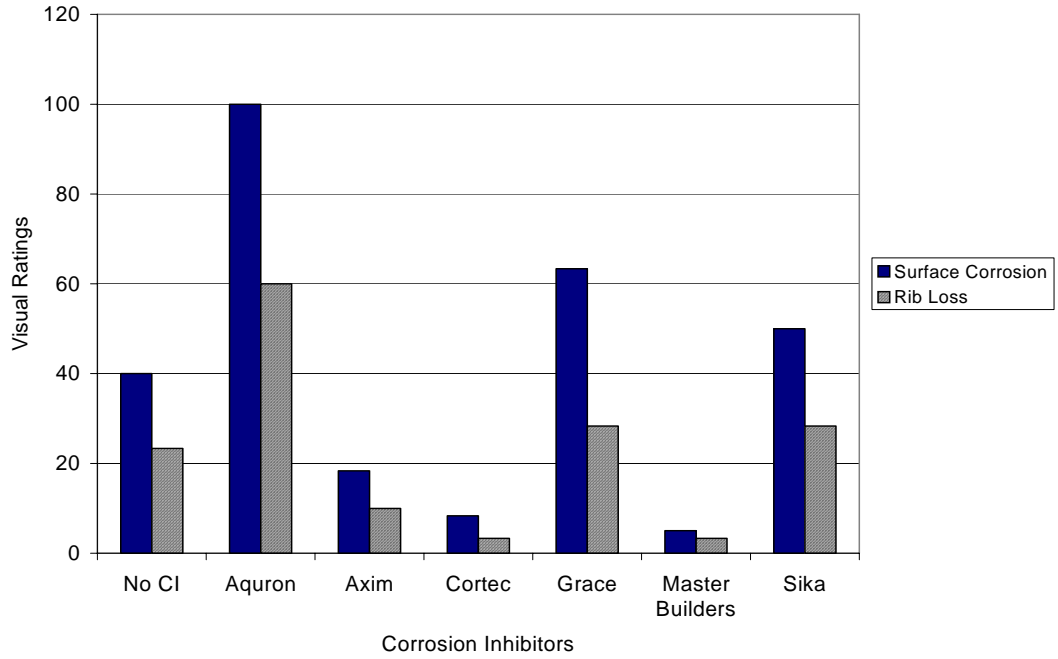

Figure G.79 – Visual Ratings for Chamber Shelf 3, 1.5% Chloride, Post-Cracked

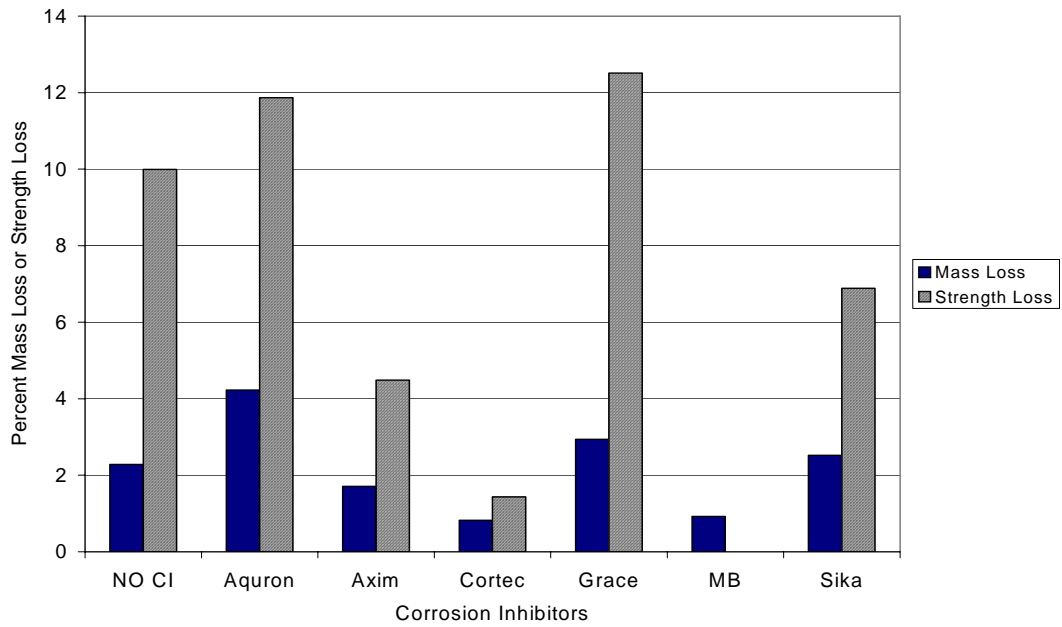

Figure G.80 – Mass Loss and Strength Loss for Chamber Shelf 3, 1.5% Chloride, Post-Cracked

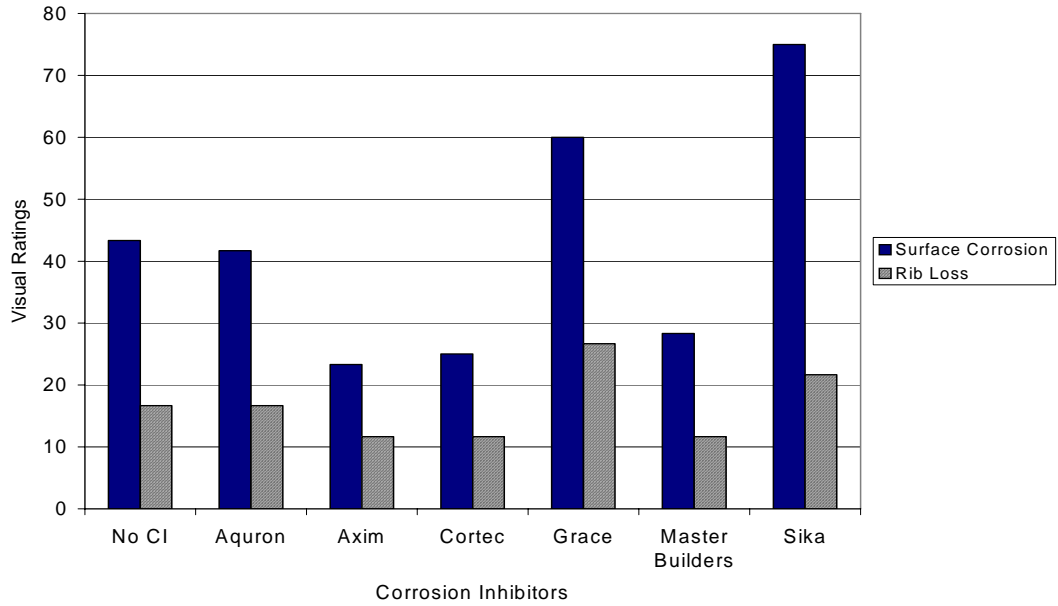

Figure G.81 – Visual Ratings for Chamber Shelf 3, 2.0% Chloride, Post-Cracked

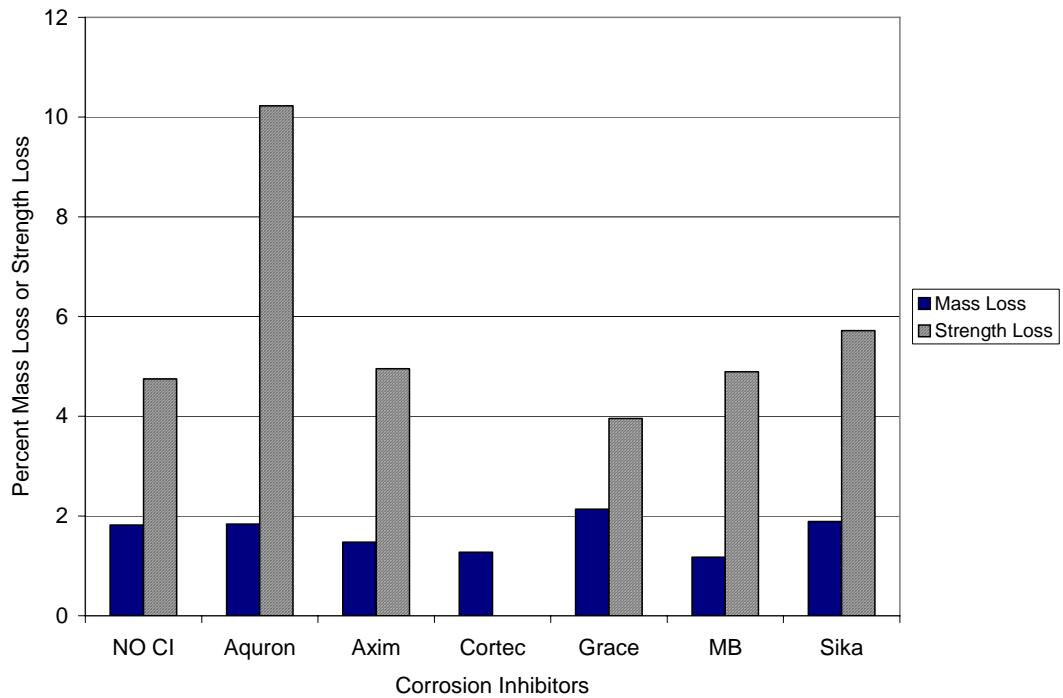

Figure G.82 – Mass Loss and Strength Loss for Chamber Shelf 3, 2.0% Chloride, Post-Cracked

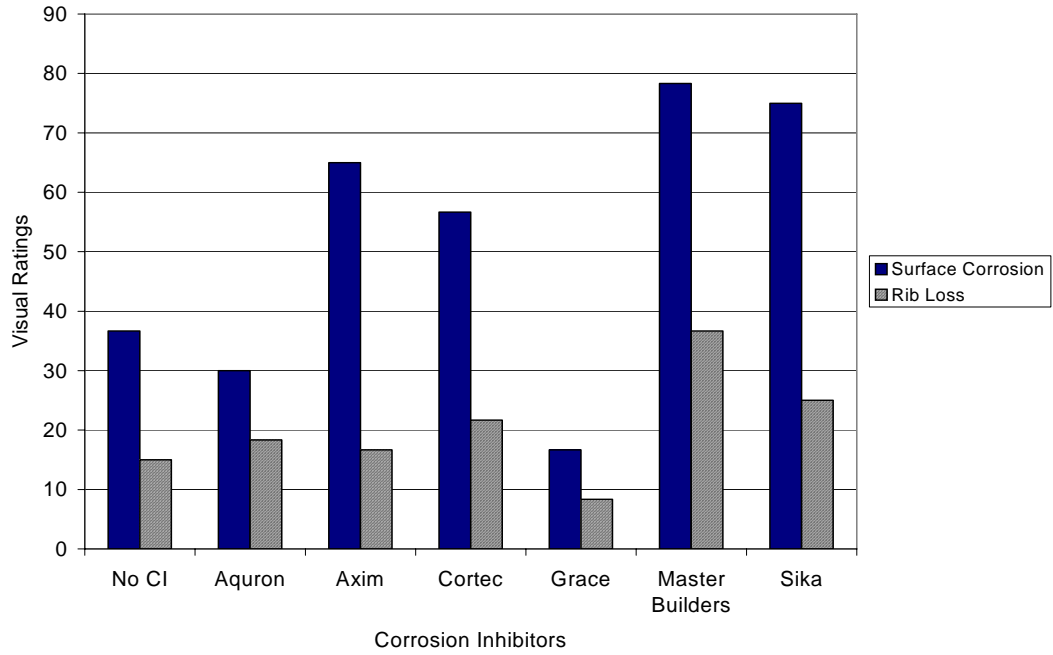

Figure G.83 – Visual Ratings for Chamber Shelf 3, 3.0% Chloride, Post-Cracked

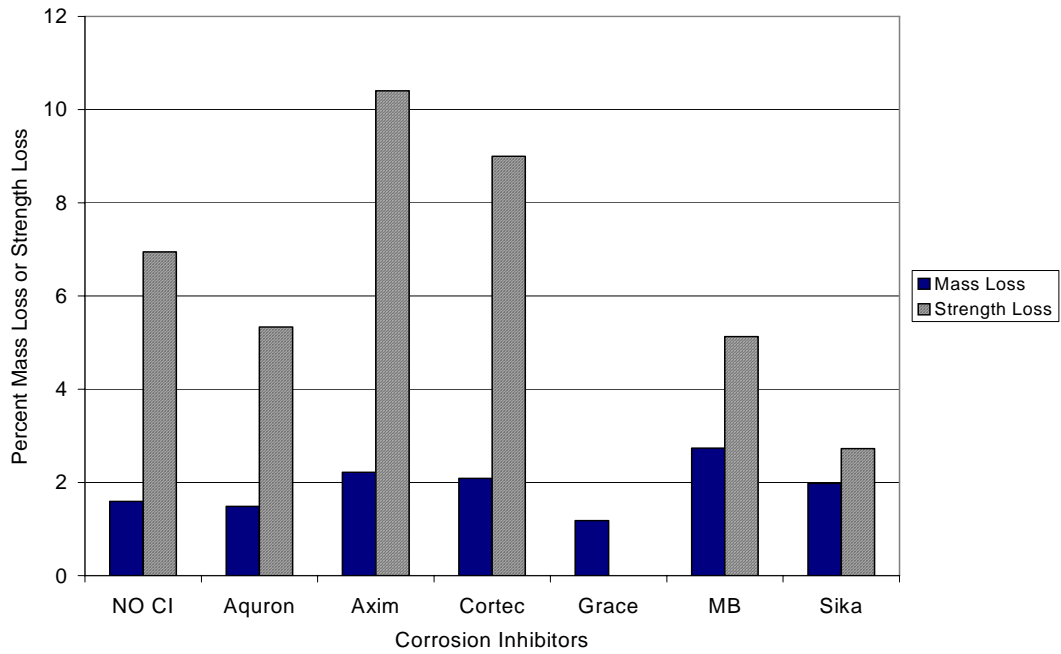

Figure G.84 – Mass Loss and Strength Loss for Chamber Shelf 3, 3.0% Chloride, Post-Cracked

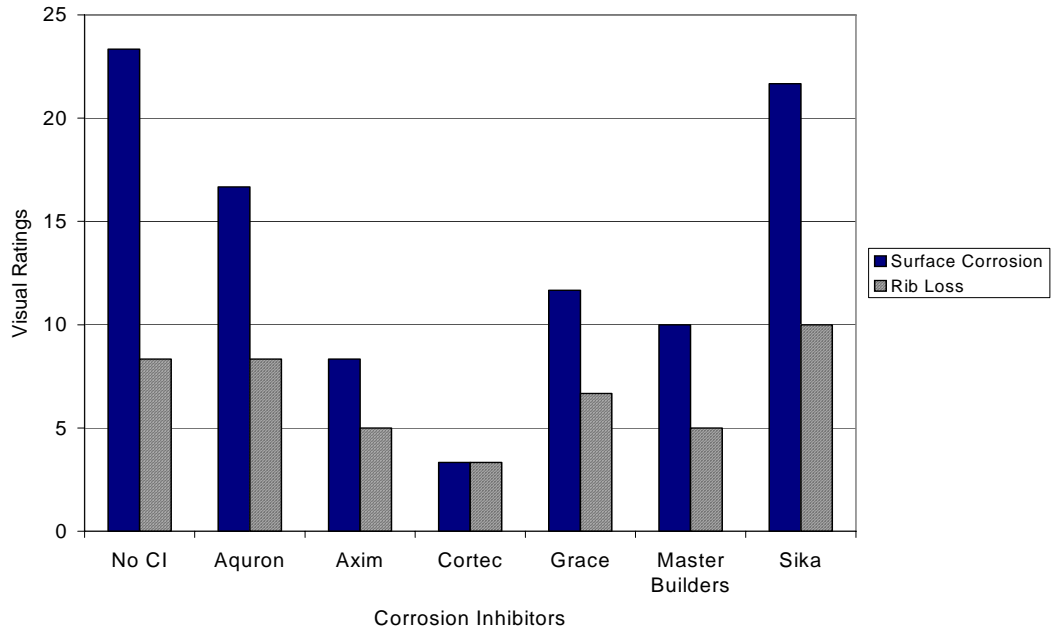

Figure G.85 – Visual Ratings for Chamber Shelf 4, 0.0% Chloride, Pre-Cracked

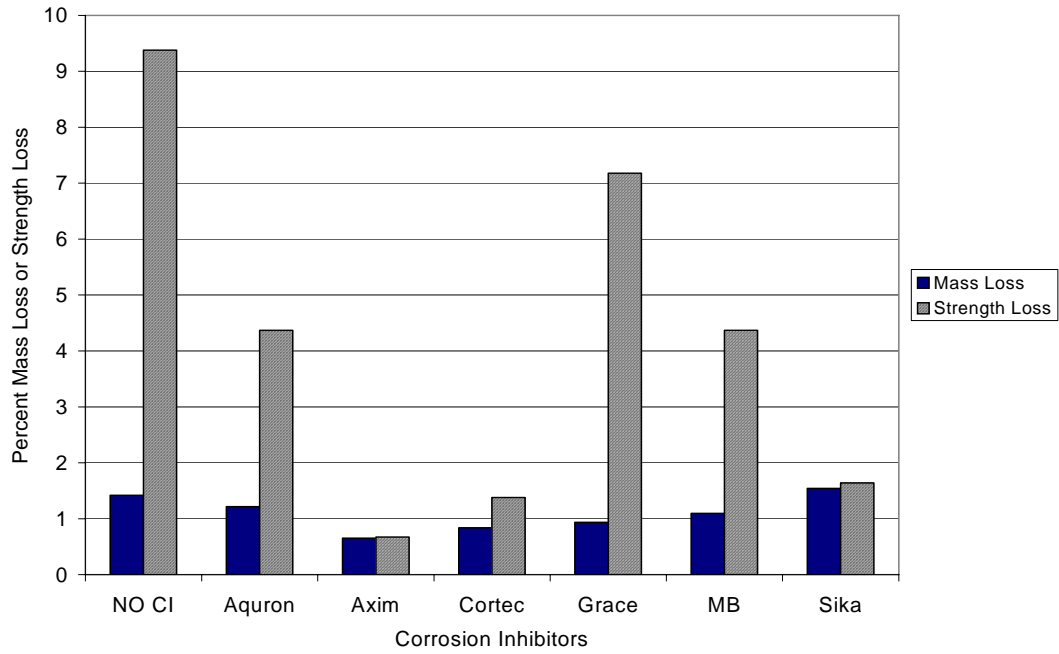

Figure G.86 – Mass Loss and Strength Loss for Chamber Shelf 4, 0.0% Chloride, Pre-Cracked

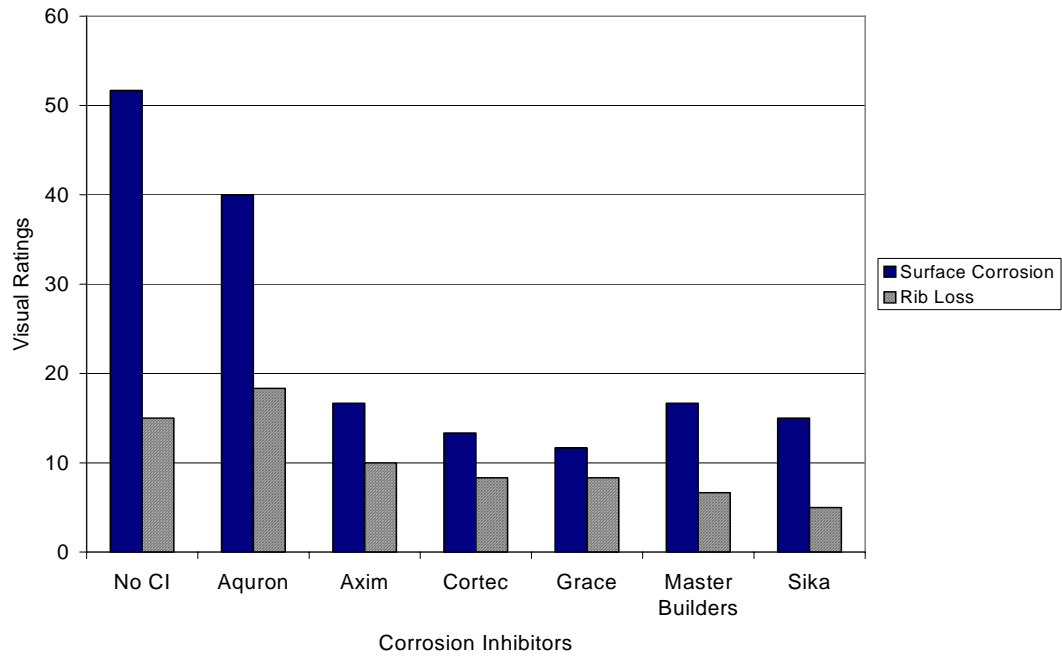

Figure G.87 – Visual Ratings for Chamber Shelf 4, 0.5% Chloride, Pre-Cracked

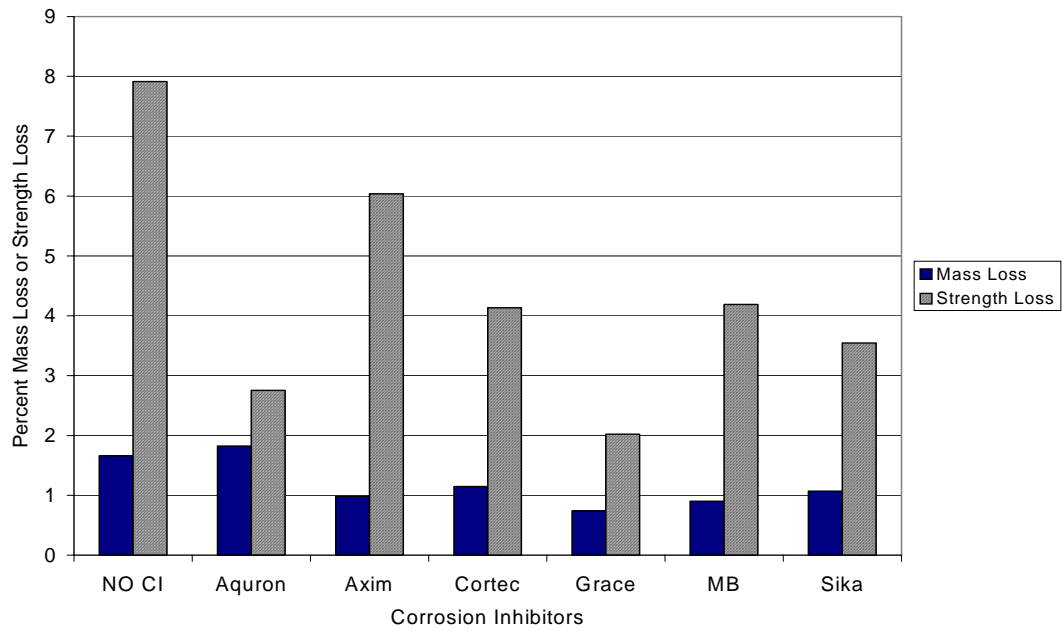

Figure G.88 – Mass Loss and Strength Loss for Chamber Shelf 4, 0.5% Chloride, Pre-Cracked

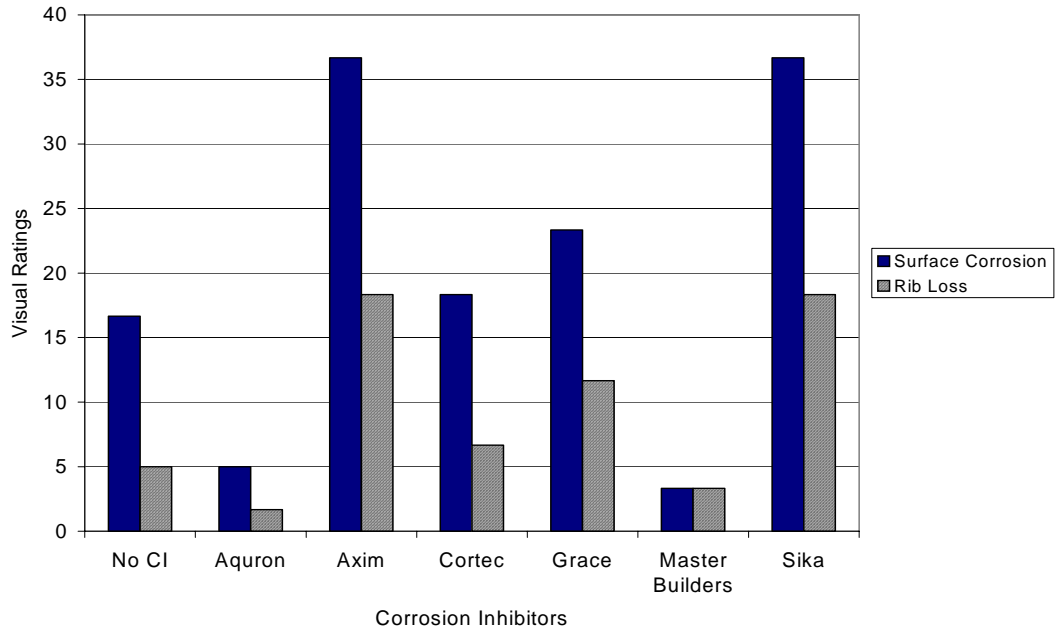

Figure G.89 – Visual Ratings for Chamber Shelf 4, 1.0% Chloride, Pre-Cracked

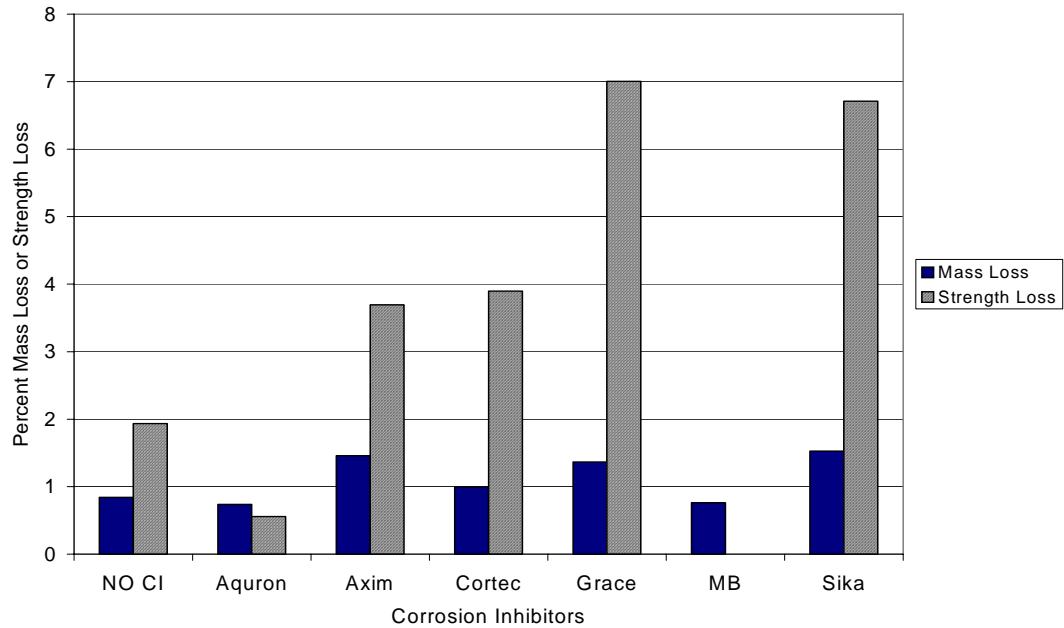

Figure G.90 – Mass Loss and Strength Loss for Chamber Shelf 4, 1.0% Chloride, Pre-Cracked

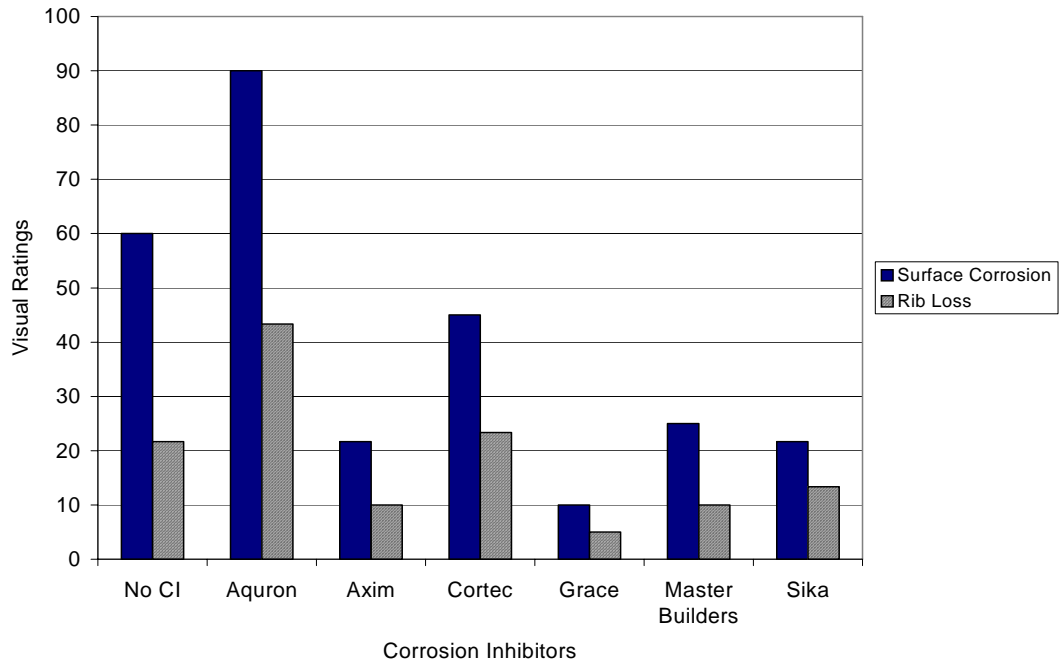

Figure G.91 – Visual Ratings for Chamber Shelf 4, 1.5% Chloride, Pre-Cracked

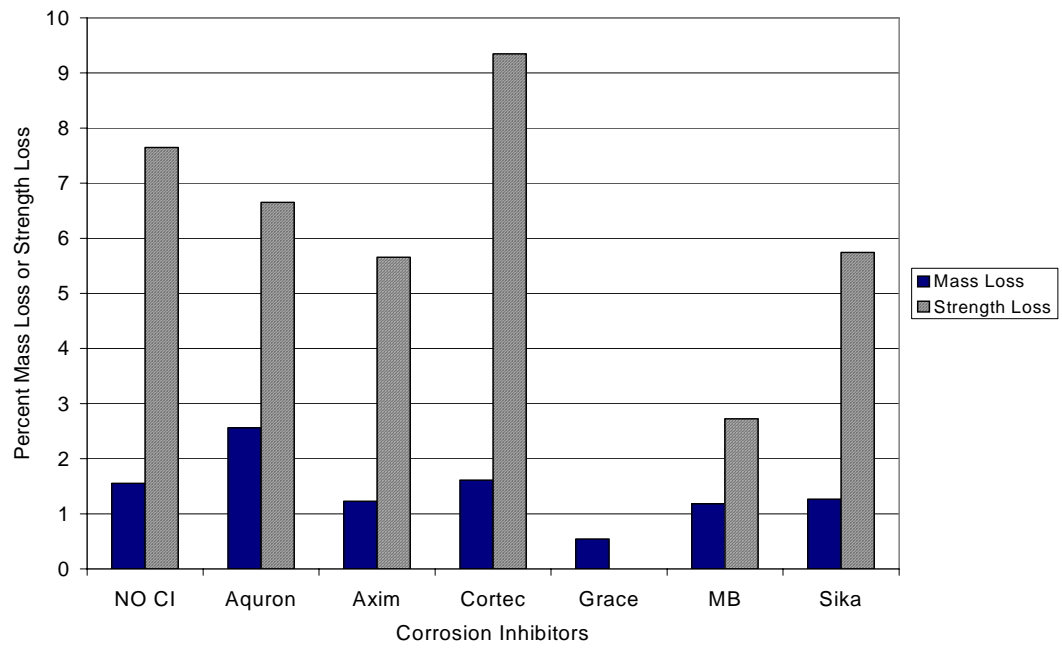

Figure G.92 – Mass Loss and Strength Loss for Chamber Shelf 4, 1.5% Chloride, Pre-Cracked

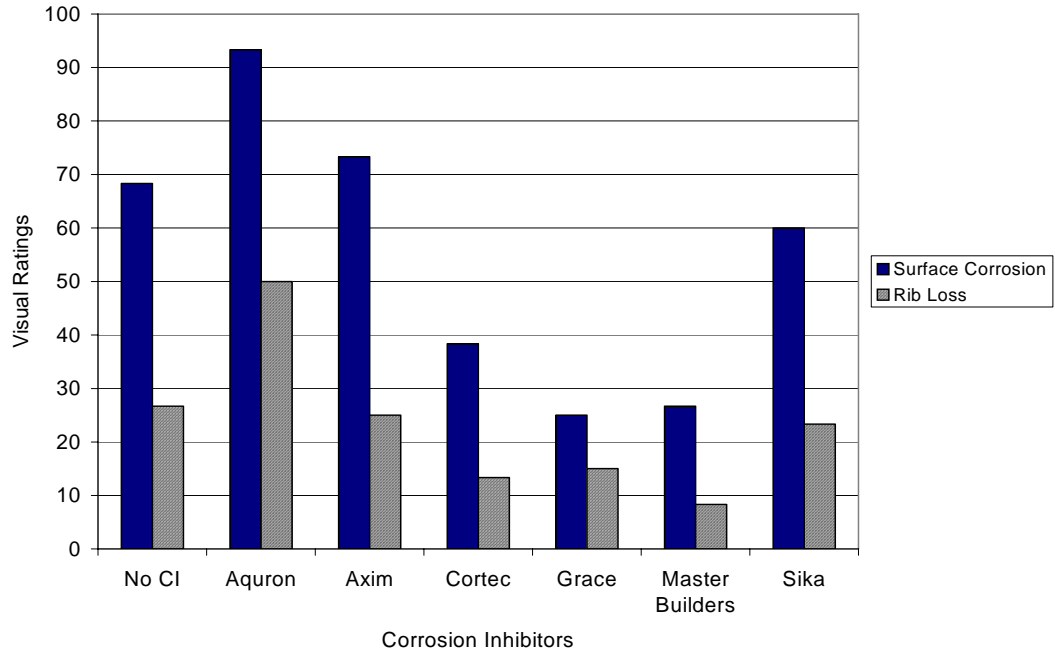

Figure G.93 – Visual Ratings for Chamber Shelf 4, 2.0% Chloride, Pre-Cracked

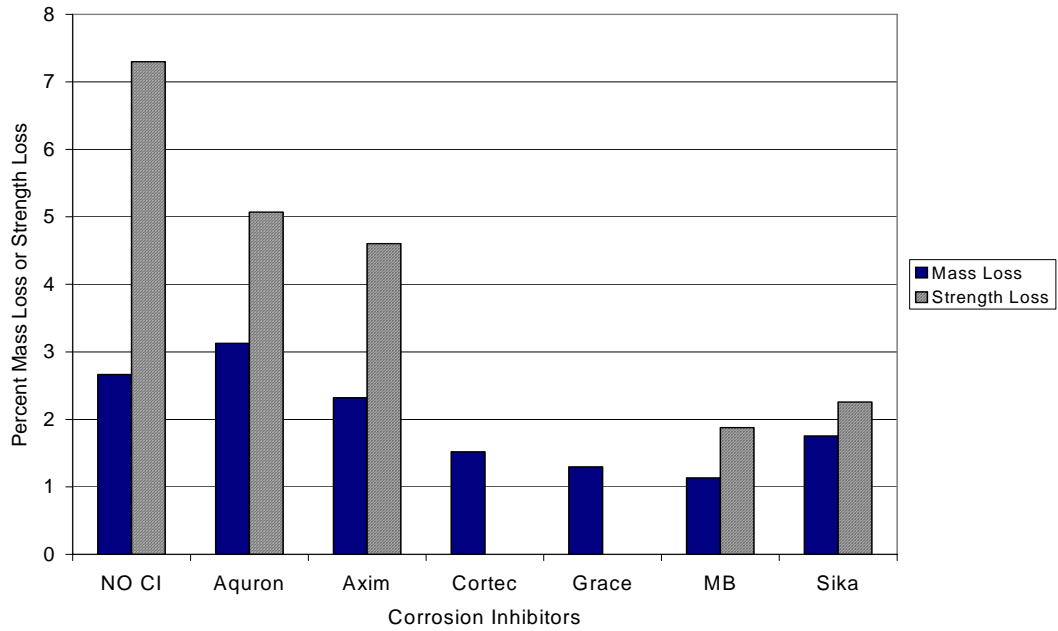

Figure G.94 – Mass Loss and Strength Loss for Chamber Shelf 4, 2.0% Chloride, Pre-Cracked

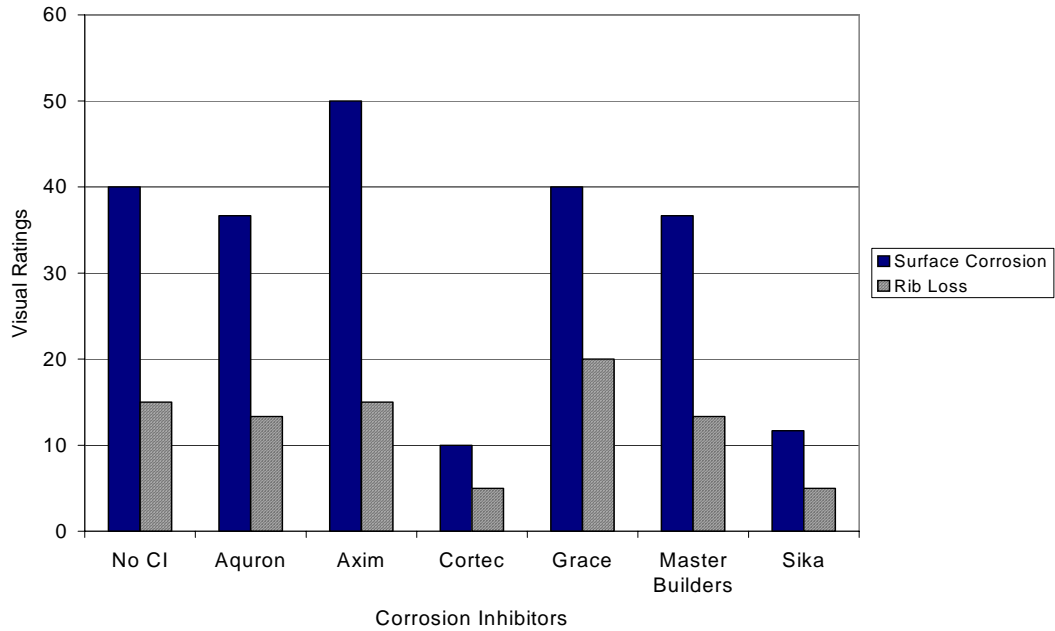

Figure G.95 – Visual Ratings for Chamber Shelf 4, 3.0% Chloride, Pre-Cracked

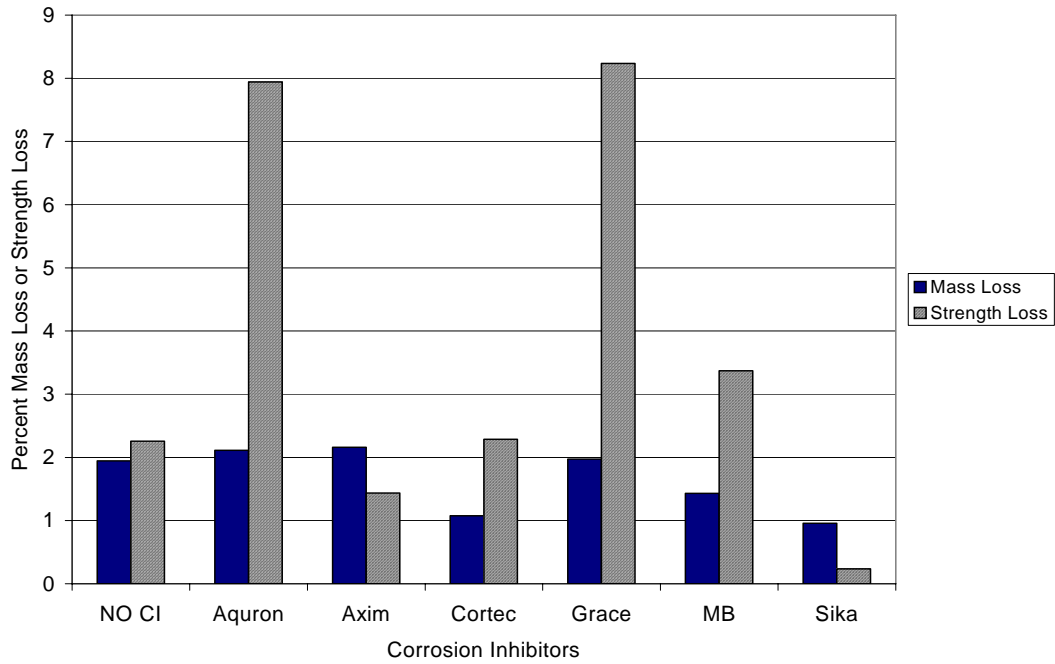

Figure G.96 – Mass Loss and Strength Loss for Chamber Shelf 4, 3.0% Chloride, Pre-Cracked