



TEXAS TECH UNIVERSITY

Multidisciplinary Research in Transportation

Develop a New Testing and Evaluation Protocol to Assess Flexbase Performance Using Strength of Soil Binder

Priyantha W. Jayawickrama, Michael E. Merrick, Sanjaya P. Senadheera

Performed in Cooperation with the Texas Department of Transportation
and the Federal Highway Administration

Research Project 0-5873
Research Report 0-5873-1
<http://www.techmrt.ttu.edu/reports.php>

NOTICE

The United States Government and the State of Texas do not endorse products or manufacturers. Trade or manufacturers' names appear herein solely because they are considered essential to the object of this report

Technical Report Documentation Page

1. Report No.: FHWA/TX – 08-0-5873-1	2. Government Accession No.:	3. Recipient's Catalog No.:	
4. Title and Subtitle: Develop a New Testing and Evaluation Protocol to Assess Flexbase Performance Using Strength of Soil Binder		5. Report Date:	
		6. Performing Organization Code: TechMRT	
7. Author(s): Priyantha W. Jayawickrama, Michael E. Merrick and Sanjaya P. Senadheera		8. Performing Organization Report No. 0-5873-1	
9. Performing Organization Name and Address: Texas Tech University College of Engineering Box 41023 Lubbock, Texas 79409-1023		10. Work Unit No. (TRAIS):	
		11. Contract or Grant No. : Project 0-5873	
12. Sponsoring Agency Name and Address Texas Department of Transportation Research and Technology Implementation Office P. O. Box 5080 Austin, TX 78763-5080		13. Type of Report and Period Cover: Technical Report April 2007 - August 2008	
		14. Sponsoring Agency Code:	
15. Supplementary Notes: This study was conducted in cooperation with the Texas Department of Transportation and the Federal Highway Administration			
15. Abstract This research involved a detailed laboratory study of a new test method for evaluating road base materials based on the strength of the soil binder. In this test method, small test specimens (5.0in length and 0.75in square cross section) of binder material are load tested to obtain a flexural strength value. The laboratory study conducted in this research included material collected from 19 different sources. The results from the study demonstrated that good correlation can be established between the binder strength and 0-psi Texas Triaxial strength for certain types of base materials such as crushed limestone and materials treated with cement or flyash. However, the test method could not be used to measure the flexural strengths of many sand and gravel materials because these materials did not produce consistent data. The data obtained from repeatability analyses provided an average Coefficient of Variation (COV) of 12.6% for the base binder flexometer test and a COV of 23.2% for the 0-psi Texas Triaxial Test. The research effort also included the design and fabrication of a low cost, easy-to-operate prototype test device for the measurement of binder flexural strength. The reliability of the test equipment was verified by running parallel tests using another commercially available loading device.			
17. Key Words Flexible base, Flexural strength, Texas Triaxial test, Base binder		18. Distribution Statement: No restrictions. This document is available to the public through the National Technical Information Service, Springfield, VA www.ntis.gov	
19. Security Classif. (of this report) Unclassified	20. Security Classif. (of this page) Unclassified	21. No. of Pages 122	22. Price

Form DOT F 1700.7 (8-72)

Develop a New Testing and Evaluation Protocol to Assess Flexbase Performance Using Strength of Soil Binder

By

Priyantha W. Jayawickrama, Ph.D.
Associate Professor of Civil and Environmental Engineering,
Texas Tech University

Michael Merrick, P.E.
Assistant Area Engineer, Snyder Area Office, Abilene
Texas Department of Transportation

and

Sanjaya P. Senadheera, Ph.D.
Associate Professor of Civil and Environmental Engineering,
Texas Tech University

Texas Tech University
Project Report 0-5873-1
Project Number 0-5873

Performed in Cooperation with the
Texas Department of Transportation
and the
Federal Highway Administration

Center for Multidisciplinary Research in Transportation
Department of Civil and Environmental Engineering
Texas Tech University
Box 41023
Lubbock, TX 79409-1023

February 2009

AUTHOR'S DISCLAIMER

The contents of this report reflect the views of the authors who are responsible for the facts and the accuracy of the data presented herein. The contents do not necessarily reflect the official view of policies of the Texas Department of Transportation or the Federal Highway Administration. This report does not constitute a standard, specification, or regulation.

PATENT DISCLAIMER

There was no invention or discovery conceived or first actually reduced to practice in the course of or under this contract, including any art, method, process, machine, manufacture, design or composition of matter, or any new useful improvement thereof, or any variety of plant which is or may be patentable under the patent laws of the United States of America or any foreign country.

ENGINEERING DISCLAIMER

Not intended for construction, bidding, or permit purposes.

TRADE NAMES AND MANUFACTURERS' NAMES

The United States Government and the State of Texas do not endorse products or manufacturers. Trade or manufacturers' names appear herein solely because they are considered essential to the object of this report.

ACKNOWLEDGEMENTS

The authors wish to thank the project director, Ms. Stacey Young, P.E. and project monitoring committee member, Mr. Benito Sanchez, P.E. for their guidance and assistance throughout the project. They would also like to extend their appreciation to Dr. German Claros, P.E. for his service as the project coordinator, and for his valuable suggestions for improvement of the prototype test device. We also wish to thank all TxDOT District laboratory personnel for their active participation in the project.

TABLE OF CONTENTS

Technical Documentation Page	i
Title Page	ii
Disclaimers	iii
Acknowledgements.....	iv
Table of Contents.....	v
1. INTRODUCTION	
General.....	1
Research Objectives.....	3
Report Organization.....	4
2. LITERATURE REVIEW	
Current TxDOT Practice.....	5
Flexible Base Material Test Methods	7
Texas Triaxial Test	7
Wet Ball Mill Test	11
Tube Suction Test.....	12
Flexural Strength Test.....	14
3. DEVELOPMENT OF THE CONCEPTUAL TEST PROCEDURE AND PROTOTYPE TEST DEVICE	
Development of the Conceptual Test Procedure	18
Choice of Suitable Test Specimen Dimensions	19
Determination of the Optimum Mixing Moisture Content.....	21
Sample Consolidation Procedure.....	22
Curing of the Test Specimens.....	24
Flexural Testing of the Specimens.....	26
Development of the Prototype Loading Device.....	28
Loading Method.....	29
Cam/Spring Loading Mechanism	30
Specimen Size and Loading System.....	31
Power Supply	32
4. MATERIAL SAMPLING AND TESTING	
Overview.....	36
Material Sampling.....	36
Source Selection.....	36
Sampling Procedures	37
Laboratory Testing.....	41
Phase I Lab Test Program.....	41
Phase II Lab Test Program.....	41
5. DATA REVIEW AND ANALYSIS	
Overview.....	48
Review of Data Collected in Phase I – Lab Test Program	48

Flexural Strength versus Texas Triaxial Strength Correlation	53
Repeatability of the Flexometer Test.....	57
Review of Data Collected in Phase II – Lab Test Program	60
Phase II-A Test Program: Effect of Test Specimen Size	60
Phase II-B Test Program: Flexometer Testing with Accelerated Curing ...	63
Phase II-C Test Program: Validation of the Flexometer Test Device	65
6. CONCLUSIONS AND RECOMMENDATIONS	
Conclusions.....	69
Recommendations.....	71
REFERENCES	73
APPENDIX A: Standard Test Procedure for Strength of Soil Binder by Flexural Testing	A-1
APPENDIX B: Laboratory Test Data.....	B-1

List of Tables

2.1	Specification ITEM 247 Requirements for Flexible Base Materials	6
3.1	Details of the Curing Procedure	26
3.2	Comparison between Texas Triaxial and Base Binder Flexometer Test Procedures	27
4.1	Properties of Flexible Base Material Sources Selected; Gradation and Atterberg Limits.....	39
4.2	Properties of Flexible Base Material Sources Selected; Wet Ball Mill, Texas Triaxial, and Compaction Test Data.....	40
4.4	Test Parameters Corresponding Intermediate and Large Size Specimen Testing	43
5.1	Flexural and Texas Triaxial Strength Data for the Base Materials Tested	52
5.2	Correlation Coefficient, n for the Base Material Tested.....	54
5.3	Regression Models for Type I, Type II and Modified Materials	57
5.4	Standard Deviation and Coefficient of Variation of Binder Flexural Strength for the Selected 5 Sources	58
5.5	Standard Deviation and Coefficient of Variation of Texas Triaxial Strength at 0-psi	59

List of Figures

2.1	Triaxial Test Device Developed by Casagrande at WES	8
2.2	Triaxial Test Device Proposed by Seiffert	8
2.3	TxDOT Triaxial Apparatus	10
2.4	Material Classification Chart for Texas Triaxial Test Result.....	11
2.5	Adek Percometer Test Device	14
2.6	Third-Point Loading Configuration Used in ASTM D 1635	16
3.1	Bending Diagram for 3-Point Loading of the Beam Specimen	20
3.2	A Sample of Oven-Dried Crushed Limestone Material	21
3.3	Mixing Moisture Model.....	23
3.4	Sample Consolidation by Lifting One Side of the Tray and Dropping it on Hard Surface.....	23
3.5	Moist Interface Created by Over-Consolidation of Bottom Lift	24
3.6	Flexural Strength versus Test Moisture Content Relationship.....	27
3.7	Original Plan for Testing the Proposed Concept	28
3.8	Loading Device with Cam and Spring Mechanism.....	29
3.9	Loading System Used in the Current Prototype	31
3.10	Relationship between Applied Load and Flexural Strength for Selected Lengths of Test Specimens	33
3.11	Final Prototype Loading Device.....	34
3.12	Schematic Views of the Finished Prototype Test Device.....	35
4.1	Participating TxDOT Districts and Base Material Sources Sampled	38
4.2	Small, Intermediate and Large Sized Test Specimens Used for Flexural Strength Testing: (a) Cured Test Specimens, (b) Molds Used for Making Intermediate Size Test Specimens, (c) Mold Used for Making Large Size Test Specimen	42

4.3	Compaction Hammers Used in the Preparation of (a) Intermediate and (b) Large Size Test Specimens	44
4.4	Flexural Testing of Intermediate Size Specimens Using Snapshot Loading Device	44
4.5	Flexural Testing of Large Size Specimens: (a) Accessories Fabricated and Used for 3-Pint Loading, (b) Triaxial Loading Frame.....	45
5.1	Flexural Strength versus Test Moisture Content Relationship San Antonio/Hunter Pit.....	49
5.2	Flexural Strength versus Test Moisture Content Relationship El Paso/Jobe Pit.....	49
5.3	Determination of the Binder Flexural Strength for Material Recovered from Tabasco Pit, Pharr District.....	51
5.4	0-psi Triaxial Strength versus Binder Flexural Strength	53
5.5	Coefficient, <i>n</i> versus Binder Flexural Strength.....	55
5.6	Coefficient, <i>n</i> versus Binder Flexural Strength for Type I, Type II and Modified Materials.....	56
5.7	Flexural Strength versus Test Moisture Content Data for Intermediate Size Specimens	61
5.8	Flexural Strength versus Test Moisture Content Data for Large Size Specimens.....	62
5.9	Comparison of Data Obtained from Standard, 4-Day Flexometer and Accelerated Flexometer Tests; Brownwood-Prater Source	64
5.10	Comparison of Data Obtained from Standard, 4-Day Flexometer and Accelerated Flexometer Tests; San Angelo-CSA/Turner Source.....	64
5.11	Comparison of Data Obtained from Standard, 4-Day Flexometer and Accelerated Flexometer Tests, Waco-Frost Source	65
5.12	Anomalous Trend in Flexural Strength Data Measured by the Base Binder Flexometer.....	66
5.13	Comparison of Data Obtained from Base Binder Flexometer and Snapshot Loading Device; Brownwood-Prater Source.....	67
5.14	Comparison of Data Obtained from Base Binder Flexometer and Snapshot Loading Device; San Angelo-CSA/Turner Source	67
5.15	Comparison of Data Obtained from Base Binder Flexometer and Snapshot Loading Device; Waco-Frost Source.....	68

CHAPTER 1

INTRODUCTION

GENERAL

The base and the subbase layers of a pavement system play an important role in determining the overall structural capacity of the pavement. These layers contribute to improved pavement performance by reducing pavement stresses, strains and deflections under applied traffic loads. In addition, they provide necessary protection to the natural subgrade from numerous climate-induced damage mechanisms. Thus, the properties of base and subbase materials have important bearing on the performance of the pavement structure during its service life. Therefore, it is important that the quality of base and subbase materials used in pavement construction is carefully controlled through a properly designed material screening and selection program. Among the essential elements in a successful material selection program is a material specification that is capable of identifying material with good field performance based on its laboratory-determined properties.

With thousands of lane miles in the Texas Transportation System and a high volume of construction, it is important that the above material testing procedures can be performed in a reliable but also an expedient manner. The characterization of base and subbase materials is typically done based on material properties that include gradation, soil plasticity, resistance to degradation, strength, and moisture susceptibility. It is generally agreed that strength and moisture susceptibility have the most significant impact on the base material performance in the field. Strength is also related to the stiffness and permanent deformation characteristics of these materials that control the development of major pavement distresses.

Texas Department of Transportation (TxDOT) currently classifies base and subgrade materials based on their strength as determined by the Texas Triaxial Test. In this test protocol, a base or subgrade material is classified according to a graduated scale between Classes 1 and 6 with Class 1 representing the highest quality. This Texas Triaxial Class for a soil is determined by superimposing the failure envelope from the triaxial test on a standard chart that plots shear strength and normal strength of the material.

There are a number of shortcomings in the above material qualification procedure based on the Texas Triaxial Test that limits its effectiveness:

- (a) First, there are a number of pre-requisite steps (such as moisture-density testing and moisture conditioning) that must be completed before the triaxial test can begin and therefore the entire test procedure takes approximately 3 weeks to complete. The long testing time is a major shortcoming of triaxial test procedure because such testing is required not only for initial qualification of the material, but also for subsequent quality assurance.
- (b) Many flexible base materials have difficulty meeting the 0-psi Triaxial strength requirement. When this happens, the contractor may be directed to enhance the strength of the material by mixing it with a suitable modifier such as flyash or cement. Instead, some TxDOT districts and area offices are now beginning to waive the 0-psi Triaxial test requirement and not perform the test at all.
- (c) Triaxial test results tend to show high degree of variability. Therefore, it is not uncommon for TxDOT to get results that do not agree with contractor's test data. This leads to a dispute that may be resolved by repeating the tests, but such repetitive testing generally takes a long time and often causes significant construction delays.
- (d) As mentioned above, when the material fails the specified strength requirement, one common strategy used is to incorporate a modifier such as cement or flyash. However, to determine the appropriate modifier content, material must be blended with various percentages of modifier (say 2%, 4%, 6% and 7%), perform necessary moisture-density testing for each mixture and then perform triaxial tests. Such a design requires large quantities of material (more than half-a-ton) and demands a lot of manpower.

Many of these difficulties may be overcome if a repeatable and reliable strength test method that could be performed in a short time and with small amounts of material was available. Base binder flexometer test was developed by Michael Merrick, P.E., Assistant Area Engineer, Snyder of TxDOT Abilene District with this objective in mind. Preliminary test results from the base binder flexometer suggest that flexometer test data correlate reasonably well with results from the Texas Triaxial Test. The new test procedure makes it

possible to key the pay equation more directly to performance while substantially reducing the complexity of the acceptance procedure as a whole. The potential benefits include a quick and reliable method of predicting the base and subgrade layer performance with regard to strength, deformation and moisture susceptibility, small quantity of material needed for testing, quick turn-around time (a total of 5 days for sampling, testing and reporting).

RESEARCH OBJECTIVES

The general objective of this research study is to examine the applicability and potential implementation of base binder flexometer test procedure developed by Michael Merrick, P.E. to characterize flexible and treated base materials. The specific objectives of this research study include the following:

- a) Validate the test method through cross correlation of flexometer test results with data obtained from other, more established test methods (i.e. Texas Triaxial Test).
- b) Determine the repeatability and limits of applicability of the test.
- c) Further develop the flexometer to determine the strength of base and subbase material that overcomes shortcomings of existing test equipment in terms of equipment size, thereby enabling it to be used in mobile/field laboratories and using smaller quantities of material.
- d) Provide a material testing machine which can be manufactured at low cost and easy to operate.

In this research, a flexural strength test using the flexometer will be conducted on materials sampled from various TxDOT projects for which conventional test properties such as Texas Triaxial Class, wet ball mill values and soil index properties have been determined at corresponding TxDOT laboratories.

This research study included a thorough and systematic evaluation of the new flexometer test method with the eventual goal of developing a reliable and repeatable test protocol that could be used as a quality control tool for flexible and treated base materials. The finding from this research study could be adopted for future implementation of the pavement design in Texas, resulting in lower construction costs and time savings for TxDOT.

REPORT ORGANIZATION

The next chapter of this report, Chapter 2, presents findings from a comprehensive literature review on test methods available for the characterization of flexible base materials. The special emphasis of this literature review, however, is on the Texas Triaxial Test. A description of the Department's specified method of triaxial testing is provided. The Department's Specification and the classification system are also included. Chapter 3 provides a detailed description of the development of the prototype test device and the test procedure. This includes goals and constraints that influenced the design process. The loading system is discussed and how it was optimized for the size of specimen and range of strength. The development and refinement of the test procedure as well as the changes made and problems resolved are included in the discussion. Chapter 4 is devoted to material sampling and laboratory testing. The laboratory test program conducted in this research included two separate Phases, Phase I and Phase II. In Phase I laboratory testing, all material sources sampled were tested using the standard test procedure. Meanwhile, Phase II lab testing was designed to address specific issues or concerns related to the original binder flexural strength test procedure. Chapter 5 describes the data review and analysis processes. The conclusions and recommendations from the research are presented in the final chapter, Chapter 6.

CHAPTER 2

REVIEW OF LITERATURE

CURRENT TxDOT PRACTICE

The flexible base course is an integral component of the pavement structure that works in conjunction with the asphaltic surface layer to support traffic. Directly below the base layer is the subgrade. A subgrade layer is generally a layer of indigenous material that has been reworked for consistency; consistency in material composition as well as moisture distribution. The subgrade serves as a foundation layer carrying the load distributed from the vehicles at the pavement surface. Therefore, the strengths and material characteristics of both the flexible base and the subgrade must be considered in the design of the pavement system. The useful service life of a pavement structure is highly dependent on the quality of the base course and the foundation soil that supports the structure. It is therefore very important that these foundation materials receive due consideration when making decisions related to pavement design and construction.

Flexible base and subbase materials accepted for TxDOT projects must meet the requirements stipulated in the Standard Specification Item 247 [1]. These requirements and the corresponding standard test methods are shown in Table 2.1. The flexible base and subbase materials are designated as Grades 1 through 4 with Grade 1 representing the best quality material. Materials with Grade designations 1 and 2 are used for structural layers while Grade 3 materials are recommended for use in non-structural subbases. A Grade 4 designation is provided to give districts the flexibility to develop specification requirements that are uniquely suited for local conditions and/or a specific project. The acceptance criteria used in Item 247 include gradation, soil index properties (liquid limit and plasticity index), degradation potential (determined using the wet-ball mill test) and triaxial class which is determined using results of the Texas Triaxial Test. Even though the standard specification stipulates the tests to be conducted for each material, it does not provide specific guidelines with respect to material sampling and testing frequencies. Such guidelines are found in the *Guide Schedule of Sampling and Testing* which is included in the Department's Construction Contract Administration Manual [2]. The Material Inspection Guide summarizes the responsibilities of TxDOT employees for various aspects of material testing and sampling.

Table 2.1 Specification ITEM 247 Requirements for Flexible Base Materials

Property	Test Method	Grade 1	Grade 2	Grade 3	Grade 4
Master gradation sieve size (% retained)	Tex-110-E				As shown on the plans
2½ in.		-	0	0	
1¾ in.		0	0-10	0-10	
7/8 in.		10-35	-	-	
3/8 in.		30-50	-	-	
No.4		45-65	45-75	45-75	
No.40		70-85	60-85	50-85	
Liquid Limit, % max. ¹	Tex-104-E	35	40	40	As shown on the plans
Plasticity Index, max ¹	Tex-106-E	10	12	12	As shown on the plans
Plasticity Index, min ¹		As shown on the plans			
Wet ball mill, % max ²	Tex-116-E	40	45	-	As shown on the plans
Wet ball mill, % max. increase passing the No.40 sieve		20	20	-	
Classification ³		1.0	1.1-2.3	-	As shown on the plans
Min. compressive strength ³ , psi	Tex-117-E				As shown on the plans
lateral pressure 0psi		45	35	-	
lateral pressure 15psi		175	175	-	

1. Determine plastic index in accordance with Tex-107-E (linear shrinkage) when liquid limit is unattainable as defined in Tex-104-E.
2. When soundness value is required by the plans, test material in accordance with Tex-411-A.
3. Meet both the classification and the minimum compressive strength unless otherwise shown on the plans.

In addition to the above-mentioned specifications, guides and manuals, TxDOT personnel rely on *General Notes* (also known as *Plan Notes*) that are project-based supplements to the TxDOT Standard Specifications. These general notes are attached to the plans provided to the bidders, and are used for clarification and added information in conjunction with specifications and special provisions. According to the Department *PS&E Preparation Manual*, these general notes are used “to provide, in one section of the plans, the various supplemental data required by the specifications.”

In a typical roadway construction or reconstruction project, there are two instances in which evaluation of base/subbase/subgrade materials may be undertaken. The first is the

beginning stage of assembling a set of plans for the highway improvement project (i.e. during PS&E Development stage). During initial plan preparation, roadway cores are taken at pre-determined intervals and material gathered from each core is tested for Atterberg limits, and if sufficient quantities available, for unit weight. Strength testing is generally not undertaken at this stage. The second is the construction stage. Upon awarding a highway contract, the contractor is responsible for identifying a material source that meets project specification requirements. He will then generate material stockpiles needed for the construction project. This involves a significant investment on the part of the contractor, for activities such as lease agreement, blasting, crushing and stockpiling of the material.

These operations are typical of sources that produce crushed limestone- the type of flexible base material that is most widely used in TxDOT roadway construction projects. When the base has been crushed for a project, TxDOT is notified by the contractor that sampling can be performed. Generally, the sample collected by the Department is split with the contractor. Fairly large quantities of material must be sampled so that moisture-density (Tex-113-E) and triaxial (Tex-117-E) tests can be performed.

FLEXIBLE BASE MATERIAL TEST METHODS

Texas Triaxial Test

The credit for the development of the first triaxial test device for soil testing is usually given to Arthur Casagrande. The development of the triaxial test apparatus by Casagrande occurred during the period 1930 -1941 while working at the Franklin Falls Dam site for the Waterways Experiment Station (WES), U.S. Army Corps of Engineers. Figure 2.1 shows the triaxial test apparatus developed by Casagrande [3]. Another researcher who has been credited with early work on triaxial test device is Seiffert. Seiffert developed a system device that can be used to apply and measure a confining pressure on a test specimen (Figure 2.2). This was a significant development because the device developed at the WES did not provide good control or measurement of confining pressure [4].

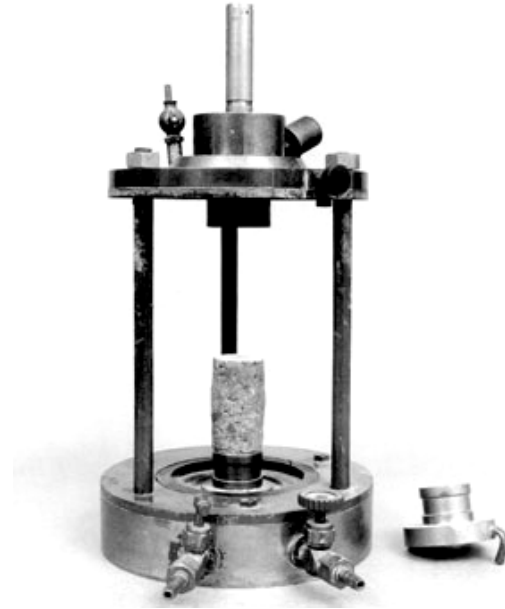

Figure 2.1 Triaxial Test Device Developed by Casagrande at WES

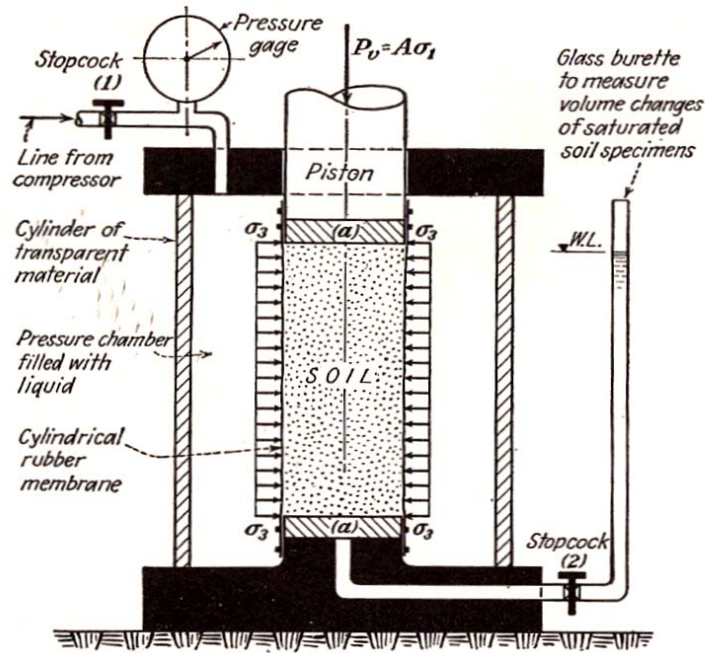

Figure 2.2 Triaxial Test Device Proposed by Seiffert

The triaxial test has retained its preeminence to the present day, not only because of its versatility, but also for its ability to control drainage, loading rate and degree of saturation so that the effects of these test conditions on soil behavior can be studied. Various agencies have made modifications to the triaxial test method and the test apparatus to meet their specific needs. TxDOT developed the Texas Triaxial Test (formerly AASHTO T 212) to characterize soil and soil-aggregate combinations according to a classification system based on six classes. The Texas Triaxial Test (Tex-117-E) differs from the standard triaxial compression test in that, in Tex-117-E, the confining pressure on the specimen is induced through compressed air between a metal triaxial cell and a thick rubber lining which is in contact with the specimen. This solves some of the problems inherent in the standard geotechnical cell. Specifically, it eliminates the need for a sophisticated system to apply confining stress on the test specimen. In contrast to the standard geotechnical cell, the membrane is part of the cell, not a consumable part of the specimen.

Figure 2.3 shows the Triaxial Test Apparatus that was developed by TxDOT. The Texas Triaxial Test (TxDOT standard test method Tex-117-E) includes a moisture conditioning phase in which the specimen, which is molded at the optimum moisture content, is allowed to absorb moisture by capillary action. The purpose of the moisture conditioning phase is to simulate moisture levels that can occur in pavements during their service life that are wetter than the optimum moisture condition. The Department allows districts to alter the moisture conditioning phase to simulate unique local conditions within the district.

The determination of the Texas Triaxial class requires testing of multiple test specimens, each at a different confining pressure. A failure envelope is then constructed for the *Mohr's Diagrams* obtained from all of the above tests. Finally this failure envelope is transferred onto a standard material classification chart shown in Figure 2.4. The current specification requirements for Class 1 base are compressive strengths of 45psi and 175psi at confining pressures of 0psi and 15psi respectively. This specification is based on shear strength parameters of cohesion (c) between 5psi and 10psi, and a friction angle (ϕ) of 50°.

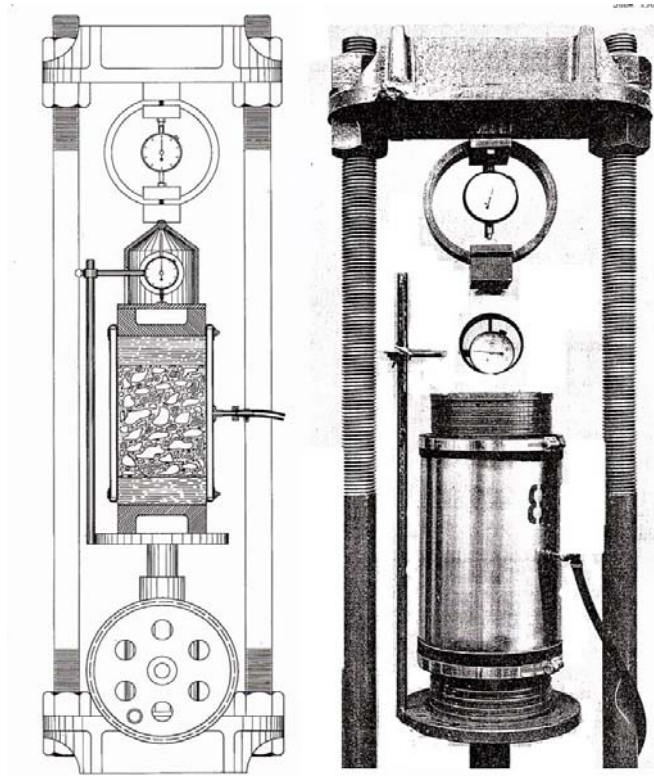

Figure 2.3 TxDOT Triaxial Apparatus

The TxDOT test device has now been replaced with a more modern triaxial system in which control of the hydraulics and sensory is accomplished through the use of the software, MTRX, that was developed at the Texas Transportation Institute (TTI) for TxDOT.

As mentioned in Chapter1, two of the major shortcomings in the Texas Triaxial Test procedure are (a) longer time required to perform the test and the necessary pre-requisite steps (such as moisture-density, moisture conditioning etc), and (b) the high degree of variability associated with test results. In addition, Yoder and Witzcak (1975) pointed out that a disadvantage of the Texas Triaxial procedure is the amount of friction that exists between rubber membrane and the chamber wall. This friction could lead to inflated axial stress value at failure. The Texas Triaxial Test was replaced in the 1986 AASHTO design guide by repeated load triaxial test.

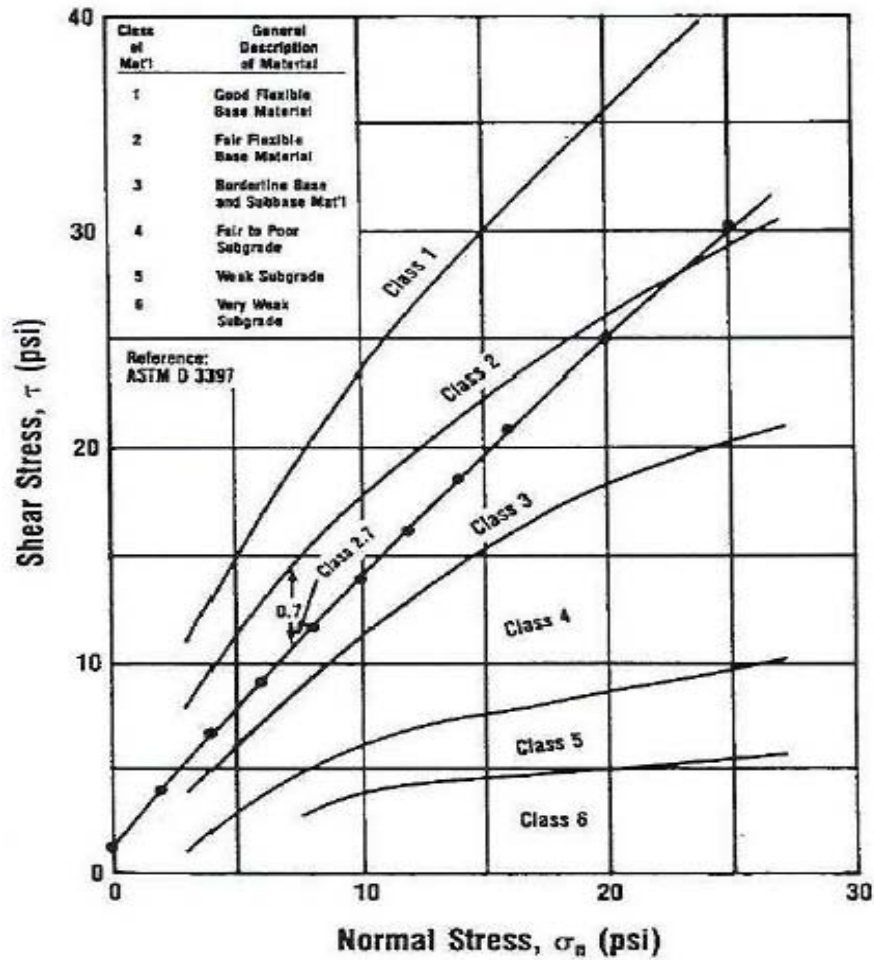

Figure 2.4 Material Classification Chart for Texas Triaxial Test Result

Wet Ball Mill Test

The Wet Ball Mill test (Tex-116-E) is a standard procedure used by TxDOT to determine the resistance of aggregate particles in flexible base material to disintegration in the presence of water. The test provides a measure of the ability of the material to withstand degradation in the road base and detects undesirably soft aggregate. This test furnishes valuable supplementary data pertaining to the quality of the aggregate in flexible base material. According to Tex-116-E, this test is more reliable than the Los Angeles abrasion test in evaluating the resistance to degradation of aggregate in base materials.

In Tex-116-E, aggregate samples are placed in a stainless steel jar with steel charge (balls) and water, and subjected to a defined rate of revolutions for a period of time. The abrasive conditions in the steel jar mimic the harsh conditions that the aggregates face in

pavements. The properties of the aggregates are measured before and after the test, which reflects the potential of the aggregate for successful performance in the field.

It may be used either to assess source rock type or the ripped rock product from the softer source rock type. Caution must be exercised when using this test to compare the qualities of different rocks because the test results can be greatly influenced by the sizing of grains which form the rock. In other words, some coarse-grained sandstone may degrade completely during the test cycles but the particles so formed may not pass the nominated test sieve upon which degradation is assessed. In the specification, different test values are therefore specified for arenaceous (sandstone) and argillaceous (mudstone) rock types which are to be crushed and used for Class 3 subbase.

Tube Suction Test

It is quite common to assign a strength rating to a soil material without giving due consideration to its sensitivity to in-situ moisture content. Moisture ingress into a pavement is a primary cause of pavement damage. The degree to which moisture ingress degrades the performance of flexible base plays a key role in the performance of the pavement. Research has demonstrated that moisture susceptibility is related to both matric and osmotic suction of granular aggregates. Matric suction is mainly responsible for the capillary phenomenon in the aggregate base layers, and osmotic suction represents the potential to develop suction due to differences in salt concentrations within the aggregate matrix. It is the amount of unbound water in the base that influences its engineering properties that include load carrying capacity and resistance to freeze-thaw cycling. The amount of unbound water that exists within an aggregate base has a direct bearing on its dielectric constant. In the tube suction test, the asymptotic value of the dielectric constant is measured at the end of 10-day capillary wetting period and is used to assess the resistance of that material to moisture-induced degradation. Based on the results of the test, the flexible base materials are ranked as excellent, good, marginal, poor etc.

Pavement base layers constructed with moisture susceptible aggregate are prone to rapid development of permanent deformation during wet weather and during periods of freeze-thaw. Texas began using the tube suction test (TST) in a trial capacity in 2001, and it is now included in the standard TxDOT specifications. The TST was developed by

Saarenketo and Scullion (1996) at the Texas Transportation Institute (TTI) to investigate the suction properties of various base course aggregates, and the test method has been further refined during the period from 1996 to 2000 in a cooperative effort between the Finnish National Road Administration and TTI [5]. In this test compacted specimens are soaked by capillary action in the laboratory for a period of 10 days. The surface dielectric value (DEV) is measured on a regular basis to assess the rate at which certain milestones relating to moisture infiltration are reached. A lower DEV is likely to result in better performance of the aggregate base material. Findings from the above research suggest that aggregate base material with dielectric values less than 10 may be ranked as neither moisture nor frost susceptible [6]. As this test is an indicator of the behavior of a material in a certain environmental setting, the generalization of such a specification is not recommended. NCHRP (2000) adopted the DEV criteria of less than 10 for good material, 10 to 16 for fair material, and more than 16 for poor material. It was found that the classification of TST correlates well with field performance of known aggregate bases. Adek PercometerTM is used in this test procedure to measure the dielectric values of specimens.

During TST, aggregate base material samples are compacted at optimum moisture using a gyratory compactor and extruded into a 12-inches high and 6-inches diameter plastic tube. The height of the sample should be 180 to 200 mm. After compaction, a perforated cover is placed at the bottom of each tube, and the samples are dried in an oven at 45 °C until no significant changes are observed in their weight. After oven drying, the samples are allowed to cool to room temperature for at least two days. When the specimen temperature is stabilized, the samples are placed on a dish containing de-ionized water to a height of approximately 20 mm. The first measurements of the dielectric constant and electrical conductivity values are taken before placing the tube samples into the water. Once in the water, measurements are taken at two-hour intervals during the first day, in addition to an initial reading which should be taken a half-hour after placing the tube samples in the water. From the second day on, only one measurement is required (in the morning) per day until the weight of the samples and the dielectric values become constant. The weight of the tube sample is measured in connection with every dielectric value measurement. Grain size, surface water content (2 inches deep), specific density and other required parameters are measured from the samples after the test.

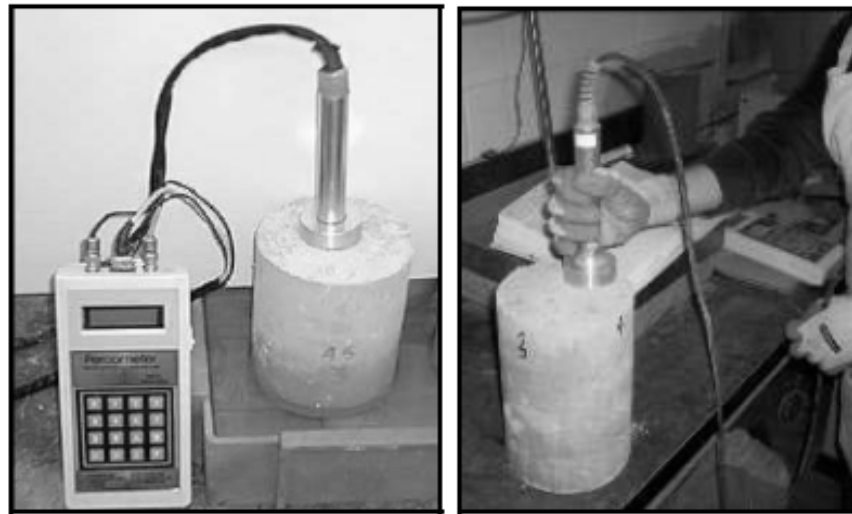

(a) Adek Percometer™ (b) Taking Dielectric Reading

Figure 2.5 Adek Percometer Test Device

The test can be conducted in the same way for bound and unbound aggregates. Dielectric moisture measurement method is based on the fact that permittivity E_r of dry material and hard constituent particles is 2 to 5 and the E_r of free water is 80. Therefore, the resulting permittivity of soil materials is mainly governed by its moisture content. The practical use of this method is complicated by the high and variable electrical losses of material during the test. Despite numerous dielectric mixture theories and formulas it is more accurate to use experimentally established dependencies between E_r and moisture content W .

The TxDOT research results show that the suction properties of base aggregates have a very significant effect on the deformation properties of the base course. Suction properties, in turn, are primarily dependent on the fines content, but also on the chemical properties and mineralogy of the aggregate. The Tube Suction Test has proved to function well in the identification of problematic aggregates as well as in defining appropriate binder types and their required amounts.

Flexural Strength Test

Flexural strength of a material is its ability to resist an applied bending stress. It is a commonly used design criterion in concrete pavements due to the propensity of the concrete

slab to bend, or 'flex' under load. Bending is a phenomenon that is not limited to concrete pavements. Anytime a stiffer pavement layer is supported on a weaker layer, which is typically the case with pavement structures, the material above is subjected to flexure. The extent of this flexure depends on the ratio between the moduli of the two layers. Therefore, determination of flexural strength is frequently necessary as part of the design of pavements.

TxDOT and other highway agencies have long recognized the need to determine the strength of soils through a flexural method. A mechanistic-empirical method that had been proposed by the National Lime Association for lime stabilized materials emphasizes the value of flexural test results in pavement design. However, they have concluded that generating such data is difficult, too time consuming and not cost effective [7]. The Federal Highway Administration has published documents that relate to the benefit of stabilization of flexible base layers with a variety of pozzolanic agents such as cement, lime, and fly ash. It is stated that, due to the nature of a stabilized layer in a flexible pavement structure, a semi-rigid course within a structure might be better quantified by flexural testing [8].

The test methods that are currently in use for determining flexural strength of pavement materials primarily target those materials that are considered *rigid* or *semi-rigid*. Examples of such test procedures are AASHTO T 97-97 (or ASTM C 78-94) for flexural testing of concrete beams under third-point loading, AASHTO T 177-97 (or ASTM C 293-94) for flexural testing of concrete beams under center-point loading and ASTM D 1632 for testing soil-cement mixtures under third point loading [9, 10, 11].

The procedure for making and curing test specimens to be used in ASTM D 1635 is outlined in ASTM D 1632 [12]. This ASTM standard for making soil-cement specimens for flexural strength tests is used primarily with soils having no more than 35 percent retained on the No. 4 sieve and no more than 85 percent retained on the No.40 sieve. The specimen size of 3in x 3in x 11.5in is used to obtain an appropriate failure pattern. Figure 2.6 shows the loading configuration used in testing soil-cement beams for flexural strength according to ASTM D 1635.

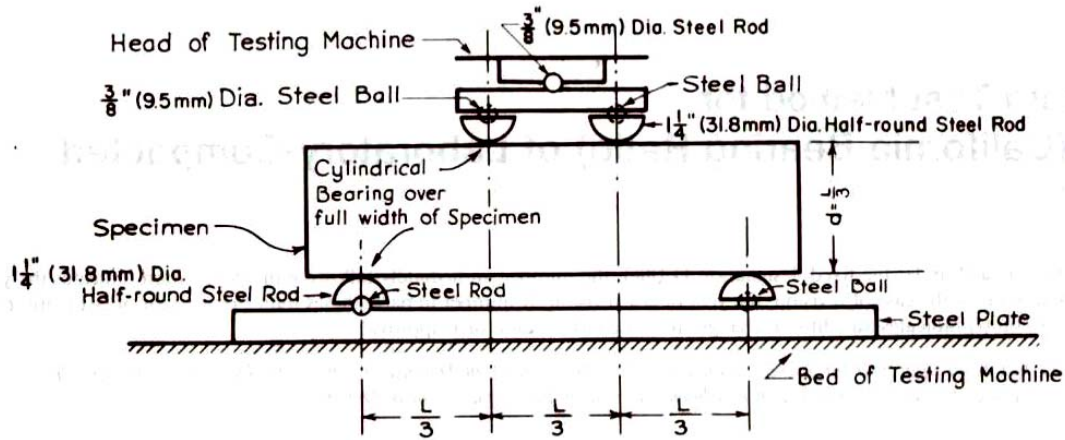

Figure 2.6 Third-Point Loading Configuration Used in ASTM D 1635

In addition to the above, tests have been conducted to determine the dynamic modulus of rupture based on flexural strength obtained from a four-point loading test [13]. The aim of this investigation was to determine the dynamic modulus of rupture for soil cement beams with 6 and 10 percent cement content. The beam specimens were prepared in accordance with ASTM D 1632. The soil selected for the tests was red marl from South Wales. The stabilizer used was ordinary Portland cement. The dynamic flexural test was carried out on a wide range of load control repetitions with frequencies from 0.001 to 1000 Hz. The frequency of 5 Hz was chosen to simulate the normal traffic loading speed and the number of load repetition was monitored. Ten beam specimens were prepared for each cement contents and tested to failure. The modulus of rupture (MOR) was calculated according to the type of beam failure. If the fracture occurs in the middle third of the span the MOR is calculated using Equation (2.1)

$$R = PL / bd^2 \quad (2.1)$$

For fracture occurring no more than 5 percent of the span length outside the middle third using Equation (2.2)

$$R = 3Pa / bd^2 \quad (2.2)$$

where, R is modulus of rupture, P is the maximum applied load, L is the beam span length, b is the average specimen width, d is the average specimen depth, and a is the distance between the line of fracture and the nearest support measured along the center line

of the bottom surface of the beam. Flexural fatigue test is easier to carry out but involves uncertainty regarding the stress induced in the extreme fibers during the test.

The base binder flexometer developed by Michael Merrick works on the same principles as described above. It can be used to conduct flexural strength of beams made using the base, subbase or subgrade material that passes the #40 sieve (i.e. binder portion). In the case of flexible base material, this material is referred to as the binder. In the above flexural-strength test, the load is applied to the top of a test beam that is the same size as the bar linear shrinkage specimen (0.75"×0.75"×5"). The test is conducted under center point loading. The failure load for the beam is recorded and the flexural strength is calculated as follows.

$$R = \frac{Pa}{bd^2} \quad (2.3)$$

In Equation (2.3), R is the modulus of rupture, P is the maximum applied load, a is the distance between the line of fracture and the nearest support measured along the center line of the bottom surface of the beam, b is the average width of the specimen and d is the average depth of specimen.

Values of modulus of rupture vary widely, depending on the base and subgrade material used for testing. An approximate relationship between modulus of rupture and compressive strength can be represented by the following formula:

$$f'_c = \frac{R^2}{100} \quad (2.4)$$

where, f'_c is the compressive strength (in psi) and R is the modulus of rupture (in psi).

CHAPTER 3

DEVELOPMENT OF THE CONCEPTUAL TEST PROCEDURE AND PROTOTYPE TEST DEVICE

DEVELOPMENT OF THE CONCEPTUAL TEST PROCEDURE

This chapter describes the work performed under two major tasks in research project 0-5873. They are: (a) development of the conceptual test procedure, and (b) development of the prototype test device. The first of these two research tasks specifically dealt with the development of standardized methods for preparing test specimens of base binder material, proper curing of test specimens and testing them under flexural loading. Special emphasis was placed on the development of a test procedure that overcomes the limitations encountered in the field implementation of the existing Texas Triaxial Test procedure. Therefore, it is important that the new test method meets the following requirements: (a) the test method should have a much quicker turn around time than the triaxial test, (b) the test method must require less material and involve less labor and, (c) the test method must produce results that are repeatable and reproducible or, in other words, the variability associated with test results must be low. Ideally, the test method must also produce results that correlate well with those from the existing Texas Triaxial Test.

The base material may be considered as a composite material that consists of two separate components, the *aggregate matrix* and the *binder*. The *binder* includes the material that passes the #40 sieve while the *aggregate matrix* represents the material component that is retained on the #40 sieve. The strength of the composite base material is likely to be governed by many factors. Such factors may include particle gradation, aggregate shape and form, mineralogy, binder-matrix interaction, binder-binder interaction and the moisture level. The ultimate goal of this research is to examine the correlation between the strength of the composite material (matrix and binder) tested in a compressive manner and the strength of the binder tested under flexural loading conditions. At the quarry where the base material is produced, the material is crushed to generate a gradation that is suitable for roadway base applications. The fines generated during the crushing process are of the same mineralogy as that of the coarse aggregate

portion of the base material. Thus, it is reasonable to expect that some correlation between the strength of the composite and that of the binder would exist.

The test device that was developed in this research for flexural testing of base and subbase materials is referred to as the *Base Binder Flexometer*. The test specimen used in this test procedure consists of a beam that can be prepared using the widely available Bar Linear Shrinkage mold. Subsequent sections in this chapter describe various phases of test procedure development in detail. The specific aspects that are discussed include the following:

- a) Choice of suitable test specimen dimensions
- b) Determination of the optimum mixing moisture content
- c) Procedure for sample consolidation
- d) Sample curing procedures
- e) Procedure for flexural testing of specimen

Choice of Suitable Test Specimen Dimensions

Factors that were considered in the selection of test specimen size included: (a) stability of the test specimen during handling and loading, (b) ability to produce data with good resolution and (c) the quantity of material needed for test specimen preparation.

Figure 3.1 is a typical bending moment diagram for a beam specimen that is supported at either end and subjected to a point load in the middle of the specimen. The equation for moment shows that the length of the specimen has a large impact of the magnitude and distribution of stresses near the center of the specimen. Shortening the bar increases the rate at which stresses increase as one moves towards the center of the test specimen while lengthening it provides a more gradual change. A gradual change in the bending moment and bottom fiber tensile stresses are more desirable. Moreover, a shorter test specimen would require a higher point load to bring the bottom fiber tensile stresses to its limiting (i.e. failure) value. This, in turn, will require a test apparatus that can apply larger force. This can be achieved but usually, the higher load capacity comes at the expense of sensitivity.

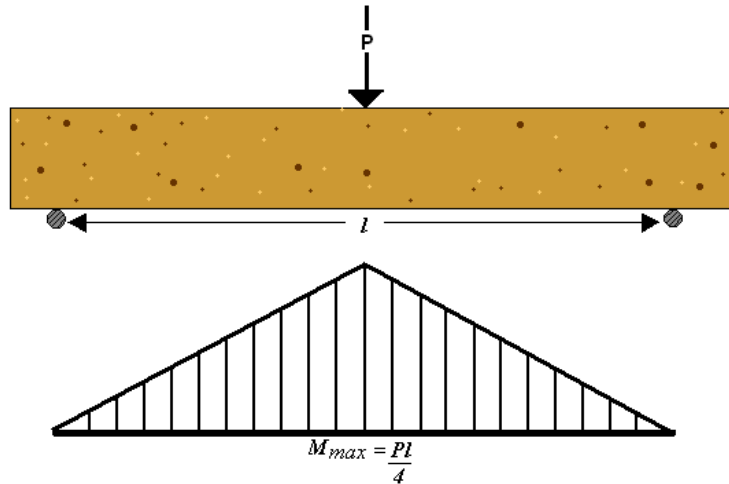

Figure 3.1. Bending Diagram for 3-Point Loading of the Beam Specimen

On the other hand, a test specimen that is too long and slender will have its own limitations. Such a test specimen will be less stable during handling. More importantly, it will not allow the rupture load to be determined with good resolution. Ideally, the test should be capable of measuring small changes in strength between “strong” and “weak” materials. This is especially important in this application because the strength range between a strong and weak material may not be very large. If the load range of the test device varies from 0-5.0lb, then the test must be designed so that the entire load range of the equipment is utilized. A beam specimen that is too long, i.e. longer than 6-in, would not allow this to be accomplished. A specimen length of 5-in was selected based on all of the above requirements. A specimen of 5in in length and $\frac{3}{4}$ ” square cross section can be prepared easily using the bar linear shrinkage mold. The specimen length-loading characteristics relationship is discussed in greater detail later in this chapter under the heading “development of the prototype test apparatus.”

Secondly, it must be recalled that one of the objectives of this research was to develop a test method that can be performed using a small quantity of material so that the time and labor required for material sampling, processing and testing can be greatly reduced. A larger test specimen could potentially nullify this benefit. The currently used Texas Triaxial Test requires seven to ten 50-lb sacks of material. The mass of a 5in (L) x $\frac{3}{4}$ -in (H) x $\frac{3}{4}$ -in (W) test specimen will be approximately 80-100 grams. A typical test

set consists of 24 to 48 specimens, or 2000 to 5000 grams of material passing the No. 40 sieve. Texas Standard Specification Item 247 specifies that base material consist of a composite material with possible 30 to 50 percent passing the 40 sieve. If the material consisted of 30% passing and a sack of 50 lb collected, that would be approximately 15 lb of binder, or 7000 grams. This quantity is more than sufficient.



Figure 3.2. A Sample of Oven Dried Crushed Limestone Material

Determination of the Optimum Mixing Moisture Content

Sample preparation at the proper mixing moisture content is very important in order to obtain test specimens that maintain their integrity during testing and yield reliable flexural strength data. If the moisture content is too low, the workability of the mix will be poor and the material would not get compacted into the mold as a homogeneous mass that is free of voids and other defects. On other hand, if the water content is too high, the excess moisture will rise to the surface during sample placement in the mold. Such a sample will be very weak and will likely develop shrinkage cracks upon drying.

In this research, the optimum mixing moisture content was determined by mixing each material at a range of water contents slightly above and below the apparent optimum value. For each material tested three specimens were prepared. The first specimen was

mixed with water until the material workability seems slightly less than desirable. The second specimen was mixed at higher water content to achieve somewhat better workability. The third specimen in the set was mixed such that the material is more workable than needed. This procedure provides a range of moisture contents that are from the driest to wettest possible conditions for mixing. The observations made during sample preparation and testing was used to determine the optimum value for mixing water content.

The mixing water contents obtained in the above manner were then correlated with other soil parameters such as LL, PI, minus #40, OMC, Maximum dry density. The objective of this exercise was to develop a “Mixing Moisture Content Model” that would eliminate the need for a trial-and-error approach in future testing. The mixing moisture model that has been established with data collected is shown in Figure 3.3.

Sample Consolidation Procedure

Material mixed at the proper moisture content is in a near liquid state while being placed in the mold. Due to the fact that the material is saturated, a compactive force or pressure will not be effective in achieving good consolidation of the material. The main intent of the test procedure is to remove the entrapped air and to ensure that the material fills all corners of the mold. The observations made during sample preparation suggested that a method similar to that used in consolidation of concrete would be appropriate. Concrete is usually consolidated by one of two available methods, either a blunt force to the forms or an immersion vibrator. Vibration was first considered for this application. A device was assembled generating a high amplitude vibration at approximately 30Hz. This did aide in some consolidation of the material. However, it was observed that it did not remove all entrapped air. A blunt force can be applied to the specimen tray by means of hammer or dropping the molds in a controlled manner. Test Procedure TEX-107-E: Determining the Bar Linear Shrinkage of Soils uses such method for sample consolidation. The specimen tray is placed on a concrete surface, each end of the tray lifted and dropped, changing sides after each drop until the material fully consolidates. The side of the tray is lifted approximately 1 inch from the surface as shown in Figure 3.4. This process continues until a sufficient number of drops have been completed.

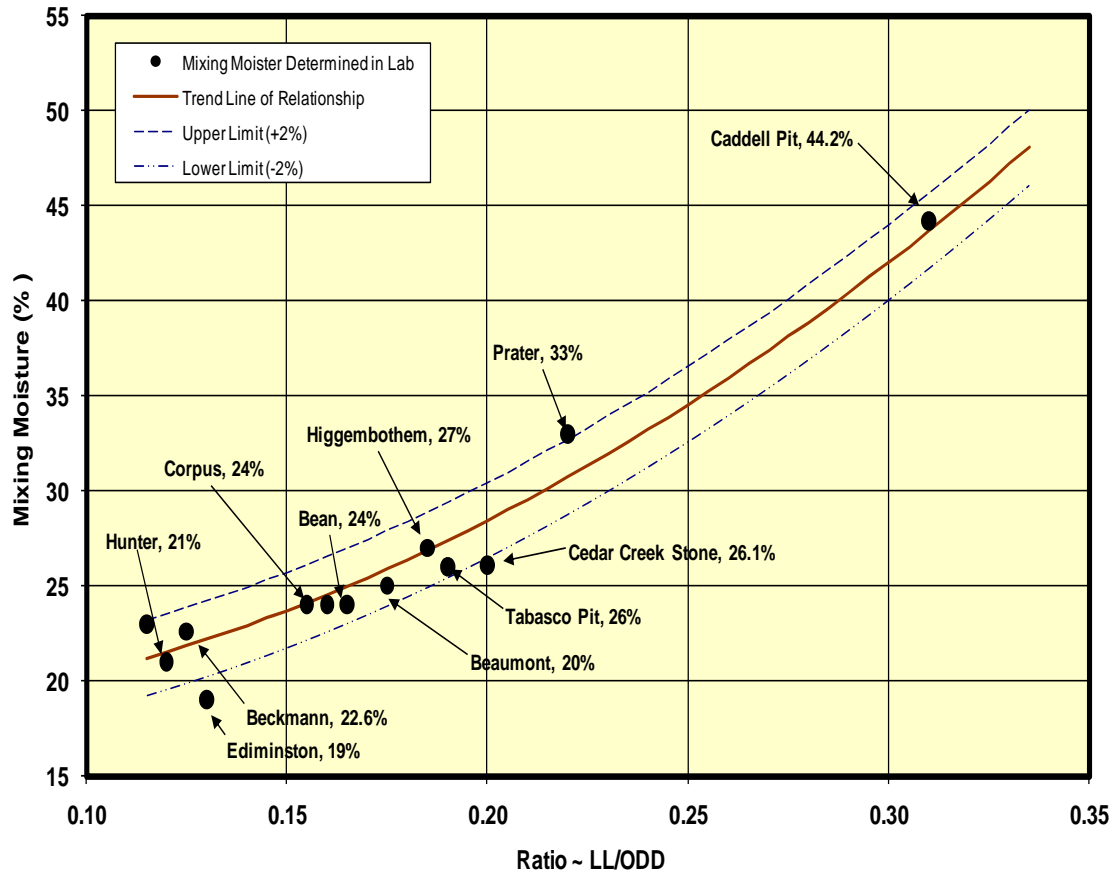

Figure 3.3 Mixing Moisture Model



Figure 3.4 Sample Consolidation by Lifting One Side of the Tray and Dropping it on Hard Surface

Specimens were prepared in 2 lifts, filling half of the mold volume each time. All six specimen partitions in the tray were filled to half capacity. The material was then consolidated as described above by using 50 drops. After the second lift is placed, another cycle sample consolidation was performed, this time using 100 drops. Thus, the sample is subjected to a total of 150 drops during consolidation.

Originally, 100 drops were used for both bottom and top lifts. However, it was observed that 100 drops for the bottom lift resulted in over-consolidation of the material. Over-consolidation caused an excessive amount of free water to float to the surface of the bottom lift. Then, when the second lift was placed, a specimen with 3 distinct layers was produced with a middle layer of high moisture content. This effect is shown in Figure 3.5. Since the desired product is a specimen with a homogeneous composition through the cross-section, the number of consolidation drops for the bottom lift was reduced to 50. 50 consolidation drops provided effective consolidation, but without floating excessive water to the surface.

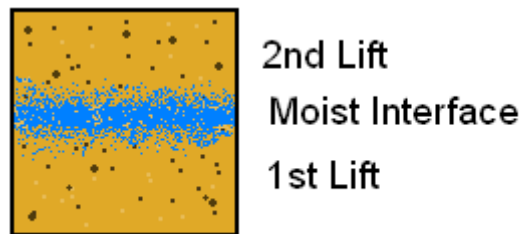

Figure 3.5 Moist Interface Created by Over-consolidation of Bottom Lift

Curing of the Test Specimens

The test specimen curing procedure was designed to simulate the conditions that a new base layer will experience in the field after its placement. In the field, the rate of moisture loss will be higher during day time and lower during night time due to differences in ambient temperature. Accordingly, in the proposed test method, the test specimens were subjected to a period of rapid moisture loss followed by a period of slow moisture loss. The duration of one such curing cycle was 24-hrs. Sample curing included four such 24-hr cycles in accordance with the guidelines given in TxDOT Special Specification 2028: Fly Ash Treatment of Base and Subbase Materials. Although

the material used in test procedure development did not include any modifiers, the expectation was that the same test procedure will be used for modified base materials as well. Therefore, a 4-day curing process was initially adopted so that a uniform test procedure could be used for all material categories. This chapter describes the initial test procedure involving 4-day curing of the test specimens. However, it must be noted that, this research also examined a shorter version of the test, called the *accelerated flexometer test*. A comparison of the data collected from the two versions of the flexometer can be found in Chapter 5.

The curing method implemented utilizes a small oven as a curing chamber with scheduled oven cycles every 12 hours. Specimens created for flexural testing will need to be able to survive the 4 day curing process without premature cracking. The oven temperatures proposed allow moisture release at a controlled rate thus avoiding cracking of the test specimens. Similarly, the moisture loss should not be too slow because that would greatly reduce the measured flexural strength.

During the 4 day curing, specimens are subjected to 4 oven cycles, each cycle lasting 24 hours. The first cycle begins immediately after placing new specimens in the curing oven. The first cycle is designed to cause a rapid decrease in the moisture content of the specimen and accordingly, the test specimens are kept at 100°F for 1 hour. Subsequently, the heating element is turned off. The second, third, and fourth cycles have been established to provide a peak temperature of 90°F in 30 minutes. At the peak, the oven heating element is turned off but air flow continues for 15 more minutes. The intent of this process is to reduce the moisture content in a pattern that is similar to daily heating and cooling due to the rise and fall of the sun in the natural environment. The oven air flow and heating was introduced to reduce the moisture content prior to load testing the specimens. The recommended curing procedure is summarized in Table 3.1.

Table 3.1 Details of the Curing Procedure

Day	Oven Cycle Duration	Temp. (F)	Description
1	1 hour	100	100 degrees entire duration
2	45 minutes	90	90 degrees @ 30 minutes, 45 minutes air flow
3	45 minutes		90 degrees @ 30 minutes, 45 minutes air flow
4	45 minutes		90 degrees @ 30 minutes, 45 minutes air flow
End of day 4	Until Testing Completed		100 degrees continuous air flow until testing completed

Flexural Testing of Specimens

Specimen testing begins at the end of 4 days of curing. At the end of the curing period, the moisture contents of the specimens are found to be several percentage points above the optimum moisture contents (OMCs) of the material as determined by TEX-113-E Laboratory Compaction Characteristics and Moisture-Density Relationship of Base Materials. Usually, specimens are found to be about 8% above OMC. This is desired because, in the next step, test specimens are load tested at various moisture contents as the specimens continue to dry out in the oven at 100°F. By doing so, a relationship between the flexural strength and the test moisture content can be established. Figure 3.6 shows an example of such flexural strength-test moisture content relationship. The strength of the material at Optimum Moisture Content (OMC) is determined from the chart and reported as the flexometer strength.

In this plot, each line represents test specimens obtained from one tray. The six test specimens contained in the tray are tested at different times as the materials dry out in the oven. The moisture contents of each specimen at the time of testing cannot be predetermined. Instead, they must be determined from the remnants of the ruptured beam after it had been tested for flexometer strength. Multiple trays serve as replicates of the test and the Merrick Flexometer strength values obtained for all 3 or 4 trays are averaged to get a more reliable estimate.

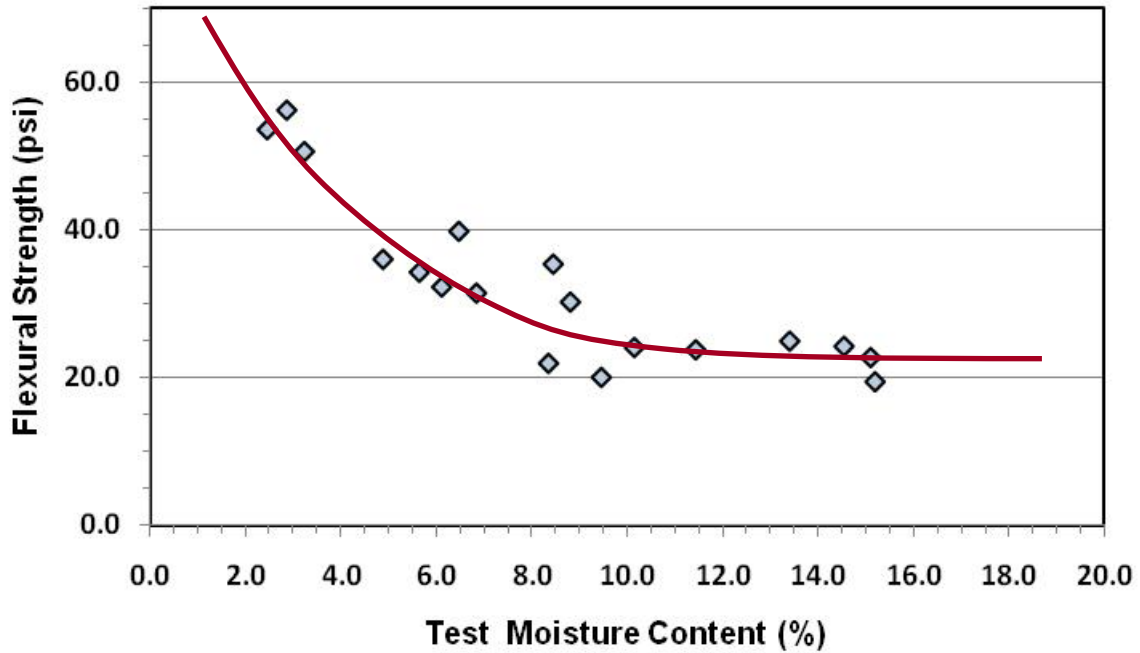

Figure 3.6. Flexural Strength versus Test Moisture Content Relationship

The following is a comparison between the Texas Triaxial Test and the base binder flexometer test in terms of quantity of material, labor and time required for the two tests. Also shown are the initial estimates for the test result variance. A standardized Merrick flexometer test procedure that has been developed according to the format used in TxDOT’s Manual of Test Procedures is found in Appendix A of this report.

Table 3.2. Comparison between Texas Triaxial and Base Binder Flexometer Test Procedures

Test Method	Duration	Material (lb)	Labor	Variance
Texas Triaxial	3 week minimum	400 minimum	High	+/- 10 psi Avg
Merrick Flexometer	5 days (with 4-day curing)	100 maximum	Low	+/- 5 psi Max

DEVELOPMENT OF THE PROTOTYPE LOADING DEVICE

This section of Chapter 3 describes the work performed under Task No.3 of the research project 0-5873; Development of the Prototype Flexometer Device. The loading device developed for the proposed test procedure was designed to be inexpensive yet sufficiently accurate and reliable for use in the proposed material testing application. Cost effectiveness is an important consideration because the objective is to develop a test device that can be made available to all engineering offices and field labs.

The first device developed was a simple frame to support a 5-in test specimen. Loading of the specimens was accomplished by adding weight to a bucket hanging from the center of the specimen (See Figure 1 below). When failure of the specimen occurred, the mass added to the bucket was measured and then the flexural strength was calculated. Although test results typically displayed a high variance, the testing results showed that the proposed concept has merit and deserved further evaluation. The initial testing also provided pertinent data such as typical flexural strengths and the general range of the load that needs to be applied.

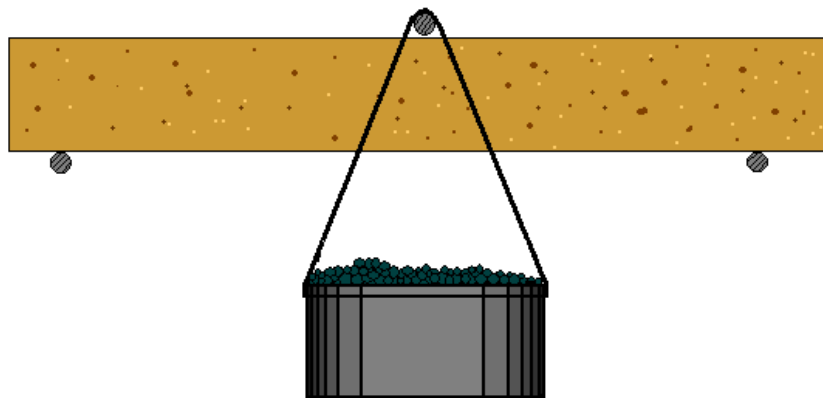

Figure 3.7 Original Plan for Testing the Proposed Concept

The device developed in the next phase is shown in Figure 3.8. This system was much more sophisticated. It provided stable loading through the use of a rotating cam that in turn caused direct displacement of a compression spring. The exact cam profile and spring stiffness were known. The displacement provided by the cam multiplied by the spring stiffness is the load applied to the specimen. The device was computer

controlled to ensure a steady, repeatable loading rate. This device provided the framework for the development of the project prototype described in this chapter. The next section describes the general guidelines and conditions used to developed the project prototype.



Figure 3.8 Loading Device with Cam and Spring Mechanism

Loading Method

Loading methods considered in the development of the prototype included: counter-weight systems, hydraulic systems, linear worm gears, and cams. These options were evaluated based on the following factors:

- a) Resolution
- b) Ability to control the loading rate
- c) Amenability for computer automation
- d) Cost

Hydraulic systems were ruled out in very early stages due to the complexity and instrumentation involved. Currently approved laboratory equipment that utilizes such systems are very expensive. Examples of such equipment are the PG Asphalt Bending Beam Rheometer, concrete cylinder testing equipment, and new generation triaxial test equipment. Although loading systems that utilize counter-weights or worm gears can be automated by logic circuitry, these systems are not ideally suited for applications that require slow loading rates or high resolution.

Stepper motors are a special class of DC motors that move in a precise quantum manner. They are used in printers, disk drives, and computer hard drives because of their precise tolerances. As the name implies, stepper motors move one step at a time with cycles of current applied to the motor coils. The motor type used in this prototype uses a bipolar stepper motor. With each pulse of current delivered in sequence, the motor rotates exactly 1.8 degrees. Thus, the motor employed requires 200 steps for 1 complete rotation. Due to these small movements, a cam designed specifically for this situation in combination with the correct compression spring could produce small variations in load yielding a high resolution. The stepping speed is dependent of the microprocessor system, not a rotational speed of the motor. These types of DC motors are generally inexpensive and come in a wide range of torque capacities.

Cam/Spring Loading Mechanism

Figure 3.9 illustrates the loading method utilized in the project prototype. The cam reaches full deflection at 180 degrees or 100 steps. By rotating the cam at 1 step per second, a semi-static loading condition is achieved. No benefit was observed by increasing the time delay to decrease the loading rate. Increasing the loading rate faster than 1 step/second increased test resulted in higher levels of variability that was beyond acceptable levels. The change in spring height results in a net change in strength of approximately .05 lbs per step. The position of the stepper motor and thus the load is controlled precisely by computer controller through an interface board built between the TTL voltage levels of the IBM PC Parallel Port and the voltage and current drain of the motor.

The cam loading system proved to be a very effective system to apply load to the specimens. Yet it can be built quite inexpensively. The system of a DC motor directly connected to a cam designed for the system provided good resolution and repeatable test results. Both prototypes using the loading method used a LV231 motor. The peak static torque is between 60 and 80 in-lb depending upon the voltage/current relationship. The LV231 is a fairly inexpensive and readily available motor size.

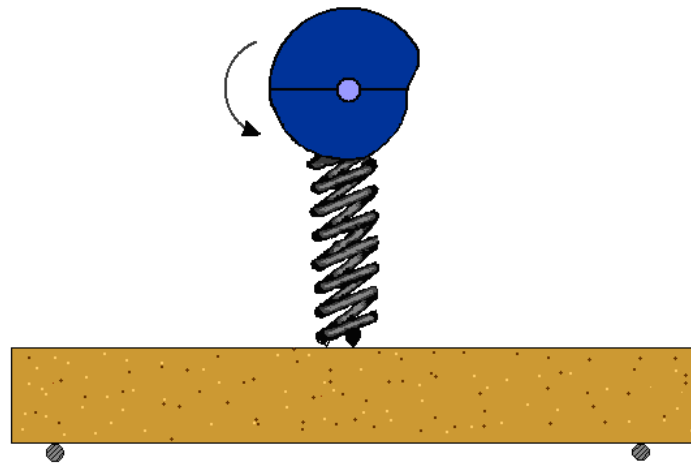

Figure 3.9 Loading System Used in the Current Prototype

Testing of flexible base binder material in this manner indicated that the material flexural strength would be at least 10 psi but not greater than 80 psi. Although 80 psi is very unusual, it is possible. A symbiotic relationship exists between the specimen length and the design of the cam/spring combination.

Specimen Size and Loading System

The loading system built into the flexometer is symbiotic with the size selected for the test specimen. The size of the specimen has a direct impact on the design of the loading system. Specimen size proportionately affects the motor strength, cam size, and spring stiffness. Therefore, if the specimen size were to change, the loading system needs to adapt accordingly. In order to keep the device cost at a minimum, the Flexometer has been designed for a specific size specimen. The following requirements must be met by any loading system used.

- 1) The test device must be capable of providing a load that meets or exceeds the maximum anticipated material strength
- 2) The test device should be designed so that it would utilize its full load spectrum of the machine (0 to 5 lb)
- 3) The test device should have high enough resolution so that even small changes in strength can be detected (0.05 lb)

Figure 3.10 illustrates the relationship between specimen length and the above design criteria for a test specimen with $\frac{3}{4}$ square cross-section. A 6-in long specimen would reach 80 psi at 3 lbs. This would cause a reduction in the resolution of the load measured. A 2-in specimen would require a load of at least 9 lb to produce a strength of 80 psi. This would require a larger motor producing more torque. By viewing the graph, a specimen 4-in to 5-in long would be optimum in terms of meeting the specified design criteria. When this specimen length is used, the load capacity of the machine is fully utilized. At the same time, there would be adequate tolerance so that there is no risk in sample strength exceeding load capacity of the machine. The minimum strength expected will be reached at small loads and an average strength of 45 psi is obtained at approximately half of the available load force. Since most of the TxDOT area offices do have linear shrinkage molds of 5-in length, a specimen length of 5-in was chosen. However the end supports are 4 $\frac{1}{2}$ -in apart. This is due to the fact that most materials experience some shrinkage during specimen curing. In order to ensure that all materials would rest on the supports despite the amount of shrinkage, the distance of 4 $\frac{1}{2}$ -in is chosen for the supports.

Power Supply

Due to the current drawn by the DC motor, 2 different power supplies are used in the operation of the flexometer. One power supply provides 12 volts at 500 milliamps for the circuitry of the interface. The other power supply provides a maximum of 24 volts up to 2 amps for the motor. The stepper motor has the capacity to function up to 75 volts which provides more torque. But the relays that control the current flow to the motor

coils have contacts rated at 24 volts 2 amps maximum. This could be increased but the design of the control circuit would then be significantly more complicated.

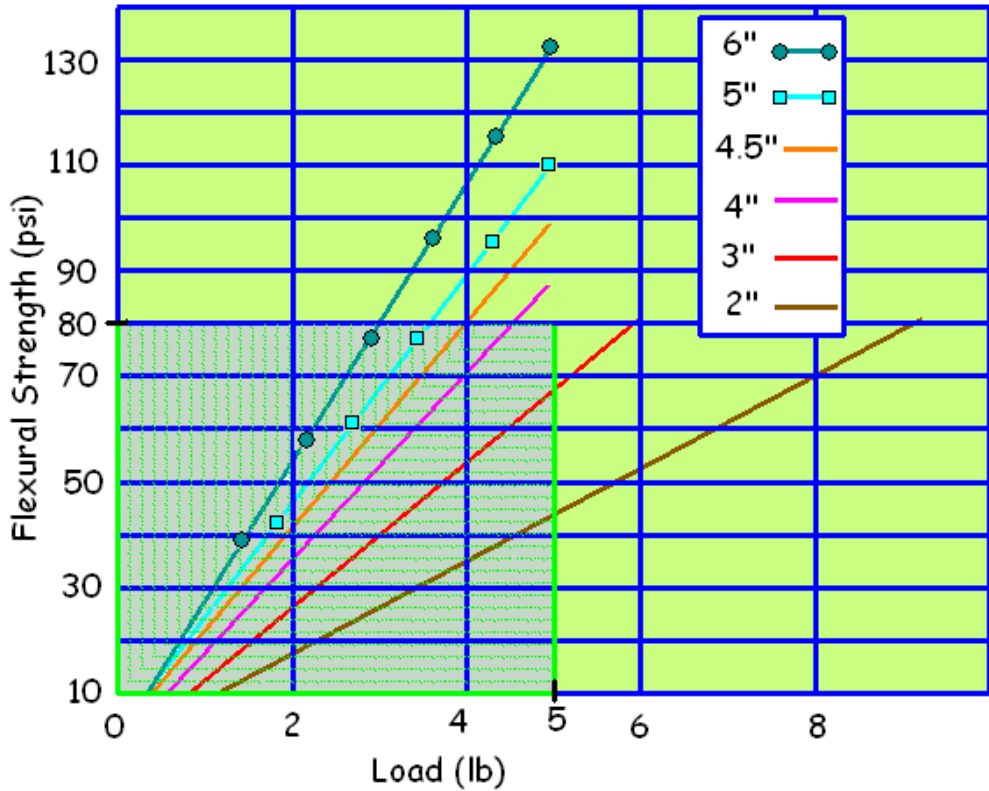

Figure 3.10 Relationship between Applied Load and Flexural Strength for Selected Lengths of Test Specimens

The current relay coils trigger at 5 volts. Increasing the contact voltage to 50 or 75 volts would have 12 to 20 coil voltages respectively. Since adequate torque is obtained by operating at a voltage at or less than 24 volts, the interface circuit continues to use the 24 volt relays. Operating the system at 24 volts and 2 amps, the motor has not exceeded the manufacturer's recommended maximum temperature of 175 degrees °F. Under continuous use, the motor runs at a temperature of 125 degrees. The final prototype loading device developed in Task 3 is shown in Figure 3.11. Figure 3.12 shows schematic views of the front and end elevations of the new test device.

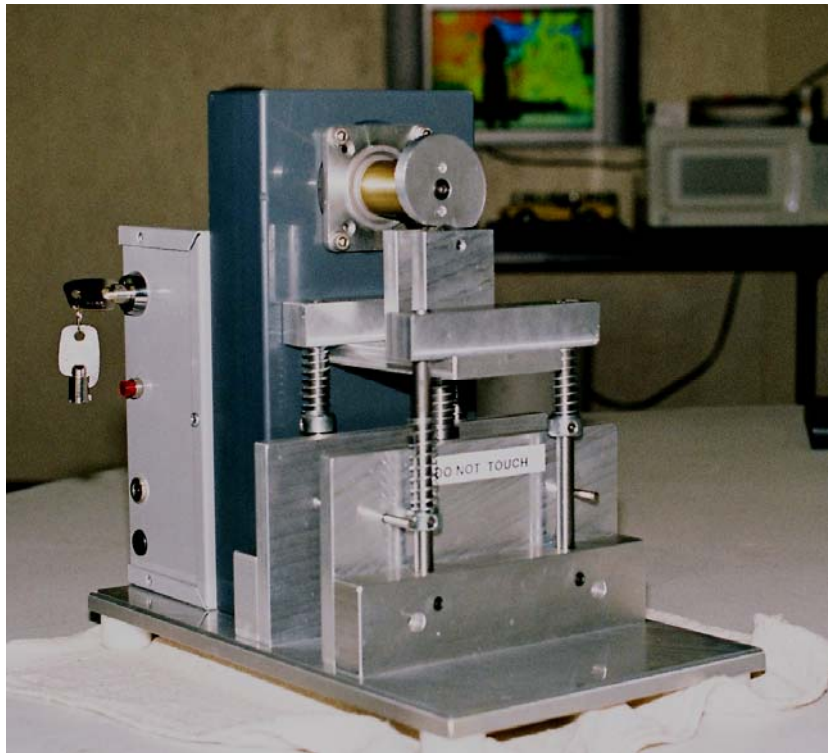
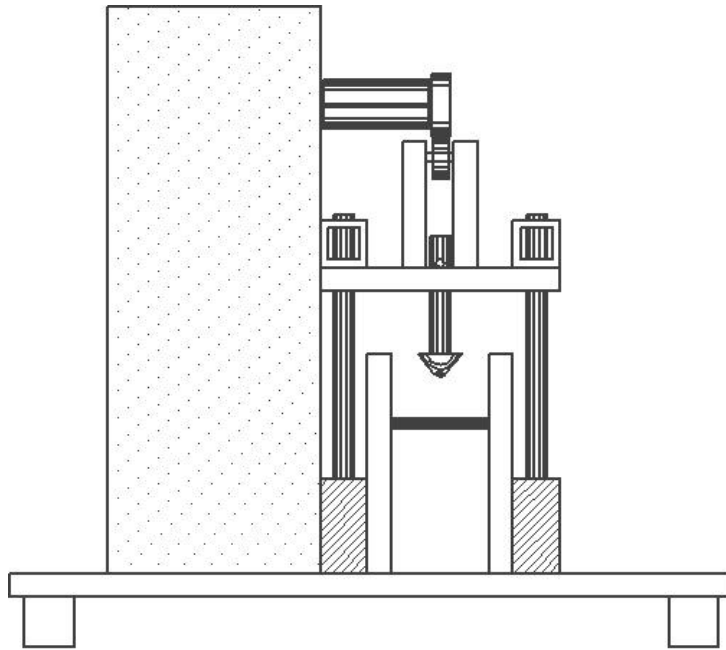
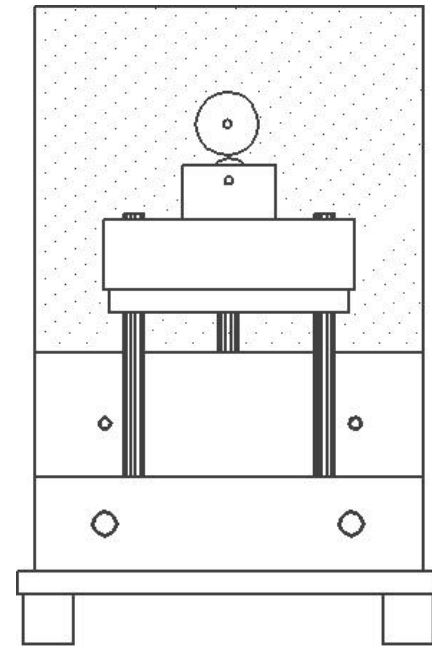

Figure 3.11 Final Prototype Loading Device



End Elevation



Front Elevation

Figure 3.12. Schematic Views of the Finished Prototype Test Device

CHAPTER 4

MATERIAL SAMPLING AND TESTING

OVERVIEW

The primary goal of this research study was to determine the suitability of the proposed base binder flexometer strength test as a future quality control test for base and subbase materials used in TxDOT construction projects. The suitability of the test method would depend on following important factors: (a) ability to produce reliable and repeatable results, (b) quantity of material needed and testing time, and (c) strength of the correlation that exists between flexometer strength and the currently used Texas triaxial strength. To evaluate the new test method with respect to the above, it was necessary to sample and test a fairly broad range of base and subbase materials. This chapter describes the material source selection and sampling process as well as the laboratory test program.

MATERIAL SAMPLING

Source Selection

As a first step, all 25 TxDOT districts were contacted and then, with the assistance from district laboratory engineers and supervisors, material sources that met the project requirements were identified. The primary criteria used in the selection of candidate sources of material were as follows:

- (a) The selected materials were should represent the broad range of materials that are commonly encountered in flexible base, treated base/subgrade in TxDOT roadway construction projects. This is an important consideration because the proposed research is expected to establish limits of applicability of flexometer test procedure based on results from lab testing. The candidate materials have been sorted according to mineralogical/lithological make up (crushed limestone, caliche, gravel, sandstone etc), according to engineering properties (e.g. high/medium/low wet ball mill values), sound materials (that easily meet flex base material specs) versus

marginal materials (that require mixing with modifiers to meet spec requirements) before making the final decisions with respect to their selection.

- (b) Only those material sources designated as “active” were selected for this research study. Those sources that did not have Texas Triaxial data could not be used for the development of cross correlations between base binder flexural strength and Texas triaxial strength but were used for the development of mixing moisture model during the development of the flexometer test procedure as described in Chapter 3.

- (c) Whenever possible, material was sampled from stockpiles that are designated for use in specific roadway construction projects. This will allow comparison of materials’ laboratory performance against their field performance at a future time. However, it should be noted that such laboratory versus field performance comparison was not attempted as a part of this research study.

Sampling Procedure

All of the selected base materials were sampled from material stockpiles. Sampling of the materials and making arrangements for their shipment was accomplished by TxDOT district personnel. A total of 12 different TxDOT Districts participated in this process. They provided samples from 19 different base materials sources. The participating districts and base material sources included in this research study are shown in Figure 4.1.

All the district offices under TxDOT were contacted for material samples. Samples of seventeen different materials were received from eleven districts. A majority of these materials consisted of crushed limestone which is the most common flexible base and subgrade material used in Texas. Some of the samples consisted of gravel and sand, and some were pit run bases. Atterberg Limits, gradation, Opsi and 15psi triaxial test data and compaction data was provided for most of the samples.

Each of the seventeen materials was tested for flexural strength using the prototype base binder flexometer. Four sources that were available in sufficiently large quantity were selected for testing using the intermediate and large size beams. Triaxial test data for Opsi

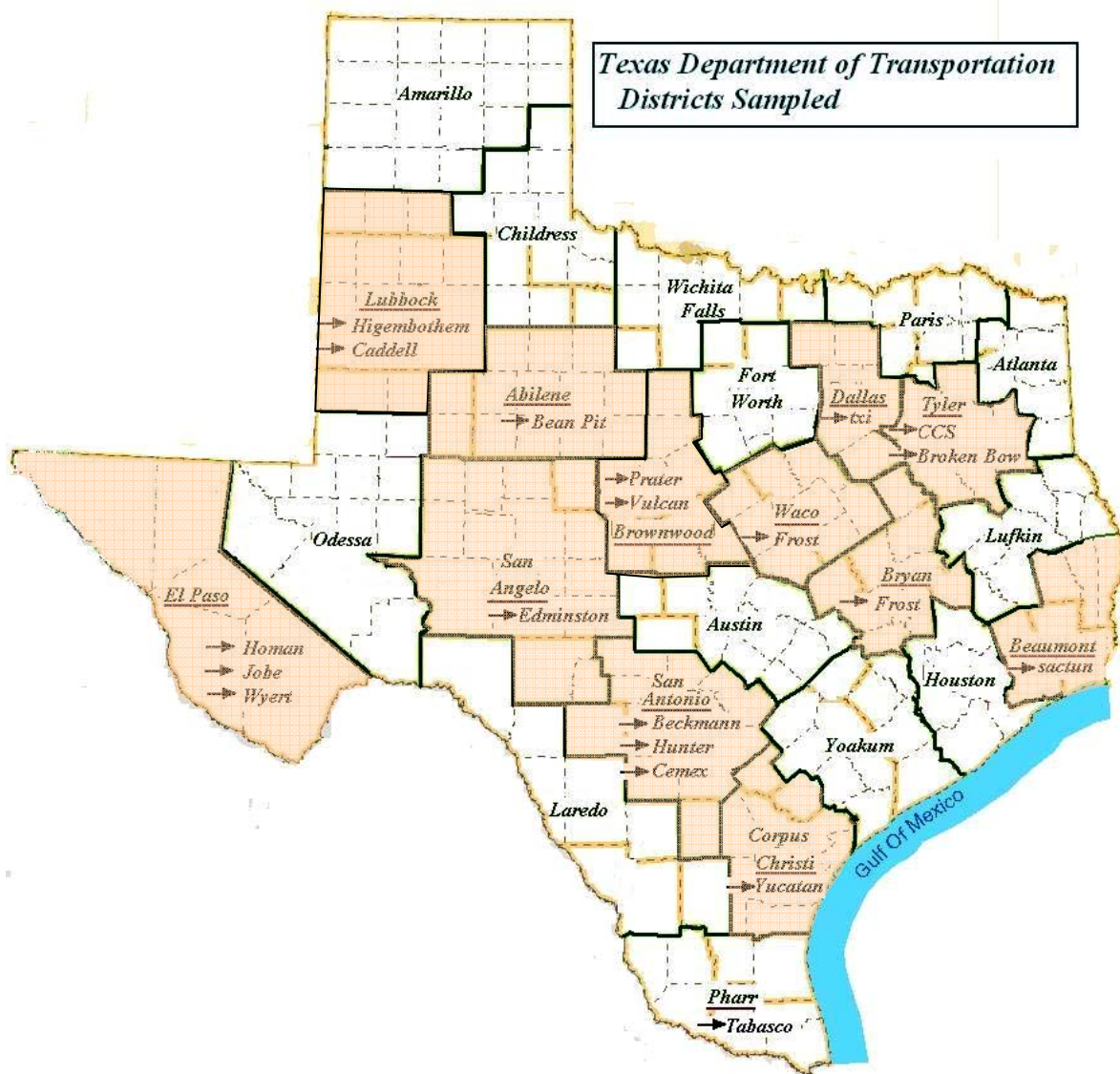

Figure 4.1. Participating TxDOT Districts and Base Material Sources Sampled

confining pressure, as low as 25 was reported or some of the materials. These materials do not meet the 0 psi triaxial strength requirement as stated in Tex-117-E. Such materials were identified and subsequently be used for testing with modifiers like flyash or cement added to them. Tables 4.1 and 4.2 list all 17 sources and the standard laboratory properties for each source.

Table 4.1 Properties of Flexible Base Material Sources Selected; Gradation and Atterberg Limits

District	Pit Name	CSJ	Material Description	Atterberg Limits			Gradation %							
				PL	LL	PI	Retained 1 3/4"	Retained 1 1/4"	Retained 7/8"	Retained 5/8"	Retained 3/8"	Retained # 4	Retained # 10	Retained # 40
Abilene	Bean	157-9-1	Crushed Limestone	12	22	10	-	-	-	-	-	-	-	-
Abilene	Vulcan/Blacklease		Crushed Limestone	12	14	2	0.0	-	-	-	-	47.0	-	80.7
San Angelo	Edminston	C148-3-23	Crushed Limestone	18	26	8	0.0	9.0	21.0	31.0	57.0	57.0	68.0	80.0
San Angelo	CSJ/Turner	0555-05-018	Crushed Limestone	13	16	3	0.0	-	-	-	-	60.7	-	79.8
Brownwood	Prater	1039-01-029	Crushed Limestone	21	28	7	2.3	-	21.9	29.6	40.4	51.6	-	73.7
Brownwood	Vulcan	QC	Crushed Limestone	12	14	2	0.0	-	-	-	-	47.0	-	80.7
Pharr *	Tabasco Pit *	1802-01-031	Pit Run Base	18	24	6	-	-	-	-	-	55.4	-	72.7
San Antonio	Beckmann Quarry	QC	Aggregate/sand mix	14	17	3	0.0	2.7	12.3	24.3	36.1	49.8	-	71.0
Tyler *	Cedar Creek Stone *	0197-06-028	Sand & Igneous Rock	22	27	5	0.0	-	-	-	-	68.1	-	77.6
San Antonio	Hunter Pit	various	Crushed Limestone	17	13	4	0.0	-	20.8	-	49.1	61.4	-	78.2
San Antonio	Cemex, New Braun.	various	Crushed Limestone	12	16	4	0.0	-	18.5	-	47.4	-	-	78.2
Beaumont	Vulcan/Sactun Mex		Crushed Limestone	15	23	8	-	-	-	-	-	-	-	-
Corpus Christi	Vulan/Yucatan Mexico	101-8-1	Crushed Igneous	<i>BLS Method **</i>		5	0.0	-	18.9	-	53.8	67.2	-	81.9
Waco	Frost Pit		Crushed Limestone	15	21	6	-	-	-	-	-	59.7	-	77.1
Dallas	TXI Bridgeport	196-2-78	Crushed Limestone	14	21	7	0.0	-	15.1	-	43.6	60.2	-	81.4
Tyler	Broken Bow S&G	10-76-7	Sand & Gravel	<i>BLS Method **</i>		3	0.0	-	22.4	-	49.4	59.2	-	76.2
El Paso	Holman	75-1-20	Sand & Gravel	<i>BLS Method **</i>		5	0.0	-	14.0	-	36.0	49.0	-	78.0
El Paso	Jobe	District Wide	Crushed Limestone	<i>BLS Method **</i>		5	0.0	-	-	-	-	49.0	-	79.0
El Paso	Wyert	0075-01-020	Sand & Gravel	<i>BLS Method **</i>		3	0.0	-	15.0	-	36.0	50.0	-	79.0
Lubbock	Reworked Base	US 62/Floyd	Reworked Base											

* The binder portion of these materials is not of the same parent material as the aggregate portion. Therefore, the binder and matrix are composed of different mineralogy and origin.

** Bar Linear Shrinkage Method used to determine Plasticity Index

Table 4.2 Properties of Flexible Base Material Sources Selected; Wet Ball Mill, Texas Triaxial, and Compaction Test Data

District	Pit Name	CSJ	Material Description	Wet Ball Mill		Triaxial		Compaction	
				Value	% Loss	0 psi	15 psi	Optimum Moisture %	Maximum Density(pcf)
Abilene	Bean	157-9-1	Crushed Limestone			46.7	206.0	8	134.1
Abilene	Vulcan/Blacklease		Crushed Limestone	33.0	12.0	28.6	191.9	5.7	145.1
San Angelo	Edminston	C148-3-23	Crushed Limestone	34.0	14.0	45.0	177.0	7.1	138.6
San Angelo	CSJ/Turner	0555-05-018	Crushed Limestone	31.0	11.0				
Brownwood	Prater	1039-01-029	Crushed Limestone	48.0	19.0	24.7	123.2	10.5	127.0
Brownwood	Vulcan	QC	Crushed Limestone	33.0	12.0	53.0	193.9	5.7	145.1
Pharr *	Tabasco Pit *	1802-01-031	Pit Run Base	35.0	N.R.	41.0	N.R.	8.7	128.7
San Antonio	Beckmann Quarry	QC	Aggregate/sand mix	39.0	10.0	47.2	176.2	6.3	134.7
Tyler *	Cedar Creek Stone *	0197-06-028	Sand & Igneous Rock	38.0	15.0	50.9	194.8	7.5	136.4
San Antonio	Hunter Pit	various	Crushed Limestone	35.0	15.0	50.3	244.4	6.1	141.8
San Antonio	Cemex, New Braun.	various	Crushed Limestone	32.0	11.0	70.3	253.8	6.0	140.3
Beaumont	Vulcan/Sactun Mexico		Crushed Limestone	38.0	7.0	64.2	N.R.	8.7	129.2
Corpus Christi	Vulan/Yucatan Mexico	101-8-1	Crushed Igneous	28.0	5.0	59.0	222.0	9.4	127.9
Waco	Frost Pit		Crushed Limestone	33.0	6.0	27.5	198.3	7.6	134.0
Dallas	TXI Bridgeport	196-2-78	Crushed Limestone	21.0	5.0	43.3	190.1	5.8	138.2
Tyler	Broken Bow S&G	10-76-7	Sand & Gravel	32.0	7.0	24.7	205.0	5.4	141.1
El Paso	Holman	75-1-20	Sand & Gravel	39.0	18.0	46.1	147.6	7.7	136.5
El Paso	Jobe	District Wide	Crushed Limestone	27.0	5.0	50.2	142.9	7.4	135.0
El Paso	Wyert	0075-01-020	Sand & Gravel	37.0	17.0	46.2	137.9	6.9	135.7
Lubbock	Reworked Base	US 62/Floyd	Reworked Base						

LABORATORY TESTING

Laboratory testing conducted in this research can be divided into two separate phases; Phase I laboratory testing and Phase II laboratory testing.

Phase I Lab Test Program

In Phase I laboratory testing, all material sources sampled were tested using the standard test procedure described in Chapter 3. This procedure, which is also outlined in detail in Appendix A, used a 4-day curing period for all test specimens. The data collected from Phase I testing were used to develop flexometer strength-Texas triaxial strength correlations and to examine the repeatability of the flexometer test data.

Phase II Lab Test Program

Meanwhile, Phase II lab testing was designed to address specific issues or concerns related to the current binder flexural strength test procedure. This test program can be further divided into Phase II-A, II-B and II-C test programs based on the specific issue that each test program was designed to investigate. The following sections describe each of these lab test programs in detail.

Phase II-A Test Program: Effect of Test Specimen Size

The current base binder flexometer strength test utilizes small test specimens (length 5 inches and $\frac{3}{4}$ in square cross section) that are prepared with the standard bar linear shrinkage molds. The material that is used in the preparation of these test specimens consisted of the binder component (i.e. the minus No.40 component) of the base material. The use of the small test specimen size significantly reduces the quantity of material needed for testing as well as the labor involved. However, it has a major shortcoming in not being able to test material that is representative of the material that is used in the field. Therefore, Phase II-A lab test program investigated the possibility of developing a flexural strength test method for larger test specimens. For this purpose, two other test specimen sizes were considered. They were: (a) intermediate size specimens (length 8 inches and 1.5in square cross section) and (b) large size specimens (length 12 inches and 3in square cross section).

Figure 4.2 (a) below compares the 3 test specimens. The test specimen molds used for intermediate and large size test specimens are shown in Figures 4.2 (b) and (c) respectively.



(a)

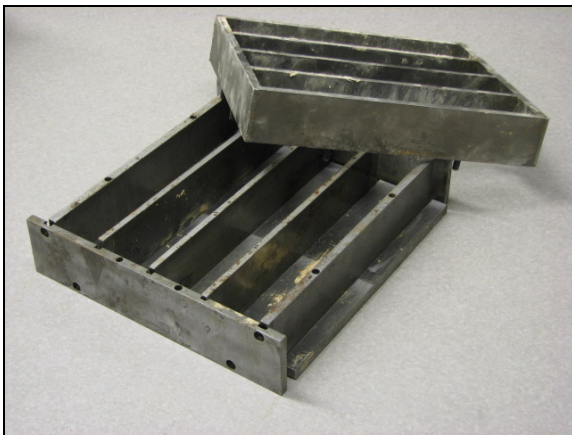

(b)



(c)

Figure 4.2 Small, Intermediate and Large Sized Test Specimens used for Flexural Strength Testing; (a) Cured Test Specimens, (b) Molds Used for Making Intermediate Size Test Specimens, (c) Mold Used for Making Large Size Test Specimens

As the size of the test specimen increased, the maximum particle size that could be accommodated in the preparation of the sample could also be increased. Accordingly, the intermediate size specimens were prepared using material passing No.4 sieve and large size

specimens were made using material passing ½-in sieve. In addition, the test specimen preparation procedures were adjusted as well. The most notable among the differences in sample preparation procedures was the compaction energy used. Each test specimen size used a specially designed compaction hammer. The hammer weight, drop height, number of blows per lift and number of lifts were adjusted to suit particular gradation of material used in each test specimen. Table 4.4 compares these test parameters. Figure 4.3 shows the hammers used in the preparation of intermediate and large size specimens.

Table 4.4 Test Parameters Corresponding Intermediate and Large Size Specimen Testing

	Intermediate Size Test Specimens	Large Size Test Specimens
Mold Size	1.5"x1.5"x8"	3"x3"x12"
Max Particle Size	No.4 Sieve	½-in sieve
Weight of Hammer (lb)	4.0	10.0
Drop Height (in)	12	18
No of Lifts	2	2
Blows/Lift	25	50
Compaction Energy (ft-lb/in ³)	11.1	13.9

Another significant observation that was made during the preparation of intermediate and large size specimens was that these large samples could not be tested at moisture contents near optimum values. At these moisture contents, the samples were found to be too weak to remain intact during handling and to produce meaningful flexural strength values from testing. Curing conditions for the samples were varied to determine the impact of the curing temperature and the relative humidity on the flexural strength of the test specimens. Based on the findings the decision was made to perform flexural strengths tests 3hrs, 5hrs and 8hrs after sample molding.

The loading systems used in the flexural strength testing of the small, intermediate and large size specimens were also different. The small size specimens were tested for their flexural strength using the *Base Binder Flexometer*, a test apparatus that was specially designed and built for this purpose. The intermediate size test specimens were tested using a loading system called the *Snapshot Testing Device* (See Figure 4.4). Similar to the testing performed on small size test specimens, center-point loading was used for intermediate size



(a)



(b)

Figure 4.3 Compaction Hammers Used in the Preparation of (a) Intermediate and (b) Large Size Test Specimens



Figure 4.4 Flexural Testing of Intermediate Size Specimens Using Snapshot Loading Device

specimens as well. However, knife edge loading - rather than point loading - was used in the case of intermediate size specimens. The loading rate used was 0.5 in/min and the load applied was measured to ± 0.02 -lb accuracy. For large size test specimens were tested for their flexural strength using a standard triaxial test load frame. Instead of the center point loading used for small and intermediate size specimens, third point loading was used for large size specimens. Figure 4.5 shows the above test set up.



(a)



(b)

Figure 4.5 Flexural Testing of Large Size Specimens: (a) Accessories Fabricated and Used for 3-Point Loading, (b) Triaxial Loading Frame

Phase II-B Test Program: Flexometer Testing with Accelerated Curing

As explained in Chapter 3, the standard flexometer test procedure used a 4-day curing of the test specimen. The rationale behind the use of the 4-day curing time was that this would allow the same test procedure to be used for both unmodified flexible base material and marginal quality materials that are blended with lime, cement or flyash for strength enhancement. Even though the 4-day curing is necessary when a material is blended with additives to allow the pozzolonic reactions to take place, this long curing period is unnecessary for unmodified materials. In fact, there is significant advantage in using a shorter curing time because it significantly cuts down the turn around time for the test. The focus of Phase II-B test program was investigate the feasibility of using a shorter curing time. This test program included a series of tests in which samples were prepared and tested in accordance with the standard flexometer test with the only exception that the curing was reduced to a few hours. In this modified test procedure the test specimens, after being molded, were placed in the curing chambers at 100°F as before. Then they were taken out periodically and weighed to monitor reduction in sample moisture content. By weighing the sample trays, it was possible to determine when the specimens have reached the same range of moisture contents that they had been tested in the original procedure. Flexural strength testing was performed using the same identical procedure as before with the Base Binder Flexometer.

Phase II-C Test Program: Validation of Flexometer Test Device

The prototype flexometer test device described in Chapter 3 does not make a direct measurement of the load being applied on the test specimen. Instead, it uses a calibrated loading spring for which the load-displacement relationship is known. Accordingly, the load is determined in the following manner. The loading cam controls the compression of the spring. The cam profile is known and therefore, as a first step, the compression of the spring can be determined for a particular loading step. Then using the load-displacement relationship and the known spring compression the load can be calculated. However, this load calculation procedure is based one major assumption. It assumes that the deflection of the beam at the loading point is negligibly small. In this research, Phase II-C Test Program checked the validity of this assumption. For this purpose, a series of parallel tests were run

on the same material using the flexometer test device and the Snapshot device describe in Phase II-A. Then the results were compared to determine whether a significant error may result from the assumption that beam deflection can be neglected.

CHAPTER 5

DATA REVIEW AND ANALYSIS

OVERVIEW

The data collected in Phase I and Phase II laboratory test programs are presented in Appendix B of this report. In this chapter, the above data are reviewed and analyzed to reach useful conclusions regarding the new base binder flexometer test procedure and flexural strength data produced. The review begins with general trends observed in the flexural strength data. Subsequent analyses examine the strength of the correlation that exists between flexometer flexural strength and the Texas Triaxial strength as well as the repeatability of the base binder flexometer test. The following sections describe the data review and analysis procedures and the conclusions derived from such review.

REVIEW OF DATA COLLECTED IN PHASE I – LAB TEST PROGRAM

As described in Chapter 4, Phase I lab test program consisted of the base binder flexometer testing of all 21 sources of base materials selected for this research study. These tests used the original test procedure outlined in Appendix A. This test procedure uses 4-day curing of test specimens. According to this procedure, typically 3 or 4 trays of test specimens are prepared and cured from each material source. Each tray would consist of 6 test specimens. Then 1 sample from each tray is taken out of the curing chamber and tested to determine the flexural strength. After the flexural strength has been determined, the remnant pieces of the ruptured test specimen are used to determine the moisture content of the material at the time of testing. After some time has elapsed, the next set of specimens are removed from the curing chamber and tested to determine flexural strength. Since these test specimens have been subjected to a slightly longer curing time, the test moisture contents for these are lower and the strengths measured are generally higher. Then these steps are repeated for all the remaining test specimens with a short time interval between different sets. When all test specimens have been tested for flexural strength, the data is plotted as shown in Figure 5.1 to produce a flexural strength versus test moisture content plot.

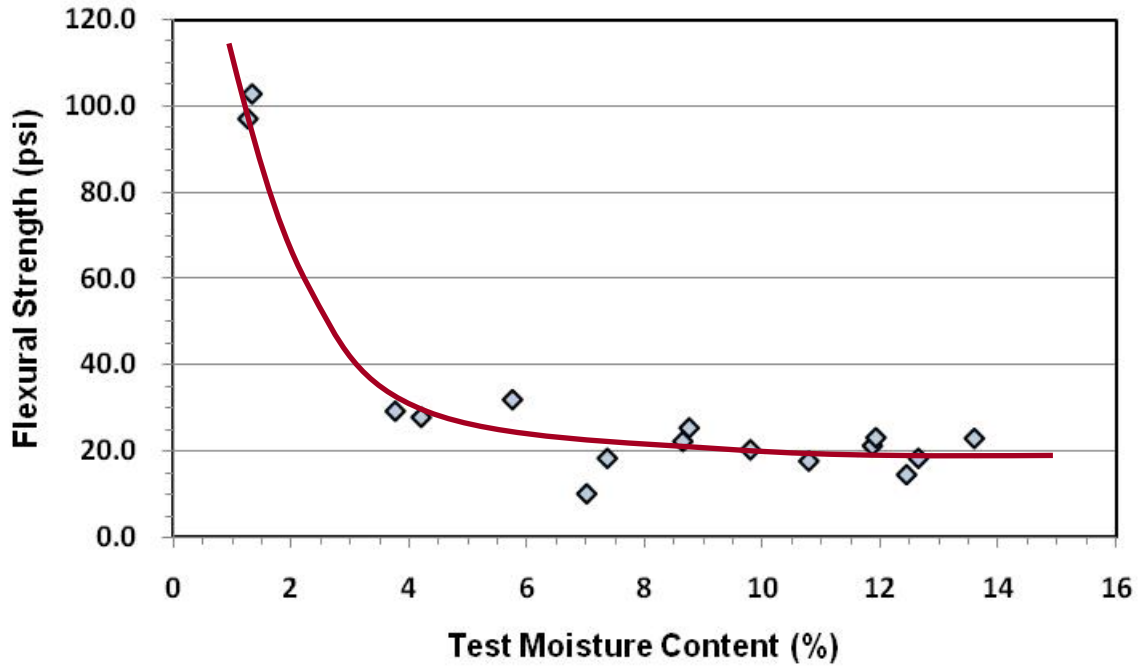

Figure 5.1 Flexural Strength versus Test Moisture Content Relationship
San Antonio/Hunter Pit

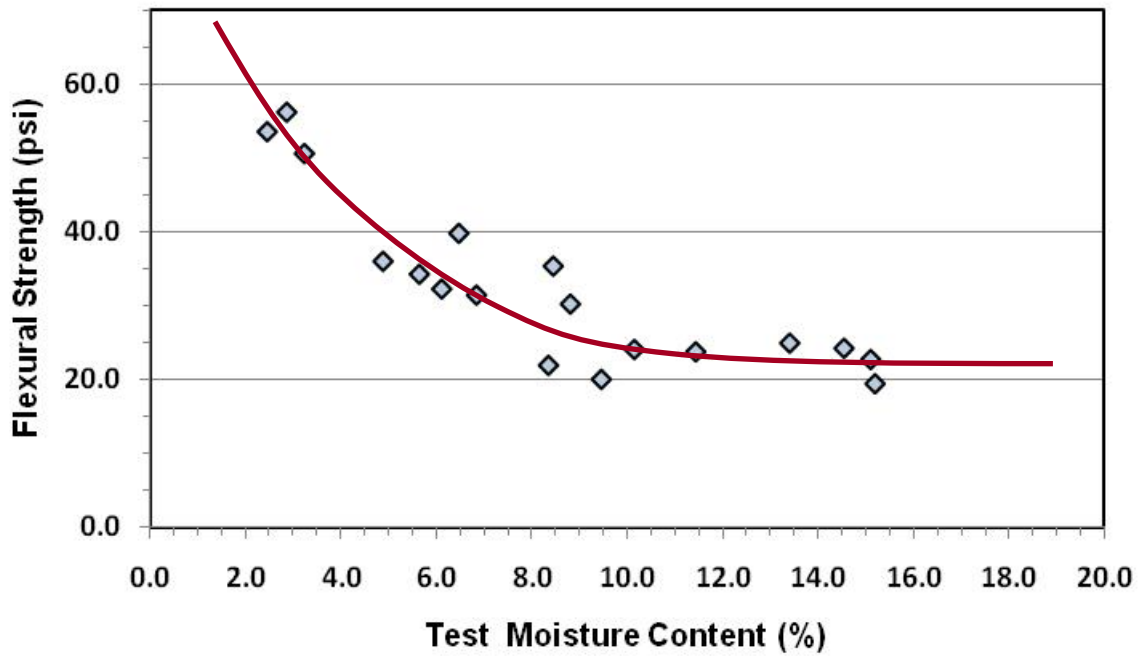

Figure 5.2 Flexural Strength versus Test Moisture Content Relationship
El Paso/Jobe Pit

The observed variation of the flexural strength with the sample moisture content represents a trend that can be expected. As the moisture content decreases, the negative pore water pressure (or suction) within the interstitial spaces of a fine grained soil increases. The higher suction values lead to larger effective stresses within the material which, in turn, cause the increase in material strength. The observed trend in flexural strength versus moisture content, however, has important implications on the interpretation of test results. In other words, the measured flexural strength value must be all reported at a pre-defined moisture content. This research examined a number of different choices for defining the moisture status of the specimen at which the flexural strength is reported. Among them were the plastic limit, the optimum moisture content, and selected moisture contents on the wet side of optimum. It was noticed that the choice of the test moisture content did not have any significant impact on the final outcomes that were of interest, i.e. the strength of the correlation between flexural strength and triaxial strength and the repeatability of the test method. Consequently, all flexural strengths were reported at the optimum water content. The following example illustrates the procedure used to obtain flexural strength from the test data. Figure 5.3 shows the data obtained for material recovered from the Tabasco Pit in Pharr District.

The general data trend in Figures 5.1, 5.2 and 5.3 can be represented by the following equation:

$$f = a + b \exp\left(-\frac{m.c.}{c}\right) \quad (5.1)$$

Where: f = flexural strength (psi)

m.c. = moisture content (%)

a, b, and c = constants determined through curve fit to data

Using the software, *TableCurve* the parameters corresponding to the best fit curve can be obtained. For the data shown in Figure 5.3, the best fit parameters are as follows: a = -16.7, b= 138.5, c= 13.89 and $R^2 = 0.89$. The best fit curve is also shown in Figure 5.3. Now, using the equation, the flexural strength corresponding to the optimum moisture content (8.7%) can be determined.

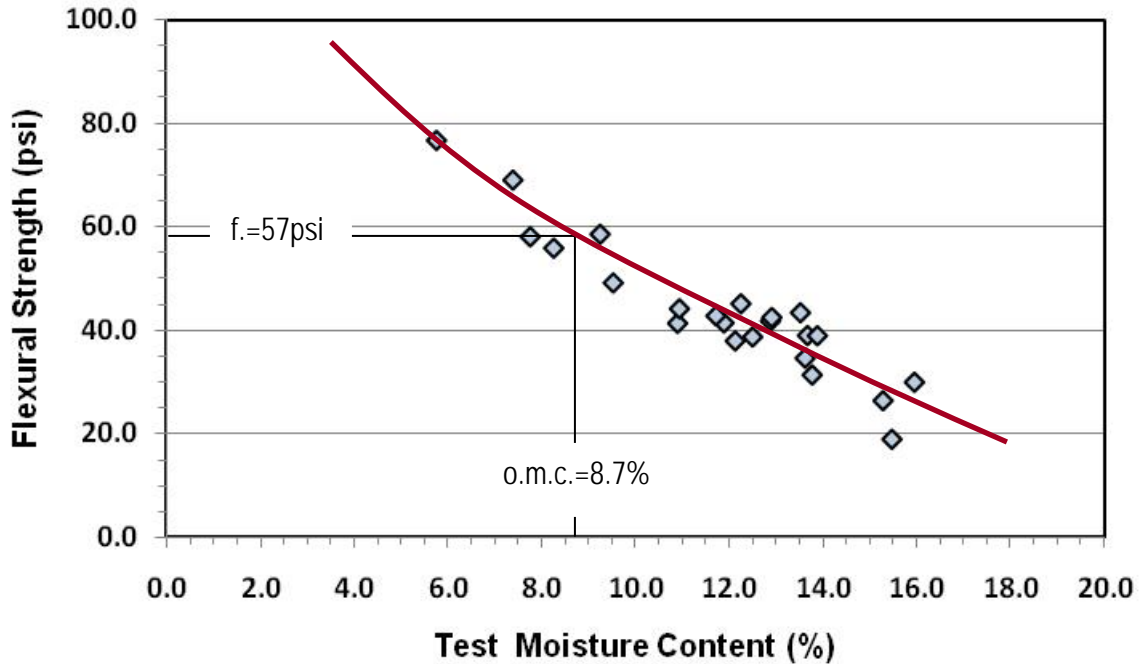

Figure 5.3 Determination of the Binder Flexural Strength for Material Recovered from Tabasco Pit, Pharr District

The flexural strength values were obtained for all material sources using the procedure described above. These values are listed in Table 5.1 below. Also, shown in this table are the Texas Triaxial strength data for the material obtained from the same source and same stockpile.

Data presented in Appendix B show that, in the case of some base materials, the flexural strength data did not follow any consistent trend. Instead, the flexural strength versus moisture content data showed a shotgun pattern. The 3 sources that belonged to this category are: Tyler Cedar creek stone, Dallas TXI and El Paso Wyert sources. Interestingly 2 of these sources are identified as “pit run gravel” and “sand & gravel” sources. The third, Dallas TXI is identified as a crushed limestone – but the material received consisted of very hard large particles and had a very small percentage of minus No.40 component. For these 3 sources, flexural strength estimate could not be determined reliably.

Table 5.1 Flexural and Texas Triaxial Strength Data for the Base Materials Tested

District	Pit Name	Binder Flexural Strength (psi)	Texas Triaxial Strength (psi)	
			0 psi	15 psi
Abilene	Vulcan/Blacklease Untreated	36.8	28.8	191.9
Abilene	Vulcan/Blacklease 2% Flyash	58.0	72.7	240.5
Abilene	Vulcan/Blacklease 4% Flyash	59.0	94.3	257.8
San Angelo	Edminston	62.4	45.0	177.0
San Angelo	CSJ/Turner	15.0	N.A.	N.A.
Brownwood	Prater	17.2	24.7	123.2
Brownwood	Vulcan	61.3	53.0	193.9
Pharr	Tabasco	57.3	41.0	N.A.
San Antonio	Beckmann	25.5	47.2	176.2
Tyler	Cedar Creek Stone	N.R.	50.9	194.8
San Antonio	Hunter	22.6	50.3	244.4
San Antonio	Cemex	61.1	70.3	253.8
Beaumont	Vulcan/Sactun	39.2	64.2	--
Corpus Christi	Vulcan/Yucatan	29.2	59.0	222.0
Waco	Frost	23.6	27.5	198.3
Dallas	TXI Bridgeport	N.R.	43.3	190.1
Tyler	Broken Bow	47.3	24.7	205.0
El Paso	Holman	41.0	46.1	147.6
El Paso	Jobe	26.0	50.2	142.9
El Paso	Wyert	N.R.	46.2	137.9
Lubbock	Reworked Base Untreated	8.6	22.6	N.A.
Lubbock	Reworked Base with 1% cement	25.8	35.2	N.A.
Lubbock	Reworked Base with 3% cement	49.8	62.5	N.A.

Notes: N.R. = No Result; Flexometer test did not produce data with any consistent trend
 N.A. = Not Available; Triaxial strength data could not be obtained from district labs

Flexural Strength versus Texas Triaxial Strength Correlation

In the next step in the data review process, the binder flexural strength data and the Texas Triaxial strength determined for the composite material were plotted against each other to determine whether there was any correlation between the two test parameters. For this purpose, triaxial strength values at 0 psi confining pressure were chosen because the binder strength will have a greater influence on the unconfined triaxial compression strength. Figure 5.4 shows the 0psi triaxial strength versus flexural strength plot.

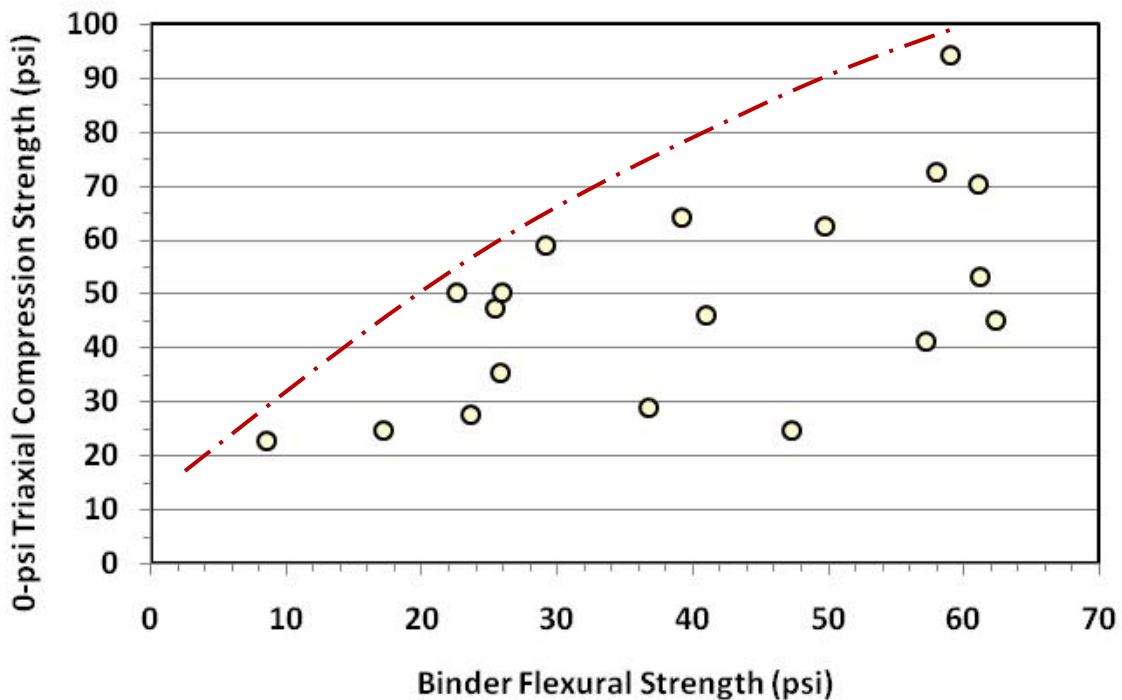

Figure 5.4 0psi Triaxial Strength versus Binder Flexural Strength

Figure 5.4 does not show a strong correlation between the two test parameters. However, it does show that the triaxial strength generally increases with increasing flexural strength. Furthermore, as indicated by the dotted line, an upper bound can be defined for the triaxial strength when the binder flexural strength is known.

An alternative approach to relate *compressive strength* to *flexural strength* can be found in the following empirical equation [13]:

$$f = n\sqrt{C} \quad (5.2)$$

where: f = flexural strength
 C = compressive strength
 n = correlation coefficient

Table 5.2 below lists the values of coefficient, n that were calculated for those base materials for which both flexural strength and 0-psi triaxial strength data were available.

Table 5.2 Correlation Coefficient, n for the Base Materials Tested

District	Pit Name	Binder Flexural Strength (psi)	0 psi Triaxial Strength (psi)	Coefficient, n
Abilene	Vulcan/Blacklease Untreated	36.8	28.8	6.86
Abilene	Vulcan/Blacklease 2% Flyash	58.0	72.7	6.80
Abilene	Vulcan/Blacklease 4% Flyash	59.0	94.3	6.07
San Angelo	Edminston	62.4	45.0	9.30
Brownwood	Prater	17.2	24.7	3.46
Brownwood	Vulcan	61.3	53.0	8.42
Pharr	Tabasco	57.3	41.0	8.95
San Antonio	Beckmann	25.5	47.2	3.71
San Antonio	Hunter	22.6	50.3	3.19
San Antonio	Cemex	61.1	70.3	7.29
Beaumont	Vulcan/Sactun	39.2	64.2	4.89
Corpus Christi	Vulcan/Yucatan	29.2	59.0	3.80
Waco	Frost	23.6	27.5	4.50
Tyler	Broken Bow	47.3	24.7	9.52
El Paso	Holman	41.0	46.1	6.04
El Paso	Jobe	26.0	50.2	3.67
Lubbock	Reworked Base Untreated	8.6	22.6	1.81
Lubbock	Reworked Base with 1% cement	25.8	35.2	4.35
Lubbock	Reworked Base with 3% cement	49.8	62.5	6.30

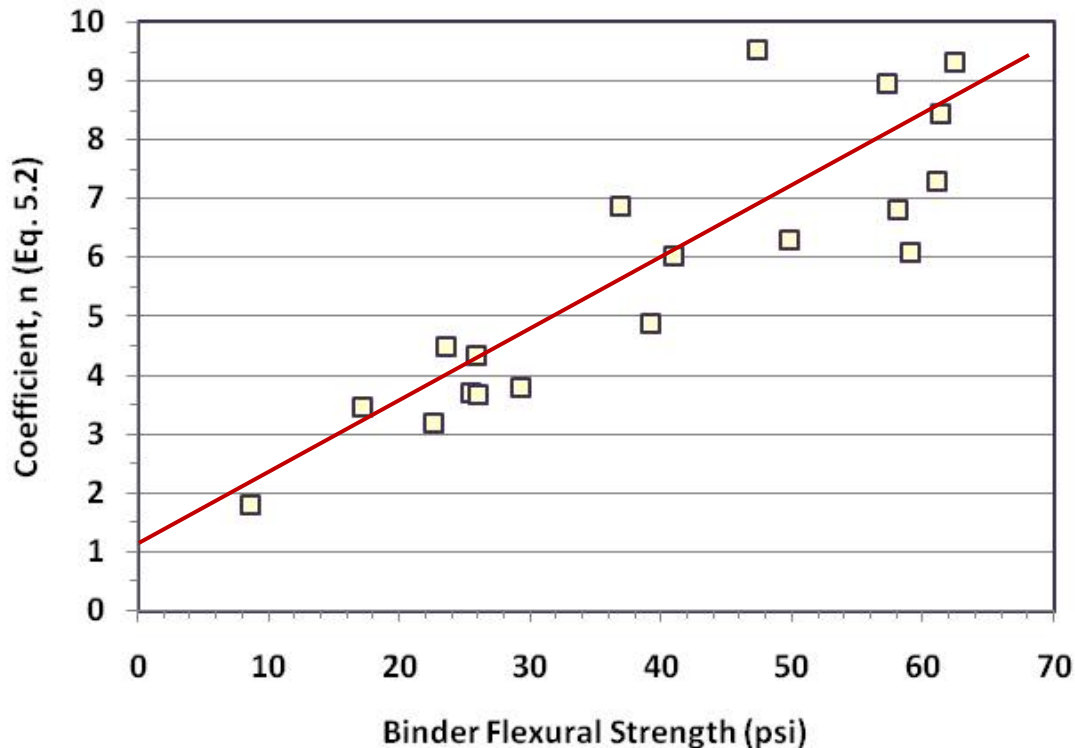

Figure 5.5 Coefficient, n versus Binder Flexural Strength

Figure 5.5 above shows the relationship between the coefficient, n calculated using Equation (5.2) for the base material tested. This represents a much better correlation than seen earlier in Figure 5.4. A linear regression performed between the two parameters yielded the following regression equation.

$$n = 1.142 + 0.116 (f) \quad (5.3)$$

$$R^2 = 0.88$$

A closer review of the flexural strength data shows reveals that the shape of the flexural strength versus test moisture content characteristic curve varies from one material to another. In some materials the flexural strength remains fairly constant as the material dries out to but then begins to increase rapidly once the moisture content reaches a certain threshold value. This threshold value is typically several percentage points below the optimum moisture content of the material. Figure 5.1 is representative of the group of material with such flexural strength-moisture content characteristic. Figure 5.2 shows a

flexural strength versus moisture content plot that shows a more gradual change in strength with varying moisture content. Nevertheless, the flexural strength reached a constant value at higher moisture contents.

Other materials, such as that represented by Figure 5.3, flexural strength versus test moisture content curve never reached a constant terminal value. In Figure 5.6 material categories are separated. In this figure, Type I refers to those materials that show a constant terminal value for the flexural strength, Type II refers to those that do not. In addition, this figure separates the materials which were tested with cement and flyash additives/modifiers. The figure suggests that if correlations were to be established for each category of material, the R^2 -values are likely to be higher. Table 5.3 provides the correlations established when each material category was considered separately.

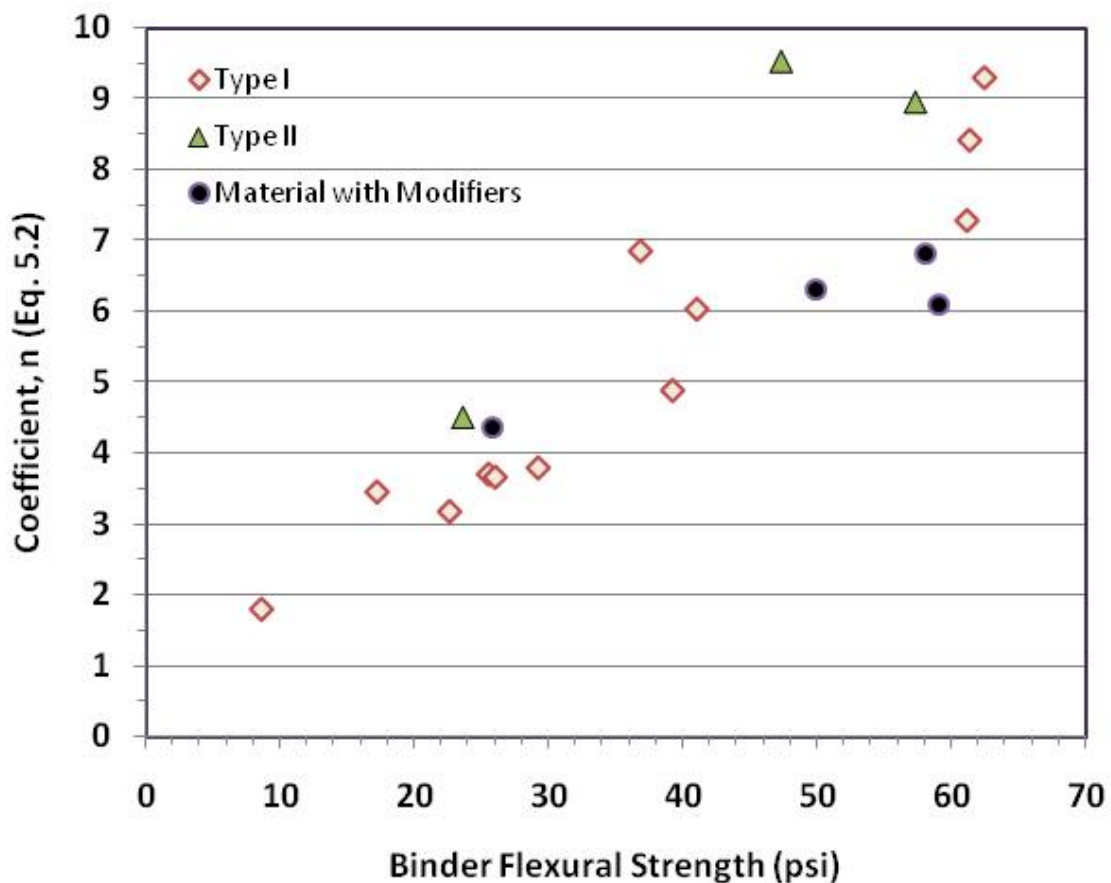

Figure 5.6 Coefficient, n versus Binder Flexural Strength for Type I, Type II and Modified Materials

Table 5.3 Regression Models for Type I, Type II and Modified Materials

Material Category	Regression Model	R²
Type I	$n = 0.746 + 0.124 \cdot f$	0.91
Type II	$n = 1.399 + 0.146 \cdot f$	0.85
Modified Base	$n = 2.784 + 0.064 \cdot f$	0.87

Repeatability of the Flexometer Test

During the initial planning of this research project, the flexometer test was conceived as one that consists of one tray - or six test specimens - of binder material. To evaluate the test method for repeatability, multiple trays of specimens were to be prepared from each material and tested for flexural strength. According to the above original plan, each tray of material would have produced a separate flexural strength measurement. This would have allowed the standard deviations of the flexural strengths to be calculated from multiple measurements available. However, during the course of the research, the data interpretation procedure was modified so that each test would combine data from 3-4 trays of test specimens. Thus, the evaluation of the test method for repeatability could not be accomplished without significant expansion of the original research plan. As an alternative plan, it was decided that the repeatability analyses would be performed on a subset of the material samples. Accordingly, 5 sources were selected for replicate flexometer testing. The flexural strength measurements made on these 5 material sources, the corresponding standard deviations and coefficients of variation are found in Table 5.4.

Next for comparison purposes, similar analysis was conducted on Triaxial strength data. These data, which were obtained from TxDOT district laboratories represented Triaxial strength measurements made on material samples collected from the same stockpile delivered to a project site. The results from the above analysis are summarized in Table 5.5. This analysis suggests that the binder flexural strength test is significantly more consistent (i.e. lower standard deviation and the coefficient of variation) than the Texas Triaxial Test.

Table 5.4 Standard Deviation and Coeff. of Variation of Binder Flexural Strength for the Selected 5 Sources

District/Source Name	Flexural Strength (psi)				Std. Deviation (psi)	Mean (psi)	C.O.V %
Pharr Tabasco	54.9	60.0	53.1	59.4	3.38	56.9	5.9
San Antonio Beckmann	27.3	21.6	26.7	26.3	2.62	25.4	10.3
San Angelo CSA/Turner	14.5	14.8	13.6	11.1	1.67	13.5	12.4
Lubbock Reworked Base	10.8	8.5	7.8	7.0	1.59	8.6	18.6
Abilene Vulcan/Blacklease	48.2	33.9	37.5	37.4	6.2	39.3	15.8
Average					3.1		12.6

Table 5.5 Standard Deviation and Coefficient of Variation of Texas Triaxial Strength at 0-psi

	Blacklease	Boothe	Fiester	Higgins	McCullum	Oatman	Oatman South	Parmelly	Phillips	Riddle	Tubbs	Yates	Average
	48	54	21	36	45.3	35.1	32.2	32	35	17	29	39	
	31	29	19.6	30.7	33	27.1	32.2	37	47.7	40	24	30	
	48		12.5	17.4		39.2	28.7	17	29.8	40		32	
	45					48	20.4	40		16			
	25					40.2	39.3			12			
	55					48.4				19			
	24									17			
	33												
	63												
	48												
	43												
	32												
	30												
	36												
	26												
	45												
Mean	39.50	41.50	17.70	28.03	39.15	39.67	30.56	31.50	37.50	23.00	26.50	33.67	
Std. Dev	11.15	12.50	3.72	7.82	6.15	7.36	6.14	8.85	7.52	10.93	2.50	3.86	7.37
COV %	28.22	30.12	21.02	27.91	15.71	18.55	20.09	28.08	20.05	47.51	9.43	11.46	23.18

REVIEW OF DATA COLLECTED IN PHASE II – LAB TEST PROGRAM

As explained in Chapter 4, the Phase II lab test program had 3 distinct components: Test Program II-A which examined the effects of sample size, Test Program II-B which investigated the feasibility of using a shorter time of curing for the test specimens, and Test Program II-C which involved tests to validate the flexometer test device. The following sections present the findings from each of these test programs.

Phase II-A Test Program: Effect of Test Specimen Size

Phase II-A test program included a limited scope laboratory study that involved flexural testing of large size test specimens. Two sizes of test specimens were included in this study; *Intermediate size specimens*: 8in long x 1.5in square section and *large size specimens*: 12 in long x 3in square section. Details with regard to material gradation used, procedures for sample preparation, curing and flexural testing were described in Chapter 4. The data obtained from Phase II-A test program are presented in this chapter.

4 material sources were included in the flexural strength test program for intermediate size specimens. They are: Abilene-Vulcan/Blacklease, Brownwood-Prater, Waco-Frost and Beaumont Vulcan-Sactun. In the meantime, only one material source was included in the flexural testing of large size specimens. This material was San Angelo-CSA/Turner. Choice of material sources for these test programs were largely based on the availability of material in the quantities needed for each test series. The flexural strength versus test moisture content plots obtained for intermediate size test specimens are shown in Figure 5.7 along with the best-fit curves. Figure 5.8 summarizes the test data obtained from the testing of large size specimens.

Phase II-A Test Program lead to following conclusions. First of all, maintaining integrity of the large size test specimens during handling and load testing was difficult when compared to the small, shrinkage mold sized test specimens. Large size specimens required longer curing (or drying) in the oven before they could be safely removed from the mold. Also, it was evident that the moisture content was not uniform within the sample cross-section. Therefore, the test moisture contents for these specimens were lower than those for the shrinkage mold sized specimens.

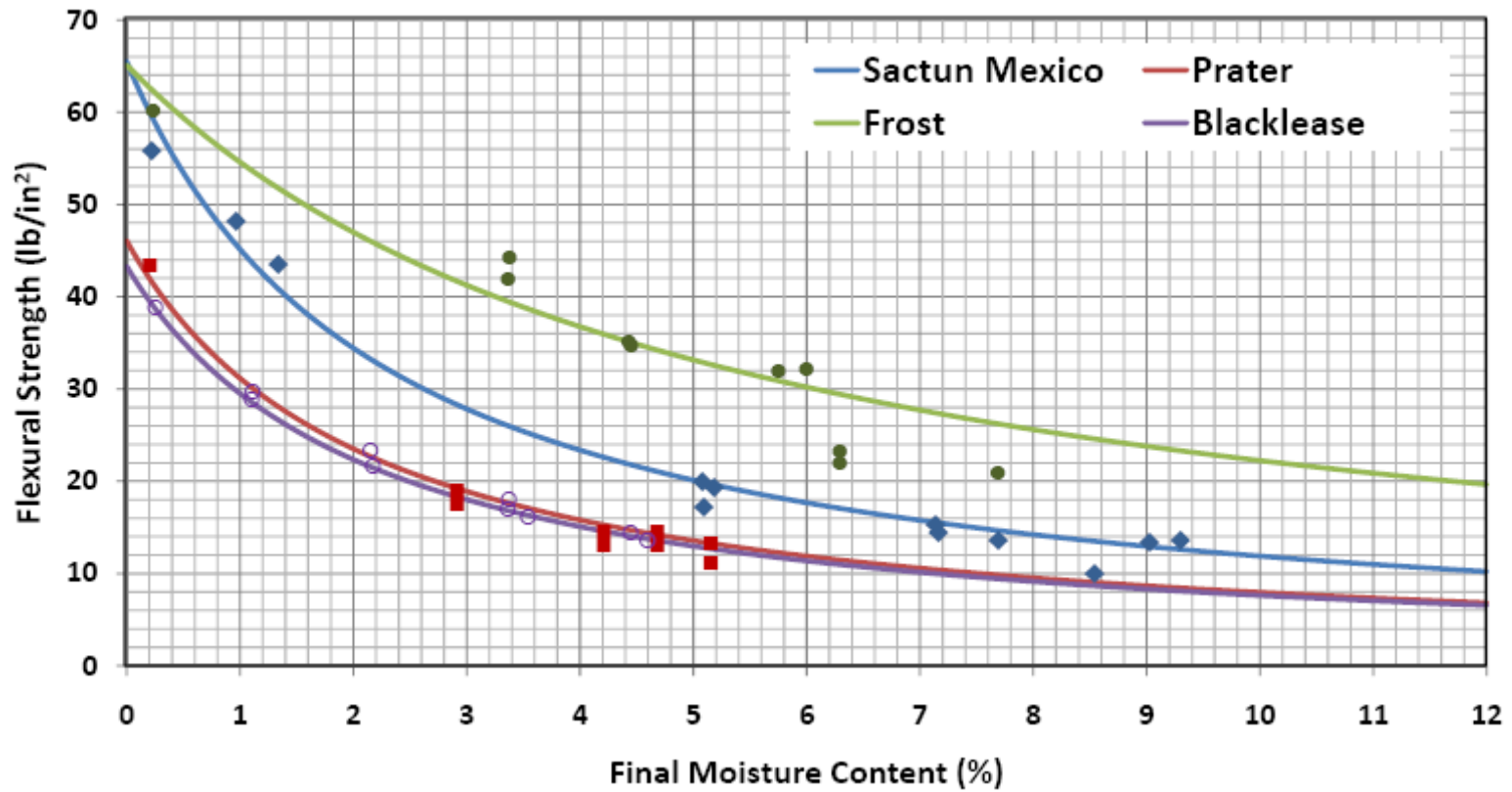

Figure 5.7 Flexural Strength versus Test Moisture Content Data for Intermediate Size Specimens

a) Loading Rate of 0.05 in/min

Soil Sample	Cured for 3 Hours	Cured for 5 Hours	Cured for 8 Hours
Flexural Strength (psi)	4.0	7.2	9.8
Moisture Content (%)	3.3	2.1	1.1

b) Loading Rate of 0.005 in/min

Soil Sample	Cured for 3 Hours		Cured for 5 Hours		Cured for 8 Hours	
Flexural Strength (psi)	4.40	4.50	7.77	7.63	10.47	10.27
Moisture Content (%)	3.3	3.4	2.0	2.1	1.2	1.2
Average Flexural Strength (psi)	4.45		7.7		10.37	

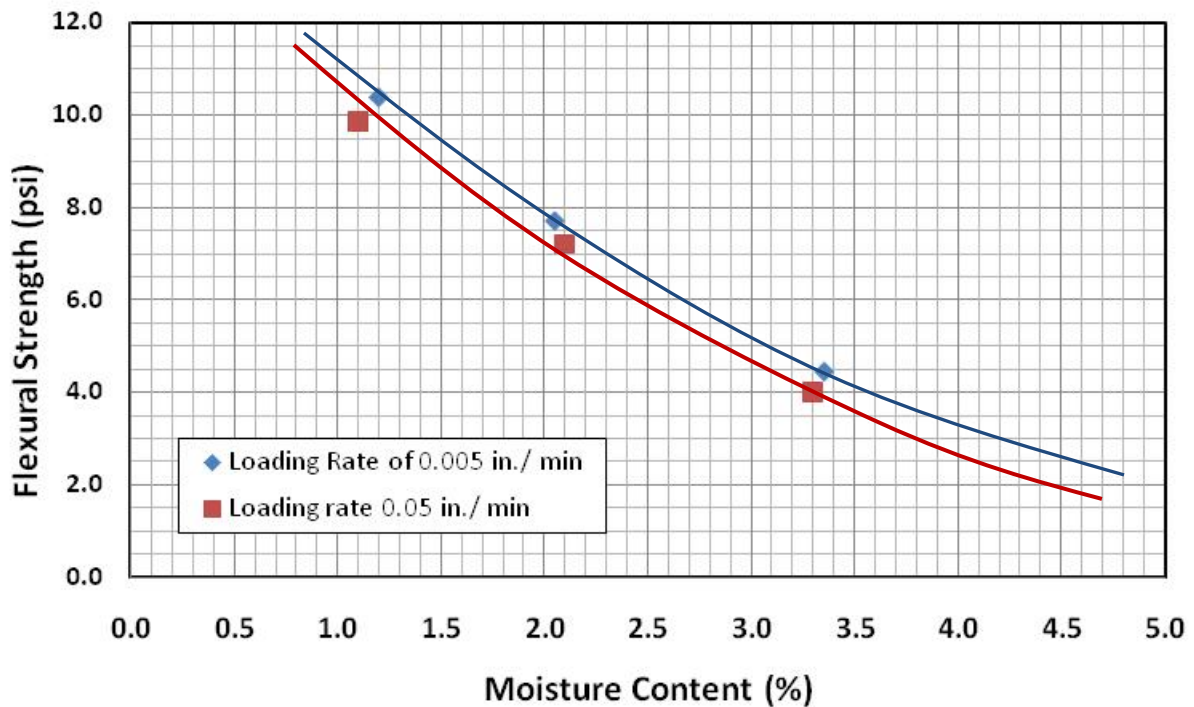

Figure 5.8 Flexural Strength versus Test Moisture Content Data for Large Size Specimens

Intermediate and large size specimens show the same flexural strength versus moisture content trend seen in shrinkage mold sized specimens. However, the flexural strengths measured at the same test moisture contents tend to be smaller for larger test specimens. The larger loading frame used for testing large sized specimens allowed the strain rate to be varied over a wide range. Therefore, testing was conducted at two different loading rates 0.05in/min and 0.005in/min. The results obtained confirmed that strain rates did not have any significant impact on the measured flexural strengths.

Phase II-B Test Program: Flexometer Testing with Accelerated Curing

Phase II-B Test Program investigated the feasibility of using a shorter curing time than that used in the standard procedure. In the standard procedure described in Appendix A, the rate of drying of all test specimens is controlled so that a fixed, 4-day curing time can be used for all materials regardless of whether the material has been treated with additives such as flyash and cement or not. Controlled drying is achieved by sealing the test specimens in polyethylene plastic bags. In this test program, flexural strength tests were repeated for 3 selected materials using an accelerated curing process. The primary difference in the curing process used in the accelerated test is that test specimens remain in the curing chamber which is maintained at 100°F and are never removed and sealed in plastic bags to slow down drying. The 3 material sources that were used in Phase II-B Test Program are: Brownwood-Prater, San Angelo-CSA/Turner and flexural and Waco-Frost. Once again, material availability was the primary factor considered in the selection of base materials to be included in this test program. The flexural strength versus moisture content characteristics obtained for the 3 materials using the accelerated test and the standard test are shown in Figures 5.9 through 5.11.

The comparison in figures 5.9 through 5.11 shows that the flexural strength-moisture content relationships obtained from both the standard and accelerated tests are similar. However, at the same time, it can be noticed that longer curing period provides a more gradual change in flexural strength versus moisture content. In other words, the accelerated test provides a graph with sharper curvature. As a result, the two test procedures will not yield the same flexural strength at the optimum water content.

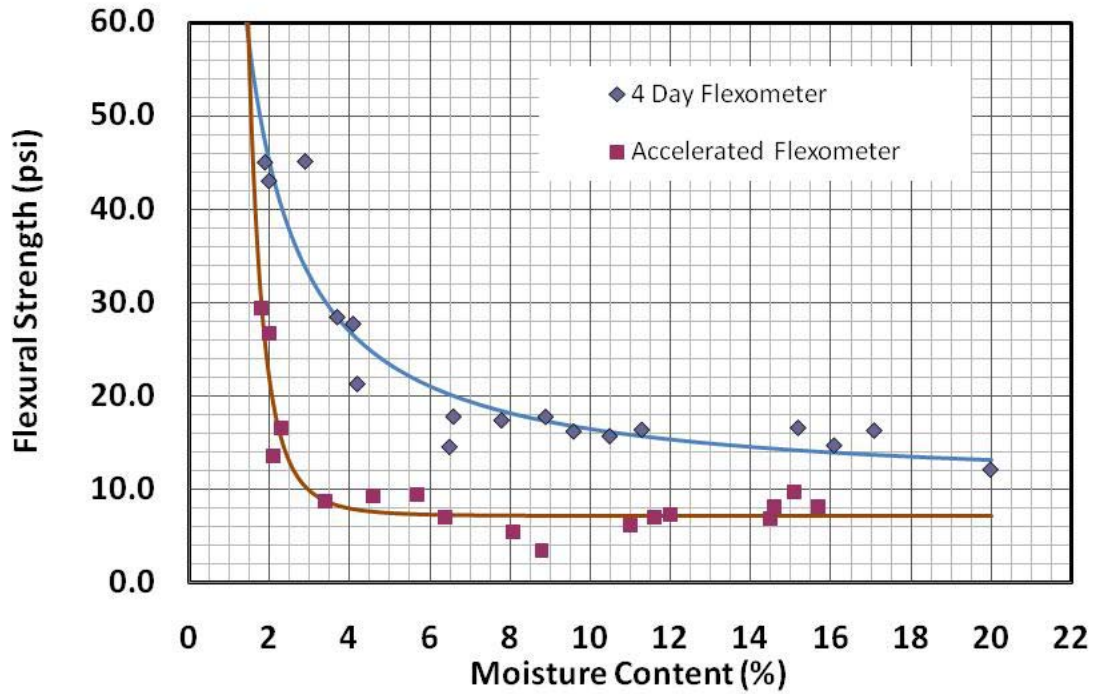

Figure 5.9 Comparison of Data Obtained from Standard, 4-Day Flexometer and Accelerated Flexometer Tests; Brownwood-Prater Source

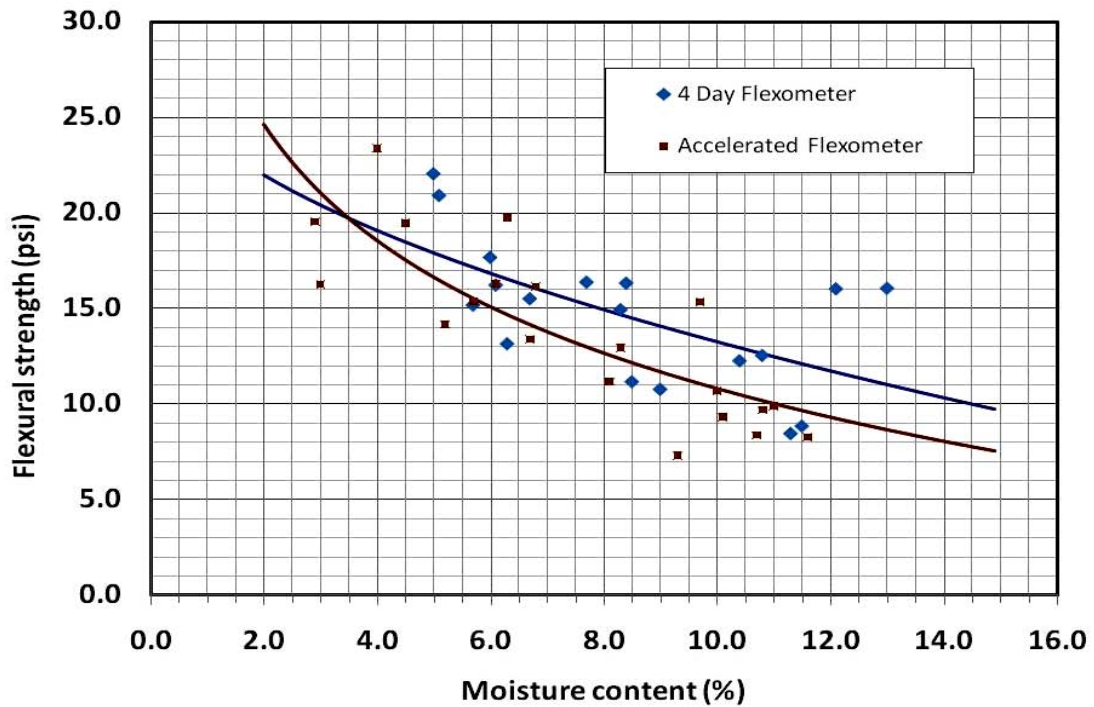

Figure 5.10 Comparison of Data Obtained from Standard, 4-Day Flexometer and Accelerated Flexometer Tests; San Angelo-CSA/Turner Source

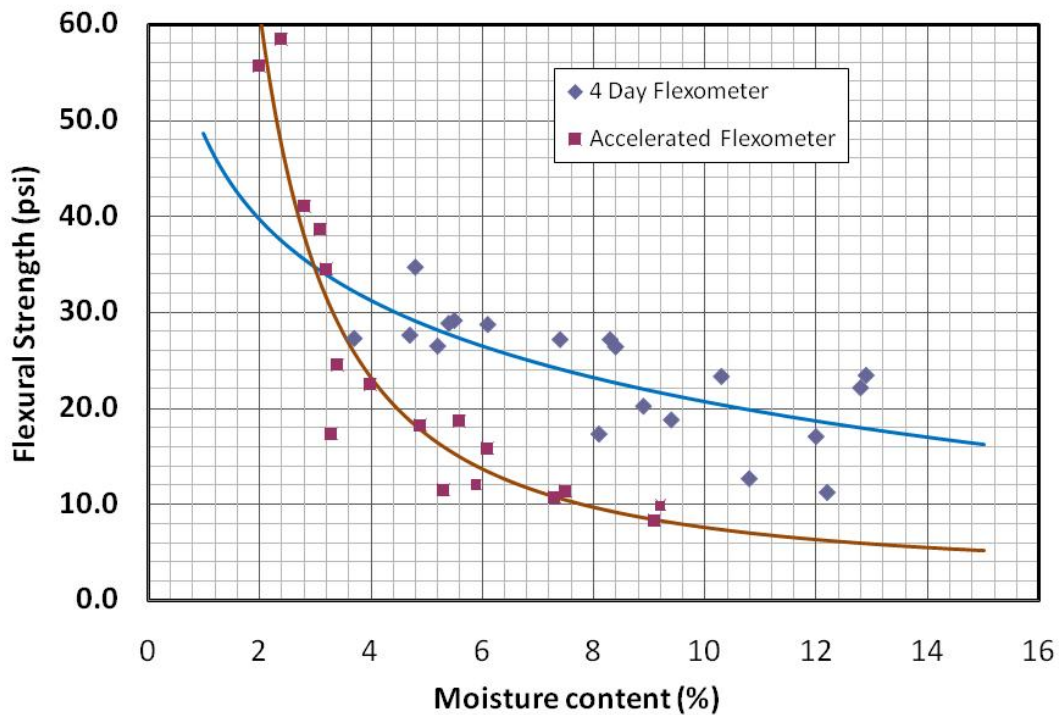

Figure 5.11 Comparison of Data Obtained from Standard, 4-Day Flexometer and Accelerated Flexometer Tests; Waco-Frost Source

Phase II-C Test Program: Validation of the Flexometer Test Device

Phase II-C Test Program was conducted with the primary objective of investigating the accuracy of the flexural strength measurements made using the prototype flexometer device developed in this research. This investigation was prompted by some anomalies observed in the flexural strength data measured using this test device. Figure 5.12 shows an example of the anomalous data trend mentioned above. As it can be noted, the flexural strength values measured for this material are higher at very high moisture contents than those measured at intermediate moisture contents.

Therefore, to investigate the above, a set of parallel tests were conducted using another loading device. The loading device used for this purpose was the Snapshot equipment used for testing intermediate size specimens. The materials used for this test series are the same as those used in Phase II-B test program, namely Brownwood-Prater, San Angelo-CSA/Turner and flexural and Waco-Frost.

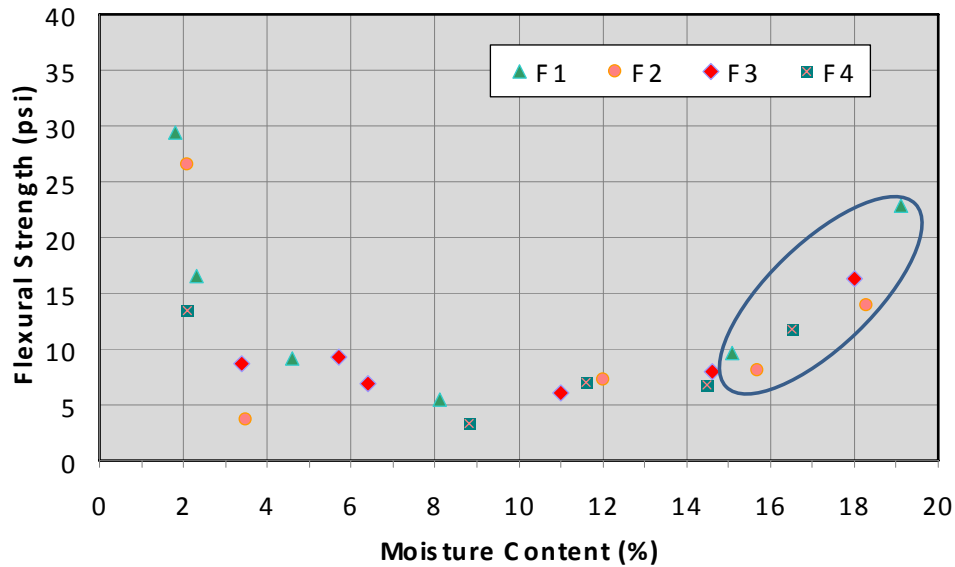

Figure 5.12 Anomalous Trend in Flexural Strength Data Measured by the Base Binder Flexometer

The comparison of data obtained from parallel testing revealed that the above data anomaly is a result of an assumption made in the calculation of the applied force. As explained in Chapter 3, the base binder flexometer does not make a direct measurement of the applied load. Instead, it calculates the force from the cam displacement which is known. When calculating the load, the cam displacement is assumed to be equal to the compression of the loading spring. However, this assumption is valid only when the beam deflection is zero or negligibly small. At higher moisture contents, the beam deflection is not negligible. Therefore, the compression of the spring should be calculated as: $\text{compression of the spring} = \text{cam displacement} - \text{beam deflection}$. When this correction is applied the actual load applied will be smaller. Figures 5.13 through 5.15 show the comparison of flexural strength versus moisture content plots obtained from parallel tests. In these plots, flexural strength measurements made with base binder flexometer at very high water contents have been disregarded. The data plots show fairly good comparison between data obtained from the two loading devices.

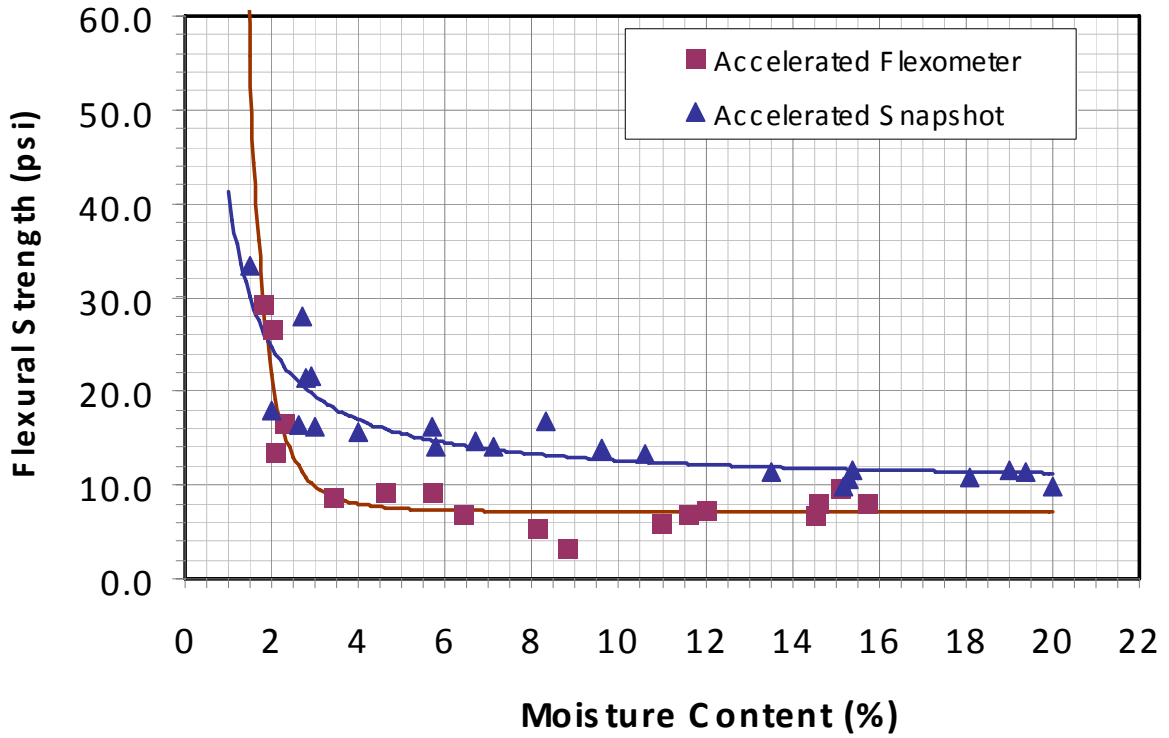

Figure 5.13 Comparison of Data Obtained from Base Binder Flexometer and Snapshot Loading Device; Brownwood-Prater Source

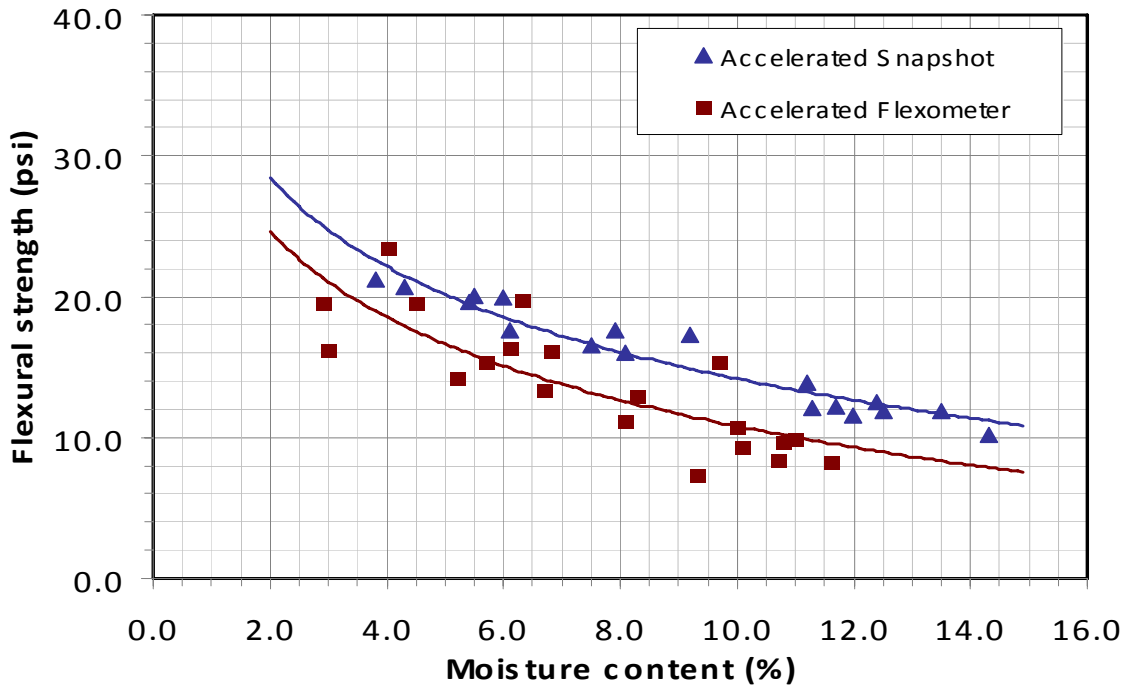

Figure 5.14 Comparison of Data Obtained from Base Binder Flexometer and Snapshot Loading Device; San Angelo-CSA/Turner Source

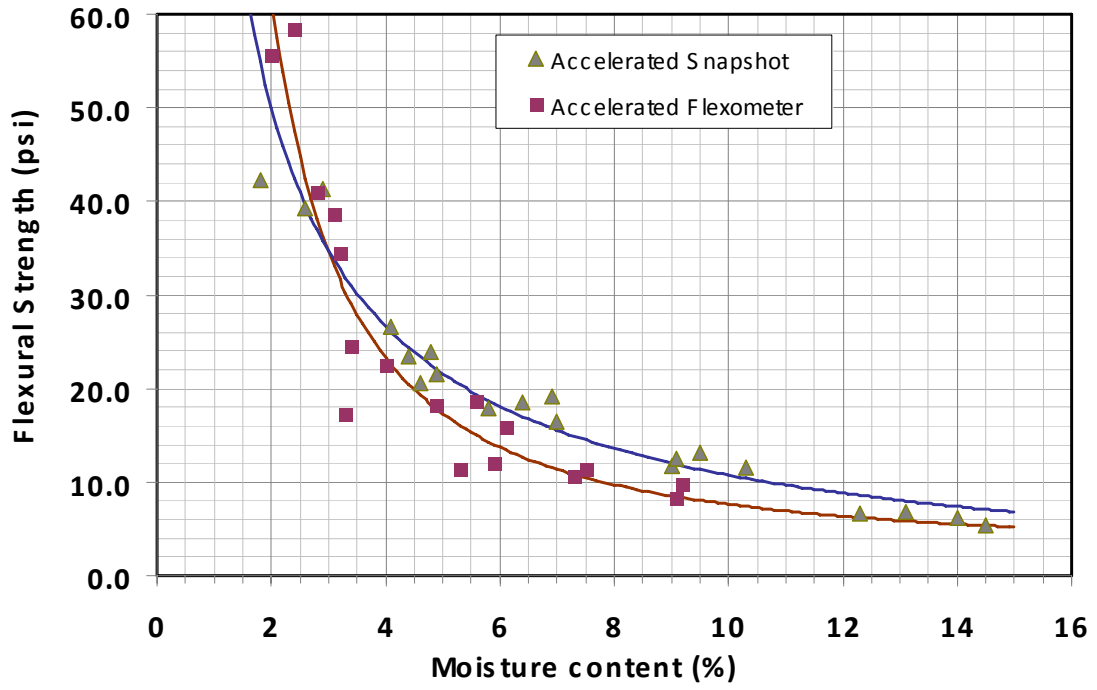

Figure 5.15 Comparison of Data Obtained from Base Binder Flexometer and Snapshot Loading Device; Waco-Frost Source

CHAPTER 6

CONCLUSIONS AND RECOMMENDATIONS

This research was initiated with the primary objective of evaluating a new test procedure proposed by Michael Merrick, P.E., Assistant Area Engineer, Snyder of TxDOT Abilene District for testing road base materials. This test procedure, called the *base binder flexometer test*, was developed by Mr. Merrick to fulfill the need for a repeatable and reliable strength test that can also be performed in a short time and with small amounts of material. The test procedure involves testing of a shrinkage mold size beam specimen under flexural loading. The test specimens are prepared using the minus #40 component, or the binder component, of a base material. The rationale behind the proposed test procedure is that the flexural strength of the binder will correlate well with the 0-psi Texas Triaxial Test strength. Limited amount of preliminary test data available suggested that such a correlation may exist.

The specific objectives of this research study included: (a) Detailed review of the test procedure so that specific shortcomings and limitations can be identified, (b) Examination of the correlation between strength data obtained from the flexometer and Texas triaxial tests, (c) Evaluation of the repeatability of the proposed flexometer test method, (d) Design a low cost, easy-to-operate base binder flexometer and build a prototype test device.

To accomplish these research objectives, a total of 19 base materials from 12 TxDOT districts were sampled and tested. The following are the conclusions that were drawn from the research study.

CONCLUSIONS

The data collected and analyzed in this research study support the view that the strength of binder component of roadway base materials has significant influence on the strength of the composite material. The data showed that a reasonably good correlation can be established between the binder strength and 0-psi Texas Triaxial strength. The strength of the correlation could be further improved when materials are categorized into sub-groups viz. Type I and II materials. This categorization of material as Type I and Type II is based on the shape of the flexural strength-moisture content characteristic curve. Type I materials are those characterized by a flexural strength-moisture content curve that flattens out at high

moisture contents. All crushed limestone materials with the exception one source, i.e. Dallas, Bridgeport/TXI, belonged to this category. In Type II materials, the flexural strength-moisture content curve never reaches such a terminal value. Only 3 material sources were identified as Type II. 2 out of the 3 were sand and gravel sources. The remaining sand and gravel sources did not produce any consistent trend in data and therefore could not be included in correlation studies. Therefore, it is reasonable to conclude that estimation of composite strength based on binder strength is not viable for sand and gravel materials.

The data collected using the proposed flexural strength test method showed that this test procedure, which utilizes shrinkage mold size test specimens, is capable of producing reliable estimates of the binder strength. However, in many cases, it was found that single tray of specimens (i.e. six test specimens) was not sufficient to provide a good data spread. Use of 3-4 trays (or 18-24 test specimens) greatly enhanced the reliability of the flexural strength measurement. Increasing the number of test specimens has very little impact on the time, effort and material needed to run the test.

Testing larger sized specimens for flexural strength proved to be a lot more difficult. The intermediate and large size specimens could not be tested at near optimum moisture conditions. The test specimens needed to be much drier in order to ensure that the specimens would maintain their integrity during handling and load testing. Other concerns related to testing of large size specimens were: influence of self weight on the measured flexural strength and non-uniformity in moisture content over the cross section of the sample.

The repeatability of the test procedure was examined in a limited scope laboratory study that included a sub set of only 5-materials. The data showed that the average Coefficient of Variation (COV) for the base binder flexometer test was 12.6%. This estimate of COV is significantly better than the COV of 23.2% calculated for the 0-psi Texas Triaxial Test. Better repeatability should be expected for the flexural strength test because it uses only a small quantity of material to prepare test specimens. The Texas Triaxial test, by comparison, uses a much larger quantity of material and degree of variability that exists between larger samples should be greater.

The data obtained from the prototype test device developed in this research compared well with data collected from a more sophisticated and expensive test equipment. However,

this comparison revealed that the prototype test device had the tendency to over-predict the flexural strengths whenever there was measurable deflection of the test specimen at the point of loading. Significant deflection of the test specimen occurred only under extremely wet conditions. This did not introduce an error into the flexural strength measurement because such measurement is taken at much drier water contents. Nevertheless, this limitation of the test device should be addressed before implementation of the test device.

The standardized test procedure used in this research utilizes a 4-day curing period for all materials tested. The 4-day curing period was selected because base materials modified with additives such as lime, flyash and cement require long curing time to allow stabilization reactions to take place. For unmodified materials, the 4-day curing is not necessary but was used only because a uniform test procedure was desired. Data collected from an accelerated test with shortened curing time produced data trends that were very similar to those obtained from the standard test. This observation suggests that the accelerated flexometer test is a viable test procedure which deserves consideration candidate during final implementation.

RECOMMENDATIONS

Based on the findings from this research study, we recommend that the base binder flexometer test be implemented as a supplementary test procedure in selected TxDOT road construction projects. Accordingly, the new test procedure should be run *in addition to* the test methods that are performed currently according to the existing specifications. The lab technicians who perform the binder flexural test for these projects should have prior experience with the new test method or should have received adequate training.

Outlined below are some recommended guidelines that should be used when sampling and testing material for the above trial implementation projects.

- (a) Use a sub-sample of material collected for triaxial testing to perform the binder flexometer test
- (b) Sample sufficient quantity of material so that 4-trays of test specimens can be prepared and tested for flexural strength

(c) Perform both accelerated and standard versions of the flexural strength test.

(d) Take extra precaution when testing test specimens at high water contents.

Preferably use an independent and direct measurement of load applied to calculate flexural strength.

It is also recommended that the following aspects of the test procedure be further investigated through future research.

One of the areas where the new test procedure may be found to be most useful is in the evaluation of lime, flyash and cement modified base materials. The test method may be used as a tool for preliminary evaluation to determine which type of modifier is best suited. Once a particular type of modifier has been selected, the test could also be used to determine the optimum modifier content. The limited number of tests performed in this research on flyash and cement modified base materials showed that the test procedure requires further evaluation and refinement. The areas that deserve special attention are: (a) determination of modifier content to be used in sample preparation, (b) determination of molding water content, and (c) flexural strength-moisture content relationships.

Another aspect that deserves further study involves the single-lab and multi-lab variability in the test procedure. To establish the single and multi-lab variability for the test method, it is recommended that a comprehensive and systematic study be conducted with involvement from several TxDOT district laboratories.

REFERENCES

1. Standard Specifications for Construction and Maintenance of Highways, Streets, and Bridges, Texas Department of Transportation, June 2004.
2. Construction Contract Administration Manual, Texas Department of Transportation, October 2007.
3. Fatherree, Ben H., Dr. (2000), "Birth of Soil Mechanics at the Waterways Experiment Station, 1930-1941." *The History of Geotechnical Engineering at the Waterways Experiment Station 1932-2000*, US Army Corps of Engineers, Chapter 2, Research and Development Center, Vicksburg, MS. <<http://gsl.erdc.usace.army.mil/gl-history/Chap2.htm>>, Accessed: March 15, 2008.
4. Tschiebortarioff, Gregory P. (1951), "The Shearing Strength and the Shearing Deformation of Soils." *Soil Mechanics, Foundations, and Earth Structures, An Introduction to the Theory and Practice of Design and Construction*, McGraw-Hill Book Company, Inc., New York, pp.128-131.
5. Saarenketo, T., and T. Scullion, (1996), *Using Electrical Properties to Classify the Strength Properties of Base Course Aggregates*. Research Report 1341-2. Texas Transportation Institute, Texas A&M University System, College Station, Texas.
6. Guthrie, W. Spencer and Scullion, Tom (2003), "Interlaboratory Study of the Tube Suction Test," Research Report 0-4114-2, Texas Transportation Institute, Texas A&M University System, College Station, Texas.
7. Mallela, Jagannath, Quintus, Harold Von, P.E., and Smith, Kelly L., (2004). "Consideration of Lime-Stabilized Layers in Mechanistic-Empirical Pavement Design." The National Lime Association, Arlington, Virginia, pp.28-30.
8. Federal Highway Administration (FHWA) (1995), "Recycled Materials in the Highway Environment." *Coal Fly Ash*, Turner-Fairbank Highway Research Center, <<http://www.tfhrc.gov/hnr20/recycle/waste/cfa55.htm>>, Accessed: March 27, 2008.
9. AASHTO Designation T 97-97: Standard Test Method for Flexural Strength of Concrete Using Simple Beam with Third-Point Loading, Standard Specifications for Transportation Materials and Methods Sampling and Testing, 22nd Edition, Part 2A, American Association of State Highway and Transportation Officials, 2002.
10. AASHTO Designation T 177-97: Standard Test Method for Flexural Strength of Concrete Using Simple Beam with Center-Point Loading, Standard Specifications for Transportation Materials and Methods Sampling and Testing, 22nd Edition, Part 2A, American Association of State Highway and Transportation, 2002.
11. ASTM D 1635: Standard Test Method for Flexural Strength of Soil-Cement Using Simple Beam with Third-Point Loading, Annual Book of ASTM Standards, Volume 04.08, American Society for Testing and Materials, 2008.

12. ASTM D 1632: Standard Practice for Making and Curing Soil-Cement Compression and Flexure Specimens in the Laboratory, Annual Book of ASTM Standards, Volume 04.08, American Society for Testing and Materials, 2008.
13. Design and Control of Concrete Mixtures, 12th Edition, Portland Cement Association (PCA), Skokie, Illinois, 1979, pp. 11-60.

Appendix A

Standard Test Procedure for Strength of Soil Binder by Flexural Testing

Chapter XX: Tex-1xx-A, Strength of Soil Binder by Flexural Testing

Section 1. Overview

Effective date: xxxx

This test method covers the determination of flexural strength of flexible base binders and subgrade materials. Results are to be used to evaluate relative increase in strength and/or triaxial correlation for modification with a cementitious product or QM monitoring of stockpile production.

Units of Measurement

Material weights are done in grams. Lengths and dimensions are represented in inches, load as pound-force, strength in pounds per square inch (psi).

Section 2. Apparatus

The following apparatus is required:

- ◆ 3 point flexural testing device (**Merrick Flexometer**)
 - load specimens $\frac{3}{4}$ " square, 5" in length.
 - Produce a loading rate at not more than 0.01 lbf/second, loaded at specimen center.
- ◆ Linear shrinkage bar molds.
- ◆ Forced air flow oven at range of temperature from room to 200 degrees F with a volume of 1.5 CF.
- ◆ Oven at 140 degrees F.
- ◆ Scale capable of measurement to 0.01 grams.
- ◆ Tools such as trowel, spatula, mixing boles, and sample container capable of preventing sample moisture loss.
- ◆ Caliper

Section 3. Sampling Requirements

The sampling requirements for subgrade and flexible bases used for this test are:

- ◆ Obtain the sample of subgrade according to "[Tex-100-E](#), "Surveying and Sampling Soils for Highways."
- ◆ Prepare linear shrinkage molds by cleaning with a brass bristle brush and penetrating oil. Never use water.

Section 4. Procedures Part IA

Sample Preparation for Obtaining Flexural Strength for Subgrade.

The following table describes the steps used in obtaining flexural strength using the [Merrick Flexometer](#).

Subgrade Sample Preparation	
Step	Action
1	<ul style="list-style-type: none"> ◆ Shake the sample over a #40 sieve to obtain a consistent sample. Do not allow the sample to dry out completely. ◆ Place the -40 material in an air tight container.
2	<ul style="list-style-type: none"> ◆ Take approximately 10grams of material and place in oven and dry to constant weight to obtain sample moisture content. ◆ Obtain a sample large enough to fill all 6 slots of a linear shrinkage bar mold. Depending on the material, approximately 475 to 525 grams.
3	<ul style="list-style-type: none"> ◆ Specimens are to be prepared at a moisture content determined by optimum moisture and material PI. The correct moisture content will be determined by spreadsheet 'Weighup.xls' ◆ Use spreadsheet 'Weighup.xls' to determine the amount of water to add to obtain water needed to mix in to sample.
4	<ul style="list-style-type: none"> ◆ When the sample material has been uniformly mixed, using a small spatula, place sample material in all 6 molds (1 linear shrinkage tray) in ½ lifts. After the first lift, rock the mold on a hard surface 50 times to consolidate sample and release trapped air bubbles. Rock the mold 100 times after the second lift. ◆ After both lifts have been placed, strike off the specimens to a smooth surface and place in oven at 72 deg. F +/- 2 deg. with NO airflow.
5	<ul style="list-style-type: none"> ◆ If samples are modified with cement or fly ash, used spreadsheet 'Weighup.xls' to determine the amount of paste and additional water. The spreadsheet calculates paste based upon desired percentage multiplied by dry soil weight. Add water is determined by 1.2 x percent modifier x percent dry soil. ◆ Repeat steps 2 through 4 for each mold tray. Each tray should represent only 1 point of interest such as a control tray, 1% cement tray, and a 3% cement tray.

Section 4. Procedures Part 1B

Sample Preparation for Obtaining Flexural Strength for Flexible Base.

The following table describes the steps used in obtaining flexural strength using the **Merrick Flexometer**.

Flexible Base Sample Preparation	
Step	Action
1	<ul style="list-style-type: none"> ◆ Perform a washed gradation according to TEX-200-F to obtain -40 material. Do not allow the sample to dry out completely. ◆ Place the -40 material in an air tight container.
2	<ul style="list-style-type: none"> ◆ Take approximately 40grams of material and place in oven and dry to constant weight to obtain sample moisture content. ◆ Obtain a sample large enough to fill all 6 slots of a linear shrinkage bar mold. Depending on the material, the amount needed will be 500 grams to 600 grams
3	<ul style="list-style-type: none"> ◆ Specimens are to be prepared at a moisture content determined by material Liquid Limit and Optimum Dry Density. The correct moisture content will be determined by spreadsheet 'Weighup.xls' ◆ Use spreadsheet 'Weighup.xls' to determine the amount of water to add to obtain water needed to mix in to sample.
4	<ul style="list-style-type: none"> ◆ When the sample material has been uniformly mixed, using a small spatula, place sample material in all 6 molds (1 linear shrinkage tray) in ½ lifts. After the first lift, rock the mold on a hard surface 50 times to consolidate sample and release trapped air bubbles. Rock the mold 100 times after the second lift. ◆ After both lifts have been placed, strike off the specimens to a smooth surface and place in oven at 72 deg. F +/- 2 deg. with NO airflow.
5	<ul style="list-style-type: none"> ◆ If samples are modified with cement or fly ash, used spreadsheet 'Weighup.xls' to determine the amount of paste and additional water. The spreadsheet calculates paste based upon desired percentage multiplied by dry soil weight. Add water is determined by 1.2 x percent modifier x percent dry soil. ◆ Repeat steps 2 through 4 for each mold tray. Each tray should represent only 1 point of interest such as a control tray, 1% cement tray, and a 3% cement tray.

Section 4. Procedures Part 2

Specimen Curing and Breaking Subgrades and Flexible Base.

The following table describes the steps used in obtaining flexural strength using the **Merrick Flexometer**.

Sample Curing and Breaking	
Step	Action
1	<ul style="list-style-type: none"> ◆ Begin the curing process by placing the specimen trays in the curing oven for 1 hour at 130 degrees for 1 hour. At the end of the initial hour turn the oven heat and airflow off. Do not disturb the samples for the remaining of the first day. The beginning of the second day is the beginning of the second curing cycle. On the beginning of the 2nd day, turn the curing oven air flow on with the heat set to 100 degrees. After 30 minutes has lapsed, turn the oven heat off. Allow the oven air flow to continue for 30 additional minutes then turn the oven off. ◆ At the end of this cycle, remove the specimen trays from the oven. Place each tray in an individual plastic bag. Seal the bag to prevent airflow. Place the specimen trays back in the oven until 4 days have lapsed.
3	<ul style="list-style-type: none"> ◆ After 4 days have lapsed, remove the trays from the plastic bags. ◆ While holding the specimen tray in one hand, invert the specimen tray over the other hand to allow the specimens to fall on the empty hand. Lay the bottom side of the tray on the specimens. Carefully invert again leaving the specimens on the bottom of the specimen tray as shown in Figure A. Place the tray with specimens in the oven. <p>The remaining portion of this procedure involves use of the Merrick Flexometer. Insure that Flexometer is calibrated, cam settings correct and the software running.</p>
4	<p>The intent of specimen testing is to provide a strength result at a moisture content at optimum moisture as determined by TEX 113-E. Specimens should be tested at moisture contents wetter than optimum and drier than optimum to produce a relational graph of strength vs. moisture.</p> <p>Begin this procedure by inspecting the specimens and identify the specimens that contain more moisture than others. The specimens with the least moisture should be broken first. Then test a specimen that appears to have the most moisture but will still fail by rupture not by slow strain failure. This will help insure that a specimen test result will be reported on both sides of the OMC content.</p>
5	<ul style="list-style-type: none"> ◆ At the end of 4 days, turn the oven airflow on and dial the heat to 100 degrees. Specimens should remain in the oven until they are tested. After selecting a specimen, remove it from the oven and place in the Flexometer orientated as shown in Figure B. In this orientation, the specimen will be loaded on it's side with the top facing the back and bottom facing the front. ◆ Initiate the software and begin loading. Continue loading until failure of the specimen occurs. Using a caliper, measure the specimen width and height and record in the worksheet beamsheet.xls. While measuring the height measure in the center of the specimen as shown in Figure C. Also record the stepping information shown on the computer screen.
6	<ul style="list-style-type: none"> ◆ Determine the moisture of the specimen tested by taking ½ of tested specimen and breaking it down with a mortar. Place the sample in the oven and determine the moisture

content. Record this data in the sheet beamsheet.xls
◆ Repeat steps 5 and 6 until all specimens have been tested.

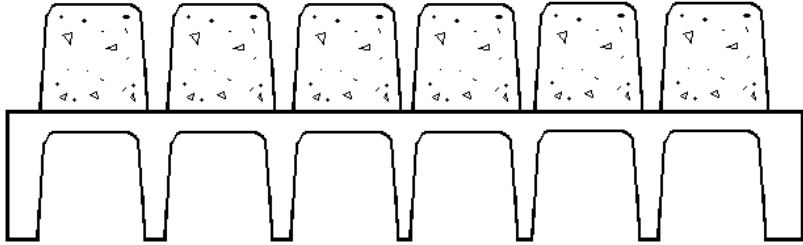

Figure A

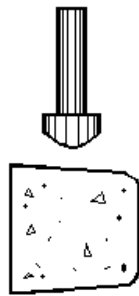

Figure B

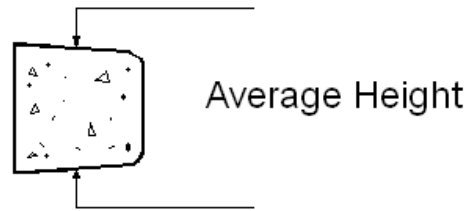

Figure C

Section 5. Calculation

Calculations are performed in the sheet beamsheet.xls

Appendix B

Laboratory Test Data

District	Pit Name	CSJ	Material Description	Atterberg Limits			Gradation %								
				PL	LL	PI	Retained 1 3/4"	Retained 1 1/4"	Retained 7/8"	Retained 5/8"	Retained 3/8"	Retained # 4	Retained # 10	Retained # 40	
Abilene	Bean	157-9-1	Crushed Limestone	12	22	10	-	-	-	-	-	-	-	-	
Abilene	Vulcan/Blacklease		Crushed Limestone	12	14	2	0.0	-	-	-	-	47.0	-	80.7	
San Angelo	Edminston	C148-3-23	Crushed Limestone	18	26	8	0.0	9.0	21.0	31.0	57.0	57.0	68.0	80.0	
San Angelo	CSJ/Turner	0555-05-018	Crushed Limestone	13	16	3	0.0	-	-	-	-	60.7	-	79.8	
Brownwood	Prater	1039-01-029	Crushed Limestone	21	28	7	2.3	-	21.9	29.6	40.4	51.6	-	73.7	
Brownwood	Vulcan	QC	Crushed Limestone	12	14	2	0.0	-	-	-	-	47.0	-	80.7	
Pharr *	Tabasco Pit *	1802-01-031	Pit Run Base	18	24	6	-	-	-	-	-	55.4	-	72.7	
San Antonio	Beckmann Quarry	QC	Aggregate/sand mix	14	17	3	0.0	2.7	12.3	24.3	36.1	49.8	-	71.0	
Tyler *	Cedar Creek Stone *	0197-06-028	Sand & Igneous Rock	22	27	5	0.0	-	-	-	-	68.1	-	77.6	
San Antonio	Hunter Pit	various	Crushed Limestone	17	13	4	0.0	-	20.8	-	49.1	61.4	-	78.2	
San Antonio	Cemex, New Braun.	various	Crushed Limestone	12	16	4	0.0	-	18.5	-	47.4	-	-	78.2	
Beaumont	Vulcan/Sactun Mex		Crushed Limestone	15	23	8	-	-	-	-	-	-	-	-	
Corpus Christi	Vulan/Yucatan Mexico	101-8-1	Crushed Igneous	<i>BLS Method **</i>		5	0.0	-	18.9	-	53.8	67.2	-	81.9	
Waco	Frost Pit		Crushed Limestone	15	21	6	-	-	-	-	-	59.7	-	77.1	
Dallas	TXI Bridgeport	196-2-78	Crushed Limestone	14	21	7	0.0	-	15.1	-	43.6	60.2	-	81.4	
Tyler	Broken Bow S&G	10-76-7	Sand & Gravel	<i>BLS Method **</i>		3	0.0	-	22.4	-	49.4	59.2	-	76.2	
El Paso	Holman	75-1-20	Sand & Gravel	<i>BLS Method **</i>		5	0.0	-	14.0	-	36.0	49.0	-	78.0	
El Paso	Jobe	District Wide	Crushed Limestone	<i>BLS Method **</i>		5	0.0	-	-	-	-	49.0	-	79.0	
El Paso	Wyert	0075-01-020	Sand & Gravel	<i>BLS Method **</i>		3	0.0	-	15.0	-	36.0	50.0	-	79.0	
Lubbock	Reworked Base	US 62/Floyd	Reworked Base												

* The binder portion of these materials is not of the same parent material as the aggregate portion.
Therefore, the binder and matrix are composed of different mineralogy and origin.

** Bar Linear Shrinkage Method used to determine Plasticity Index

District	Pit Name	CSJ	Material Description	Wet Ball Mill		Triaxial		Compaction	
				Value	% Loss	0 psi	15 psi	Optimum Moisture %	Maximum Density(pcf)
Abilene	Bean	157-9-1	Crushed Limestone			46.7	206.0	8	134.1
Abilene	Vulcan/Blacklease		Crushed Limestone	33.0	12.0	28.6	191.9	5.7	145.1
San Angelo	Edminston	C148-3-23	Crushed Limestone	34.0	14.0	45.0	177.0	7.1	138.6
San Angelo	CSJ/Turner	0555-05-018	Crushed Limestone	31.0	11.0				
Brownwood	Prater	1039-01-029	Crushed Limestone	48.0	19.0	24.7	123.2	10.5	127.0
Brownwood	Vulcan	QC	Crushed Limestone	33.0	12.0	53.0	193.9	5.7	145.1
Pharr *	Tabasco Pit *	1802-01-031	Pit Run Base	35.0	N.R.	41.0	N.R.	8.7	128.7
San Antonio	Beckmann Quarry	QC	Aggregate/sand mix	39.0	10.0	47.2	176.2	6.3	134.7
Tyler *	Cedar Creek Stone *	0197-06-028	Sand & Igneous Rock	38.0	15.0	50.9	194.8	7.5	136.4
San Antonio	Hunter Pit	various	Crushed Limestone	35.0	15.0	50.3	244.4	6.1	141.8
San Antonio	Cemex, New Braun.	various	Crushed Limestone	32.0	11.0	70.3	253.8	6.0	140.3
Beaumont	Vulcan/Sactun Mexico		Crushed Limestone	38.0	7.0	64.2	N.R.	8.7	129.2
Corpus Christi	Vulan/Yucatan Mexico	101-8-1	Crushed Igneous	28.0	5.0	59.0	222.0	9.4	127.9
Waco	Frost Pit		Crushed Limestone	33.0	6.0	27.5	198.3	7.6	134.0
Dallas	TXI Bridgeport	196-2-78	Crushed Limestone	21.0	5.0	43.3	190.1	5.8	138.2
Tyler	Broken Bow S&G	10-76-7	Sand & Gravel	32.0	7.0	24.7	205.0	5.4	141.1
El Paso	Holman	75-1-20	Sand & Gravel	39.0	18.0	46.1	147.6	7.7	136.5
El Paso	Jobe	District Wide	Crushed Limestone	27.0	5.0	50.2	142.9	7.4	135.0
El Paso	Wyert	0075-01-020	Sand & Gravel	37.0	17.0	46.2	137.9	6.9	135.7
Lubbock	Reworked Base	US 62/Floyd	Reworked Base						

MERRICK FLEXOMETER SAMPLE IDENTIFICATION

DISTRICT:	Abilene	SAMPLE NUMBER	
COUNTY:	various	PRODUCER:	Vulcan/Blacklease

Optimum	
Density (pcf)	145.1
Moisture(%)	5.7
LL	14
PL	12
PI	2
Sample Weight lb	

Triaxial	
0 psi	28.6
15 psi	191.9
Wet Ball	33
% Increase	12

Sieve	Percent
1 3/4	
1 1/4	
7/8	
5/8	
3/8	
#4	47.0
#10	
#40	80.7

Tray	Specimen		Initial Steps	Total Steps	Beam % Moisture	Width (inches)	Height (inches)	Load (lb)	M max in-lb	Flexural (psi)
	Beam									
1	1		17	38	10.16	0.687	0.700	1.449	1.630	29.11
1	2		17	42	8.82	0.676	0.691	1.790	2.014	37.41
1	3		15	59	2.46	0.673	0.695	3.341	3.759	69.48
1	4		19	44	6.85	0.670	0.697	1.862	2.095	38.63
1	5		18	46	4.89	0.679	0.692	2.089	2.350	43.25
1	6		19	45	4.21	0.681	0.694	1.950	2.194	40.1
2	1		21	38	11.21	0.687	0.689	1.238	1.393	25.7
2	2		20	42	8.20	0.676	0.687	1.635	1.839	34.5
2	3		22	44	7.34	0.67	0.68	1.693	1.905	36.8
2	4		21	44	4.11	0.679	0.682	1.752	1.971	37.6
2	5		23	45	4.69	0.681	0.68	1.72	1.935	37.0
2	6		19	57	2.19	0.673	0.679	2.986	3.359	64.8
3	1		24	37	12.06	0.689	0.705	0.972	1.094	19.19
3	2		21	40	9.90	0.690	0.704	1.407	1.583	27.72
3	3		23	55	3.21	0.692	0.705	2.587	2.910	50.78
3	4		20	40	6.99	0.690	0.708	1.463	1.646	28.56
3	5		20	48	5.02	0.697	0.705	2.158	2.428	41.95
3	6		21	46	5.89	0.689	0.707	1.926	2.167	37.74
4	1		17	38	10.16	0.687	0.700	1.449	1.630	29.11
4	2		17	42	8.82	0.676	0.691	1.790	2.014	37.41
4	3		15	59	2.46	0.673	0.695	3.341	3.759	69.48
4	4		19	44	6.85	0.670	0.697	1.862	2.095	38.63
4	5		18	46	4.89	0.679	0.692	2.089	2.350	43.25
4	6		19	45	4.21	0.681	0.694	1.950	2.194	40.07

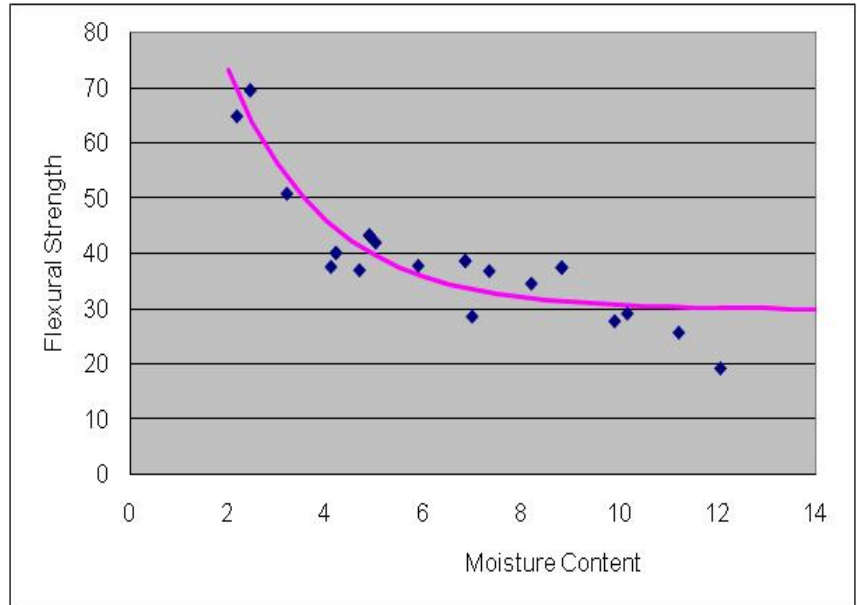

FLEXOMETER SAMPLE IDENTIFICATION

DISTRICT:	San Angelo	SAMPLE NUMBER	
COUNTY:	various	PRODUCER:	Edminston

Optimum	
Density (pcf)	138.6
Moisture(%)	7.1
LL	26
PL	18
PI	8
Sample Weight lb	

Triaxial	
0 psi	45.0
15 psi	177.0
Wet Ball % Increase	34
	14

Sieve	Percent
1 3/4	0.0
1 1/4	9.0
7/8	21.0
5/8	31.0
3/8	57.0
#4	57.0
#10	68.0
#40	80.0

Specimen		Initial Steps	Total Steps	Beam % Moisture	Width (inches)	Height (inches)	Load (lb)	M max in-lb	Flexural (psi)
Tray	Beam								
1	1	9	59	9.65	0.686	0.712	3.394	3.818	66.0
1	2	1	40	12.27	0.704	0.718	1.898	2.135	35.3
1	3	1	54	9.65	0.724	0.71	3.071	3.455	56.8
1	4	1	49	14.78	0.725	0.719	2.648	2.979	47.6
1	5	6	62	6.23	0.725	0.708	3.697	4.159	68.8
1	6	10	71	4.46	0.735	0.71	4.291	4.827	78.3
2	1	8	54	12.74	0.728	0.721	2.999	3.374	53.6
2	2	1	53	11.08	0.718	0.720	2.987	3.360	54.2
2	3	5	57	6.23	0.719	0.708	3.301	3.714	61.7
2	4	1	51	7.73	0.710	0.716	2.817	3.169	52.3
2									
3									
3									
3									
3									
3									
3									
3									
4									
4									
4									
4									
4									
4									

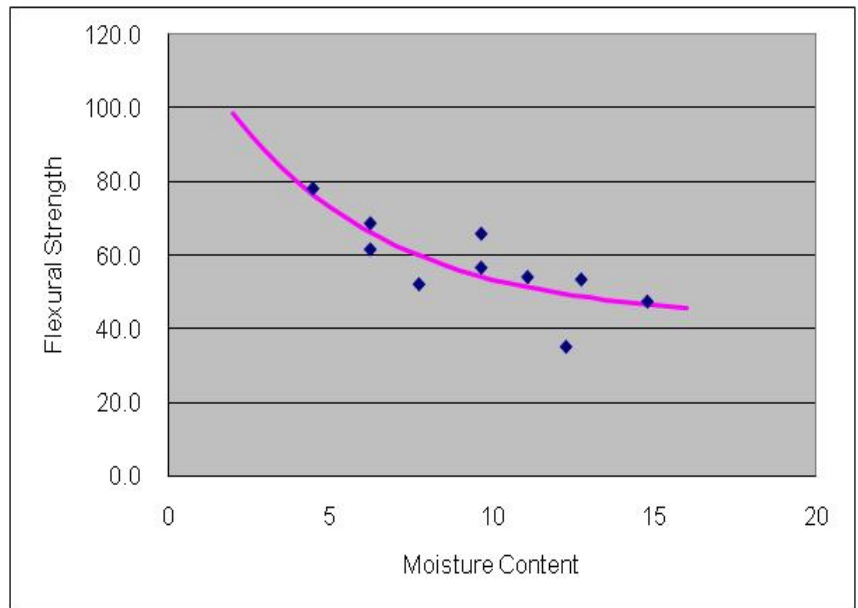

MERRICK FLEXOMETER SAMPLE IDENTIFICATION

DISTRICT: San Angelo	SAMPLE NUMBER
COUNTY: various	PRODUCER: CSA/Turner

Optimum	
Density (pcf)	
Moisture(%)	
LL	13
PL	16
PI	3
Sample Weight lb	

Triaxial	
0 psi	
15 psi	
Wet Ball	31
% Increase	11

Sieve	Percent
1 3/4	
1 1/4	
7/8	
5/8	
3/8	
#4	
#10	
#40	

Specimen		Initial Steps	Total Steps	Beam % Moisture	Width (inches)	Height (inches)	Load (lb)	M max in-lb	Flexural (psi)
Tray	Beam								
1	1	15	29	7.68	0.710	0.693	0.828	0.932	16.39
1	2	16	24	11.27	0.713	0.701	0.440	0.495	8.46
1	3	12	24	3.81	0.711	0.701	0.598	0.673	11.56
1	4	17	25	11.54	0.714	0.700	0.459	0.516	8.85
1	5	9	25	4.29	0.709	0.702	0.749	0.843	14.50
1	6	15	30	5.96	0.705	0.698	0.901	1.014	17.7
2	1	7	31	5.09	0.735	0.712	1.218	1.37	22.1
2	2	12	28	8.37	0.723	0.705	0.869	0.978	16.3
2	3	11	24	10.37	0.723	0.692	0.63	0.709	12.3
2	4	11	27	6.68	0.720	0.708	0.830	0.934	15.5
2	5	12	27	5.69	0.72	0.703	0.799	0.899	15.2
2	6	13	28	6.11	0.716	0.696	0.834	0.938	16.2
3	1	13	27	8.36	0.707	0.699	0.764	0.860	14.95
3	2	9	30	5.00	0.714	0.706	1.101	1.239	20.93
3	3	16	29	12.10	0.713	0.680	0.784	0.882	16.04
3	4	10	26	2.95	0.714	0.700	0.790	0.889	15.25
3	5	16	26	8.51	0.717	0.694	0.572	0.644	11.17
3	6	1	13	6.90	0.720	0.718	0.198	0.223	3.61
4	1	11	25	10.79	0.728	0.716	0.695	0.782	12.55
4	2	11	24	10.33	0.730	0.702	0.630	0.709	11.85
4	3	12	28	12.95	0.725	0.710	0.869	0.978	16.07
4	4	11	24	8.87	0.730	0.698	0.630	0.709	11.95
4	5	15	25	9.47	0.723	0.690	0.549	0.618	10.77
4	6								

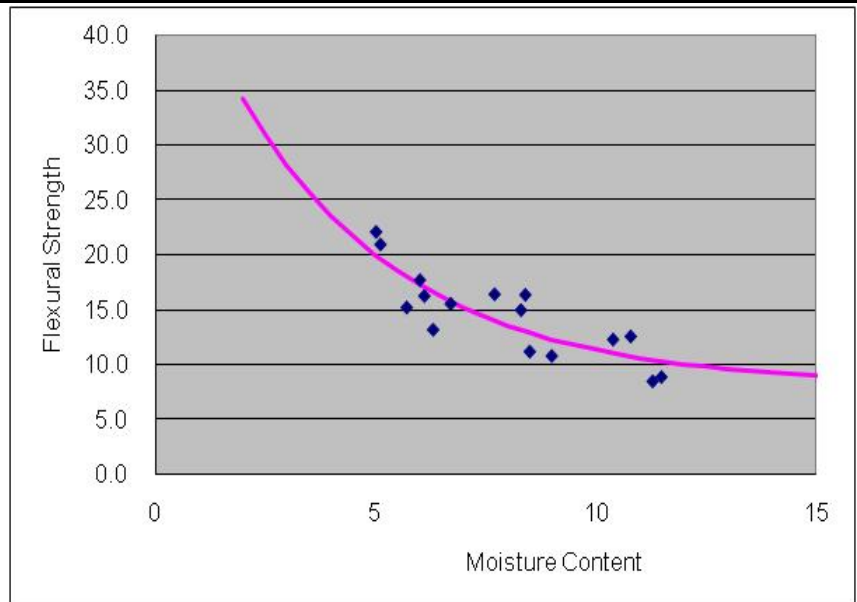

MERRICK FLEXOMETER SAMPLE IDENTIFICATION

DISTRICT: Brownwood	SAMPLE NUMBER
COUNTY: various	PRODUCER: Prater

Optimum	
Density (pcf)	127.0
Moisture(%)	10.5
LL	28
PL	21
PI	7
Sample Weight lb	

Triaxial	
0 psi	24.7
15 psi	123.2
Wet Ball	48
% Increase	19

Sieve	Percent
1 3/4	2.3
1 1/4	
7/8	21.9
5/8	29.6
3/8	40.4
#4	51.6
#10	
#40	73.6

Specimen		Initial Steps	Total Steps	Beam % Moisture	Width (inches)	Height (inches)	Load (lb)	M max in-lb	Flexural (psi)
Tray	Beam								
1	1	1	20	21.24	0.681	0.709	0.522	0.587	10.3
1	2	16	31	20.71	0.695	0.697	0.877	0.987	17.6
1	3	10	28	16.65	0.71	0.71	0.881	0.991	16.6
1	4	8	30	13.8	0.687	0.705	1.066	1.199	21.0
1	5	8	28	8.7	0.693	0.702	0.929	1.045	18.3
1	6	6	36	3.88	0.691	0.705	1.546	1.739	30.4
2	1	6	32	21.39	0.688	0.711	1.246	1.402	24.2
2	2	8	28	20.45	0.686	0.709	0.929	1.045	18.2
2	3	11	26	21.73	0.667	0.697	0.722	0.812	15.1
2	4	12	26	17.98	0.678	0.680	0.690	0.776	14.8
2	5	9	27	12.74	0.681	0.712	0.841	0.946	16.4
2	6	13	31	5.73	0.687	0.706	0.995	1.119	19.7
3									
3									
3									
3									
3									
3									
3									
4									
4									
4									
4									
4									
4									

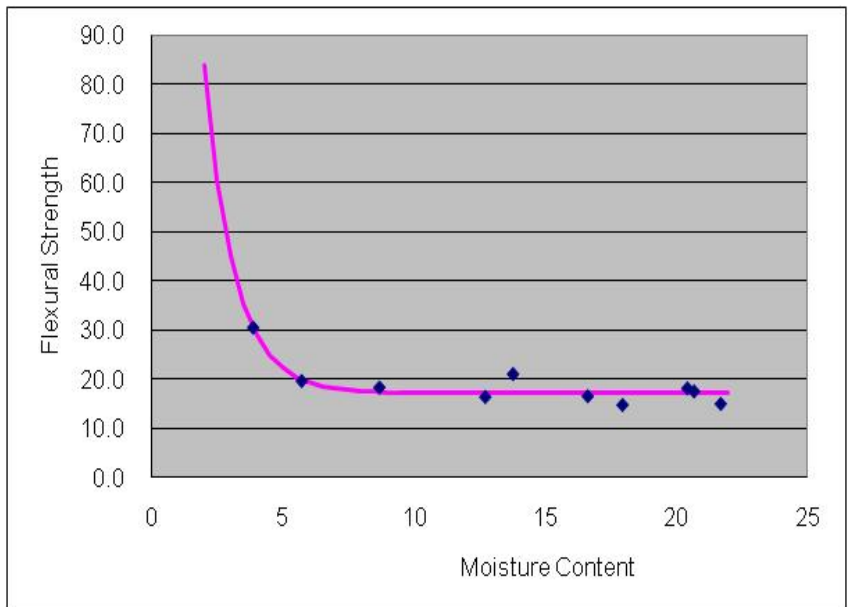

MERRICK FLEXOMETER SAMPLE IDENTIFICATION

DISTRICT:	Brownwood	SAMPLE NUMBER	
COUNTY:	various	PRODUCER:	Vulcan (Eastland)

Optimum	
Density (pcf)	145.1
Moisture(%)	5.7
LL	14
PL	12
PI	2
Sample Weight lb	

Triaxial	
0 psi	53.0
15 psi	193.9
Wet Ball % Increase	33 12

Sieve	Percent
1 3/4	0.0
1 1/4	
7/8	
5/8	
3/8	
#4	47.0
#10	
#40	80.7

Specimen		Initial Steps	Total Steps	Beam % Moisture	Width (inches)	Height (inches)	Load (lb)	M max in-lb	Flexural (psi)
Tray	Beam								
1	1	22	87	2.08	0.737	0.683	4.668	5.252	91.5
1	2	18	70	2.19	0.713	0.688	3.919	4.409	78.6
1	3	9	55	4.92	0.723	0.682	3.061	3.444	61.5
1	4	14	49	4.94	0.7	0.683	2.397	2.697	49.5
1	5	14	52	8.11	0.718	0.689	2.651	2.982	52.4
1	6	19	48	9.25	0.721	0.679	2.092	2.354	42.5
2	1	1	72	3.24	0.710	0.710	4.481	5.041	84.4
2	2	1	64	5.02	0.722	0.710	3.890	4.376	72.3
2	3	8	55	6.32	0.725	0.711	3.084	3.470	56.9
2	4	9	59	7.02	0.724	0.705	3.394	3.818	63.8
2	5	10	56	7.47	0.709	0.710	3.119	3.509	59.0
2									
3	1	15	67	2.61	0.720	0.694	3.831	4.310	74.4
3	2	7	57	7.17	0.710	0.701	3.271	3.680	63.2
3	3	1	51	7.68	0.717	0.693	2.817	3.169	55.18
3	4	11	56	9.57	0.720	0.689	3.090	3.476	61.1
3	5	16	50	9.59	0.700	0.681	2.401	2.701	49.98
3									
4									
4									
4									
4									
4									
4									

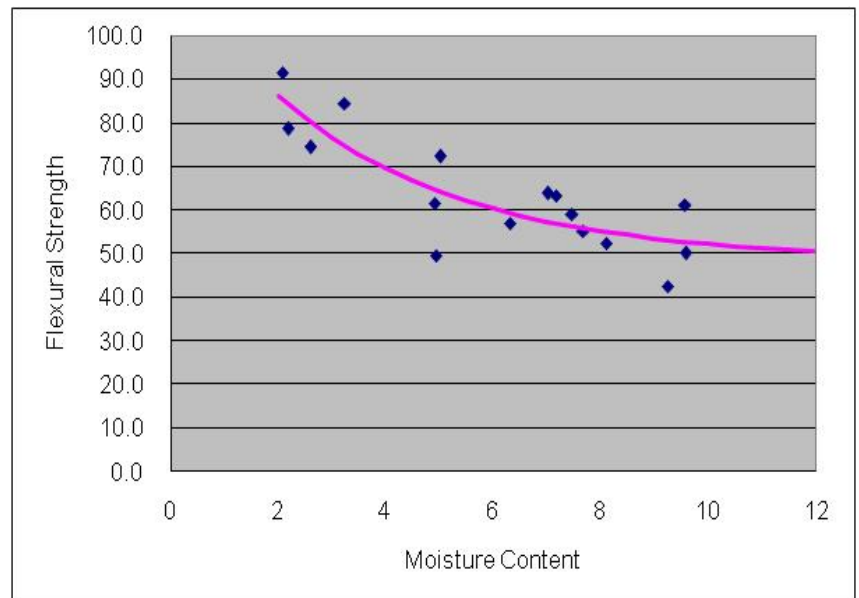

MERRICK FLEXOMETER SAMPLE IDENTIFICATION

DISTRICT: Pharr	SAMPLE NUMBER
COUNTY: various	PRODUCER: Tabasco

Optimum	
Density (pcf)	128.7
Moisture(%)	8.7
LL	24
PL	18
PI	6
Sample Weight lb	

Triaxial	
0 psi	41.0
15 psi	
Wet Ball % Increase	25 16

Sieve	Percent
1 3/4	
1 1/4	
7/8	
5/8	
3/8	
#4	55.4
#10	
#40	72.7

Specimen		Initial Steps	Total Steps	Beam % Moisture	Width (inches)	Height (inches)	Load (lb)	M max in-lb	Flexural (psi)
Tray	Beam								
1	2	5	28	15.48	0.698	0.71	0.979	1.101	18.8
1	1	13	41	13.63	0.7	0.702	1.766	1.987	34.5
1	3	3	43	12.51	0.717	0.722	2.14	2.408	38.6
1	4	6	42	12.14	0.719	0.708	2.026	2.279	37.9
1	5	7	45	11.9	0.73	0.71	2.259	2.541	41.4
1	6	8	57	7.77	0.728	0.721	3.251	3.657	58.1
2	1	15	65	5.77	0.701	0.679	3.678	4.138	76.8
2	2	12	55	9.26	0.715	0.693	2.975	3.347	58.6
2	3	16	46	11.73	0.718	0.674	2.063	2.321	42.7
2	4	10	47	12.26	0.735	0.693	2.359	2.654	45.1
2	5	20	47	12.89	0.713	0.667	1.957	2.202	41.7
2	6	14	44	13.68	0.720	0.690	1.976	2.223	38.9
3	1	24	58	8.27	0.694	0.680	2.659	2.991	55.9
3	2	17	45	10.91	0.695	0.675	1.935	2.177	41.3
3	3	18	48	10.95	0.700	0.685	2.141	2.409	44.12
3	4	17	44	13.89	0.695	0.680	1.851	2.082	38.89
3	5	15	37	15.96	0.683	0.674	1.370	1.541	29.85
3	6								
4	1	11	58	7.40	0.698	0.675	3.257	3.664	69.08
4	2	18	50	9.54	0.702	0.673	2.310	2.599	49.13
4	3	13	44	12.92	0.696	0.678	2.013	2.265	42.42
4	4	20	48	13.53	0.697	0.676	2.041	2.296	43.35
4	5	16	39	13.78	0.699	0.677	1.486	1.672	31.27
4	6	21	39	15.29	0.698	0.677	1.243	1.398	26.29

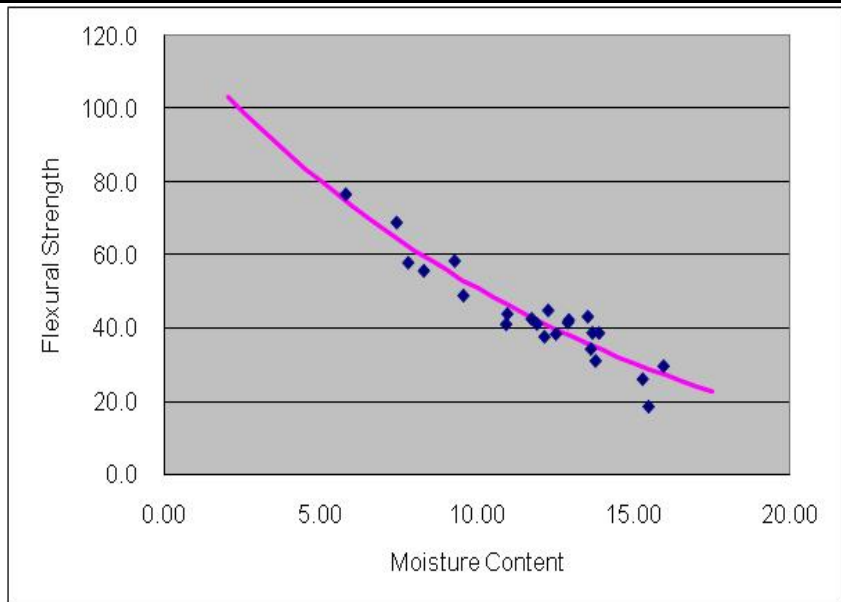

MERRICK FLEXOMETER SAMPLE IDENTIFICATION

DISTRICT:	San Antonio	SAMPLE NUMBER	
COUNTY:	various	PRODUCER:	Beckman

Optimum	
Density (pcf)	134.7
Moisture(%)	6.3
LL	17
PL	14
PI	3
Sample Weight lb	

Triaxial	
0 psi	47.2
15 psi	176.2
Wet Ball % Increase	39 10

Sieve	Percent
1 3/4	0.0
1 1/4	2.7
7/8	12.3
5/8	24.3
3/8	36.1
#4	49.8
#10	
#40	71.0

Specimen		Initial Steps	Total Steps	Beam % Moisture	Width (inches)	Height (inches)	Load (lb)	M max in-lb	Flexural (psi)
Tray	Beam								
1	1	1	62	1.69	0.656	0.725	3.732	4.199	73.2
1	2	6	55	1.96	0.689	0.715	3.120	3.510	59.8
1	3	3	32	5.3	0.662	0.719	1.277	1.437	25.2
1	4	2	35	8.03	0.673	0.720	1.504	1.692	29.1
1	5	9	35	12.28	0.664	0.721	1.41	1.586	27.6
1	6								
2	1	1	55	1.66	0.673	0.724	3.155	3.549	60.3
2	2	10	36	3.60	0.683	0.700	1.461	1.644	29.5
2	3	7	31	5.54	0.686	0.715	1.157	1.302	22.3
2	4	5	35	5.80	0.707	0.727	1.483	1.668	26.8
2	5	9	28	13.3	0.7	0.711	0.907	1.02	17.3
2	6								
3	1	4	66	1.84	0.713	0.719	4.034	4.538	73.8
3	2	7	43	2.76	0.695	0.723	2.092	2.354	38.9
3	3	8	32	6.97	0.687	0.707	1.209	1.360	23.8
3	4	5	35	10.08	0.669	0.718	1.483	1.668	29.07
3	5	6	34	12.74	0.676	0.720	1.394	1.568	26.88
3	6								
4	1	12	59	1.91	0.730	0.685	3.308	3.722	65.04
4	2	7	27	4.43	0.692	0.692	0.883	0.993	17.99
4	3	14	39	4.94	0.684	0.681	1.567	1.763	33.35
4	4	21	45	9.08	0.694	0.679	1.736	1.953	36.63
4	5	23	35	14.29	0.710	0.670	0.817	0.919	17.3
4	6								

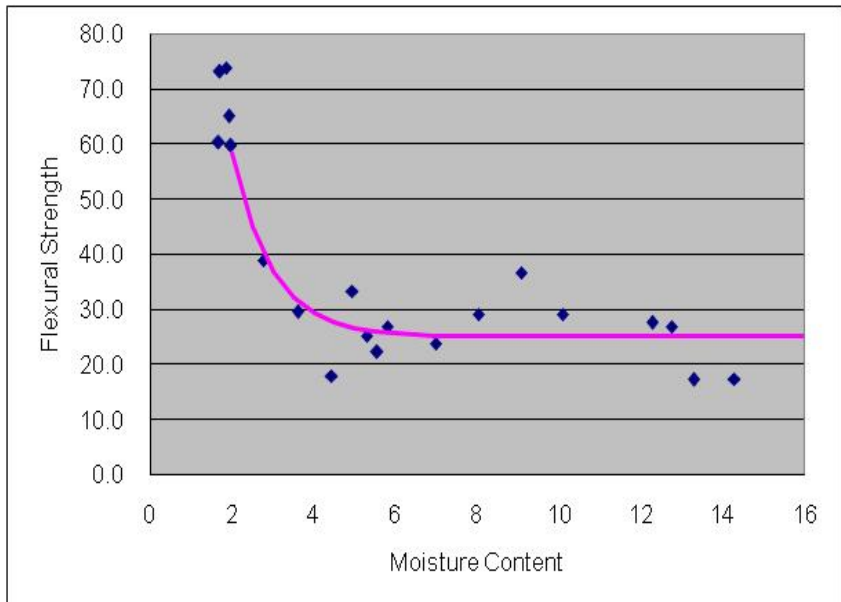

MERRICK FLEXOMETER SAMPLE IDENTIFICATION

DISTRICT:	Tyler	SAMPLE NUMBER	
COUNTY:	various	PRODUCER:	Ceder Creek Stone

Optimum	
Density (pcf)	136.4
Moisture(%)	7.5
LL	N/A
PL	N/A
PI	5
Sample Weight lb	

Triaxial	
0 psi	50.9
15 psi	194.8
Wet Ball	38
% Increase	15

Sieve	Percent
1 3/4	0.0
1 1/4	
7/8	
5/8	
3/8	
#4	68.1
#10	
#40	77.6

Specimen		Initial Steps	Total Steps	Beam % Moisture	Width (inches)	Height (inches)	Load (lb)	M max in-lb	Flexural (psi)
Tray	Beam								
1	1	19	30	13.76	0.699	0.71	0.667	0.75	12.8
1	4	16	28	12.25	0.710	0.723	0.670	0.754	12.2
1	2	19	29	9.80	0.719	0.724	0.598	0.673	10.7
1	3	20	29	9.27	0.715	0.715	0.547	0.615	10.1
1	5	16	28	8.6	0.705	0.714	0.67	0.754	12.6
1	6	21	34	7.08	0.702	0.718	0.854	0.961	15.9
2	1	19	40	16.06	0.711	0.675	1.427	1.605	29.8
2	2	22	38	15.33	0.705	0.700	1.108	1.247	21.6
2	3	15	32	15.1	0.704	0.708	0.991	1.115	19.0
2	4	21	30	9.97	0.714	0.707	0.563	0.633	10.7
2	5	20	32	6.64	0.715	0.724	0.759	0.854	13.7
2	6								
3	1	29	41	16.96	0.674	0.665	0.911	1.025	20.7
3	3	21	34	14.06	0.694	0.671	0.854	0.961	18.42
3	2	20	34	13.07	0.707	0.675	0.907	1.020	19.0
3	5	26	33	6.17	0.710	0.680	0.484	0.545	9.96
3	4	27	34	5.95	0.700	0.668	0.494	0.556	10.67
3	6								
4									
4									
4									
4									
4									
4									

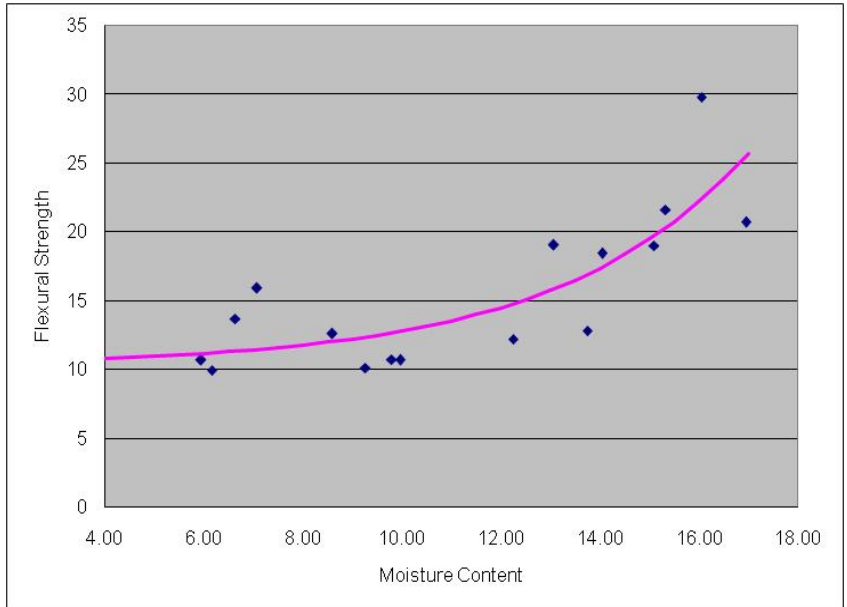

MERRICK FLEXOMETER SAMPLE IDENTIFICATION

DISTRICT:	San Antonio	SAMPLE NUMBER	
COUNTY:	various	PRODUCER:	Hunter

Optimum	
Density (pcf)	141.8
Moisture(%)	6.1
LL	17
PL	13
PI	4
Sample Weight lb	400.00

Triaxial	
0 psi	50.3
15 psi	244.4
Wet Ball	35
% Increase	15

Sieve	Percent
1 3/4	0.0
1 1/4	
7/8	20.8
5/8	
3/8	49.1
#4	61.4
#10	
#40	78.2

Specimen		Initial Steps	Total Steps	Beam % Moisture	Width (inches)	Height (inches)	Load (lb)	M max in-lb	Flexural (psi)
Tray	Beam								
1	1	7	25	12.44	0.702	0.713	0.756	0.851	14.3
1	2	11	33	13.59	0.710	0.710	1.206	1.357	22.7
1	3	10	22	7.01	0.701	0.705	0.51	0.574	9.9
1	4	4	35	4.20	0.725	0.710	1.493	1.680	27.6
1	5	6	94	1.26	0.729	0.722	5.461	6.144	96.9
1									
2	1	8	30	9.79	0.71	0.71	1.066	1.199	20.1
2	2	8	28	12.64	0.708	0.700	0.929	1.045	18.1
2	3	6	28	7.36	0.718	0.709	0.966	1.087	18.1
2	4	1	36	3.76	0.712	0.718	1.582	1.780	29.1
2	5								
2	6								
3	1	7	30	11.86	0.703	0.705	1.086	1.222	21.0
3	2	1	27	10.78	0.711	0.713	0.935	1.052	17.4
3	3	6	38	5.75	0.705	0.718	1.703	1.916	31.7
3	4	7	94	1.33	0.718	0.707	5.445	6.126	102.63
3	5								
3	6								
4	1	11	34	8.75	0.712	0.695	1.280	1.440	25.15
4	2	9	32	11.92	0.729	0.693	1.186	1.334	22.88
4	3	9	31	8.64	0.715	0.692	1.114	1.253	22.01
4	4	12	43	4.14	0.714	0.694	1.964	2.210	38.54
4	5								
4	6								

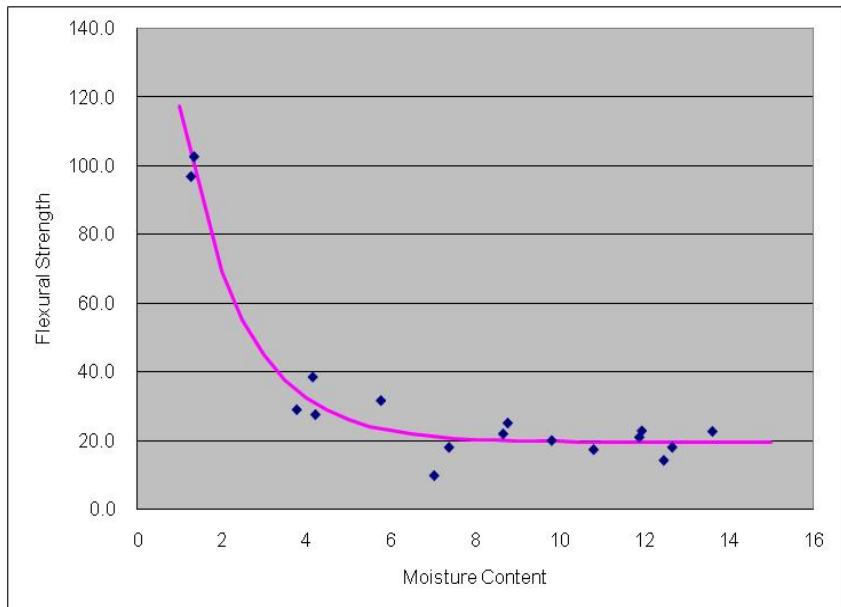

MERRICK FLEXOMETER SAMPLE IDENTIFICATION

DISTRICT:	San Antonio	SAMPLE NUMBER	
COUNTY:	various	PRODUCER:	Cemex

Optimum	
Density (pcf)	140.3
Moisture(%)	6.0
LL	16
PL	12
PI	4
Sample Weight lb	Approx. 400.00

Triaxial	
0 psi	70.3
15 psi	253.8
Wet Ball % Increase	32 11

Sieve	Percent
1 3/4	100.0
1 1/4	
7/8	81.5
5/8	
3/8	52.6
#4	
#10	
#40	21.8

Specimen		Initial Steps	Total Steps	Beam % Moisture	Width (inches)	Height (inches)	Load (lb)	M max in-lb	Flexural (psi)
Tray	Beam								
1	1	18	59	8.39	0.712	0.670	3.066	3.449	64.91
1	2	20	43	13.30	0.703	0.680	1.622	1.825	33.72
1	3	11	55	7.57	0.725	0.688	3.007	3.383	59.07
1	4	14	58	5.14	0.724	0.685	3.155	3.549	62.66
1	5	14	90	1.98	0.718	0.692	5.150	5.794	101.25
1	6								
2	1	3	46	10.57	0.72	0.718	2.39	2.689	43.5
2	2	1	51	7.28	0.722	0.713	2.817	3.169	51.8
2	3	5	54	7.99	0.714	0.716	3.049	3.43	56.3
2	4	1	95	2.77	0.725	0.720	5.513	6.202	98.8
2	5	7	61	3.23	0.724	0.722	3.599	4.049	64.4
2	6								
3	1	16	46	11.28	0.710	0.705	2.063	2.321	39.52
3	2	7	54	6.27	0.709	0.720	3.019	3.396	55.32
3	3	1	77	3.26	0.735	0.718	4.803	5.403	85.45
3	4	10	70	4.77	0.728	0.711	4.221	4.749	77.44
3									
3									
4	1	10	49	10.32	0.694	0.720	2.528	2.844	47.4
4	2	8	46	9.39	0.693	0.717	2.323	2.613	43.98
4	3	4	45	5.86	0.690	0.724	2.299	2.586	42.94
4	4	13	93	4.05	0.700	0.724	5.263	5.921	96.99
4	5	5	57	5.81	0.719	0.724	3.301	3.714	59.23
4									

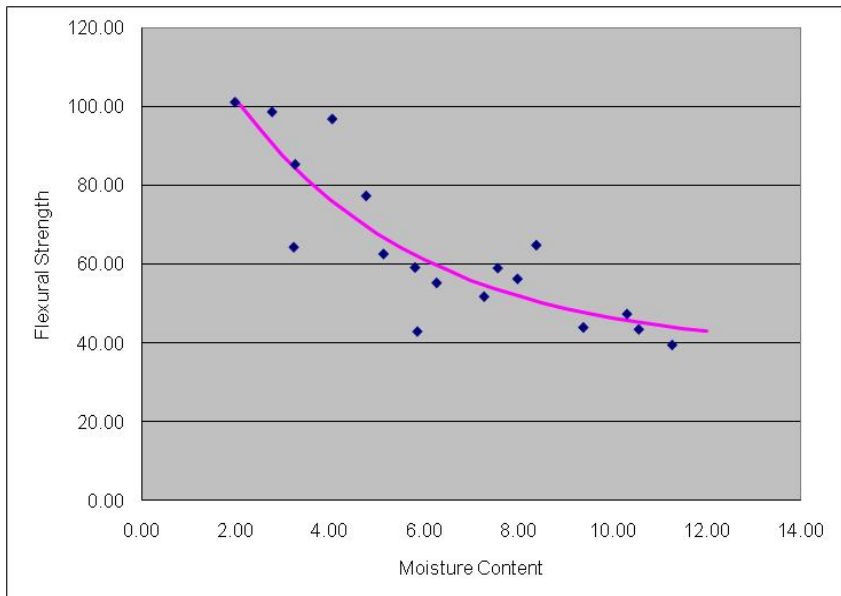

MERRICK FLEXOMETER SAMPLE IDENTIFICATION

DISTRICT:	Waco	SAMPLE NUMBER	
COUNTY:	various	PRODUCER:	Frost

Optimum	
Density (pcf)	134.0
Moisture(%)	7.6
LL	21
PL	15
PI	6
Sample Weight lb	17.75

Triaxial	
0 psi	27.5
15 psi	198.3
Wet Ball % Increase	33 11

Sieve	Percent
1 3/4	
1 1/4	97.6
7/8	
5/8	
3/8	
#4	40.3
#10	
#40	22.9

Specimen		Initial Steps	Total Steps	Beam % Moisture	Width (inches)	Height (inches)	Load (lb)	M max in-lb	Flexural (psi)
Tray	Beam								
1	1	14	34	10.29	0.716	0.690	1.178	1.325	23.32
1	2	14	33	12.78	0.710	0.688	1.104	1.242	22.14
1	3	8	34	8.40	0.719	0.695	1.357	1.527	26.40
1	4	19	40	5.38	0.725	0.679	1.427	1.605	28.83
1	5	1	35	5.49	0.723	0.695	1.505	1.693	29.12
1	6								
2	1	20	31	7.81	0.722	0.69	0.687	0.773	13.5
2	2	1	29	8.87	0.716	0.706	1.069	1.203	20.2
2	3	9	28	8.1	0.719	0.7	0.907	1.02	17.3
2	4	9	40	4.82	0.718	0.700	1.804	2.030	34.7
2	5	2	34	3.67	0.717	0.702	1.429	1.608	27.3
2	6	8	35	4.72	0.712	0.702	1.433	1.612	27.6
3	1	1	23	10.84	0.727	0.709	0.688	0.774	12.7
3	2	6	32	12.85	0.729	0.702	1.246	1.402	23.4
3	3	3	22	12.15	0.740	0.711	0.626	0.704	11.27
3	4	1	36	6.11	0.731	0.713	1.582	1.780	28.71
3									
3									
4	1	7	29	9.37	0.719	0.713	1.017	1.144	18.79
4	2	8	35	8.29	0.713	0.707	1.433	1.612	27.14
4	3	5	27	12.03	0.719	0.708	0.913	1.027	17.07
4	4	11	36	5.18	0.717	0.710	1.433	1.612	26.74
4	5	15	38	7.44	0.715	0.710	1.448	1.629	27.15
4									

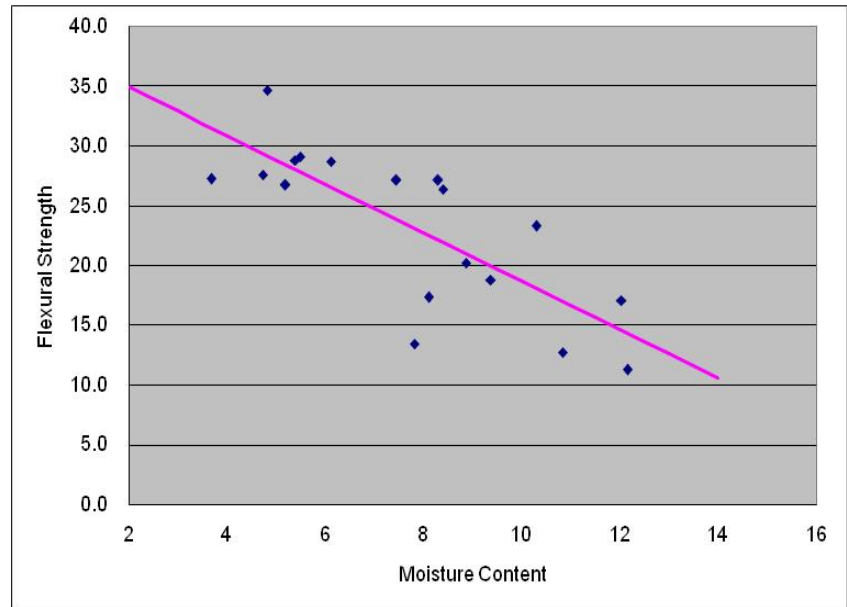

MERRICK FLEXOMETER SAMPLE IDENTIFICATION

DISTRICT:	Dallas	SAMPLE NUMBER	
COUNTY:	various	PRODUCER:	TXI

Optimum	
Density (pcf)	138.2
Moisture(%)	5.8
LL	21
PL	14
PI	7
Sample Weight lb	

Triaxial	
0 psi	43.3
15 psi	190.1
Wet Ball % Increase	21
	5

Sieve	Percent
1 3/4	
1 1/4	
7/8	15.1
5/8	
3/8	43.6
#4	60.2
#10	
#40	81.4

Specimen		Initial Steps	Total Steps	Beam % Moisture	Width (inches)	Height (inches)	Load (lb)	M max in-lb	Flexural (psi)
Tray	Beam								
1	1	15	23	4.58	0.696	0.694	0.398	0.448	8.01
1	2	15	21	0.93	0.700	0.686	0.285	0.321	5.86
1	3	15	20	3.70	0.697	0.693	0.232	0.261	4.69
1	4	13	19	4.71	0.715	0.695	0.257	0.289	5.02
1	5	14	25	2.94	0.705	0.689	0.227	0.289	0.94
1									
2	1	2	21	5.93	0.692	0.701	0.575	0.647	11.4
2	2	15	20	4.98	0.683	0.700	0.232	0.261	4.7
2	3	11	19	5.07	0.68	0.7	0.322	0.362	6.5
2	4	19	27	8.53	0.688	0.690	0.464	0.522	9.6
2	5	19	23	0.68	0.682	0.658	0.217	0.244	5.0
2									
3	1	13	20	5.87	0.690	0.698	0.308	0.347	6.18
3	2	18	24	9.63	0.702	0.701	0.324	0.365	6.33
3	3	16	23	7.61	0.705	0.677	0.356	0.401	7.46
3	4	16	20	7.21	0.676	0.704	0.190	0.214	3.82
3	5	11	20	6.42	0.685	0.705	0.373	0.420	7.4
3	6								
4	1	1	31	6.14	0.671	0.721	1.209	1.360	23.35
4	2	15	34	10.42	0.690	0.705	1.139	1.281	22.47
4	3	1	23	5.88	0.661	0.722	0.688	0.774	13.5
4	4	1	28	3.13	0.683	0.721	1.001	1.126	19.06
4	5								
4	6								

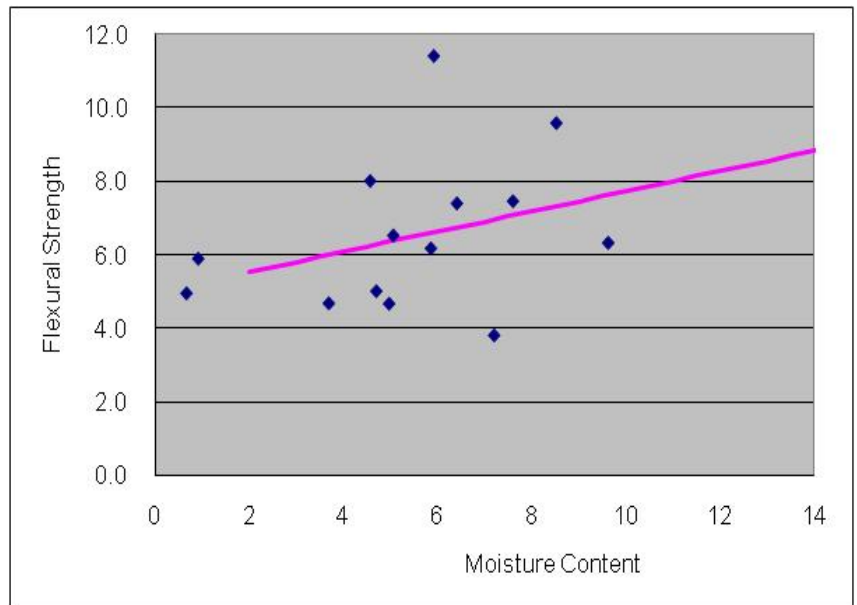

MERRICK FLEXOMETER SAMPLE IDENTIFICATION

DISTRICT: El Paso	SAMPLE NUMBER
COUNTY: various	PRODUCER: Holman

Optimum	136.5
Density (pcf)	
Moisture(%)	
LL	5
PL	
PI	
Sample Weight lb	

Triaxial	46.1
0 psi	
15 psi	
Wet Ball % Increase	39
	18

Sieve	Percent
1 3/4	100.0
1 1/4	
7/8	86.0
5/8	
3/8	64.0
#4	51.0
#10	
#40	22.0

Specimen		Initial Steps	Total Steps	Beam % Moisture	Width (inches)	Height (inches)	Load (lb)	M max in-lb	Flexural (psi)
Tray	Beam								
1	1	1	38	13.85	0.724	0.713	1.738	1.955	31.82
1	2	1	41	12.99	0.701	0.711	1.980	2.228	37.72
1	3	2	36	13.74	0.714	0.708	1.581	1.779	29.85
1	4	15	45	9.27	0.705	0.696	2.021	2.274	39.97
1	5	12	49	11.24	0.714	0.700	2.468	2.777	47.64
1	6	7	51	3.76	0.733	0.700	2.765	3.111	51.9
2	1	13	32	15.27	0.701	0.698	1.067	1.2	21.1
2	2	13	40	14.81	0.695	0.692	1.684	1.895	34.2
2	3	12	41	12.21	0.693	0.691	1.8	2.025	36.6
2	4	13	45	6.55	0.700	0.694	2.097	2.359	42.0
2	5	12	44	7.49	0.715	0.69	2.047	2.303	40.5
2	6	10	51	3.39	0.704	0.702	2.697	3.034	52.5
3									
3									
3									
3									
3									
3									
3									
4									
4									
4									
4									
4									
4									

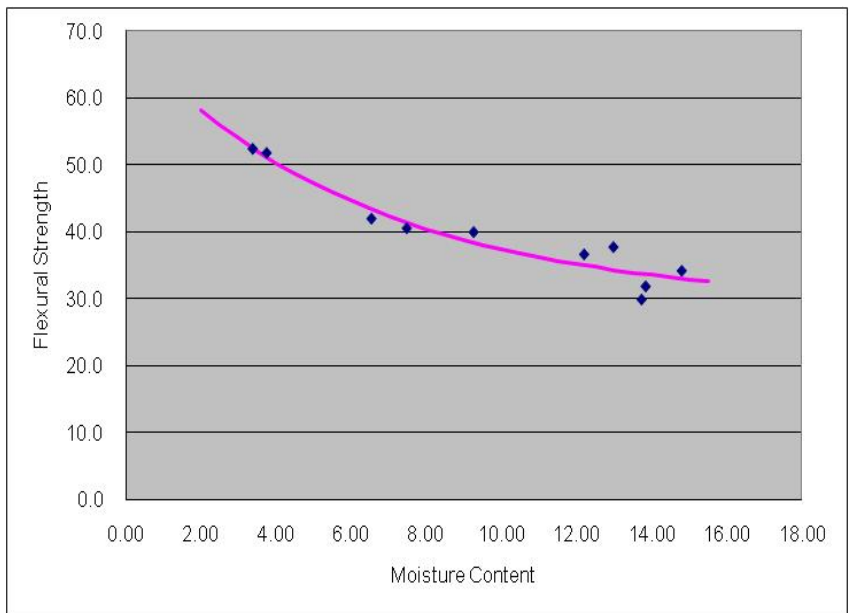

MERRICK FLEXOMETER SAMPLE IDENTIFICATION

DISTRICT:	El Paso	SAMPLE NUMBER	
COUNTY:	various	PRODUCER:	Jobe

5

Optimum	
Density (pcf)	135.0
Moisture(%)	7.4
LL	
PL	
PI	5
Sample Weight lb	

Triaxial	
0 psi	50.2
15 psi	142.9
Wet Ball	27
% Increase	5

Sieve	Percent
1 3/4	0.0
1 1/4	
7/8	
5/8	
3/8	
#4	49.0
#10	
#40	79.0

Specimen		Initial Steps	Total Steps	Beam % Moisture	Width (inches)	Height (inches)	Load (lb)	M max in-lb	Flexural (psi)
Tray	Beam								
1	1	17	35	10.16	0.687	0.700	1.201	1.351	24.13
1	2	17	38	8.82	0.676	0.691	1.449	1.630	30.28
1	3	15	50	2.46	0.673	0.695	2.577	2.899	53.59
1	4	19	40	6.85	0.670	0.697	1.517	1.707	31.48
1	5	18	42	4.89	0.679	0.692	1.741	1.959	36.05
1	6	19	36	14.56	0.681	0.694	1.182	1.330	24.3
2	1	20	36	15.12	0.67	0.707	1.128	1.269	22.8
2	2	22	38	11.45	0.674	0.704	1.179	1.326	23.8
2	3	18	34	8.36	0.673	0.7	1.072	1.206	22.0
2	4	26	46	6.12	0.670	0.709	1.612	1.814	32.3
2	5	24	46	5.65	0.68	0.71	1.744	1.962	34.3
2	6	23	54	3.24	0.672	0.705	2.502	2.815	50.6
3	1	12	30	15.21	0.698	0.710	1.015	1.142	19.49
3	2	15	35	13.42	0.692	0.709	1.291	1.452	24.99
3	3	14	31	9.47	0.689	0.705	1.018	1.145	20.08
3	4	12	40	8.46	0.694	0.708	1.822	2.050	35.40
3	5	18	46	6.48	0.697	0.712	2.089	2.350	39.84
3	6	17	55	2.87	0.696	0.709	2.918	3.283	56.22
4									
4									
4									
4									
4									
4									

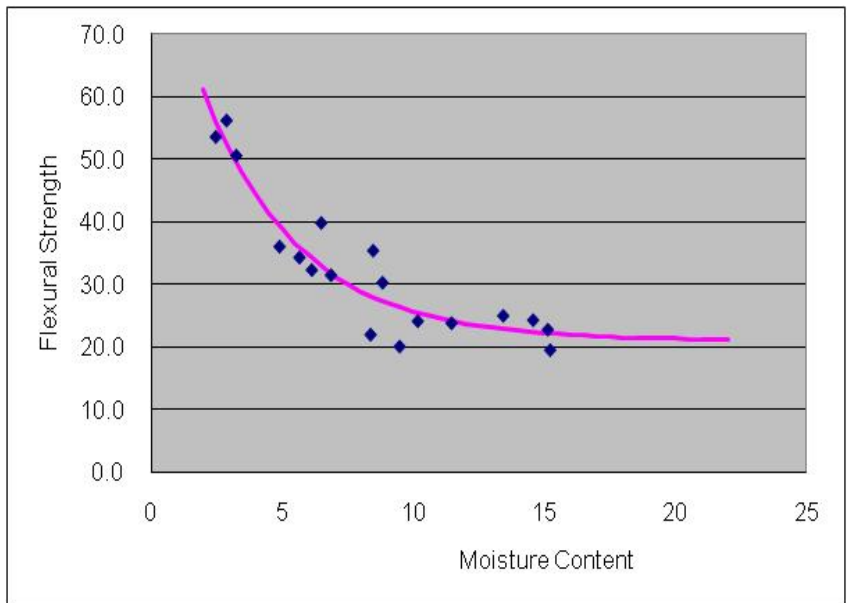

MERRICK FLEXOMETER SAMPLE IDENTIFICATION

DISTRICT:	El Paso	SAMPLE NUMBER	
COUNTY:	various	PRODUCER:	Wyerts

Optimum	
Density (pcf)	135.7
Moisture(%)	6.9
LL	
PL	
PI	3
Sample Weight lb	

Triaxial	
0 psi	46.2
15 psi	137.9
Wet Ball % Increase	37
	17

Sieve	Percent
1 3/4	100.0
1 1/4	
7/8	85.0
5/8	
3/8	64.0
#4	50.0
#10	
#40	21.0

Specimen		Initial Steps	Total Steps	Beam % Moisture	Width (inches)	Height (inches)	Load (lb)	M max in-lb	Flexural (psi)
Tray	Beam								
1	1	10	31	12.16	0.704	0.704	1.089	1.225	21.03
1	2	9	32	12.38	0.711	0.712	1.186	1.334	22.19
1	3	1	31	8.91	0.700	0.718	1.209	1.360	22.60
1	4	4	31	6.31	0.700	0.717	1.198	1.348	22.48
1	5	1	32	4.53	0.712	0.722	1.281	1.441	23.33
1	6								
2	1	16	36		0.679	0.698	1.25	1.406	25.6
2	2	15	34	11.20	0.681	0.693	1.139	1.281	23.5
2	3	11	35	7.67	0.683	0.705	1.356	1.526	27.0
2	4	8	31	2.54	0.673	0.704	1.137	1.279	23.0
2	5	16	31	1.85	0.68	0.691	0.877	0.987	18.2
2	6								
3	1	3	31	11.37	0.692	0.721	1.205	1.356	22.63
3	2	1	30	13.08	0.690	0.718	1.138	1.280	21.57
3	3	1	31	9.34	0.692	0.722	1.209	1.360	22.62
3	4	1	28	6.88	0.688	0.709	1.001	1.126	19.57
3	5								
3	6								
4	1	1	31	6.14	0.671	0.721	1.209	1.360	23.35
4	2	15	34	10.42	0.690	0.705	1.139	1.281	22.47
4	3	1	23	5.88	0.661	0.722	0.688	0.774	13.5
4	4	1	28	3.13	0.683	0.721	1.001	1.126	19.06
4	5								
4	6								

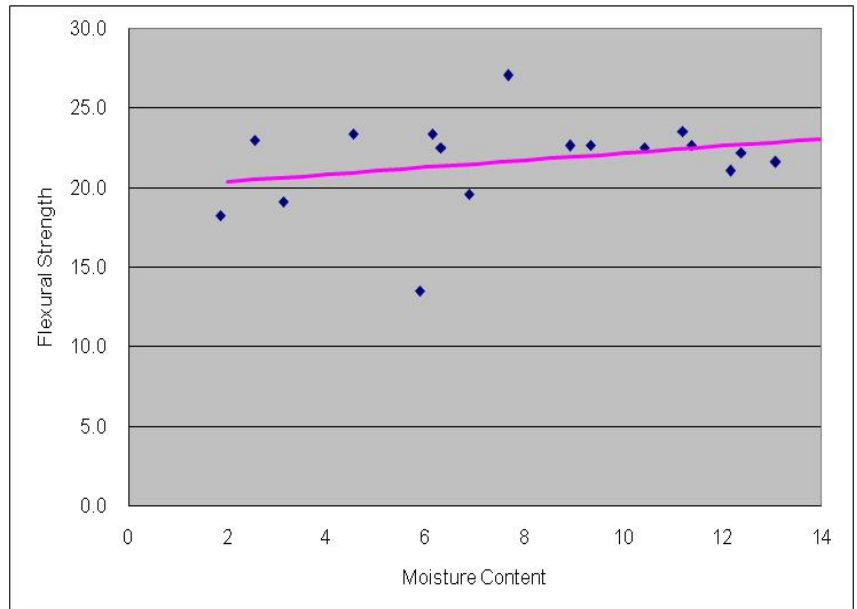

MERRICK FLEXOMETER SAMPLE IDENTIFICATION

DISTRICT: Lubbock	SAMPLE NUMBER
COUNTY: various	PRODUCER: Reworked Base

Optimum	
Density (pcf)	
Moisture(%)	
LL	
PL	
PI	
Sample Weight lb	

Triaxial	
0 psi	
15 psi	
Wet Ball % Increase	

Sieve	Percent
1 3/4	
1 1/4	
7/8	
5/8	
3/8	
#4	
#10	
#40	

Specimen		Initial Steps	Total Steps	Beam % Moisture	Width (inches)	Height (inches)	Load (lb)	M max in-lb	Flexural (psi)
Tray	Beam								
1	1	22	27	14.18	0.656	0.703	0.325	0.366	6.77
1	2	14	21	13.65	0.642	0.716	0.342	0.385	7.03
1	3	11	20	12.97	0.660	0.715	0.391	0.440	7.83
1	4	10	23	5.69	0.650	0.710	0.595	0.669	12.24
1	5	12	21	8.02	0.655	0.710	0.415	0.467	8.50
1	6								
2	1	13	20	12.95	0.658	0.715	0.324	0.365	6.5
2	2	18	25	11.12	0.639	0.698	0.410	0.461	8.9
2	3	19	25	6.96	0.658	0.689	0.358	0.403	7.8
2	4	20	27	5.36	0.645	0.700	0.440	0.495	9.4
2	5	14	25	3.83	0.658	0.708	0.59	0.664	12.1
2	6								
3	1	21	25	15.08	0.656	0.703	0.248	0.279	5.16
3	2	19	24	12.97	0.642	0.716	0.293	0.330	6.03
3	3	16	22	12.65	0.660	0.715	0.316	0.356	6.33
3	4	18	26	4.75	0.650	0.710	0.477	0.537	9.83
3	5	16	28	2.87	0.655	0.710	0.712	0.801	14.58
3	6								
4	1	18	23	11.50	0.661	0.704	0.282	0.317	5.81
4	2	14	20	9.35	0.669	0.700	0.286	0.322	5.9
4	3	19	24	7.46	0.670	0.698	0.293	0.330	6.06
4	4	19	26	4.35	0.659	0.694	0.425	0.478	9.01
4	5	15	24	3.14	0.663	0.700	0.484	0.545	10.04
4	6								

Untreated Material

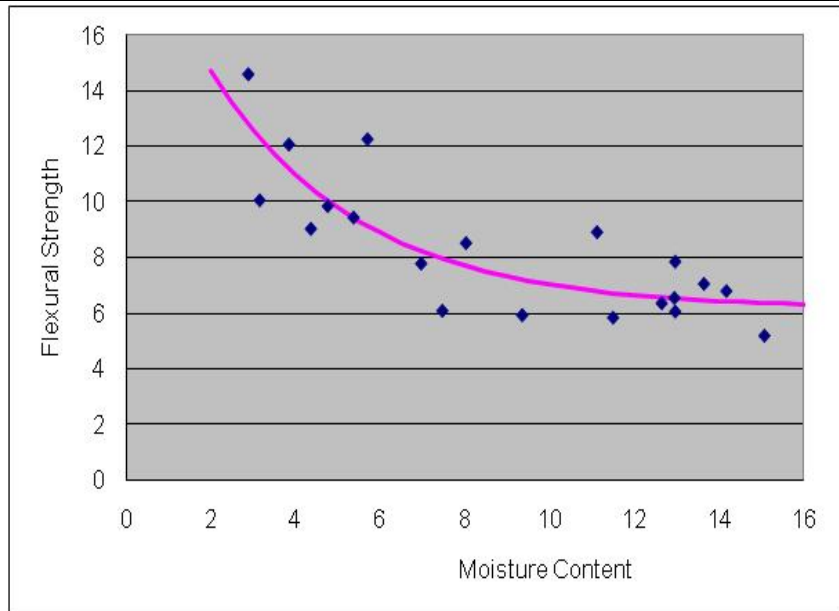

MERRICK FLEXOMETER SAMPLE IDENTIFICATION

DISTRICT:	San Angelo	SAMPLE NUMBER	
COUNTY:	various	PRODUCER:	CSA/Turner

Optimum	
Density (pcf)	
Moisture(%)	
LL	
PL	
PI	
Sample Weight lb	

Triaxial	
0 psi	
15 psi	
Wet Ball	
% Increase	

Sieve	Percent
1 3/4	
1 1/4	
7/8	
5/8	
3/8	
#4	
#10	
#40	

Specimen		Initial Steps	Total Steps	Beam % Moisture	Width (inches)	Height (inches)	Load (lb)	M max in-lb	Flexural (psi)
Tray	Beam								
1	1	19	27	11.00	0.710	0.691	0.494	0.556	9.85
1	2	15	24	10.80	0.693	0.697	0.484	0.545	9.69
1	3	12	20	9.30	0.695	0.690	0.359	0.404	7.34
1	4	9	24	6.70	0.709	0.697	0.684	0.770	13.42
1	5	15	29	6.10	0.716	0.692	0.828	0.932	16.29
1	6	11	32	4.00	0.707	0.700	1.199	1.349	23.4
2	1	18	25	11.63	0.703	0.689	0.41	0.461	8.3
2	2	17	26	10.04	0.697	0.690	0.526	0.592	10.7
2	3	18	27	8.14	0.697	0.688	0.546	0.614	11.2
2	4	13	23	3.31	0.713	0.698	0.500	0.563	9.7
2	5	16	28	5.18	0.703	0.694	0.712	0.801	14.2
2	6	14	28	6.81	0.702	0.689	0.796	0.896	16.2
3	1	9	21	10.08	0.721	0.710	0.501	0.564	9.31
3	2	11	25	8.33	0.723	0.708	0.695	0.782	12.94
3	3	9	17	6.67	0.722	0.708	0.290	0.326	5.39
3	4	10	26	5.73	0.703	0.702	0.790	0.889	15.37
3	5	9	29	4.47	0.713	0.707	1.028	1.157	19.48
3	6	10	27	2.99	0.718	0.704	0.859	0.966	16.27
4	1	11	21	10.74	0.715	0.710	0.447	0.503	8.38
4	2	10	27	9.68	0.723	0.722	0.859	0.966	15.36
4	3	6	29	6.30	0.723	0.716	1.084	1.220	19.76
4	4	10	15	4.77	0.715	0.705	0.175	0.197	3.32
4	5	2	28	2.93	0.715	0.708	1.036	1.166	19.56
4									

Same Day Flexometer Test

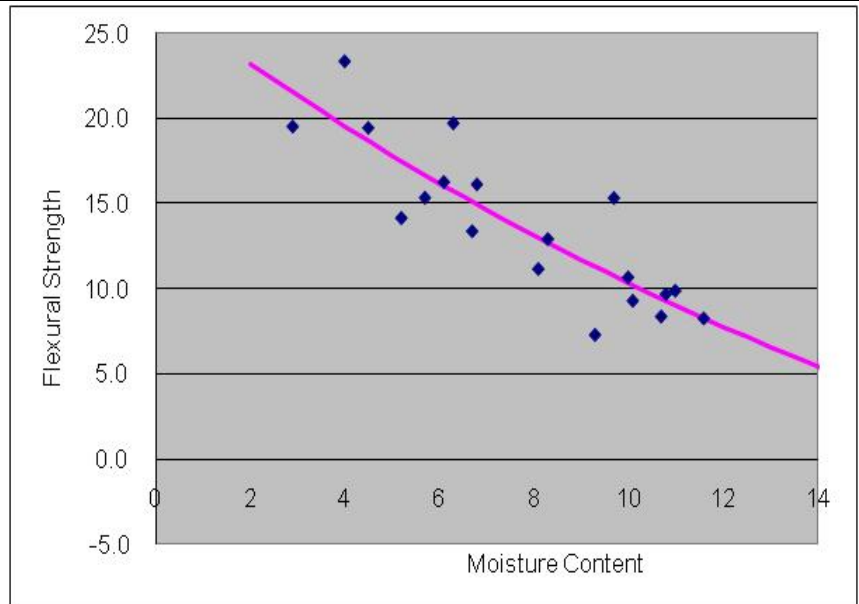

MERRICK FLEXOMETER SAMPLE IDENTIFICATION

DISTRICT: San Angelo	SAMPLE NUMBER
COUNTY: various	PRODUCER: CSA/Turner

Optimum	
Density (pcf)	
Moisture(%)	
LL	
PL	
PI	
Sample Weight lb	

Triaxial	
0 psi	
15 psi	
Wet Ball	
% Increase	

Sieve	Percent
1 3/4	
1 1/4	
7/8	
5/8	
3/8	
#4	
#10	
#40	

Specimen Tray	Beam	Beam % Moisture	Width (inches)	Height (inches)	Length (inches)	Flexural (psi)	Flexural (psi)
1	1	12.02	0.710	0.690	4	0.65	11.54
1	2	7.52	0.700	0.697	4	0.94	16.59
1	3	5.34	0.704	0.690	4	1.12	20.05
1	4	5.80	0.698	0.695	4	1.12	19.93
1	5						
1							
2	1	12.51	0.731	0.694	4	0.70	11.93
2	2	11.22	0.731	0.688	4	0.70	12.14
2	3	8.06	0.733	0.7	4	0.96	16.04
2	4	7.93	0.723	0.694	4	1.02	17.57
2	5	5.40	0.723	0.694	4	1.14	19.64
2							
3	1	12.49	0.720	0.720	4	0.78	12.54
3	2	11.65	0.728	0.725	4	0.78	12.23
3	3	9.21	0.725	0.725	4	1.10	17.32
3	4	6.06	0.716	0.724	4	1.10	17.59
3	5	4.31	0.726	0.726	4	1.32	20.70
3	6	3.78	0.714	0.729	4	1.34	21.19
4	1	14.34	0.725	0.710	4	0.62	10.18
4	2	13.52	0.723	0.710	4	0.72	11.85
4	3	11.14	0.725	0.716	4	0.86	13.88
4	4	8.34	0.721	0.717	4	1.08	17.48
4	5	3.45	0.720	0.718	4	1.40	22.63
4	6	4.23	0.725	0.718	4	1.28	20.55

Same Day Snapshot Test

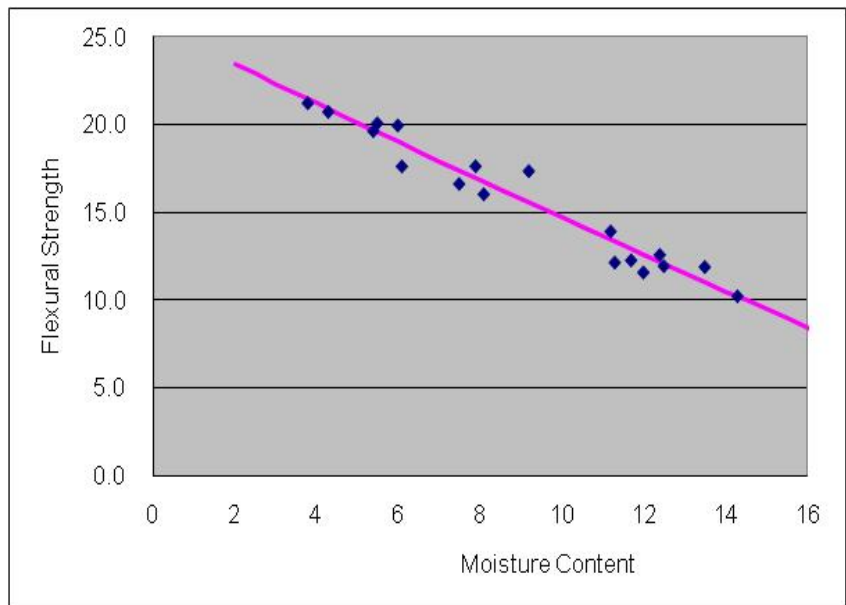

MERRICK FLEXOMETER SAMPLE IDENTIFICATION

DISTRICT: Brownwood	SAMPLE NUMBER
COUNTY: various	PRODUCER: Prater

Optimum	
Density (pcf)	127.0
Moisture(%)	10.5
LL	28
PL	21
PI	7
Sample Weight lb	

Triaxial	
0 psi	45.0
15 psi	177.0
Wet Ball	48
% Increase	19

Sieve	Percent
1 3/4	2.3
1 1/4	
7/8	21.9
5/8	29.6
3/8	40.4
#4	51.6
#10	
#40	73.6

Specimen		Initial Steps	Total Steps	Beam % Moisture	Width (inches)	Height (inches)	Load (lb)	M max in-lb	Flexural (psi)
Tray	Beam								
1	1	19	31	2.27	0.681	0.686	0.786	0.884	16.57
1	2	19	26	4.06	0.665	0.685	0.425	0.478	9.20
1	3	19	38	1.75	0.667	0.681	1.348	1.517	29.35
1	4	20	27	15.05	0.672	0.677	0.440	0.495	9.63
1	5	15	33	19.05	0.678	0.703	1.132	1.274	22.85
1	6	13	19	8.08	0.692	0.697	0.270	0.304	5.4
2	1	16	23	15.7	0.677	0.682	0.377	0.424	8.1
2	2	8	32	2.10	0.677	0.692	1.276	1.436	26.6
2	3	15	22	12	0.687	0.697	0.36	0.405	7.3
2	4	11	25	18.30	0.682	0.702	0.695	0.782	13.9
2	5	20	23	3.5	0.687	0.681	0.176	0.198	3.7
2	6								
3	1	17	30	18.00	0.682	0.703	0.811	0.912	16.27
3	2	15	21	11.00	0.686	0.700	0.301	0.339	6.05
3	3	11	21	3.40	0.697	0.708	0.447	0.503	8.64
3	4	5	20	5.70	0.700	0.728	0.513	0.577	9.33
3	5	14	21	6.40	0.690	0.696	0.342	0.385	6.91
3	6	14	22	14.60	0.689	0.700	0.401	0.451	8.01
4	1	13	17	8.80	0.682	0.705	0.169	0.190	3.37
4	2	16	27	2.10	0.695	0.680	0.641	0.721	13.47
4	3	14	21	11.60	0.682	0.697	0.342	0.385	6.99
4	4	11	19	14.50	0.677	0.705	0.336	0.378	6.73
4	5	23	31	16.50	0.685	0.682	0.556	0.626	11.79
4	6								

Same Day Flexometer Test

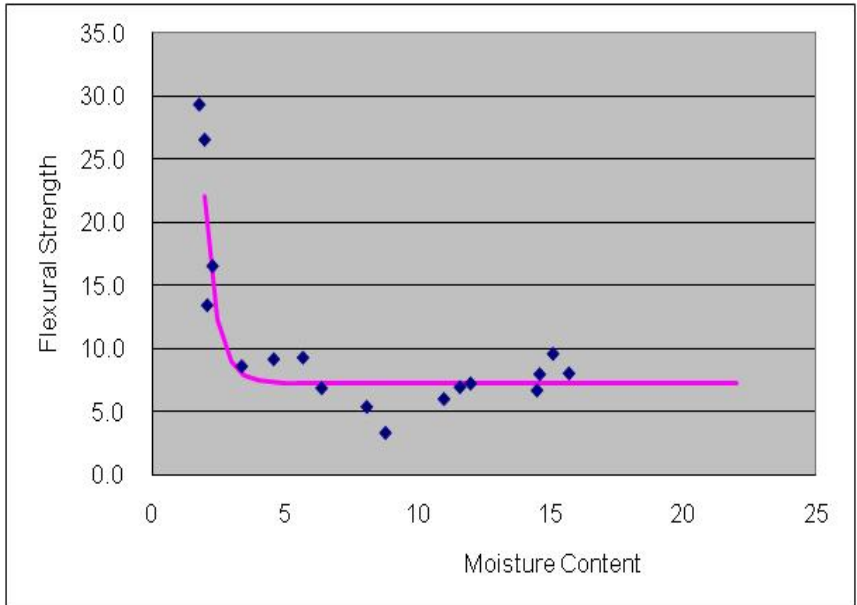

MERRICK FLEXOMETER SAMPLE IDENTIFICATION

DISTRICT: Brownwood	SAMPLE NUMBER
COUNTY: various	PRODUCER: Prater

Optimum	
Density (pcf)	127.0
Moisture(%)	10.5
LL	28
PL	21
PI	7
Sample Weight lb	

Triaxial	
0 psi	45.0
15 psi	177.0
Wet Ball % Increase	48 19

Sieve	Percent
1 3/4	2.3
1 1/4	
7/8	21.9
5/8	29.6
3/8	40.4
#4	51.6
#10	
#40	73.6

Specimen		Beam % Moisture	Width (inches)	Height (inches)	Length (inches)	Flexural (psi)	Flexural (psi)
Tray	Beam						
1	1	2.75	0.681	0.678	4	1.12	21.47
1	2	6.70	0.698	0.678	4	0.78	14.59
1	3	18.07	0.698	0.679	4	0.58	10.81
1	4	13.51	0.702	0.683	4	0.62	11.36
1	5	1.47	0.714	0.695	4	1.92	33.40
1							
2	1	5.67	0.685	0.707	4	0.92	16.12
2	2	3.02	0.679	0.710	4	0.92	16.13
2	3	19.02	0.683	0.708	4	0.66	11.57
2	4	15.36	0.696	0.710	4	0.68	11.63
2	5	8.25	0.687	0.706	4	0.96	16.82
2		4.04	0.687	0.708	4	0.90	15.68
3	1	2.70	0.694	0.685	4	1.52	28.01
3	2	7.12	0.695	0.690	4	0.78	14.14
3	3	20.00	0.675	0.675	4	0.50	9.75
3	4	15.16	0.727	0.695	4	0.58	9.91
3	5	9.58	0.698	0.687	4	0.76	13.84
3	6	1.97	0.691	0.737	4	1.12	17.90
4	1	-538.12	0.682	0.709	4	1.24	21.70
4	2	5.83	0.685	0.704	4	0.80	14.14
4	3	19.35	0.690	0.687	4	0.62	11.42
4	4	15.26	0.679	0.704	4	0.60	10.70
4	5	10.59	0.692	0.706	4	0.76	13.22
4	6	2.67	0.698	0.708	4	0.96	16.46

Same Day Snapshot Test

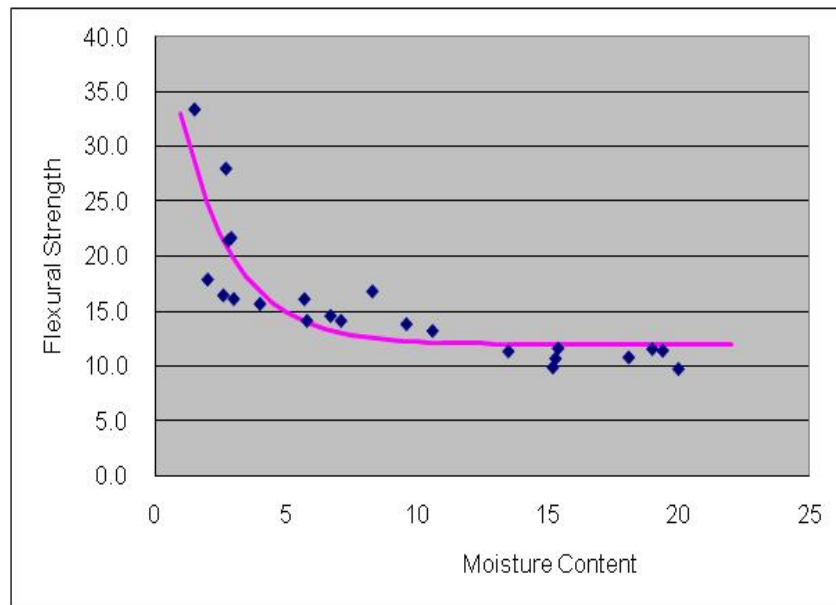

MERRICK FLEXOMETER SAMPLE IDENTIFICATION

DISTRICT: Waco	SAMPLE NUMBER
COUNTY: various	PRODUCER: Frost

Optimum	
Density (pcf)	
Moisture(%)	
LL	
PL	
PI	
Sample Weight lb	

Triaxial	
0 psi	
15 psi	
Wet Ball % Increase	

Sieve	Percent
1 3/4	
1 1/4	
7/8	
5/8	
3/8	
#4	
#10	
#40	

Specimen		Initial Steps	Total Steps	Beam % Moisture	Width (inches)	Height (inches)	Load (lb)	M max in-lb	Flexural (psi)
Tray	Beam								
1	1	19	56	2.40	0.695	0.695	2.902	3.265	58.48
1	2	17	31	4.90	0.689	0.690	0.887	0.998	18.22
1	3	20	32	11.30	0.692	0.680	0.809	0.910	17.09
1	4	22	33	12.20	0.689	0.682	0.772	0.869	16.28
1	5	19	32	5.60	0.675	0.680	0.863	0.971	18.65
1	6	19	44	3.20	0.693	0.686	1.862	2.095	38.6
2	1	22	47	2.8	0.695	0.68	1.955	2.199	41.1
2	2	15	24	9.20	0.690	0.695	0.484	0.545	9.8
2	3	2	32	14.1	0.69	0.72	1.334	1.501	25.1
2	4	16	28	12.20	0.690	0.700	0.712	0.801	14.2
2	5	10	23	7.5	0.69	0.715	0.595	0.669	11.4
2	6	16	33	4.00	0.692	0.687	1.088	1.224	22.5
3	1	12	51	2.00	0.691	0.698	2.778	3.125	55.64
3	2	14	28	6.10	0.705	0.695	0.796	0.896	15.81
3	3	18	31	11.80	0.712	0.703	0.838	0.943	16.09
3	4	18	29	12.70	0.705	0.680	0.688	0.774	14.22
3	5	17	27	5.90	0.705	0.688	0.595	0.669	12.05
3	6	20	32	3.40	0.690	0.677	0.809	0.910	17.31
4	1	25	45	3.20	0.700	0.667	1.591	1.790	34.51
4	2	15	25	7.30	0.696	0.707	0.549	0.618	10.66
4	3	21	35	13.60	0.695	0.677	0.990	1.114	20.95
4	4	15	23	9.10	0.695	0.703	0.421	0.474	8.29
4	5	21	29	5.30	0.692	0.670	0.526	0.592	11.46
4	6	13	33	3.40	0.690	0.695	1.210	1.361	24.51

Same Day Flexometer Test

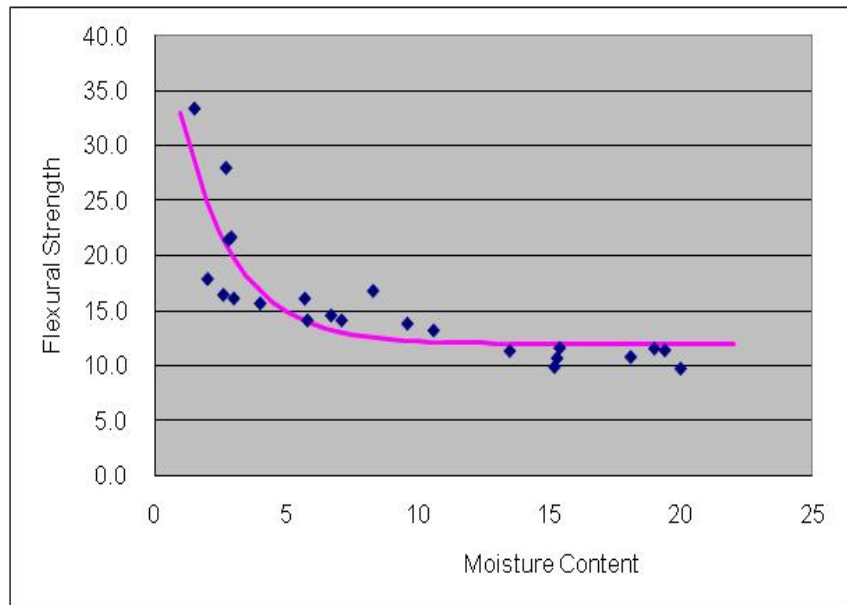

MERRICK FLEXOMETER SAMPLE IDENTIFICATION

DISTRICT: Waco COUNTY:	SAMPLE NUMBER PRODUCER: Frost
----------------------------------	---

Optimum	
Density (pcf)	
Moisture(%)	
LL	
PL	
PI	
Sample Weight lb	

Triaxial	
0 psi	
15 psi	
Wet Ball % Increase	

Sieve	Percent
1 3/4	
1 1/4	
7/8	
5/8	
3/8	
#4	
#10	
#40	

Specimen		Beam % Moisture	Width (inches)	Height (inches)	Length (inches)	Flex Load (psi)	Flexural (psi)
Tray	Beam						
1	1	2.91	0.699	0.691	4	2.30	41.35
1	2	7.01	0.705	0.685	4	1.06	19.23
1	3	14.03	0.705	0.682	4	0.34	6.22
1	4	9.49	0.706	0.681	4	0.72	13.19
1	5	4.77	0.701	0.687	4	1.32	23.94
1	6	1.12	0.705	0.690	4	5.18	92.60
2	1	1.33	0.697	0.714	4	4.82	81.39
2	2	6.96	0.719	0.691	4	0.94	16.43
2	3	14.46	0.686	0.725	4	0.32	5.32
2	4	9.05	0.691	0.719	4	0.74	12.43
2	5	4.09	0.707	0.719	4	1.62	26.59
2	6	2.60	0.697	0.716	4	2.34	39.29
3	1	1.79	0.675	0.687	4	2.24	42.19
3	2	4.57	0.678	0.681	4	1.08	20.61
3	3	12.27	0.665	0.678	4	0.34	6.67
3	4	10.33	0.674	0.680	4	0.60	11.55
3	5	6.44	0.687	0.679	4	0.98	18.56
3	6	1.14	0.686	0.693	4	4.30	78.31
4	1	1.13	0.698	0.711	4	4.86	82.64
4	2	5.82	0.697	0.701	4	1.02	17.87
4	3	13.07	0.675	0.689	4	0.36	6.74
4	4	9.01	0.690	0.700	4	0.66	11.71
4	5	4.44	0.699	0.701	4	1.34	23.41
4	6	4.93	0.697	0.703	4	1.24	21.60

Same Day Snapshot Test

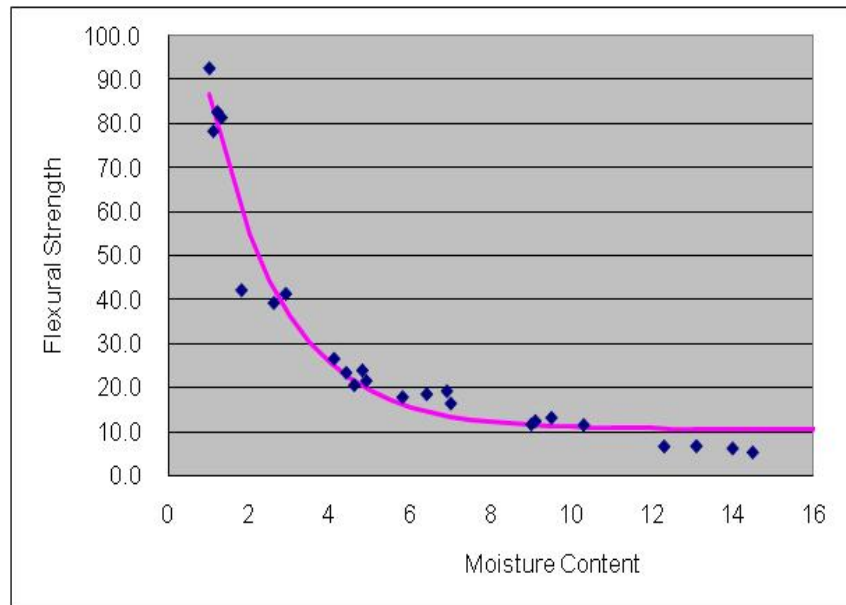

MERRICK FLEXOMETER SAMPLE IDENTIFICATION

DISTRICT: Lubbock COUNTY:	SAMPLE NUMBER PRODUCER: Reworked Material
-------------------------------------	---

Optimum	
Density (pcf)	
Moisture(%)	
LL	
PL	
PI	
Sample Weight lb	

Triaxial	
0 psi	
15 psi	
Wet Ball	
% Increase	

Sieve	Percent
1 3/4	
1 1/4	
7/8	
5/8	
3/8	
#4	
#10	
#40	

Specimen		Beam % Moisture	Width (inches)	Height (inches)	Length (inches)	Flex Load (psi)	Flexural (psi)
Tray	Beam						
1	1	13.89	0.675	0.714	4	1.09	19.01
1	2	11.89	0.672	0.709	4	1.04	18.47
1	3	8.25	0.670	0.717	4	1.38	24.04
1	4	6.47	0.681	0.707	4	1.39	24.50
1	5	3.45	0.674	0.710	4	1.74	30.73
1	6						
2	1	15.04	0.682	0.711	4	1.05	18.27
2	2	12.78	0.679	0.705	4	1.18	20.98
2	3	9.45	0.676	0.709	4	1.22	21.54
2	4	4.12	0.685	0.707	4	1.78	31.19
2	5						
2	6						
3	1	11.59	0.691	0.709	4	1.24	21.42
3	2	8.45	0.696	0.714	4	1.28	21.64
3	3	5.74	0.692	0.711	4	1.46	25.04
3	4	3.75	0.697	0.709	4	1.86	31.85
3	5						
3	6						
4	1	10.45	0.699	0.711	4	1.22	20.72
4	2	6.78	0.696	0.705	4	1.55	26.88
4	3	5.24	0.704	0.710	4	1.51	25.53
4	4	3.78	0.700	0.709	4	1.72	29.33
4	5	2.45	0.702	0.714	4	2.24	37.55
4	6	4.93				1.24	21.60

with 1% Cement

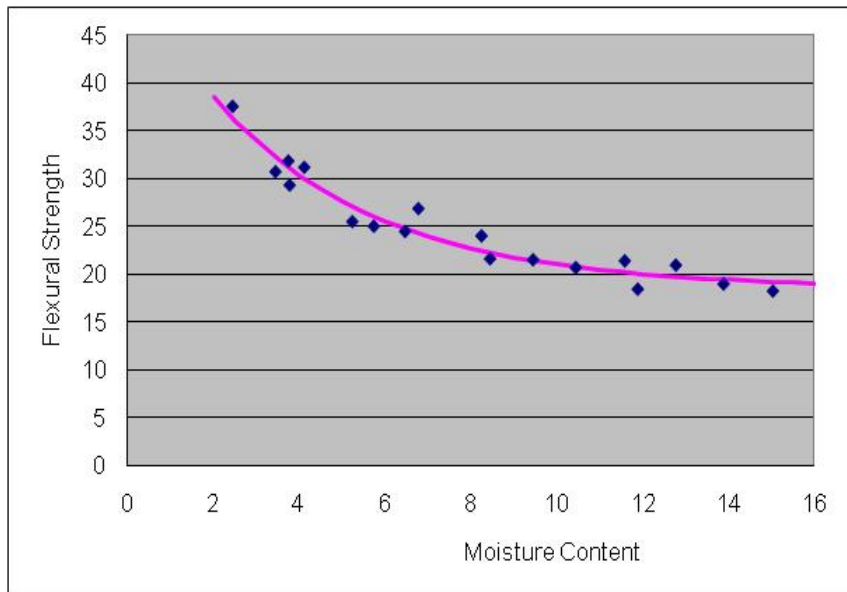

MERRICK FLEXOMETER SAMPLE IDENTIFICATION

DISTRICT: Lubbock COUNTY:	SAMPLE NUMBER PRODUCER: Reworked Base
-------------------------------------	---

Optimum	
Density (pcf)	
Moisture(%)	
LL	
PL	
PI	
Sample Weight lb	

Triaxial	
0 psi	
15 psi	
Wet Ball	
% Increase	

Sieve	Percent
1 3/4	
1 1/4	
7/8	
5/8	
3/8	
#4	
#10	
#40	

Specimen		Beam % Moisture	Width (inches)	Height (inches)	Length (inches)	Flex Load (psi)	Flexural (psi)
Tray	Beam						
1	14.89	2.91	0.698	0.715	4	2.30	38.67
1	12	7.01	0.702	0.709	4	2.50	42.51
1	7.42	14.03	0.690	0.712	4	2.78	47.69
1	5	9.49	0.694	0.717	4	3.08	51.80
1	2.89	4.77	0.700	0.714	4	4.43	74.48
1							
2	15.3	1.33	0.689	0.709	4	2.04	35.34
2	12	6.96	0.685	0.705	4	2.40	42.30
2	10.45	14.46	0.692	0.708	4	2.70	46.70
2	8	9.05	0.680	0.702	4	2.86	51.21
2	4.35	4.09	0.683	0.709	4	3.02	52.78
2							
3	11	1.79	0.701	0.714	4	2.40	40.29
3	10	4.57	0.700	0.715	4	2.64	44.26
3	5	12.27	0.705	0.710	4	3.40	57.40
3	3	10.33	0.701	0.712	4	3.98	67.20
3							
3							
4	8	1.13	0.710	0.709	4	2.70	45.39
4	5	5.82	0.713	0.702	4	2.90	49.52
4	4	13.07	0.708	0.700	4	3.40	58.80
4	3	9.01	0.708	0.704	4	4.20	71.82
4							
4							

With 3% Cement

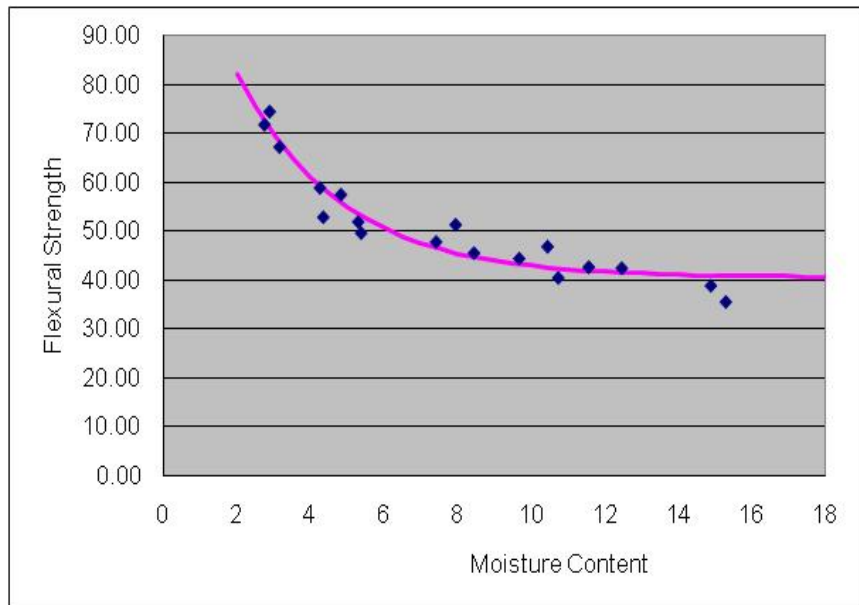

MERRICK FLEXOMETER SAMPLE IDENTIFICATION

DISTRICT: Abilene	SAMPLE NUMBER
COUNTY: various	PRODUCER: Vulcan/Blacklease

Optimum	
Density (pcf)	145.1
Moisture(%)	5.7
LL	14
PL	12
PI	2
Sample Weight lb	

Triaxial	
0 psi	28.6
15 psi	191.9
Wet Ball % Increase	33
	12

Sieve	Percent
1 3/4	
1 1/4	
7/8	
5/8	
3/8	
#4	47.0
#10	
#40	80.7

Specimen		Initial Steps	Total Steps	Beam % Moisture	Width (inches)	Height (inches)	Load (lb)	M max in-lb	Flexural (psi)
Tray	Beam								
1	1	16	45	22.35	0.716	0.704	2.097	2.359	39.92
1	2	18	47	18.95	0.709	0.703	2.176	2.448	41.97
1	3	17	47	13.23	0.702	0.700	2.225	2.503	43.58
1	4	22	49	10.97	0.700	0.683	2.130	2.396	43.99
1	5								
1	6								
2	1	23	47	19.61	0.705	0.667	1.894	2.131	40.8
2	2	23	48	19.81	0.707	0.662	1.982	2.230	43.2
2	3	20	48	14.39	0.695	0.662	2.158	2.428	47.8
2	4	19	50	9.94	0.700	0.666	2.387	2.685	52.0
2	5								
2	6								
3	1	9	43	16.11	0.730	0.705	2.166	2.437	40.33
3	2	11	44	14.07	0.720	0.698	2.199	2.474	42.32
3	3	12	47	10.19	0.720	0.688	2.429	2.733	48.21
3	4	9	52	6.35	0.720	0.683	2.951	3.320	59.36
3	5	11	55	3.12	0.725	0.675	3.154	3.548	64.38
3	6								
4	1	11	40	17.72	0.717	0.710	1.854	2.086	34.6
4	2	16	45	12.50	0.709	0.700	2.097	2.359	40.67
4	3	10	48	10.79	0.718	0.710	2.577	2.899	48.09
4	4	10	55	4.17	0.713	0.705	3.183	3.581	60.69
4	5	9	61	2.79	0.700	0.710	3.702	4.165	70.75
4	6	11	58	3.08	0.718	0.714	3.405	3.831	62.74

With 2% Flyash

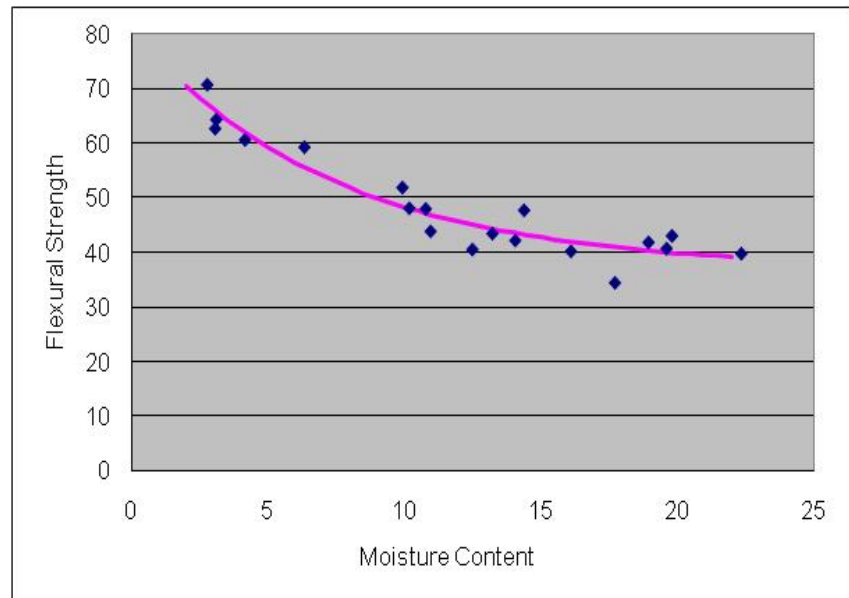

MERRICK FLEXOMETER SAMPLE IDENTIFICATION

DISTRICT: Abilene	SAMPLE NUMBER
COUNTY: various	PRODUCER: Vulcan/Blacklease

Optimum	
Density (pcf)	145.1
Moisture(%)	5.7
LL	14
PL	12
PI	2
Sample Weight lb	

Triaxial	
0 psi	28.6
15 psi	191.9
Wet Ball % Increase	33
	12

Sieve	Percent
1 3/4	
1 1/4	
7/8	
5/8	
3/8	
#4	47.0
#10	
#40	80.7

Specimen		Initial Steps	Total Steps	Beam % Moisture	Width (inches)	Height (inches)	Load (lb)	M max in-lb	Flexural (psi)
Tray	Beam								
1	1	17	41	20.41	0.703	0.702	1.703	1.916	33.13
1	2	10	46	14.94	0.720	0.710	2.402	2.702	44.61
1	3	11	48	13.34	0.702	0.713	2.548	2.867	48.21
1	4	16	50	9.80	0.710	0.705	2.534	2.851	48.55
1	5	14	50	10.77	0.712	0.709	2.618	2.945	49.48
1	6	16	58	4.81	0.705	0.705	3.215	3.617	61.9
2	1	11	40	21.1	0.702	0.694	1.854	2.086	36.9
2	2	13	40	14.60	0.707	0.702	1.787	2.010	34.6
2	3	14	40	17.64	0.7	0.695	1.749	1.968	34.9
2	4	12	42	13.42	0.704	0.695	1.993	2.242	39.6
2	5	11	40	11.99	0.695	0.7	1.854	2.086	36.7
2	6	9	45	5.50	0.707	0.700	2.340	2.633	45.6
3	1	13	40	19.09	0.713	0.710	1.787	2.010	33.50
3	2	16	48	12.70	0.710	0.700	2.359	2.654	45.76
3	3	16	46	14.18	0.712	0.705	2.184	2.457	41.64
3	4	15	50	8.31	0.709	0.709	2.577	2.899	48.71
3	5	14	52	6.00	0.712	0.712	2.792	3.141	52.25
3	6	11	62	3.24	0.709	0.705	3.726	4.192	71.39
4	1	11	40	21.63	0.707	0.700	1.854	2.086	36.14
4	2	12	46	11.47	0.705	0.697	2.341	2.634	46.13
4	3	14	46	11.93	0.705	0.700	2.268	2.552	44.22
4	4	11	44	13.77	0.710	0.698	2.199	2.474	42.96
4	5	10	46	11.52	0.705	0.700	2.402	2.702	46.82
4	6	12	56	4.60	0.705	0.691	3.206	3.607	64.24

With 4% Flyash

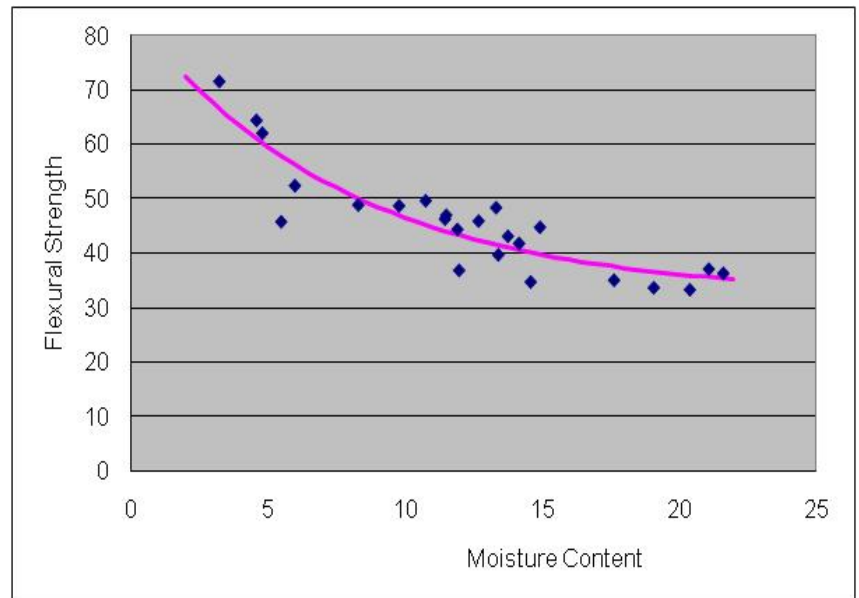



TEXAS TECH UNIVERSITY

Multidisciplinary Research in Transportation

Texas Tech University | Lubbock, Texas 79409
P 806.742.3503 | F 806.742.4168