

**A STUDY OF
WEIGH STATION TECHNOLOGIES
AND PRACTICES**

NOVEMBER 2008

A REPORT BY

**THE CONNECTICUT
ACADEMY OF SCIENCE
AND ENGINEERING**

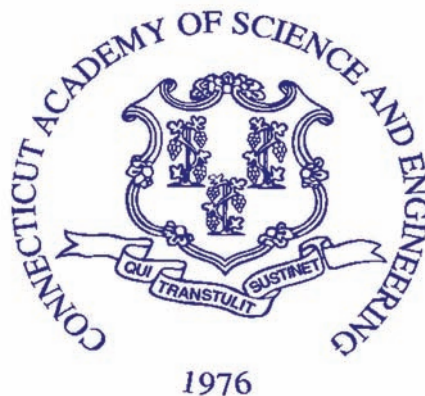

FOR

**THE CONNECTICUT DEPARTMENT OF
TRANSPORTATION**

A STUDY OF WEIGH STATION TECHNOLOGIES AND PRACTICES

A REPORT BY

THE CONNECTICUT ACADEMY
OF SCIENCE AND ENGINEERING

ORIGIN OF INQUIRY: CONNECTICUT DEPARTMENT OF
TRANSPORTATION (CONNDOT)

DATE INQUIRY
ESTABLISHED: OCTOBER 15, 2007

DATE RESPONSE
RELEASED: NOVEMBER 14, 2008

This study was initiated at the request of the Connecticut Department of Transportation on October 15, 2007. The project was conducted by an Academy Study Committee with the support of David Pines, PhD, Study Manager and Clara Fang, PhD, Study Consultant. The content of this report lies within the province of the Academy's Transportation Systems Technical Board. The report has been reviewed by Academy Members Peter G. Cable, PhD and Herbert S. Levinson, PE. Martha Sherman, the Academy's Managing Editor, edited the report. The report is hereby released with the approval of the Academy Council.

Richard H. Strauss
Executive Director

Disclaimer

The contents of this report reflect the views of the authors who are responsible for the facts and accuracy of the data presented herein. The contents do not necessarily reflect the official views or policies of the Connecticut Department of Transportation. The report does not constitute a standard, specification, or regulation.

The US Government and the Connecticut Department of Transportation do not endorse products or manufacturers.

A STUDY OF WEIGH STATION TECHNOLOGIES AND PRACTICES

Technical Report Documentation Page

1. Report No. CT-2257-F-08-7	2. Government Accession No.	3. Recipients Catalog No.	
4. Title and Subtitle A Study of Weigh Station Technologies and Practices		5. Report Date November 2008	
		6. Performing Organization Code SPR-2257	
7. Author(s) David Pines, PhD, Study Manager Clara Fang, PhD, Study Consultant		8. Performing Organization Report No. CT-2257-F-08-7	
9. Performing Organization Name and Address Connecticut Academy of Science & Engineering 179 Allyn Street, Suite 512 Hartford, CT 06103		10. Work Unit No. (TRIS)	
		11. Contract or Grant No. CT Study No. SPR-2257	
		13. Type of Report and Period Covered Final Report October 2007 - November 2008	
12. Sponsoring Agency Name and Address Connecticut Department of Transportation 2800 Berlin Turnpike Newington, CT 06131-7546		14. Sponsoring Agency Code SPR-2257	
15. Supplementary Notes Project partners: Connecticut DOT - Bureau of Engineering and Highway Operations, Division of Research; Connecticut Academy of Science and Engineering. Prepared in cooperation with the U. S. Department of Transportation, Federal Highway Administration.			
16. Abstract This study was requested in response to concerns about the operation of the Greenwich Weigh and Inspection Station (Greenwich Station) on I-95 Northbound. The Station's configuration, combined with both the size and volume of trucks and buses (commercial vehicles) which must use it, severely impact the Station's ability to operate effectively to assure commercial vehicle compliance with the state's weight and safety regulations and requirements. This report identifies technologies and practices that have the potential to increase the efficiency and effectiveness of weigh and inspection stations to deter the passage of overweight and unsafe vehicles across the state's highways; increase the transit efficiency for the large percentage of commercial vehicles that are compliant with Connecticut laws and regulations; and utilize information gathered through weigh system technologies for the multiple purposes of enforcement and transportation infrastructure decision-making and budgeting, including pavement design and highway maintenance and rehabilitation.			
17. Key Words WIM, weigh-in-motion, weigh stations, weight and safety inspection, piezoelectric, load cells, and bending plates, e-screening; Comprehensive Roadside Network, CVISN, PRISM, FMCSA SAFER		18. Distribution Statement No restrictions. This document is available to the public through the National Technical Information Service, Springfield, VA 22161	
19. Security Classif. (Of this report) Unclassified	20. Security Classif. (Of this page) Unclassified	21. No. of Pages 162	22. Price

Form DOT F 1700.7 (8-72)

Reproduction of completed page authorized

CONNECTICUT ACADEMY OF SCIENCE AND ENGINEERING

**MEMBERS OF THE STUDY COMMITTEE ON
WEIGH STATION TECHNOLOGIES AND PRACTICES**

David Jones

Transportation Specialist
Federal Highway Administration

Tom Kearney

Truck Size and Weight Team
Federal Highway Administration

James Mahoney

Executive Program Director,
CT Transportation Institute &
Program Director/Head Research Engineer,
CT Advanced Pavement Laboratory
University of Connecticut

Louis Manzione, PhD (*Academy Member*),
Chairman

Dean, College of Engineering,
Technology and Architecture
University of Hartford

Nejat Olgac, PhD (*Academy Member*)

Professor, Department of
Mechanical Engineering
University of Connecticut

Herbert Southgate

Kentucky Department of Transportation (ret)

Robert G. Wheeler, PhD (*Academy Member*)

Harold Hodgkinson Professor Emeritus of
Engineering & Applied Science, and
Professor of Physics
Yale University

George R. Wisner (*Academy Member*)

Principal
Wisner Associates

CONNDOT TECHNICAL LIAISON

Anne-Marie McDonnell, P.E.

Transportation Engineer, Division of Research, ConnDOT

RESEARCH TEAM

STUDY MANAGER

David Pines, PhD, Associate Professor and
Chair of Civil, Environmental, and
Biomedical Engineering
University of Hartford

STUDY CONSULTANT

Clara Fang, PhD, Assistant Professor,
Department of Civil Engineering,
University of Hartford

ACADEMY PROJECT STAFF

Richard H. Strauss, Executive Director
Connecticut Academy of Science & Engineering
Phone: 860-527-2161
Email: rstrauss@ctcase.org

Ann G. Bertini, Assistant Director
for Programs

Connecticut Academy of Science & Engineering
Phone: 860-527-2161
Email: anngbertini@ctcase.org

EXECUTIVE SUMMARY

This study was requested in response to concerns about the operation of the Greenwich Weigh and Inspection Station (Greenwich Station) on I-95 Northbound. The Station's configuration, combined with both the size and volume of trucks and buses (commercial vehicles) which must use it, severely impacts the ability of enforcement personnel to operate the Station effectively to assure commercial vehicle compliance with the state's weight and safety regulations and requirements. During the Station's hours of operation, the queue of commercial vehicles rapidly extends into travel lanes on the highway, creating a potential safety concern. This commonly occurs within a 90-second period, requiring Station staff to close and open the Station throughout an operational shift. To eliminate this potential safety hazard, the Station is periodically closed, allowing commercial vehicles to legally bypass without being weighed or inspected. In addition to being a potential safety concern, the operation of undetected overweight commercial vehicles on Connecticut highways contributes to excessive road damage. This damage creates an increase in the frequency of road repairs and associated traffic delays, resulting in increased maintenance and user costs.

STUDY DESCRIPTION

The objective of the study is to provide a literature-based and best practices review of the current state of knowledge regarding weigh and inspection station technologies with respect to their application and consideration for use in Connecticut. The focus of the study is identification of technologies and practices that have the potential to increase the efficiency and effectiveness of weigh and inspection stations to deter the passage of overweight and unsafe vehicles across the state's highways; increase the transit efficiency for the large percentage of commercial vehicles that are compliant with Connecticut laws and regulations; and utilize information gathered through weigh system technologies for the multiple purposes of enforcement and transportation infrastructure decision-making and budgeting, including pavement design and highway maintenance and rehabilitation.

Review of Connecticut Weigh Station Operations, Weigh-In-Motion and Electronic Safety and Screening Technology, and Best Practices

This report includes a review of the design and operation of Connecticut's six permanent weigh and inspection stations and the extensive experience that the Connecticut Department of Transportation (ConnDOT), Department of Motor Vehicles (DMV), and Department of Public Safety (DPS) have using technologies such as weigh-in-motion (WIM) and electronic safety and credential screening ("e-screening") systems. Because of the regional issues associated with the efficient and effective operation of weigh and inspection stations, a review of how the Connecticut's neighboring states perform these functions is also provided. This is followed by a description and comparison of the mature WIM sensor technologies (piezoelectric, load cells, and bending plates) and a summary of a promising non-intrusive bridge WIM scale technology that has been used in Europe but not in the United States. A review of pertinent literature indicates that it is very evident that physical site conditions play a major role in the overall accuracy of WIM scales. Thus, a summary of the Standard Specification for Highway Weigh-

In-Motion Systems (ASTM E 1318-02) regarding the installation and site conditions required to meet the accuracy needed for enforcement purposes is also provided.

Additionally, a description of selected best practices that have been employed using WIM scales has been provided for review and consideration. This section includes a summary of the Federal Highway Administration's (FHWA) Long-Term Pavement Performance (LTPP) program regarding the evaluation of WIM sensor technologies and site conditions needed to meet design-level data requirements; the effective use of a WIM system used for enforcement purposes in Louisiana; the use of virtual weigh and inspection stations (see page xi for a description of virtual weigh and inspection stations) in Minnesota for both enforcement and data collection; and the data management system deployed in the Netherlands for maximum utilization of WIM and electronic screening data.

SUMMARY OF FINDINGS AND SUGGESTIONS

This summary provides an overview of the findings and suggestions section of the study report. The findings and suggestions identify several actions that are recommended for improving the efficiency and effectiveness of the state's commercial vehicle weight and inspection program, along with related activities that involve the collection and use of WIM information for other purposes. The Study Committee identified improvements to the Greenwich Station as the highest priority for the state's consideration. This overview approaches the findings and suggestions from the general to the more specific recommendations, including suggestions for improving the efficiency and effectiveness of the Greenwich Station.

Implementation of the study committee's suggestions and recommendations for the Greenwich Station and for the development of a Comprehensive Roadside System, including installation and the use of WIM and e-screening technologies for the state's network of permanent and portable weigh and inspection stations, is expected to achieve increased efficiency and effectiveness of the state's enforcement activities while at the same time serving to encourage commercial vehicle compliance with state requirements and regulations. The statewide network of mainline WIM and e-screening systems, especially at the Greenwich Station, will allow enforcement personnel to focus their attention on those vehicles most likely to be either overweight or with safety issues. This will provide for a more effective use of limited enforcement personnel resources, while also achieving state goals of improving the safety of commercial vehicles and the safety of the state's highways.

Development of a Statewide Comprehensive Roadside Network

Based upon a review of available information regarding WIM and electronic safety and credential screening technology as well as discussion with the ConnDOT, DMV and DPS staff, officials from other states, and members of the Study Committee, it is suggested that Connecticut develop a Comprehensive Roadside Network that combines the functions of credential verification, safety inspection, and weight enforcement with the goal of having a statewide system that is compatible with federal systems and neighboring states so data sharing can further increase the efficiency and effectiveness of commercial vehicle enforcement activities and the efficiency of the trucking industry in the Northeast. Additional high-speed mainline WIM sites beyond those needed for enforcement should be included to meet all of the state's data requirements, including research and planning. An important resource that should be

utilized in designing and implementing this statewide system is the FHWA Smart Roadside Initiative program. This comprehensive network will provide an opportunity to improve upon the efficiency gains that DPS and DMV have already realized through the installation of low-speed WIM scales at the Greenwich and Union Stations.

Benefits of a Comprehensive Roadside Network

The implementation of a Comprehensive Roadside Network will provide significant benefits to the state, including the following:

- Improved safety of commercial vehicles
- Safer highways
- Better protection of the state's highways and road assets
- Enhanced pavement research and design by having an improved data collection and management system that provides accurate truck volume, classification and weight data
- Possible reduction in premature failure of pavements as a result of the potential reduction of overweight vehicles operating on the state's highways
- Efficient movement of compliant commercial vehicles through the state and the region without delays and weigh and inspection station stops
- Reduction in productivity losses due to congestion as a result of lane closures required for premature highway maintenance and repair

Implementation, Operation, and Governance

It is suggested that a multi-agency task force ("Task Force") consisting of representatives from ConnDOT, DMV, and DPS be established that will be responsible for leading the design, operation, and maintenance of the Comprehensive Roadside Network. In addition, the Task Force shall be responsible for identifying annual goals and continually seeking to improve the effectiveness of the state's weigh and inspection program. It is suggested that one goal of the state's enforcement program should be a continual annual reduction in the number of citations/violations issued through a consistent enforcement effort that encourages compliance with weight and inspection requirements.

The full implementation of a Comprehensive Roadside Network will require a long-term plan with sufficient funding to meet each of the milestones identified by the Task Force. The plan should include at minimum the following:

- Prioritization of implementation of Comprehensive Roadside Network
- Identification of WIM scale and e-screening locations
 - Permanent Weigh and Inspection Stations
 - ◆ Review and consider retaining all permanent weigh and inspection station sites or converting some to virtual weigh and inspection stations

- ◆ Keep existing layouts or modify stations to take advantage of efficiency improvements through the installation of high-speed mainline WIM scales and e-screening systems
- Virtual Weigh and Inspection Stations
- Pavement research and design requirements
- Planning requirements
- Site location considerations: availability of access to power and phone; adequate location for controller cabinet; adequate drainage; free flow traffic conditions; and minimal need for lane changing
- Selection of System Hardware
 - Compatibility with WIM scale and e-screening technology used at Union Station or consideration of next generation technology for all systems.
 - Promote and encourage the use of in-vehicle transponders for commercial vehicles to maximize participation in the e-screening system.
 - Incorporate the use of continuous automatic vehicle classification (AVC) systems on bypass routes in the vicinity of weigh stations
- Identification of WIM scale and e-screening data applications and users (including undertaking a regional effort to have all northeastern states provide data to the national Safety and Fitness Electronic Record (SAFER) system so that this data would then be available to all states)
 - Provides basis for software requirements and design of a fiber optic/wireless communication system
- Funding Requirements
 - Installation costs
 - Data management and software development
 - Operation and maintenance

The following sections summarize several key elements of the plan.

System Implementation

HIGHEST PRIORITY: GREENWICH STATION IMPROVEMENTS

Initially, the highest priority should be given to improving the efficiency and effectiveness of the operations of the Greenwich Station due to the significant number of commercial vehicles entering Connecticut from the State of New York. For Greenwich Station, it is suggested to

- Install a high-speed mainline WIM and e-screening system on I-95 in advance of the

Station for commercial vehicle screening to allow enforcement operations to focus efforts only on those vehicles suspected of being overweight or with credential or inspection issues, and possibly eliminate the low-speed WIM scale at the Station as a result of installation of the high-speed mainline WIM system.

- Consider lane reconfiguration from the New York border through the area of the Station to create four travel lanes, with the right lane serving as a “truck only” lane with all commercial vehicles being required to travel in the right lane until they are beyond the Greenwich Station.
- Conduct the planned site feasibility study for the purpose of maximizing the efficiency of the Station, including consideration of installing a hazardous materials off-loading area and an enclosed inspection facility, similar to those that are installed at the Union Station.

Regardless of the outcome of the Greenwich Station site feasibility study, the installation of a high-speed mainline WIM and an e-screening system at this location is most critical for achieving an acceptable level of operational capability at the Station. It is suggested that if this cannot be accomplished, then consideration should be given to seeking alternative locations for permanent and or virtual weigh and inspection stations in Fairfield County. The least attractive alternative is to maintain operations at the Greenwich Station under current conditions.

The design of the Greenwich Station WIM and e-screening system should be consistent with the technology being used at Union Station because the state has already invested in a mainline WIM and CVISN (Commercial Vehicle Information Systems and Networks) system at this location. It is very important that the state develop one system that meets the needs of all six permanent weigh and inspection stations rather than six individual systems using different types of technologies; that latter would make data communication difficult and result in no commonality concerning maintenance of the systems’ hardware and software.

VIRTUAL WEIGH AND INSPECTION STATIONS

A virtual weigh and inspection station system includes components of a permanent weigh and inspection station, except that it does not include a permanent facility with a fixed static scale. A virtual weigh and inspection station system is intended to provide high-speed WIM system real-time weight, and e-screening data that enables enforcement personnel to focus their attention on portable static scale weighing operations and vehicle inspections for only those commercial vehicles that have been identified as being possibly overweight or having safety/ inspection issues, and to allow all other vehicles to efficiently bypass virtual station operations.

Virtual weigh and inspection stations should be used to supplement enforcement and data collection at permanent weigh and inspection stations. Consideration should be given to locating high-speed mainline WIM scales that include an e-screening capability for virtual weigh and inspection stations at the same locations where portable weight scales are currently being used (see 2008 Connecticut Size and Weight Enforcement Plan). These sites meet the requirement of being able to safely stop trucks so they can be weighed using portable scales and inspected.

Analysis of data collected from the virtual weigh and inspection station high-speed mainline WIMs, as well as from the permanent weigh and inspection stations on a continuous basis, should be used for determining where and when to set up enforcement activities. Enforcement personnel must be able to access real-time data in a user-friendly format from the virtual WIM scales and the e-screening system so that they can effectively target commercial vehicles that are likely to be overweight and/or have safety violations.

ADDITIONAL WIM SITES FOR PLANNING, PAVEMENT RESEARCH, AND OTHER APPLICATIONS

WIM scale sites, in addition to the permanent and virtual weigh stations used for weight and inspection enforcement, may be necessary to collect the data needed by ConnDOT's Planning, Research and Pavement Management groups. Also, consideration should be given to developing WIM sites at additional key locations, such as at port, rail, air cargo, and major distribution centers; this could provide valuable data that will be helpful for highway design purposes to enable ConnDOT to have a better understanding of commercial vehicle trip operations, including freight movements.

These additional locations should be included in the network of WIM scales that continuously collect and send data to a central database. Because these WIM scales will not be tied to permanent or portable static scales, it will be necessary to calibrate these WIM scales at a minimum of once a year using trucks of known static weight. The calibration procedure should follow the same procedure as that used in the LTPP study. Furthermore, it is suggested that internal checks be included in the WIM system software algorithms and analyses that can provide a monitoring capability and an early warning as to the accuracy and potential malfunctioning of the WIM scale. These include comparison of the distribution of vehicle gross weights and verification that the front axle weight for unloaded FHWA Class 9 vehicles is within a lower and upper limit.

SUGGESTED WIM SCALE TECHNOLOGY

ConnDOT, DMV, and DPS have experience using quartz, bending plates, and load cell WIM scales, which are the most mature and proven technologies available. Because site conditions are such an important factor in determining the accuracy of the WIM scales, it is difficult to quantify which of the technologies provides the most accurate estimates of a vehicle's static weight. However, taking into account installation, maintenance, safety, and cost, it is suggested that Connecticut invest in the quartz piezoelectric technology for new and replacement WIM scale installations. This suggestion should be verified as the analysis of data from the LTPP Phase 2 study results becomes available to see if this technology still provides the best overall characteristics compared to the other WIM technologies. Furthermore, the use of three rows of quartz piezoelectric sensors versus the standard two-row configuration should be considered. The three-row configuration will initially be more expensive for purchase and installation. However it has the potential to reduce sensor life cycle cost as a result of a reduction in the highway smoothness necessary to attain the required accuracy needed for enforcement applications (i.e., Type III ASTM requirements).

Additionally, bridge WIM scales, a promising non-intrusive technology, should be considered as a supplement to quartz piezoelectric WIM scales to provide a more comprehensive WIM

network. Experience from research in Connecticut and other parts of the United States and Europe should be used to determine when the development of the bridge WIM technology is mature enough to meet Type III ASTM requirements.

WIM SCALE ACCURACY

The accuracy requirements of the WIM system will vary depending on the application (i.e., enforcement, pavement design, planning, research). WIM scales at a minimum should meet ASTM Type III requirements that are needed for the screening of commercial vehicles for enforcement purposes. WIM sensors must be able to provide consistent results in asphalt pavement under a wide range of temperature conditions. Proper site conditions and installation requirements must be met for the sensors to be able to perform as an effective screening tool. While maintenance requirements of the WIM scales in the road should be minimized for safety reasons, maintenance of required site conditions is necessary for ensuring required accuracy and must be included in the agency's budget.

The development of a quality assurance and quality control (QA/QC) system is imperative so that the WIM-scale network consistently provides data of the quality needed for effective enforcement, pavement design, planning and research. It is important that software should be developed or procured that will continually perform a statistical comparison of a commercial vehicle's static weight to the WIM scale's estimate of static weight. This requires that commercial vehicles be identified utilizing in-vehicle transponders or some other method of vehicle identification (e.g., cameras, inductor loops for measuring axle spacing).

DATA MANAGEMENT

The development of the comprehensive roadside network will require that software be developed and/or procured to meet a wide range of applications. Specifically, the data collected should automatically be stored in a database management system and be available in a format that meets the reporting requirements of all users.

CONCLUDING REMARKS

The overall benefits of a statewide network of high-speed mainline WIMs coupled with e-screening capability and a comprehensive virtual and permanent weigh and inspection station system, include encouraging commercial vehicle compliance with state regulations, improving the efficiency of weight and inspection program operations, and improving air quality. The state may also be able to utilize valuable information collected from the system's operation for highway pavement design purposes.

TABLE OF CONTENTS

EXECUTIVE SUMMARY	vii
TABLE OF CONTENTS	xv
I. INTRODUCTION AND HISTORY	1
II. CONNECTICUT WEIGH AND INSPECTION STATIONS AND WIM SCALE EXPERIENCES.....	
III. WEIGH STATION OPERATION AND WIM DATA COLLECTION IN NEIGHBORING STATES	25
IV. WEIGH-IN-MOTION (WIM) SENSOR TECHNOLOGIES	35
V. WIM SYSTEM SPECIFICATIONS, INSTALLATION REQUIREMENTS, AND INTEGRATION INTO A COMPREHENSIVE ROADSIDE DATA MANAGEMENT SYSTEM.....	43
VI. BEST PRACTICES.....	49
VII. SUMMARY OF FINDINGS AND CONCLUDING REMARKS	61
REFERENCES	73
ACKNOWLEDGEMENTS	75
APPENDICES.....	77
Appendix A: Physics of Weigh-in-Motion Sensors.....	77
Appendix B: Commercial Vehicle Information Systems and Networks (CVISN) and Performance and Registration Information Systems and Networks.....	81
Appendix C: Union Weigh and Inspection Station High-Speed Mainline Screening and Clearance System Description.....	83
Appendix D-1: Union Weigh and Inspection Station Full Staffing Requirements	85
Appendix D-2: Greenwich Weigh and Inspection Station Full Staffing Requirements	86
Appendix E: Motor Carrier Safety Assistance Program Inspections.....	87
Appendix F: Overview: ConnDOT’s Weigh-in-Motion Research Experience in Connecticut	89
Appendix G: Survey Questions Regarding Practices on Neighboring States’ WIM Systems.....	98
Appendix H: Bridge Weigh-In-Motion	99
Appendix I: Summary of Phase 1 LTPP Data Collection with WIM Systems	102
Appendix J: Performance Audit: Overweight/Oversize Commercial Vehicles (2003).....	103

I. INTRODUCTION

This study was conducted for the Connecticut Department of Transportation (ConnDOT) by the Connecticut Academy of Science and Engineering (CASE).

The objective of the study is to provide a literature-based and best practices review of the current state of knowledge regarding weigh and inspection station technologies for their application and consideration for use in Connecticut. The focus of the study includes the identification of technologies and practices that have the potential to

1. Increase the efficiency and effectiveness of Connecticut weigh and inspection stations to deter the passage of overweight and unsafe vehicles across the state's highways.
2. Increase the transit efficiency for the large percentage of trucks and buses (commercial vehicles) moving across Connecticut that are compliant with Connecticut laws and regulations.
3. Utilize information gathered through weigh system technologies for the purposes of commercial vehicle weight and safety inspection enforcement as well as transportation infrastructure decision-making and budgeting, including pavement design and highway maintenance and rehabilitation.

BACKGROUND

The large and growing volume of commercial vehicle traffic, along with geometric constraints, outdated technology and inadequate equipment at many Connecticut weigh and inspection stations on I-84, I-91, and I-95, cause commercial vehicles to queue onto the highway during weigh station operations. To eliminate this potential safety hazard, these stations are periodically closed and reopened throughout an operational shift. This situation most frequently occurs at the Greenwich Weigh and Inspection Station (Greenwich Station) on I-95 Northbound. In addition to being a potential safety concern, the operation of undetected overweight commercial vehicles on Connecticut highways contributes to excessive road damage. This damage creates an increase in the frequency of road repairs and associated traffic delays, resulting in increased maintenance and user costs.

Weigh-In-Motion (WIM) technology enables weigh station operations to rapidly weigh and screen commercial vehicles as a component of a comprehensive enforcement system. To be most effective, the WIM technology must be selected, implemented, and integrated into a system that satisfies enforcement requirements for weight, safety, and verification of credentials. It must also provide data in a usable format to those state agencies that would benefit from knowing the number, classification, and weight of commercial vehicles traveling through Connecticut; through analyses of this data, information regarding traffic characteristics and patterns can be determined. A critical aspect of any system is a quality assurance and quality control (QA/QC) plan, so that all users are informed of and therefore have confidence in the accuracy of the WIM data to determine if it meets the requirements for their application.

WIM systems, utilizing technologies such as bending plates, load cells or piezoelectric sensors, indirectly measure the static force plus the dynamic force of a moving vehicle. Enforcement agencies need to know the static force (i.e., axle weights or gross vehicle weight) component of the measured total force in order to determine if a vehicle is in compliance with the state's weight requirements. The additional dynamic force measured by the WIM sensor varies as the truck travels along the road, and is a function of the road surface roughness, vehicle acceleration/braking, age of tires, out-of-round tires, dynamically unbalanced wheels, tire inflation pressure, vehicle suspension, pavement temperature, and aerodynamic forces (e.g., wind). In general, a calibration factor is used to convert the measured force to the corresponding static tire, axle, and axle group loads. Because the dynamic force component is variable and depends on the site conditions, truck characteristics, and driver behavior, there are inherent limitations on how accurate a WIM sensor can be in estimating the static weight of a vehicle. Therefore, it is important to use a high-quality WIM sensor and electronics, properly install the sensor, and maintain site conditions in order to be able to confidently screen overweight vehicles. An analysis of the physics of WIM systems is given in Appendix A.

Most mainline WIM systems used for enforcement screening have four elements:

1. Roadway components that include a high-speed WIM scale and detectors to check for vehicle presence. Some systems also include cameras as an added tool for vehicle identification.
2. A computer component that processes the sensor input, and estimates the static weight, speed, and classification of the vehicle.
3. A signalization component that consists of a control assembly, directional signals, and variable message signs.
4. A tracking component that consists of a series of inductive loops to verify that the commercial vehicle is proceeding as directed (Laurita et al., 1994).

APPROACH

The tasks conducted as part of this study were to

1. provide background on the design and operation of weigh-in-motion systems, noting both their advantages and limitations;
2. review current weigh station and inspection operations in Connecticut;
3. conduct a review of several key best practice WIM systems and weigh and inspection station operations in the United States and other countries; and
4. Identify potential implementation strategies for increasing the efficiency and effectiveness of Connecticut Weigh and Inspection Stations.

II. CONNECTICUT WEIGH AND INSPECTION STATIONS AND WIM SCALE EXPERIENCE

CONNECTICUT WEIGH AND INSPECTION STATIONS

Three state agencies are involved in the operation of Connecticut Weigh Stations: the Connecticut Department of Transportation (ConnDOT), the Connecticut Department of Public Safety (DPS), and the Connecticut Department of Motor Vehicles (DMV).

ConnDOT is responsible for the design, construction, and maintenance of the weigh station facilities. The Office of Construction is responsible for the construction of weigh stations, the Office of Maintenance for the maintenance of equipment and pavement, and the Office of Facilities handles the contract for the maintenance and calibration of the static scales and the maintenance of buildings located at each weigh station. Also, ConnDOT is responsible for

- the state's oversize and overweight commercial vehicle program including the issuance of oversize/overweight permits;
- issuance of permits for the transport of radioactive materials;
- development and submission of an annual commercial vehicle size and weight program plan to the Federal Highway Administration (FHWA) and the filing of an annual plan compliance report with FHWA.

The DPS and DMV share the responsibility of operating the weigh station facilities per Section 14-270c of the Connecticut General Statutes.

The primary goal of the weigh and inspection stations is to deter commercial vehicle traffic from operating under conditions that reduce the safety of all vehicle traffic, and reduce pavement life cycle and infrastructure fatigue life.

There are six weigh station facilities located in the state. The weigh stations are commonly referred to by town location. The following is a list of weigh stations by town and route locations:

- Greenwich on Northbound I-95
- Waterford on Northbound I-95
- Waterford on Southbound I-95
- Danbury on Eastbound I-84
- Union on Westbound I-84
- Middletown on Northbound I-91

Only the Union Weigh and Inspection Station (“Union Station”) was designed using principles and an understanding of the requirements for weigh and inspection station operations. The two sites in Waterford were built during original construction of the Connecticut Turnpike in the 1950s. The site in Greenwich is located on the former site of the Connecticut Turnpike’s Greenwich toll station. The site in Middletown was a last-minute addition to the construction of the Middletown rest area.

A comparison of the physical characteristics and frequency of operation of the state’s weigh and inspection stations is provided in Table II-1. Except for the Union Station, the general consensus provided by DPS and DMV is that the weigh stations have inadequate facilities, resulting in safety issues, and inadequate equipment, including both outdated technologies and signage. In addition, they are not designed for the current or potential future volume of commercial vehicle traffic. The space available at the Greenwich Station for the weighing and inspection of vehicles is very limited, such that during the operation of the station commercial vehicles queue into traffic lanes on the highway. This results in traffic congestion and increased safety concerns.

DMV is primarily responsible for operating the Union facility and DPS’s Connecticut State Police Traffic Services Unit is responsible for operating the other five weigh stations. DMV’s Commercial Vehicle Safety Division is currently staffed with 45 enforcement officers, and has two vehicles equipped with four pairs of portable scales for use in weighing commercial vehicles. DPS’s Traffic Services Unit has 51 sworn troopers and 10 civilian inspectors who are trained in weighing and inspection of commercial vehicles. In addition, DPS currently has 18 vehicles assigned to troopers within the Traffic Services Unit that are each equipped with between three and five pairs of portable scales for use in weighing commercial vehicles. However, it is noted that these staff resources may be used for other state police activities and as such are not solely dedicated to weight and safety inspection operations.

Public Act No. 98-248, Section 1 identifies operational requirements for the state’s weigh areas. The weigh stations are operated on various day, evening, and night shifts, as well as on weekends. This legislation identifies the number of shifts in a seven-day period that the Greenwich, Danbury and Union Stations are required to be staffed, and requires that Middletown and Waterford weigh stations be operated based on availability of DPS staff. Additionally, the legislation requires that portable scale operations should be conducted on a regular basis with a focus on those areas of the state that have fewer hours of operation of the permanent weigh stations. The legislation also requires that the hours of operation at the state’s weigh stations should be adjusted to “effectuate an unpredictable schedule.”

	Greenwich Northbound	Danbury Eastbound	Waterford Southbound	Waterford Northbound	Union Westbound	Middletown Northbound
WIM Sorter System	Yes/LS	No	No	No	Yes/LS & HS	No
Static Scale Pads	4	3	2	1	4	3
Scale Pad Length (ft)	82	82	60	50	83	74
E-Screening	No	No	No	No	Yes	No
Truck Parking	~33	~26	~12	~12	~35	~28
Flashing Lights	Yes	No	Yes	Yes	Yes	Yes
Illuminated Message Board	Yes	No	Yes	Yes	Yes	No
Enclosed Inspection Area with Pit	No	No	No	No	Yes	No
Hazardous Material Contaminant Area	Yes	No	No	No	Yes	No
Operation ***	8+ Shifts/Wk	3+ Shifts/Wk	~3 Shifts/Wk	~3 Shifts/Wk	~5 Shifts/Wk	~3 Shifts/Month
Comments	Station is small & built into a hillside; access limitations	Facility driveway is shared & interferes with rest area traffic	Too small - commercial vehicles quickly fill the ramp; access limitations	Too small - commercial vehicles quickly fill the ramp; access limitations	More modern facility	Too small - commercial vehicles quickly fill the ramp & co-located with rest area; access limitations - crossing traffic with rest area

*** DPS is responsible for operations at all stations, except Union, which is operated by DMV
LS = Low-Speed WIM; HS = High-Speed WIM

TABLE II-1. CONNECTICUT WEIGH STATION CHARACTERISTICS AND OPERATION

Weigh Station Operation

The following two sections describe the operation of the Union and Greenwich Stations, which provide examples of the differences in the geometric constraints encountered and the technologies currently being used.

UNION WEIGH AND INSPECTION STATION

The Union Station is the only facility with a comprehensive roadside system (CRS) that includes a high-speed mainline WIM system, e-screening, and an enclosed inspection area.

High-speed Mainline WIM Scale and E-Screening System

The components of the high-speed mainline WIM and screening and clearance system are an Automated Vehicle Identification (AVI) system that includes the WIM scale, Advance AVI Reader, Notification AVI Reader, and Compliance AVI Reader. The WIM scale system layout is depicted in Figure II-1 and the systems communication network is shown in Figure II-2. As commercial vehicles approach the station, an "Open/Closed" weigh station sign, displaying "Open," directs all commercial vehicles to stop at the station except those that have a transponder, who may receive a bypass signal (see Figure II-3). These transponders, which cost \$40 per unit, provide commercial vehicles with the capacity to participate in the pre-clearance and screening system and perform EZPass-like toll payment on all toll bridges, toll tunnels, and toll roads in the Northeast, including Pennsylvania and New Jersey.

Vehicles then pass through the Advance AVI Reader located approximately ½ mile in advance of the Union Station (see Figure II-4). This Reader consists of two sets of inductive loops about 15' apart that are located in the right and center lanes. The WIM scale is approximately 15' downroad from the AVI inductive loops. Originally, this high-speed WIM scale was a bending plate technology but was recently replaced with a quartz piezoelectric high-speed WIM scale. The last element of the Advance AVI Reader is a transponder reader with an antenna, located at a distance of 50' feet from the WIM scale, that communicates with an in-vehicle transponder mounted in the cab of a screened vehicle. These data are sent to a screening computer in the station, which correlates WIM and classification data, and credentials and safety information, as well as the transponder information. A photograph of the Advance AVI Reader is shown in Figure II-5.

The second element of the AVI process is a Notification AVI Reader that is located approximately 1,300 feet after the Advance AVI Reader and about ¼ mile before the Union facility (see Figure II-6). This consists of a transponder reader with an overhead antenna that communicates with an in-vehicle transponder to notify drivers if they can bypass the weigh station. In addition to weight, the system also provides electronic screening of credentials, inspections and federal safety ratings. (See the next section for a description of the Electronic Safety and Screening System.)

The final element of the AVI system is the Compliance AVI Reader (see Figure II-7) that is located on the mainline of I-84, adjacent to the station between its entrance and exit ramps. It includes the transponder readers (with antennae), antennae poles, and truck detectors, with associated computer software that provides compliance alarms. The Compliance AVI Reader and transponder reader are used to determine if an unauthorized vehicle bypass of the station has occurred.

A STUDY OF WEIGH STATION TECHNOLOGIES AND PRACTICES
CONNECTICUT WEIGH AND INSPECTION STATIONS AND WIM SCALE EXPERIENCE

A more detailed description of each of the components of the high-speed mainline WIM system is given in Appendix B.

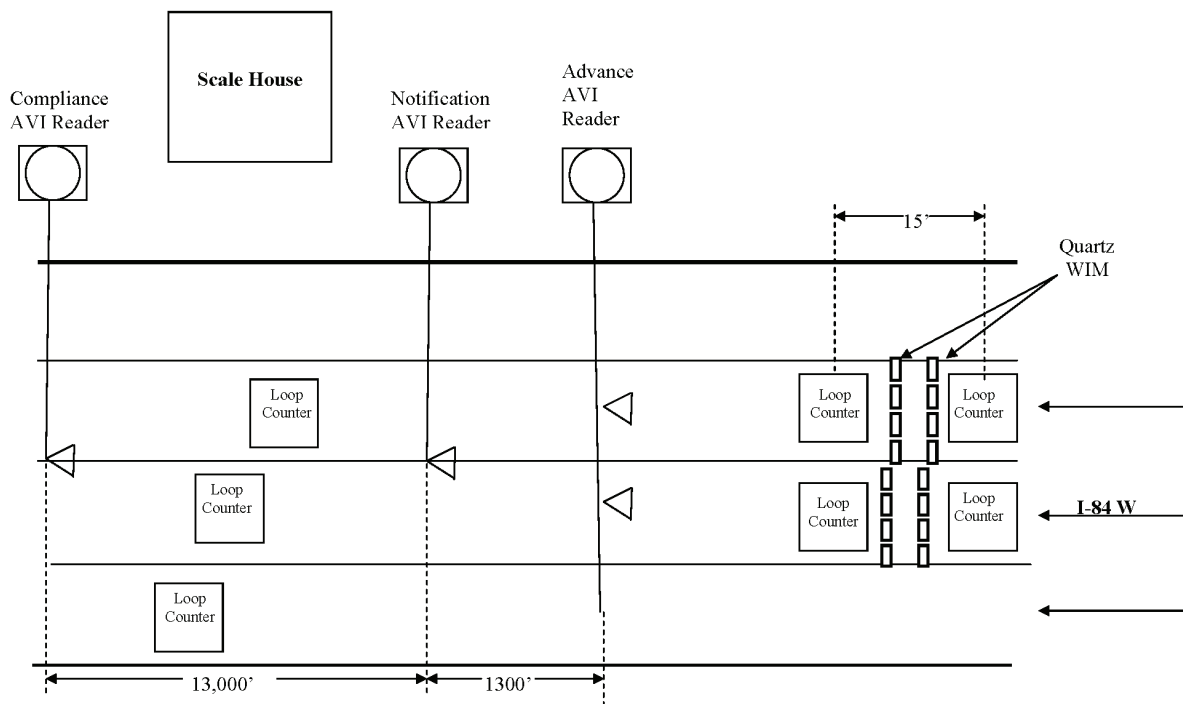
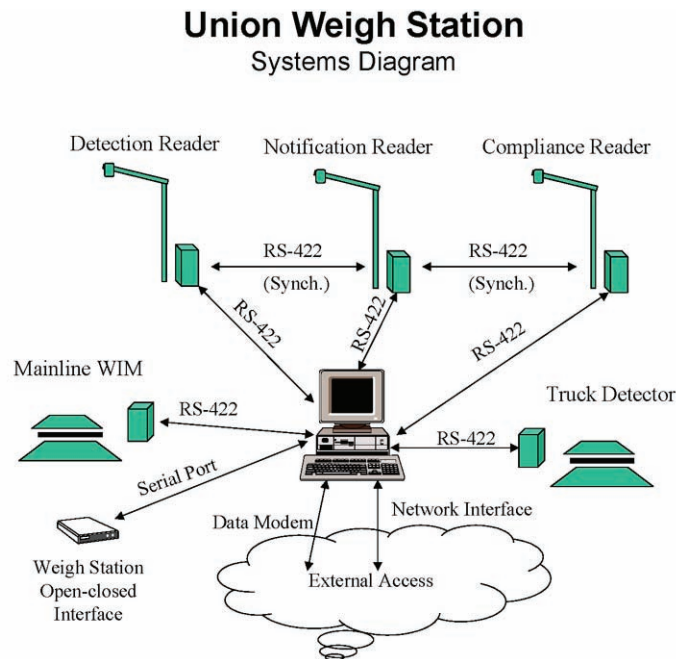

FIGURE II-1. UNION WEIGH AND INSPECTION STATION WIM SYSTEM LAYOUT
(NOT TO SCALE)



Source: Kentucky Transportation Center
FIGURE II-2. "MODEL MACS"- THE MAINLINE AUTOMATED CLEARANCE SYSTEM:
SYSTEM OVERVIEW AND IMPLEMENTATION GUIDE



Source: ConnDOT
FIGURE II-3. UNION WEIGH AND INSPECTION STATION SIGNAGE

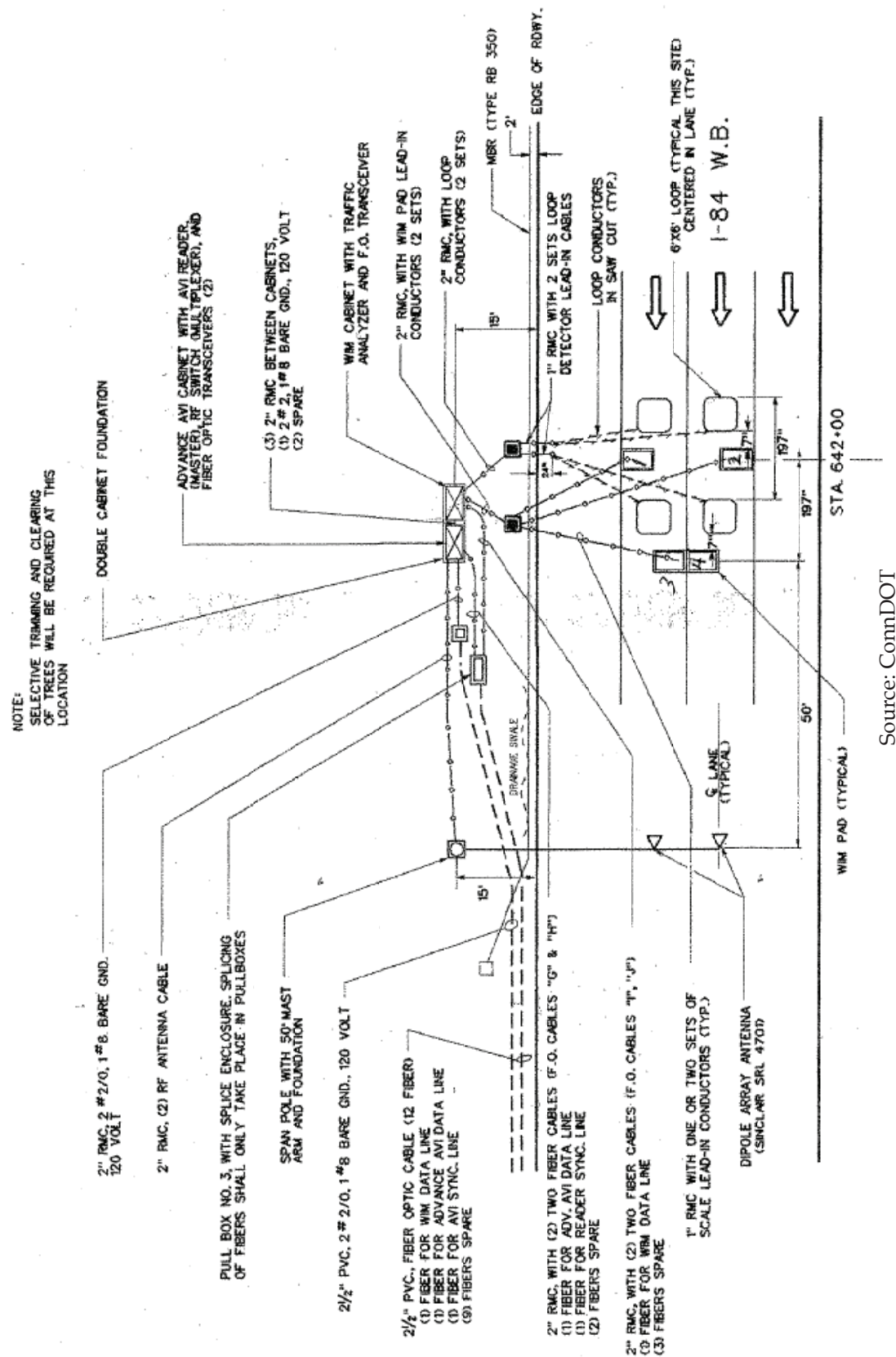
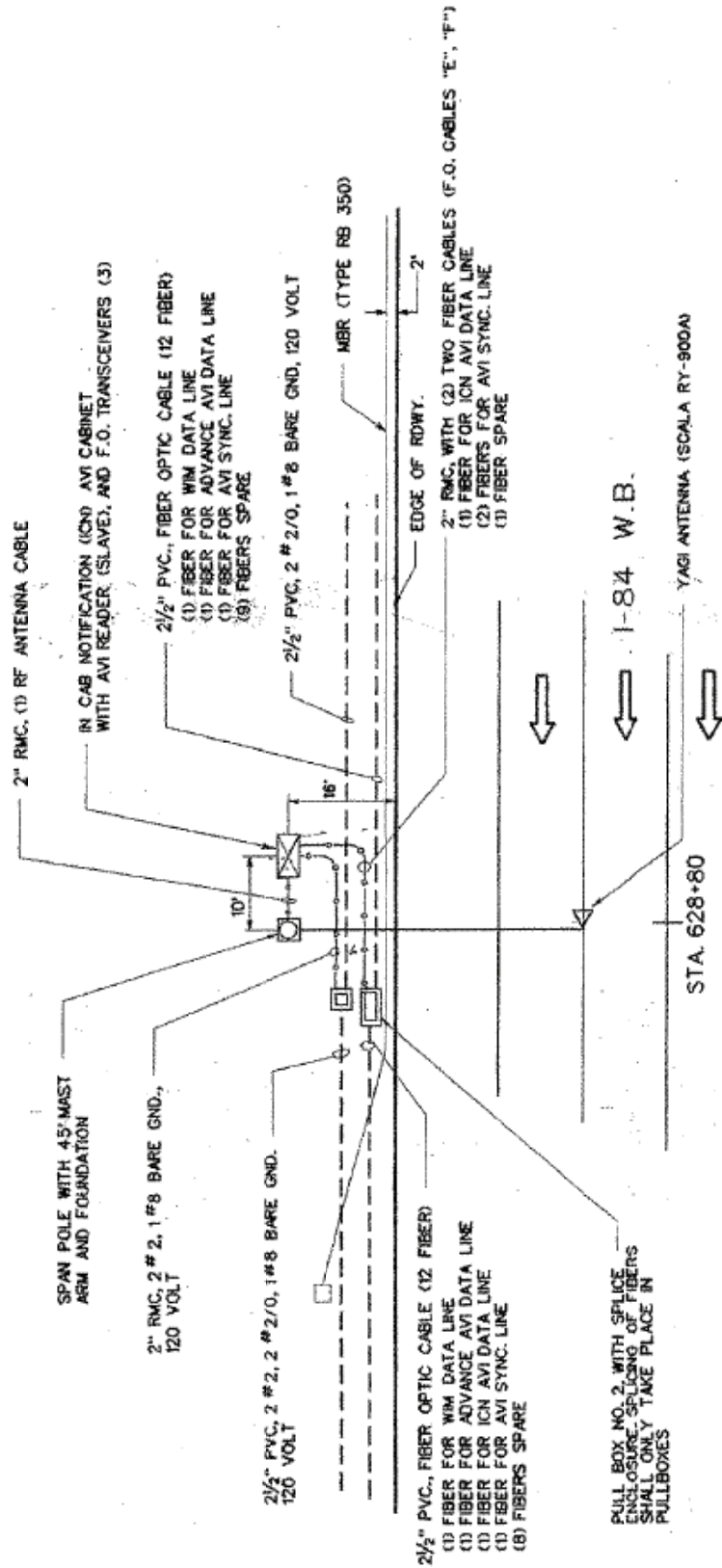

FIGURE II-4. ADVANCE AVI READER AND WIM SCALE LAYOUT



Source: ConnDOT

FIGURE II-5. ADVANCE AVI READER AND HIGH-SPEED MAINLINE WIM SCALE



Source: ConnDOT

FIGURE II-6. NOTIFICATION AVI LAYOUT

E-Screening System

The high-speed mainline WIM scale is part of the e-screening system that is used to identify the weight of vehicles, properly credentialed vehicles, motor carrier safety rating of vehicles, and to provide compliance statistics to support program and policy development decisions. At the present time, this is a voluntary system that allows participating registered commercial vehicles – with participation requiring the purchase of a specialized transponder – to bypass the “Open” Union Station if they are not overweight, are in compliance with all regulations and are not randomly selected. Currently, only a small percentage of commercial vehicles are equipped with the required transponder that allows them to participate in the e-screening system.

Also, although not a part of the electronic screening system, a Safety and Credentials Information Exchange capability allows roadside enforcement personnel to upload commercial vehicle safety inspection reports to the national Safety and Fitness Electronic Record (SAFER) system for the purpose of exchanging interstate carrier and vehicle snapshots among states. This system also allows state administrative and enforcement personnel to share and access credentials-related and safety status information about carriers and their vehicles. As described on the SAFER website, “the SAFER system is a component of the Department of Transportation’s Intelligent Transportation System (ITS) which is being designed to increase roadway safety, reduce motorist delays and air pollution, and improve the overall productivity of commercial vehicle operations (CVO) through the use of advanced technology.” Connecticut participates in the SAFER system.

The electronic safety and screening operation is part of Connecticut’s Commercial Vehicle Information Systems and Networks (CVISN) Program and its Performance and Registration Information Systems Management (PRISM) Project. These programs combine two federal-state initiatives that use Intelligent Transportation Systems technology to promote the safe and legal movement of commercial vehicle traffic within the state and across the nation. Both initiatives seek to improve highway safety by rewarding safe motor carriers, penalizing unsafe carriers and removing unsafe commercial vehicles from the roadways. A more detailed description of the CVISN and PRISM program are in Appendix C.

The Connecticut CVISN program is a cooperative effort among the following agencies:

- Connecticut Department of Motor Vehicles (Lead Agency)
- Connecticut Department of Information Technology
- Connecticut Department of Public Safety
- Connecticut Department of Revenue Services
- Connecticut Department of Transportation
- Federal Motor Carrier Safety Administration
- Motor Transport Association of Connecticut, Inc.

Union Weigh and Inspection Station Operation

For those commercial vehicles that must enter the station, they first pass over a low-speed WIM scale. If the vehicle is overweight, going too fast over the low-speed WIM, or accelerating/ decelerating too quickly, a directional signal will automatically indicate to the driver to proceed to the static scale. Also, the DMV static scale operator can manually direct any vehicle to the static scale and inspection area for any reason, not just if they observe apparent safety violations. Otherwise, the driver can proceed directly back onto the highway. A schematic layout of the Union Station is shown in Figure II-8.

The typical operation of the Union Station includes three DMV inspectors for each shift. DMV, in conjunction with DPS, has indicated that full staffing to meet the operational requirements for the current Union Station operations would require a total of nine inspectors. The responsibilities of each of the inspectors that comprise the full staffing scenario are listed in Appendix D-1.

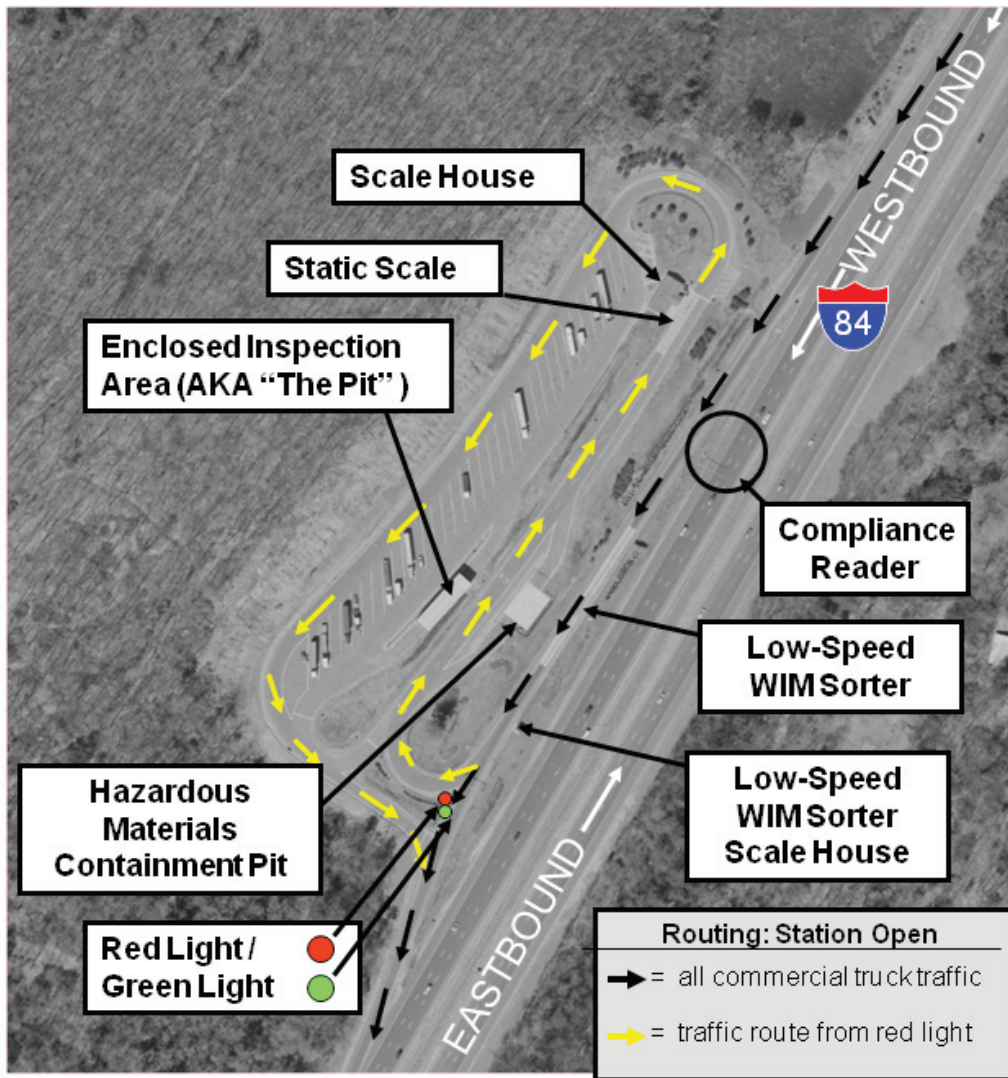

FIGURE II-8. SCHEMATIC LAYOUT OF THE UNION WEIGH AND INSPECTION STATION

GREENWICH WEIGH AND INSPECTION STATION

The typical operation of the station for each shift consists of two state troopers and two weight and safety technicians. One weight and safety technician is positioned in the low-speed WIM booth that is located just after vehicles enter the weigh station property. This technician is responsible for the following:

- Manually operating the electronic directional signal that indicates to drivers whether they must enter the weigh and safety inspection area or if they can bypass the station onto the acceleration lane back onto I-95. Manual operation of the directional signal is required because of the limited distance between the WIM scale and the directional signal; the currently installed automated system does not respond fast enough to give drivers the correct signal before they pass the electronic directional signal.
- Directing commercial vehicles with apparent safety violations to the weight and inspection area. It is noted that the technicians monitor low speed WIM vehicle weights as compared to static scale vehicle weights and that any variances are manually compensated for in the operation of the system.
- Monitoring traffic backup on the ramp. Since the operator in the scale house does not have direct line of sight to the traffic queue, in case of a traffic backup onto the mainline, the technician contacts the static scale house to close the weigh station until it is safe to reopen it.

The officer in charge is stationed in the static scale house and is responsible for weighing vehicles and directing the other officers and technicians conducting the actual vehicle inspections and issuing violations. The trooper in the static scale house is also responsible for controlling the signal lights on I-95 that indicate when the scale is open or closed to commercial vehicle traffic. With only four DPS staff operating the station, they are not available to stop trucks that bypass the scale house using Exit 2 or trucks that pass the “open” weigh station without stopping.

DPS, in conjunction with DMV, has indicated that full staffing of the Greenwich Station would require ten troopers and a minimum of three weight and inspection technicians. The responsibilities of each of the troopers and inspection technicians that constitute the full staffing scenario are listed in Appendix D-2.

The Greenwich Station presents the most challenges due to the high volume of commercial vehicle traffic, the location of the Exit 2 on-ramp approximately ½ mile before the station, and the limited availability of land that is needed for the safe and efficient operation of the station. A schematic layout of the Greenwich Station is presented in Figure II-9.



FIGURE II-9. SCHEMATIC LAYOUT OF THE GREENWICH WEIGH AND INSPECTION STATION

Further complicating the situation is the fact that this station is not staffed at the levels needed for DPS to effectively perform the size and weight enforcement needed to minimize the number of overweight and unsafe commercial vehicles entering the state.

Other factors of concern include the traffic flow within the station property for commercial vehicles exiting the static scale and accessing the highway from the weigh station.

Weigh Station Reporting Requirements

Public Act No. 07-7, Section 99 requires that on and after January 1, 2008, logs that have the following information be maintained for all weigh station operations:

1. Location, date and hours of each shift
2. Hours the "OPEN" sign is illuminated
3. Number of Department of Motor Vehicles and Department of Public Safety officers or civilian technicians for each shift
4. Number and weight of all vehicles inspected
5. Type of vehicle inspections
6. Number and types of citations issued
7. Amount of fines that may be imposed for overweight or other violations
8. Operating costs for each shift
9. Number of vehicles that pass through the weigh station during each shift

Starting January 1, 2008, and semi-annually thereafter, the Commissioner of Public Safety shall submit a written report that contains a summary of the above information for the preceding six-month period to the joint standing committee of the General Assembly having cognizance of matters relating to transportation. The report shall also be posted on the websites of the Departments of Motor Vehicles and Public Safety.

WEIGH STATION ACTIVITY SUMMARY REPORT: JULY 1 - DECEMBER 31, 2007

As a result of the above legislation, the first report was generated for the six-month period between July 1, 2007 and December 31, 2007. The reporting period covered a total of 26,496 hours, assuming that each of the six weigh stations could be open a maximum of 4,416 hours over the six-month period. The weigh stations were actually operational for almost 4,000 hours, representing 14.9% of the total hours in the reporting period. The breakdown of the operational hours between the weigh stations is shown in Figure II-10. During this period, 340,000 commercial vehicles were weighed. About 245,000 commercial vehicles were allowed to bypass the static scales at Greenwich and Union Stations because their weight was screened by a low-speed WIM system and was determined to be in compliance with Connecticut's weight regulations. The increase in weigh station efficiency by having a WIM system integrated into the operation of the station can be seen in Figure II-11, where the distribution between the number of vehicles that were weighed using the low-speed WIM systems at Greenwich and

Union is compared to the total number of vehicles statically weighed at all six weigh stations. The Department of Public Safety publishes a semi-annual Weigh Station Summary Activity Report that is available on their website at: www.ct.gov/dps.

Additionally, the following is an overview of DPS and DMV portable (non-fixed facility) operations. It is noted that the staff assigned to these units are trained to visually pre-screen commercial vehicles for portable weighing and inspection, which results in a greater percentage of vehicles that are cited with violations, as compared to the percentage of vehicles cited at the permanent weigh and inspection stations:

- In FY 2008, DPS inspected 31,520 commercial vehicles in portable operations. A total of 842 overweight violations were cited, although DPS records do not accurately identify how many of the inspected vehicles were weighed.
- DMV has two portable operations units that are assigned to the Central and West Truck Teams, with each working independently of the other. In FY2008, a total of 627 commercial vehicles were weighed with portable scales, resulting in 367 gross weight violations; 457 axle weight violations; 9 Federal Bridge Formula violations; 468 overweight vehicles; 32 axle shifts; 85 gross off-loads; and 153 axle off-loads. A total of 369 infractions were issued with potential fines of \$800,147.

Figure II-12 shows a breakdown of where the approximately 95,000 vehicles were inspected (inspection is defined as a vehicle being weighed on a static scale and at minimum a cursory walk-around examination) during this period. Of these, 46% of the commercial vehicles were statically weighed and inspected at the Greenwich Station. The Union Station was open 24% of the total operational hours of all weigh stations, but only inspected 9% of the total vehicles inspected during this period. This is due to DMV's emphasis on conducting the Motor Carrier Safety Assistance Program (MCSAP) inspections that are very comprehensive safety inspections and more time consuming compared to DPS's cursory vehicle inspections, although DPS does utilize MCSAP inspection guidelines for some inspections.

MCSAP inspections are divided into different levels of scrutiny. They are

- Level I - North American Standard Inspection
- Level II - Walk-Around Driver/Vehicle Inspection
- Level III - Driver/Credential Inspection

A description of the MCSAP inspection levels is provided in Appendix E. (Additional references are available on the Commercial Vehicle Safety Alliance website at: http://www.cvsa.org/programs/nas_levels.aspx#a2.) As shown in Figure II-13, 53% of the MCSAP inspections were conducted at the Union Station. Of the 2,200 MCSAP inspections, 36% were Level I, 52% were Level II, and 12% were Level III.

A typical Level I MCSAP inspection conducted by either DMV or DPS takes approximately 50 minutes. It should be noted that MCSAP inspections are dependent upon circumstances and the time required to conduct an inspection can vary widely. cursory walk-around inspections are screening inspections that identify limited types of obvious defects. A cursory walk-around inspection takes approximately 2 minutes.

A STUDY OF WEIGH STATION TECHNOLOGIES AND PRACTICES
CONNECTICUT WEIGH AND INSPECTION STATIONS AND WIM SCALE EXPERIENCE

There were 6,925 citations issued during the referenced six-month reporting period at all weigh and inspection stations. The breakdown on the types of violations is shown in Figure II-14. (Note that the distribution of the types of citations identified in Figure II-14 does not include the 337 violations cited at the Union Station because the breakdown regarding the type of citation was not available at the time when the report was produced.) With only 15% of the total citations being overweight violations, it is evident that the weigh stations perform many more tasks than just weighing vehicles. These tasks include identifying safety defects, driver deficiencies, and unsafe motor carrier practices.

It is also important to note that the number of citations issued is not a measure of the effectiveness of the weigh and inspection stations. Furthermore, the number of citations may even have limited use as an indication of the percentage of commercial vehicles that are either compliant or noncompliant with Connecticut state laws, because each weigh station is only operational on average about 15% of the time and it is not certain that the "Open" hours are statistically representative of the total number of commercial vehicles traveling on Connecticut interstate highways. However, the citation data does provide qualitative information on the extent and nature of non-compliant vehicles operating on Connecticut interstate highways at these locations when each weigh station is open.

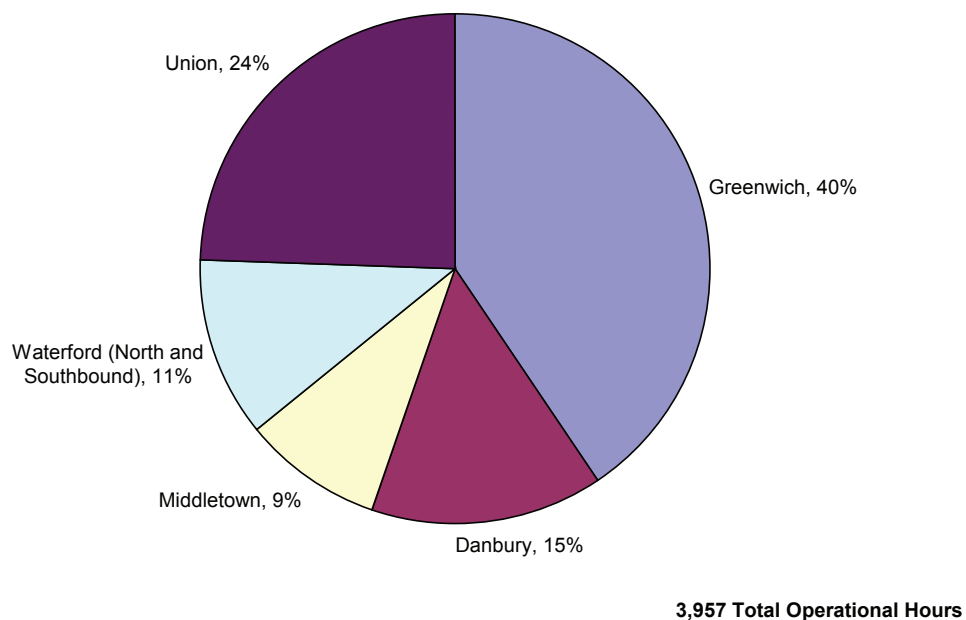

Source: Data provided from DPS, 2008 report to Connecticut General Assembly

FIGURE II-10. OPERATION OF CONNECTICUT WEIGH STATIONS FROM
JULY 1, 2007 - DECEMBER 31, 2007

A STUDY OF WEIGH STATION TECHNOLOGIES AND PRACTICES
CONNECTICUT WEIGH AND INSPECTION STATIONS AND WIM SCALE EXPERIENCE

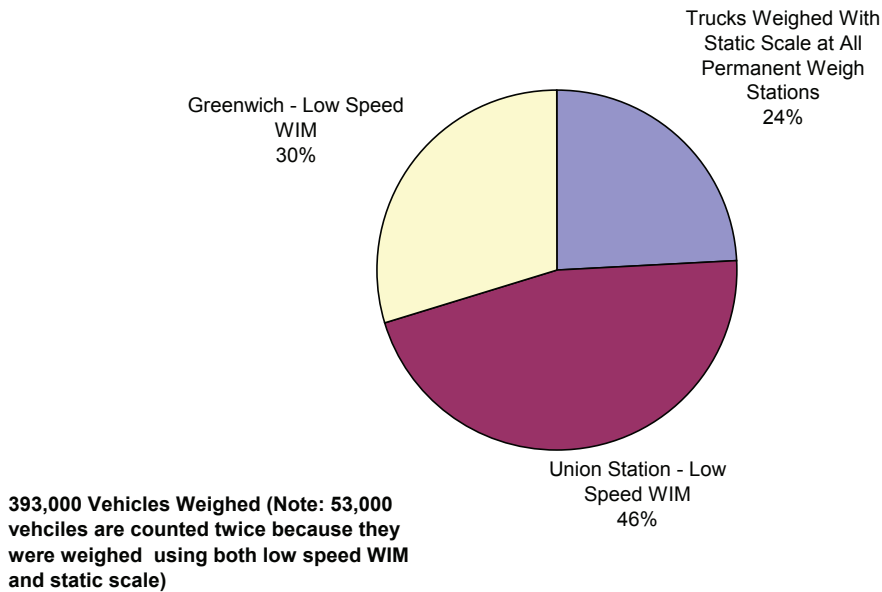

Source: Data provided from DPS, 2008 report to Connecticut General Assembly

FIGURE II-11. PERCENTAGE OF VEHICLES WEIGHED USING LOW-SPEED WIM AT GREENWICH AND UNION TO COMPARED TO STATICALLY WEIGHED AT PERMANENT WEIGH AND INSPECTION STATIONS IN CONNECTICUT FROM JULY 1, 2007 – DECEMBER 31, 2007

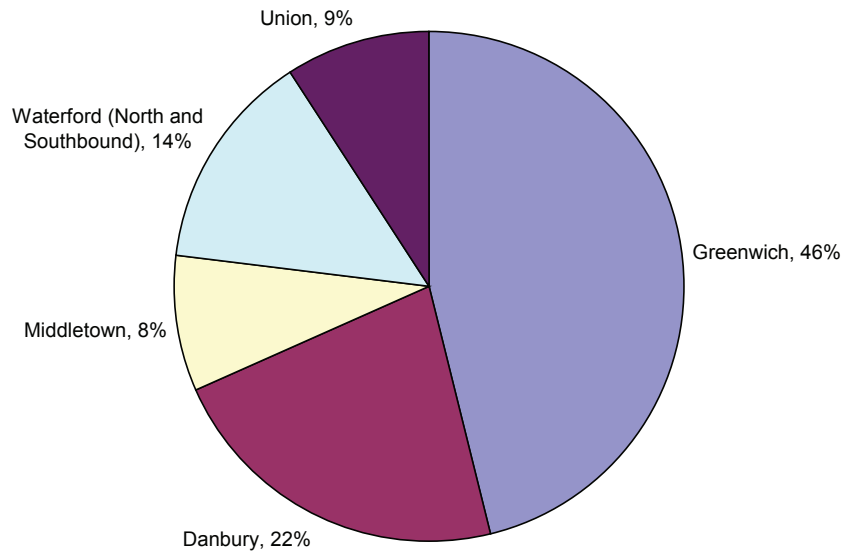

94,818 Vehicles Inspected

Source: Data provided from DPS, 2008 report to Connecticut General Assembly

FIGURE II-12. VEHICLES STATICALLY WEIGHED AND INSPECTED AND IN CONNECTICUT FROM JULY 1, 2007 – DECEMBER 31, 2007

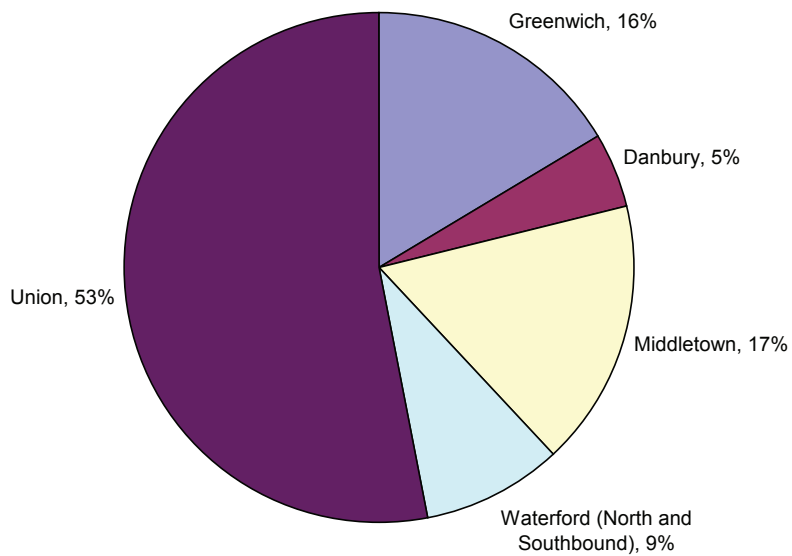

2,200 Total MCSAP Inspections

Source: Data provided from DPS, 2008 report to Connecticut General Assembly

FIGURE II-13. MCSAP INSPECTIONS IN CONNECTICUT FROM JULY 1, 2007 – DECEMBER 31, 2007

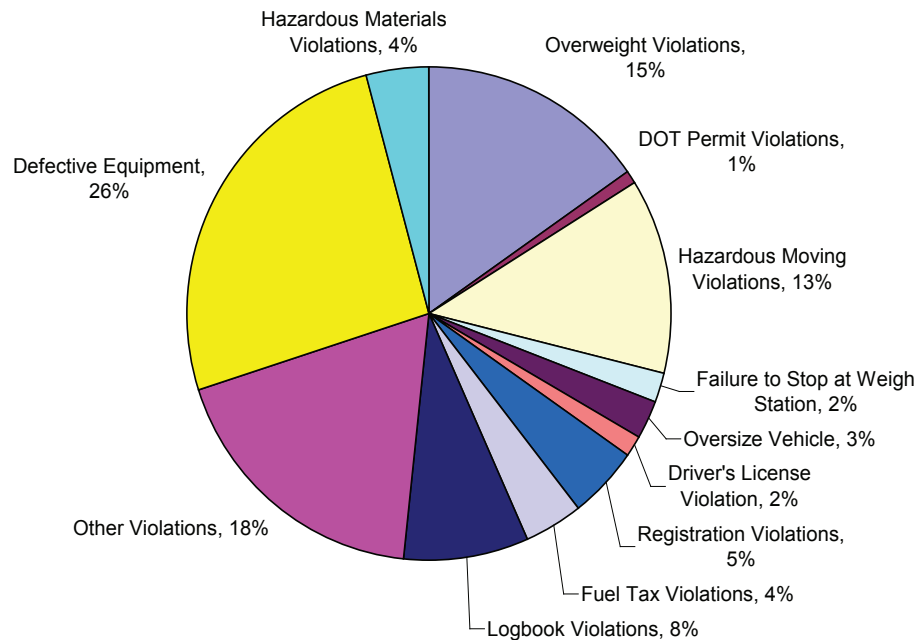

6,588 Total Citations (Not including Union Weigh Station)

Source: Data provided from DPS, 2008 report to Connecticut General Assembly

FIGURE II-14. DISTRIBUTION OF THE TYPES OF VIOLATIONS IN CONNECTICUT FROM JULY 1, 2007 – DECEMBER 31, 2007 (NOT INCLUDING UNION WEIGH AND INSPECTION STATION)

Weigh Station Funding

The funding to operate the weigh and inspection stations comes from both federal and state sources under a number of different programs through each of the departments with weigh station operational responsibilities. Following is an overview of program funding.

ConnDOT: Provides funding for weigh scale repairs and maintenance. The Office of Maintenance currently provides funding for an annual contract for the maintenance of the Union high-speed mainline WIM on an as-needed basis in an amount not to exceed \$100,000 annually. Additionally, the Office of Maintenance is responsible for mowing, plowing/snow removal, and pavement repairs for each of the weigh stations. However, the annual cost of these services is not readily identified. The department's Property and Facilities Office is responsible for the repair and maintenance of all structures/buildings as well as static and WIM scales at each of the weigh stations. Current annual scale maintenance contract costs for each station are as follows: Greenwich: \$13,978; Middletown: \$8,038; Danbury: \$11,470; Waterford (North): \$9,490; Waterford (South): \$9,490; and Union: \$14,804. The annual cost of repairs and maintenance for structures/buildings at the weigh stations is not readily available.

DMV: Motor Carrier Safety Assistance Program (MCSAP) - A grant for 80% of the funding for this program comes from the federal government if the state meets requirements for performing MCSAP inspections. The other 20% is funded by the state. In the federal fiscal year 2008, total program expenses were \$1.86 million. For the state's fiscal year 2007, a total of 7,924 tickets were issued with total potential revenue from fines of \$2,903,975. For the first six months of the state's fiscal year 2008, a total of 3,209 tickets were issued with total potential revenue from fines of \$1,266,147.

DPS: Provides funding for the operation of the Danbury, Greenwich, Middletown, and Waterford weigh stations and for portable scale operations. For fiscal year 2008, DPS's cost for their operation of the state's Size & Weight Enforcement Program was approximately \$3,743,486, including \$93,000 for the acquisition of 24 portable scales that was funded through ConnDOT. Additionally, a total of 16,980 tickets were issued with total potential revenue from fines of \$4,709,936.

CONNDOT PLANNING PROGRAM USING WIM SCALES FOR DESIGN AND FEDERALLY REQUIRED DATA COLLECTION

ConnDOT's Bureau of Policy and Planning is responsible for collecting traffic data as required by FHWA to obtain federal funding and to support ConnDOT's planning and engineering activities. This is accomplished by maintaining 40 continuous count sites that monitor vehicle volume, speed, and class and collecting commercial vehicle weight data on an annual basis from 30 of the 120 sites that have permanently installed WIM sensors.

The WIM scales used for the data collection are polymeric piezoelectric sensors. They are Measurement Specialties Inc.'s Roadtrax Brass Linguini (BL) Traffic sensors, which are spiral-wrapped polyvinylidene fluoride (PVDF) piezoelectric film with a 0.016" thick brass outer sheath. Installation of the sensor requires a ¾" x 1" deep slot in the road with an acrylic or polyurethane epoxy used to hold the sensor in place along with installation of an inductive loop. Using portable Micro Electronics electronic controllers, data is collected for 48 consecutive hours

from 30 of the permanent WIM sensor sites each year on a three-year cycle. Prior to collecting data, the calibration of the WIM system output is checked by comparing WIM output to the calibrator's experience or working knowledge of knowing the estimated weight of trucks based on visual identification of trucks passing over the WIM. Calibration is not done using trucks of known static weight because of the expense involved in using this more formal procedure. Typically data collection is done either from Monday – Wednesday or Wednesday – Friday.

The WIM sensors are not monitored on a continual basis because of the expense in purchasing individual controllers for each unit. Therefore, there is no way to know if the WIM sensor or inductive loop has been damaged over the three-year period since it was last used for data collection until the mobile controller is connected to the sensor. A primary cause of damage to the sensor system is pavement deterioration at the WIM system location. This may cause the WIM system to give inaccurate and inconsistent output or cause the system to fail. If repairs are needed to the sensor system or pavement, coordination of multiple ConnDOT functional groups is required.

ConnDOT's planning group is concerned about combining data collection for planning purposes and enforcement operations in one system because it is important for design purposes to record "normal" traffic data, volumes, classifications and vehicle weights. It is thought that there is a potential for drivers to skew the weight data (e.g., driver behavior or scale avoidance) if they knew the sensor could also be used for enforcement purposes as part of a virtual weigh station system.

A virtual weigh and inspection station system includes components of a permanent weigh and inspection station, except that it does not include a permanent facility with a fixed static scale. A virtual weigh and inspection station system is intended to provide high-speed WIM system real-time weight, and e-screening data that enables enforcement personnel to focus their attention on portable static scale weighing operations and vehicle inspections on only those commercial vehicles that have been identified as being possibly overweight or with safety/inspection issues, and to allow all other vehicles to efficiently bypass virtual station operations.

Funding for maintenance of traffic monitoring sensors and equipment for required data collection activities is typically split, with FHWA covering 80% of the cost and ConnDOT responsible for the remaining 20% of the cost.

CONNDOT WEIGH-IN-MOTION RESEARCH EXPERIENCE

A summary of ConnDOT's weigh-in-motion research experience in Connecticut from 1987 – 2008 is included in Appendix F.

The conclusions from ConnDOT's research efforts indicate that a great deal has been learned about the practical aspects of operating WIM sites in Connecticut. The quartz piezoelectric weigh-in-motion sensors installed in 2003 at several sites offer a practical option for collecting accurate data. The results are highly site-specific. The pavement approach is a critical component of a WIM system. Sensor response did not appear to be speed- or load-specific at the test sites in Connecticut. In general, the quartz piezoelectric sensors installed in 2003 locations have continued to perform for over five years.

III. WEIGH STATION OPERATION AND WIM DATA COLLECTION IN NEIGHBORING STATES

To better understand how weigh stations and WIM systems are operated in Connecticut's neighboring states including Massachusetts, Rhode Island, New York and New Jersey, an email questionnaire and phone interviews were conducted with state DOT and state police staff. The topics discussed focused on four areas:

1. WIM sensor technologies used in the state including the type of sensors, their design configuration, installation and calibration
2. WIM data collection, usage and data quality
3. Electronic safety and screening system, including data management and sharing of data on a regional basis with other states
4. WIM program experience

A list of questions utilized for conducting the survey and interviews is provided in Appendix G. In addition, a literature review of each state's WIM programs and their weigh station operations is also provided for this section of the report.

MASSACHUSETTS

Weight Enforcement Sites

The Massachusetts weight and inspection program does not utilize fixed permanent weigh stations. Instead, the state uses park and rest areas as its roadside weight enforcement locations. The Massachusetts State Police (MSP) Commercial Vehicle Enforcement unit establishes the operation schedule for these enforcement locations. The MSP varies the schedule, which is not made public, to maximize their enforcement efforts. Portable weighing scales or semi-portable scales are used to weigh vehicles at these sites.

High-speed WIM Sensor Technologies

The Massachusetts Highway Department (MHD) manages and operates approximately 24 high-speed WIM sites throughout the state on interstate highways. At present, they do not use any of these sites for enforcement purposes, nor do they coordinate their studies with the MSP. The highway segments with high traffic volumes are usually selected as WIM sites. These sites are operated to meet the guidelines specified in FHWA's Traffic Monitoring Guide.

A typical four-lane traffic data collection station's layout showing loops, WIM sensors and other supporting devices such as a cabinet, power, communications, etc. is illustrated in Figure III-1. "AMP BL Roadtrax" piezo sensors are embedded in saw cuts in the roadway with 12-foot spacing and between these sensors. There is a 6' X 6' magnetic loop detector. The two sensors

at 12-foot spacing enable the system to detect axle distances and vehicle speeds, as well as the average of the weights recorded by the two sensors.

To collect and store the data, the MHD uses a portable WIM Automatic Traffic Recorder (ATR), usually the Peek ADR 2000 Model. In the past, the International Road Dynamics, Inc. (IRD)/PAT Traffic Recording System WIM ATR was utilized. However, this unit has had some software problems that are currently being rectified by the manufacturer. Nevertheless, the exact piezo and loop roadway placements have been installed in accordance with the manufacturer's specifications.

MHD has experienced some problems with the piezo sensors installed at many of the sites, particularly the epoxy/grout used to seal the units in the pavement saw cuts. Currently MHD is experimenting with installing these sensors "sub-surface" in the "binder" course of the roadway. Whether this practice will deliver accurate readings, as the manufacturer claims, will require additional field study.

Individual axle weights for Class 4 vehicles and above, according to the FHWA/Scheme F, are collected. The individual axle weights for Class 4 vehicles and greater are used to calculate "ESALS" (Equivalent Single Axle Loads), an important factor used in bridge and pavement design. Other WIM data collected include volumes, speeds, weights, classes, ESALS, lengths, etc. Data are sometimes provided for special requests or to various agencies.

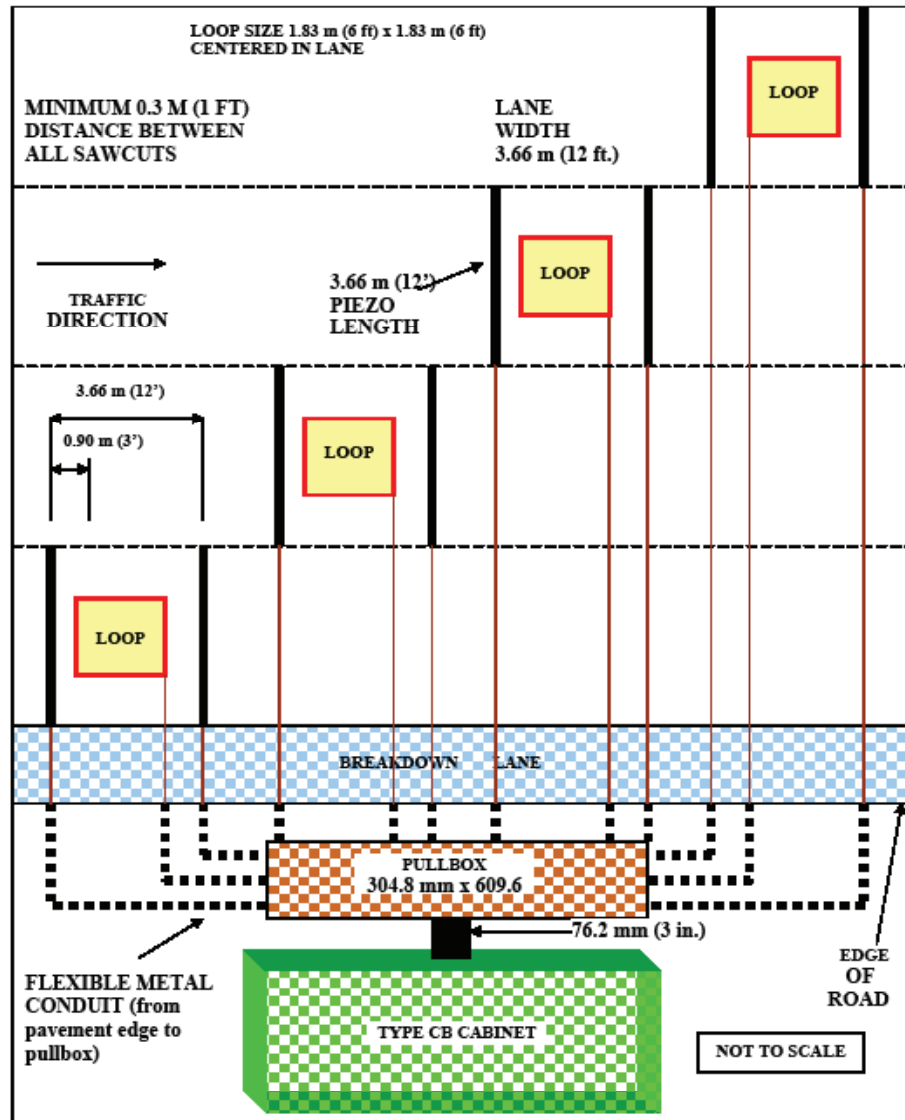

Source: Massachusetts Highway Department

FIGURE III-1. TYPICAL 4-LANE LAYOUT OF WIM SENSORS AND
 CABINET LOCATION

High-speed WIM Calibration and Data Accuracy

The installation of new WIMs is done by selected contractors by following the piezo manufacturer's recommended installation procedures. Auto-calibration of the WIM sites is accomplished using vendor-supplied software. Most high-speed WIM ATRs have a built-in calibration feature that is user definable. The customary method is to calibrate the weights from the front (steering) axle of FHWA type 9 vehicles. The target value is 10 kips (10,000 lbs). Ideally, a vehicle of known total and individual axle weights should pass over the installation in each lane for at least 6 - 10 runs to test the system's accuracy. This procedure is not always feasible. A plus or minus gross weight difference of 10% is considered acceptable for a high-speed WIM site for MHD's data collection purposes, but would not be usable for enforcement purposes, except to "flag" potential overweight vehicles for further weighing on a static scale if such sites were to be used for enforcement purposes.

On-site visual checking is conducted for verification purposes to assure the quality of the data, which are then analyzed for any abnormalities.

Approximately 12 of the 24 WIM data collection sites are currently operational. The MHD obtains two continuous weeks of data per quarter from operational sites each calendar year. Approximately 15% of the time, the sites are operational and supplying good data, according to MHD staff.

Electronic Safety and Screening System

Currently, Massachusetts does not have an electronic safety and screening system. Truck data (weight, credentials, etc.) is not shared with neighboring states or with the I-95 Corridor Coalition.

NEW JERSEY

Weight Enforcement Sites

The New Jersey State Police manages and operates two fixed-weight enforcement sites. One, which was recently built, is located on I-78 near the Pennsylvania border, and the other is on I-295 near the Delaware border. These stations are not equipped with electronic safety and screening systems. However, the state is considering the use of either PrePASS or NorPASS for an electronic safety and screening system. New Jersey does not share information with neighboring states.

Bending plate low-speed WIM sorters are used off the mainline on the ramps into the station. The accuracy of these bending plate WIMs is within 1%- 2% of static scale vehicle weights.

WIM Sensor Technologies

The New Jersey Department of Transportation (NJDOT) maintains more than 80 WIM sites throughout the state for data collection and reporting. All sites use ceramic-polymer piezoelectric sensors. Their standard sensor array is loop-piezo-loop-piezo-loop (L-P-L-P-L) in each lane with the center loop redundant. The first loop turns the piezos on and both loops measure the

vehicle length. The two piezos measure the speed, axle spacing, and weights. The middle loop is connected but in off position and is not used when both piezo sensors are working. However, the center loop plays an important role when one of the piezos fails. The configuration is then changed to L-P-L. The middle loop and, depending on which sensor fails, the first or third loop are activated. With the L-P-L configuration, the loops measure the vehicle speed, length and axle spacing. If the first loop fails, the first piezo will no longer activate and the configuration becomes L-P-L, using the middle loop as the first and disabling the first loop and first piezos. When both sensors fail, the two loops are still available to measure volume and vehicle length.

NJDOT staff also identified their consideration and experience with other various WIM technologies. Bending plates were used at some of the earlier WIM sites with the expectation that they would be more accurate and durable. However, the bending plate systems have not produced more accurate results and have also presented much greater maintenance challenges. Therefore, New Jersey no longer uses these bending plate WIM systems and has either removed them or welded them into place in their frames. Hydraulic load cells were never utilized by New Jersey. Staff noted that when installing piezo sensors, it is essential that the slots be pressure washed and thoroughly clean and dry before pouring grout as part of the installation process. This is a challenge since most of WIM sites are installed at night to minimize the impact to traffic flow, and there is barely enough time for the grout to cure before lanes must be reopened to traffic.

Initial calibration of new WIM sites is the responsibility of the equipment manufacturer at the expense of the general contractor. Subsequent annual calibration is accomplished by NJDOT staff on Saturdays using a truck and driver provided by NJ Department of the Treasury. The procedure involves a 5-axle tractor trailer with a dry van loaded with a non-shifting load resulting in a gross weight of 75,000 - 80,000 pounds. Repeated passes are made to obtain five consistent readings of axle and gross weight. Following adjustment, if necessary, an additional five consistent readings are obtained within the required system tolerance.

NJDOT staff indicated that out of the state's 80 WIM sites, 50 are fully operable; 10 are partially operable (counting and classifying); 6 are completely out of service; 5 are in the process of being newly constructed; and 9 are in the process of being reconstructed. New Jersey has experienced pavement issues and hardware reliability issues in the operation of their WIM systems. Most WIMs are in locations where they serve both directions even on divided highways, with a few being installed in only one direction. Additionally, as a base for collection of data, some short-term (usually a week) continuous counts were taken in the fall and winter of 2007 at some additional locations, with the results providing consistency for FHWA class 9 and higher.

WIM Data Usage

In addition to weight data, WIM sites collect a variety of traffic data including traffic volume, speed, directional distribution, lane distribution, date and time of passage, axle spacing, and vehicle classification. Consequently, four reports – Traffic Volume, Vehicle Classification, Truck Weight ESAL and Vehicle Speeds – are published on the NJDOT website (<http://www.state.nj.us/transportation/refdata/roadway/>).

These data are mainly used for FHWA reporting. Other applications include determining 18-kip equivalent single axle load factors from the collected WIM data for pavement design. In addition, New Jersey is involved at the research stage in using WIM data to determine truck

routing using data mining. The state also has a Large Truck Monitoring Program (LTMP) for the purpose of monitoring the volume and patterns of large truck movements throughout the state. It is expected that weight data will be added to this program after calibration is completed.

NEW YORK

The following section will focus on the New York State Department of Transportation (NYSDOT)'s efforts to develop and implement the state's first automated roadside e-screening system for commercial vehicles.

Electronic safety and screening system

NYSDOT is a member of the New York State Interagency Motor Carrier Task Force, which deals with all aspects of commercial vehicle regulation, credentialing, compliance and enforcement. The Task Force also includes representatives from the state Departments of Motor Vehicles, Taxation and Finance; the Division of State Police; the NYS Thruway Authority; and the New York State Motor Truck Association. One of NYSDOT's key commercial vehicle responsibilities is managing and directing the Commercial Vehicle Information System and Networks program (CVISN). The CVISN program incorporates a variety of commercial vehicle-related programs including New York State's e-credentialing OSCAR (One Stop Credentialing and Registration) website (www.oscar.state.ny.us/), which allows customers to use the internet to apply for approximately 85% of the required credentials needed to operate a commercial vehicle in New York State. These credentials include registration (International Registration Plan [IRP]), fuel tax permits (International Fuel Tax Agreement [IFTA]), and Highway User Tax [HUT] credentials.

As part of the CVISN program, NYSDOT is managing a project to research and develop an automated roadside electronic screening system for commercial vehicles. The first installation of this integrated electronic safety and screening system along I-90 at Schodack, NY, is near completion. This project integrates and tests automated vehicle identification via 915 MHz transponders or license plates, and vehicle WIM devices at highway speeds. Once identified and weighed, a commercial vehicle's credentials will be instantaneously checked against the definitive, authoritative database developed by the Interagency Task Force to determine whether or not the vehicle is in compliance. If the vehicle meets all the screened requirements, it will not be stopped at the roadside inspection area. The project has demonstrated the ability of the system's technology to identify a vehicle via transponder readers. Currently, this project focuses on the total integration of WIMs and license plate readers (LPRs) with video recognition capabilities into the current system using transponders. It is anticipated that a comprehensive, fully integrated commercial vehicle e-screening system will be tested and ready for operational deployment by the end of 2008. This site is also designed to be a fully compliant classification highway data collection site that can be accessed in real time via a high-speed internet connection.

In addition, NYSDOT is also partnering with other agencies to develop and test the software and hardware needed to integrate commercial vehicles into the ongoing USDOT Vehicle Infrastructure Integration (VII) program. NYSDOT is working with New York State telecommunication agencies to deploy a 13-mile VII capable corridor along the New York State Thruway's I-87 corridor from Suffern to the Tappan Zee Bridge. Wireless transmission of key data to the roadside from the vehicle at highway speeds will be tested, including driver

identification, driver verification and vehicle safety information. The NYSDOT is also exploring the possibility of installing another fully developed system in the new dedicated commercial vehicle inspection facility at Champlain, NY, which is an international border with Canada.

WIM Technologies

In order to select the most appropriate WIM technology for integration with e-screening systems, NYSDOT is researching, procuring, installing and field testing several available WIM technologies, including piezoelectric, quartz piezoelectric and single load cell, for integration with roadside electronic safety and screening operations. These selected WIM technologies are installed at the Schodack, NY, site and will be subjected to similar weather and traffic conditions to allow for an engineering- and statistic-based evaluation and comparison. Additional factors to be evaluated include weather impacts and WIM field performance on standard, asphalt-based pavement.

While there may have been individual studies on the various types of high-speed WIM use and accuracy involving high cost, specialized concrete pavement, there is very little, if any, data available for a comparative analysis under field conditions at a specific, integrated site where pavement conditions are less than ideal. It is anticipated that this research effort will address many of these issues and provide comprehensive, field-based data and information that will help transportation agencies decide the most appropriate WIM technology for electronic safety and screening integration and asset management. However, the results of this study are not yet available.

DATA SHARING AMONG NEIGHBORING STATES

Interviews with NYSDOT staff indicated that, in theory, data sharing with neighboring states would be valuable.

WEIGHT ENFORCEMENT SITES

There are more than 100 locations used throughout New York State for roadside enforcement by state police. These sites are often rest areas along the Interstate highways, but there are no fixed weigh stations in New York. NYSDOT is responsible for the infrastructure issues involving commercial vehicle enforcement.

WIM DATA

Similar to other states, NYSDOT collects various WIM data including weights, speeds, and volumes. In addition, images of commercial vehicles are also captured. These data are collected on a 24/7 basis and stored mainly for FHWA reporting purposes. Quality assurance of these WIM sites is based on automated software program calibration combined with physical calibration using a known vehicle load run over the sensors ten times per lane.

RHODE ISLAND

The Rhode Island State Police (RISP) is responsible for the Rhode Island vehicle weight enforcement program. Roadside mobile weigh checkpoints are used instead of having permanent weigh stations. Park/rest areas or roadsides with sufficient clear zones are used to weigh commercial vehicles and examine their credentials including registration, taxes, permits, and safety records. When a roadside weigh station is open, all trucks are signaled into the station area to pass over a portable low-speed capacitive mat WIM sensor. Capacitive mats consist of two inductive loops and one capacitive weight sensor per lane that are installed perpendicular to the direction of the vehicle in the traffic lane. In a portable setup, the inductive stick-on loops and the capacitive weight sensor are placed on top of the road pavement for temporary use, usually up to 30 days.

The “possible” overweight commercial vehicles are sorted out and directed to static scales that meet enforcement calibration requirements.

The roadside weigh station locations vary, with the RISP concentrating their efforts on the most problem-prone locations and infrastructure. Currently the state has placed restrictions on trucks going over two bridges: the Route 24 bridge over the Sakonnet River and the Route I-95 bridge over the Pawtucket River. There is a 22-ton weight limit for both bridges and vehicles with more than two axles are banned from passing over the bridges. The RISP has equipped portable scales, laptops and wireless communications for enforcing vehicle weight on both directions of the bridges. Overweight trucks are directed to travel on detour routes.

An electronic screening system that provides for the verification of truck credentials is under development and is in the planning stage. The state is considering implementing the Commercial Vehicle Information Systems and Networks (CVISN) system. Discussion with the RISP indicated that an integrated electronic safety and screening system in New England and along I-95 corridor would be beneficial.

With state, I-95 Corridor Coalition, and other funding sources, the RISP has utilized laptop and wireless communications technologies at the roadside to retrieve, capture/enter, and upload commercial vehicles safety inspection information. This system is an initial deployment that enables state inspectors and enforcement officers to focus roadside inspections on high-risk carriers and gain experience for the expected future implementation of CVISN. It is expected that this roadside information system will also be linked to the Motor Vehicle International Registration Plan (IRP), International Fuel Tax Agreement (IFTA) and the state’s public utility commission so that inspectors and enforcement officers have real-time access to pertinent motor carrier records.

WIM Sites

The Rhode Island Department of Transportation (RI DOT) maintains four permanent high-speed WIM sites on I-95 and two low-speed sites on Route 146 for data collection. These WIM sites are used only for data collection, not enforcement purposes, and are usually not in close proximity to the state’s enforcement sites. Five of the sites have encapsulated ceramic piezoelectric sensors while one site uses quartz piezoelectric sensors.

The traffic data are collected 24 hours per day and 7 days per week. The system collects date, time, vehicle speed, vehicle classification, axle spacing distance, axle weights, total vehicle

weight, and vehicle length, and is used primarily for FHWA reporting. Occasionally, vehicle classification data are provided to other RI DOT divisions.

The WIM sensors were installed per the vendor's (IRD) instructions in order to maintain the system's warranty. The sites were initially calibrated using a 5-axle tractor trailer of known weight. After that, an auto-calibration software program provided by the system vendor is used to calibrate the WIM system. This process calculates and applies an adjustment to scale calibration factors for changing environmental conditions based on built-in known sensitivities in the axle sensors.

IV. WEIGH-IN-MOTION (WIM) SENSOR TECHNOLOGIES

CURRENT WIM SENSOR TECHNOLOGIES

The most commonly used WIM sensor technologies are bending plates, piezoelectric sensors (quartz, polymer, and ceramic), and load cells. The following sections provide a brief overview of each technology and typical site layout.

Bending Plate System

SENSOR TECHNOLOGIES

A bending plate system incorporates strain gauges attached to the bottom of a steel plate as shown in Figure IV-1. When a vehicle travels over the plates, the strain introduced by the loading is measured and converted to a dynamic weight. The static load is estimated by multiplying the measured load by its calibration factor.

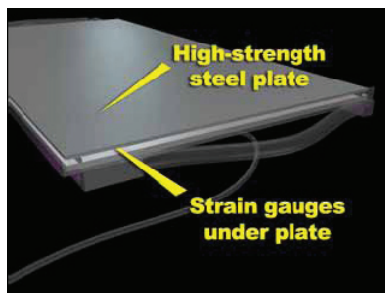

Source: Liu, et al, 2005

FIGURE IV-1. BENDING PLATE

TYPICAL SITE LAYOUT

A typical bending plate system consists of WIM scale(s), inductive loops and other supporting devices such as processor, communication and operating software (see Figure IV-2). Either one or two bending plates are placed in the travel lanes perpendicular to the direction of travel. When two scales are used, a scale is used in each wheel path either side by side or staggered by 16 feet. Two inductive loops are used upstream and downstream from the scales to determine the presence of a vehicle and to determine vehicle speed and axle spacing.

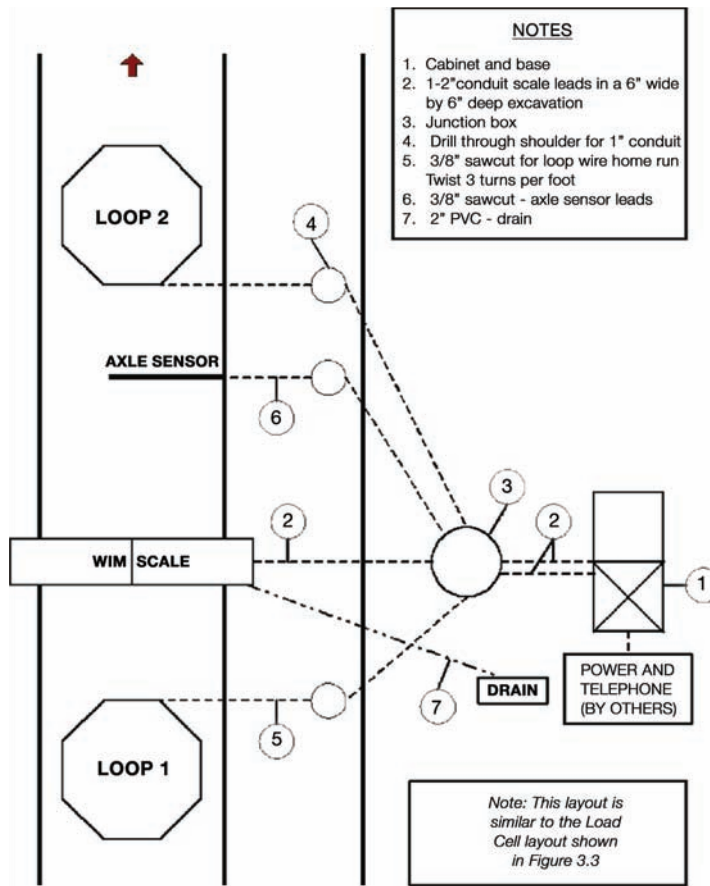

Source: McCall and Vodrazka, 1997

FIGURE IV-2. TYPICAL BENDING PLATE SYSTEM LAYOUT

Piezoelectric Sensor Systems

SENSOR TECHNOLOGIES

Piezoelectric sensors measure the change in voltage induced as a vehicle passes over sensors as shown in Figure IV-3. As with all WIM sensors, the static load is estimated by using the measured load and a calibration factor. The piezoelectric materials can be polymer molecular chains (e.g., polyvinylidene fluoride), ceramics (e.g., lead zirconate titanate) or crystals (e.g., quartz).

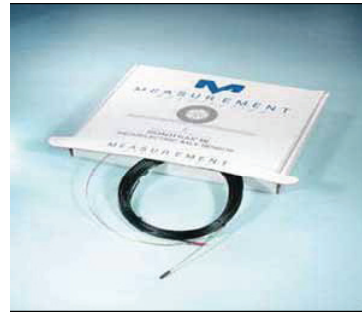

Source: Liu, et al, 2005

FIGURE IV-3. PIEZOELECTRIC SENSORS

Polymeric and ceramic piezoelectric are the least expensive WIM sensor alternatives, but these sensors are temperature sensitive, thus making their overall performance unsatisfactory for enforcement applications. For example, the BL WIM sensor used by ConnDOT Planning has a reported sensitivity of 0.2%/degrees F. typical, dependent on the grout used, according to the specification information provided by the manufacturer, Measurement Specialties, Inc (MSI). This temperature dependence is most problematic on sunny days with cool nights, when the temperature of the pavement can change significantly over the course of the day.

As compared to polymeric and ceramic piezoelectric sensors, quartz crystal piezoelectric sensors have been shown to have good linearity and remain stable under changing temperature conditions. An example of a quartz-based sensor is shown in Figure IV-4. In this configuration, the sensor housing is the key element in isolating the vertical force and minimizing the effect of the horizontal forces.

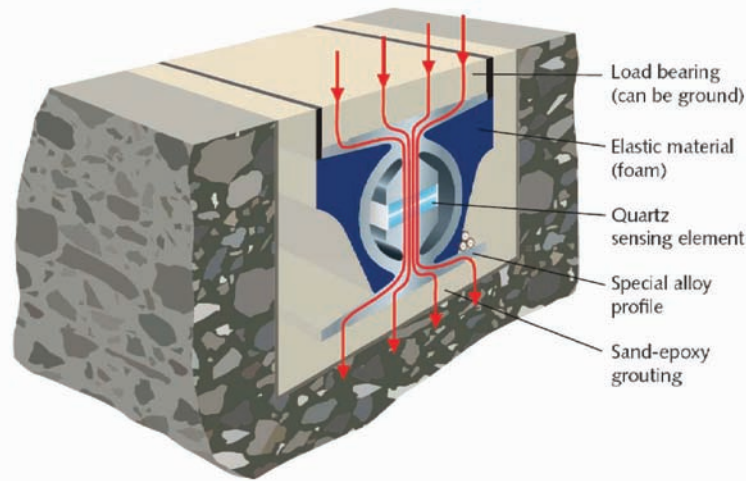

Source: Kistler Instruments Corporation at <http://www.kistler.com/>

FIGURE IV-4. EXAMPLE OF QUARTZ PIEZOELECTRIC SENSOR

TYPICAL SITE LAYOUT

Polymeric and ceramic piezoelectric sensors are placed in the pavement perpendicular to the travel lane as shown in Figure IV-5. The sensors are installed using a grout that is ground smooth with the pavement surface after it is cured. The sensors span the travel lane so that both tires ride across the surface. Inductive loops are also used to detect vehicles and to determine vehicle speeds and axle spacing. A standard Kistler quartz piezoelectric WIM scale layout is shown in Figure IV-6. This layout includes two rows having four quartz piezoelectric sensors each that are perpendicular to the travel lane. Additionally, in the United States, various staggered half-lane configurations have been deployed for various purposes including reducing the impact of vehicle dynamics to improve accuracy and, in some cases, to reduce system cost by installing fewer sensors, but with a resulting reduction in accuracy.

Similar to other WIM systems, static weight is estimated by use of a calibration factor. The first installation and evaluation of quartz piezoelectric sensors on a US highway was conducted in Connecticut in 1997 (Appendix F).

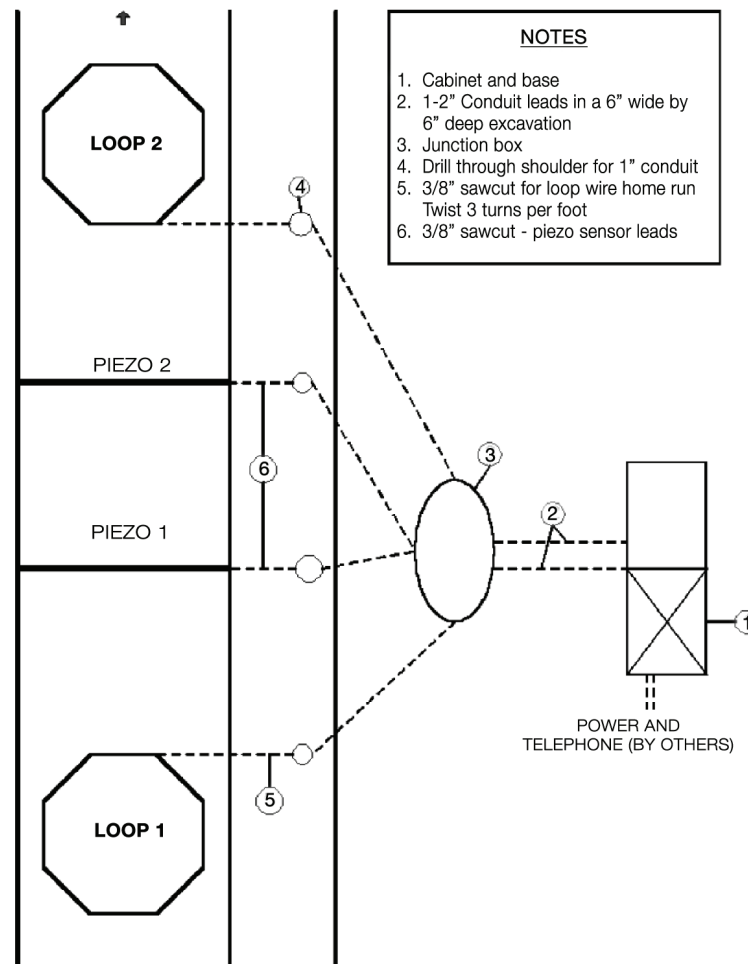

Source: McCall and Vodrazka, 1997

FIGURE IV-5. TYPICAL PIEZOELECTRIC SYSTEM LAYOUT

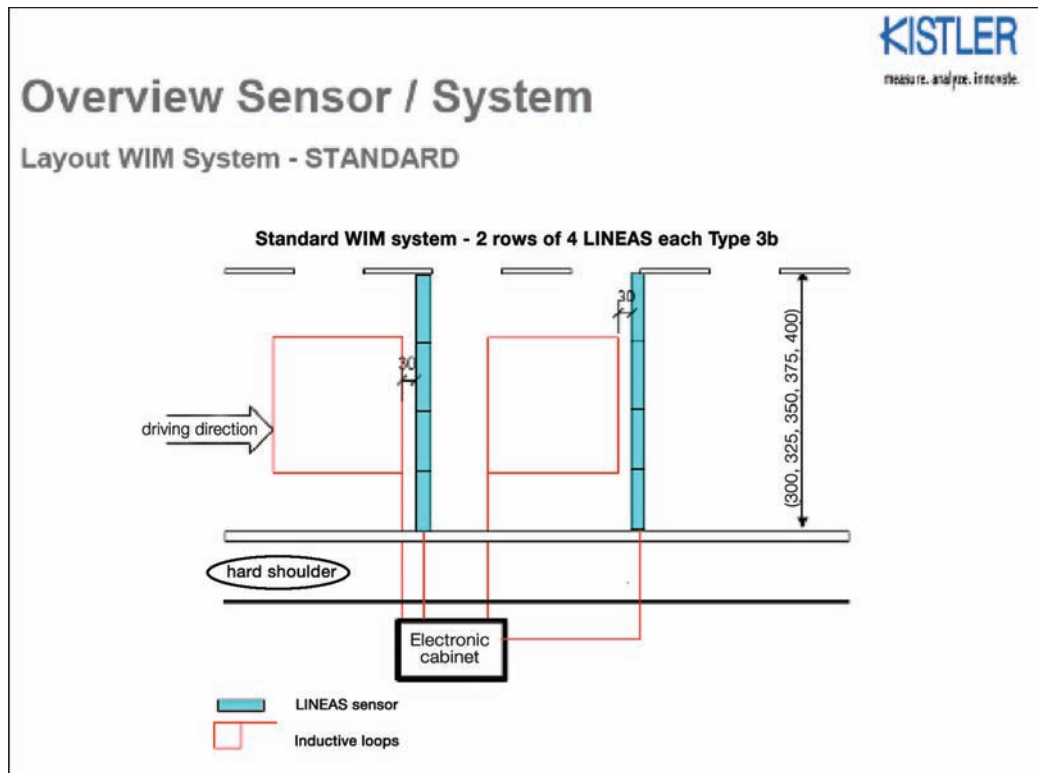

Source: Kistler Instruments Corporation at <http://www.kistler.com>

FIGURE IV-6. STANDARD QUARTZ PIEZOELECTRIC WIM SYSTEM LAYOUT

Load Cell Sensor System

SENSOR TECHNOLOGY

In a load cell-based WIM sensor, a load cell is mounted centrally in each scale mechanism across the traffic lane as shown in Figure IV-7. All loading on the weighing surface sensor is transferred to the load cell through load transfer tubes. Typically there are two six-foot long scales covering one lane width, which weigh wheels at both sides of an axle simultaneously. The scale is mounted in a frame and installed in a vault which is flush with the road surface.

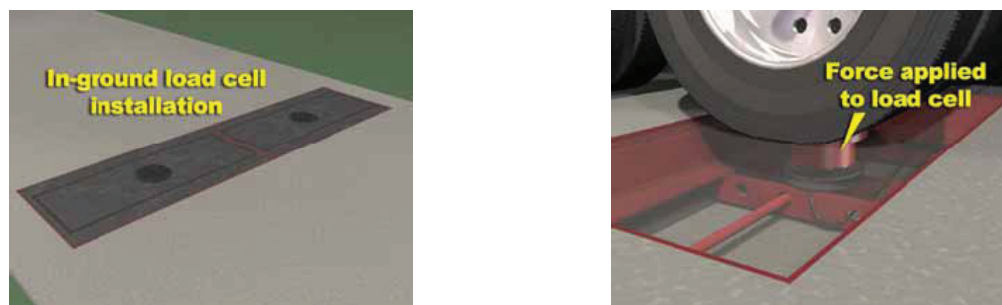

Source: Liu, et al, 2005

FIGURE IV-7. LOAD CELL-BASED WIM SENSOR

TYPICAL SITE LAYOUT

Each load cell has two scales that detect an axle and weigh both the right and left sides at the same time. Then, a sum is taken of the two scales in order to determine an axle weight. At least one inductive loop and one axle sensor is installed with the inductive loop upstream to determine when vehicles are approaching the system. If a second loop is used, axle spacing is used to determine vehicle speed. Again, the dynamic force detected by the load cell is converted to a static weight using a calibration factor. As shown in Figure IV-8, the load cell site configuration is very similar to the bending plate layout of Figure IV-2.

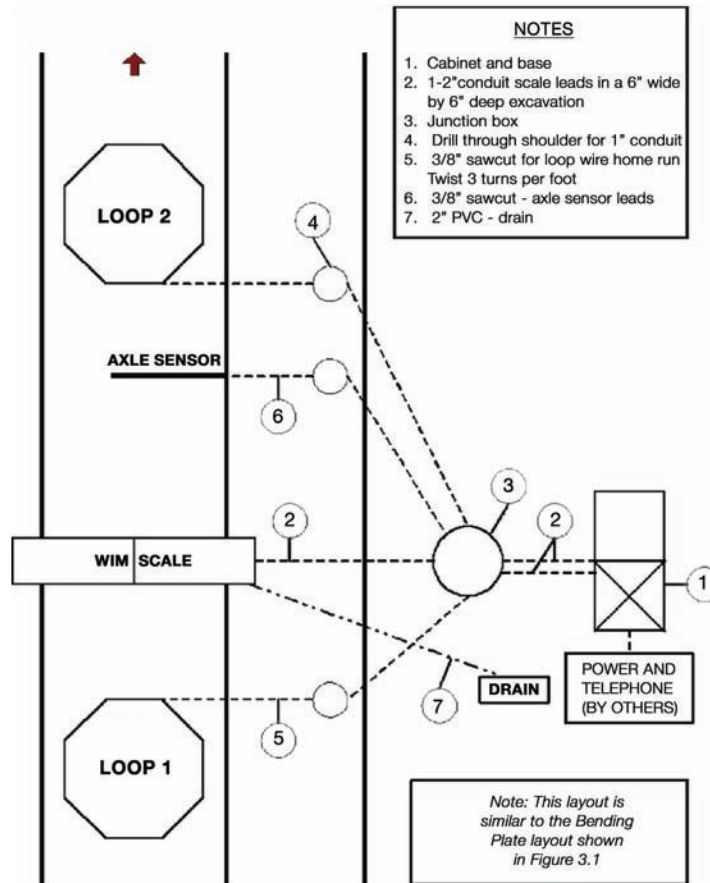

Source: McCall and Vodrazka, 1997

FIGURE IV-8. TYPICAL LOAD CELL SYSTEM LAYOUT

COMPARISON OF CURRENT WIM TECHNOLOGIES

Because the accuracy of a WIM scale depends not only on the sensor technology but also on the site conditions, truck characteristics, and driver behavior, it is very difficult to precisely quantify the accuracy of each of the sensor technologies. Instead, it was decided to qualitatively compare characteristics such as ease of installation, maintenance, safety, and cost, along with accuracy in determining the technology or technologies that would be most appropriate for Connecticut. A qualitative comparison of the four most common WIM sensors is given in Table IV-1.

A STUDY OF WEIGH STATION TECHNOLOGIES AND PRACTICES
WEIGH-IN-MOTION SENSOR TECHNOLOGIES

	Quartz Piezoelectric Sensor	Polymeric and Ceramic Piezoelectric Sensors	Bending Plates	Load Cells	Bridge WIM
Performance	Can Meet Enforcement Requirements with 2 rows of sensors. Better accuracy can be achieved with 3 rows through averaging out of vehicle dynamics	Not Acceptable - Temperature Sensitive	Can Meet Enforcement Requirements	Can Meet Enforcement Requirements	More Research Needed to Verify Accuracy
Installation	Small Road Cuts 1 Day to Complete	Small Road Cuts 1 Day to Complete	Significant Road Cut with Proper Drainage Required Multiple Days to Complete	Significant Road Cut with Proper Drainage Required Multiple Days to Complete	Non - Intrusive Instrumentation
Maintenance	Must maintain surface smoothness and seal properly to achieve satisfactory performance	Must maintain surface smoothness and seal properly to achieve satisfactory performance	Inadequate drainage can cause bending plates to come out of the roadway. Required 6 month checks and annual in-road inspection	Corrosion of load cell if not sealed correctly	Minimal
Safety Issues	One Day for System Installation and During Periods of In-Road Maintenance	One Day for System Installation and During Periods of In-Road Maintenance	Significant safety issue if bending plate comes out of the roadway Multiple Day System Installation and During Periods of In-Road Maintenance	Multiple Days for System Installation and During Periods of In-Road Maintenance	None
Cost of System Including Installation	Low-Medium Cost	Low Cost	Medium-High Cost	High Cost	Low Cost
Mature / Proven Technology	Yes	Yes	Yes	Yes	Not in United States
Suggested Sensor for Connecticut - Enforcement and Data Collection	X - Near Term				X - Long term potential application for some locations

TABLE IV-1. COMPARISON OF HIGH-SPEED WIM SCALE TECHNOLOGIES

Polymeric and ceramic piezoelectric sensors, which are temperature sensitive, are not suggested because they do not provide the necessary accuracy under all conditions to meet the requirements for enforcement. Load cells and bending plates can provide accuracy that is comparable to quartz piezoelectric sensors, but these technologies are not suggested because multiple days are required for installation of the sensor, thus creating a safety hazard. Furthermore, if proper drainage is not provided, bending plate sensors can become safety hazards if they work their way out of the pavement over time, and load cell installations are very expensive compared to other technologies.

DEVELOPING WIM SENSOR TECHNOLOGIES

The primary developing WIM sensor technology is bridge WIMs. The non-intrusive characteristic of these systems is the primary advantage of this technology compared to piezoelectric, bending plates, and load cells because of the safety issues and cost of having to install and maintain these WIM scales in the pavement. Other technologies such as capacitance mats, vertical strain reducers, fiber optical sensors, and microwave sensors have been investigated, but their performance in the field has been limited by their accuracy and/or reliability. At this time, these other technologies are not considered viable WIM sensors for enforcement and data collection applications in Connecticut.

Bridge WIM

Bridge weigh-in-motion (BWIM), further described in Appendix H, is a method of determining the weight of a truck as it crosses over a highway bridge by measuring the strain or deflection of the bridge's structural members. Preliminary research in Connecticut demonstrated the feasibility of using long-term bridge monitoring systems for BWIM purposes.

V. WIM SYSTEM SPECIFICATIONS, INSTALLATION REQUIREMENTS, AND INTEGRATION INTO A COMPREHENSIVE ROADSIDE DATA MANAGEMENT SYSTEM

WIM SCALE SPECIFICATIONS

ASTM E 1318-02, Standard Specification for Highway Weigh-In-Motion Systems with User Requirements and Test Methods (2002) should be the basis for a WIM system specification. The standard provides four types of classifications of WIM systems based on type of application, speed ranges, and data gathering capabilities. In general, ASTM Type I WIM systems are used for data collection while ASTM Type III has higher accuracy requirements needed for enforcement applications. The following is a summary of the four application types defined by ASTM.

ASTM Type I WIM systems are used for traffic data collection on one or more lanes of travel at speeds between 10 and 80 mph. The data collected for each vehicle are listed in Table V-1. ASTM Type II WIM systems are similar to Type I except that their accuracy is not as stringent, vehicle speeds are between 15 and 80 mph, and data on wheel loads are not provided (see Table V-2). The test methods for Type I and Type II WIM systems for verifying that they meet the requirements given in Table V-2 are the same.

ASTM Type III WIM systems are installed in one or more lanes either off the main highway or in the main highway lanes to identify vehicles traveling at speeds between 10 and 80 mph that are suspected of weight-limit or load-limit violations. The systems will measure all items in Table V-1 except vehicle class, wheelbase, and equivalent single-axle loads. In addition, acceleration will be measured for systems installed off the main highway. Type III systems will include automatic traffic control devices that direct suspected overweight vehicles to a static scale for confirmation weighing. Test methods for Type III WIM systems are similar to Type I and Type II, except a deceleration test is also required for off main highway systems. Type IV WIM systems are for conceptual development purposes and have not yet been approved for use in the United States. They will be used at weight enforcement stations to detect weight-limit or load-limit violations for vehicles speeds between 2 and 10 mph. This type of system will collect the same data as Type III systems except for lane and direction of travel. The required accuracy requirements for Type III and Type IV WIM systems are also given in Table V-2.

A STUDY OF WEIGH STATION TECHNOLOGIES AND PRACTICES
WIM SYSTEM SPECIFICATIONS, INSTALLATION REQUIREMENTS, AND INTEGRATION
INTO A COMPREHENSIVE ROADSIDE DATA MANAGEMENT SYSTEM

1	Wheel Load
2	Axle Load
3	Axle-Group Load
4	Gross Vehicle Weight
5	Speed
6	Center-to-Center Spacing Between Axles
7	Vehicle Class (via axle arrangement)
8	Site Identification Code
9	Lane and Direction of Travel
10	Date and Time of Passage
11	Sequential Vehicle Identification Number
12	Wheelbase (front-most to rear-most axle)
13	Equivalent Single-Axle Loads (ESALs)
14	Violation Code

TABLE V-1. DATA ITEMS PRODUCED BY WIM SYSTEM (FROM ASTM E 1318-02)

Function	Tolerance for 95% Probability of Conformity				
	Type 1	Type II	Type III	Type IV	
				Value \geq lb (kg) ^A	\pm lb (kg)
Wheel Load	$\pm 25\%$		$\pm 20\%$	5,000 (2300)	300 (100)
Axle Load	$\pm 20\%$	$\pm 30\%$	$\pm 15\%$	12,000 (5400)	500 (200)
Axle-Group Load	$\pm 15\%$	$\pm 20\%$	$\pm 10\%$	25,000 (11,300)	1,200 (500)
Gross-Vehicle Weight	$\pm 10\%$	$\pm 15\%$	$\pm 6\%$	60,000 (27,200)	2,500 (1100)
Speed	± 1 mph (2 km/h)				
Axle-Spacing	± 0.5 ft (0.15 m)				

^ALower values are not usually a concern in enforcement

TABLE V-2. FUNCTIONAL PERFORMANCE REQUIREMENTS FOR WIM SYSTEMS
(FROM ASTM E 1318-02)

WIM SITE SPECIFICATIONS

Selection and continuing maintenance of a WIM site are extremely important factors in a WIM system's performance at the level needed to provide the necessary confidence to use it as a screening tool for enforcement purposes. A summary of the site conditions needed as per ASTM E 1308-02 is given in Table V-3.

A STUDY OF WEIGH STATION TECHNOLOGIES AND PRACTICES
WIM SYSTEM SPECIFICATIONS, INSTALLATION REQUIREMENTS, AND INTEGRATION
INTO A COMPREHENSIVE ROADSIDE DATA MANAGEMENT SYSTEM

Roadway Characteristic	Type I, II, III WIM Classification	Type IV Classification
Horizontal Curvature	Radius > 5,700 ft. measured along the centerline	Radius > 5,700 ft. measured along the centerline
Longitudinal Alignment (Profile)	Longitudinal Gradient < 2%	Longitudinal Gradient < 1%
Cross Slope	< 3%	< 1%
Lane Width and Markings	12 - 14 ft., inclusive	12 - 14 ft., inclusive
Surface Smoothness	6" diameter circular plate 0.125" thick can not be passed beneath a 20-ft. long straightedge	6" diameter circular plate 0.125" thick can not be passed beneath a 20-ft. long straightedge

TABLE V-3. SITE CONDITION REQUIREMENTS: 200 FEET IN ADVANCE; AND 100 FEET BEYOND THE WIM SENSOR PER ASTM E 1308-02

The specification indicates that

1. Adequate pavement structure is required to maintain surface smoothness throughout the design life of the WIM sensor.
2. At a site with flexible pavement, a 50-foot long section of full-depth-asphalt, or black-base, design should be considered for installation at each end of the Portland cement concrete pavement structure to effect a stiffness transition between the two pavement structural types.
3. Experience has indicated that a Portland cement concrete (i.e., rigid) pavement structure generally retains its surface smoothness over a longer period of time than a bituminous (i.e., flexible) pavement under heavy traffic flows. Consideration should be given to providing a 300-foot long continuously reinforced concrete pavement or a jointed concrete pavement, with transverse joints spaced 20 feet or less apart, at permanent WIM sites on highways. The surface of every such rigid pavement should be ground smooth after curing and before installing WIM sensors.

AASHTO MP 14-05 – Provisional Standard Specification for Smoothness of Pavement in WIM Systems also provides additional guidance for verifying adequate smoothness of the pavement. The pavement smoothness is characterized by the output of a Class I profiler collecting data at 25 mm intervals (ASTM E 950). The data produced by such a profiler will approximate the perpendicular deviation of the pavement surface from an established horizontal reference parallel to the lane directions in the wheel tracks. Computer software is then used to calculate indices of long- and short-range pavement surface roughness. Lower and upper threshold values for long-range, short-range, and peak short-range are given in Table V-4 for Type I and II WIM sensors. It is expected that values below the lower threshold will produce acceptable weighing error (see Table V-2) and those above the upper threshold are likely to produce an unacceptable weighing error.

A STUDY OF WEIGH STATION TECHNOLOGIES AND PRACTICES
WIM SYSTEM SPECIFICATIONS, INSTALLATION REQUIREMENTS, AND INTEGRATION
INTO A COMPREHENSIVE ROADSIDE DATA MANAGEMENT SYSTEM

This standard is currently under review and revision based on field testing and performance results.

Index	Type I		Type II	
	Lower Threshold (inch/mile)	Upper Threshold (inch/mile)	Lower Threshold (inch/mile)	Upper Threshold (inch/mile)
Long Range	31.7	133.1	57	240.8
Short Range	31.7	133.1	79.2	361.2
Peak Short Range	47.5	183.7	101.4	418.2

TABLE V-4. ROUGHNESS INDEX THRESHOLDS FOR TYPE I & II WIM
(FROM AASHTO MP 14-05)

TEST METHODS FOR WIM SYSTEM PERFORMANCE

A summary of the test methods required by ASTM E 1318-02 is listed in Table V-5.

Type of Vehicle	Test Description	Number of Vehicles
Test Vehicles	Each test vehicle makes five or more runs over the sensors in each lane at an attempted speed approximately 5 mph less than the maximum speed, and then five or more additional runs at an attempted speed approximately 5 mph greater than the minimum speed. At each speed, one or more test runs shall be made with the test vehicle tires near the left hand edge, and near the right-hand edge	2
Additional Vehicles	Additional vehicles included in the loading test unit serve the function of subjecting the WIM system to loading by a representative variety of vehicle classes	51

TABLE V-5. ASTM E 1308-02 TEST METHODS FOR VERIFYING
WIM SYSTEM PERFORMANCE

INTEGRATION OF WIM SCALE INTO COMPREHENSIVE ROADSIDE DATA MANAGEMENT SYSTEM

The design of a statewide network of WIM scales into a smart roadside system should be compatible with the system that has been implemented at the Union Station. This is of utmost importance because the FHWA Smart Roadside Initiative that was completed in December 2007 found that transportation systems were not gaining the maximum amount of potential benefits from the wide deployment of roadside technologies such as WIM scales, automated vehicle

A STUDY OF WEIGH STATION TECHNOLOGIES AND PRACTICES
WIM SYSTEM SPECIFICATIONS, INSTALLATION REQUIREMENTS, AND INTEGRATION
INTO A COMPREHENSIVE ROADSIDE DATA MANAGEMENT SYSTEM

identification systems, e-screening sites, electronic tolling facilities, weather monitoring stations, wireless truck and bus inspections, and electronic verification of over-dimensional permits. It was found that these systems largely remain independent and do not share data.

The goal of the FHWA Smart Roadside Initiative is to take these disparate technologies (building blocks) and organize them into a comprehensive roadside program that will be able to

- reduce the number of commercial vehicle crashes and improve responses to crashes that do occur;
- improve the efficiency of motor carriers' trips;
- improve the efficiency of operations at intermodal facilities and border crossings;
- reduce infrastructure and enforcement costs;
- enhance preservation of infrastructure;
- improve security and tracking for high-risk/regulated cargo; and
- improve air quality.

These same outcomes should also be considered as goals of a comprehensive roadside system for Connecticut.

VI. BEST PRACTICES

A description of selected best practices that have been employed using WIM scales has been provided for review and consideration. This includes a summary of FHWA’s Long Term Pavement Performance (LTPP) program’s evaluation of WIM sensor technologies and site conditions needed to meet design level data requirements; the effective use of a WIM system used for enforcement purposes in Louisiana; the use of virtual weigh and inspection stations in Minnesota for both enforcement and data collection; and the data management system deployed in the Netherlands for maximum utilization of WIM and e-screening data.

Long-Term Pavement Performance Study – Results on WIM Accuracy

An FHWA pooled-fund study involving 22 states, including Connecticut, was conducted to improve the quality and increase the quantity of WIM data at Long-Term Pavement Performance (LTPP) Specific Pavement Study (SPS) sites. This study, initiated in 2003, involved multiple agencies to install, assess, evaluate, and calibrate WIM and Vehicle Classification (VC) systems used to produce research-quality traffic data at SPS sites across the United States. Research-quality data is defined to be at least 210 days a year of data of known calibration meeting LTPP’s precision requirements as listed in Table VI-1 and in the draft copy of the LTPP Field Operations Guide for SPS WIM Sites. These precision requirements must be demonstrated utilizing a calibration and validation protocol specified by LTPP that includes operating two trucks of known weight with a minimum of 20 passes per truck, for three speed ranges and three pavement temperature ranges. The precision thresholds are based on two standard deviations (95% confidence limits) of normal or student’s t-distributions of sample errors. For each site, after the WIM data are acquired, the mean and two standard deviation values for differences in gross vehicle weight (GVW), single axle weights, tandem axle weights, speeds and axle spacing are computed and compared against the thresholds. In cases where the site exceeds one or more threshold values, recommendations are made for corrective action.

Loading Data	SPS-1, -2, -5, -6 and -8 Sites	95% Confidence Limit of Error
	Loaded single axles	±20%
	Loaded tandem axles	±15%
	Gross vehicle weights (GVW)	±10%
	Vehicle speed	±1 mph [2 km/hr]
	Axle spacing length	± 0.5 feet [150 mm]
Classification Data	No more than 2% of the vehicles recorded are reported as “unclassified” and The number of classification errors involving <u>truck</u> classifications is less than 2%.	

Source: SPS Traffic Pooled Fund Study: Phase I Assessment and Evaluation Report

TABLE VI-1. LTPP PRECISION REQUIREMENTS ON LOADING AND VEHICLE CLASSIFICATION DATA

The LTPP study is divided into two concurrent phases. Phase I consists of assessing existing WIM equipment that has the potential for meeting LTPP's precision requirements and performing annual field validations on existing WIM equipment.

Phase II involves determining if a site is suitable for installing a WIM system, installing and maintaining a new WIM system, performing the initial calibration for a newly installed WIM system, downloading and performing validation checks for the previous day's data for the site, and providing a five-year warranty of the system after acceptance of the site by the FHWA. Two contractors are selected to perform the Phase I and Phase II activities.

Although all sites are performing well now, the initial visits to most of the sites indicated substandard performance for the existing WIM system. A great deal of communication and coordination on the part of the states, the FHWA, and its contractors helped raise the performance of these sites by installing a WIM system suitable for the site to produce research-quality traffic data. WIMs that are calibrated using at least two test trucks and are located in smooth pavement have demonstrated good results. The results from 4 of the 28 sites in this study regarding the performance of WIM sensors are summarized in Appendix I. These results include the location of each site, project phase, and various potential factors contributing to the performance of WIM systems. These factors include the WIM technology used, installation and calibrations, pavement conditions, test trucks, vehicle speed and temperature changes. The sites selected for the purpose of this report include Texas (SPS -1), Illinois (SPS-6), Arkansas (SPS-2) and Delaware (SPS-1). Newly installed bending plate or quartz piezo WIM technologies are located at each of these sites.

Regardless of the type of technology used and equipment errors involved, the study has shown that pavement smoothness is a significant parameter for achieving WIM system precision. At these successful Phase II sites, the WIMs are installed in 400 feet of rigid pavement. The rigid pavement provides the smoothness needed as a vehicle passes over the WIM, and provides more accurate and less variable measurements. The pavement needs to remain free of any surface distress, such as rutting, that might influence the motion of a vehicle as it passes over the WIM, which would then affect the quality of data collected by the system. Regardless of the type of pavement, flexible or rigid, in which the WIM is installed, the smoothness of the WIM location must be checked annually. One method recommended by the LTPP program is to check the WIM location smoothness using a high-speed profiler. The method for constructing this profiler is provided in the AASHTO standard specification for Smoothness of Pavement in WIM Systems. The results from the high speed profiler can then be entered into the LTPP WIM smoothness index software to verify pavement smoothness.

The four sites listed in Appendix I can be considered as examples of best practices in installation and calibration of a WIM system. The following section summarizes the test procedures applied in the LTPP study.

Equipment Diagnostics: Identify all possible existing conditions that may contribute to failure of an evaluation without actually using test trucks. Assessment of WIM equipment includes verification of speed, spacing and coarse weight, software and communication requirements, and video capture capabilities. Coarse weight verification is performed using a front axle weight method at the sites. A truck sample will be taken and front axle weights will be compared with historical data from the site to determine if a significant amount of drift has occurred.

Test Trucks: All sites were evaluated using a minimum of two trucks. The first truck was a Class 9 (5-axle tractor-trailer combination) with standard tandems and air suspensions on the tractor and trailer tandems. The vehicle was loaded between 76,000 and 80,000 pounds. The loads were legal in terms of GVW and axle weights. The second truck selected was the most predominant truck (including dump trucks) based on axle loads for the particular SPS site.

WIM Evaluation: A minimum of 40 truck runs were made with at least two runs per truck at each of three speeds and three temperatures. For each run, the axle weights, spacing between each axle, speed of the test truck, pavement temperature at the time of the test run, and the calibration factors used by the WIM scale were recorded. At the completion of the test, an analysis was conducted to determine the 95% confidence limits of error for comparison to the threshold values.

WIM Calibration: Using the data obtained in the evaluation phase of the site, the WIM sensor is calibrated according to the manufacturer's recommendations.

Pavement Conditions: The condition of the pavement is assessed for a distance of 275 m prior to and 30 m after the WIM scale. This section of pavement is considered to be the area that influences the measured dynamic load of the vehicle. Pavement distress was surveyed during the site visit and is qualitatively evaluated according to the LTPP's distress identification manual. The LTPP WIM smoothness index provides a qualitative measure of the likelihood for a working, unbiased WIM installation to produce research-quality data. The index indicates if the scale should produce research-quality data, or if it is not worth doing a site evaluation before addressing pavement deficiencies. Observations are also made of trucks traveling in the lane to look for bouncing that may not be dampened by the time a vehicle crosses the scale.

Louisiana WIM System

Since 1997, the Louisiana Department of Transportation (LA DOT) has contracted with IRD to install six dual high-speed mainline WIM sorter systems at permanent weigh station locations. The systems are designed to

- sort and direct traffic flow through the station and inform the operator of potential violations;
- detect vehicles attempting to bypass the station and alert the operator; and
- maintain a record of each vehicle that has passed through the station.

The WIM sorter system uses a load cell that is installed in concrete pavement for estimating the static weight of a vehicle. From LA DOT's experience, the load cells maintain their calibration within the ASTM Type 3 specification and require recalibration no more than once every six months. Calibration is done manually by IRD by adjusting the calibration factor based on the comparison of high-speed mainline WIM output of vehicles that are also statically weighed at the station. Also, from their experience, the load cells last for about ten years, with one having to be replaced after five years. While they are designed to be air tight, water does seep into the load cell assembly.

In addition to the WIM sensors, the system includes electromagnetic sensing loops and pressure-activated axle sensors that

- determine the total number of axles and distance between the axles so that the system controller can determine the class of the vehicle;
- monitor the position of vehicles as they travel through the system; and
- activate lane directional signals to instruct drivers as to the appropriate action to take.

Enforcement cameras (color for daytime and black and white at night) are located both at the WIM scales and at bypass points, and a photo of each truck is displayed with its vehicle record. Also, the cameras are positioned so that the photo that is taken includes both the trucks and the message sign for confirmation of any trucks that illegally bypass the weigh station. The Louisiana system also includes an over-height detector.

From these sensors, the WIM system automatically calculates and records

- lane;
- vehicle type;
- vehicle speed;
- total number of axles;
- vehicle length;
- distance between the axles;
- weight per axle; and
- total weight.

Data from the input sensors is sent to the iSINC controller. If automatic vehicle sorting has been selected by the operator, the controller first determines the truck's vehicle classification by its number of axles and distance between axles. Next, the controller calculates the percentage of allowed vehicle weight by taking the WIM data that has been converted to a static load and dividing it by the state's compliance requirements for that class of vehicle. The controller then compares the percentage of allowed vehicle weight to the set point that will trigger the vehicle to be sent to the weigh station. This set point can be set to between 50% and 150% of allowed vehicle weight, with LA DOT setting it at 78,000 pounds for an 80,000 pound legal weight limit. Also, the user of the system can select the percentage of vehicles that are randomly selected to report to the static scale. Typically, LA DOT sets the random selection of vehicles from 2%–6%. If desired, automatic sorting of vehicles can be disabled and vehicle sorting done manually by the operator. This option is necessary if the queue to the static scale presents an unsafe condition.

Message signs are then used to give directions to the drivers to either bypass or enter the scales. The messages are

- TRUCK OK TO BYPASS
- TRUCK MUST EXIT

The WIM system is controlled by an operator from a workstation that enables the operator to

- monitor the traffic through the system, including which lane the vehicle has entered;
- display the reason why a vehicle has been signaled to the station;
- view information about a vehicle that is stored in the local database;
- view estimated weights;
- monitor static scales;
- print violations; and
- direct vehicles where to go after static weighing.

Also, the operator is notified by an alarm if a vehicle does not proceed to the correct location (e.g., scale house or inspection).

The WIM sorter system is partially integrated into Louisiana's Pre-Pass credential verification system. Trucks that have Pre-Pass transponders can bypass the weigh station if their transponder gives them a green light (acceptable credential information and weight within acceptable limits) and the message sign gives them the "TRUCK OK TO BYPASS" message. Because the systems are not completely integrated, there are two situations where the driver will get conflicting messages. They are

1. The Pre-Pass transponder gives the driver a bypass signal while message sign flashes "TRUCK MUST EXIT." This occurs because the truck is randomly selected by the WIM sorter to stop at the weigh station.
2. The Pre-Pass transponder gives the driver a red light indicating that the truck must stop at the weigh station while the message sign flashes "TRUCK OK TO BYPASS." This can occur for two reasons: the credential check done by Pre-Pass indicates that the truck needs to stop, or Pre-Pass has randomly selected the truck to be weighed and inspected.

When receiving conflicting messages, the truckers must stop at the weigh station. Louisiana has distributed information to the truck drivers on multiple occasions to increase awareness of their responsibility.

Other experiences from Louisiana's use of WIM scales for over ten years include the following:

- Use of high-speed mainline WIM systems has significantly increased the efficiency of their size and weight enforcement program. They are now statically weighing fewer vehicles but are able to capture a greater percentage of the vehicles that are overweight.

- Weigh and inspection station operators are one of the greatest proponents of the WIM sorter system. When the system is not working, they are the most vocal about getting it fixed. During the time when it is not operational, all commercial vehicles are required to enter the weigh station. Similar to the operating experience at the Greenwich Station, the commercial vehicles entering the station can quickly queue into highway lane traffic and cause a potentially unsafe situation. This requires the operator to manually close the weigh station until the queue is reduced before reopening.
- Maintenance is key to the effective operation of the system. With six dual weigh stations, the decision was to create a position in LA DOT that was responsible for the operation of the WIM scales as opposed to paying for a vendor service contract.
- The pavement smoothness requirement is extremely important for accurate measurement. With the WIM scale installed in concrete pavement and the weather conditions in Louisiana, no additional resurfacing has been required to maintain the necessary smoothness.
- Many of the truck drivers are required to stop at a weigh station as a result of their “trying to beat the system.” The WIM scale sorter system is designed to require every truck to stop if it does not get a valid reading. Therefore, trucks that accelerate/ decelerate as they go over the WIM scale or try to drive around the scale will automatically get the “TRUCK MUST EXIT” message.

Minnesota Virtual Weigh Station Demonstration Program

The Minnesota Department of Transportation (MNDOT) completed a demonstration project (2007) to establish a virtual weigh station that was built around existing WIM sites. The goals of the project were to enhance the WIM sites so that they supported both MNDOT’s planning activities and the Minnesota State Patrol’s (MSP) weight enforcement functions.

The following is a summary of the findings and accomplishments from the project.

1. A network of future WIM sites was defined and mapped out and reference materials for MSP that included inspection site maps and photos were produced.
2. Several brands of WIM controllers that were connected to quartz piezo sensors and installed to MNDOT standards were evaluated. All of the systems were found to be acceptable for satisfying basic planning level needs in terms of accuracy and data produced. However, it was found that the format of the data generated would need to be changed so that the information collected would be useful for enforcement. A Weigh-in-Motion Compliance Assessment Tool (WIMCAT) was created and included the following information for any series of daily time periods:
 - Hour of the week violation rates
 - Hour of the day violation rates
 - Excessive Equivalent Single Axle Load (ESAL) results
 - Excessive Load Ratio performance measure

- Odds of capturing a violator
 - Data quality checks
 - WIMCAT was an important addition to the system because it provides a tool for real-time enforcement purposes, and establishes performance measures that can be used to guide the WIM deployment process. It can be used to recommend optimal hours of the week for enforcement activity and can be used for estimating damage caused by overweight vehicles.
3. MSP's roadside weigh measurements were successfully used to check and recalibrate the WIM scales. The quality and reliability of WIM data are important issues for all stakeholders. It is important for WIM calibration to be validated on a regular basis for the following reasons:
- Enforcement officer confidence in knowing that stopping a suspected overweight vehicle based on mainstream WIM data will correspond to a static overweight violation.
 - Accuracy of pavement and bridge damage estimates is based on accuracy of WIM data.
 - Timely WIM maintenance is based on accuracy of WIM error reports, which is essential for minimizing system down time and reducing the quantity of unacceptable data. Errors that can be corrected with a strong QA/QC program in place are rough pavement, temperature variability, WIM equipment malfunctions, hardware drift, and electronic drift.
 - Implementation of a successful feedback system that gives drivers instant notification of their weight is highly dependent on the WIM scales being accurate.
 - Importance of generating accurate federally mandated reports that could possibly have budget ramifications if WIM scale data is inaccurate.

There are other methods that can also be used to verify calibration of the high-speed mainline WIM systems in addition to comparing WIM scale output to roadside static scale measurement. They include the following:

- Left versus Right Scale Comparison – Based on research conducted at Purdue University, the left and right scale readings are compared after correcting for the crown of the road. Since most trucks are loaded along their center of gravity, both scales should give very similar results. This algorithm can provide an early warning that one of the scales may be malfunctioning or needs recalibrating. However, the algorithm needs to be verified for applicability and use in Connecticut.
- Front Axle Upper/Lower Limits – The weight of the front axles on most standard trucks fall within a narrow range for both loaded and unloaded vehicles. This provides a point of comparison for the first axles crossing the scale. If a significant number of trucks have weights falling outside this range,

the scale may be malfunctioning. The data system can include an algorithm to indicate if the scale is weighing light, heavy, or if it is erratic.

The combination of methods used by MNDOT (comparison of roadside static weight to WIM scale, left versus right scale comparison, and front axle upper/lower limits) all provide a means for verifying the calibration of WIM scales at a lower cost than having to use calibration trucks for this task.

4. Pilot technology was demonstrated at an existing WIM site that resolved technical and institutional issues of virtual weigh station operations. It was determined that it was necessary to include a digital image of each violating vehicle along with the WIM data to improve the ability to single out suspect vehicles, especially during high truck volume conditions. It was also found that the current technology for license plate recognition systems has not evolved enough to include it as part of a virtual weigh station.
5. The performance measures of the system were determined by the following:
 - Overall weight compliance rating including violation rate by day of week and hour of the day
 - Estimates of preventable damage were determined in terms of potential pavement life extension
6. It was recommended that communication between the WIM, MSP vehicles, and the central processing operation at the Transportation Data Analysis Center use either a wireless application based upon a cellular card or wireless high-speed internet service. Two communication architectures were also investigated as shown in Figure VI-A. Architecture "A" links the enforcement vehicle to each of the virtual weigh station sites while Architecture "B" links the enforcement vehicle to a single central processing system. Architecture "A" was recommended for the near term because it enables immediate use of existing WIMs without the need for a central server. However, in the future, it may be more cost effective to switch to Architecture "B" to increase functionality and save on costs when a central server is operational.

Architecture "A"

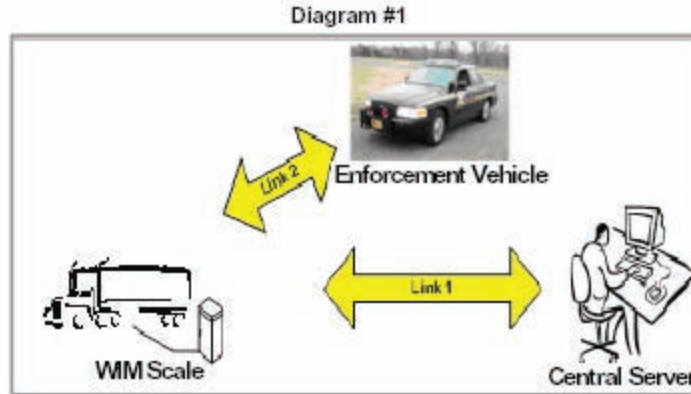

Architecture "B"

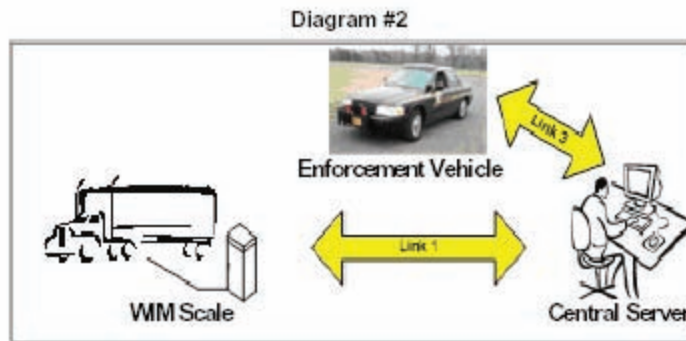

Source: Minnesota Department of Transportation

FIGURE VI-1. MINNESOTA VIRTUAL WEIGH STATION DEMONSTRATION REPORT

The feasibility of a dynamic feedback system was assessed. The goal of this system would be to promote weight compliance by providing truck drivers with accurate information about their weights. Often drivers are not aware that they are operating their vehicles above legal load limits. It is thought that this type of system could reduce the need for MSP enforcement efforts.

Effective Use of WIM Data: Netherlands Case Study

The US transportation agencies have long recognized that WIM data can be used for many applications such as safety analysis, traffic operation and control, facility planning and programming, and standards and policy development, but this data has typically been limited to vehicle enforcement through prescreening and to support pavement infrastructure design. The Dutch Ministry of Transport, National Police, and Transport Inspectorate are developing a WIM data management system that also supports long-term planning and decision-making activities in addition to increasing the efficiency of their enforcement and pavement design activities. An important aspect of the data management system that they have developed is the incorporation of quality control and quality assurance protocols so that users of the data have confidence in the information provided.

As of 2006, there are six WIM+VID (video identification) sites on major highways leading to and from the Port of Rotterdam with two more sites scheduled for design and construction. Each site is equipped with a double row of Kistler Lineas™ piezo-quartz WIM sensors in the right two lanes, two cameras on each side of the road to capture vehicle image, and cameras above to capture license plates. To detect bypassing vehicles, electronic loops are installed in the third lane and in the right shoulder. The system accurately classifies 96-98% of vehicles and error rates for 95% of vehicles measured cannot exceed $\pm 15\%$ and $\pm 2\%$ for axle weight and speed, respectively.

All data for each of the WIM+VID sites is sent to the National Traffic Information and Communications Network. This is an open data communication network that links all users to the WIM+VID data and allows the data to be integrated with department-specific internal databases. For example, the Ministry of Transport's Road and Hydraulic Engineering Institute uses the data to make policy recommendations on traffic and transport.

A two-stage assurance policy is used to ensure the quality of the data. First, the data are filtered to identify unreasonable data records (e.g., speeds below 37 mph and above 93 mph, vehicle lengths greater than 164 feet, and axle loads less than 110 pounds or greater than 66,140 pounds). Typically, this is less than 2% of the data filtered. The system's second quality assurance procedure is to compare the WIM axle weight measures to the static axle weights measured by the National Police during their enforcement activities for the same vehicles. If the error rate exceeds the $\pm 15\%$ requirement for 95% of the vehicles measured, the problem is quickly corrected through system recalibration or other remedial action. This process is performed at minimum on a weekly basis. A quality assurance report is then generated which accompanies every request for data; this report allows the user to determine if the accuracy of the data meets their specific needs.

While the Dutch utilize mobile rather than fixed weigh stations for enforcement activities, the same prescreening approach is used for pre-selection of non-compliant vehicles. The WIM prescreening approach has been credited with increasing the efficiency of the officers as defined by the number of citations issued compared to the number of vehicles stopped. The Dutch Transport Ministry believes that the trucking industry is reacting positively to pre-selection controls by better self-monitoring of loading behavior.

To further increase the efficiency of their enforcement personnel, WIM+VID data is used to identify the time of day, day of week, and location of high overweight vehicle activity, and to schedule mobile enforcement activities based on this analysis. This type of WIM data analysis to support mobile enforcement scheduling has only been used in select states in the United States. For example, Montana DOT uses Measurement of Enforcement Activity Reporting Software (MEARS) for directing mobile enforcement activities.

To further improve the efficiency of the WIM+VID enforcement activities, the Transport Inspectorate has shifted its focus to habitually non-compliant carriers. In the Inspectorate's view, preventive visits to offending companies provides much greater benefits in reducing overweight vehicles than roadside inspections that reach only a single driver or vehicle at a time. The system works as follows:

1. Those transport companies that have the highest monthly offenses as determined from the WIM+VID data are sent a written notice. The Inspectorate arranges an on-site visit to discuss overloads and attempts to reach an agreement to work cooperatively to prevent future overloading.
2. A two-month compliance period begins where the company receives an overview of their performance twice during this period. If there is a positive decrease in loading behavior as indicated by a decrease of at least 75% in overload violations, the intensity of the monitoring of the company will decrease. Continued compliance will then return the company to the same status as all other compliant transport companies.
3. If a transport company continues to be non-compliant, the National Police are informed to stop all company vehicles, loaded or empty, for further inspection through the roadside enforcement process. For extremely problematic companies, mobile scales are placed at the company's entrance/exit to ensure that no overload vehicles are released from the facility.

Providing WIM+VID data to multiple users with different needs has required the Dutch to address many developmental challenges. These have included technical challenges such as durability of WIM sensors; integration of various system components supporting the WIM data management system; security and management of different data networks; and conversion of data formats to support various and diverse applications. Also, organizational challenges had to be overcome, including agency priorities, cultures, approaches, and privacy restrictions on data collected and exchanged.

Through the Ministry of Transport, the plan is to establish a comprehensive network of WIM+VID systems at more than 30 locations along major roadways. This will allow nationwide monitoring of non-compliant vehicles, compliant vehicles, general goods movement, and vehicles transporting dangerous goods. It will also enable long-term planning and decision activities that are currently limited by the deployment of WIM+VID systems at only six sites.

VII. SUMMARY OF FINDINGS AND CONCLUDING REMARKS

The Study Committee developed its findings and suggestions based on a review of available information regarding WIM and electronic safety and credential screening (“e-screening”) technology, and discussions with the ConnDOT, DMV and DPS staff, staff from other states, and members of the Study Committee.

It is noted that the state’s Auditors of Public Accounts (Kevin P. Johnston and Robert G. Jaekle) conducted a “Performance Audit – Overweight/Oversize Commercial Vehicles” that was issued on June 21, 2003 and is included in this report as Appendix J (<http://www.cga.ct.gov/apa/pdf2003/Overweight%20P301.pdf>). The findings, suggestions and recommendations of this study report were developed independently and without knowledge of the recommendations included in the Auditor’s report.

OVERVIEW

The operation of the Greenwich Weigh and Inspection Station (Greenwich Station) was a principal reason for undertaking this study. The Station configuration and size and volume of commercial vehicle traffic severely impact the ability of the Greenwich Station to operate effectively to assure commercial vehicle compliance with weight and safety regulations and requirements. During the hours of operation of the Station, the queue of commercial vehicles rapidly extends into travel lanes on the highway, creating a potential safety concern. This commonly can occur within a 90-second period, and requires Station staff to close and open the Station throughout an operational shift. Additionally, commercial vehicles and passenger cars between the New York border and the Greenwich Station frequently change lanes, which also results in a potential safety concern, with DPS reporting that accidents related to lane switching occur more frequently in this area as compared to other sections of I-95 in this area of the state.

The findings and suggestions presented in this report cover a range of issues regarding weigh and inspection station operations, management and system maintenance. The Study Committee believes that the highest priority for the state’s weight and inspection program is to improve the effectiveness of the operations of the Greenwich Station due to the significant number of commercial vehicles entering Connecticut from the State of New York.

Principal recommendations regarding the Greenwich Station include the following:

- Install a high-speed mainline WIM and e-screening system on I-95 in advance of the Station for commercial vehicle screening to allow enforcement operations to focus efforts only on those vehicles suspected of being overweight or with credential or safety issues.
- Consider lane reconfiguration from the New York border through the area of the Station to create four travel lanes with the right lane serving as a “truck only” lane and with all commercial vehicles being required to travel in the right lane until traveling beyond the Greenwich Station. It is noted that similar lane modifications – adding a special purpose

lane to the highway – have been implemented on several Los Angeles, California, freeways and on the Tappan Zee Bridge in New York. Primary goals of adding a special purpose lane include improving operating efficiency and traffic safety.

- Eliminate the low-speed WIM scale at the Station following installation of the high-speed mainline WIM system. This suggestion is conditioned upon finding that
 - the high speed WIM systems provide a level of accuracy necessary for the quality screening of vehicles;
 - station staff has confidence that the high-speed WIM systems can be operated consistently and effectively for vehicle screening to the same or similar level of that of low-speed WIM systems;
 - significant participation in the e-screening system is achieved through use of transponders by commercial vehicles.

- Conduct the planned site feasibility study for the purpose of maximizing the efficiency of the Station, including consideration of installing a hazardous materials off-loading area and an enclosed inspection facility, similar to those that are installed at the Union Station.

Regardless of the outcome of the Greenwich Station site feasibility study, the installation of a high-speed mainline WIM and e-screening system at this location is most critical for achieving an acceptable level of operational capability at the Station. It is suggested that if this cannot be accomplished, then consideration should be given to seeking alternative locations for permanent and/or virtual weigh and inspection stations in Fairfield County. The least attractive alternative is to maintain operations at the Greenwich Station under current conditions.

Also, it is important to recognize that the effectiveness of weight and inspection program enforcement efforts at the Greenwich Station is dependent upon the state having an overall effective statewide weight and inspection program.

Implementation of the study committee’s suggestions and recommendations for the Greenwich Station and for the development of a Comprehensive Roadside System including installation and the use of WIM and e-screening technologies for the state’s network of permanent and portable weigh and inspection stations, is expected to achieve increased efficiency and effectiveness of the state’s enforcement activities while at the same time serving to encourage commercial vehicle compliance with state requirements and regulations. The statewide network of mainline WIM and e-screening systems, especially at the Greenwich Station, will allow enforcement personnel to focus their attention on those vehicles most likely to either be overweight or have safety issues. This will provide for a more effective use of limited enforcement personnel resources, while also achieving state goals of improving the safety of commercial vehicles and the safety of the state’s highways.

Connecticut WIM Scale Experience

The State of Connecticut has significant experience using WIM scales for a variety of

applications. These include DPS and DMV for enforcement, ConnDOT Planning for data collection, and ConnDOT Research for evaluation of technologies and pavement research. The following are the high-speed mainline and low-speed WIM scale technologies that have been used in Connecticut:

- High-Speed Mainline WIM
 - Bending plate and quartz piezoelectric for the WIM scale at the Union Weigh and Inspection Station (Union Station) that is operated by DMV
 - Polymeric piezoelectric WIM scales that are installed at 111 locations throughout Connecticut and used by ConnDOT Planning
 - Ceramic piezoelectric WIM scales for evaluation and long-term pavement performance studies that were conducted by ConnDOT Research
 - Quartz piezoelectric WIM scales for evaluation and long-term pavement performance studies that are conducted by ConnDOT Research
- Low-Speed WIM
 - Load cell WIM scales at the Union Station and Greenwich Station that are operated by DMV and DPS, respectively.

Use of low-speed WIM scales at Union and Greenwich Stations significantly increases the efficiency of these stations in the weighing of trucks and buses (commercial vehicles). From July 2007 - December 2007, 76% of the commercial vehicles were weighed by low-speed WIM scales at these two locations compared to only 24% that were weighed using static scales at the state's six weigh stations.

The efficiency of weighing and inspecting commercial vehicles can be further enhanced by development of a high-speed mainline WIM scale and Comprehensive Roadside System as part of a permanent and virtual weigh and inspection station system. This added technology would further enhance deterrence of overweight and unsafe commercial vehicles traveling on Connecticut highways. Furthermore, it would reduce the frequency with which commercial vehicles would be stopped, and would increase the efficiency of commercial vehicle operations that are in compliance with Connecticut weight and safety regulations.

It should be emphasized that both high-speed mainline and low-speed WIMs are screening tools and do not replace the need for static scales that are required for enforcement. Additionally, appropriate signage and signaling are important components of an effective weigh and inspection station design and operation. It is also suggested that along with informative signage and signaling, a driver education program should be developed to inform drivers about how to drive over WIM system sensors, as well as the implications of avoiding a WIM system.

Suggested WIM Scale Technology

ConnDOT, DMV, and DPS have experience using quartz, bending plates, and load cell WIM scales, which are the most mature and proven technologies available. Because site conditions are such an important factor in determining the accuracy of the WIM scales, it is difficult to quantify

which of the technologies provides the most accurate estimates of a vehicle's static weight. Taking into account accuracy, maintenance, safety, and cost, it is suggested that Connecticut invest in the quartz piezoelectric technology for new and replacement WIM scale installations. Although less expensive, polymeric piezoelectric WIM scales are not suggested for use because they are temperature sensitive and will not produce the required accuracy under all weather conditions.

The suggestion for using quartz piezoelectric sensors should be verified as the analysis of data from the LTPP Phase 2 study results becomes available to see if this technology still provides the best overall characteristics compared to the other WIM technologies. Furthermore, the use of three rows of quartz piezoelectric sensors versus the standard two-row configuration should be considered. This configuration will initially be more expensive to purchase and install. However it has the potential to reduce sensor life-cycle cost as a result of a reduction in the highway smoothness necessary to attain the required accuracy needed for enforcement applications (i.e., Type III ASTM requirements).

Additionally, bridge WIM scales, a promising non-intrusive technology, should be considered as a supplement to quartz WIM scales to provide a more comprehensive WIM network. Experience from research in Connecticut and other parts of the United States and Europe should be used to determine when the development of the bridge WIM technology is mature enough to meet ASTM Type III requirements.

WIM Accuracy Requirements

WIM data has many potential uses and the design of a statewide WIM network should consider all possible applications and not just the independent needs of enforcement, Federal Highway Administration (FHWA) reporting, or pavement design. For example, accurate WIM data would improve pavement design and provide important planning information that could be useful to several state agencies.

The accuracy requirements of the WIM system will vary depending on the application. At a minimum, WIM scales should meet ASTM Type III requirements that are needed for the screening of commercial vehicles for enforcement purposes. WIM sensors must be able to provide consistent results in asphalt pavement under a wide range of temperature conditions. Proper site conditions and installation requirements must be met for the sensors to be able to perform as an effective screening tool. While maintenance requirements of WIM scales in the road should be minimized for safety reasons, maintenance of required site conditions is necessary for ensuring required accuracy and must be included in the agency's budget.

Integration of WIM Scales at Permanent Weigh Stations

The physical constraints at each of the six permanent weigh and inspection stations will present different challenges. Two of the stations investigated as part of this study represented two extremes.

Union Station has sufficient space for mainline and low-speed WIM to operate most of the

time without negatively impacting the free and safe flow of traffic. The state has invested in the Commercial Vehicle Information Systems and Networks (CVISN) system, including a WIM scale at Union, and this station should be used as the model to be replicated at the other stations. This will require that the technology selected for Union be consistent with the needs of the other permanent weigh and inspection stations. A review of the Union Station indicated that the following limitations should be addressed:

- High-speed mainline, low-speed WIM and static scale software need to be upgraded so that the accuracy of the WIM systems can be compared to the same commercial vehicle's static weight measurements. This cross checking of weights using commercial vehicles under real road conditions should be a major part of the WIM's QA/QC system.
- Data collected should automatically be stored in a database management system and be available in a format that meets user reporting requirements.
- Effectiveness of system calibration and data collection efforts requires commercial vehicles to be identified utilizing in-vehicle transponders or some other method of vehicle identification.

Additionally, based upon Louisiana's experience using a mainline WIM and e-screening system without the use of a low-speed WIM system, it is suggested that consideration be given to potentially eliminating the use of low-speed WIM system at the Union Station, and at the Greenwich Station if a mainline WIM system is installed at this location. This suggestion is conditioned upon finding that

- the high speed WIM systems provide a level of accuracy necessary for the quality screening of vehicles;
- station staff has confidence that the high-speed WIM systems can be operated consistently and effectively for vehicle screening to the same or similar level of that of low-speed WIM systems;
- significant participation in the e-screening system is achieved through use of transponders by commercial vehicles.

It is also suggested that if use of the low-speed WIM systems are eliminated for day-to-day operations, they could still be left in place at these two stations and used as a back-up system during periods when the mainline WIM systems are inoperable due to repair and maintenance or for other reasons.

Unlike Union, the Greenwich Station has insufficient space for static weighing and inspection under the current methods of operation and configuration of station facilities. While developing a detailed design layout for the Greenwich Station is beyond the scope of this project, it is suggested that implementation of a high-speed mainline WIM system coupled with e-screening capability for access to carrier and vehicle safety/inspection data, WIM data, and other credentials will increase the efficiency and effectiveness of the station in meeting its required functions, and the efficiency of compliant commercial vehicles transiting the area. It is noted that the participation of carriers/commercial vehicles in the e-screening program will need to be

encouraged and maximized to achieve maximum Station efficiency and effectiveness. Additionally, it is suggested that consideration be given to the following:

- Conducting a site feasibility study to determine how best to utilize the complete Greenwich Station property to maximize efficient and effective operations and to enhance safety, including consideration of installing a hazardous materials off-loading area and an enclosed inspection facility, similar to those that are installed at the Union Station. Additionally, installation and use of a high-speed mainline WIM system offers the potential to eliminate the low-speed WIM as a component of the Greenwich Station system and could further improve operation efficiency. It is noted that ConnDOT is currently in the process of negotiating a scope of work for a site feasibility study. Regardless of the outcome of the Greenwich Station site feasibility study, the installation of a high-speed mainline WIM and e-screening system at this location is most critical to achieve an acceptable level of operational capability at the Station. If this cannot be accomplished, then consideration should be given to seeking alternative locations for permanent and or virtual weigh and inspection station locations in Fairfield County. The least attractive alternative is to maintain operations at the Greenwich Station under current conditions.
- Changing the lane configuration of the highway in the area of the station. The heavy volume of traffic in the vicinity of the Greenwich Station, including traffic merging to and from Exit 2 just before the entrance of the station, trucks that are required to enter the station when it is open, and other vehicles changing lanes through normal vehicle operations, represents an ongoing safety problem. Creating four travel lanes in the vicinity of the station by utilizing the left “breakdown lane” road shoulder and shifting the three travel lanes to the left, and requiring all trucks transiting the area to utilize a fourth new “truck only” right lane beginning at the New York line, has the potential to greatly improve the safety of vehicle operations in the vicinity of the weigh station. It is recognized that this lane configuration may not be “standard” from a highway design standpoint for the very short distances involved, but the safety considerations make this worthy of consideration. Additionally, it is suggested that the state secure cooperation with the State of New York if it is necessary to install the high-speed mainline WIM scale and/or necessary signage in New York for the effective operation of the station, as well as for providing advance notice to vehicles regarding operational status of the station. Creating a “truck only” lane for the approach to the station provides an opportunity to consider, if necessary, installing the high-speed WIM system in this travel lane only due to heavy traffic in this area and resulting travel delays for installation, repair and maintenance of a full highway width or two-lane WIM system. Depending on the type of installation, the state could require that regardless of whether the station is open, commercial vehicles be required to travel in the “truck only” lane so as to capture WIM data on a 24/7 basis, and also allow for periodic virtual station operations even when the station is closed.

All Connecticut weigh and inspection station equipment and instruments need to be able to communicate with each other and be configured so data can be downloaded to a central database system using existing CVISN-based technology. The CVISN system presently in use should be deployed as designed so that all weigh and inspection stations and enforcement personnel can access relevant stored data. Enforcement operations need real-time access to high-speed mainline WIM scale output for the operation of permanent and virtual weigh stations.

In addition, enforcement and other state agencies need access to a central database with report templates that meet their specific requirements. Currently, WIM system data collected at the Union Station by DMV is only retained for a short period of time, and it is not in a format designed for the easy generation and customization of reports to meet the needs of the various users that would benefit from analysis of this data. WIM system data collected by DPS at the Greenwich Station is not retained beyond one day's operation and pertinent statistics are manually recorded on a daily basis by DPS staff. It is suggested that the information technology systems for all existing and future weight and inspection program WIM and e-screening systems be upgraded and networked to provide for the automatic collection and retention of data, with the capability for generating customized reports to meet the needs of all state agencies that would benefit from analysis of this information. Additionally, staff resources should be committed to maintaining and continually updating and improving the reporting capabilities to meet the evolving needs of system users.

Proper operation of weigh and inspection stations requires staffing needed to meet the weigh and inspection requirements and to prevent commercial vehicles from bypassing open weigh stations. Maintaining longer "open" hours while not having required staffing reduces the effectiveness of the weigh and inspection stations in meeting the goals of increasing the safety of vehicles traveling through Connecticut and preserving the state's bridge and pavement assets.

All weigh stations should be operated in the same manner to meet the weight and safety inspection requirements of the state, the FHWA, and the Federal Motor Carrier Safety Administration (FMCSA). At the present time, Union is operated by DMV, which emphasizes MCSAP inspections and also weighs vehicles. DPS operates the other weigh stations, which emphasize enforcement of size and weight requirements, and uses the MCSAP inspection process, but generally only undertakes cursory walk-around basic level inspections. While both agencies realize that there is overlap between their functions, it is suggested that the goals of all the weigh stations and their operation be the same. Further, it is suggested that the state should utilize a consistently applied, multi-tiered MCSAP inspection program for all safety inspection operations – regardless of the agency conducting the inspections – along with cursory walk-around inspections that both agencies utilize.

Virtual Weigh and Inspection Stations Using High-Speed Mainline WIM Scales

Virtual weigh and inspection stations using high-speed mainline WIM scales as a screening tool for size and weight and safety/inspection information and enforcement should be used to supplement enforcement and data collection at permanent weigh and inspection stations. When developing a network-level strategy, first consideration should be given to locating high-speed mainline WIM scales that include an e-screening capability for virtual weigh and inspection stations at the same locations where portable weight scales are currently being used (see 2008 Connecticut Size and Weight Enforcement Plan). These sites meet the requirement of being able to safely stop trucks so that they can be weighed using portable scales and inspected.

Analysis of data collected from the virtual weigh and inspection station high-speed mainline WIMs on a continuous basis should be used for determining where and when to set up enforcement activities. Enforcement personnel must be able to access real-time data in a user-friendly format from the virtual WIM scales and the e-screening system so that they can effectively target commercial vehicles that are likely to be overweight and/or have safety violations.

Comprehensive Roadside System

WIM system is only one part of a comprehensive roadside system. It is suggested that a network of permanent and virtual weigh and inspection stations be developed that combines the functions of credential verification, safety inspection, and weigh-in-motion with static and portable weighing, and visual inspection of commercial vehicles as required. The FHWA Smart Roadside Initiative program should be used as a resource for the design and implementation of this system.

Connecticut provides and receives information to/from the Federal Motor Carrier Safety Administration's Safety and Fitness Electronic Records (SAFER) System. The status of state participation is shown in Figure VII-1. This system enables states to share carrier, vehicle and driver safety and credential information for permanent and virtual weigh and inspection station enforcement purposes. Connecticut's statewide permanent and virtual weigh and inspection station system should fully participate in this data sharing.

Additionally, Connecticut should encourage multi-state cooperation and participation in the SAFER program, or other similar data sharing systems for a seamless multi-state weighing and inspection program that will provide an incentive for commercial vehicles to operate in compliance with weight and safety requirements. This type of regional weight and inspection cooperation should have the goal of increasing the efficiency of enforcement operations and the trucking industry in the Northeast.

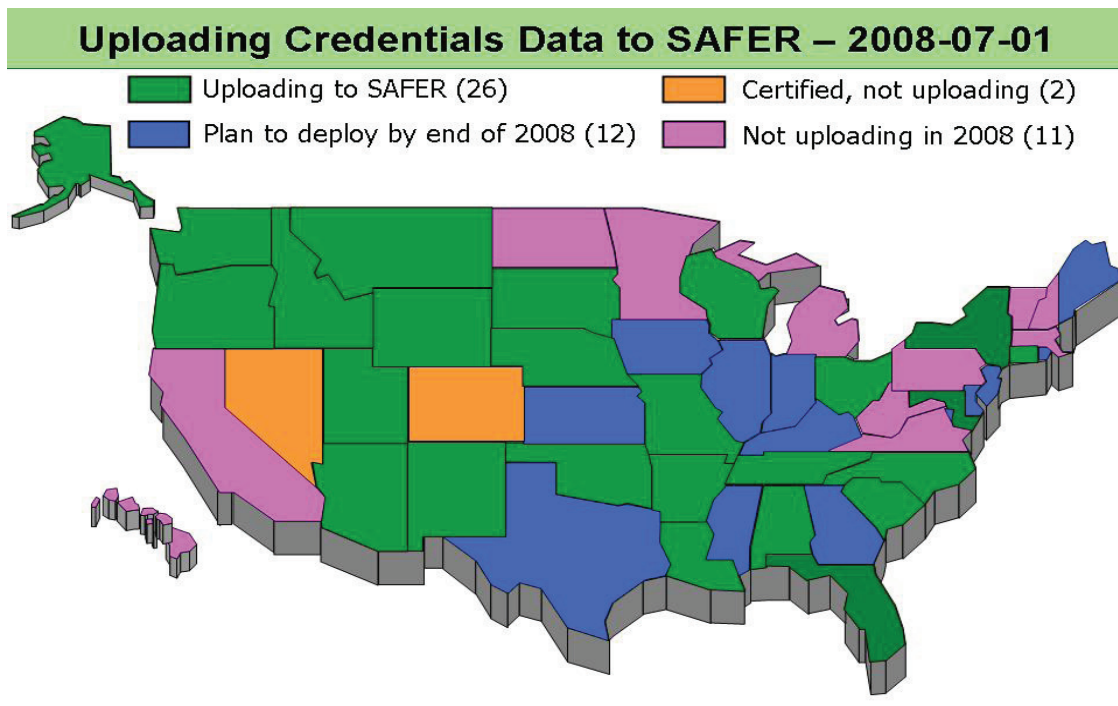

Source: Federal Motor Carrier Safety Administration

FIGURE VII-1. SAFER – STATUS OF STATE PARTICIPATION

Additional WIM Sites for Planning, Pavement Research, and Other Applications

WIM scale sites, in addition to the permanent and virtual weigh stations used for weight and inspection enforcement, may be necessary to collect the data needed by ConnDOT's Planning, Research and Pavement Management groups. Also, consideration should be given to developing WIM sites at additional key locations such as at port, rail, air cargo, and major distribution centers; this can provide valuable data that will be helpful for highway design purposes to enable ConnDOT to have a better understanding of commercial vehicle trip operations including freight movements.

These additional locations should be included in the network of WIM scales that continuously collect and send data to a central database. Because these WIM scales will not be tied to permanent or portable static scales, it will be necessary to calibrate these WIM scales at a minimum of once a year using trucks of known static weight. The calibration procedure should follow the same procedure as used in the LTPP study. Furthermore, it is suggested that internal checks be included in the WIM system software algorithms and analyses that can provide a monitoring capability and an early warning as to the accuracy and potential malfunctioning of the WIM scale. These include comparison of the distribution of vehicle gross weights and verification that the front axle weight for unloaded FHWA Class 9 vehicles is within a lower and upper limit.

Operation and Governance

The current organizational structure for weigh and inspection station program operations and management is provided by three agencies to meet the requirements of the FHWA and the Federal Motor Carrier Safety Administration (FMCSA). It is suggested that a coordinating Weigh Station and Inspection Operations and Management Program Coordinating Task Force be created that consists of representatives of each department. The Task Force would have responsibilities for the following:

- Siting, operation and management of the permanent and virtual weigh and inspection stations. This task should include an analysis of the location and number of permanent and virtual weigh and inspection stations that are needed for operating an effective weight and inspection program, and WIM sites to meet ConnDOT's planning, research, and pavement design needs.
- Weight and inspection enforcement activities.
- Systems installation, maintenance and repair.
- Facilities and grounds maintenance.
- Coordinating and scheduling of highway surface repairs, overlays, and reconstruction to maintain high speed WIM system accuracy.
- Identifying and securing staffing necessary for enforcement activities to meet program goals.
- Collecting and maintaining system data and information.

Additionally, a mechanism for the motor carrier industry/stakeholders to serve in a liaison capacity to the Task Force to enable ongoing input from interested parties regarding program operations should be considered.

The capability for multiple constituencies to use data and information produced by the WIM and e-screening system is critical; this capability includes providing reports required by each department to meet their needs, as well as producing these reports in formats as required by FHWA and FMCSA. All weight and vehicle classification information collected from program operations, including high-speed mainline WIM systems, should be made available to ConnDOT's Pavement Design Office for their use in designing pavement projects on the state's highways, as well as to others that utilize vehicle classification information. The program's information system should have the capability to produce customized reports that meet the needs of the real-time requirements of these offices, including access to system data for reporting purposes.

The Task Force should develop a clear vision, mission and comprehensive strategy for the state's permanent and virtual weight and inspection program, and should be held accountable for meeting program goals and objectives. It is suggested that one goal of the state's enforcement program should be a continual annual reduction in the number of citations/violations issued through a consistent enforcement effort that encourages compliance with weight and inspection requirements.

The total cost for the Weigh Station and Inspection Operations and Inspection Program should be identified, even if funding is to be provided separately by each department. These costs should include ConnDOT's expenses for facility, WIM system, static scale, repairs and maintenance, as well as highway repairs associated with WIM scale locations to maintain conditions to the standards required for WIM scale operations. This should include the development of an annual program budget and annual reporting of actual program cost. All revenue received from the federal government and from fines and fees related to enforcement and other related activities should also be identified and reported through the budget and actual reporting requirements that are established.

The Task Force shall be responsible for identifying annual goals and continually seeking to improve the effectiveness of the state's weight and inspection program. An annual report should be produced and made available to the agencies that make up the Task Force, committees of cognizance of the General Assembly, the governor and the public. The annual report should include a summary of operations and progress toward the accomplishment of program goals, as well as identifying needs and requirements for the improvement of the program in the future.

Additionally, consideration should be given to having the General Assembly amend Section 14-270c (Official Weighing Areas. Staffing Requirements) of the Connecticut General Statutes to allow the Commissioners of Public Safety and Motor Vehicles to determine the number of shifts and hours of operation for the state's permanent weigh and inspection stations and portable scale operations, and if implemented, the system of virtual weigh and inspection stations, without specific requirements established by legislation. Analysis of weigh and inspection data from the network of WIM systems by the Task Force should be used on an ongoing basis to determine the location of weigh and inspection operations at permanent, portable and virtual weigh and inspection sites. This process would enable the departments to devote limited

human resources to those areas of the state where the greatest number of violations are suspected and to target and randomize the operation of enforcement activities. It is suggested that this flexible operational philosophy will help to achieve an enforcement system that serves as an effective incentive for carrier compliance.

Additional Suggestions for Improving Commercial Vehicle Efficiency

Use of in-vehicle transponders that are linked to permanent and virtual weigh and inspection station WIM/electronic screening systems by commercial carriers and participation in the state's safety and e-screening program should be encouraged to maximize the efficient movement of commercial vehicle traffic. This system also has the potential to serve as a significant incentive for compliance with state weight and safety regulations, as it will allow compliant vehicles to bypass weigh and inspection stations much of the time. This technology is expected to play a significant role in improving the efficiency and effectiveness of the state's weight and inspection program by enabling enforcement operations to focus their efforts on vehicles that are most likely to be overweight or have safety issues.

Although transponders are not widely in use today, efforts should be made to adopt a single standard and technology for the United States. The selected technology should provide commercial carriers/vehicles one device for paying electronic tolls (currently EZPASS) and for weigh and inspection station pre-clearance use. Connecticut should work with its neighboring states to encourage the federal government to adopt a national standard and system.

CONCLUDING REMARKS

The development of a statewide network of high-speed mainline WIM scales that is integrated into a comprehensive electronic screening and clearance system will provide significant benefits to the state and the commercial carrier industry. Carriers that consistently meet weight and safety regulations will be able to bypass open weigh stations the majority of the time, thus increasing their operational efficiency. It is suggested that transitioning to a system that encourages and maximizes transponder enrollment for commercial vehicles should be considered upon a determination that the Union high-speed WIM and electronic screening system is operating effectively. This will provide the state and the motor carrier industry with operational experience necessary for full statewide deployment.

The businesses and residents of Connecticut will benefit through better protection of the state's highway and road assets. Accurate truck volume and weight data is needed in order to properly design pavements, and fewer overweight vehicles operating on the state's highways will significantly reduce the premature failure of pavements. This will also reduce productivity losses due to congestion as a result of lane closures required for highway maintenance and repair.

An efficient Comprehensive Roadside Vehicle Inspection System will also have the benefit of improving the safety of commercial vehicles and the safety of the state's highways. Less time will be required to statically weigh every truck, providing more time for safety inspections. Furthermore, a comprehensive approach will assure that each weigh station has

the same emphasis on safety inspections, with a consistently applied, multi-tiered MCSAP inspection program being utilized for all safety inspection operations, along with cursory walk-around inspections utilized by DMV and DPS..

The implementation of a statewide WIM network will require an initial investment for purchasing and installing each quartz WIM scale and controller. Additional costs for the acquisition and installation of video cameras for confirmation of vehicle identification may be necessary. It is beyond the scope of this study to determine whether the number of WIM scales needed is 20 or 100, but the determination of the exact number and location should be made jointly by DPS, DMV, and ConnDOT through the proposed program task force. Historical truck movement data that is available from ConnDOT's Planning Office may be helpful in determining virtual weigh and inspection station WIM system locations.

Also, a fiber optic/wireless communication network will need to be constructed, and a data management and QA/QC program will need to be developed so that the WIM and electronic credential and safety data can be used to its fullest potential. Maintaining smooth pavement and other site conditions are critical for collecting accurate weight information. Therefore, the program budget should include annual expenses for system maintenance.

Additionally, since many commercial vehicles traveling over the state's highways are on interstate trips, it is suggested that an effort be made to develop a regional weight and inspection council for the purposes of sharing information, with a goal of integrating weight and inspection information and operational and enforcement best practices across state boundaries to further encourage the efficient passage of compliant commercial vehicles throughout the northeastern United States.

In conclusion, the overall benefits of a statewide network of high-speed mainline WIMs, coupled with electronic safety and credential screening capability and a comprehensive virtual and permanent weight and inspection station system, have the potential to encourage commercial vehicle compliance with state regulations and to improve the efficiency of their operations, as well as providing potential air quality improvement. The state will also benefit from utilizing valuable information collected from the system's operation for highway pavement design purposes.

REFERENCES

ASTM Standard E1318-02, Highway Weigh-in-Motion (WIM) Systems with User Requirements and Test Methods, Annual Book of ASTM Standards, 2002

Bushman, R. and Pratt, A., "Weigh In Motion Technology - Economics and Performance," presented at NATMEC '98, Charlotte, North Carolina, 1998

Cebon, D., "Handbook of Vehicle-Road Interaction," Swets and Zeitlinger B.V., Lisse, Netherlands, 600pp, 1999

"Effective Use of Weigh-In-Motion Data: The Netherlands Case Study," prepared by FHWA, Office of International Program

Katz A., and Rakha, H., "Field and Modeling Framework and Case Study of Truck Weigh Station Operations," prepared for the Virginia Tech Transportation Institute, 2002

Laurita, J. Sellner, G. and Du Plessis D., "Weigh-in-Motion Technology Improves Highway Truck Weight Regulation," Public Works Journal Corporation, VOL. 125, No. 7, June 1994, P. 41-42

Liu R., Chen, X, Li J., et al., "Evaluate Innovative Sensors and Techniques for Measuring Traffic Loads", TxDOT 0-4509, October, 2005, 144pp

Long Term Pavement Performance (LTPP) Specific Pavement Study (SP) Traffic Pooled Fund Study, "Phase I - SPS Traffic Site Evaluation - Pilots Summary and Lessons Learned," FHWA, available at http://www.fhwa.dot.gov/pavement/pub_details.cfm?id=256

Long Term Pavement Performance (LTPP) Specific Pavement Study (SP) Traffic Pooled Fund Study, Phase II - Statement of Work, Validation Reports, FHWA (provided by the LTPP program)

Marsh, J. and Jewell, R. (1994), "Vertical Pavement Strain as Means of Weighing Vehicles," Journal of Transportation Engineering, 120(4), 617-633

McCall B. and Vodrazka W., "State's Successful Practices Weigh-in-Motion Handbook," Federal Highway Administration, December, 1997, 127pp

Rooke, A., Shipp, C., et al, "Project REMOVE Final Report," TREN-03-ST-s07.30766, 2006

"Scientific Expert Group IR6 on the Dynamic Interaction between Vehicles and Infrastructure Experiment," (DIVINE project), DSTI/DOT/RTR/IR6 (98)1/Final

Walls III, J. and Smith, M., "Life-cycle Cost Analysis in Pavement Design - Interim Technical Bulletin," FHWA-SA-98-079, September 1998, 107pp

ACKNOWLEDGEMENTS

This study benefited from the cooperation, support, and input of ConnDOT, DMV, DPS and the Motor Carrier Association of Connecticut. The individuals from these agencies and organization that contributed to this project are listed below. Their interest and efforts in this study are greatly appreciated by the Connecticut Academy of Science and Engineering.

CONNDOT

ConnDOT Research

Drew Coleman, Transportation Engineer 3
Richard Hanley, Transportation Engineer 3
Matthew A. Herboldt, Transportation Engineer 2
Michael Longo, Transportation Engineer 2
Anne-Marie McDonnell, Transportation Engineer 3
Bradley J. Overturf, Transportation Photolog Supervisor

ConnDOT Facilities

David Hartley, Plant Facilities Engineer 2
Daniel Smachetti, Director of Property and Facilities Services

ConnDOT Highway Operations

James Mona, Manager Highway Operations

ConnDOT Pavement Management

Edgardo Block, Transportation Supervising Engineer

ConnDOT Planning

Andy Asaro, Transportation Planning Director (Acting)
Wayne Fahr, Transportation Planner 2
Jacqueline Henry-Rafiq, Transportation Supervising Planner
Kerry Ross, Transportation Supervising Planner
Daniel Woods, Transportation Planner 1

ConnDOT Engineering (Highway Design)

Brian Cunningham, Transportation Supervising Engineer

ConnDOT Consultant to Design

CME Associates, Inc., Brett Stark, Project Manager

DMV

John E. Herman, Jr., DMV Deputy Commissioner / CVISN Project Sponsor
Robert Sardo, DMV Division Manager / CVISN Program Manager
Lt. Donald Bridge, Jr., DMV MV Lieutenant in the DMV Commercial Vehicle Safety Division (CVSD), & State Motor Carrier Assistance Program (MCSAP) Coordinator

DMV (CONTINUED)

Sgt. Christopher Smith, DMV MV Sergeant in the DMV Commercial Vehicle Safety Division (CVSD)
Dennis Walsh, MV Planning Specialist / CVISN Management Coordinator
Keith Kennedy, MV Systems Developer IV / Former CVISN Program Manager (Retired)

DPS

The following staff participated administratively, either by attendance of meetings and/or in reviewing project materials:

Lt. Peter Wack, Commanding Officer, Traffic Services Unit
Sgt. Frank Sawicki, Executive Officer
Sgt. James Chiappetta, Administrative Officer
Sgt. Greg Guerra, Western Operations Supervisor
Sgt. Roger Beaupre, Central Operations Supervisor
Sgt. William Krauss, Eastern Operations Supervisor

The following personnel were present during the study group's visit to the Greenwich Weigh & Safety Inspection Station:

TFC Robert Ambrogio, Commercial Vehicle Enforcement
TFC Richard Henderson, Commercial Vehicle Enforcement
Insp. Floyd Thompson, Commercial Vehicle Enforcement
Insp. Roger Cone, Commercial Vehicle Enforcement

FHWA

Deborah Walker, Research Highway Engineering

MOTOR CARRIER ASSOCIATION OF CONNECTICUT

Michael J. Riley, President, Motor Transport Association of Connecticut

UNIVERSITY OF CONNECTICUT

Richard Christenson, PhD, Assistant Professor, Civil and Environmental Engineering

APPENDIX A PHYSICS OF WEIGH-IN-MOTION SENSORS

The static axle loads and/or gross vehicle weights of heavy vehicles can be measured on a conventional static scale with the vehicle stationary and horizontal. As shown in Figure A-1, the sum of response forces (R_r , R_f) generated from the pavement or scale is equal to the gross weight of the vehicle, i.e., $R_r + R_f = mg$.

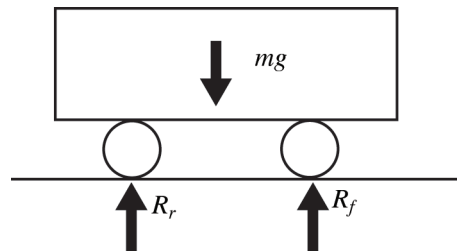

FIGURE A-1. FREE-BODY DIAGRAM OF A STATIONARY VEHICLE

Static axle loads (or gross vehicle weights) are used by enforcement personnel to check trucks for overweighting, and by highway agencies in calculating traffic loading data for pavement design and transport statistics.

As a screening tool, a WIM system can estimate the static axle loads (or gross vehicle weights) when commercial vehicles are traveling on the mainline at highway speeds or on weigh and inspection station access ramps at slow speeds. A variety of sensors can be used as part of a WIM system, but they all indirectly measure the reaction force generated by each axle of a moving vehicle through a change in the sensor's physical or electrical properties. As shown in Figure A-2, the sensors respond to the reaction force, which is a function of the static load due to gravity and the vertical acceleration/deceleration of the truck. Depending on the installation of the sensor, it may also detect horizontal forces which adds another variable that must be compensated for in estimating the static load.

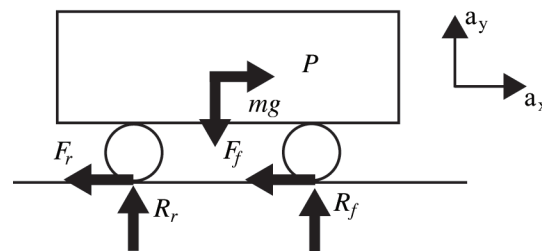

FIGURE A-2. FREE-BODY DIAGRAM OF A MOVING TRUCK

From the free-body diagram shown in Figure A-2, the vehicle's vertical motion (i.e., y direction) derived using the Newton's Law of Motion is:

$$(R_r + R_f) - mg = ma_y \quad (1)$$

where

R_r, R_f : Reaction forces from the measurement or pavement applied on front tires (R_f) and rear tires (R_r)

mg : Static weight of a vehicle

a_y : Acceleration in y direction

The magnitude of reaction forces ($R_r + R_f$) is the same as the static weight of a vehicle (mg) if there is no vertical acceleration ($a_y = 0$).

Cebon (1999) analyzed the response of multiple WIM sensors located along the road to determine how the spatial location of the WIM sensor affects the measured response to the total tire force (see Figure A-3). As a vehicle travels over the array of sensors, each tire generates the total tire force, $p(t)$, which is the sum of the static tire force P_0 and the dynamic tire force $P(t)$ at time t given by:

$$p(t) = P_0 + P(t) \quad (2)$$

The total tire force $p(t)$ is shown as a solid line and varies along the road because the vertical acceleration (i.e., vibration) of the truck depends on the roughness of the pavement, truck characteristics, and driver behavior. In contrast, P_0 (static tire force) as shown by a horizontal dash line is a constant. The difference between the total tire force ($p(t)$) and static tire force (P_0) is defined by Cebon (1999) as the dynamic tire force ($P(t)$).

If there is no measurement error, the output of a sensor S for the tire force is:

$$S = p(t) = P_0 + P(t) \quad (3)$$

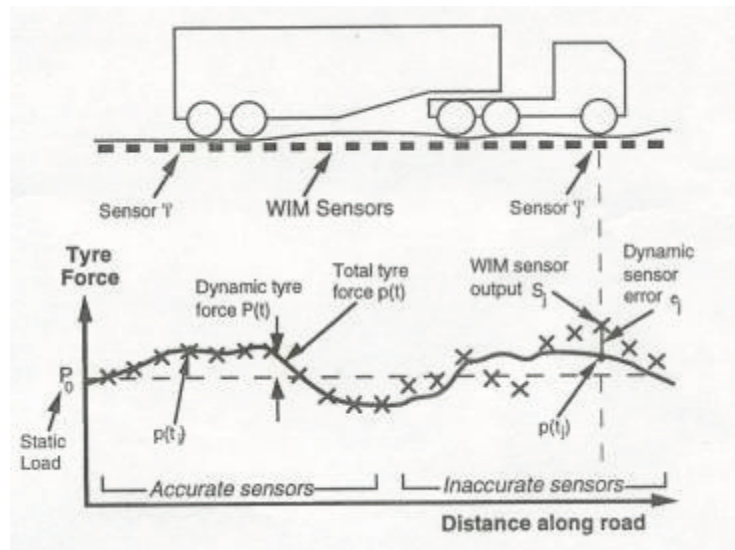

Source: Cebon, 1999

FIGURE A-3. VARIATION IN WIM SENSOR OUTPUT

Fundamentally, Equations 1-3 present the same concept. The sensor measurement, S (or the reaction force, R) is the sum of the static load, P_0 (or the static weight, mg) and the dynamic force, $P(t)$ induced by the vertical acceleration, ma_y .

All WIM sensors also have a dynamic sensor error e_j . Thus, the sensor output S_j is:

$$S_j = P_0 + P(t) + e_j \quad (4)$$

To estimate the static load (P_0), the sensor measurement S_j must be corrected (or calibrated) for the dynamic force ($P(t)$) and sensor error (e_j). The factors influencing the magnitude of these forces are discussed below.

Dynamic forces $P(t)$

The dynamic force $P(t)$ is caused by the vertical acceleration, which typically increases as the speed of the vehicle increases. This vertical acceleration is caused by the roughness of the pavement, vehicle characteristics, and driver behavior. They include:

1. "Bouncing" of vehicle caused by the roughness of the pavement, the speed of the vehicle and the type of suspension system
2. Acceleration and deceleration (i.e., braking) of the vehicle
3. Physical shifting of the load

Sensor Error e_j

Sensor error is caused by the design and installation of the sensor. Some common sensor errors include the following:

- Electrical noise, which is a random error that does not have a bias and causes non-uniformity of sensor output
- Temperature
- Physical and electrical properties of the sensor
- Installation of the sensor in pavement (e.g., stiffness of the adhesive used to mount sensor in pavement)
- Sensitivity to loaded area
- Duration and rate of loading
- Non-linearity between applied load and output

An example of how significantly the dynamic load can change over time (i.e., as the commercial vehicle travels down the highway) compared to the constant static load is shown in Figure A-4. The dynamic force and some sensor errors can be minimized by collecting sufficient measurements of the total tire force. According to Cebon (1999), this would require tens or even hundreds of measurements as the truck travels along the road to reduce the variability of the measurement.

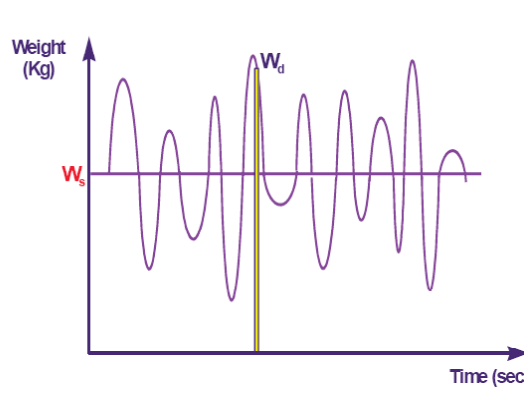

Source: Bushman and Pratt, 1998

FIGURE A-4. STATIC AND DYNAMIC WEIGHING

WIM systems (including sensor, installation of sensor, pavement smoothness, and sampling rate) are installed to minimize the dynamic loading effects, but they cannot be totally eliminated. Therefore, the uncertainty of the estimated static load from a WIM system will always be greater than the uncertainty of a calibrated static scale measurement.

APPENDIX B

UNION WEIGH AND INSPECTION STATION HIGH-SPEED MAINLINE SCREENING AND CLEARANCE SYSTEM DESCRIPTION

Provided by DMV

Dedicated Short-Range Communications (DSRC) is used to provide data communications between a moving vehicle and roadside equipment in support of the screening process. This communication is accomplished by means of an in-vehicle transponder, mounted in the cab of the vehicle, and by readers and antennas located along the highway at the roadside weigh and inspection station. The tag provides transponder-related information that is read and linked to databases with vehicle-specific information, such as: vehicle identification numbers, the registration plate, associated operating credentials (interstate registrations, oversize/overweight permits and fuel use tax permits) and motor carrier/registrator safety records for the vehicle being screened. The transponder-provided information, along with the linked data for the vehicle screened, is used by a scale house computer to reach a bypass/pull-in decision that is sent, using DSRC, to the in-cab transponder to notify the driver of a bypass or a pull-in (a green light or a red light is indicated on the transponder) decision.

The **High-Speed Mainline Weigh-in-Motion (WIM) Component** measures approximate axle weights as a vehicle moves across in-pavement sensors and determines, based upon the axle weights and spacing, the gross vehicle weight and the classification. Although not usually as accurate as information provided by static scales, the WIM component allows for the weight of a vehicle to be estimated for screening purposes while the vehicle maintains highway speeds.

The **Automatic Vehicle Classification Component** is used to classify the various types of vehicles passing screening checkpoints. This information is necessary at Weigh-in-Motion-equipped sites since vehicle classification plays a vital role in determining the legal, allowable, weight of the traveling vehicle.

Vehicle Tracking Loops track vehicle positions as vehicles pass through the site and are necessary since this information is required to synchronize lane signaling with correct vehicles.

The **Automated Vehicle Identification (AVI) Component** currently includes two advanced readers – one notification reader and one compliance reader. Communication between the vehicle operator and the scale house is accomplished by the use of an in-cab transponder and the readers (with antenna) located along the highway at the weigh and inspection station. The two advance detection readers are located approximately one-half mile in advance of the Union facility and are used to read the signal from the transponders that approach the facility for forwarding to the scale house computer. The notification reader is located approximately one-quarter mile in advance of the facility and is used to notify the operators of trucks with screening and clearance transponder-equipped commercial trucks of the clearance decision (bypass or pull-in). The compliance reader is located on the interstate highway adjacent to the facility and is utilized to identify bypassing trucks for the purpose of compliance verification,

including those vehicles that have incorrectly bypassed the facility. The AVI Component includes the readers (with antennae), antennae poles, truck detectors, compliance alarms, modems and all other associated components and items identified for making electronic screening and clearance decisions, but does not include the scale house computer, printers or the transponders.

The **Scale House Computer** uses **Screening and Clearance Software** [Connecticut uses Mainline Automated Clearance System (ModelMACS) software provided free by the Commonwealth of Kentucky Transportation Cabinet] to receive vehicle-related data that originates from the Weigh-in-Motion (WIM) Component, the Automatic Vehicle Classification Component, the Vehicle Tracking Loops and the Automated Vehicle Identification Component and to analyze this data, along with data from other state and federal systems. The software associates the vehicle-specific information with other stored information, such as vehicle identification numbers, the registration plate, operating credentials (interstate registrations, oversize/overweight permits and fuel use tax permits) and motor carrier/registrant safety records provided by the US Department of Transportation, for the vehicle being screened. The transponder-provided information, along with the linked data for the vehicle screened, is used by the scale house computer to reach the clearance decision that is sent to the roadside notification site, which then sends the DSRC signal to the in-cab transponder to notify the driver of the bypass or pull-in decision.

APPENDIX C

COMMERCIAL VEHICLE INFORMATION SYSTEMS AND NETWORKS (CVISN) AND PERFORMANCE AND REGISTRATION INFORMATION SYSTEMS MANAGEMENT (PRISM)

Provided by DMV

CVISN - Commercial Vehicle Information Systems and Networks refers to the collection of information and communication systems owned, operated or funded by the Federal Motor Carrier Safety Administration, Federal Highway Administration, individual states, motor carriers and other stakeholders. It organizes these commercial vehicle operations (CVO) related systems, allowing them to operate in an integrated manner. CVISN components apply emerging technologies to enable the delivery of new electronic services and to improve the effectiveness and efficiency of state and private commercial vehicle operations stakeholders in the three broad functional areas of information exchange, operating credentials, and electronic screening /clearance. Examples of services include providing timely safety and credentials information to safety enforcement personnel at the roadside; allowing states to exchange registration and fuel tax information electronically; providing operating credentials to motor carriers electronically; and electronically screening commercial vehicles at fixed and mobile inspection sites while vehicles travel at highway speeds.

CVISN roadside screening is a selection mechanism for law enforcement officials to target high-risk operators of large commercial motor vehicles and to make efficient use of weigh and inspection station resources, including enforcement personnel. Electronic screening is the application of technologies to make more informed inspection decisions.

The application of electronic screening technologies is affected by many constraints, including site limitations, availability of support staff, and funding. Each roadside weigh and inspection station has a unique design because of state policies and practices, traffic flow, traffic volume, the number of lanes, available site space, legacy system characteristics, existing solutions, the vintage of roadside facilities and communications equipment, and available resources for making changes. When properly implemented, electronic screening can result in improved traffic flow and a better focus for limited inspection resources, and ultimately achieves the goals of increased highway safety and reduced operating costs.

Performance and Registration Information Systems Management (PRISM), operated by DMV, links the safety fitness of commercial motor carriers with the ability to register commercial motor vehicles that operate on an interstate basis. The PRISM Program includes two major processes – the Commercial Vehicle Registration Process and the Motor Carrier Safety Improvement Process (MCSIP) – that work in parallel to identify motor carriers and hold them responsible for the safety of their operation. The performance of unsafe carriers is improved through identification, education, awareness, safety monitoring and treatment.

The CVISN and PRISM Programs share the following key concepts:

- Focus safety enforcement on high risk operators
- Use open standards for data communications
- Use a standardized algorithm for determining a carrier's safety fitness
- Use data exchange systems that conform to the National Intelligent Transportation Systems (ITS) Architecture

Links to additional information

For more information on the federal CVISN program, please go to <http://cvisn.fmcsa.dot.gov/>.

For more information on the federal PRISM program, please go to <http://www.fmcsa.dot.gov/factsfigs/prism.htm>.

APPENDIX D-1 UNION WEIGH AND INSPECTION STATION FULL STAFFING REQUIREMENTS

Provided by DMV

DMV in conjunction with DPS identified that full staffing to meet the operational requirements for the current Union Station includes a total of 9 inspectors as follows:

Post #1: I-84 w/b Exit Ramp 74 – Inspector responsible for stopping all trucks/buses exiting to address the issue of scale bypass and evading scale operation. Only trucks making local deliveries are allowed to exit when scale is OPEN.

Post #2: Right-hand shoulder west of entrance to weigh station – Inspector responsible for stopping and/or chasing all trucks/buses that pass the weigh station when it is OPEN.

Post #3: Low-speed WIM Booth – Inspector is responsible for directing trucks that are apparently overweight or with apparent violations into the weigh station. All other trucks/buses are directed onto the bypass acceleration lane and back onto the highway. This inspector would also notify inspector stationed at post #2 of those vehicles that failed to follow directions to proceed into weigh station. Also, this inspector is responsible for monitoring tracking problems or back-ups in the entrance to the weigh station or on I-84.

Post #4: Static Scale Booth inside the Scale House – Inspector is responsible for directing the scale operations and is the Officer-in-Charge. The inspector weighs the trucks on the static scale, collects information (driver/vehicle) of vehicles found with violations for other inspectors conducting MCSAP inspections. Additionally, this inspector controls the signal lights that identify when the weigh station is open or closed as well as monitors the CVISN system.

Post #5,6,7: Enforcement inspectors – Inspectors are responsible for conducting enforcement; MCSAP inspections along with judicial process (infractions/misdemeanors) actions.

Post #8: Roving Patrol on Route 190 – Inspector is responsible for monitoring truck/bus traffic on Route 190 with special attention to truck traffic coming from Massachusetts into Connecticut.

Post #9: Relief Inspector – Inspector is responsible for relieving other inspectors or posts when the need arises. Can assist with Posts # 2 or posts #5,6,7 until needed as relief at other posts.

APPENDIX D-2 GREENWICH WEIGH AND INSPECTION STATION FULL STAFFING REQUIREMENTS

Provided by DPS

The DPS, in conjunction with DMV, identified that full staffing to meet the operational requirements for the current Greenwich Station includes a total of 13 individuals (10 Troopers and at least 3 Weight and Safety Technicians) as follows:

Post #1: I-95 Exit Ramp 2 – Trooper responsible for stopping all trucks exiting to address the issue of scale bypass and evading scale operation. Only trucks making local deliveries are allowed to exit when scale is OPEN.

Post #2: Right-hand shoulder north of entrance to weigh station – Trooper responsible for stopping and/or chasing all trucks that pass the weigh station when it is OPEN.

Post #3: Low-Speed WIM Booth – Trooper is responsible for directing trucks that are apparently overweight or with apparent violations into the weigh station. All other trucks are directed onto the bypass acceleration lane and back onto the highway. Also, this trooper is responsible for monitoring tracking problems or back-ups in the entrance to the weigh station or on I-95.

Post #4: Static Scale Booth inside the Scale House – Trooper is responsible for directing the scale operations and is the Officer-in-Charge. The trooper weighs the trucks on the static scale, directs the weight and safety technicians conducting the inspections, and controls the signal lights that identify when the weigh station is open or closed.

Post #5,6,7,8: Inside Weigh Station / Scale Building – Troopers are responsible for writing enforcement actions as directed by the Officer-in-Charge.

Post #9: Roving Patrol on Route 1 – Trooper is responsible for monitoring truck traffic on Route 1 with special attention to truck traffic coming from New York into Connecticut. Signs are posted that indicate “No Through Trucks” are permitted.

Post #10: Relief Trooper – Trooper is responsible for relieving other troopers or posts when the need arises.

Weight and Safety Technicians –

Weight and Safety Technicians are responsible for performing the truck inspections and bringing the portable scales to locations where needed. Staffing of a minimum of three technicians is needed at any given time.

APPENDIX E

MOTOR CARRIER SAFETY ASSISTANCE PROGRAM INSPECTIONS

Provided by DMV

General

Of foremost importance, as the lead agency in Connecticut for the Motor Carrier Safety Assistance Program (MCSAP), the Department of Motor Vehicles (DMV) must ensure that it complies with all the elements of the program. As stated in 49 CFR §350.101, MCSAP is a federal grant program that provides financial assistance to states to reduce the number and severity of accidents and hazardous materials incidents involving commercial motor vehicles (CMV).

To understand the MCSAP inspection process, it is necessary to have an awareness of the levels of inspections as defined by the Commercial Vehicle Safety Alliance (CVSA). The **North American Standard Inspection Levels** are as follows:

LEVEL I: Full Inspection - An inspection that includes examination of driver's license; medical examiner's certificate and Skill Performance Evaluation (SPE) Certificate (if applicable); alcohol and drugs; driver's record of duty status as required; hours of service; seat belt; vehicle inspection report (if applicable); brake systems; coupling devices; exhaust systems; frame; fuel systems; lighting devices (turn signals, brake lamps, tail lamps, head lamps and lamps/flags on projecting loads); safe loading; steering mechanism; suspension; tires; van and open-top trailer bodies; wheels and rims; windshield wipers; emergency exits for buses; hazardous materials ("HM") requirements as applicable. HM required inspection items will be inspected by certified HM inspectors.

LEVEL II: Walk-Around Driver/Vehicle Inspection - An examination that includes each of the items specified under the North American Standard Inspection Level II Walk-Around Driver/Vehicle Inspection. As a minimum, Level II inspections must include examination of: driver's license; medical examiner's certificate and Skill Performance Evaluation (SPE) Certificate (if applicable); alcohol and drugs; driver's record of duty status as required; hours of service; seat belt; vehicle inspection report (if applicable); brake systems; coupling devices; exhaust systems; frame; fuel systems; lighting devices (turn signals, brake lamps, tail lamps, head lamps and lamps/flags on projecting loads); safe loading; steering mechanism; suspension; tires; van and open-top trailer bodies; wheels and rims; windshield wipers; emergency exits on buses, and HM requirements as applicable. HM required inspection items will be inspected by certified HM inspectors. It is contemplated that the walk-around driver/vehicle inspection will include only those items, which can be inspected without physically getting under the vehicle.

LEVEL III: Driver/Credential Inspection - As a minimum, Level III inspections must include, where required and/or applicable, examination of the driver's license; medical examiner's certificate and Skill Performance Evaluation (SPE) Certificate; driver's record of duty status; hours of service; seat belt; vehicle inspection report; and HM requirements.

A MCSAP Inspection of a CMV, irrespective of the level of inspection performed, is not simply a cursory visual inspection of a vehicle. A MCSAP inspection, rather, is a detailed documented inspection that includes those items defined by CVSA above and more specifically the following:

1. Driver – status, the license for proper class and validity, if the driver has any outstanding arrest warrants, checking the driver’s hours of service to ensure proper rest, Past Inspection Query (PIQ) and observing driver behavior for use of illegal substances (e.g. alcohol/ drugs);
2. Vehicle(s) credentials – valid registrations for each motor vehicle, insurance, proper shipping papers, road use tax decals, proper permits and PIQ;
3. Motor Carrier – checking their status for unpaid tickets, registration, suspension, US DOT#’s, PIQ, operating authority or out-of-service orders;
4. Inspection of the vehicle(s) – this averages 30 to 60 minutes and may include going beneath the vehicle to do an in-depth check of the vehicle(s) critical components (e.g. steering, suspension and brakes). The length of time is dependent on a minimum of three factors: driver’s knowledge of the vehicle and required documents, the vehicle’s condition and the level of inspection performed (I, II or III);
5. Load(s) – ensuring loads are secured properly as well as checking for the presence of hazardous materials (HM), and if present, ensure proper packaging, blocking and bracing; and
6. Completing the Driver/Vehicle Examination Report (aka. Inspection). This, in itself, requires about 20 minutes (minimum) of the inspection time. This is the official record and historical documentation of the stop/inspection. All CVSD personnel are required to document their MCSAP activities by completing these reports.

The levels of inspections performed are normally dictated on the basis of the inspector’s training and experience as well as the presence of a CVSA decal, PIQ or other contributing factors including but not limited to: location, weather and time of day.

APPENDIX F OVERVIEW CONNDOT'S WEIGH-IN-MOTION RESEARCH EXPERIENCE

Provided by ConnDOT

The following is a summary of weigh-in-motion research in Connecticut from 1987 through 2008 that was prepared by ConnDOT's Office of Research and Materials.

Background / Overview

In the 1980s, there was considerable interest in acquiring the ability to automatically obtain vehicle weight and classification data at highway speeds in Connecticut. Numerous transportation applications requiring load data existed. The durability and longevity of pavement or bridge structures are determined by a number of factors, including the number of loads applied over the life of a structure. To address this research need, Connecticut Department of Transportation (ConnDOT) research engineers explored the potential use of emerging WIM technologies in Connecticut. Prior to the emergence of piezoelectric sensors, fully-automated WIM systems had not been installed in Connecticut for traffic monitoring due to their high cost and complexity of the installations.

In 1987, LTPP (Long-Term Pavement Performance) studies were initiated as part of the Strategic Highway Research Program (SHRP) that began under the passage of the Surface Transportation and Uniform Relocation Assistance Act of 1987. This twenty-year study was the first congressionally-mandated, large-scale national research program to measure pavement performance under a range of different conditions. Test sections were established to monitor in-service pavements at over 1,000 locations in the United States and Canada. LTPP's mission includes the creation of a National Pavement Performance Database. Initially, in 1987, four LTPP - General Pavement (GPS) test sections were selected in Connecticut. In 1996, a fifth test section was built that was the SPS-9A (Specific Pavement Study of SuperPAVE).

The locations of the LTPP test sites in Connecticut are: Vernon (I-84 westbound), Manchester (I-84 westbound), Glastonbury (Route 2 westbound), Groton (CT 117 northbound) and Lebanon (CT Route 2 eastbound & westbound). Load data are a critical component to understanding the performance of pavements. Therefore, a requirement of the program was to collect research-quality weight data that included vehicle counts and classification data at the five study sites.

Consequently, the two research needs were: 1) to evaluate emerging weigh-in-motion (WIM) technology under Connecticut's field conditions, and 2) to collect automated weight and classification data for LTPP. These research needs fit together and could be achieved through concurrent research studies.

ConnDOT engineers considered the technologies available on the market in 1987, and in 1990 initiated a study entitled "An Evaluation of a Piezoelectric Weigh-In-Motion System" under ConnDOT Research Project Number HPR-1411. This study evaluated ceramic, coaxial-encapsulated, piezoelectric sensors under Connecticut's field conditions.

In late 1996, based on the findings of the earlier research (HPR-1411) and the need to collect highly accurate data for the proposed LTPP SPS-9A experimental test site, ConnDOT engineers again assessed the technologies on the market and conducted inquiries of other states' experiences with weigh-in-motion. The outcome was a second research study in 1997 to evaluate an emerging WIM technology and simultaneously collect data needed for LTPP. A study, entitled "Installation and Evaluation of a Weigh-In-Motion System Utilizing Quartz Piezoelectric Sensor Technology," was created through sponsorship from the then Priority Technologies Program (FHWA-PTP) and through ConnDOT Research Project Number SPR-2306. This study was the first installation and evaluation of a quartz-piezoelectric weigh-in-motion system on an in-service highway in the United States.

Findings from ConnDOT's research studies on weigh-in-motion are summarized below for this Weigh Station Technologies study being conducted by the Connecticut Academy of Science and Engineering, and have been disseminated in a traffic-monitoring context through publication of reports, presentations and participation at national and international levels.

Piezoceramic WIM Sensor Evaluation (1990-1998)

In the 1980s, inventors searched for materials and systems to lower the cost of WIM operation. One such class of materials that became marketed as a low-cost alternative to many of the then-available WIM systems was piezoceramics. At the time, the use of piezoelectric cables as sensors to measure the weight of passing vehicles had only been recently attempted and preliminary results were favorable. Commercial systems were available but had not been tested under conditions prevalent in Connecticut. A research -level study was established to provide information to the unanswered questions regarding accuracy, reliability, and survivability of sensors in various types of Connecticut's pavements under actual traffic and field conditions.

Locations were selected based on the need to collect site-specific data for LTPP, curvature of the road, minimum roughness (IRI), proximity to roadway structures and availability of telephone and electrical services. In 1991, nine lanes were instrumented at four different locations; each location had a different pavement type and experienced different traffic distributions and characteristics. The sensors were encapsulated ceramic coaxial piezoelectric sensors. The sensor configuration was an inductance loop, followed by two full-lane-width ceramic piezoelectric sensors (12 feet apart), with a partial-length sensor to act as an off-scale device installed halfway between them. Each system was equipped with a pavement temperature sensor, according to the manufacturer's specifications, and vendor representation was on-site during installations. Each system was equipped with a full set of electronics and modem communications for continuous monitoring capabilities.

The experiment included field validations of the weight output using trucks of known weight. In the period from April 1992 to May 1996, eleven field validation/calibration efforts were conducted. In all, over two thousand passes of trucks of known weight were conducted with at least one 5-axle, semi-trailer dump truck and two additional trucks of various configurations and suspensions for each validation effort. Early results (1991- 1992) showed system drift of approximately 16% at three of the four test sites over a six-month time period. Further investigation revealed the system adjustment factors, or "auto calibration," was based on specific assumptions for the front-axle weights of Class 9 vehicles to compensate for

variabilities, including temperature, over time. The incorrect presumed weight ranges resulted in the significant drift. Additional issues were encountered, including the linking of vehicles and additional or “ghost” axles. The manufacturer has since improved the algorithms and modified the systems to include two inductive loops in each system to improve the delineation of individual vehicles. After these improvements, the experiment results varied by site and by vehicle. Standard deviation based on samples of ten vehicle passes ranged from 3.2- 33.9 %. Warmer temperature weather (April- October) validation data yielded more favorable results (Standard deviation = 6.4%) as compared to the colder temperature weather (November- March) validation data (Standard deviation = 26.5%). Variability was observed from the validation data between mornings and afternoons when the pavements would warm. One test site, that was located under a bridge and on concrete pavement, produced less variable results. It was thought that the results would stabilize once the adjustment algorithms that accounted for temperature had established sufficient data to properly account for the differences at each site. This was not found to be the case as these algorithms continued to change from lane to lane, site to site and year to year.

Data analysis methods were adopted to evaluate the data over time. These included the tracking the percentage of data classified as erroneous and unclassified vehicles, and plotting the distributions of front-axle and gross-vehicle weights over time (as developed by Dahlin & Novak, in Minnesota). These results indicated the need for significant amounts of work to be conducted, most often manually, to assess the data quality on a weekly basis.

Work was also conducted to evaluate the vehicle classification data collected at the WIM test sites. This was done by comparing the results of the count and classification data generated by the WIM with the data generated from both manual field collection and manually generated from a videotaped sequence, for the same time period. As a result some minor changes were conducted to the classification scheme and the vehicle timing to avoid linking cars traveling close in proximity and to better classify the vehicles.

Effort was required to support and maintain these field systems. The hard-drives and modems used in the field system (1990) did not operate well in the harsh field conditions that include extremes in heat, cold, vibration and dust.

Significant experience was gathered in the orchestration of field calibration/validation using trucks of known static weight. It was concluded, at that time, that it was necessary to conduct these operations at least twice a year, based on the temperature fluctuations in Connecticut and that more than more than the ten passes were necessary to quantify the results.

Overall, the work conducted on this project provided insights as to the functionality and variability of the ceramic piezoelectric sensors, issues encountered regarding temperature dependence of ceramic piezoelectric WIM systems, logistics and need to perform field validations, variability between test trucks, and the need for data analyses for the data quality assessment process. The original piezoelectric sensor systems appeared to be an attractive option to states seeking sensors that had a low initial cost. It became apparent that the cost of collecting data needed to include all aspects of data collection, including the required data analysis and the resulting data quality. In addition, the successful deployment of traffic data collection equipment could not be considered “turn-key” systems as initially envisioned. The LTPP data application required research-quality traffic data, defined by LTPP as similar to the

ASTM Type I systems. Based on the research conducted in Connecticut, concerns about the data quality for use in the LTPP program were communicated at the 1994 National Traffic Data Acquisition Conference (then called NATDAC) and at the LTPP 10th year program in 1996.

Quartz Piezoelectric WIM Sensor Evaluation (1997-present)

In 1997, ConnDOT in cooperation with FHWA and the FHWA-PTP established a research study with the objective to install a quartz-piezoelectric based WIM system and determine sensor survivability, accuracy, and reliability under actual traffic conditions in Connecticut's environment. The sensors offered features that encouraged ConnDOT engineers to pursue further study. Specifically, the sensors promised to provide a higher level of accuracy, not have the temperature dependence of ceramic (traditional) piezoelectric sensors, provided a sensor design that better isolated the vertical forces and could be ground flush to the road surface, with relatively easy installation.

The test site, located on Route 2 in Lebanon, CT, is a four-lane, median-divided highway, functionally classified as a principal arterial. The test location was selected based on the need to measure traffic for the LTPP SPS-9A test sites, availability of power and telephone, roadway grade and proximity to nearby structures. The pavement is a SuperPAVE bituminous mix-design, which was placed in 1997 on existing bituminous pavement that had undergone partial depth milling. A sensor layout was selected in order to gather data for direct comparison with conventional piezoelectric WIM systems. The layout configuration is induction loop, two full lane-width strips of WIM sensors and a second induction loop that is depicted in Figure E-1. The full lane-width strip of quartz-piezoelectric WIM sensors was assembled by laying four one-meter sensors end-to-end. The sensors were attached by metal plates according to the sensor manufacturer's guidelines.

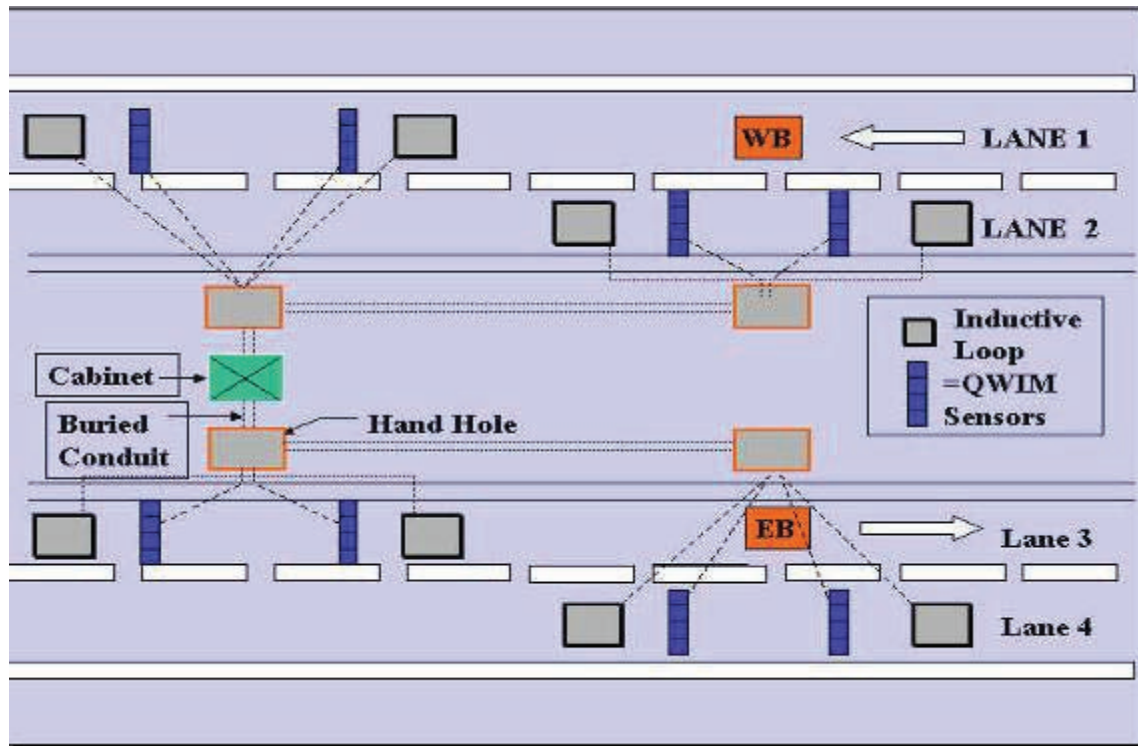

FIGURE F-1. SCHEMATIC OF THE QUARTZ WIM SENSOR LAYOUTS, CT ROUTE 2

A representative from the sensor manufacturer and the WIM vendor were on site during all installations. A temperature sensor was installed for the purpose of recording temperature data collection in the study. All software compensation factors, including autocalibration features that account for temperature, were disabled in the vendor software.

The first sensor installations were in October 1997. Early in the project, some problems were encountered with reduced sensor signal strengths that were contributed to moisture infiltration from testing. There were drainage issues at the site that allowed water into the conduit that the open cables were drawn through. Reinstallations with an improved cable design and installation methods were employed in 1998. One sensor was replaced in 2000; the sensor was damaged by a rodent chewing through the cables.

In all, thirteen field validations/calibrations were performed from 1999 to 2006. Each validation/calibration included two loaded FHWA Class 9 (5-axle single trailer) vehicles with one required to have air-ride suspension. At each validation, the goal was to achieve at least 20 passes of the vehicle without system adjustments, within the allotted time. Beginning in 2001, the test vehicle speed was varied for each pass in five mph increments (55, 60 and 65 mph) for the duration of the field validations. Overall, the field data demonstrated that it is possible to collect research quality data that can meet ASTM 1318-02 Functional Performance Requirements for Type I WIM systems.

Sample results are offered in Table E-1 for both gross vehicle weight and steering axles from early tests. Of the four lanes instrumented, Lanes 1 & 4 (slow lanes) provided the most accurate

data. Lane 3 (Eastbound, high-speed) always exhibited greater variability. All calibration data is available upon request. These calibrations are similar to the efforts outlined by FHWA-LTPP. Data was analyzed for the Third International Conference on Weigh-in-Motion (ICWIM3 Conference) by the Laboratoire Central des Ponts et Chaussées (LCPC) for data from the Connecticut test site from 1998-2001. The accuracy analysis according to the COST 323 European Specification of WIM test conditions yielded accepted classes accordingly: Lane 1=B(10), Lane 2=C(15), Lane 3=C15, Lane 4=B+(7). (McDonnell, ICWIM3, 2002.) More specific information on the lane demarcation and experiment is available.

Date	(GVW)	No.	GVW (%)		Steer (%)		Drive (%)	
	(kg)		Passes	Error	StdDev	Error	StdDev	Error
Oct-98	36397	25	0.19	2.02	0.76	2.78	0.22	2.71
Oct-98	35231	25	3.31	2.01	3.58	4.72	6.29	1.98
Mar-99	34619	21	1.62	1.51	-1.2	3.27	0.92	1.92
Mar-99	36492	21	-1.67	5.26	-0.56	4.54	1.44	2.54
Mar-99	14071	21	-0.75	2.23	-2.97	2.62	0.27	2.78
Oct-99	33475	20	0.54	2.35	-0.94	2.83	-0.52	3.1
Oct-99	32940	20	-0.99	2.99	-1.78	3.05	2.73	3.62
Apr-00	31525	25	1.16	2.86	0.45	2.95	3.27	3.22
Apr-00	12791	27	0.25	2.57	2.32	6.35	2.38	4.16

TABLE F-1. LANE 1 (EASTBOUND SLOW SPEED LANE) SAMPLE TRUCK VALIDATION DATA

The investigation included analyses on the influence of speed, loading, test vehicle and pavement profile and temperature on the quartz WIM system responses. Early results indicated that there was not an appreciable change in the test vehicle response due to temperature changes over the course of the day or from season to season. In April 2001 and November 2001, testing was conducted and a statistical analysis was performed that determined that there was not a strong correlation between speed of the test vehicles and the resulting gross vehicle weight or the front-axle weights captured at the WIM for the two lanes tested (slow speed lanes) in the test range of 55-65 mph.

Testing was conducted in an attempt to duplicate findings in Minnesota (Dahlin/Chalkline, TRB 2001) that showed the percent error was a function of the gross-vehicle weight. To achieve this, test runs were conducted by the same test vehicle at different loadings. A statistical analysis concluded that the test in Connecticut did not duplicate the earlier Minnesota findings. Specifically, the accuracy of the system was not dependent upon the load range being tested. The accuracy of the unloaded FHWA Class 9 vehicles, while often not the focus of pavement design or enforcement data needs, is important in the application of quality-control testing for monitoring the distribution of front-axles for unloaded FHWA Class 9 vehicles. It is likely that vehicle response varies by site characteristics and, therefore, at some sites, the WIM response results indicate that the system is speed and load dependent.

Pavement profiles and roughness data (in the form of IRI - International Roughness Index) were measured periodically during the course of the study and found not to have changed significantly. The relationship between the pavement profile and the system performance is

still under investigation. Further investigations were considered to apply the findings from the studies (Cebon, TRR, 1991) that indicate the optimization of measurements by measuring at three points to reduce the smoothness required by the pavement approach. The sensor configurations would possibly also require adaptations to the vendor software.

The study of the quartz sensor provided for longer periods of consistent data. From this, researchers learned more about the role of vehicle dynamics (between different calibration vehicles), pavement approach variability, and calibration practices. They developed an algorithm to automate the data quality assessment and it was introduced at the ICWIM3 conference in 2002. In addition it was concluded that, if possible, one of the same test vehicles should be used from calibration to calibration to help to differentiate the test vehicle variability from the validation results.

In 2003, it became necessary to consider options for collecting load data at the remaining LTPP-GPS sites where earlier WIM installations were no longer operational. Quartz piezoelectric WIM systems were selected to meet the LTPP one-lane monitoring needs. A one-lane of reduced sensor configurations (See Figure E-2) were selected for the sole purpose of saving money.

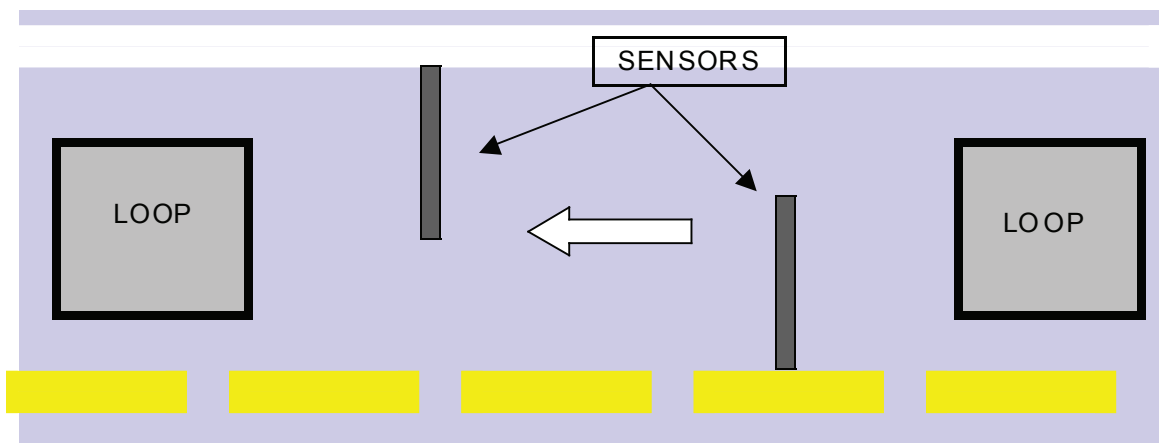

FIGURE F-2. SCHEMATIC OF REDUCED QUARTZ SENSOR LAYOUT

These were installed at the Groton, Manchester and Vernon locations. The performance varied at these locations and provided interesting information. The standard deviation is the most meaningful value, as that is an indication of the system repeatability.

The Groton test site on CT Route 117 is a 35 mph full-depth asphalt pavement that exhibited some surface cracking that was sealed. The results at this location were extremely repeatable and did not require recalibration from visit to visit. The June 2005 field verification showed the data achieved on average within 1% static GVW and a standard deviation +/- 1.5% for twenty passes.

In contrast, the Manchester site on I-84 Westbound, a full-depth, jointed, concrete pavement, with a speed limit of 65 mph, resulted in less than 1% of GVW, but had a standard deviation of +/- 12.5% for nine passes.

The Vernon site, on I-84 Westbound, an asphalt overlay of continuous reinforced concrete, with a speed limit of 65 mph, the standard deviation for twenty passes resulted in +/- 2.5%, but varied from validation to validation.

These results serve to further demonstrate that good results are achievable, but are site- and lane-specific. The pavement approach combined with the number of sensor measuring points and the sensor layout are critical factors to the data outcome.

Early in the study there were concerns about the rigid sensor in the flexible pavement and some early cracking that developed around the ends. Following up on these observations, it was found that the cracking did not deteriorate further and cracking and the sensors remained stable upon visual inspections. Cracking did not occur at the other installations in Connecticut (from 2003). Therefore, the concerns are not the same in 2008 as they were reported in 2002. Throughout the study, there were issues encountered with rodent infestations. Efforts were made to rid the Lebanon site of rodents. Lessons were learned regarding the type of hand-hole used for low-voltage field instrumentation and these findings were communicated with the ConnDOT Division of Traffic Engineering. The returning presence of rodents has compromised the conclusions of this experiment. In conclusion, any sensor that began to reduce signal output over time could be contributed to the presence of rodents and the possible chewing on the wires. The sites need to be designed with better protection against rodents and moisture. It was possible to continue data collection at the Lebanon test site with a reduced number of sensors, due to the initial layout design.

Over the period of 1997-present, the ConnDOT Office of Research dispersed information through the traffic data conferences and received a multitude of inquiries regarding their experience. Many states have expressed how knowledge from the work in Connecticut enabled them to make informed decisions. The State of Minnesota expressed how the experiments in Connecticut had a direct impact for the improvement their WIM program. According to the sensor manufacturer (as of 2006), over 35 states had installed the quartz sensors in an estimated 600 lanes. Input from this project was provided to LTPP through active involvement in the TRB-LTPP Expert Task Group on Traffic Data.

Conclusions

A great deal has been learned about the practical aspects of operating WIM sites in Connecticut. The quartz piezoelectric weigh-in-motion sensors offer a practical option for collecting accurate data. The results are highly site-specific. The pavement approach is a critical component of the WIM system. The sensor response did not show to be speed- or load-specific at the test site in Connecticut. It is difficult to distinguish sensor longevity from damage due to the rodents at the Lebanon test site. Sensors installed in 2003 at three other locations have continued to perform for over five years.

REFERENCES

ASTM 1318-02

Cebon D and Winkler CB, 'Multiple-sensor weigh-in-motion: Theory and experiments.'
Transportation Research Record, TRB, 1311 pp 70-78, 1991

Dahlin, Curtis and Chalkline, Margaret, " Comparison of Data Collected by Two Weigh-In-Motion Systems Monitoring Identical Traffic on the Same Segment of Roadway (02-997), TRB 81st Annual Meeting, 2002

Larsen, D.A. and McDonnell, A.H., " Second Interim Report on the Installation and Evaluation of Weigh-In-Motion Utilizing Quartz-Piezo Sensor Technology, Connecticut Department of Transportation, Report # 2306-2-99-7, November 1999

McDonnell, A. H, "Bringing Piezoelectric Weigh-In-Motion On-Line at LTPP Sites in Connecticut, " National Traffic Data Acquisition Conference (NATDAC'94) Proceedings, Volume II, FHWA-CT-RD-2304-F2-94-1, 1994

McDonnell, A. H., "Installation and Evaluation of Weigh-In-Motion Utilizing Quartz Piezoelectric Technology," North American Traffic Monitoring Exhibition and Conference, 1998

McDonnell, A. H, "Evaluation of A Weigh-In-Motion System Utilizing Quartz-Piezoelectric Sensor Technology, "Proceedings of the Third International Conference on Weigh-In-Motion (ICWIM3), May 2002.

Figure E-1 from McDonnell, ICWIM3 Presentation, 2002

Table E-1, Excerpt from McDonnell, ICWIM3, paper

COST 323 Analysis, from McDonnell, ICWIM3 paper

Schematic E-2 Modified From PowerPoint Presentation: McDonnell, A. H. and Block, E. "An Evaluation of Quartz-Piezoelectric Weigh-In-Motion Technology" North American Traffic Monitoring Exhibition and Conference, 2006

APPENDIX G

SURVEY QUESTIONS REGARDING WIM SYSTEMS PRACTICES OF NEIGHBORING STATES

Interview Questions:

The following questions are used as general guidelines to interview state DOT staff and other state agency staff regarding their WIM systems and technologies.

1. How are weigh stations operated in your state? Which agencies are involved in managing and operating weigh stations? What kind weigh stations (fixed or roadside) do you have?
2. WIM System Technologies
 - What type of WIM technologies or sensors is used at the sites?
 - Do you use WIM technologies for electronic screening of trucks? How are they integrated? Do you have any successful experience or lessons learned?
 - Do you use WIM systems for data collection/reporting and/or enforcement?
 - Can you provide more detailed information regarding your WIM systems such as sensor design layout, the location of WIM sensors relative to the station, etc.?
 - Do you use any specific calibration and installation procedure to make sure that the WIM systems meet specifications? (Is the calibration done by a contractor?)
3. Electronic screening and regional data sharing and cooperation:
 - Does the weigh station system perform an electronic check of credentials (taxes, insurance, permits, etc.)?
 - How is data sharing of truck information (weight, credentials, etc.) important for the I-95 operational management?
4. WIM Data:
 - What type of WIM data do you collect? Do you use this data other than for FHWA reporting?
 - What percentage of time would you say your sites are up and supplying good data?
 - Do you do data quality assurance testing or verification of the operation of your WIM sites?
5. What works best in your program? What is the biggest problem or challenge in your WIM program?

APPENDIX H BRIDGE WEIGH-IN-MOTION

Provided by ConnDOT and UConn

Bridge weigh-in-motion (BWIM) is a method of determining the weight of a truck as it crosses over a highway bridge by measuring the strain or deflection of the bridge's structural members. Bridge weigh-in-motion has the advantage over traditional WIM technologies in that

- the sensors and associated equipment can all be located under the bridge deck and off of the roadway, improving safety;
- the longer sensing time as the truck travels over the bridge reduces the effect of vehicle dynamics; and
- the road profile before the bridge is less critical than the actual profile at the expansion joint, reducing the need to mill the roadway before the site (European Commission, 2001).

The concept of using bridge responses for calculating vehicle weights has been around since the late 1970s (Moses, 1979). Early attempts to implement bridge weigh-in-motion in the 1980s showed promising results, but in general lacked the accuracy necessary for enforcement and planning purposes. Recent advances in sensor technology and data acquisition may now be able to address some of the challenges faced in the initial studies. In recent years success has been found in Europe (Slovenia, France, etc.) where BWIM is being used as a screening tool for enforcement purposes at some locations.

Researchers at the University of Connecticut in cooperation with ConnDOT and the FHWA are in the early stages of exploring BWIM as an adjunct to other research on a network of permanently monitored bridges in Connecticut. While the primary objective of long-term bridge monitoring is to provide structural health monitoring, sensors on the bridges can be used to collect traffic data and specifically, gross vehicle weights of trucks traveling over these highway bridges.

Preliminary research was conducted by running trucks of known weight over a long-term bridge monitoring system on I-91 in Cromwell to evaluate the feasibility of using existing systems for bridge weigh-in-motion. The Cromwell Bridge has three lanes of traffic and an average daily traffic in excesses of 50,000 vehicles per day, with approximately 9% trucks. The Cromwell system uses strain gauges, placed at the top and bottom of the steel girders, both at the center of the primary span and in the adjacent span. Load tests were conducted on multiple runs using two test vehicles (class 9 5-axle semi-trucks) of known weight. The algorithm used for this BWIM system is adapted from a system that was developed by Ojio and Yamada (2002). The general principle is that as a load passes over a bridge at a certain speed it produces an influence area recorded by strain sensors that is proportional to the weight of the truck.

This preliminary research in Connecticut demonstrated the feasibility of using long-term bridge monitoring systems for BWIM. The system was shown to provide gross vehicle weights with less than a 5% error in predicted weight to the known static weight. Data collected with multiple passes demonstrated consistency in the data collection. Results from this test were presented at the 2006 North American Travel Monitoring Exhibition and Conference (NATMEC) (McDonnell et al, 2006) and most recently at the Alabama Bridge Weigh-in-Motion Symposium (Christenson, 2008), and are documented in A.J. Cardini's MS thesis (Cardini, 2007) and a Journal Paper currently in review as of October 2008.

BWIM has typically been conducted under very limited circumstances, specifically for bridges with the following characteristics:

- Structures of short length that allow just one vehicle on the bridge at a time
- That are simply supported
- With little skew
- With low volumes of traffic

Bridge WIM systems designed for one specific type of bridge may have difficulty being directly applied to another type of bridge. Algorithm development has progressed very little over the past three decades and the current leading system, SiWIM, is a proprietary system developed in Europe for European bridges and trucks. The potential advancement of algorithms with availability of multiple types of sensors and high fidelity data is great.

There are some current limitations to BWIM. Research is needed to determine

- if BWIM technologies are capable of meeting higher demands under a wider range of field conditions
- if this approach to WIM can be applied to longer bridge spans
- the specifics of what is needed to apply BWIM data for network enforcement applications

The State of Connecticut is uniquely situated to explore the possibility of BWIM with over twenty years experience with bridge monitoring and current state-of-the-art bridge monitoring capabilities.

REFERENCES

Cardini, A.J., "Structural Health Monitoring and Development of a Bridge Weigh-In Motion System For a Multi-Girder Steel Composite Bridge", Submitted in Partial Fulfillment of the Requirements for the Degree of Master of Science, University of Connecticut, 2007

Christenson, R.E., "Leveraging Long-Term Bridge Monitoring for B-WIM", presentation at the 2008 B-WIM Workshop, University of Alabama, Birmingham, Alabama, August 11-12, 2008.

Ojio, T and Yamada K, " Bridge Weigh-In-Motion Systems Using Stringers of Plate Girder Bridges, "Pre-Proceedings of the Third International Conference on Weigh-In-Motion (ICWIM3, ISBN: 0-9652310-5-4, May 2002, p. 209-218

McDonnell, A.H, Cardini, A., D'Attilio, P., DeWolf, J.T., Feldblum E.G., Orlund J., "Use of Bridge-Strain Health Monitoring System for Weigh-In-Motion Evaluation", presentation at the National Traffic Monitoring Exhibition and Conference (NATMEC 2006), Minneapolis, MN, June 4-7, 2006.

Moses, Fred, "Weigh-in-Motion System Using Instrumented Bridges", ASCE Transportation Engineering Journal, v 105, n 3, May, 1979, p 233-249

European Commission, DG VII - Transport, 4th Framework Programme Transport, "Weighing-in-Motion of Axles and Vehicles for Europe (WAVE)", Report of Work Package 1.2, Bridge WIM systems (B-WIM), 2001

APPENDIX I SUMMARY OF PHASE II LTPP DATA COLLECTION WITH WIM SYSTEMS

Source: SPS Traffic Pooled Fund Study: Phase I Assessment and Evaluation, Phase II Calibration and Validation

Site (Location)	WIM Sensors & Controller	Project Phases	Test Trucks	Pavement	Speed (mph)	Temp (F)	WIM Results ¹																																
Texas SPS-1 (Rt. 281, 9.1 miles north of Rt. 186)	PAT bending plate Loop sensors with DAW-190	Phase II- Validation	-3S2 with a tractor having an air suspension tandem and a trailer with a standard tandem and air suspension loaded to 77,650 lbs. -3S3 with a tractor having a walking beam suspension tandem and trailer with tandem and air suspension, loaded to 79,940 lbs. -3S2 with a tractor having an air suspension tandem and a trailer with a standard rear tandem and a leaf spring suspension, loaded to 56,990 lbs.	Satisfactory, no distress, WIM index was not exceeded			<p>Evaluation - LTPP Precision Requirement</p> <table border="1"> <tr><td>Loaded single axles</td><td>± 20%</td><td>-4.95% ± 6.3%</td><td>Pass</td></tr> <tr><td>Loaded tandem axles</td><td>± 15%</td><td>1.8% ± 6.6%</td><td>Pass</td></tr> <tr><td>Gross vehicle weights</td><td>± 10%</td><td>1.4% ± 3.9%</td><td>Pass</td></tr> <tr><td>Vehicle speed</td><td>± 1 mph</td><td>± 2.5 ± 2.0 mph</td><td>Fail</td></tr> <tr><td>Axle spacing length</td><td>± 0.5 ft</td><td>-0.1 ± 0.4 ft</td><td>Pass</td></tr> </table> <p>Evaluation - ASTM E-1318-02 (Type I)</p> <table border="1"> <tr><td>Single axles</td><td>100%</td><td></td><td>Pass</td></tr> <tr><td>Axle Groups</td><td>100%</td><td></td><td>Pass</td></tr> <tr><td>Gross vehicle weights</td><td>± 10%</td><td>100%</td><td>Pass</td></tr> </table> <p>(Wheel load is not included.)</p>	Loaded single axles	± 20%	-4.95% ± 6.3%	Pass	Loaded tandem axles	± 15%	1.8% ± 6.6%	Pass	Gross vehicle weights	± 10%	1.4% ± 3.9%	Pass	Vehicle speed	± 1 mph	± 2.5 ± 2.0 mph	Fail	Axle spacing length	± 0.5 ft	-0.1 ± 0.4 ft	Pass	Single axles	100%		Pass	Axle Groups	100%		Pass	Gross vehicle weights	± 10%	100%	Pass
Loaded single axles	± 20%	-4.95% ± 6.3%	Pass																																				
Loaded tandem axles	± 15%	1.8% ± 6.6%	Pass																																				
Gross vehicle weights	± 10%	1.4% ± 3.9%	Pass																																				
Vehicle speed	± 1 mph	± 2.5 ± 2.0 mph	Fail																																				
Axle spacing length	± 0.5 ft	-0.1 ± 0.4 ft	Pass																																				
Single axles	100%		Pass																																				
Axle Groups	100%		Pass																																				
Gross vehicle weights	± 10%	100%	Pass																																				
Illinois SPS-6 (I-57, 10 mile south of the I-57/I-72)	bending plate and iSINC electronics	Phase II - Validation	-5-axle tractor-trailer with a tractor having an air suspension and trailer with a standard rear tandem and air suspension loaded to 73,690 lbs., -5-axle tractor semi-trailer with a tractor having an air suspension and a trailer with a standard rear tandem and a steel leaf suspension loaded to 52,010 lbs.	Satisfactory, no distress, WIM index was not exceeded	45 ~ 65	56 ~ 103	<p>Evaluation - LTPP Precision Requirement</p> <table border="1"> <tr><td>Loaded single axles</td><td>± 20%</td><td>-3.1 ± 11.3%</td><td>Pass</td></tr> <tr><td>Loaded tandem axles</td><td>± 15%</td><td>1.0 ± 7.2 %</td><td>Pass</td></tr> <tr><td>Gross vehicle weights</td><td>± 10%</td><td>0.2 ± 4.9 %</td><td>Pass</td></tr> <tr><td>Vehicle speed</td><td>± 1 mph</td><td>0.2 ± 1.3 mph</td><td>Fail</td></tr> <tr><td>Axle spacing length</td><td>± 0.5 ft</td><td>0.0 ± 0.1 ft</td><td>Pass</td></tr> </table> <p>Evaluation - ASTM E-1318-02 (Type I) (Same as Texas SPS-1)</p>	Loaded single axles	± 20%	-3.1 ± 11.3%	Pass	Loaded tandem axles	± 15%	1.0 ± 7.2 %	Pass	Gross vehicle weights	± 10%	0.2 ± 4.9 %	Pass	Vehicle speed	± 1 mph	0.2 ± 1.3 mph	Fail	Axle spacing length	± 0.5 ft	0.0 ± 0.1 ft	Pass												
Loaded single axles	± 20%	-3.1 ± 11.3%	Pass																																				
Loaded tandem axles	± 15%	1.0 ± 7.2 %	Pass																																				
Gross vehicle weights	± 10%	0.2 ± 4.9 %	Pass																																				
Vehicle speed	± 1 mph	0.2 ± 1.3 mph	Fail																																				
Axle spacing length	± 0.5 ft	0.0 ± 0.1 ft	Pass																																				
Arkansas SPS-2 (I-30, 39 miles west of Little Rock)	bending plate and iSINC electronics	Phase II - Validation	-5-axle tractor-trailer with a tractor having an air suspension and a trailer with a standard rear tandem and an air suspension loaded to 77,150 lbs., -5-axle tractor semi-trailer with a tractor having an air suspension and a trailer with a standard rear tandem and a steel leaf suspension loaded to 63,040 lbs.,	Satisfactory, no distress, WIM index was not exceeded	43 ~ 65	70 ~ 104	<p>Evaluation - LTPP Precision Requirement</p> <table border="1"> <tr><td>Loaded single axles</td><td>± 20%</td><td>-2.0% ± 7.0%</td><td>Pass</td></tr> <tr><td>Loaded tandem axles</td><td>± 15%</td><td>1.6% ± 5.7%</td><td>Pass</td></tr> <tr><td>Gross vehicle weights</td><td>± 10%</td><td>1.1% ± 3.6%</td><td>Pass</td></tr> <tr><td>Vehicle speed</td><td>± 1 mph</td><td>-0.3 ± 1.6 mph</td><td>Fail</td></tr> <tr><td>Axle spacing length</td><td>± 0.5 ft</td><td>-0.0 ± 0.0 ft</td><td>Pass</td></tr> </table> <p>Evaluation - ASTM E-1318-02 (Type I) (Same as Texas SPS-1)</p>	Loaded single axles	± 20%	-2.0% ± 7.0%	Pass	Loaded tandem axles	± 15%	1.6% ± 5.7%	Pass	Gross vehicle weights	± 10%	1.1% ± 3.6%	Pass	Vehicle speed	± 1 mph	-0.3 ± 1.6 mph	Fail	Axle spacing length	± 0.5 ft	-0.0 ± 0.0 ft	Pass												
Loaded single axles	± 20%	-2.0% ± 7.0%	Pass																																				
Loaded tandem axles	± 15%	1.6% ± 5.7%	Pass																																				
Gross vehicle weights	± 10%	1.1% ± 3.6%	Pass																																				
Vehicle speed	± 1 mph	-0.3 ± 1.6 mph	Fail																																				
Axle spacing length	± 0.5 ft	-0.0 ± 0.0 ft	Pass																																				
Delaware SPS-1 (US 113, milepost 25.04)	quartz piezo WIM and iSINC electronics.	Phase II - Validation	-5-axle tractor-trailer with a tractor having an air suspension and a trailer with a standard rear tandem and an air suspension loaded to 78,880 lbs., -5-axle tractor semi-trailer with a tractor having a 4 full leaf suspension and a trailer with a tandem and an air suspension loaded to 66,300 lbs	Satisfactory, no distress, WIM index was not exceeded	39 ~ 55	53 ~ 76	<p>Evaluation - LTPP Precision Requirement</p> <table border="1"> <tr><td>Loaded single axles</td><td>± 20%</td><td>-1.8 ± 5.9%</td><td>Pass</td></tr> <tr><td>Loaded tandem axles</td><td>± 15%</td><td>-0.8 ± 7.2%</td><td>Pass</td></tr> <tr><td>Gross vehicle weights</td><td>± 10%</td><td>-0.5 ± 5.9%</td><td>Pass</td></tr> <tr><td>Vehicle speed</td><td>± 1 mph</td><td>-</td><td>-</td></tr> <tr><td>Axle spacing length</td><td>± 0.5 ft</td><td>0.0 ± 0.0 ft</td><td>Pass</td></tr> </table> <p>Evaluation - ASTM E-1318-02 (Type I) (Same as Texas SPS-1)</p>	Loaded single axles	± 20%	-1.8 ± 5.9%	Pass	Loaded tandem axles	± 15%	-0.8 ± 7.2%	Pass	Gross vehicle weights	± 10%	-0.5 ± 5.9%	Pass	Vehicle speed	± 1 mph	-	-	Axle spacing length	± 0.5 ft	0.0 ± 0.0 ft	Pass												
Loaded single axles	± 20%	-1.8 ± 5.9%	Pass																																				
Loaded tandem axles	± 15%	-0.8 ± 7.2%	Pass																																				
Gross vehicle weights	± 10%	-0.5 ± 5.9%	Pass																																				
Vehicle speed	± 1 mph	-	-																																				
Axle spacing length	± 0.5 ft	0.0 ± 0.0 ft	Pass																																				

1. The results are compared with LTPP precision requirements as indicated in Table VI-1

APPENDIX J

STATE OF CONNECTICUT

**PERFORMANCE AUDIT
OVERWEIGHT/OVERSIZE
COMMERCIAL VEHICLES**

June 21, 2003

AUDITORS OF PUBLIC ACCOUNTS
KEVIN P. JOHNSTON ♦ ROBERT G. JAEKLE

TABLE OF CONTENTS

EXECUTIVE SUMMARY	<i>i-vi</i>
AUDIT OBJECTIVES, SCOPE, AND METHODOLOGY	1
BACKGROUND	2
Department Staff Committed to Commercial Vehicle Weight and Size Program	3
Permits for Overweight/Oversize Vehicles.....	4
Enforcement	5
NOTEWORTHY ACCOMPLISHMENTS.....	10
RESULTS OF REVIEW	11
Item No. 1 - Compliance - Section 14-270c of the General Statutes	11
Item No. 2 - Weigh Stations - Hours of Operation	13
Item No. 3 - Data Collection – Weigh Station Activity.....	14
Item No. 4 - Calculation of Fines.....	17
Item No. 5 - Reduction of Fines – In Violation of Section 14-267a, Subsection (f)(5), of the General Statutes.....	18
Item No. 6 - Permit Fees – Issued for a “Base Permit” under Section 14-270 of the General Statutes	19
Item No. 7 - Permit Fees – Issued for an “Annual Permit” under Section 14-270 of the General Statutes	21
Item No. 8 - Effectiveness - Fixed versus Portable Scales.....	23
Item No. 9 - Additional Fines – Habitual Offenders	27
RECOMMENDATIONS.....	29
CONCLUSION	33
EXHIBITS:	
Section 14-270c of the General Statutes.....	A
Divisible Load Type Restrictions.....	B
Section 14-267a, Subsection (f)(2) and (f)(5), of the General Statutes	C

EXECUTIVE SUMMARY

In accordance with the provisions of Section 2-90 of the Connecticut General Statutes and with *Government Auditing Standards* issued by the Comptroller General of the United States, we have conducted a performance audit of the permit process and enforcement of overweight and oversize commercial vehicles. Due to concerns over traffic safety and damage to roadways and bridges, commercial vehicles that operate overweight and/or oversize have been a concern for some time. Public Act 98-248, codified, in part, as Section 14-270c of the General Statutes, was enacted during the February 1998 Regular Session of the General Assembly, to require that certain weigh stations be open for specific periods of time.



The conditions noted during the audit, along with our recommendations, are summarized below. Our findings are discussed in detail in the “Results of Review” section of this report.

Compliance - Section 14-270c of the General Statutes



Section 14-270c of the General Statutes presents specific staffing requirements at the Greenwich, Danbury and Union weigh stations. Each week, the Greenwich station must be staffed for eight work shifts, the Danbury station must be staffed for three work shifts, and the Union station must be staffed for between five and eight work shifts.

We reviewed the above shift requirements for the three weigh stations over a twelve week period. We noted that the minimum staffing requirements had not been met at the Danbury station four times and at the Greenwich station twice. At each of the stations, one of the exceptions was due to the placement of Department of Public Safety staff on “Presidential Detail.” One other exception at each station was due to a holiday during the week.

It should be noted that subsection (e) of Section 14-270c allows the Commissioner of Public Safety to reassign personnel if necessary to ensure public safety.

When planned shifts at the commercial vehicle weigh stations are cancelled, additional shifts should be scheduled to ensure that minimum staffing requirements are met. (See Item 1.)

**Weigh Stations -
Hours of
Operation**



As described above, Section 14-270c of the General Statutes requires certain weigh stations to be staffed for a minimum number of shifts. Operations at the individual weigh stations are often suspended due to circumstances such as bad weather and heavy traffic. The Statute does not address the issue of temporary closures as regards “minimal weigh station operations.”

Our review of activity reports disclosed that the number of commercial vehicles weighed during “open” shifts varies significantly. At times, general explanations are entered on production reports to explain a significant drop in the number of vehicles inspected. However, there are no records to determine the times or duration of closures.

The use of a log or other device to document the times that weigh stations are actually operating should be instituted. As regards minimum staffing requirements, consideration should also be given to “compensate” for shifts in which activity is minimal by adding additional shifts. (See Item 2.)

**Data Collection –
Weigh Station
Activity**

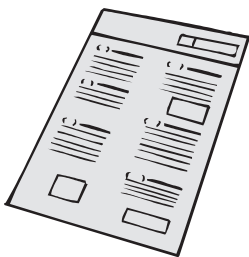

The Departments of Public Safety and Motor Vehicles report on the number of commercial vehicles weighed each shift at the individual weigh stations. Also reported, are the number of vehicles found in violation, as well as the fines issued, in total.

Our review disclosed that there is not a consistent system in place to report the above data. The Department of Motor Vehicles uses a summary sheet which presents the number of vehicles that are weighed on the “weigh in motion” (WIM) and fixed scales, as well as the number of infractions and fines issued. The Department of Public Safety uses a summary worksheet for the Greenwich and Danbury weigh stations, which presents the number of vehicles weighed on the WIM scale in Greenwich and the “fixed” scale in Danbury. Also presented are the number of infractions issued and the fines associated with those infractions, in total. For the Union station, the Department of Public Safety utilizes a manually completed daily activity report. This report has fields to capture the number of vehicles weighed on the WIM and fixed scales, as well as infraction and fine totals.

Our review of reports prepared by the Department of Public Safety disclosed that data was often missing or “approximated.” The Greenwich station has a WIM and fixed scale; however, the report used only has one field to capture such information. It was noted that the number of vehicles

weighed was often presented as an “even hundred” amount, which would indicate that the totals were either approximated or rounded. The daily activity reports used at the Union station by the Department of Public Safety had been set up to present the number of vehicles that are weighed on the WIM and fixed scales. However, we noted that Department personnel routinely only present one or the other. No record of man hours committed to each shift or troopers on duty, was present on the Department’s activity reports at the Union station.

The Departments of Motor Vehicles and Public Safety should use a uniform report and reporting system for commercial vehicle inspections and infractions. More care needs to be taken to ensure that reports are completely filled out using exact and not estimated information. (See Item 3.)

Calculation of Fines



Our review and recalculation of a sample of 393 overweight infractions disclosed that 31, or 7.9 percent, were calculated in error. The average error for the 31 infractions was \$232, or 30 percent of the \$772 average infraction.

More care needs to be taken to calculate infractions issued for overweight vehicles under Section 14-267a, subsection (f)(2), of the General Statutes. (See Item 4.)

Reduction of Fines – In Violation of Section 14-267a, Subsection (f)(5), of the General Statutes.



According to Section 14-267a, subsection (f)(5), of the General Statutes, no more than 25 percent of any fine imposed under the Section may be reduced unless the court determines that there are mitigating circumstances related to an infraction, and specifically states such circumstances for the record.

Our review of 20 infraction/fines that were reduced significantly more than 25 percent, disclosed that “mitigating circumstances” were not presented within any of the case files.

Judges and/or Magistrates, adjudicating cases brought under Section 14-267a of the General Statutes, should document the mitigating circumstances present when a reduction to a fine exceeds 25 percent. (See Item 5.)

**Permit Fees –
Issued for a “Base
Permit” under
Section 14-270 of
the General
Statutes**



Per Section 14-270, subsection (d), of the General Statutes, a “per move” permit may be issued by the Department of Transportation for a total fee of \$26 (\$23 permit fee; \$3 transmittal fee.) Under Connecticut Regulation 14-270-14, the permit is valid for three days for one continuous move between the points designated. While an applicant may propose a route to be taken, it is the responsibility of the Department of Transportation, Motor Transport Services Unit, to make final routing itineraries.

Our observations disclosed that most permit applications and moves are not exceptionally complicated. Motor Transport Services Unit staff are aware of bridge height and weight restrictions and roadway conditions, and will route planned moves accordingly. However, occasionally there are permit requests for extraordinarily large and/or heavy moves. Depending on the source and destination points, a significant amount of time and effort is expended to develop a satisfactory route. This may include engineering services to ensure that bridges and roadways on the route are strong enough to carry heavy loads. There may also be requirements to “shore up” certain roadways and bridges, when it is determined that the structural integrity of such will be in jeopardy. For these extraordinary moves, the total permit fee remains at \$26.

The General Assembly should consider amending Section 14-270, subsection (d), of the General Statutes, to include an additional charge for permits that require significant review and/or engineering services to approve. A fee amounting to the costs incurred by the Department of Transportation to review and approve the permit would appear equitable. (See Item 6.)

**Permit Fees –
Issued for an
“Annual Permit”
under Section
14-270 of the
General Statutes**



Per Section 14-270, subsection (d)(3), of the General Statutes, an operator may obtain an annual permit fee for an overweight and/or oversize vehicle, rather than paying a \$26 fee for each move. The operator is charged an annual fee of seven dollars per thousand pounds or fraction thereof for each vehicle.

Our review disclosed that the calculated “per permit/move fee” for annual permit holders varied considerably. Of the 497 annual permits issued for the 2001-2002 fiscal year, we calculated that 76 had per permit/move fees of less than \$5.00 each. For one operator, the ultimate per permit fee amounted to only 51 cents each. The operators must still obtain approval from the Motor Transport Services Unit for each move. The Unit remains responsible for reviewing each request and routing the vehicles properly.

The General Assembly should consider amending Section 14-270, subsection (d)(3), of the General Statutes, to either place a limit on the number of individual move permits that may be issued for annual permit holders, or include a charge for each individual permit so issued. This would create a fee structure that is more equitable to the individual operators and would further correlate to the costs incurred by the Motor Transport Services Unit to review and approve each individual move request. (See Item 7.)

**Effectiveness -
Fixed versus
Portable Scales**

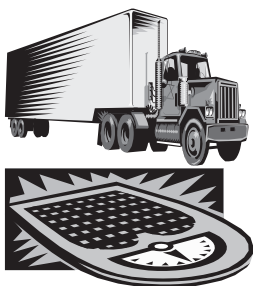

The Departments of Public Safety and Motor Vehicles enforce size and weight laws by operating the five fixed weigh stations located within the State and through the use of portable scales. The equipment and facility designs at the five weigh stations vary to a considerable degree. As explained above, the Departments report on the number of commercial vehicles weighed each shift at the individual weigh stations, the numbers of vehicles found in violation, and fines issued, in total.

Our review of enforcement data was not conclusive due to deficiencies with the reporting processes used by the two Departments. We noted that statistics among months often varied to a significant degree, and as such, strictly relying on “average” amounts over a quarterly basis is questionable. However, it does appear evident that infractions and the amount of fines issued related to such infractions, calculated on a “per manhour basis,” is relative to the level of equipment and facility designs at the fixed stations. Further, it was evident that significantly overweight vehicles are more apt to be discovered by a portable scale operation rather than at a fixed scale station.

To enhance efficiency, consideration should be given to making improvements at certain weigh stations, including an expanded use of “Weigh In Motion” (WIM) devices. In the absence of such improvements, consideration should be given to discontinuing operations at certain stations, most notably the Waterford facility, and to reallocating personnel to portable scale efforts. (See Item 8.)

**Additional Fines
– Habitual
Offenders**



Per Section 14-267a, subsection (f)(3), of the General Statutes, the Commissioner of the Department of Motor Vehicles may impose a \$2,000 civil penalty on the operator of a motor vehicle that has received three or more convictions within a calendar year for being in excess of fifteen percent overweight. This penalty is in addition to the fines and surcharges associated with the individual violations.

The Department of Motor Vehicles does not have a process in place to identify habitual offenders and to therefore collect additional fines that may be imposed under the above section.

The Department should establish procedures to collect information on habitual overweight commercial vehicle operators so that civil penalties may be imposed and collected, in accordance with Section 14-267a, subsection (f)(3), of the General Statutes. (See Item 9.)

Audit Objectives, Scope, and Methodology

The Auditors of Public Accounts, in accordance with Section 2-90 of the Connecticut General Statutes, are responsible for examining the performance of State entities to determine their effectiveness in achieving expressed legislative purposes.

We conducted this performance audit related to overweight/oversize commercial vehicles in accordance with *Government Auditing Standards* issued by the Comptroller General of the United States. This audit encompassed program and efficiency issues, which are types of performance audits. Our objective was to determine if commercial vehicle weight and size laws are adequately and efficiently enforced. More specifically, we wanted to evaluate the following criteria:

- ❖ Given the resources available, are enforcement efforts over overweight/oversize commercial vehicles satisfactory?
- ❖ Are the weigh station operating schedule requirements, specifically mandated by Section 14-270c of the General Statutes, being met?
- ❖ Are fines and other measures, directed toward habitual offenders, serving as satisfactory deterrents?
- ❖ Can the State units responsible for enforcing overweight limits be organized more efficiently?
- ❖ Are there duplicative processes that could be eliminated?
- ❖ Are permits and fines properly calculated, collected and deposited?

A significant percentage of our audit work was performed at the Department of Transportation, Department of Public Safety, and Department of Motor Vehicles. We performed site visits at the above agencies as well as to the fixed weigh stations to observe and review operations

Our review at the Department of Transportation consisted of a review of the permit process and fee schedule for overweight/oversize vehicles, as well as a recalculation of the fees collected for issued permits. At the Department of Motor Vehicles and Department of Public Safety, we performed a review of staff and shift schedules for compliance with minimum staffing requirements, reviewed the fine structure in place and re-calculated a sample of infractions issued. We also performed an analysis of activity and reviewed data collection practices. Further, we reviewed the progress made at the Department of Motor Vehicles to identify and pursue additional fines from habitual offenders. At the Judicial Department we reviewed the disposition of fines issued, to determine if reduced fines were done so properly.

We did not rely on computer generated data to any material degree and did not, therefore, assess the reliability of such. We obtained certain information from certain databases and considered the reasonableness of such data where possible.

BACKGROUND

The State of Connecticut has a highly developed highway infrastructure system that is shared by automobile and commercial vehicle traffic. Due to concerns over traffic safety, and damage to roadways and bridges, specific weight and size limits for commercial vehicles have been established, as follows:

- ❖ Section 14-267a, subsection (b), of the General Statutes prescribes weight restrictions for vehicles and trailers; subsection (f)(2) of the Section prescribes fines for vehicles that do not comply with the weight limits.
- ❖ Section 14-262 of the General Statutes imposes vehicle width and length limits, and provides that vehicles in violation of those limits are subject to a \$500 fine, as prescribed by subsection (d) of the Section.
- ❖ Section 14-264 of the General Statutes presents a specific vehicle height limit, and provides that vehicles in violation of the limit are subject to a \$1,500 fine.

Specific enforcement efforts were mandated with the enactment of Public Act 98-248 of the February 1998 Regular Session of the General Assembly. Sections of the Act, codified within Section 14-270c of the General Statutes (**Exhibit A**), address operating schedules of the fixed commercial vehicle weigh stations and require minimal portable scale efforts, as described below.

The State is required to submit an “Annual Size and Weight Enforcement Plan” each Federal fiscal year (October 1st through September 30th) in accordance with Title 23, of the Code of Federal Regulations, Part 657. The Commissioner of the Department of Transportation was appointed by the Governor to serve as the State’s official designee, as regards the submission of certification statements of compliance with respect to vehicle size and weight enforcement. This plan presents the following information, by Section:

- I. Purpose
- II. Policy
- III. Authority
- IV. Equipment
- V. Facilities
- VI. Resources
- VII. Personnel
- VIII. Plan of Operations
- IX. Goals

If the Federal Department of Transportation is satisfied with the plan, it is formally approved and serves as the guide for the Statewide approach to commercial vehicle weight and size enforcement. At the conclusion of each Federal fiscal year the Department of Transportation submits an “Annual Certification” which, among other things, certifies that laws governing commercial vehicle size and weight were enforced during the year, presents the number of vehicles weighed, and summarizes the number of citations issued. The status of goals presented in the original plan is also presented.

Department Staff Committed to Commercial Vehicle Weight and Size Program:

Department of Transportation:

The reporting of cumulative data to the Federal Department of Transportation, and the issuing of permits and routing of oversize/overweight vehicle moves is the responsibility of the Department of Transportation. Such activity is administered in an Oversize/Overweight Permit Section, which is within the Bureau of Engineering and Highway Operations, as follows:

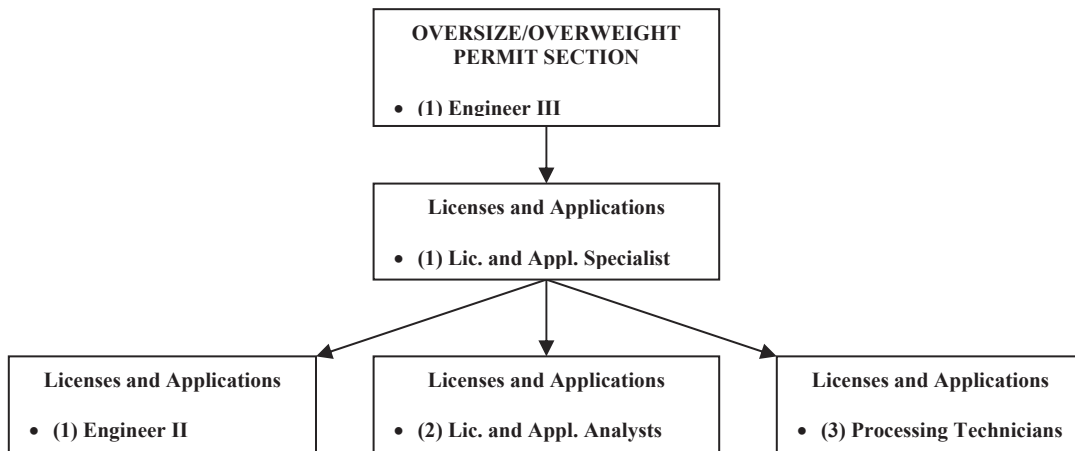

Department of Public Safety:

The enforcement of commercial vehicle weight and size limits is the responsibility of the Department of Public Safety and Department of Motor Vehicles. Enforcement is generally accomplished through the operation of fixed commercial vehicle weigh stations and the use of portable scales, as described below. Department of Public Safety staff are organized as follows:

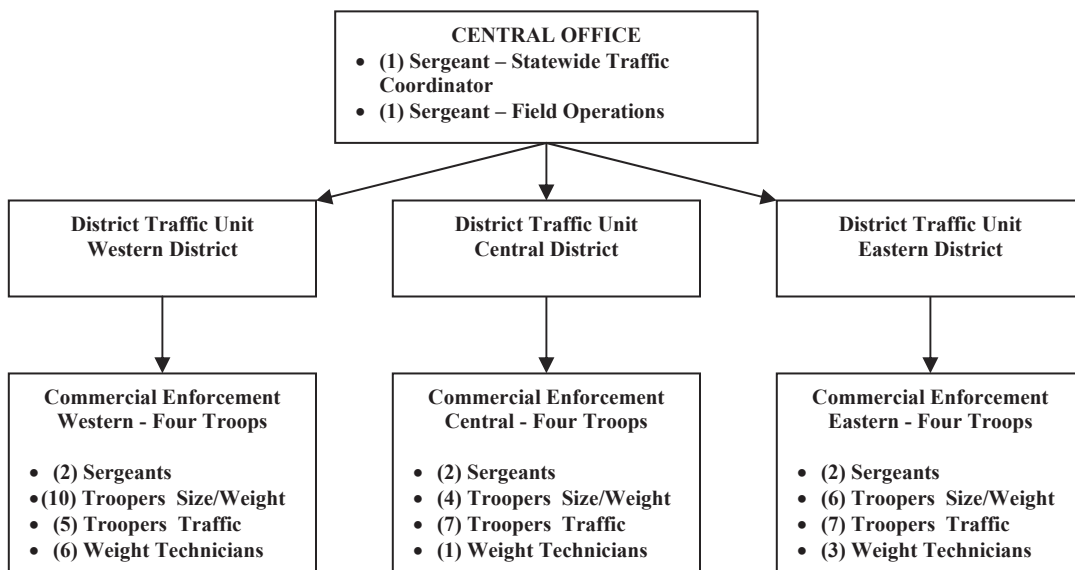

Department of Motor Vehicles:

Enforcement activities at the Department of Motor Vehicles are administered in the “Commercial Vehicle Operations Unit” within the Bureau of Safety and Enforcement. The principal duties of the Unit are to perform safety inspections. Size and weight inspections are one facet of that responsibility. There are approximately 36 staff within the Unit, as follows:

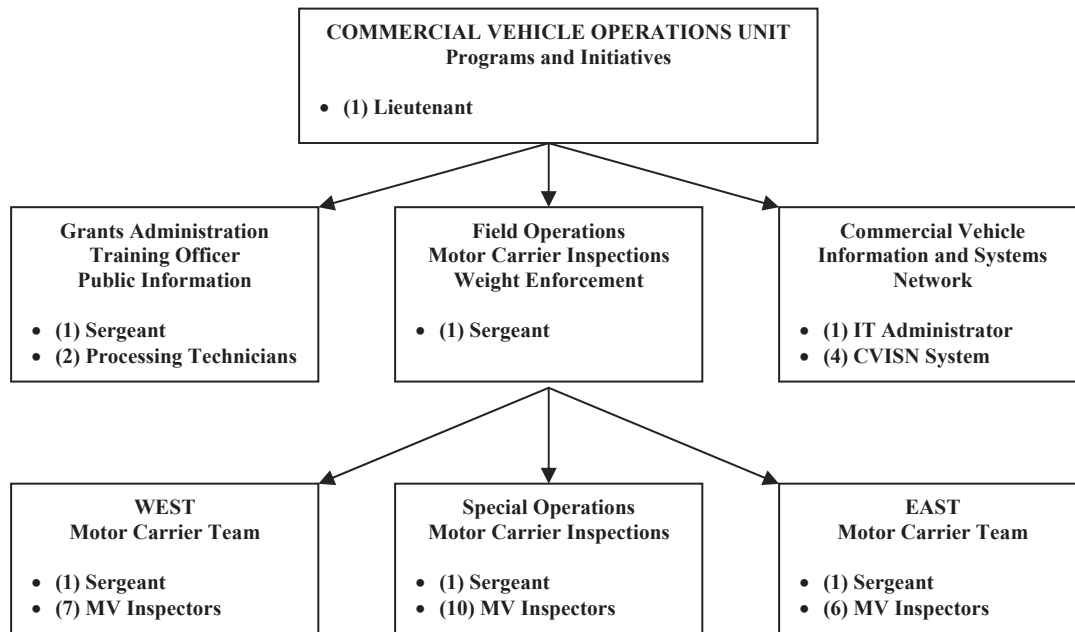

Permits for Overweight/Oversize Vehicles:

Section 14-270 of the General Statutes allows the Department of Transportation to issue permits for vehicles that do not meet the weight and size restrictions presented within the above Sections. After reviewing an operator’s request, the Department may grant a permit on either a “per move” or annual basis.

Whether a vehicle load is “Divisible” or “Indivisible” is critical. In general terms, loads that are divisible will not be issued permits, as a load may easily be altered to meet size and weight limits. However, there are certain exceptions to this principle related to the type of commodity being moved. Per the Department’s “Divisible Load Permit Policy”, permits may be issued for specific “bulk materials and raw products.” These items such as sand, gravel, asphalt, raw milk, ash, salt and logs, may not be bundled, bagged and/or palletized. A complete list of allowable commodities is presented in **Exhibit B**.

Divisible Load “any load consisting of a product, material or equipment which can be reduced in height, weight, length and/or width to the specified statutory limit.” [Regulation 14-270-1(b)]

Indivisible Load “a vehicle or load which cannot be dismantled, disassembled, or loaded as to meet the specified statutory limit for height, weight, length and/or width of the subject vehicle.” [Regulation 14-270-1(h)]

The “per move” permit fee, which includes a \$3.00 transmittal fee, totals \$26.00. Annual permit fee holders are charged at the rate of \$7.00 per thousand pounds or fraction thereof for each vehicle. The annual fee may be issued in any monthly increment for up to one year, provided the owner shall pay a fee of one-tenth of the annual fee for such vehicle for each month or fraction thereof.

We comment on the permit fee structure, in the “Results of Review” section of this report.

Enforcement:

As presented above, the Department of Public Safety (State Police) and Department of Motor Vehicles share in the inspection of commercial vehicles and the issuance of infractions for weight and size violations. The Department of Public Safety is viewed as having more of an “enforcement” approach, while the Department of Motor Vehicles is viewed as having more of a “compliance” purpose. The Department of Motor Vehicles considers the weight and size of a commercial vehicle to be one facet within its safety inspection. The Department is more apt to follow-up on safety problems disclosed as a part of their safety inspections, with the motor carriers in violation.

Enforcement is accomplished through the operation of the “Fixed Commercial Vehicle Weigh Stations” and the use of portable scales.

As regards the portable scales, they may be used 1) to set-up a weighing operation at designated areas throughout the State that are safe and conducive for such efforts, or 2) to weigh a vehicle at the request of any law enforcement agency. The Department of Motor Vehicles Inspectors themselves use the scales, while the Department of Public Safety has civilian weight technicians. Often the scales are used to weigh vehicles that are suspected of purposely bypassing a fixed weigh station. Section 14-270c of the General Statutes requires that the scales be in operation for ten shifts in each seven-day period from Sunday through Saturday.

Currently there are five fixed weigh stations. Three of the stations have the following minimal operating schedules as required by Section 14-270c of the General Statutes:

- ❖ **Greenwich** - *Eight work shifts in each seven-day period from Sunday through Saturday.*
- ❖ **Danbury** – *Three work shifts in each seven-day period from Sunday through Saturday.*
- ❖ **Union** – *Between five and eight work shifts in each seven-day period from Sunday through Saturday.*

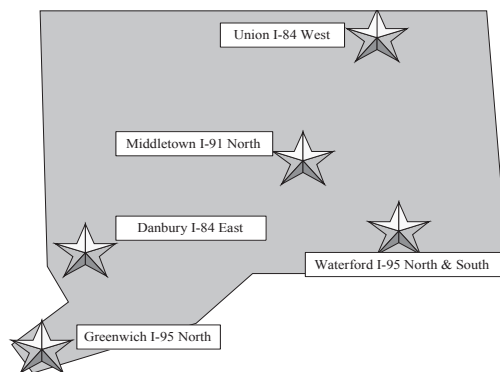

We comment on exceptions we noted to the above requirements and our concern over stations that are deemed “open” but not always operating, in the “Results of Review” section of this report.



The conditions/effectiveness of the stations vary considerably. The Union station is the most “state-of-the art” facility while the Waterford stations (north and southbound) are barely operable. The Union and Greenwich stations have “Weigh In Motion” (WIM) devices, which may be used to increase the efficiency of operations. These WIM’s identify the weight of a vehicle at a slow rate of speed as they pull into the weigh station. The vehicles that do not appear to be overweight are allowed to return to the highway without stopping if the operator has instructed the system to do so. This allows efforts to be targeted towards violators to a greater degree. A general description of basic operations at the Union station follows:

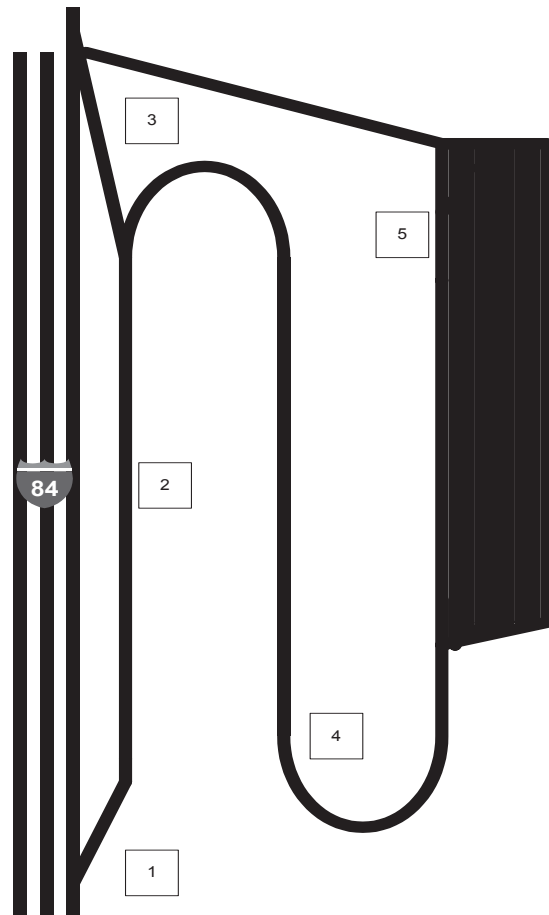

1. As commercial vehicles travelling Interstate 84 Westbound approach the Union station, they are instructed to stop at the weigh station if it is open and in operation.



2. The vehicles pass through the Weigh In Motion (WIM) device at a low rate of speed.



3. If the vehicle is deemed to be in compliance based on the WIM sensors it is normally allowed to return to the highway. An operator at the fixed scale building is in view of the vehicles and may bypass the system to either direct all vehicles to return to the highway or to pull onto the fixed scale.



4. Vehicles directed to the fixed scale are officially weighed at this point. The drivers are routinely asked for vehicle/registration/license information and their driver log.



5. Vehicles in violation are directed to a large lot. This area is also used to perform safety inspections. On the left is a covered “pit” which allows inspectors to walk underneath vehicles as they perform such inspections.



The conditions and available equipment at the five weigh stations vary considerably. As such, the level of production at each facility varies significantly as well. We comment on station conditions, manpower requirements and the effects of such on the level of enforcement, in the “Results of Review” section of this report.

It should be noted that new technology (Commercial Vehicle Information Systems and Networks [CVISN]) is in the process of being implemented. This new system will serve as a clearinghouse for a number of databases including vehicle registration, insurance, tax, prior violations and permits. The principal purpose of this technology is to identify “high risk” carriers and to allow safe and legal vehicles to proceed unimpeded. Motor carriers must obtain a transponder to participate. This will be accomplished at the Union station, as follows:

- ❖ Approximately one mile from the weigh station, an Overhead Advance Vehicle Identifier (AVI) will identify a vehicle (via its transponder) as it crosses a high-speed WIM; the information is forwarded to the weigh station via fiber optic cable.

- ❖ The weigh station will query the CVISN system and observe the weight information.
- ❖ A signal will be sent to a transmitter approximately one-half mile from the weigh station. This signal (read by the vehicles transponder) will direct the driver to stop at the station if the system or weight reading indicate that there is some form of violation; the vehicle will be instructed to bypass the station if it is deemed to be “legal.”

Fines for width, height and length violations are imposed at a fixed rate of \$500 for width and length violations (Section 14-262 of the General Statutes) and \$1,500 for height violations (Section 14-264 of the General Statutes.) Fines for weight violations are structured in a way that imposes more severe penalties on the more significant violators, as follows:

- ❖ Section 14-267a, subsection (f)(2) (**Exhibit C**), presents the base fines assessed against overweight vehicles.
 - ❖ Vehicles up to 5 percent overweight - \$3.00 per hundred pounds of the amount overweight
 - ❖ Vehicles over 5 and up to 10 percent - \$5.00 per hundred pounds of the amount overweight
 - ❖ Vehicles over 10 and up to 15 percent - \$6.00 per hundred pounds of the amount overweight
 - ❖ Vehicles over 15 and up to 20 percent - \$7.00 per hundred pounds of the amount overweight
 - ❖ Vehicles over 20 and up to 25 percent - \$10.00 per hundred pounds of the amount overweight
 - ❖ Vehicles over 25 and up to 30 percent - \$12.00 per hundred pounds of the amount overweight
 - ❖ Vehicles over 30 percent overweight - \$15.00 per hundred pounds of the amount overweight
- ❖ A 50 percent “infrastructure fine” is imposed, as specified within Section 13b-70.
- ❖ A 12.5 percent charge to fund police training, imposed under Section 51-56a, subsection (c), is added to the base fine as well.
- ❖ An additional \$20 surcharge, per Section 54-143a of the General Statutes, is also imposed.

Minimum base fines are imposed under Section 14-267a, subsection (f)(2)

All fractional dollar amounts are rounded up to the next whole dollar.

As an example, the fine for a vehicle with a 80,000 pound gross vehicle weight limit which is weighed in at 88,500 pounds would be \$849.00, as calculated to the right.

<i>Base fine (14-267a) ... (85 x \$6 [10.6% over])</i>	<i>\$ 510.00</i>
<i>Infrastructure fine (13b-70) ... (\$510.00 x .50)</i>	<i>255.00</i>
<i>Police Training (51-56a) ... (\$510.00 x 12.5%)</i>	<i>64.00</i>
<i>Court Surcharge (54-143a) ...</i>	<i><u>20.00</u></i>
<i>TOTAL AMOUNT DUE</i>	<i><u>\$849.00</u></i>

Base fines for vehicles that are operating under an overweight permit that exceed the weight specified in such permit, are calculated at the rate of \$15.00 per hundred pounds overweight or fraction thereof.

Per Department of Motor Vehicles records, 2,423 infractions for overweight/oversize violations were issued during the period of October 1, 2001, through September 30, 2002. The fines related to those infractions totaled \$1,483,255. The Department tracks the ultimate collection of fines in total, and determined that approximately 50 percent of the fines were collected. Staff familiar with collections believe that the collection rate for the period is consistent with past years.

Per Department of Public Safety records, 3,445 infractions for overweight/oversize violations were issued during the period of October 1, 2001, through September 30, 2002. The fines related to those infractions totaled \$2,260,876. The Department does not track the ultimate collection of such fines. However, staff have been informed by the Judicial Department's Centralized Infractions Bureau that approximately 60 percent of such fines are ultimately collected.

Section 14-267a, subsection (f)(5), of the General Statutes (**Exhibit C**), provides that no more than 25 percent of any overweight fine may be reduced unless the court determines that there are mitigating circumstances and specifically states such circumstances for the record.

Our concerns over the calculation of fines and the adjudication of certain fines are presented in the "Results of Review" section of this report.

The reporting of enforcement efforts is not uniform. While similar information is reported concerning the number of vehicles weighed, infractions issued and fines imposed, we noted that the Departments of Public Safety and Motor Vehicles presented it in different form. We also noted some inconsistencies that are presented in the "Results of Review" section of this report.

NOTEWORTHY ACCOMPLISHMENTS

As regards the Commercial Vehicle Information Systems and Networks (CVISN) program, our observations during a site visit at the Union weigh station disclosed that much of the hardware necessary to operate the system had been installed and tested. We noted that the high speed Weigh In Motion (WIM) devices had been set into the roadway and that transmitter equipment had been mounted. We were informed that the system was set to begin operating in September 2002; however, a mechanical failure has postponed the start date until the beginning of 2003. The Greenwich site is in the design phase; a start date in Spring 2003 is planned.

RESULTS OF REVIEW

Our examination of the permit process and enforcement of overweight and oversize commercial vehicles disclosed matters of concern requiring disclosure and attention. We presented individual recommendations to the Department of Transportation, Department of Public Safety, Department of Motor Vehicles and/or the Judicial Department, depending on the relevance of each recommendation to the individual agencies, and requested a response. Those responses are incorporated within this section of the report.

Item No. 1 - Compliance - Section 14-270c of the General Statutes:

Background: Due to concerns over traffic safety, and damage to roadways and bridges, specific weight and size limits for commercial vehicles have been established. The General Assembly enacted minimum enforcement efforts as described below.

Criteria: Section 14-270c, subsections (a)(1) through (a)(3), of the General Statutes present specific staffing requirements at the Greenwich, Danbury and Union weigh stations. Each week, the Greenwich station must be staffed for eight work shifts, the Danbury station must be staffed for three work shifts, and the Union station must be staffed for between five and eight work shifts. The premise behind such enforcement efforts is that potential violators will be less apt to operate illegally.

Condition: We reviewed the shift requirements mandated by Section 14-270c of the General Statutes for the three weigh stations over a twelve week period. We noted that the minimum staffing requirements had not been met at the Danbury station four times and at the Greenwich station twice.

Effect: Mandated shift requirements at the weigh stations were not always complied with. This could ultimately lead to an environment whereby violators are more apt to operate. As such, the risk of infrastructure damage increases as do safety concerns.

Cause: At each of the stations, one of the exceptions was due to the placement of Department of Public Safety staff on “Presidential Detail.” One other exception at each station was due to a holiday during the week.

It should be noted that subsection (e) of Section 14-270c allows the Commissioner of Public Safety to reassign personnel if necessary to ensure public safety.

Recommendation: When planned shifts at the commercial vehicle weigh stations are cancelled, additional shifts should be scheduled to ensure that minimum staffing requirements are met. (See Recommendation 1.)

Agency Responses: **Department of Public Safety:**
“While Connecticut General Statute 14-270c does specify staffing requirements at Official Weighing Stations, the law states in subsection (e) that “Nothing in this section shall prohibit the Commissioner of Public Safety from reassigning personnel in the Traffic Unit as he deems necessary in order to ensure public safety.” This section seems to imply the legislature did not intend to micro manage the day-to-day operations of the Traffic Units but to provide a framework in which they were to work.

The Connecticut State Police is meeting the intent of this law. Traffic Unit personnel are scheduled to work the required shifts at the scales and do not leave these sites unless absolutely necessary. The occasions that troopers are reassigned to other details is primarily because of their specialized knowledge, the staffing impact on patrol troops if they had to be assigned to the detail, budgetary considerations, truck accident investigations and to meet subpoena obligations. These troopers cannot be replaced at the same time because other certified troopers are not available.

To meet the full letter of law, shifts would have to be reassigned or extended which would incur overtime costs. We could also run into officer safety issues concerning the number of work hours the troopers are assigned in a workday. Presidential details can take 10-12 hours. Requiring a trooper to put in an additional 8-hour shift at the scale will bring his workday to approximately 20 hours. This is a violation of Department policy, becomes an officer safety issue and causes a ripple effect on scheduling to cover the next shift and next day operations.”

Department of Motor Vehicles:
“The Department of Motor Vehicles has complied with the statute. Mandated hours of operation at Union have been met or exceeded. The DMV makes every effort to replace or reassign shifts when scheduled shifts have not been met for whatever reason.”

Item No. 2 - Weigh Stations - Hours of Operation:

Background: While weigh stations are considered “open” during specific shifts throughout a scheduled period, there are often times during those shifts when commercial vehicles will not be directed to stop at the stations. This may be due to traffic, weather and/or staffing concerns.

Criteria: Section 14-270c, subsections (a)(1) through (a)(3), of the General Statutes present specific staffing requirements at the Greenwich, Danbury and Union weigh stations. Each week, the Greenwich station must be staffed for eight work shifts, the Danbury station must be staffed for three work shifts, and the Union station must be staffed for between five and eight work shifts.

The Department of Public Safety and Department of Motor Vehicles develop schedules to ensure that the above staffing/shift requirements are met.

Condition: Our review of activity reports disclosed that the number of commercial vehicles weighed during “open” shifts varies significantly. At times, general explanations are entered on production reports to explain a significant drop in the number of vehicles inspected. However, there are no records to determine the times or duration of closures.

Effect: Mandated shifts are not “open” for operation the entire time that they are deemed to be. We question whether the spirit of Section 14-270c is being satisfied.

Cause: There are no logs or other records to document the times that “open” weigh stations are actually operating or temporality closed.

Recommendation: The use of a log or other device to document the times that weigh stations are actually operating should be instituted. As regards minimum staffing requirements, consideration should also be given to “compensate” for shifts in which activity is minimal by adding additional shifts. (See Recommendation 2.)

Agency Responses: **Department of Public Safety:**
“A policy of maintaining a log for the times that a particular weigh station is open can be instituted. We currently maintain daily activity records for each trooper. These day sheets include time spent at the scale and time spent at other assignments. If one

trooper is working at a scale, the scale is considered open even if he is tied up with an inspection.

It is important to remember that each facility is different and the troopers assigned to the scales have specialized training in commercial vehicle enforcement and inspection. Due to this specialized knowledge, they are called upon to help in certain situations. Staffing of scales can vary depending on commitments for that day i.e. court subpoenas, accident investigation assignments, requests for assistance to local police departments, training needs etc. As documented in this report a reduction in staff will result in varied numbers for vehicles weighed at the scale.

In order to meet the strict letter of the law concerning minimum staffing levels, the number of troopers assigned to commercial vehicle enforcement will need to be increased. To compensate for closed shifts, replacement shifts will need to be assigned and the troopers assigned will have to be compensated at an overtime rate.”

Department of Motor Vehicles:

“The system software currently being used should be modified to capture and produce reports with WIM and static scale statistics which will accurately depict the level of scale operation for any time period. The DMV will propose to DOT that they consider modifying current or developing enhanced system software to allow for a more automated reporting system. In the interim the DMV will review the current reporting system to ensure necessary data is being collected.”

Item No. 3 - Data Collection – Weigh Station Activity:

Background: The Department of Public Safety and Department of Motor Vehicles staff the fixed weigh stations located within the State.

Criteria: The collection and compilation of weigh station statistics regarding the number of vehicles weighed and infractions issued is a good tool to monitor enforcement efforts. The Departments of Public Safety and Motor Vehicles report on the number of commercial vehicles weighed each shift at the individual weigh stations. Also reported, are the number of vehicles found in violation, as well as the fines issued, in total.

Condition: Our review disclosed that there is not a consistent system in place to report the above data. The Department of Motor Vehicles uses a summary sheet which presents the number of vehicles that are weighed on the “weigh in motion” and fixed scales, as well as the number of infractions and fines issued. The Department of Public Safety uses a summary worksheet for the Greenwich and Danbury weigh stations, which presents the number of vehicles weighed on the “weigh in motion” scale in Greenwich and the “fixed” scale in Danbury. Also presented are the number of infractions issued and the fines associated with those infractions, in total. For the Union station, the Department of Public Safety utilizes a manually completed daily activity report. This report has fields to capture the number of vehicles weighed on the weigh in motion and fixed scales, as well as infraction and fine totals.

Our review of Department of Public Safety reports disclosed that data was often missing or “approximated.” The Greenwich station has a weigh in motion and fixed scale; however, the report used only has one field to capture such information. It was noted that the number of vehicles weighed was often presented as an “even hundred” amount, which would indicate that the totals were either approximated or rounded. The daily activity reports used at the Union station by the Department of Public Safety had been set up to present the number of vehicles that are weighed on the weigh in motion and fixed scales. However, we noted that Department personnel routinely only present one or the other. It was also noted that “troopers assigned,” or some other record to calculate man hours committed to each shift, was not present on the Department’s activity reports at the Union station.

Effect: It is difficult to evaluate enforcement efforts without having accurate, uniform and comparable information or reporting methods.

Cause: The Department of Public Safety and Department of Motor Vehicles have not worked collectively to establish a uniform reporting system for weigh station activities.

Recommendation: The Departments of Motor Vehicles and Public Safety should use a uniform report and reporting system for commercial vehicle inspections and infractions. More care needs to be taken to ensure that reports are completely filled out using “actual” and complete information. (See Recommendation 3.)

Agency Responses: **Department of Public Safety:**

“While both Public Safety and Motor Vehicles staff the fixed scales we do collect and compile different data. This is primarily due to the fact that we have different reporting requirements. The Department of Public Safety is the enforcement arm for the Department of Transportation’s Statewide Size and Weight Plan. For this plan, specific data has to be collected and submitted to the Department of Transportation for its annual report to the Federal Highway Administration. The Department of Motor Vehicles has a different reporting requirement to the Federal Government. Its reports are submitted to the Federal Highway Administration as part of their MCSAP grant requirements.

We believe that there is always a better way to do business. We have a core group of DPS and DMV supervisors who meet quarterly. The feasibility of creating a reporting system that includes both our reporting requirements was brought up at a recent meeting. However, no commitment was made at the time, as it will have to be determined how all users of such information will be satisfied by a report that is approximately the same in length/detail as the current report.

The suggestion that the Department of Public Safety establish a uniform reporting system for scale operations can be instituted immediately. Using the current daily activity sheets and ensuring they are completely filled out should satisfy this suggestion.”

Department of Motor Vehicles:

“One issue that has contributed to the lack of a uniform reporting system is the ultimate user of the data; in DMV’s case the Federal Motor Carrier Safety Administration (MCSAP) and in Public Safety’s case the Department of Transportation and the Federal Highway Administration. For instance, the MCSAP is focussed on driver and vehicle inspections and emphasis is given to that type of data, however, size and weight enforcement data is also collected as part of the inspection process. In the case of the DPS, the focus of the data is on size and weight and compliance with that program to protect and preserve the highway infrastructure. Each agency collects different data destined for different purposes and users.

The DMV and DPS will work to develop one uniform reporting mechanism that will collect the necessary data elements to satisfy both ultimate users and ensure a consistent and accurate method of statistical reporting. Care must be taken in developing such a report considering each agency has different reporting requirements. Agreement and consensus must be reached with the

DOT and the DPS regarding the specifics of what data is needed and must be collected.”

Item No. 4 – Calculation of Fines:

Background: Infractions for overweight/oversize commercial vehicles are issued by Department of Public Safety and Department of Motor Vehicles enforcement staff.

Criteria: Fines for width, height and length violations are imposed at a fixed rate of \$500 for width and length violations (Section 14-262 of the General Statutes) and \$1,500 for height violations (Section 14-264 of the General Statutes.) Fines for weight violations are structured in a way that imposes more severe penalties on the more significant violators. Per Section 14-267a, subsection (f)(2), base fines are calculated by applying a rate for each hundred pounds overweight, or portion thereof. This rate increases with the severity of the infraction, from \$3.00 per hundred pounds overweight for vehicles that are up to five percent overweight, to \$15.00 per hundred pounds overweight for vehicles that are over 30 percent overweight. Surcharges are calculated and added to the base fines as well.

Condition: Our review and recalculation of a sample of 393 infractions disclosed that 31, or 7.9 percent, were calculated incorrectly. The average error was \$232, or 30 percent of the \$772 average infraction. Of the 31 errors, three exceeded \$1,000, and ten were between \$100 and \$999. We did not consider rounding errors and/or those errors less than \$10 in the above totals.

Effect: Commercial vehicle operators that are issued infractions for being overweight are often either overcharged or undercharged.

Cause: The computation of base fines and the addition of surcharges requires a number of calculations which are susceptible to error.

Recommendation: More care needs to be taken to calculate infractions issued for overweight vehicles under Section 14-267a of the General Statutes. (See Recommendation 4.)

Agency Responses: **Department of Public Safety:**
“DPS truck squad supervisors were asked to review the summonses in question. The review found that errors were made by percentages being rounded up or down. In addition there were basic math errors of which the majority were in favor of the accused. Traffic unit sergeants showed these deficiencies to their

troopers and the troopers were counseled. In the future, supervisors will do random audits of the summonses issued by their personnel to ensure uniformity and minimize math errors.

We did find that some of the calculation errors were not errors on our part but that the auditor did not understand the procedure to calculate fines for permitted loads. Permitted load overweight fines are calculated in a different manner from normal overweight calculations. Permitted fines are calculated from the permitted weight and not the allowed weight for the truck. These tickets were the high fines that were discovered.”

Department of Motor Vehicles:

“A review of the errors identified in calculating fines were found generally to be simple math errors or errors in rounding. Field operations Sergeants have been made aware of the issue. Random spot checks of infractions and weight calculation addendum will be instituted and the issue will be placed on the training curriculum and agenda for regular annual in service and annual certification training. A sample spreadsheet program will be developed to assist in the computation of fines.”

Auditors’ Concluding Comments:

As concerns the Department of Public Safety response, a misunderstanding concerning the rate of fines for permitted loads did occur during our initial review. After being made aware of the fines calculated in that manner, we recalculated the tested infractions, and did not include them in the totals presented in the “Condition” section.

Item No. 5 - Reduction of Fines – In Violation of Section 14-267a, subsection (f)(5), of the General Statutes:

Background: As with any infraction issued, operators cited for overweight/oversize commercial vehicle violations may plead “not guilty” to a charge and have his/her case brought forward within the Judicial system. For overweight/oversize infractions, the Centralized Infractions Bureau refers such cases to the applicable geographical courts for adjudication.

Criteria: According to subsection (f)(5) of Connecticut General Statutes 14-267a, no more than 25 percent of any fine imposed under the Section may be reduced unless the court determines that there are mitigating circumstances related to an infraction, and specifically states such circumstances for the record.

Condition: Our review of 20 infraction/fines that were reduced more than 25 percent, disclosed that “mitigating circumstances” were not presented within any of the case files.

It is estimated that only 50 and 60 percent of fines issued by the Departments of Motor Vehicles and Public Safety, respectively, are ultimately collected.

Effect: Infractions are routinely being reduced by more than 25 percent without documented justification, as required.

Cause: It appears that court personnel are not aware of the requirement that fines reduced by more than 25 percent have documented “mitigating circumstances” within the court record.

Recommendation: Judges and/or Magistrates, adjudicating cases brought under Section 14-267a of the General Statutes, should document the mitigating circumstances present when a reduction to a fine exceeds 25 percent. (See Recommendation 5.)

Agency Response: **Judicial Department:**
“We have reviewed this area and concur that improvements are appropriate. Please note that correspondence has been distributed to Judges, Senior Judges, Judge Trial Referees and Motor Vehicle Magistrates reminding them generally of the requirements set forth by Connecticut General Statute Section 14-267a and more specifically the need for documentation of mitigating circumstances.”

Item No. 6 - Permit Fees – Issued for a “Base Permit” under Section 14-270 of the General Statutes:

Background: Commercial vehicle operators that desire to transport goods exceeding weight and/or size restrictions may obtain a permit from the Department of Transportation to do so.

Criteria: Per Section 14-270, subsection (d), of the General Statutes, a “per move” permit may be issued by the Department of Transportation for a total fee of \$26 (\$23 permit fee; \$3 transmittal fee.) Under Connecticut Regulation 14-270-14, the permit is valid for three days for one continuous move between the points designated. While an applicant may propose a route to be taken, it is the responsibility of the Department of Transportation, Motor Transport Services Unit, to make final routing itineraries.

Condition: Our observations disclosed that most permit applications and moves are not exceptionally complicated. Motor Transport Services Unit staff are aware of bridge height and weight restrictions and roadway conditions, and will route planned moves accordingly. However, occasionally there are permit requests for extraordinarily large and/or heavy moves. Depending on the source and destination points, a significant amount of time and effort is expended to develop a satisfactory route. This may include engineering services to ensure that bridges and roadways on the route are strong enough to carry heavy loads. There may also be requirements to “shore up” certain roadways and bridges, when it is determined that the structural integrity of such will be in jeopardy. For these extraordinary moves, the total permit fee remains at \$26.

Effect: The fee structure in place does not appear equitable. The Motor Transport Services Unit expends significant time and effort to approve extraordinary large and/or heavy moves. The value of such time and effort significantly exceeds \$26.

Cause: A cause for this condition was not determined. Fees charged are specifically prescribed by statute.

Recommendation: The General Assembly should consider amending Section 14-270, subsection (d), of the General Statutes, to include an additional charge for permits that require significant review and/or engineering services to approve. A fee amounting to the costs incurred by the Department of Transportation to review and approve the permit would appear equitable. (See Recommendation 6.)

Agency Response: **Department of Transportation:**
“The Department of Transportation has submitted legislation for this year’s legislative session (FY03/04) that would amend Section 14-270(d) of the Connecticut General Statutes. The proposed legislation would assess the following engineering fees in an attempt to recoup costs to review and approve the permits.

(d) (1) THE OWNER OR LESSEE OF ANY VEHICLE SHALL PAY A FEE OF THIRTY-FIVE DOLLARS FOR EACH PERMIT ISSUED UNDER THIS SECTION OR A FEE DESCRIBED IN SUBDIVISION (2) OF THIS SUBSECTION FOR SUCH VEHICLE. EXCEPT FOR A SINGLE UNIT VEHICLE THAT IS OPERATING UNDER AN ACCOUNT CODE, A FIFTY DOLLAR ENGINEERING FEE WILL BE ASSESSED TO ANY SINGLE UNIT VEHICLE THAT EXCEEDS ANY OF THE

FOLLOWING GROSS WEIGHT LIMITS: ONE HUNDRED AND TEN THOUSAND POUNDS ON FOUR AXLES, ONE HUNDRED FOURTEEN THOUSAND FIVE HUNDRED POUNDS ON FIVE AXLES AND ONE HUNDRED FIFTEEN THOUSAND POUNDS ON SIX AXLES AND ANY VEHICLE COMBINATION WEIGHING LESS THAN TWO HUNDRED THOUSAND POUNDS WHEN ROUTING REQUIRES SUCH VEHICLE TO TRAVERSE A STRUCTURE WITH A NON-POSTED LIMIT. A TWO HUNDRED DOLLAR ENGINEERING FEE SHALL BE ASSESSED TO ANY VEHICLE COMBINATION WEIGHING TWO HUNDRED THOUSAND POUNDS OR MORE AND A FIVE HUNDRED DOLLAR ENGINEERING FEE SHALL BE ASSESSED TO ANY VEHICLE COMBINATION WEIGHING FIVE HUNDRED THOUSAND POUNDS OR MORE. VEHICLES REQUIRED TO PAY AN ENGINEERING FEE ARE AUTHORIZED TO USE APPROVED ROUTING FOR A SIX-MONTH PERIOD, SO LONG AS THE VEHICLE CONFIGURATION AND/OR ROUTING IS NOT CHANGED.”

Item No. 7 - Permit Fees – Issued for an “Annual Permit” under Section 14-270 of the General Statutes:

Background: Commercial vehicle operators that desire to transport goods that exceed weight and/or size restrictions may obtain a permit from the Department of Transportation to do so.

Criteria: Per Section 14-270, subsection (d)(3), of the General Statutes, an operator may obtain an annual permit fee for an overweight and/or oversize vehicle, rather than paying a \$26 fee for each move. The operator is charged an annual fee of seven dollars per thousand pounds or fraction thereof for each vehicle. The permit holder must continue to contact the Department of Transportation to obtain routing directives for each individual move.

Condition: Our review disclosed that the calculated “per permit/move fees” for annual permit holders varied considerably. Of the 497 annual permits issued for the 2001-2002 fiscal year, 76 had calculated per permit/move fees of less than \$5.00 each. For one operator, the ultimate per permit fee amounted to only 51 cents each. The operators must still obtain approval from the Motor Transport Services Unit for each move. The Unit remains responsible for reviewing each request and routing the vehicles accordingly.

Effect: The fee structure in place does not appear equitable. For operators that obtain a significant number of individual permits from an annual permit, the calculated fee per move is significantly lower than the related costs incurred by the Motor Transport Services Unit.

Cause: A cause for this condition was not determined. Fees charged are specifically prescribed by statute.

Recommendation: The General Assembly should consider amending Section 14-270, subsection (d)(3), of the General Statutes, to either place a limit on the number of individual move permits that may be issued for annual permit holders, or include a charge for each individual permit so issued. This would create a fee structure that is more equitable to the individual operators and would further correlate to the costs incurred by the Motor Transport Services Unit to review and approve each individual move request. (See Recommendation 7.)

Agency Response: **Department of Transportation:**
“The legislation submitted by the Department of Transportation for this year’s legislative session (FY03/04) also includes language to amend Section 14-270(d)(3) of the Connecticut General Statutes. The proposed legislation increases the fee from \$7.00 per one thousand pounds to \$9.00 per one thousand pounds. The proposed language also increases the monthly fee from 1/10 of the annual fee per month to \$100 per month. However, the proposed language does not fix the inequity problem cited by the audit. The proposed language was written before the audit and the increase was based solely on the rate of inflation from 1992.

The inequity problem is with account codes. Currently, the annual fee for an account code is based on a vehicle’s gross weight at \$7.00 per one thousand pounds. When we divided the total revenue that was collected for account codes by the number of permits that were issued to them, the cost per trip was less than \$10.00 per permit. Electronic payments could be one method to eliminate this inequity. The Department is currently developing a new Oversize/Overweight (OS/OW) Vehicle Permitting System with electronic payment capabilities. This system was the third contract award of the State’s Commercial Vehicle Information System and Network (CVISN) implementation project. Once CVISN is fully operational, commercial vehicle owners and operators would be able to purchase permits and other credentials electronically. The Department anticipates the OS/OW component to be fully operational by September 2004.

The change proposed to Section 14-270(d)(3) is as follows:
(2)THE COMMISSIONER MAY ISSUE A PERMIT FOR ANY VEHICLE TRANSPORTING (A) A DIVISIBLE LOAD, (B) AN OVERWEIGHT OR OVERSIZED-OVERWEIGHT INDIVISIBLE LOAD, OR (C) AN OVERSIZED INDIVISIBLE LOAD. THE OWNER OR LESSEE SHALL PAY AN ANNUAL FEE OF NINE DOLLARS PER THOUSAND POUNDS OR FRACTION THEREOF FOR EACH SUCH VEHICLE. A DIVISIBLE LOAD PERMIT MAY BE ISSUED IN ANY INCREMENT UP TO ONE YEAR, PROVIDED THE OWNER OR LESSEE SHALL PAY A MONTHLY FEE OF ONE HUNDRED DOLLARS PER MONTH FOR SUCH VEHICLE OR VEHICLE COMBINATION. THE ANNUAL PERMIT FEE FOR ANY VEHICLE TRANSPORTING AN OVERSIZED INDIVISIBLE LOAD SHALL NOT BE LESS THAN SIX HUNDRED AND FIFTY DOLLARS. SAID FEES ARE NOT PRORATED, TRANSFERABLE OR REFUNDABLE.”

Item No. 8 – Effectiveness - Fixed versus Portable Scales:

Background: The Departments of Public Safety and Motor Vehicles weigh commercial vehicles at either the fixed-scale weigh stations or through the use of portable scale units.

Criteria: Section 14-267a, subsection (b), of the General Statutes prescribes weight restrictions for vehicles and trailers; subsection (f)(2) of the Section prescribes fines for vehicles that do not comply with the weight limits. Section 14-262 of the General Statutes imposes vehicle width and length limits, and provides that vehicles in violation of those limits are subject to a \$500 fine. Section 14-264 of the General Statutes presents a specific vehicle height limit, and provides that vehicles in violation of the limit are subject to a \$1,500 fine.

The Departments of Public Safety and Motor Vehicles enforce size and weight laws by operating five fixed weigh stations located within the State and through the use of portable scales. The equipment and facility designs at the five weigh stations vary to a considerable degree. The Departments report on the number of commercial vehicles weighed each shift at the individual weigh stations, the number of vehicles found in violation, and the amount of fines issued, in total.

Condition: Our review of enforcement data was not conclusive due to deficiencies with the reporting processes used by the two Departments. We also noted that statistics between months often varied to a significant degree, and as such, strictly relying on “average” amounts over a quarterly basis is questionable. However, it does appear evident that infractions and the amount of fines issued related to such infractions, calculated on a “per manhour basis,” is relative to the level of equipment and facility designs at the fixed stations. Further, it was quite evident that vehicles that significantly exceed weight limits are more apt to be discovered by a portable scale operation rather than at a fixed scale station.

From the limited data we could analyze, our audit tests disclosed the following averages of charges and fines per man hour:

- The Department of Motor Vehicles is the agency principally responsible for the Union station. At the Union station, staff issued .074 infractions and \$25.10 in fines per man hour. At the Greenwich station, staff issued .040 infractions and \$18.77 in infractions per man hour.
- The Department of Public Safety is the agency principally responsible for the Greenwich and Danbury stations. At the Greenwich station, staff issued .164 infractions and \$64.26 in fines per man hour. At the Danbury station, staff issued .086 infractions and \$37.67 in fines per man hour.
- The Department of Public Safety had summary data for portable scale operations. For such operations, staff issued .125 infractions and \$162.12 in fines per man hour.

Our review of the design and condition of the Waterford stations, as well as discussions with Department of Motor Vehicles and Department of Public Safety personnel, disclosed that the stations are antiquated.

Effect: From the limited data available, it would appear that enforcement efforts at the older less-equipped weigh stations are inefficient. The more severe commercial vehicle weight violators are more apt to be identified by a portable scale operation.

As enforcement decreases the risk of noncompliance increases. This results in a higher risk that highway damage increases and/ or safety concerns increase.

Cause: A cause for this condition was not determined other than the fact that the older weigh stations were not fitted/equipped efficiently.

Recommendation: To enhance efficiency, consideration should be given to making improvements at certain weigh stations, including an expanded use of “Weigh In Motion” (WIM) devices. In the absence of such improvements, consideration should be given to discontinuing operations at certain stations, most notably the Waterford facility, and to reallocating personnel to portable scale efforts. (See Recommendation 8.)

Agency Responses: **Department of Public Safety:**

“We agree that to enhance efficiency, considerations should be given to expand the use of “Weigh in Motion” WIM scales. In fact, under ideal conditions, every interstate point of entry (I-84, I-91, I-95) should have a fixed scale facility with a WIM. Currently, only I-84 has fixed facilities at both the New York and Massachusetts borders. Scales at all points of entry, would ensure that commercial vehicles entering Connecticut would be exposed to inspections and guarantee the commercial vehicles are safe for our roads.

We strongly disagree that the Waterford scale should be closed without a replacement facility being built and in place to service South Eastern Connecticut.

In eastern Connecticut, the volume of trucks passing through the Union Scale is greater than Waterford and the quality of trucks in Union is much better. We have found that the commercial vehicles coming through the Waterford scale are in worse shape than Union. When comparing the activity of troopers working at the Union and Waterford scales, the Waterford operations tend to issue more summonses with higher potential fines than Union. Many of the trucks in Waterford are regional and local service commercial vehicles and not long haul interstate truckers. A large number of these vehicles are sea-land containers on pole trailers coming out of the Port of New York and Port Elizabeth New Jersey. These containers and trailers tend to be parked for long periods of time resulting in equipment that is in poor condition. We have also found that many of the regional drivers do not have the proper documentation to operate commercial vehicles. In addition, products coming out of the Port of New London have been found to be overweight. The need for a weighing facility in this area cannot be underestimated.

A report was completed and submitted to the Legislature on December 28, 1998 as required by Public Act 98-248. The subject

of this report was on status of weigh stations in the state with a recommendation for an alternate weigh station site in South Eastern Connecticut. The report recommended that a replacement scale facility be considered on I-95 in the North Stonington area. There were two possible sites identified and the approximate cost for a new facility, at that time, was approximately \$4,000,000.”

Department of Motor Vehicles:

“A viable and productive alternative called “Virtual Weigh Stations” should be given great consideration. The DMV fully supports this concept and initiative. Virtual weigh stations, in several other states, have proven effective, productive and extremely efficient. Although not discussed in detail during the audit process we feel this should not be omitted. Virtual weigh stations use WIM technology in remote, secondary or locations not physically able to support a “scale house or fixed site.” High speed WIMS are installed and wirelessly transmit weight data to mobile enforcement that can monitor traffic off site a distance away. Overweight violators can be identified downstream and taken to areas where portable scales can be used for official weight enforcement. Virtual weigh station deployment costs are a fraction of fixed sites and multiple locations can be deployed for the cost of one fixed site. Existing data indicates they are highly productive and effective. High speed WIM in conjunction with Mainline Automated Clearance is being expanded to Greenwich and possibly Danbury. Design limitations at Middletown and Waterford do not allow for the expansion of this technology.

In the absence of a suitable Waterford facility, DOT should consider the construction of a new facility in the area. In the interim the DMV will continue portable scale operations in this area.”

Auditors’ Concluding Comments:

As concerns the Department of Public Safety response, the Waterford facilities are in poor condition and not conducive to efficient operations. The argument presented, concerning the poor quality of vehicles passing through the Waterford area may be valid. Due to the lack of adequate weigh station activity records, described in detail within Item 3, we can not confirm nor deny the claim. Regardless, improvements or a new station are necessary, especially if that area does have a higher proportion of non-complying commercial vehicles.

Item No. 9 – Additional Fines – Habitual Offenders:

- Background:* Due to concerns over operators that severely exceed weight limits and are repeat offenders, the General Assembly has taken steps to discourage such activity by establishing a supplementary fine for a repeat conviction.
- Criteria:* Per Section 14-267a, subsection (f)(3), of the General Statutes, the Commissioner of the Department of Motor Vehicles is to receive information on commercial vehicle operators that are convicted of overweight violations in excess of fifteen percent of established limits. Upon a third or subsequent conviction in a calendar year, the Commissioner may schedule a hearing to review the record of the motor vehicle registrant. At the hearing, information and evidence is to be presented regarding the frequency of the registrant's operations, the size of the registrant's fleet, and the culpability, if any, of the shipper. After the hearing, a civil penalty in the amount of \$2,000 may be imposed on the owner or lessee of such motor vehicle.
- Condition:* The Department of Motor Vehicles does not have a process in place to identify habitual offenders and to therefore collect additional fines that may be imposed under the above Section.
- Effect:* Potential revenues have been lost, since the Department does not have a method to identify situations in which additional fines are due.
- Cause:* The Department is attempting to create a program to operate off the current core information system, to identify repeat offenders that are subject to the additional penalties that may be imposed. However, the system is not operational.
- Recommendation:* The Department should establish procedures to collect information on habitual overweight commercial vehicle operators so that civil penalties may be imposed and collected, in accordance with Section 14-267a, subsection (f)(3), of the General Statutes. (See Recommendation 9.)
- Agency Response:* **Department of Motor Vehicles:**
“Regarding the Implementation of Public Act 02-70, Section 64, which amends the Connecticut General Statute 14-267a, permits the Commissioner of Motor Vehicles to take administrative action

relative to vehicles overweight in excess of fifteen percent of the gross vehicle weight limits.

Conviction information transmitted to the Department of Motor Vehicles by the Judicial Information System now contains appropriate information to specifically identify those over weight violations that meet the criteria of the new statutory language. However, the Department does not have information system resources available to initiate an automated function at this time. Until such time that resources become available the DMV will exercise its option not to impose administrative sanctions. A recent review has indicated that only one carrier has accumulated 3 such violations in a one-year period.

Roadside enforcement on known and habitual over weight violators will continue. The DMV can provide additional enforcement, based on Judicial Information System data, through audits or compliance reviews at the violators' principal place of business. These audits are comprehensive in nature and examine the carriers complete safety posture in addition to overweight violations.

We will attempt to initiate a manual system should the projection for implementation of an automated system be untimely or cost prohibited.”

RECOMMENDATIONS

- 1. When planned shifts at the commercial vehicle weigh stations are cancelled, additional shifts should be scheduled to ensure that minimum staffing requirements are met.**

Comment:

Section 14-270c of the General Statutes presents specific staffing requirements at the Greenwich, Danbury and Union weigh stations. We reviewed the shift requirements mandated for the three weigh stations over a twelve week period, and noted that the minimum staffing requirements had not been met at the Danbury station four times and at the Greenwich station twice.

- 2. The use of a log or other device to document the times that weigh stations are actually operating should be instituted. As regards minimum staffing requirements, consideration should also be given to “compensate” for shifts in which activity is minimal by adding additional shifts.**

Comment:

Section 14-270c of the General Statutes presents specific staffing requirements at the Greenwich, Danbury and Union weigh stations. Our review of activity reports disclosed that the numbers of commercial vehicles weighed during “open” shifts varies significantly. At times, general explanations are entered on production reports to explain a significant drop in the number of vehicles inspected. However, there are no records to determine the times or duration of closures. We question whether the spirit of Section 14-270c is being satisfied.

- 3. The Departments of Motor Vehicles and Public Safety should use a uniform report and reporting system for commercial vehicle inspections and infractions. More care needs to be taken to ensure that reports are completely filled out using exact and not estimated information.**

Comment:

The collection and compilation of weigh station statistics regarding the number of vehicles weighed and infractions issued is a good tool to monitor enforcement efforts. The Departments of Public Safety and Motor Vehicles report on the number of commercial vehicles weighed each shift at the individual weigh stations. Also reported, are the numbers of vehicles found in violation, as well as the fines issued, in total. Our review disclosed that there is not a consistent system in place to report the above data.

4. **More care needs to be taken to calculate infractions issued for overweight vehicles under Section 14-267a, subsection (f)(2), of the General Statutes.**

Comment:

Our review and recalculation of a sample of 393 infractions disclosed that 31, or 7.9 percent, were calculated incorrectly. The average error was \$232, or 30 percent of the \$772 average infraction. Of the 31 errors, three exceeded \$1,000, and ten were between \$100 and \$999.

5. **Judges and/or Magistrates, adjudicating cases brought under Section 14-267a of the General Statutes, should document the mitigating circumstances present when a reduction to a fine exceeds 25 percent.**

Comment:

According to Section 14-267a, Subsection (f)(5), of the General Statutes, no more than 25 percent of any fine imposed under the Section may be reduced unless the court determines that there are mitigating circumstances related to an infraction, and specifically states such circumstances for the record. Our review disclosed that “mitigating circumstances” are not routinely presented within case files.

It is estimated that only 50 and 60 percent of fines issued by the Departments of Motor Vehicles and Public Safety, respectively, are ultimately collected.

6. **The General Assembly should consider amending Section 14-270, subsection (d), of the General Statutes, to include an additional charge for permits that require significant review and/or engineering services to approve. A fee amounting to the costs incurred by the Department of Transportation to review and approve the permit would appear equitable.**

Comment:

Occasionally there are permit requests for extraordinarily large and/or heavy moves. Depending on the source and destination points, a significant amount of time and effort is expended to develop a satisfactory route. For these extraordinary moves, there is no adjustment to the standard permit fee of \$26.

7. **The General Assembly should consider amending Section 14-270, subsection (d)(3), of the General Statutes, to either place a limit on the number of individual move permits that may be issued for annual permit holders, or include a charge for each individual permit so issued. This would create a fee structure that is more equitable to the individual operators and would further correlate to the costs incurred by the Motor Transport Services Unit to review and approve each individual move request.**

Comment:

Per Section 14-270, subsection (d)(3), of the General Statutes, an operator may obtain an annual permit fee for an overweight and/or oversize vehicle, rather than paying a \$26 fee for each move. The operator is charged an annual fee of seven dollars per thousand pounds or fraction thereof for each vehicle, and must continue to contact the Department of Transportation to obtain routing directives for each individual move. Calculated “per permit/move fees” for annual permit holders varied considerably. Of the 497 annual permits issued for the 2001-2002 fiscal year, 76 had calculated per permit/move fees of less than \$5.00 each. For one operator, the ultimate per permit fee amounted to only 51 cents for each trip.

8. **To enhance efficiency, consideration should be given to making improvements at certain weigh stations, including an expanded use of “Weigh In Motion” (WIM) devices. In the absence of such improvements, consideration should be given to discontinuing operations at certain stations, most notably the Waterford facility, and to reallocating personnel to portable scale efforts.**

Comment:

The Departments of Public Safety and Motor Vehicles enforce size and weight laws by operating five fixed weigh stations located within the State and through the use of portable scales. The equipment and facility designs at the five weigh stations vary to a considerable degree. The results of our review indicate that infractions and the amount of fines issued related to such infractions is relative to the level of equipment and facility designs at the fixed stations. Further, data suggested that vehicles that significantly exceed weight limits are more apt to be discovered by a portable scale operation rather than at a fixed scale station.

9. **The Department should establish procedures to collect information on habitual overweight commercial vehicle operators so that civil penalties may be imposed and collected, in accordance with Section 14-267a, subsection (f)(3), of the General Statutes.**

Comment:

The Department of Motor Vehicles does not have a process in place to identify habitual offenders and to therefore collect additional fines that may be imposed under Section 14-267a, subsection (f)(3), of the General Statutes.

CONCLUSION

In conclusion, we wish to express our appreciation for the cooperation and courtesies extended to our representatives by the officials and staff of the Department of Transportation, Department of Public Safety, Department of Motor Vehicles and the Judicial Department.

John A. Rasimas
Principal Auditor

Approved:

Kevin P. Johnston
Auditor of Public Accounts

Robert G. Jaekle
Auditor of Public Accounts

EXHIBIT A

Section 14-270c of the General Statutes

Sec. 14-270c. Official weighing areas. Staffing requirements. (a) The Commissioners of Public Safety and Motor Vehicles shall staff the official weighing areas as follows:

(1) Greenwich: Eight work shifts in each seven-day period from Sunday through Saturday. No such shifts shall be worked consecutively, except that two shifts may be worked consecutively on not more than three days;

(2) Danbury: Three work shifts in each seven-day period from Sunday through Saturday. The Commissioner of Public Safety shall, whenever possible, coordinate coverage between this official weighing area and the official weighing area in Greenwich in order to ensure concurrent coverage;

(3) Union: Between five and eight work shifts in each seven-day period from Sunday through Saturday. The Commissioner of Motor Vehicles shall coordinate the hours of operation of this official weighing area; and

(4) Portable scale locations: Ten shifts in each seven-day period from Sunday through Saturday which shall be staggered throughout the four geographical areas established by the Commissioner of Public Safety with concentration in areas that have fewer hours of operation for the permanent weighing areas.

(b) The Commissioners of Public Safety and Motor Vehicles shall adjust the work shifts required in subsection (a) of this section on a daily basis in order to effectuate an unpredictable schedule.

(c) The Commissioner of Public Safety may assign any remaining personnel in the traffic unit to the permanent weighing areas in Waterford and Middletown or to the portable scale operations.

(d) The Commissioner of Public Safety shall assign personnel from the traffic unit to work between nine and twelve shifts in each seven-day period from Sunday through Saturday to patrol and enforce laws relative to the safe movement of all vehicles on the highways of the state.

(e) Nothing in this section shall prohibit the Commissioner of Public Safety from reassigning personnel in the traffic unit as he deems necessary in order to ensure public safety.

(P.A. 98-248, S. 1.)

EXHIBIT B

DIVISIBLE LOAD TYPE RESTRICTIONS

THE DEPARTMENT OF TRANSPORTATION HAS RENEWED THE DIVISIBLE LOAD PERMIT POLICY. THE OVERSIZE/OVERWEIGHT PERMIT UNIT WILL CONTINUE TO ISSUE DIVISIBLE LOAD PERMITS BETWEEN THE MONTHS OF MAY 1, 2002 AND APRIL 30, 2003. THE AXLE WEIGHT AND GROSS WEIGHT LIMITS THAT WERE ALLOWED LAST YEAR SHALL REMAIN IN EFFECT.

DIVISIBLE LOAD PERMITS ARE LIMITED TO THE FOLLOWING **BULK MATERIALS AND RAW PRODUCTS**. BUNDLED, BAGGED AND/OR PALLETIZED MATERIALS OR PRODUCTS DO NOT QUALIFY FOR DIVISIBLE LOAD PERMITS.

SOILS

SAND
TOPSOIL
LOAM
CONTAMINATED SOIL

STONE

RIP-RAP
AGGREGATE
RECYCLED AGGREGATE
ROCK
STONE DUST
GRAVEL

BITUMINOUS

ASPHALT
BITUMINOUS RUBBLE
ROAD MILLING
RECYCLED ASPHALT

PROCESSED PRODUCTS

RAW MILK
FEED/GRAIN
MULCH
LIQUID CONCRETE
ASH
CRUSHED GLASS
LIQUID ASPHALT/BITUMINOUS
LIQUID CALCIUM CHLORIDE
PROCESS RESIDUE
AUTO-FLUFF

SALT
MYCELIUM
LIME

UNPROCESSED PRODUCTS

*DEMOLITION/CONSTRUCTION MATERIAL
6 month test period

FOREST PRODUCTS

LOGS

REQUESTS FOR ADDITIONAL BULK MATERIALS AND/OR RAW PRODUCTS WILL BE CONSIDERED. PLEASE SEND ALL REQUESTS TO:

**DEPARTMENT OF TRANSPORTATION
OVERSIZE/OVERWEIGHT PERMIT UNIT
ROOM 1119
P.O. BOX 317546
NEWINGTON, CT 06131-7546**

EXHIBIT C

Section 14-267a, Subsections (f)(2) and (f)(5), of the General Statutes

Sec. 14-267a. Weight restrictions for vehicles, trailers or other objects. Highway weighing procedure. Penalties for overweight violations. Fines for failure to comply. Regulations.

(f)(2) Any person who violates any provision of this section shall be subject to the following penalties: (A) For an overweight violation of not more than five per cent of the gross weight or axle weight limits in subsection (b) of this section, a fine of three dollars per hundred pounds or fraction thereof of such excess weight; (B) for an overweight violation of more than five per cent and not more than ten per cent of either such weight limit, a fine of five dollars per hundred pounds or fraction thereof of such excess weight or a minimum fine of fifty dollars; (C) for an overweight violation of more than ten per cent but not more than fifteen per cent of either such weight limit, a fine of six dollars per hundred pounds or fraction thereof of such excess weight or a minimum fine of one hundred dollars; (D) for an overweight violation of more than fifteen per cent but not more than twenty per cent of either such weight limit, a fine of seven dollars per hundred pounds or fraction thereof of such excess weight or a minimum fine of two hundred dollars; (E) for an overweight violation of more than twenty per cent but not more than twenty-five per cent of either such weight limit, a fine of ten dollars per hundred pounds or fraction thereof of such excess weight or a minimum fine of three hundred dollars; (F) for an overweight violation of more than twenty-five per cent but not more than thirty per cent of either such overweight limit, a fine of twelve dollars per hundred pounds or fraction thereof of such excess weight or a minimum fine of five hundred dollars; and (G) for an overweight violation of more than thirty per cent of either such overweight limit, a fine of fifteen dollars per one hundred pounds or fraction thereof of such excess weight or a minimum fine of one thousand dollars.

(f)(5) No more than twenty-five per cent of any fine imposed pursuant to this subsection may be remitted unless the court determines that there are mitigating circumstances and specifically states such circumstances for the record.

MAJOR STUDIES OF THE ACADEMY

2008

- A Needs-Based Analysis of the University of Connecticut Health Center Facilities Plan

2007

- A Study of the Feasibility of Utilizing Fuel Cells to Generate Power for the New Haven Rail Line
- Guidelines for Developing a Strategic Plan for Connecticut's Stem Cell Research Program

2006

- Energy Alternatives and Conservation
- Evaluating the Impact of Supplementary Science, Technology, Engineering and Mathematics Educational Programs
- Advanced Communications Technologies
- Preparing for the Hydrogen Economy: Transportation
- Improving Winter Highway Maintenance: Case Studies for Connecticut's Consideration
- Information Technology Systems for Use in Incident Management and Work Zones
- An Evaluation of the Geotechnical Engineering and Limited Environmental Assessment of the Beverly Hills Development, New Haven, Connecticut

2005

- Assessment of a Connecticut Technology Seed Capital Fund/Program
- Demonstration and Evaluation of Hybrid Diesel-Electric Transit Buses
- An Evaluation of Asbestos Exposures in Occupied Spaces

2004

- Long Island Sound Symposium: A Study of Benthic Habitats

- A Study of Railcar Lavatories and Waste Management Systems

2003

- An Analysis of Energy Available from Agricultural Byproducts, Phase II: Assessing the Energy Production Processes
- Study Update: Bus Propulsion Technologies Available in Connecticut

2002

- A Study of Fuel Cell Systems
- Transportation Investment Evaluation Methods and Tools
- An Analysis of Energy Available from Agricultural Byproducts, Phase 1: Defining the Latent Energy Available

2001

- A Study of Bus Propulsion Technologies in Connecticut

2000

- Efficacy of the Connecticut Motor Vehicle Emissions Testing Program
- Indoor Air Quality in Connecticut Schools
- Study of Radiation Exposure from the Connecticut Yankee Nuclear Power Plant

1999

- Evaluation of MTBE as a Gasoline Additive
- Strategic Plan for CASE

1998

- Radon in Drinking Water

1997

- Agricultural Biotechnology
- Connecticut Critical Technologies

CONNECTICUT ACADEMY OF SCIENCE AND ENGINEERING

179 Allyn Street, Suite 512, Hartford, CT 06103

Phone or Fax: 860-527-2161

e-mail: acad@ctcase.org

web: www.ctcase.org

CONNECTICUT ACADEMY OF SCIENCE AND ENGINEERING

The Connecticut Academy is a non-profit institution patterned after the National Academy of Sciences to identify and study issues and technological advancements that are or should be of concern to the state of Connecticut. It was founded in 1976 by Special Act of the Connecticut General Assembly.

VISION

The Connecticut Academy will foster an environment in Connecticut where scientific and technological creativity can thrive and contribute to Connecticut becoming a leading place in the country to live, work and produce for all its citizens, who will continue to enjoy economic well-being and a high quality of life.

MISSION STATEMENT

The Connecticut Academy will provide expert guidance on science and technology to the people and to the State of Connecticut, and promote its application to human welfare and economic well being.

GOALS

- Provide information and advice on science and technology to the government, industry and people of Connecticut.
- Initiate activities that foster science and engineering education of the highest quality, and promote interest in science and engineering on the part of the public, especially young people.
- Provide opportunities for both specialized and interdisciplinary discourse among its own members, members of the broader technical community, and the community at large.

CONNECTICUT ACADEMY OF SCIENCE AND ENGINEERING
179 Allyn Street, Suite 512, Hartford, CT 06103
Phone or Fax: 860-527-2161
e-mail: acad@ctcase.org
web: www.ctcase.org