



# **State of the Art Evaluation of Traffic Detection and Monitoring Systems**

**Volume I – Phases A & B: Design**

**Final Report 627 (1)**

**Prepared by:**

Dan Middleton, Ph.D., P.E.  
Ryan Longmire  
Shawn Turner, P.E.  
Texas Transportation Institute  
Texas A&M University  
College Station, TX 77843-3135

**October 2007**

**Prepared for:**

Arizona Department of Transportation  
206 South 17<sup>th</sup> Avenue  
Phoenix, Arizona 85007  
in cooperation with  
U.S. Department of Transportation  
Federal Highway Administration

The contents of this report reflect the views of the authors who are responsible for the facts and accuracy of the data presented herein. The contents do not necessarily reflect official views or policies of the Arizona Department of Transportation or the Federal Highway Administration. The report does not constitute a standard, specification, or regulation. Trade or manufacturers' names that appear herein are cited only because they are considered essential to the objectives of the report. The U.S. Government and the State of Arizona do not endorse products or manufacturers.

### Technical Report Documentation Page

1. Report No. FHWA-AZ-07-627(1)		3. Recipient's Catalog No.
4. Title and Subtitle State of the Art Evaluation of Traffic Detection and Monitoring Systems Volume I – Phases A & B: Design	5. Report Date October 2007	6. Performing Organization Code
	8. Performing Organization Report No.	
7. Author Dan Middleton, Ryan Longmire, and Shawn Turner	10. Work Unit No.	
9. Performing Organization Name and Address Texas Transportation Institute, Texas A&M University 2929 Research Parkway 3135 TAMU College Station, TX 77843-3135	11. Contract or Grant No. SPR-PL1-(71)627 JPA 07-006T	
	13. Type of Report & Period Covered INTERIM REPORT February 2007-October 2007	
12. Sponsoring Agency Name and Address Arizona Department of Transportation 206 S. 17th Avenue Phoenix, Arizona 85007  Project Manager: Stephen R. Owen, P.E.	14. Sponsoring Agency Code R0627-19P	
	15. Supplementary Notes Prepared in cooperation with the U.S. Department of Transportation, Federal Highway Administration	
16. Abstract This report covers the Phase A and B activities of Research Project SPR 627 for the Arizona Department of Transportation (ADOT). Phase C is planned as a separate research activity and is anticipated to begin in the near term, following the completion of Phases A and B. The need for a better evaluation program for new traffic detection systems came in part from a lack of confidence in existing detectors, as well as the need for non-intrusive detectors to replace failing embedded inductive loops. The primary objectives of this research were to identify the most promising vehicle detection technologies to meet ADOT needs, to identify candidate test sites, to develop a field test evaluation plan, and to develop and deliver a detailed design of the detection testbed on the selected segment of freeway. The Texas Transportation Institute (TTI) met these objectives through an Internet and literature search, a state-of-the-practice review, a search of relevant new detector systems, and through meetings with the Technical Advisory Committee (TAC). Relying on TAC input, TTI developed first a conceptual design, followed by a detailed design and budget for a proposed test facility located on I-10 in Phoenix just west of the 16 <sup>th</sup> Street interchange.  Detectors selected for test in the initial period of 12-plus months during Phase C (and the technology used) are as follows: Wavetronix SS-125 (microwave radar), Sensys Networks (magnetic), Global Traffic Technologies microloops (magnetic) and Autoscope Solo Pro (video imaging). The baseline system selected for providing ground truth data is the Peek ADR-6000 using inductive signatures as its basis of detection. It is anticipated that this Phase C testing will include two summer seasons to expose selected detectors to the extreme heat and related environmental conditions found in the Phoenix area. The initial cost of the testbed will include detectors sufficient to ultimately cover eight lanes in the westbound direction (currently seven lanes) and six lanes in the eastbound direction. Besides the detectors, the total cost estimate includes a 12 ft by 12 ft node building, three equipment cabinets, inductive loops for the baseline system, conduit, and boring. The total cost of the facility is estimated to be approximately \$566,000.		
17. Key Words Vehicle detection, non-intrusive detector, inductive loop, magnetometer, video imaging, microwave radar.	18. Distribution Statement Document is available to the U.S. Public through the National Technical Information Service, Springfield, Virginia, 22161	23. Registrant's Seal
19. Security Classification Unclassified	20. Security Classification Unclassified	21. No. of Pages 124
		22. Price

## **SI\* (MODERN METRIC) CONVERSION FACTORS**

<b>APPROXIMATE CONVERSIONS TO SI UNITS</b>					<b>APPROXIMATE CONVERSIONS FROM SI UNITS</b>				
Symbol	When You Know	Multiply By	To Find	Symbol	Symbol	When You Know	Multiply By	To Find	Symbol
<b><u>LENGTH</u></b>					<b><u>LENGTH</u></b>				
in	inches	25.4	millimeters	Mm	mm	millimeters	0.039	inches	in
ft	feet	0.305	meters	M	m	meters	3.28	feet	ft
yd	yards	0.914	meters	M	m	meters	1.09	yards	yd
mi	miles	1.61	kilometers	Km	km	kilometers	0.621	miles	mi
<b><u>AREA</u></b>					<b><u>AREA</u></b>				
in <sup>2</sup>	Square inches	645.2	square millimeters	mm <sup>2</sup>	mm <sup>2</sup>	square millimeters	0.0016	square inches	in <sup>2</sup>
ft <sup>2</sup>	square feet	0.093	square meters	m <sup>2</sup>	m <sup>2</sup>	square meters	10.764	square feet	ft <sup>2</sup>
yd <sup>2</sup>	Square yards	0.836	square meters	m <sup>2</sup>	m <sup>2</sup>	square meters	1.195	square yards	yd <sup>2</sup>
ac	acres	0.405	hectares	Ha	ha	hectares	2.47	acres	ac
mi <sup>2</sup>	square miles	2.59	square kilometers	km <sup>2</sup>	km <sup>2</sup>	square kilometers	0.386	square miles	mi <sup>2</sup>
<b><u>VOLUME</u></b>					<b><u>VOLUME</u></b>				
fl oz	fluid ounces	29.57	milliliters	mL	mL	milliliters	0.034	fluid ounces	fl oz
gal	gallons	3.785	liters	L	L	liters	0.264	gallons	gal
ft <sup>3</sup>	Cubic feet	0.028	cubic meters	m <sup>3</sup>	m <sup>3</sup>	cubic meters	35.315	cubic feet	ft <sup>3</sup>
yd <sup>3</sup>	Cubic yards	0.765	cubic meters	m <sup>3</sup>	m <sup>3</sup>	cubic meters	1.308	cubic yards	yd <sup>3</sup>
NOTE: Volumes greater than 1000L shall be shown in m <sup>3</sup> .									
<b><u>MASS</u></b>					<b><u>MASS</u></b>				
oz	ounces	28.35	grams	G	g	grams	0.035	ounces	oz
lb	pounds	0.454	kilograms	Kg	kg	kilograms	2.205	pounds	lb
T	short tons (2000lb)	0.907	megagrams (or "metric ton")	mg (or "t")	mg (or "t")	megagrams (or "metric ton")	1.102	short tons (2000lb)	T
<b><u>TEMPERATURE (exact)</u></b>					<b><u>TEMPERATURE (exact)</u></b>				
°F	Fahrenheit temperature	5(F-32)/9 or (F-32)/1.8	Celsius temperature	°C	°C	Celsius temperature	1.8C + 32	Fahrenheit temperature	°F
<b><u>ILLUMINATION</u></b>					<b><u>ILLUMINATION</u></b>				
fc	foot-candles	10.76	lux	Lx	lx	lux	0.0929	foot-candles	fc
fl	foot-Lamberts	3.426	candela/m <sup>2</sup>	cd/m <sup>2</sup>	cd/m <sup>2</sup>	candela/m <sup>2</sup>	0.2919	foot-Lamberts	fl
<b><u>FORCE AND PRESSURE OR STRESS</u></b>					<b><u>FORCE AND PRESSURE OR STRESS</u></b>				
lbf	poundforce	4.45	Newtons	N	N	Newtons	0.225	poundforce	lbf
lbf/in <sup>2</sup>	poundforce per square inch	6.89	kilopascals	kPa	kPa	kilopascals	0.145	poundforce per square inch	lbf/in <sup>2</sup>

SI is the symbol for the International System of Units. Appropriate rounding should be made to comply with Section 4 of ASTM E380

# TABLE OF CONTENTS

	<u>Page</u>
EXECUTIVE SUMMARY .....	1
PART ONE: STATE OF THE PRACTICE	
1. INTRODUCTION .....	5
BACKGROUND .....	5
SCOPE OF THE PROJECT .....	6
ORGANIZATION OF THE CONTENTS .....	7
2. PHOENIX AREA DETECTORS .....	9
INTRODUCTION .....	9
FREEWAY MANAGEMENT SYSTEM (FMS) DETECTORS .....	9
3. LITERATURE AND INTERNET SEARCH; STATE CONTACTS .....	15
INTRODUCTION .....	15
SINGLE TECHNOLOGY SOURCES .....	15
SINGLE AREA TECHNOLOGIES .....	28
RECENT MULTIPLE TECHNOLOGY SOURCES .....	29
FOLLOW-UP PHONE CALLS TO SELECTED STATES .....	39
4. VEHICLE DETECTOR TESTBEDS .....	43
INTRODUCTION .....	43
CALTRANS I-405 TESTBED IN IRVINE, CALIFORNIA .....	43
MNDOT NON-INTRUSIVE TEST FACILITY ON I-394 .....	45
TTI TESTBED IN AUSTIN .....	49
TTI TESTBED IN COLLEGE STATION .....	51
PART TWO: DESIGN DEVELOPMENT	
5. TESTBED SITE SELECTION AND CONCEPTUAL DESIGN .....	55
INTRODUCTION .....	55
TESTBED SITE SELECTION .....	55
TESTBED CONCEPTUAL DESIGN .....	58
PRIMARY DETECTION SYSTEMS .....	60
SPECIALIZED DETECTOR (OPTIONAL) .....	63
SPEEDINFO: A UNIQUE BUSINESS PLAN .....	63
PROGRAM BUDGET .....	63
6. DETECTOR EVALUATION PROGRAM .....	67
INTRODUCTION .....	67
SELECTION, SCREENING, AND TESTING PROCEDURES .....	67
PROJECT MANAGEMNT / DESIGN .....	69

## TABLE OF CONTENTS (Continued)

	<u>Page</u>
CONSTRUCTION .....	70
MAINTENANCE .....	70
SYSTEMS ISSUE MANAGEMENT .....	70
EVALUATION .....	70
APPROVED PRODUCT LISTS .....	74
7. DETAILED DESIGN .....	75
INTRODUCTION .....	75
BASELINE SYSTEM .....	75
EQUIPMENT CABINETS .....	78
CONDUIT AND PULL BOXES .....	78
EQUIPMENT POLE .....	79
NODE BUILDING .....	79
DETECTOR EQUIPMENT .....	79
OTHER ON-SITE EQUIPMENT .....	81
PROGRAM BUDGET .....	82
APPENDICES .....	91
APPENDIX A: OVERVIEW OF SELECTED DETECTION SYSTEMS .....	91
APPENDIX B: CONDUIT CHART .....	97
APPENDIX C: INDUCTIVE SIGNATURE TECHNOLOGIES, INC .....	101
APPENDIX D: SPEEDINFO .....	105
LIST OF REFERENCES .....	113

## LIST OF FIGURES

<u>Figure</u>		<u>Page</u>
1	FMS Detector Locations .....	10
2	FMS Cabinet with Inductive Loop Equipment .....	12
3	SmarTek SAS-1 Contact-closure Cards .....	12
4	Phoenix Metro FMS Existing and Planned Projects .....	13
5	Speed Comparison of ADR-6000, Doppler Radar, and Video Imaging System .....	18
6	PATH Traffic Detector and Surveillance Sub-Testbed .....	44
7	MnDOT NIT Site Layout .....	45
8	Catwalk for Mounting Detectors Overhead .....	46
9	Aluminum Tower for Sidefire Mounting .....	47
10	View of NIT Building from the Catwalk .....	47
11	MnDOT Shelter Schematic Layout .....	48
12	Layout of TxDOT's I-35 Site .....	50
13	Views of I-35 Testbed .....	51
14	Layout of S.H. 6 College Station Testbed .....	52
15	View of S.H. 6 Testbed Looking South .....	53
16	View of Equipment Cabinets and Weather Station .....	53
17	Aerial View of I-10 at 13 <sup>th</sup> Street .....	57
18	Ground Level View of I-10 at 13 <sup>th</sup> Street Facing Northward .....	57
19	Conceptual Testbed Design .....	59
20	Aerial View of 16 <sup>th</sup> Street Interchange Ramps (View to North) .....	61
21	ADR-6000 Loop Layout .....	77
22	Arizona DOT Testbed – General Arrangement & Details (22a & b) .....	83
23	DVSS-100 Doppler Vehicle Speed Sensor .....	110

## LIST OF TABLES

<u>Table</u>	<u>Page</u>
1 Peek ADR-6000 Classification Accuracy Comparison for I-35 .....	18
2 SAS-1 Count Error Rates on S.H. 6 during Dry Weather .....	25
3 SAS-1 Count Error Rates on S.H. 6 during Wet Weather .....	25
4 Detector Cost Comparison .....	30
5 Detector Error Rates .....	30
6 Detector Ease of Installation and Reliability .....	31
7 Estimated Life-Cycle Costs for a Typical Freeway Application .....	31
8 Sensor Performance Descriptions (Hawaii) .....	32
9 Site Descriptions (Pennsylvania) .....	33
10 Results of Portable Setup Field Testing (Pennsylvania) .....	34
11 Comparisons of Mean Percentage Volume Errors (Nebraska) .....	36
12 Overall Results for Volume and Speed Detections (Minnesota) .....	37
13 Result Summary for Length-Based Class Detection (Minnesota) .....	38
14 FY 2006 TTI Detector Test Plan (Texas) .....	38
15 Annualized Life-Cycle Cost of Detectors on Freeways .....	62
16 Qualitative Assessment of Detectors .....	62
17 Responsibilities for Detector Evaluation .....	67
18 Anticipated Testbed Initial Costs for Phase 1 and Phase 2 .....	86
19 Sources of Cost Estimates .....	88
20 Conduit Sizes and Types for Detailed Design .....	99
21 Estimated Cost of the IST System Using Existing Loops .....	102



## TERMS, ACRONYMS, AND ABBREVIATIONS

AADT	Average Annual Daily Traffic
AC	Alternating Current
ADOT	Arizona Department of Transportation
ADR	Automatic Data Recorder
AP	Access Point Unit (Sensys)
APD	Absolute Percent Difference
ASIM	ASIM Technologies, Ltd, Detector manufacturer in Switzerland
ASTM	American Society for Testing and Materials
ATR	Automatic Traffic Recorder
ATRC	Arizona Transportation Research Center (ADOT)
AWG	American Wire Gauge
Caltrans	California Department of Transportation
CCD	Charge-Coupled Device (camera)
DC	Direct Current
DETT	Detector Evaluation and Testing Team (Caltrans)
DRI	(Caltrans) Division of Research and Innovation
DSL	Digital Subscriber Line (communication)
EIS	Electronic Integrated Systems, Inc.
FHWA	Federal Highway Administration
F.M.	Farm-to-Market (Texas)
FMS	Freeway Management System
FTP	File Transfer Protocol
GTT (3M)	Global Traffic Technologies, LLC (formerly a 3M business unit)
HD	High Definition (Wavetronix SS-125)
IST	Inductive Signature Technologies, Inc.
ITD	Intermodal Transportation Division (ADOT)
ITS	Intelligent Transportation Systems
JPEG	Joint Photographic Experts Group (graphic image format)
LAN	Local Area Network
MAG	Maricopa Association of Governments
MAPE	Mean Absolute Percent Error
MnDOT	Minnesota Department of Transportation
NB	Northbound
NDOR	Nebraska Department of Roads
NIST	National Institute of Standards and Technology
NIT	Non-Intrusive Tests (by MnDOT)

NTP	Network Time Protocol
NTSC	National Television Standards Committee
ORADS	Off-Road Axle Detection Sensor, from Spectra Research
ORITE	Ohio Research Institute for Transportation and the Environment
PAD	Passive Acoustic Detector
PATH	Partners for Advanced Transit and Highways (at UC Berkeley)
PCD	Phoenix Construction District (ADOT)
PeMS	(Caltrans) Performance Measurement System
PennDOT	Pennsylvania Department of Transportation
PMD	Phoenix Maintenance District (ADOT)
PMD ITS	Phoenix Maintenance District Intelligent Transportation Systems
PNITD	Portable Non-Intrusive Traffic Detection System
PVR	Per Vehicle Records
RMSE	Root Mean Squared Error
RTMS	Remote Traffic Microwave Sensor
S.H.	State Highway (Texas)
SR	State Route (Arizona and Pennsylvania)
SAS-1	SmarTek Acoustic Sensor
SEO	Schwartz Electro-Optics
SRF	Consulting Group in Minnesota
STIP	Short-Term In-Pavement
SUV	Sport Utility Vehicle
TAC	Technical Advisory Committee
TCPEC	Traffic Control Product Evaluation Committee
TDS <sup>2</sup>	Traffic Detector Surveillance Sub-Testbed (Caltrans)
TIRTL	The InfraRed Traffic Logger
TOC	Traffic Operations Center
TOG	Transportation Operations Group (of TTI)
TPD	Transportation Planning Division (ADOT)
TTG	Transportation Technology Group (ADOT)
TTI	Texas Transportation Institute (of Texas A&M University System)
TxDOT	Texas Department of Transportation
VIP	Video Image Processor
VISION	PCD Field Office (ADOT)
VSV	Video Signature Vector (Caltrans testbed)

# **EXECUTIVE SUMMARY**

## **INTRODUCTION**

Accurate, complete, and timely traffic data is critical to the effective management of Arizona's highway system. Limitations in current traffic monitoring abilities are an ongoing challenge for the Arizona Department of Transportation (ADOT) and for its customers in both urban and rural areas. Many technologies exist for detecting vehicles and determining traffic volume, speed, and lane occupancy.

This research project, as performed by the Texas Transportation Institute (TTI), included a state-of-the-practice review, intended to assist ADOT and other Arizona transportation agencies in identifying the most appropriate detection technologies to meet local needs. The scope of this project also required the development of a design for a detector testbed facility, which ADOT proposed to develop in the near future, in the Phoenix area.

## **CURRENT PHOENIX AREA DETECTION SYSTEMS**

Embedded inductive loops and pole-mounted passive acoustic detectors (PADs) are currently the primary detectors used on the roughly 250 centerline miles of freeways in the Phoenix metro area. Inductive loops are a mature and accurate technology but lane closures for their installation and maintenance have become less feasible in recent years due to traffic volumes, safety issues, and costs.

PADs have not been as accurate as originally anticipated, so viable alternative detectors are needed. ADOT's preference, due to the historical problems noted with embedded roadway sensor designs, was to focus the study initially on new non-intrusive detection concepts.

## **LITERATURE AND INTERNET SEARCH**

A thorough literature and Internet search produced a number of useful documents on the topic of vehicle detection on freeways. Due to the dynamic nature of this topic and the ever changing nature of the detector market, the most useful information came recently – from the late 1990s until the most recent. None of the newer non-intrusive detectors appear to be as accurate in vehicle presence detection as loops under all environmental conditions, but many agencies have determined that other positive features outweigh the modest reduction in accuracy.

Close scrutiny of literature and Internet sources reveals that comparing each research project's findings is difficult at best due to the use of different metrics, different traffic conditions, different models of the same detector (or at least different firmware), and different positioning of detectors. In general, however, a few of the newer detectors can count traffic consistently within 5 percent of true counts. Speed estimates from these devices indicate similar accuracy, and in limited cases exceed the speed estimates of standard inductive loops (e.g., Doppler radar). The non-intrusive technologies that have withstood the scrutiny of several installations and have the most promise for replacing inductive loops are

microwave radar, video imaging, and magnetic detectors. Of the two prominent magnetic detectors, one is intrusive but is still deemed worthy of consideration.

## **VEHICLE DETECTOR TESTBEDS**

Existing field test facilities in California, Minnesota, and Texas make use of components that were already in place along existing freeways such as overhead structures, poles, and conduit. For example, the Caltrans facility on I-405 in Irvine, California utilizes a unique camera system to establish ground truth, substantially reducing the need for manual viewing of recorded video. It also has inductive loops in the pavement to be used as needed. The Minnesota test facility on I-394 near downtown Minneapolis used standard inductive loops for ground truth and mounted test systems either on an overhead bridge, on movable telescoping poles (sidefire), or underneath the pavement. The Texas facility on I-35 near downtown Austin used an upscale vehicle classifier, the Peek ADR-6000, for ground truth, existing luminaire poles and conduit, and an overhead sign bridge. Most of the test detectors were mounted on the luminaire pole. Lessons learned from these vehicle detector testbeds could provide useful information as this project moves forward.

## **STATE CONTACTS**

The information gathered in this section complements the other sections. The literature and Internet search helped identify states that had tested and installed new technology detectors, and the state contacts brought some of the information up to date. In summary, all three states – California, Minnesota, and Texas – have conducted research on some of the same detectors but there are differences in how the research is being implemented. The various districts in California and Texas are installing a wide variety of non-intrusive detectors to replace failing loops, but Minnesota continues to install and rely almost exclusively on loops.

## **TESTBED SITE SELECTION AND CONCEPTUAL DESIGN**

The site selected for the future ADOT testbed consists of a mainline element, which is on Interstate 10 at 13<sup>th</sup> Street (see map page 3), and a westbound entrance ramp element from the nearby 16<sup>th</sup> Street interchange. Some strengths of this site include its central location, high traffic volume (including trucks), number of lanes, proximity to the I-10 tunnels (related to lane closures), space availability for testbed equipment and parking, and unobstructed view of approaching traffic. The conceptual testbed design includes many of the existing and proposed components of the testbed such as equipment cabinets, underground boring, pull boxes, ground truth devices, and safety barriers. The offset sign bridges offer locations for mounting detectors and surveillance cameras overhead, and proposed poles could be used for mounting sidefire detectors and surveillance cameras. Horizontal 3-inch bores spaced 18 feet apart can accommodate microloops from Global Traffic Technologies (GTT, formerly 3M).

Peek ADR-6000 inductive loops in the roadway on the upstream side of each structure are intended to be used for ground truth. It is anticipated that if the testbed is built in two stages that initial equipment installation will emphasize the westbound direction of traffic flow on the north side of the freeway.

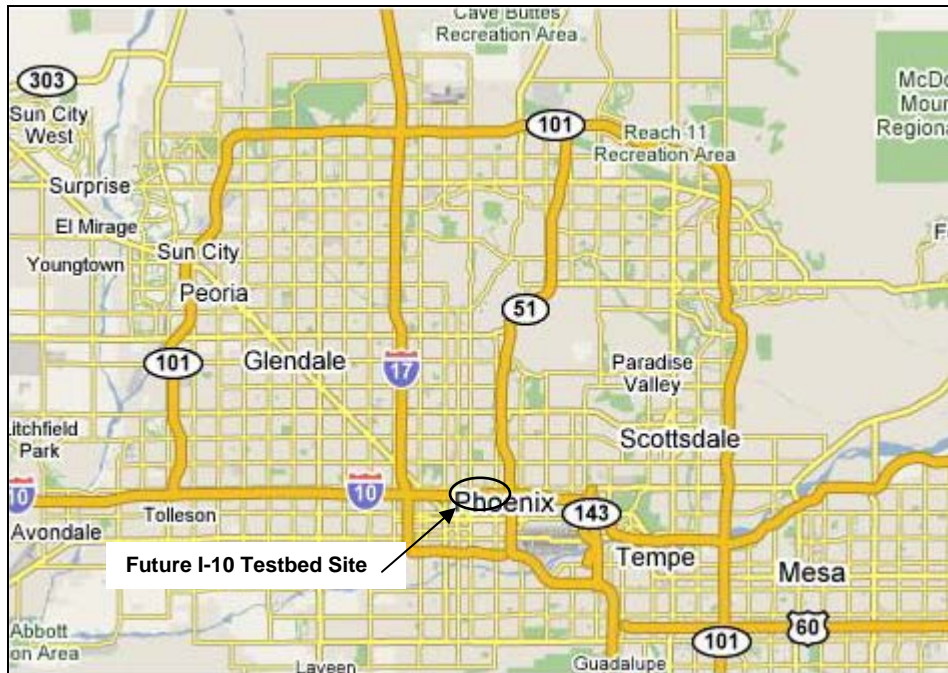

## **DETAILED DESIGN AND TESTING PROGRAM DEVELOPMENT**

Building on what had already been accomplished in the conceptual design and the site selection process, the detailed design provided more accurate information on quantities and sizes of components. Given the uncertainties of installing shallow inductive loops in the rubberized asphalt pavement layer, there was also an investigation of the Inductive Signature Technologies (IST) system as an alternative baseline system instead of the Peek ADR-6000. The Technical Advisory Committee (TAC) decided that the IST system did not have the maturity needed, electing to stay with the Peek unit. Components of the Detailed Design that evolved or were modified from the Conceptual Design included the use of more ADOT-furnished components such as pull boxes, poles, and cabinets. The poles (two on the north side of I-10) will now be standard ADOT poles without mast arms. Also, the existing on-site camera will provide surveillance coverage, supplemented by two proposed Autoscope video imaging systems, one per direction of traffic flow.

The overall detector evaluation process is currently envisioned as a seven-step process, and it is anticipated that the Transportation Technology Group (TTG) will be primarily responsible for selecting detectors for test and the exact procedures to be used. The total cost of the ADOT testbed facility on I-10 is estimated to be about \$566,000. Some components will be provided by ADOT at no cost to the project; however, all proposed traffic detector systems to be evaluated are included in the budget estimate. Other major cost elements include infrastructure, communications, detector mountings, node building, design package, construction management, and contingency.



# **PART I: STATE OF THE PRACTICE**

## **1. INTRODUCTION**

### **BACKGROUND**

The Arizona Department of Transportation spends about \$50,000 at each location to install Freeway Management System (FMS) detection, and another \$1,000 per year to maintain each site. For roughly 250 centerline miles of freeway in the greater Phoenix area (termed “Metro Phoenix”), ADOT anticipates spending about \$25 million to install traffic sensors at some 500 sites, and another \$10 million to maintain them, over the 20-year life of the Regional Transportation Program. Added together, these costs represent a substantial investment, but not making a serious commitment to traffic monitoring equipment would undoubtedly result in even greater cost in terms of reduced safety, lost federal funding, greater motorist delay, and heightened motorist frustration.

Accurate, complete, and timely traffic data are critical to the effective management of Arizona’s highway system. Limitations in current traffic monitoring abilities are an ongoing negative issue for the Arizona Department of Transportation and for its customers as well in both urban and rural areas. Many technologies exist for detecting vehicles and determining traffic volume, type, lane occupancy, and speed. The key is to invest wisely in the appropriate traffic monitoring technology, and hence, the need for this research project.

The Maricopa Association of Governments (MAG), ADOT’s Transportation Planning Division (TPD), and others use data from the Freeway Management System (FMS) traffic detectors for planning and budgeting purposes. It is critical for ADOT to be aware of the state-of-the-art in traffic monitoring technology, and to implement the latest and best technology for both planning and operations applications. The metropolitan freeway ramp metering program is another critical focus area for this study of detection options. ADOT needs to identify the best of the new standard detector designs for its basic long-term needs, and to also consider specialized systems for various localized data issues. To this end, the Texas Transportation Institute was requested to conduct this study, to include the key facility design deliverables for ADOT.

### **Transportation Technology Group**

ADOT’s Transportation Technology Group, established in July 1996, has the responsibility for the planning, development, deployment, management, and operation of new technologies related to the transportation industry. Prior to the establishment of TTG, a variety of different organizations managed technology-related activities. However, TTG is not responsible for the Department’s information resources; this effort is handled by the Information Technology Group (ITG).

Intelligent Transportation Systems (ITS) is the application of computers, electronics, control systems, communications technologies, and management strategies to transportation systems

in an integrated manner, providing travel information to increase the safety and efficiency of the surface transportation systems.

Since the creation of TTG, all ITS activities throughout the State have been consolidated within one dedicated group, interfacing with one another, and proceeding toward the same goals and objectives. With a vision focused primarily on the ITS activities throughout the State and close coordination and interaction, this Group plans, develops, deploys, manages, and operates ITS projects to better serve its customers.

### **Texas Transportation Institute**

ADOT project stakeholders recommended the selection of TTI to conduct this research, recognizing the unique abilities and qualifications of TTI to perform the work. The brief overview below describes the organization, and the specific units involved in the research.

Established in 1950, TTI is the world's largest university-based transportation research and education institute. TTI's objective is to solve transportation problems through research, to transfer technology and to develop diverse human resources to meet the transportation challenges of tomorrow. The Texas Transportation Institute is part of the Texas A&M University System and maintains research divisions, regional divisions, research centers, and field offices. Within TTI, the Transportation Operations Group (TOG) is a national leader in transportation operations. TOG's mission is "to facilitate innovations in transportation system operations through leadership in research, education and technology transfer." TOG has access to all the equipment and resources within TTI and actively coordinates work within TTI and with partners to provide effective services to sponsors.

TOG facilities provide outstanding capabilities for conducting leading edge research in all aspects of the transportation operations research program. Examples of TOG facilities include the TransLink<sup>®</sup> Laboratory, a multi-modal, multi-agency public/private program of research, development and professional education; freeway and intersection field test laboratories; and a Traffic Control Device Outdoor Laboratory and Demonstration Facility. Additional information about the TOG research program, staff, and facilities can be found at <http://transops.tamu.edu/>. It also contains links to other TOG/TTI websites.

### **SCOPE OF THE PROJECT**

The research objectives are:

- Gather information on the current vehicle detection systems used in Arizona.
- Identify the most promising vehicle detection technologies to meet the needs of ADOT and other Arizona agencies.
- Identify candidate test sites, develop preliminary site design, and develop field test evaluation plan.
- Develop a detailed design of the detection testbed on the selected freeway segment.



ADOT Research Project SPR-627 has a total of three phases, but this report only covers the work by TTI on the first two – Phase A and Phase B. Phase A is the “Global ‘State-of-the-Practice’ Review and Conceptual Design,” and Phase B is the “Detailed Design.”

Phase C, the initial long-term detector evaluation study, is expected to be done as part of a separate agreement to be developed at a later date.

The work plan consisted of eight tasks. In Task 1, information was collected on detection elements currently used in the Phoenix area. This information came primarily from the project’s Technical Advisory Committee (TAC) members. Task 2 was a state of the practice review of embedded and non-intrusive traffic detection technologies that have the potential to more accurately monitor key data of volume, lane occupancy and speed. TTI gathered this information through a global Internet survey and literature search of relevant new products and innovations. Task 3 involved a search of relevant new detector systems including both breadth of detector types and success stories that could apply to ADOT and local Arizona agencies. Task 4 involved development and presentation of an interim state-of-the-practice report to the TAC.

Task 5 involved identifying the testbed site, calibration equipment, a benchmark “truthing system” for comparison of results, and the detection systems that are proposed to be tested. Task 6 involved planning and conducting TAC meetings for Phases A and B. Task 7 was the detailed design and included development of the testing program. Task 8 involved development of deliverables.

## **ORGANIZATION OF THE REPORT**

This report consists of seven chapters. Following this introductory chapter is Chapter 2, which covers Phoenix area detectors that are currently being used. Following that is Chapter 3, which details findings of the literature and Internet search. Chapter 4 covers vehicle detector testbeds in California, Minnesota, and Texas, and information gathered in phone calls to the same three states. Chapter 5 covers the testbed site selection and the conceptual design of the testbed. Chapter 6 discusses a proposed seven-step evaluation program for selected detectors. Chapter 7 describes the final detailed design, including the budget for implementing the testbed.



## **2. PHOENIX AREA DETECTORS**

### **INTRODUCTION**

With the exception of a few vehicle detectors installed in the Phoenix area for test and evaluation, the detectors currently used by the Arizona Department of Transportation are inductive loops and passive acoustic detectors (PADs) from SmarTek (SAS-1).

### **FREEWAY MANAGEMENT SYSTEM (FMS) DETECTORS**

Original ADOT Freeway Management System detector locations were every 1/3-mile along most of the major highways in the Phoenix area. Following FMS deployment, approximately two-thirds of the locations were decommissioned, which leaves operating detector stations about every mile. Figure 1 on page 10 shows ADOT Freeway Management System (FMS) detector locations in the Phoenix area, indicating all 219 locations that are currently maintained (not decommissioned) for collecting traffic data for operations or planning purposes. Red triangles represent PAD locations and green circles are loop sites.

### **Inductive Loops**

As a general rule, loops are no longer being installed on Phoenix freeways due to the disruption to traffic imposed by their installation and the fact that if lanes shift laterally, the existing loops are no longer useful. Loops are a mature technology and, in most cases, are sufficiently accurate for most purposes if properly installed and maintained. However, installation and replacement of loops represent a significant cost when traffic control, motorist delay, and increased crash risk during installation/maintenance are considered. Also, when loops are installed using a sawcutting procedure, a weakening of the pavement occurs. Some of the recent installations on Phoenix freeways have utilized preformed loops placed on top of an existing pavement in advance of a hot-mix asphalt overlay, overcoming the negative aspects of sawcutting. One exception to the general moratorium on freeway loop installation is where an accurate truth system is needed such as for a detector test facility.

The existing inductive loop sites in the Phoenix area have different numbers of wire turns, different loop depths, and different wire gauges. The loops are either 18 gauge wire with five turns (below the hot mix asphalt overlay) or 14 gauge wire with four turns (in the upper portion of the hot mix asphalt overlay). Some of the preformed loops were probably forced out of position by the paving operation. The nominal spacing of the loops is 18 feet, but the actual spacing varies from 17 feet to 24 feet. Checks of speeds based on assumed loop spacing indicates that speeds are off by as much as 15 mph.

Investigating data discrepancies requires an awareness of not only the detector accuracy but other aspects of data processing in the cabinet and communication elements providing information to ADOT's Traffic Operations Center (TOC). Discrepancies in data received at the TOC could be caused by detector calibration issues or by communication errors. Potential issues with inductive loops include: incorrect loop placement (loop shift during overlay),

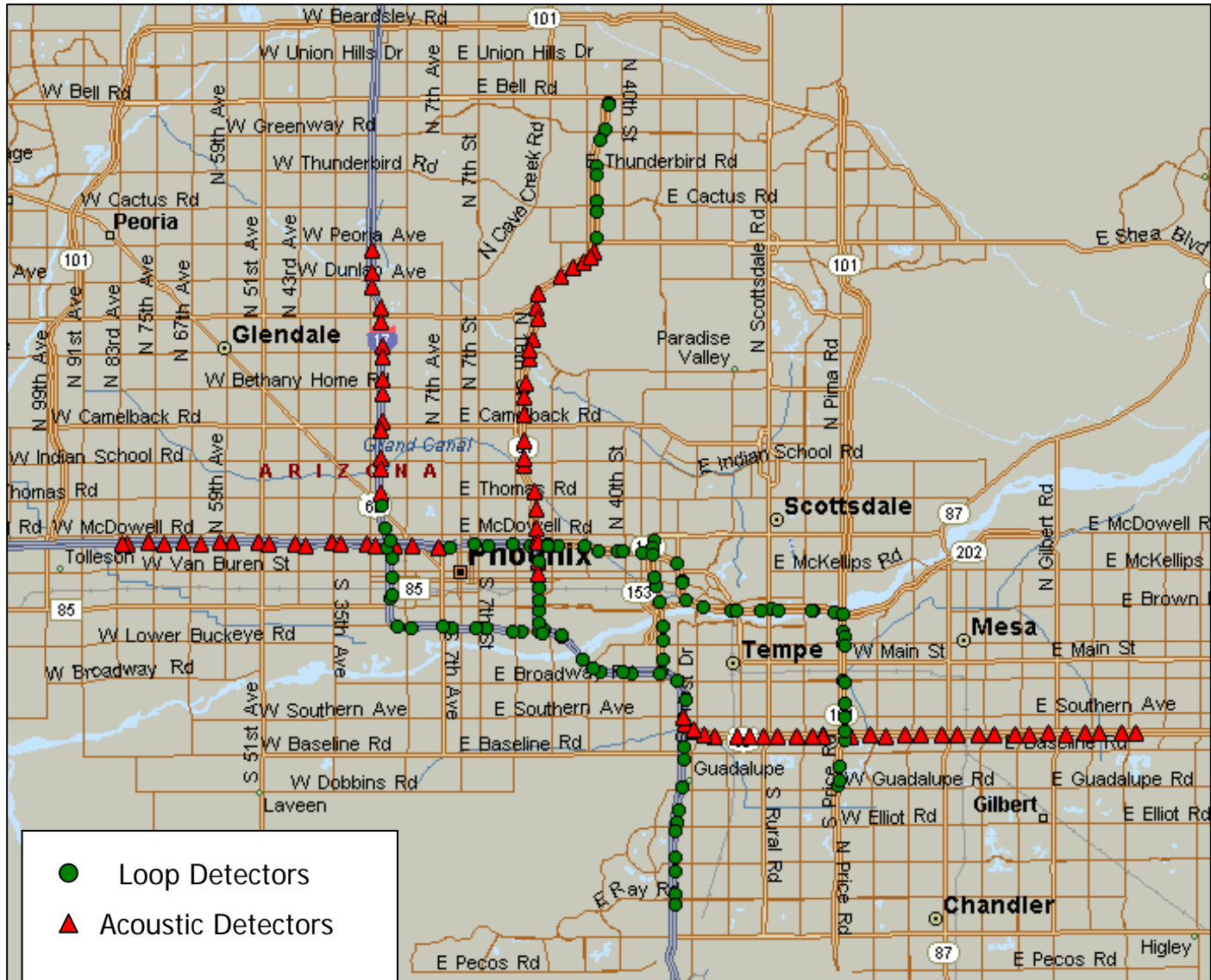

Figure 1: FMS Detector Locations

Broken and/or shorted loops, false actuations due to similar frequencies, sensitivity settings, and malfunctioning detector cards. Potential issues with the acoustic detectors include: pavement texture, echoes/reflections, detector alignment, and various software settings. Unless data are buffered locally at the cabinet, there is a chance of incorrect and/or missing data when it is received by the TOC. Detector actuations that are sent to the controller as contact-closure events are potentially lost when there are communication errors between the cabinet and the TOC.

### **Passive Acoustic Detectors**

There seems to be general agreement among local agencies that the PADs are a significant contributor to data errors, but there may also be errors introduced either in the cabinet or beyond the cabinet. Input based on other Texas Transportation Institute (TTI) research suggests that calibration of the PADs may be an issue at some sites. One calibration issue requires that PADs be recalibrated following a “quiet pavement” rubberized asphalt overlay.

Figure 2 on page 12 is a typical cabinet, and Figure 3 shows a SAS-1 contact closure card for PAD sites. These cabinets house Model 179 controllers to process data provided by vehicle detectors (PADs and loops), detector cards (SAS Relay Interfaces or loop detector cards), and a fiber-optic data transceiver. FMS data are transmitted from the cabinets to the Traffic Operations Center (TOC) on a dual-ring fiber-optic network, or via analog modem over twisted pair.

### **FMS Improvements**

Figure 4 on page 13 shows the FMS improvements planned. These corridors planned for improvement will be useful as detector test site identification moves forward since it may be desirable to locate the test facility within a construction project and perhaps even share funding with the construction project.

### **ADOT Transportation Planning Division (TPD) Test Site**

The ADOT Transportation Planning Division Data Bureau operates a test site at the interchange of Northern Avenue and Loop 101. The sensors installed there are GTT (3M) magnetometers, microwave radar (RTMS and Wavetronix), and inductive loops. This research project scope includes identifying other candidate sites that ADOT could choose from to implement a full-scale, long-term freeway vehicle detector test facility. It also includes developing a conceptual plan for the proposed test facility. In related non-ADOT tests, Sensys Networks magnetometers were installed in Scottsdale in early 2006 but not for long enough to fully explore longevity.



**Figure 2: FMS Cabinet with Inductive Loop Equipment**



**Figure 3: SmarTek SAS-1 Contact-closure Cards**

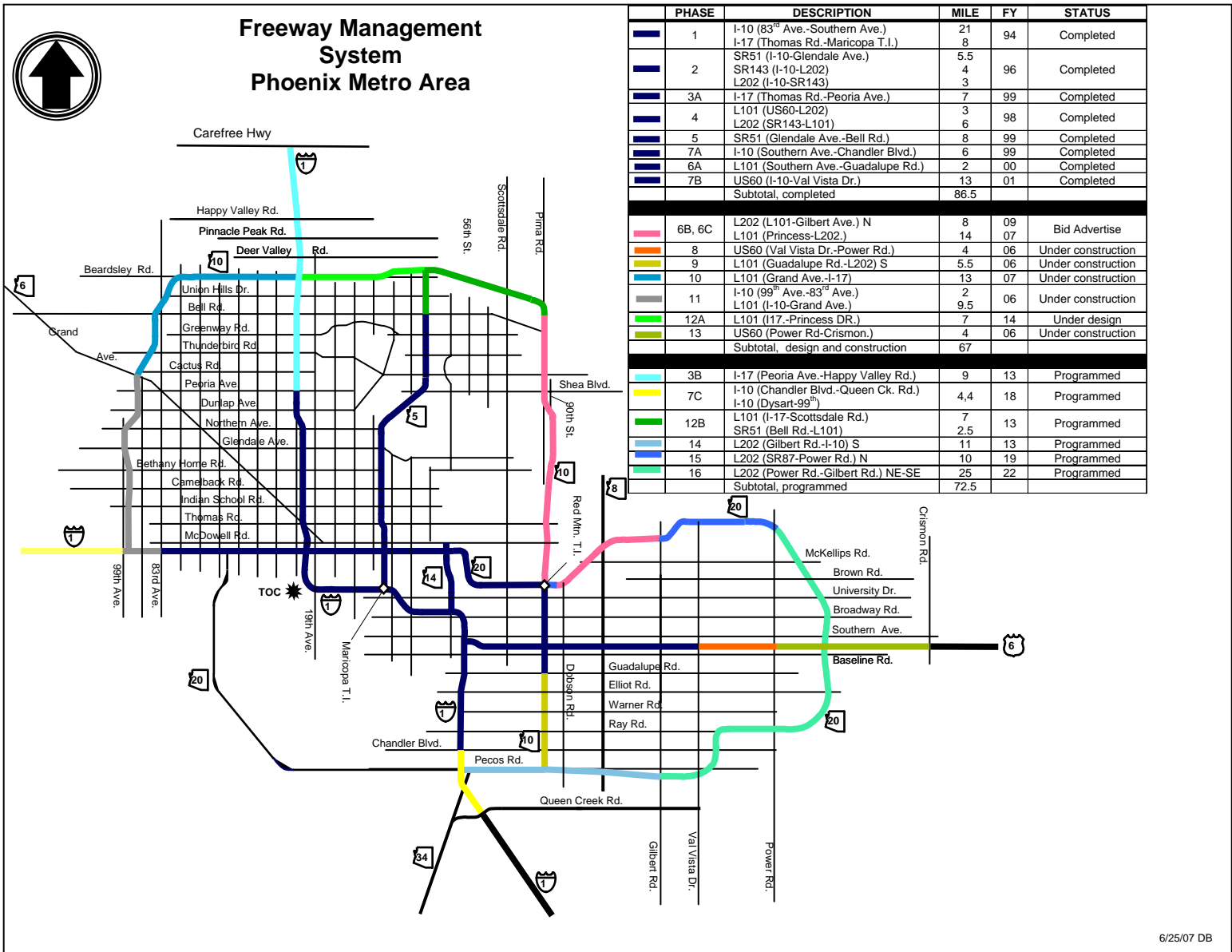

Figure 4: Phoenix Metro FMS Existing and Planned Projects

6/25/07 DB





### **3. LITERATURE AND INTERNET SEARCH; STATE CONTACTS**

#### **INTRODUCTION**

TTI researchers conducted a comprehensive literature search covering the past five years and an Internet search to determine emerging and promising vehicle detector systems that are worthy of further consideration by the Arizona Department of Transportation (ADOT) and other Arizona agencies. Previous TTI research covered the time period prior to this five year period. A keyword search used a variety of combinations of words such as freeways, non-intrusive detectors, performance, reliability, cost, video image detection, machine vision, microwave, radar, Doppler radar, passive acoustic, inductive loop detectors, installation methods, count accuracy, speed accuracy, occupancy accuracy, non-intrusive vehicle classification, FHWA classification, length-based classification, field test lab, freeway test site, testbed, and testbed conceptual plan. The search yielded over 150 total records. Of these, some were duplicates of each other or reports found elsewhere, and many others were not as useful as first thought. The remainder is included in this document.

Beyond using the key word search to develop the list of document summaries, some of the criteria used for selecting detectors for further evaluation included:

- Technologies known or found to be reliable and reasonably accurate.
- Emphasis on detectors that cover multiple lanes.
- Technologies of reasonable cost.
- Emphasis on vehicle detection and not pedestrian or bicycle detection.
- Emphasis on freeways and not signalized intersections.
- Emphasis on non-intrusive detectors but not to the total exclusion of others.

The organization of the literature and Internet findings in this section begins with findings pertaining to single technologies – providing the reader with detailed performance on each technology separately. Findings from research projects that used similar environmental and traffic conditions to compare technologies are toward the end of the section (e.g., comparing PADs with microwave radar). Within this structure, the more sophisticated multiple-lane detection systems come first followed by single detection area devices. Findings are also organized chronologically with the most recent research results placed last.

#### **SINGLE TECHNOLOGY SOURCES**

Detection technologies discussed below are primarily non-intrusive, although there is also information on loops because they remain the most prominent detection system used

around the country. Two of the early series of detector research projects whose findings still have current relevance in this context were conducted by the Minnesota Department of Transportation (MnDOT) along with consultant SRF Consulting, Inc. <sup>(1, 2, 3, 4)</sup> and by the Texas Transportation Institute. <sup>(5, 6, 7, 8, 9, 10, 11)</sup> The more recent study findings will be emphasized but some of the earlier findings are included as well.

The MnDOT Phase I Non-Intrusive Tests (NIT) ran from November 1995 to January 1997, involved 17 devices representing eight technologies, and used standard inductive loops for ground truth in both phases. Volume and speed data were the primary parameters tested, with classification also included on some devices. Phase II included building a permanent test shelter at the site, which was completed in April 2001, purchasing the detectors to be tested, and pre-testing the detectors through the summer of 2001. The official freeway data collection lasted from October 2001 to early March 2002. The most recent round of detector tests was the Portable Non-Intrusive Traffic Detection System (PNITDS), which began in 2003 and concluded in 2005. <sup>(12)</sup>

Recent TTI research projects on this topic span a time period from 1995 to 2007. These projects relied on two freeway test facilities, one in College Station on S.H. 6 and the other on I-35 near downtown Austin. The College Station testbed maintains free-flow conditions while the Austin site is usually free-flow during off-peak periods but becomes congested with stop-and-go traffic during peak times or due to incidents. Cross-sections of the two roadways are different as well – the College Station site has four lanes with two in each direction with a 60-ft depressed grass median while the Austin site has five contiguous lanes in the southbound direction with a center median barrier.

TTI developed and equipped the two freeway testbeds with equipment such as equipment cabinets, computers, baseline inductive loops, charged couple display (CCD) cameras, Digital Subscriber Line (DSL) communication, and baseline inductive loops. More information on both of these facilities is provided later in this document. Detectors investigated in this TTI research included: Autoscope Solo Pro (video imaging), Accuwave (microwave), Remote Traffic Microwave Sensor (RTMS) (microwave radar), non-invasive microloops by GTT (3M) (magnetic), SAS-1 by SmarTek (acoustic) Traficon VIP (video imaging), Iteris Vantage (video imaging). Other detectors tested by TTI with less viability were not included in this document.

### **Inductive Loop Detectors**

It is appropriate that a comparison be made of newer detectors with the most commonly used detector in current practice—the inductive loop. If non-intrusive detector accuracy compares favorably with loops and they are otherwise similar but non-intrusive, there are many agencies that would choose the non-loop option. <sup>(1,2,3)</sup> The Minnesota research used 6 ft by 6 ft loops installed in previous tests for baseline comparison of counts and speed accuracy. Therefore, the inductive loops were only approximately four years old when this Minnesota research began. Initial loop accuracy tests showed that the loops in lanes 1 and 2 on the freeway undercounted by 0.1 percent, while the high-occupancy vehicle (HOV) lane loops undercounted by 0.9 percent. Speed tests indicated that lane 1 loops

underestimated true speed by 6.1 percent, and lane 2 loops underestimated speed by 1.9 percent.

### Peek ADR-6000

The Peek ADR-6000 is a high-end vehicle classification system (using Idris technology) which exclusively uses inductive loops as its in-pavement sensors. It is unique in the fact that it uses inductive loops as axle sensors, using vehicle signatures generated from loop actuations for its classification algorithm. Therefore, its speed, count, and classification results exceeded previous experience from the more typical classifiers using loops and axle sensors (e.g., piezoelectric sensors). The ADR stored classification data internally to be downloaded later to a site computer or to other computers via the Internet using file transfer protocol (FTP).<sup>(7)</sup>

TTI findings (from I-35 only) indicated that the ADR-6000 was accurate for classification, counts, speeds, and lane occupancy (although TTI had to develop software to monitor occupancy). Table 1 on page 18 shows the classification result for a dataset of 1923 vehicles, indicating only 21 errors and resulting in a classification accuracy of 99 percent (ignoring Class 2 and 3 discrepancies). This data sample occurred during the morning peak and included some stop-and-go traffic. For count accuracy, the Peek in this same dataset only missed one vehicle (it accurately accounted for vehicles changing lanes). Figure 5 on page 18 shows the close agreement of the ADR with two other test systems – an overhead Doppler radar system, and an Autoscope Solo Pro – using one-minute speed bins from the Peek. The graphic indicates discrepancies only at slow speeds (below about 15 mph) where the Doppler radar is known to drop out and the Autoscope speed accuracy decreases slightly.<sup>(7)</sup>

Researchers expect the future of the ADR-6000 in similar applications to be a function of its cost, willingness of agencies to continue installing inductive loops, and willingness of multiple agencies to develop agreements to share maintenance responsibilities (e.g., for shared data) due to its high cost. The fact that it can serve a dual role is expected to be a positive factor, especially at more demanding locations with extremely high volumes and where it can serve both the traffic operations and traditional data needs.

## **Video Image Vehicle Detection Systems**

### Autoscope Solo

The Autoscope Solo is a video imaging system whose cameras can be mounted either overhead or to the side of the road. MnDOT tests of the Autoscope 30 ft over the center of three lanes indicated excellent performance. The absolute percent volume difference between the sensor data and loop data was under 5 percent for all three lanes. The detector also performed well for speed detection. The absolute average percent difference was 7 percent in lane one, 3.1 percent in lane two, and 2.5 percent in lane three. For other mounting locations beside the roadway, the detector performed best when mounted high and closest to the roadway.<sup>(4)</sup>

**Table 1: Peek ADR-6000 Classification Accuracy Comparison for I-35**

	Vehicle Classification												Total	Errors
	1	2	3	4	5	6	7	8	9	10	11	12		
Lane 1 Count	0	330	118	1	9	0	0	2	15	0	1	0	476	
Errors	0	0	0	0	1	0	0	0	2	0	0	0		3
Lane 2 Count	0	299	84	0	16	3	1	11	23	0	1	0	438	
Errors	2	1		3	1				1					8
Lane 3 Count	2	306	96	1	11	3	0	7	6	0	0	0	432	
Errors		1			2	1			1					5
Lane 4 Count	0	312	88	1	14	1	0	4	2	0	0	0	422	
Errors			1	1	1	1								4
Lane 5 Count	0	106	36	0	5	3	0	0	5	0	0	0	155	
Errors		1												1
Totals	4	1356	423	7	60	12	1	24	55	0	2	0	1923	
Total Errors	2	3	1	4	5	2	0	0	4	0	0	0		21

Source: Reference 7.

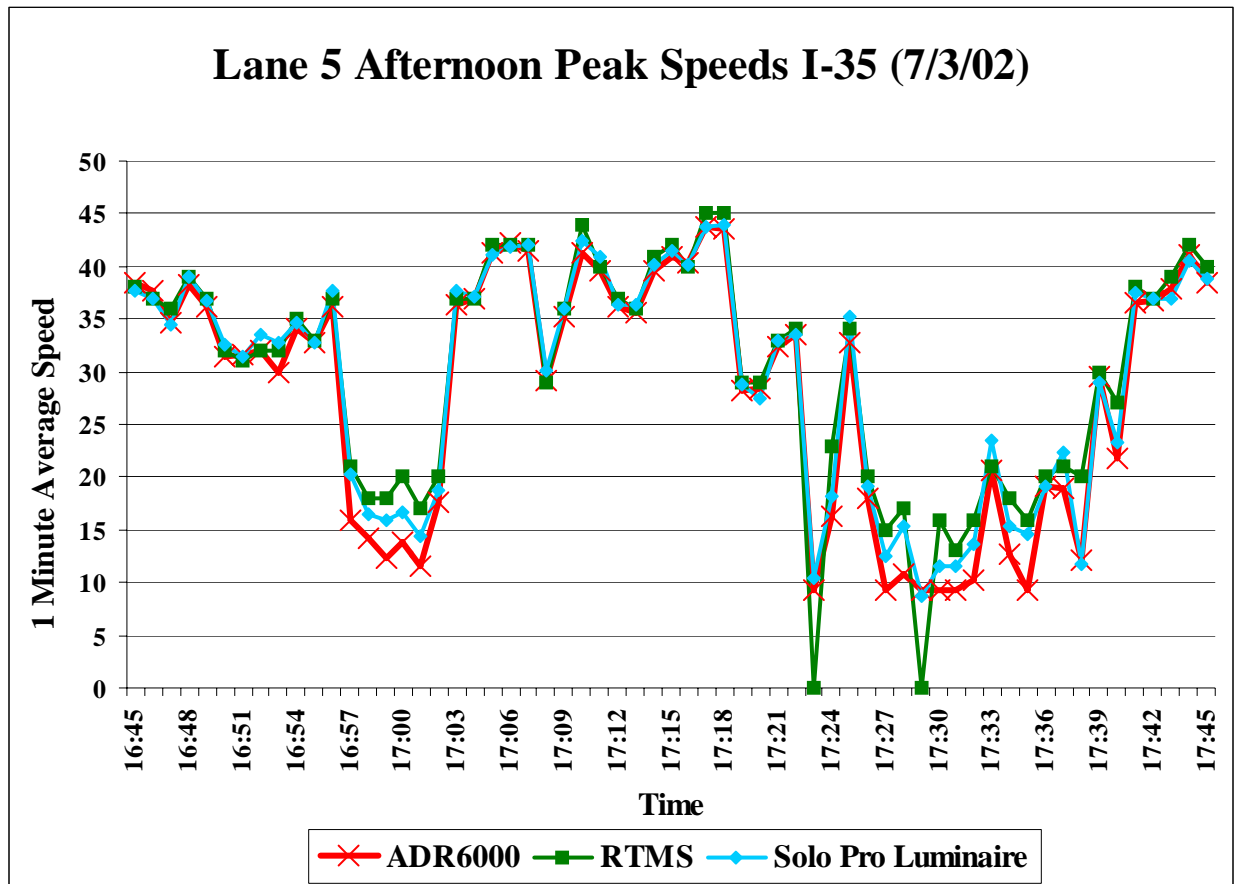

Source: Reference 7.

**Figure 5: Speed Comparison of ADR-6000, Doppler Radar, and Video Imaging System**

## Autoscope Solo Pro

At the time of this TTI research, the Autoscope Solo Pro was the latest version of the integrated camera and processor. TTI tested this detector at both testbeds, but the results reported in this section come from the I-35 testbed and are based on five-minute samples of count and speed data. The I-35 site has five southbound lanes with lane 1 (the median lane) being furthest from the detector. For these tests, the Solo Pro was 35 ft above the pavement and 6 ft from the nearest lane. <sup>(7)</sup>

In TTI research which ended in 2002, the Autoscope Solo Pro count accuracy was within 5 to 10 percent of the baseline counts during free-flow conditions, but it generally diminished in all lanes when 5-minute interval speeds dropped below 40 mph and especially during stop-and-go conditions. On all four of the monitored lanes, it overcounted during free flow, but almost always within 10 percent of baseline counts. During the peak periods, however, it undercounted. On lane 1, its error was always within 10 percent. On lane 2, its undercounts were about half within 10 percent and half between 10 and 20 percent. On lane 3 (closer to the camera), its undercounts were two-thirds within 10 percent and one-third between 10 to 20 percent of baseline counts. On lane 4, the Autoscope had 9 out of 10 within 10 percent and one out of 10 between 10 and 20 percent. Speed and occupancy of the Solo Pro were the best of any non-intrusive devices tested by TTI in this research project. Speeds were almost always within 0 to 3 mph of the baseline system. Its 15-minute cumulative occupancy values differed from loops by as much as 4 percent, but during most intervals its difference was less than 1 percent. <sup>(7)</sup>

## Iteris Vantage

TTI tested the Iteris Vantage on I-35 immediately following its initial release for freeway applications. It had the highest standard deviation during free flow of all test devices on both lanes 1 and 3. Overall, the Iteris count accuracy was not as dependent on prevailing freeway speeds as some other devices. It did not have a significant bias toward overcounting or undercounting. Its lane 1 morning peak counts were between -1 and -22 percent during slow speeds (20 to 30 mph); then it overcounted by as much as 10 percent when speeds increased. It mostly overcounted in lane 1 during the afternoon peak with a range from -4 to +10 percent. Lane 2 Iteris morning peak counts were all within the range of 0 to -10 percent except one and that one was at +5 percent. In the afternoon, its range was -5 to +10 percent, and all but four of its intervals were within  $\pm 5$  percent. Lane 3 Iteris morning peak counts were all within the range of +2 to -7 percent. In the afternoon peak, the Iteris was +5 to -10 percent. Lane 4 counts were not available. <sup>(7)</sup>

For speed accuracy, the Iteris standard deviation was among the lowest of the devices tested on both lanes 1 and 3. Its mean values of speed differences were lowest on lane 3, perhaps indicating better calibration than on lane 1. The Iteris Vantage speed estimates were both higher and lower than the baseline speeds but usually within 5 mph in lane 1 during the morning peak. During the afternoon peak, it was always within 5 mph on lane 1. On lane 2, its morning peak speed estimates exceeded the baseline by as much as 15 mph. During the afternoon peak, it was always within 5 mph on lane 2. On lane 3 during

the morning peak, its speeds were excellent in all intervals showing speeds within 0 to 2 mph of the baseline. During the afternoon peak, it was within 5 mph of the baseline. On lane 4, the Iteris was consistently within 5 mph of baseline during the morning peak. Speeds during the afternoon peak were not available. <sup>(7)</sup>

Of the three non-intrusive devices tested for occupancy output in lanes 3 and 4, the Iteris Vantage was the second most accurate. Its 15-minute cumulative occupancy values differed from loops by as much as 8.1 percent, but during most intervals its difference was less than 6 percent.

### Traficon NV

MnDOT Phase II tests mounted the Traficon camera directly over the lanes at heights of 21 ft and 30 ft facing downstream. The preferred orientation was facing oncoming vehicles, but site features precluded this orientation. At the 21-ft height, the absolute percent difference between the sensor data and loop volume data was under 5 percent for all three lanes. At the 30-ft height, its off-peak performance was similar but it undercounted during congested flow showing an absolute percent difference of some 15-minute intervals from 10 percent to as high as 50 percent. Reasons suspected for the reduced accuracy were snow flurries and sub-optimal calibration. Its speed accuracy at 21 ft indicated good performance. Its absolute average percent difference was 3 percent in lane 1, 5.8 percent in lane 2, and 7.2 percent in lane 3. During the snowfall, its speed accuracy declined to a range of 8.9 percent to 13 percent. <sup>(4)</sup>

A critical finding of the Phase I NIT research was that mounting video detection devices is a more complex procedure than that required for other types of devices. Camera placement is crucial to the success and optimal performance of this detection device. Lighting variations were the most significant weather-related condition that impacted the video devices. Shadows from vehicles and other sources and day/night transitions also impacted count accuracy. <sup>(3)</sup>

### **Microwave Radar Detectors**

Minnesota Phase I researchers tested one radar device, the RTMS X2 by Electronic Integrated Systems, Inc. (EIS). This device can be mounted either overhead or in a sidefire position aimed perpendicular to traffic. The RTMS is easily mounted but requires a moderate amount of calibration to achieve optimal performance. MnDOT researchers found that rain affected the performance of the RTMS, although they attributed this degradation to water entering the device and not to limitations of the technology. When the RTMS was mounted overhead, it undercounted vehicles by 2 percent or less at the freeway site. When it was in a sidefire orientation, it undercounted traffic by approximately 5 percent. <sup>(3)</sup>

Results of research ending in 2002 at TTI's I-35 testbed in Austin indicated that the RTMS X2 is more accurate in both counts and speeds in the overhead position although it covers only one lane in that orientation. The more popular orientation is sidefire, so the following discussion focuses on its sidefire accuracy. In sidefire, the RTMS can generate

speeds and counts for five lanes with reasonable accuracy. (The tests at the I-35 site used five lanes.) Its advantages also include being mounted only 17 ft above the roadway, and good user interface. Its coverage and initial cost make the RTMS an economical means of monitoring several lanes. <sup>(7)</sup>

More specifically, the TTI research found that the RTMS undercounted in all lanes during both peak and off-peak intervals. Its five-minute counts in lane 1 were all in the -10 to -25 percent range. (The detector location was nearest lane 5, so lane 1 was farthest away.) Researchers did not evaluate lane 2. In lane 3, 95 percent of the time intervals were within 5 percent of baseline. In lane 4, 98 percent of the time intervals were within 15 percent of baseline counts. These findings indicate that distance from the detector and occlusion affected count accuracy. Lane 1 was slightly worse than lane 3, and lane 4 was slightly worse than lane 3, suggesting either calibration differences or middle lanes naturally being better than either extreme. Aggregated speed estimates by the siderefire RTMS differed from baseline speeds by as much as 15 mph during peak periods, but it was usually within 5 to 10 mph of baseline speeds during the off-peak. This research did not include occupancy tests on the RTMS. <sup>(10)</sup>

In the overhead position, the RTMS was more accurate in counting vehicles, but it only covers one lane. In TTI tests, the overhead RTMS (Doppler mode) generated excellent speeds until prevailing traffic speeds dropped below about 15 mph. It is a mature product and is not significantly affected by weather or lighting conditions. <sup>(7)</sup>

The Detector Evaluation and Testing Team (DETT) of the California Department of Transportation (Caltrans) tested two radar detectors, the RTMS X3 and the Wavetronix SmartSensor. <sup>(13)</sup> The test site was the Caltrans test facility on I-405 near the University of California at Irvine, which uses the seven northbound lanes for tests. Traffic volume at this site is about 3 million vehicles per week. Another technology tested at this site was the Inductive Signature Technologies (IST) product that has the capability of tracking vehicles using inductive loop signatures. The team collected both 30-second and 5-minute aggregate data at this site. Results indicate that the ground truth inductive loops overcounted by 1.0 to 1.5 percent. This overcounting is due at least in part to lane changers that cross sensors in two adjacent lanes.

The California tests indicated that with proper installation and calibration either detector can deliver better than 95 percent overall vehicle count accuracy at 5-minute and 30-second intervals and 95 percent speed accuracy at 5-minute intervals. However, due to a very strict Caltrans specification, neither detector was found to be suitable for determining occupancy. One of the comments from researchers was that the RTMS requires considerable effort to achieve acceptable data accuracy, requiring expert know-how and a lot of time to set up and calibrate. The Wavetronix only required 15 to 20 minutes total to set up, whereas a factory representative took about one hour per lane for the RTMS. Also, the technology can be very accurate in the center of a roadway but the presence of trucks and heavy traffic can cause the detectors to miss counting of some vehicles as well as to create some false readings in side lanes. <sup>(13)</sup>

Since a number of previous studies had compared aggregate data from one or more detectors to concurrent measurements from another device (perhaps a ground truth device), Coifman<sup>(14)</sup> chose to compare actuations of individual vehicles at one detector to concurrent measurements of the same vehicle at another detector. He used four inductive loop sensor models and the RTMS. More specifically, the research used the following loop detection units: Peek GP6 and Reno A&E Model 222 inductive loop detectors, along with the reportedly higher performing GTT (3M) and IST Model 222 detectors. The research used the Berkeley Highway Laboratory to collect data from all five of the detectors using Videosync, the software package developed by Caltrans Division of Research and Innovation (DRI), as the primary tool for data reduction. This software allows the direct comparison between concurrent detector and video data.

Each of the sensors exhibited problems. Study conclusions stated that agencies could identify and correct most of the problems with additional fine-tuning in the data processing by the controller or data aggregator, but most operating agencies did not attempt to accomplish the correction. Therefore, the study findings should replicate conventional practice. Some of the errors could be corrected by improved controller logic, but some would require a trip to the field to correct. The Reno detector tended to flicker on for short periods in absence of a vehicle in the detection zone, which could be correctable in the controller software. Other errors resulted from lane-changing maneuvers over the detection zone. IST and Peek tended to detect such vehicles in both lanes, while the Reno and GTT (3M) sensors tended to underestimate the on-time of vehicles changing lanes in one lane while not detecting them in the other.<sup>(14)</sup>

The RTMS showed systemic errors in its performance—manifested as differences between nearest (small detection zone) and farthest lanes (occlusion). This systematic change in on-time would be an important consideration for applications that rely on occupancy. Also, the RTMS count and on-time are typically noisier than loops, although pluses and minuses tend to cancel each other. Detection zone sizes varied across all detectors, from the larger detection zones of the RTMS and even across the four models of loop detectors whose in-pavement dimensions were the same. These variations will impact the occupancy values. Of course, the sizes of loop detection areas are a function of sensitivity settings, but perhaps equally important are site-specific factors.<sup>(14)</sup>

Another relevant report by Coifman<sup>(15)</sup> also used the Berkeley Highway Laboratory to investigate aggregate data from the RTMS sensor. The study evaluated the performance of the RTMS in sideref mode relative to loop detectors in the freeway setting. The documented results first reported the aggregated data by the RTMS using its internal controller emulation and compared these results with data from nearby dual-loop detectors. The RTMS measures of flow and occupancy are noisier than loop detectors, although the RTMS estimates for speeds are almost as good as those from single-loop detectors. The second aspect of the study considered aggregate measurements from contact closure data and compared RTMS results against the dual-loop detectors. For reference, the research also compared one loop against the adjacent loop in the same lane in a trap loop configuration. In the flow measurements, the RTMS was within 10 percent of values generated by the loops with the loops being within 3 percent of each other.



Occupancies were not as accurate, ranging from 13 percent to 40 percent, again compared to the inductive loops.

A research project conducted by the Ohio Research Institute for Transportation and the Environment (ORITE) investigated the use of a custom-built trailer fitted with two microwave radar detectors to monitor traffic along selected segments of roadway. The trailer consisted of a steel frame with a solar panel plus battery box containing four deep-cycle gel batteries and a power controller. The solar unit was rated at 225 watts and outputs 12V DC; it was also equipped with a charge controller capable of regulating up to 15 amps of current. As equipped, the system can run for 8 days on batteries without sunlight. The trailer had two telescoping poles capable of reaching heights of 20 ft; it had four sockets so that the poles could be erected on either side of the trailer. It also had anti-theft devices such as a removable hitch, and special lock-nuts on the wheels. <sup>(16)</sup>

During a traffic monitoring session, the ORITE trailer used one Wavetronix SmartSensor model SS105 attached to each pole, with each detector pointed in the same direction and operating in parallel. The available information did not specify the separation distance, but photos indicated a separation of about 8 ft. The available information also did not discuss the possibility of interference between the two detectors, which would likely occur at that spacing and orientation. ORITE typically operated both detectors in the sidefire orientation. The trailer also housed a controller, which was a small computer used to collect the data from each sensor and combine the data into a single text file. Storage of the text file is on the computer's hard drive and on a 256 MB flash memory card. Setup of the entire operation takes about 45 minutes—30 minutes for the trailer and about 15 minutes for the sensors. <sup>(16)</sup>

The data collected by the system include: timestamp, lane number, and moving average speed (based on the last 16 vehicles) from the first sensor followed by a similar dataset from the second sensor. Next came an average of the two running speeds, vehicle length, and speeds for each sensor. Vehicle classes for this research were: Class 0 (0 to 20 ft), Class 1 (21 to 40 ft), and Class 2 (at least 41 ft). A portion of the ground truth came from videotape with time-stamped video synchronized with the same laptop the radar units were synchronized with. The baseline vehicle speeds came from a Kustom Signals TR-6 radar unit. <sup>(16)</sup>

Results indicate that the Wavetronix system misses some vehicles due to occlusion and it sometimes registers phantom vehicles from extraneous radar echoes (e.g., from a truck in an adjacent lane). On one of the test days, the number of phantoms was 7.03 percent, but on other days, the number of phantoms and misses was always less than 5 percent, and often under 1 percent. Speeds measured by the Wavetronix system (based on the moving average technique) usually correlated well with true speeds. These moving average speeds were a combination of the speeds detected by both sensors. The largest difference was 3 mph. The standard deviations in data measured by the trailer were always higher than those from the hand-held radar unit, generally by a factor of 2 to 3. The smallest difference found was 0.1 mph (2.0 mph Wavetronix vs. 1.9 mph radar), and the largest difference was 3.8 mph (4.2 mph Wavetronix vs. 1.1 mph radar). <sup>(16)</sup>

Other results based on vehicle length (or classification) were not as accurate. For example, one dataset had 8 percent true vehicles with lengths over 40 ft while the Wavetronix data indicated 21.4 percent with lengths over 40 ft. Some results were better and some were worse, but the authors conclude that the system does not reliably estimate the number of trucks in the traffic stream. Weather was not a factor in any of the tests. <sup>(16)</sup>

### **Passive Acoustic Detectors**

In MnDOT phase II tests, the sensor was bench-tested in the lab in March 2001, and then was mounted on the sidefire tower in May 2001. These tests used a total of five heights and three offsets during the actual field tests on the freeway between October 2001 and January 2002. Results indicated that at the first base (15 ft from the first lane), the detector provided better results for lanes 2 and 3 than for lane 1. The 24-hour data show that the absolute percent differences for lanes 2 and 3 were under 8 percent at all heights, and between 12 percent and 16 percent for lane 1 with heights less than 30 ft. Results were good for free-flow traffic conditions, but the detector undercounted during congested flow when speeds dropped.

Test data showed that 15-minute absolute percent differences were between 0 and 5 percent during off-peak, and varied from 10 percent to 50 percent during congested periods, depending on site geometry. In speed detection, the detector performed well at base one. The absolute average percent differences were under 8 percent for most mounting heights and between 12 percent and 16 percent for lane 1 at heights less than 30 ft. Overall test results show that the detector performs best when mounted with equal height and horizontal offset between the detector and the centerline of multiple lanes (45-degree angle). <sup>(4)</sup>

The first full test of the SAS-1 by TTI was at its S.H. 6 testbed in research ending in 2000. <sup>(6)</sup> The only factor found to compromise the SAS-1 count accuracy in this series of tests was rainfall. The detector's performance declined during wet weather, as indicated by a comparison of Tables 2 and 3 (page 25). The vendor, who was involved on-site in the initial setup, discovered an error in the lane sensitivity setting that might have accounted for the undercounting that occurred during rain. Unfortunately, there was no other wet weather during these tests to verify the assumed improvement.

The second project at TTI to test the SmarTek SAS-1 detector ended in 2002. The SAS-1 height above the freeway was 35 ft and its offset from the nearest lane (lane 5) was 6 ft. Its count accuracy for lane 1 (farthest) dropped during congested flow compared to free flow, but on lane 3 the accuracy was similar for the two conditions. The SAS-1 generally undercounted almost all intervals. In lane 1 during the a.m. peak and while speeds were over 40 mph its count range was 0 to -10 percent. During slower speeds, its range was -12 to -32 percent. Its range for lane 1 afternoon peak intervals was +2 to -20 percent with all but two intervals between 0 and -10 percent. The SAS-1 lane 2 ranges for the morning and afternoon peaks were between +5 to -18 percent and 0 to -10 percent, respectively. Lane 3 counts fell in the range of +6 to -12 percent during the morning peak and -2 to -14

percent during the afternoon peak. In lane 4, it undercounted during both the morning and afternoon peak by the range of -3 to -15 percent and 0 to -12 percent, respectively. <sup>(7)</sup>

**Table 2: SAS-1 Count Error Rates on S.H. 6 during Dry Weather**

Error Range (%)	Lane	
	Left	Right
0 to 10 %	353 of 378 (93.4 %)	376 of 378 (99.5 %)
10 to 20 %	25 of 378 (6.6 %)	2 of 378 (0.5 %)
20 to 30 %	0	0

*Source: Reference 6.*

**Table 3: SAS-1 Count Error Rates on S.H. 6 during Wet Weather**

Error Range (%)	Lane	
	Left	Right
0 to 10 %	4 of 20 (20.0 %)	4 of 20 (20.0 %)
10 to 20 %	12 of 20 (60.0 %)	3 of 20 (15.0 %)
20 to 30 %	4 of 20 (20.0 %)	13 of 20 (65.0 %)

*Source: Reference 6.*

The speed accuracy of the SAS-1 was similar in congested flow and free flow on lane 1. For lane 3, its mean and standard deviations indicate that its accuracy was more consistent in free flow than in congested flow. The SAS-1 consistently overestimated speeds in lane 1 during the morning peak by 5 to 10 mph. During the afternoon peak, it overestimated speed by as much as 20 to 25 mph during very slow speeds then improved to within 5 mph as speeds reached free-flow conditions. On lane 2 during both the morning and afternoon peaks, the SAS-1 was almost always over the baseline system by 0 to 5 mph with a maximum of 10 mph. On lane 3 this detector was consistently within 2 to 5 mph of the baseline system. On lane 4, its morning peak speed estimates were consistently within 5 mph and its afternoon peak speed estimates were less consistent but still within  $\pm 5$  mph. <sup>(7)</sup>

This research also compared the lane occupancy output of the SAS-1 with the baseline loop system in lanes 3 and 4. Its 15-minute cumulative occupancy values differed from loops by as much as 14.7 percent, but during most intervals the difference was less than 4 percent. <sup>(7)</sup>

### Active Infrared Detectors

Preliminary testing of active infrared detectors by public agencies indicates promising results for monitoring vehicle speeds and classifications. Active infrared systems appear to be immune to lighting changes but appear to be affected by heavy fog and heavy dust. Disadvantages of infrared sensors include: cost; inconsistent beam patterns caused by changes in infrared energy levels due to passing clouds, shadows, fog, and precipitation;

lenses used in some devices may be sensitive to moisture, dust, or other contaminants; and the system may not be reliable under high-volume conditions. <sup>(5)</sup>

An active infrared device detects vehicle presence by emitting a laser beam toward the road surface and measuring the time required for the reflected signal to return. The presence of a vehicle reduces the return time for the reflected signal to the detection unit. Phase I of the Minnesota project evaluated one active infrared device, the Schwartz Electro-Optics (SEO) Autosense I, and only on the freeway. In addition to detecting stationary and moving vehicles by presence, the Autosense I can obtain vehicle speed and vehicle profile (which researchers can use for classification). Heavy snowfall, as well as rain and freezing rain, caused the detector to both overcount and undercount vehicles. During snow, the undercounting was attributed to vehicles traveling out of the detection zone, while overcounting was probably the result of falling snow reflecting the laser beams causing false detections. These discrepancies were attributed to the change in reflectivity properties of the pavement. <sup>(3)</sup>

In research aimed at reducing the number of trucks stopping at isolated signalized intersections, TTI tested the SEO Autosense II as one of the options for detecting and classifying vehicles. Weaknesses included its cost (\$10,000 per lane in 1995), lack of ruggedness for field applications, inconsistent speed accuracy, and requirement for mounting directly over the lane. For a sample of 160 vehicles, it missed 3 percent and misclassified 7.5 percent. <sup>(9)</sup>

## **Magnetic Detectors**

Passive magnetic devices measure the change in the earth's magnetic flux created when a vehicle passes through the detection zone. The only two systems deemed appropriate for this research are the GTT (3M) non-invasive microloop and Sensys Networks magnetometers. Both systems are passive sensing systems that are based on the earth's magnetic field. When a vehicle passes through the detection zone, it temporarily distorts the earth's magnetic field enough to create a measurable change in the field. <sup>(4)</sup> A passive magnetic device must be relatively close to the vehicles it is detecting; therefore most applications require installation below the pavement. The Sensys Networks magnetometers require a 4-inch diameter core to a depth of 3 inches, mount flush with the pavement surface, use wireless communication to the roadside, and require a short lane closure for installation or replacement. The GTT (3M) detectors use copper wire connections, are more time-consuming to install requiring a horizontal bore in most cases, but can be installed at depths up to about 36 inches without significant loss in accuracy. Both systems can be used for vehicle speed, length, and occupancy if two detectors are available per lane at a known spacing.

### GTT (3M) Microloops

MnDOT results indicated that GTT (3M) probe performance was compromised by water in the conduit. During periods of heavy rain, erratic performance could have been due to

intermittent grounding problems. Vehicles straying from the normal lanes resulted in overcounting during periods of snow. <sup>(3)</sup>

Besides installation in a horizontal bore underneath the roadway, GTT (3M) detectors have also performed successfully under bridge decks. Installers must first use a magnetometer to determine proper placement of the probes; otherwise optimum performance requires a trial-and-error process. One of the requirements of this system is that the probes remain relatively vertical, so keeping the horizontal bores straight is critical. Probes placed in a non-vertical orientation can lead to speed errors. MnDOT tests under pavement indicated excellent volume and speed results. The absolute percent volume difference between sensor and baseline was under 2.5 percent, which is within the accuracy capability of the baseline loop system. For speeds, the test system generated 24-hour test data with absolute percent difference of average speed between baseline and test system from 1.4 to 4.8 percent for all three lanes. <sup>(4)</sup>

TTI tested GTT (3M) microloops at its S.H. 6 testbed in College Station. At this relatively low- to moderate-volume site over a six-day count period, TTI found that microloop counts were within 5 percent of baseline counts 99.4 percent of the time in the right lane (dual probes). In the left lane (single probes), 94.5 percent of the 15-minute intervals were within 5 percent, 4.5 percent were between 5 and 10 percent, and in 1.0 percent there was a more than 10 percent difference from baseline. <sup>(6)</sup>

### Sensys Networks

Cheung et al. investigated the use of single wireless magnetic detectors as an alternative to inductive loops for traffic monitoring on freeways as well as at intersections. Their advantages appear to include cost, ease of deployment and maintenance, and enhanced measurement capabilities. Components of this magnetic detector include “sensor nodes,” which communicate with an Access Point (AP) unit installed at the roadside. A sensor node is comprised of a magnetic sensor, a microprocessor, a radio, and a battery. <sup>(17)</sup>

The paper covers two experiments, with the first and longer one being a two-hour monitoring session on Hearst Avenue in Berkeley, California, downstream of a signalized intersection. During this two-hour session, 332 vehicles passed through the detection zone. The single magnetic sensor achieved a detection accuracy of 99 percent (100 percent if motorcycles are excluded), and average vehicle length and speed estimates that appear to exceed 90 percent. <sup>(17)</sup>

For vehicle classification, a single dual-axis magnetic sensor measures the earth’s magnetic field in both the vertical direction and along the direction of the lane, each sampled at 64 Hz. A simple algorithm uses the information to classify the vehicle into six types: passenger vehicles, SUV, van, bus, mini-truck, and truck. Of the sampled vehicles, the detector correctly classified 24 out of 37 vehicles (63 percent). Combining classified vehicles into the FHWA classification scheme suggests an 83-percent accuracy rate for the FHWA scheme. The sample size was small, but the results appear to be promising. The sensor correctly classified all buses, vans, and passenger vehicles, but it had

problems with SUVs and mini-trucks. Further experiments are needed to determine its accuracy with trucks. It is important to note that adding length as a measured feature of the single magnetic sensor would probably improve the classification accuracy.<sup>(17)</sup>

This research compared this single magnetic detector and its capabilities with inductive loops. In comparison, measuring accurate lengths with loops requires two loops compared to only one magnetic detector. The magnetic detector is easily installed and measures the earth's magnetic field, which is a three-dimensional vector. This detector records the changes in the field caused by different parts of the vehicle and that is how it can classify the vehicle. The size of an inductive loop, on the other hand, is larger, causing it to lose some of the distinctive features from the inductive signature. In other words, magnetic signatures provide more detail on the vehicle to improve its use as a classifier.

Other advantages of magnetic detectors include the ability to install them on bridges, where sawcuts (for loops) would weaken the structure. Finally, wireless magnetic sensor networks should be much less expensive to maintain than inductive loops while providing more of the needed information.<sup>(17)</sup>

The authors suggest that both the speed and classification accuracy could be improved significantly by using two magnetic detectors spaced a known distance apart. They predict vehicle classification accuracies in the 80-percent range would be likely. The authors planned on additional tests to further develop the classification accuracy.<sup>(17)</sup>

## **SINGLE AREA TECHNOLOGIES**

The next three sub-sections cover single area detector systems using the following three technologies: passive infrared, microwave, and pulse ultrasonic. These detectors are simpler than the detectors covered above in that they do not distinguish vehicles by lane. The application of these detectors in a freeway environment might be most appropriate for ramps (e.g., ramp metering or queue length monitoring).

### **Passive Infrared Detectors**

MnDOT researchers found that passive infrared devices were not impacted by weather conditions and were very easy to mount, aim, and calibrate. However, there were significant differences in performances of the devices tested. Eltec Models 833 and 842 showed significant fluctuations in count accuracy. The ASIM IR 224 was easy to mount and calibrate, and repeatability was good. Results for these detectors were as good as within 1 percent of baseline data for freeway tests.<sup>(3)</sup> Two other research projects that included passive infrared detectors found mediocre results.<sup>(18, 19)</sup>

### **Microwave Detectors**

The MnDOT research tested four different Doppler microwave devices, but the research team presented detailed data for only two. All four devices were easily mounted and

calibrated, and none of the devices seemed to be affected by weather conditions. The devices tested revealed differences in performance. Both the Peek PODD and the Whelen TDN-30 required mounting overhead or slightly to the side of the roadway.

Under optimal conditions, the Peek PODD was able to count vehicles at the freeway site within 1 percent of the baseline, provided that the device was properly aimed. During one of the procedures, it detected vehicles in the adjacent lane. The Whelen TDN-30 undercounted at the freeway site by approximately 3 percent. <sup>(20)</sup>

### **Pulse Ultrasonic Detectors**

The Minnesota research team tested two pulse ultrasonic devices, the Microwave Sensors TC-30 and the Novax Lane King. Overhead mounting of the devices provided optimal signal return and vehicle detection; however, sidefire mounting is possible for some devices. Pulse ultrasonic devices are relatively easy to mount and weather does not affect performance; however, the ease of calibration varies with devices. Calibration for the Lane King was extensive for optimum performance.

Both detectors were accurate in counting vehicles at the freeway site, but the two pulse ultrasonic devices interfered with one another when mounted side by side for tests, which would not be done in practice. <sup>(3)</sup>

## **RECENT MULTIPLE TECHNOLOGY SOURCES**

### **University of Utah**

In a report published in 2003, Martin and Feng developed a traffic detector selection procedure which included the following technologies: inductive loops, magnetic, active infrared, passive infrared, microwave radar, ultrasonic, passive acoustic, and video image vehicle detection systems.

The selection criteria included: general installation conditions, cost, data accuracy, reliability, and ease of installation and maintenance.

Tables 4 and 5 (page 30) and Tables 6 and 7 (page 31) summarize this information. <sup>(21)</sup>

**Table 4: Detector Cost Comparison**

Technology/Sensor	Device Cost	Lanes <sup>d</sup>	Mounting <sup>d</sup>
3M Microloop	2 ch. Canoga Detector \$546 4 ch. Canoga Detector \$704 702 Microloop Probe \$160 701 Microloop Probe \$138 Installation kit \$114 Carriers \$355/pkg Cable: \$0.39/ft	S	3-inch conduit placed under roadway
SmarTek SAS-1	\$3500/unit	M (5 lanes)	S (25-40 ft)
Autoscope	Autoscope Solo <sup>a</sup> Single direction: \$4900	M (32) <sup>b</sup>	O/S
	Autoscope 2020 Single direction: \$4820		
Traficon	\$4000 per camera (camera, processor, housing, lens, cables, surge protection, setup & training) <sup>c</sup>	M (24) <sup>b</sup>	O/S (25-45 ft)

Source: Adapted from Martin and Feng: Reference 21.

<sup>a</sup> Autoscope solo has integrated camera and processor.

<sup>b</sup> Maximum number of detection zones per camera.

<sup>c</sup> A high resolution CCD black/white or color camera. The video camera should provide detailed video without lag, image retention, or geometric distortion.

<sup>d</sup> S – Single lane detector, M – Multiple lane detector, O – Overhead, S – Sidefire.

**Table 5: Detector Error Rates**

Sensor	Mounting Location	Count	Speed <sup>a</sup>	Evaluation Organization (Year)
3M Microloop	Pavement	2.5%	1.4%-4.8%	MnDOT (2002)
3M Microloop	Bridge	1.2%	1.8%	MnDOT (2002)
3M Microloop	Pavement	5%	$\mu = -0.25$ mph $\sigma = 3.6$ mph	TTI (2000)
SAS-1	Sidefire	8%-16%	4.8%-6.3%	MnDOT (2002)
SAS-1	Sidefire	4.0%-6.8%	3.4%-6.8%	TTI (2000)
SAS-1	Sidefire	10%	$\mu = -0.5$ mph $\sigma = 4.8$ mph	TTI (2000)
Autoscope Solo	Sidefire	5%	8%	MnDOT (2002)
Autoscope Solo	Overhead	5%	2.5%-7%	MnDOT (2002)
Autoscope Solo	Sidefire	2.1%-3.5%	0.8%-3.1%	TTI (2000)
Traficon	Sidefire	5% (45 ft)	2%-12%	MnDOT (2002)
Traficon	Overhead	10%-15% (25-30 ft)	3%-7.2%	MnDOT (2002)

Source: Adapted from Martin and Feng: Reference 21.

<sup>a</sup>  $\mu$  = mean,  $\sigma$  = standard deviation.



**Table 6: Detector Ease of Installation and Reliability**

Technology/Sensor	Ease of Installation <sup>b</sup>	Ease of Calibration <sup>b</sup>	Reliability <sup>a</sup>
3M Microloop	0	1	2
RTMS	2	1	1
SmarTek SAS-1	2	2	2
Autoscope Solo	2	1	2
Traficon	2	1	2

Source: Adapted from Martin and Feng: Reference 21.

<sup>a</sup> Reliability level is based on the performance shown in tests.

<sup>b</sup> 2: Performs satisfactorily in the stated condition; 1: Meets some but not all criteria for satisfactory performance; 0: Does not perform satisfactorily in the stated condition.

**Table 7: Estimated 2003 Life-Cycle Costs for a Typical Freeway Application**

Detector	Initial Cost	Mounting Type <sup>c</sup>	Install. Cost	Ann. Mtce. Cost	System Life (yrs)	Life-Cycle Cost/system <sup>a</sup>
3M Microloops	\$13,125 <sup>b</sup>			\$200	15	\$1380
RTMS	\$6600	O	\$2400	\$200	7	\$1700
		S	\$400			\$1370
SmarTek SAS-1	\$7000	S	\$800	\$400	7	\$1700
Autoscope Solo Pro	\$9800	O	\$3000	\$400	10	\$1980
		S	\$1000			\$1730
Traficon	\$8000	O	\$3000	\$400	10	\$1760
		S	\$1000			\$1510

Source: Adapted from Martin and Feng: Reference 21.

<sup>a</sup> Costs are for a total of six freeway lanes, three per direction.

<sup>b</sup> Total of 16 lanes and 32 probes.

<sup>c</sup> O - Overhead, S - Sidefire.

## University of Hawaii

The Department of Civil and Environmental Engineering at the University of Hawaii at Manoa evaluated eight vehicle detectors (five non-intrusive) at several locations in portable and permanent installations. These systems are: GTT (3M) microloops, Spectra Research ORADS portable laser sensor, RTMS model X2, SmarTek SAS-1, and Wavetronix SmartSensor SS105. The research retrieved data from these detectors using TrafInfo's Trafmate satellite modem, TrafficWerks cellular system, and conventional 9600 baud modems. <sup>(22)</sup>

The GTT (3M) microloops and ORADS portable laser sensor require installations below or very near the road surface, respectively. Lane closures are not required but personnel are still exposed to traffic. The GTT (3M) microloops and Canoga 702 detector card provided excellent volume and speed results. They are expected to have a long life cycle but their initial cost and installation were expensive. The ORADS laser sensor from Spectra Research did well with volume counts but performed poorly in classification. It was found that the ORADS laser sensor did not perform well on uneven pavement. <sup>(22)</sup>

The research included RTMS X2, SmarTek SAS-1, and SmartSensor SS105 in sidefire mode at various heights and distances from the roadway, and in inclement weather conditions. Researchers found that these three sensors could provide high-quality data at a low cost, with low energy consumption, and simple calibration. Installation required a pole at least 20 ft tall, and offset at least 20 ft from the first lane. Researchers retrofitted a trailer-based “light plant” with the sensors and deep-cycle batteries for power. They deployed this portable, stand-alone unit at various locations where sensor mounting options were limited. <sup>(22)</sup>

The baseline system for determining the volume, speed, and classification performance aspects of the sensors was usually pre-existing loops, supplemented in some cases with manual counts. Table 8 on page 32 summarizes the values associated with some qualitative ratings of the detectors. Based on comparisons of volume counts and speeds, the non-intrusive detectors rated as follows:

- The count rating for the RTMS X2 and RTC data unit by EIS was good to very good. The speed rating for the X2 and RT data unit was very good to excellent.
- The count rating for the SAS-1 acoustic sensor and SAS-CT board by SmarTek was good to very good. The speed rating for the SAS-1 and SAS-CT board was very good to excellent.
- The research did not rate the SmartSensor SS105 by Wavetronix by values from the table for either speeds or counts, but described its performance as similar to the RTMS unit.

**Table 8: Sensor Performance Descriptions (Hawaii)**

Rating	Volume/Classification (% error)	Speed (mph)
Excellent	±1	±3
Very Good	±3	±6
Good	±5	±10
Possibly Adequate	±10	±15
Inadequate	> ±10	> ±15

Source: Prevedouros: Reference 22.

Researchers recommended the SmartSensor as the top sensor based on ease of setup, lower height requirement, and exceptional feedback and assistance from the vendor. The SmartSensor’s auto-ranging and calibration features made it the quickest sensor to install. The researchers recommended both the SmartSensor and the RTMS for quiet rural locations with power already available. They recommended the SAS-1 for battery or solar power operations due to its minimal power consumption. The SAS-1 was able to detect bicycles in quiet locations, but loud music and other background noises caused the sensor to register a count. <sup>(22)</sup>

## Pennsylvania Department of Transportation

In a research article published in 2006 sponsored by the Pennsylvania Department of Transportation (PennDOT) and the Federal Highway Administration, a research team field-tested selected non-intrusive traffic data collection equipment. The site selection process provided a cross-section of roadside environments for the equipment setup and utilized sites near in-pavement traffic counting stations operated by PennDOT. These ground truth data sources were either Automated Traffic Recorder (ATR) sites or Short-Term In-Pavement (STIP) sites. <sup>(23)</sup>

Two of the detectors tested were RTMS microwave radar sensors by Electronic Integrated Systems and two were SAS-1 acoustic sensors by SmarTek. The RTMS model used in this research was the X2. Mobility Technologies, a local data provider, participated in the selection of sites and equipment to ensure that test detectors were operating properly. This process involved a quality control process that was not covered in detail in the report. Of the six sites selected by Mobility Technologies, two were in the Pittsburgh area and four were in the Philadelphia area. The other two test detectors were the Wavetronix SS105, and “The InfraRed Traffic Logger” (TIRTL). Some tests were set up in a portable scenario and some were permanent; the difference was in how the detectors were mounted. <sup>(23)</sup>

One limitation of the study was its short duration – in its entirety lasting only two days (September 14 and 15, 2005). Vendor representatives were allowed a maximum of two hours for setup of the equipment, and the data collection at each site was only four hours in duration. The authors calculated absolute percent difference (APD) as follows:

$$APD = \frac{|V_S - V_M|}{V_M} \times 100\%$$

where:

APD = Absolute Percent Difference (%)

V<sub>s</sub> = Volume from the sensor or ATR/STIP (vehicles)

V<sub>m</sub> = Volume from the manual count (vehicles)

Table 9 provides summary information on the four sites. Site number 1 and site number 3 are in the same location; however site 1 used only the northbound lanes, while site 3 used both directions simultaneously with a single sensor. <sup>(23)</sup>

**Table 9: Site Descriptions (Pennsylvania)**

Site No.	Description
1	S.R. 0119, NB only, freeway – single direction
2	S.R. 0040, both directions – two-lane highway
3	S.R. 0119, both directions – freeway
4	S.R. 0040, both directions – 5-lane suburban arterial

Source: French and French: Reference 23.

Table 10 summarizes the results of the portable setup tests for data collected in 2005. It provides the average APD data across the 16 15-minute time intervals along with the APD between the sensor and manual count in the total four-hour volume. In these tests, the sensor that matched the manual counts most closely was the SmartSensor. For the permanent setup comparisons, there was no statistically significant difference at the 95 percent confidence level between the best performing microwave sensor and the best performing acoustic sensor. <sup>(23)</sup>

**Table 10: Results of Portable Setup Field Testing (Pennsylvania)**

Site No. (Dir.)	SmartSensor		SAS-1		TIRTL		RTMS	
	APD%	4-Hr%	APD%	4-Hr%	APD%	4-Hr%	APD%	4-Hr%
1 (NB)	6	5.8	1	1.0	1	0.2	6	4.1
2 (EB)	4	3.7	2	0.7	1	0.0	3	1.3
2(WB)	2	0.5	20	20.4	1	0.2	25	24.9
3(NB)	2	1.4	1	0.8	19	18.5	2	1.5
3(SB)	2	0.9	3	1.0	26	26.0	1	0.1
4(EB)	2	1.2	3	1.1	25	25.7	2	0.2
4(WB)	3	1.1	5	5.0	15	14.9	43	40.6
Average	3	2.1	5	4.3	13	12.2	12	10.4

Source: French and French: Reference 23.

### Nebraska Department of Transportation

Like other states, Nebraska has used inductive loop detectors as its dominant means of detection for many years. However, the installation and maintenance of loops has become an issue due to the necessary lane closures that cause excessive delays to motorists and unacceptable risks for construction workers. These factors, along with the increased availability of emerging non-intrusive detectors that could be used to replace loops led to this research project to investigate the pertinent aspects of two of the newer detectors – the Autoscope RackVision by Econolite and the SmartSensor SS105 by Wavetronix. Even though previous research had evaluated these detectors, the Nebraska Department of Roads (NDOR) believed it was important to test them under local conditions because of the differences in detection systems, applications, and operating conditions. Study goals were to compare count accuracy of the two detection systems and compare them to inductive loops and also to compare speed and vehicle classification characteristics. <sup>(24)</sup>

The test location for this research was on I-80 at the 36<sup>th</sup> Street overpass in Omaha, Nebraska. The paper did not provide traffic volume data, but it indicated that it was adjacent to an interchange which experienced over 3 million hours of delay in the year 2002, ranking it among the top 60 bottlenecks in the United States. <sup>(25)</sup> Three major elements needed for this test were: 1) a data collection trailer equipped with the SmartSensor and positioned beside the roadway, 2) a data collection van equipped with the Autoscope camera and video recording equipment, and 3) an existing NDOR loop detector station with a single inductive loop in each freeway lane. <sup>(24)</sup>

The van was positioned so cameras were centered over the eastbound lanes of I-80 and cameras were 63.1 feet above the roadway. Recorded video from the van was post-processed using the Autoscope RackVision in a laboratory setting. Lane numbering used the convention of lane 1 being the outside lane and lane 5 is closest to the median. The SmartSensor was installed in sidewire configuration at a mounting height of 18 feet and was 19 feet away from lane 1. The SmartSensor system had a Click!100™ module which provided contact closure data to a Peek Automated Data Recorder (ADR) model ADR-1000 Plus, where data were stored. The data were subsequently downloaded to a laptop computer at the end of each data collection period. <sup>(24)</sup>

Data collection for this research occurred on three weekday morning peaks (Tuesday, Thursday, and Friday) during the week of August 8 to 12, 2005 from 6:00 a.m. to 10:00 a.m. and two afternoon peak periods of the same week (Wednesday and Thursday) from 3:00 p.m. to 7:00 p.m. A critical element in all tests of this type is clock synchronization on all systems. In this case, researchers used the clock associated with the loop detectors as the standard clock for all other detectors and they used an accurate digital watch to synchronize other systems to the loop detectors. They checked and synchronized clocks at the beginning of each four hour data collection period and found that clock drift within that four hour window was insignificant. The ground truth for this research came from manual counts of the recorded videotapes in 15 minute intervals. <sup>(24)</sup>

One of the statistics used to compare the three systems (inductive loops, SS-105, and Autoscope RackVision) was percentage volume errors. The null hypothesis was that the mean percentage volume errors of the three sensors were statistically equal. The analysis used the F statistic to investigate the null hypothesis. The larger the F statistic, the more likely it is that the null hypothesis will be rejected. The research first developed a comparison of aggregate data (all lanes, all conditions) and then developed a disaggregate comparison by lane, by speed, by weather condition, and by lighting conditions for the Autoscope (weather does not affect the other two systems). <sup>(24)</sup>

The results of the aggregate comparison indicated that the Autoscope had the lowest mean percentage error of 0.67 percent and the SmartSensor had the highest mean percentage error of 1.39 percent. All three technologies had positive mean percentage errors, indicating overcounts. The SmartSensor had the highest standard deviation (S.D. = 4.290) of the three technologies. On the basis of the F statistic at  $\alpha = 0.05$ , the null hypothesis was rejected, concluding that the mean percentage volume errors of the technologies were not all statistically equal. However, the mean percentage errors of all three systems were within 2 percent, so their average accuracies were greater than 98 percent. The authors conclude that, even though there were statistically significant differences between the systems, they were practically very similar and would be suitable for most volume counting applications. <sup>(24)</sup>

The next computation was disaggregated by lane. For the SS-105, lane 1 was closest and lane 5 was the lane furthest from the sensor. The Autoscope was centered over lane 3 so lanes 1 and 5 were furthest from the camera. In this case, the null hypothesis was that the mean percentage errors of the three sensors were statistically equal (at  $\alpha = 0.05$ ) across all

lanes. The corresponding F statistic indicated that the mean percentage errors of the three sensors were not statistically equal for any of the five lanes. Lane 1 data had the largest F statistic ( $F = 111.52$ ) while lane 4 had the smallest ( $F = 8.79$ ) indicating that each individual detector's performance was a function of lane location. The SS-105 had mean percentage volume errors in lanes 2, 3, and 4 in the range of 1 to 2 percent, but lane 5 results indicated larger overcounting errors (mean = 5.7 percent) and larger undercounting errors in lane 1 (mean = -3.5 percent).

For the Autoscope, the mean percentage errors in lanes 1 through 4 were approximately zero but the mean percentage error in lane 5 was higher at about 3 percent. Researchers hypothesized that the presence of trucks in lane 4 might have occasionally activated the detector in lane 5 and caused the overcounting errors in lane 5. <sup>(24)</sup>

In another analysis, results were disaggregated by speed where "normal" traffic involved average 15-minute speed greater than 50 mph and "slow" traffic involved average 15-minute speed less than or equal to 50 mph. Of the three systems, the SS-105 was most affected by speed – overcounting in normal speeds and undercounting during slow speeds. The Autoscope displayed a similar pattern although the effect was not as pronounced. Inductive loops showed little variation by condition. <sup>(24)</sup>

When results were disaggregated by weather (rain and dry), the mean percentage errors of the three sensors were not statistically different. Across clear and rainy conditions, the mean percentage errors for all three sensors were very close with differences within 0.3 percent. This finding indicates that rainy weather did not seem to affect performance of any of the sensors. <sup>(24)</sup>

The research also investigated the effects of light on the Autoscope. The mean percentage errors of the Autoscope data collected under dark and daylight conditions were found to be 0.797 percent (S.D. = 2.116 percent) and 0.767 percent (S.D. = 2.503 percent), respectively. Both mean percentages fall within plus or minus 1 percent, which indicates Autoscope performs well under both conditions. Table 11 (page 37) summarizes the results of this research. <sup>(24)</sup>

Finally, the research investigated the influence that levels of aggregation had on results. Findings indicate that the SS105 is more sensitive to the data aggregation type chosen. The analysis using combined lane and cumulative approaches produce lower percentage errors as compared to the by lane approach. The reason for this finding is that undercounting on lane 1 is balanced by overcounting in lane 5.

From a practical perspective, all three technologies performed adequately for most volume counting applications faced by transportation agencies – particularly with respect to total counts. The body of the paper ends with a discussion of speed and vehicle length, but this section is inconclusive because ground truth was not available for comparison. <sup>(24)</sup>

**Table 11: Comparison of Mean Percentage Volume Errors (Nebraska)**

% Error	N	Loop		SmartSensor SS105		Autoscope RackVision		F	Sig.
		Mean	Std. Deviation	Mean	Std. Deviation	Mean	Std. Deviation		
Overall	320	0.911	1.229	1.390	4.290	0.669	2.507	4.939	0.007*
<b>“Lane” based analysis:</b>									
Lane 1	64	1.066	1.266	-3.479	2.183	0.350	1.978	111.523	0.000*
Lane 2	64	0.956	1.077	1.695	2.499	-0.006	1.574	14.135	0.000*
Lane 3	64	1.022	1.002	1.066	1.580	0.078	1.565	10.058	0.000*
Lane 4	64	1.010	1.141	1.974	4.214	-0.096	2.093	8.787	0.000*
Lane 5	64	0.501	1.538	5.698	4.294	3.021	3.386	40.140	0.000*
<b>“Traffic Condition” based analysis:</b>									
Normal	293	0.971	1.231	1.609	4.176	0.739	2.543	7.029	0.000*
Slow	27	0.266	1.022	-0.981	4.857	-0.083	1.962	1.178	0.313
<b>“Weather Condition” based analysis:</b>									
Clear	220	0.946	1.239	1.481	4.375	0.675	2.454	4.156	0.016*
Rainy	100	0.834	1.211	1.193	4.111	0.657	2.632	0.883	0.415

\* indicates a statistical difference at  $\alpha = 0.05$  level of significance.

Source: Zhang et al.: Reference 24.

### Minnesota Department of Transportation

In 2005, MnDOT published results from its most recent Pooled Fund study on non-intrusive detectors, entitled “Evaluation of Portable Non-Intrusive Traffic Detection System” (PNITDS). While a substantial part of the report addressed mounting techniques, it also covered detector accuracy for three systems – the Wavetronix SS105, RTMS by EIS, and SAS-1 by SmarTek. It also provides some limited results on the TIRTL classifier. Table 12 is a brief overall summary of results for the first three. The report also provided results by individual site where testing occurred. These sites were on the following cross-sections: an eight-lane freeway, a four-lane freeway, a four-lane arterial, a two-lane roadway with a side wall, an unparallel lane at a freeway exit ramp, and a narrow local street without center striping.<sup>(12)</sup>

**Table 12: Overall Result for Volume and Speed Detections (Minnesota)**

	SS105	RTMS	SAS-1
Volume Detection	1.4% - 4.9%	2.4% - 8.6%	9.9% - 11.8%
Speed Detection	3.0% - 9.7%	4.4% - 9.0%	5.6% - 6.8%
Heavy Traffic Impact	No	No	Yes, Undercount
Weather Impact	No	No	No
Barrier Impact	Minimal	Moderate	Not tested

Source: MnDOT: Reference 12.

Table 13 on page 38 summarizes results of vehicle length data collected from the RTMS and SS105 microwave radar detectors. Researchers collected two hours of data at each of two sites, monitoring three lanes at each site.

**Table 13: Result Summary for Length-Based Class Detection (Minnesota)**

Lane	SS105	RTMS
1	0.8% to 5.6%	1.2% to 4.4%
2	0.6% to 4.7%	0.2% to 1.2%
3	0.4% to 1.5%	0.4% to 1.4%

Source: MnDOT: Reference 12.

### Texas Department of Transportation

TTI's most recent vehicle detector research project used both the I-35 testbed and the S.H. 6 testbed. Table 14 summarizes the detectors that were included in the final year of the project. The original intent was to include GTT (3M) microloops as well but an adequate site that met all the criteria was not found.

**Table 14: FY 2006 TTI Detector Test Plan (Texas)**

Detector	Technology	Test Location (No. Lanes)	
		Austin	College Station
Autoscope Solo Pro	Video Imaging	I-35 (5 lanes) <sup>a</sup>	S.H. 6 (2 lanes)
Iteris Vantage	Video Imaging	I-35 (5 lanes)	S.H. 6 (2 lanes)
SmarTek SAS-1	Passive Acoustic	I-35 (5 lanes)	S.H. 6 (2 lanes)
Sensys Networks	Magnetometer	I-35 (2 lanes)	S.H. 6 (2 lanes)
SmartSensor SS105	Microwave Radar	I-35 (4 lanes) <sup>b</sup>	S.H. 6 (4 lanes)
Traficon VIP	Video Imaging	I-35 (5 lanes)	S.H. 6 (2 lanes)

<sup>a</sup> The I-35 site has a total of five southbound lanes, but lane 1 has a failed inductive loop.

<sup>b</sup> The mounting pole was too close to lane 5, so the SmartSensor could only monitor three lanes.

Detector performance in this TTI research was compared against the Peek ADR-6000, a high-end vehicle classifier using inductive loop signatures for baseline count, speed, and occupancy data. Sidefired microwave radar detectors in this research exhibited consistent speed accuracy, although limited tests of an overhead-mounted SmartSensor SS105 in its Doppler mode was even better (it can only cover one lane in Doppler mode). Therefore, the SmartSensor SS105 should be considered as an accurate speed detector for replacing loops with its orientation depending on site-specific accuracy needs. For a three-color urban speed map display, most of the detectors tested in this research have the needed speed accuracy.

All non-intrusive technologies that are mounted beside and above the roadway appear to be affected by side-to-side occlusion and even more so in congested conditions. When congestion reaches a point where the prevailing speed begins to drop, the accuracy of most non-intrusive detectors typically declines significantly. Especially for video imaging, it is critical that installers place cameras high enough to minimize these effects. The height is not as critical for measuring speeds as it is for achieving the desired accuracy in counts and occupancies. To investigate camera placement needs, TTI utilized three-dimensional visualization software and a two-dimensional occlusion calculator



using Microsoft Excel to develop camera placement criteria. For example, a typical camera mounting height of 35 feet at an offset of 10 feet (from the nearest monitored lane) would only cover two lanes adequately.

From a performance standpoint, microwave radar, magnetometers, and certain video image vehicle detection systems are probably all suitable for freeway applications but certain caveats apply. Beyond camera mounting as noted above, video imaging is more complex, requires periodic lens cleaning, and is usually more expensive, but a positive attribute is that it offers a view of the traffic stream. Some limited weather and lighting conditions may affect the latest video imaging systems although the manufacturers have reduced those impacts in recent models.

Sensys Networks magnetometers warrant continued evaluation over a longer period of time. Accuracy levels were certainly acceptable but its battery life needs to be verified in high-volume traffic and in extreme temperatures. One negative attribute is that it is an intrusive device, requiring interference with traffic for installation. It is a promising replacement for loops since installation would take less time than loops. Finally, the SmartSensor SS105 (and its newer version, the HD) is a rugged device that can be mounted on an existing pole, automatically calibrates speed and configures lane positions for each lane monitored, can cover up to eight lanes (10 lanes for the HD) in sidereflection orientation, and is apparently not affected by any weather or lighting conditions.

## **FOLLOW-UP PHONE CALLS TO SELECTED STATES**

TTI contacted states to follow up on information gathered from the written literature and from the Internet. States that were helpful in this regard were California, Minnesota, and Texas. All three states have excellent detector test facilities.

### **California**

TTI contacted the engineer with the Caltrans Detector Evaluation and Test Team (DETT) who was responsible for one research project which used the I-405 test facility in Irvine to evaluate two microwave radar detectors, the RTMS and the Wavetronix SS105.<sup>(13)</sup> His comments were mostly about the test results, but they provide insight on Caltrans expectations on these detectors at the time. This and other research of vehicle detectors was at least in part a result of aggressive promotion and sales by manufacturers without proper guidance on setup.

The basic conclusions of Caltrans based on the DETT tests (published in 2004) are that inductive loops will continue to be the detection method of choice. Caltrans will probably continue to use the RTMS and SmartSensor SS105 microwave detectors but only for counts in locations where loops are not available or perhaps where a short-term count is needed. Where microwave detectors are used, Caltrans will most likely use contact closures to emulate loops and use them only for traffic counts (presence detection). The Caltrans spokesman doubts that his agency has the technical expertise to properly set up these microwave detectors and get performance that is similar to factory installers.

Another phone interview was with a seasoned research engineer with the Caltrans Division of Research and Innovation (DRI). Caltrans received \$10 million in 2006 for districts to improve vehicle detection across the state. The various districts have elected to spend their share for different types of detectors, resulting in a wide variety of freeway detector types. Some districts fixed existing inductive loops or installed new loops while other districts chose to purchase non-intrusive detectors to replace failed loops. For example, District 8 (San Bernadino) purchased Wavetronix radar detectors and Sensys Networks magnetometers. These new magnetometers are getting the attention of Caltrans engineers because their accuracy appears to be commendable, especially under free-flow conditions. Based on early results of testing in California, their accuracy appears to be better than radar but they require lane closures for installation or replacement.

Caltrans tracks the performance of its detectors through a database called the California Freeway Performance Measurement System (PeMS) database, which provides input on “detector health.” Not long ago, vehicle detectors in this database (mostly loops) were no better than 75 percent functional overall. However, Caltrans has determined that properly installed and maintained loops were 99 percent accurate. Their conclusion was that other components, perhaps within the cabinet, are also sources of error.

Of the newer detectors, San Diego State University is currently evaluating the TIRTL. One of the applications initially envisioned for this sensor was in Yosemite and perhaps other remote locations. However, there is substantial snowfall three to four months out of the year at the Yosemite site, which would undoubtedly degrade its accuracy. One of the recent additions to the lineup of test detectors at the I-405 test facility in Irvine is the Wavetronix SS125 High Definition (HD). Based on a short observation period during free-flow traffic, it appeared to be working quite well, but its behavior during more congested or even stop-and-go conditions was not as well known.

The camera system developed by a Cal Poly professor and installed at the I-405 test facility was a subject of interest. The camera system works very well during daylight hours but not at night. The intent in developing the camera system was in its use as a ground truth system and for re-identification of vehicles. Both require adequate lighting for success. Besides lighting, another of its requirements is an overhead structure to mount the cameras. There is one camera mounted to the bridge structure pointing downward (near vertical) over each lane. Installation personnel initially had concerns about vandalism or even kids playing on the structure leading to serious injury but none of that has happened to date.

## **Minnesota**

The Twin Cities Traffic Management Center has cameras at most interchanges on the twin cities freeway network as well as ramp meters. MnDOT uses inductive loops at almost all of these locations, both on the mainline and on the ramps for ramp metering. MnDOT uses loops for its AADT counts as well. There are 77 ATR sites statewide but many are being converted to classification sites by adding an axle sensor. The state is using piezoelectric sensors for axle detectors along with inductive loops.

MnDOT is trying only a few non-intrusive detection systems as possible replacements for inductive loops in the near future or for gathering data where loops are not appropriate. Two systems that MnDOT is currently testing are the TIRTL and the Wavetronix SmartSensor SS125 (or High Definition). MnDOT reported on initial results of the TIRTL at the 2006 North American Travel Monitoring and Exhibition Conference (NATMEC). This system shows promise for some limited applications, but MnDOT does not plan on purchasing any more of these classifiers. The cost of the detector is one negative at \$25,000 each. Another factor is the time to set it up at the data collection site, requiring two persons at each location.

MnDOT purchased two of the Wavetronix detectors and is seriously considering collecting length data using a length-based classification scheme. This unit has, or soon will have, eight length bins for this classification mode. MnDOT has not used length-based classification before so there are some uncertainties, since FHWA still wants reports to use the standard Scheme F with 13 classes.

Another detector that MnDOT is considering but is not committed to is Nu-Metrics “Groundhog” magnetometers, which will be used at Road Weather Information Systems (RWIS) sites. Using two of these per site will facilitate speed data collection. Another detector which was recently demonstrated to MnDOT was the magneto-resistive sensor by Sensys Networks. However, MnDOT is currently not serious about buying any of these detectors. One final detector that has been demonstrated recently is the Peek AxleLight™ and is similar in concept to the TIRTL.

One of the reasons inductive loops continue to be the most popular form of detection is that they last as long as 10 or even 15 years. A few of the non-intrusive detectors are used to fill in gaps. One example is the RTMS by EIS, which the state uses to conduct high-volume counts. These appear to work satisfactorily for this application. MnDOT also does some classification counts manually.

## **Texas**

The Texas Department of Transportation (TxDOT) districts use a variety of detection technologies, with inductive loops continuing to be used in many cases until they fail. While the Traffic Operations Division in Austin provides support and guidance to districts in choosing among the technologies, each district decides what detectors to use. In a few cases, especially smaller districts still rely on loops so they replace failed loops with more loops. District decision-makers are practically unanimous in believing that none of the newer technologies are as accurate as properly installed and properly maintained loops. However, most districts replace failed loops with another technology due to some legitimate reasons.

The costs of some of the newer technologies such as video imaging have declined over the past five or more years, especially at signalized intersections, where each camera replaces several loop detectors. At the same time, districts are facing much higher lane closure costs and they realize that closing lanes increases safety risks for both installation

crews and motorists along with increasing motorist delay. One other important consideration is that newer technologies have improved over the past 10 or so years for both intersections and freeways.

The larger urban districts have been installing newer technologies longer than most of the smaller, less urbanized districts. Most districts make incremental changes by installing a few units for observation before making a wholesale changeover in the types of detectors used. When a purchase is made, it is often on a low-bid basis, leading to unsatisfactory results and also resulting in multiple technologies being deployed across each district. It is anticipated that recent TxDOT-sponsored research on vehicle detectors will make a difference, but it will take time. Following are a few examples of the larger urban districts that may be helpful.

The Austin District allows contractors on construction projects to determine the detection technology as long as district requirements are met. The district still uses loops far more than any other technology even with this freedom of choice, mostly because contractors know how to install loops and they are not as familiar with newer technologies. In the Dallas District, inductive loops on freeways are being replaced by Autoscope Solo Pro and SmartSensor SS105. The Corpus Christi District has had many problems with loops and has reverted to video imaging systems but with disappointing results with that technology as well. The El Paso District still largely relies on inductive loops but has replaced some of them with RTMS and a few video imaging systems at intersections.

The Fort Worth District has discontinued the installation of inductive loops in lieu of Wavetronix SmartSensors, RTMS, and video imaging systems. The Houston District has had more than its share of inductive loop problems for many years and was one of the first to install video imaging systems on freeways. In fact, the district began using that technology before it had matured enough to be reliable. Problems led the district to abandon many of the video units and continue its search for an adequate technology.

The most recent interest has been in the Wavetronix SmartSensor 105. The San Antonio District has had success with inductive loops on freeways and at signalized intersections and these units are anticipated to continue to serve the needs of the district. For signalized intersections, the district primarily installs video imaging systems.

TIRTL vendors have contacted TxDOT's planning division to demonstrate the detector but the TxDOT representatives do not plan to purchase them in the immediate future. A recent installation of two Wavetronix SmartSensor SS125 High Definition detectors was in conjunction with other planning division classification sites to investigate the count accuracy of the two SmartSensor detectors.

## 4. VEHICLE DETECTOR TESTBEDS

### INTRODUCTION

The following three testbeds provide information that may be helpful in guiding the planning of the ADOT testbed. These testbeds are in California, Minnesota, and Texas.

#### CALTRANS I-405 TESTBED IN IRVINE, CALIFORNIA

This vehicle detector testbed is called by different names in the literature and Internet sources. The first article on this testbed by Yazdan comes from *Intellimotion* and describes the Traffic Detector and Surveillance Sub-Testbed (TDS<sup>2</sup>) as a detector evaluation facility located on a seven-lane section of Interstate 405 south of Irvine, California. This test facility is a partnership led by Partners for Advanced Transit and Highway (PATH) researchers at UC Irvine and supported by the Caltrans Division of Research and Innovation, Inductive Signature Technologies, Inc., and Loragen Corporation. The overall purpose of the TDS<sup>2</sup> is to “provide a real-world laboratory for the development and evaluation of emerging traffic detection and surveillance technologies.”

The article pays specific attention to one of two overcrossing structures used at the field lab. The lab incorporates both structures so that vehicles can be re-identified and provide travel times between the two locations. TDS<sup>2</sup> cameras mounted vertically on the overcrossing structure capture pictures of every passing vehicle at both upstream and downstream sites. Detection modules use the video data to generate a numeric Video Signature Vector (VSV) for each vehicle, and transmit these to a central Internet connected computer. A correlation computer matches the VSVs and re-identifies the vehicles. This system provides an extremely reliable source of ground truth data and it also allows the same detector to be mounted at the two locations to evaluate reproducibility. Figure 6 on page 44 is a photograph of this facility showing the overhead cameras, one directly over each lane of the freeway.<sup>(26)</sup>

The TDS<sup>2</sup> has a number of unique features that are optimized for detector evaluation, which in aggregate are not duplicated anywhere else. Some of these high-tech features are as follows:<sup>(26)</sup>

- The video “ground truth” system which takes a picture of each vehicle and automatically re-identifies it downstream independent of its lane or speed.
- Inductive signature loops that output the unique signature of each vehicle and use this information to re-identify each vehicle downstream.
- Three streaming pan-tilt-zoom video cameras that can be controlled through a password-protected web browser connected to the Internet.
- Wireless broadband communication that allows all types of information to be available in real time across the Internet.



**Figure 6: PATH Traffic Detector and Surveillance Sub-Testbed**

- The TDS<sup>2</sup> has overhead mounting and wiring systems that allow detectors to be mounted over traffic lanes without closing lanes.
- The site is equipped with poles pre-wired for installation of side-fire detectors on the outside shoulder of both sites, and on the inside shoulder of one site is a pole with wiring to evaluate HOV detectors and/or dual side-fire detectors.
- The facility has an instrumented freeway off-ramp which, in conjunction with an adjacent interchange, can be used to study freeway traffic weaving.

The system architecture of the test facility includes a cluster of rack-mount Linux computers, one per lane, and a LAN or Internet-connected database server. Each field computer interfaces with a video camera positioned above an assigned traffic lane. Each vehicle reported by the system generates a record consisting of a JPEG compressed image, a timestamp, and speed of the vehicle. Each of the traffic lanes also has a pair of trap loops at known spacing which can be used for verification as needed. The site has three roadside Caltrans Type 334C cabinets for housing related equipment. Video verification uses down-facing high-resolution NTSC video cameras that are about 33 ft above the pavement surface. The coverage area of each camera as measured along the roadway has a length of about 80 ft. The cameras have manual electronic shutters set a 1/4000 sec. to prevent image blur from moving vehicles.

Different detection zones and processing delays are accommodated for each detector. For time synchronization of all field devices, the on-site system provides a Network Time Protocol (NTP) server which must be referenced by any detector that uses delay-time signaling. Local field computers store image and data records, but then push them via SFTP on a bandwidth-available basis to a central server which stores data in a MySQL database. Local storage allows tests for up

to 20 days in duration before off-load to the central server becomes critical. Connectivity between elements at the field site is provided by a 100 Mbps LAN, whereas connectivity between field computers and central server uses multiple networks including a slower 802.11b wireless link. As a result, transferring a few hours of test data and images may take as long as 24 hours. An alternative would be to set up the server on-site to avoid bandwidth limitations.<sup>(27)</sup>

Results from a sample of about 1600 vehicles indicate that the automated data reduction system greatly reduces the workload associated with ground truth comparisons. Approximately 97 percent of vehicle detections in this sample were properly classified by the automated system as correct, false, or failure-to-detect, leaving only 3 percent for manual verification. The most common failure-to-detect errors were related to ambiguous vehicle lane positions, poor illumination for video detectors or issues for roadside-mounted radar detectors with distant lanes. Improved calibration of some devices might have reduced some of the false detection errors.<sup>(27)</sup>

### MNDOT NON-INTRUSIVE TEST FACILITY ON I-394

The Minnesota Department of Transportation installed an equipment test facility for testing non-intrusive detectors on I-394 at Penn Avenue near downtown Minneapolis, as per Figure 7.<sup>(3)</sup>

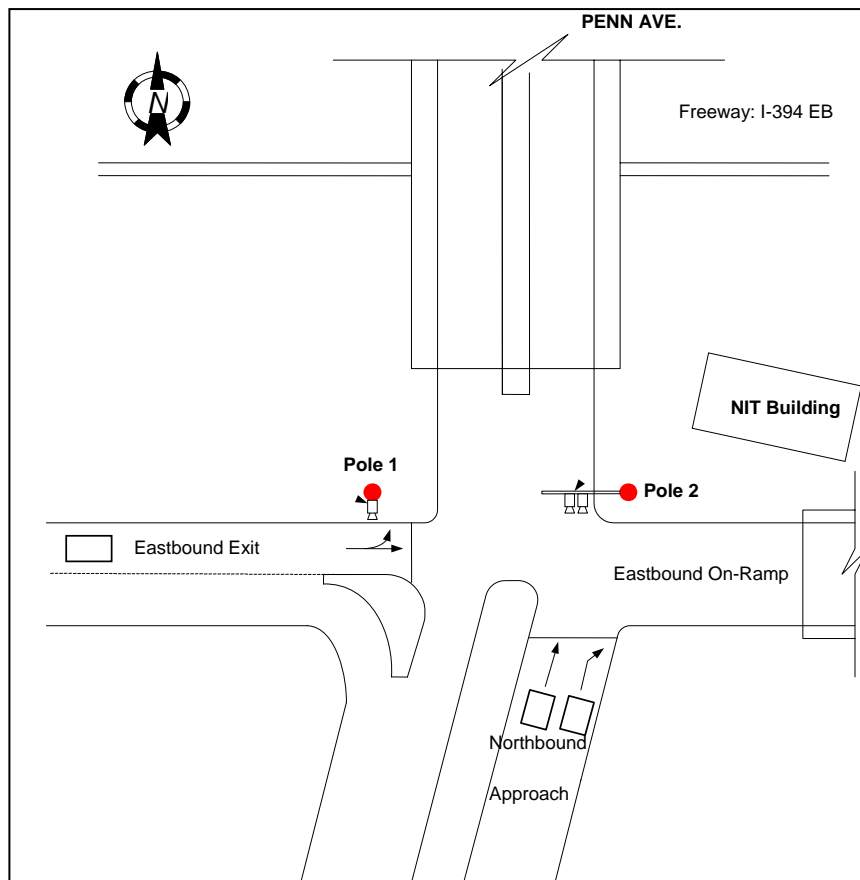

Source: Reference 3.

**Figure 7: MnDOT NIT Site Layout**

MnDOT installed a catwalk on the Penn Avenue Bridge for Phase II of this project to provide access to devices installed overhead. The test plan called for installing overhead sensors on three adjustable mounting poles attached to the catwalk, one over each lane of I-394, at varying heights ranging from 20 to 30 ft above the pavement and facing eastbound (departing traffic).

MnDOT also installed an aluminum adjustable tower for testing sidefire-installed sensors. Field personnel can adjust the crank-up tower to accommodate mounting heights ranging from 10 to 45 ft and can move the tower among three bases with offsets of 15 ft, 25 ft, and 35 ft from the nearest lane of I-394. Preinstalled concrete pads allowed the retractable tower to be moved as required. The retractable pivots at the tower base provided access to the tower top for sensor installation. Inductive loops on I-394 provided baseline data.

Figure 8 shows the catwalk on the bridge, and Figure 9 on page 47 shows the aluminum tower mounted on one of the three bases. <sup>(3)</sup>



*Source: Reference 3.*

**Figure 8: Catwalk for Mounting Detectors Overhead**

Site amenities also included a 14-ft by 26-ft permanent building (as shown in Figure 10, page 47) and security fencing. Equipment installed in the building includes computers for running vendor-specific programs, computers for data storage and archive, and equipment components needed to interface with detectors.

The NIT site offered a range of traffic conditions, to include congestion in both the morning and afternoon peak periods and lower volumes with free-flow conditions in the evenings and on weekends. The site also offered a variety of lighting conditions for testing, depending on the time of year. Low-angle sunlight created long shadows in the winter and bridge shadows year-round.





Source: Reference 3.

**Figure 9: Aluminum Tower for Sidefire Mounting**



Source: Reference 3.

**Figure 10: View of NIT Building from the Catwalk**

Figure 11 shows the shelter schematic layout. <sup>(9)</sup> MnDOT's consultant, SRF Consulting Group, Inc., used the following data acquisition hardware in the building for monitoring the test systems:

- Personal computers: used for sensor calibration, data download, data storage, and process through the interface software of different detectors.
- Television monitors: used for traffic monitoring and video detector calibration.
- Three videocassette recorders (VCRs): used for recording the traffic images during the official data collection for future data references.
- Equipment rack: used to hold data acquisition components such as television (TV), VCRs, AC power supplies, loop detector cards, vendor detector cards/processors, and the automatic data recorder.
- Peek ADR 3000: used to collect all of the loop emulation relay outputs into a single database. It allowed for the collection of all data outputs simultaneously. The ADR was programmed to collect the data from devices and baseline loops in 15-minute intervals for each 24-hour data collection period. Some data output was in the form of a simple relay contact closure, whereas other data required a serial communication link to a personal computer housed at the shelter.
- A terminal panel: used for power supply and communication between the shelter and testing sensors installed on the overhead catwalk or sidefire tower. Installers numbered terminal ends on the panel that matched with the numbers of the corresponding ends in the junction boxes on the catwalk and sidefire tower.

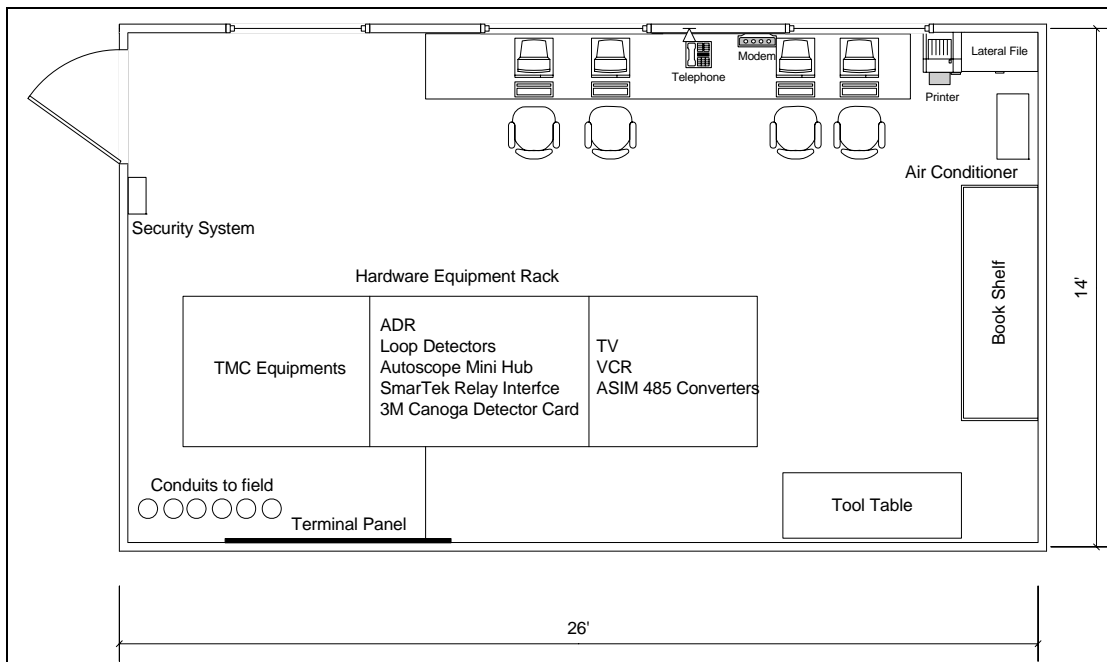

Source: Reference 3.

**Figure 11: MnDOT Shelter Schematic Layout**

## TTI TESTBED IN AUSTIN

Figure 12 on page 50 is a schematic of the TTI testbed on I-35 in Austin. The freeway has four through-lanes in each direction and a fifth lane on the southbound side, which is an exit lane to Airport Boulevard. This site is near 47<sup>th</sup> Street, which is just north of the elevated section of I-35 near downtown Austin. The elevated section is a factor in dispersion of traffic by type and by lane because an unusually high percentage of trucks use the left two lanes to stay on the lower level of the freeway and avoid the elevated section. Also, a recent truck lane restriction requires that large trucks not use the inside (leftmost lane). On most multilane roadways, a higher percentage of trucks are in the right lanes. <sup>(7)</sup>

The following description pertains to one scenario at the test facility. TxDOT had already installed 6 ft by 6 ft inductive loops under the overhead sign bridge as part of its freeway monitoring system, but they were not used for ground truth research data. As shown in Figure 12, the equipment installed on the sign bridge consisted of an RTMS on the west side facing south, an RTMS on the east side facing west (sidefire), and a SAS-1 on the east side facing west (sidefire). Installers also positioned one RTMS unit on the sign bridge to monitor only one lane in Doppler mode.

In addition, TTI mounted two Autoscope Solo Pros, the Iteris Vantage, an RTMS, and a SAS-1 on a luminaire pole 85 ft south of the southbound cabinets (west side of the freeway). The TxDOT and TTI field installation crew mounted one Autoscope on the pole at 38.5 ft above the freeway and one to the mast arm supporting the luminaire. The reason for placing them at two locations was to evaluate the effect of different offsets. Figure 13 (page 51) is a photograph of the site looking northward, with an enlargement of the pole showing the detectors mounted on it for testing. Both Autoscopes faced oncoming traffic, whereas the Iteris (placed right beside the pole Autoscope) faced departing traffic (per vendor directions). The RTMS on this same pole was 17 ft above the freeway and positioned in sidefire. The SAS-1 on this same pole was 35 ft above the freeway. Figure 12 (page 50) indicates that the detection area for all pole-mounted devices was very close to the baseline ADR-6000 loops to minimize the effect of lane changing and changes in vehicle speeds.

The field test plan for the northbound side of the freeway involved mounting the RTMS and SAS-1 on the east side of the sign bridge and sending wireless data to the cabinets on the west side of the freeway. Even though most wireless applications can send data over a longer distance, the tests were more a test of latency or other factors than determining the range of the wireless systems. Other items installed for northbound traffic included an equipment cabinet between the mainline and the northbound service road, 110V AC power from the sign bridge to the cabinet, and a conduit across the sign bridge. <sup>(7)</sup>

TTI researchers chose high-speed Internet access to remotely monitor detector systems, upload data, check sensor configurations, and stream live video. This research project revealed many benefits of using Internet communications. One benefit was the need for far fewer trips to the site, and a savings in the associated travel and labor costs. The result was more productive use of staff time and increased monitoring of detector systems.

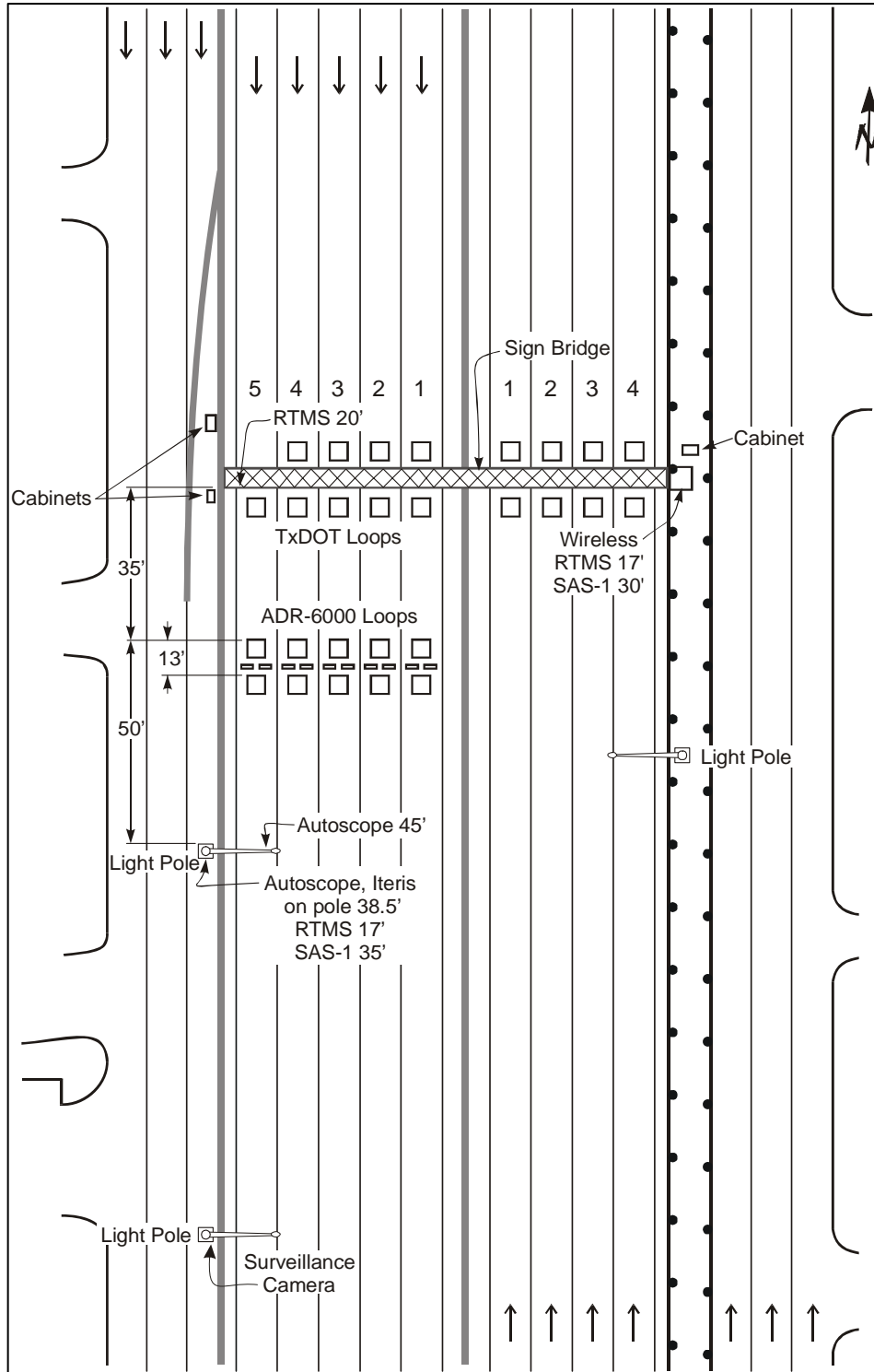

Source: Texas Transportation Institute.

**Figure 12: Layout of TxDOT's I-35 Site**

Another very important benefit of using Internet communications was the ability of detector manufacturers and vendors to remotely access the detector test site. Some of the manufacturers accessed their system remotely from across the U.S. and other parts of the world to check detector setup programs and upgrade algorithms and software. This cooperation with manufacturers helped both them and the research sponsor to get a better product in the end.

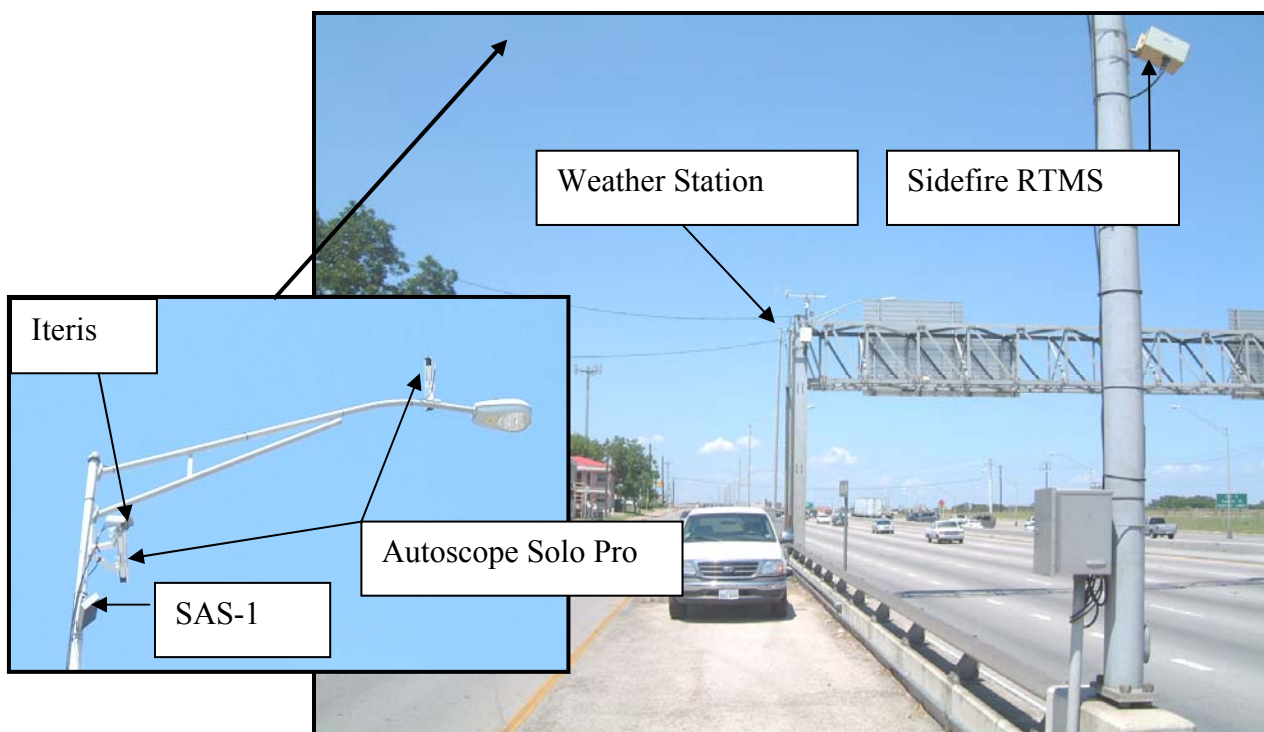

Source: Reference 11.

**Figure 13: Views of I-35 Testbed**

### **TTI TESTBED IN COLLEGE STATION**

The TTI testbed in College Station uses S.H. 6 just south of the F.M. 60 (University Drive) overpass. Figure 14 on page 52 indicates some of the features of this site and its general layout. Typical weekday traffic (both directions) on S.H. 6 at this location is approximately 35,000 to 40,000 vehicles per day with 10 percent trucks (FHWA Class 5 and above). Traffic conditions are almost always free-flow, but the noise level and the dispersion of vehicles are at desirable levels for many activities such as group demonstrations and studies that need isolated vehicles. This site has ample parking and area for growth, as well as much of the infrastructure for adding new test systems, as indicated in Figures 15 and 16 on page 53. It is within a 5 minute drive of Texas A&M University for employees and students, and is within 10 minutes of the TxDOT Bryan District offices. <sup>(5, 6, 7)</sup>

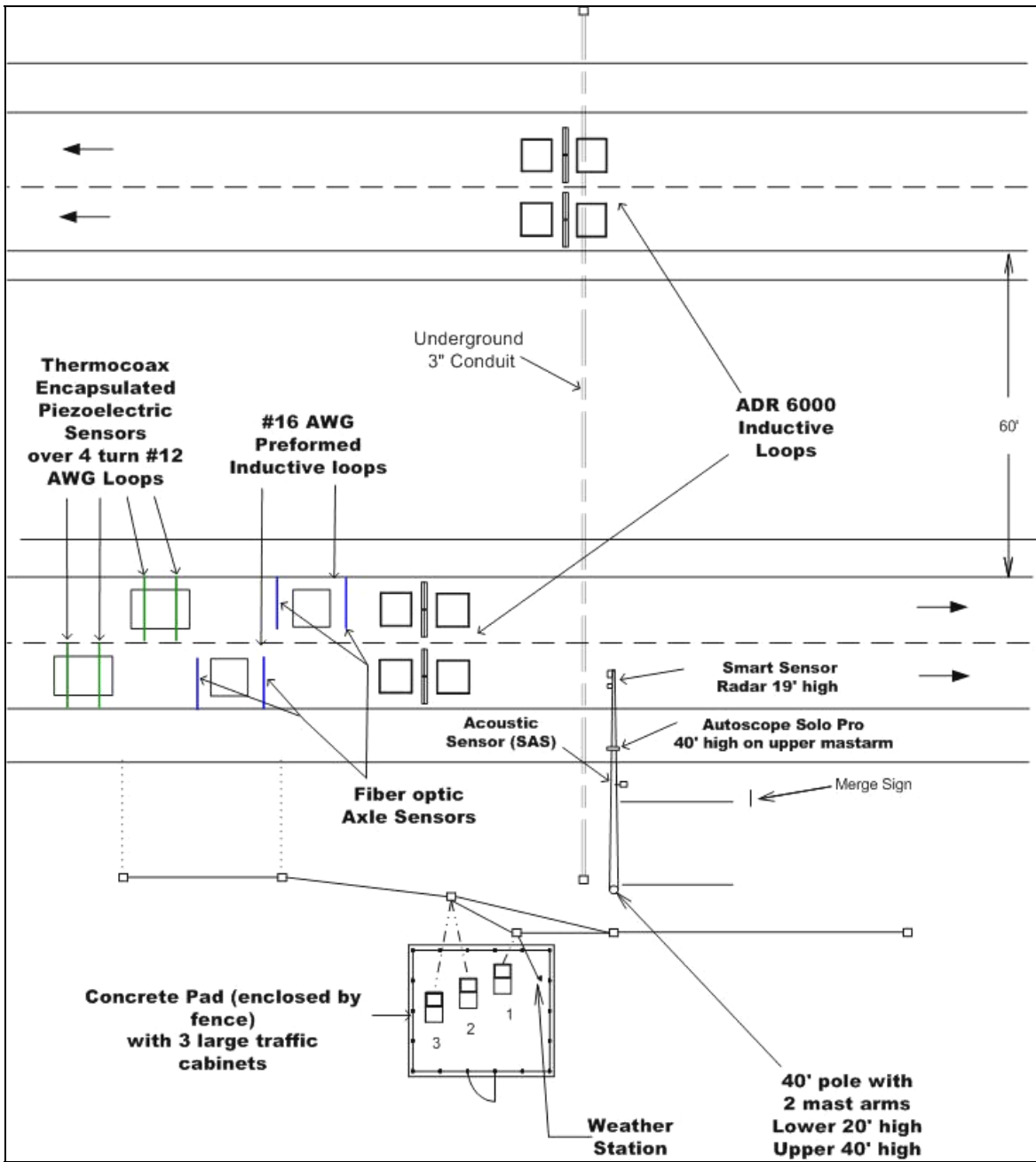

Source: Texas Transportation Institute.

Figure 14: Layout of S.H. 6 College Station Testbed





Source: Texas Transportation Institute.

**Figure 15: View of S.H. 6 Testbed Looking South**



Source: Texas Transportation Institute.

**Figure 16: View of Equipment Cabinets and Weather Station**

Equipment installed on the west side of S.H. 6 includes:

- Three Type P equipment cabinets.
- An enclosed fenced concrete pad.
- A Campbell Scientific weather station.
- A 40-ft pole with two mast arms, one at 20 ft over the road and another at 40 ft.
- Pan-tilt-zoom (PTZ) surveillance cameras.
- Roadway sensors that serve as part of the baseline system.

Sensors in or under the roadway include inductive loops, GTT (3M) microloops, two sets of Class I piezoelectric sensors, and Kistler quartz weigh-in-motion sensors. A Peek ADR-6000 with inductive loops monitoring both the northbound and southbound directions serves as the baseline system for vehicle counts, classification, and occupancy. Communications elements include a 768 kb symmetrical digital subscriber line (DSL) for high-speed communication for data and live video.

Non-intrusive detectors installed at the site include a GTT (3M) microloop (magnetic) detection system, a SAS-1 (acoustic) detector, two SmartSensor SS105 detectors with one covering a lane in forward mode and the other monitoring four lanes in sidefire, and an Autoscope Solo Pro video imaging vehicle detector. A recent intrusive sensor addition to the testbed is Sensys Networks magnetometers in both southbound lanes.



## **PART II: DESIGN DEVELOPMENT**

### **5. TESTBED SITE SELECTION AND CONCEPTUAL DESIGN**

#### **INTRODUCTION**

Accurate, complete, and timely traffic data are critical to the effective management of Arizona's highway system. Limitations in current traffic monitoring abilities are an ongoing challenge for ADOT and for its customers as well in both urban and rural areas. Many technologies exist for detecting vehicles and determining traffic volume, type, lane occupancy, and speed. The key is to invest wisely in the appropriate traffic monitoring technology, and hence, the need for this research project. The proposed field testbed is anticipated to involve a variety of components, to include a ground truth system covering both directions of traffic flow, a weather station, supporting structures such as overhead sign bridges and pole(s) beside the roadway, power and high bandwidth communication, and equipment cabinets for computers and related equipment.

#### **TESTBED SITE SELECTION**

Some of the criteria for selection of the testbed site are as follows:

- Proximity to key ADOT personnel and facilities.
- Existing inductive loops in good condition.
- Existing support structure.
- Traffic volume and type.
- Number of lanes.
- Power and communication.
- Median and side barrier.
- Safety of site personnel.
- Planned construction project (for funding).

From the outset of this research activity, the Technical Advisory Committee provided key input and oversight for major decisions. Early TAC meetings included discussions of relevant traffic, site selection, infrastructure, access, and other design factors related to the test facility. Sites that seemed to have the most support among TAC members in order of highest to lowest were:

- I-10 at the Broadway curve (monitor both directions, AADT of 300,000 vpd).
- I-10 at 13<sup>th</sup> Street (westbound is more congested than eastbound).

- Loop 101 at I-17 and between I-17 and S.R. 51 (will have fiber optic cable installed in near future but not planned for reconstruction in near term).

The research TAC meeting held on April 24, 2007, produced a consensus to use the I-10 site at the Broadway curve. However, more detailed information about pending site improvements not divulged at the meeting appears to make it less viable. Improvements for the entire I-10/US 60 interchange area to relieve the current traffic bottleneck extend through the Broadway curve area. This major construction project may last for as long as 10 years. Therefore, the I-10 site at 13<sup>th</sup> Street appeared to be the best choice for a long-term location. Previous discussions also indicated the desirability to use both sides of the selected freeway segment for planning purposes and for use as a permanent monitoring station. The site should include a weather station since some detector technologies are affected by local weather conditions.

Figures 17 and 18 on page 57 show some of the features of this site that make it desirable. The positive features of this site are as follows:

- It is centrally located.
- It has high traffic volume with congested flow on the westbound side.
- It has the requisite four or more lanes by direction.
- It has a significant number of trucks in the traffic stream.
- It has power and communication in an existing cabinet on the north side.
- It offers a good view of approaching traffic.
- It has overhead sign structures.
- The structure on the westbound side has a catwalk.
- The area appears to be reasonably safe from crime.
- The site has pole-mounted lighting just west of the cabinet.
- There is ample room for safe parking behind the sound wall.

Features that are not as desirable about this site are as follows:

- The nearest inductive loops are not close enough for use in a testbed.
- The overhead sign bridge for the eastbound traffic lanes is offset by a few hundred feet.
- It does not currently have barrier along either side or in the median area.
- It has an entrance ramp that terminates near the site (may increase lane-changing).
- It is included in a programmed construction project, but its timing will not facilitate shared funding.



**Figure 17: Aerial View of I-10 at 13<sup>th</sup> Street**



**Figure 18: Ground Level View of I-10 at 13<sup>th</sup> Street Facing Northward**

## TESTBED CONCEPTUAL DESIGN

### Mainline Detection

Figure 19 on page 59 shows the major components of the conceptual testbed design. The budget estimates that were developed also apply in a conceptual sense and had to be refined during the detail design phase of the project. The site needs to have an existing overhead structure such as an overhead sign bridge or vehicular bridge overpass for mounting equipment.

It is desirable to have detection from the ground truth and the test detectors at the same point on the freeway to minimize the effects of vehicles changing lanes. That will eventually require a pole for mounting sidfire detectors beside the freeway immediately adjacent to the ground truth loops and an overhead structure nearby for mounting video imaging systems. Video imaging cameras are aimed downward, typically facing oncoming traffic, at about a 45-degree angle. Therefore, at a height of say 30 ft above the roadway, its detection zones would be 30 ft away from the overhead structure. In all cases, the mounting conditions should replicate field conditions. For example, if video imaging cameras are not intended to be placed over lanes on Phoenix freeways, then the tests should not be over lanes either. The pole for mounting sidfire detectors should be placed at least 12 feet from the nearest lane to be monitored. The major components of this layout are as follows:

- Ground truth system – the Peek ADR-6000 (both directions of traffic) was selected although the Inductive Signature Technologies (IST) system was also evaluated.
- A 40-ft detector pole designed for two 40-ft mast arms is desirable although one or more poles without mast arms could serve this need.
- Three large equipment cabinets on the major side of the freeway (westbound direction).
- Two video surveillance cameras for each direction of traffic – one on the detector pole and one on the overhead structure centered over lanes.
- A 3-inch and a 4-inch bored conduit connecting each side of the freeway site.
- Two 3-inch conduits spaced 18 ft apart for installation of GTT (3M) microloops on both sides.
- A weather station for monitoring ambient temperature, barometric pressure, wind speed, wind direction, and rainfall amount and intensity.
- Underground and overhead-mounted conduit sized and positioned according to need.

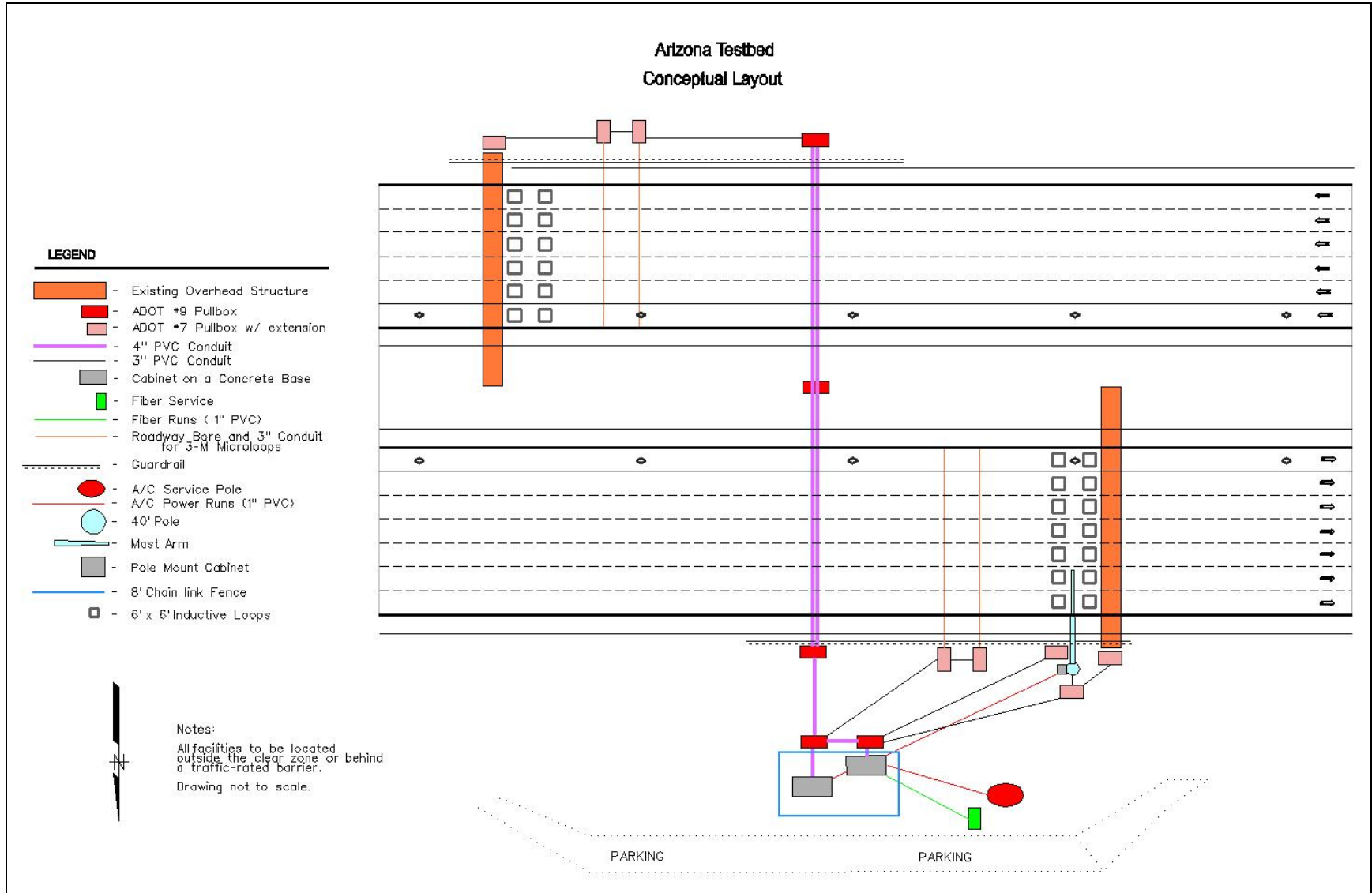

**Figure 19: Conceptual Testbed Design**

## **Ramp Detection**

In addition to the mainline testbed, ADOT and others may also need a ramp environment to test detectors. In the short term, the need is more critical for detection pertaining to ramp metering on entrance ramps. The most appropriate nearby interchange is the 16<sup>th</sup> Street westbound entrance ramp. Figure 20 on page 61 is an aerial view of a portion of this interchange with emphasis on the westbound entrance ramp. This interchange is just to the east of the 13<sup>th</sup> Street testbed site. There may also be a need for testing detectors on exit ramps for monitoring queue length at some future date. For entrance ramps, the most viable detector options would probably be video imaging or Sensys Networks magnetometers placed near the ramp metering signal.

For exit ramps, the technologies that appear most likely for success are microwave radar, video imaging, and magnetometers. One microwave device, the Wavetronix SmartSensor Advance, can cover 500 ft of ramp length and up to about 36 ft of pavement width per sensor depending on orientation and can generate discrete speed output for each vehicle. Sensys Networks magnetometers are wireless, removing the need for long conduit runs that other technologies might require. This option would require magnetometers along the ramp for the desired distance and coverage, an Access Point unit located at the cabinet for wireless communication, and repeaters along the ramp as needed for distances up to a maximum of about 1,000 ft. Since ramp widths exceed typical lane widths, side-by-side magnetometer installations should be considered.

Depending on the level of complexity needed or desired for these tests, major components of the ramp testbed could be as follows:

- Ground truth system such as inductive loops with detector cards in the cabinet;
- One equipment cabinet positioned at a point to be selected along the ramp;
- One video surveillance camera for verification purposes possibly mounted on an existing structure; and
- Underground and overhead-mounted conduit sized and positioned according to need.

## **PRIMARY DETECTION SYSTEMS**

Due to the immediate need for accurate detectors on Phoenix area freeways, ADOT will likely begin installing at least two new detection systems in the short term before full testing in the testbed can be accomplished. Considerations for selection of the best detectors include:

- Accuracy in measuring vehicle count, speed, length, and lane occupancy.
- Life-cycle cost.



- User-friendliness.
- Being relatively maintenance free.
- Support from the manufacturer and/or local distributor.



**Figure 20: Aerial View of 16<sup>th</sup> Street Interchange Ramps (View to North)**

Table 15 on page 62, adapted from recent TTI research, indicates life-cycle costs based on an assumed life for each detector and 5 percent rate of return. The costs are for all lanes of a six lane freeway with a median barrier. Building on the cost comparison in Table 15, TTI developed the list of qualitative values shown in Table 16 (page 62) based on the criteria listed above.

The values are based strictly on TTI’s experience. Table entries could range from 1 (worst) to 5 (best). The far right column shows the sum for each detector, and the detectors are ranked with the highest ranking detector at the top and the least desirable at the bottom.

To this list, one might also add a factor to account for the relative weight of each of the five criteria listed horizontally as column headings. For example, accuracy might be ranked as more important to ADOT and others than manufacturer support. Of these seven detectors (PADs are included for comparison), ADOT may decide to choose three (as provided in the work plan) to be evaluated within the testbed as soon as it is ready.

**Table 15: Annualized Life-Cycle Cost of Detectors on Freeways<sup>a</sup>**

Technology/Product	Annualized Life-Cycle Cost
Magnetometer – GTT (3M) <sup>b</sup>	\$1945
Magnetometer – SenSys Networks	\$1834
Microwave Radar – SS-105	\$891
Passive Acoustic – SAS-1	\$956
Video – Autoscope Solo Pro	\$1222

<sup>a</sup> Six-lane freeway with median barrier.

<sup>b</sup> Evaluated in an earlier research project.

Source: Adapted from TTI Reference 11.

**Table 16: Qualitative Assessment of Detectors**

Detector	Accuracy	Life-Cycle Cost	User Friendliness	Maintenance	Manuf. Support	Total
Wavetronix SS-125	5	5	5	5	5	25
Sensys Networks	5	3	4	5	5	22
Autoscope Solo Pro	5	3	3	4	5	20
Traficon VIP	4	3	4	4	5	20
GTT (3M) microloops	4	3	3	4	5	19
RTMS X3	4	5	3	4	3	19
SAS-1 (PAD)	4	4	3	4	4	19

The highest ranked detector in Table 16 is the Wavetronix SS-125, followed by the Sensys Networks magnetometer, then the two video imaging systems, and finally by GTT (3M) microloops and the RTMS. The resulting SAS-1 total score is similar to the RTMS and GTT (3M) microloops.

TTI recommends that the Wavetronix SS-125 be implemented immediately on freeways (and at the testbed when ready) and that the Sensys Networks magnetometers and one or more video imaging products be considered for evaluation at the testbed. The difficulty of installing GTT (3M) microloops (usually requires horizontal boring) and replacing failed microloops caused their ranking to drop even though their accuracy is on par with higher ranked detectors. Many sites are simply not conducive to installing these detectors due to obstructions and terrain beside the roadway, making horizontal boring difficult or even unfeasible.



Of the two video systems, the Traficon is easier to set up but the Autoscope has an advantage in accuracy based on recent TTI tests. In general, video imaging systems are more complex than some other technologies and are affected by some weather, lighting, and traffic conditions compared to other technologies. For maintenance, any video system will require periodic lens cleaning to maintain optimum performance. The exact frequency of lens cleaning depends on environmental factors but will probably need to occur two to four times per year. The advantage of video over other technologies is being able to verify traffic conditions based on the image that is available from the detectors.

### **SPECIALIZED DETECTOR (OPTIONAL)**

One of the relatively new non-intrusive detectors that can classify vehicles which may be of interest to ADOT is the TIRTL (The InfraRed Traffic Logger). It requires a sending and a receiving unit, one on either side of the monitored roadway. It can classify vehicles according to the Federal Highway Administration Scheme F with its 13 classes. The manufacturer claims it can monitor up to eight lanes. Installing it correctly requires considerable attention to detail. Negative features associated with this detector include vandalism and security issues since it mounts very low to the ground and its relatively high cost of \$25,000 per system.

### **SPEEDINFO: A UNIQUE BUSINESS PLAN (OPTIONAL)**

SpeedInfo is a relatively new company, formed in 2002 and headquartered in San Jose, California, which offers a unique business plan to transportation providers. As of June 2007, SpeedInfo had installed 640 sensors in 11 cities throughout the U.S. SpeedInfo can offer a unique data service at a fixed fee or it can simply sell the equipment to a state DOT with maintenance contracts. At the present time, the SpeedInfo system uses Doppler radar to provide speed data, and not counts or classifications. The cost for the data service option is \$110 per month per sensor for limited data use, or \$200 per month per sensor for unlimited data use. For the “limited data use” option, the DOT would still be able to use the data for all internal applications, display travel times on changeable message signs, provide data for the phone and web-based 511 system, and share the data with universities and local law enforcement agencies. However, the DOT would not be able to provide SpeedInfo data via a digital feed to any commercial third party.

ADOT elected not to pursue the SpeedInfo option due in part to stipulations on use of the data. More information is available in Appendix D, including the experience of other jurisdictions that are using SpeedInfo.

### **PROGRAM BUDGET**

The initial program budget for the ADOT field testbed estimated the startup cost. Final cost estimates are provided later in this report as part of the Detailed Design. The number of detectors of each type will depend on the detector type and the desired comparisons.

For example, checking the speed accuracy of magnetometers in all lanes would require a minimum of two in each lane spaced a known distance apart (measured in the direction of traffic). Counts could be done with one in each lane. For microwave radar detectors, one might be installed in sidefire and one overhead in Doppler mode. In the overhead configuration, the detector only covers one lane. For video imaging devices, it may be desirable to mount one over the center of lanes and one at the side of the roadway to compare the accuracy for each location.

The annual costs will depend on a number of factors, to include how much infrastructure needs to be maintained, power and communication costs, types of detectors installed, level (e.g., frequency) of usage of the facility, and number of personnel required by the facility. TTI gathered information from other states to provide possible guidance on the operating budget and management structure for the ADOT facility. Again, input came from California, Minnesota, and Texas. Even though this information does not establish definitive initial or annual costs for the ADOT testbed, it could be used to establish a range of costs under some to-be-determined scenarios of testbed usage.

Caltrans currently operates two freeway detector testbeds – one on I-405 in Irvine and the other on I-80 near Berkeley. The I-405 testbed has been available for about 10 years, which is a longer time than the Berkeley facility, but both are under the same umbrella of funding. Staffing requires a full-time manager who covers both facilities and a modest amount of technical support from each university. Caltrans established these testbeds specifically for research purposes, so a portion of the funding comes from research budgets. Caltrans is currently receiving \$1 million per year over a three-year period from SPR funds, with 80 percent of it being provided by the Federal Highway Administration and 20 percent from local sources.

As of June 2007 Caltrans was about two years into a three-year funding cycle using this FHWA funding. However, the future of this funding source is uncertain beyond June of 2008. Other funding includes contributions from local cities since the testbeds are sources of real time traffic data on a 24/7 basis at 30-second intervals. The University of California's Irvine and Berkeley programs also contribute to their respective testbeds, both monetarily and through developing research projects that utilize the test facilities. Another use of the field testbeds is for training purposes, providing data to a life-like traffic management center.

Minnesota DOT does not have anyone actually assigned to its I-394 testbed as a full-time manager, but during times when it is being used for detector testing, MnDOT assigns an engineer to take charge of the contractual matters and to also oversee the project and manage day to day activities. Even during this research period, this MnDOT engineer typically has other responsibilities not related to the test facility.

MnDOT did not have documentation on the expenses involved in operating the test facility during test periods. Major initial expenses incurred at the test facility included a permanent building on-site, several personal computers, a Peek ADR-3000 vehicle classifier and inductive loops in the pavement for ground truth, related electronic gear

inside the building, a fabricated catwalk mounted to the overhead bridge structure, underground conduit and related infrastructure, and a movable telescoping pole for mounting sidefire detectors at various heights and offsets from the freeway.

TxDOT has funded two freeway detector testbeds in recent years – one on I-35 near downtown Austin and one on S.H. 6 in College Station. The I-35 test facility was in constant use for a period of about 5 years and is now relatively unused since a pavement grinding project destroyed the inductive loops. The initial equipment cabinet belonged to TxDOT and housed freeway monitoring equipment so it was not part of the test facility. This facility has never had a dedicated manager and utilized existing roadside equipment to the extent possible by mounting non-intrusive detectors and surveillance cameras on luminaire poles and on an existing sign bridge. It does not have a building or even a cover for on-site personnel. TxDOT provided two additional equipment cabinets and TTI provided cameras and the on-site computers needed to operate these systems.

Vendors loaned most of the detectors to be tested and provided a substantial amount of technical support throughout the multi-year research activities. The research budget covered the remaining detectors and components needed to carry out the research, as well as the cost of digital subscriber line (DSL) service. TxDOT covered the cost of electrical power, installation of ground truth inductive loops, and the Peek ADR-6000 that provided ground truth data. Since the initial ADR-6000 was new to the U.S. market, it was also considered to be one of the detector systems under evaluation while it simultaneously provided valuable data.

The S.H. 6 testbed in College Station has been active for the past 15 years with equipment added incrementally as funding or needs dictated. It has more equipment installed specifically for detector testing than the I-35 site and it has a greater variety of sensors installed. For example, it has three sets of weigh-in-motion sensors installed in the pavement. Like the I-35 site, vendors provided most of the detectors and TxDOT provided significant support through bucket truck usage and installation of in-pavement sensors. TTI has been totally responsible for the installation of site infrastructure through a cooperative agreement with TxDOT. This testbed has also never had a dedicated manager but TTI has always had one or two engineers and support necessary to manage and maintain the site. Like the I-35 site, it has DSL service available and relies on TxDOT for electrical power.



## 6. DETECTOR EVALUATION PROGRAM

### INTRODUCTION

The Arizona Department of Transportation (ADOT) detector evaluation program can be described as an ongoing seven-step process. It begins with the selection and screening of new and promising detectors. Once a decision has been made to test a new detector, the process will involve a variety of different offices within and outside ADOT. Table 17 shows the anticipated involvement of each group and the long-term responsibility of each. Some of these roles may change as this process matures.

The core testbed sponsor/stakeholder groups may include the Transportation Technology Group (TTG), the Phoenix Maintenance District (PMD), the Phoenix Construction District (PCD), the Transportation Planning Division (TPD), the Traffic Control Product Evaluation Committee (TCPEC), and the research TAC. The core group as listed would be a cross-section of responsible agencies, rather than just a single office.

The overall detector evaluation process can be thought of as a periodic cyclical process that begins with step 1 in Table 17 followed by steps 2 through 7. Historically, there have been improvements in detectors or perhaps new detectors coming on the market at fairly predictable intervals. ADOT may either set an interval to reevaluate detectors or wait until an internal need or the market dictates that the entire seven-step process be repeated.

**Table 17: Responsibilities for Detector Evaluation**

<b>Procedural Step</b>	<b>Description</b>	<b>Responsible Group</b>
1	Selection, screening, and testing	TTG or Testbed Core Team
2	Project management and design	TTG
3	Construction	PCD/VISION field office
4	Maintenance	PMD – ITS Group
5	Systems issues management	TTG internal
6	Evaluation	AZ universities
7	Approved products list	TCPEC

### SELECTION, SCREENING, AND TESTING PROCEDURES

The Texas Transportation Institute has developed the following procedures based on previous experience, both in Texas and from procedures used by others. In the future, it is anticipated that the TTG will be primarily responsible for selecting detectors for testing, and for the procedures to be used.

## **Selection**

The selection process is theoretically open to any viable detector system that collects speed, count, occupancy, or classification data and makes it available on a real-time basis. Technologies that may be considered include, but are not limited to, the following: microwave radar, video imaging, magnetic, passive acoustic, ultrasonic, and infrared. Some of these technologies can be further subdivided into active and passive devices. Consistent with the Phase A report, the initial tests at the I-10 test facility will probably involve the following technologies: microwave radar, magnetic, and video imaging.

## **Screening**

This program would not test every device that became available. A screening process will be necessary to filter out detectors that do not look promising for the Arizona environment and initially do not appear to meet the criteria established for cost, data type, data quality, system longevity, and compatibility with other ADOT components. The screening process would be internal to ADOT, and the TTG/PMD/PCD/TPD partnering group would decide on testing candidates. It may be necessary to contact other agencies, local vendors, and research organizations, and attend conferences to stay abreast of the ever-growing list of detectors. This could happen strictly through ADOT personnel or it may require hiring a consultant or university-based research organization to provide periodic guidance. Based on these ongoing contacts, ADOT should maintain a list of promising detectors to be tested in the Arizona environment.

## **Testing**

Once detectors have been short-listed (selection) and screened, they must be tested in a field environment that replicates year-round temperature fluctuations and other environmental conditions found in Arizona. It is anticipated that the first round of testing (designated Phase C of the SPR 627 project) – involving at least three detectors – will occur over a period of two summers at the ADOT I-10 test facility. Beyond Phase C, the length of testing will be designated short-term (period of six months) or long-term (longer than six months and up to three years), also at the I-10 facility. The budget will need to reflect purchase of some of the detectors, especially those designated for long-term tests. Vendors are often willing to loan detectors for shorter periods of time. For the more detailed aspects of detector testing, ADOT may choose to follow or at least utilize a standardized test methodology such as the American Society for Testing and Materials (ASTM) “Standard Test Methods for Evaluating Performance of Highway Traffic Monitoring Devices.”<sup>(28)</sup>

The system that provides the baseline data or “ground truth” must be a reliable and stable system, but it must also be checked periodically to ensure its continuing accuracy and reliability. One way to check it is to record high-quality video using an on-site video recording system with a minimum of two CCD cameras – one with an overhead view of freeway lanes (or ramps) and the other with a side view but high enough to minimize occlusion. One camera should be sufficient for single-lane and dual-lane ramps if

mounted properly. The other means of verification is to use two or more of the test detection systems to corroborate the baseline system, once ADOT is confident of the performance of these systems. Recorded video is reliable as long as at least two observers are involved in a “double-blind” test where both observers work independently of each other.

A critical factor in comparing two or more systems - baseline systems to test detectors – is being able to synchronize clocks on all systems. Even if all systems start at the same time (say to the nearest second), computerized systems almost always experience some clock drift. The system operator must monitor every system being tested at least once per day to check internal clocks. If drift occurs, corrections must be made. The frequency depends on the amount of drift in each system, and that amount will not be known without closely monitoring each system during the initial installation period. The time stamp synchronization on all electronic equipment should be verified daily using the NIST Internet (<http://tf.nist.gov/timefreq/index.html>) or telephone time service (303-499-7111) or a comparable time standard.

To fully understand the performance characteristics of each detector, ADOT needs to test in the same conditions expected in areas where the detectors will be subsequently deployed. Weather and lighting are factors that affect the performance of some technologies such as video imaging. Special attention must be given to data comparisons during known periods of problems. In addition to weather and lighting conditions, critical test conditions might also include slow speeds during periods of congested flow. As traffic flow increases from free-flow to congested flow and reaches unstable flow, the stop-and-go traffic conditions that may occur are especially challenging for detectors.

The data collection interval, weather conditions, lighting conditions, and level of congestion all must be considered in parsing the data for subsequent evaluation (step 6). For research purposes, the evaluation needs to be done on a vehicle-by-vehicle basis to fully understand performance attributes of each detector. However, a more practical approach for use by DOTs is to use a binned interval comparison for most or all of the data comparisons for best use of limited resources. Each comparison should be done on a lane-by-lane basis for the best understanding of occlusion or other effects.

## **PROJECT MANAGEMENT / DESIGN**

This function will be the responsibility of the Transportation Technology Group. As newly screened detectors become available, the TTG will undertake any design changes that might be necessary at the test facility on I-10. This might include modifications to accommodate the communication protocols and bandwidth needs of the new system. It will also include necessary electrical hookups and other components inside the cabinets, conduits, and pull boxes and inside the node building. For this activity to be successful, it will need to have some amount of lead time, say one month, for TTG to do the necessary design.

Other activities that may be involved in this step will be related to project management. This could include allowing access by anyone besides ADOT to have access to any of the test systems. In some cases, ADOT may allow manufacturers access to their system to upgrade firmware or to run a simple system test. Later in the project, ADOT may allow Arizona universities some level of access to detectors to do a required evaluation. Project management could also include keeping track of scheduled I-10 tunnel closures to ensure optimum use of lanes free of public traffic. There may be special detector tests that need to be run during tunnel closures that could not feasibly be done with the freeway open to the public.

## **CONSTRUCTION**

Construction will involve installing new detectors at the I-10 facility and any necessary modifications to the field infrastructure. This might involve acquiring or fabricating installation hardware for a new detector. This construction will be managed by the appropriate ADOT group(s). Once the TTG begins the design process, it should communicate with the field office to alert its personnel that this detector needs to be installed within some specified period of time.

## **MAINTENANCE**

Each detector that is installed for test could potentially require maintenance to be performed while it is being tested. It will be important for future decisions to know exactly how much maintenance is needed and the type of maintenance required. This function will also include troubleshooting problems that may occur in each detector. Some systems such as video imaging require periodic maintenance such as lens cleaning for optimum performance. Others such as microwave radar and magnetometers should not require routine maintenance. Once they are installed and calibrated, they do not usually require much attention. This function will be the responsibility of the Phoenix Maintenance District, Intelligent Transportation Systems Maintenance Group (PMD ITS).

## **SYSTEMS ISSUE MANAGEMENT**

There may be unexpected events that transpire during the test and evaluation of the detectors at the I-10 facility. The group that will be responsible for dealing with these situations will be the TTG internal staff. Some of the situations that might arise include: on-site vehicular crashes that damage or destroy some of the components used for testing, extreme weather events, power and communication outages, lack of anticipated support from vendors, and turnover of key personnel who are most familiar with the test facility layout.

## **EVALUATION**

It is anticipated that Arizona universities may be involved in the evaluation of selected detection systems. The evaluation should begin with an appropriate experimental design



which considers all the variables involved in vehicle detector testing. These variables include: weather, lighting (intensity and sun angle) speed of traffic, and level of congestion. Collecting and segregating data needs to occur with the idea of keeping all similar data together. The following list is a starting point for establishing the list of common conditions that need to be considered:

- Morning – “a.m. peak” period.
- Afternoon – “p.m. peak” period.
- Off-peak.
- Dry weather.
- Wet weather.
- Congested conditions with slow speeds.
- Free-flow conditions.
- Intense fog.
- Blowing dust.
- Full sunlight.
- Full dark.
- Light transitions (dawn and dusk).
- Snow and/or ice (if applicable).

Keeping all similar data as one analysis package means using only data from a period during which conditions do not change. For example, analysts might collect data during a 24-hour period with conditions that might include daylight, dark, dry, wet, peak, and off-peak conditions. The analysis would segregate similar conditions such as the following:

- Daylight, dry, off-peak.
- Daylight, dry, peak.
- Daylight wet, off-peak.
- Daylight wet, peak.

- Night, dry, off-peak.
- Night, dry, peak (if available).
- Night, wet, off-peak.
- Night, wet, peak (if available).

“Peak” might be further subdivided into congested flow and free flow. Congested flow could be broken into stop-and-go traffic and slow speed uninterrupted flow.

A number of different statistical tests could be used to evaluate detector results. The different error formulations described below are all valid measures of accuracy but each provides a slightly different view of the error. The mean absolute percent error (MAPE) should be used when comparing the magnitude of error, whereas the sign and magnitude of the mean percent error should be used to assess measurement bias. Because the mean percent error does not use absolute error values (as MAPE does), the mean percent error formulation is better formulated to reveal whether there is a consistent bias in measurements (i.e., measured values are consistently less than or greater than the “correct” value). The root mean squared error (RMSE) is an error formulation that is commonly available in many statistical software applications.

The mean absolute error (see Equation 1, also referred to as the mean absolute deviation) is a basic accuracy measure that is expressed in the units of the observed value (e.g., mph for speed, minutes or seconds for travel time).

$$\text{Mean Absolute Error} = \left( \frac{1}{n} \right) \times \left( \sum_{i=1}^n |x_i - x_{reference}| \right) \quad \text{Equation 1}$$

where:  $x_i$  = the observed data value  
 $x_{reference}$  = the reference value  
 $n$  = the total number of observed data values

The mean absolute percent error (see Equation 2) is calculated similarly, with the exception that the error is divided by the reference value.

$$\text{Mean Absolute Percent Error, MAPE (\%)} = \left( \frac{1}{n} \right) \times \left( \sum_{i=1}^n \left| \frac{x_i - x_{reference}}{x_{reference}} \right| \right) \quad \text{Equation 2}$$

where:  $x_i$  = the observed data value  
 $x_{reference}$  = the reference value  
 $n$  = the total number of observed data values

The mean percent error (see Equation 3) is the only accuracy measure presented here that can indicate measurement bias based on the sign and magnitude. For example, a negative mean percent error value means that the observed values are consistently lower than the reference value. However, the magnitude of the mean percent error can also be misleading, as large positive and negative error values can cancel each other when averaged, leading some to mistakenly conclude that the error is low and the accuracy is high.

$$\text{Mean Percent Error (\%)} = \left(\frac{1}{n}\right) \times \left(\sum_{i=1}^n \frac{x_i - x_{reference}}{x_{reference}}\right) \quad \text{Equation 3}$$

where:  $x_i$  = the observed data value  
 $x_{reference}$  = the reference value  
 $n$  = the total number of observed data values

The root mean squared error (RMSE, see Equation 4) is calculated by squaring the error terms instead of taking absolute values. The RMSE is reported in the units of the observed data value (e.g., mph for speed, minutes or seconds for travel time). The RMSE can also be expressed as a percentage value (e.g., % RMSE). When so specified, the % RMSE is the RMSE divided by the average of all reference data values.

$$\text{Root Mean Squared Error, RMSE} = \sqrt{\left(\frac{1}{n}\right) \times \left(\sum_{i=1}^n (x_i - x_{reference})^2\right)} \quad \text{Equation 4}$$

where:  $x_i$  = the observed data value  
 $x_{reference}$  = the reference value  
 $n$  = the total number of observed data values

The Mean Absolute Percent Error is often used for determining count error as its range of values is large. On the other hand, the speed error is within a much smaller range of values, so the analysis that is often used is the Root Mean Squared Error. These metrics allow an easy comparison of detectors since smaller values indicate less error compared to the baseline system.

For classification accuracy, results are most often expressed as percent error, either overall (across all classes) or a percent error per vehicle class. Another variation is to lump all large trucks together such as Class 5 and above (Federal Highway Administration Scheme F) for purposes of pavement and bridge wear.

Making the determination of when a particular detector passes or fails a particular test will depend on ADOT (or perhaps other) specifications. The specifications must be written considering the technology that is being considered and what it is designed to do. For example, a detector that has a maximum of four length bins cannot directly output all 13 of the Federal Highway Administration (FHWA) classification bins. ADOT, in

conjunction with the FHWA, might develop an optimized scenario for using four bins to be extrapolated to represent FHWA Scheme F vehicles. The test detector would then be judged based on how well it achieves the desired accuracy for four classes instead of the full 13 classes.

## **APPROVED PRODUCT LISTS**

Once a selected and screened detector goes through full field testing and passes the criteria established by ADOT based on the evaluation by Arizona universities, it will be recommended to the Traffic Control Product Evaluation Committee, consulting as appropriate with the core sponsors from the program TAC. Unless other reasons arise not to select the evaluated detector for the approved product list, it will be added to the list and will then be available for ADOT use. Reasons for not being added at this point might include:

- Uncertainty regarding technical support or other concerns related to the manufacturer.
- Significant cost increases since the initial unit was tested.
- New information from third parties regarding untested aspects of the detector.
- Finding out that the detector is somehow incompatible with ADOT control systems.

## **7. DETAILED DESIGN**

### **INTRODUCTION**

This project's detailed design products include a comprehensive MicroStation plan of the testbed facility, incorporating all existing site details. This design was sourced primarily from "as-built" drawings from the Arizona Blue Stake service, as well as from site inventories by ADOT and TTI. The drawing is intended to show proposed features with solid lines and to show existing features with broken lines. In general, the plan proposes all new conduit and pull boxes although space is available in some of the existing infrastructure. A more complete inventory of on-site facilities during the construction phase may reveal that some of the proposed conduit and/or pull boxes can be reduced by using existing components. However, this additional capacity might also be reserved for future expansion. The MicroStation software facilitates creating layers of information so that the user can turn off layers that are not needed for a particular task and work in a less cluttered environment. The computer version of this drawing, as delivered to ADOT, takes advantage of this feature.

The major proposed components of the I-10/13<sup>th</sup> Street site are covered in the following categories: 1) baseline system, 2) equipment cabinets, 3) conduit and pull box system, 4) equipment pole, 5) node building, and 6) detector equipment to be tested in the initial test. Ramp detection systems are not proposed for the initial evaluation field deployment.

### **BASELINE SYSTEM**

The equipment that has been identified as most desirable for providing the baseline or "ground truth" data for all other detectors being tested is the Peek ADR-6000. The information provided in this document is based primarily on two installations in Texas around the year 2000, so minor updates may be needed for installations in Phoenix.

An alternate truthing system was also investigated as part of this project – the system offered by Inductive Signature Technologies, Inc. (IST), headquartered in Knoxville, Tennessee. The need for an alternative system was primarily associated with the proposed Peek ADR-6000 axle loops, which need to be no deeper than ½ inch from the surface of the pavement. Since the rubberized asphalt layer is nominally 1 inch thick (varying from about ½ inch to 1 ½ inches) and might not have the appropriate strength properties to support loops within that layer, the loops would have to be installed in the pavement layer below the rubberized asphalt.

Investigations revealed that the IST loops could be installed at greater depths than the Peek axle loops, so IST loops could be installed below the rubberized asphalt layer. However, one uncertainty and concern with some TAC members with the IST system was its perceived lack of maturity compared to the Peek system even though it had been successfully installed in San Diego in 20 locations for a few years. Therefore, ADOT would incur a risk with either system. The final decision was to choose the Peek ADR-6000 instead of the IST system. More information is available on IST in Appendix C.

The Peek ADR-6000 is a high-end vehicle classifier that uses four inductive loops per lane, two that are 6.5 ft by 6.5 ft (nominally 2 meters by 2 meters) and two that are smaller (5 ft by 18 inches) axle loops. The bottom half of Figure 21 (page 77) shows the configuration of these four loops and the top half shows a detail of an axle loop. The two axle loops are wound as quadrapoles for greater sensitivity in detecting steel belted tires or the metal in each wheel that passes over it. The classifier has special inductive loop amplifiers for the axle loops and standard trap loops that require onsite manual tuning for each lane before the system is operational.

At the time of the Texas installations, field personnel had no written procedure for setting up the loop amplifiers so a Peek factory representative had to set up and check the system using Peek's raw loop signature computer program. Upon installation of the inductive loops, the user had to connect to the system with a serial cable and a computer running Microsoft Windows HyperTerminal to set up the system configuration software. At the completion of the Texas tests, the ADR-6000 still had a very limited user manual; the system runs on the Linux operating system and assumes that the user knows the basic Linux commands and syntax.

The ADR-6000 stores three types of data – raw loop signatures, bin data, and per vehicle records (PVR). Raw loop signature data, which take up large amounts of disk storage, can be turned off or on for diagnosing problems with the system. TTI did not have access to the software to analyze this data, so there was no need to keep this feature turned on. The other two types of data – PVR and bin data – were available for verification of the ADR-6000 classification accuracy and for verification of other (non-intrusive) detectors.

The user can turn off or leave on PVR data files, and can store them in two different directories in a compressed or uncompressed format. Data retrieval is available through the Internet using file transfer protocol (FTP), and remote access is possible using terminal command line system Telnet (Network Virtual Terminal Protocol). Each PVR file contains approximately 30 minutes of data. The files contain date, time, lane number, length, speed, loop 1 "on" time, loop 2 "on" time, classification, distance between axles, and number of axles. At the time of the initial tests in Texas, the ADR-6000 could not generate occupancy data directly. TTI researchers wrote an occupancy program using LabView® and tested it against known reliable inductive loops. Initial and subsequent tests indicated that it was extremely reliable and accurate.

TxDOT used its own Transportation Planning and Programming inductive loop installation crews to install all five lanes of inductive loops for the ADR-6000 in one night, beginning at 9:00 p.m. on February 15, 2000. Representatives from TTI and Peek were on site to support the operation. Immediately after installation, TTI measured and documented inductance, resistance, quality, and frequency for all of the inductive loops to verify proper installation.

For the ADR-6000 to perform its best, the saw-cut depth and the dimensions for the axle and main loops had to be precisely maintained. The depth from the top of the pavement to the top quadrapole wire could be a maximum of 0.375 inch, but 0.25 inch was

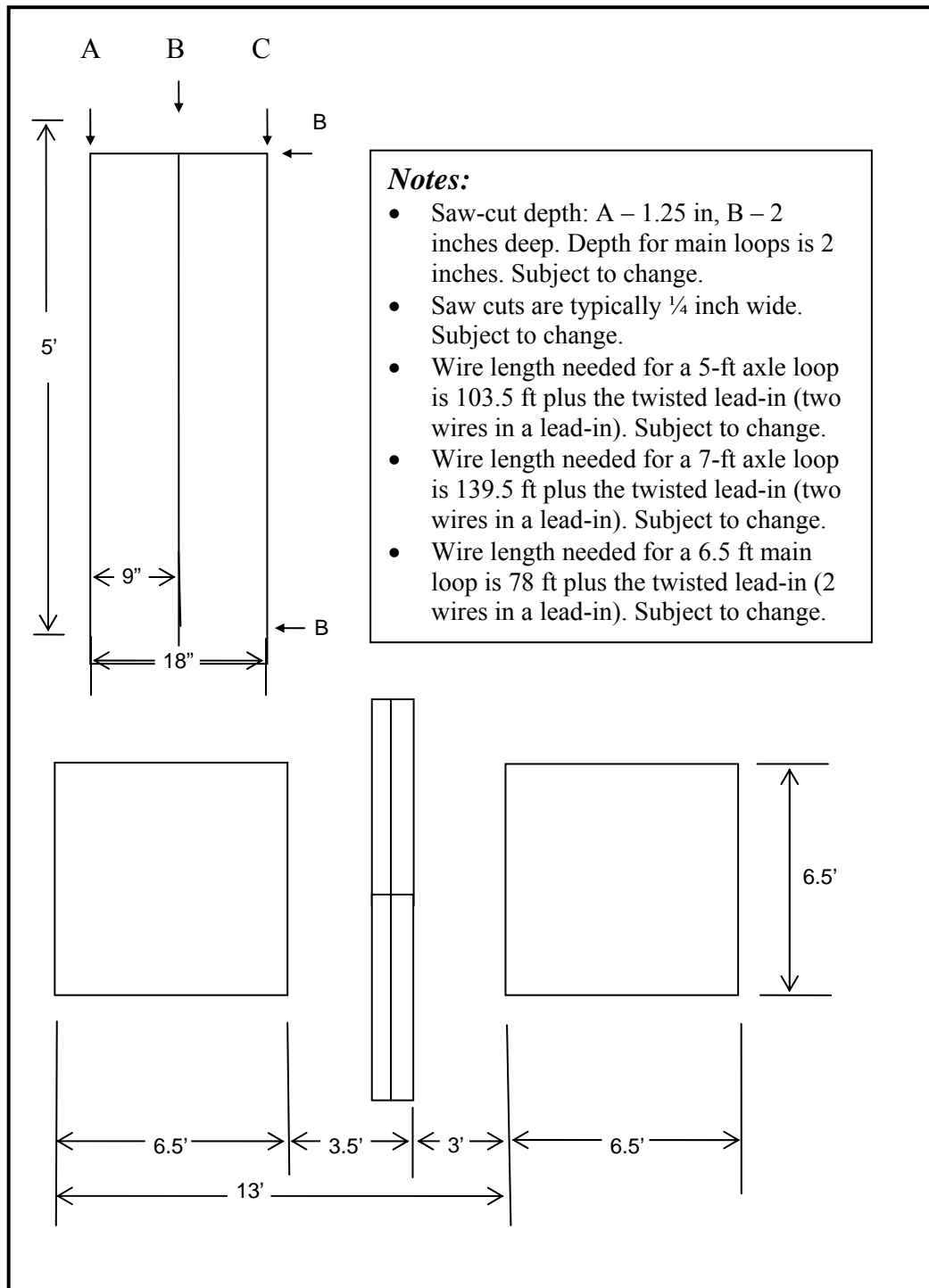

**Figure 21: ADR-6000 Loop Layout**

preferable for maximum sensitivity. This close tolerance meant that saw-cut depth had to be maintained at 1.25 inches for the outside of the quadrupole and 2 inches for the inside cut. The depth for the main loops was 2 inches.

The Peek on-site factory representative marked all the saw cuts for TxDOT. As an indication of the precision needed in the saw-cutting, after completing the first axle loop cuts the Peek representative asked the saw operator to raise the saw blade  $\frac{1}{4}$  inch on the next center cut for the axle loops. These details are clear indication that ADOT needs to determine the scheduling of any improvements to the I-10 pavement at the testbed prior to installing these loops. Since this pavement has recently received rubberized treatment, it is anticipated that pavement rehabilitation will not be needed for about eight years.

The cost of the ADR-6000 is based on the number of lanes to be covered. In this case, Peek will design one processor for the westbound side and a separate unit for the eastbound side. Peek representatives provided two different cost estimates for a system to cover 14 lanes, varying from \$50,000 to \$80,000. This document uses the higher estimate of \$35,000 for a six-lane unit (eastbound) and about \$45,000 for an eight-lane unit. The westbound unit will be housed in one of the three cabinets on the north side, whereas the eastbound detection unit will be on the south side of the freeway. The additional cost for cutting the inductive loops for both sides of the freeway is estimated to be \$3,000 per lane, for a total of \$42,000. Peek now requires that the contractor be certified to install these loops. The cost of traffic control will also need to be added unless the installation occurs along with tunnel closures. That cost is about \$2,000 per lane. Another cost that may need to be considered is the cost to have a Peek representative on-site in case the installer is not certified. That cost must be verified with Peek.

## **EQUIPMENT CABINETS**

The current plan will locate four large (Type 341) equipment cabinets, three on a 12 ft by 12 ft slab on the westbound side. These three will be staggered as shown on the plans to facilitate adequate view of approaching traffic. Doors will be hinged on the right side for all three of these large cabinets. The concrete slab for these cabinets will be adjacent to the node building, and all will be located on the north side of the freeway near the gate in the sound wall. The fourth large cabinet will be on the eastbound side.

There will also be three small (Type 343) cabinets located strategically on the test site. One will be attached to the pole on the north side, one will be attached to one of the vertical supports for the westbound sign bridge, and one will be attached to one of the vertical supports of the eastbound sign bridge. These cabinets will probably come from ADOT stocks, so the research project might not include these costs.

## **CONDUIT AND PULL BOXES**

Proposed conduit is mostly either 3-inch or 4-inch PVC conduit. GTT (3M) microloops require 3-inch PVC conduit placed at a depth of 24 inches to 36 inches below the surface of the roadway. Installation of these horizontal conduit runs will require horizontal bores



drilled from the median of the freeway. Horizontal boring from the sides of the freeway will probably not be feasible due to the freeway being depressed below natural ground and the cut slopes on both sides. The bores for the microloops will extend under all freeway lanes although it may be challenging to keep the microloop probes vertical over that length as the carrier system is moved into position inside the 3-inch conduit. All other conduit is sized to accommodate not only the expected wiring but additional wiring that may be needed for future detection systems. There is a quantity of 3-inch metal conduit needed primarily on the overhead sign bridges, along with a small quantity of 1-inch PVC to connect fiber to the node building from cabinets.

Pull boxes are either ADOT #7 or ADOT #9 to accommodate conduit connecting points or for GTT (3M) microloop installation and removal. All pull boxes are oversize to allow for future growth. The costs of these components are based on recent Arizona DOT projects.

### **EQUIPMENT POLE**

The equipment pole is proposed to be located immediately adjacent to and centered longitudinally between the two large ADR loops in each lane on the westbound side. It will be used mostly for installing cameras, video imaging systems, and side fire detectors. ADOT will provide at least one and possibly two poles. The poles need to be about 40 ft high and could be a standard luminaire pole since it would have a short mast arm for better positioning of cameras. The location of the second pole is anticipated to be on the north side, but its exact location will be determined later. The concrete pole bases should be designed for the poles that are available and with an appropriate bolt pattern. The cost of the bases is estimated to be about \$3,000 each.

### **NODE BUILDING**

The node building would be built adjacent to the sound wall on the north side of the freeway and near the opening in the wall. The desired size is 12 ft by 12 ft and it should be equipped with climate control for on-site personnel and sensitive equipment. It should be arranged inside to provide room for at least one person to work comfortably with ample windows for viewing the freeway. Based on ADOT price checks, the cost of a 12-ft by 12-ft building in the Phoenix area would be about \$23,000 for the building. After adding the cost of a concrete slab, the total cost would be about \$32,000. The cost of the contents is unknown.

### **DETECTOR EQUIPMENT**

The detector equipment that is being proposed for the initial round of tests at the I-10 facility will be the Wavetronix SS-125, Autoscope Solo Pro, Global Traffic Technologies, LLC (3M) microloops, and Sensys Networks magnetometers. Appendix A has additional information on these detectors.

The proposed quantities that ADOT will install are:

- Two Wavetronix SS-125 microwave radar detectors, one for each direction of traffic (sidefire mounted on poles).
- Two Autoscope Solo Pro video imaging systems, one for each direction (mounted either on poles or on the overhead sign bridges).
- Sufficient GTT (3M) microloops for all lanes (four per lane, 56 total) covering both directions (installed in horizontally bored 3-inch conduits).
- Sufficient Sensys Networks for all lanes (two per lane, 28 total) covering both directions (installed flush with the surface using coring machine).

Positioning of each detector is critical to optimizing its performance. The SS-125 will be mounted sidefire at a minimum height of 17 ft above the surface of the freeway (but actual height in accordance with offset as recommended by Wavetronix). Its offset from the nearest lane to be monitored must be a minimum of 6 ft and the maximum monitored distance is no more than 250 ft. One SS-125 detector will ultimately cover eight lanes on the westbound side and the other will cover six lanes on the eastbound side. The westbound detector should be mounted on the new pole to be provided by ADOT and placed beside the roadway, centered longitudinally between the two large ADR-6000 inductive loops. The best mounting location on the eastbound side appears to be on the existing pole located about 40 ft from the south sign bridge support. Early mounting of these detectors with some types of overhead structures (e.g., sign bridges) resulted in interference from overhead structural components and reduced performance, so mounting directly on the sign bridge support may not result in optimum performance.

ADOT wants to use the Autoscope Solo Pro for both detection tests and for surveillance of the freeway, although the surveillance function may be compromised by its relatively limited field of view. The manufacturer recommends a steep camera angle for best performance, but this angle limits coverage area along the freeway. While the detector will provide a view of the freeway and can be used to verify some aspects of the traffic stream, it will not cover as much of the desired view as a camera designated specifically for this purpose. For testing purposes, TTI recommends mounting the detectors such that they replicate the height and offset to be used throughout the freeway network. Mounting high and centered over monitored lanes optimizes detection accuracy, but usually requires traffic control. Therefore, the best location at the I-10 site appears to be near the end of each sign bridge over the edge of the shoulder (risers are an option to increase height). Another option on the north side is on the pole to be provided by ADOT.

GTT (3M) microloops are typically installed inside a horizontally bored 3-inch PVC conduit that is at a 90-degree angle with the direction of traffic. ADOT will probably want to space the two bores at 18 ft apart. Once the conduit is in place, installers slide each probe into position inside the conduit by working from a large pull box beside the roadway. This process begins by measuring how far from the pull box each detector probe needs to be for proper positioning under each lane. For 12 ft lanes, the centers of each probe group will be 12 ft apart as each of the carrier components is snapped into

place. The proposed use of two probes per station (four per lane, 12 ft lanes) requires spacing each group of probes about 4 ft apart with 12 ft of distance between the centers of each group. For predictable and optimum performance from these probes, they must remain vertical as the carrier system is inserted and slid into the conduit. Keeping the bores perfectly straight is one of the more challenging aspects of this process. If a curve in one or more of the bores results, installers must compensate during the probe installation process. Once the conduit is installed and even during installation, there is very little interference of this process with traffic.

Sensys Networks magnetometers use wireless communication with the roadside and mount from the surface of the roadway, requiring a small vertical core of pavement (4-inches in diameter) to be removed to a depth of 3 inches. The top of these sensor nodes should be flush with the surface when properly installed and backfilled with the manufacturer-recommended epoxy. Cure time for this epoxy is about 10 minutes, depending on ambient temperature. The total time required for each lane closure can be as little as 30 to 45 minutes if two crews are working in parallel (two detectors per station, four per lane). Installation of the sensors in the rubberized asphalt pavement is not anticipated to be a problem since the Scottsdale installations resulted in only minor “gumming up” of the core drill as heat melted a small amount of the surface material. The detector node system will require one Access Point unit for each direction of traffic flow beside the roadway for receiving data. In other situations, one or more repeaters might also be needed for distances over 150 ft between nodes in the pavement and the AP unit. The positioning of these nodes could be in the center of each of the large ADR-6000 loops to ensure measurement of the same traffic (in case of lane changing). TTI has not experienced interference with other RF transmission due to this configuration. For 14 lanes, a total of 28 sensor nodes will be needed.

The cost of these detectors is included in the initial cost estimates, although vendors may be willing to donate some of this equipment on a one-time basis. It has been TTI’s experience with the selected manufacturers that most will probably be willing to donate equipment for test. For example, Wavetronix and Sensys Networks have been very cooperative in providing loaned detection components, but contacts with local vendors or with the manufacturer will be necessary in all cases to know for sure.

## **OTHER ON-SITE EQUIPMENT**

The other on-site equipment that should be considered includes barriers and/or crash cushions for safety of motorists and on-site personnel, and cameras for purposes of verification. ADOT forces may be called upon to install a sufficient length of barrier and/or crash cushions on one or possibly both sides of the freeway.

### **CCD Cameras**

One CCD camera already exists near the test facility location and should be helpful in providing video for verification purposes. However, at a minimum there needs to be one other CCD camera to supplement the existing camera. TTG/PMD may be able to supply

an additional camera from the current inventory if needed for a second surveillance camera. In the short term, ADOT will use the Autoscope Solo as a second means of verification, although as noted above, its use for this purpose may not be satisfactory. It is anticipated that at least one other camera, dedicated specifically to verification, will be needed to satisfy this need. Even using two sources of visual verification covering seven or eight lanes may not be sufficient to minimize the effects of occlusion.

### **Barriers and/or Crash Cushions**

TTI originally proposed the use of approved barriers on both sides of the freeway, but that design included a larger pole with mast arm which would probably not be designed with a “break-away” base. The poles that ADOT will install will be smaller break-away poles, so danger to motorists will be reduced. However, ADOT is considering the need for sand barrels (crash cushions) to be placed in front of the poles. When the freeway is widened on the westbound side, the necessary barrier could be included in the construction project if needed.

### **Computers**

TTI originally proposed the use of industrial computers. However, with a climate controlled node building on site, it is conceivable that standard ADOT computers could be used, and this change would reduce the overall cost. The industrial computers have been removed from the budget.

### **Detailed Design Drawing**

Figure 22 on page 83 is a line drawing which shows the detailed view of the I-10 testbed facility. Figure 22 shows the entire site, while Figure 22a (page 84) is an enlargement showing only the westbound direction and Figure 22b (page 85) shows only the eastbound direction. These drawings evolved from the conceptual design drawing, Figure 19, on page 60. TTI is also providing ADOT with a MicroStation file that will show some of the details that may not be fully legible at the scale of this report document. Design elements on this file are arranged in “layers” and will provide considerable additional information (e.g., existing infrastructure) not found in this document.

### **PROGRAM BUDGET**

Table 18 on page 86 is an estimate of the costs for phase 1 and phase 2 of the testbed. As noted above, quantities of some items may change, and unit costs could change even more depending on vendor contributions, local conditions at the testbed, and availability of components from within ADOT’s existing inventory. Based on recent ADOT TAC input, the costs include all detection devices since the number of donated or loaned units is unknown. Table 19 on page 88 indicates sources for some of the costs used in the Table 18 estimates. Some items are anticipated to be furnished from existing ADOT inventory, so they are designated as “ADOT inventory.” Appendix B provides a conduit schedule which complements other information in Table 18.

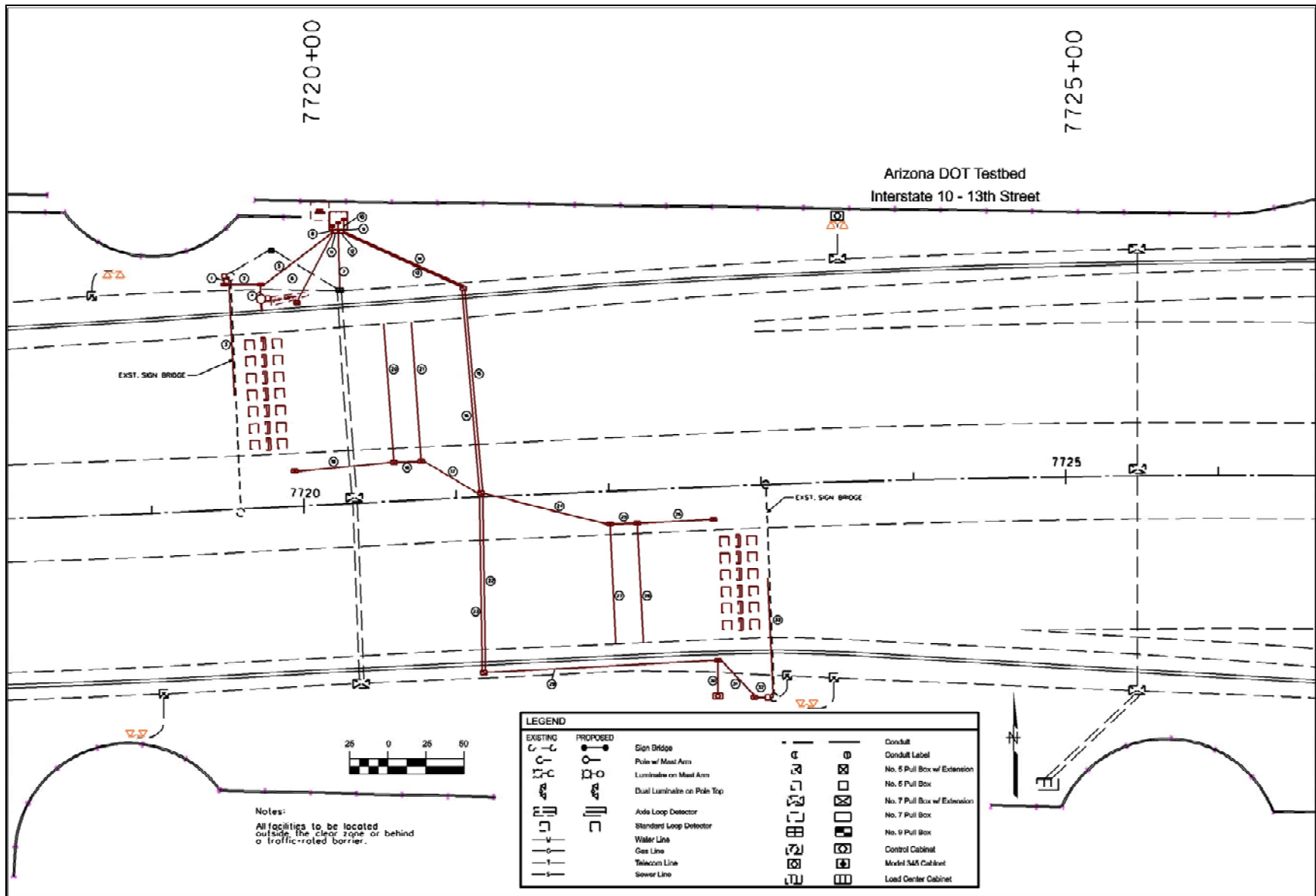

Figure 22: Arizona DOT Testbed – General Arrangement

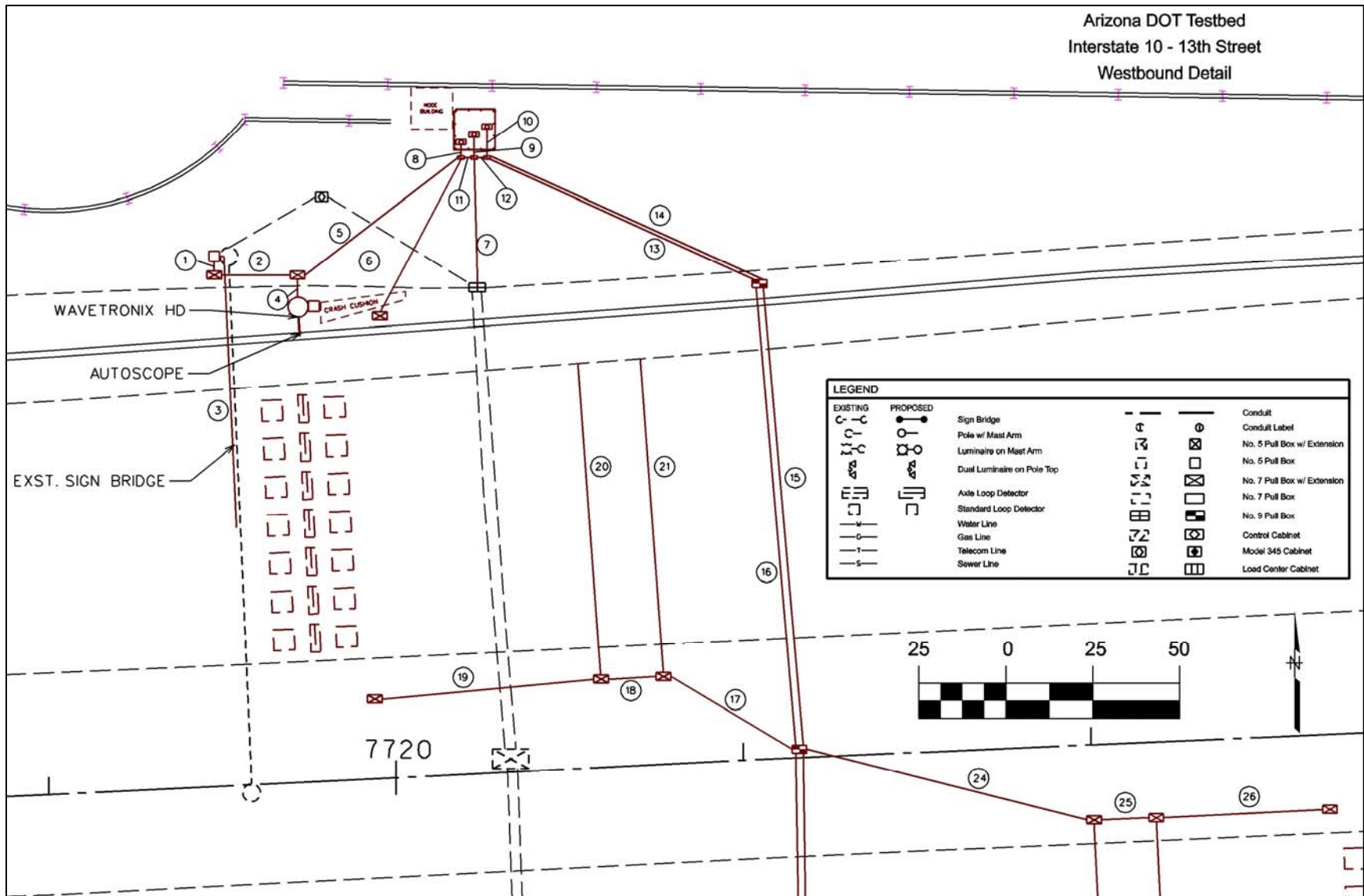

Figure 22a: Arizona DOT Testbed – Westbound Direction

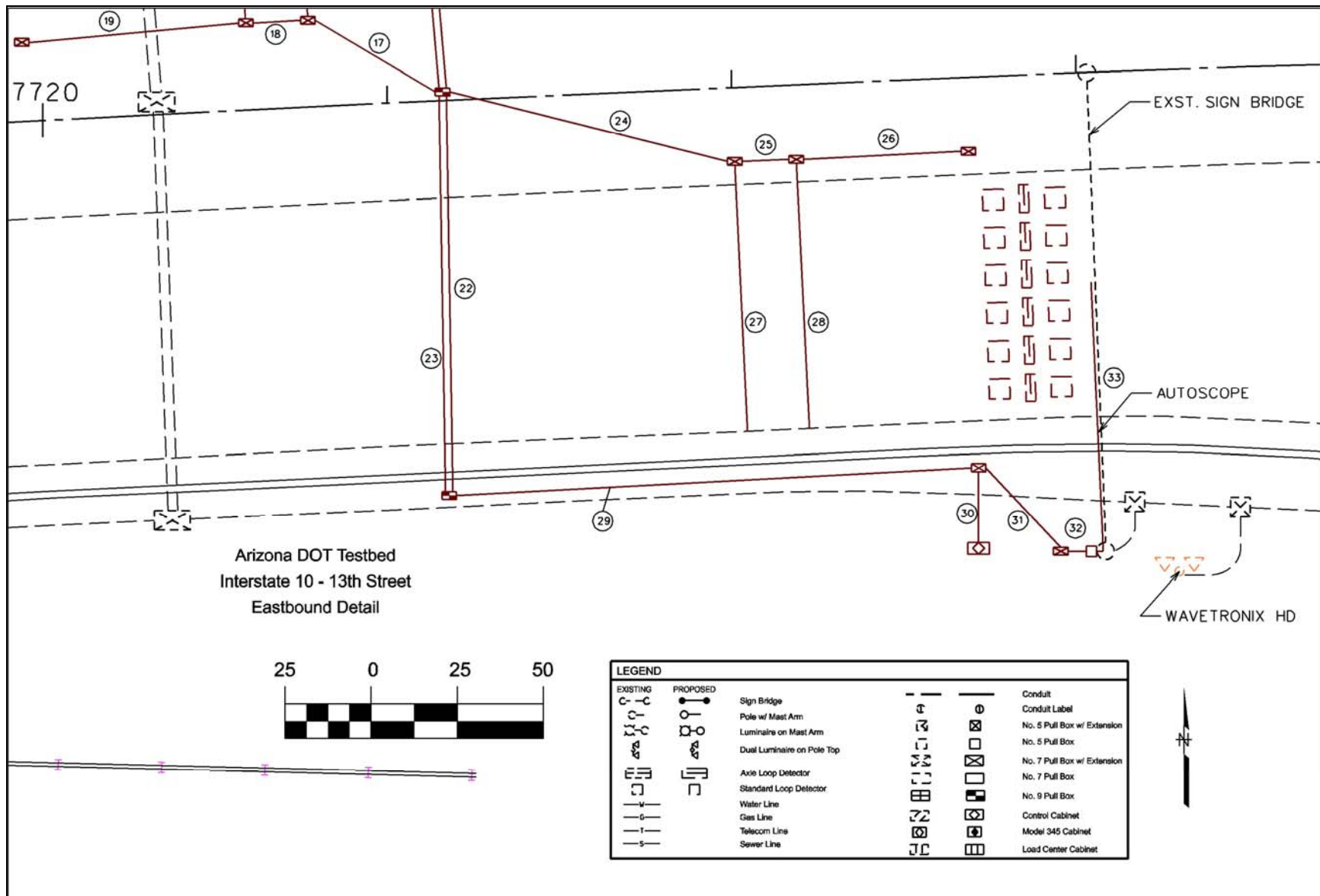

Figure 22b: Arizona DOT Testbed – Eastbound Direction

**Table 18: Anticipated Testbed Initial Costs for Phase 1 and Phase 2**

Description	Unit	Qty Ph1	Qty Ph2	Unit cost	Phase 1	Phase 2	Total cost
8 ft chain link fence, 10' x 10'	LF	40	0	\$ 12.95	\$ 518.14	\$ -	\$ 518.14
Pedestrian gate (4'X 6') (Barb top)	EA	1	0	\$ 355.00	\$ 355.00	\$ -	\$ 355.00
Concrete pad, 12' x 12'	SF	144	0	\$ 34.73	\$ 5,001.12	\$ -	\$ 5,001.12
Lightning rods and cable	EA	1	0	\$ 250.00	\$ 250.00	\$ -	\$ 250.00
Hardware firewall	EA	1	0	\$ 650.00	\$ 650.00	\$ -	\$ 650.00
Industrial computers	EA	0	0	\$ 2,500.00	\$ -	\$ -	\$ -
Weather station	EA	0	1	\$ 5,000.00	\$ -	\$ 5,000.00	\$ 5,000.00
Network Ethernet hubs (high temperature)	EA	1	1	\$ 400.00	\$ 400.00	\$ -	\$ 400.00
Direct burial Ethernet cable	LF	0	525	\$ 0.31	\$ 162.75	\$ -	\$ 162.75
Barriers and crash cushions	LF	0	0	\$ -	\$ -	\$ -	\$ -
Roadway bore and 4" conduit	LF	270	236	\$ 63.00	\$ 17,010.00	\$ 14,868.00	\$ 31,878.00
2' x 4' pullboxes (use ADOT #7 with extension)	EA	6	5	\$ 1,500.00	\$ -	\$ -	\$ -
3' x 5' pullboxes (use ADOT #9 pullbox)	EA	5	1	\$ 3,400.00	\$ 17,000.00	\$ 3,400.00	\$ 20,400.00
Install pullboxes (#7)	Lump	1	0	\$ 8,000.00	\$ 5,000.00	\$ 3,000.00	\$ 8,000.00
Surge protector for power service	EA	1	0	\$ 150.00	\$ 150.00	\$ -	\$ 150.00
Peek ADR-6000 (8 lanes WB and 6 lanes EB)	EA	1	1	\$ 35,000.00	\$ 45,000.00	\$ 35,000.00	\$ 80,000.00
Loop installation for Peek ADR-6000	Lump	1	1	\$ 3,000.00	\$ 24,000.00	\$ 18,000.00	\$ 42,000.00
Traffic Control for Installing ADR-6000 loops	LA	8	6	\$ 2,000.00	\$ 16,000.00	\$ 12,000.00	\$ 28,000.00
SmartSensor SS-125 vehicle detector	EA	1	1	\$ 8,000.00	\$ 8,000.00	\$ 8,000.00	\$ 16,000.00
Autoscope Solo Pro	EA	1	1	\$ 6,500.00	\$ 6,500.00	\$ 6,500.00	\$ 13,000.00
Sensys Networks mag. & epoxy (14 lanes, 2/1a)	EA	16	12	\$ 465.00	\$ 7,440.00	\$ 5,580.00	\$ 13,020.00
Sensys Networks Access Point & hardware	EA	1	1	\$ 3,300.00	\$ 3,300.00	\$ 3,300.00	\$ 6,600.00
GTT (3M), detector cards (all lanes)	Lump	1	1	\$ -	\$ 17,170.40	\$ 12,877.80	\$ 30,048.20
GTT (3M) bore (initiate from median)	LF	232	184	\$ 50.00	\$ 11,600.00	\$ 9,200.00	\$ 20,800.00
Pole structure 40' to be provided by ADOT	EA	1	1	\$ 20,000.00	\$ -	\$ -	\$ -
Pole foundation	EA	1	1	\$ 3,000.00	\$ 3,000.00	\$ 3,000.00	\$ 6,000.00



**Table 18: Anticipated Testbed Initial Costs for Phase 1 and Phase 2 (Continued)**

Description	Unit	Qty Ph1	Qty Ph2	Unit cost	Phase 1	Phase 2	Total cost
4" PVC conduit (pull box interconnect, etc)	LF	302	178	\$ 28.00	\$ 8,456.00	\$ 4,984.00	\$ 13,440.00
1" PVC conduit (for fiber connection)	LF	200	0	\$ 18.00	\$ 3,600.00	\$ -	\$ 3,600.00
3" PVC for pull box interconnections, power, coaxial	LF	197	198	\$ 25.00	\$ 4,925.00	\$ 4,950.00	\$ 9,875.00
3" steel conduit for sign bridge	LF	98	78	\$ 93.00	\$ 9,114.00	\$ 7,254.00	\$ 16,368.00
Equipment cabinets, large (Type 341) by ADOT	EA	3	1	\$ 8,000.00	\$ -	\$ -	\$ -
Cabinet foundations	EA	3	1	\$ 2,000.00	\$ 6,000.00	\$ 2,000.00	\$ 8,000.00
Equipment cabinets, small (Type 343) by ADOT	EA	2	1	\$ 2,000.00	\$ -	\$ -	\$ -
Node building (small)	EA	1	0	\$ 32,000.00	\$ 32,000.00		\$ 32,000.00
<b>Subtotal</b>					<b>\$252,602.41</b>	<b>\$158,913.80</b>	<b>\$ 411,516.21</b>
Bid package (10% of Subtotal)	Lump	1			\$ 25,260.24	\$ 15,891.38	\$ 41,151.62
Construction management (15% of Subtotal)	Lump	1			\$ 37,890.36	\$ 23,837.07	\$ 61,727.43
<b>Grand Subtotal</b>					<b>\$315,753.01</b>	<b>\$198,642.25</b>	<b>\$ 514,395.26</b>
Contingency (10%)					\$ 31,575.30	\$ 19,864.23	\$ 51,439.53
<b>Grand Total</b>					<b>\$347,328.31</b>	<b>\$218,506.48</b>	<b>\$ 565,834.79</b>

**Table 19: Sources of Cost Estimates**

<b>Description</b>	<b>Source</b>	<b>Comment</b>
8 ft chain link fence, 10' x 10'	Internet	<a href="http://www.yourfencestore.com/cl/clcost.html">http://www.yourfencestore.com/cl/clcost.html</a>
Pedestrian gate (4'X 6') (Barb top)	Internet	<a href="http://www.yourfencestore.com/cl/clcost.html">http://www.yourfencestore.com/cl/clcost.html</a>
Concrete pad, 12' x 12'	Internet	
Lightning rods and cable	Internet	<a href="http://www.glenmartin.com/catalog/lightning.htm">http://www.glenmartin.com/catalog/lightning.htm</a>
Hardware firewall	Internet	<a href="http://www.cdwg.com/shop/tools/sbb/vendor.aspx?MFG=WTG">http://www.cdwg.com/shop/tools/sbb/vendor.aspx?MFG=WTG</a>
Industrial computers	N/A	
Weather station (Campbell Scientific)	CS 2004 Pricing	Based on the following modules: CR10XT, HMP45C-LC, TE525 WS-LC, LI200X-LC, 05103-LC.
Network Ethernet hubs (high temperature)	Internet	<a href="http://www.sewelldirect.com">www.sewelldirect.com</a>
Direct burial Ethernet cable	Internet	Allied Electronics <a href="http://www.alliedelec.com">www.alliedelec.com</a>
Roadway bore and 4" conduit	TTG	
Roadway bore and 3" conduit for 3-M micro-loops	TTG	
2' x 4' pullboxes (use ADOT #7 with extension)	ADOT inventory	
3' x 5' pullboxes (use ADOT #9 pullbox)	ADOT inventory	
Install pullboxes (#7)	TTG/PMD	
Surge protector for power service	Internet	Allied Electronics <a href="http://www.alliedelec.com">www.alliedelec.com</a>
Peek ADR-6000 for 8 lanes	Vance Williams, Peek	Phone: (941) 809-6670
Loop installation for Peek ADR-6000 <sup>a</sup>	Britt-Rice Electric, College Station, TX	Phone: (979) 693-4076
Traffic Control for Installing ADR-6000 loops	PMD	
SmartSensor SS-125 vehicle detector	Paradigm Traffic, Ft Worth, TX	<a href="http://www.ptsicatalog.com/QISV/QISVWavetronix[1].htm">http://www.ptsicatalog.com/QISV/QISVWavetronix[1].htm</a>
Autoscope Solo Pro	Paradigm Traffic, Ft Worth, TX	<a href="http://www.ptsicatalog.com/QISV/QISVVideo.htm">http://www.ptsicatalog.com/QISV/QISVVideo.htm</a>
Sensys Networks mag. & epoxy (14 lanes, 2/1a)	Michael Volling, SN, Austin	Phone (512) 686-1770
Sensys Networks Access Point & hardware	Michael Volling, SN, Austin	Phone (512) 686-1770
Global Traffic Technologies sensors, detector cards	George Coffee, GTT	Phone (651) 592-2537
Global Traffic Technologies bore (initiate from median)	George Coffee, GTT	Phone (651) 592-2537
Pole structure 40' to be provided by ADOT	ADOT inventory	
Pole foundation	PMD	

**Table 19: Sources of Cost Estimates (Continued)**

Description	Source	Comment
4" PVC conduit (pull box interconnect, etc)	TTG	Phase 9, FMS
1" PVC conduit (for fiber connection)	TTG	Phase 9, FMS
3" PVC for pull box interconnections, power, coaxial	TTG	Phase 9, FMS
3" steel conduit for sign bridge	TTG	Phase 9, FMS
Equipment cabinets, large (Type 341) by ADOT	ADOT inventory	
Cabinet foundations	PMD	
Equipment cabinets, small (Type 343) by ADOT	ADOT inventory	
Node building (small)	PMD, Internet <sup>b</sup>	

<sup>a</sup> Quote based on local contractor used by TTI because few agencies continue to install loops; includes loop sealant and wire specification: 3M detector loop sealant 5000; Type XHHW 14-gage stranded copper wire with XHHW insulation conforming to IMSA 51-3 requirements.

<sup>b</sup> PMD cost of the building without foundation: \$23,000.



## **APPENDIX A**

### **OVERVIEW OF SELECTED DETECTION SYSTEMS**



## INTRODUCTION

Appendix A provides further perspectives and clarifications gleaned from vendor resources on the selected detection systems to be evaluated in Phase C of the project as well as information on the ground truth system, the Quixote (Peek) ADR-6000. Systems that are anticipated to be tested are the Wavetronix SS-125 (microwave radar), Sensys Networks magnetometers (magnetic), Global Traffic Technologies microloops (magnetic), and Autoscope Solo Pro (video imaging detector).

### **Quixote (Peek) ADR-6000**

By combining the Idris algorithms with special Peek inductive loop detectors, Peek Traffic and DCS developed the first urban data collection device to collect accurate axle classification and volume data in heavily congested areas (95% accuracy in congestion or free-flow), using inductive loop technology.

The ADR-6000 is a modular single or multilane data collection system that offers accurate vehicle count and axle based classification in traffic conditions ranging from free flow to stop and go congestion. The classification scheme used is configurable based on any features extracted by the ADR-6000. These features include vehicle length, speed, or number and spacing of axles.

The ADR-6000 can be set up and operated by remote telemetry or directly in the field with a computer using simple communications software. The remote telemetry link can be via modem or direct connection and can be simple ASCII transfer or protocol protected. If the ADR-6000 is part of a complex system, it will continue to operate as a standalone unit in the event of telemetry link failure. <sup>(29)</sup>

### **Sensys Networks Magnetometers**

The Sensys Wireless Vehicle Detection System uses pavement-mounted magnetic sensors to detect the presence and movement of vehicles. The magneto-resistive sensors are wireless, transmitting their detection data in real-time via low-power radio technology to a nearby Sensys Access Point (AP) that then relays the data to one or more local or remote traffic management controllers and systems.

A single Sensys installation thus consists of a number of Sensys wireless sensors installed in or on the roadway at various locations as required by the particular vehicle detection application, a Sensys Access Point to receive the data from the sensors and process and relay it onward, and one or more Sensys repeaters as may be needed to support sensors installed beyond the radio range of the Sensys AP. Each Sensys installation can then communicate its detection data in several ways:

- Via contact closure to a roadside traffic controller.
- Via IP (Internet Protocol) communications over twisted pair, coaxial cable, fiber optic cable, cellular data services, or other connectivity to one or more central

servers and traffic management systems, where the Sensys Networks Archive, Proxy, and Statistics (SNAPS) server is an example of such a central server.

- Via both paths, simultaneously supporting local traffic signal control as well as centralized traffic management and information systems.<sup>(30)</sup>

### **Global Traffic Technologies (3M) Microloops**

The GTT (3M) Traffic Sensing System II is a matched component system that provides complete, accurate and reliable data for traffic monitoring and classification at low life cycle costs - in every lane, 24 hours a day, 365 days a year. Sensors which are installed unobtrusively below the road surface are protected from pavement stress and road maintenance activities.

The 702 Traffic Sensor is a matched component of the GTT (3M) Traffic Sensing System II and consists of probe sensors and the installation kit, which includes carriers for sliding the probes into position in the conduit. Key considerations are as follows:

- 702 Non-invasive Traffic Sensors are used in single, double or triple assemblies connected in series to extend the coverage range. Each assembly is available with standard lead-in cable length.
- 3M Traffic Monitoring Cards or 3M Canoga™ C900 Series Vehicle Detectors are required to achieve the expected performance.
- The non-invasive traffic sensor's small size permits easy insertion into a 3-inch (7.6 cm) plastic conduit installed 18-24 inches (45-61 cm) below the pavement surface.

Installing the non-invasive traffic sensor into a conduit leaves the road surface intact and bypasses the effects of poor pavement conditions, and sensors are naturally shielded from catastrophic weather and require no maintenance.

3M Canoga™ C900/C900E Series Vehicle Detectors measure vehicle presence, count and roadway occupancy with industry-leading accuracy and reliability through superior inductive vehicle detection. The C900/C900E Series provides accurate performance when connected to GTT (3M)'s traffic sensors or to inductive loops.<sup>(31)</sup>

### **Econolite Autoscope Solo Pro II**

The Autoscope Solo® Pro II MVP sensor, offers field-proven reliability and the flexibility to meet more detection objectives. Its features increase the effectiveness of the world's first integrated wide-area video detection system for traffic management professionals everywhere.

The Solo Pro II sensor compliments the advanced Autoscope® product suite and system architecture. This product is ideal for freeway, intersection, bridge, tunnel, railroad,



traffic monitoring, and incident prevention applications. With the Autoscope Communications Server Software Developer's Kit (SDK), a programmer can easily create new client applications for display, incident alarms, and traffic parameter databases.

The Autoscope Solo Pro II sensor provides an economic alternative to loops and other detection technologies. Twisted-pair wiring to the Solo Pro II sensor is faster and easier to install than higher-cost coaxial cables. Remote connections as simple as a phone line or wireless radio can bring compressed video and data back to a traffic management center.<sup>(32)</sup>

### **Wavetronix SmartSensor SS-125 (HD)**

The Wavetronix SmartSensor HD uses the latest technology to collect consistently accurate traffic data in high definition. Patented Digital Wave Radar II™ measures traffic volume, individual vehicle speed, average speed, 85th percentile speed, average headway, average gap, lane occupancy, vehicle classification and presence. Operating at five times the bandwidth, SmartSensor HD has five times the resolution of the original SmartSensor, a detection range of 250 feet and the ability to detect up to 10 lanes of traffic simultaneously.

SmartSensor HD's unique Dual Radar design is incredibly accurate, providing individual vehicle speeds to within four miles per hour as well as more precise vehicle classifications. Digital Wave Radar II reduces “spillover”; works over barriers, guardrails, medians and gores; and accurately detects partially occluded vehicles. Armed with high definition radar, SmartSensor HD sees all vehicles in its field of view, and not just those in pre-defined zones.

SmartSensor HD is easy to install and includes a pointing assistant for precise alignment. Like all SmartSensors, SmartSensor HD's patented auto-configuration process is quick and simple. HD Manager™ detects lanes by observing traffic flow, and immediately provides visual confirmation of a successful configuration. This unique auto-configuration and operation software has been developed especially for Pocket PC® handheld devices and laptops.<sup>(33)</sup>



**APPENDIX B**

**CONDUIT CHART**  
**ADOT TESTBED DETAILED DESIGN**



**Table 20: Conduit Sizes and Types for Detailed Design**

Conduit Number	Length (ft)	Size - Type	Notes
1	5	3" PVC	WB sign bridge detectors
2	24	3" PVC	WB sign bridge detectors
3	98	3" Steel	WB sign bridge detectors
4	10	3" PVC	WB Pole/Mast arm det
5	53	4" PVC	WB sign bridge and Pole/Mast arm det
6	46	4" PVC	16 LI (4 lanes WB)
7	30	3" PVC	Interface existing FMS
8	6	4" PVC	To CAB1
9	11	4" PVC	To CAB2
10	16	4" PVC	To CAB3
11	8	4" PVC	CAB1 – CAB2
12	8	4" PVC	CAB1 – CAB3
13	77	4" PVC	12 LI, GTT (x2)
14	77	4" PVC	Ethernet, GTT (x2)
15	135	4" PVC	Bore (WB). Ethernet, GTT (x2)
16	135	4" PVC	Bore (WB). 12 LI, GTT(x2)
17	45	3" PVC	12 LI, GTT (x2)
18	18	3" PVC	12 LI, GTT
19	65	3" PVC	12 LI
20	116	3" PVC	Roadway bore for GTT Microloops (WB)
21	116	3" PVC	Roadway bore for GTT Microloops (WB)
22	118	4" PVC	Bore (EB). 12 LI, Ethernet
23	118	4" PVC	Bore (EB).
24	87	3" PVC	12 LI, GTT (x2)
25	18	3" PVC	12 LI, GTT
26	50	3" PVC	12 LI
27	92	3" PVC	Roadway bore for GTT Microloops (EB)
28	92	3" PVC	Roadway bore for GTT Microloops (EB)
29	154	4" PVC	12 LI, Ethernet
30	24	4" PVC	12 LI, EB sign bridge detectors, Ethernet
31	34	3" PVC	EB sign bridge detectors
32	9	3" PVC	EB sign bridge detectors
33	78	3" Steel	EB sign bridge detectors



## **APPENDIX C**

**INDUCTIVE SIGNATURE TECHNOLOGIES, INC.  
ALTERNATIVE EMBEDDED GROUND-TRUTH SYSTEM**





## INTRODUCTION

An alternate truthing system was also investigated as part of this project – the system offered by Inductive Signature Technologies, Inc. (IST), headquartered in Knoxville, Tennessee. The need for an alternative system was primarily associated with the proposed Peek ADR-6000 axle loops, which need to be no deeper than ½ inch from the surface of the pavement. Since the rubberized asphalt layer is nominally 1 inch thick (varying from about ½ inch to 1 ½ inches) and might not have the appropriate strength properties to support loops within that layer, the loops would have to be installed in the pavement layer below the rubberized asphalt. Subsequent investigations revealed that the IST loops could be installed at greater depths than the Peek axle loops, so IST loops could be installed below the rubberized asphalt layer.

However, one uncertainty and concern with some TAC members with the IST system was its perceived lack of maturity compared to the Peek system even though it had been successfully installed in San Diego in 20 locations for a few years. Therefore, ADOT would incur a risk with either system. With the Peek system, installing shallow axle loops would be risky. With the IST system, some TAC members believed the lack of maturity and the seven turns of wire in the smaller 8-inch by 12-ft blade loops would be an even greater risk. The TAC chose to purchase and install the Peek ADR-6000.

If the ADOT testbed installation begins soon, IST representatives recommended installing two sets of loops for their system – one set of 2 meter by 2 meter loops and the other set using an innovative IST loop concept called the “blade.” The blade system had not been perfected at the time of the investigation, so ADOT could install both types of loops and use the larger loops initially but transition to the blades as the software was debugged and the improved accuracy levels that it should achieve were demonstrated.

One suggestion from the TAC was to install both the Peek ADR-6000 and the IST system if funding was available. There did not seem to be a consensus on that recommendation, but an alternative would utilize the two larger Peek loops (also 2 meters by 2 meters) for either system, especially if the shallow Peek axle loops did not survive in the rubberized layer. Table 21 is a summary of the incremental costs that would be incurred for the IST system, assuming that the ADR-6000 loops are already available. Traffic control costs might need to be added if installation does not occur during tunnel closure.

**Table 21: Estimated Cost of the IST System Using Existing Loops**

Component	Cost per cabinet or per lane	Subtotal
PC with all IST software and IST support (per cabinet (1))	\$ 3,850.00	\$3,850.00
IST-222-PSO version 1.2 (or current version) (per lane (14))	\$ 1,000.00	\$14,000.00
Monthly cost communications & support from IST: \$70 cell; \$80 support (for 12 months)		\$1,800.00
Total cost plus support and communications for one year		\$9,650.00



## **APPENDIX D**

### **SPEEDINFO DETECTION SYSTEMS AND DATA-ONLY SERVICES**



## INTRODUCTION

SpeedInfo is a relatively new company, formed in 2002 and headquartered in San Jose, California, which offers a unique business plan to transportation providers. As of June 2007, SpeedInfo had installed 640 sensors in 11 cities throughout the U.S. SpeedInfo can offer a unique data service at a fixed fee or it can simply sell the equipment to a state DOT with maintenance contracts. At the present time, the SpeedInfo system uses Doppler radar to provide speed, and not counts or classifications.

The current cost for the data service option is \$110 per month per sensor for limited data use, or \$200 per month each for unlimited data use. For the “limited data use” option, the DOT would still be able to use the data for all internal applications, display travel times on changeable message signs, provide data for the phone and web-based 511 system, and share the data with universities and local law enforcement agencies. However, the DOT would not be able to provide SpeedInfo data via a digital feed to any commercial third party. This will enable SpeedInfo to establish, if possible, a commercial market for the data to share costs with the private sector and offset costs to the DOT. In reality, local media will use the posted 511 system for TV and radio traffic reports, effectively removing this market potential. So far, most states have purchased the limited data service option from SpeedInfo, but one purchased the equipment with its capital budget, and is paying annual maintenance fees. System purchase options also come with limited or unlimited data use and maintenance programs that can be used to lower up-front costs.

Most DOTs and MPOs are using the SpeedInfo system to improve traveler information systems and generate travel times for their freeways from the fixed point speed measurements. North Carolina, Nebraska, the San Francisco Bay Area MTC, Caltrans, and the future LA 511 system are using or are planning to use the system data to calculate and display average travel times.

The sensor sample rate is programmable, but the system default samples traffic speeds every 30 seconds and transmits an average measurement every minute via the AT&T Wireless network. The sensors are mounted about one mile apart in urban areas or about three miles apart in rural areas. The system can provide more frequent reporting under certain conditions, such as speed below a certain threshold. Each detector is mounted about 20 feet high on an existing structure beside the freeway and, as long as there are no obstructions or grade separations, it can cover both directions of traffic and up to a total of eight lanes. The effective range of the sensor is 1800 feet.

Mounting the sensor on a structure only takes a two person crew about 20 minutes since it gets power from its own solar panel, and uses wireless communication. SpeedInfo guarantees 90 percent availability of data from the network although it has historically been in the 98 percent range. The redundant, fail-over network server up-time is 99.8 percent. If service drops below 90 percent per month, SpeedInfo will pro-rate and reduce its charges to the state until the service level improves. This makes for a powerful incentive to maintain the network and for a sensor design that incorporates commercial service reliability.

The system was designed to withstand extreme temperatures. The unit has operated normally in temperatures ranging from -23 degrees C internal temperature to +85 degrees C in extended thermal testing. More information is available at the end of this appendix on the equipment specifications used by SpeedInfo and frequently asked questions.

## **EXPERIENCE OF OTHER JURISDICTIONS WITH SPEEDINFO**

TTI contacted some of the agencies that are currently using SpeedInfo's business plan or just the equipment from SpeedInfo to get information that might be useful to ADOT in making a decision regarding this company. Contacts included the District of Columbia Department of Transportation, the Nebraska Department of Roads, and the North Carolina Department of Transportation. It is clear that SpeedInfo offered some special programs to early participants, at least partly to encourage participation and grow the SpeedInfo business at a faster pace. Similar arrangements may be more difficult as time goes on.

### **District of Columbia Department of Transportation**

As of July 5, 2007, the District of Columbia Department of Transportation (DCDOT) had not verified the accuracy of the system even though it had been installed for a few months. Its output seemed reasonable and the department had no reason to suspect any problems based on spot checks. The department has had no major problems with the system and is getting the data at no cost. Apparently, SpeedInfo is providing the equipment and data for DCDOT in order to get the bigger accounts that might come from Virginia and Maryland.

One of the DCDOT engineers stated that each site only required 20 minutes of installation time. The format of the data provided to the department is XML. There was a modest amount of work on the receiving end to accommodate this format. Neither the communication nor the other elements of the SpeedInfo system have caused much downtime. There has been no maintenance cost to the department since SpeedInfo has covered it all, even the installation cost. According to the DCDOT spokesman, SpeedInfo is planning on modifying its equipment in the near future to be able to provide counts and occupancies as well as speeds.

### **Nebraska Department of Roads**

The SpeedInfo system had only been installed a few weeks when TTI contacted the Nebraska Department of Roads (NDOR) on July 5, 2007. Overall, NDOR is very pleased with both the equipment installed and the process of negotiation with SpeedInfo. The purpose of the data from the system is to populate a three-color speed map and to determine travel times for some corridors. At the time of the call, SpeedInfo was providing a generic map showing the speeds. NDOR was in the process of getting Delcan's software implemented for a longer term application.

Installing the equipment was straightforward and there have been no serious problems with the sensors, power systems, or communications. There has been only a very small amount of downtime. The radar device is quite forgiving in how it is installed and does not require a specific offset or angle with respect to the roadway. The data sent to NDOR is pushed from the SpeedInfo server in XML format. Each field device sends data via the Internet to the SpeedInfo server, which in turn pushes it to NDOR. NDOR personnel discussed the data format with both Delcan and Oz Engineering (system integrator) and neither anticipated any problems with receiving the SpeedInfo data.

SpeedInfo contracted with a local company, Bright Lights, to install and maintain the detector system. NDOR did not have to contract with this local service provider since SpeedInfo handled all of that. The NDOR contract costs them \$100 per month per detector site. Their contract with SpeedInfo allows NDOR to share data with other public entities but not with private entities. SpeedInfo also required that a disclaimer be placed in the contract to cover erroneous data that was not the fault of SpeedInfo. Determining the locations of each of the detectors was a joint effort between NDOR and SpeedInfo.

### **North Carolina Department of Transportation**

As of July 6, 2007, the North Carolina Department of Transportation (NCDOT) had 75 of the SpeedInfo units installed, partly in rural and partly in urban areas. The department originally installed 20 in the Raleigh-Durham area and 20 in rural areas along I-95 to test them for their 511 system before buying more of these units. These detection systems are used for displaying speeds on a speed map, for travel times, and for displaying spot speeds at specified locations. The department purchased full use of the data due to restrictions of non-DOT personnel on NCDOT right-of-way.

The NCDOT conducted a cost comparison between this system and the RTMS which had been deployed in the past and found that the SpeedInfo system was just over half the cost of the RTMS system. The RTMS cost was \$15,000 for each installation for the sensor, power, and communication costs. According to the NCDOT contact, the comparison that was done used life-cycle cost. The original NCDOT contract period was for 36 months at a cost of \$100 per month per sensor, or \$1,200 per year per sensor. This cost includes the cost of maintenance of the sensors. There have been a limited number of equipment problems but SpeedInfo has always been very prompt about either fixing the problem or replacing the defective unit. There have been no communication issues other than very brief (a minute or two) loss of connectivity. The only weather-related issue NCDOT has found is during the first minute or two of rain when the radar detector detects the rain. NCDOT contractor developed a remedy to solve most of the problem, but SpeedInfo is also working on it.

Both the initial and long-term reactions to the SpeedInfo system have been positive. NCDOT likes the system and user feedback is very positive. Its accuracy has been verified in terms of speed accuracy from point to point and in terms of it being able to identify incidents on the freeway system.

## **EQUIPMENT USED BY SPEEDINFO**

SpeedInfo's DVSS-100 Doppler Vehicle Speed Sensor is a fully self contained, roadside mounted, vehicle speed measurement sensor. In addition to low unit cost, SpeedInfo claims that the sensor is extremely robust and will perform maintenance free for years. The sensor is battery powered, solar charged, and mounts quickly on existing poles or overpasses. The DVSS-100 uses a 24.125 GHz Doppler microwave transceiver that is coupled to a Digital Signal Processor, to measure and calculate vehicle speed. The DVSS-100 is capable of determining average or composite vehicle speed for a multiple lane freeway or highway. Speed information is backhauled to SpeedInfo's data server over a GSM cellular data link. Figure 23 is a photograph of the equipment used.



**Figure 23: DVSS-100 Doppler Vehicle Speed Sensor**

### **Specifications**

#### **Coverage**

- Range up to 1800 ft
- Installs on existing infrastructure – no new poles; mounts on virtually anything
- 20 minute installation and calibration time; 10 minute replacement time
- Configurable coverage areas to suit specific installation requirements

#### **Communication**

- Real-Time Traffic Information reporting
- GPRS wireless modem data-backhaul (850/1900 MHz); additional frequencies available
- Adaptive traffic speed reporting (Variable reporting schedules based on congestion level)
- Full duplex/Bi-directional



## **Measurement**

- Bi-directional traffic data collection
- Configurable data acquisition/sample rate
- Average speed accuracy within +/- 1mph
- 1/10<sup>th</sup> mph for single vehicle in field of view

## **Mechanical**

- Enclosure
  - Anodized aluminum extrusion
  - Bright white powder coat
  - 14.3" length (.36m)
  - 4" Tube diameter (.10m)
- Weight
  - 13 Lbs (5.9kg) w/o mounting bracket and solar panel
  - 16 Lbs (7.3kg) with mounting bracket and 5 watt solar panel

## **FCC**

- Part 15 certified

## **Environmental**

- Operating temperature
  - -30°C to +70°C
- Relative Humidity
  - 0% to 100%
- Shock and vibration
  - Shock of 5 g 10 ms half sine wave
  - Vibration of 2g up to 200Hz

## **System Power**

- Battery and charge system
  - 12V 5 Amp hour sealed tin/lead acid battery
  - 17 day operation w/o re-charge (No sunlight condition)
  - 8-10 year battery life
- Solar panel charging system
  - 5 or 10 watt solar panel
  - Approximately 1 sq. ft. in total area
  - Battery/charge alarms

## **Reliability**

- MTBF greater than 60,000 hours

## **Sensor Platform/Modularity**

- Temperature and fog sensors
- Visual sensors for incident verification
- Vehicle counts

**Serviceability**

- On board diagnostics/self test
- Over-the-air software updates (No service calls)

Specifications subject to change

**For more information:**

SpeedInfo website: <http://www.speedinfo.com/>

## LIST OF REFERENCES

1. Website for Minnesota Department of Transportation, <http://www.dot.state.mn.us/guidestar/nitfinal/index.htm>, *Field Test of Monitoring of Urban Vehicle Operations Using Non-Intrusive Technologies, Final Report*, accessed February 25, 2007.
2. Website for Minnesota Department of Transportation, <http://www.dot.state.mn.us/guidestar/pdf/nit2final/finalreport.pdf>, *NIT Phase II Evaluation of Non-Intrusive Technologies for Traffic Detection*, accessed February 25, 2007.
3. Kranig, J., E. Minge, and C. Jones. *Field Test of Monitoring of Urban Vehicle Operations Using Non-Intrusive Technologies*. Report Number FHWA-PL-97-018, Minnesota Department of Transportation – Minnesota Guidestar, St. Paul, MN, and SRF Consulting Group, Minneapolis, MN, May 1997.
4. Minnesota Department of Transportation and SRF Consulting Group, Inc. *NIT Phase II Evaluation of Non-Intrusive Technologies for Traffic Detection, Final Report*. Minnesota Department of Transportation, St. Paul, MN, September 2002.
5. Middleton, D., D. Jasek, and R. Parker. *Evaluation of Some Existing Technologies for Vehicle Detection*. Research Report FHWA/TX-00/1715-S, Texas Transportation Institute, The Texas A&M University System, College Station, TX, September 1999.
6. Middleton, D. and R. Parker. *Initial Evaluation of Selected Detectors to Replace Inductive Loops on Freeways*. Research Report FHWA/TX-00/1439-7, Texas Transportation Institute, The Texas A&M University System, College Station, TX, April 2000.
7. Middleton, D. and R. Parker. *Vehicle Detector Evaluation*. Research Report FHWA/TX-03/2119-1, Texas Transportation Institute, The Texas A&M University System, College Station, TX, October 2002.
8. Woods, D. *Texas Evaluation of Loop Detector Installation Procedures and Preparation of a Texas Traffic Signal Detector Manual*. Report No. FHWA/TX-90/1163-1, Texas Transportation Institute, The Texas A&M University System, College Station, TX, July 1992.
9. Middleton, D., D. Jasek, H. Charara, and D. Morris. *Evaluation of Innovative Methods to Reduce Stops to Trucks at Isolated Intersections*. Research Report FHWA/TX-97/2972-1F, Texas Transportation Institute, The Texas A&M University System, College Station, TX, August 1997.

10. Bonneson, J., D. Middleton, K. Zimmerman, H. Charara, and M. Abbas. *Intelligent Detection-Control System for Rural Signalized Intersections*. Research Report FHWA/TX-02/4022-2, Texas Transportation Institute, The Texas A&M University System, College Station, TX, August 2002.
11. Middleton, D., R. Parker, and R. Longmire. *Investigation of Vehicle Detector Performance and ATMS Interface*. Research Report FHWA/TX-07/4750-2, Texas Transportation Institute, The Texas A&M University System, College Station, TX, March 2007.
12. Website for Minnesota Department of Transportation, <http://www.dot.state.mn.us/guidestar/pdf/pnitds/final-report.pdf>, *Evaluation of Portable Non-Intrusive Traffic Detection System*, accessed April 12, 2007.
13. Wald, W. *Microwave Vehicle Detection Final Report*. The California Department of Transportation, Detector Evaluation and Testing Team, Sacramento, CA, January 2004.
14. Coifman, B. "Vehicle Level Evaluation of Loop Detectors and the Remote Traffic Microwave Sensor (RTMS)." Transportation Research Board 84<sup>th</sup> Annual Meeting Compendium of Papers CD-ROM, January 2005, Washington, D.C.
15. Coifman, B. "Freeway Detector Assessment: Aggregate Data from Remote Traffic Microwave." *Transportation Research Record: Journal of the Transportation Research Board*, No. 1917, Washington, D.C., 2005, pp. 149-163.
16. Zwahlen, H., A. Russ, E. Oner, and M. Parthasarathy. "Evaluation of Microwave Radar Trailers for Nonintrusive Traffic Measurements." Transportation Research Board 84<sup>th</sup> Annual Meeting Compendium of Papers CD-ROM, January 2005, Washington, D.C.
17. Cheung, S., S. Coleri, B. Dunder, S. Ganesh, C. Tan, and P. Varaiya. "Traffic Measurement and Vehicle Classification with a Single Magnetic Sensor." Transportation Research Board 84<sup>th</sup> Annual Meeting Compendium of Papers CD-ROM, January 2005, Washington, D.C.
18. Klein, L. and M. R. Kelley. *Detection Technology for IVHS*, Volume 1 Final Report, FHWA-RD-96-100. Performed by Hughes Aircraft Company, Turner-Fairbank Research Center, Federal Highway Administration Research and Development, U.S. Department of Transportation, Washington, D.C., 1996.
19. Duckworth, G., J. Bing, S. Carlson, M. Frey, M. Hamilton, J. Heine, S. Milligan, R. Miawski, C. Remer, S. Ritter, L. Warner, L. Watters, R. Welsh, and D. Whittmore. "A Comparative Study of Traffic Monitoring Sensors." Proceedings, 1994 Annual Meeting of IVHS America, Washington, D.C.

20. Website for Minnesota Department of Transportation, <http://www.dot.state.mn.us/guidestar/nitfinal/part2.htm>, *Field Test of Monitoring of Urban Vehicle Operations Using Non-Intrusive Technologies Final Report*, accessed February 25, 2007.
21. Martin, P. and Y. Feng. *Traffic Detector Selection Procedure (Guideline Draft)*. Report No. UT-03.30, University of Utah, Salt Lake City, UT, June 2003.
22. Prevedouros, P. *Investigation of Traffic Detectors for Use in Hawaii: Detector Installations and Tests*. Department of Civil and Environmental Engineering, University of Hawaii at Manoa, Honolulu, HI, December 2004.
23. French, J. and M. French. *Traffic Data Collection Methodologies*, Report No. FHWA-PA-2006-005-040219, French Engineering, LLC; Pennsylvania Department of Transportation. Federal Highway Administration, Washington, DC, April 2006.
24. Zhang, L., L. Rilett, E. Jones, N. Bhaven, and J. Appiah. "An Analysis of Aggregated and Disaggregated Traffic Data Obtained from Non-Intrusive Traffic Detection Sensors," Transportation Research Board 86<sup>th</sup> Annual Meeting Compendium of Papers CD-ROM, January 2007, Washington, D.C.
25. *Unclogging America's Arteries – Effective Relief for Highway Bottlenecks 1999-2004*. American Highway Users Alliance. Washington, D.C., 2004.
26. Yazdan, F. "World's Premiere Roadway Detector Evaluation Facility 'Open for Business'," *Intellimotion*. Vol. 10, no. 2. 2003. pp1-3.
27. MacCarley, A. and J. Slonaker. "Automated Consensus-based Data Verification in the Caltrans Detector Testbed," Transportation Research Board 86<sup>th</sup> Annual Meeting Compendium of Papers CD-ROM, January 2007, Washington, D.C.
28. American Society for Testing and Materials, ASTM E2532-06, "Standard Test Methods for Evaluating Performance of Highway Traffic Monitoring Devices," Washington, D.C., 2006.
29. Website for Quixote (Peek) ADR-6000, <http://www.quixtraffic.com/products/data/ADR-6000-05.pdf>, accessed October 30, 2007.
30. Website for Sensys Networks, <http://www.sensysnetworks.com/system.html>, accessed October 30, 2007.
31. Website for Global Traffic Technologies, [http://solutions.3m.com/wps/portal/3M/en\\_US/Traffic\\_Safety/TSS/Offerings/Products/Intelligent\\_Trans\\_Systems/?PC\\_7\\_RJH9U5230GE3E02LECFTDQOV36\\_nid=CPV2VZBVNCbeMRKM0WZXCWgl](http://solutions.3m.com/wps/portal/3M/en_US/Traffic_Safety/TSS/Offerings/Products/Intelligent_Trans_Systems/?PC_7_RJH9U5230GE3E02LECFTDQOV36_nid=CPV2VZBVNCbeMRKM0WZXCWgl), accessed October 30, 2007.

32. Website for Econolite products,  
[http://www.econolite.ca/docs/autoscope/autoscope\\_soloproII\\_data\\_sheet.pdf](http://www.econolite.ca/docs/autoscope/autoscope_soloproII_data_sheet.pdf),  
accessed October 30, 2007.
33. Website for Wavetronix SS-125, <http://www.wavetronix.com/smartsensor/125/>,  
accessed October 30, 2007.