



California Department
of Transportation

Highway Design Manual

U.S. Customary Units

Seventh Edition

This manual is continuously revised and published on the world wide web at <https://dot.ca.gov/programs/design/manual-highway-design-manual-hdm>.

Information concerning the contents of this manual may be obtained by writing:

**STATE OF CALIFORNIA
DEPARTMENT OF TRANSPORTATION
CHIEF, DIVISION OF DESIGN
P.O. BOX 942874, MS 28
SACRAMENTO, CALIFORNIA 94274 – 0001**

FOREWORD

Purpose

This manual was prepared for the California Department of Transportation (Department) by the Division of Design for use on the California State highway system. This manual establishes uniform policies and procedures to carry out the State highway design functions of the Department. It is neither intended as, nor does it establish, a legal standard for these functions.

The standards, procedures, and requirements established and discussed herein are for the information and guidance of the officers and employees of the Department.

Many of the instructions given herein are subject to amendment as conditions and experience warrant. Special situations may call for deviation from policies and procedures, subject to Division of Design approval, or such other approval as may be specifically provided for in the text of this manual.

It is not intended that any standard of conduct or duty toward the public shall be created or imposed by the publication of this manual. Statements as to the duties and responsibilities of any given classification of officers or employees mentioned herein refer solely to duties or responsibilities owed by these in such classification to their superiors. However, in their official contacts, each employee should recognize the necessity for good relations with the public.

Scope

This manual is not a textbook or a substitute for engineering knowledge, experience, or judgment. It includes techniques as well as graphs and tables not ordinarily found in textbooks. These are intended as aids in the quick solutions of field and office problems. Except for new developments, no attempt is made to detail basic engineering techniques; for these, standard textbooks should be used.

Form

The loose-leaf form was chosen because it facilitates change and expansion. New instructions or updates will be issued as sheets in the format of this manual and made available on-line on the Department Design website: <https://dot.ca.gov/programs/design/manual-highway-design-manual-hdm>. The new instructions or updates may consist of additional sheets or new sheets to be substituted for those superseded. Users of this manual are encouraged to utilize the most recent version available on-line on the Department Design website.

Organization of the Manual

A decimal numbering system is used which permits identification by chapter, topic, and index, each of which is a subdivision of the preceding classification. For example:

Chapter 40 Federal-Aid

Topic 42 Federal-Aid System

July 1, 2020

Index 42.2 Interstate

The upper corner of each page shows the page number and the date of issue.

Use the Table of Contents

The Table of Contents gives the index number and page number for each topical paragraph together with corresponding dates of issue. If the holder of the manual chooses to maintain a paper copy, the holder is responsible for keeping the paper copy up to date and current. Revised Table of Contents will be issued on the Department Design website as the need arises.

Use of the Highway Design Manual in U.S. Customary (English) Units

This Seventh Edition of the Highway Design Manual is in U.S. Customary (English) units. Departmental policy established by Director's Policy 15-R1 and Deputy Directive Number 12-R1, both effective October 2006, state that the Department has adopted the use of the U.S. Customary (English) units as its preferred system of units and measures. All projects designed and constructed in English units shall follow the standards in this manual.

Use of the HDM as a Reference in Other Media

No warranty is made regarding the results of use of this Caltrans Highway Design Manual (HDM) or that the HDM will accurately and reliably test construction designs for compliance with any Federal, State or industry standards, or that the HDM will predict or test the safety or other feature or a structure. Engineering judgment must be used to apply the HDM to designs and to adjust designs to fit individual site conditions. The HDM is not intended to be a substitute for engineering knowledge, experience or judgment. In no event shall the Department be liable for costs of procurement of substitute goods, loss of profits, or for any indirect, special, consequential or incidental damages, however caused, by use of the HDM. The Department shall not be liable for any claims in connection with the use of the HDM, including without limitation, liability arising from third-party claims, liability related to the quality of calculations or the safety or quality or structures, liability for scheduling delays or re-design, retrofit or re-work of structures, or other similar liability.

Table of Contents

CHAPTER 10 – DIVISION OF DESIGN..... 10-1
 Topic 11 – Organization and Functions 10-1
 Index 11.1 – Organization..... 10-1

CHAPTER 20 – DESIGNATION OF HIGHWAY ROUTES..... 20-1
 Topic 21 – Highway Route Numbers 20-1
 Index 21.1 – Legislative Route Numbers and Descriptions 20-1
 21.2 Sign Route Numbers 20-1

CHAPTER 40 – FEDERAL-AID 40-1
 Topic 41 – Enabling Legislation 40-1
 Index 41.1 – General 40-1
 Topic 42 – Federal-Aid System..... 40-1
 42.1 National Highway System 40-1
 42.2 Interstate..... 40-1
 Topic 43 – Federal-Aid Programs 40-2
 43.1 Surface Transportation Program (STP) 40-2
 43.2 California Stewardship and Oversight Agreement with FHWA 40-2
 43.3 Congestion Mitigation and Air Quality Improvement Program (CMAQ) 40-2
 43.4 Bridge Replacement and Rehabilitation Program 40-3
 43.5 Federal Lands Program 40-3
 43.6 Highway Safety Improvement Program 40-3
 43.7 Special Programs 40-3
 Topic 44 – Funding Determination 40-3
 44.1 Funding Eligibility..... 40-3
 44.2 Federal Participation Ratio 40-4
 44.3 Emergency Relief 40-4

CHAPTER 60 – NOMENCLATURE 60-1
 Topic 61 – Abbreviations 60-1
 Index 61.1 – Official Names..... 60-1

July 1, 2020

Topic 62 – Definitions	60-1
62.1 Geometric Cross Section.....	60-1
62.2 Highway Structures	60-3
62.3 Highway Types	60-5
62.4 Interchanges and Intersections at Grade.....	60-6
62.5 Landscape Architecture.....	60-8
62.6 Right of Way.....	60-8
62.7 Pavement	60-9
62.8 Highway Operations	60-13
62.9 Drainage.....	60-15
62.10 Users	60-15
CHAPTER 80 – APPLICATION OF DESIGN STANDARDS.....	80-1
Topic 81 – Project Development Overview	80-1
Index 81.1 – Philosophy	80-1
81.2 Highway Context	80-1
81.3 Place Types.....	80-2
81.4 Type of Highway.....	80-5
81.5 Access Control	80-6
81.6 Design Standards and Highway Context.....	80-6
Topic 82 – Application of Standards	80-6
82.1 Highway Design Manual Standards.....	80-6
82.2 Approvals for Nonstandard Design.....	80-9
82.3 FHWA and AASHTO Standards and Policies.....	80-10
82.4 Mandatory Procedural Requirements	80-10
82.5 Effective Date for Implementing Revisions to Design Standards.....	80-10
82.6 Design Information Bulletins and Other Caltrans Publications	80-11
82.7 Traffic Engineering	80-11
CHAPTER 100 – BASIC DESIGN POLICIES.....	100-1
Topic 101 – Design Speed	100-1
Index 101.1 – Highway Design Speed.....	100-1

101.2 Highway Design Speed Standards 100-3

Topic 102 – Design Capacity & Level of Service 100-4

102.1 Design Capacity (Automobiles)..... 100-4

102.2 Design Capacity and Quality of Service (Pedestrians and Bicycles) 100-5

Topic 103 – Design Designation 100-5

103.1 Relation to Design 100-5

103.2 Design Period 100-6

Topic 104 – Control of Access 100-6

104.1 General Policy 100-6

104.2 Access Openings..... 100-6

104.3 Frontage Roads 100-7

104.4 Protection of Access Rights 100-8

104.5 Relation of Access Opening to a Median Opening 100-8

104.6 Maintaining Local Community Access 100-8

104.7 Cross References 100-8

Topic 105 – Pedestrian Facilities 100-8

105.1 General Policy 100-8

105.2 Sidewalks and Walkways 100-9

105.3 Pedestrian Grade Separations..... 100-11

105.4 Accessibility Requirements 100-12

105.5 Guidelines for the Location and Design of Curb Ramps 100-13

105.6 Pedestrian Crossings..... 100-14

Topic 106 – Stage Construction and Utilization of Local Roads..... 100-14

106.1 Stage Construction 100-14

106.2 Utilization of Local Roads 100-16

Topic 107 – Roadside Installations 100-17

107.1 Roadway Connections 100-17

107.2 Maintenance and Police Facilities on Freeways 100-17

107.3 Location of Border Inspection Stations 100-18

Topic 108 – Coordination With Other Agencies 100-18

108.1 Divided Nonfreeway Facilities 100-18

108.2 Transit Loading Facilities 100-19

July 1, 2020

108.3 Commuter and Light Rail Facilities Within State Right of Way 100-21

108.4 Bus Loading Facilities..... 100-22

108.5 Bus Rapid Transit..... 100-22

108.6 High-Occupancy Toll and Express Toll Lanes..... 100-23

108.7 Coordination with the FHWA 100-23

Topic 109 – Scenic Values in Planning and Design..... 100-24

109.1 Basic Precepts..... 100-24

109.2 Design Speed 100-24

109.3 Aesthetic Factors..... 100-24

Topic 110 – Special Considerations 100-25

110.1 Design for Overloaded Material Hauling Equipment..... 100-25

110.2 Control of Water Pollution..... 100-26

110.3 Control of Air Pollution..... 100-31

110.4 Wetlands Protection 100-32

110.5 Control of Noxious Weeds - Exotic and Invasive Species 100-33

110.6 Earthquake Consideration 100-33

110.7 Traffic Control Plans 100-34

110.8 Safety Reviews..... 100-36

110.9 Value Analysis..... 100-38

110.10 Proprietary Items 100-38

110.11 Conservation of Materials and Energy..... 100-39

110.12 Tunnel Safety Orders 100-41

Topic 111 – Material Sites and Disposal Sites..... 100-45

111.1 General Policy 100-45

111.2 Investigation of Local Materials Sources 100-46

111.3 Materials Information Furnished to Prospective Bidders 100-47

111.4 Materials Arrangements 100-48

111.5 Procedures for Acquisition of Material Sites and Disposal Sites 100-48

111.6 Mandatory Material Sites and Disposal Sites on Federal-aid Projects 100-50

Topic 112 – Contractor's Yard and Plant Sites 100-50

112.1 Policy..... 100-50

112.2 Locating a Site..... 100-51

Topic 113 – Geotechnical Design Report 100-51

 113.1 Policy 100-51

 113.2 Content 100-51

 113.3 Submittal and Review 100-51

Topic 114 – Materials Report 100-52

 114.1 Policy 100-52

 114.2 Requesting Materials Report(s) 100-52

 114.3 Content 100-53

 114.4 Preliminary Materials Report 100-53

 114.5 Review and Retention of Records 100-54

Topic 115 – Designing for Bicycle Traffic 100-54

 115.1 General 100-54

Topic 116 – Bicyclists and Pedestrians on Freeways 100-55

 116.1 General 100-55

CHAPTER 200 – GEOMETRIC DESIGN AND STRUCTURE STANDARDS 200-1

Topic 201 – Sight Distance 200-1

 Index 201.1 – General 200-1

 201.2 Passing Sight Distance 200-1

 201.3 Stopping Sight Distance 200-3

 201.4 Stopping Sight Distance at Grade Crests 200-3

 201.5 Stopping Sight Distance at Grade Sags 200-3

 201.6 Stopping Sight Distance on Horizontal Curves 200-4

 201.7 Decision Sight Distance 200-4

Topic 202 – Superelevation 200-5

 202.1 Basic Criteria 200-5

 202.2 Standards for Superelevation 200-10

 202.3 Restrictive Conditions 200-12

 202.4 Axis of Rotation 200-12

 202.5 Superelevation Transition 200-19

 202.6 Superelevation of Compound Curves 200-22

 202.7 Superelevation on City Streets and County Roads 200-22

July 1, 2020

Topic 203 – Horizontal Alignment	200-22
203.1 General Controls	200-22
203.2 Standards for Curvature	200-24
203.3 Alignment Consistency	200-24
203.4 Curve Length and Central Angle	200-24
203.5 Compound Curves	200-25
203.6 Reversing Curves	200-25
203.7 Broken Back Curves	200-25
203.8 Spiral Transition	200-25
203.9 Alignment at Bridges	200-25
Topic 204 – Grade	200-26
204.1 General Controls	200-26
204.2 Position With Respect to Cross Section	200-26
204.3 Standards for Grade	200-27
204.4 Vertical Curves	200-27
204.5 Sustained Grades	200-29
204.6 Coordination of Horizontal and Vertical Alignment	200-31
204.7 Separate Grade Lines	200-31
204.8 Grade Line of Structures	200-32
Topic 205 – Road Connections and Driveways	200-35
205.1 Access Openings on Expressways	200-35
205.2 Private Road Connections	200-35
205.3 Urban Driveways	200-36
205.4 Driveways on Frontage Roads and in Rural Areas	200-37
205.5 Financial Responsibility	200-38
Topic 206 – Pavement Transitions	200-38
206.1 General Transition Standards	200-38
206.2 Pavement Widening	200-38
206.3 Pavement Reductions	200-40
206.4 Temporary Freeway Transitions	200-40
Topic 207 – Airway-Highway Clearances	200-40
207.1 Introduction	200-40

207.2 Clearances 200-41

207.3 Submittal of Airway-Highway Clearance Data 200-41

Topic 208 – Bridges, Grade Separation Structures, and Structure Approach Embankment
..... 200-46

208.1 Bridge Lane and Shoulder Width 200-46

208.2 Cross Slope 200-48

208.3 Median 200-48

208.4 Bridge Sidewalks 200-48

208.5 Open End Structures 200-48

208.6 Bicycle and Pedestrian Overcrossings and Undercrossings 200-48

208.7 Equestrian Undercrossings and Overcrossings 200-49

208.8 Cattle Passes, Equipment, and Deer Crossings 200-49

208.9 Railroad Underpasses and Overheads 200-49

208.10 Bridge Barriers and Railings 200-50

208.11 Structure Approach Embankment 200-55

Topic 209 – Structure Approach Slabs 200-59

209.1 Purpose and Application 200-59

209.2 General Considerations 200-59

209.3 Structural Approach System Drainage 200-61

209.4 Structure Approach Slab Rehabilitation Considerations 200-61

Topic 210 – Reinforced Earth Slopes and Earth Retaining Systems 200-63

210.1 Introduction 200-63

210.2 Construction Methods and Types 200-64

210.3 Alternative Earth Retaining Systems (AERS) 200-70

210.4 Value Engineering Change Proposal (VECP) 200-71

210.5 Aesthetic Consideration 200-72

210.6 Safety Railing, Fences, and Concrete Barriers 200-72

210.7 Design Responsibility 200-73

210.8 Guidelines for Type Selection and Plan Preparation 200-73

CHAPTER 300 – GEOMETRIC CROSS SECTION 300-1

Topic 301 – Traveled Way Standards 300-1

July 1, 2020

Index 301.1 – Lane Width.....	300-1
301.2 Class II Bikeway (Bike Lane) Lane Width.....	300-1
301.3 Cross Slopes.....	300-4
Topic 302 – Highway Shoulder Standards.....	300-5
302.1 Width.....	300-5
302.2 Cross Slopes.....	300-5
302.3 Tapered Edge.....	300-7
Topic 303 – Curbs, Dikes, and Side Gutters.....	300-8
303.1 General Policy.....	300-8
303.2 Curb Types and Uses.....	300-9
303.3 Dike Types and Uses.....	300-11
303.4 Curb Extensions.....	300-13
303.5 Position of Curbs and Dikes.....	300-16
303.6 Curbs and Dikes on Frontage Roads and Streets.....	300-17
Topic 304 – Side Slopes.....	300-17
304.1 Side Slope Standards.....	300-17
304.2 Clearance From Slope to Right of Way Line.....	300-19
304.3 Slope Benches and Cut Widening.....	300-19
304.4 Contour Grading and Slope Rounding.....	300-19
304.5 Stepped Slopes.....	300-20
Topic 305 – Median Standards.....	300-21
305.1 Width.....	300-21
305.2 Median Cross Slopes.....	300-23
305.3 Median Barriers.....	300-23
305.4 Median Curbs.....	300-23
305.5 Paved Medians.....	300-23
305.6 Separate Roadways.....	300-24
Topic 306 – Right of Way.....	300-24
306.1 General Standards.....	300-24
306.2 Right of Way Through the Public Domain.....	300-24
Topic 307 – Cross Sections for State Highways.....	300-24
307.1 Cross Section Selection.....	300-24

307.2 Two-lane Cross Sections for New Construction..... 300-26

307.3 Two-lane Cross Sections for 2R, 3R, and other Projects..... 300-26

307.4 Multilane Divided Cross Sections 300-28

307.5 Multilane All Paved Cross Sections with Special Median Widths 300-28

307.6 Multilane Cross Sections for 2R and 3R Projects 300-32

307.7 Reconstruction Projects 300-32

Topic 308 – Cross Sections for Roads Under Other Jurisdictions 300-32

 308.1 City Streets and County Roads..... 300-32

Topic 309 – Clearances 300-33

 309.1 Horizontal Clearances for Highways..... 300-33

 309.2 Vertical Clearances..... 300-36

 309.3 Tunnel Clearances..... 300-42

 309.4 Lateral Clearance for Elevated Structures 300-42

 309.5 Structures Across or Adjacent to Railroads 300-42

Topic 310 – Frontage Roads..... 300-47

 310.1 Cross Section 300-47

 310.2 Outer Separation 300-48

 310.3 Headlight Glare..... 300-48

CHAPTER 400 – INTERSECTIONS AT GRADE..... 400-1

 Topic 401 – Factors Affecting Design 400-1

 Index 401.1 – General 400-1

 401.2 Human Factors 400-1

 401.3 Traffic Considerations..... 400-2

 401.4 The Physical Environment 400-2

 Table 401.3 400-3

 401.5 Intersection Type 400-3

 401.6 Transit..... 400-4

 Topic 402 – Operational Features Affecting Design..... 400-4

 402.1 Capacity..... 400-4

 402.2 Collisions 400-5

 402.3 On-Street Parking 400-5

July 1, 2020

402.4 Consider All Users	400-6
402.5 Speed-Change Areas	400-6
Topic 403 – Principles of Channelization	400-6
403.1 Preference to Major Movements.....	400-6
403.2 Areas of Conflict	400-6
403.3 Angle of Intersection.....	400-7
403.4 Points of Conflict.....	400-8
403.5 (Currently not in Use)	400-9
403.6 Turning Traffic	400-9
403.7 Refuge Areas.....	400-11
403.8 Prohibited Turns	400-11
403.9 Effective Signal Control	400-11
403.10 Installation of Traffic Control Devices	400-13
403.11 Summary	400-13
403.12 Other Considerations.....	400-13
Topic 404 – Design Vehicles	400-14
404.1 General.....	400-14
404.2 Design Considerations	400-14
404.3 Design Tools.....	400-15
404.4 Design Vehicles and Related Definitions.....	400-16
404.5 Turning Templates & Vehicle Diagrams	400-18
Topic 405 – Intersection Design Standards	400-26
405.1 Sight Distance	400-26
405.2 Left-turn Channelization	400-30
405.3 Right-turn Channelization	400-36
405.4 Traffic Islands	400-37
405.5 Median Openings	400-40
405.6 Access Control	400-41
405.7 Public Road Intersections.....	400-43
405.8 City Street Returns and Corner Radii	400-43
405.9 Widening of 2-lane Roads at Signalized Intersections.....	400-43
405.10 Roundabouts	400-46

Topic 406 – Ramp Intersection Capacity Analysis 400-52

CHAPTER 500 – TRAFFIC INTERCHANGES..... 500-1

 Topic 501 – General 500-1

 Index 501.1 – Concepts 500-1

 501.2 Warrants 500-1

 501.3 Spacing..... 500-1

 Topic 502 – Interchange Types..... 500-1

 502.1 General..... 500-1

 502.2 Local Street Interchanges 500-2

 502.3 Freeway-to-Freeway Interchanges 500-7

 Topic 503 – Interchange Design Procedure..... 500-10

 503.1 Basic Data 500-10

 503.2 Reviews 500-11

 Topic 504 – Interchange Design Standards 500-11

 504.1 General..... 500-11

 504.2 Freeway Entrances and Exits 500-11

 504.3 Ramps 500-16

 504.4 Freeway-to-Freeway Connections 500-37

 504.5 Auxiliary Lanes 500-38

 504.6 Mainline Lane Reduction at Interchanges..... 500-38

 504.7 Weaving Sections 500-40

 504.8 Access Control..... 500-46

Chapters 600 – 670 Pavement Engineering..... 600-1

Chapter 600 – General Aspects 600-1

 Topic 601 – Introduction 600-1

 Topic 602 – Pavement Structure Layers..... 600-1

 Index 602.1 – Description 600-1

 Topic 603 – Types of Pavement Projects 600-3

 603.1 New Construction 600-3

 603.2 Widening..... 600-4

July 1, 2020

603.3 Pavement Preservation	600-4
603.4 Roadway Rehabilitation.....	600-6
603.5 Reconstruction.....	600-6
603.6 Temporary Pavements and Detours.....	600-7
603.7 Stage Construction	600-7
Topic 604 – Roles, Resources, and Proprietary Items.....	600-7
604.1 Roles and Responsibilities for Pavement Engineering	600-7
604.2 Pavement Recommendations.....	600-9
604.3 Other Resources	600-9
Topic 605 – Record Keeping	600-11
605.1 Documentation	600-11
605.2 Subsequent Revisions.....	600-11
Topic 606 – Research and Special Designs	600-11
606.1 Research and Experimentation	600-11
606.2 Special Designs.....	600-12
606.3 Mechanistic-Empirical Design.....	600-12
606.4 Proprietary Items	600-14
CHAPTER 610 – PAVEMENT ENGINEERING CONSIDERATIONS.....	610-1
Topic 611 – Factors In Selecting Pavement Type	610-1
Index 611.1 – Pavement Type Selection.....	610-1
611.2 Selection Criteria	610-1
Topic 612 – Pavement Design Life	610-2
612.1 Definition	610-2
612.2 New Construction and Reconstruction	610-2
612.3 Widening	610-2
612.4 Pavement Preservation	610-3
612.5 Roadway Rehabilitation.....	610-3
612.6 Temporary Pavements and Detours.....	610-3
612.7 Non-Structural Wearing Courses.....	610-3
Topic 613 – Traffic Considerations	610-4
613.1 Overview	610-4

613.2 Traffic Volume Projections 610-4

613.3 Traffic Index Calculation 610-5

613.4 Axle Load Spectra 610-6

613.5 Specific Traffic Loading Considerations..... 610-9

Topic 614 – Soil Characteristics..... 610-19

614.1 Engineering Considerations..... 610-19

614.2 Unified Soil Classification System (USCS) 610-19

614.3 California R-Value..... 610-20

614.4 Expansive soils 610-22

614.5 Other Considerations..... 610-22

Topic 615 – Climate 610-23

Topic 616 – Existing Pavement Type and Condition..... 610-24

Topic 617 – Materials..... 610-26

617.1 Availability of Materials 610-26

617.2 Recycling 610-26

Topic 618 – Maintainability and Constructability 610-27

618.1 Maintainability 610-27

618.2 Constructability 610-27

Topic 619 – Pavement Life-Cycle 610-29

619.1 Life-Cycle Cost Analysis 610-29

619.2 Life-Cycle Assessment 610-30

CHAPTER 620 – RIGID PAVEMENT 620-1

Topic 621 – Types of Rigid Pavements..... 620-1

Index 621.1 – Continuously Reinforced Concrete Pavement (CRCP)..... 620-1

621.2 Jointed Plain Concrete Pavement (JPCP) 620-1

621.3 Precast Concrete Pavement (PCP) 620-1

Topic 622 – Engineering Requirements 620-3

622.1 Engineering Properties 620-3

622.2 Performance Factors 620-3

622.3 Types of Concrete 620-3

622.4 Pavement Joints 620-6

December 31, 2020

622.5	Transitions Panels, Terminal Joints and End Anchors	620-7
622.6	Joint Seals.....	620-9
622.7	Dowel Bars and Tie Bars.....	620-10
622.8	Base Interlayer	620-11
622.9	Texturing	620-11
622.10	Pavement Smoothness	620-12
Topic 623	– Engineering Procedure for New, Widening, and Reconstruction Projects...	620-12
623.1	Catalog.	620-12
Topic 624	– Engineering Procedures for Pavement Preservation.....	620-26
624.1	Preventive Maintenance	620-26
Topic 625	– Engineering Procedures for Pavement Rehabilitation	620-27
Topic 626	– Other Considerations	620-30
CHAPTER 630	– FLEXIBLE PAVEMENT.....	630-1
Topic 631	– Types of Flexible Pavements & Materials	630-1
Index 631.1	– Hot Mix Asphalt (HMA)	630-1
631.2	Dense Graded HMA	630-1
631.3	Rubberized Hot Mixed Asphalt Gap Graded (RHMA-G).....	630-1
631.4	Open Graded Friction Course (OGFC).....	630-2
631.5	Rubberized HMA (RHMA) Use.....	630-2
631.6	Other Types of Flexible Pavement Surface Courses.....	630-3
631.7	Warm Mix Asphalt Technology.....	630-3
631.8	Pavement Interlayers.....	630-4
Topic 632	– Asphalt Binder.....	630-5
632.1	Binder Classification	630-5
632.2	Binder Selection	630-5
Topic 633	– Engineering Procedures for New Construction and Reconstruction.....	630-7
633.1	Empirical Method.....	630-7
633.2	Mechanistic-Empirical Method.....	630-12
634.1	Preventive Maintenance	630-16
634.2	Capital Preventive Maintenance (CAPM).....	630-16
Topic 635	– Engineering Procedures for Flexible Pavement Rehabilitation	630-18

635.1 Rehabilitation Warrants 630-18

635.2 Empirical Method 630-18

635.3 Rehabilitation of Existing RHMA-G Surfaced Flexible Pavements..... 630-33

635.4 Mechanistic-Empirical Method 630-34

Topic 636 – Other Considerations 630-36

636.1 Traveled Way..... 630-36

636.2 Shoulders 630-36

636.3 Intersections 630-37

636.4 Roadside Facilities..... 630-37

Topic 637 - Engineering Analysis Software..... 630-37

CHAPTER 640 – COMPOSITE PAVEMENTS..... 640-1

Topic 641 – Types of Composite Pavement 640-1

 Index 641.1 – Asphalt Over Concrete Composite Pavement..... 640-1

 641.2 Concrete Over Asphalt Composite Pavement 640-2

Topic 642 – Engineering Criteria..... 640-2

 642.1 Engineering Properties 640-2

 642.2 Performance Factors 640-2

 642.3 Overlay Limits 640-2

Topic 643 – Engineering Procedures for New Construction and Reconstruction..... 640-3

 643.1 Empirical Method 640-3

 643.2 Mechanistic-Empirical Method 640-3

Topic 644 – Engineering Procedures for Pavement Preservation 640-3

 644.1 Preventive Maintenance 640-3

 644.2 Capital Preventive Maintenance (CAPM) 640-3

Topic 645 – Engineering Procedures for Pavement Rehabilitation..... 640-4

 645.1 Empirical Method 640-4

 645.2 Mechanistic-Empirical Method 640-5

CHAPTER 650 – PAVEMENT DRAINAGE..... 650-1

Topic 651 – General Considerations..... 650-1

 Index 651.1 – Impacts of Drainage on Pavement..... 650-1

 651.2 Drainage System Components and Requirements..... 650-1

July 1, 2020

Topic 652 – Subsurface Drainage and Storm Water Management.....	650-5
Topic 653 – Other Considerations	650-5
653.1 New Construction Projects	650-5
653.2 Widening Projects	650-7
653.3 Rehabilitation and Reconstruction Projects	650-7
653.4 Ramps	650-7
653.5 Roadside Facilities	650-7
CHAPTER 660 – PAVEMENT FOUNDATIONS	660-1
Topic 661 – Engineering Considerations	660-1
Index 661.1 – Description.....	660-1
661.2 Purpose	660-1
Topic 662 – Types of Bases	660-1
662.1 Aggregate Base.....	660-1
662.2 Treated Base.....	660-2
662.3 Treated Permeable Base.....	660-2
662.4 Subbase	660-3
Topic 663 – Engineering Properties for Base and Subbase Materials.....	660-4
663.1 Selection Criteria	660-4
663.2 Base and Subbase for Rigid Pavements	660-4
663.3 Base and Subbase for Flexible Pavements	660-4
Topic 664 - Subgrade Enhancement	660-7
664.1 Overview	660-7
664.2 Mechanical Subgrade Enhancement.....	660-7
664.3 Chemical Stabilization	660-7
664.4 Subgrade Enhancement Geosynthetics	660-8
Topic 665 – Subgrade Enhancement Geosynthetic Fabrics.....	660-8
665.1 Purpose	660-8
665.2 Properties of Geosynthetics	660-9
665.3 Required Tests	660-9
665.4 Mechanical Stabilization Using SEG	660-9
665.5 Selecting Geosynthetic Type and Design Parameters	660-10
665.7 Other Design Considerations	660-12

665.9 SEG Abbreviations and Definitions..... 660-13

Topic 666 – Foundation Strength Parameters for Mechanistic-Empirical Design of New Construction and Rehabilitation of Flexible Pavements 660-15

666.1 Resilient Modulus 660-15

CHAPTER 670 – TAPERS AND SHOULDER BACKING 670-1

Topic 671 – Pavement Tapers..... 670-1

Index 671.1 – Background and Purpose..... 670-1

671.2 Engineering Requirements and Considerations..... 670-1

671.3 Tapers into Existing Pavement or Structure 670-2

Topic 672 – Shoulder Backing 670-8

672.1 Background and Purpose 670-8

672.2 Alternate Materials and Admixtures 670-8

672.3 Design 670-9

CHAPTER 680 – PAVEMENT DESIGN FOR WIDENING PROJECTS 680-1

Topic 681 – Pavement Widening Overview 680-1

Index 681.1 – Background..... 680-1

Topic 682 – Design Considerations 680-1

682.1 Standards 680-1

682.2 Pre-Design Evaluation 680-2

682.3 Pre-Design Considerations..... 680-2

682.4 Scoping, Estimating, and Detailing 680-3

682.5 Other Considerations..... 680-8

682.6 Life-Cycle Cost Analysis for Widening Projects 680-10

CHAPTER 700 – MISCELLANEOUS STANDARDS..... 700-1

Topic 701 – Fences 700-1

Index 701.1 – Type, Intent and Purpose of Fences 700-1

701.2 Freeway and Expressway Access Control Fence..... 700-2

701.3 Private Fences..... 700-4

701.4 Temporary Fences..... 700-4

701.5 Other Fences 700-4

Topic 702 – Miscellaneous Traffic Items 700-5

July 1, 2020

702.1 References	700-5
Topic 703 – Special Structures and Installation	700-5
703.1 Truck Weighing Facilities.....	700-5
703.2 Rockfall Restraining Nets	700-5
Topic 704 – Contrast Treatment	700-6
704.1 Policy.....	700-6
Topic 705 – Materials and Color Selection	700-6
705.1 Special Treatments and Materials	700-6
705.2 Colors for Steel Structures	700-6
Topic 706 – Roadside Management and Vegetation Control	700-7
706.1 Roadside Management	700-7
706.2 Vegetation Control.....	700-8
Topic 707 – Slope Treatment Under Structures.....	700-8
707.1 Policy.....	700-8
707.2 Guidelines for Slope Treatment.....	700-9
707.3 Procedure.....	700-9
CHAPTERS 800 – 890 HIGHWAY DRAINAGE DESIGN	800-1
CHAPTER 800 – GENERAL ASPECTS	800-1
Topic 801 – General	800-1
Index 801.1 – Introduction.....	800-1
801.2 Drainage Design Philosophy	800-1
801.3 Drainage Standards.....	800-1
801.4 Objectives of Drainage Design	800-2
801.5 Economics of Design.....	800-3
801.6 Use of Drainage References	800-3
Topic 802 – Drainage Design Responsibilities.....	800-4
802.1 Functional Organization.....	800-4
802.2 Culvert Committee.....	800-6
802.3 Bank and Shore Protection Committee	800-6
Topic 803 – Drainage Design Policies	800-7
803.1 Basic Policy	800-7

803.2 Cooperative Agreements 800-7

803.3 Up-Grading Existing Drainage Facilities 800-7

Topic 804 – Floodplain Encroachments 800-8

804.1 Purpose 800-8

804.2 Authority 800-8

804.3 Applicability 800-9

804.4 Definitions 800-9

804.5 Procedures 800-10

804.6 Responsibilities 800-10

804.7 Preliminary Evaluation of Risks and Impacts for Environmental Document Phase .
..... 800-11

804.8 Design Standards 800-12

804.9 Coordination with the Local Community 800-12

804.10 National Flood Insurance Program 800-12

804.11 Coordination with FEMA 800-16

Topic 805 – Preliminary Plans 800-17

805.1 Required FHWA Approval 800-17

805.2 Bridge Preliminary Report..... 800-17

805.3 Storm Drain Systems..... 800-17

805.4 Unusual Hydraulic Structures 800-17

805.5 Levees and Dams Formed by Highway Fills..... 800-18

805.6 Geotechnical..... 800-18

805.7 Data Provided by the District 800-18

Topic 806 – Definitions of Drainage Terms 800-19

806.1 Introduction 800-19

806.2 Drainage Terms 800-19

Topic 807 – Selected Drainage References..... 800-45

807.1 Introduction 800-45

807.2 Federal Highway Administration Hydraulic Publications 800-45

807.3 American Association of State Highway and Transportation Officials (AASHTO)....
..... 800-47

807.4 California Department of Transportation 800-48

July 1, 2020

807.5 U.S. Department of Interior - Geological Survey (USGS).....	800-48
807.6 U.S. Department of Agriculture - Natural Resources Conservation Service (NRCS)	800-49
807.7 California Department of Water Resources	800-49
807.8 University of California - Institute of Transportation and Traffic Engineering (ITTE)	800-49
807.9 U.S. Army Corps of Engineers.....	800-49
Topic 808 – Selected Computer Programs	800-49
CHAPTER 800 – HYDROLOGY	810-1
Topic 811 – General	810-1
Index 811.1 – Introduction.....	810-1
811.2 Objectives of Hydrologic Analysis	810-1
811.3 Peak Discharge	810-2
811.4 Flood Severity	810-2
811.5 Factors Affecting Runoff.....	810-2
Topic 812 – Basin Characteristics	810-3
812.1 Size	810-3
812.2 Shape.....	810-3
812.3 Slope	810-4
812.4 Land Use.....	810-4
812.5 Soil and Geology	810-4
812.6 Storage.....	810-4
812.7 Elevation.....	810-5
812.8 Orientation.....	810-5
Topic 813 – Channel and Floodplain Characteristics.....	810-5
813.1 General.....	810-5
813.2 Length and Slope	810-6
813.3 Cross Section	810-6
813.4 Hydraulic Roughness	810-6
813.5 Natural and Man-made Constrictions	810-6
813.6 Channel Modifications	810-7

813.7 Aggradation - Degradation..... 810-7

813.8 Debris 810-7

Topic 814 – Meteorological Characteristics 810-8

814.1 General..... 810-8

814.2 Rainfall..... 810-8

814.3 Snow..... 810-9

814.4 Evapo-transpiration 810-9

814.5 Tides and Waves..... 810-9

Topic 815 – Hydrologic Data..... 810-10

815.1 General..... 810-10

815.2 Categories 810-11

815.3 Sources 810-11

815.4 Stream Flow 810-12

815.5 Precipitation..... 810-13

815.6 Adequacy of Data 810-13

Topic 816 – Runoff..... 810-13

816.1 General..... 810-13

816.2 Overland Flow 810-13

816.3 Subsurface Flow 810-13

816.4 Detention and Retention 810-14

816.5 Flood Hydrograph and Flood Volume 810-14

816.6 Time of Concentration (Tc) and Travel Time (Tt)..... 810-15

Topic 817 – Flood Magnitude..... 810-19

817.1 General..... 810-19

817.2 Measurements 810-19

Topic 818 – Flood Probability And Frequency 810-20

818.1 General..... 810-20

818.2 Establishing Design Flood Frequency 810-22

818.3 Stationarity and Climate Variability 810-23

Topic 819 – Estimating Design Discharge 810-24

819.1 Introduction..... 810-24

819.2 Empirical Methods 810-24

July 1, 2020

819.3 Statistical Methods	810-31
819.4 Hydrograph Methods	810-32
819.5 Transfer of Data	810-34
819.6 Hydrologic Software	810-36
819.7 Region-Specific Analysis	810-37
CHAPTER – 820 CROSS DRAINAGE	820-1
Topic 821 – General	820-1
Index 821.1 – Introduction	820-1
821.2 Hydrologic Considerations.....	820-2
821.3 Selection of Design Flood.....	820-2
821.4 Headwater and Tailwater.....	820-3
821.5 Effects of Tide and Storm	820-4
Topic 822 – Debris Control	820-37
822.1 Introduction.....	820-37
822.2 Debris Control Methods.....	820-37
822.3 Economics.....	820-38
822.4 Classification of Debris	820-38
822.5 Types of Debris Control Structures.....	820-38
Topic 823 – Culvert Location	820-38
823.1 Introduction.....	820-38
823.2 Alignment and Slope	820-38
Topic 824 – Culvert Type Selection	820-39
824.1 Introduction.....	820-39
824.2 Shape and Cross Section.....	820-39
Topic 825 – Hydraulic Design of Culverts	820-40
825.1 Introduction.....	820-40
825.2 Culvert Flow	820-40
825.3 Computer Programs	820-41
825.4 Coefficient of Roughness	820-41
Topic 826 – Entrance Design.....	820-41
826.1 Introduction.....	820-41

826.2 End Treatment Policy 820-42

826.3 Conventional Entrance Designs..... 820-42

826.4 Improved Inlet Designs 820-43

Topic 827 – Outlet Design..... 820-44

 827.1 General..... 820-44

 827.2 Embankment Protection 820-44

Topic 828 – Diameter and Length..... 820-45

 828.1 Introduction 820-45

 828.2 Minimum Diameter..... 820-45

 828.3 Length..... 820-45

Topic 829 – Special Considerations..... 820-46

 829.1 Introduction..... 820-46

 829.2 Bedding and Backfill 820-46

 829.3 Piping..... 820-47

 829.4 Joints 820-48

 829.5 Anchorage 820-48

 829.6 Irregular Treatment..... 820-48

 829.7 Siphons and Sag Culverts 820-49

 829.8 Currently Not In Use 820-49

 829.9 Dams 820-49

 829.10 Reinforced Concrete Box Modifications 820-50

CHAPTER 830 – TRANSPORTATION FACILITY DRAINAGE..... 830-1

 Topic 831 – General 830-1

 Index 831.1 – Basic Concepts 830-1

 831.2 Highway Grade Line 830-2

 831.3 Design Storm and Water Spread 830-2

 831.4 Other Considerations..... 830-3

 831.5 Computer Programs 830-6

 Topic 832 – Hydrology 830-6

 832.1 Introduction..... 830-6

 832.2 Rational Method..... 830-6

July 1, 2020

832.3 Time of Concentration	830-6
Topic 833 – Roadway Cross Sections	830-7
833.1 Introduction.....	830-7
833.2 Grade, Cross Slope and Superelevation	830-7
Topic 834 – Roadside Drainage	830-7
834.1 General.....	830-7
834.2 Median Drainage	830-7
834.3 Ditches and Gutters.....	830-8
834.4 Overside Drains.....	830-10
Topic 835 – Dikes and Berms.....	830-11
835.1 General.....	830-11
835.2 Earth Berms	830-11
835.3 Dikes	830-11
Topic 836 – Curbs and Gutters.....	830-12
836.1 General.....	830-12
836.2 Gutter Design	830-12
Topic 837 – Inlet Design	830-13
837.1 General.....	830-13
837.2 Inlet Types	830-13
837.3 Location and Spacing	830-17
837.4 Hydraulic Design	830-18
837.5 Local Depressions	830-20
Topic 838 – Storm Drains	830-21
838.1 General.....	830-21
838.2 Design Criteria.....	830-22
838.3 Hydraulic Design	830-22
838.4 Standards	830-22
838.5 Appurtenant Structures.....	830-23
Topic 839 – Pumping Stations	830-25
839.1 General.....	830-25
839.2 Pump Type	830-25
839.3 Design Responsibilities	830-25

839.4 Trash and Debris Considerations 830-25

839.5 Maintenance Consideration 830-26

839.6 Groundwater Considerations 830-26

CHAPTER 840 – SUBSURFACE DRAINAGE 840-1

 Topic 841 – General 840-1

 Index 841.1 – Introduction 840-1

 841.2 Subsurface (Groundwater) Discharge 840-1

 841.3 Preliminary Investigations 840-2

 841.4 Exploration Notes 840-2

 841.5 Category of System 840-2

 Topic 842 – Pipe Underdrains..... 840-4

 842.1 General..... 840-4

 842.2 Single Installations..... 840-4

 842.3 Multiple Installations 840-4

 842.4 Design Criteria 840-4

 842.5 Types of Underdrain Pipe 840-5

 842.6 Design Service Life..... 840-5

 842.7 Pipe Selection..... 840-6

CHAPTER 850 – PHYSICAL STANDARDS 850-1

 Topic 851 – General..... 850-1

 Index 851.1 – Introduction 850-1

 851.2 Selection of Material and Type 850-1

 Topic 852 – Pipe Materials..... 850-3

 852.1 Reinforced Concrete Pipe (RCP)..... 850-3

 852.2 Concrete Box and Arch Culverts..... 850-3

 852.3 Corrugated Steel Pipe, Steel Spiral Rib Pipe and Pipe Arches 850-4

 852.4 Corrugated Aluminum Pipe, Aluminum Spiral Rib Pipe and Pipe Arches 850-7

 852.5 Structural Metal Plate 850-9

 852.6 Plastic Pipe..... 850-10

 852.7 Special Purpose Types..... 850-11

July 1, 2020

Topic 853 – Pipe Liners and Linings for Culvert Rehabilitation	850-11
853.1 General.....	850-11
853.2 Caltrans Host Pipe Structural Philosophy.....	850-12
853.3 Problem Identification and Coordination.....	850-12
853.4 Alternative Pipe Liner Materials	850-12
853.5 Cementitious Pipe Lining.....	850-14
853.6 Invert Paving with Concrete.....	850-14
853.7 Structural Repairs with Steel Tunnel Liner Plate	850-17
Topic 854 – Pipe Connections	850-17
854.1 Basic Policy	850-17
Topic 855 – Design Service Life	850-20
855.1 Basic Concepts.....	850-20
855.2 Abrasion	850-23
855.3 Corrosion.....	850-34
855.4 Protection of Concrete Pipe and Drainage Structures from Acids, Chlorides and Sulfates	850-35
855.5 Material Susceptibility to Fire.....	850-40
Topic 856 – Height of Fill	850-41
856.1 Construction Loads.....	850-41
856.2 Concrete Pipe, Box and Arch Culverts	850-41
856.3 Metal Pipe and Structural Plate Pipe.....	850-42
856.4 Plastic Pipe.....	850-43
856.5 Minimum Height of Cover	850-43
Topic 857 – Alternate Materials	850-61
857.1 Basic Policy	850-61
857.2 Alternative Pipe Culvert Selection Procedure Using AltPipe	850-61
857.3 Alternative Pipe Culvert (APC) and Pipe Arch Culvert List.....	850-64
CHAPTER 860 – ROADSIDE CHANNELS.....	860-1
Topic 861 – General	860-1
Index 861.1 – Introduction.....	860-1
861.2 Hydraulic Considerations.....	860-2

861.3 Selection of "Design Flood" 860-3

861.4 Safety Considerations..... 860-3

861.5 Maintenance Considerations 860-4

861.6 Economics 860-5

861.7 Coordination with Other Agencies 860-5

861.8 Environment..... 860-5

861.9 Unlined Channels 860-5

861.10 Lined Channels..... 860-6

861.11 Water Quality Channels 860-6

861.12 References 860-6

Topic 862 – Roadside Drainage Channel Location 860-7

 862.1 General..... 860-7

 862.2 Alignment and Grade..... 860-7

 862.3 Point of Discharge 860-8

Topic 863 – Channel Section 860-8

 863.1 Roadside and Median Channels..... 860-8

 863.2 Triangular 860-8

 863.3 Trapezoidal..... 860-8

 863.4 Rectangular 860-9

Topic 864 – Channel Stability Design Concepts 860-9

 864.1 General..... 860-9

 864.2 Stable Channel Design Procedure..... 860-10

 864.3 Side Slope Stability 860-12

Topic 865 – Channel Linings..... 860-12

 865.1 Flexible Verses Rigid 860-12

 865.2 Rigid 860-13

 865.3 Flexible 860-15

 865.4 Composite Lining Design..... 860-17

 865.5 Bare Soil Design and Grass Lining..... 860-17

 865.6 Rolled Erosion Control Products..... 860-22

Topic 866 – Hydraulic Design of Roadside Channels 860-23

 866.1 General..... 860-23

July 1, 2020

866.2 Flow Classifications	860-23
866.3 Open Channel Flow Equations	860-24
866.4 Water Surface Profiles.....	860-29
Topic 867 – Channel Changes.....	860-29
867.1 General.....	860-29
867.2 Design Considerations	860-30
Topic 868 – Freeboard Considerations	860-30
868.1 General.....	860-30
868.2 Height of Freeboard.....	860-30
CHAPTER 870 – BANK PROTECTION – EROSION CONTROL	870-1
Topic 871 – General	870-1
871.1 Introduction.....	870-1
871.2 Design Philosophy.....	870-1
871.3 Selected References	870-3
Topic 872 – Planning and Location Studies.....	870-4
872.1 Planning	870-4
872.2 Class and Type of Protection	870-6
872.3 Geomorphology and Site Consideration.....	870-6
872.4 Data Needs	870-27
872.5 Rapid Assessment.....	870-28
Topic 873 – Design Concepts	870-28
873.1 Introduction.....	870-28
873.2 Design High Water and Hydraulics.....	870-29
873.3 Armor Protection.....	870-30
873.4 Training Systems.....	870-52
873.5 Summary and Design Check List	870-59
873.6 Coordination with the Division of Engineering Services and Structures Maintenance and Investigations	870-61
CHAPTER 880 – SHORE PROTECTION.....	880-1
Topic 881 – General	880-1

Index 881.1 – Introduction 880-1

881.2 Design Philosophy 880-1

881.3 Selected References 880-2

Topic 882 – Planning and Location Studies 880-2

882.1 Planning 880-2

882.2 Class and Type of Protection 880-3

882.3 Site Consideration 880-4

Topic 883 – Design 880-5

883.1 Introduction 880-5

883.2 Design High Water, Design Wave Height and Sea-Level Rise 880-5

883.3 Armor Protection 880-21

CHAPTER 890 – STORM WATER MANAGEMENT 890-1

Topic 891 – General 890-1

Index 891.1 – Introduction 890-1

891.2 Philosophy 890-1

Topic 892 – Storm Water Management Strategies 890-1

892.1 General 890-1

892.2 Types of Strategies 890-2

892.3 Design Considerations 890-3

892.4 Mixing with Other Waste Streams 890-3

Topic 893 – Maintenance Requirements for Storm Water Management Features 890-5

893.1 General 890-5

CHAPTER 900 – LANDSCAPE ARCHITECTURE – ROADSIDES 900-1

Topic 901 – Landscape Architecture General 900-1

Index 901.1 – Landscape Architecture Program 900-1

901.2 Landscape Architecture Design Standards 900-1

901.3 Landscape Architecture Administered Facilities 900-4

Topic 902 – Sight Distance and Clear Recovery Zone Standards 900-4

902.1 Landscape Sight Distance and Clear Recovery Zone Standards 900-4

Topic 903 – Landscape Site Design 900-4

July 1, 2020

903.1 Landscape Site Analysis 900-4

903.2 Landscape Site Layout 900-5

903.3 Roadside Amenities..... 900-5

903.4 Additional Roadside Site Design Considerations..... 900-5

Topic 904 – Planting Design 900-5

904.1 Planting Design General..... 900-5

904.2 Site Preparation..... 900-6

904.3 Plant Selection..... 900-7

904.4 Locating Plants 900-8

904.5 Locating Trees..... 900-9

904.6 Locating Plants in Conformance with Sight Distances..... 900-10

904.7 Vine Planting 900-12

904.8 Planting in the Vicinity of Airports and Heliports 900-12

904.9 Plant Establishment..... 900-12

Topic 905 – Irrigation Design 900-13

905.1 Irrigation Design General..... 900-13

905.2 Water Supply 900-13

905.3 Irrigation Conduit 900-13

905.4 Irrigation System Equipment 900-14

905.5 Temporary Irrigation 900-16

Topic 906 – Erosion Control 900-16

906.1 Erosion Control General 900-16

906.2 Soil Surface Protection 900-16

906.3 Planting 900-17

906.4 Sediment Control..... 900-18

906.5 Permanent Erosion Control Establishment..... 900-18

CHAPTER 910 – LANDSCAPE ARCHITECTURE – ROADSIDE SITES910-1

Topic 911 – General 910-1

Index 911.1 Roadside Sites General..... 910-1

Topic 912 – Roadside Sites Design..... 910-1

912.1 Roadside Sites Layout..... 910-1

912.2 Parking Area Design 910-2

912.3 Site Furnishings 910-4

Topic 913 – Safety Roadside Rest Areas 910-4

913.1 Safety Roadside Rest Areas General 910-4

913.2 Safety Roadside Rest Area Site Selection 910-5

913.3 Safety Roadside Rest Area Layout 910-5

913.4 Safety Roadside Rest Area Buildings and Structures 910-6

913.5 Safety Roadside Rest Area Utilities and Facilities 910-7

913.6 Safety Roadside Rest Area Parking 910-9

913.7 Safety Roadside Rest Area Signage 910-9

913.8 Public Information Display 910-10

913.9 Vending Facilities 910-10

Topic 914 – Vista Points 910-11

914.1 Vista Points General 910-11

914.2 Vista Point Site Selection 910-11

914.3 Vista Point Amenities 910-11

914.4 Vista Point Parking 910-12

Topic 915 – Park & Ride Facilities 910-12

915.1 Park & Ride Facilities General 910-12

915.2 Site Selection 910-13

CHAPTER 1000 – BICYCLE TRANSPORTATION DESIGN 1000-1

Topic 1001 – Introduction 1000-1

Index 1001.1 – Bicycle Transportation 1000-1

1001.2 Streets and Highways Code References 1000-1

1001.3 Vehicle Code References 1000-2

1001.4 Bikeways 1000-2

Topic 1002 – Bikeway Facilities 1000-3

1002.1 Selection of the Type of Facility 1000-3

Topic 1003 – Bikeway Design Criteria 1000-5

1003.1 Class I Bikeways (Bike Paths) 1000-5

1003.2 Class II Bikeways (Bike Lanes) 1000-16

July 1, 2020

1003.3 Class III Bikeways (Bike Routes).....	1000-16
1003.4 Trails.....	1000-17
1003.5 Miscellaneous Criteria	1000-18
CHAPTER 1100 – HIGHWAY TRAFFIC NOISE ABATEMENT.....	1100-1
Topic 1101 – General Requirements	1100-1
Index 1101.1 – Introduction.....	1100-1
1101.2 Objective	1100-1
1101.3 Terminology.....	1100-2
1101.4 Procedures for Assessing Noise Impacts	1100-2
1101.5 Prioritizing Construction of Retrofit Noise Barriers.....	1100-2
Topic 1102 – Design Criteria	1100-3
1102.1 General.....	1100-3
1102.2 Noise Barrier Location	1100-5
1102.3 Noise Barrier Height and Position.....	1100-16
1102.4 Noise Barrier Length.....	1100-16
1102.5 Alternative Noise Barrier Designs.....	1100-17
1102.6 Noise Barrier Aesthetics	1100-17
1102.7 Maintenance Consideration in Noise Barrier Design	1100-17
1102.8 Emergency Access Considerations in Noise Barrier Design	1100-17
1102.9 Drainage Openings in Noise Barrier	1100-17

July 1, 2020

Table 202.2C	Minimum Radii for Design Superelevation Rates, Design Speeds, and $e_{max}=8\%$	200-15
Table 202.2D	Minimum Radii for Design Superelevation Rates, Design Speeds, and $e_{max}=10\%$	200-16
Table 202.2E	Minimum Radii for Design Superelevation Rates, Design Speeds, and $e_{max}=12\%$	200-17
Figure 202.2	Maximum Comfortable Speed on Horizontal Curves*	200-18
Figure 202.5A	Superelevation Transition	200-20
Figure 202.5B	Superelevation Transition Terms & Definitions	200-21
Figure 202.6	Superelevation of Compound Curves	200-23
Table 204.3	Maximum Grades for Type of Highway and Terrain Conditions.....	200-27
Figure 204.4	Vertical Curves	200-28
Figure 204.5	Critical Lengths of Grade for Design	200-30
Table 204.8	Falsework Span and Depth Requirements	200-34
Figure 205.1	Access Openings on Expressways	200-36
Figure 206.2	Typical Two-lane to Four-lane Transitions	200-39
Figure 207.2A	Airway-Highway Clearance Requirements (Civil Airports)	200-42
Figure 207.2B	Airway-Highway Clearance Requirements (Heliport).....	200-43
Figure 207.2C	Airway-Highway Clearance Requirements (Military Airports).....	200-44
Figure 207.2D	Airway-Highway Clearance Requirements (Navy Carrier Landing Practice Field).....	200-45
Figure 208.1	Offsets to Safety-Shape Barriers	200-47
Figure 208.10A	Vehicular Railings for Bridge Structures	200-51
Figure 208.10B	Combination Vehicular Barrier and Pedestrian Railings for Bridge Structures	200-52
Figure 208.10C	Pedestrian Railings for Bridge Structures	200-53
Figure 208.11A	Limits of Structure Approach Embankment Material	200-57
Figure 208.11B	Abutment Drainage Details	200-58
Figure 209.1	Structure Approach Slab Layout	200-60
Figure 209.4A	Structure Approach Drainage Details (Rehabilitation)	200-62
Figure 209.4B	New Structure Approach Pavement Transition Details	200-64
Table 210.2	Types of Reinforced Earth Slopes and Earth Retaining Systems ⁽¹⁾	200-65
Figure 210.8	Type Selection and PS&E Process for Reinforced Earth Slopes and Earth Retaining Systems	200-75

CHAPTER 300 – GEOMETRIC CROSS SECTION 300-1

Figure 301.2A Typical Class II Bikeway (Bike Lane) Cross Sections 300-3

Table 302.1 Boldface Standards for Paved Shoulder Widths on Highways 300-6

Table 303.1 Selection of Curb Type..... 300-10

Figure 303.3 Dike Type Selection and Placement⁽¹⁾ 300-12

Figure 303.4A Typical Bulbout with Class II Bikeway (Bike Lane)..... 300-14

Figure 303.4B Typical Bulbout without Class II Bikeway (Bike Lane)..... 300-15

Figure 305.6 Optional Median Designs for Freeways with Separate Roadways 300-25

Table 307.2 Shoulder Widths for Two-lane Roadbed
New Construction Projects..... 300-26

Figure 307.2 Geometric Cross Sections for Two-lane Highways (New Construction)....
..... 300-27

Figure 307.4A Geometric Cross Sections for Freeways and Expressways 300-29

Figure 307.4B Geometric Cross Sections for Freeways and Expressways 300-30

Figure 307.5 Geometric Cross Sections for All Paved Multilane Highways 300-31

Table 309.2A Minimum Vertical Clearances 300-38

Figure 309.2 Department of Defense Rural and Single Interstate Routes 300-39

Table 309.2B California Routes on the Rural and Single Interstate Routing System
..... 300-40

Table 309.5A Minimum Vertical Clearances Above Highest Rail 300-43

Figure 309.5A Typical Horizontal Railroad Clearance from Grade Separated Structures
..... 300-44

Figure 309.5B Permanent Railroad Clearance Envelope 300-45

Table 309.5B Minimum Horizontal Clearances to Centerline of Nearest Track.... 300-46

CHAPTER 400 – INTERSECTIONS AT GRADE 400-1

Table 401.3 Vehicle Characteristics/Intersection Design Elements Affected 400-3

Figure 403.3A Angle of Intersection (Minor Leg Skewed to the Right) 400-8

Figure 403.3.B Class II Bikeway Crossing Railroad 400-8

Figure 403.6A Typical Bicycle and Motor Vehicle Movements at Intersections of
Multilane Streets without Right-Turn-Only Lanes 400-10

Figure 403.6B Bicycle Left-Turn-Only Lane..... 400-12

Figure 404.5A STAA Design Vehicle 56-Foot Radius 400-19

July 1, 2020

Figure 404.5B	STAA Design Vehicle 67-Foot Radius	400-20
Figure 404.5C	California Legal Design Vehicle 50-Foot Radius.....	400-21
Figure 404.5D	California Legal Design Vehicle 60-Foot Radius.....	400-22
Figure 404.5E	40-Foot Bus Design Vehicle	400-23
Figure 404.5F	45-Foot Bus & Motorhome Design Vehicle	400-24
Figure 404.5G	60-Foot Articulated Bus Design Vehicle.....	400-25
Table 405.1B	Application of Sight Distance Requirements	400-28
Figure 405.1	Corner Sight Distance (b)	400-29
Table 405.1A	Corner Sight Distance Time Gap (T _g) for Unsignalized	400-29
	Intersections	400-29
Figure 405.2A	Standard Left-turn Channelization	400-31
Figure 405.2B	Minimum Median Left-turn Channelization (Widening on one Side of Highway).....	400-32
Figure 405.2C	Minimum Median Left-turn Channelization (Widening on Both Sides in Urban Areas with Short Blocks).....	400-33
Table 405.2A	Bay Taper for Median Speed-change Lanes	400-35
Table 405.2B	Deceleration Lane Length.....	400-35
Table 405.4	Parabolic Curb Flares Commonly Used.....	400-39
Figure 405.4	Pedestrian Refuge Island.....	400-40
Figure 405.5	Typical Design for Median Openings	400-42
Figure 405.7	Public Road Intersections	400-44
Figure 405.9	Widening of Two-lane Roads at Signalized Intersections	400-45
Figure 405.10	Roundabout Geometric Elements.....	400-47
Table 406	Vehicle Traffic Flow Conditions at Intersections at Various Levels of Operation	400-54
Figure 406A	Spread Diamond.....	400-55
Figure 406B	Tight Diamond	400-56
Figure 406C	Two-quadrant Cloverleaf.....	400-57
 CHAPTER 500 – TRAFFIC INTERCHANGES		 500-1
Figure 502.2	Typical Local Street Interchanges.....	500-3
Figure 502.2	Typical Local Street Interchanges (Cont.).....	500-4
Figure 502.3	Typical Freeway-to-freeway Interchanges	500-9

Figure 502.3	Typical Freeway-to-freeway Interchanges (Cont.)	500-10
Figure 504.2A	Single Lane Freeway Entrance	500-13
Figure 504.2B	Single Lane Freeway Exit	500-14
Figure 504.2C	Location of Freeway Ramps on a Curve.....	500-15
Table 504.3	Ramp Widening for Trucks.....	500-17
Figure 504.3A	Typical Freeway Entrance Loop Ramp Metering (1 GP Lane + 1 HOV Preferential Lane)	500-19
Figure 504.3B	Typical Successive Freeway Entrance Ramp Metering (1 GP Lane + 1 HOV Preferential Lane).....	500-20
Figure 504.3C	Restrictive Condition Freeway Entrance Ramp Metering (1 GP Lane)	500-22
Figure 504.3D	Restrictive Condition Freeway Entrance Loop Ramp Metering (1 GP Lane).....	500-23
Figure 504.3E	Typical Multilane Freeway Diagonal Entrance Ramp Metering (2 GP Lanes + 1 HOV Preferential Lane).....	500-25
Figure 504.3F	Typical Multilane Freeway Loop Entrance Ramp Metering (2 GP Lanes + 1 HOV Preferential Lane).....	500-26
Figure 504.3G	Typical Freeway-to-Freeway Connector Ramp Metering (1 GP Lane + 1 HOV Preferential Lane).....	500-28
Figure 504.3H	Typical Freeway-to-Freeway Connector Ramp Metering (2 GP Lanes + 1 HOV Preferential Lane).....	500-29
Figure 504.3I	Location of Ramp Intersections on the Crossroads	500-33
Figure 504.3J	Transition to Two-lane Exit Ramp	500-34
Figure 504.3K	Two-Lane Connectors and Entrance/Exit Ramps	500-35
Figure 504.4	Diverging Branch Connections.....	500-39
Figure 504.7A	Design Curve for Freeway and Collector Weaving	500-41
Figure 504.7B	Lane Configuration of Weaving Sections	500-42
Table 504.7C	Percent of Through Traffic Remaining in Outer Through Lane (Level of Service D Procedure).....	500-43
Figure 504.7D	Percentage Distribution of On- and Off-ramp Traffic in Outer Through Lane and Auxiliary Lane (Level of Service D Procedure).....	500-44
Figure 504.7E	Percentage of Ramp Traffic in the Outer Through Lane (No Auxiliary Lane) (Level of Service D Procedure).....	500-45
Figure 504.8	Typical Examples of Access Control at Interchanges	500-47

CHAPTER 600 – GENERAL ASPECTS	600-1
Figure 602.1 Basic Pavement Layers of the Roadway	600-5
CHAPTER 610 – PAVEMENT ENGINEERING CONSIDERATIONS	610-1
Table 613.3A ESAL Constants	610-7
Table 613.3B Lane Distribution Factors for Multilane Highways	610-7
Table 613.3C Conversion of ESAL to Traffic Index.....	610-8
Table 613.5A Traffic Index (TI) Values for Ramps and Connectors.....	610-11
Figure 613.5A Shoulder Design for TI Equal to Adjacent Lane TI.....	610-13
Figure 613.5B Shoulder Design for TI Less Than Adjacent Lane TI	610-14
Table 613.5B Minimum TI's for Safety Roadside Rest Areas	610-19
Table 614.2 Unified Soil Classification System (from ASTM D 2487).....	610-21
Figure 615.1 Pavement Climate Regions	610-25
CHAPTER 620 – PAVEMENT ENGINEERING CONSIDERATIONS	620-1
Figure 621.1 Types of Rigid Pavement.....	620-2
Table 622.1 Concrete Properties Used in Developing Rigid Pavement	
Design Catalog	620-4
Table 622.2 Concrete Pavement Performance Factors.....	620-5
Figure 622.5A Concrete Pavement to Asphalt Pavement Transition Panel	620-7
Table 622.5 Use of Terminal Joints and Expansion Joints in CRCP	620-8
Figure 622.5B Expansion Terminal Joint System Between CRCP and.....	
Structure Approach Slab.....	620-9
Figure 623.1 Rigid Pavement Catalog Decision Tree	620-13
Table 623.1A Relationship Between Subgrade Type ⁽¹⁾	620-13
Table 623.1B Rigid Pavement Catalog (North Coast, Type I Subgrade	
Soil) ^{(1), (2), (3), (4), (5)}	620-14
Table 623.1C Rigid Pavement Catalog (North Coast, Type II Subgrade Soil)	
(1), (2), (3), (4), (5).....	620-15
Table 623.1D Rigid Pavement Catalog (South Coast/Central Coast,	
Type I Subgrade Soil) ^{(1), (2), (3), (4), (5)}	620-16

Table 623.1E	Rigid Pavement Catalog (South Coast/Central Coast, Type II Subgrade Soil) ^{(1), (2), (3), (4), (5)}	620-17
Table 623.1F	Rigid Pavement Catalog (Inland Valley, Type I Subgrade Soil) ^{(1), (2), (3), (4), (5)}	620-18
Table 623.1G	Rigid Pavement Catalog (Inland Valley, Type II Subgrade Soil) ^{(1), (2), (3), (4), (5)}	620-19
Table 623.1H	Rigid Pavement Catalog (Desert, Type I Subgrade Soil) ^{(1), (2), (3), (4), (5)}	620-20
Table 623.1I	Rigid Pavement Catalog (Desert, Type II Subgrade Soil) ^{(1), (2), (3), (4), (5)}	620-21
Table 623.1J	Rigid Pavement Catalog (Low Mountain/South Mountain, Type I Subgrade Soil) ^{(1), (2), (3), (4), (5)}	620-22
Table 623.1K	Rigid Pavement Catalog (Low Mountain/South Mountain, Type II Subgrade Soil) ^{(1), (2), (3), (4), (5)}	620-23
Table 623.1L	Rigid Pavement Catalog (High Mountain/High Desert, Type I Subgrade Soil) ^{(1), (2), (3), (4), (5)}	620-24
Table 623.1M	Rigid Pavement Catalog (High Mountain/High Desert, Type II Subgrade Soil) ^{(1), (2), (3), (4), (5)}	620-25
Table 625.2	Thicknesses for Crack, Seat, and Flexible Overlay.....	620-29
Figure 626.1	Preferred Limits of Rigid Pavement at Flexible Pavement Ramp or Connector Gore Area.....	620-31
Table 626.2	Shoulder Concrete Pavement Designs (“S” Dimension)	620-33
Figure 626.2A	Rigid Shoulders Through Ramp and Gore Areas.....	620-33
Figure 626.2B	Widened Slab Shoulder with Concrete Remainder Designs	620-34
Figure 626.4	Rigid Bus Pad	620-36
CHAPTER 630 – FLEXIBLE PAVEMENT.....		630-1
Table 632.1	Asphalt Binder Performance Grade Selection.....	630-6
Table 633.1	Gravel Equivalent (GE) and Thickness of Structural Layers (ft) ..	630-10
Table 633.2	Selecting ME Project Testing Level	630-14
Table 633.3	Minimum Reliability Depending on Project Testing Level.....	630-15
Table 635.2A	Tolerable Deflections at the Surface (TDS) in 0.001 inches.....	630-22
Table 635.2B	Gravel Equivalence Needed to Reduce Surface Deflection	630-23
Table 635.2C	Commonly Used Gf for Flexible Pavement Rehabilitation.....	630-24
Table 635.2D	Reflective Crack Retardation Equivalencies (Thickness in feet)	630-26

July 1, 2020

Table 636.4	Minimum Pavement Structures for Park & Ride Facilities.....	630-38
CHAPTER 650 – PAVEMENT DRAINAGE.....		650-1
Figure 651.2A	Typical Section with Treated Permeable Base Drainage Layer	650-3
Figure 651.2B	Cross Drain Interceptor Details For Use with Treated	
	Permeable Base	650-5
Figure 651.2C	Cross Drain Interceptor Trenches	650-6
CHAPTER 660 – PAVEMENT FOUNDATIONS		660-1
Table 663.2	Base and Subbase Material Properties for Rigid Pavement	
	Catalog	660-5
Table 663.3	Gravel Factor and California R-value for Bases and Subbases	
	Used in Flexible Pavement Design	660-6
Figure 665.5	Flowchart for SEG Selection.....	660-11
Table 666.1A	Typical Resilient Modulus and Poisson’s Ratio for Standard Base	
	and Subbase Materials Used in ME-Based Flexible Pavement	
	Design.....	660-16
Table 666.1B	Typical Resilient Modulus and Poisson’s Ratio for Subgrade Soils	
	Used in ME-Based Flexible Pavement Design	660-17
CHAPTER 670 – TAPERS AND SHOULDER BACKING		670-1
Figure 671.2A	Tapering Into a Previously Overlaid Pavement.....	670-2
Figure 671.2B	New Structure Approach Pavement Transition Details	670-3
Figure 671.3A	Transverse Transition Tapers for Pavement Preservation Projects .	670-5
Figure 671.3B	Longitudinal Tapers at Shoulders, Curbs, Dikes, Inlets, and	
	Guardrail	670-6
Figure 671.3C	Transition Taper Underneath Overcrossing/Bridge.....	670-7
Figure 672.3A	Typical Application of Shoulder Backing	670-10
Figure 672.3B	Alternative Placement for Existing Slopes Steeper than 6:1	670-10
Figure 672.3C	Placement of Shoulder Backing Thickness Greater Than 0.50	
	foot for Slope Repair	670-11
Figure 672.3D	Placement of Shoulder Backing Behind Dikes.....	670-11
Figure 672.3E	Longitudinal Drainage (Roadside Ditches/Gutters).....	670-12
CHAPTER 680 – PAVEMENT DESIGN FOR WIDENING PROJECTS.....		680-1
Figure 682.4A	Typical Concrete Pavement Widening Median Lane	
	and Outer Lane.....	680-5

Figure 682.4B Widening Previously Cracked, Seated, and HMA Overlay Concrete Pavement in Good Condition 680-7

Figure 682.4C Widening Asphalt Pavement in Good Condition 680-9

CHAPTER 800 – GENERAL ASPECTS 800-1

Figure 804.7A Technical Information for Location Hydraulic Study 800-13

Figure 804.7B Floodplain Evaluation Report Summary 800-15

Table 808.1 Summary of Related Computer Programs and Web Applications 800-50

CHAPTER 800 – HYDROLOGY 810-1

Figure 812.1 Automated Watershed Delineation 810-3

Figure 813.1 Post-Fire Debris 810-8

Figure 816.5 Typical Flood Hydrograph 810-14

Table 816.6A Roughness Coefficients For Sheet Flow 810-16

Table 816.6B Intercept Coefficients for Shallow Concentrated Flow 810-17

Figure 816.6 Velocities for Upland Method of Estimating Travel
Time for Shallow Concentrated Flow 810-18

Figure 816.7 Digital Elevation Map (DEM) 810-19

Figure 817.2 Gaging Station 810-20

Figure 817.3 High Water Marks 810-20

Figure 818.1 Overtopping Flood 810-22

Figure 818.2 Maximum Historic Flood 810-22

Figure 819.2A Runoff Coefficients for Undeveloped Areas Watershed Types 810-27

Table 819.2B Run off Coefficients for Developed Areas⁽¹⁾ 810-28

Figure 819.2C Regional Flood-Frequency Regions 810-30

Figure 819.4 Basic Steps to Developing and Applying a Rainfall-runoff
Model for Predicting the Required Design Flow 810-34

Table 819.5A Summary of Methods for Estimating Design Discharge 810-35

Figure 819.7A Desert Regions in California 810-38

Table 819.7A Regional Regression Equations for California’s Desert Regions ... 810-39

Table 819.7B Runoff Coefficients for Desert Areas 810-41

Table 819.7C Watershed Size for California Desert Regions 810-41

Figure 819.7B Example Depth-Area Reduction Curve 810-43

Table 819.7D Hydrologic Soil Groups 810-44

July 1, 2020

Table 819.7E	Curve Numbers for Land Use-Soil Combinations	810-46
Figure 819.7C	San Bernardino County Hydrograph for Desert Areas	810-48
Figure 819.7D	USBR Example S-Graph	810-49
Table 819.7F	Channel Routing Methods	810-51
Table 819.7G	Channel Method Routing Guidance	810-52
Table 819.7H	Design Storm Durations.....	810-53
Table 819.7I	Bulking Factors & Types of Sediment Flow	810-55
Figure 819.7E	Soil Slips vs. Slope Angle	810-55
Figure 819.7F	Alluvial Fan	810-56
Table 819.7J	Adjustment-Transportation Factor Table.....	810-60
Figure 819.7H	Recommended Bulking Factor Selection Process	810-61
CHAPTER – 820 CROSS DRAINAGE		820-1
Figure 821.1	Annual exceedance probability (AEP) of daily maximum ocean water level.....	820-6
Table 821.1	Boundaries, Locations and Length Scales of Water-level Provinces.....	820-8
Figure 821.2	California Open Coast and Bayfront Water Level Province Map	820-9
Figure 821.3A	One-Percent Compound Frequency Curve for Province 1, (Based on NOAA # 9419750, Crescent City).....	820-10
Figure 821.3B	One-Percent Compound Frequency Curve for Province 2, (Based on NOAA # 9418767, North Spit, Humboldt)	820-11
Figure 821.3C	One-Percent Compound Frequency Curve for Province 2a, (Based on NOAA # 9414290, Golden Gate Bridge).....	820-12
Figure 821.3D	One-Percent Compound Frequency Curve for Province 3, (Based on NOAA # 9413450, Monterey)	820-13
Figure 821.3E	One-Percent Compound Frequency Curve for Province 4, (Based on NOAA # 9412110, Port San Luis).....	820-14
Figure 821.3F	One-Percent Compound Frequency Curve for Province 5, (Based on NOAA # 9411340, Santa Barbara)	820-15
Figure 821.3G	One-Percent Compound Frequency Curve for Province 6, (Based on NOAA # 9410660, Los Angeles).....	820-16
Figure 821.3H	One-Percent Compound Frequency Curve for Province 7, (Based on NOAA # 9410230, La Jolla Scripps Pier).....	820-17

Figure 821.3I	One-Percent Compound Frequency Curve for Province 8, (Based on NOAA # 9414750, Alameda)	820-18
Figure 821.3J	One-Percent Compound Frequency Curve for Province 9, (Based on NOAA # 9415056, Pinole Point, San Pablo Bay).....	820-19
Figure 821.3K	One-Percent Compound Frequency Curve for Province 9a, (Based on NOAA # 9415144, Port Chicago).....	820-20
Figure 821.3L	One-Percent Compound Frequency Curve for Province 10, (Based on NOAA # 9414523, Redwood City)	820-21
Figure 821.3M	One-Percent Compound Frequency Curve for Province 11, (Based on NOAA # 9410170, San Diego Bay, Navy Pier)	820-22
Figure 821.3N	One-Percent Compound Frequency Curve for Province 12, (Based on Otay River Sonde)	820-23
Figure 821.4	Distances needed to guide interpolation	820-24
Figure 821.5	Weighting factor, Kx for interpolation	820-25
 CHAPTER 830 – TRANSPORTATION FACILITY DRAINAGE		 830-1
Table 831.3	Desirable Roadway Drainage Guidelines.....	830-4
Figure 834.3	Side Gutter and Trapezoidal Channel.....	830-9
Figure 837.1	Storm Drain Inlet Types	830-14
Table 838.4	Minimum Pipe Diameter for Storm Drain Systems.....	830-23
 CHAPTER 840 – SUBSURFACE DRAINAGE		 840-1
Table 842.4	Suggested Depth and Spacing of Pipe Underdrains for Various Soil Types.....	840-6
 CHAPTER 850 – PHYSICAL STANDARDS		 850-1
Table 851.2	Manning "n" Value for Alternative Pipe Materials ⁽¹⁾	850-2
Table 853.1A	Allowable Alternative Pipe Liner Materials	850-13
Table 853.1B	Guide for Plastic Pipeliner Selection in Abrasive Conditions ⁽²⁾ to Achieve 50 Years of Maintenance-Free Service Life	850-15
Table 854.1	Joint Leakage Selection Criteria	850-21
Figure 855.1	Minor Bedload Volume.....	850-24
Figure 855.2	Abrasion Test Panels	850-25
Table 855.2A	Abrasion Levels and Materials	850-26
Table 855.2B	Bed Materials Moved by Various Flow Depths and Velocities	850-30

July 1, 2020

Table 855.2C	Guide for Anticipated Service Life Added to Steel Pipe by Abrasive Resistant Protective Coating ⁽²⁾	850-31
Table 855.2D	Guide for Anticipated Wear to Metal Pipe by Abrasive Channel Materials	850-32
Table 855.2E	Relative Abrasion Resistance Properties of Pipe and Lining Materials*	850-32
Table 855.2F	Guide for Minimum Material Thickness of Abrasive Resistant Invert Protection to Achieve 50 Years of Maintenance-Free Service Life	850-33
Figure 855.3A	Minimum Thickness of Metal Pipe for 50-Year Maintenance-Free Service Life ⁽²⁾	850-36
Figure 855.3B	Chart for Estimating Years to Perforation of Steel Culverts	850-37
Table 855.4A	Guide for the Protection of Cast-In-Place and Precast Reinforced and Unreinforced Concrete Structures ⁽⁵⁾ Against Acid and Sulfate Exposure Conditions ^{(1),(2)}	850-38
Table 855.4B	Guide for Minimum Cover Requirements for Cast-In-Place and Precast Reinforced Concrete Structures ⁽³⁾ for 50-Year Design Life in Chloride Environments	850-39
Table 856.3A	Corrugated Steel Pipe Helical Corrugations	850-44
Table 856.3B	Corrugated Steel Pipe Helical Corrugations	850-45
Table 856.3C	Corrugated Steel Pipe 2 ² / ₃ " x 1/2" Annular Corrugations.....	850-46
Table 856.3D	Corrugated Steel Pipe Arches 2 ² / ₃ " x 1/2" Helical or Annular Corrugations	850-47
Table 856.3E	Steel Spiral Rib Pipe 3/4" x 1" Ribs at 11 1/2" Pitch	850-48
Table 856.3F	Steel Spiral Rib Pipe 3/4" x 1" Ribs at 8 1/2" Pitch	850-49
Table 856.3G	Steel Spiral Rib Pipe 3/4" x 3/4" Ribs at 7 1/2" Pitch	850-50
Table 856.3H	Corrugated Aluminum Pipe Annular Corrugations	850-51
Table 856.3I	Corrugated Aluminum Pipe Helical Corrugations.....	850-52
Table 856.3J	Corrugated Aluminum Pipe Arches 2 ² / ₃ " x 1/2" Helical or Annular Corrugations	850-53
Table 856.3K	Aluminum Spiral Rib Pipe 3/4" x 1" Ribs at 11 1/2" Pitch.....	850-54
Table 856.3L	Aluminum Spiral Rib Pipe 3/4" x 3/4" Ribs at 7 1/2" Pitch.....	850-54
Table 856.3M	Structural Steel Plate Pipe 6" x 2" Corrugations	850-55
Table 856.3N	Structural Steel Plate Pipe Arches 6" x 2" Corrugations	850-56
Table 856.3O	Structural Aluminum Plate Pipe 9" x 2 1/2" Corrugations.....	850-57

Table 856.3P	Structural Aluminum Plate Pipe Arches 9" x 2½" Corrugations.....	850-58
Table 856.4	Thermoplastic Pipe Fill Height Tables.....	850-59
Table 856.5	Minimum Thickness of Cover for Culverts.....	850-60
Table 857.2	Allowable Alternative Materials	850-63
CHAPTER 860 – ROADSIDE CHANNELS		860-1
Figure 861.1	Small Roadside Channel.....	860-1
Figure 861.2	Roadside Channel Outlet to Storm Drain at Drop Inlet	860-2
Figure 861.3	Damaged Channel	860-4
Figure 861.4	Concrete Lined Channel with Excessive Weed Growth	860-5
Figure 862.1	Small-Rock Lined Channel Outside of Clear Recovery Zone.....	860-7
Figure 863.1	Small-Rock Lined Triangular Channel with Rounded Bottom	860-9
Figure 865.1	Steep-Sloped Channel with Composite Vegetative Lining	860-13
Table 865.1	Concrete ⁽²⁾ Channel Linings.....	860-14
Figure 865.2	Concrete Lined Channel	860-14
Figure 865.3	Long-Term Flexible Lining.....	860-16
Figure 865.4	Grass-Lined Median Channel	860-18
Table 865.2	Permissible Shear and Velocity for Selected Lining Materials ⁽²⁾	860-20
Table 866.3A	Average Values for Manning's Roughness Coefficient (n)	860-26
Figure 866.3C	Specific Energy Diagram.....	860-27
Table 868.2	Guide to Freeboard Height.....	860-31
CHAPTER 870 – BANK PROTECTION – EROSION CONTROL		870-1
Table 872.1	Guide to Selection of Protection.....	870-3
Figure 872.1	Stream Classification	870-10
Figure 872.2	Diagram of a Braided River Channel	870-11
Figure 872.3	Bed Load and Suspended Load.....	870-14
Figure 872.4	Longitudinal Encroachments.....	870-15
Figure 872.5	Slope Failure Due to Loss of Toe.....	870-19
Table 872.2	Failure Modes and Effects Analysis for Riprap Revetment	870-20
Figure 872.6	Mature Valley with Meandering Stream	870-23
Figure 872.7	Alternative Highway Locations Across Debris Cone	870-25

July 1, 2020

Figure 872.8	Alluvial Fan	870-26
Figure 872.9	Desert Wash Longitudinal Encroachment.....	870-26
Figure 872.10	Stage Construction	870-27
Figure 873.3A	Stone Shape	870-35
Table 873.3A	RSP Class by Median Particle Size ⁽³⁾	870-36
Table 873.3B	RSP Class by Median Particle Weight ⁽³⁾	870-37
Figure 873.3B	Medium Density Vegetation	870-44
Figure 873.3C	Gabion Lined Streambank	870-45
Figure 873.3D	Rock Slope Protection	870-46
Figure 873.3E	Concreted-Rock Slope Protection.....	870-47
Figure 873.3F	Toe Failure – Concreted RSP.....	870-48
Figure 873.4A	Thalweg Redirection Using Bendway Weirs	870-53
Figure 873.4B	Bendway Weir Typical Cross Section and Layout	870-55
Figure 873.4C	Bendway Weir Rock Size Chart.....	870-56
Figure 873.4D	Example of Spur Design	870-57
Figure 873.4E	Bridge Abutment Guide Banks.....	870-58
Figure 873.6A	Bridge Abutment Failure Example	870-61
Figure 873.6B	Habitat Enhancement Example	870-62
Figure 873.6C	Lateral Stream Migration Within a Canyon Setting Example	870-63
Figure 873.6D	Conceptual Geotechnical Failures Resulting from	
	Abutment Scour	870-63
CHAPTER 880 – SHORE PROTECTION.....		880-1
Figure 883.2A	Nomenclature of Tidal Ranges	880-7
Figure 883.2B	Significant Wave Height Prediction Nomograph	880-11
Figure 883.2C	Design Breaker Wave	880-12
Figure 883.2D	California 12 Tide Gauges	880-14
Figure 883.2E	Crescent City Example	880-16
Table 883.1A	Crescent City Example Comparison for 2060	880-17
Table 883.1B	Projected Sea-Level Rise (feet) at Crescent City.....	880-18
Figure 883.2F	Crescent City MHHW.....	880-20
Figure 883.2G	Wave Run-up on Smooth Impermeable Slope.....	880-22

Figure 883.2H	RSP Lined Ocean Shore.....	880-22	
Table 883.2	Dimensionless Breaker Parameter and Wave Types.....	880-24	
Figure 883.2I	Rock Slope Protection.....	880-26	
Figure 883.2J	Typical Groin Layout with Resultant Beach Configuration	880-29	
Figure 883.2K	Alignment of Groins to an Oblique Sea Warrants Shortening Proportional to Cosine of Obliquity	880-30	
Figure 883.2L	Typical Stone Dike Groin Details	880-31	
CHAPTER 890 – STORM WATER MANAGEMENT		890-1	
Figure 892.3	Example of Cumulative Hydrograph With and Without Detention	890-4	
CHAPTER 900 – LANDSCAPE ARCHITECTURE – ROADSIDES		900-1	
Table 904.5	Large Tree Setback Requirements on Conventional Highways	900-11	
CHAPTER 910 – LANDSCAPE ARCHITECTURE – ROADSIDE SITES.....		910-1	
Table 912.2	Vehicle Parking Stall Standards	910-3	
CHAPTER 1000 – BICYCLE TRANSPORTATION DESIGN		1000-1	
Figure 1003.1A	Two-Way Class I Bikeway (Bike Path).....	1000-7	
Figure 1003.1B	Typical Cross Section of Class I Bikeway (Bike Path)	Parallel to Highway	1000-9
Table 1003.1	Bike Path Design Speeds	1000-11	
Figure 1003.1C	Minimum Length of Bicycle Path Crest Vertical Curve (L)	Based on Stopping Sight Distance (S).....	1000-12
Figure 1003.1D	Minimum Lateral Clearance (m) on Bicycle Path	Horizontal Curves	1000-13
Figure 1003.5	Railroad Crossing Class I Bikeway	1000-19	

CHAPTER 10 – DIVISION OF DESIGN

Topic 11 – Organization and Functions

Index 11.1 – Organization

The Division of Design (DOD), a part of Project Delivery, is comprised of the Engineering Program with the following offices: CADD and GIS, Highway Drainage Design, Innovative Design and Delivery, Performance Management, Project Support, Standards and Procedures, Storm Water Management Design; as well as the Landscape Architecture Program with the following offices: Landscape Architecture Standards and Procedures, Landscape Architecture Support and Planning, Professional Development, and Strategic Information & Business Management. Additionally, the Project Delivery Coordinators represent the Chief, DOD, in the California Department of Transportation (Department) Districts, maintaining liaison and coordinating District and Headquarters activities, ensuring consistent and uniform application of statewide policies, standards, procedures, guidelines and practices. See Figure 11.1 for information on the functional duties performed by the various offices in the DOD.

As the Chief Design Engineer within the DOD, the Chief, Division of Design provides technical and procedural advice and assistance to the Districts in support of the development of transportation projects as follows: establishes, maintains and monitors the project development process in accord with all applicable State and Federal laws and regulations; establishes engineering standards and procedures for application of standards on a statewide basis; approves exceptions to non-delegated boldface design standards; monitors project development related reports, facilitates performance management and process improvement activities. The Chief, DOD also is a member of the AASHTO Subcommittee on Design.

July 1, 2020

Figure 11.1

Division of Design Functional Organization Chart

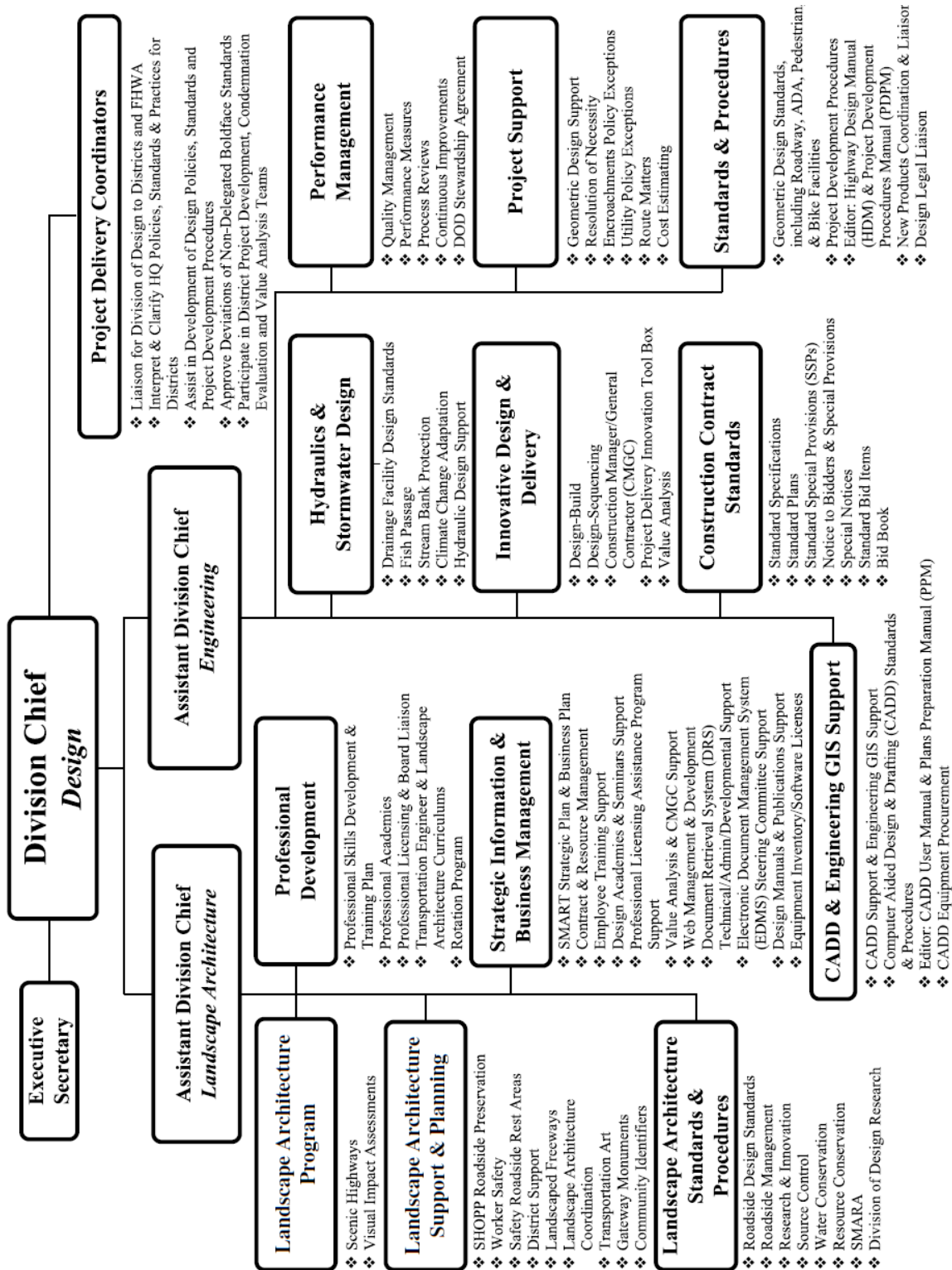

CHAPTER 20 – DESIGNATION OF HIGHWAY ROUTES

Topic 21 – Highway Route Numbers

Index 21.1 – Legislative Route Numbers and Descriptions

The Legislature designates all State highway routes and assigns route numbers. The description and number of each route are contained in Chapter 2, Article 3 of the Streets and Highways Code. These route numbers are used for all administrative purposes.

The Legislature has stated its intent that the routes of the State Highway System serve the State's heavily traveled rural and urban corridors, that they connect the communities and regions of the State, and that they serve the State's economy by connecting centers of commerce, industry, agriculture, mineral wealth, and recreation.

A legislative route description generally runs south to north or west to east. To the extent possible, the number used on each route's guide signs is the same as the legislatively designated route number.

A specific location on any State highway is described by its post mile designation (formerly known as kilometer post). Post miles typically start at the west or south county line and end at the east or north county line. Generally, post mile information is available in the Caltrans State Highway Log, and is maintained by the Department's, Office of System Management Planning.

21.2 Sign Route Numbers

Each route in the State Highway System is given a unique number for identification and signed with distinctive numbered Interstate, U.S. or California State route shields to guide public travel. Route numbers used on one system are not duplicated on another system. Odd numbered routes are generally south to north and even numbered routes are generally west to east.

(1) *Interstate and Defense Highways (Interstate System)*. The Interstate System is a network of freeways of national importance, created by Congress and constructed with Federal-aid Interstate System funds. Routes in the system are signed with the Interstate route shields (See Index 42.2 and Figure 21.1) and the general numbering convention is as follows: routes with one or two-digit numbers are north-south or east-west through routes, routes with three-digit numbers, the first of which is odd, are interstate spur routes. For example, I-110 is a spur route off of I-10. Routes in three-digit numbers, the first of which is even, are loops through or belt routes around cities. I-805 in San Diego is an example of a loop off of I-5. The numbering of Interstate routes was developed by AASHTO with concurrence by the states.

July 1, 2020

Figure 21.1

Interstate Highway System in California

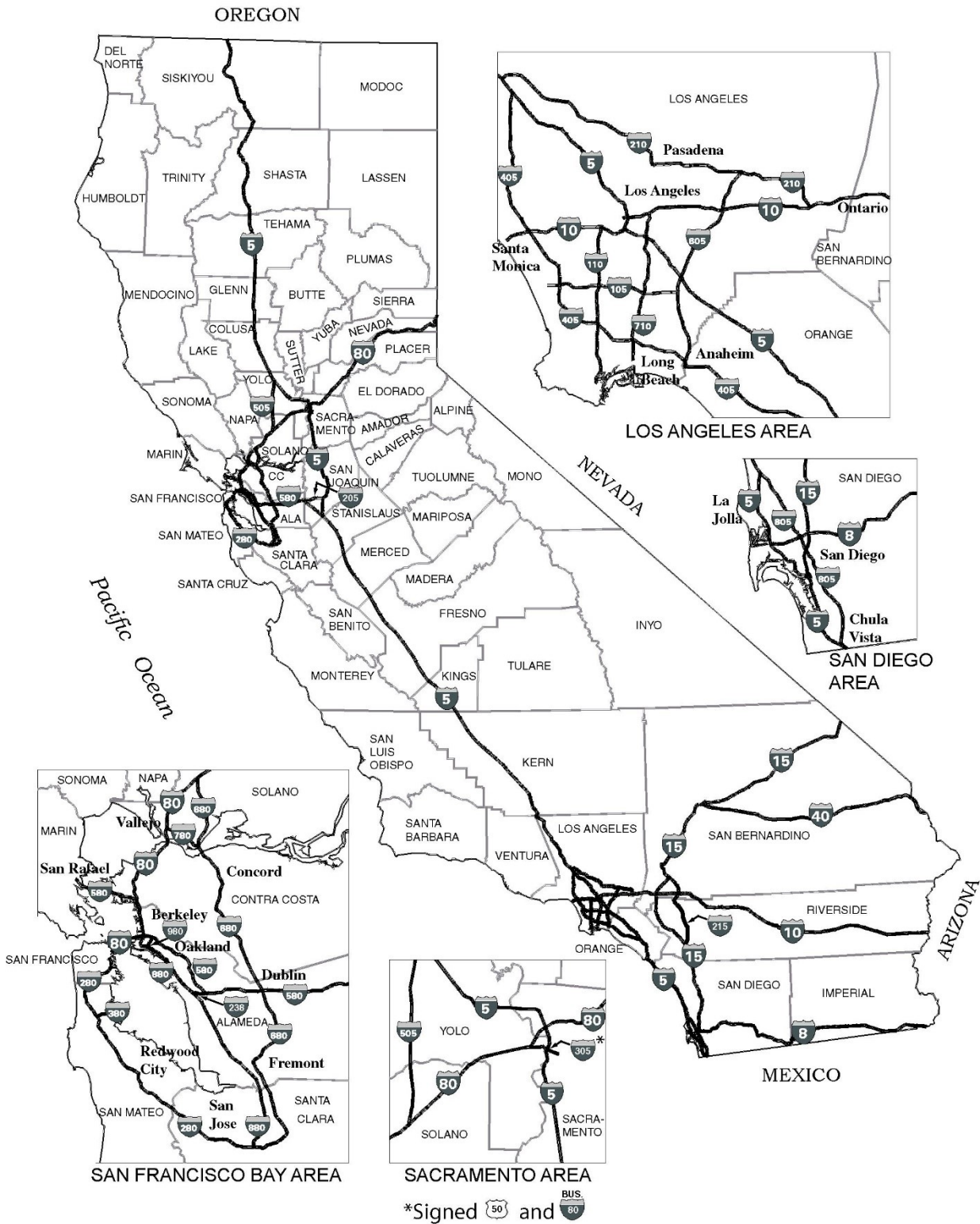

Renumbering of Interstate routes requires the approval of AASHTO to assure conformity with established numbering procedures. Such revisions also are a system action that must be approved by the Federal Highway Administrator.

The Transportation System Information Program is responsible for processing requests for changes to the system to AASHTO and FHWA for their consideration.

- (2) *United States Numbered Routes.* United States Numbered Routes are a network of State highways of statewide and national importance. These highways can be conventional roadways or freeways.

The establishment of a U.S. number as a guide for interstate travel over certain roads has no connection with Federal control, any Federal-aid System, or Federal construction financing. The Executive Committee of AASHTO, with the concurrence of the states, has full authority for numbering U.S. routes.

The Transportation System Information Program is responsible for processing requests for numbering U.S. routes to AASHTO for their consideration. *State Sign Routes.* State Sign Routes are State highways within the State, other than the above signed routes, which are distinctively signed to serve intrastate and interstate travel.

- (3) *State Sign Routes.* State Sign Routes are State highways within the State, other than the above signed routes, which are distinctively signed to serve intrastate and interstate travel.

- (4) *Business Routes.* A Business Route generally is a local street or road in a city or urban area, designated by the same route number as the through Interstate, U.S., or State highway to which it is connected, with the words "Business Route" attached to the identifying route shields. The Business Route designation provides guidance for the traveling public to leave the main highway at one end of a city or urban area, patronize local businesses, and continue on to rejoin the main route at the opposite end of the city or urban area.

The Transportation System Information Program is responsible for approval of Business Route designations. Applications for Business Route designation and signing must be made by written request from the local government agency to the Chief of the Transportation System Information Program. U.S. and Interstate Business Routes require approval by the AASHTO Executive Committee.

CHAPTER 40 – FEDERAL-AID

Topic 41 – Enabling Legislation

Index 41.1 – General

The Intermodal Surface Transportation Efficiency Act (ISTEA) of 1991 is the first transportation legislation since the Interstate System was enacted. ISTEA has changed the established Federal-Aid system. During the 20 years prior to ISTEA there were four Federal-Aid systems: Interstate, Primary, Secondary, and Urban. Now, instead of four Federal-aid systems there are two, the National Highway System (NHS) and the Interstate System, which is a component of the National Highway System.

In 2005, the Safe, Accountable, Flexible, Efficient Transportation Enhancement Act, Legacy for the Users, better known as SAFETEA-LU, was passed. SAFETEA-LU, invests in highway, transit and safety programs. While ISTEA created new federal-aid programs, SAFETEA-LU continued those programs such as the Surface Transportation Program, National Highway System, Congestion Mitigation and Air Quality Improvement Program and the Bridge Replacement and Rehabilitation Program.

A variety of other programs also continued to exist to provide flexibility in determining transportation solutions and promote a multi-modal system approach. Some of these programs include those that target funding for rail and transit projects while others provide funds for environmental enhancement such as habitat mitigation and wetland banking. Numerous other funding categories are also available for use during the six year term of the act.

Topic 42 – Federal-Aid System

42.1 National Highway System

After consultation with the States, in 1995 the Secretary of Transportation proposed a National Highway System (NHS) consisting of approximately 160,000 miles across the United States. The NHS consists of all Interstate routes, a large percentage of urban and rural principal arterials, the defense strategic highway network, and strategic highway connectors.

42.2 Interstate

As a result of ISTEA the Interstate System is a part of the NHS, but will retain its separate identity and receive separate funding. SAFETEA-LU continued those funding programs for the Interstate and NHS; however, SAFETEA-LU concentrated on safety and congestion. SAFETEA-LU also addressed other important aspects of an effective and efficient highway program.

July 1, 2020

Topic 43 – Federal-Aid Programs

43.1 Surface Transportation Program (STP)

The Surface Transportation Program is a funding program which may be used for roads (including NHS) that are not functionally classified as local or rural minor collectors. These roads are now collectively referred to as Federal-aid roads.

The STP includes safety and enhancement programs. Ten percent of the STP funds must be used for safety construction activities, hazard elimination and rail-highway crossings. Another ten percent of the program is designated for transportation enhancement, which encompasses a broad range of environmental related activities. The remainder of the STP funds are divided as follows; 50 percent is to be divided between areas of the State based on population; the remaining 30 percent can be used in any area.

43.2 California Stewardship and Oversight Agreement with FHWA

The goal under the Stewardship and Oversight Agreement (Agreement) is to document the roles and responsibilities of the FHWA's California Division Office and Caltrans with respect to project approvals and related responsibilities, and to document the methods of oversight which will be used to efficiently and effectively deliver the Federal-aid Highway Program. The Agreement states that "Caltrans [Department] and the FHWA will jointly determine which projects are considered to be projects of Division or Corporate Interest (PODI and/or POCI). The initial PODI and POCI determination will be made at the Caltrans [Department] District level in conjunction with the FHWA." Projects not selected as PODIs or POCIs will be considered as Delegated Projects and, the Department will have approval authority for all aspects of a Federal-aid project, except those which may not be delegated by federal law (requiring FHWA approval). For the Delegated Projects, FHWA will verify compliance with federal regulations via annual program and process reviews. See the Project Development Procedures Manual for other essential procedures regarding the Stewardship and Oversight Agreement between the Department and FHWA. For additional information see the FHWA webpage on Stewardship and Oversight. See the Department Design website for the current Stewardship and Oversight Agreement between FHWA California Division Office and Caltrans.

43.3 Congestion Mitigation and Air Quality Improvement Program (CMAQ)

The Congestion Mitigation and Air Quality Improvement Program directs funds toward transportation projects in Clean Air Act non-attainment areas for ozone and carbon monoxide. Projects using CMAQ funds contribute to meeting the attainment of national ambient area air quality standards. CMAQ funds may not be used for projects which will increase capacity for single occupant vehicles. Exceptions might include HOV lanes which allow single occupant vehicles at other than peak travel times or auxiliary lanes.

43.4 Bridge Replacement and Rehabilitation Program

The Bridge Replacement and Rehabilitation Program was continued in order to provide assistance for any bridge on public roads. Caltrans, Division of Engineering Services, Office of Structures Maintenance and Investigation, develops the bridge sufficiency rating for bridges on the State system and sets a sufficiency threshold for the use of Bridge Replacement and Rehabilitation Funds.

43.5 Federal Lands Program

The Federal Lands Program authorizations are available through three categories: Indian Reservation roads, Parkways and Park roads, and Public Lands Highways (which incorporates the previous Forest Highway category).

43.6 Highway Safety Improvement Program

SAFETEA-LU established the Highway Safety Improvement Program (HSIP) as a core Federal-aid program for safety funding to achieve a significant reduction in traffic fatalities and serious injuries on all public roads. The state apportionment of funds is subject to a set aside for construction and operational improvements on high risk rural roads (HRR). HRR are functionally classified as rural major or minor collectors or rural roads with a fatal or injury crash rate above statewide average for those functional classes of roadways, injury crash rates above those functional classes of roadways, or those roads which are likely to experience an increase in traffic volumes that could lead to a crash rate in excess of the statewide rate.

The HSIP also created a planning process for safety which is overseen by the Department. The Strategic Highway Safety Plan is developed with input from stakeholders to better coordinate funding and safety efforts on the State highway system

43.7 Special Programs

Special Program funds are allocated for projects which generally fall into the following groups: Special Projects-High Cost Bridge, Congestion Relief, High Priority Corridors on the NHS, Rural and Urban Access, Priority Intermodal and Innovative Projects; National High Speed Ground Transportation Programs; Scenic Byways Program; Use of Safety Belts and Motorcycle Helmets; National Recreational Trails Program; Emergency Relief.

Topic 44 – Funding Determination

44.1 Funding Eligibility

Each Federal program has certain criteria and requirements. During design the project engineer is to consult with the FHWA reviewer to determine the appropriate Federal program each individual project is eligible for and the level of future Federal involvement. The final determination to request Federal participation will be made by Caltrans, Budgets Program, Federal Resource Branch.

July 1, 2020

44.2 Federal Participation Ratio

SAFETEA-LU designates the percentage of Federal participation in several programs and fund types. The Interstate System reimbursement allotment is approximately 90 percent. The remainder of projects on the NHS, STP and CMAQ reimbursement allotments is approximately 80 percent. For certain safety improvements, the federal share may be up to 100%. FHWA determines the final detailed ratio based on a formula applied to each State. Contact Caltrans, Budgets Program, Federal Resources Branch for the most current reimbursement rates.

44.3 Emergency Relief

Emergency opening projects are funded 100 percent for the first 180 days following a disaster. For restoration projects and emergency opening projects after 180 days Federal participation is pro-rated.

CHAPTER 60 – NOMENCLATURE

Unless indicated otherwise in this manual, wherever the following abbreviations, terms, or phrases are used, their intent and meaning shall be as identified in this Chapter.

Topic 61 – Abbreviations

Index 61.1 – Official Names

AASHTO	American Association of State Highway and Transportation Officials
Caltrans or Department	California Department of Transportation
CFR	Code of Federal Regulations
CTC or Commission	California Transportation Commission
DES	Division of Engineering Services
District	Department of Transportation Districts
DOT	U.S. Department of Transportation
DOD	Division of Design
FAA	Federal Aviation Administration
FHWA	Federal Highway Administration
GS	Geotechnical Services
METS	Office of Materials Engineering and Testing Services
OAP	Office of Asphalt Pavements
OCP	Office of Concrete Pavements
PP	Pavement Program
PS&E	Plans, Specifications, and Estimate
PUC	Public Utilities Commission
SD	Structure Design
SHOPP	State Highway Operation and Protection Plan
STIP	State Transportation Improvement Program

Topic 62 – Definitions

62.1 Geometric Cross Section

(1) Lane.

- a) Auxiliary Lane--The portion of the roadway for weaving, truck climbing, speed change, or for other purposes supplementary to through movement.
- b) Lane Numbering--On a multilane roadway, the lanes available for through travel in the same direction are numbered from left to right when facing in the direction of travel.
- c) Multiple Lanes--Freeways and conventional highways are sometimes defined by the number of through lanes in both directions. Thus an 8-lane freeway has 4 through lanes in each direction. Likewise, a 4-lane conventional highway has 2 through lanes in each

July 1, 2020

direction. Lanes that are not equally distributed to each direction would otherwise be described as appropriate.

- d) Median Lane--A speed change lane within the median to accommodate left turning vehicles.
- e) Speed Change Lane--An auxiliary lane, including tapered areas, primarily for the acceleration or deceleration of vehicles when entering or leaving the through lanes.
- f) Traffic Lane/Vehicle Lane--The portion of the traveled way for the movement of a single line of vehicles, both motor vehicle and bicycle.

(2) *Bikeways.*

- a) Class I Bikeway (Bike Path). Provides a completely separated facility for the exclusive use of bicycles and pedestrians with crossflow by vehicles minimized.
- b) Class II Bikeway (Bike Lane). Provides a striped lane for one-way bike travel on a street or highway.
- c) Class III Bikeway (Bike Route). Provides for shared use with pedestrian or motor vehicle traffic.
- d) Class IV Bikeway (Separated Bikeway). Provides for the exclusive use of bicycles and includes a separation (e.g., grade separation, flexible posts, inflexible physical barrier, or on-street parking) required between the separated bikeway and the through vehicular traffic.

(3) *Maintenance Vehicle Pullout (MVP).* Paved areas, or appropriate all weather surfaces, adjacent to the shoulder for field personnel to park off the traveled way and access the work site.

(4) *Median.* The portion of a divided highway separating the traveled ways in opposite directions.

(5) *Outer Separation.* The portion of an arterial highway between the traveled ways of a roadway and a frontage street or road.

(6) *Roadbed.* That portion of the roadway extending from curb line to curb line or shoulder line to shoulder line. Divided highways are considered to have two roadbeds.

(7) *Roadside.* A general term denoting the area adjoining the outer edge of the roadbed to the right of way line. Extensive areas between the roadbeds of a divided highway may also be considered roadside.

(8) *Roadway.* That portion of the highway included between the outside lines of the sidewalks, or curbs and gutters, or side ditches including also the appertaining structures, and all slopes, ditches, channels, waterways, and other features necessary for proper drainage and protection.

(9) *Shoulder.* The portion of the roadway contiguous with the traveled way for the accommodation of stopped vehicles, for emergency use, for errant vehicle recovery, and for lateral support of base and surface courses. The shoulder may accommodate on-street parking as well as bicyclists and pedestrians, see the guidance in this manual as well as DIB 82.

(10) *Sidewalk.* A surfaced pedestrian way contiguous to a roadbed used by the public where the need for which is created primarily by the local land use. See DIB 82 for further guidance.

(11) *Traveled Way*. The portion of the roadway for the movement of vehicles and bicycles, exclusive of shoulders.

62.2 Highway Structures

(1) *Illustration of Types of Structures*. Figure 62.2 illustrates the names given to common types of structures used in highway construction. This nomenclature must be used in all phases of planning.

(2) *Bridges*. A structure including supports erected over a depression or an obstruction, such as water, highway, or railway, and having a track or passageway for carrying traffic or other moving loads; and having an opening measured along the center of the roadway of more than 20 feet between undercopings of abutments or spring lines of (buried) arches, or extreme ends of openings for (buried) multiple boxes. It may also include (buried) multiple pipes, where the clear distance between openings is less than half of the smaller contiguous opening.

(3) *Culverts*. A type of buried structure without a bridge number, see Index 806.2.

Any structure that fits the definition of a bridge shall be assigned a bridge number by Structure Maintenance and Investigation. Buried structures that meet the definition of a bridge but are made of a collection of culverts will only be considered as bridges for the purposes of design and structural maintenance record, not for definitions in specifications.

Buried structures, with or without bridge numbers, covered by Caltrans Standard Plans can be designed by the District. Culvert modifications to Standard Plans can be designed by the District and shall be reviewed by the Division of Engineering Services. Buried structure with a bridge number but not covered by Standard Plans shall be designed by the Division of Engineering Services.

July 1, 2020

Figure 62.2

Types of Structures

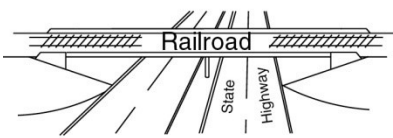

UNDERPASS

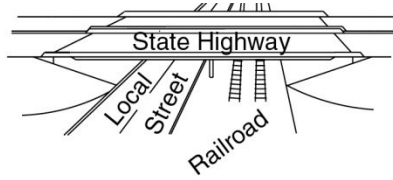

OVERHEAD

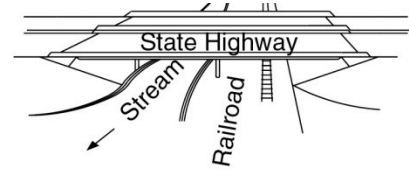

BRIDGE & OVERHEAD

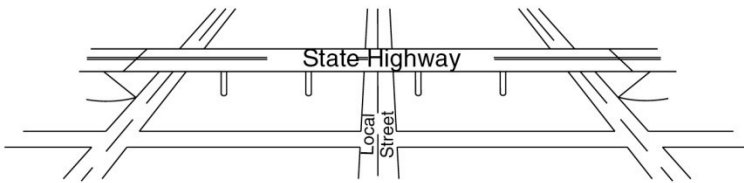

VIADUCT

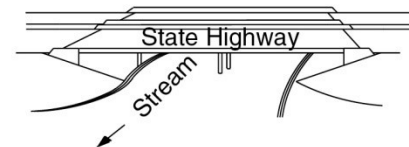

BRIDGE

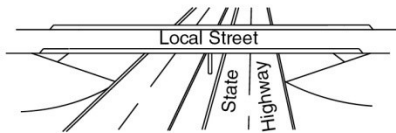

OVERCROSSING

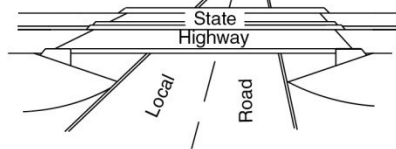

UNDERCROSSING



SEPARATION

62.3 Highway Types

- (1) *Freeway*. A freeway, as defined by statute, is a highway in respect to which the owners of abutting lands have no right or easement of access to or from their abutting lands or in respect to which such owners have only limited or restricted right or easement of access. This statutory definition also includes expressways.
- (2) The engineering definitions for use in this manual are:
 - a) Freeway--A divided arterial highway with full control of access and with grade separations at intersections.
 - b) Expressway--An arterial highway with at least partial control of access, which may or may not be divided or have grade separations at intersections.
- (3) *Controlled Access Highway*. In situations where it has been determined advisable by the Director or the CTC, a facility may be designated a "controlled access highway" in lieu of the designation "freeway". All statutory provisions pertaining to freeways and expressways apply to controlled access highways.
- (4) *Conventional Highway*. A highway without control of access which may or may not be divided. Grade separations at intersections or access control may be used when justified at spot locations.
- (5) *Highway*. In general a public right of way for the purpose of travel or transportation.
 - (a) Alley--A road passing through a continuous row of houses, buildings, etc. that permits access from the local street network to backyards, garages, etc.
 - (b) Arterial Highway--A general term denoting a highway primarily for through travel usually on a continuous route.
 - (c) Bypass--An arterial highway that permits users to avoid part or all of a city or town center, a suburban area, or an urban area.
 - (d) Collector-Distributor Road--A separated freeway system adjacent to a freeway, which connects two or more local road ramps or freeway connections to the freeway at a limited number of points.
 - (e) Collector Road--A route that serves travel of primarily intracounty rather than statewide importance in rural areas or a route that serves both land access and traffic circulation within a residential neighborhood, as well as commercial and industrial areas in urban and suburban areas.
 - (f) Divided Highway--A highway with separated roadbeds for traffic traveling in opposing directions.
 - (g) Major Street or Major Highway--An arterial highway with intersections at grade and direct access to abutting property on which geometric design and traffic control measures are used to expedite the safe movement of through traffic.
 - (h) Through Street or Through Highway--The highway or portion thereof at the entrance to which vehicular traffic from intersecting highways is regulated by "STOP" signs or traffic control signals or is controlled when entering on a separate right-turn roadway by a "YIELD" sign.
- (6) *Parkway*. An arterial highway for noncommercial vehicles, with full or partial control of access, which is typically located within a park or a ribbon of park-like development.

July 1, 2020

- (7) *Scenic Highway*. A State or county highway, in total or in part, that is recognized for its scenic value, protected by a locally adopted corridor protection program, and has been officially designated by the Department.
- (8) *Street or Road*.
- Cul-de-Sac Street--A local street open at one end only, with special provisions for turning around.
 - Dead End Street/No Outlet--A local street open at one end only, without special provisions for turning around.
 - Frontage Street or Road--A local street or road auxiliary to and located on the side of an arterial highway for service to abutting property and adjacent areas and for control of access.
 - Local Street or Local Road--A street or road primarily for access to residence, business or other abutting property.
 - Private Road or Private Driveway--A way or place in private ownership and used for travel by the owner and those having express or implied permission from the owner but not by other members of the public.
 - Street--A way or place that is publicly maintained and open for the use of the public to travel. Street includes highway.
 - Toll Road, Bridge or Tunnel--A highway, bridge, or tunnel open to traffic only upon payment of a toll or fee.
- (9) *Throughway*. A conventional highway or a suburban arterial in developed or developing areas, that is characterized by lower density (not built out) land uses, adjacent undeveloped land or parkland, direct access to abutting property, at-grade intersections, and that may have shoulders with or without curb and gutter.

62.4 Interchanges and Intersections at Grade

- (1) *Central Island*. The raised area in the center of a roundabout around which traffic circulates. The central island does not necessarily need to be circular in shape.
- (2) *Circulatory Roadway*. The curved roadbed that users of a roundabout travel on in a counterclockwise direction around the central island.
- (3) *Channelization*. The separation or regulation of conflicting movements into definite paths of travel by the use of pavement markings, raised islands, or other suitable means to facilitate the safe and orderly movement of vehicles, bicycles and pedestrians.
- (4) *Convergence Point*. The point of convergence occurs where the right ETW of the entrance ramp is one lane width from the right ETW of the freeway.
- (5) *Crosswalk*. Crosswalk is either:
- That portion of a roadway included within the prolongation or connection of the boundary lines of sidewalks at intersections where the intersecting roadways meet at approximately right angles, except the prolongation of such lines from an alley across a street.
 - Any portion of a roadway distinctly indicated for pedestrian crossing by lines or other markings on the surface.
- (6) *Geometric Design*. The arrangement of the visible elements of a road, such as alignment, grades, sight distances, widths, slopes, and other similar elements.

- (7) *Gore*. The area between a through roadway and an exit ramp. This term may also refer to the similar area between a through roadway and a converging entrance ramp.
- (8) *Grade Separation*. A crossing of two highways, highway and local road, or a highway and a railroad at different levels.
- (9) *Inscribed Circle Diameter*. The distance across the circle of a roundabout, inscribed by the outer curb (or edge) of the circulatory roadway. It is the sum of the central island diameter and twice the circulatory roadway width.
- (10) *Interchange*. A system of interconnecting roadways in conjunction with one or more grade separations that provides for the movement of vehicles between two or more roadways on different levels.
- (11) *Interchange Elements*.
- (a) Branch Connection--A multilane connection between two freeways.
 - (b) Freeway-to-freeway Connection--A single or multilane connection between freeways or any two high speed facilities.
 - (c) Ramp--A connecting roadway between a freeway or expressway and another highway, road, or roadside area.
- (12) *Intersection*. The general area where two or more roadways join or cross, including the roadway and roadside facilities for movements in that area.
- (13) *Island*. A defined area between roadway lanes for control of vehicle movements or for pedestrian refuge. Within an intersection a median or an outer separation is considered an island.
- (14) *Landscape Buffer/Strip*. A planted section adjacent to the legs of a roundabout that separates users of the roadway from users of the shared use/Class I Bikeway and assists with guiding pedestrians to the designated crossing locations. Also known as "way finding."
- (15) *Minimum Turning Radius*. The radius of the path of the outer front wheel of a vehicle making its sharpest turn.
- (16) *Offset Left-Turn Lanes*. Left-turn lanes are shifted as far to the left as practical rather than aligning the left-turn lane exactly parallel with and adjacent to the through lane.
- (17) *Offtracking*. The difference between the paths of the front and rear wheels of a vehicle as it negotiates a turn.
- (18) *Pedestrian Refuge*. A section of pavement or sidewalk, completely surrounded by asphalt or other road materials, where users can stop before completing the crossing of a road.
- (19) *Roundabout*. A type of circular intersection with specific geometric and traffic control features that in combination lower speed operations and lower speed differentials among all users immediately prior to, through, and beyond the intersection. Vehicle speed is controlled by deflection in the path of travel, and the "yield upon entry" rule for traffic approaching the roundabout's circulatory roadway. Curves and deflections are introduced that limit operating speeds.
- (20) *Splitter Island*. A raised or painted traffic island that separates traffic in opposing directions of travel. They are typically used at roundabouts and on the minor road approaches to an intersection.
- (21) *Skew Angle*. The complement of the acute angle between two centerlines which cross.
- (22) *Swept width*. The total width needed by the vehicle body to traverse a curve. It is the distance measured along the curve radius from the outer front corner of the body to the

July 1, 2020

inner rear corner of the body as the vehicle traverses around a curve. This width is used to determine lane width and clearance to objects, such as signs, poles, etc., as well as vehicles, bicycles, and pedestrians.

- (23) *Tracking width*. The total width needed by the tires to traverse a curve; it is the distance measured along the curve radius from the outer front tire track to the inner rear tire track as the vehicle traverses around a curve. This width is used to determine the minimum width required for the vehicle turning. Consideration for additional width may be needed for other vehicles, bicycles and pedestrians.
- (24) *Truck Apron*. The traversable portion of the roundabout central island adjacent to the circulatory roadway that may be needed to accommodate the wheel tracking of large vehicles. A truck apron is sometimes provided on the outside of the circulatory roadway, but cannot encroach upon the pedestrian crossing.
- (25) *Weaving Section*. A length of roadway, designed to accommodate two traffic streams merging and diverging within a short distance.
- (26) *Wheelbase*. For single-unit vehicles, the distance from the first axle to the single rear axle or, in the case of a tandem or triple set of rear axles, to the center of the group of rear axles. See Topic 404

62.5 Landscape Architecture

- (1) *Classified Landscaped Freeway*. A classified landscaped freeway is a planted section of freeway that meets the criteria established by the California Code of Regulations Outdoor Advertising Regulations, Title 4, Division 6. This designation is used in the control and regulation of outdoor advertising displays.
- (2) *Park and Ride*. A paved area for parking which provides a connection point for public access to a variety of modal options. See Topic 915.
- (3) *Safety Roadside Rest Area System*. The safety roadside rest area system is a component of the highway system providing roadside areas where travelers can stop, rest and manage their travel needs. Planned with consideration of alternative stopping opportunities such as truck stops, commercial services, and vista points, the rest area system provides public stopping opportunities where they are most needed, usually between large towns and at entrances to major metropolitan areas. See Topic 913.
- (4) *Site Furnishings*. Features such as newspaper boxes, bicycle racks, bus shelters, benches, trash receptacles, interpretive panels, art or drinking fountains that occupy space on or alongside pedestrian sidewalks.
- (5) *Vista Point*. Typically a paved dedicated area beyond the shoulder that permits travelers to stop and view a scenic area. See Topic 914.

62.6 Right of Way

- (1) *Acquisition*. The process of obtaining rights of way.
- (2) *Air Rights*. The property rights for the control or specific use of a designated airspace involving a highway.
- (3) *Appraisal*. An expert opinion of the market value of property including damages and special benefits, if any, as of a specified date, resulting from an analysis of facts.
- (4) *Business District (or Central Business District)*. The commercial and often the geographic heart of a city, which may be referred to as “downtown.” Usually contains retail stores,

theatres, entertainment and convention venues, government buildings, and little or no industry because of the high value of land. Historic sections may be referred to as "old town."

- (5) *Condemnation*. The process by which property is acquired for public purposes through legal proceedings under power of eminent domain.
- (6) *Control of Access*. The condition where the right of owners or occupants of abutting land or other persons to access in connection with a highway is fully or partially controlled by public authority.
- (7) *Easement*. A right to use or control the property of another for designated purposes.
- (8) *Eminent Domain*. The power to take private property for public use without the owner's consent upon payment of just compensation.
- (9) *Encroachment*. In terms of exceptions and permits, includes, but is not limited to, any structure, object, or activity of any kind or character which is within the State right of way, but it is not a part of the State facility or serving a transportation need.
- (10) *Inverse Condemnation*. The legal process which may be initiated by a property owner to compel the payment of just compensation, where the property has been taken for or damaged by a public purpose.
- (11) *Negotiation*. The process by which property is sought to be acquired for project purposes through mutual agreement upon the terms for transfer of such property.
- (12) *Partial Acquisition*. The acquisition of a portion of a parcel of property.
- (13) *Relinquishment*. A transfer of the State's right, title, and interest in and to a highway, or portion thereof, to a city or county.
- (14) *Right of Access*. The right of an abutting land owner for entrance to or exit from a public road.
- (15) *Severance Damages*. Loss in value of the remainder of a parcel which may result from a partial taking of real property and/or from the project.
- (16) *Vacation*. The reversion of title to the owner of the underlying fee where an easement for highway purposes is no longer needed.

62.7 Pavement

The following list of definitions includes terminologies that are commonly used in California as well as selected terms from the "AASHTO Guide for the Design of Pavement Structures" which may be used by FHWA, local agencies, consultants, etc. in pavement engineering reports and research publications.

- (1) *Asphalt Concrete*. See Hot Mix Asphalt (HMA).
- (2) *Asphalt Rubber*. A blend of asphalt binder, reclaimed tire rubber, and certain additives in which the rubber component is at least 15 percent by weight of the total blend and has reacted in the hot asphalt binder sufficiently to cause swelling of the rubber particles.
- (3) *Asphalt Treated Permeable Base (ATPB)*. A highly permeable open-graded mixture of crushed coarse aggregate and asphalt binder placed as the base layer to assure adequate drainage of the structural section, as well as structural support.
- (4) *Base*. A layer of selected, processed, and/or treated aggregate material that is placed immediately below the surface course. It provides additional load distribution and contributes to drainage and frost resistance.

July 1, 2020

- (5) *Basement Soil/Material*. See Subgrade.
- (6) *Borrow*. Natural soil obtained from sources outside the roadway prism to make up a deficiency in excavation quantities.
- (7) *California R-Value*. A measure of resistance to deformation of the soils under saturated conditions and traffic loading as determined by the stabilometer test (CT301). The California R-value, also referred to as R-value, measures the supporting strength of the subgrade and subsequent layers used in the pavement structure. For additional information, see Topic 614.
- (8) *Capital Preventive Maintenance*. Typically, Capital Preventive Maintenance (CAPM) consists of work performed to preserve the existing pavement structure utilizing strategies that preserve or extend pavement service life. The CAPM program is divided into pavement preservation and pavement rehabilitation. For further discussion see Topic 603.
- (9) *Cement Treated Permeable Base (CTPB)*. A highly permeable open-graded mixture of coarse aggregate, portland cement, and water placed as the base layer to provide adequate drainage of the structural section, as well as structural support.
- (10) *Composite Pavement*. These are pavements comprised of both rigid and flexible layers. Currently, for purposes of the procedures in this manual, only flexible over rigid composite pavements are considered composite pavements.
- (11) *Crack*. Separation of the pavement material due to thermal and moisture variations, consolidation, vehicular loading, or reflections from an underlying pavement joint or separation.
- (12) *Crack, Seat, and Overlay (CSO)*. A rehabilitation strategy for rigid pavements. CSO practice requires the contractor to crack and seat the rigid pavement slabs, and place a flexible overlay with a pavement reinforcing fabric (PRF) interlayer.
- (13) *Crumb Rubber Modifier (CRM)*. Scrap rubber produced from scrap tire rubber and other components, if required, and processed for use in wet or dry process modification of asphalt paving.
- (14) *Deflection*. The downward vertical movement of a pavement surface due to the application of a load to the surface.
- (15) *Dense Graded Asphalt Concrete (DGAC)*. See Hot Mix Asphalt (HMA).
- (16) *Depression*. Localized low areas of limited size that may or may not be accompanied by cracking.
- (17) *Dowel Bar*. A load transfer device in a rigid slab usually consisting of a plain round steel bar.
- (18) *Edge Drain System*. A drainage system, consisting of a slotted plastic collector pipe encapsulated in treated permeable material and a filter fabric barrier, with unslotted plastic pipe vents, outlets, and cleanouts, designed to drain both rigid and flexible pavement structures.
- (19) *Embankment*. A prism of earth that is constructed from excavated or borrowed natural soil and/or rock, extending from original ground to the grading plane, and designed to provide a stable support for the pavement structure.
- (20) *Equivalent Single Axle Loads (ESAL's)*. The number of 18-kip standard single axle load repetitions that would have the same damage effect to the pavement as an axle of a specified magnitude and configuration. See Index 613.3 for additional information.

- (21)*Flexible Pavement*. Pavements engineered to transmit and distribute vehicle loads to the underlying layers. The highest quality layer is the surface course (generally asphalt binder mixes) which may or may not incorporate underlying layers of base and subbase. These types of pavements are called "flexible" because the total pavement structure bends or flexes to accommodate deflection bending under vehicle loads. For further discussion, see Chapter 630.
- (22)*Grading Plane*. The surface of the basement material upon which the lowest layer of subbase, base, pavement surfacing, or other specified layer, is placed.
- (23)*Gravel Factor (G_f)*. Refers to the relative strength of a given material compared to a standard gravel subbase material. The cohesiometer values were used to establish the G_f currently used by Caltrans.
- (24)*Hot Mix Asphalt (HMA)*. Formerly known as asphalt concrete (AC), HMA is a graded asphalt concrete mixture (aggregate and asphalt binder) containing a small percentage of voids which is used primarily as a surface course to provide the structural strength needed to distribute loads to underlying layers of the pavement structure.
- (25)*Hot Recycled Asphalt (HRA)*. The use of reclaimed flexible pavement which is combined with virgin aggregates, asphalt, and sometimes rejuvenating agents at a central hot-mix plant and placed in the pavement structure in lieu of using all new materials.
- (26)*Joint Seals*. Pourable, extrudable or premolded materials that are placed primarily in transverse and longitudinal joints in concrete pavement to deter the entry of water and incompressible materials (such as sand that is broadcast in freeze-thaw areas to improve skid resistance).
- (27)*Lean Concrete Base*. Mixture of aggregate, portland cement, water, and optional admixtures, primarily used as a base for portland cement concrete pavement.
- (28)*Longitudinal Joint*. A joint normally placed between roadway lanes in rigid pavements to control longitudinal cracking; and the joint between the traveled way and the shoulder.
- (29)*Maintenance*. The preservation of the entire roadway, including pavement structure, shoulders, roadsides, structures, and such traffic control devices as are necessary for its safe and efficient utilization.
- (30)*Open Graded Asphalt Concrete (OGAC)*. See Open Graded Friction Course (OGFC).
- (31)*Open Graded Friction Course (OGFC)*. Formerly known as open graded asphalt concrete (OGAC), OGFC is a wearing course mix consisting of asphalt binder and aggregate with relatively uniform grading and little or no fine aggregate and mineral filler. OGFC is designed to have a large number of void spaces in the compacted mix as compared to hot mix asphalt. For further discussion, see Topic 631.
- (32)*Overlay*. An overlay is a layer, usually hot mix asphalt, placed on existing flexible or rigid pavement to restore ride quality, to increase structural strength (load carrying capacity), and to extend the service life.
- (33)*Pavement*. The planned, engineered system of layers of specified materials (typically consisting of surface course, base, and subbase) placed over the subgrade soil to support the cumulative vehicle loading anticipated during the design life of the pavement. The pavement is also referred to as the pavement structure and has been referred to as pavement structural section.
- (34)*Pavement Design Life*. Also referred to as performance period, pavement design life is the period of time that a newly constructed or rehabilitated pavement is engineered to perform before reaching a condition that requires CAPM, (see Index 603.4). The selected pavement

July 1, 2020

design life varies depending on the characteristics of the highway facility, the objective of the project, and projected vehicle volume and loading.

- (35)*Pavement Drainage System.* A drainage system used for both asphalt and rigid pavements consisting of a treated permeable base layer and a collector system which includes a slotted plastic pipe encapsulated in treated permeable material and a filter fabric barrier with unslotted plastic pipe as vents, outlets and cleanouts to rapidly drain the pavement structure. For further discussion, see Chapter 650.
- (36)*Pavement Preservation.* Work done, either by contract or by State forces to preserve the ride quality, safety characteristics, functional serviceability and structural integrity of roadway facilities on the State highway system. For further discussion, see Topic 603.
- (37)*Pavement Service Life.* Is the actual period of time that a newly constructed or rehabilitated pavement structure performs satisfactorily before reaching its terminal serviceability or a condition that requires major rehabilitation or reconstruction. Because of the many independent variables involved, pavement service life may be considerably longer or shorter than the design life of the pavement. For further discussion, see Topic 612.
- (38)*Pavement Structure.* See Pavement.
- (39)*Pumping.* The ejection of base material, either wet or dry, through joints or cracks, or along edges of rigid slabs resulting from vertical movements of the slab under vehicular traffic loading. This phenomena is especially pronounced with saturated structural sections.
- (40)*Raveling.* Progressive disintegration of the surface course on asphalt concrete pavement by the dislodgement of aggregate particles and binder.
- (41)*Rehabilitation.* Work undertaken to extend the service life of an existing facility. This includes placement of additional surfacing and/or other work necessary to return an existing roadway, including shoulders, to a condition of structural or functional adequacy, for the specified service life. This might include the partial or complete removal and replacement of portions of the pavement structure. Rehabilitation is divided into pavement rehabilitation activities and roadway rehabilitation activities (see Indexes 603.3 and 603.4).
- (42)*Resurfacing.* A supplemental surface layer or replacement layer placed on an existing pavement to restore its riding qualities and/or to increase its structural (load carrying) strength.
- (43)*Rigid Pavement.* Pavement engineered with a rigid surface course (typically Portland cement concrete or a variety of specialty cement mixes for rapid strength concretes) which may incorporate underlying layers of stabilized or unstabilized base or subbase materials. These types of pavements rely on the substantially higher stiffness of the rigid slab to distribute the vehicle loads over a relatively wide area of underlying layers and the subgrade. Some rigid slabs have reinforcing steel to help resist cracking due to temperature changes and repetitive loading.
- (44)*Roadbed.* The roadbed is that area between the intersection of the upper surface of the roadway and the side slopes or curb lines. The roadbed rises in elevation as each increment or layer of subbase, base or surface course is placed. Where the medians are so wide as to include areas of undisturbed land, a divided highway is considered as including two separate roadbeds.
- (45)*Asphalt Rubber Binder.* A blend of asphalt binder modified with crumb rubber modifier (CRM) that may include less than 15 percent CRM by mass.
- (46)*Rubberized Hot Mix Asphalt (RHMA).* Formerly known as rubberized asphalt concrete (RAC). RHMA is a material produced for hot mix applications by mixing either asphalt rubber

or asphalt rubber binder with graded aggregate. RHMA may be gap- (RHMA-G) or open- (RHMA-O) graded.

(47) *R-value*. See California R-Value.

(48) *Serviceability*. The ability at time of observation of a pavement to serve vehicular traffic (automobiles and trucks) which use the facility. The primary measure of serviceability is the Present Serviceability Index (PSI), which ranges from 0 (impossible road) to 5 (perfect road).

(49) *Settlement*. Localized vertical displacement of the pavement structure due to slippage or consolidation of the underlying foundation, often resulting in pavement deterioration, cracking and poor ride quality.

(50) *Structural Section*. See Pavement Structure.

(51) *Structural Section Drainage System*. See Pavement Drainage System.

(52) *Subbase*. Unbound aggregate or granular material that is placed on the subgrade as a foundation or working platform for the base. It functions primarily as structural support, but it can also minimize the intrusion of fines from the subgrade into the pavement structure, improve drainage, and minimize frost action damage.

(53) *Subgrade*. Also referred to as basement soil, it is the portion of the roadbed consisting of native or treated soil on which pavement surface course, base, subbase, or a layer of any other material is placed.

(54) *Surface Course*. One or more uppermost layers of the pavement structure engineered to carry and distribute vehicle loads. The surface course typically consists of a weather-resistant flexible or rigid layer, which provides characteristics such as friction, smoothness, resistance to vehicle loads, and drainage. In addition, the surface course minimizes infiltration of surface water into the underlying base, subbase and subgrade. A surface course may be composed of a single layer with one or multiple lifts, or multiple layers of differing materials.

(55) *Tie Bars*. Deformed reinforcing bars placed at intervals that hold rigid pavement slabs in adjoining lanes and exterior lane-to-shoulder joints together and prevent differential vertical and lateral movement.

62.8 Highway Operations

(1) *Annual Average Daily Traffic*. The average 24-hour volume, being the total number during a stated period divided by the number of days in that period. Unless otherwise stated, the period is a year. The term is commonly abbreviated as ADT or AADT.

(2) *Delay*. The time lost while road users are impeded by some element over which the user has no control.

(3) *Density*. The number of vehicles per mile on the traveled way at a given instant.

(4) *Design Vehicles*. See Topic 404.

(5) *Design Volume*. A volume determined for use in design, representing traffic expected to use the highway. Unless otherwise stated, it is an hourly volume.

(6) *Diverging*. The dividing of a single stream of traffic into separate streams.

(7) *Headway*. The time in seconds between consecutive vehicles moving past a point in a given lane, measured front to front.

(8) *Level of Service*. A rating using qualitative measures that characterize operational conditions within a traffic stream and their perception by users.

July 1, 2020

- (9) *Managed Lanes.* Lanes that are proactively managed in response to changing operating conditions in efforts to achieve improved efficiency and performance. Typically employed on highways with increasing recurrent traffic congestion and limited resources.
- (a) High-Occupancy Vehicle (HOV) Lanes--An exclusive lane for vehicles carrying the posted number of minimum occupants or carpools, either part time or full time.
 - (b) High Occupancy Toll (HOT) Lanes--An HOV lane that allows vehicles qualified as carpools to use the facility without a fee, while vehicles containing less than the required number of occupants to pay a toll. Tolls may change based on real time conditions (dynamic) or according to a schedule (static).
 - (c) Express Toll Lanes--Facilities in which all users are required to pay a toll, although HOVs may be offered a discount. Tolls may be dynamic or static.
- (10) *Merging.* The converging of separate streams of traffic into a single stream.
- (11) *Running Time.* The time the vehicle is in motion.
- (12) *Spacing.* The distance between consecutive vehicles in a given lane, measured front to front.
- (13) *Speed.*
- (a) Design Speed--A speed selected to establish specific minimum geometric design elements for a particular section of highway or bike path.
 - (b) Operating Speed--The speed at which drivers are observed operating their vehicles during free-flow conditions. The 85th percentile of the distribution of a representative sample of observed speeds is used most frequently to measure the operating speed associated with a particular location or geometric feature.
 - (c) Posted Speed--The speed limit determined by law and shown on the speed limit sign.
 - (d) High Speed – A speed greater than 45 mph.
 - (e) Low Speed – A speed less than or equal to 45 mph.
 - (f) Running Speed--The speed over a specified section of highway, being the distance divided by running time. The average for all traffic, or component thereof, is the summation of distances divided by the summation of running times.
- (14) *Traffic.* A general term used throughout this manual referring to the passage of people, vehicles and/or bicycles along a transportation route.
- (15) *Traffic Control Devices.*
- (a) Markings--All pavement and curb markings, object markers, delineators, colored pavements, barricades, channelizing devices, and islands used to convey regulations, guidance, or warning to users.
 - (b) Sign--Any traffic control device that is intended to communicate specific information to users through a word, symbol and/or arrow legend. Signs do not include highway traffic signals or pavement markings, delineators, or channelizing devices.
 - (c) Highway Traffic Signal--A power-operated control device by which traffic is warned or directed to take a specific action. These devices do not include signals at toll plazas, power-operated signs, illuminated pavement markers, warning lights, or steady burning electrical lamps.

- (d) **Changeable Message Sign**--An electronic traffic sign used on roadways to give travelers information about traffic congestion, accidents, roadwork zones, speed limits or any dynamic information about current driving conditions.
- (16) **Volume**. The number of vehicles passing a given point during a specified period of time.
- (17) **Weaving**. The crossing of traffic streams moving in the same general direction accomplished by merging and diverging.
- (18) **Ramp Metering**. A vehicular traffic management strategy which utilizes a system of traffic signals on freeway entrance and connector ramps to regulate the volume of vehicles entering a freeway corridor in order to maximize the efficiency of the freeway and thereby minimizing the total delay in the transportation corridor.

62.9 Drainage

See Chapter 800 for definition of drainage terms.

62.10 Users

- (1) **Bicycle**. A device propelled via chain, belt or gears, exclusively by human power.
- (2) **Bus**. Any vehicle owned or operated by a publicly owned or operated transit system, or operated under contract with a publicly owned or operated transit system, and used to provide to the general public, regularly scheduled transportation for which a fare is charged. A general public paratransit vehicle is not a transit bus.
- (3) **Bus Rapid Transit (BRT)**. A flexible rubber-tired rapid-transit mode that combines stations, vehicles, services, exclusive running ways, and Intelligent Transportation System elements into an integrated system with a strong positive identity that evokes a unique image.
- (4) **Commuter Rail**. Traditional rapid and heavy rail passenger service intended to provide travel options in suburban and urban areas. Corridor lengths are typically shorter than intercity passenger rail services. Top operating speeds are in the range of 90 to 110 miles per hour. The tracks may or may not be shared with freight trains and typically are in a separate right of way.
- (5) **Conventional Rail**. Traditional intercity passenger rail and interregional freight rail. Top operating speeds are in the range of 60 to 110 miles per hour. The tracks may or may not be shared by passenger and freight trains and typically run within their own right of way corridor.
- (6) **Design Vehicle**. The largest vehicle commonly expected on a particular roadway. Descriptions of these vehicles are found in Index 404.4.
- (7) **Equestrian**. A rider on horseback.
- (8) **High Speed Rail**. A type of intercity and interregional passenger rail service that operates significantly faster than conventional rail. Top operating speeds are typically 150 to 220 miles per hour. These trains may be powered by overhead high voltage lines or technologies such as Maglev. The tracks are grade separated within a separate controlled access right of way and may or may not be shared with freight trains.
- (9) **Light Rail**. A form of urban transit that uses rail cars on fixed rails in a right of way that may or may not be grade separated. Motorized vehicles and bicycles may share the same transportation corridor. These railcars are typically electrically driven with power supplied from an overhead line rather than an electrified third rail. Top operating speeds are typically 60 miles per hour.

July 1, 2020

- (10) *Pedestrian*. A person who is afoot or who is using any of the following: (a) a means of conveyance propelled by human power other than a bicycle, or (b) an electric personal assistive mobility device. Includes a person who is operating a self-propelled wheelchair, motorized tricycle, or motorized quadricycle and, by reason of physical disability, is otherwise unable to move about as a pedestrian as specified in part (a) above.
- (11) *Street Car, Trams or Trolley*. A passenger rail vehicle which runs on tracks along public urban streets and also sometimes on separate rights of way. It may also run between cities and/or towns, and/or partially grade separated structures.
- (12) *Transit*. Includes light rail; commuter rail; motorbus; street car, tram, trolley bus; BRT; automated guideway; and demand responsive vehicles. The most common application is for motorbus transit. See Index 404.4 for a description of the design vehicle as related to buses.
- (13) *Vehicle*. A device to move, propel or draw a person upon a highway, except a device on rails or propelled exclusively by human power. This definition, abstracted from the CVC, is intended to refer to motor vehicles, excluding those devices necessary to provide mobility to persons with disabilities.

CHAPTER 80 – APPLICATION OF DESIGN STANDARDS

Topic 81 – Project Development Overview

Index 81.1 – Philosophy

The Project Development process seeks to provide a degree of mobility to users of the transportation system that is in balance with other values. In the development of transportation projects, social, economic, and environmental effects must be considered fully along with technical issues so that final decisions are made in the best overall public interest. Attention should be given to such considerations as:

- (a) Need to provide transportation for all users (motorists, bicyclists, transit riders, and pedestrians) of the facility and transportation modes.
- (b) Attainment of community goals and objectives.
- (c) Needs of low mobility and disadvantaged groups.
- (d) Costs and benefits of eliminating or minimizing adverse effects on natural resources, environmental values, public services, aesthetic values, and community and individual integrity.
- (e) Planning based on realistic financial estimates.
- (f) The cost, ease, and safety of maintaining whatever is built.

Proper consideration of these items requires that a facility be viewed from the perspectives of the user, the nearby community, and larger statewide interests. For the user, efficient travel, mode selection, and safety are paramount concerns. At the same time, the community often is more concerned about local aesthetic, social, and economic impacts. The general population, however, tends to be interested in how successfully a project functions as part of the overall transportation system and how large a share of available capital resources it consumes. Therefore, individual projects must be selected for construction on the basis of overall system benefits as well as community goals, plans, and values.

Decisions must also emphasize the connectivity between the different transportation modes so that they work together effectively.

The goal is to increase person and goods throughput, highway mobility and safety in a manner that is compatible with, or which enhances, adjacent community values and plans.

81.2 Highway Context

The context of a highway is a critical factor when developing the purpose and need statement for a project in addition to making fundamental design decisions such as its typical cross section and when selecting the design elements and aesthetic features such as street furniture and construction materials. Designing a highway that is sensitive to, and respectful

July 1, 2020

of, the surrounding context is critical for project success in the minds of the Department and our stakeholders.

A “one-size-fits-all” design philosophy is not Departmental policy. Designers need to be aware of and sensitive to land use, community context and the associated user needs of the facility. In some instances, the design criteria and standards in this manual are based on the land use contexts in which the State highway is located, for instance: large population areas and downtowns in urban areas, small rural towns and communities, suburban commercial/residential areas, and rural corridors. This approach ensures the standards are flexible, and the approach allows and encourages methods to minimize impacts on scenic, historic, archaeological, environmental, and other important resources.

Beyond their intended transportation benefits, State highways can significantly impact the civic, social and economic conditions of local communities. Designing transportation facilities that integrate the local transportation and land uses while making the design responsive to the other needs of the community support the livability of the community and are usually a complementary goal to meeting the transportation needs of the users of the State highway system.

To do this successfully, the designer needs to have an understanding of the area surrounding the highway and the users of the highway, its function within the regional and State transportation systems, (which includes all transportation modes), and the level of access control needed. To gain this understanding, the designer must consult the Transportation Concept Reports and work with the planning division and the local agencies.

In this manual, the following concepts are used to discuss the context of a highway:

- Place Type - the surrounding built and natural environment;
- Type of Highway - the role the highway plays in terms of providing regional or interregional connectivity and local access; and,
- Access Control - the degree of connection or separation between the highway and the surrounding land use.

A “Main Street” design is not specific to a certain place type, but is a design philosophy to be applied on State highways that also function as community streets. A “Main Street” design serves pedestrians, bicyclists, businesses and public transit with motorized traffic operating at speeds of 20 to 40 miles per hour. See the Department’s “Main Street, California” document for more information.

81.3 Place Types

A place type describes the area’s physical environment and the land uses surrounding the State highway. The place types described below are intentionally broad. Place types should be agreed upon in partnership with all of the project stakeholders; however, there likely may be more than one place type within the limits of a project. Ultimately, the place types selected can be used to determine the appropriate application of the guidance provided in this manual. These place type definitions are independent of the Federal government definitions of urban and rural areas. See Title 23 United States Code, Section 13 for further information.

Identifying the appropriate place type(s) involves discussions with the project sponsors, ideally through the Project Development Team (PDT) process, and requires coordination with the land use planning activities associated with the on-going local and regional planning activities. Extensive community engagement throughout both the project planning and project development processes helps to formulate context sensitive project alternatives and transportation facilities that coordinate with the local land uses.

The following place types are used in this manual:

(1) *Rural Areas*. Rural areas are typically sparsely settled and developed. They can consist of protected federal and State lands, agricultural lands, and may include tourist and recreational destinations. However, as rural lands transition into rural communities, they can become more developed and suburban and urban-like by providing for a mixture of housing, commercial, industrial and public institutions. For the use of this manual, rural areas have been subcategorized as Natural Corridors, Developing Corridors and City/Town Centers (Rural Main Streets).

(a) *Natural Corridors*. Typically, the desire in these corridors is to preserve the natural and scenic countryside while at the same time provide transportation services to support the travel and tourism that occurs when visiting these locations. Examples of this place type are: National/State Forests and Parklands; agricultural lands with scattered farm buildings and residences; and, low density development. See Topic 109 for additional information.

(b) *Developing Corridors*. State highways traveling through these lands tend to be increasingly clustered with industrial, commercial, and residential areas as they lead into a rural city or town center. These corridors can be a transition zone among the aforementioned areas. Highways associated with these locations help to deliver tourists, but they also need to support the local communities and their local economies. In addition, these highways also serve a role and should be efficient at moving people and goods between regions.

Industrial, commercial and retail buildings tend to be located separately from housing and are typically set back from the highway with parking areas placed in front. Truck traffic on these highways tends to serve the needs of these industrial, commercial and retail buildings; however, there will be a component of the truck traffic that is transporting their loads inter-regionally. Therefore, corridors in areas that are in transition may need to accommodate design vehicles.

(c) *City or Town Centers (Rural Main Streets)*. State highways in this scenario are usually a conventional main street through the rural city or town, or they may be the only main street. The use of the State highway in this environment varies depending upon the individual community, as does the mix of buildings, services, businesses, and public spaces. Transit is often present and should be incorporated into the transportation system as appropriate. Transportation improvement projects on these main street highways can be more complicated and costly than similar projects in more rural settings. A balance usually needs to be maintained between the needs of the through traffic and those of the local main street environment. Thus, analyzing the pedestrian and bicyclist needs early in the development of the project and then following through on the agreements during the design of highway projects in these locations can be especially important. Accommodating the pedestrian and bicyclist needs concurrently in projects leads to greater efficiency in the use of funding.

(2) *Suburban Areas*. Suburban areas lead into and can completely surround urban areas. A mixture of land uses is typical in suburban areas. This land use mixture can consist of housing, retail businesses and services, and may include regional centers such as

July 1, 2020

shopping malls and other similar regional destinations; which are usually associated with suburban communities (cities and towns) that can be connected with larger urban centers and cities. Assessing the needs of pedestrians, bicyclists, and transit users in concert with the vehicular needs of motorists and truck drivers is necessary during the project planning, development and design of highway projects in these locations. Accommodating all of these needs concurrently into a project leads to greater efficiency in the use of funding. For the use of this manual, suburban areas have been categorized as either Lower Density/Residential Neighborhoods or Higher Density/Regional Community Centers (Suburban Main Streets).

- (a) Lower Density / Residential Neighborhoods. State highways typically do not cross through this place type. This place type usually feeds users onto the State highway system and is typically under the jurisdiction of a local entity. State highways, if they do interact with this place type, usually just connect at the edges of them where the pedestrians, bicyclists, and motor vehicle operators integrate into the highway system that includes transit facilities.
 - (b) Higher Density / Regional Community Centers (Suburban Main Streets). As suburban areas grow they tend to merge together into each other's boundaries. Growth in some locations can create "Megacommunities." While these megacommunities seem to function as individual cities, they typically have multiple distinct community centers that require highways with the capacity to serve not only each center, but the center-to-center traveler needs. These areas typically require the State highway to serve not only the originally urbanized area, but also the newer suburban areas that have been created where the housing, shopping and employment opportunities are all centered. Anticipating and accommodating growth in this place type can be a challenge. State and local governments, the business community and citizens groups, and metropolitan planning organizations all need to agree on how to meet the community needs, and at times the interregional needs of the highway.
- (3) *Urban and Urbanized Areas*. Urban areas generally are the major population centers in the State. Large numbers of people live in these urbanized areas where growth is expected to continue. Bicycling, transit, and walking are important transportation modes in these areas and as the facilities for pedestrians, transit and bicyclists expand in these areas, the percentage and number of travelers walking, using transit and bicycling is also likely to increase. State agencies and the local governmental entities, the business community and citizens groups, congestion management agencies and the local/regional metropolitan planning organization (MPO) need to all agree upon the concept of the transportation facilities being provided so that the community needs can be met.

Urban areas are typically high-density locations such as central business districts, downtown communities, and major activity centers. They have a full range of land uses and are associated with a large diversity of activities. For the use of place types in this manual, urban areas have been categorized as Lower Density Parklands and Residential Neighborhoods and Higher Density Urban Main Streets. Higher Density Urban Main Streets have been further characterized as Community Centers and Downtown Cores.

- (a) Lower Density Parklands and Residential Neighborhoods. Large numbers of people live in these urbanized areas and bicycling, transit and walking are important transportation modes in these areas. Parklands can enhance these neighborhoods and parkland preservation is a concern, as well as, access to support travel and tourism to the parklands.

(b) High Density Urban Main Streets.

- Community Centers or Corridor. Strategically improving the design and function of the existing State highways that cross these centers is typically a concern. Providing transportation options to enhancing these urban neighborhoods that combine highway, transit, passenger rail, walking, and biking options are desirable, while they also help promote tourism and shopping.
- Downtown Cores. Similar to community centers, much of the transportation system has already been built and its footprint in the community needs to be preserved while its use may need to be reallocated. Successfully meeting the mobility needs of a major metropolitan downtown core area requires a balanced approach. Such an approach is typically used to enhance the existing transportation network's performance by adding capacity to the highways, sidewalks, and transit stations for all of the users of the system, and/or adding such enhancement features as HOV lanes, BRT, walkable corridors, etc. Right of way is limited and costly to purchase in these locations. Delivery truck traffic that supports the downtown core businesses can also create problems.

The HEPGIS tool on the FHWA website is available to determine if the project is in an urban area. Urban areas are found on the Highway Information tab of the tool.

81.4 Type of Highway

Much of the following terminology is either already discussed in Chapter 20 or defined in Topic 62. The additional information in this portion of the manual is being provided to connect these terms with the guidance that is being provided.

(1) *Functional Classification.* One of the first steps in the highway design process is to define the function that the facility is to serve. The two major considerations in functionally classifying a highway are access and throughput. Access and mobility are inversely related; as access is increased, mobility decreases. In the AASHTO "A Policy on Geometric Design of Highways and Streets", highways are functionally classified first as either urban or rural. The hierarchy of the functional highway system within either an urban or rural area consists of the following:

- Principal arterial - main movement (high mobility, limited access) Typically 4 lanes or more;
- Minor arterial - interconnects principal arterials (moderate mobility, limited access) Typically 2 or 3 lanes with turn lanes to benefit through traffic;
- Collectors - connects local roads to arterials (moderate mobility, moderate access) with few businesses; and,
- Local roads and streets - permits access to abutting land (high access, limited mobility).

The California Road System (CRS) maps are the official functional classification maps approved by Federal highway Administration. These maps show functional classification of roads.

(2) *Interstate Highways.* The interstate highway system was originally designed to be high-speed interregional connectors and it is a portion of the National Highway System (NHS). In urban and suburban areas, a large percentage of vehicular traffic is carried on the interstate highway system, rather than on the local arterials and streets.

July 1, 2020

(3) *State Routes*. The State highway system is described in the California Streets and Highway Code, Division 1, Chapter 2 and they are further defined in this manual in Topic 62.3, Highway Types which provides definitions for freeways, expressways, and highways.

81.5 Access Control

Index 62.3 defines a controlled access highway and a conventional highway. The level of access control plays a part in determining the design standards that are to be utilized when designing a highway. See Index 405.6 for additional access control guidance.

81.6 Design Standards and Highway Context

The design standards were initially established to increase highway mobility and development, promoting a State transportation system that operated at selected levels of service consistent with projected traffic volumes and highway classification. Design standards revolved around FHWA's controlling criteria, evolving over time to more fully consider adjacent community values, local decisions making, and area context.

The design guidance and standards in this manual have been developed with the intent of ensuring that:

- Designers have the ability to design for all modes of travel (vehicular, bicycle, pedestrian, truck and transit); and,
- Designers have the flexibility to tailor a project to the unique circumstances that relate to it and its location, while meeting driver expectation to achieve established project goals.

Designers should balance the interregional transportation needs with the needs of the communities they pass through. The design of projects should, when possible, expand the options for biking, walking, and transit use. In planning and designing projects, the project development team should work with locals that have any livable policies as revitalizing urban centers, building local economies, and preserving historic sites and scenic country roads. The "Main Streets: Flexibility in Planning, Design and Operations" published by the Department should be consulted for additional guidance as should the FHWA publication "Flexibility in Highway Design".

Early consultation and discussion with the Project Delivery Coordinator and the District Design Liaison during the Project Initiation Document (PID) phase is also necessary to avoid issues that may arise later in the project development process. Design Information Bulletin 78 "Design Checklist for the Development of Geometric Plans" is a tool that can be used to identify and discuss design features that may deviate from standard.

Topic 82 – Application of Standards

82.1 Highway Design Manual Standards

(1) *General*. The highway design criteria and policies in this manual provide a guide for the engineer to exercise sound judgment in applying standards, consistent with the above Project Development philosophy, in the design of projects. This guidance allows for

flexibility in applying design standards and documenting design decisions that take the context of the project location into consideration; which enables the designer to tailor the design, as appropriate, for the specific circumstances while maintaining safety.

The design standards used for any project should equal or exceed the minimum given in the Manual to the maximum extent feasible, taking into account costs (initial and life-cycle), traffic volumes, traffic and safety benefits, project goals, travel modes, facility type, right of way, socio-economic and environmental impacts, maintenance, etc. Because design standards have evolved over many years, many existing highways do not conform fully to current standards. It is not intended that current manual standards be applied retroactively to all existing State highways; such is neither warranted nor economically feasible. However, when warranted, upgrading of existing roadway features such as guardrail, lighting, superelevation, roadbed width, etc., should be considered, either as independent projects or as part of larger projects. A record of the decision not to upgrade existing non-standard design features are to be provided through the process described in Index 82.2.

This manual does not address temporary construction features. It is recognized that the construction conditions encountered are so diverse and variable that it is not practical to set geometric criteria. Guidance for use of traffic control devices for temporary construction zones can be found in Part 6 – Temporary Traffic Control of the California Manual on Uniform Traffic Control Devices (California MUTCD). Guidance for the engineering of pavements in temporary construction zones is available in Index 612.6. In this manual, design standards and guidance are described as follows (see Index 82.4 for other procedural requirements):

- (2) *Absolute Requirements.* Design guidance related to requirements of law, policy, or statute that do not allow exception are phrased by the use of “must,” “is required,” “without exception,” “are to be,” “is to be,” “in no event,” or a combination of these terms.
- (3) *Controlling Criteria.* The FHWA has designated the following ten controlling criteria for projects on the National Highway System (NHS) as comprehensive design standards which cover a multitude of design characteristics, allowing flexibility in application:
 - Design Speed
 - Lane Width
 - Shoulder Width
 - Horizontal Curve Radius
 - Superelevation Rate
 - Stopping Sight Distance
 - Maximum Grade
 - Cross Slope
 - Vertical Clearance
 - Design Loading Structural Capacity (non-geometric)

Design loading structural capacity criteria applies to all NHS facility types. See the Technical Publications – DES Manuals for further information.

July 1, 2020

The remaining geometric criteria listed above are applicable to the NHS as follows: (1) On high-speed roadways (Interstate highways, other freeways, and roadways with design speeds of greater than or equal to 50 mph), all the geometric criteria apply. The stopping sight distance criteria applies to horizontal alignments and vertical alignments except for sag vertical curves; and (2) On low-speed roadways (non-freeways with design speeds less than 50 mph), only the design speed criteria applies.

The two speed categories stated above that FHWA designates match the high- and low-speed definitions in Index 62.8(13) when considering that design speed and posted speed are set in 5 mph increments.

The design standards related to the geometric criteria are identified in Table 82.1A among other important geometric standards in this manual regardless of the design speed of the roadway and whether or not the roadway is part of the NHS.

- (4) *Standards.* Design standards are those considered most essential to achievement of overall design objectives. Many pertain to requirements of law or regulations such as those embodied in the FHWA's ten controlling criteria (see Index 82.1(3)). In addition to the FHWA's ten controlling criteria are "Caltrans-only" standards that have been identified by Caltrans as most essential pertaining to requirements of State law, policy or objectives. The design standards are shown in this manual as either **Boldface** type (listed in Table 82.1A) or Underlined type (listed in Table 82.1B) to indicate the approval authority for nonstandard design according to Index 82.2.
- (5) *Decision Requiring Other Approvals.* There are design criteria decisions that are not bold or underlined text which require specific approvals from individuals to whom such decisions have been delegated. These individuals include, but are not limited to, District Directors, Project Delivery Coordinators or their combination as specified in this manual. These decisions should be documented as the individual approving desires.
- (6) *Permissive Standards.* All guidance other than absolute requirements, standards, or decisions requiring other approvals, whether indicated by the use of "should", "may", or "can" are permissive.
- (7) *Other Caltrans Publications.* In addition to the design standards in this manual, see Index 82.7 for general information on the Department's traffic engineering policy, standards, practices and study warrants.

Caution must be exercised when using other Caltrans publications which provide guidelines for the design of highway facilities, such as HOV lanes. These publications do not contain design standards; moreover, the designs suggested in these publications do not always meet Highway Design Manual Standards. Therefore, all other Caltrans publications must be used in conjunction with this manual.

- (8) *Transportation Facilities Under the Jurisdiction of Others.* Generally, if the local road or street is a Federal-aid route it should conform to AASHTO standards; see Topic 308 – Cross Sections for Roads Under Other Jurisdictions. Occasionally though, projects on the State highway system involve work on adjacent transportation facilities that are under the jurisdiction of cities and counties. Some of these local jurisdictions may have published standards for facilities that they own and operate. The guidance in this manual may be applicable, but it was prepared for use on the State highway system. Thus, when project work impacts adjacent transportation facilities that are under the jurisdiction of cities and counties, local standards and AASHTO guidance must be used in conjunction with this manual to encourage designs that are sensitive to the local context and community values. Agreeing on which standards will be used needs to be decided early in the project delivery process and on a project by project basis.

82.2 Approvals for Nonstandard Design

(1) ***Boldface Standards.*** Design features or elements which deviate from standards indicated in boldface type require the approval of the Chief, Division of Design. This approval authority has been delegated to the District Directors for projects on conventional highways and expressways, and for certain other facilities in accordance with the current District Design Delegation Agreement. Approval authority for design standards indicated in boldface type on all other facilities has been delegated to the Project Delivery Coordinators except as noted in Table 82.1A where: (a) the standard has been delegated to the District Director, (b) the standards in Chapters 600 through 670 requires the approval of the State Pavement Engineer, and (c) specifically delegated to the District Director per the current District Design Delegation Agreements and may involve coordination with the Project Delivery Coordinator. See the HQ Division of Design website for the most current District Design Delegation Agreements.

The current procedures and documentation requirements pertaining to the approval process for deviation from design standards indicated in boldface type as well as the dispute resolution process are contained in Chapter 21 of the Project Development Procedures Manual (PDPM).

Design exception approval must be obtained pursuant to the instructions in PDPM Chapter 9.

The Moving Ahead for Progress in the 21st Century Act (MAP-21) of 2012 allowed significant delegation to the states by FHWA to approve and administer portions of the Federal-Aid Transportation Program. MAP-21 further allowed delegation to the State DOT's and in response to this a Stewardship and Oversight Agreement (SOA) document between FHWA and Caltrans was signed. The SOA outlines the process to determine specific project related delegation to Caltrans. In general, the SOA delegates approval of deviations from design standards related to the ten controlling criteria on all Interstate projects whether FHWA has oversight responsibilities or not to Caltrans. Exceptions to this delegation would be for projects of FHWA Division Interest, which are determined on a project by project basis. See Index 43.2 for additional information. Consultation with FHWA should be sought as early in the project development process as possible. However, formal FHWA approval, if applicable, shall not be requested until the appropriate Caltrans representative has approved the design decision document.

FHWA approval is not required for deviations from "Caltrans-only" standards. Table 82.1A identifies these "Caltrans-only" standards. Where FHWA approval of a deviation from a design standard is required, only cite the standards that are identified by the FHWA as ten controlling criteria, see Index 82.1(3).

For local facilities crossing the State right of way see Index 308.1.

(2) ***Underlined Standards.*** The authority to approve deviations from standards indicated in underlined type has been delegated to the District Directors. A list of these standards is provided in Table 82.1B. Proposals for deviations from these standards can be discussed with the District Design Liaison during development of the approval documentation. The responsibility for the establishment of procedures for review, documentation, and long term retention of approved design decisions from these standards has also been delegated to the District Directors.

(3) ***Decisions Requiring Other Approvals.*** The authority to approve specific decisions identified in the text are also listed in Table 82.1C. The form of documentation or other instructions are provided as directed by the approval authority.

July 1, 2020

- (4) *Permissive Standards.* A record of deviation from permissive standards and the disclosure of the engineering decisions in support of the deviation should be documented and placed in the project file. This principle of documentation also applies when following other Division of Design guidance, e.g., Design Information Bulletins and Design Memos. The form of documentation and other instructions on long term retention of these engineering decisions are to be provided as directed by the District approval authority.
- (5) *Local Agencies.* Cities and counties are responsible for the design decisions they make on transportation facilities they own and operate. The responsible local entity is delegated authority to exercise their engineering judgment when utilizing the applicable design guidance and standards, including those for bicycle facilities established by Caltrans pursuant to the Streets and Highways Code Sections 890.6 and 890.8 and published in this manual. For further information on this delegation and the delegation process, see the Caltrans Local Assistance Procedures Manual, Chapter 11.

82.3 FHWA and AASHTO Standards and Policies

The standards in this manual generally conform to the standards and policies set forth in the AASHTO publications, "A Policy on Geometric Design of Highways and Streets" (2018) and "A Policy on Design Standards-Interstate System" (2016). A third AASHTO publication, the latest edition of the "Roadside Design Guide", focuses on creating safer roadsides. These three documents, along with other AASHTO and FHWA publications cited in 23 CFR Ch 1, Part 625, Appendix A, contain most of the current AASHTO policies and standards, and are approved references to be used in conjunction with this manual.

AASHTO policies and standards, which are established as nationwide standards, do not always satisfy California conditions. When standards differ, the instructions in this manual govern, except when necessary for FHWA project approval (Index 108.7, Coordination with the FHWA).

The use of publications and manuals that are developed by organizations other than the FHWA and AASHTO can also provide additional guidance not covered in this manual. The use of such guidance coupled with sound engineering judgment is to be exercised in collaboration with the guidance in this manual.

82.4 Mandatory Procedural Requirements

Required procedures and policies for which Caltrans is responsible, relating to project clearances, permits, licenses, required tests, documentation, value engineering, etc., are indicated by use of the word "must". Procedures and actions to be performed by others (subject to notification by Caltrans), or statements of fact are indicated by the word "will".

82.5 Effective Date for Implementing Revisions to Design Standards

Revisions to design standards will be issued with a stated effective date. It is understood that all projects will be designed to current standards unless a design decision has been approved in accordance with Index 82.2 or otherwise noted by separate Design Memorandum.

On projects where the project development process has started, the following conditions on the effective date of the new or revised standards will be applied: For all projects where the PS&E has not been finalized, the new or revised design standards shall be incorporated unless this would impose a significant delay in the project schedule or a significant increase in the project engineering or construction costs. The Project Delivery Coordinator or individual delegated authority must make the final determination on whether to apply the new or previous design standards on a project-by-project basis for roadway features.

- For all projects where the PS&E has been submitted to Headquarters Office Engineer for advertising or the project is under construction, the new or revised standards will be incorporated only if they are identified in the Change Transmittal as requiring special implementation.

For locally-sponsored projects, the Oversight Engineer must inform the funding sponsor within 15 working days of the effective date of any changes in design standards as defined in Index 82.2.

82.6 Design Information Bulletins and Other Caltrans Publications

In addition to the design standards in this manual, Design Information Bulletins (DIBs) establish policies and procedures for the various design specialties of the Department that are in the Division of Design. Some DIBs may eventually become part of this manual, while others are written with the intention to remain as design guidance in the DIB format. References to DIBs are made in this manual by the “base” DIB number only and considered to be the latest version available on the Department Design website. See the Department Design website for further information concerning DIB numbering protocol and postings.

Caution must be exercised when using other Caltrans publications, which provide guidelines for the design of highway facilities, such as HOV lanes. These publications do not contain design standards; moreover, the designs suggested in these publications do not always meet Highway Design Manual Standards. Therefore, all other Caltrans publications must be used in conjunction with this manual.

82.7 Traffic Engineering

The Division of Traffic Operations maintains engineering policy, standards, practices and study warrants to direct and guide decision-making on a broad range of design and traffic engineering features and systems, which are provided to meet the site-specific safety and mobility needs of all highway users.

The infrastructure within a highway or freeway corridor, segment, intersection or interchange is not “complete” for drivers, bicyclists and pedestrians unless it includes the appropriate traffic control devices; traffic safety systems; operational features or strategies; and traffic management elements and or systems. The presence or absence of these traffic elements and systems can have a profound effect on safety and operational performance. As such, they are commonly employed to remediate performance deficiencies and to optimize the overall performance of the “built” highway system. For additional information visit the Division of Traffic Operations website at <http://www.dot.ca.gov/trafficops/>.

July 1, 2020

Table 82.1A**Boldface Standards**

CHAPTER 100	BASIC DESIGN POLICIES
Topic 101	Design Speed
Index 101.1	Technical Reductions of Design Speed
101.1	Selection of Design Speed - Local Facilities
101.1	Selection of Design Speed - Local Facilities - with Connections to State Facilities
101.2	Design Speed Standards
Topic 104	Control of Access
Index 104.4	Protection of Access Rights ⁽¹⁾
CHAPTER 200	GEOMETRIC DESIGN AND STRUCTURE STANDARDS
Topic 201	Sight Distance
Index 201.1	Stopping Sight Distance Standards
Topic 202	Superelevation
Index 202.2	Standards for Superelevation
202.7	Superelevation on City Streets and County Roads
Topic 203	Horizontal Alignment
Index 203.1	Horizontal Alignment - Local Facilities
203.1	Horizontal Alignment and Stopping Sight Distance
203.2	Standards for Curvature – Minimum Radius
203.2	Standards for Curvature – Lateral Clearance
Topic 204	Grade
Index 204.1	Standards for Grade - Local Facilities

Design exception approval of Boldface Standards for nonfreeway facilities, including local streets and roads at interchanges, has been delegated to the Districts. In addition, some District delegations included Boldface Standards applicable to freeways. See your District Design Delegation Agreement for specific delegation.

(1) Caltrans-only Boldface Standard.

(2) Authority to approve deviations from this Boldface Standard is delegated to the State Pavement Engineer.

Table 82.1A**Boldface Standards (Cont.)**

204.3	Standards for Grade
204.8	Vertical Falsework Clearances ⁽¹⁾
Topic 205	Road Connections and Driveways
Index 205.1	Sight Distance Requirements for Access Openings on Expressways
Topic 208	Bridges, Grade Separation Structures, and Structure Approach Embankment
Index 208.1	Bridge Width ⁽¹⁾
208.4	Bridge Sidewalk (Width) ⁽¹⁾
208.10	Barriers on Structures with Sidewalks ⁽¹⁾
208.10	Bridge Approach Railings ⁽¹⁾
CHAPTER 300	GEOMETRIC CROSS SECTION
Topic 301	Traveled Way Standards
Index 301.1	Lane Width
301.2	Class II Bikeway Lane Width ⁽¹⁾
301.3	Cross Slopes – New Construction
301.3	Cross Slopes – Resurfacing or widening
301.3	Cross Slopes – Unpaved Roadway
301.3	Algebraic Differences in Cross Slopes
Topic 302	Shoulder Standards
Index 302.1	Shoulder Width
302.1	Shoulder Width with Rumble Strip
302.2	Shoulder Cross Slopes -Bridge
302.2	Shoulder Cross Slopes – Left
302.2	Shoulder Cross Slopes – Paved Median

Design exception approval of Boldface Standards for nonfreeway facilities, including local streets and roads at interchanges, has been delegated to the Districts. In addition, some District delegations included Boldface Standards applicable to freeways. See your District Design Delegation Agreement for specific delegation.

(1) Caltrans-only Boldface Standard.

(2) Authority to approve deviations from this Boldface Standard is delegated to the State Pavement Engineer.

July 1, 2020

Table 82.1A**Boldface Standards (Cont.)**

302.2	Shoulder Cross Slopes - Right
Topic 305	Median Standards
Index 305.1	Median Width – Conventional Highways ⁽¹⁾
305.1	Median Width – Freeways and Expressways ⁽¹⁾
Topic 307	Cross Sections for State Highways
Index 307.2	Shoulder Standards for Two-lane Cross Sections for New Construction
Topic 308	Cross Sections for Roads Under Other Jurisdictions
Index 308.1	Cross Section Standards for City Streets and County Roads without Connection to State Facilities
308.1	Minimum Width of 2-lane Over-crossing Structures for City Streets and County Roads without Connection to State Facilities ⁽¹⁾
308.1	Cross Section Standards for City Streets and County Roads with Connection to State Facilities
308.1	Two-Lane Local Road Lane Width for City Streets and County Roads within Interchange
308.1	Multi-Lane Local Road Lane Width for City Streets and County Roads within Interchange
308.1	Shoulder Width Standards for City Streets and County Roads Lateral Obstructions
308.1	Shoulder Width Standards for City Streets and County Roads with Curbs and Gutter
308.1	Minimum Width for 2-lane Overcrossing at Interchanges ⁽¹⁾
Topic 309	Clearances
Index 309.1	Horizontal Clearances and Stopping Sight Distance
309.1	Horizontal Clearances ⁽¹⁾
309.1	High Speed Rail Clearances – Minimum Shoulder Width

Design exception approval of Boldface Standards for nonfreeway facilities, including local streets and roads at interchanges, has been delegated to the Districts. In addition, some District delegations included Boldface Standards applicable to freeways. See your District Design Delegation Agreement for specific delegation.

(1) Caltrans-only Boldface Standard.

(2) Authority to approve deviations from this Boldface Standard is delegated to the State Pavement Engineer.

Table 82.1A**Boldface Standards (Cont.)**

309.2	Vertical Clearances - Minor Structures
309.2	Vertical Clearances - Rural and Single Interstate Routing System
309.3	Horizontal Tunnel Clearances ⁽¹⁾
309.3	Vertical Tunnel Clearances
309.4	Lateral Clearance for Elevated Structures ⁽¹⁾
309.5	Structures Across or Adjacent to Railroads - Vertical Clearance
Topic 310	Frontage Roads
Index 310.1	Frontage Road Width Cross Section
CHAPTER 400	INTERSECTIONS AT GRADE
Topic 404	Design Vehicles
Index 404.2	Design Vehicle–Traveled Way ⁽¹⁾
Topic 405	Intersection Design Standards
Index 405.2	Left-turn Channelization - Lane Width
405.2	Left-turn Channelization - Lane Width – Restricted Urban
405.2	Two-way Left-turn Lane Width
405.3	Right-turn Channelization – Lane and Shoulder Width
CHAPTER 500	TRAFFIC INTERCHANGES
Topic 501	General
Index 501.3	Interchange Spacing ⁽¹⁾
Topic 502	Interchange Types
Index 502.2	Isolated Off-Ramps and Partial Interchanges ⁽¹⁾
502.3	Route Continuity ⁽¹⁾

Design exception approval of Boldface Standards for nonfreeway facilities, including local streets and roads at interchanges, has been delegated to the Districts. In addition, some District delegations included Boldface Standards applicable to freeways. See your District Design Delegation Agreement for specific delegation.

(1) Caltrans-only Boldface Standard.

(2) Authority to approve deviations from this Boldface Standard is delegated to the State Pavement Engineer.

July 1, 2020

Table 82.1A**Boldface Standards (Cont.)**

Topic 504	Interchange Design Standards
Index 504.2	Location of Freeway Entrances & Exits ⁽¹⁾
504.2	Ramp Deceleration Lane and “DL” Distance ⁽¹⁾
504.3	Ramp Lane Width
504.3	Ramp Shoulder Width
504.3	Ramp Lane Drop Taper Past the Limit Line ⁽¹⁾
504.3	Metered Multi-Lane Ramp Lane Drop Taper Past the Limit Line ⁽¹⁾
504.3	Ramp Meters on Connector Ramps ⁽¹⁾
504.3	Metered Connector Lane Drop ⁽¹⁾
504.3	Distance Between Ramp Intersection and Local Road Intersection ⁽¹⁾
504.4	Freeway-to-freeway Connections – Shoulder Width – 1 and 2-Lane
504.4	Freeway-to-freeway Connections – Shoulder Width – 3-Lane
504.7	Minimum Entrance Ramp-to-Exit Ramp Spacing ⁽¹⁾
504.8	Access Control along Ramps ⁽¹⁾
504.8	Access Control at Ramp Terminal ⁽¹⁾
504.8	Access Rights Opposite Ramp Terminals ⁽¹⁾
CHAPTER 610	PAVEMENT ENGINEERING CONSIDERATIONS
Topic 612	Pavement Design Life
Index 612.2	Design Life for New Construction and Reconstruction ^{(1), (2)}
612.3	Pavement Design Life for Widening Projects ^{(1), (2)}

Design exception approval of Boldface Standards for nonfreeway facilities, including local streets and roads at interchanges, has been delegated to the Districts. In addition, some District delegations included Boldface Standards applicable to freeways. See your District Design Delegation Agreement for specific delegation.

(1) Caltrans-only Boldface Standard.

(2) Authority to approve deviations from this Boldface Standard is delegated to the State Pavement Engineer.

Table 82.1A**Boldface Standards (Cont.)**

612.5	Pavement Design Life for Pavement Roadway Rehabilitation Projects ^{(1), (2)}
Topic 613	Traffic Considerations
Index 613.5	Shoulder Traffic Loading Considerations ^{(1), (2)}
613.5	Depth of Shoulder Pavement Structural Section ^{(1), (2)}
CHAPTER 620	RIGID PAVEMENT
Topic 622	Engineering Requirements
Index 622.5	Transition Panels, Terminal Joints and End Anchors ^{(1), (2)}
Index 622.7	Dowel Bars and Tie Bars ^{(1), (2)}
Topic 625	Engineering Procedures for Pavement Rehabilitation
Index 625.2	Rigid Pavement Rehabilitation Strategies ^{(1), (2)}
Topic 626	Other Considerations
Index 626.2	Shoulder ^{(1), (2)}
626.2	Tied Rigid Shoulders or Widened Slab Standards ^{(1), (2)}
626.2	Tied Rigid Shoulders or Widened Slab at Ramps and Gore Standard ^{(1), (2)}
CHAPTER 630	FLEXIBLE PAVEMENT
Topic 635	Engineering Procedures for Flexible Pavement Rehabilitation
Index 635.2	Limits of Paving on Resurfacing Projects ^{(1), (2)}
CHAPTER 700	MISCELLANEOUS STANDARDS
Topic 701	Fences

Design exception approval of Boldface Standards for nonfreeway facilities, including local streets and roads at interchanges, has been delegated to the Districts. In addition, some District delegations included Boldface Standards applicable to freeways. See your District Design Delegation Agreement for specific delegation.

(1) Caltrans-only Boldface Standard.

(2) Authority to approve deviations from this Boldface Standard is delegated to the State Pavement Engineer.

July 1, 2020

Table 82.1A**Boldface Standards (Cont.)**

Index 701.2	Fences on Freeways and Expressways ⁽¹⁾
CHAPTER 900	LANDSCAPE ARCHITECTURE
Topic 904	Planting Design
Index 904.9	Plant Establishment
Topic 905	Irrigation Design
Index 905.2	Water Supply
Topic 912	Roadside Site Design
Index 912.1	Freeway Ramp Design
Topic 913	Safety Roadside Rest Areas
Index 913.5	Public Pay Telephone
CHAPTER 1000	BICYCLE TRANSPORTATION DESIGN
Topic 1003	Design Criteria
Index 1003.1	Class I Bikeway Widths ⁽¹⁾
1003.1	Class I Bikeway Shoulder Width ⁽¹⁾
1003.1	Class I Bikeway Horizontal Clearance ⁽¹⁾
1003.1	Class I Bikeway Structure Width ⁽¹⁾
1003.1	Class I Bikeway Vertical Clearance ⁽¹⁾
1003.1	Class I Bikeway Minimum Separation From Edge of Traveled Way ⁽¹⁾
1003.1	Physical Barriers Adjacent to Class I Bikeways ⁽¹⁾
1003.1	Class I Bikeway in Freeway Medians ⁽¹⁾
1003.1	Class I Bikeway Design Speeds ⁽¹⁾
1003.1	Stopping Sight Distance

Design exception approval of Boldface Standards for nonfreeway facilities, including local streets and roads at interchanges, has been delegated to the Districts. In addition, some District delegations included Boldface Standards applicable to freeways. See your District Design Delegation Agreement for specific delegation.

(1) Caltrans-only Boldface Standard.

(2) Authority to approve deviations from this Boldface Standard is delegated to the State Pavement Engineer.

Table 82.1B**Underlined Standards**

1003.1	Bikeway Shoulder Slope ⁽¹⁾
1003.1	Obstacle Posts or Bollards in Bicycle Paths ⁽¹⁾
CHAPTER 1100	HIGHWAY TRAFFIC NOISE ABATEMENT
Topic 1102	Design Criteria
Index 1102.2	Horizontal Clearance to Noise Barrier ⁽¹⁾
1102.2	Noise Barrier on Safety Shape Concrete Barrier ⁽¹⁾
CHAPTER 100	BASIC DESIGN POLICIES
Topic 101	Design Speed
Index 101.1	Selection of Design Speed – Local Facilities
101.1	Selection of Design Speed – Local Facilities – with Connections to State Facilities
101.2	Design Speed Standards
Topic 104	Control of Access
Index 104.5	Relation of Access Opening to Median Opening
Topic 105	Pedestrian Facilities
Index 105.2	Minimum Sidewalk Width – Next to a Building
105.2	Minimum Sidewalk Width – Not Next to a Building
105.5	Curb Ramp for each Crossing
Topic 107	Roadside Installations
Index 107.1	Standards for Roadway Connections
107.1	Number of Exits and Entrances Allowed at Roadway Connections
CHAPTER 200	GEOMETRIC DESIGN AND STRUCTURE STANDARDS
Topic 201	Sight Distance
Index 201.3	Stopping Sight Distance on Sustained Grades
201.7	Decision Sight Distance
Topic 202	Superelevation
Index 202.2	Superelevation on Same Plane for Rural Two-lane Roads
202.5	Superelevation Transition
202.5	Superelevation Runoff

July 1, 2020

Table 82.1B**Underlined Standards (Cont.)**

202.5	Superelevation in Restrictive Situations
202.6	Superelevation of Compound Curves
202.7	Superelevation on City Streets and County Roads
Topic 203	Horizontal Alignment
Index 203.1	Horizontal Alignment – Local Facilities
203.3	Alignment Consistency and Design Speed
203.5	Compound Curves
203.5	Compound Curves on One-Way Roads
203.6	Reversing Curves – Transition Length
203.6	Reversing Curves – Transition Rate
Topic 204	Grade
Index 204.1	Standards for Grade – Local Facilities
204.3	Standards for Grade
204.3	Ramp Grades
204.4	Vertical Curves – 2 Percent and Greater
204.4	Vertical Curves – Less Than 2 Percent
204.5	Decision Sight Distance at Climbing Lane Drops
204.6	Horizontal and Vertical Curves Consistency in Mountainous or Rolling Terrain
Topic 205	Road Connections and Driveways
Index 205.1	Access Opening Spacing on Expressways
205.1	Access Opening Spacing on Expressways – Location
Topic 206	Pavement Transitions
Index 206.3	Lane Drop Transitions
206.3	Lane Width Reductions
Topic 208	Bridges, Grade Separation Structures, and Structure Approach Embankment
Index 208.3	Decking of Bridge Medians

Table 82.1B**Underlined Standards (Cont.)**

208.6	Minimum width of Walkway of Pedestrian Overcrossings
208.6	Minimum Vertical Clearance of Pedestrian Undercrossings
208.6	Class I Bikeways Exclusive Use
208.10	Protective Screening on Overcrossings
208.10	Bicycle Railing Locations
Topic 210	Earth Retaining Systems
Index 210.6	Cable Railing
CHAPTER 300	GEOMETRIC CROSS SECTION
Topic 301	Traveled Way Standards
Index 301.2	Class II Bikeway Lane Width
301.3	Algebraic Differences of Cross Slopes at Various Locations
Topic 303	Curbs, Dikes, and Side Gutters
303.1	Use of Curb with Posted Speeds of 40 mph and Greater
303.3	Dike Selection
303.4	Bulbout Design
Topic 304	Side Slopes
Index 304.1	Side Slopes 4:1 or Flatter
Topic 305	Median Standards
Index 305.1	Median Width Freeways and Expressways – Urban
305.1	Median Width Freeways and Expressways – Rural
305.1	Median Width Conventional Highways – Urban and Rural Main Streets
305.1	Median Width Conventional Highways – Climbing or Passing Lanes
305.2	Median Cross Slopes
Topic 309	Clearances
Index 309.1	Clear Recovery Zone – 4:1 or Flatter Apply on All Highways
309.1	Clear Recovery Zone – Necessary Highway Features

July 1, 2020

Table 82.1B**Underlined Standards (Cont.)**

309.1	Clear Recovery Zone – Discretionary Fixed Objects
309.1	Safety Shaped Barriers at Retaining, Pier, or Abutment Walls
309.1	High Speed Rail Clearance
309.5	Structures Across or Adjacent to Railroads – Vertical Clearance
Topic 310	Frontage Roads
Index 310.2	Outer Separation – Urban and Mountainous Areas
310.2	Outer Separation – Rural Areas
CHAPTER 400	INTERSECTIONS AT GRADE
Topic 403	Principles of Channelization
Index 403.3	Angle of Intersection
403.6	Optional Right-Turn Lanes
403.6	Right-Turn-Only Lane and Bike Lane
Topic 404	Design Vehicles and Related Definitions
Index 404.4	STAA Design Vehicles on the National Network, Terminal Access, California Legal, and Advisory routes
404.4	California Legal Design Vehicle Accommodation
404.4	45-Foot Bus and Motorhome Design Vehicle
Topic 405	Intersection Design Standards
Index 405.1	Corner Sight Distance – No Sight Obstruction in Clear Sight Triangle
405.1	Corner Sight Distance – Driver Set Back
405.1	Corner Sight Distance –Minimum Corner Sight Distance and Table
405.1	Corner Sight Distance at Signalized Public Road Intersections
405.1	Corner Sight Distance at Private Road Intersections
405.1	Decision Sight Distance at Intersections
405.3	Curve Radius for Free Right-Turn with Pedestrian Crossing
405.4	Pedestrian Refuge by Area Place Type
405.5	Emergency Openings and Sight Distance

Table 82.1B**Underlined Standards (Cont.)**

405.5	Median Opening Locations
405.10	Entry Speeds – Single and Multilane Roundabouts
CHAPTER 500	TRAFFIC INTERCHANGES
Topic 504	Interchange Design Standards
Index 504.2	Ramp Entrance and Exit Standards
504.2	Collector-Distributor Deceleration Lane and “DL” Distance
504.2	Paved Width at Gore
504.2	Contrasting Surface Treatment
504.2	Auxiliary Lanes
504.2	Freeway Exit Nose Design Speed
504.2	Decision Sight Distance at Exits and Branch Connections
504.2	Design Speed and Alignment Consistency at Inlet Nose
504.2	Freeway Ramp Profile Grades
504.2	Differences in Pavement Cross Slopes at Freeway Entrances and Exits
504.2	Vertical Curves Beyond Freeway Exit Nose
504.2	Crest Vertical Curves at Freeway Exit Terminal
504.2	Sag Vertical Curves at Freeway Exit Terminal
504.2	Ascending Entrance Ramps with Sustained Upgrades
504.3	Ramp Terminus Design Speed
504.3	Ramp Lane Drop Taper At 6-foot Separation Point
504.3	Ramp Lane Drop Location
504.3	Metered Entrance Ramps (1 GP + 1 HOV Preferential Lane) Auxiliary Lane
504.3	Metered Entrance Ramps (1 GP + 1 HOV Preferential Lane) Auxiliary Lane on Sustained Grades and Certain Truck Volumes
504.3	HOV Preferential Lane Restrictive Condition Auxiliary Lane
504.3	Metered Multi-Lane Entrance Ramps Lane Drop
504.3	Metered Multi-Lane Entrance Ramps Auxiliary Lane

July 1, 2020

Table 82.1B**Underlined Standards (Cont.)**

504.3	Metered Multi-Lane Entrance Ramps Auxiliary Lane on Sustained Grades and Certain Truck Volumes
504.3	Metered Freeway-to-Freeway Connector Lane Drops
504.3	Ramp Terminals and Grade
504.3	Ramp Terminals and Sight Distance
504.3	Distance between Ramp Intersection and Local Road Intersection
504.3	Entrance Ramp Lane Drop
504.3	Single-Lane Ramp Widening for Passing
504.3	Two-lane Exit Ramps
504.3	Two-lane Exit Ramps and Auxiliary Lanes
504.3	Distance Between Successive On-ramps
504.3	Distance Between Successive Exits
504.4	Freeway-to-freeway Connections Design Speed
504.4	Profile Grades on Freeway-to-freeway Connectors
504.4	Single-lane Freeway-to-freeway Connector Design
504.4	Single-lane Connector Widening for Passing
504.4	Volumes Requiring Branch Connectors
504.4	Merging Branch Connector Design
504.4	Diverging Branch Connector Design
504.4	Merging Branch Connector Auxiliary Lanes
504.4	Diverging Branch Connector Auxiliary Lanes
504.4	Freeway-to-freeway Connector Lane Drop Taper
504.6	Mainline Lane Reduction at Interchanges
504.8	Access Control at Ramp Terminal
CHAPTER 610	PAVEMENT ENGINEERING CONSIDERATIONS
Topic 612	Pavement Design Life
Index 612.6	Traffic Loading for Temporary Pavements and Detours

Table 82.1B**Underlined Standards (Cont.)**

CHAPTER 620	RIGID PAVEMENT
Topic 625	Engineering Procedures for Pavement Rehabilitation
Index 625.2	Rigid Pavement Rehabilitation Strategies
CHAPTER 640	COMPOSITE PAVEMENTS
Topic 645	Engineering Procedures for Pavement Rehabilitation
Index 645.1	Empirical Method
CHAPTER 700	MISCELLANEOUS STANDARDS
Topic 701	Fences
Index 701.2	Fences on Freeways and Expressways
CHAPTER 900	LANDSCAPE ARCHITECTURE
Topic 904	Locating Plants
Index 904.4	Median Planting on freeways
904.5	Minimum Tree Setback
904.5	Large trees on freeway and expressway medians
Table 904.5	Large Tree Setback Requirements on Conventional Highways
904.9	Plant Establishment Period
Topic 905	Irrigation Design
Index 905.4	Irrigation Controller
CHAPTER 1000	BICYCLE TRANSPORTATION DESIGN
Topic 1003	Bikeway Design Criteria
Index 1003.1	Class I Bikeway Horizontal Clearance
1003.1	Class I Bikeway in State Highway or Local Road Medians

July 1, 2020

Table 82.1C**Decision Requiring Other Approvals**

CHAPTER 100	BASIC DESIGN POLICIES
Topic 103	Design Designation
Index 103.2	Design Period
Topic 108	Coordination With Other Agencies
Index 108.2	Transit Loading Facilities – Location
108.2	Transit Loading Facilities - ADA
108.3	Rail Crossings*
108.3	Parallel Rail Facilities*
108.5	Bus Rapid Transit – Location and ADA
108.7	Coordination With the FHWA - Approvals
Topic 110	Special Considerations
Index 110.1	Overload Category
110.8	Safety Review Items and Employee Exposure
110.10	Proprietary Items
110.10	Proprietary Items – On Structure
110.10	Proprietary Items – National Highway System
Topic 111	Material Sites and Disposal Sites
Index 111.1	Mandatory Material Sites on Federal-aid Projects
111.6	Mandatory Material Sites and Disposal Sites on Federal-aid Projects
Topic 116	Bicyclists and Pedestrians on Freeway
Index 116	Bicycles and Pedestrians on Freeways
CHAPTER 200	GEOMETRIC DESIGN AND STRUCTURE STANDARDS
Topic 204	Grade

* Authority to approve deviations from this “Decision Requirement” is delegated to the District Director.

Table 82.1C**Decision Requiring Other Approvals (Cont.)**

Index 204.8	Grade Line of Structures – Temporary Vertical Clearances
Topic 205	Road Connections and Driveways
Index 205.1	Conversion of a Private Opening
Topic 208.10	Bridge Barriers and Railing
Index 208.10	Barrier Separation and Bridge Rail Selection
208.10	Concrete Barrier Type 80
208.10	Concrete Barrier Type 80SW
208.11	Deviations from Foundation and Embankment Recommendations
210.4	Cost Reduction Incentive Proposals
CHAPTER 300	GEOMETRIC CROSS SECTION
Topic 303	Curbs, Dikes, and Side Gutters
Index 303.4	Busbulbs
Topic 304	Side Slopes
Index 304.1	Side Slopes – Erosion Control
304.1	Side Slopes – Structural Integrity
309.2	Vertical Clearance on National Highway System
309.2	Vertical Clearance Above Railroad Facilities
309.5	Horizontal and Vertical Clearances at Railroad Structures
CHAPTER 500	TRAFFIC INTERCHANGES
Topic 502	Interchange Types
Index 502.2	Other Types of Interchanges
Topic 503	Interchange Procedure
Index 503.2	Interchange Geometrics

*Authority to approve deviations from this “Decision Requirement” is delegated to the District Director.

July 1, 2020

Table 82.1C**Decision Requiring Other Approvals (Cont.)**

Topic 504	Interchange Design Standards
Index 504.3	HOV Preferential Lane
504.3	Modification to Existing HOV Preferential Lanes
504.3	Enforcement Areas and Maintenance Pullouts – Required Enforcement Area
504.3	Enforcement Areas and Maintenance Pullouts – Removal
504.3	Enforcement Areas and Maintenance Pullouts - Length
504.6	Mainline Lane Reduction
CHAPTER 600	PAVEMENT ENGINEERING
Topic 604	Roles and Responsibilities for Pavement Engineering
Index 604.2	Standard Plans
604.2	Supplemental District Standards
Topic 606	Research and Special Designs
Index 606.1	Research and Experimentation – Pilot Projects
606.1	Research and Experimentation – Special Designs
CHAPTER 610	PAVEMENT ENGINEERING CONSIDERATIONS
Topic 614	Other Considerations
Index 614.5	Compaction
CHAPTER 620	RIGID PAVEMENT
Topic 626	Other Considerations
Index 626.2	Shoulder – Widened Slab
CHAPTER 700	MISCELLANEOUS STANDARDS
Topic 701	Fences
Index 701.2	Locked Gates - Maintenance Force Use
701.2	Locked Gates - Used by Utility Companies*

*Authority to approve deviations from this “Decision Requirement” is delegated to the District Director

Table 82.1C**Decision Requiring Other Approvals (Cont.)**

701.2	Locked Gates - Used by Other Public Agencies or by Non-Utility Entities – FHWA Approval Required on Interstates
Topic 706	Roadside Management and Vegetation Control
Index 706.2	Vegetation Control
CHAPTER 800	HIGHWAY DRAINAGE DESIGN
Topic 805	Preliminary Plans
Index 805.1	Requires FHWA Approval
805.2	Bridge Preliminary Report
805.4	Unusual Hydraulic Structures
805.5	Levees and Dams Formed by Highway Fills
805.6	Geotechnical
Topic 808	Selected Computer Programs
Index 808.1	Table 808.1
CHAPTER 820	CROSS DRAINAGE
Topic 829	Other Considerations
Index 829.9	Dams
CHAPTER 830	TRANSPORTATION FACILITY DRAINAGE
Topic 837	Inlet Design
Index 837.2	Inlet Types
CHAPTER 850	PHYSICAL STANDARDS
Topic 853	Pipe Liners and Linings for Culvert Rehabilitation
Index 853.4	Alternative Pipe Liner Materials
CHAPTER 870	CHANNEL AND SHORE PROTECTION – EROSION CONTROL
Topic 872	Planning and Location Studies
Index 872.3	Site Consideration
Topic 873	Design Concepts
Index 873.1	Introduction
873.3	Armor Protection

*Authority to approve deviations from this “Decision Requirement” is delegated to the District Director.

December 31, 2020

Table 82.1C**Decision Requiring Other Approvals (Cont.)**

CHAPTER 900	LANDSCAPE ARCHITECTURE - ROADSIDES
Topic 904	Planting Design
Index 904.1	Planting Design General
Index 904.3	Plant Selection
Topic 905	Irrigation Design
Index 905.1	Irrigation Design General
Index 905.4	Irrigation System Equipment
CHAPTER 910	LANDSCAPE ARCHITECTURE – ROADSIDE SITES
Topic 912	Roadside Sites Design
Index 912.1	Roadside Sites Layout
Index 912.3	Site Furnishings
Topic 913	Safety Roadside Rest Areas
Index 913.4	Safety Roadside Rest Area Buildings and Structures
Index 913.5	Safety Roadside Rest Area Utilities and Facilities
Topic 914	Vista Points
Index 914.3	Vista Point Amenities
Topic 915	Park & Ride Facilities
Index 915.1	Park & Ride Facilities General
CHAPTER 1000	BICYCLE TRANSPORTATION DESIGN
Topic 1003	Miscellaneous Criteria
Index 1003.5	Bicycle Path at Railroad Crossings
CHAPTER 1100	HIGHWAY TRAFFIC NOISE ABATEMENT
Topic 1101	General Requirements
Index 1101.2	Objective – Extraordinary Abatement

*Authority to approve deviations from this “Decision Requirement” is delegated to the District Director.

CHAPTER 100 – BASIC DESIGN POLICIES

Topic 101 – Design Speed

Index 101.1 – Highway Design Speed

(1) *General.* Highway design speed is defined as: "a speed selected to establish specific minimum geometric design elements for a particular section of highway". These design elements include vertical and horizontal alignment, and sight distance. Other features such as widths of pavement and shoulders, horizontal clearances, etc., are generally not directly related to highway design speed.

A highway carrying a higher volume of traffic may justify a higher design speed than a lower classification facility in similar topography, particularly where the savings in user operation and other costs are sufficient to offset the increased cost of right of way and construction. A lower design speed, however, should not be assumed for a secondary road where the topography is such that drivers are likely to travel at higher speeds.

It is preferable that the design speed for any section of highway be a constant value. However, during the detailed design phase of a project, situations may arise in which engineering, economic, environmental, or other considerations make it impractical to provide the minimum elements for other design standards (e.g., curve radius, stopping sight distance, etc.) established by the design speed. See Topic 82 for documenting localized exceptions to features preventing the standard design speed.

The cost to correct such restrictions may not be justified. Technically, this will result in a reduction in the effective design speed at the location in question. **Such technical reductions in design speed shall be discussed with and documented as required by the District approval authority or Project Delivery Coordinator depending upon the current District Design Delegation Agreement.**

Where a reason for limiting speed is obvious to approaching drivers or bicyclists, these users are more apt to accept a lower operating speed than where there is no apparent reason for it.

(2) *Selection.* Selecting the design speed for a highway is part of the Project Development Team process. See the Project Development Procedures Manual for additional guidance.

(a) Considerations--The chosen design speed, for a highway segment or project, needs to take into consideration the following:

- The selected design speed should be consistent with the operating speeds that are likely to be expected on a given highway facility. Drivers and bicyclists adjust their speed based on their perception of the physical limitations of the highway and its vehicular and bicycle traffic. In addition, bicycling and walking can be encouraged when bicyclists and pedestrians perceive an increase in safety due to lower vehicular speeds.
- In California the majority of State highway projects modify existing facilities. When modifying existing facilities, the design speed selected should reflect the observed motor vehicle speed (operating speed) or the anticipated operating speed upon completion of modifications. Generally the posted speed is a reliable indicator of operating speed although operating speeds frequently exceed posted speeds.

July 1, 2020

Speed limits and speed zones are discussed in Chapter 2 of the California MUTCD, which include references to the California Vehicle Code.

For existing limited access highways and conventional highways in rural areas other than Main Streets, the selected design speed for these higher-speed facilities typically is 15 to 20 mph higher than the observed motor vehicle speed (operating speed).

For existing lower-speed conventional highways in urban areas and rural highways that are Main Streets with observed or proposed operating speeds of 45 mph or less, the design speed should be selected to be consistent with the highway context which may discourage high-speed operating behavior. Select a design speed that is logical with respect to topography, operating speed (or anticipated operating speed if the corridor is being redesigned and the physical characteristics of the highway are being changed), adjacent land use, design volumes for all users, collision history, access control, and facility type.

On projects where posted speeds or observational data is not available, the choice of design speed is influenced principally by whether the area is rural or urban, the character of terrain, economic considerations, environmental factors, type and anticipated volume of vehicular traffic, presence of non-motorized traffic, functional classification of the highway, existing and planned adjacent land use. A highway in level or rolling terrain justifies a higher design speed than one in mountainous terrain. As discussed under Topic 109, scenic values are also a consideration in the selection of a design speed.

- (b) Freeways and Expressways--In addition to the considerations above, as high a design speed as feasible should be selected for use on freeways and expressways, which are higher-speed facilities.
- (c) Conventional Highways

- (1) *State Highways*. In addition to the considerations above, the existing and planned highway context in terms of area place type, land use, types of users, etc. influence the selection of the appropriate design speed and should be taken into account by the Project Development Team.

Consideration should also be given to Local Agency standards and transportation plans for the facility when selecting the design speed.

- (2) *Local Streets or Roads*. **Local streets or roads within the State right of way, including facilities which will be relinquished after construction (such as frontage roads), shall have minimum design speeds conforming to AASHTO standards, as per the functional classification of the facility in question. If the local agency having jurisdiction over the facility in question maintains design standards that exceed AASHTO standards, then the local agency standards should apply.**

Where the local facility connects to a freeway or expressway (such as ramp terminal intersections), the design speed of the local facility shall be a minimum of 35 miles per hour. However, the design speed should be 45 miles per hour when feasible.

Every effort should be made to avoid decreasing the design speed of a local facility through the State's right of way, and all due consideration should be given to local plans to upgrade or improve the facility in the near future.

101.2 Highway Design Speed Standards

Table 101.2 shows appropriate ranges of design speeds that shall be used for the various types of facilities, place types, and conditions listed. For additional guidance, see Index 101.1(2).

Table 101.2

Vehicular Design Speed

Facility Type	Design Speed (mph)
LIMITED ACCESS HIGHWAYS	
Freeways and expressways in mountainous terrain	50-80
Freeways in urban areas	55-80
Freeways and expressways in rural areas	70-80
Expressways in urban areas	50-70
CONVENTIONAL HIGHWAYS ⁽²⁾	
Rural	
Flat terrain	55-70
Rolling terrain	50-60
Mountainous terrain	40-50
Main Streets – Cities, Towns, and Community Centers	30-40
Urban	
Arterials – Throughways	40-60
Arterials - Main Streets and Regional/Community Centers	30-40
Downtowns and City Centers	30
LOCAL FACILITIES	
(Within State right of way)	
Facilities crossing a freeway or expressway, connecting to a conventional highway or traversing a State facility	AASHTO ⁽¹⁾
Facilities connecting to a freeway or expressway	35 ^B /45 ^U
	B=Boldface Standard U=Underlined Standard

(1) If outside of State right of way and no specific local standards apply, the minimum design speed shall be 30 miles per hour.

(2) For conventional highways eligible or designated as State scenic highways, see Index 109.2.

July 1, 2020

Topic 102 – Design Capacity & Level of Service

102.1 Design Capacity (Automobiles)

Design capacity (automobiles) is the maximum volume of vehicle traffic for which a projected highway can provide a selected level of service. Design capacity varies with a number of factors, including:

- (a) Level of service selected.
- (b) Width of lanes.
- (c) Number of lanes.
- (d) Presence or absence of shoulders.
- (e) Grades.
- (f) Horizontal alignment.
- (g) Operating speed.
- (h) Lateral clearance.
- (i) Side friction generated by parking, drive ways, intersections, and interchanges.
- (j) Volumes of trucks, transit, recreational vehicles, bicycles and pedestrians.
- (k) Spacing and timing of traffic signals, and the required timing to accommodate pedestrian crossing

Level of Service (LOS) is largely related to speed and density among many variables. Freeways should be designed to accommodate the design year peak hour traffic volumes and to operate at a LOS determined by District Planning and/or Traffic Operations. For a rough approximation of the number of lanes required on a multilane freeway, use the following design year peak hour traffic volumes per lane at the specified LOS:

	Level of Service	Design Year Peak Hour Vehicle Traffic Volume (Average Automobiles Per Lane Per Hour)
Urban	C-E	1400-2400
Rural	C-D	1000-1850

For conventional highways and expressways, District Planning and Traffic Operations should be consulted.

Automobile traffic volumes can be adjusted for the effect of grades and the mix of automobiles, trucks, and recreational vehicles if a more refined calculation is desired. In those cases, consult the "Highway Capacity Manual", published by the Transportation Research Board.

102.2 Design Capacity and Quality of Service (Pedestrians and Bicycles)

Sidewalks are to accommodate pedestrians at a Level of Service (LOS) equal to that of vehicles using the roadway, or better. More detailed guidance on design capacity for sidewalks is available in the “Highway Capacity Manual” (HCM), published by the Transportation Research Board. The HCM also has guidance regarding LOS for bicycle facilities for both on- and off-street applications. The LOS for on-street bicycle facilities should be equal to that of vehicles using the roadway or better. The design of off-street bicycle facilities can use the LOS methodology in the HCM when conditions justify deviations from the standards in Chapter 1000.

Topic 103 – Design Designation

103.1 Relation to Design

The design designation is a simple, concise expression of the basic factors controlling the design of a given highway. Following is an example of this expression:

$$\begin{aligned} \text{ADT (2015)} &= 9800 & D &= 60 \% \\ \text{ADT (2035)} &= 20\,000 & T &= 12 \% \\ \text{DHV} &= 3000 & V &= 70 \text{ mph} \\ \text{ESAL} &= 4\,500\,000 & \text{TI}_{20} &= 11.0 \end{aligned}$$

CLIMATE REGION = Desert

The notation above is explained as follows:

ADT (2015) -- The average daily traffic, in number of vehicles, for the construction year.

ADT (2035) -- The average daily traffic for the future year used as a target in design.

CLIMATE REGION -- Climate Region as defined in Topic 615. In addition to establishing design requirements for the project, this information is used by the Resident Engineer during construction to determine which clauses in the Standard Specifications apply to the project.

DHV -- The two-way design hourly volume, vehicles.

D -- The percentage of the DHV in the direction of heavier flow.

ESAL -- The equivalent single axle loads forecasted for pavement engineering. See Topic 613.

T -- The truck traffic volume expressed as a percent of the DHV (excluding recreational vehicles).

TI_{20} -- Traffic Index used for pavement engineering. The number in the subscript is the pavement design life used for pavement design. See Index 613.3(3).

V -- Design speed in miles per hour.

Within a project, one design designation should be used except when:

December 31, 2020

- (a) The design hourly traffic warrants a change in the number of lanes, or
- (b) A change in conditions dictates a change in design speed.
- (c) The design daily truck traffic warrants a change in the Traffic Index.

The design designation should be stated in project initiation documents and project reports and should appear on the typical cross section for all new, reconstructed, or rehabilitation (including Capital Preventative Maintenance) highway construction projects.

103.2 Design Period

Geometric design of new facilities and reconstruction projects should typically be based on estimated traffic 20 years after completion of construction. For new facilities and reconstruction projects on the Interstate System a minimum 20-year design period is required. With justification, for projects other than on the Interstate System, design periods less than 20 years may be approved by the District Director with concurrence by the Project Delivery Coordinator.

For roundabout design period guidance, see Index 405.10.

Safety, Resurfacing, Restoration, and Rehabilitation (RRR), and operational improvement projects should be designed on the basis of current ADT, including projects on the Interstate System.

Complimentary to the design period, various components of a project (e.g., drainage facilities, structures, pavement structure, etc.) have a design life that may differ from the design period. For pavement design life requirements, see Topic 612.

Topic 104 – Control of Access

104.1 General Policy

Control of access is achieved by acquiring rights of access to the highway from abutting property owners and by permitting ingress and egress only at locations determined by the State.

On freeways, direct access from private property to the highway is prohibited without exception. Abutting ownerships are served by frontage roads or streets connected to interchanges.

104.2 Access Openings

See Index 205.1 for the definition and criteria for location of access openings. The number of access openings on highways with access control should be held to a minimum. (Private property access openings on freeways are not allowed.) Parcels which have access to another public road or street as well as frontage on the expressway are not allowed access to the expressway. In some instances, parcels fronting only on the expressway may be given access to another public road or street by constructing suitable connections if such access can be provided at reasonable cost.

With the exception of extensive highway frontages, access openings to an expressway are limited to one opening per parcel. Wherever possible, one opening should serve two or more parcels. In the case of a large highway frontage under one ownership, the cost of limiting access to one opening may be prohibitive, or the property may be divided by a natural barrier such as a stream or ridge, making it necessary to provide an additional opening. In the latter case, it may be preferable to connect the physically separated portions with a low-cost structure or road rather than permit two openings.

104.3 Frontage Roads

(1) *General Policy.*

(a) Purpose--Frontage roads are provided on freeways and expressways to:

- Control access to the through lanes, thus increasing safety for traffic.
- Provide access to abutting land ownerships.
- Provide or restore continuity of the local street or road systems.
- Provide for bicycle and pedestrian traffic that might otherwise need to use the freeway.

(b) Economic Considerations--In general, a frontage road is justified on freeways and expressways if the costs of constructing the frontage road are less than the costs of providing access by other means. Right of way considerations often are a determining factor. Thus, a frontage road would be justified if the investment in construction and extra right of way is less than either the severance damages or the costs of acquiring the affected property in its entirety. Frontage roads may be required to connect parts of a severed property or to serve a landlocked parcel resulting from right of way acquisition.

(c) Access Openings--Direct access to the through lanes is allowable on expressways. When the number of access openings on one side of the expressway exceeds three in 1,600 feet, a frontage road should be provided (see Index 104.2).

(2) *New Alignment.* Frontage roads generally are not provided on freeways or expressways on new alignment since the abutting property owners never had legal right of access to the new facility. They may be provided, however, on the basis of considerations mentioned in (1) above.

(3) *Existing Alignment.* Where a freeway or expressway is developed parallel to an existing highway or local street, all or part of the existing roadway often is retained as a frontage road. In such cases, if access to remainders of land on the side of the freeway or expressway right of way opposite the old road cannot be provided by other means, a frontage road must be constructed to serve the landlocked remainders or the remainders must be purchased outright. The decision whether to provide access or purchase should be based on considerations of cost, right of way impacts, street system continuity and similar factors (see (1) above).

(4) *Railroad Crossings.* Frontage roads on one or both sides of a freeway or expressway on new alignment, owing to safety and cost considerations, frequently are terminated at the railroad right of way. When terminating a frontage road at the railroad crossing, bicycle and pedestrian traffic still needs to have reasonable access through the community.

Any new railroad grade crossings and grade separations, and any relocations or alterations of existing crossings must be cleared with the railroad and approved by the PUC.

December 31, 2020

(5) *Frontage Roads Financed by Others.* Frontage roads which are not a State responsibility under this policy may be built by the State upon request of a local political subdivision, a private agency, or an individual. Such a project must be covered by an agreement under which the State is reimbursed for all construction, right of way, and engineering costs involved.

104.4 Protection of Access Rights

For proper control of acquired access rights, fencing or other approved barriers shall be installed on all controlled access highways except as provided in Index 701.2(3)(e).

104.5 Relation of Access Opening to a Median Opening

Access openings should not be placed within 300 feet of a median opening unless the access opening is directly opposite the median opening.

Details on access openings are given under Index 205.1.

104.6 Maintaining Local Community Access

When planning and designing a new freeway or expressway, the designer needs to consider the impacts of an access controlled facility on the local community. Closing non-expressway local road connections may negatively impact access for pedestrians, bicyclists and equestrians. A new facility may inadvertently sever local non-motorized access creating long out of direction travel. Designers need to coordinate with local agencies for access needs across an access controlled facility.

104.7 Cross References

- (a) Access Control at Intersections at Grade (see Index 405.6).
- (b) Access Control at Interchanges (see Index 504.8).

Topic 105 – Pedestrian Facilities

105.1 General Policy

The California Vehicle Code Section 21949 has stated a policy for the Department to provide safe and convenient travel for pedestrians. Conventional highways can be used by pedestrians. Although the Department will work to provide safe and convenient pedestrian travel on these highways, not all of these highways will contain sidewalks and walkways. Connections between different modes of travel should be considered when designing highway facilities, as all people may become pedestrians when transferring to a transit based facility. Pedestrian use near transit facilities should be considered during the planning phase of transportation improvement projects. See DIB 82 for accessibility guidance of pedestrian facilities. See also Topics 115 and 116 for guidance regarding designing for bicycle traffic.

105.2 Sidewalks and Walkways

The design of sidewalks and walkways varies depending on the setting, standards, and requirements of local agencies. Sidewalks are desirable on conventional highways and on other areas of State highway right of way to serve pedestrians when warranted by sufficient population, density and development. Coordination with the local agency that the State highway passes through is needed to determine the appropriate time to provide sidewalks.

Most local agencies in California have adopted varying design standards for urban and rural areas, as well as more specific requirements that are applicable to residential settings, downtowns, special districts, and other place types. These standards are typically tied to zoning requirements for land use established by local agencies. These land use decisions should take into account the ultimate need for public right of way, including the transportation needs of bicyclists and pedestrians. The minimum width of a sidewalk should be 8 feet between a curb and a building when in urban and rural main street place types. For all other locations the minimum width of sidewalk should be 6 feet when contiguous to a curb or 5 feet when separated by a planting strip. Sidewalk width does not include curbs. See Index 208.4 for bridge sidewalks. Using the minimum width may not be enough to satisfy the actual need if additional width is necessary to maintain an acceptable Level of Service (LOS) for pedestrians. Note that street furniture, buildings, utility poles, light fixtures and platoon generators, such as window displays and bus stops, can reduce the effective width of sidewalks and likewise the LOS of the walkway. Also, adequate width for curb ramps and driveways are other important accessibility considerations.

See Index 205.3(6) and the Standard Plans for sidewalk requirements at driveways.

See Index 208.6 for information on pedestrian overcrossings and undercrossings and Index 208.4 for sidewalks on bridges.

“A Policy on Geometric Design of Highways and Streets”, issued by AASHTO, and the “Highway Capacity Manual”, published by the Transportation Research Board contain pedestrian LOS criteria. These are means of measuring the ability of the existing pedestrian facilities to provide pedestrian mobility and to determine the need for improvements or expansions. If adequate capacity is not provided, pedestrian mobility may be seriously impeded.

Traffic volume-pedestrian warrants for sidewalks or other types of walkways along highways have not been established. In general, whenever the roadside and land development conditions are such that pedestrians regularly move along a highway, those pedestrians should be furnished with a sidewalk or other walkway, as is suitable to the conditions. Sidewalks are typically within public right of way of the local agency or the State. When within the State highway right of way, the need for sidewalks becomes a shared interest, since the zoning, planned development, and growth are under the local agency’s purview. The State may assume financial responsibility for the construction of sidewalks and walkways under the conditions described below. See the Project Development Procedures Manual for further discussion of the State’s responsibility in providing pedestrian facilities.

- (1) *Replacement in Kind.* Where existing sidewalks are to be disturbed by highway construction, the replacement applies only to the frontages involved and no other sidewalk construction is authorized except:

July 1, 2020

- (a) As part of a right of way agreement.
 - (b) Where the safety or capacity of the highway will be improved.
- (2) *Conventional Highways.* The roadway cross section usually provides areas for pedestrians. If the safety or capacity of the highway will be improved, the State may contribute towards the cost of building a pedestrian facility with a local agency project or fund it entirely with a State highway project. The city, county, or property owner whose adjacent development generated the pedestrian traffic may build sidewalks on State right of way under a permit in accordance with the route concept report.
- (3) *Freeway and other Controlled Access Facilities.* Sidewalks should be built across the freeway right of way on overcrossings and through undercrossings where necessary to connect with existing or planned sidewalks. Construction of planned sidewalks should be imminent. Within the foregoing criteria, sidewalks can be part of the original project or added later when the surrounding area develops.
- (4) *Overcrossing and Undercrossing Approaches.* Where sidewalks are planned on overcrossing structures or under a structure, an area should be provided to accommodate future sidewalks.
- (5) *School Pedestrian Walkways.* School pedestrian walkways may be identified along a route used by school pedestrians that is not limited to crossing locations, but includes where physical conditions require students to walk in or along rural or suburban roadways.
- (6) *Frontage Roads.* Sidewalks may be built along frontage roads connecting local streets that would otherwise dead end at the freeways. Such sidewalks can be new or replacements of existing facilities. Sidewalks may not be needed on the freeway side of frontage roads except where connections must be made to pedestrian separations or other connections where appropriate.
- (7) *Separated Cross Streets.* Sidewalks may be built on separated cross streets where reconstruction of the cross street is made necessary by the freeway project and where the criteria of paragraph (3) above apply.
- (8) *Transit Stops.* Sidewalks should be built to connect transit stops to local streets.
- (9) *Vehicular Tunnels.* Sidewalks and pedestrian facilities may be built as part of vehicular tunnels which do not require ventilation as part of the tunnel structure. Contact the Division of Engineering Services - Structure Design (DES-SD), regarding allowable conditions.
- (10) *Maintenance.* The State is responsible for maintaining and replacing damaged sidewalks within the right of way except:
- (a) Where the sidewalk was placed by a private party under encroachment permit that requires the permittee to maintain the sidewalk, but only if the original permittee still owns the abutting property.
 - (b) Where the city or county has placed nonstandard sidewalks with colored or textured surfaces, or meandering alignment. See Maintenance Manual for additional discussion on State's maintenance responsibilities regarding sidewalks.

105.3 Pedestrian Grade Separations

- (1) Pedestrian grade separation takes the form of pedestrian overcrossings or undercrossings. These grade separations are suitable for crossing freeways, rivers, railroads, canyons and other obstacles for which no other crossing opportunities exist. See Index 208.6 for design guidance for pedestrian and bicycle overcrossings and undercrossings.

The need for a pedestrian grade separation is based on a study of the present and future needs of a particular area or community. Each situation should be investigated and considered on its own merits. The study should cover pedestrian generating sources in the area, pedestrian crossing volumes, type of highway to be crossed, location of adjacent crossing facilities, circuitry, zoning, land use, sociological and cultural factors, and the predominant age of persons expected to utilize the facility.

Pedestrian patterns should be maintained across freeway routes where these patterns have been previously established. Where vehicular crossings are inadequate for pedestrians, separate structures should be provided. In general, if a circuitous route is involved, a pedestrian separation may be justified even though the number of pedestrians is small.

State participation in the financing of pedestrian separations at ramp terminals is not normally justified because of the crash history at these locations. Exceptions to this general policy should be considered only in special circumstances where no less expensive alternative is feasible.

Where a pedestrian grade separation is justified, an overcrossing is preferred. Undercrossings tend to provide less visibility which provides more opportunities for vandalism and criminal activity. Consideration may be given to an undercrossing when specifically requested in writing by a local agency. Unobstructed visibility should be provided through the structure and approaches.

See Index 105.4 for discussion of provisions for persons with disabilities.

(2) *Financing.*

- (a) Freeways--Where the pedestrian grade separation is justified prior to award of the freeway contract, the State should pay the full cost of the pedestrian facility. In some cases, construction of the separation may be deferred; however, where the need has been established to the satisfaction of the Department prior to award of the freeway contract, the State should pay the entire cost of the separation.

Local jurisdictions have control (by zoning and planning) of development that influences pedestrian traffic patterns. Therefore, where a pedestrian grade separation is justified after the award of a freeway contract, the State's share of the total construction cost of the separation should not exceed 50 percent. The State must enter into a cooperative agreement with the local jurisdiction on this basis.

- (b) Conventional Highways--Grade separations are not normally provided for either cars or pedestrians on conventional highways. However, in those rare cases where pedestrian use is extensive, where it has been determined that placement and configuration of the grade separation will result in the majority of pedestrians using it, and where the local agency has requested in writing that a pedestrian separation be constructed, an overcrossing may be considered. The State's share of the total construction cost of the pedestrian facility should not exceed 50 percent. The State must enter into a cooperative agreement with the local jurisdiction on this basis.

July 1, 2020

105.4 Accessibility Requirements

(1) *Background.*

The requirement to provide equivalent access to facilities for all individuals, regardless of disability, is stated in several laws adopted at both the State and Federal level. Two of the most notable references are The Americans with Disabilities Act of 1990 (ADA) which was enacted by the Federal Government and took effect on January 26, 1992, and Section 4450 of the California Government Code.

(a) Americans with Disabilities Act Highlights.

- Title II of the ADA prohibits discrimination on the basis of disability by state and local governments (public entities). This means that a public entity may not deny the benefits of its programs, activities and services to individuals with disabilities because its facilities are inaccessible. A public entity's services, programs, or activities, when viewed in their entirety, must be readily accessible to and usable by individuals with disabilities. This standard, known as "program accessibility," applies to all existing facilities of a public entity.
- Public entities are not necessarily required to make each of their existing facilities accessible. Public entities may achieve program accessibility by a number of methods (e.g., providing transit as opposed to structurally accessible pedestrian facilities). However, in many situations, providing access to facilities through structural methods, such as alteration of existing facilities and acquisition or construction of additional facilities, may be the most efficient method of providing program accessibility.
- Where structural modifications are required to achieve program accessibility, a public entity with 50 or more employees is required to develop a transition plan setting forth the steps necessary to complete such modifications.
- In compliance with the ADA, Title 28 of the Code of Federal regulations (CFR) Part 35 identifies all public entities to be subject to the requirements for ADA regardless of funding source. It further states that the Uniform Federal Accessibility Standards (UFAS) and the Americans with Disabilities Act Accessibility Guidelines for Buildings and Facilities (ADAAG) are acceptable design guidelines that may be used. However, FHWA has directed Caltrans to use the ADAAG as the Federal design guidelines for pedestrian accessibility.

(b) California Government Code 4450 et seq. Highlights.

- Sections 4450 (through 4461) of the California Government Code require that buildings, structures, sidewalks, curbs, and related facilities that are constructed using any State funds, or the funds of cities, counties, or other political subdivisions be accessible to and usable by persons with disabilities.

(2) *Policy.*

It is Caltrans policy to:

- Comply with the ADA and the Government Code 4450 et seq. by making all State highway facilities accessible to people with disabilities to the maximum extent feasible. In general, if a project on State right of way is providing a pedestrian facility, then accessibility must be addressed.

(3) *Procedures.*

- (a) The engineer will consider pedestrian accessibility needs in the project initiation documents for all projects where applicable.
- (b) All State highway projects administered by Caltrans or others with pedestrian facilities must be designed in accordance with the requirements in Design Information Bulletin 82, "Pedestrian Accessibility Guidelines for Highway Projects."
- (c) The details of the pedestrian facilities and their relationship to the project as a whole should be discussed with the District Design Liaison for the application of DIB 82, the guidance of this manual, as well as other required design guidance.

ADA compliance must be recorded on the Ready-to-List certification for State-administered projects. Appropriate project records should document the fact that necessary review and approvals have been obtained as required above.

In addition to the above mentioned Design procedures, the Districts and Regions have established procedures for certifying that the project "as-built" complies with the ADA standards in DIB 82 before a project can achieve Construction Contract Acceptance (CCA) or before the Notice of Completion is provided for a permit project.

105.5 Guidelines for the Location and Design of Curb Ramps

- (1) *Policy.* On all State highway projects adequate and reasonable access for the safe and convenient movement of persons with disabilities are to be provided across curbs that are constructed or replaced at pedestrian crosswalks. This includes all marked and unmarked crosswalks, as defined in Section 275 of the Vehicle Code.

Access should also be provided at bridge sidewalk approaches and at curbs in the vicinity of pedestrian separation structures.

Where a need is identified at an existing curb on a conventional highway, a curb ramp may be constructed either by others under encroachment permit or by the State.

- (2) *Location Guidelines.* When locating curb ramps, designers must consider the position of utilities such as power poles, fire hydrants, street lights, traffic signals, and drainage facilities.

When curb ramps are constructed or reconstructed, one curb ramp should be provided for each pedestrian street crossing. A blended transition that spans the curb return across both pedestrian crossings serves the purpose of two curb ramps. For example, at intersection corners where two pedestrian street crossings are located, two curb ramps should be constructed; if only one pedestrian street crossing is located at a corner, one curb ramp may be constructed. See Index 105.6 for further information. The usage of the one-ramp design should be restricted to those locations where the volume of pedestrians and vehicles making right turns is low. This will reduce the potential frequency of conflicts between turning vehicles and persons with disabilities entering the common crosswalk area to cross either street.

Ramps and/or curb openings should be provided at midblock crosswalks and where pedestrians cross curbed channelization or median islands at intersections. Often, on traffic signalization, channelization, and similar projects, curbs are proposed to be modified only on portions of an existing intersection. In those cases, consideration should be given to installing retrofit curb ramps on all legs of the intersection.

July 1, 2020

(3) *Ramp Design.* Curb ramp designs should conform to current Standard Plans. See Index 105.4(3) for review procedures.

105.6 Pedestrian Crossings

There are various standards related to pedestrian crossings in this manual (e.g., the two curb ramps at each corner and pedestrian refuge island standards), as well as in DIB 82 (e.g., the curb ramp requirement) that depend on the existence of a pedestrian crossing as prescribed in the California Vehicle Code (CVC).

Pedestrian facilities that support pedestrian crossings occur at marked and unmarked crosswalks.

Per the CA MUTCD, a marked crosswalk is striped, including at midblock locations. An unmarked crosswalk is not striped and, per the CVC, depends on two elements: 1) it occurs at an intersection, and 2) it occurs where the sidewalk connects to the intersection. Without these two elements, there is no unmarked crosswalk.

Per the CVC, pedestrian crossings are provided across highways as marked or unmarked crosswalks, thereby requiring vehicles to yield to pedestrians (CVC 21950). Two examples in Figure 105.6 clarify the existence of unmarked crosswalks at “T” intersections, but may also apply to four legged intersections. This example is based on the following CVC citations:

- Section 275 - For the definition of crosswalk, see Index 62.4(5). Section 275 describes marked and unmarked crosswalks.
- Section 360 - A highway is a way or place of whatever nature, publicly maintained and open to the use of the public for purposes of vehicular travel. Highway includes street.
- Section 365 - An “intersection” is the area embraced within the prolongations of the lateral curb lines, or, if none, then the lateral boundary lines of the roadways, of two highways which join one another at approximately right angles or the area within which vehicles traveling upon different highways joining at any other angle may come in conflict.
- Section 530 - A “roadway” is that portion of a highway improved, designed, or ordinarily used for vehicular travel.
- Section 555 - A “sidewalk” is that portion of a highway, other than the roadway, set apart by curbs, barriers, markings or other delineation for pedestrian travel.

Topic 106 – Stage Construction and Utilization of Local Roads

106.1 Stage Construction

(1) *Cost Control Measures.* When funds are limited and costs increase, estimated project costs often exceed the amounts available in spite of the best efforts of the engineering staff. At such times the advantages of reducing initial project costs by some form of stage construction should be considered by the Project Delivery Team as an alternative to deferring the entire project. Stage construction may include one or more of the following:

- (a) Shorten the proposed improvement, or divide it into segments for construction in successive years;

Figure 105.6

Typical Pedestrian Crossings at “T” Intersections

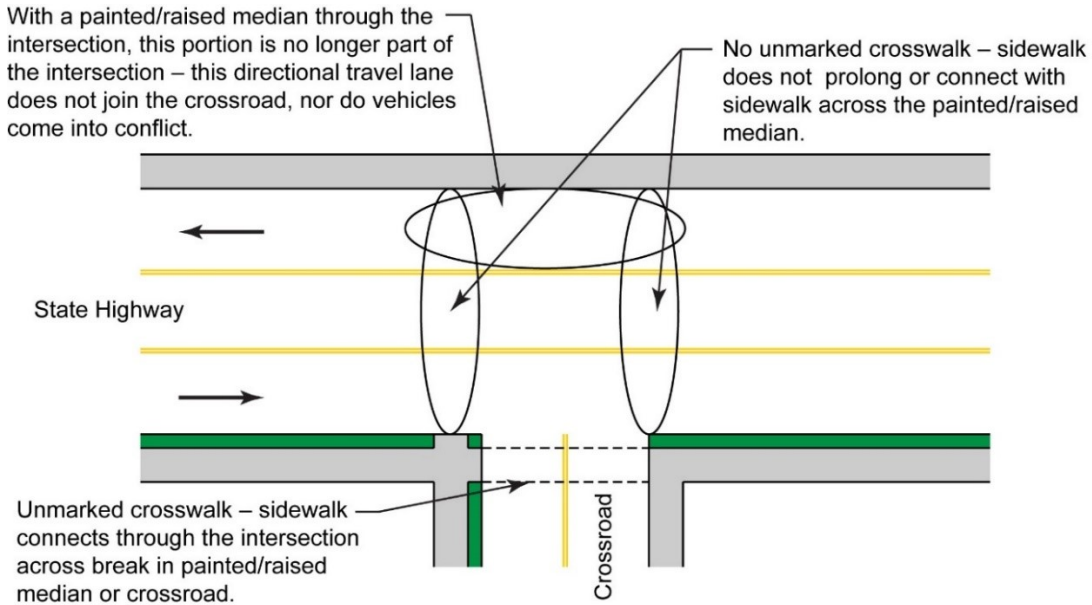

Example 1: State Highway with Partial Intersection

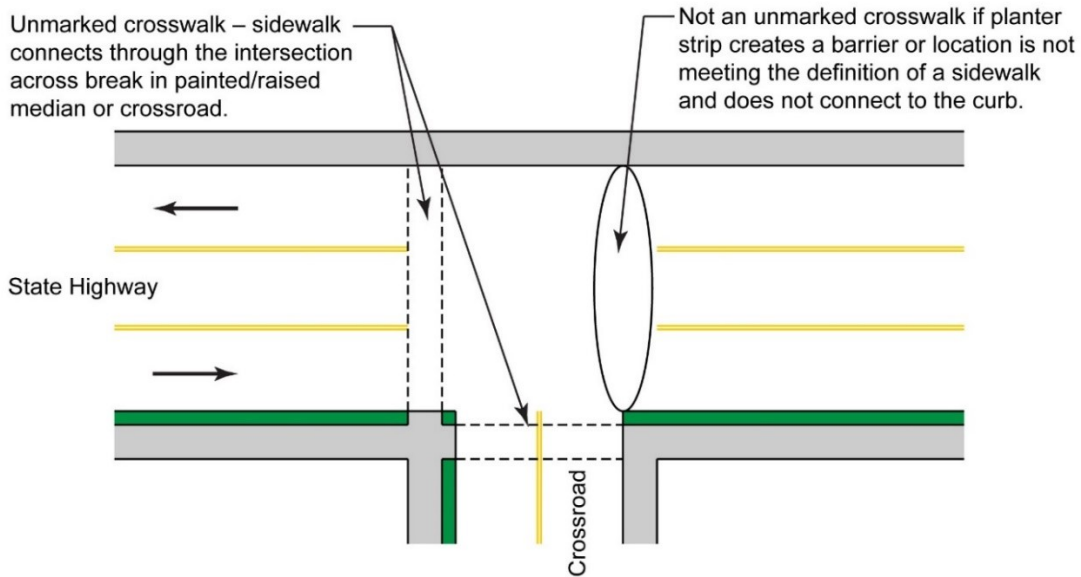

Example 2: State Highway Intersection



July 1, 2020

- (b) Reduce number of lanes for initial construction. For example, a 4-lane freeway in a rural area with low current traffic volumes might be staged for two lanes initially with capacity adequate for at least 10 years after construction. Similarly, a freeway might be constructed initially four or six lanes wide with provision for future widening in the median to meet future traffic needs.
- (c) Down scope geometric design features. This last expedient should be considered only as a last resort; geometric features such as alignment, grade, sight distance, weaving, or merging distance, are difficult and expensive to change once constructed. All nonstandard features need to comply with Index 82.2.

A choice among cost reducing alternatives should be made only after weighing the benefits and disadvantages of each, particularly as they apply to interchange designs, which have a substantial effect on cost. See Index 502.3(2) for design considerations regarding freeway interchanges.

106.2 Utilization of Local Roads

In the construction of freeways or other highways by stages or construction units, it frequently becomes necessary to use portions of the local road system at one or more stages prior to completion of the whole route. Usually the local road is used as a traversable connection between the newly completed segment and the existing State highway.

Where such use of a local road is required, it may be handled by:

- (a) Temporarily adopting the local road system as a traversable State highway, or
- (b) Designating the local road system as a detour until the next or final stage is constructed.

(1) *Temporary Adoption of Local Roads as State Routes.* Temporary adoption of a local road system as a traversable route requires CTC action. Temporary adoption should be implemented where, for example, one unit of the freeway construction has been completed and the District wishes to route all users over the new roadway without waiting for completion of the next succeeding units, and the use of local roads is necessary to connect the freeway with the old State highway. Temporary adoption is useful where construction of the next freeway unit is a number of years in the future.

Such a temporary CTC adoption makes it legally possible to relinquish the old highway portion superseded by relocation.

Normally, the Department will finance any needed improvement required to accommodate all users during the period the local road system is a traversable State route. Financing by the local agency is not required. However, adoption of the local road by the CTC must precede State financing and construction of the proposed improvements.

When a local facility is adopted as a traversable route, the Department is responsible for all maintenance costs of the local facility unless otherwise provided for under the terms of a cooperative agreement. The Department normally would not assume maintenance until the road is in use as a connection or, when necessary, until the award of an improvement contract.

Formal concurrence of the local agency must be obtained before an adoption action is presented to the CTC.

If the local agency wants more improvements than are needed to accommodate all users during the period when the local road is used as a State highway connection, betterments are to be financed by the local agency. In such cases a cooperative agreement would be necessary to define the responsibilities of each party for construction and maintenance.

(2) *Local Roads Used as Detours.* In lieu of temporary adoption by the CTC, a local road may be designated a detour to serve as a connection between the end of State highway construction and the old State highway following completion of a State highway construction unit and pending completion of the next unit. Local road detours are useful if the adjoining construction unit is scheduled in a few years or less and the local road connection is short and direct. Adoption by the CTC is not required when a local road is designated as a temporary detour.

Under Section 93 of the Streets and Highways Code, the Department can finance any needed improvements required to accommodate the detour of all users during the period the local road is utilized to provide continuity for State highway users. A cooperative agreement is usually required to establish terms of financing, construction, maintenance, and liability. If the local agency wants more than the minimum work needed to accommodate users on the local road during its use as a State highway, such betterments are to be financed by the local agency.

Section 93 also makes the Department responsible for restoration of the local road or street to its former condition at the conclusion of its use as a detour. The Department is responsible for all reasonable additional maintenance costs incurred by local agencies attributable to the detour. If a betterment is requested by the local agency as a part of restoration it should be done at no cost to the Department.

Topic 107 – Roadside Installations

107.1 Roadway Connections

All connections to vista points, truck weighing or brake inspection stations, safety rest areas, park and ride lots, transit stations or any other connections used by the traveling public, should be constructed to standards commensurate with the standards established for the roadway to which they are connected. On freeways this should include standard acceleration and deceleration lanes and all other design features required by normal ramp connections (Index 504.2). On conventional highways and expressways, the standard public road connection should be the minimum connection (Index 405.7).

Only one means of exit and one means of entry to these installations should be allowed.

107.2 Maintenance and Police Facilities on Freeways

Roadside maintenance yards and police facilities other than truck weighing installations and enforcement areas are not to be provided with direct access to freeways. They should be located on or near a cross road having an interchange which provides for all turning movements. This policy applies to all freeways including Interstate Highways.

Maintenance Vehicle Pullouts (MVPs) provide parking for maintenance workers and other field personnel beyond the edge of shoulder. This improves safety for field personnel by separating them from traffic. It also frees up the shoulder for its intended use. The need and location of MVPs should be determined by the PDT during the Project

July 1, 2020

Initiation Document phase. MVPs should only be provided if it has been determined that maintenance access from outside the state right of way through an access gate or a maintenance trail within the state right of way is not feasible. Where frequent activity of field personnel can be anticipated, such as at a signal control box (See Index 504.3 (2)(j)) or at an irrigation controller, the MVP should be placed upstream of the work site, so that maintenance vehicles can help shield field personnel on foot. If the controller or roadside feature is located within the clear recovery zone, relocating it outside the clear recovery zone should be considered (See Index 309.1). The shoulder adjacent to MVPs should be wide enough for a maintenance vehicle to use for acceleration before merging onto the traveled way. If adequate shoulder width is unattainable, sufficient sight distance from the MVP to upstream traffic should be provided to prevent maintenance vehicles from disrupting traffic flow. When considering drainage alongside a MVP, it is preferable to provide a flow line around the MVP rather than along the edge of shoulder to collect the drainage before the MVP. This will prevent ponding between the MVP and edge of shoulder. See Standard Plan H9 for a typical MVP layout plan and section detail.

107.3 Location of Border Inspection Stations

Other agencies require vehicles entering California to stop at buildings maintained by these agencies for inspection of vehicles and cargoes. No such building, parking area, or roadway adjacent to the parking area at these facilities should be closer than 30 feet from the nearest edge of the ultimate traveled way of the highway.

Topic 108 – Coordination With Other Agencies

108.1 Divided Nonfreeway Facilities

Per Section 144.5 of the Streets and Highways Code, advance notice is required when a conventional highway, which is not a declared freeway, is to be divided or separated into separate roadways, if such division or separation will result in preventing traffic on existing county roads or city streets from making a direct crossing of the State highway at the intersection. In this case, 30 day notice must be given to the City Council or Board of Supervisors having jurisdiction over said roads or streets.

The provisions of Section 144.5 of the Streets and Highways Code are considered as not applying to freeway construction, or to temporary barriers for the purpose of controlling traffic during a limited period of time, as when the highway is undergoing repairs, or is flooded. As to freeway construction, it is considered that the local agency receives ample notice, by virtue of the freeway agreement, of the manner in which all local roads will be affected by the freeway, and that the special notice would therefore be superfluous.

When the notice is required, a letter should be prepared and submitted to the appropriate authorities at least 60 days before road revision will occur. Prior to the submittal of the letter and before plans are completed, the appropriate authorities should be contacted and advised of contemplated plans. The timing of this notice should provide ample opportunity for consideration of any suggestions or objection made. In general, it is intended that the formal

notice of intent which is required by law will confirm the final plans which have been developed after discussions with the affected authorities.

The PS&E package should document the date notice was given and the date of reply by the affected local agencies.

The Division of Design must be notified by letter as soon as possible in all cases where controversy develops over the closures to crossing traffic.

108.2 Transit Loading Facilities

(1) *Freeway Application.* These instructions are applicable to projects involving transit loading facilities on freeways as authorized in Section 148 of the Streets and Highways Code. Instructions pertaining to the provisions for mass public transportation facilities in freeway corridors, authorized in Section 150 of the Streets and Highways Code, are covered in other Departmental written directives.

- (a) During the early phases of the design process, the District must send to the PUC, governing bodies of local jurisdictions, and common carriers or transit authorities operating in the vicinity, a map showing the proposed location and type of interchanges, with a request for their comments regarding transit loading facilities. The transmittal letter should state that transit loading facilities will be constructed only where they are in the public interest and where the cost is commensurate with the public benefits to be derived from their construction. It should also state that if the agency desires to have transit loading facilities included in the design of the freeway that their reply should include locations for transit stops and any supporting data, such as estimates of the number of transit passengers per day, which would help to justify their request.
- (b) *Public Meeting and Hearings.* No public meeting or hearing is to be held when all of the contacted agencies respond that transit loading facilities are not required on the proposed freeway. The freeway should be designed without transit loading facilities in these cases.

Where any one of the agencies request transit loading facilities on the proposed freeway, the District should hold a public meeting and invite representatives of each agency.

Prior to the public meeting, the District should prepare geometric designs of the transit loading facilities for the purpose of making cost estimates and determining the feasibility of providing the facilities. Transit loading facilities must be approved by the District Director with concurrence from the Project Delivery Coordinator (see Topic 82 for approvals).

- (c) *Justification.* General warrants for the provision of transit loading facilities in terms of cost or number of passengers have not been established. Each case should be considered individually because the number of passengers justifying a transit loading facility may vary greatly between remote rural locations and high volume urban freeways.

Transit stops adjacent to freeways introduce security and operational concerns that may necessitate relocating the stop at an off-freeway location. These concerns go beyond having a facility located next to high speed traffic, but also entail the pedestrian route to the facility through a low density area removed from the general public.

July 1, 2020

It may be preferable for patrons to board and leave the bus or transit facility at an off-freeway location rather than use stairways or ramps to freeway transit stops. Where existing highways with transit service are incorporated into the freeway right of way, it may be necessary to make provisions for bus service for those passengers who were served along the existing highway. This may be accomplished either by providing freeway bus and/or transit loading facilities or by the bus leaving and re-entering the freeway at interchanges. See "A Policy on Geometric Design of Highways and Streets", AASHTO, and "Guide for Geometric Design of Transit Facilities on Highways and Streets", AASHTO for a discussion of transit design and bus stop guidelines.

- (d) Reports. On projects where all the agencies contacted have expressed the view that transit stops are not needed, a report to the Division of Design is not required. However, a statement to the effect that the PUC, bus companies, and local governmental agencies have been contacted regarding transit stops and have made no request for their provisions should be included in the final environmental document or the PS&E submittal, whichever is appropriate.

For projects where one or more of the agencies involved have requested transit loading facilities either formally or informally during public meeting(s), a complete report should be incorporated in the final environmental document. It should include:

- A map showing the section of freeway involved and the locations at which transit loading facilities are being considered.
 - A complete discussion of all public meetings held.
 - Data on type of transit service provided, both at present and after completion of the freeway.
 - Estimate of cost of each facility, including any additional cost such as right of way or lengthening of structures required to accommodate the facility.
 - Number of transit trips or buses per day and the number of on and off passengers per day served by the transit stops and the number estimated to use the proposed facilities.
 - District's recommendation as to the provision of transit loading facilities. If the recommendation is in favor of providing transit loading facilities, drawings showing location and tentative geometric designs should be included.
- (e) The DES-Structure Design has primary responsibility for the structural design of transit loading facilities involving structures. See Index 210.7. See also DIB 82 for instructions on submitting rail and transit station plans to the Department of General Services – Division of the State Architect (DSA) for review and approval of pedestrian facilities with regard to accessibility features. Accessible paths of travel must be provided to all pedestrian facilities, including shelters, tables, benches, drinking fountains, telephones, vending machines, and information kiosks. The path of travel from designated accessible parking, if applicable, to accessible facilities should be as short and direct as practical, must have an even surface, and must include curb ramps, marked aisles and crosswalks, and other features as required to facilitate use of the facility by individuals using wheelchairs, walkers or other mobility aids. See the Department of General Services, Division of the State Architect, as well as the California Department of Transportation enforce the California Building Code (Title 24) for the various on-site improvements.

- (f) A cooperative agreement should be used to document the understanding between the Department and any local agency which desires a transit facility. The agreement covers items such as funding, ownership, maintenance, and legal responsibility.
 - (g) Detailed design requirements can be obtained from the transit authority having jurisdiction over the transit facility. See Index 504.2(6) for design standards related to bus loading facilities on freeways.
- (2) *Conventional Highway Application.* This guidance is applicable to projects involving transit loading facilities on conventional highways as authorized in Section 148 of the Streets and highways Code. Instructions pertaining to the provisions for Bus Rapid Transit (BRT) in conventional highway corridors are covered in other Departmental policy and directives.
- (a) The selection of transit facilities on conventional highways should follow the general outline as noted above for transit facilities on freeways. Transit facilities shall be approved by the District Director as part of the authorizing document (PID or PR).
 - (b) A cooperative agreement should be used to document the understanding between the Department and any local agency which desires a transit facility. The agreement covers items such as funding, ownership, maintenance, and legal responsibility.
 - (c) Detailed design requirements can be obtained from the transit authority having jurisdiction over the transit facility.
 - (d) See also DIB 82 for instructions on submitting rail and transit station plans to the Department of General Services – Division of the State Architect (DS) for review and approval of pedestrian facilities with regard to accessibility features. Accessible paths of travel must be provided to all pedestrian facilities, including shelters, tables, benches, drinking fountains, telephones, vending machines, and information kiosks. The path of travel from designated accessible parking for persons with disabilities, if applicable, to accessible facilities should be as short and direct as practical, must have an even surface, and must include curb ramps, marked aisles, and crosswalks, and other features as required to facilitate use of the facility with wheelchairs, walkers and other mobility aides. See Topic 404 for guidance regarding the Design Vehicle, and Index 626.4(3) for structural section guidance for bus pads.

108.3 Commuter and Light Rail Facilities Within State Right of Way

- (1) *General.* These facilities may cross or operate parallel to a highway or other multi modal facility owned and operated by the Department. The following guidance covers all rail facilities, and all transportation facilities owned and operated by the Department. See the Project Development Procedures Manual for additional information and procedures regarding encroachments within State right of way. See Index 309.1(4) for high speed rail guidance.
- (2) *Rail Crossings.* Ideally, rail crossings of transportation facilities should be grade separated. Grade separations must not impact the ability of the Department to operate and maintain its facilities, which includes the ability to expand the existing transportation facilities in the future. All rail crossings are to be approved by the District Director. See the California MUTCD for guidance regarding traffic controls for grade crossings.
- (3) *Parallel Rail Facilities.* Rail facilities may be sited within Department right of way when feasible alternatives do not exist for separate facilities. As necessary, rail facilities may be located within the median. If rail facilities are located in the median, they must not impact the ability of the Department to reasonably operate and maintain its facilities,

July 1, 2020

which includes the ability to expand the existing transportation facilities in the foreseeable future. All parallel rail facilities are to be approved by the District Director.

- (4) *Design Standards.* Transit facilities are to be designed and constructed per the standards contained elsewhere in this manual and exceptions are to be documented as discussed in Chapter 80. The California Public Utilities Commission (CPUC) website also provides design standards and other requirements at <https://www.cpuc.ca.gov/crossings>.
- (5) *Cooperative Agreements.* The design and construction of rail facilities within the Department right of way should be covered in a cooperative agreement. Subsequent maintenance and operations requirements should be addressed in a maintenance agreement or encroachment permit as necessary.

108.4 Bus Loading Facilities

- (1) *General.* A bus stop is a marked location for bus loading and unloading. Bus stops may be midblock, adjacent to, but before an intersection (near side) or adjacent to but after an intersection (far side). The far side location is preferred as pedestrians may cross the intersection behind the bus, allowing the bus to re-enter the travel stream following a break in traffic caused by the signal timing.
- (2) *Design Standards.* Transit facilities are to be designed and constructed per the standards contained elsewhere in this manual and exceptions are to be documented as discussed in Chapter 80.

Bus stops and busbays (see Index 303.4(3) for busbays) should have pavement structures designed in accordance with Index 626.4(3). See the “Guide for Geometric Design of Transit Facilities on Highways and Streets”, AASHTO, for guidance on the selection and design of transit loading facilities.

- (3) *Cooperative Agreements.* Close coordination with the transit provider(s) is required for the successful design and operation of bus stops and other transit facilities.

108.5 Bus Rapid Transit

For the purpose of design and coordination, Bus Rapid Transit (BRT) is to be considered the same as commuter and light rail facilities with regards to approvals and design guidance.

BRT often makes use of the existing infrastructure for its operation within State right of way. As a joint user of the State right of way, BRT may not eliminate pedestrian or bicycle facilities. Because of potential conflicts, BRT facilities located on conventional highways and expressways should follow, as appropriate, the guidance for traffic control in the California MUTCD for light rail facilities. Transit Cooperative Report Program (TCRP) Report Numbers 90, 117 and 118 have additional guidance on BRT planning, design, and implementation. BRT located on freeways should be designed in accordance with the HOV Guidelines.

- (1) *Design Standards.* Transit facilities are to be designed and constructed per the standards contained elsewhere in this manual, and exceptions are to be documented as discussed in Chapter 80.
- (2) *Cooperative Agreements.* The design and construction of BRT facilities within the Department right of way should be covered in a cooperative agreement. Subsequent maintenance and operations requirements should be addressed in a maintenance agreement or encroachment permit as necessary.

108.6 High-Occupancy Toll and Express Toll Lanes

- (1) *General.* This guidance is applicable to projects involving High-Occupancy Toll (HOT) and Express Toll Lanes on freeways. These facilities are operated by a regional transportation agency or Caltrans under statutory authority or with the approval of the California Transportation Commission. The HOV Guidelines are to be consulted when considering the design and operation of these facilities.
- (2) *Design Standards.* HOT and Express Toll Lane facilities are to comply with the standards contained elsewhere in this manual. Exceptions are to be documented as discussed in Chapter 80. Therefore, caution must be exercised when using other Department publications such as the HOV Guidelines if conflicts in design standards are identified.
- (3) *Cooperative Agreements.* For HOT or Express lane facilities sponsored by a regional transportation agency, a cooperative agreement is to be used to document the understanding between the Department and the regional transportation agency. The agreement must address all matters related to design, construction, maintenance, and operation of the toll facility, including, but not limited to, liability, financing, repair, rehabilitation, and reconstruction. The regional transportation agency must also enter into an agreement with the California Highway Patrol that addresses all law enforcement matters related to the toll facility.

108.7 Coordination with the FHWA

FHWA representatives should be contacted as indicated by the Joint Stewardship and Oversight Agreement.

- (1) *General.* As early in the design process as possible, FHWA should be kept informed of proposed activities on Federal-aid routes. See the Appendix of the Project Development Procedures Manual for a complete list of FHWA involvement.
- (2) *Approvals.* The District Directors are responsible for obtaining formal FHWA approval for the following items on Federal-aid routes, see the Project Development Procedures Manual and the FHWA Joint Stewardship Oversight Agreement for a more complete list:
 - (a) Route Adoption. See the Project Development Procedures Manual for a discussion of procedures to be followed to NEPA and design approvals.
 - (b) Changes in access control lines, changes in locations of connection points, adding connection points, or deleting connection points on the Interstate System (even when no Federal money is involved).
 - (c) Addition of or changes in locked gates under certain conditions See Index 701.2.
 - (d) Partial interchanges on the Interstate system. See Index 502.2.
 - (e) Design-life on Interstates System projects.

Approximately twelve months prior to PS&E submittal, a project review should be arranged by the District with the Project Delivery Coordinator and, as required, the FHWA per the Stewardship & Oversight Agreement, see Index 43.2, to discuss nonparticipating items and unusual or special design features. The importance of early contact is emphasized to avoid delays when final plans are prepared.

For additional information, see the Project Development Procedures Manual.

July 1, 2020

Topic 109 – Scenic Values in Planning and Design

109.1 Basic Precepts

For any highway, having a pleasing appearance is an important consideration. Scenic values must be considered along with safety, utility, economy, and all the other factors considered in planning and design. This is particularly true of the many portions of the State Highway System situated in areas of natural beauty. The location of the highway, its alignment and profile, the cross section design, and other features should be in harmony with the setting.

109.2 Design Speed

The design speed should be carefully chosen as it is the key element which establishes standards for the horizontal alignment and profile of the highway. These requirements in turn directly influence how well the highway blends into the landscape. Scenic values, particularly in areas of natural scenic beauty must play a part along with the other factors set forth under Index 101.1 in selecting a design speed.

109.3 Aesthetic Factors

Throughout planning and design consider the following:

- (a) The location of the highway should be such that the new construction will preserve the natural environment and will lead to and unfold scenic positions. In some cases, additional minor grading not required for roadbed alignment may expose an attractive view or hide an unsightly one.
- (b) The general alignment and profile of the highway should fit the character of the area traversed so that unsightly scars of excavation and embankment will be held to a minimum. Curvilinear horizontal alignment should be coordinated with vertical curvature to achieve a pleasing appearance.
- (c) Existing vegetation (e.g., trees, specimen plants, diminishing native species or historical plantings) should be preserved and protected to the maximum extent feasible during the planning, design, and construction of transportation projects. Whenever specimen or mature trees are present, a tree survey should be made to provide accurate data on the variety, condition, location, size, and ground elevations of trees affected.
- (d) Appropriate replacement planting should be provided when existing planting is removed. When native or specimen trees are removed, replacement planting should reflect the visual importance of the plantings lost.

Provisions for watering and establishment of replacement planting should also be considered. Consult with the District Landscape Architect early in the planning and design process to ensure appropriate conservation and revegetation measures are incorporated.

- (e) Existing vegetation such as trees or large brush may be selectively thinned or removed to open up scenic vistas or provide a natural looking boundary between forest and cleared areas. Vegetation removal for aesthetic purposes should be undertaken only with the concurrence of the District Landscape Architect.
- (f) Vista points should be provided when views and scenery of outstanding merit occur and feasible sites can be found. (See Topic 914 for site selection criteria.)

- (g) Whenever feasible, wide medians and independent roadways should be provided on multilane facilities as these features add scenic interest and relieve the monotony of parallel roadways.
- (h) Bridges, tunnels, and walls merit consideration in lieu of prominent excavation and embankment slopes when costs of such alternates are not excessive.
- (i) Slopes should be flattened and rounded whenever practical and vegetation provided so that lines of construction are softened.
- (j) Structures should be located and designed to give the most pleasing appearance.
- (k) Scars from material sites should be avoided. Planting compatible with the surroundings should be undertaken to revegetate such scars when they are unavoidable.
- (l) Drainage appurtenances should be so located that erosion, sumps, and debris collection areas are hidden from view or eliminated when site conditions permit.
- (m) Interchange areas should be graded as flat as reasonable with slope rounding and contouring to provide graceful, natural looking appearance. The appearance can be further enhanced by planting a vegetative cover appropriate to the locality, being careful to maintain driver visibility.
- (n) In locations where graffiti has been excessive, concepts such as limiting accessibility, planting, and surface treatments should be considered to deter graffiti.
- (o) Roadsides should be designed to deter weed growth along the traveled way, and to provide for mechanical litter collection.

Topic 110 – Special Considerations

110.1 Design for Overloaded Material Hauling Equipment

Sometimes bid costs can be reduced by allowing the hauling of overloads on a construction contract. The savings may warrant designing structures and structural sections of new roadways to carry the heavier loads and also reconstructing roadbeds used by overloaded material hauling equipment.

In general, hauling of overloads is restricted to the project limits. However, overloads are permitted on portions of existing highways which are to be abandoned, repaired or reconstructed with a new structural section, if the overloads do not affect the design of the reconstructed structural section.

Any overload requirements should be determined before detailed plans are prepared. The District should request from the Division of Engineering Services – Structures Design (DES - SD) the estimated additional cost of the structures to carry overloads and use this information in making economic comparisons.

Factors to be considered in making the comparisons should include the costs of strengthening structures, haul costs, amount of material to be hauled, repair or reconstruction of structural sections, construction of separate haul roads or structures, strengthening of the new structural section, sequence of construction operations, and other pertinent factors. In some cases, consideration should be given for requiring the contractor to construct a separate haul structure over a heavily traveled surface street when large quantities of material are involved.

July 1, 2020

The comparison and all factors leading to the decision should be complete, fully documented, and retained in the project files.

The design of structures for overloads will normally be governed by one of the following categories:

- (1) *Category 1.* Structures definitely planned to carry overloads. This category should be used only when the structures are to be constructed under a separate contract prior to a grading contract and the estimated savings in grading costs exceed the extra structure costs. The District must request the DES - SD to design for the permissible overloading.
- (2) *Category 2.* Structures which are designed to allow the contractor the option of strengthening to carry overloads. The contract plans will include alternative details for strengthening the structure and the contractor can decide at the time of bidding whether to haul around the structure, build his own haul road structures, use "legal load" equipment on the unstrengthened structure, or construct the structure in accordance with the strengthened alternative design. The District should notify the DOS regarding structures to have optional designs. Undercrossings, overheads, separations, and stream crossings are most likely to be in this category.
- (3) *Category 3.* Structures which will not be designed to carry overloads. Most overcrossing, ramp, and frontage road structures are in this category.

The District should consult with the DOS early in the design phase when determining the design overload category of each bridge in the project. Each case where hauling of overloads is permitted must be specifically described in the Special Provisions. Each structure designed under Categories 1 and 2 must also be designated in the Special Provisions. The design load must not exceed the weight limitation of Section 7-1.02, "Weight Limitations", of the Standard Specifications. The District Director or designated representative must approve the overload category for each structure.

110.2 Control of Water Pollution

Water pollution related to the construction of highways and to the drainage of completed highways should be limited to the maximum extent practicable. This objective should be considered from the early planning, through the detailed design phase, to the end of construction of each project.

Proposed alterations of existing drainage patterns and creation of disturbed soil areas should consider the potential for erosion and siltation. Where interdisciplinary analysis (engineering, biology, geology, chemical) indicates that harmful physical, chemical, or biological pollution of streams, rivers, lakes, reservoirs, coastal waters, or groundwater may occur, preventive measures and practices will be required. These measures include temporary erosion control features during construction, scheduling of work, as well as the permanent facilities to be built under the contract. The control of erosion associated with permanent drainage channels and ditches is covered in Chapter 860,

Open Channels. Permanent vegetation erosion control is covered in Topic 906.

The Department's Project Planning and Design Guide identifies the procedures and practices to be employed in order for projects to comply with the Storm Water Management Plan and the National Pollutant Discharge Elimination System Permit, issued by the State Water Resources Control Board.

Districts must initiate contact with the appropriate agencies responsible for water quality as early as feasible in development of transportation projects to ensure full identification of pollution problems, and to ensure full cooperation, understanding, and agreement between the Department and the other agencies. The agencies to be contacted will vary from project to project depending on the nature of the project, the aquatic resources present, and the uses of the water. The agencies that may be interested in a project include but are not limited to the following: U.S. Army Corps of Engineers, U.S. Fish and Wildlife Service, U.S. Environmental Protection Agency, California Regional Water Quality Control Boards, California Department of Fish and Game, Flood Control Districts, and local water districts. The District Environmental Unit can provide assistance in determining which agencies should be contacted.

Recommendations for mitigation measures or construction and operational controls contained in the project's Storm Water Data Report should receive full consideration in the development of the project. The Department is legally bound to comply with the appropriate permits as outlined in the California Permit Handbook. The Department is also legally bound to comply with any water quality mitigation measures specified in the project's environmental document. Plans and specifications should reflect water quality protection measures in a manner that is enforceable in contracts.

On almost all projects, early contact should be established between the District project development personnel, Landscape Architecture, biologists, geologists, and other specialists available in the Headquarters Environmental Program, the Division of Engineering Services (DES) Office of Structural Foundations, FHWA, or other Districts, to ensure optimum development of water quality control measures.

Because siltation resulting from erosion is recognized as a major factor in water pollution, continuous efforts should be made to improve erosion control practices.

(1) *Project Planning Phase.* When project planning studies are started, consideration should be given to the items in the following list:

- (a) Identify all waters in the vicinity of a highway project which might affect construction, maintenance and operational activities.

The environmental factors that might affect preconstruction activities should be looked into for the benefit of the resident engineer and contractor. An example would be relocation of drilling of pile foundations in a sensitive stream to prevent possible impacts.

- (b) Identify for each project all waters, both fresh and saline, surface and underground, where water quality may be affected by the proposed construction.
- (c) Determine if any watersheds, aquifers, wells, reservoirs, lakes, or streams are sources for domestic water supplies.
- (d) Determine if any sensitive fishery, wildlife, recreational, agricultural, or industrial aquatic resources are located in the vicinity of the project.
- (e) Consider possible relocation or realignment that could be made to avoid or minimize the possibility of pollution of existing waters.
- (f) Identify variations in the erosive characteristics of the soils in the area, and consider relocation or grade changes that would minimize erosion.

July 1, 2020

- (g) Where possible, avoid unstable areas where construction may cause future landslides.
 - (h) Identify construction season preference of regulatory agencies.
 - (i) Evaluate the need for additional right of way to allow for flatter, less erosive slopes.
- (2) *Design Phase.* During the design phase, the items listed above should again be considered. More specific items for consideration are presented in the following checklist:
- (a) Provide for the preservation of roadside or median vegetation beyond the limits of construction by special provisions and depiction on the plans. See Index 904.2(1).
 - (b) Design slopes as flat as is reasonable with slope rounding, landforming/geomorphic grading, contouring, or stepping to minimize erosion and to promote plant growth. Consider retaining walls when practical to reduce slope length and steepness. Remove or excavate, stockpile, and apply topsoil and/or duff on the final slope to improve soil health for plant growth. Contact the District Landscape Architect for more information. See Index 904.2(2) for soil health information.
 - (c) Provide erosion control to all soil areas to be disturbed by construction activities. Consider the need to require the contractor to apply permanent erosion control in phases, as slopes become substantially complete, instead of allowing all erosion control to be applied at the end of the construction project. Prior to winterizing the project, the designer must plan for temporary erosion control on slopes not substantially complete. Refer to Topic 906 for information on Vegetated Erosion Control.

If a highway planting project is anticipated immediately following roadway construction, disturbed soil areas can-not be left unprotected. The use of mulch could be considered as an erosion control method during the interim. Contact the District Landscape Architect for assistance.
 - (d) When planning for temporary erosion control, consider the use of vegetation, mulches, fiber mats, fiber rolls, netting, dust palliatives, crust forming chemicals, silt fences, or another procedure that may be necessary to prevent erosion. The District Storm Water Coordinator, District Landscape Architect, and the District Storm Water Unit can assist in the selection and design of temporary erosion control measures.
 - (e) Design overside drains, surface, subsurface, and cross drains so that they will discharge in locations and in such a manner that surface and subsurface water quality will not be affected. The outlets may require aprons, bank protection, desilting basins, or energy dissipaters.
 - (f) Provide for adequate fish passage through highway culverts or under bridges when necessary to protect or enhance fishery resources.
 - (g) Provide bank protection where the highway is adjacent to rivers, streams, lakes, or other bodies of water.
 - (h) Where required, provide slope protection or channel lining, energy dissipaters, etc. for channel changes.
 - (i) Where the State has made arrangements for materials, borrow, or disposal sites, grading plans should be provided and revegetation required. Special provisions should require the contractor to furnish plans for grading and replanting of sites.

- (j) Check right of way widths for adequate space to reduce slope gradients and minimize slope angles, for rounding at tops of cuts and bottoms of fills, for adequate slope protection ditches and for incorporation of treatment control measures (e.g., infiltration basins, detention basins, traction sand traps). Also consider right of way or encroachment rights for temporary work such as desilting basins, stream diversion, or stream crossing protection.
 - (k) All ditches should be designed to minimize erosion. These treatments include but are not limited to grass lining, fiber mats, rock lining (with or without geotextile underlayment), and paving. The District Hydraulics Unit can assist with the selection and design of ditch treatment. Consideration should be given to using soil stabilization materials in median ditches or other wide drainage areas that cannot be vegetated.
 - (l) Temporary construction features for water pollution control that can be predicted should be made a part of the plans, specifications, and contract pay items. Such items as mulching and seeding of slopes, berms, dikes, ditches, pipes, dams, silt fences, settling basins, stream diversion channels, slope drains, and crossings over live streams should be considered. Since all contingencies probably cannot be foreseen, supplemental work funds should be set up for each project. Pay items for temporary erosion control should not be adjusted for increased or decreased quantity.
 - (m) Special consideration should be given to using vegetated ditches to remove highway runoff pollutants. The District Hydraulics and Landscape Architecture Units can provide assistance in designing and constructing vegetated ditches.
 - (n) Mandatory order of work clauses sometimes result in increased costs or longer time limits, but they must be considered where their use would eliminate the expense of temporary construction or where they result in earlier protection of erodible areas, or improved handling of site runoff.
- (3) *Abandonment and Destruction of Water Wells.* The abandonment and destruction of water wells within the highway right of way must be handled in accordance with requirements established by statute and by agreement with the Department of Water Resources (DWR) to avoid pollution of underground water and ensure public safety. Sections 13700 to 13806 of the California Water Code deal, in general, with the construction and destruction of wells. Section 24400 to 24404 of the Health and Safety Code require that abandoned wells be covered, filled, or fenced for safety reasons. Statewide standards for construction, maintenance and destruction of water wells, monitoring wells and cathodic protection wells have been issued by the California DWR in Bulletin 74 - 81, "Water Well Standards: State of California", dated December, 1981, and Bulletin 74 - 81", dated January, 1990. Pursuant to these standards and interagency agreement with DWR, the following procedures are to be followed to determine requirements for abandonment and destruction of wells within State highway rights of way.
- (a) Before producing water wells within the highway right of way are abandoned, a determination should be made of the possible future uses of the wells. Such future uses include landscape irrigation, safety roadside rest areas, vista points, maintenance facilities, truck weighing facilities, and others.
 - (b) The District Project Development and Right of Way Branches determine the location of water wells that will be affected by highway construction on a project basis.
 - (c) The District submits a letter to the Director, Department of Water Resources, 1416 Ninth Street, Sacramento, CA. 95814 Attention: Water Resources Evaluation Section, Division of Resources Development, listing the wells to be abandoned and any information that may be known about them. The letter should include the

July 1, 2020

scheduled PS&E date and the anticipated advertising date for the project. Two copies of a map, or maps, showing the location of each well accurately enough so it can be located in the field should be included with the letter. A copy of this package should also be provided to Headquarters Construction.

- (d) DWR will investigate the wells and write a report recommending procedures to be used in destruction of the wells within the highway right of way. The interagency agreement provides for reimbursement of the DWR's cost for these investigations and reports.
 - (e) DWR will forward its report to the District.
 - (f) Provisions for destruction of abandoned wells occasioned by highway construction and planting projects must be included in the District PS&E report. The work, usually done by filling and sealing, normally should be included in the contract Special Provisions. Steps must be taken to insure that wells are left in a safe condition between the time the site is acquired by the State and the time the well is sealed.
 - (g) In some cases, local ordinances or conditions will require the filling and sealing of the well prior to the highway contract in order to leave the well in a safe condition.
 - (h) The contractor who does the work to abandon the well must file the Notice of Intent (Form DWR 2125) and the Water Well Drillers Report (Form DWR 188) required by the Department of Water Resources.
 - (i) Also, under California Water Code Section 13801, after January 15, 1990, all cities and counties are required to have adopted ordinances that require prior acquisition of permits for all well construction, reconstruction and destruction and requiring possession of an active C-57 contractor's license as the minimum qualification for persons permitted to work on wells.
- (4) *Summary.* To prevent pollution of all waters that could be affected by a highway construction project, it is desirable to avoid involvement with the water or avoid the construction of erodible features. Since it is seldom possible to avoid all such features, the design of effective erosion and sediment control measures should be included with the project. Material resulting from erosion should either be discharged in locations where no negative environmental impacts will occur, or be deposited in locations that are accessible to maintenance forces for removal. District Landscape Architecture can provide technical assistance in assessing the impacts of erosion and in designing erosion control features.

Project Development personnel should ensure that all aspects of erosion control and other water quality control features considered during design are fully explained to the Resident Engineer. Such data is essential for review of the contractor's water pollution control program. Judgment must be used in differentiating between planned temporary protection features and work which the contractor must perform in order to fulfill their responsibility to protect the work from damage.

To reduce contract change orders and ensure erosion control goals are met, important protection should not be left to the contractor's judgment. It is desirable that all predictable temporary protection measures be incorporated in the plans and specifications and items for payment included in the contract items of work.

Topsoil should be stripped, stockpiled, and restored to disturbed slopes because existing soil nutrients and native seeds contained within the topsoil are beneficial for establishing vegetative cover and controlling erosion.

In addition, the abandonment of water wells must be given special attention in accordance with Section (3) above.

110.3 Control of Air Pollution

Air pollution associated with the construction of highways and to completed highway facilities should be held to the practical minimum. The designer should consider the impacts of haul roads, disposal sites, borrow sites, and other material sources in addition to construction within the highway right of way.

- (1) *Control of Dust.* Many of the items listed under Index 110.2, Control of Water Pollution, are applicable to dust control. Consideration should be given to these items and additional material presented in the following list:
 - (a) See Index 110.2(2)(a), (c), (d), (k) and (n).
 - (b) Flat areas not normally susceptible to erosion by water may require erosion control methods such as planting, stabilizing emulsion, protective blankets, etc., to prevent wind erosion.
 - (c) Cut and or fill slopes can be sources of substantial wind erosion. They will require planting or other control measures even if water erosion is only a minor consideration.
 - (d) In areas subject to dust or sand storms, vegetative wind breaks should be considered to control dust. Use of soil sealant may also be considered.
 - (e) Special provisions should be used requiring the contractor to restore material, borrow, or disposal sites, and temporary haul roads to a condition such that their potential as sources of blowing dust or other pollution is no greater than in their original condition. Work for this purpose that can be predicted should be made a part of the PS&E, which should require submission of the contractors plan for grading, seeding, mulching or other appropriate action.
 - (f) Stockpiling and respreading topsoil may speed revegetation of the roadside and reduce wind erosion. Refer to Index 904.2(2)(a).
- (2) *Control of Burning.* Health and Safety Code provisions and rules issued by Air Pollution Control Boards will preclude burning on most highway projects. Off-site disposal of debris must not create contamination problems and should not be specified simply as an expedient resolution of the problem without imposing adequate controls on how such disposal site is to be handled. Designers should seek disposal site locations within the right of way where it will be permissible to dispose of debris. Proper procedures, including compaction and burial, should be specified. Debris should not be disposed of within the normal roadway. Burying within the right of way should be done in such a fashion that the layers of debris will not act as a permeable layer or otherwise be detrimental to the roadway. Acceptable alternates based on economic, aesthetic, safety, and other pertinent considerations should be included in the contract if possible.

On projects where burning will not be permitted and disposal of debris within the right of way is not possible, optional disposal sites should be made available. Information on such site arrangements should be made available in the "Materials Information" furnished to prospective bidders. Reference is made to the applicable portion of Index 111.3 and 111.4 for handling this requirement. Special requirements for disposal of debris and final

July 1, 2020

appearance of the disposal site should be covered in the Special Provisions. The intent of this instruction is that the designer should make sure that prospective bidders have adequate information on which to make a realistic bid on clearing and grubbing.

When feasible, tree trunks, branches, and brush should be reduced to chips and incorporated with the soil, spread on fill slopes, used as a cover mulch or disposed of in other ways compatible with the location. In forest areas where they will not look out of place, limbs and trunks of trees that are too large for chipping may be limbed and cut to straight lengths and the pieces lined up at the toes of the slope. An earth cover may be necessary for aesthetic reasons, or to reduce fire hazards. Under certain conditions salvage of merchantable timber may be desirable, or may be required by right of way commitments. Whenever merchantable timber is to be salvaged, appropriate specifications should be provided. Stumps and unsightly clumps of debris should be chipped or buried in areas where they will not create future problems.

Care should be taken not to block drainage or to interfere with maintenance operations.

Before proposing chipping as the method of disposal, the designer should investigate to determine if plant disease or insect pests will be spread to disease-free or insect-free areas. Procedures to decontaminate such chips before use should be included in the contract if necessary. Designers should seek advice from local experts and County Agricultural Extension Offices to determine the extent of such problems and the procedures and chemicals to be specified.

The U.S. Forest Service and the State Division of Forestry should be contacted during the design stage to ascertain the requirements that these agencies will make upon any disposal methods to be used in areas under their control.

It will be noted that under certain limited conditions the prohibition against burning may be eliminated from the Special Provisions.

There will be some areas of the State where Air Pollution Control Boards may consider issuing a permit for open burning where the effect on air quality is expected to be negligible and few if any residents would be affected. The individual situation should be studied and appropriate special provisions prepared for each project to fully cover all possible methods of disposal of debris that will be available to the contractor.

The local Air Pollution Control Board should be contacted to determine the current regulations.

- (3) *Summary.* Special consideration should be given to the direction of prevailing winds or high-velocity winds in relation to possible sources of dust and downwind residential, business, or recreational areas. Every practical means should be incorporated in the design of the highway and in the provisions of the contract to prevent air pollution resulting from highway construction and operation.

110.4 Wetlands Protection

The Nation's wetlands are recognized on both the Federal and State level as a valuable resource. As such, there have been several legislative and administrative actions which provide for special consideration for the preservation of wetlands. These are embodied on the Federal level in Executive Order 11990, DOT Order 5660.1A, Section 404 of the Clean Water Act, including Section 404(b)(1) guidelines, and the NEPA 404 Integration Process for Surface Transportation Projects, and the August 24, 1993 Federal Wetlands Policy. Wetlands are covered on the State level by the Porter-Cologne Water Quality Act and the Resources Agency's Wetlands Policy. The District Environmental Unit can provide

assistance with permitting strategies, identifying wetlands, determining project impacts, and recommending mitigation measures, in coordination with the District Landscape Architect.

110.5 Control of Noxious Weeds - Exotic and Invasive Species

Highway corridors provide the opportunity for the transportation of exotic and invasive weed species through the landscape. Species that have the ability to harm the environment, human health or the economy are of particular concern. In response to the impact of exotic and invasive species, Executive Orders 11987, 13112, and 13751 direct Federal Agencies to expand and coordinate efforts to combat the introduction and spread of non-native plants and animals. Grading, excavation, and fill operations during construction may introduce invasive species or promote their spreading. Because of this, the FHWA implemented guidance for State Departments of Transportation for preventing the introduction and controlling the spread of invasive plant species on highway rights of way on transportation improvement projects. District Environmental Unit and Landscape Architecture can provide assistance in identifying invasive or exotic species which should be controlled, and in recommending mitigation or control methods to be included in appropriate highway improvement projects.

110.6 Earthquake Consideration

Earthquakes are naturally occurring events that have a high potential to cause damage and destruction. While it is not possible to completely assure earthquake proof facilities, every attempt should be made to limit potential damage and prevent collapse.

There are certain measures that should be considered when a project is to be constructed in or near a known zone of active faulting.

Early in the route location process, active and inactive faults should be mapped by engineering geologists. A general assessment of the seismic risk of various areas within the study zone should then be prepared. The DOS and Office of Structural Foundations are available to assist in the assessment of seismic risk.

Strong consideration must be given to the location of major interchanges. They must be sited outside of heavily faulted areas unless there are exceptional circumstances that make it impractical to do so. Where close seismic activity is highly probable, consideration should be given to avoiding complex multilevel interchanges in favor of simple designs with low skew, short span structures close to the original ground, and maximum use of embankment. Single span bridges which are designed to tolerate large movements are desirable.

Early recognition of seismic risk may lead the designer to modify alignment or grade in order to minimize high cuts, fills, and bridge structures in the area. Slopes should be made as flat as possible both for embankment stability and to reduce slide potential in cuts. Buttress fills can be constructed to improve cut stability. The DOS and the Office of Structural Foundations, should be consulted early when considering various alternatives to obtain recommendations for mitigating earthquake damage.

When subjected to an earthquake, fills may crack, slump, and settle. In areas of high water table, liquefaction may cause large settlement and shifting of the roadway. It is not economically feasible to entirely prevent this damage. One possible mitigation for existing

July 1, 2020

soils would be to have the contract Special Provisions provide for removal of loose and compressible material from fill foundation areas, particularly in canyons, side hill fills, and ravines and for foundation preparation on existing hillsides at the transition between cut and fill.

No modification is necessary in the design of the pavement structural sections for the purpose of reducing damage due to future earthquakes. Normally it is not possible to reduce this damage, since the structural section cannot be insulated from movements of the ground on which it rests. In active fault areas, consideration should be given to the use of flexible pipes or pipes with flexible couplings for cross drains, roadway drainage and conduits.

Additional expenditure for right of way and construction to make highways and freeways more earthquake resistant in a known active fault area should be kept in balance with the amount of impact on the traveling public if the facility may be put out of service following a disastrous earthquake. Loss of a major interchange, however, may have a tremendous influence on traffic flow and because of the secondary life-safety and economic impacts some additional expenditure may be justified.

110.7 Traffic Control Plans

This section focuses mainly on providing for vehicular traffic through the work zone; however, providing for bicyclists, pedestrians, and transit through the work zone is also necessary when they are not prohibited.

A detailed plan for moving all users of the facility through or around a construction zone must be developed and included in the PS&E for all projects to assure that adequate consideration is given to the safety and convenience of motorists, transit, bicyclists, pedestrians, and workers during construction. Design plans and specifications must be carefully analyzed in conjunction with Traffic, Construction, and Structure personnel (where applicable) to determine in detail the measures required to warn and guide motorists, transit, bicyclists, and pedestrians through the project during the various stages of work. Starting early in the design phase, the project engineer should give continuing attention to this subject, including consideration of the availability of appropriate access to the work site, in order that efficient rates of production can be maintained. In addition to reducing the time the public is exposed to construction operations, the latter effort will help to hold costs to a minimum.

The traffic control plans should be consistent with the California MUTCD, and the philosophies and requirements contained in standard traffic control system plans developed by the Headquarters Division of Traffic Operations for use on State highways and should cover, as appropriate, such items as:

- Signing.
- Flagging.
- Geometrics of detours.
- Methods and devices for delineation and channelization.
- Application and removal of pavement markings.
- Placement and design of barriers and barricades.

- Separation of opposing vehicular traffic streams (See 23 CFR 630J).
- Maximum lengths of lane closures.
- Speed limits and enforcement.
- Use of COZEEP (see Construction Manual Section 2-215).
- Use of pilot cars.
- Construction scheduling.
- Staging and sequencing.
- Length of project under construction at any one time.
- Methods of minimizing construction time without compromising safety.
- Hours of work.
- Storage of equipment and materials.
- Removal of construction debris.
- Treatment of pavement edges.
- Roadway lighting.
- Movement of construction equipment.
- Access for emergency vehicles.
- Clear roadside recovery area.
- Provision for disabled vehicles.
- Surveillance and inspection.
- Needed modifications of above items for inclement weather or darkness.
- Evaluate and provide for as appropriate the needs of bicyclists and pedestrians (including ADA requirements; see Index 105.4).
- Provisions to accommodate continued transit service.
- Consideration of complete facility closure during construction.
- Consideration of ingress/egress requirements for construction vehicles.
- Any other matters appropriate to the safety objective.

Normally, not all the above items will be pertinent to any one traffic control plan. Depending on the complexity of the project and the volume of traffic affected, the data to be included in the traffic control plan can vary from a simple graphic alignment of the various sequences to the inclusion of complete construction details in the plans and special provisions. In any event, the plans should clearly depict the exact sequence of operation, the construction details to be performed, and the traveled way to be used by all modes of traffic during each construction phase. Sufficient alignment data, profiles, plan dimensions, and typical sections should be shown to ensure that the contractor and resident engineer will have no difficulty in providing traffic-handling facilities.

In some cases, where the project includes permanent lighting, it may be helpful to install the lights as an early order of work, so they can function during construction. In other cases, temporary installations of high-level area lighting may be justified.

July 1, 2020

Temporary roadways with alignment and surfacing consistent with the standards of the road which has just been traveled by the motorist should be provided if physically and economically possible.

Based on assessments of safety benefits, relative risks and cost-effectiveness, consideration should be given to the possibility of including a bid item for continuous traffic surveillance and control during particular periods, such as:

- (a) When construction operations are not in progress.
- (b) When lane closures longer than a specified length are delineated by cones or other such nonpermanent devices, whether or not construction operations are in progress.
- (c) Under other conditions where the risk and consequences of traffic control device failure are deemed sufficient.

Potentially hazardous working conditions must be recognized and full consideration given to the safety of workers as well as the general public during construction. This requirement includes the provision of adequate clearance between public traffic and work areas, work periods, and lane closures based on careful consideration of anticipated vehicle traffic volumes, and minimum exposure time of workers through simplified design and methods.

If a Transportation Management Plan (TMP) is included in the project, the traffic control plans (TCP) may need to be coordinated with the public information campaign and the transportation demand management elements. Any changes in TMP or TCP must be made in harmony for the plans to succeed. The "TMP Guidelines", available from the Headquarters Division of Traffic Operations should be reviewed for further guidance.

Traffic control plans along with other features of the design should be reviewed by the District Safety Review Committee prior to PS&E as discussed in Index 110.8.

The cost of implementing traffic control plans must be included in the project cost estimate, either as one or more separate pay items or as extra work to be paid by force account.

It is recognized that in many cases provisions for traffic control will be dependent on the way the contractor chooses to execute the project, and that the designer may have to make some assumptions as to the staging or sequence of the contractor's operations in order to develop definite temporary traffic control plans. However, safety of the public and the workers as well as public convenience demand that designers give careful consideration to the plans for handling all traffic even though a different plan may be followed ultimately. It is simpler from a contract administration standpoint to change a plan than to add one where none existed. The special provisions should specify that the contractor may develop alternate traffic control plans if they are as sound or better than those provided in the contract PS&E.

See Section 2-30, Traffic, of the Construction Manual for additional factors to be considered in the preparation of traffic control plans.

110.8 Safety Reviews

Formal safety reviews during planning, design and construction have demonstrated that safety-oriented critiques of project plans help to ensure the application of safety standards. An independent team not involved in the design details of the project is generally able to conduct reviews from a fresh perspective. In many cases, this process leads to highly cost-

effective modifications that enhance safety for motorists, bicyclists, pedestrians, and highway workers without any material changes in the scope of the project.

(1) *Policy.* During the planning stage all projects must be reviewed by the District Safety Review Committee prior to approval of the appropriate project initiation document (PID).

During design, each major project with an estimated cost over the Minor A limit must be reviewed by the District Safety Review Committee.

Any project, regardless of cost, requiring a Traffic Control Plan must be reviewed by the District Safety Review Committee. During construction, the detection of the need for safety-related changes is the responsibility of construction personnel, as outlined in the Construction Manual.

Safety concepts that are identified during these safety reviews which directly limit the exposure of employees to vehicular and bicycle traffic shall be incorporated into the project unless deletion is approved by the District Director.

(2) *Procedure.* Each District must have a Safety Review Committee, composed of at least one engineer from the Construction, Design, Maintenance, and Traffic functions and should designate one of the members as chairperson. Committee members should familiarize themselves with current standards and instructions on highway safety so that they can identify items in need of correction.

The Committee should conduct at least two design safety reviews of each major project. The Design Project Engineer has the basic responsibility to notify the committee chairperson when a review is needed. The chairperson should schedule a review and coordinate participation by appropriate committee members.

Reviews, evaluating safety from the perspectives of the motorists, bicyclists, and pedestrians, should include qualitative and/or quantitative safety considerations of such items as:

- Exposure of employees to vehicular and bicycle traffic.
- Traffic control plans.
- Transportation Management Plans.
- Traversability of roadsides.
- Elimination or other appropriate treatment of fixed objects.
- Susceptibility to wrong-way moves.
- Safety of construction and maintenance personnel.
- Sight distance.
- ADA design.
- Guardrail.
- Run off road concerns.
- Superelevation, etc.
- Roadside management and maintenance reduction.
- Access to facilities from off of the freeway.
- Maintenance vehicle pull-out locations.

July 1, 2020

The objective is to identify all elements where safety improvement may be practical and indicate desirable corrective measures. Reviews should be scheduled when the report or plans are far enough along for a review to be fruitful, but early enough to avoid unnecessary delay in the approval of the report or the completion of PS&E.

A simple report should be prepared on the recommendations made by the Safety Committee and the response by the Design Project Engineer. The reports should be included in the project files.

110.9 Value Analysis

The use of Value Analysis techniques should begin early in the project development process and be applied at various milestones throughout the PS&E stage to reduce life-cycle costs. See the Project Development Procedures Manual for additional information.

110.10 Proprietary Items

The use of proprietary items is discouraged in the interest of promoting competitive bidding. If it is determined that a proprietary item is needed and beneficial to the State, their use must be approved by the District Director or by the Deputy District Director of Design (if such approval authority has been specifically delegated by the District Director). The Division Chief of Engineering Services must approve the use of proprietary items on structures and other design elements under their jurisdiction. The Department's guidelines on how to include proprietary items in contract plans are covered in the Office Engineer's Ready to List and Construction Contract Award Guide (RTL Guide) under "Proprietary Products."

On projects that utilize federal funds, the use of proprietary items requires an additional approval through a Public Interest Finding (PIF). A PIF is approved by the Federal Highway Administration (FHWA) Division Office for "High Profile Projects" or by the Division of Budgets, California Federal Resources Engineer for Delegated Projects, in accordance with the Stewardship Agreement. Additional information on the PIF process can be found through the Division of Budgets, Office of Federal Resources.

The use of proprietary materials, methods, or products will not be approved unless:

- (a) There is no other known material of equal or better quality that will perform the same function, or
- (b) There are overwhelming reasons for using the material or product in the public's interest, which may or may not include cost savings, or
- (c) It is essential for synchronization with existing highway or adjoining facilities, or
- (d) Such use is on an experimental basis, with a clearly written plan for "follow-up and evaluation."

If the proprietary item is to be used experimentally and there is Federal participation, the request for FHWA approval must be submitted to the Chief, Office of Landscape Architecture Standards and Procedures in the Division of Design. The request must include a Construction Evaluated Work Plan (CEWP), which indicates specific functional managers, and units, which have been assigned responsibility for objective follow-up, evaluation, and documentation of the effectiveness of the proprietary item.

110.11 Conservation of Materials and Energy

Paving materials such as cement, asphalt, and rock products are becoming more scarce and expensive, and the production processes for these materials consume considerable energy. Increasing evidence of the limitation of nonrenewable resources and increasing worldwide consumption of most of these resources require optimal utilization and careful consideration of alternates such as the substitution of more plentiful or renewable resources and the recycling of existing materials.

- (1) *Rigid Pavement.* The crushing and reuse of old rigid pavement as aggregate in new rigid or flexible pavement does not now appear to be a cost-effective alternate, primarily because of the availability of good mineral aggregate in most areas of California. However, if this is a feasible option, because of unique project conditions or the potential lack of readily available materials, it may be included in a cost comparison of alternate solutions.
- (2) *Flexible Pavement.* Recycling of existing flexible pavement must be considered, in all cases, as an alternative to placing 100 percent new flexible pavement.
- (3) *Use of Flexible Pavement Grindings, Chunks and Pieces.* When constructing transportation facilities, the Department frequently uses asphalt in mixed or combined materials such as flexible pavement. The Department also uses recycled flexible grindings and chunks. There is a potential for these materials to reach the waters of the State through erosion or inappropriate placement during construction. Section 5650 of the Fish and Game Code states that it is unlawful to deposit asphalt, other petroleum products, or any material deleterious to fish, plant life, or bird life where they can pass into the waters of the State. In addition, Section 1601 of the Fish and Game Code requires notification to the California Department of Fish and Game (DFG) prior to construction of a project that will result in the disposal or deposition of debris, waste, or other material containing crumbled, flaked, or ground pavement where it can pass into any river, stream, or lake designated by the DFG.

The first step is to determine whether there are waters of the State in proximity to the project that could be affected by the reuse of flexible pavement. Waters of the State include: (1) perennial rivers, streams, or lakes that flow or contain water continuously for all or most of the year; or (2) intermittent lakes that contain water from time to time or intermittent rivers or streams that flow from time to time, stopping and starting at intervals, and may disappear and reappear. Ephemeral streams, which are generally exempt under provisions developed by the Department and DFG, are those that flow only in direct response to rainfall.

The reuse of flexible pavement grindings will normally be consistent with the Fish and Game Code and not require a 1601 Agreement when these materials are placed where they cannot enter the waters of the State. However, there are no set rules as to distances and circumstances applicable to the placement of asphaltic materials adjacent to waters of the State. Placement decisions must be made on case-by-case basis, so that such materials will be placed far enough away from the waters of the State to prevent weather (erosion) or maintenance operations from dislodging the material into State waters. Site-specific factors (i.e., steep slopes) should be given special care. Generally, when flexible pavement grindings are being considered for placement where there is a potential for this material to enter a water body, DFG should be notified to assist in determining whether a 1601 Agreement is appropriate. DFG may require mitigation strategies to prevent the

July 1, 2020

materials from entering the Waters of the State. When in doubt, it is recommended that the DFG be notified.

If there is the potential for reused flexible materials to reach waters of the State through erosion or other means during construction, such work would normally require a 1601 Agreement. Depending on the circumstances, the following mitigation measures should be taken to prevent flexible grindings from entering water bodies:

- The reuse of flexible pavement grindings as fill material and shoulder backing must conform to the California Department of Transportation (Department) Standard Specifications, applicable manuals of instruction, contract provisions, and the MOU described below.
- Flexible chunks and pieces in embankment must be placed above the water table and covered by at least one foot of material.

A Memorandum of Understanding (MOU) dated January 12, 1993, outlines the interim agreement between the DFG and the Department regarding the use of asphaltic materials. This MOU provides a working agreement to facilitate the Department's continued use of asphaltic materials and avoid potential conflicts with the Fish and Game Code by describing conditions where use of asphalt road construction material by the Department would not conflict with the Fish and Game Code.

Specific Understandings contained in the MOU are:

- Asphalt Use in Embankments
The Department may use flexible pavement chunks and pieces in embankments when these materials are placed where they will not enter the waters of the State.
- Use of flexible pavement grindings as Shoulder Backing
The Department may use flexible pavement grindings as shoulder backing when these materials are placed where they will not enter the waters of the State.
- Streambed Alteration Agreements

The Department will notify the DFG pursuant to Section 1601 of the Fish and Game Code when a project involving the use of asphaltic materials or crumbled, flaked, or ground pavement will alter or result in the deposition of pavement material into a river, stream, or lake designated by the DFG. When the proposed activity incorporates the agreements reached under Section 1601 of the Fish and Game Code, and is consistent with Section 5650 of the Fish and Game Code and this MOU, the DFG will agree to the use of these materials.

There may be circumstances where agreement between the DFG and the Department cannot be reached. Should the two agencies reach an impasse, the agencies enter into a binding arbitration process outlined in Section 1601 of the Fish and Game Code. However, keep in mind that this arbitration process does not exempt the Department from complying with the provisions of the Fish and Game Code. Also it should be noted that this process is time consuming, requiring as much as 72 days or more to complete. Negotiations over the placement of flexible pavement grindings, chunks, and pieces are to take place at the District level as part of the 1601 Agreement process.

110.12 Tunnel Safety Orders

Projects and work activities that include human entry into tunnels, shafts or any of a variety of underground structures to conduct construction activities must address the requirements of the California Code of Regulations (CCR), Title 8, Subchapter 20 – Tunnel Safety Orders (TSO). Activities that can be considered of a maintenance nature, such as cleaning of sediment and debris from culverts or inspection (either condition inspection for design purposes or inspection as a part of construction close-out) of tunnels, shafts or other underground facilities are not affected by these regulations.

TSO requires the Department, as owner of the facility, to request the Department of Industrial Relations, Division of Occupational Safety and Health (Cal-OSHA), Mining and Tunneling Unit, to review and classify tunnels and shafts for the potential presence of flammable gas and vapors prior to bidding. The intent of the TSO regulations are to protect workers from possible injury due to exposure to hazardous conditions. Failure to comply is punishable by fine. The complete TSO regulations are available at the following website: (<http://www.dir.ca.gov/title8/sub20.html>), with Sections 8403 and 8422 containing information most applicable to project design.

The TSO regulations require classification whenever there is human entry into a facility defined as a tunnel or entry into, or very near the entrance of, a shaft. Some of the common types of activities where human entry is likely and that will typically require classification include:

- Pipe jacking or boring operations
- Culvert rehabilitation
- Large diameter pile construction, as described in the following text
- Pump house vaults
- Cut-and-cover operations connected to ongoing underground construction and are covered in a manner that creates conditions characteristic of underground construction
- Well construction
- Cofferdam excavations
- Deep structure footings/shafts/casings, as described in the following text

Virtually any project that will lead to construction or rehabilitation work within a pipe, caisson, pile or underground structure that is covered by soil is subject to the TSO regulations. This typically applies to underground structures of 30 inches or greater diameter or shaft excavations of 20 feet or more in depth. Since a shaft is defined as any excavation with a depth at least twice its greatest cross section, the regulations will apply to some structure footing or cofferdam excavations.

Cut and cover operations (typical of most pipe, junction structure and underground vault construction) do not fall under the TSO regulations as long as worker entry to the pipe or system (usually for grouting reinforced concrete pipe, tightening bolts on structural plate pipe, etc.) is conducted prior to covering the facility with soil. Connecting new pipe to existing buried pipe or structures does fall under the TSO regulations unless the existing pipe system is physically separated by a bulkhead to prevent entry into the buried portion. Designers

July 1, 2020

must either incorporate requirements for such separation of facilities into the PS&E or they must obtain the required classification from Cal-OSHA. For any project that requires classification, specifications must be included that alert the Contractor to the specific location and classification that Cal-OSHA has provided.

The TSO regulations should be viewed as being in addition to, and not excluding, other requirements as may apply to contractor or Department personnel covered in the Construction Safety Orders (see CCR, Title 8, Subchapter 4, Article 6 at <http://www.dir.ca.gov/title8/sub4.html>), safety and health procedures for confined spaces (see Chapter 14 of the Caltrans Safety Manual), or any other regulations that may apply to such work.

Prior to PS&E submittal on a project that includes any work defined in CCR Section 8403, a written request must be submitted for classification to the appropriate Mining and Tunneling (M&T) Unit office. Each M&T Unit office covers specific counties as shown on Figure 110.12. Classification must be obtained individually for each separate location on a project. For emergency projects or other short lead-time work, it is recommended that the appropriate M&T Unit office be contacted as soon as possible to discuss means of obtaining classification prior to the start of construction activities.

The request must include all pertinent and necessary data to allow the M&T Unit to classify the situation. The data specified under paragraph (a) of Section 8422 (complete text of Section 8422 reprinted below) is typical of new construction projects, however for culvert rehabilitation and other type of work affecting an existing facility, not all of the indicated items are typically available or necessary for submittal. The appropriate M&T Unit office should be contacted for advice if there is any question regarding data to submit.

In many instances it may not be known during design if there will be human entry into facility types that would meet the definition of a tunnel or shaft. If there is any anticipation that such entry is likely to occur, classification should be requested. As permit acquisition is typically the responsibility of the District, it is imperative that there be close coordination between District and Structures Design staff regarding the inclusion of any facilities in the structures PS&E that could be defined as a tunnel or shaft and have potential for human entry. The following text is taken directly from Section 8422:

8422 Tunnel Classifications

- (a) When the preliminary investigation of a tunnel project is conducted, the owner or agency proposing the construction of the tunnel shall submit the geological information to the Division for review and classification relative to flammable gas or vapors. The preliminary classification shall be obtained from the Division prior to bidding and in all cases prior to actual underground construction. In order to make the evaluation, the following will be required:
- (1) Plans and specifications;
 - (2) Geological report;
 - (3) Test bore hole and soil analysis log along the tunnel alignment;

Figure 110.12

California Mining and Tunneling Districts

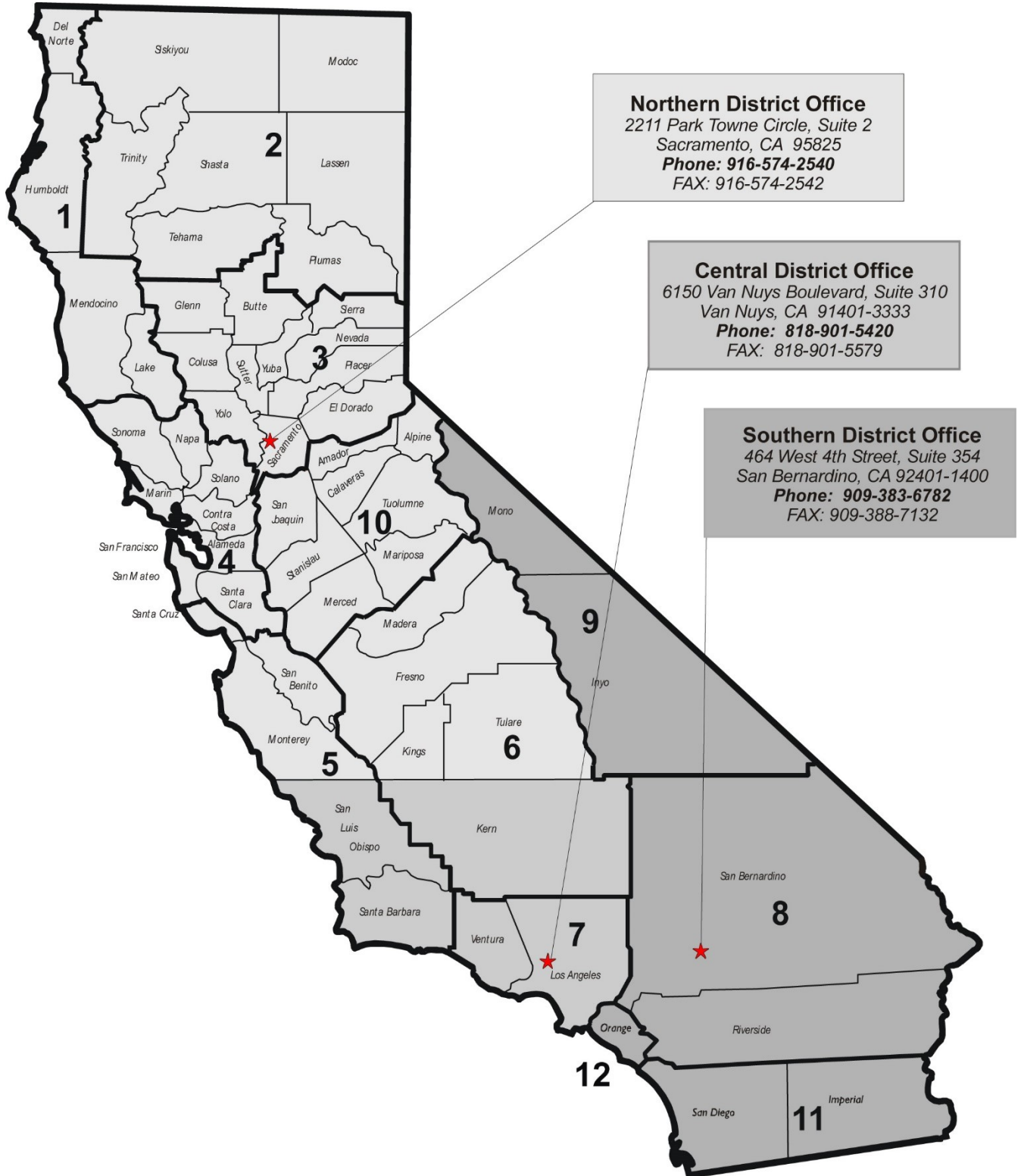

July 1, 2020

- (4) Proximity and identity of existing utilities and abandoned underground tanks.
 - (5) Recommendation from owner, agency, lessee, or their agent relative to the possibility of encountering flammable gas or vapors;
 - (6) The Division may require additional drill hole or other geologic data prior to making gas classifications.
- (b) The Division shall classify all tunnels or portions of tunnels into one of the following classifications:
- (1) Nongassy, which classification shall be applied to tunnels where there is little likelihood of encountering gas during the construction of the tunnel.
 - (2) Potentially gassy, which classification shall be applied to tunnels where there is a possibility flammable gas or hydrocarbons will be encountered.
 - (3) Gassy, which classification shall be applied to tunnels where it is likely gas will be encountered or if a concentration greater than 5 percent of the LEL of:
 - (A) flammable gas has been detected not less than 12 inches from any surface in any open workings with normal ventilation.
 - (B) flammable petroleum vapors that have been detected not less than 3 inches from any surface in any open workings with normal ventilation.
 - (4) Extra hazardous, which classification shall be applied to tunnels when the Division finds that there is a serious danger to the safety of employees and:

Flammable gas or petroleum vapor emanating from the strata has been ignited in the tunnel; or

 - (A) A concentration of 20 percent of the LEL of flammable gas has been detected not less than 12 inches from any surface in any open working with normal ventilation; or
 - (B) A concentration of 20 percent of LEL petroleum vapors has been detected not less than three inches from any surface in any open workings with normal ventilation.
- (c) A notice of the classification and any special orders, rules, special conditions, or regulations to be used shall be prominently posted at the tunnel job site, and all personnel shall be informed of the classification.
- (d) The Division shall classify or reclassify any tunnel as gassy or extra hazardous if the preliminary investigation or past experience indicates that any gas or petroleum vapors in hazardous concentrations is likely to be encountered in such tunnel or if the tunnel is connected to a gassy or extra hazardous excavation and may expose employees to a reasonable likelihood of danger.
- (e) For the purpose of reclassification and to ensure a proper application of classification, the Division shall be notified immediately if a gas or petroleum vapor exceeds any one of the individual classification limits described in subsection (b) above. No underground works shall advance until reclassification has been made.
- (1) A request for declassification may be submitted in writing to the Division by the employer and/or owner's designated agent whenever either of the following conditions occur:
 - (A) The underground excavation has been completed and/or isolated from the ventilation system and/or other excavations underway, or

- (B) The identification of any specific changes and/or conditions that have occurred subsequent to the initial classification criteria such as geological information, bore hole sampling results, underground tanks or utilities, ventilation system, air quality records, and/or evidence of no intrusions of explosive gas or vapor into the underground atmosphere.

NOTE: The Division shall respond within 10 working days for any such request. Also, the Division may request additional information and/or require specific conditions in order to work under a lower level of classification.

Topic 111 – Material Sites and Disposal Sites

111.1 General Policy

The policies and procedures concerning material sites and disposal sites are listed below. For further information concerning selection and procedures for disposal, staging and borrow sites, see DIB 85.

- (a) Materials investigations and environmental studies of local materials sources should be made to the extent necessary to provide a basis for study and design. Location and capacity of available disposal sites should be determined for all projects requiring disposal of more than 10,000 cubic yards of clean material. Sites for disposal of any significant amount of material in sensitive areas should be considered only where there is no practical alternative.
- (b) Factual information obtained from such investigations should be made readily available to prospective bidders and contractors.
- (c) The responsibility for interpreting such information rests with the contractor and not with the State.
- (d) Generally, the designation of optional material sites or disposal sites will not be included in the special provisions. Mandatory sites must be designated in the special provisions or Materials Information Handout as provided in Index 111.3 of this manual and Section 2-1.03 of the Standard Specifications. A disposal site within the highway right of way (not necessarily within the project limits) should be provided when deemed in the best interest of the Department as an alternative to an approved site for disposal of water bearing residues generated by grinding or grooving operations, after approval is obtained from the Regional Water Quality Control Board (RWQCB) having jurisdiction over the area.
- (e) Material agreements or other arrangements should be made with owners of material sites whenever the absence of such arrangements would result in restriction of competition in bidding, or in other instances where it is in the State's interest that such arrangements be made.
- (f) The general policy of Caltrans is to avoid specifying mandatory sources unless data in support of such sources shows certain and substantial savings to the State. Mandatory sources must not be specified on Federal-aid projects except under exceptional circumstances, and prior approval of the FHWA is required. Supporting data in such cases should be submitted as early as possible. This policy also applies to disposal sites.
- (g) It is the policy of Caltrans to cooperate with local authorities to the greatest practicable extent in complying with environmental requirements for all projects. Any corrective measures wanted by the local authorities should be provided through the permit process.

July 1, 2020

Any unusual requirements, conditions, or situations should be submitted to the Division of Design for review (see Indexes 110.2 and 110.3).

- (h) The use of any materials site requires compliance with environmental laws and regulations, which is normally a part of the project environmental documentation. If the need for a site occurs after approval of the project environmental document, a separate determination of environmental requirements for the materials site may be required.
- (i) If the materials site is outside the project limits and exceeds 1-acre in size, or extraction will exceed 1,000 cubic yards, it must comply with the Surface Mining and Reclamation Act of 1975 (SMARA) and be included on the current "AB 3098 List" published by the Department of Conservation before material from that site can be used on a State project. There are limited exceptions to this requirement and the District Materials Engineer should be consulted.

111.2 Investigation of Local Materials Sources

- (1) *Extent of Explorations.* Possible sources of materials should be investigated to the extent necessary to assure that the design of each project is based on the most economical use of available materials compatible with good environmental design practices. Where it can be reasonably assumed that all required materials can be most economically obtained from commercial sources on the current "AB 3098 List", it should be unnecessary to investigate other sites. In all other cases material sites should be investigated. Exploration of materials sources should not be restricted to those properties where the owner expresses willingness to enter into agreement with the State. Unless it is definitely known that the owner will under no circumstances permit removal of materials, the site should be considered as a possible source of local materials.
- (2) *Geotechnical Design Report or Materials Report.* The Geotechnical Design Report or Materials Report should include complete information on all sites investigated and should discuss the quality, cost, SMARA status, and availability of materials from commercial plants on the current "AB 3098 List". Sufficient sampling of sites must be performed to indicate the character of the material and the elevation of the ground water surface, and to determine changes in the character of the material, both laterally and vertically. Sampling must be done in such a manner that individual samples can be taken from each horizon or layer. Composite samples of two or more different types of material are unsatisfactory, as there is no assurance that the materials would be so combined if the materials source were actually used. Testing of blends of two or more types of materials is permissible, provided the test report clearly indicates the combination tested. The test report must clearly indicate the location of the sample and the depth represented. The fact that materials sites are not designated in the Special Provisions does not reduce the importance of thorough exploration and testing.

As tabulations of test data for local materials will be furnished to prospective bidders, and the test reports may be examined by bidders if they so request, it is important that only factual data be shown on the test report and that no conclusions, opinions, or interpretation of the test data be included. Under "Remarks", give only the pertinent factual information regarding the scalping, crushing, blending, or other laboratory processing performed in preparing samples for testing, and omit any comments as to suitability for any purpose. Any discussion of the quality, suitability, or quantity of material in local materials sites necessary for design purposes should be included in the Geotechnical Design Report or Materials Report, and not noted on the test reports. For any potential materials source explored or tested, all boring and test data must be furnished, including those tests which indicate unsuitable or inferior material.

Materials information to be furnished bidders may include data on a materials source previously investigated for the same project or some other project provided all of the following conditions are met:

- (a) There has been no change in test procedures subsequent to the time the earlier tests were made.
- (b) The materials source has not been altered by stream action, weathering, or other natural processes.
- (c) The material sampled and represented by the tests has not been removed.
- (d) There has been no change in SMARA status, or inclusion or exclusion on the "AB 3098 List".

It will be necessary for each District to maintain a filing system such that all preliminary test reports for potential materials sites are readily accessible. This will necessitate preparation of test reports covering all preliminary tests of materials. It will also be essential to maintain some type of materials inventory system, whereby sites in the vicinity of any project can be readily identified and the test reports can be immediately accessible. Filing only by numerical or chronological order will not be permissible.

111.3 Materials Information Furnished to Prospective Bidders

(1) *Materials Information Compilation.* It is the intent that all test data applicable to material sites for a project be furnished to prospective bidders. To obtain uniformity in the "handouts" furnishing this information to prospective bidders, the District Materials Unit should develop the "handout" and the following information must be included:

- (a) A cover page entitled, "Materials Information", should show District, County, Route, kilometer post limits, and geographical limits. There should be a note stating where the records, from which the information was compiled, may be inspected. Also, an index, listing investigated material sites, and disposal sites, maps, test reports, tabulation sheets, SMARA status, and agreements is to be shown on the cover page.
- (b) A vicinity map showing the location of investigated materials sites and disposal sites in relation to the project.
- (c) A map of each material site showing the location and identification of boring or test pits.
- (d) A tabulation of the test data for each material site, showing complete information on the location, depth, and processing of each sample tested, together with all test results.
- (e) Copies of all options or agreements with owners of the material sites, if such arrangements have been made.
- (f) Soil survey sheets or suitable terrain maps showing borings and tests along the highway alignment.
- (g) A tabulation of which sites comply with environmental laws and regulations and are included on the current "AB 3098 List".
- (h) Material site grading and reclamation plan and disposal site grading plans, if they have been prepared.
- (i) Copies of local use permits and clearances (when they have been obtained by the State) such as environmental clearances, mining permits, Forest Service Fire

July 1, 2020

Regulations, water quality control clearances, etc. If documents are of unusual length, a statement should be included that they have been obtained and are available for inspection at the District office or Sacramento Plans Counter.

Maps, test reports, and other data included in the "Materials Information" must be factual, and should not include any comments, conclusions, or opinions as to the quality, quantity, suitability, depth, or area of the materials in any material site or along the highway.

Reproducible copies of all material to be included in the "Material Information" package should be submitted to the Office Engineer.

The Office Engineer will reproduce the "Materials Information," and copies will be available to prospective bidders upon request in the same manner that plans and special provisions are furnished.

111.4 Materials Arrangements

Materials agreements or other arrangements must be made in accordance with the policy stated under Index 111.1(e).

The determination of when and where materials agreements or other arrangements are to be obtained is the responsibility of the District, see Section 8.25.00.00 of the Right of Way Manual.

The District should also determine the maximum royalty that can be paid economically on the basis of availability of competitive sources.

In preparing agreements, guaranteed quantity provisions should not be included, as the opportunity exists for possible token removal, with the result that the State would be required to pay for the guaranteed quantity even though the material would not actually be removed. Also, requirements that the State perform construction work on the owner's property, such as fences, gates, cattle guards, roads, etc., should be included only when the cost of such items and possible resulting benefits have been properly considered in the derivation of the royalty.

111.5 Procedures for Acquisition of Material Sites and Disposal Sites

These instructions establish procedures to be followed in the purchase of material sites and disposal sites when such purchase is deemed necessary by the District. The steps to be taken are listed in order as follows:

(1) *General Procedure.*

(a) A District report proposing and establishing the necessity for purchase of the site is required. The report should contain the following information:

- The project or projects on which the site is to be used and programming of proposed construction.
- The location and description of the property, zoning, and site restoration/reclamation proposals including necessary vicinity and site maps.

- The amount and quality of material estimated to be available in the site and amount needed for the project or projects, or amount of excess material to be disposed of and the capacity of the site or sites.
- An economic analysis using the estimated purchase price and value of land after removal of material or deposit of excess material. The total estimated savings over other possible alternatives must be clearly demonstrated. Alternatives must be shown from the standpoint of what would have to be done if the site was not purchased. Alternatives could be changes in location or grade as well as alternative sources of material.
- A statement as to whether or not the use of the site should be mandatory, with a separate statement regarding the effect for each proposed project for which mandatory use of the site is considered necessary, including complete justification for the mandatory specification (see Index 111.6). Three copies of each map or other attachment, folded letter size, are required for mandatory sites on all Federal-aid projects.
- A statement of the type of environmental documentation.
- Other justification.

Send one copy to the Division of Design and one copy to DES Materials Engineering and Testing Services for information.

- (b) If the project or projects are to have Federal aid, the District will prepare a request, with supporting environmental clearance, for FHWA approval to specify the source as mandatory. One copy of this request should be sent to the Office Engineer and one copy to Division of Design.
 - (c) If the estimated purchase price is over \$300,000, the District should include the item in the STIP and corresponding budget.
 - (d) When the proposed purchase has been approved, the Project Engineer should notify the District Division of Right of Way, District Environmental Division and the District Materials Unit and request that Right of Way purchase the site (or obtain a Materials Agreement; the Materials Unit should assist in the development of the agreement) and the Environmental Division obtain environmental authorization to proceed.
 - (e) The District must include the cost of purchase in the proper fiscal year program and/or budget as part of the District targets.
 - (f) After budgeting, the District must submit an expenditure authorization to cover purchase of the site. This could be concurrent if the project is added to the budget during a fiscal year. The expenditure authorization request should be processed through the District Project Management and Administration Units and obtain District Director approval.
 - (g) After issuance of an expenditure authorization, the District Division of Right of Way will complete purchase of the site.
- (2) *Material and Disposal Sites in Federal Lands.* The applicable sections of the Federal Highway Act of 1958 for procurement of borrow or disposal sites, Sections 107(d) and 317, are set forth in Section 8.18.02.00 of the Right of Way Manual; Section 107(d) applies to the Interstate System while Section 317 applies to other Federal-aid highways. Whenever Federal public lands are required for a material or a disposal site, and after preliminary negotiations at the local level with the Federal agency having jurisdiction, the District must submit a letter report to the FHWA. This report should observe the

July 1, 2020

requirements of Index 111.5 of this manual and Section 8.18.02.03 of the Right of Way Manual.

Following submittal of the proposal by the District to the FHWA, the latter, acting on behalf of the State transmits the proposal with a favorable recommendation to the Federal agency having control of the site proposal with a favorable recommendation to the Federal agency having control of the site.

See Section 8.18.02.03 of the Right of Way Manual.

111.6 Mandatory Material Sites and Disposal Sites on Federal-aid Projects

The contract provisions must not specify a mandatory site for the disposal of surplus excavated materials unless a particular site is needed for environmental reasons or the site is found to be the most economical for one or more Federal-aid projects. All points listed in Index 111.5(1)(a) and (b) must be covered and one copy of all attachments submitted. Supporting data must be submitted to the FHWA during the project planning phase or early in the project design phase as almost all cases of mandatory sites must go to the FHWA for decision.

Section 635.407 of 23 CFR 635D states in part:

"The designation of a mandatory material source may be permitted based on environmental considerations, provided the environment would be substantially enhanced without excessive cost."

"The contract provisions ... shall not specify mandatory a site for the disposal of surplus excavated materials unless there is a finding by the State highway agency with the concurrence of the FHWA Division Administrator that such placement is the most economical except that the designation of a mandatory site may be permitted based on environmental considerations, provided the environment would be substantially enhanced without excessive cost."

Topic 112 – Contractor's Yard and Plant Sites

112.1 Policy

The Project Engineer should, during the early design phase of a project, consider the need and availability of sites for the contractor's yards and materials plants. This is particularly important in areas where dust, noise, and access problems could limit the contractor in obtaining sites on their own in a timely manner. Material storage, handling, and recycling in a designated area will encourage transport of materials during non-peak times, reduce the number of delivery trips, and encourage the use of recycled materials. Asphalt concrete recycling projects pose special problems of material storage, access, and plant location; see Index 110.11. Temporary storage areas should be considered for grooving and grinding projects. As a general rule, the use of material sites designated in the Special Provisions should be optional. The Project Engineer should locate and determine the appropriate size for the type of project as optional staging / storage area(s) for the contractor's use. Should

the materials site be desired, the contractor shall provide notice to the Resident Engineer within a designated time period after approval of the contract (30 days would be a minimum, but not more than 60 days except in unusual situations). All environmental requirements must be satisfied and local permits must be obtained prior to submittal of the PS&E. Right of Way, Permits, and Environmental units must be informed early in the process. The contractor will be allowed to use these sites only for work on the designated project(s).

112.2 Locating a Site

The Project Engineer should consult with District Division of Right of Way concerning appropriately sized parcels currently being held in the airspace inventory, nearby property held by Caltrans for future construction, or as excess land. If such space is available in the vicinity of the project, the District Environmental Division should be consulted to determine what environmental requirements are necessary for the use of these properties for the intended purpose. Full restoration of the area is required for re-landscaping and replacement of irrigation or other facilities in the project PS&E. If sufficient space does not appear to be available for yard or plant, the Project Engineer must see that the appropriate wording is placed in the contract Special Provisions.

Topic 113 – Geotechnical Design Report

113.1 Policy

The Project Engineer must review the project initiation document and Preliminary Geotechnical Design Report, if any, to ascertain the scope of geotechnical involvement for a project. A Geotechnical Design Report (GDR) is to be prepared by the Roadway Geotechnical Engineering Branches of the Division of Engineering Services, Geotechnical Services (DES-GS) (or prepared by a consultant with technical oversight by DES-GS) for all projects that involve designs for cut slopes, embankments, earthwork, landslide remediation, retaining walls, groundwater studies, erosion control features, subexcavation and any other studies involving geotechnical investigations and engineering geology. A GDR is not required for projects that solely include those design features described in Index 114.1.

113.2 Content

The GDR is to conform to the “Guidelines for Geotechnical Reports” which is prepared by the Office of Structural Foundations.

113.3 Submittal and Review

Final copies of the GDR are to be submitted to the Project Engineer, District Materials Unit, and the Division of Design. For consultant developed reports, the GDR is to be submitted to DES-GS for review and approval. DES-GS will then transmit the approved GDR to the Project Engineer, District Materials Unit, and the Division of Design.

July 1, 2020

Topic 114 – Materials Report

114.1 Policy

A Materials Report must be prepared for all projects that involve any of the following components:

- Pavement structure recommendations and/or pavement studies
- Culverts (or other drainage materials)
- Corrosion studies
- Materials disposal sites
- Slide prone areas with erosive soils

The Materials Report may be either a single report or a series of reports that contains one or several of the components listed above. Materials Reports are prepared for project initiation documents, project reports, and PS&E. Materials Report(s) are signed and stamped with an engineer's seal by the engineer in responsible charge for the findings and recommendations. The District Materials Engineer will either prepare the Materials Report or review and accept Materials Report(s) prepared by others. The Material Report is signed by the Registered Engineer that prepared the report.

114.2 Requesting Materials Report(s)

The Project Engineer (or equivalent) is responsible for requesting a Materials Report. The District Materials Engineer can assist the Project Engineer in identifying what components need to be addressed, when to request them, and what information is needed. At a minimum, the following information needs to be included in all requests:

- (1) *Project location.*
- (2) *Scope of work.* Project Engineer should spell out the type of work to be done that will affect materials. If pavements are involved, state type of pavement work. Provide type of project, such as new construction, widening, or rehabilitation. Note if culverts will be installed, extended, or replaced. Note if material or disposal sites are needed, see Topic 111 for criteria.
- (3) *Proposed design life for pavements and culverts.*
- (4) *Design Designation.* Include for projects involving pavement structural enhancements. Does not apply to pavement preservation activities.
- (5) *Special Considerations or Limitations.* Include any information that may affect the materials recommendations. Examples include traffic management requirements or environmental restrictions.

114.3 Content

All Materials Reports must contain the location of the project, scope of work, and list of special conditions and assumptions used to develop the report. Materials Reports must contain the following information when the applicable activity is included in the scope of the project.

- (1) *Pavement*. At minimum, the Materials Report must document the material data to be used to engineer the pavement structure, including the following:
 - Engineering studies, tests, and cores performed to collect data for the project.
 - Deflection studies for existing flexible pavement rehabilitation projects (see Index 635.1), and
 - Special material requirements that should be incorporated such as justifications for using (or not using) particular materials in the pavement structure.
 - Pavement strategy/structural recommendations are not included as part of the Materials Report. See Index 604.2 for discussion on preparation of pavement recommendations.
- (2) *Drainage Culverts or Other Materials*. The Materials Report must contain a sufficient number of alternatives that materially meet or exceed the culvert design life (and other drainage related) standards for the Project Engineer to establish the most maintainable, constructible, and cost effective alternative in conformance with FHWA regulations (23 CFR 635D).
- (3) *Corrosion*. Corrosion studies are necessary when new culverts, culvert rehabilitation, or culvert extensions are part of the scope of the project. Studies should satisfy the requirements of the “Corrosion Guidelines”. Copies of the guidelines can be obtained from the Corrosion Technology Branch in DES Materials Engineering and Testing Services or on the DES Materials Engineering and Testing Services website.
- (4) *Materials or Disposal Sites*. See Topic 111 “Material Sites and Disposal Sites” for conditions when sites need to be identified and how to document.

114.4 Preliminary Materials Report

Because resources and/or time are sometimes limited, it is not always possible to complete all the tests and studies necessary for a final Materials Report during the planning/scooping phase. In these instances, a Preliminary Materials Report may be issued using the best information available and good engineering judgment. Accurate traffic projections and design designations are still required for the Preliminary Materials Report. Preliminary Materials Reports should not be used for project reports or PS&E development. When used, Preliminary Materials Reports must document the sources of information used and assumptions made. It must clearly state that the Preliminary Materials Report is to be used for planning and initial cost estimating only and not for final design. The Department Pavement website contains supplemental guidance for developing preliminary pavement structures.

July 1, 2020

114.5 Review and Retention of Records

A copy of the Draft Materials Report is to be submitted for review and comment to the District Materials Engineer. The District Materials Engineer reviews the document for the Department to assure that it meets the standards, policies, and other requirements found in Department manuals, and supplemental district guidance (Index 604.2(2)). If it is found that the document meets these standards, the District Materials Engineer accepts the Materials Report. If not, the report is returned with comments to the submitter.

After resolution of the comments, a final copy of the Materials Report is submitted to the District Materials Engineer who then furnishes it to the Project Engineer. The original copy of the Materials Report must be permanently retained in the District's project history file and be accessible for review by others when requested.

Topic 115 – Designing for Bicycle Traffic

115.1 General

Under the California Vehicle Code, bicyclists generally have the same rights and duties that motor vehicle drivers do when using the State highway system. For example, they make the same merging and turning movements, they need adequate sight distance, they need access to all destinations, etc. Therefore, designing for bicycle traffic and designing for motor vehicle traffic are similar and based on the same fundamental transportation engineering principles. The main differences between bicycle and motor vehicle operations are lower speed and acceleration capabilities, as well as greater sensitivity to out of direction travel and steep uphill grades. Design guidance that addresses the safety and mobility needs of bicyclists on Class II bikeways (bike lanes) is distributed throughout this manual. See Chapter 1000 for additional bicycle guidance for Class I bikeways (bike paths) and Class III bikeways (bike routes). See Design Information Bulletin (DIB) 89 for Class IV bikeways (separated bikeways) guidance.

All city, county, regional and other local agencies responsible for bikeways or roads except those freeway segments where bicycle travel is prohibited shall follow the bikeway design criteria established in this manual and the California MUTCD, as authorized in the Streets and Highways Code Sections 890.6 and 891(a). However, a local agency may utilize alternative design criteria as prescribed in the Streets and Highways Code Section 891(b). The decision to develop bikeways should be made in consultation and coordination with local agencies responsible for bikeway planning to ensure connectivity and network development.

Generally speaking, bicycle travel can be enhanced by bikeways or improvements to the right-hand portion of roadways, where bicycles are required to travel. When feasible, a wider shoulder than minimum standard should be considered since bicyclists are required to ride to as far to the right as possible, and shoulders provide bicyclists an opportunity to pull over to let faster traffic pass.

All transportation improvements are an opportunity to improve safety, access, and mobility for the bicycle mode of travel.

Topic 116 – Bicyclists and Pedestrians on Freeways

116.1 General

Seldom is a freeway shoulder open to bicycle, pedestrian or other non-motorized travel, but they can be opened for use if certain criteria assessing the safety and convenience of the freeway, as compared with available alternate routes, is met. However, a freeway should not be opened to bicycle or pedestrian use if it is determined to be incompatible. The District Traffic Engineer or designee and the Project Delivery Coordinator must approve any proposals to open freeways to bicyclists, pedestrian or other non-motorized use. See the California MUTCD and CVC Section 21960.

When a new freeway segment is to remain open or existing freeway segment is to be reopened to these modes, it is necessary to evaluate the freeway features for their compatibility with safe and efficient travel, including:

- Shoulder widths
- Drainage grates; see Index 1003.5(2)
- Expansion joints
- Utility access covers on shoulders
- Frequency and spacing of entrance/exit ramps
- Multiple-lane entrance/exit ramps
- Traffic volumes on entrance/exit ramps and on lanes merging into exit ramps
- Sight distance at entrance/exit ramps
- Freeway to freeway interchanges
- The presence and design of rumble strips
- Longitudinal edges and joints

If a freeway segment has no suitable non-freeway alternative and is closed because certain features are considered incompatible, the feasibility of eliminating or reducing the incompatible features should be evaluated. This evaluation may include removal, redesign, replacement, relocation or retrofitting of the incompatible feature, or installation of signing, pavement markings, or other traffic control devices.

Where no reasonable, convenient and safe non-freeway alternative exists within a freeway corridor, the Department should coordinate with local agencies to develop new routes, improve existing routes or provide parallel bicycle and pedestrian facilities within or adjacent to the freeway right of way. See Project Development Procedures Manual Chapter 1, Article 3 (Regional and System Planning) and Chapter 31 (Nonmotorized Transportation Facilities) for discussion of the development of non-freeway transportation alternatives.

CHAPTER 200 – GEOMETRIC DESIGN AND STRUCTURE STANDARDS

Topic 201 – Sight Distance

Index 201.1 – General

Sight distance is the continuous length of highway ahead, visible to the highway user. Four types of sight distance are considered herein: passing, stopping, decision, and corner. Passing sight distance is used where use of an opposing lane can provide passing opportunities (see Index 201.2). Stopping sight distance is the minimum sight distance for a given design speed to be provided on multilane highways and on 2-lane roads when passing sight distance is not economically obtainable. Stopping sight distance also is to be provided for all users, including motorists and bicyclists, at all elements of interchanges and intersections at grade, including private road connections (see Topic 504, Index 405.1, & Figure 405.7). Decision sight distance is used at major decision points (see Indexes 201.7 and 504.2). Corner sight distance is used at intersections (see Index 405.1, Figure 405.7, and Figure 504.3I).

Table 201.1 shows the minimum standards for stopping sight distance related to design speed for motorists. Stopping sight distances given in the table are suitable for Class II and Class III bikeways. The stopping sight distances are also applicable to roundabout design on the approach roadway, within the circulatory roadway, and on the exits prior to the pedestrian crossings. Also shown in Table 201.1 are the values for use in providing passing sight distance.

See Chapter 1000 for Class I bikeway sight distance guidance.

Chapter 3 of "A Policy on Geometric Design of Highways and Streets," AASHTO, contains a thorough discussion of the derivation of stopping sight distance.

201.2 Passing Sight Distance

Passing sight distance is the minimum sight distance required for the driver of one vehicle to pass another vehicle safely and comfortably. Passing must be accomplished assuming an oncoming vehicle comes into view and maintains the design speed, without reduction, after the overtaking maneuver is started.

July 1, 2020

Table 201.1

Sight Distance Standards

Design Speed ⁽¹⁾ (mph)	Stopping ⁽²⁾ (ft)	Passing (ft)
10	50	---
15	100	---
20	125	800
25	150	950
30	200	1,100
35	250	1,300
40	300	1,500
45	360	1,650
50	430	1,800
55	500	1,950
60	580	2,100
65	660	2,300
70	750	2,500
75	840	2,600
80	930	2,700

Notes:

(1)See Topic 101 for selection of design speed.

(2)For sustained downgrades, refer to underlined standard in Index 201.3

The sight distance available for passing at any place is the longest distance at which a driver whose eyes are 3 ½ feet above the pavement surface can see the top of an object 4 ¼ feet high on the road. See Table 201.1 for the calculated values that are associated with various design speeds.

In general, 2-lane highways should be designed to provide for passing where possible, especially those routes with high volumes of trucks or recreational vehicles. Passing should be done on tangent horizontal alignments with constant grades or a slight sag vertical curve. Not only are drivers reluctant to pass on a long crest vertical curve, but it is impracticable to design crest vertical curves to provide for passing sight distance because of high cost where crest cuts are involved. Passing sight distance for crest vertical curves is 7 to 17 times longer than the stopping sight distance.

Ordinarily, passing sight distance is provided at locations where combinations of alignment and profile do not require the use of crest vertical curves.

Passing sight distance is considered only on 2-lane roads. At critical locations, a stretch of 3- or 4-lane passing section with stopping sight distance is sometimes more economical than two lanes with passing sight distance.

Passing on sag vertical curves can be accomplished both day and night because headlights can be seen through the entire curve.

See Part 3 of the California Manual on Uniform Traffic Control Devices (California MUTCD) for criteria relating to the placement of barrier striping for no-passing zones. Note, that the passing sight distances shown in the California MUTCD are based on traffic operational criteria. Traffic operational criteria are different from the design characteristics used to develop the values provided in Table 201.1 and Chapter 3 of AASHTO, A Policy on Geometric Design of Highways and Streets. The aforementioned table and AASHTO reference are also used to design the vertical profile and horizontal alignment of the highway. Consult the District Traffic Engineer or designee when using the California MUTCD criteria for traffic operating-control needs.

Other means for providing passing opportunities, such as climbing lanes or turnouts, are discussed in Index 204.5. Chapter 3 of AASHTO, A Policy on Geometric Design of Highways and Streets, contains a thorough discussion of the derivation of passing sight distance.

201.3 Stopping Sight Distance

The minimum stopping sight distance is the distance required by the user, traveling at a given speed, to bring the vehicle or bicycle to a stop after an object $\frac{1}{2}$ -foot high on the road becomes visible. Stopping sight distance for motorists is measured from the driver's eyes, which are assumed to be $3\frac{1}{2}$ feet above the pavement surface, to an object $\frac{1}{2}$ -foot high on the road. See Index 1003.1(10) for Class I bikeway stopping sight distance guidance.

The stopping sight distances in Table 201.1 should be increased by 20 percent on sustained downgrades steeper than 3 percent and longer than one mile.

201.4 Stopping Sight Distance at Grade Crests

Figure 201.4 shows graphically the relationships between length of highway crest vertical curve, design speed, and algebraic difference in grades. Any one factor can be determined when the other two are known.

201.5 Stopping Sight Distance at Grade Sags

From the curves in Figure 201.5, the minimum length of vertical curve which provides headlight sight distance in grade sags for a given design speed can be obtained.

If headlight sight distance is not obtainable at grade sags, lighting may be considered. The District approval authority or Project Delivery Coordinator, depending upon the current District Design Delegation Agreement, and the District Traffic Engineer or designee shall be contacted to review proposed grade sag lighting to determine if such use is appropriate.

July 1, 2020

201.6 Stopping Sight Distance on Horizontal Curves

Where an object off the pavement such as a bridge pier, building, cut slope, or natural growth restricts sight distance, the minimum radius of curvature is determined by the stopping sight distance.

Available stopping sight distance on horizontal curves is obtained from Figure 201.6. It is assumed that the driver's eye is 3 ½ feet above the center of the inside lane (inside with respect to curve) and the object is ½-foot high. The line of sight is assumed to intercept the view obstruction at the midpoint of the sight line and 2 feet above the center of the inside lane when the road profile is flat (i.e. no vertical curve). Crest vertical curves can cause additional reductions in sight distance. The clear distance (m) is measured from the center of the inside lane to the obstruction.

The design objective is to determine the required clear distance from centerline of inside lane to a retaining wall, bridge pier, abutment, cut slope, or other obstruction for a given design speed. Using radius of curvature and minimum sight distance for that design speed, Figure 201.6 gives the clear distance (m) from centerline of inside lane to the obstruction.

See Index 1003.1(13) for bikeway stopping sight distance on horizontal curve guidance.

When the radius of curvature and the clear distance to a fixed obstruction are known, Figure 201.6 also gives the sight distance for these conditions.

See Index 101.1 for technical reductions in design speed caused by partial or momentary horizontal sight distance restrictions. See Index 203.2 for additional comments on glare screens.

Cuts may be widened where vegetation restricting horizontal sight distance is expected to grow on finished slopes. Widening is an economic trade-off that must be evaluated along with other options. See Topic 902 for sight distance requirements on landscape projects.

201.7 Decision Sight Distance

At certain locations, sight distance greater than stopping sight distance is desirable to allow drivers time for decisions without making last minute erratic maneuvers (see Chapter III of AASHTO, A Policy on Geometric Design of Highways and Streets, for a thorough discussion of the derivation of decision sight distance.)

On freeways and expressways the decision sight distance values in Table 201.7 should be used at lane drops and at off-ramp noses to interchanges, branch connections, safety roadside rest areas, vista points, and inspection stations. When determining decision sight distance on horizontal and vertical curves, Figures 201.4, 201.5, and 201.6 can be used. Figure 201.7 is an expanded version of Figure 201.4 and gives the relationship among length of crest vertical curve, design speed, and algebraic difference in grades for much longer vertical curves than Figure 201.4.

Decision sight distance is measured using the 3 ½-foot eye height and ½-foot object height. See Index 504.2 for sight distance at secondary exits on a collector-distributor road.

Table 201.7

Decision Sight Distance

Design Speed(mph)	Decision Sight Distance(ft)
30	450
35	525
40	600
45	675
50	750
55	865
60	990
65	1,050
70	1,105
75	1,180
80	1,260

Topic 202 – Superelevation

202.1 Basic Criteria

When a vehicle moves in a circular path, it undergoes a centripetal acceleration that acts toward the center of curvature. This force is countered by the perceived centrifugal force experienced by the motorist.

On a superelevated highway, this force is resisted by the vehicle weight component parallel to the superelevated surface and by the side friction developed between the tires and pavement. It is impractical to balance centrifugal force by superelevation alone, because for any given curve radius a certain superelevation rate is exactly correct for only one driving speed. At all other speeds there will be a side thrust either outward or inward, relative to the curve center, which must be offset by side friction.

If the vehicle is not skidding, these forces are in equilibrium as represented by the following simplified curve equation, which is used to design a curve for a comfortable operation at a particular speed:

July 1, 2020

Figure 201.4

Stopping Sight Distance on Crest Vertical Curves

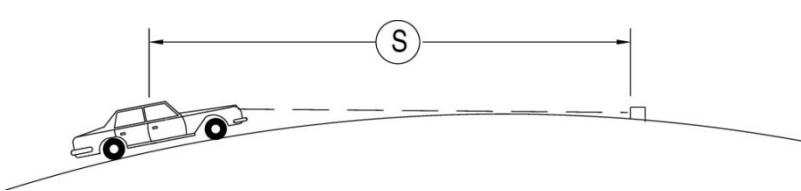

Drivers eye height is 3 ½ feet.
Object height is ½-foot.

L = Curve Length (feet)
 A = Algebraic Grade Difference (%)
 S = Sight Distance (feet)
 V = Design Speed for "S" in mph
 K = Distance in feet required to achieve a 1% change in grade. K value as shown on graph is valid when S < L.

Notes:

- Before using this figure for intersections, branch connections and exits, see Indexes 201.7 and 405.1, and Topic 504.
- See Figure 204.4 for vertical curve formulas.
- See Index 204.4 for minimum length of vertical curve

When $S > L$	When $S < L$
$L = 2S - \frac{1329}{A}$	$L = \frac{AS^2}{1329}$

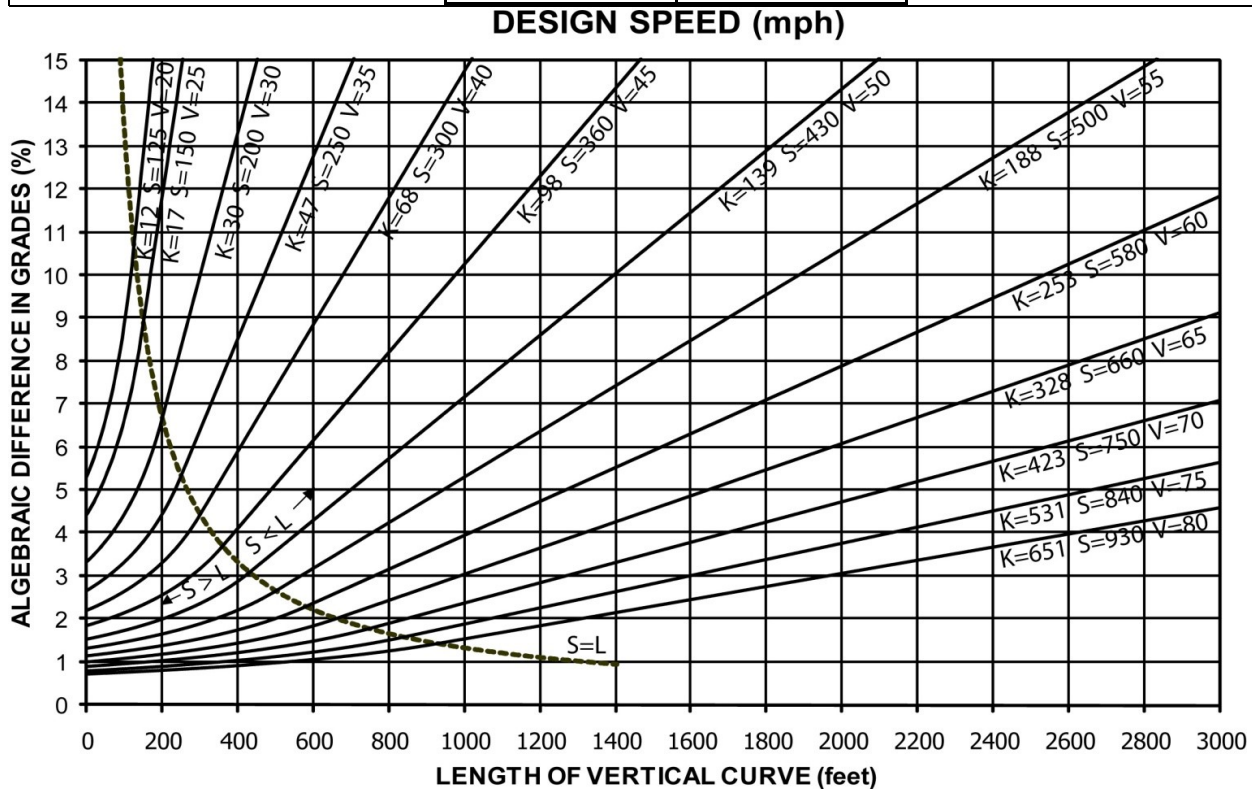
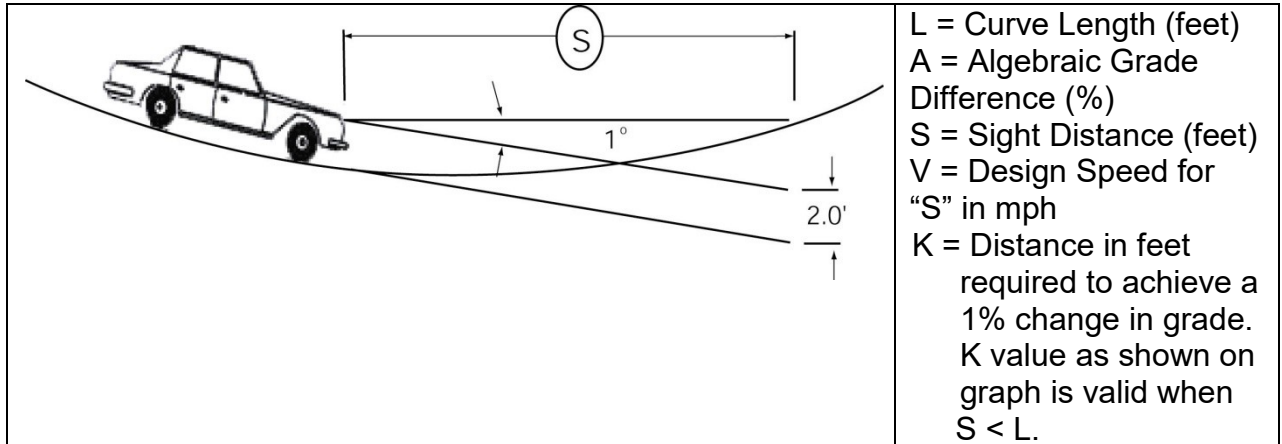

Figure 201.5

Stopping Sight Distance on Sag Vertical Curves



Notes:

- For sustained downgrades, see Index 201.3.
- Before using this figure for intersections, branch connections and exits, see Indexes 201.7 and 405.1, and Topic 504.
- See Figure 204.4 for vertical curve formulas.
- See Index 204.4 for minimum length of vertical curve.

When $S > L$	When $S < L$
$L = 2S - (400 + 3.5S)/A$	$L = AS^2 / (400 + 3.5S)$

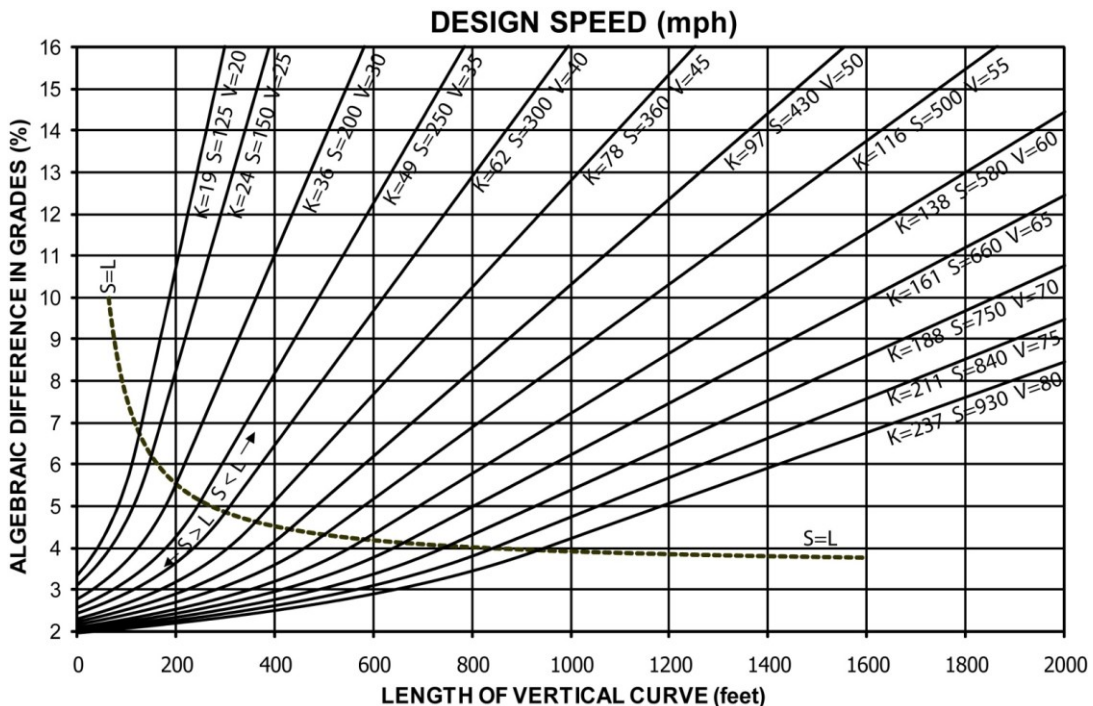

July 1, 2020

Figure 201.6

Stopping Sight Distance on Horizontal Curves

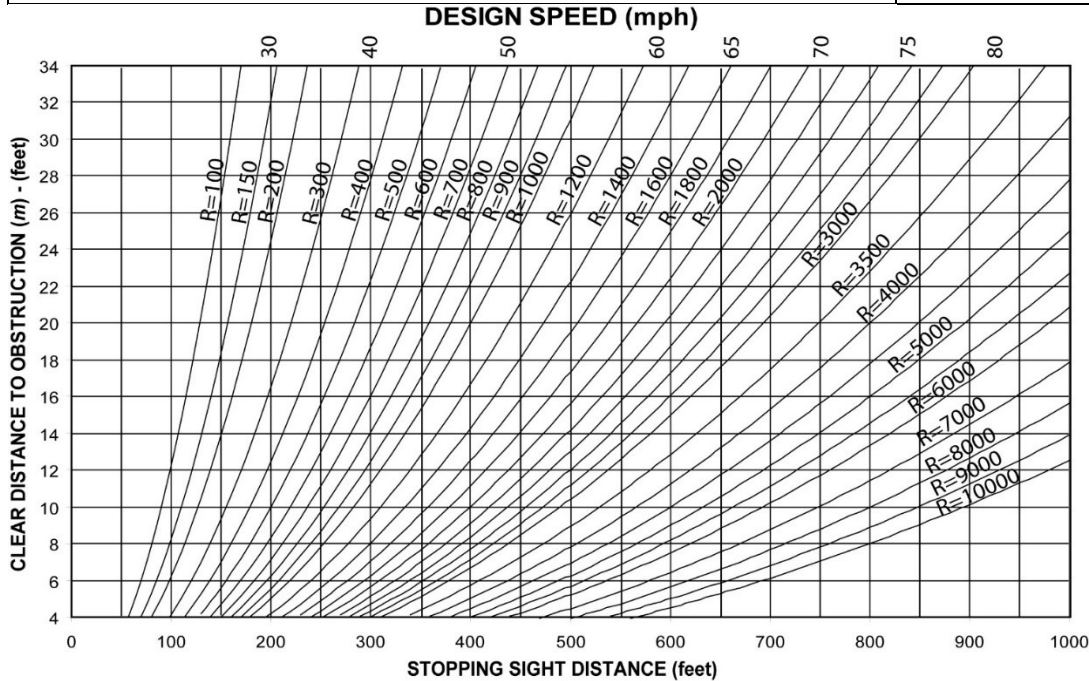
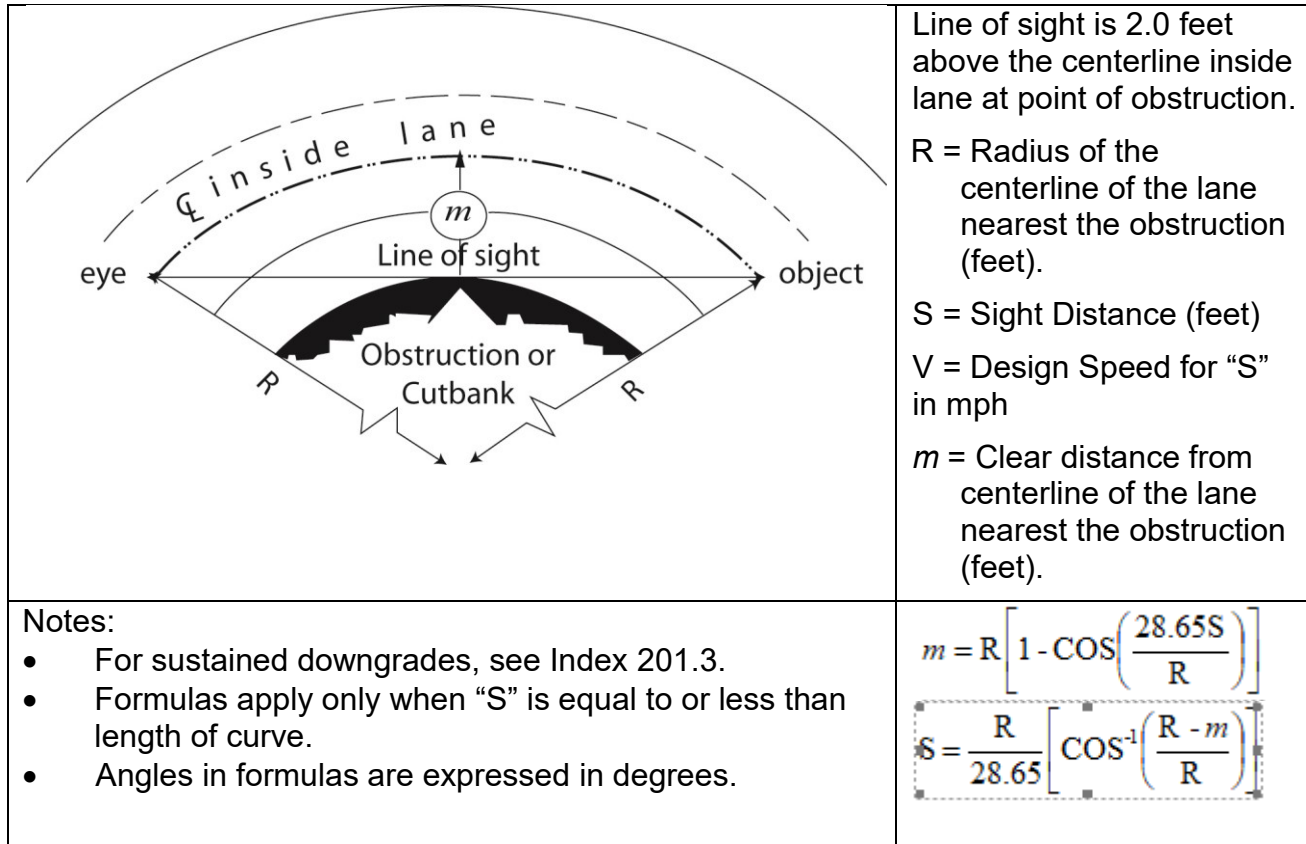
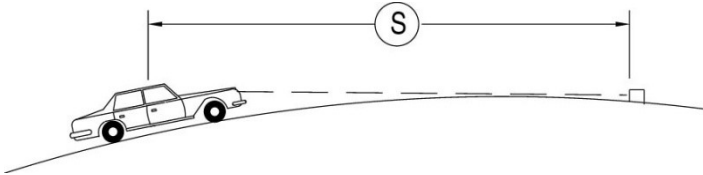

Figure 201.7

Decision Sight Distance on Crest Vertical Curves



Drivers eye height is 3½ feet.
Object height is ½-foot.

L = Curve Length (feet)
A = Algebraic Grade Difference (%)
S = Sight Distance (feet)
V = Design Speed for "S" in mph
K = Distance in feet required to achieve a 1% change in grade.
K value as shown on graph is valid when S < L.

Notes:

- Before using this figure for intersections, branch connections and exits, see Indexes 201.7 and 405.1, and Topic 504.
- See Figure 204.4 for vertical curve formulas.
- See Index 204.4 for minimum length of vertical curve.

When $S > L$	When $S < L$
$L = 2S - 1329/A$	$L = AS^2 / 1329$

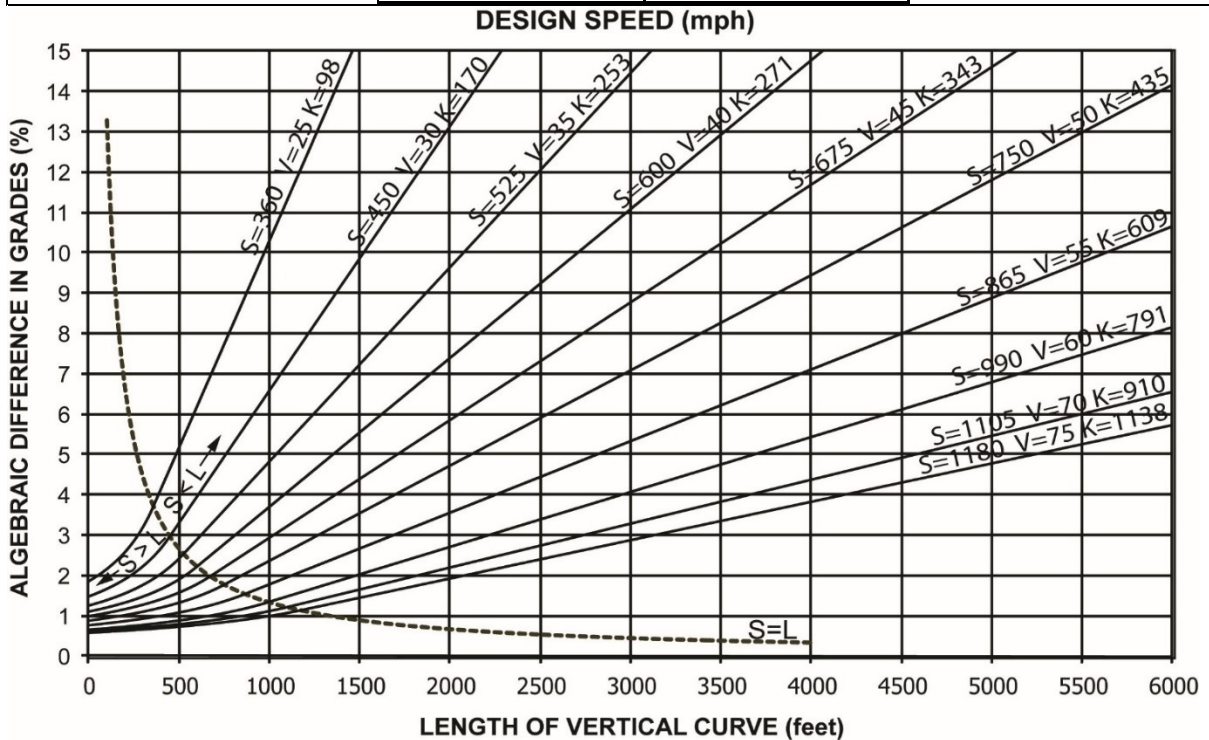

July 1, 2020

$$e+f = \frac{0.067V^2}{R} = \frac{V^2}{15R}$$

Where:

e = Roadway superelevation slope, feet per foot

f = Side friction factor

R = Curve radius, feet

V = Vehicle speed, miles per hour

Standard superelevation rates are designed to hold the portion of the centrifugal force that must be taken up by tire friction within allowable limits. Friction factors as related to speed are shown on Figure 202.2. The factors apply equally to flexible and rigid pavements.

202.2 Standards for Superelevation

(1) *Highways.* Maximum superelevation rates for various highway conditions are shown in Tables 202.2A through 202.2E. The maximum rates of superelevation (e_{max}) used on highways are controlled by four factors: climate conditions (i.e., frequency and amount of snow and ice); terrain conditions (i.e., flat, rolling, or mountainous); type of area (i.e., rural or urban); and frequency of slow-moving vehicles whose operations might be affected by high superelevation rates. Consideration of these factors jointly leads to the conclusion that no single maximum superelevation rate is universally applicable.

The highest superelevation rate for highways in common use is 10 percent, although 12 percent is used in some cases. Superelevation rates above 8 percent are only used in areas without snow and ice. Although higher superelevation rates offer an advantage to vehicles at high speeds, current practice considers that rates in excess of 12 percent are beyond practical limits. This practice recognizes the combined effects of construction processes, maintenance difficulties, and operation of vehicles at low speeds.

Where traffic congestion or the clustered land use of developing corridors (i.e., industrial, commercial, and residential) restricts top speeds, it is common practice to utilize a lower maximum rate of superelevation (typically 4 to 6 percent). Similarly, either a low maximum rate of superelevation or no superelevation is employed within intersection areas or where there is a tendency to drive slowly because of turning and crossing movements, warning devices, and signals. In these areas it is difficult to warp crossing pavements for drainage without providing negative superelevation for some turning movements. Therefore, use of Tables 202.2D and 202.2E for urban roads may not apply in these locations.

Roadways described below, (a) through (e), shall be designed with the e_{max} indicated. Design of local roads should generally use (d) and (e).

- (a) Use $e_{max}=12\%$ for ramps, connectors, 2-lane conventional highways, and frontage roads. See Index 202.7 for frontage roads under other jurisdictions.
- (b) Use $e_{max}=10\%$ for freeways, expressways, and multilane conventional highways.
- (c) Use $e_{max}=8\%$ when snow and ice conditions prevail (usually over 3,000 feet elevation).
- (d) Use $e_{max}=6\%$ for urban roads with design speeds 35 to 45 miles per hour.

(e) Use $e_{\max}=4\%$ for urban roads with design speeds less than 35 miles per hour.

Based on the above e_{\max} , superelevation rates from Tables 202.2A through 202.2E shall be used with the minimum curve radii and design speed (V_d). If the superelevation rate is not a whole number, the superelevation rate may be rounded up to the next whole number. If less than standard superelevation rates are approved (see Index 82.1), Figure 202.2 shall be used to determine superelevation based on the curve radius and maximum comfortable speed.

When using Tables 202.2A through 202.2E for a given radius, interpolation is not necessary as the superelevation rate should be determined from a radius equal to, or slightly smaller than, the radius provided in the table. The result is a superelevation rate that is rounded up to the nearest 0.2 of a percent. For example, a 50 mph curve with a maximum superelevation rate of 8 percent and a radius of 1,880 feet should use the radius of 1,830 feet to obtain a superelevation of 5.4 percent. Also, Tables 202.2A through 202.2E use the following terms as defined:

- (1) "normal crown" (NC) designates a traveled way cross section used on curves that are so flat that the elimination of adverse cross slope is not needed, and thus the normal cross slope sections can be used. See Index 301.3 for further guidance.
- (2) "remove adverse crown" (RC) designates curves where the adverse cross slope should be eliminated by superelevating the entire roadway at the normal cross slope rate.

Maximum comfortable speed is determined by the formula given on Figure 202.2. It represents the speed on a curve where discomfort caused by centripetal acceleration is evident to a driver. AASHTO, A Policy on Geometric Design of Highways and Streets, states, "In general, studies show that the maximum side friction factors developed between new tires and wet concrete pavements range from about 0.5 at 20 miles per hour to approximately 0.35 at 60 miles per hour. In all cases, the studies show a decrease in friction values as speeds increase.

To use Figure 202.2, the designer must decide on the relative importance among three variables. Normally, when a nonstandard superelevation rate is approved, Figure 202.2 will be entered with the superelevation rate and a desired curve radius. It must then be determined whether the resulting maximum comfortable speed is adequate for the conditions or whether further adjustments to radius and superelevation may be needed.

Except for short radius curves, the standard superelevation rate results in very little side thrust at speeds less than 45 miles per hour. This provides maximum comfort for most drivers.

Superelevation for horizontal curves with radii of 10,000 feet and greater may be deleted in those situations where the combination of a flat grade and a superelevation transition would create undesirable drainage conditions on the pavement.

Superelevated cross slopes on curves extend the full width of the traveled way and shoulders, except that the shoulder slope on the low side should be not less than the minimum shoulder slope used on the tangents (see Index 304.3 for cross slopes undercut widening conditions).

July 1, 2020

On rural 2-lane roads, superelevation should be on the same plane for the full width of traveled way and shoulders, except on transitions (see Index 304.3 for cut widening conditions).

(2) *Bikeways*. Superelevation design criteria in Index 202.2(1) also accommodates Class II, III, and IV bikeways. See Index 1003.1 for Class I guidance.

202.3 Restrictive Conditions

Lower superelevation rates than those given in either Table 202.2 or Figure 202.2 may be necessary in areas where restricted speed zones or ramp/street intersections are controlling factors. Other typical locations are short radius curves on ramps near the local road juncture, either at an intersection or where a loop connects with an overcrossing structure. Often, established street grades, curbs, or drainage may prove difficult to alter and/or superelevation transition lengths would be undesirably short.

Such conditions may justify a reduction in the superelevation rate, different rates for each half of the roadbed, or both. In any case, the superelevation rate provided should be appropriate for the conditions allowing for a smooth transition while providing the maximum level of comfort to the driver. Where standard superelevation rates cannot be attained, discussions should be held with the District Design Liaison and/or the Project Delivery Coordinator to determine the proper solution and the necessity of preparing a design standard decision document. In warping street or ramp surface areas for drainage, adverse superelevation should be avoided (see Figure 202.2).

202.4 Axis of Rotation

(1) *Undivided Highways*. For undivided highways the axis of rotation for superelevation is usually the centerline of the roadbed. However, in special cases such as desert roads where curves are preceded by long relatively level tangents, the plane of superelevation may be rotated about the inside edge of traveled way to improve perception of the curve. In flat country, drainage pockets caused by superelevation may be avoided by changing the axis of rotation from the centerline to the inside edge of traveled way.

(2) *Ramps and Freeway-to-freeway Connections*. The axis of rotation may be about either edge of traveled way or centerline if multilane. Appearance and drainage considerations should always be taken into account in selection of the axis of rotation.

(3) *Divided Highways*.

(a) *Freeways* – Where the initial median width is 65 feet or less, the axis of rotation should be at the centerline.

Where the initial median width is greater than 65 feet and the ultimate median width is 65 feet or less, the axis of rotation should be at the centerline, except where the resulting initial median slope would be steeper than 10:1. In the latter case, the axis of rotation should be at the ultimate median edges of traveled way.

Where the ultimate median width is greater than 65 feet, the axis of rotation should normally be at the ultimate median edges of traveled way.

To avoid sawtooth on bridges with decked medians, the axis of rotation, if not already on centerline, should be shifted to the centerline.

Table 202.2A

Minimum Radii for Design Superelevation Rates, Design Speeds, and $e_{\max}=4\%$

e (%)	V _d (mph)						
	20	25	30	35	40	45	50
	R (ft)						
NC	1410	2050	2830	3730	4770	5930	7220
RC	902	1340	1880	2490	3220	4040	4940
2.2	723	1110	1580	2120	2760	3480	4280
2.4	513	838	1270	1760	2340	2980	3690
2.6	388	650	1000	1420	1930	2490	3130
2.8	308	524	817	1170	1620	2100	2660
3.0	251	433	681	982	1370	1800	2290
3.2	209	363	576	835	1180	1550	1980
3.4	175	307	490	714	1010	1340	1720
3.6	147	259	416	610	865	1150	1480
3.8	122	215	348	512	730	970	1260
4.0	86	154	250	371	533	711	926

July 1, 2020

Table 202.2B

Minimum Radii for Design Superelevation Rates, Design Speeds, and
 $e_{\max}=6\%$

e (%)	V_d (mph)								
	20	25	30	35	40	45	50	55	60
	R (ft)								
NC	1580	2290	3130	4100	5230	6480	7870	9410	11100
RC	1120	1630	2240	2950	3770	4680	5700	6820	8060
2.2	991	1450	2000	2630	3370	4190	5100	6110	7230
2.4	884	1300	1790	2360	3030	3770	4600	5520	6540
2.6	791	1170	1610	2130	2740	3420	4170	5020	5950
2.8	709	1050	1460	1930	2490	3110	3800	4580	5440
3.0	635	944	1320	1760	2270	2840	3480	4200	4990
3.2	566	850	1200	1600	2080	2600	3200	3860	4600
3.4	498	761	1080	1460	1900	2390	2940	3560	4250
3.6	422	673	972	1320	1740	2190	2710	3290	3940
3.8	358	583	864	1190	1590	2010	2490	3040	3650
4.0	309	511	766	1070	1440	1840	2300	2810	3390
4.2	270	452	684	960	1310	1680	2110	2590	3140
4.4	238	402	615	868	1190	1540	1940	2400	2920
4.6	212	360	555	788	1090	1410	1780	2210	2710
4.8	189	324	502	718	995	1300	1640	2050	2510
5.0	169	292	456	654	911	1190	1510	1890	2330
5.2	152	264	413	595	833	1090	1390	1750	2160
5.4	136	237	373	540	759	995	1280	1610	1990
5.6	121	212	335	487	687	903	1160	1470	1830
5.8	106	186	296	431	611	806	1040	1320	1650
6.0	81	144	231	340	485	643	833	1060	1330

Table 202.2C

Minimum Radii for Design Superelevation Rates, Design Speeds, and $e_{max}=8\%$

e (%)	V_d (mph)													
	15	20	25	30	35	40	45	50	55	60	65	70	75	80
	R (ft)													
NC	932	1640	2370	3240	4260	5410	6710	8150	9720	11500	12900	14500	16100	17800
RC	676	1190	1720	2370	3120	3970	4930	5990	7150	8440	9510	10700	12000	13300
2.2	605	1070	1550	2130	2800	3570	4440	5400	6450	7620	8600	9660	10800	12000
2.4	546	959	1400	1930	2540	3240	4030	4910	5870	6930	7830	8810	9850	11000
2.6	496	872	1280	1760	2320	2960	3690	4490	5370	6350	7180	8090	9050	10100
2.8	453	796	1170	1610	2130	2720	3390	4130	4950	5850	6630	7470	8370	9340
3.0	415	730	1070	1480	1960	2510	3130	3820	4580	5420	6140	6930	7780	8700
3.2	382	672	985	1370	1820	2330	2900	3550	4250	5040	5720	6460	7260	8130
3.4	352	620	911	1270	1690	2170	2700	3300	3970	4700	5350	6050	6800	7620
3.6	324	572	845	1180	1570	2020	2520	3090	3710	4400	5010	5680	6400	7180
3.8	300	530	784	1100	1470	1890	2360	2890	3480	4140	4710	5350	6030	6780
4.0	277	490	729	1030	1370	1770	2220	2720	3270	3890	4450	5050	5710	6420
4.2	255	453	678	955	1280	1660	2080	2560	3080	3670	4200	4780	5410	6090
4.4	235	418	630	893	1200	1560	1960	2410	2910	3470	3980	4540	5140	5800
4.6	215	384	585	834	1130	1470	1850	2280	2750	3290	3770	4310	4890	5530
4.8	193	349	542	779	1060	1390	1750	2160	2610	3120	3590	4100	4670	5280
5.0	172	314	499	727	991	1310	1650	2040	2470	2960	3410	3910	4460	5050
5.2	154	284	457	676	929	1230	1560	1930	2350	2820	3250	3740	4260	4840
5.4	139	258	420	627	870	1160	1480	1830	2230	2680	3110	3570	4090	4640
5.6	126	236	387	582	813	1090	1390	1740	2120	2550	2970	3420	3920	4460
5.8	115	216	358	542	761	1030	1320	1650	2010	2430	2840	3280	3760	4290
6.0	105	199	332	506	713	965	1250	1560	1920	2320	2710	3150	3620	4140
6.2	97	184	308	472	669	909	1180	1480	1820	2210	2600	3020	3480	3990
6.4	89	170	287	442	628	857	1110	1400	1730	2110	2490	2910	3360	3850
6.6	82	157	267	413	590	808	1050	1330	1650	2010	2380	2790	3240	3720
6.8	76	146	248	386	553	761	990	1260	1560	1910	2280	2690	3120	3600
7.0	70	135	231	360	518	716	933	1190	1480	1820	2180	2580	3010	3480
7.2	64	125	214	336	485	672	878	1120	1400	1720	2070	2470	2900	3370
7.4	59	115	198	312	451	628	822	1060	1320	1630	1970	2350	2780	3250
7.6	54	105	182	287	417	583	765	980	1230	1530	1850	2230	2650	3120
7.8	48	94	164	261	380	533	701	901	1140	1410	1720	2090	2500	2970
8.0	38	76	134	214	314	444	587	758	960	1200	1480	1810	2210	2670

July 1, 2020

Table 202.2D

Minimum Radii for Design Superelevation Rates, Design Speeds, and
 $e_{\max}=10\%$

e (%)	V_d (mph)										
	30	35	40	45	50	55	60	65	70	75	80
	R (ft)										
NC	3320	4350	5520	6830	8280	9890	11700	13100	14700	16300	18000
RC	2440	3210	4080	5050	6130	7330	8630	9720	10900	12200	13500
2.2	2200	2900	3680	4570	5540	6630	7810	8800	9860	11000	12200
2.4	2000	2640	3350	4160	5050	6050	7130	8040	9010	10100	11200
2.6	1840	2420	3080	3820	4640	5550	6550	7390	8290	9260	10300
2.8	1690	2230	2840	3520	4280	5130	6050	6840	7680	8580	9550
3.0	1570	2060	2630	3270	3970	4760	5620	6360	7140	7990	8900
3.2	1450	1920	2450	3040	3700	4440	5250	5930	6680	7480	8330
3.4	1360	1790	2290	2850	3470	4160	4910	5560	6260	7020	7830
3.6	1270	1680	2150	2670	3250	3900	4620	5230	5900	6620	7390
3.8	1190	1580	2020	2510	3060	3680	4350	4940	5570	6260	6990
4.0	1120	1490	1900	2370	2890	3470	4110	4670	5270	5930	6630
4.2	1060	1400	1800	2240	2740	3290	3900	4430	5010	5630	6300
4.4	994	1330	1700	2120	2590	3120	3700	4210	4760	5370	6010
4.6	940	1260	1610	2020	2460	2970	3520	4010	4540	5120	5740
4.8	890	1190	1530	1920	2340	2830	3360	3830	4340	4900	5490
5.0	844	1130	1460	1830	2240	2700	3200	3660	4150	4690	5270
5.2	802	1080	1390	1740	2130	2580	3060	3500	3980	4500	5060
5.4	762	1030	1330	1660	2040	2460	2930	3360	3820	4320	4860
5.6	724	974	1270	1590	1950	2360	2810	3220	3670	4160	4680
5.8	689	929	1210	1520	1870	2260	2700	3090	3530	4000	4510
6.0	656	886	1160	1460	1790	2170	2590	2980	3400	3860	4360
6.2	624	846	1110	1400	1720	2090	2490	2870	3280	3730	4210
6.4	594	808	1060	1340	1650	2010	2400	2760	3160	3600	4070
6.6	564	772	1020	1290	1590	1930	2310	2670	3060	3480	3940
6.8	536	737	971	1230	1530	1860	2230	2570	2960	3370	3820
7.0	509	704	931	1190	1470	1790	2150	2490	2860	3270	3710
7.2	483	671	892	1140	1410	1730	2070	2410	2770	3170	3600
7.4	460	641	855	1100	1360	1670	2000	2330	2680	3070	3500
7.6	437	612	820	1050	1310	1610	1940	2250	2600	2990	3400
7.8	416	585	786	1010	1260	1550	1870	2180	2530	2900	3310
8.0	396	558	754	968	1220	1500	1810	2120	2450	2820	3220
8.2	377	533	722	930	1170	1440	1750	2050	2380	2750	3140
8.4	359	509	692	893	1130	1390	1690	1990	2320	2670	3060
8.6	341	486	662	856	1080	1340	1630	1930	2250	2600	2980
8.8	324	463	633	820	1040	1290	1570	1870	2190	2540	2910
9.0	307	440	604	784	992	1240	1520	1810	2130	2470	2840
9.2	291	418	574	748	948	1190	1460	1740	2060	2410	2770
9.4	274	395	545	710	903	1130	1390	1670	1990	2340	2710
9.6	256	370	513	671	854	1080	1320	1600	1910	2260	2640
9.8	236	343	477	625	798	1010	1250	1510	1820	2160	2550
10.0	200	292	410	540	694	877	1090	1340	1630	1970	2370

Table 202.2E

Minimum Radii for Design Superelevation Rates, Design Speeds, and $e_{max}=12\%$

e (%)	V_d (mph)											
	25	30	35	40	45	50	55	60	65	70	75	80
	R (ft)											
NC	2460	3370	4390	5580	6910	8370	9990	11800	13200	14800	16400	18100
RC	1820	2490	3260	4140	5130	6220	7430	8740	9840	11000	12300	13600
2.2	1640	2250	2950	3750	4640	5640	6730	7930	8920	9980	11200	12400
2.4	1500	2060	2690	3420	4240	5150	6150	7240	8160	9130	10200	11300
2.6	1370	1890	2470	3140	3900	4730	5660	6670	7510	8420	9380	10500
2.8	1270	1740	2280	2910	3600	4380	5240	6170	6960	7800	8700	9660
3.0	1170	1620	2120	2700	3350	4070	4870	5740	6480	7270	8110	9010
3.2	1090	1510	1970	2520	3130	3800	4550	5370	6060	6800	7600	8440
3.4	1020	1410	1850	2360	2930	3560	4270	5030	5690	6390	7140	7940
3.6	953	1320	1730	2220	2750	3350	4020	4740	5360	6020	6740	7500
3.8	896	1250	1630	2090	2600	3160	3790	4470	5060	5700	6380	7100
4.0	845	1180	1540	1980	2460	2990	3590	4240	4800	5400	6050	6740
4.2	798	1110	1460	1870	2330	2840	3400	4020	4560	5130	5750	6420
4.4	756	1050	1390	1780	2210	2700	3240	3830	4340	4890	5490	6120
4.6	717	997	1320	1690	2110	2570	3080	3650	4140	4670	5240	5850
4.8	681	948	1260	1610	2010	2450	2940	3480	3960	4470	5020	5610
5.0	648	904	1200	1540	1920	2340	2810	3330	3790	4280	4810	5380
5.2	618	862	1140	1470	1840	2240	2700	3190	3630	4110	4620	5170
5.4	589	824	1090	1410	1760	2150	2590	3060	3490	3950	4440	4980
5.6	563	788	1050	1350	1690	2060	2480	2940	3360	3800	4280	4800
5.8	538	754	1000	1300	1620	1980	2390	2830	3230	3660	4130	4630
6.0	514	723	960	1250	1560	1910	2300	2730	3110	3530	3990	4470
6.2	492	694	922	1200	1500	1840	2210	2630	3010	3410	3850	4330
6.4	471	666	886	1150	1440	1770	2140	2540	2900	3300	3730	4190
6.6	452	639	852	1110	1390	1710	2060	2450	2810	3190	3610	4060
6.8	433	615	820	1070	1340	1650	1990	2370	2720	3090	3500	3940
7.0	415	591	790	1030	1300	1590	1930	2290	2630	3000	3400	3820
7.2	398	568	762	994	1250	1540	1860	2220	2550	2910	3300	3720
7.4	382	547	734	960	1210	1490	1810	2150	2470	2820	3200	3610
7.6	366	527	708	928	1170	1440	1750	2090	2400	2740	3120	3520
7.8	351	507	684	897	1130	1400	1700	2020	2330	2670	3030	3430
8.0	336	488	660	868	1100	1360	1650	1970	2270	2600	2950	3340
8.2	321	470	637	840	1070	1320	1600	1910	2210	2530	2880	3260
8.4	307	452	615	813	1030	1280	1550	1860	2150	2460	2800	3180
8.6	294	435	594	787	997	1240	1510	1810	2090	2400	2740	3100
8.8	281	418	574	762	967	1200	1470	1760	2040	2340	2670	3030
9.0	270	403	554	738	938	1170	1430	1710	1980	2280	2610	2960
9.2	259	388	535	715	910	1140	1390	1660	1940	2230	2550	2890
9.4	248	373	516	693	883	1100	1350	1620	1890	2180	2490	2830
9.6	238	359	499	671	857	1070	1310	1580	1840	2130	2440	2770
9.8	228	346	481	650	832	1040	1280	1540	1800	2080	2380	2710
10.0	219	333	465	629	806	1010	1250	1500	1760	2030	2330	2660
10.2	210	320	448	608	781	980	1210	1460	1720	1990	2280	2600
10.4	201	308	432	588	757	951	1180	1430	1680	1940	2240	2550
10.6	192	296	416	568	732	922	1140	1390	1640	1900	2190	2500
10.8	184	284	400	548	707	892	1110	1350	1600	1860	2150	2460
11.0	175	272	384	527	682	862	1070	1310	1560	1820	2110	2410
11.2	167	259	368	506	656	831	1040	1270	1510	1780	2070	2370
11.4	158	247	351	485	629	799	995	1220	1470	1730	2020	2320
11.6	149	233	333	461	600	763	953	1170	1410	1680	1970	2280
11.8	139	218	312	434	566	722	904	1120	1350	1620	1910	2230
12.0	119	188	272	381	500	641	807	1000	1220	1480	1790	2130

July 1, 2020

**Figure 202.2
Maximum Comfortable Speed on Horizontal Curves***

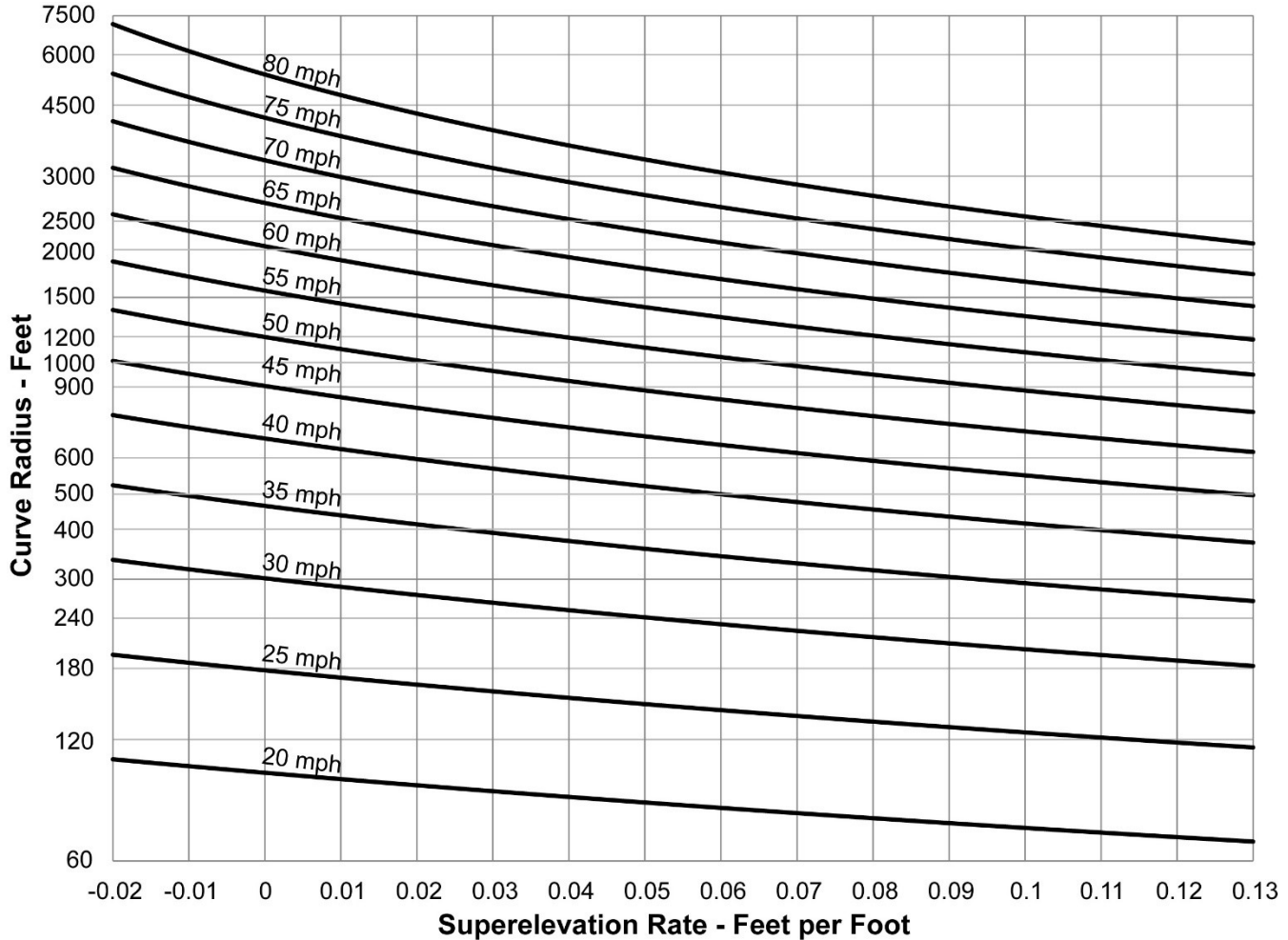

NOTES:

*See Index 202.2(1) for application of this figure.

Speed (mph)	Side Friction Factor "f"
20	0.27
30	0.20
40	0.16
50	0.14
55	0.13
60	0.12
65	0.11
70	0.10
75	0.09
80	0.08

NOTES:

This figure is not intended to represent standard superelevation rates or curve radius. The standards are contained in Tables 202.2A through 202.2E. This figure should be used as an aid to designers to determine maximum comfortable speeds. Use of this figure in lieu of the standards must be documented as discussed in Index 82.2.

e = Superelevation (feet per foot)

f = Side Friction Factor

V = Speed (mph)

R = Radius (feet)

$$e+f = \frac{0.067V^2}{R}$$

(b) Conventional Highways – The axis of rotation should be considered on an individual project basis and the most appropriate case for the conditions should be selected.

Aesthetics, grade distortion, superelevation transitions, drainage, and driver perception should be considered when selecting the axis of rotation (see Index 204.2).

202.5 Superelevation Transition

(1) *General.* The superelevation transition generally consists of the crown runoff and the superelevation runoff as shown on Figure 202.5A and 202.5B.

A superelevation transition should be designed in accordance with the diagram and tabular data shown in Figure 202.5A to satisfy the requirements of safety, comfort and pleasing appearance. The length of superelevation transition should be based upon the combination of superelevation rate and width of rotated plane in accordance with the tabulated superelevation runoff lengths on the bottom of Figure 202.5A.

Edge of traveled way and shoulder profiles should be plotted and irregularities resulting from interactions between the superelevation transition and vertical alignment of the roadway should be eliminated by introducing smooth curves. Edge of traveled way and shoulder profiles also will reveal flat areas which are undesirable from a drainage standpoint and should be avoided.

(2) *Runoff.* Two-thirds of the superelevation runoff should be on the tangent and one-third within the curve. This results in two-thirds of the full superelevation rate at the beginning or ending of a curve. This may be altered as required to adjust for flat spots or unsightly sags and humps, or when conforming to existing roadway.

(3) *Restrictive Situations.* In restrictive situations, such as on two lane highways in mountainous terrain, interchange ramps, collector roads, frontage roads, etc., where curve radius and length and tangents between curves are short, standard superelevation rates and/or transitions may not be attainable. In such situations the highest possible superelevation rate(s) and transition length should be used, but the rate of change of cross slope should not exceed 6 percent per 100 feet.

(4) *Superelevation Transitions on Bridges.* Superelevation transitions on bridges should be avoided whenever possible (See Index 203.9).

(5) *Shoulder Transitions.* The shoulder plane rotates about the adjacent edge of traveled way as well as the rotational axis of the traveled way. Shoulder superelevation transitions should be smooth and compatible with the transition of the adjacent pavements.

July 1, 2020

Figure 202.5A

Superelevation Transition

Formulas	Explanation of Terms
2-Lane Roads $L = 2500 e$	(L) = Length of Superelevation Runoff - ft
Multilane Roads & Branch Connections $L = 150 D e$	(e) = Superelevation rate - ft/ft
Ramps Multilane $L = 2500 e$ if possible Single Lane $L = 2000 e$	(D) = Distance from axis of rotation to outside edge of lanes - ft
MINIMUM L = 150 FT	MAXIMUM L = 510 FT

Adjust computed length to nearest 10 ft. length divisible by 3

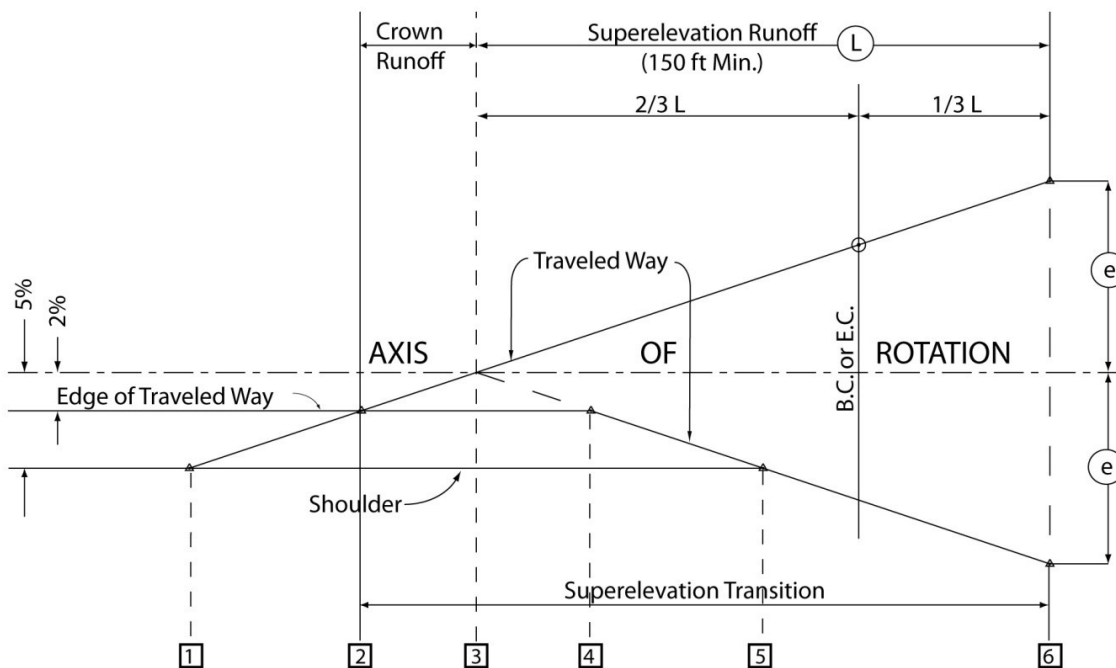

Superelevation Runoff Lengths



Length, L (feet)

Superelevation Rate "e" ft/ft	2-Lane Highways & Multilane Ramps	Single Lane Ramps	Multilane Highways and Branch Connections with Various "D" Widths						
			24 ft	36 ft	48 ft	51 ft	60 ft	63 ft	75 ft
0.02	150	150	150	150	150	150	180	180	240
0.03	150	150	150	180	210	240	270	270	330
0.04	150	150	150	210	300	300	360	390	450
0.05	150	150	180	270	360	390	450	480	510
0.06	150	150	210	330	450	450	510	510	
0.07	180	150	270	390	510	510			
0.08	210	150	300	450					
0.09	240	180	330	480					
0.10	240	210	360	510					
0.11	270	210	390						
0.12	300	240	420						

For widths of "D" not included in table, use formula above.

Figure 202.5B

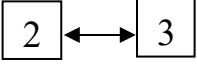
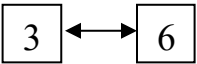
Superelevation Transition Terms & Definitions

Term	Definition
Crown Runoff 	The distance from the station where the high side of the superelevating section surfaces are at a cross slope of 2% to where the high side of the section surfaces reaches a cross slope of 0%.
Superelevation Runoff (L) 	The distance from the station where the high side of the superelevating section surfaces are at a cross slope of 0% to the station where the entire cross section is at full superelevation.
Superelevation Transition 	The distance from the station where the high side of the superelevating sections are crowned at a cross slope of 2% to the station where the entire cross section is at full superelevation. The Crown Runoff Length plus the Superelevation Runoff Length (L) equals the Superelevation Transition Length.
%L On tangent	The percentage of the superelevation runoff length (L) that is outside of the curve ($2/3L$). See Index 202.5(2).
%L On curve	The percentage of the superelevation runoff length (L) that is within the curve ($1/3L$). See Index 202.5(2). The % On Tangent and % On curve values must total 100%.

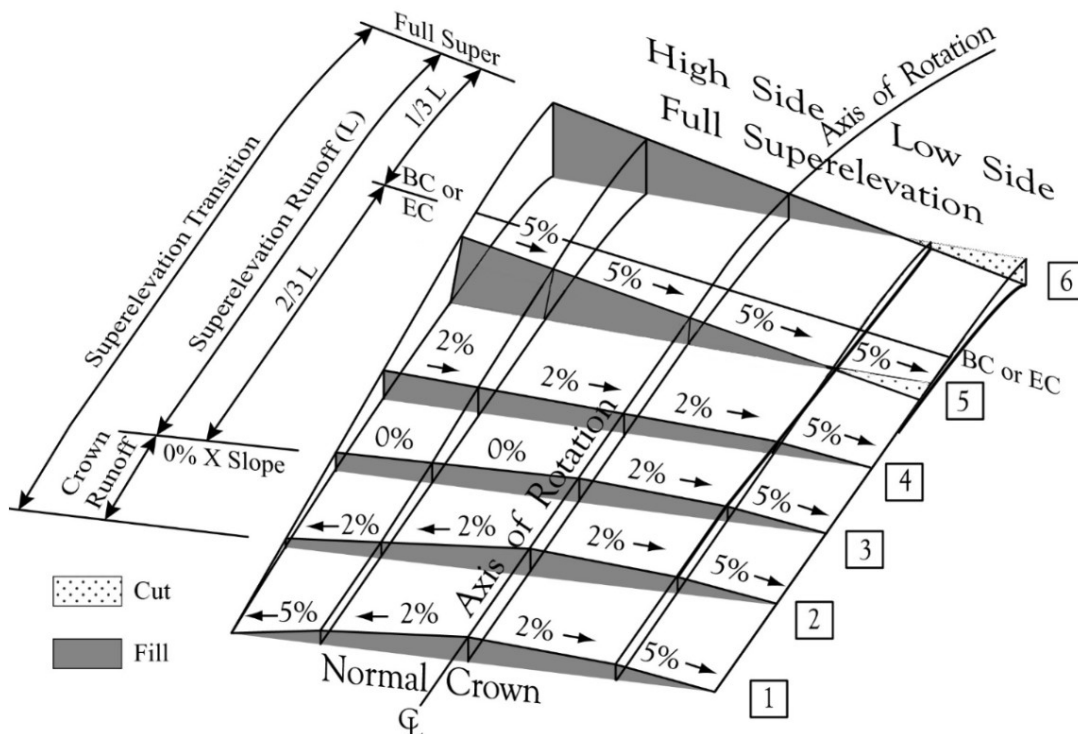

Elements of a Superelevation Transition (Right Curve)

July 1, 2020

202.6 Superelevation of Compound Curves

Superelevation of compound curves should follow the procedure as shown in Figure 202.6. Where feasible, the criteria in Index 202.5 should apply.

202.7 Superelevation on City Streets and County Roads

Superelevation rates of local streets and roads which are within the State right of way (with or without connection to State facilities) shall conform to AASHTO standards, for the functional classification of the facility in question. If the local agency having jurisdiction over the local facility in question maintains standards that exceed AASHTO standards, then the local agency standards should prevail.

See Index 202.2 for Frontage Roads within the State right of way. Frontage roads that will be relinquished after construction should follow AASHTO or local standards as stated above.

Topic 203 – Horizontal Alignment

203.1 General Controls

Horizontal alignment should provide for safe and continuous operation at a uniform design speed for substantial lengths of highway. The standards which follow apply to curvature on both 2-lane and multilane highways except when otherwise noted. These standards also apply to portions of local streets and roads within the State right of way which connect directly to a freeway or expressway, or are expected to do so in the foreseeable future. **For local facilities which are within the State right of way and where there is no connection or the connection is to a non-controlled access facility (conventional highway), AASHTO standards shall prevail. If the local agency having jurisdiction over the local facility in question maintains standards that exceed AASHTO standards, then the local agency standards should prevail.**

The major considerations in horizontal alignment design are safety, profile, type of facility, design speed, geotechnical features, topography, right of way cost and construction cost. In design, safety is always considered, either directly or indirectly. On freeways in metropolitan areas, alternative studies often indicate that right of way considerations influence alignment more than any other single factor. Topography controls both curve radius and design speed to a large extent. The design speed, in turn, controls sight distance, but sight distance must be considered concurrently with topography because it often demands a larger radius than the design speed. All these factors must be balanced to produce an alignment which optimizes the achievement of various objectives such as safety, cost, harmony with the natural contour of the land, and at the same time adequate for the design classification of the highway.

Horizontal alignment shall provide at least the minimum stopping sight distance for the chosen design speed at all points on the highway, as given in Table 201.1 and explained in Index 201.3. See Index 101.1 for technical reductions in design speed.

Figure 202.6

Superelevation of Compound Curves

- L = Length of superelevation runoff - ft
- e_s = Superelevation rate for smaller radius curve - ft/ft or percent
- e_L = Superelevation rate for larger radius curves - ft/ft or percent

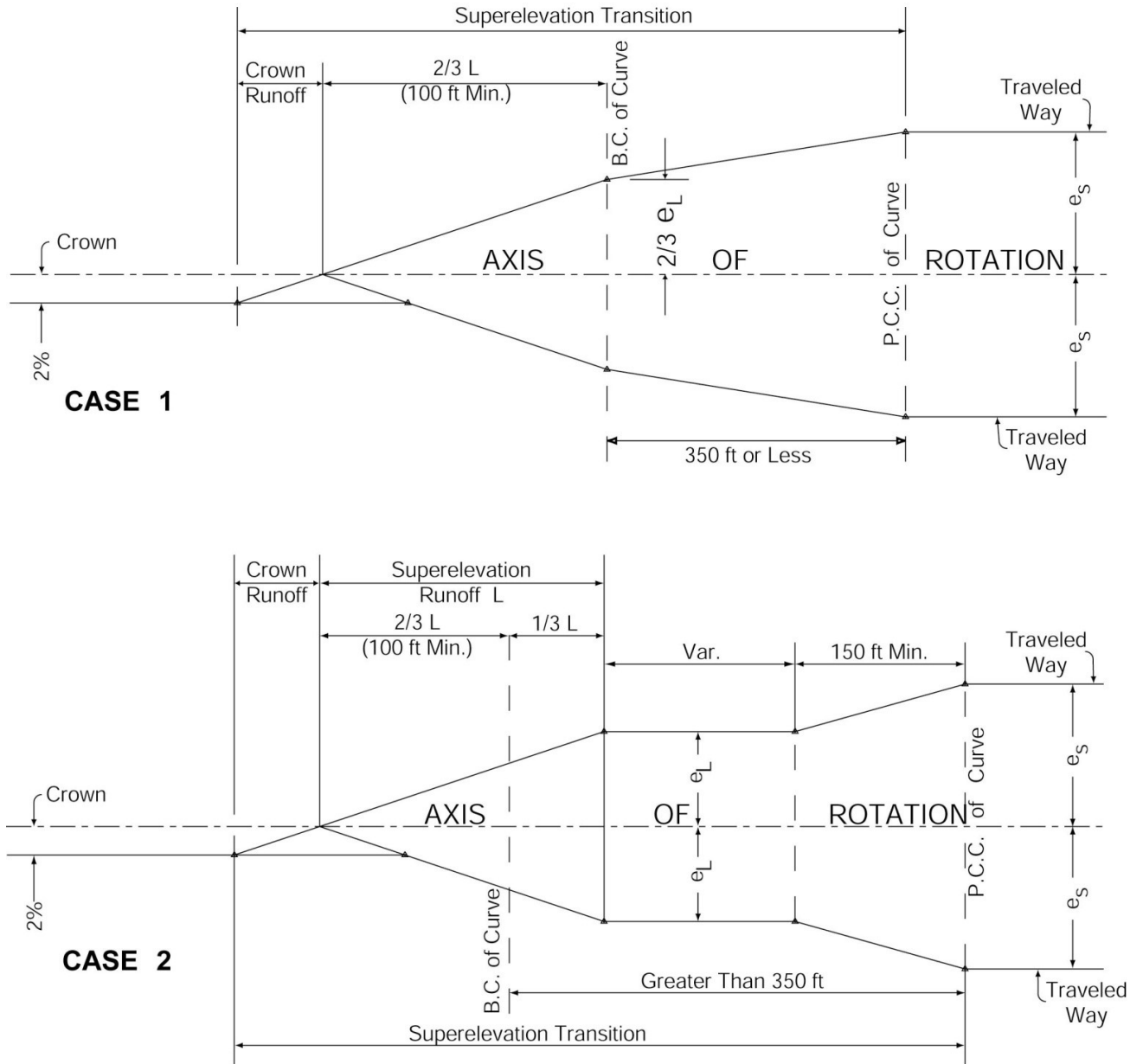

July 1, 2020

203.2 Standards for Curvature

Tables 202.2A through 202.2E shall be the minimum radius of curve for superelevation rates and design speeds on highways. These tables are based upon the relationship between design speed and curvature and on their joint relationship with superelevation and side friction. Though these relationships originate from the laws of mechanics, the actual values for use in design depend on practical limits and factors determined empirically. **If the minimum radii indicated in Tables 202.2A through 202.2E do not provide the desired lateral clearance to an obstruction, Figure 201.6 shall govern.**

See Index 202.2(1) for further information regarding the use of the tables.

Every effort should be made to exceed minimum radii values for the e_{\max} of the table being used. Such minimum radii should be used only when the cost or other adverse effects of realizing a higher standard are inconsistent with the benefits. Use of Figure 202.2, in lieu of the above standards must be documented as discussed in Index 82.2.

The recommended minimum radii for freeways are 5,000 feet in rural areas and 3,000 feet in urban areas.

If a glare screen or a median barrier is contemplated, either initially or ultimately, adjustments may be necessary to maintain the required sight distance on curves on divided highways. In such cases, a larger curve radius or a wider median may be required throughout the length of the curve. For design purposes, a planting screen is presumed to be 8 feet wide. See Traffic Safety Systems Guidance for glare screen criteria.

203.3 Alignment Consistency

Sudden reductions in alignment standards should be avoided. Where physical restrictions on curve radius cannot be overcome and it becomes necessary to introduce curvature of lower standard than the design speed for the project, the design speed between successive curves should change not more than 10 miles per hour. Introduction of curves with lower design speeds should be avoided at the end of long tangents, steep downgrades, or at other locations where high approach speeds may be anticipated.

The horizontal and vertical alignments should be coordinated such that horizontal curves are not hidden behind crest vertical curves. Sharp horizontal curves should not follow long tangents because some drivers tend to develop higher speeds on the tangent and could over drive the curve.

See "Combination of Horizontal and Vertical Alignment" in Chapter 3 of AASHTO, A Policy on Geometric Design of Highways and Streets, for further guidance on alignment consistency.

203.4 Curve Length and Central Angle

The minimum curve length for central angles less than 10 degrees should be 800 feet to avoid the appearance of a kink. For central angles larger than 30 minutes, a curve is required without exception. Above a 20,000-foot radius, a parabolic curve may be used. Sight

distance or other safety considerations are not to be sacrificed to meet the above requirements.

On 2-lane roads a curve should not exceed a length of one-half mile and should be no shorter than 500 feet.

203.5 Compound Curves

Compound curves should be avoided because drivers who have adjusted to the first curve could over drive the second curve if the second curve has a smaller radius than the first. Exceptions can occur in mountainous terrain or other situations where use of a simple curve would result in excessive cost. Where compound curves are necessary, the shorter radius should be at least two-thirds the longer radius when the shorter radius is 1,000 feet or less. On one-way roads, the larger radius should follow the smaller radius.

The total arc length of a compound curve should be not less than 500 feet.

203.6 Reversing Curves

When horizontal curves reverse direction the connecting tangents should be long enough to accommodate the standard superelevation runoffs given on Figure 202.5A. If this is not possible, the 6 percent per 100 feet rate of change should govern (see Index 202.5(3)). When feasible, a minimum of 400 feet of tangent should be considered.

203.7 Broken Back Curves

A broken back curve consists of two curves in the same direction joined by a short tangent. Broken back curves are unsightly and undesirable.

203.8 Spiral Transition

Spiral transitions are used to transition from a tangent alignment to a circular curve and between circular curves of unequal radius. Spiral transitions may be used whenever the traffic lane width is less than 12 feet, the posted speed is greater than 45 miles per hour, and the superelevation rate exceeds 8 percent. The length of spiral should be the same as the Superelevation Runoff Length shown in Figure 202.5A. In the typical design, full superelevation occurs where the spiral curve meets the circular curve, with crown runoff being handled per Figure 202.5A. For a general discussion of spiral transitions see AASHTO *A Policy on the Geometric Design of Streets and Highways*. When used, spirals transitions should conform to the Clothoid definition.

203.9 Alignment at Bridges

Due to the difficulty in constructing bridges with superelevation rates greater than 10 percent, the curve radii on bridges should be designed to accommodate superelevation rates of 10 percent or less. See Index 202.2 for standard superelevation rates.

Superelevation transitions on bridges are difficult to construct and almost always result in an unsightly appearance of the bridge and the bridge railing. Therefore, if possible, horizontal

July 1, 2020

curves should begin and end a sufficient distance from the bridge so that no part of the superelevation transition extends onto the bridge.

Alignment and safety considerations, however, are paramount and must not be sacrificed to meet the above criteria.

Topic 204 – Grade

204.1 General Controls

The grade line is a reference line by which the elevation of the pavement and other features of the highway are established. It is controlled mainly by topography, type of highway, horizontal alignment, performance of heavy vehicles, right of way costs, safety, sight distance, construction costs, cultural development, drainage, and pleasing appearance.

All portions of the grade line must meet sight distance requirements for the design speed classification of the road.

In flat terrain, the elevation of the grade line is often controlled by drainage considerations. In rolling terrain, some undulation in the grade line is often advantageous for construction economy. This should be done with appearance in mind; for example, a grade line on tangent alignment exhibiting a series of humps visible for some distance ahead should be avoided whenever possible. In rolling hills or mountainous terrain, however, the grade line usually is more closely dependent upon physical controls.

In considering alternative profiles, economic comparisons involving earthwork quantities and/or retaining walls should be made. A balanced earthwork design is most cost effective. When long or steep grades are involved, economic comparisons should include vehicle operating costs.

The standards in Topic 204 also apply to portions of local streets and roads within the State right of way which connect directly to a freeway or expressway, or are expected to do so in the foreseeable future. **For local facilities which are within the State right of way and where there is no connection or the connection is to a non-controlled access facility (conventional highway), AASHTO standards shall prevail.** If the local agency having jurisdiction over the local facility in question maintains standards that exceed AASHTO standards, then the local agency standards should prevail.

204.2 Position With Respect to Cross Section

The grade line should generally coincide with the axis of rotation for superelevation (see Index 202.4). Its relation to the cross section should be as follows:

- (1) *Undivided Highways.* The grade line should coincide with the highway centerline.
- (2) *Ramps and Freeway-to-freeway Connections.* Although the grade line is usually positioned at the left edge of traveled way, either edge of traveled way or centerline may be used on multilane facilities.
- (3) *Divided Highways.* The grade line should be positioned at the centerline of the median for paved medians 65 feet wide or less, thus avoiding a “saw tooth” section, which can reduce horizontal stopping sight distance.

The grade line may be positioned at the ultimate median edge of traveled way when:

- (a) The median edges of traveled way of the two roadways are at equal elevation.
- (b) The two roadways are at different elevations as described in Index 204.8.
- (c) The width of median is nonuniform (see Index 305.6).

204.3 Standards for Grade

Table 204.3 shows the maximum grades which shall not be exceeded for the condition indicated.

Steep grades affect truck speeds and overall capacity. They also cause operational problems at intersections. For these reasons it is desirable to provide the flattest grades practicable (see Index 204.5 for information on truck issues with grades).

Table 204.3

Maximum Grades for Type of Highway and Terrain Conditions

Type of Terrain	Freeways and Expressways	Rural Highways	Urban Highways
Level	3%	4%	6%
Rolling	4%	5%	7%
Mountainous	6%	7%	9%

Minimum grades should be 0.5 percent in snow country and 0.3 percent at other locations. Except for conventional highways in urban or suburban areas, a level grade line is permissible in level terrain where side fill slopes are 4:1 or flatter and dikes are not needed to carry water in the roadbed. Flat grades are not permissible in superelevation transitions due to flat spots which cause ponding on the roadbed.

Ramp grades should not exceed 8 percent. On descending on-ramps and ascending off-ramps, one percent steeper is allowed (see Index 504.2(5)).

204.4 Vertical Curves

Properly designed vertical curves should provide adequate sight distance, safety, comfortable driving, good drainage, and pleasing appearance.

A parabolic vertical curve is used. Figure 204.4 gives all necessary mathematical relations for computing a vertical curve, either at crests or sags. For algebraic grade differences of 2 percent and greater, and design speeds equal to or greater than 40 miles per hour, the minimum length of vertical curve in feet should be equal to $10V$, where V = design speed. As an example, a 65 miles per hour design speed would require a 650-foot minimum vertical curve length. For algebraic grade differences of less than 2 percent, or design speeds less than 40 miles per hour, the vertical curve length should be a minimum of 200 feet. Vertical curves are not required where the algebraic difference in grades is 0.5 percent or less. Grade

July 1, 2020

Figure 204.4

Vertical Curves

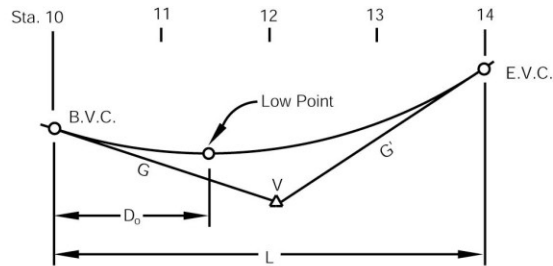
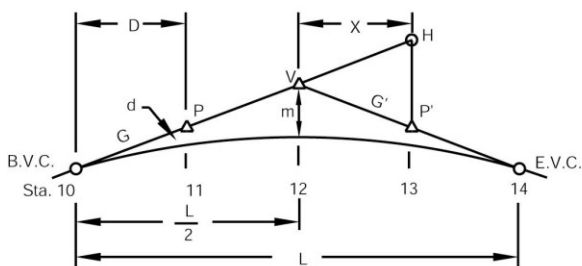

IN ANY VERTICAL CURVE :

$$(1) \quad m = \frac{(G'-G)L}{8}$$

$$(2) \quad m = \frac{1}{2} \left(\frac{EI.B.V.C. + EI.E.V.C.}{2} - EI.V \right)$$

$$(3) \quad d = m \left(\frac{D}{L/2} \right)^2 = \frac{4m}{L^2} D^2$$

$$(4) \quad d = \frac{D^2(G'-G)}{2L} = \frac{-50D^2}{K}$$

$$(5) \quad X = \frac{100(H-P')}{(G'-G)}$$

$$(6) \quad S = G - D \left(\frac{G-G'}{L} \right) = G - \frac{100D}{K}$$

$$(7) \quad D_0 = \frac{LG}{G-G'}$$

$$(8) \quad A = G - G'$$

$$(9) \quad K = \frac{L}{A} (100) = \frac{L}{G-G'} (100)$$

WHERE:

L = Length of curve - measured horizontally -
100 ft. units or stations

G and G' = Grade rates - percent.

m = Middle ordinate - feet.

d = Correction from grade line to curve - feet.

D = Distance from B.V.C. or E.V.C. to any point
on curve - stations.

S = Slope of the tangent to the curve at any
point - percent.

X = Distance, from P' to V - feet.

H = Elevation of grade G projected to station
of P'

P and P' = Elevation on respective grades.

D₀ = Distance to low or high point from extremity
of curve - stations.

K = Distance in feet required to achieve a
1% change in grade.

NOTES:

A rising grade carries a plus sign, while a falling grade
carries a minus sign.

Thus, in a crest vertical curve as above, G carries a plus
sign and G' carries a minus sign when progressing in the
direction of the stationing. When progressing in the opposite
direction, G becomes a minus grade and G' a plus grade.

breaks should not be closer together than 50 feet and a total of all grade breaks within 200 feet should not exceed 0.5 percent.

Since flat vertical curves may develop poor drainage at the level section, adjusting the gutter grade or shortening the vertical curve may overcome any drainage problems.

On 2-lane roads, extremely long crest vertical curves, over one-half mile, should be avoided, since many drivers refuse to pass on such curves despite adequate sight distance. It is sometimes more economical to construct passing lanes than to obtain passing sight distance by the use of a long vertical curve.

Broken-back vertical curves consist of two vertical curves in the same direction separated by a short grade tangent. A profile with such curvature normally should be avoided, particularly in sag where the view of both curves is not pleasing.

204.5 Sustained Grades

(1) *General.* Maximum grade is not a complete design control. The length of an uphill grade is important as well, because it affects capacity, level of service, and delay when slow moving trucks, buses, and recreational vehicles are present.

A common criterion for all types of highways is to consider the addition of a climbing lane where the running speed of trucks falls 10 miles per hour or more below the running speed of remaining traffic. Figure 204.5 shows the speed reduction curves for a 200 lb/hp truck, which is representative of large trucks operating near maximum gross weight. The 10 miles per hour reduction criterion may be used as one method of determining need, however the Highway Capacity Manual should be consulted for detailed analysis.

(2) *Freeway Climbing Lanes.* If design year traffic volumes are expected to be near capacity, right of way acquisition and grading for a future lane should be considered at locations where the upgrade exceeds 2 percent and the total rise exceeds 50 feet.

Regardless of traffic volumes, the need for a climbing lane should be investigated on sustained upgrades greater than 2 percent if the total rise is greater than 250 feet. Refer to the Highway Capacity Manual for passenger car equivalent factors and sample calculations.

Decision sight distance (Table 201.7) should be provided at climbing lane drops on freeways.

(3) *Two-lane Road Climbing and Passing Lanes.* Climbing and passing lanes are most effective on uphill grades and curving alignment where the speed differential among vehicles is significant. Climbing and passing lanes should normally not be constructed on tangent sections where the length of tangent equals or exceeds the passing sight distance, because passing will occur at such locations without a passing lane and the double barrier stripe increases delay for opposing traffic. Where the ADT exceeds 5000, 4-lane passing sections may be considered. See Index 305.1(2) for median width standards.

The Headquarters Division of Traffic Operations should be consulted regarding the length of climbing and passing lanes, which will vary with the design speed of the highway, the traffic volume, and other factors.

July 1, 2020

Figure 204.5

Critical Lengths of Grade for Design

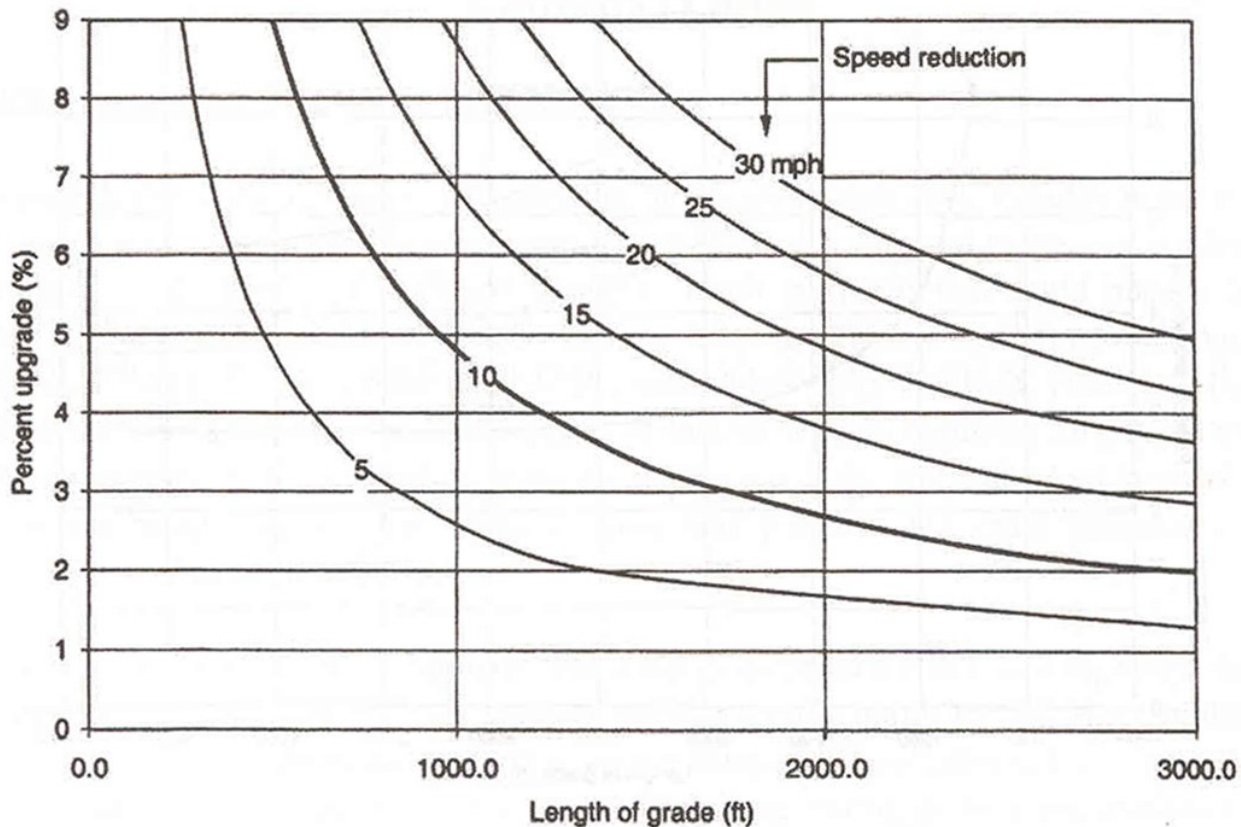

ASSUMED TYPICAL HEAVY TRUCK OF 200 lb/hp

(4) Turnouts

- (a) *General.* On a two-lane highway where passing is limited, the California Vehicle Code requires slow-moving vehicles followed by five or more vehicles to turn off at designated turnouts or wherever sufficient area for a safe turnout exists. Designated turnouts may be constructed in hilly or mountainous terrain or on winding roads in other areas.

Where less than 4-foot shoulders are provided on ascending grades, consideration should be given to providing several short sections of 4 feet or wider shoulder as turnouts for bicycle passing. Frequent turnouts that are at least 30 feet in length are recommended on sustained uphill grades. These turnouts will allow safe passing of bicycles by other bicyclists and vehicles in addition to providing resting opportunities on the sustained grade for bicyclists.

- (b) *Length.* Designated turnouts should be from 200 feet to 500 feet long including a short taper (usually 50 feet) at each end. Approach speeds, grades, traffic volumes, and available space are some factors to be considered in determining the length. The District Traffic Engineer or designee should be consulted if longer turnouts are desired.

- (c) *Width.* Paved widths of at least 15 feet in fill sections and 12 feet in cut sections are recommended. Width is measured from the edge of traveled way. On the outside of curves along steep fill slopes or dropoffs, greater width or the installation of guardrail should be considered.
- (d) *Location.* Turnouts should be located where there is stopping sight distance for approaching drivers to see vehicles leaving and re-entering the through lanes.

204.6 Coordination of Horizontal and Vertical Alignment

A proper balance between curvature and grades should be sought. When possible, vertical curves should be superimposed on horizontal curves. This reduces the number of sight restrictions on the project, makes changes in profile less apparent, particularly in rolling country, and results in a pleasing appearance. Where the change in horizontal alignment at a grade summit is moderate, a pleasing appearance may be attained by making the vertical curve overlap the horizontal curve.

When horizontal and vertical curves are superimposed, the combination of superelevation and profile grades may cause distortion in the outer pavement edges which could create drainage concerns or confuse drivers at night. In such situations edge of pavement profiles should be plotted and smooth curves introduced to eliminate any irregularities or distortion.

On highways in mountainous or rolling terrain where horizontal and vertical curves are superimposed at a grade summit or sag, the design speed of the horizontal curve should be at least equal to that of the crest or sag, and not more than 10 miles per hour less than the measured or estimated running (85th percentile) speed of vehicles on the approach roadway.

On long open curves, a uniform grade line should be used because a rolling profile makes for a poor appearance.

Horizontal and vertical curvature at intersections should be as flat as physical conditions permit.

See “Combination of Horizontal and Vertical Alignment” in Chapter III of AASHTO, A Policy on Geometric Design of Highways and Streets, for further guidance on an alignment consistency.

204.7 Separate Grade Lines

Separate or independent grade lines are appropriate in some cases for freeways and expressways.

They are not normally considered appropriate where medians are less than 65 feet wide (see Index 305.6). Exceptions to this may be minor differences between opposing grade lines in special situations. In addition, for either interim or ultimate expressways, any appreciable grade differential between roadbeds should be avoided in the vicinity of at-grade intersections. For traffic entering from the crossroad, confusion and wrong-way movements could result if the pavement of the far roadway is obscured because of excessive grade differential.

July 1, 2020

204.8 Grade Line of Structures

(1) *Structure Depth.* The depth to span ratio for each structure is dependent on many factors. Some of these are: span, type of construction, aesthetics, cost, falsework limitations, and vertical clearance limitations. For purposes of preliminary planning and design, the depth to span ratios listed below may be used in setting grade lines at grade separations.

(a) Railroad Underpass Structures.

- Single track, through girder type structures: use 5-foot depth from top of rail to structure soffit (bottom of girder).
- Deck-type structures: for simple spans use d/s (depth to span ratio) = 0.08; for continuous multiple span structures use $d/s = 0.07$. These ratios do not include the additional 2 feet required above the deck for ballast and rail height.

(b) Highway Structures.

- Structures with single spans of 100 feet or less, use $d/s = 0.06$.
- Structures with single spans between 100 feet and 180 feet use $d/s = 0.045$.
- Continuous structures with multiple spans of 100 feet or less, use $d/s = 0.055$.
- Continuous structures with multiple spans of more than 100 feet, use $d/s = 0.04$.
- Geometric plans should be submitted to the DES – Structure Design prior to preparation of the project report so that preliminary studies can be prepared.

Preliminary bridge type selection should be a joint effort between the DES – Structure Design and the District.

(2) *Steel or Precast Concrete Structures.* Steel and precast concrete girders in lieu of cast-in-place concrete eliminate falsework, and may permit lower grade lines and reduced approach fill heights. Potential cost savings from elimination of falsework, lowered grade lines, and the ability to accommodate settlement beneath the abutments should be considered in structure type selection along with unit price, aesthetics, uniformity, and any other relevant factors. Note that grade lines at grade separations frequently need to be adjusted after final structure depths are determined (see Index 309.2(3)). Details of traffic handling and stage construction should be provided when the bridge site plan is submitted to the DES – Structure Design if the design or construction of the structure is affected (see Drafting and Plans Manual, Section 3-3.2).

(3) *Depressed Grade Line Under Structures.* Bridge and drainage design will frequently be simplified if the low point in the grade line is set a sufficient distance from the intersection of the centerlines of the structure and the highway so that drainage structures clear the structure footings.

(4) *Grade Line on Bridge Decks.* Vertical curves on bridge decks should provide a minimum fall of 0.05-foot per station. This fall should not extend over a length greater than 100 feet. The flattest allowable tangent grade should be 0.3 percent.

(5) *Falsework.* In many cases, it is economically justified to have falsework over traffic during construction in order to have a support-free open area beneath the permanent structure. The elimination of permanent obstructions usually outweighs objections to the temporary inconvenience of falsework during construction.

Because the width of traffic openings through falsework can, and oftentimes does, significantly affect costs, special care should be given to determining opening widths. The following should be considered: staging and traffic handling requirements,

accommodation of pedestrians and bicyclists, the width of approach roadbed that will exist at the time the bridge is constructed, traffic volumes, needs of the local agencies, controls in the form of existing facilities, and the practical challenges of falsework construction.

The normal width of traffic openings and required falsework spans are shown in Table 204.8.

The normal spans shown in Table 204.8 are for anchored temporary K-rail. When temporary K-rail is not anchored, add 4 feet to normal span to include K-rail deflection.

The minimum vertical falsework clearance over freeways and nonfreeways shall be 15 feet. The following items should be considered:

- Mix, volume, and speed of traffic.
- Effect of increased vertical clearance on the grade of adjacent sections.
- Closing local streets to all traffic or trucks only during construction.
- Detours.
- Carrying local traffic through construction on subgrade.
- Temporary or permanent lowering of the existing facility.
- Cost of higher clearance versus cost of traffic control.
- Desires of local agency.

Worker safety should be considered when determining vertical falsework clearance. Requests for approval of temporary vertical clearances less than 15 feet should discuss the impact on worker safety.

Temporary horizontal clearances less than shown in Table 204.8 or temporary vertical clearances less than 15 feet should be noted in the PS&E Transmittal Report.

To establish the grade of a structure to be constructed with a falsework opening, allowance must be made for the depth of the falsework. The minimum depths required for various widths of traffic opening are shown in Table 204.8.

Where vertical clearances, either temporary or permanent are critical, the District and the DES – Structure Design should work closely during the early design stage when the preliminary grades, structure depths, and falsework depths can be adjusted without incurring major design changes.

Where the vertical falsework clearance is less than 15 feet, advance warning devices are to be specified or shown on the plans. Such devices may consist of flashing lights, overhead signs, over-height detectors, or a combination of these or other devices.

Warning signs on the cross road or in advance of the previous off-ramp may be required for overheight permit loads. Check with the Regional Permit Manager.

After establishing the opening requirements, a field review of the bridge site should be made by the District designer to ensure that existing facilities (drainage, other bridges, or roadways) will not conflict with the falsework.

The placement and removal of falsework requires special consideration. During these operations, traffic should either be stopped for short intervals or diverted away from the

July 1, 2020

Table 204.8

Falsework Span and Depth Requirements

Facility to be Spanned	Minimum Normal Width of Traffic Opening (2)(3)(4)	Resulting Falsework Normal Span ⁽¹⁾	Depth of Superstructure ⁽⁵⁾			
			Up to 6 feet	Up to 8 feet	Up to 10 feet	Up to 12 feet
Freeway & Non Freeway	20'	28'	1'-9"	1'-10"	1'-10"	1'-10½"
	25'	33'	1'-10½"	2'-1'	2'-1'	2'-8½"
	32'	40'	2'-0"	2'-8½"	2'-9"	3'-0"
	37'	45'	2'-9"	2'-11½"	3'-0"	3'-3"
	40'	48'	3'-0"	3'-0"	3'-2½"	3'-3"
	49'	57'	3'-3"	3'-3½"	3'-3½"	3'-3½"
	52'	60'	3'-3"	3'-3½"	3'-3½"	3'-4"
	61'	69'	3'-5"	3'-5"	3'-7"	3'-7½"
	64'	72'	3'-5"	3'-7½"	3'-7½"	3'-8"
	73'	81'	3'-6"	3'-9"	3'-9"	3'-9"

NOTES:

- ⁽¹⁾Includes 8' for two temporary K-rails and 2' to center line of post including 3" clearance between K-rail and footing pad. This is for K-rail anchored to the pavement.
- ⁽²⁾Approach roadway width measured normal to lanes. Use next highest width if the approach roadway width is not shown in the table.
- ⁽³⁾Dependent upon the width of approach roadbed available at the time of bridge construction.
- ⁽⁴⁾Clear vehicular opening between temporary railings.
- ⁽⁵⁾See Index 204.8 for preliminary depth to span ratios. For more detailed information, contact the Division of Engineering Services, Structure Design and refer to the Bridge Design Aids.

span where the placement or removal operations are being performed. The method of traffic handling during these operations is to be included in the Special Provisions.

Topic 205 – Road Connections and Driveways

205.1 Access Openings on Expressways

Access openings are used only on expressways. The term access opening applies to openings through the right of way line which serve abutting land ownerships whose remaining access rights have been acquired by the State.

- (1) *Criteria for Location.* Access openings should not be spaced closer than one-half mile to an adjacent public road intersection or to another private access opening that is wider than 30 feet. When several access openings are closely spaced, a frontage road should be considered (see Index 104.3). To discourage wrong-way movements, access openings should be located directly opposite, or at least 300 feet from a median opening.

Sight distance equivalent to that required for public road intersections shall be provided (see Index 405.1).

- (2) *Width.* The normal access opening width should be 30 feet. A greater width may result in large savings in right of way costs in some instances, but should be considered with caution because of the possibility that public use might develop. Conversion of a private opening into a public road connection requires the consent of the CTC, which cannot be committed in advance (see the Project Development Procedures Manual).
- (3) *Recessed Access Openings.* Recessed access openings, as shown on Figure 205.1, are desirable at all points where private access is permitted and should be provided whenever they can be obtained without requiring alterations to existing adjacent improvements. When recessed openings are required, the opening should be located a minimum distance of 75 feet from the nearest edge of the traveled way.
- (4) *Joint Openings.* A joint access opening serving two or more parcels of land is desirable whenever feasible. If the property line is not normal to the right of way line, care should be taken in designing the joint opening so that both owners are adequately served.
- (5) *Surfacing.* All points of private access should be surfaced with adequate width and depth of pavement to serve the anticipated traffic. The surfacing should extend from the edge of the traveled way to the right of way line.

205.2 Private Road Connections

The minimum private road connection design is shown on Figure 205.1. Sight distance requirements for the minimum private road connection are shown on Figure 405.7 (see Index 405.1(2)(c)).

July 1, 2020

Figure 205.1

Access Openings on Expressways

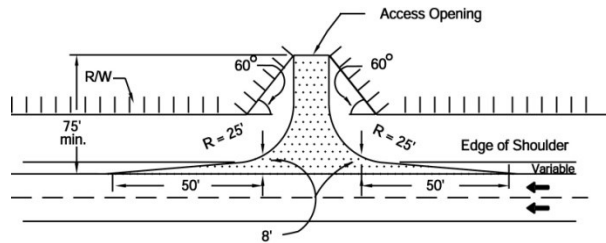

RECESSED OPENING

NOTES:

- By widening the expressway shoulder, deceleration lanes may be provided where justified.
- This detail, without the recess, may be used on conventional highways.

205.3 Urban Driveways

These instructions apply to the design of driveways to serve property abutting on State highways in cities or where urban type development is encountered.

Details for driveway construction are shown on the Standard Plans. Corner sight distance requirements are not applied to urban driveways. See Index 405.1(2) for further information.

- (1) *Correlation with Local Standards.* Where there is a local requirement regulating driveway construction, the higher standard will normally govern.
- (2) *Driveway Width.* The width of driveways for both residential and commercial usage is measured at the throat, exclusive of any flares. ("W" as shown in Standard Plan A87A).
- (3) *Residential Driveways.* The width of single residential driveways should be 12 feet minimum and 20 feet maximum. The width of a double residential driveway such as used for multiple dwellings should be 20 feet minimum and 30 feet maximum. The width selected should be based on an analysis of the anticipated volume, type and speed of traffic, location of buildings and garages, width of street, etc.
- (4) *Commercial Driveways.* Commercial driveways should be limited to the following maximum widths:
 - (a) When the driveway is used for one-way traffic, the maximum width should be 25 feet. If the driveway serves a large parcel, where large volumes of vehicles or large vehicles are expected, the entrance maximum width should be 40 feet and the exit maximum width should be 35 feet.
 - (b) When the driveway is used for two-way traffic, the maximum width should be 35 feet. If the driveway serves a large parcel, where large volumes of vehicles or large vehicles are expected, then the maximum width should be 45 feet.
 - (c) When only one driveway serves a given property, in no case should the width of the driveway including the side slope distances exceed the property frontage.
 - (d) When more than one driveway is to serve a given property, the total width of all driveways should not exceed 70 percent of the frontage where such a frontage is 100 feet or less. Where the frontage is more than 100 feet, the total driveway width

- should not exceed 60 percent of the frontage. In either case, the width of the individual driveway should not exceed those given in the preceding paragraphs. Where more than one driveway is necessary to serve any one property, not less than 20 feet of full height curb should be provided between driveways. This distance between driveways also applies to projects where curbs and gutters are not to be placed.
- (e) Certain urban commercial driveways may need to accommodate the maximum legal vehicle. The width will be determined by the use of truck turn templates.
- (5) *Surfacing.* Where curbs, gutters, and sidewalks are to be placed, driveways should be constructed of portland cement concrete. Where only curbs and gutters are to be placed and pedestrian traffic or adjacent improvements do not warrant concrete driveway construction, the driveway may be paved with the same materials used for existing surfacing on the property to be served.
- (6) *Pedestrian Access.* Where sidewalks traverse driveways, the sidewalk shall continue across the driveway to alert driveway users that they are crossing a pedestrian walkway, and must yield to pedestrians on the sidewalk. Driveway corner radii should also be minimized to encourage low-speed turns by motorized vehicles and bicycles. For accessibility requirements, see DIB 82. Provision of this feature, as indicated in the Standard Plans, may require the acquisition of a construction easement or additional right of way. Assessment of these needs must be performed early enough in the design to allow time for acquiring any necessary permits or right of way. Additionally, designers should consider the following:
- In many cases providing the pathway along the back of the driveway will lower the elevation at the back of the sidewalk. Depending on grades behind the sidewalk the potential may exist for roadway generated runoff to enter private property. The need for features such as low berms within the construction easement, or installation of catch basins upstream of the driveway should be determined.

When there are no sidewalks or other pedestrian facilities that follow the highway, the designer may develop driveway details that eliminate the flatter portion along the back edge in lieu of using the Standard Plans for driveways. Refer to Topic 105 for additional information related to pedestrian facilities.

205.4 Driveways on Frontage Roads and in Rural Areas

On frontage roads and in rural areas where the maximum legal vehicle must be accommodated, standard truck-turn templates should be used to determine driveway widths where the curb or edge of traveled way is so close to the right of way line that a usable connection cannot be provided within the standard limits.

Where county or city regulations differ from the State's, it may be desirable to follow their regulations, particularly where jurisdiction of the frontage road will ultimately be in their hands.

For corner sight distance, see Index 405.1(2)(c).

Driveways connecting to State highways shall be paved a minimum of 20 feet from the edge of shoulder or to the edge of State right of way, whichever is less to minimize or eliminate gravel from being scattered on the highway and to provide a paved surface for vehicles and bicycles to accelerate and merge. Where larger design vehicles are using the driveway (e.g., dump trucks, flat bed trucks, moving vans, etc.), extend paving so the drive wheels will be on

July 1, 2020

a paved surface when accelerating onto the roadway. For paving at crossings with Class I bikeways (Bike Paths), see Index 1003.1(6)

205.5 Financial Responsibility

Reconstructing or relocating any access openings, private road connections, or driveways required by revisions to the State highway facility should be done at State expense by the State or its agents. Reconstruction or relocation requested by others should be paid for by the requesting party.

Topic 206 – Pavement Transitions

206.1 General Transition Standards

Pavement transition and detour standards should be consistent with the section having the features built to the highest design standards. The transition should be made on a tangent section whenever possible and should avoid locations with horizontal and vertical sight distance restrictions. Whenever feasible, the entire transition should be visible to the driver of a vehicle approaching the narrower section. The design should be such that intersections at grade within the transition area are avoided. For decision sight distance at lane drops, see Index 201.7.

206.2 Pavement Widening

- (1) *Through Lane Additions.* Where through lanes, climbing lanes, or passing lanes are added, the minimum recommended distance over which to transition traffic onto the additional width is 250 feet per lane. Figure 206.2 shows several examples of acceptable methods for adding a lane in each direction to a two-lane highway.
- (2) *Turning, Ramp, and Speed Change Lanes.* Transitions for lane additions, either for left or right turns or to add a lane to a ramp, should typically occur over a length of 120 feet. Lengths shorter than 120 feet are acceptable where design speeds are below 45 miles per hour or for conditions as stated in Index 405.2(2)(c).

Where insufficient median width is available to provide for left turn lanes, through traffic will have to be shifted to the outside. See Figures 405.2A, B and C for acceptable methods of widening pavement to provide for median turn lanes.
- (3) *Lane Widening.* An increase in lane width can occur at short radius curves which are widened for truck off-tracking, at ramp terminals with large truck turning volumes, or when new construction matches existing roadways with narrow lane widths. Extensive transition lengths are not necessary as the widening does not restrict the driver's expectations. Transition tapers for these types of situations should be at 10:1 (longitudinal to lateral).
- (4) *Shoulder and Bicycle Lane Widening.* Shoulder and bicycle lane widening should normally be accomplished in a manner that provides a smooth transition.

Figure 206.2

Typical Two-lane to Four-lane Transitions

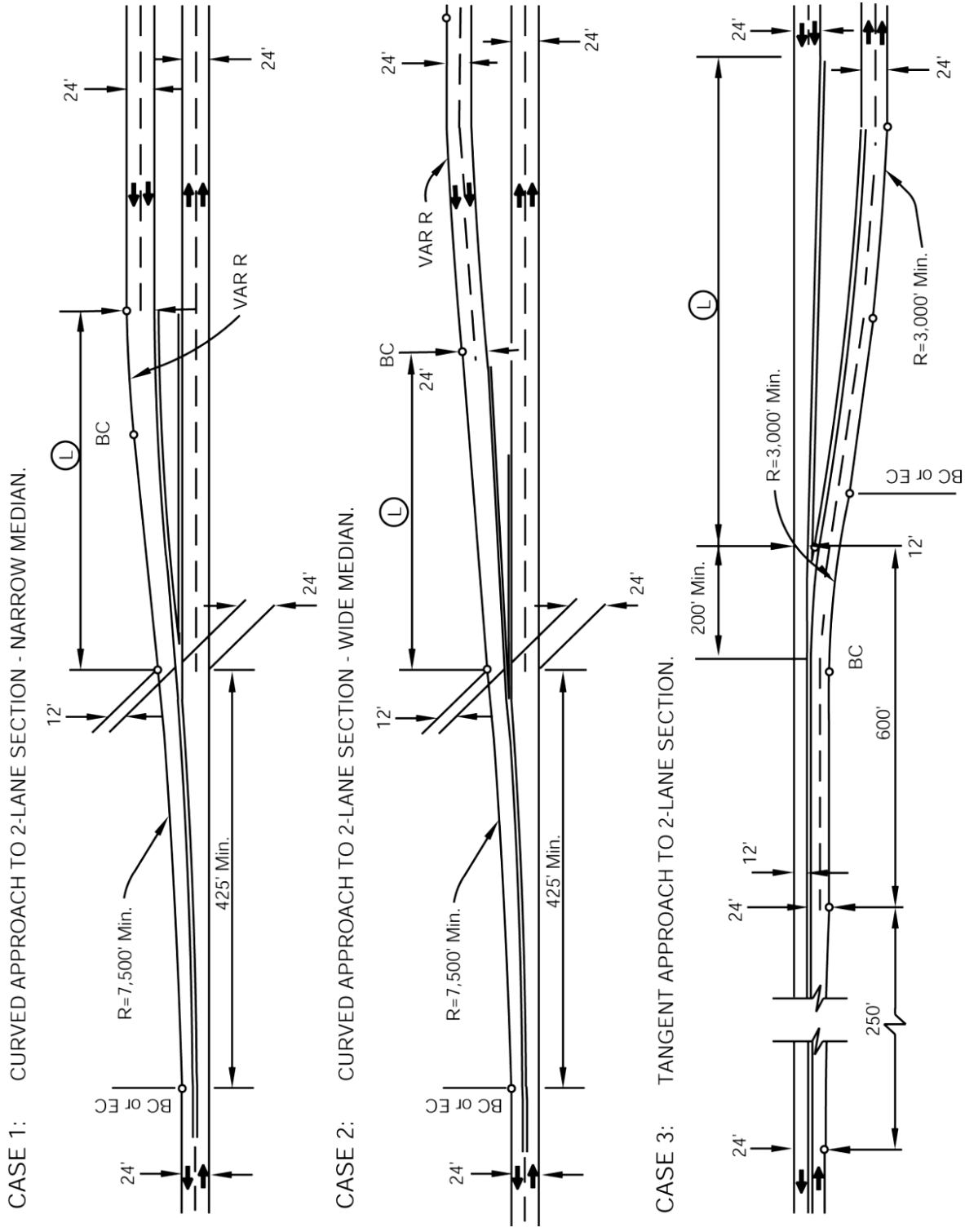

NOTE:
 See Manual of Uniform Control Devices

EQUATION
 $L = WV$
 Where L = Length of variable width traveled way - feet.
 V = Design speed in mph
 W = Lane Width - feet.

July 1, 2020

206.3 Pavement Reductions

(1) *Through Lane Drops.* When a lane is to be dropped, it should be done by tapering over a distance equal to WV , where W = Width of lane to be dropped and V = Design Speed. In general, the transition should be on the right so that traffic merges to the left. Figure 206.2 provides several examples of acceptable lane drops at 4-lane to 2-lane transitions. The exception to using the WV criteria is for the lane drop/freeway merge movement on a branch connection which is accomplished using a 50:1 taper.

(2) *Ramp and Speed Change Lanes.* As shown in Figures 504.2A and 504.3K, the standard taper for a ramp merge into a through traffic lane is 50:1 (longitudinal to lateral). Where ramp lanes are dropped prior to the merge with the through facility, the recommended taper is 50:1 for design speeds over 45 miles per hour, and the taper distance should be equal to WV for speeds below 45 miles per hour.

The "Ramp Meter Design Guidelines" also provide information on recommended and minimum tapers for ramp lane merges. These guideline values are typically used in retrofit or restricted right-of-way situations, and are acceptable for the specific conditions stated in the guidelines.

Figure 405.9 shows the standard taper to be used for dropping an acceleration lane at a signalized intersection. This taper can also be used when transitioning median acceleration lanes.

Figures 405.2A, B and C show the recommended methods of transitioning pavement back into the median area on conventional highways after the elimination of left-turn lanes.

(3) *Lane Reductions.* At any location where lane widths are being reduced, the minimum length over which to accomplish the transition should be equal to WV . See Index 504.6 for mainline lane reductions at interchanges.

(4) *Shoulder Reduction.* Shoulder reductions should typically occur over a length equal to $\frac{3}{4}WV$. However, when shoulder widths are being reduced in conjunction with a lane addition or widening (as in Alt. A of Figure 504.3J), the shoulder reduction should be accomplished over the same distance as the addition or widening.

206.4 Temporary Freeway Transitions

It is highly desirable that the design standards for a temporary transition between the end of a freeway construction unit and an existing highway should not change abruptly from the freeway standards. Temporary freeway transitions must be reviewed by the District approval authority or Project Delivery Coordinator, depending upon the current District Design Delegation Agreement.

Topic 207 – Airway-Highway Clearances

207.1 Introduction

(1) *Objects Affecting Navigable Airspace.* An object is considered an obstruction to air navigation if any portion of that object is of a height greater than the approach and transitional surfaces extending outward and upward from the airport runway. These

objects include overhead signs, light standards, moving vehicles on the highway and overcrossing structures, equipment used during construction, and plants.

- (2) *Reference.* The Federal Aviation Administration (FAA) has published Federal Aviation Regulation (FAR) Part 77 relative to airspace clearance entitled, Safe, Efficient Use, and Preservation of the Navigable Airspace, dated July 21, 2010. This is an approved reference to be used in conjunction with this manual.

207.2 Clearances

- (a) Civil Airports--See Figure 207.2A.
- (b) Heliports--See Figure 207.2B.
- (c) Military Airports--See Figure 207.2C.
- (d) Navy Carrier Landing Practice Fields--See Figure 207.2D.

207.3 Submittal of Airway-Highway Clearance Data

The following procedure must be observed in connection with airway-highway clearances in the vicinity of airports and heliports.

Notice to the FAA is required when highway construction is planned near an airport (civil or military) or a heliport. As a practical guide, the need to provide notice to the FAA should be reviewed any time construction or alteration is planned within 5 miles of an airport. A "Notice of Proposed Construction or Alteration" must be submitted to the FAA Administrator when required under criteria listed in Paragraph 77.9 of the latest Federal Aviation Regulations, Part 77. Such notice should be given as soon as highway alignment and grade are firmly established. However, at a minimum except for certain emergency situations outlined in FAR Part 77, the notice must be provided at least 45 days before the start date of the proposed construction or alteration or the date an application for a construction permit is filed, whichever is earlier. It should be noted that these requirements apply to both permanent objects and construction equipment. Electronic filing of FAA Form 7460-1, "Notice of Proposed Construction", is preferred by the FAA. This form and guidance for the submission may be found at <https://oeaaa.faa.gov/oeaaa/external/portal.jsp>.

When required, four copies of FAA Form 7460-1, and accompanying scaled maps should be sent to:

Mail Processing Center
Federal Aviation Administration
Southwest Regional Office
Obstruction Evaluation Group
10101 Hillwood Parkway
Fort Worth, TX 76177
Fax: (817) 222-5920

Copies of FAA Form 7460-1 may be obtained from the Caltrans, Division of Aeronautics or at <https://oeaaa.faa.gov/oeaaa/external/portal.jsp>.

July 1, 2020

Figure 207.2A

Airway-Highway Clearance Requirements (Civil Airports)

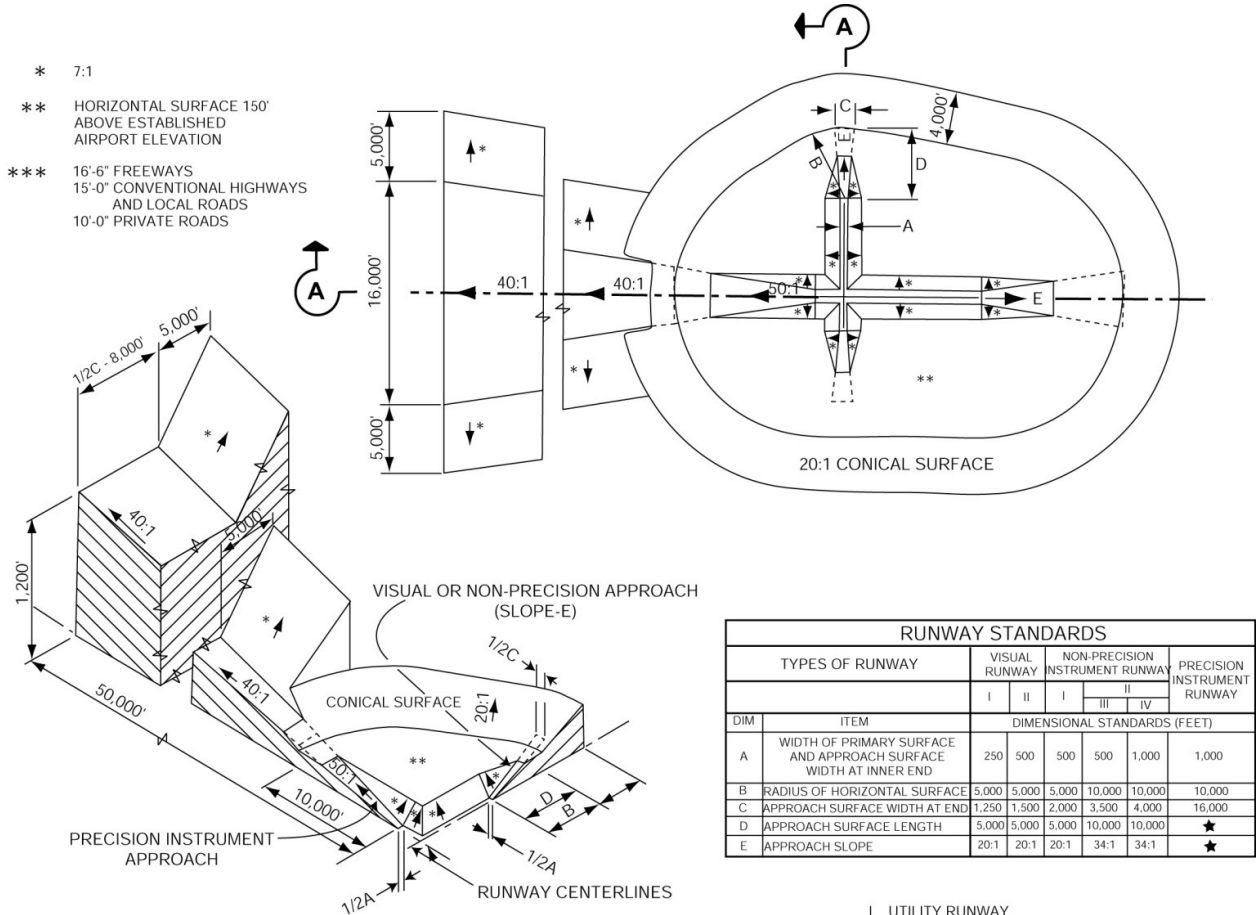

ISOMETRIC VIEW OF SECTION A-A

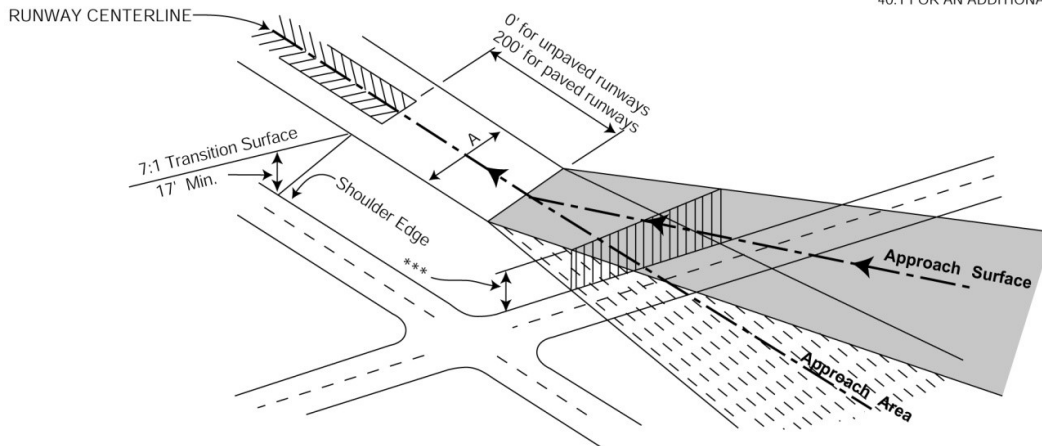

- I UTILITY RUNWAY
- II RUNWAYS LARGER THAN UTILITY
- III VISIBILITY MINIMUMS GREATER THAN 3/4 MILE
- IV VISIBILITY MINIMUMS AS LOW AS 3/4 MILE
- ★ PRECISION INSTRUMENT APPROACH SLOPE IS 50:1 FOR INNER 10,000 FEET AND 40:1 FOR AN ADDITIONAL 40,000 FEET

Figure 207.2B

Airway-Highway Clearance Requirements (Heliport)

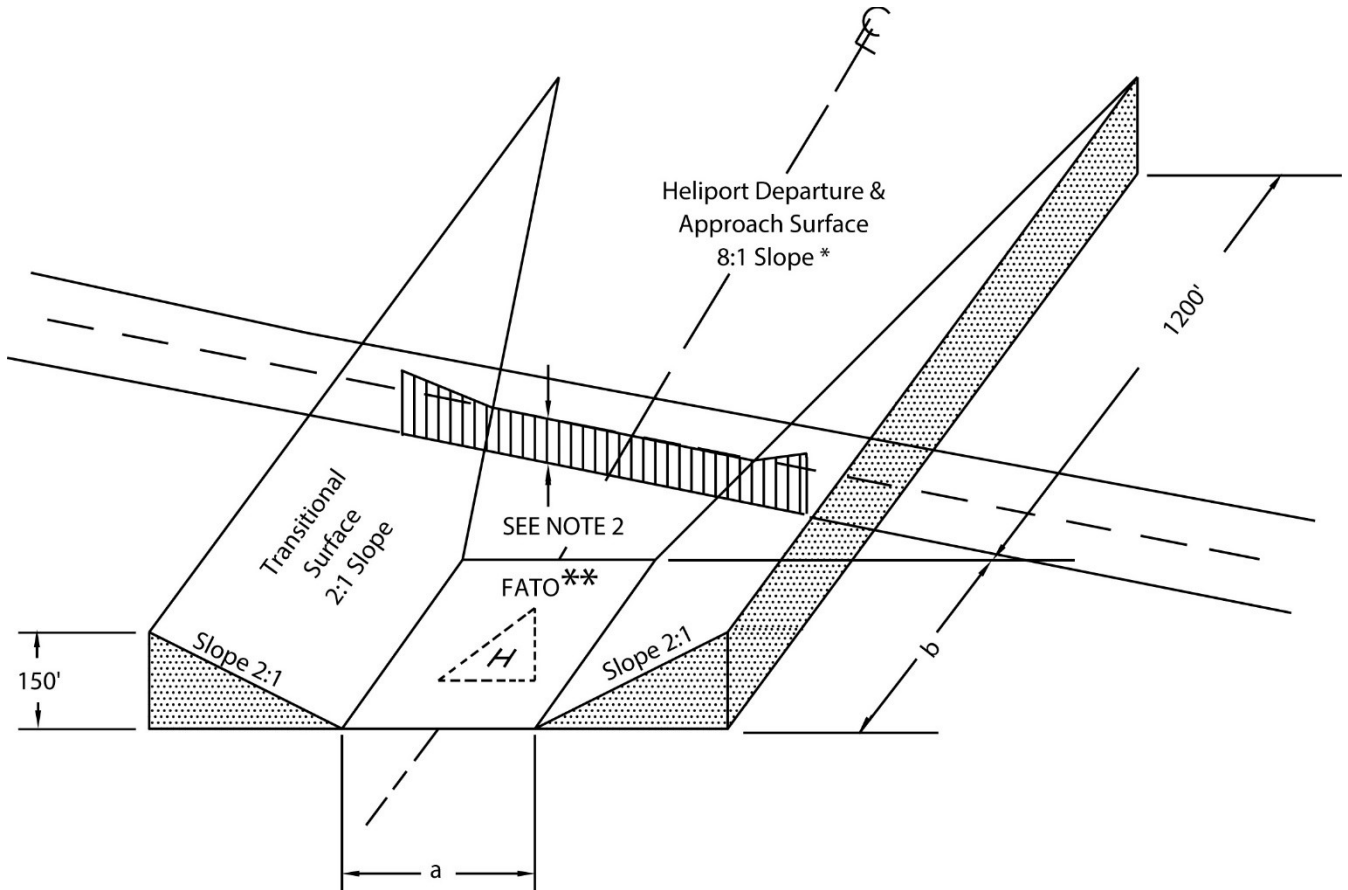

NOTES:

- (1) FATO dimensions "a" and "b" are equal to one and one-half times the overall length of the design helicopter, except for transport category heliports, where "a" equals two times the rotor diameter (100 feet Min.) and "b" equals two-times the rotor diameter (200 feet Min.). Check with heliport owner to verify helicopter category.
- (2) Minimum vertical clearance is 17'-0" for freeways and 15'-0" for conventional highways and local roads, and 10'-0" for private roads.
- (3) Contact the heliport owner/operator to determine the approved approach/departure paths.

Highway Clearance: Profile at pavement edge near airfield

*10:1 for Military Heliports

**Final Approach/Take Off Area

July 1, 2020

Figure 207.2C

Airway-Highway Clearance Requirements (Military Airports)

LEGEND

- A- PRIMARY SURFACE
- B- CLEAR ZONE SURFACE
- C- APPROACH - DEPARTURE CLEARANCE SURFACE (GLIDE ANGLE) - 50:1
- D- APPROACH - DEPARTURE CLEARANCE SURFACE (HORIZONTAL)
- E- INNER HORIZONTAL SURFACE
- F- CONICAL SURFACE - 20:1
- G- OUTER HORIZONTAL SURFACE
- H- TRANSITIONAL SURFACE - 7:1

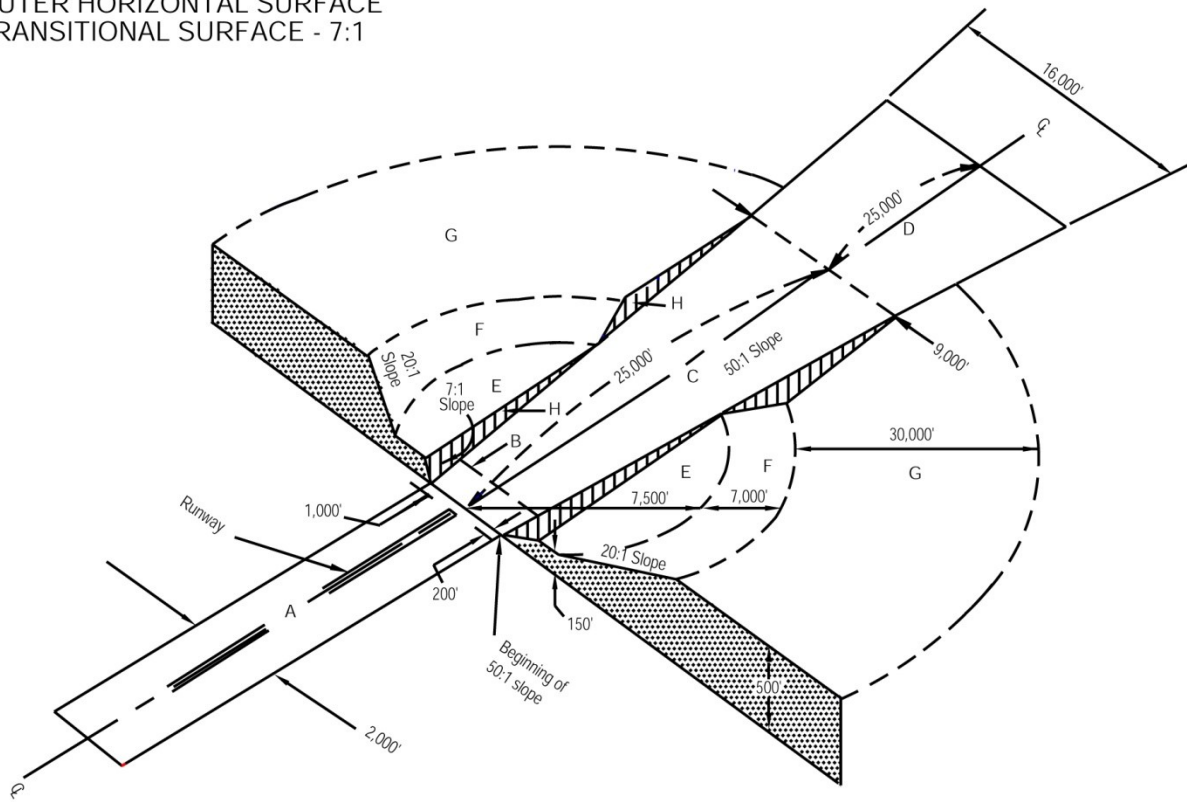

NOTE:

MINIMUM VERTICAL CLEARANCE IS 16'-6" FOR FREEWAYS, 15'-0" FOR CONVENTIONAL HIGHWAYS AND LOCAL ROADS, AND 10'-0" FOR PRIVATE ROADS.

Figure 207.2D

Airway-Highway Clearance Requirements (Navy Carrier Landing Practice Field)

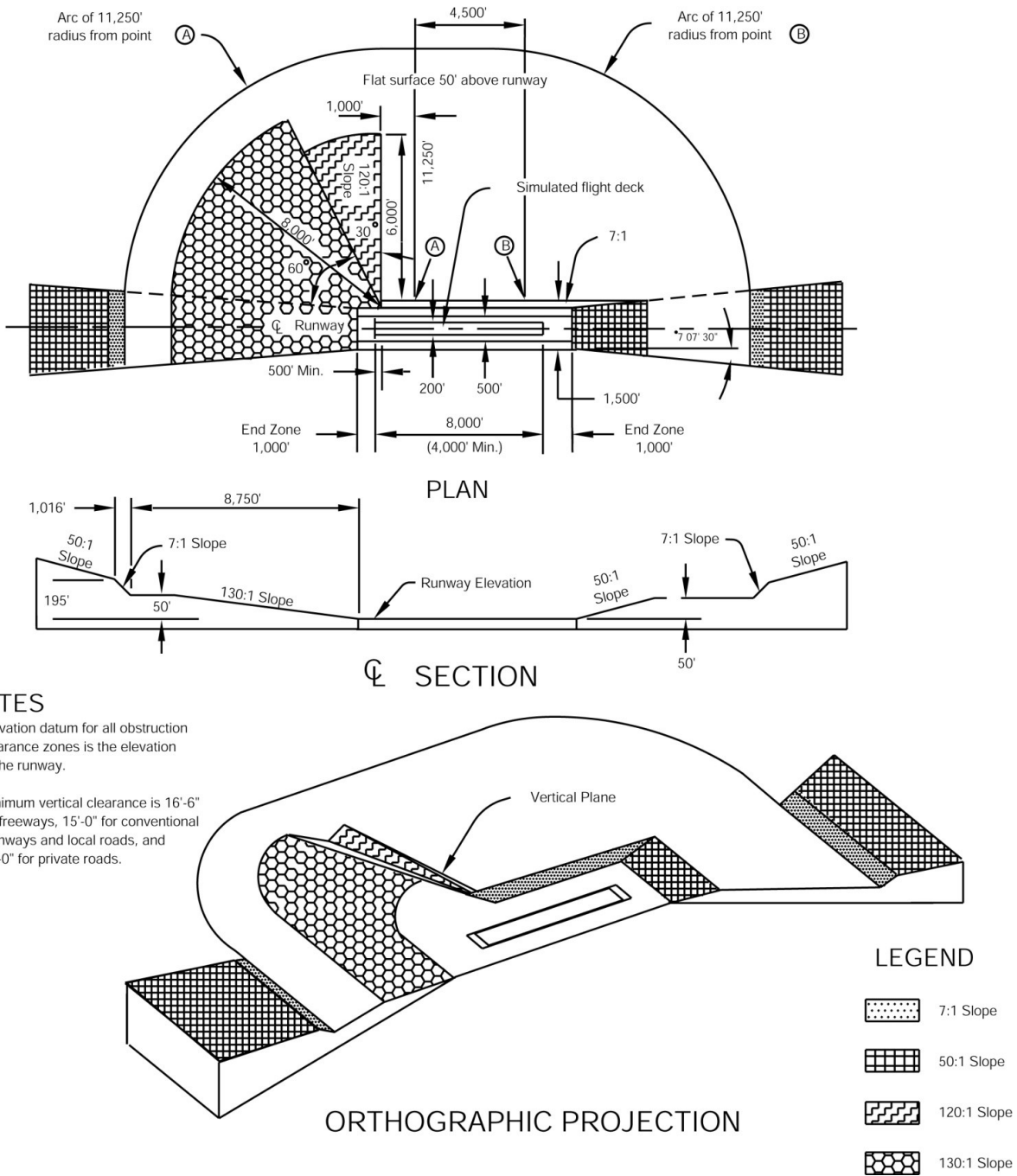

NOTES

1. Elevation datum for all obstruction clearance zones is the elevation of the runway.
2. Minimum vertical clearance is 16'-6" for freeways, 15'-0" for conventional highways and local roads, and 10'-0" for private roads.

July 1, 2020

The scaled maps accompanying FAA Form 7460-1 should contain the following minimum information.

- Distance from project to nearest runway.
- Elevation of runway thresholds.
- Relationship between the proposed highway horizontal alignment and vertical profile to the nearest runway or heliport primary surface. Include elevations of objects referenced to the elevation of the end of the runway, such as overhead lights, signs, structures, landscaping, and vehicles.

One copy of FAA Form 7460-1 should be forwarded to the Division of Design for information and one copy to the Division of Aeronautics for information and land use compatibility review.

Topic 208 – Bridges, Grade Separation Structures, and Structure Approach Embankment

208.1 Bridge Lane and Shoulder Width

(1) *State Highways.* The clear width of all bridges, including grade separation structures, shall equal the full width of the traveled way and paved shoulders on the approaches with the following exceptions:

- (a) Bridges to be constructed as replacements on existing 2-lane, 2-way roads shall not have less than a 32-foot wide roadbed for ADT less than 400, and not less than 40-foot wide roadbed for ADT greater than 400. (see Index 307.2).
- (b) When the approach shoulder width is less than 4 feet, the minimum offset on each side shall be 4 feet, and shall be documented in accordance with Index 82.2.

The width should be measured normal to the center line between faces of curb or railing measured at the gutter line. For offsets to safety shape barriers see Figure 208.1.

For horizontal and vertical clearances, see Topic 309.

(2) *Roads Under Other Jurisdictions.*

- (a) Overcrossing Widths – (See Index 308.1)
- (b) Undercrossing Span Lengths – Initial construction should provide for the ultimate requirements. In areas where the local jurisdiction has a definite plan of development, the ultimate right of way width or at least that portion needed for the roadbed and sidewalks should be spanned.

If the undercrossing street or road has no median, one should be provided where necessary to accommodate left-turn lanes or the center piers of the undercrossing structure.

Where it appears that a 2-lane road will be adequate for the foreseeable future, but no right of way width has been established, a minimum span length sufficient for a 40-foot roadbed should be provided. Additional span length should be provided to permit future sidewalks where there is a foreseeable need. If it is reasonably foreseeable that more than two lanes will be required ultimately, a greater width should be spanned.

- (c) For horizontal and vertical clearances, see Topic 309.

Figure 208.1

Offsets to Safety-Shape Barriers

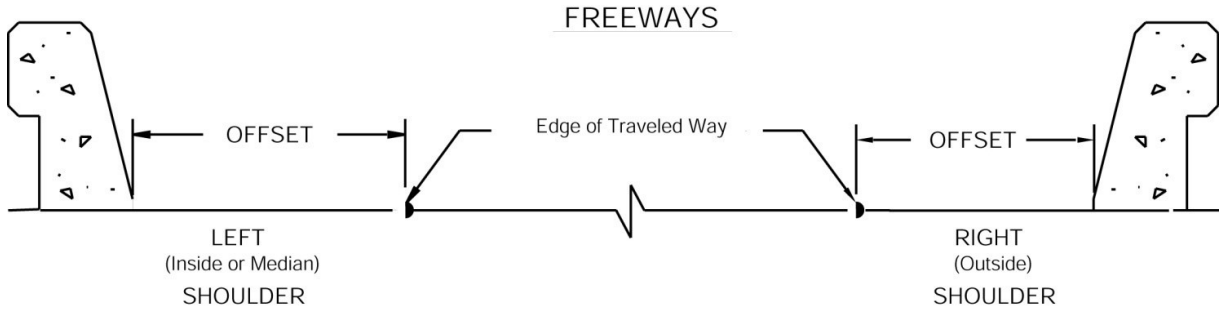

Approach Shoulder Width	Left Shoulder	Right Shoulder
* 2' & 4' (Ramps)	4'	4'
5'	5'	5'
8'	8'	8'
10'	10'	10'

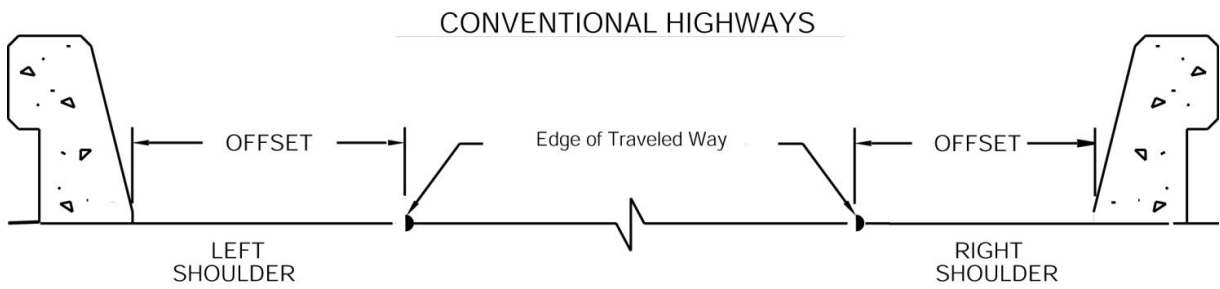

Approach Shoulder Width	Left Shoulder	Right Shoulder
* 2' & 4'	4'	4'
8'	8'	8'

* See Index 208.1(1)(b)

July 1, 2020

208.2 Cross Slope

The crown is normally centered on the bridge except for one-way bridges where a straight cross slope in one direction should be used. The cross slope should be the same as for the approach pavement (see Index 301.3 and Index 203.9).

208.3 Median

On multilane divided highways a bridge median that is 36 feet wide or less should be decked. Exceptions require individual analysis. See Traffic Safety Systems Guidance for median barrier warrants.

208.4 Bridge Sidewalks

Sidewalks on bridges should be provided wherever there are sidewalks or other pedestrian facilities that follow the highway. **The minimum width of a bridge sidewalk shall be 6 feet.** The recommended width should be 8 feet for pedestrian comfort. Bridges sidewalks in area types (see Index 81.2) with high levels of pedestrian activity may need to be greater than 8 feet (see Figure 208.10B).

208.5 Open End Structures

Embankment end slopes at open end structures should be no steeper than 1½:1 for all highways.

208.6 Bicycle and Pedestrian Overcrossings and Undercrossings

A bicycle overcrossing (BOC) or undercrossing (BUC) is a facility that provides a connection between bikeways or roads open to bicycling. They are considered Class I bikeways, or in certain situations may be considered Class IV bikeways. See Index 1003.1 for Class I bikeway guidance or DIB 89 for Class IV bikeways (separated bikeways) guidance.

A pedestrian overcrossing (POC) or undercrossing (PUC) is a facility that provides a connection between pedestrian walkways.

The minimum width of walkway for pedestrian overcrossing should be 8 feet. The minimum vertical clearance of a pedestrian undercrossing should be 10 feet. Skewed crossings should be avoided.

Class I bikeways are designed for the exclusive use of bicyclists and pedestrians; equestrian access is prohibited. See Chapter 1000 for Class I bikeway design guidance and Index 208.7 for equestrian undercrossing guidance. For additional information about the need to separate bicyclists from equestrian trails, see Index 1003.4.

POC's and PUC's must be designed to comply with DIB 82.

See Topic 309 for vertical clearances.

208.7 Equestrian Undercrossings and Overcrossings

Such structures should normally provide a clear opening 10 feet high and 10 feet wide. Skewed crossings should be avoided. The structure should be straight so the entire length can be seen from each end. Sustained grades should be a maximum of 10 percent. Decomposed granite or similar material should be used for the trail surface. While flexible pavement is permissible, a rigid pavement should not be used. See Index 1003.4 for separation between bicycle paths and equestrian trails. See DIB 82 for when trails are open to pedestrians.

Design guidance for equestrian overcrossings is pending.

208.8 Cattle Passes, Equipment, and Deer Crossings

Private cattle passes and equipment crossings may be constructed when economically justified by a right of way appraisal, as outlined in Section 7.09.09.00 of the Right of Way Manual.

The standard cattle pass should consist of either a standard box culvert with an opening 8 feet wide and 8 feet high or a metal pipe 120 inches in diameter. The invert of metal pipe should be paved with concrete or bituminous paving material.

If equestrian traffic is expected to use the culvert a minimum 10 feet wide by 10 feet high structure may be provided. However, the user of the facility should be contacted to determine the specific requirements.

If conditions indicate a reasonable need for a larger than standard cattle pass, it may be provided if economically justified by the right of way appraisal.

In some cases the installation of equipment or deer crossings is justified on the basis of public interest or need rather than economics. Examples are:

- (a) A deer crossing or other structure for environmental protection purposes.
- (b) Equipment crossings for the Forest Service or other governmental agencies or as a right of way obligation.

These facilities should be installed where necessary as determined by consultation with the appropriate affected entities.

A clear line of sight should be provided through the structure.

208.9 Railroad Underpasses and Overheads

Generally, it is desirable to construct overheads rather than underpasses whenever it is necessary for a highway and railroad to cross. Railroads should be carried over highways only when there is no other reasonable alternative.

Some undesirable features of underpasses are:

- (a) They create bottlenecks for railroad operations.
- (b) It is difficult to widen the highway.
- (c) Pumping plants are often required to drain the highway.

July 1, 2020

- (d) They are likely to lead to cost participation controversies for initial and future construction.
- (e) Shooflies (temporary tracks) are generally required during construction.
- (f) Railroads are concerned about the structure maintenance and liability costs they incur.

Advantages of overheads are:

- (a) Railroads can use most of their right of way for maintenance.
- (b) Overheads can be widened at a relatively low cost and with little difficulty.
- (c) Less damage may be incurred in the event of a derailment.
- (d) Agreements for design and maintenance can be reached more easily with railroads.
- (e) Initial costs are generally lower.

The State, the railroads, and the public in general can usually benefit from the construction of an overhead structure rather than an underpass. See Topic 309 for vertical clearances.

208.10 Bridge Barriers and Railings

- (1) *General.* There are four classes of railings, each intended to perform a different function.
 - (a) Vehicular Barrier Railings –The primary function of these railings is to retain and redirect errant vehicles.
 - (b) Combination Vehicular Barrier and Pedestrian Railings –These railings perform the dual function of retaining both vehicles and pedestrians on the bridge. They consist of two parts: A concrete parapet barrier, generally with a sidewalk, and metal handrailing or fence-type railing.
 - (c) Pedestrian Railings –These railings prevent pedestrians from accidentally falling from the structure and, in the case of fence-type railing, reduce the risk of objects being dropped on the roadway below. See DIB 82 for additional requirements.
 - (d) Bicycle Railings –These railings retain bicycles and riders on the structure. They may be specifically designed for bicycles, or may be a combination type consisting of a vehicular barrier surmounted by a fence or metal handrail.

- (2) *Policies.* To reduce the risk of objects being dropped or thrown upon vehicles, protective screening in the form of fence-type railings should be installed along new overcrossing structure sidewalks in urban areas (Sec. 92.6 California Streets and Highways Code). Screening should be considered for the opposite side of structures having one sidewalk. Screening should be installed at such other locations determined to be appropriate.

Railings and barriers with sidewalks should not be used on structures with posted speeds greater than 45 miles per hour without barrier separation. All structure railings with a sidewalk in the Standard Plans are approved for posted speeds up to 45 miles per hour. **Any use of railings and barriers with sidewalks on structures with posted speeds greater than 45 miles per hour shall have a barrier separation between the roadway and the sidewalk.** The barrier separation type and the bridge rail selection requires approval by the District Traffic Engineer or designee.

The approved types of railings for use on bridge structures are listed below and illustrated in Figures 208.10A, B, and C. Railing types not listed are no longer in general use; however, they may be specified in those cases where it is desirable to match an existing condition.

Figure 208.10A

Vehicular Railings for Bridge Structures

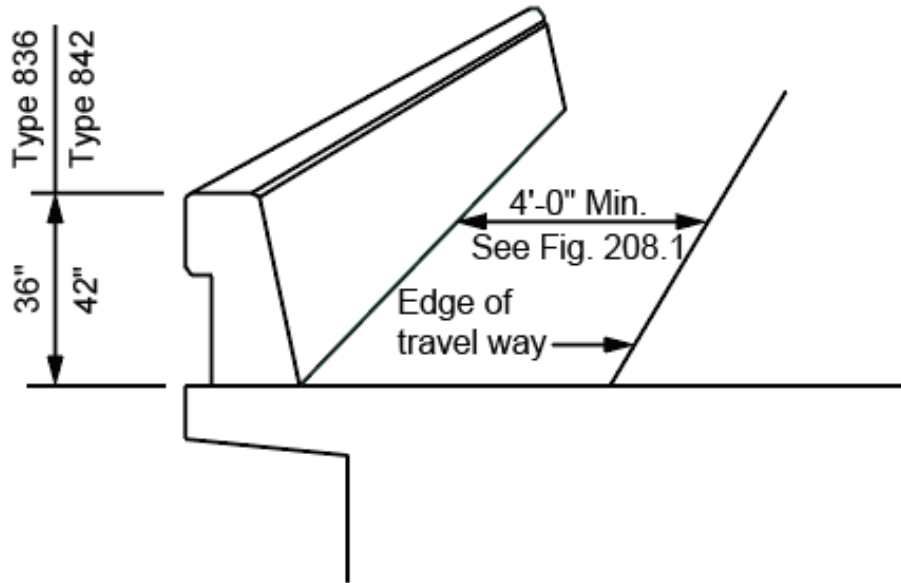

CONCRETE BARRIERS TYPE 836 AND TYPE 842
(MASH 2016 Compliant)

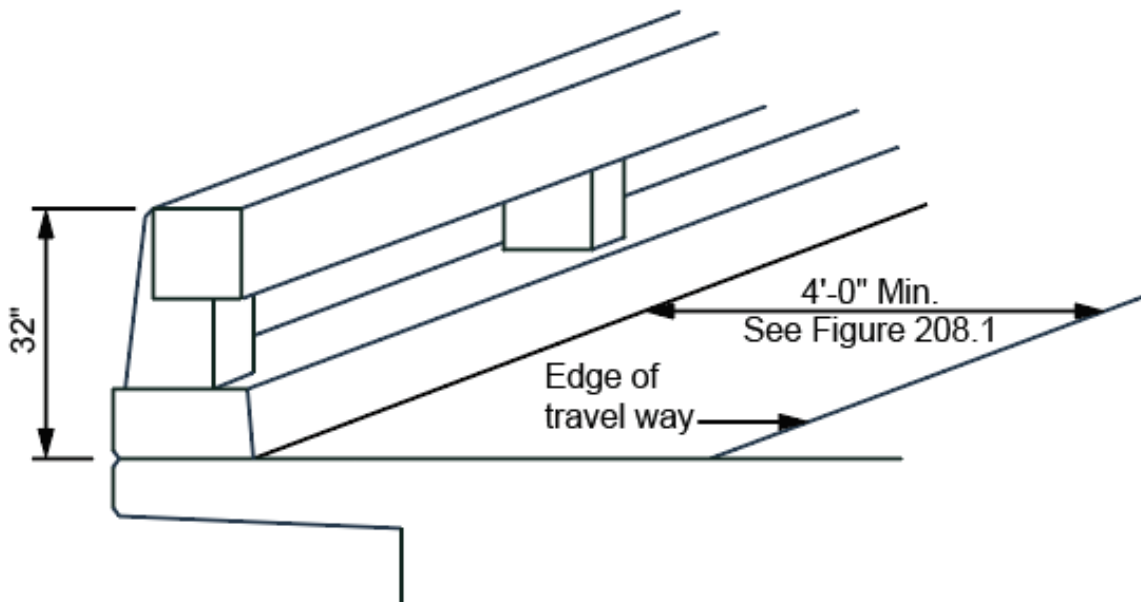

CONCRETE BARRIER TYPE 80
(NCHRP Report 350 Compliant)

July 1, 2020

Figure 208.10B

Combination Vehicular Barrier and Pedestrian Railings for Bridge Structures

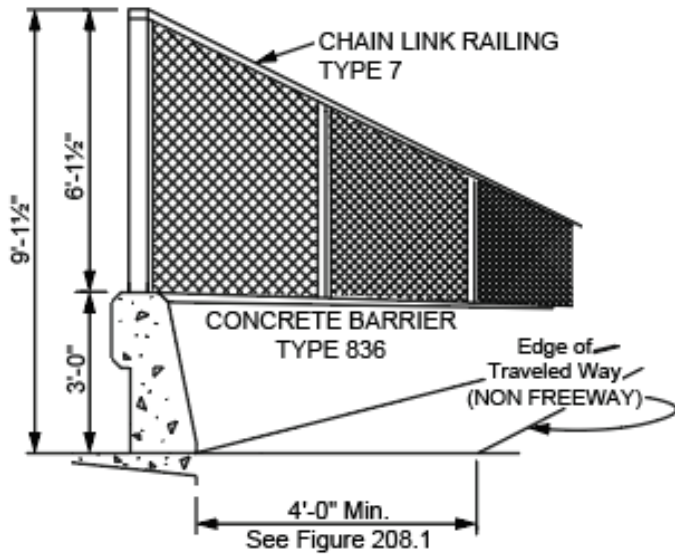

TYPE 836 WITH TYPE 7

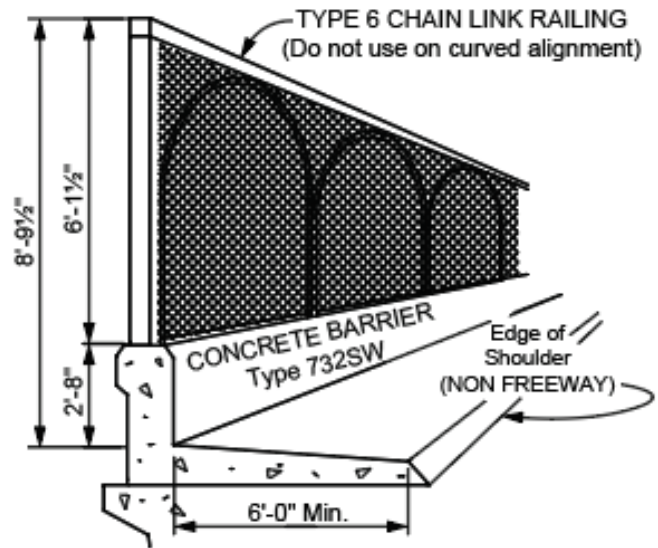

TYPE 732SW WITH TYPE 6

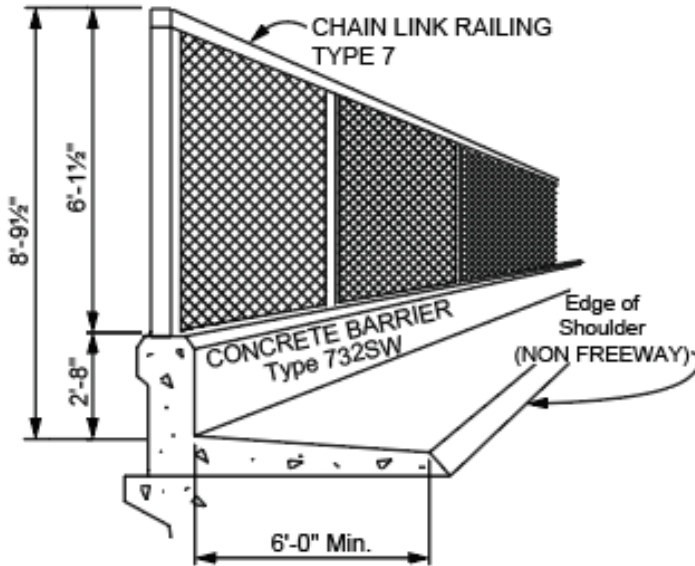

TYPE 732SW WITH TYPE 7

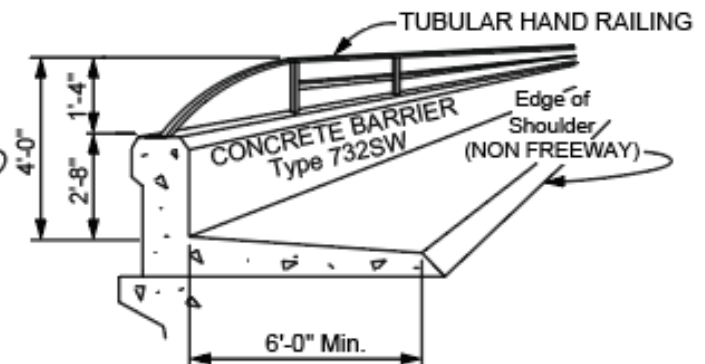

TYPE 732SW WITH TUBULAR HAND RAILING

Figure 208.10C

Pedestrian Railings for Bridge Structures

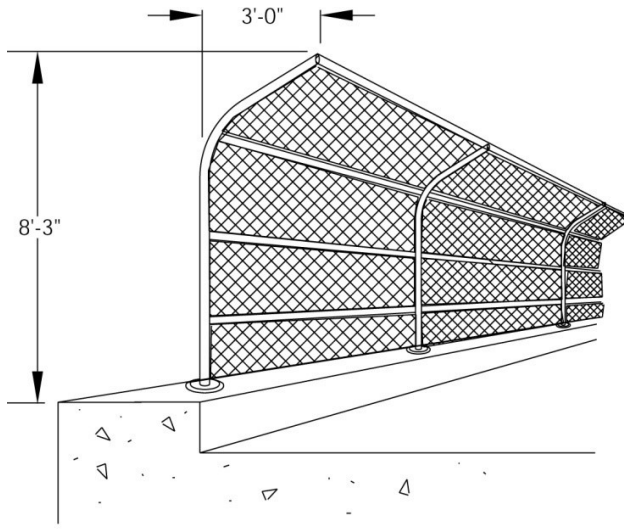

CHAIN LINK RAILING TYPE 3

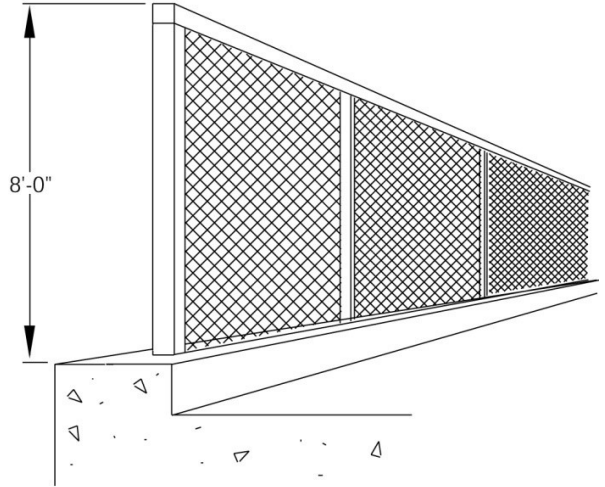

CHAIN LINK RAILING TYPE 7 (MODIFIED)

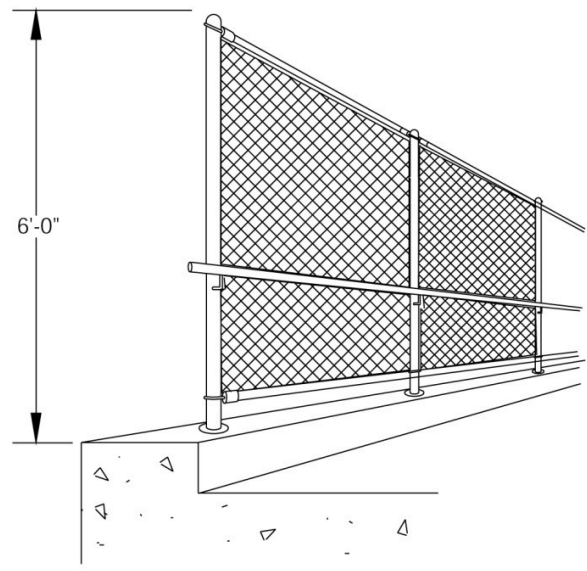

CHAIN LINK RAILING

CHAIN LINK RAILING

July 1, 2020

The District should specify in the bridge site data submittal the rail type to be used after consideration has been given to the recommendations of the local agency (where applicable) and the DES-SD.

Barriers and railings are denoted by crash testing criteria and crash test level (TL). For more information on the crash test level, see the Traffic Safety Systems Guidance, Table 1, issued by the Division of Traffic Operations.

(3) *Vehicular Barriers*. See Figure 208.10A.

- (a) Concrete Barrier Type 836 and 842 are TL-4 systems and satisfy the Manual for Assessing Safety Hardware (MASH 2016) – These vehicular barriers are for general use adjacent to traffic. Figure 208.1 illustrates the position of the barrier relative to the edge of traveled way.
- (b) Concrete Barrier Type 80 and bridge metal rail barriers – Use of these barriers is intended in scenic areas where more see-through area is desired than is provided by a solid concrete parapet. These TL-4 barriers satisfy NCHRP Report 350.
- (c) California ST-70SM Side Mounted Bridge Rail – This TL-4 steel barrier is 42 inches in height. This vehicular barrier is for general use adjacent to traffic. This barrier is especially useful when there are right-of-way issues or space limitations. This barrier satisfies MASH 2016.
- (d) California ST-75 Bridge Rail – This TL-4 steel barrier is 36 inches in vehicular railing height and 42 inches in bicycle railing height. This combination vehicular barrier is for general use adjacent to traffic. This barrier replaces NCHRP Report 350 compliant California ST-70 or California ST-20S Bridge Rails. This barrier satisfies MASH 2016.
- (e) Concrete Barrier Type 85 – This TL-4 concrete barrier is 36 inches in vehicular railing height and 42 inches in bicycle railing height. This combination vehicular barrier is for general use adjacent to traffic. This barrier replaces NCHRP Report 350 compliant Concrete Barrier Type 80.

(4) *Combination Railings*. See Figure 208.10B.

- (a) Concrete Barrier Type 732SW – This is TL-2 bridge railing for general use when sidewalks are provided on a bridge. It must be accompanied with a tubular handrailing or a fence-type railing. See Index 208.4 for minimum width, however, this width may be varied as circumstances require. This barrier satisfies MASH 2016.
- (b) Concrete Barrier Type 80SW – Similar to the Concrete Barrier Type 80, modified with a raised integral sidewalk and tubular handrailing. This TL-2 barrier is intended for use in lower speed scenic areas where more see-through area is desired than is provided by a solid concrete parapet. See Index 208.4 for minimum width, however, this width may be varied as circumstances require. This barrier satisfies NCHRP Report 350.
- (c) Aesthetic Low Maintenance Guardrail System – This TL-3 system is a combination railing (without integral sidewalk) of an aesthetic see-through bridge railing on a trench footing as an aesthetic low maintenance alternative to guardrail.
- (d) Chain Link Railing Type 7 – This is the fence-type railing for general use with Type 732SW or Type 80SW barrier railing with sidewalk to reduce the risk of objects being dropped off the edge of a structure. When a sidewalk is provided on one side of a bridge and Type 736 barrier railing on the other side, Type 7 railing may be placed on top of the Type 736 as additional protection from dropped objects. Consideration should be given to the effect of the Type 7 railing on sight distance at the bridge ends

- and view over the side of the bridge. Lighting fixtures may be provided with Type 7 railings.
- (e) Chain Link Railing Type 6 – This railing may be used in lieu of Type 7 when special architectural treatment is required. It should not be used on curved alignment because of fabrication difficulties.
 - (f) Tubular Handrailing – This railing is used with Type 732SW, and Type 80SW to increase the combined rail height for the safety of pedestrians. It should be used in lieu of Type 7 where object dropping will not be a problem or at the ends of bridges to increase sight distance if fence-type railing would restrict sight distance.
- (5) *Pedestrian Railings.* See Figure 208.10C
- (a) Chain Link Railing Type 3 – This railing is used on pedestrian structures to reduce the risk of objects being dropped on the roadway below.
 - (b) Chain Link Railing Type 7 (Modified) – This railing is similar to Type 7 except that it is mounted on the structure at the sidewalk level.
 - (c) Chain Link Railing – This railing is not as high as Types 3 or 7 and therefore, its use is restricted to those locations where object dropping or throwing will not be a problem.
 - (d) Chain Link Railing (Modification) – Existing railing may be modified for screening under the protective screening policy. The DES-SD should be contacted for details.
- (6) *Bicycle Railing.* The height of bicycle rail shall not be less than 42.0 inches, measured from the top of the riding surface. In some cases the bicycle railing shall be offset 15.0 inches behind the face of the vehicular rail. Contact DES, Office of Design and Technical Services for more information. Pedestrian railings and combination railings consisting of a concrete barrier surmounted by a fence or tubular railing are satisfactory for bicycles, if a minimum 42-inch height is met. Bicycles are not considered to operate on a sidewalk, except in special cases where signs specifically direct cyclists to use a bike path or the sidewalk.
- As a general policy, bicycle railings should be installed at the following locations:
- (a) On a Class I bikeway, except that a lower rail may be used if a curbed sidewalk, not signed for bicycle use, separates the bikeway from the rail or a shoulder at least 8 feet wide exists on the other side of the rail.
 - (b) On the outside of a Class II or III bikeway, unless a curbed sidewalk, not signed for bicycle use, separates the bikeway from the rail.
 - (c) In other locations where the designer deems it reasonable and appropriate.
- (7) *Bridge Approach Railings.* **Approach railings shall be installed at the ends of bridge railings exposed to approach traffic.**

Refer to Traffic Safety Systems Guidance for placement and design criteria of guardrail.

208.11 Structure Approach Embankment

- (1) *General.* Structure approach embankment is that portion of the fill material within approximately 150 feet longitudinally of the structure. Refer to Figure 208.11A for limits, the Standard Specifications, and Standard Special Provisions for more information.
- Quality requirements for embankment material are normally specified only in the case of imported borrow. When select material or local borrow for use in structure abutment embankments is shown on the plans, the Resident Engineer (RE) is responsible for assuring the adequacy of the quantity and quality of the specified material. The Project

July 1, 2020

Engineer should include adequate information and guidance in the RE File to assist the RE in fulfilling this responsibility.

- (2) *Foundations and Embankment Design.* Overall performance of the highway approach to the bridge depends, to a significant degree, upon the long-term settlement/consolidation of the approach foundation and structure abutment embankment. A design that minimizes this post construction settlement/consolidation is essential. Factors that influence settlement/consolidation include soil types and depths, static and dynamic loads, ground water level, adjacent operations, and changes in any of the above. The PE must follow the foundation and embankment recommendations by the Division of Engineering Services, Geotechnical Services (DES-GS) and District Materials Engineer (DME). The DME and/or DES-GS must approve any deviations from their recommendations including Construction Change Orders (CCO's).

The relative compaction of material within the embankment limits must be at least 95 percent, except for the outer 5 feet of embankment measured horizontally from the side slope (see Figure 208.11A). The DME and/or OSF may recommend using select material, local and/or imported borrow to assure that the compaction requirements are met and that shrink/swell problems are avoided. They may also recommend a height and duration of embankment surcharge to accelerate foundation consolidation.

Poor quality material, such as expansive soils, must be precluded from structure abutment embankments unless treated. If sufficient quality roadway excavation material is unavailable for constructing of structure abutment embankments, the designer may specify select material, local borrow, or imported borrow to satisfy the design requirements.

- (3) *Abutment Drainage.* Special attention must be given to providing a positive drainage system that minimizes the potential for water damage to the structure approach embankment, see Chapter 870 for further details. The Division of Engineering Services (DES), Structures Design (DES-SD) is responsible for the design of the structure approach drainage system, which includes:
- A geocomposite drain covered with filter fabric placed behind both the abutment wall and wingwalls, as indicated in Figure 208.11B.
 - A slotted plastic pipe drain, encapsulated with treated permeable material, placed along the base of the inside face of the abutment wall as illustrated in Figure 208.11B.

- (4) *Slope Treatment.* See Topic 707, Slope Treatment Under Structures, for guidance regarding the treatment of bridge approach end slopes.

The District Hydraulic Engineer or Project Engineer must design a pipe outlet that ties into the structure approach drainage system as it exits the structure. A pipe outlet system should carry the collected water to a location where it will not cause erosion. Storm Water Best Management Practices should be incorporated. For further information on Storm Water Management, visit the Division of Design Storm Water website.

Coordination with DES is necessary for the exit location of the pipe system. The outlet type should be chosen from the standard edge drain outlet types shown in the Standard Plans or tied into an underground drainage system. The PE must review the drainage design to ensure the adequacy of the drainage ties between the structure approach drainage system and either new or existing drainage facilities. For alternative details, see Bridge Design Aids.

Figure 208.11A

Limits of Structure Approach Embankment Material

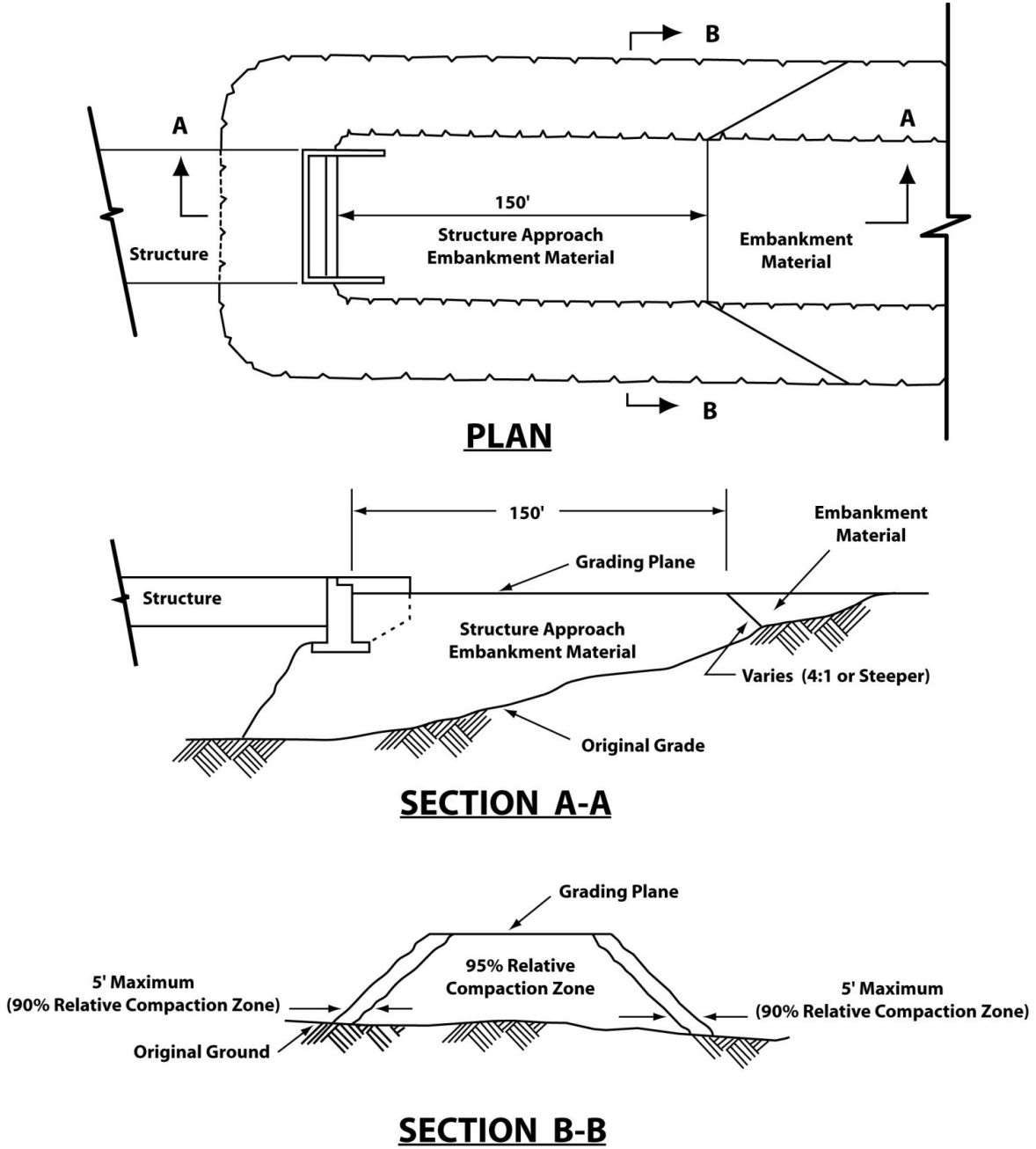

July 1, 2020

Figure 208.11B

Abutment Drainage Details

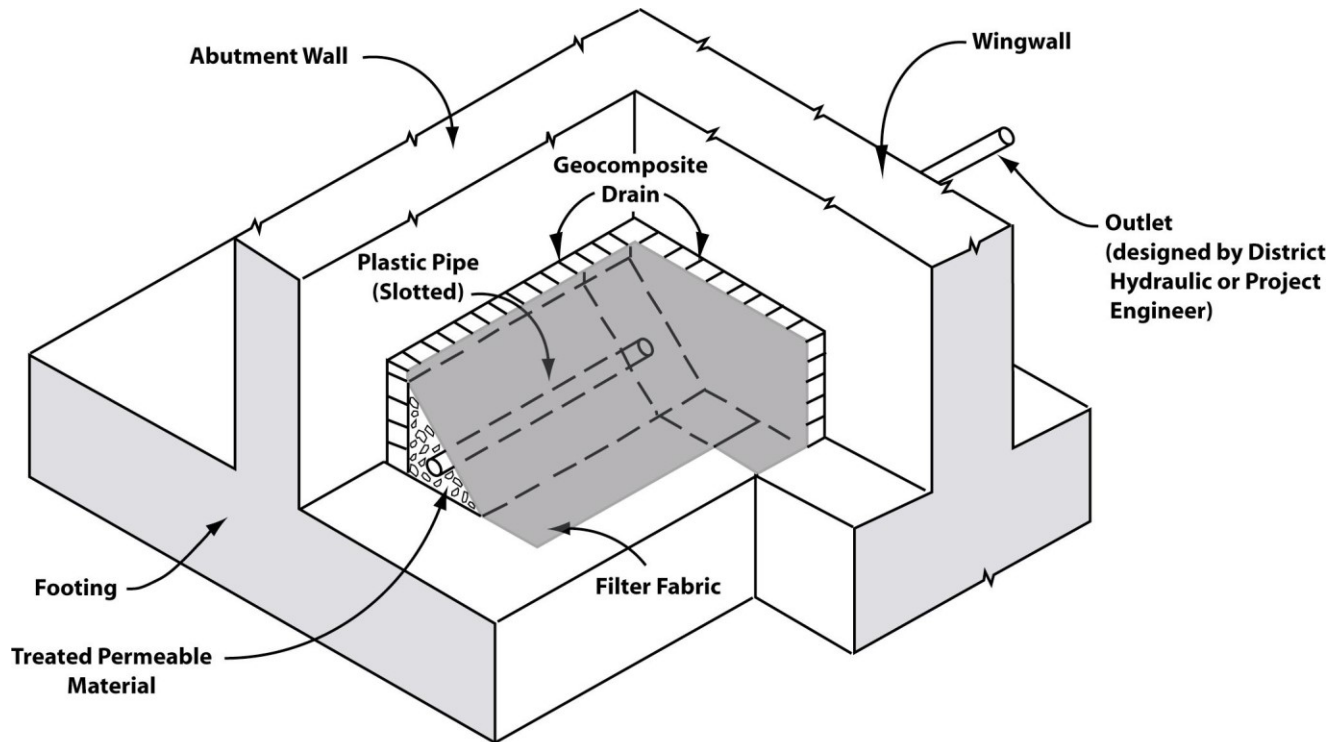
**NOTES:**

1. Applicable to new construction only.
2. Reference Structures Design Standard Detail XS22-17
3. All details shown are designed by the DES except where noted otherwise.
4. Outlet may be in wingwall of abutment wall.

Topic 209 – Structure Approach Slabs

209.1 Purpose and Application

- (1) *Purpose.* The approaches to any structure, new or existing, often present unique geometric, drainage, pavement, and traffic situations that require special considerations.

Structure approach slabs provide a smooth transition between a pavement that is generally supported on a yielding medium (soil that is subject to consolidation and settlement) and a structure, which is supported on a relatively unyielding foundation (bridge).

These guidelines should be followed in the engineering of all structure approach slab projects involving new construction, reconstruction, widening, preservation, or rehabilitation of structure approaches. They are not, however, a substitute for engineering knowledge, experience, or sound judgment.

- (2) *Application.* There are several alternatives that may be considered in the design of a structure approach slab system. These alternatives are designated as Types 45, 30, and 10 structure approach slab systems. Standard details and special provisions for each type of approach slab system can be found on the Structure Design website. Figure 209.1 shows a generic structure approach slab system layout. Structure Design Bridge Memo 5-3 provides the criteria for the selection and design of structure approach slabs. In the event of discrepancies between this manual and Structure Design Bridge Memo 5-3, Memo 5-3 shall govern.

Structure approach slabs extend the full width of the traveled way and shoulders. The Division of Engineering Services (DES) will select the appropriate structure approach slab and provide applicable details, specifications, and an estimate of cost for inclusion in the Plans Specifications and Estimates (PS&E) package. The Project Engineer (PE) must coordinate with structure engineer to assure that the proper structure approach slab is included in the PS&E package.

On new construction projects, overcrossing structures constructed in conjunction with the State highway facility should receive the same considerations as the highway mainline.

209.2 General Considerations

- (1) *Field Investigations.* Adequate information must be available early in the project development process if all factors affecting the selection and engineering of a structure approach slab system are to be adequately addressed. A field review will often reveal existing conditions, which must be taken into consideration during the design.
- (2) *Load Transfer at Approach Slab/Concrete Pavement Joint.* No matter what structure approach slab alternative is being considered, it is recommended that dowel bars be placed at the transverse joint between the structure approach slab and new rigid pavement to ensure load transfer at the joint. If the structure approach slab is being replaced but the adjacent rigid pavement is not, a dowel bar retrofit is not necessary. The thinner of either the pavement or the structure approach slab will govern placement of the dowel bar at half the thickness of the thinner slab. The standard plans provide other details for transitions from the structure approach slabs to flexible pavement.

July 1, 2020

Figure 209.1

Structure Approach Slab Layout

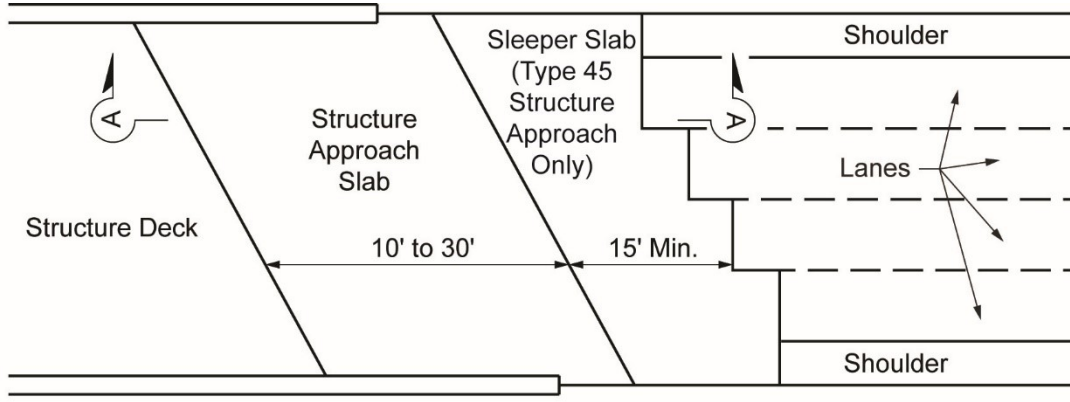

PLAN VIEW

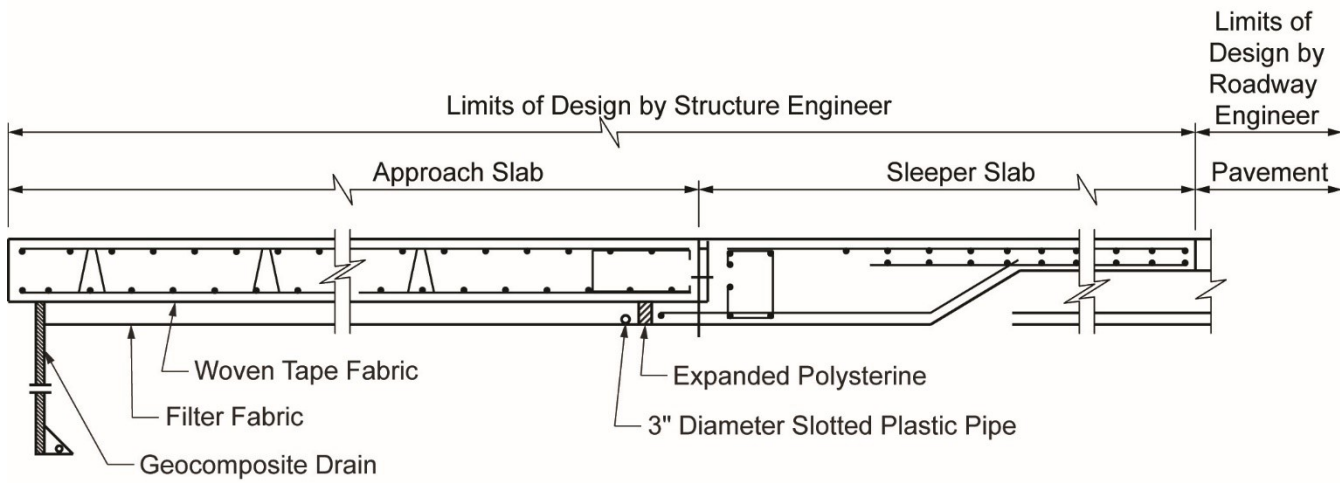

SECTION A-A

- (3) *Barriers*. On new construction, the structure approach slab extends laterally to coincide with the edge of structure. Any concrete barriers next to the structure approach slab will therefore need to be placed on top of the structure approach slab and part of the responsibilities of the structures engineer. The PE should coordinate with structure engineers to coordinate the limits and responsibility for barriers.
- (4) *Guardrails*. The extension of the structure approach and sleeper slabs across the full width of the outside shoulder creates a conflict between the outside edge of these slabs and the standard horizontal positioning of some guardrail posts. Consult with district traffic branch if a conflict is encountered. See DES Standard Details and the Standard Plans.

209.3 Structural Approach System Drainage

- (1) *Subsurface Drainage*. Figure 209.1 shows the components of the positive structural drainage system. Filter fabric should be placed on the grading plane to minimize contamination of the treated permeable base (TPB) for all types of structure approach systems. The plastic pipe shall have a proper outlet to avoid erosion of the structure approach embankment. On all new construction projects, regardless of the system, which normally drain through the wingwall. The highway engineer is responsible for engineering the collection and disposal system, which begins on the outside face of the wingwall.

Surface Drainage. Roadway surface drainage should be intercepted before reaching the approach/sleeper slab. The objective is to keep water away from the structure approach embankment. The surface water, once collected, should be discharged at locations where it will not create erosion. Refer to Chapter 831 for more information.

209.4 Structure Approach Slab Rehabilitation Considerations

- (1) *Approach Slab Replacement*. Approach slabs are replaced only when they exhibit sufficient cracking or patching that they are no longer maintainable as is. Structure Maintenance and Investigations (SMI) typically determines when an approach slab warrants replacement. Approach slabs that otherwise experience only rough ride, subsidence, or minor damage are ground, overlaid, or patched as recommended by SMI. Approach slab repairs are typically funded from one of the bridge repair programs in the SHOPP, but can also be funded from another fund program with the agreement of the Headquarters Program Manager for that program when no other bridge work is involved.

Replacement of a structural approach slabs consists of removing the existing pavement, approach slab, underlying base and subsealing material (if applicable) and then replacing with an appropriate type of structure approach system. Depending on the thickness of the existing surface and base layers to be removed, the minimum 1-foot approach slab thickness may have to be increased. The PE needs to make sure the structure engineer addresses this in their reports, plans, and specifications.

- (2) *Approach Slab Overlays*. Asphalt pavement overlays should not be placed on structure decks and approach slabs without the concurrence of Structures Maintenance and Investigations (SMI). If an overlay is needed, SMI will provide the recommended strategy. If another strategy such as polyester concrete is used, either SMI or the Office of Structure Design (OSD) will provide the design details.
- (3) *Structure Approach Slab Drainage*. Typical details for providing positive drainage of a full-width structure approach system are shown in Figure 209.4A. Cross drains are placed at the abutment backwall and at the transverse joint between the existing pavement and the structure approach slab by the structure engineer. A collector/outlet system is placed adjacent to the wingwall at the low side of pavement. The collected

Figure 209.4A

Structure Approach Drainage Details (Rehabilitation)

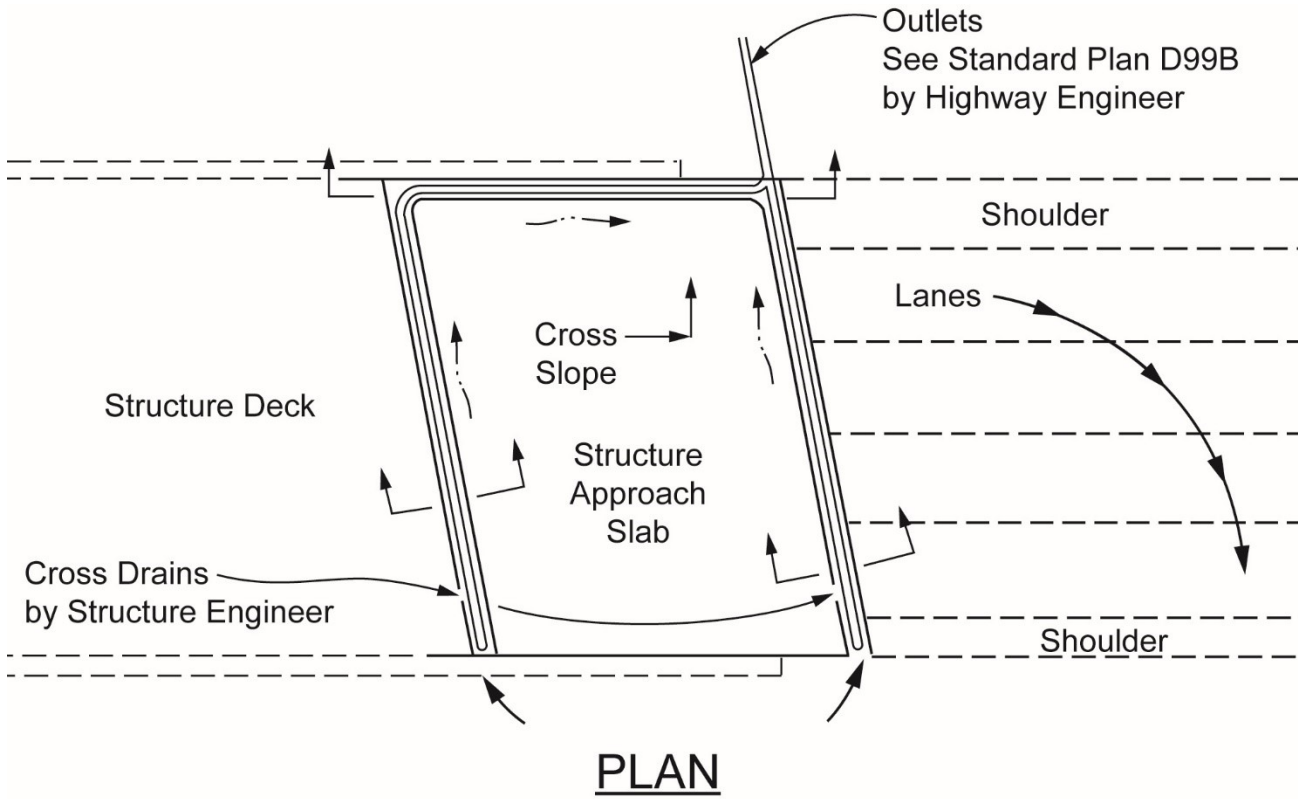

Legend

---> Direction of Flow

water is carried away from the structure approach slab at a location where it will not cause erosion. The PE is responsible for the engineering of the outlet for the structure approach slab drainage. Storm Water Best Management Practices should be considered.

Storm water guidelines are available on the Division of Design, Storm Water website.

The structure approach slab edge details to prevent entry of water at the barrier rail face apply when the wingwalls and/or bridge barrier railing are not being reconstructed.

(4) *Transition Details with Pavement Overlays.* Modification to structure approach slab thicknesses are advantageous when structure approach slabs will be replaced in conjunction with a pavement overlay strategy to promote a smooth transition between structure and pavement. Figure 209.4B, which is applicable to full-width slab replacement, illustrates a method of transitioning from an asphalt overlay thickness to a structure approach slab by tapering the thickness of the structure approach slab. Care should be taken in areas with flat grades to avoid creating a ponding condition at the structure abutment.

(5) *Traffic Handling.* Traffic handling considerations typically preclude full-width construction procedures. Structure approach rehabilitation is therefore usually done under traffic control conditions, which require partial-width construction.

District Division of Traffic Operations should be consulted for guidance on lane closures and traffic handling.

When developing traffic handling plans for structure approach slabs, where replacing markings is necessary, and where there is a need to maintain traffic during construction, the engineer should be aware that pavement joints should not be located underneath any of the wheel paths.

Topic 210 – Reinforced Earth Slopes and Earth Retaining Systems

210.1 Introduction

Constructing roadways on new alignments, widening roadways on an existing alignment, or repairing earth slopes damaged by landslides are situations that may require the use of reinforced earth slopes or earth retaining systems. Using cut and embankment slopes that are configured at slope ratios that are stable without using reinforcement is usually preferred; however, topography, environmental concerns, and right of way (R/W) limitations may require the need for reinforced earth slopes or an earth retaining system.

The need for reinforced earth slopes or an earth retaining system should be identified as early in the project development process as possible, preferably during the Project Initiation Document (PID) phase.

July 1, 2020

Figure 209.4B

New Structure Approach Pavement Transition Details

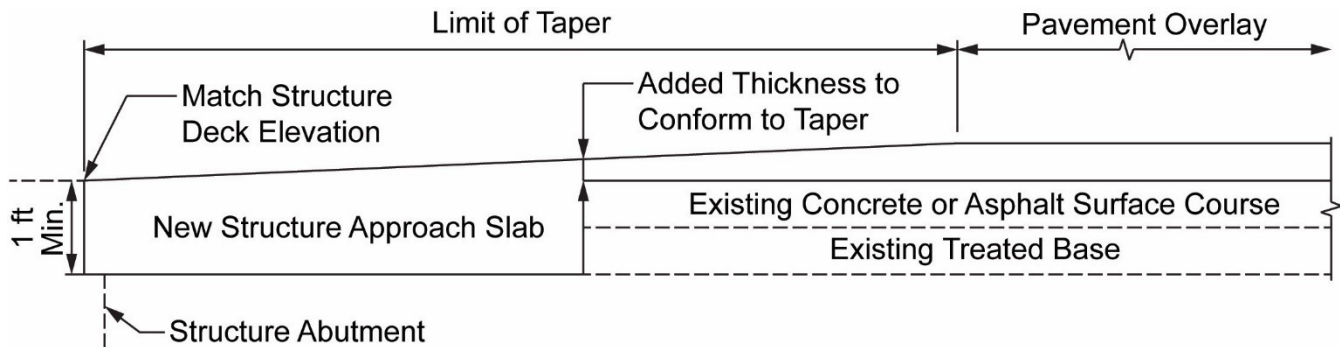

210.2 Construction Methods and Types

(1) Construction Methods

Both reinforced earth slopes and earth retaining systems can be classified by the method in which they are constructed, either top-down or bottom-up.

- “Top-down” construction – This method of construction begins at the top of the reinforced slope or earth retaining system and proceeds in lifts to the bottom of the reinforced slope or earth retaining system.

If required, reinforcement is inserted into the in situ material during excavation.

- “Bottom-up” construction – This method of construction begins at the bottom of the reinforced slope or earth retaining system, where a footing/leveling pad is constructed, construction then proceeds towards the top of the reinforced slope or earth retaining system. If required, reinforcement is placed behind the face of the reinforced slope or earth retaining system. It should be noted that if a “Retaining Wall” earth retaining system is to be used in a cut situation, a temporary back cut or shoring system is required behind the wall.

The District Project Engineer (PE) should conduct an initial site visit and assessment to determine all potential construction limitations. The preferred construction method is top-down due to the reduced shoring, excavation and backfilling. However, this method is not always available or appropriate based on the physical and geotechnical site conditions. The site should also be examined for R/W or utility constraints that would restrict the type of excavation or limit the use of some equipment. In addition, the accessibility to the site for construction and contractor staging areas should be considered.

Table 210.2 summarizes the various reinforced earth slopes and earth retaining systems that are currently available for use, along with the method in which they are constructed.

Table 210.2

Types of Reinforced Earth Slopes and Earth Retaining Systems⁽¹⁾

EARTH RETAINING SYSTEM	Construction Method ⁽²⁾	PS&E By	Typical Facing Material	Recommended Maximum Vertical Height, ft	Ability to Tolerate Differential Settlement ⁽³⁾
Reinforced Earth Slopes					
Reinforced Embankments	BU	District PE	Vegetation/Soil	160	E
Rock/Soil Anchors	TD	District PE	Soil/Rock	130	E
State Designed Earth Retaining Systems with Standard Plans					
Concrete Cantilever Wall, Type 1 & 1A	BU	District PE	Concrete	36, 12, 22 ⁽⁴⁾	P
Concrete L-Type Cantilever Wall, Type 5	BU	District PE	Concrete	12 ⁽⁴⁾	P
Concrete Masonry Wall, Type 6	BU	District PE	Masonry	6 ⁽⁴⁾	P
Crib Wall: Concrete, Steel	BU	District PE	Concrete, Steel	50, 36, ⁽⁴⁾	P
State Designed Earth Retaining Systems Which Require Special Designs					
Standard Plan Walls with modified wall geometry, foundations or loading conditions	BU	Structure PE	Concrete, Steel, Timber	50	P-F
Non-Gravity Cantilevered Walls					
Sheet Pile Wall	TD	Structure PE	Steel	20	F
Soldier Pile Wall with Lagging	TD/BU	Structure PE	Concrete, Steel, Timber	20	F-G
Tangent Soldier Pile Wall	TD/BU	Structure PE	Concrete	30	F
Secant Soldier Pile Wall	TD	Structure PE	Concrete	30	F
Slurry Diaphragm Wall	TD	Structure PE	Concrete, Shotcrete	80 ⁽⁵⁾	F
Deep Soil Mixing Wall	TD	Structure PE	Shotcrete	80 ⁽⁵⁾	F-G
Anchored Wall (Structural or Ground Anchors)	TD	Structure PE	Concrete, Steel, Timber	80 ⁽⁶⁾	F-G
Gravity Walls					
Concrete Gravity Wall	BU	Structure PE	Concrete	6	P
Rock Gravity Wall	BU	District PE	Rock	13	E
Gabion Basket Wall	BU	District PE	Wire & Rock	26	E
Soil Reinforcement Systems					
Mechanically Stabilized Embankment	BU	Structure PE	Concrete	50	G
Salvaged Material Retaining Wall	BU	District PE	Steel, Timber	16	G
Soil Nail Wall	TD	Structure PE	Concrete, Shotcrete	80	F
Tire Anchored Timber Wall	BU	District PE	Timber	32	G
Proprietary Earth Retaining Systems (Pre-approved)					
The list of Pre-approved systems is available at the website shown in Index 210.2(3)(c).					
Proprietary Earth Retaining Systems (Pending)					
These systems are under review by DES-SD. For more information, see Index 210.2(3)(d).					
Experimental State Designed Earth Retaining Systems					
Geosynthetic Reinforced Walls	BU	Structure PE/ District PE	Concrete Blocks, Steel, Vegetation, Fabric	65	E
Mortarless Concrete Blocks Gravity Walls	BU	District PE	Concrete Blocks	8	P
NOTES: 1. Comparative cost data is available from DES-SD. 4. Maximum Design Height					
2. BU = Bottom Up; TD = Top Down 5. Anchors may be required					
3. E = Excellent; G = Good; F = Fair; P = Poor 6. With lagging					

July 1, 2020

(2) Reinforced Earth Slopes (PS&E by District PE)

Reinforced earth slopes incorporate metallic or non-metallic reinforcement in construction of embankments and cut slopes with a slope angle flatter than 70 degrees from the horizontal plane. Reinforced earth slopes should be used in conjunction with erosion mitigation measures to minimize future maintenance costs. The slope face is typically erosion protected with the use of systems such as geosynthetics, bio-stabilization, rock slope protection, or reinforced concrete facing.

(3) Earth Retaining Systems

Earth retaining systems can be divided into five major categories depending upon the nature of the design and whether they are designed by the owner (State designed), a Proprietary vendor or a combination thereof. The term "State designed" as referenced herein is utilized to encompass earth retaining systems that are designed by the State or by Local or Private entities on behalf of the State.

No assignment of roles and responsibilities is intended. The five categories are as follows:

(a) State Designed Earth Retaining Systems which utilize Standard Plans (PS&E by District PE).

Standard Plans are available for a variety of earth retaining systems (retaining walls). Loading conditions and foundation requirements are as shown on the Standard Plans. For sites with requirements that are not covered by the Standard Plans, a special design is required. To assure conformance with the specific Standard Plan conditions and requirements, and subsequent completion of the PS&E in a timely fashion, the District PE should request a foundation investigation for each location where a retaining wall is being considered. Retaining walls that utilize Standard Plans are as follows:

- Retaining Wall Types 1 and 1A (Concrete Cantilever). These walls have design heights up to 36 feet and 12 feet respectively, but are most economical below 20 feet. Concrete cantilever walls can accommodate traffic barriers, and drainage facilities efficiently. See Standard Plans for further details.

Retaining Wall Type 5 (Concrete L-Type Cantilever). This wall has a design height up to 12 feet. Although more costly than cantilever walls, these walls may be required where site restrictions do not allow for a footing projection beyond the face of the wall stem. See Standard Plans for further details.

Retaining Wall Type 6 (Concrete Masonry Walls). These walls may be used where the design height of the wall does not exceed 6 feet. These walls are generally less costly than all other standard design walls or gravity walls. Where traffic is adjacent to the top of the wall, guardrail should be set back as noted in the Standard Plans. See Standard Plans for further details.

- Crib Walls. The following types are available:

Concrete Crib Wall - This type of crib wall may be used for design heights up to 50 feet. Concrete crib walls are suited to coastal areas and higher elevations where salt air and deicing salts may limit the service life of other types of crib walls. See Standard Plans for further details.

Steel Crib Wall - This type of crib wall may be used for design heights up to 36 feet. Steel crib walls are light in weight; easily transported and installed; and, therefore, suited for relatively inaccessible installations and for emergency repairs. See Standard Plans for further details.

Concrete crib walls constructed on horizontal alignments with curves or angle points require special details, particularly when the wall face is battered. Because crib wall faces can be climbed, they are not recommended for use in urban locations where they may be accessible to the public.

(b) State Designed Earth Retaining Systems which requires Special Designs.

Some locations will require a special design to accommodate ground contours, traffic, utilities, man-made features, site geology, economics, or aesthetics.

Some special design earth retaining systems are as follows:

- Standard Plan Walls (PS&E by Structure PE). The design loadings, heights, and types of walls in the Standard Plans cover frequent applications for earth retaining systems. However, special designs are necessary if the imposed loading exceeds that shown on the Standard Plan. Railroad live loads; building surcharge; loads imposed by sign structures, electroliers, or noise barriers are examples of loading conditions that will require special designs. Foundation conditions that require pile support for the wall and angle points in the wall geometry necessitate a special design.
- Non-Gravity Cantilevered Walls (PS&E by Structure PE). These walls include sheet pile walls, soldier pile walls with lagging, tangent soldier pile walls, secant soldier pile walls, slurry diaphragm walls, and deep soil mixing walls. These walls are most practical in cut sections and are best suited for situations where excavation for a retaining wall with a footing is impractical because of traffic, utilities, existing buildings, or R/W restrictions. In embankment sections, a non-gravity cantilevered wall is a practical solution for a roadway widening where design heights are less than 15 feet. They are also practical for slip-out corrections. Non-gravity cantilevered walls can consist of concrete, steel, timber, or cemented soil piles that may be either driven into place or placed in drilled holes and trenches.
- Anchored Walls (PS&E by Structure PE). These walls are typically composed of the same elements as non-gravity cantilevered walls, but derive additional lateral resistance from ground anchors (tiebacks), concrete anchors, or pile anchors. These anchors are located behind the potential failure surfaces in the retained soil and are connected to the wall structurally. The method of support and anchorage depends on site conditions, design height, and loading imposed. The cost of these walls is variable depending on earth retaining requirements, site geology, aesthetic consideration, and site restraints, but is generally higher than "Standard Design Walls" for the same wall geometry and loading conditions. Anchored walls may be used to stabilize an unstable site provided that adequate material exists at the site for the anchors. Economical wall heights up to 80 feet are feasible.
- Gravity Wall Systems that require special designs are Concrete Gravity, Rock Gravity, and Gabion Basket Walls. Concrete Gravity Walls (PS&E by Structure PE). Concrete gravity walls are most economical at design heights below 4 feet. However, they may be constructed at heights up to 6 feet. These walls can be used in connection with a cantilever wall if long lengths of wall with design heights of less than 4 feet are required.

July 1, 2020

- Rock Gravity Walls (PS&E by District PE). Rock gravity walls consist of rocks that are 100 pounds to 200 pounds, stacked on top of each other at slight batter. These walls are typically used in areas where a rock appearance is desirable for aesthetic reasons. Wall heights range from 1 foot 6 inches to 15 feet, but are most economical for heights less than 10 feet.
- Gabion Basket Walls (PS&E by District PE). Gabion basket walls use compartmented units filled with stones and can be constructed up to 26 feet in height. Each unit is a rectangular basket made of galvanized steel wire. The stone fill is 4 inches to 16 inches in size. Gabion basket walls are typically used for soil and stream bank stabilization. Service life of the gabion basket wall is highly dependent on the environment in which they are placed. Corrosion, abrasion, rock impact, fire and vandalism are examples of site-specific factors that would influence the service life of the wall and should be taken into consideration by the District PE during the design of the project. See Standard Plans for further details.
- Soil Reinforcement Systems. Soil reinforcement systems consist of facing elements and soil reinforcing elements incorporated into a compacted or in situ soil mass. The reinforced soil mass functions similar to a gravity wall.
- Soil reinforcing elements can be any material that provides tensile strength and pullout resistance, and possesses satisfactory creep characteristics and service life. Generally, reinforcing elements are steel, but polymeric and fiberglass systems may be used.
- Facing elements for most systems are either reinforced concrete, light gauge steel, or treated wood. Polymeric reinforced walls may be faced with masonry-like elements or even planted with local vegetation. Selection of facing type is governed by aesthetics and service life.
- Special details are required when drainage structures, overhead sign supports or noise barriers on piles are within the reinforced soil mass. Concrete traffic barriers require a special design support slab when used at the top of the facing of these systems. These systems cannot be used where site restrictions do not allow necessary excavation or placement of the soil reinforcing elements.
- Soil reinforcement systems that require special design are as follows:
- Mechanically Stabilized Embankment (MSE) (PS&E by Structure PE). This system uses welded steel wire mats, steel strips or polymeric materials as soil reinforcing elements. The facing elements are precast concrete. In many cases, this system can be constructed using on-site backfill materials.
- When the bottom-up construction method is possible and other conditions permit their use, these systems are generally the most economical choice for wall heights greater than 20 feet. They may also be the most economical system for wall heights in the 10-foot to 20-foot range, depending on the specific project requirements.
- Because of the articulated nature of the facing elements these systems use, they can tolerate greater differential settlement than can monolithic conventional rigid retaining walls, such as concrete cantilever retaining walls.
- Steel elements used in this method are sized to provide sacrificial steel to compensate for anticipated corrosion; and may be galvanized to provide additional protection.

- Salvaged Material Retaining Wall (PS&E by District PE). This system utilizes C-channel sections as soil reinforcement. Galvanized guardrail elements, timber posts or concrete panels are used as facing elements. Often these materials can be salvaged from projects. The District Recycle Coordinator should be consulted as to the availability of salvaged materials.
- Soil Nail Wall (PS&E by Structure PE). This system reinforces either the original ground or an existing embankment during the excavation process. Soil nailing is always accomplished from the top-down in stages that are typically 4 feet to 6 feet in height. After each stage of excavation, corrosion protected soil reinforcing elements, "soil nails", are placed and grouted into holes which have been drilled at angles into the in situ material. The face of each stage of excavation is protected by a layer of reinforced shotcrete. After the full height of wall has been excavated and reinforced, a finish layer of concrete facing is placed either by the shotcreting method or by casting within a face form.
- When top-down construction is possible and conditions permit its use, soil nail wall systems are generally the most economical choice for wall heights greater than 10 feet. Wall heights in excess of 80 feet are feasible in specific locations.
- Because soil nailing is accomplished concurrent with excavation, and thus results in an unloading of the foundation, there is typically no significant differential settlement.
- Steel "soil nails" used in this method are protected against corrosion either by being epoxy coated or encapsulated within a grout filled corrugated plastic sheath, and surrounded by portland cement grout placed during construction. Soil nail lengths typically range from 80 to 100 percent of the wall height, the actual length depends on the nail spacing used and the competency of the in situ soil.
- Recycled Tire Anchor Timber (TAT) Walls (PS&E by District PE). This system utilizes steel bars with recycled tire sidewalls attached by cross bars as soil reinforcing elements. The facing elements are treated timber. TAT walls have a rustic appearance, which makes them suitable in rural environments. The length of commercially available timber post generally controls the height of wall but heights up to 32 feet are feasible.

(c) Proprietary Earth Retaining Systems (Pre-approved).

These conventional retaining walls, cribwalls, and soil reinforcement systems are designed, manufactured, and marketed by vendors. These systems are termed "proprietary" because they are patented. "Pre-approval" status means that these systems may be listed in the Special Provisions of the project as an Alternative Earth Retaining System (AERS), see Index 210.3, when considered appropriate for a particular location. For a proprietary system to be given "pre-approval" status, the vendor must submit standard plans and design calculations to the Division of Engineering Services – Structure Design (DES-SD) for their review and approval. The Proprietary earth retaining systems that have been pre-approved are included in the Department's Authorized Material List, located on the following website: <http://www.dot.ca.gov/aml/>.

Design details and specifications of "pre-approved" proprietary earth retaining systems may be found on the vendor websites listed in the Authorized Material List. New systems are added to the website list once they are pre-approved for use.

(d) Proprietary Earth Retaining Systems (Pending).

July 1, 2020

The systems in this category have been submitted by vendors to DES-SD for evaluation. Upon approval of DES-SD, pending systems are added to the website list of “pre-approved” proprietary earth retaining systems and included in the project specific Special Provisions.

If a proprietary system is the only retaining system deemed appropriate for use at a specific location, the construction of that system must be justified or designated an experimental construction feature in accordance with existing Departmental Policy concerning sole source purchases. See Index 110.10 for additional guidance on the use of proprietary items.

(e) Experimental State Designed Earth Retaining Systems.

Every earth retaining system is evaluated before being approved for routine use by the Department. Newly introduced designs, unproven combinations of proprietary and non-proprietary designs or products, are considered experimental. Once an experimental system has been evaluated and approved, it will be made available for routine use. The use of these systems is only permitted upon consultation with the Division of Engineering Services – Geotechnical Services (DES-GS).

Some earth retaining systems which are currently considered experimental follow:

- Geosynthetic Reinforced Walls (PS&E by District PE). These systems utilize geosynthetic material as the soil reinforcing elements. The face of these walls can be left exposed if the geosynthetic material has been treated to prevent decay from ultra-violet rays. Concrete panels, mortarless masonry, tar emulsion, or air blown mortar may be used as facing materials or the face may be seeded if a more aesthetic treatment is preferred. Design is by DES-GS.
- Mortarless Concrete Block Gravity Walls (PS&E by District PE). These wall types consist of vertically stacked, dry cast, concrete blocks. This system utilizes the friction and shear developed between the blocks and the combined weight of the blocks to retain the backfill. Some of these walls have been used as erosion protection at abutments and on embankments. They can be used as an aesthetic treatment for geosynthetic material reinforced walls. All of these walls require a batter. Design is by the DES-GS.

210.3 Alternative Earth Retaining Systems (AERS)

Using the Alternative Earth Retaining Systems (AERS) procedure encourages competitive bidding and potentially results in project cost savings. Therefore, AERS must be considered in all projects where earth retaining systems are required.

The AERS procedure may result in one or more earth retaining systems being included in the contract bid package. Under this procedure, a fully detailed State designed earth retaining system will be provided for each location, and will be used as the basis for payment. Additional systems may be presented in the contract documents as alternatives to the fully detailed State design and can be considered for use at specified locations. The fully detailed State designed earth retaining system may be either a Standard Plan system or a special design system. Alternative systems may also be State designed systems, “pre-approved”

proprietary systems or experimental systems, as appropriate. The State designed alternative systems, both Standard Plan walls and special design systems, are to be completely designed and specified in the PS&E. Alternative systems are to be listed in the Special Provisions as AERS.

The AERS procedure requires the involvement of the District PE, DES-SD, and the DES-GS. The District PE should submit pertinent site information (site plans, typical sections, etc.) to DES-GS for a feasibility study as early as possible in the project development process.

Under the AERS procedure, parts of the PS&E package which pertain to the earth retaining systems will be prepared as follows:

- Contract plans for State designed systems can be prepared by the District PE (Standard Plan systems), the DES-GS (special design soil reinforcement systems and experimental systems), or the Structure PE (Standard Plan systems and special design systems).
- “Pre-approved” proprietary systems that are determined, based on consultation with DES-SD, to be appropriate alternatives to the State designed earth retaining system, are to be listed in the Special Provisions.
- Specifications and Estimates shall be developed for the fully detailed State designed system, which will be used as the basis for payment.

The earth retaining systems utilizing this procedure are to be measured and paid for by the square yard area of the face of the earth retaining system. Should an AERS be constructed, payment will be made based on the measurements of the State designed system which was designated as the basis of payment. The contract price paid per square yard is for all items of work involved and includes excavation, backfill, drainage system, reinforcing steel, concrete, soil reinforcement, and facing. Any barrier, fence, or railing involved is measured and paid for as separate contract cost items.

210.4 Value Engineering Change Proposal (VECP)

Sometimes Contractors submit proposals for an earth retaining system under Section 4-1.07 of the Standard Specifications, “Value Engineering.” The Contractor proposed system may modify or replace the earth retaining system permitted by the contract. The VECP process allows vendors of proprietary earth retaining systems an alternative method for having their systems used prior to obtaining “pre-approval” (see Index 210.2(3)(c)). VECP submittals are administered by the Resident Engineer. However, Contract Change Orders are not to be processed until the VECP is approved by Headquarters Construction with review assistance provided by the District or Structure PE as appropriate.

July 1, 2020

210.5 Aesthetic Consideration

The profile of the top of wall should be designed to be as pleasing as the site conditions permit. All changes in the slope at the top of cast-in-place concrete walls should be rounded with vertical curves at least 20 feet in length. Abrupt changes in the top of the wall profile should be avoided by using vertical curves, slopes, steps, or combinations thereof. Side slopes may be flattened or other adjustments made to provide a pleasing profile.

Where walls are highly visible, special surface treatments or provisions for landscaping should be considered. The aesthetic treatment of walls should be discussed with the District Landscape Architect and when necessary referred to DES Structure Design Services for additional study by the Office of Transportation Architecture.

The wall area between the grade line and 6 feet above it shall be free of any designed indentations or protrusions that may snag errant vehicles.

When alternative wall types are provided on projects with more than one wall site, any restrictions as to the combination of wall types should be specified in the Special Provisions.

210.6 Safety Railing, Fences, and Concrete Barriers

Cable railing should be installed for employee protection in areas where employees may work adjacent to and above vertical faces of retaining walls, wingwalls, abutments, etc. where the vertical fall is 4 feet or more.

If cable railing is required on a wall which is less than 4 feet 6 inches tall and that wall is located within the clear recovery zone, then the cable railing should be placed behind the wall. See Standard Plan B11-47 for details of cable railing.

Special designs for safety railing may be considered where aesthetic values of the area warrant special treatment. In addition, if the retaining wall is accessible to the public and will have pedestrians or bicycles either above or below the retaining wall, then the provisions of Index 208.10 shall apply.

Concrete barriers may be mounted on top of retaining walls. Details for concrete barriers mounted on top of retaining walls Type 1 through 5 are shown in the Standard Plans. A concrete barrier slab is required if a concrete barrier is to be used at the top of a special design earth retaining system. DES-SD should be contacted for preparation of the plans involved in the special design.

Retaining walls joining right of way fences should be a minimum of 6 feet clear height.

The District PE should examine the proposed retaining wall location in relation to the provisions of Index 309.1 to ensure adequate horizontal clearances to the structure or to determine the type and placement of the appropriate roadside safety devices.

210.7 Design Responsibility

The Structure PE has primary responsibility for the structural design and preparation of the contract documents (PS&E) for special design earth retaining systems involving Standard Plans non-gravity cantilevered walls, anchored walls, concrete and rock gravity walls, mechanically stabilized embankment, and soil nail walls. The DES-GS has primary responsibility for the geotechnical design of all reinforced earth slopes and earth retaining systems. DES-SD will prepare the Specifications and Engineer's Estimate for contracts when the AERS procedure is used. DES-SD reviews and approves standard plan submittals for proprietary earth retaining systems submitted by vendors. DES-SD and DES-GS assist Headquarters Construction in evaluating the VECP submitted by contractors.

Districts may prepare contract plans, specifications, and engineer's estimate for Standard Plan retaining walls provided the foundation conditions and site requirements permit their use. A foundation investigation is required for all reinforced earth slopes and earth retaining systems. PS&E's for slurry walls, deep soil mixing walls, gabion walls, tire anchored timber walls, salvaged material walls, and experimental walls will be prepared by the District PE with assistance from DES-GS. Earth retaining systems may be included in the PS&E as either highway or structure items.

The time required for DES-SD to provide the special design of a retaining system is site and project dependent. Therefore, the request for a special design should be submitted by the District PE to DES-SD as far in advance as possible, but not less than 6 months prior to PS&E delivery. At least 3 months is required to conduct a foundation investigation for an earth retaining system. A site plan, index map, cross sections, vertical and horizontal alignment, and utility and drainage requirements should be sent along with the request.

DES-GS has the responsibility for preparing a feasibility study for AERS. The District PE should submit project site information (site plans, typical sections, etc.) as early in the planning stage as possible so that determination of the most appropriate earth retaining system to use can be made.

210.8 Guidelines for Type Selection and Plan Preparation

- (1) *Type Selection.* Type selection for reinforced earth slopes and earth retaining systems should be based on considerations set forth in Index 210.2.

The District PE should request a feasibility study for a reinforced slope or earth retaining system from DES-GS as early as possible in the project development process. After the feasibility study, the District PE should request an Advanced Planning Study (APS) from DES-SD for all special design earth retaining systems that DES-SD may be required to include in the PS&E.

If the District PE decides that the course of action favors an earth retaining system in which the PS&E will be delivered by DES-SD, then a Bridge Site Data Submittal – Non-Standard Retaining Wall/Noise Barrier must be submitted to DES-Structure Design Services & Earthquake Engineering – Preliminary Investigations (PI) Branch. A copy of this submittal will be forwarded to DES-SD and DES-GS by PI.

The Structure PE, with input from DES-GS and the District PE, will then type select the appropriate earth retaining system for the site and project. After an earth retaining system has been type selected, then DES-GS will prepare a Geotechnical Design Report.

July 1, 2020

The process for type selecting and developing the PS&E for reinforced earth slopes and earth retaining systems is set forth in Figure 210.8.

All appropriate State designed and proprietary earth retaining systems should be considered for inclusion in the contract documents to promote competitive bidding, which can result in cost savings.

(2) *Foundation Investigations.* DES-GS should be requested to provide a foundation recommendation for all sites involving a reinforced slope or an earth retaining system. Any log of test boring sheets accompanying the foundation reports must be included with the contract plans as project information, for the bidders use.

(3) *Earth Retaining Systems with Standard Plans.* The following guidelines should be used to prepare the contract plans for earth retaining systems, which are found in the Standard Plans:

(a) *Loads.* All wall types selected must be capable of supporting the field surcharge conditions. The design surcharges can be found in the Standard Plans. Deviance from these loadings will require a special design

(b) *Footing Steps.* For economy and ease of construction of wall Types 1 through 6, the following criteria should be used for layout of footing steps.

- Distance between steps should be in multiples of 8 feet.
- A minimum number of steps should be used even if a slightly higher wall is necessary. Small steps, less than 1 foot in height, should be avoided unless the distance between steps is 96 feet or more. The maximum height of steps should be held to 4 feet. If the footing thickness changes between steps, the bottom of footing elevation should be adjusted so that the top of footing remains at the same elevation.

(c) *Sloping Footings.* The following criteria should be used for layout of sloping footings.

- The maximum permissible slope for reinforced concrete retaining walls is 3 percent. Maximum footing slope for masonry walls is 2 percent.
- When sloping footings are used, form and joint lines are permitted to be perpendicular and parallel to the footing for ease of construction.
- In cases where vertical electroliers or fence posts are required on top of a wall, the form and joint lines must also be vertical. A sloping footing should not be used in this situation since efficiency of construction would be lost.

Sloping footing grades should be constant for the entire length of the wall. Breaks in footing grade will complicate forming and result in loss of economy. If breaks in footing grade are necessary, a level stepped footing should be used for the entire wall.

- When the top of wall profile of crib walls is constant for the entire length, the bottom of wall profile may be sloped to avoid steps in the top of wall. In this case, all steps to compensate for changes of wall height and original ground profile would be made in the bottom of wall. The maximum permissible slope is 6 percent. If vertical electroliers or fence posts are required on top of the wall, the crib wall should not be sloped. Sloping crib walls are permissible with guard railing with vertical posts.

Figure 210.8

Type Selection and PS&E Process for Reinforced Earth Slopes and Earth Retaining Systems

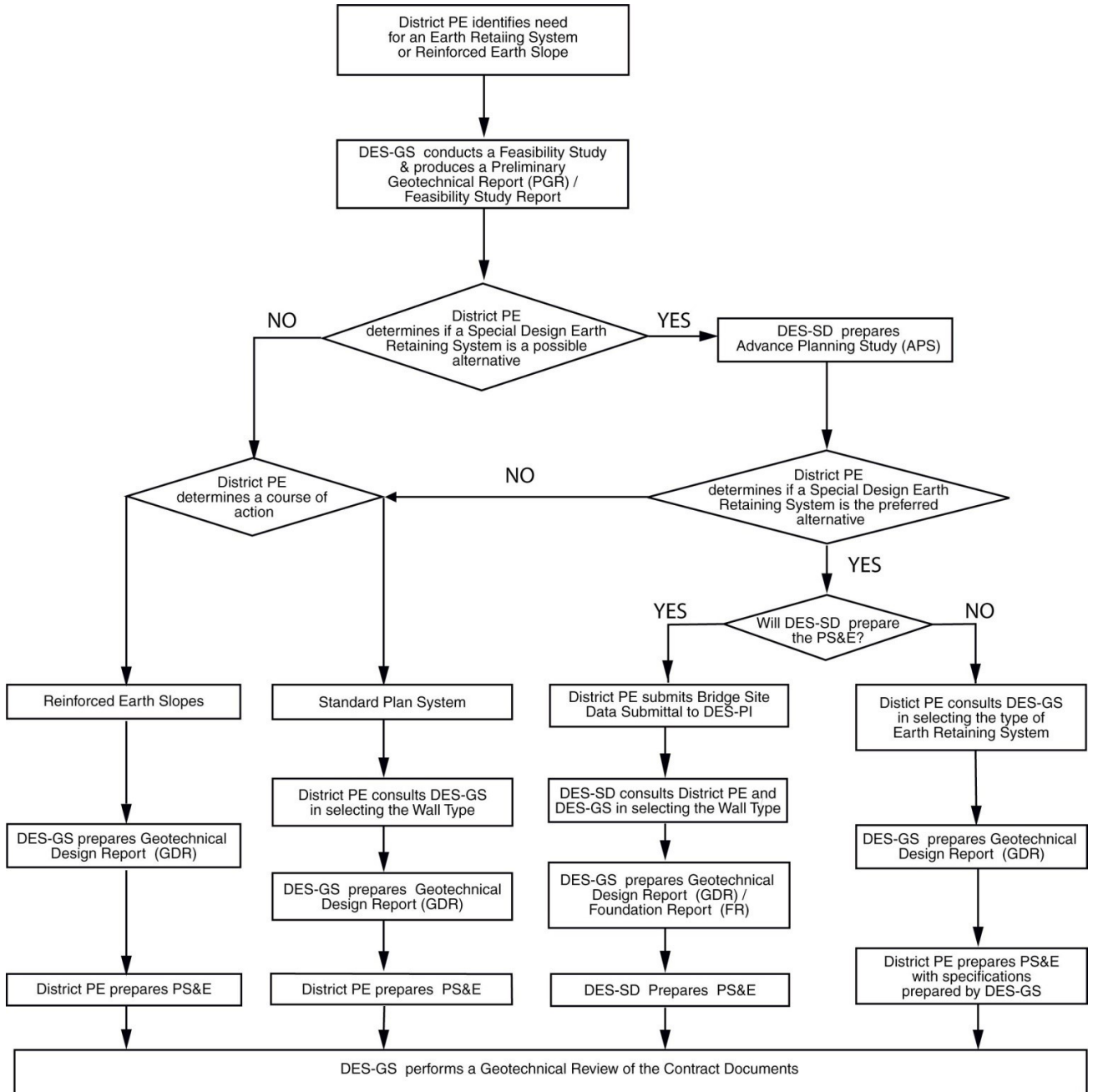

July 1, 2020

- (d) **Wall Joints.** General details for required wall joints on wall Types 1, 1A, 2, and 5 are shown on Standard Plan B0-3. Expansion joints, Bridge Detail 3-3, should be shown at maximum intervals of 96 feet. Shorter spaces should be in multiples of 8 feet. Expansion joints generally should be placed near angle points in the wall alignment. When concrete barriers are used on top of retaining walls, the waterstop in the expansion joint must be extended 6 inches into the barrier. This detail should be shown or noted on the wall plans. Weakened plane joints, Bridge Detail 3-2, should be shown at nearly equal spaces between joints.
 - (e) **Drainage.** Gutters should be used behind walls in areas where it is necessary to carry off surface water or to prevent scour. Low points in wall vertical alignment or areas between return walls must be drained by downspouts passing through the walls. Standard Plan B3-9 shows typical drainage details. Special design of surface water drainage facilities may be necessary depending on the amount of surface water anticipated. Where ground water is likely to occur in any quantity, special provisions must be made to intercept the flow to prevent inundation of the backfill and unsightly continuous flow through weep holes.
 - (f) **Quantities.** When the AERS procedure is not utilized, quantities for each wall item of work are usually developed for payment. The quantities for concrete, expansion joint waterstop, structure excavation, structure backfill, pervious backfill material, concrete barrier or railing, and gutter concrete must also be tabulated. Quantities should be tabulated on the plans for each wall.
- (4) **Soil Reinforcement Systems.** The following guidelines should be used to prepare the contract plans for soil reinforcement systems:
- (a) **Leveling Pads.** Most soil reinforcement systems do not require extensive foundation preparation. It may be necessary, however, to design a concrete leveling pad on which to construct the face elements. A reinforced concrete leveling pad will be required in areas prone to consolidation or frost disturbance.

Steps in the leveling pad should be the same height as the height of the facing elements or thickness of the soil layer between the soil reinforcement.

Distance between steps in the leveling pad should be in increments equivalent to the length of individual facing elements.

A minimum number of steps should be used even if a slightly higher wall is necessary.
 - (b) **Drainage.** Gutters should be used behind walls in areas where it is necessary to carry off surface water or to prevent scour. Low points in wall vertical alignment or areas between return walls must be drained by downspouts passing through the walls. Special design of surface water drainage facilities will be necessary and should be prepared by DES-SD. Where ground water is likely to occur in any quantity, special provisions must be made to intercept the flow to prevent inundation of the backfill.
- (5) **Quantities.** When the AERS procedure is not utilized, quantities for each item of work are usually developed for payment. Bid items must include, but not be limited to: excavation and backfill for the embedment depth, soil reinforcement, facing elements, and concrete for leveling pad construction. Additional bid items for inclusion are any drainage system, pervious backfill, concrete barrier, railings, and concrete gutters. Quantities should be tabulated on the plans for each wall.

(5) *Earth Retaining Systems*. The following miscellaneous details are applicable to all earth retaining systems:

- (a) *Utilities*. Provisions must be made to relocate or otherwise accommodate utilities conflicting with the retaining wall. A utility opening for a Type 1 wall is shown on Standard Plan B3-9. Any other utility openings will require special design details and should be reviewed by DES-SD.
- (b) *Electroliers and Signs*. Details for mounting electroliers and signs on earth retaining systems are designed by DES-SD. Requests for preparation of details should be made at least 3 months in advance of the PS&E submittal to District Officer Engineer date. To accommodate the base plates for overhead signs, a local enlargement may affect the horizontal clearance to both the edge of pavement and the right of way line. This type of enlargement should be considered at the time of establishing the wall layout and a need for a design standard decision document determined. For mounting details, furnish DES-SD a complete cross section of the roadway at the sign and the layout and profile of the earth retaining system.
- (c) *Fence and Railing Post Pockets*. Post pocket details shown for cable railing in the Standard Plans may also be used for mounting chain link fence on top of retaining walls. Special details may be necessary to accommodate the reinforcement in soil reinforcement systems.
- (d) *Return Walls*. Return walls should be considered for use on the ends of the walls to provide a finished appearance. Return walls are necessary when wall offsets are used or when the top of wall is stepped. Return walls for soil reinforcement systems will require special designs to accommodate the overlapping of soil reinforcing elements.

All special wall details such as sign bases, utility openings, drainage features, fences, and concrete barriers should be shown on the plan sheet of the wall concerned or included on a separate sheet with the wall plan sheets. Details should be cross-referenced on the wall sheets to the sheets on which they are shown.

CHAPTER 300 – GEOMETRIC CROSS SECTION

The selection of a cross section is based upon the joint use of the transportation corridor by vehicles, including trucks, public transit, cyclists and pedestrians. Designers should recognize the implications of this sharing of the transportation corridor and are encouraged to consider not only vehicular movement, but also movement of people, distribution of goods, and provision of essential services. Designers need also to consider the plan for the future of the route, consult Transportation Concept Reports for state routes.

Topic 301 – Traveled Way Standards

The traveled way width is determined by the number of lanes required to accommodate operational needs, terrain, safety and other concerns. The traveled way width includes the width of all lanes, but does not include the width of shoulders, sidewalks, curbs, dikes, gutters, or gutter pans. See Topic 307 for State highway cross sections, and Topic 308 for road cross sections under other jurisdictions.

Index 301.1 – Lane Width

The minimum lane width on two-lane and multilane highways, ramps, collector-distributor roads, and other appurtenant roadways shall be 12 feet, except as follows:

- **For conventional State highways with posted speeds less than or equal to 40 miles per hour and AADTT (truck volume) less than 250 per lane that are in urban, city or town centers (rural main streets), the minimum lane width shall be 11 feet.** The preferred lane width is 12 feet. See Index 81.3 for place type definitions.

Where a 2-lane conventional State highway connects to a freeway within an interchange, the lane width shall be 12 feet.

Where a multilane State highway connects to a freeway within an interchange, the outer most lane of the highway in each direction of travel shall be 12 feet.

- For highways, ramps, and roads with curve radii of 300 feet or less, widening due to offtracking in order to minimize bicycle and vehicle conflicts must be considered. See Index 404.1 and Table 504.3A.
- For lane widths on roads under other jurisdictions, see Topic 308.

301.2 Class II Bikeway (Bike Lane) Lane Width

- (1) **General. Class II bikeways (bike lanes), for the preferential use of bicycles, may be established within the roadbed and shall be located immediately adjacent to a traffic lane as allowed in this manual.** A buffered bike lane may also be established within the roadbed, separated by a marked buffer between the bike lane and the traffic lane or parking lane. See the California MUTCD for further buffered bike lane marking and signing guidance. Contraflow bike lanes are designed for bike travel

July 1, 2020

in the opposite direction as adjacent vehicular traffic, and are only allowed on one-way streets. See the California MUTCD for contraflow bike lane marking and signing guidance. Typical Class II bikeway configurations are illustrated in Figure 301.2A. A bikeway located behind on-street parking, physical separation, or barrier within the roadway is a Class IV bikeway (separated bikeway). See DIB 89 for Class IV bikeway (separated bikeway) design guidance. **The minimum Class II bike lane width shall be 4 feet, except where:**

- Adjacent to on-street parking, the minimum bike lane should be 5 feet.
- Posted speeds are greater than 40 miles per hour, the minimum bike lane should be 6 feet, or
- **On highways with concrete curb and gutter, a minimum width of 3 feet measured from the bike lane stripe to the joint between the shoulder pavement and the gutter shall be provided.**

Class II bikeways may be included as part of the shoulder width See Topic 302.

As grades increase, downhill bicycle speeds can increase, which increases the width needed for the comfort of bicycle operation. If bicycle lanes are to be marked, additional bike lane width is recommended to accommodate these higher bicycle speeds. See Index 204.5(4) for guidance on accommodating bicyclists on uphill grades where a Class II bikeway is not included.

If bike lanes are to be located on one-way streets, they may be placed on either or both sides of the street. When only one bicycle lane is provided, it should be located on the side of the street that presents the lowest number of conflicts for bicyclists which facilitates turning movements and access to destinations on the street.

- (2) *On-Street Parking Adjacent to Class II Bikeways.* Parking adjacent to bike lanes is discussed in subsection (1) above and addressed in Table 302.1, Note (7). Part-time bike lanes with part-time on-street parking is discouraged. This type of bike lane may only be considered if the majority of bicycle travel occurs during the hours of parking prohibition. When such an installation is being considered refer to the California MUTCD and traffic operations for direction regarding proper signing and marking.
- (3) *Reduction of Cross Section Elements Adjacent to Class II Bikeways.* There are situations where it may be desirable to reduce the width of the lanes in order to add or widen bike lanes or shoulders. In determining the appropriateness of narrower traffic lanes, consideration should be given to factors such as motor vehicle speeds, truck volumes, alignment, bike lane width, sight distance, and the presence of on-street parking. When on-street parking is permitted adjacent to a bike lane, or on a shoulder where bicycling is not prohibited, reducing the width of the adjacent traffic lane may allow for wider bike lanes or shoulders, to provide greater clearance between bicyclists and driver-side doors when opened.

Figure 301.2A

Typical Class II Bikeway (Bike Lane) Cross Sections

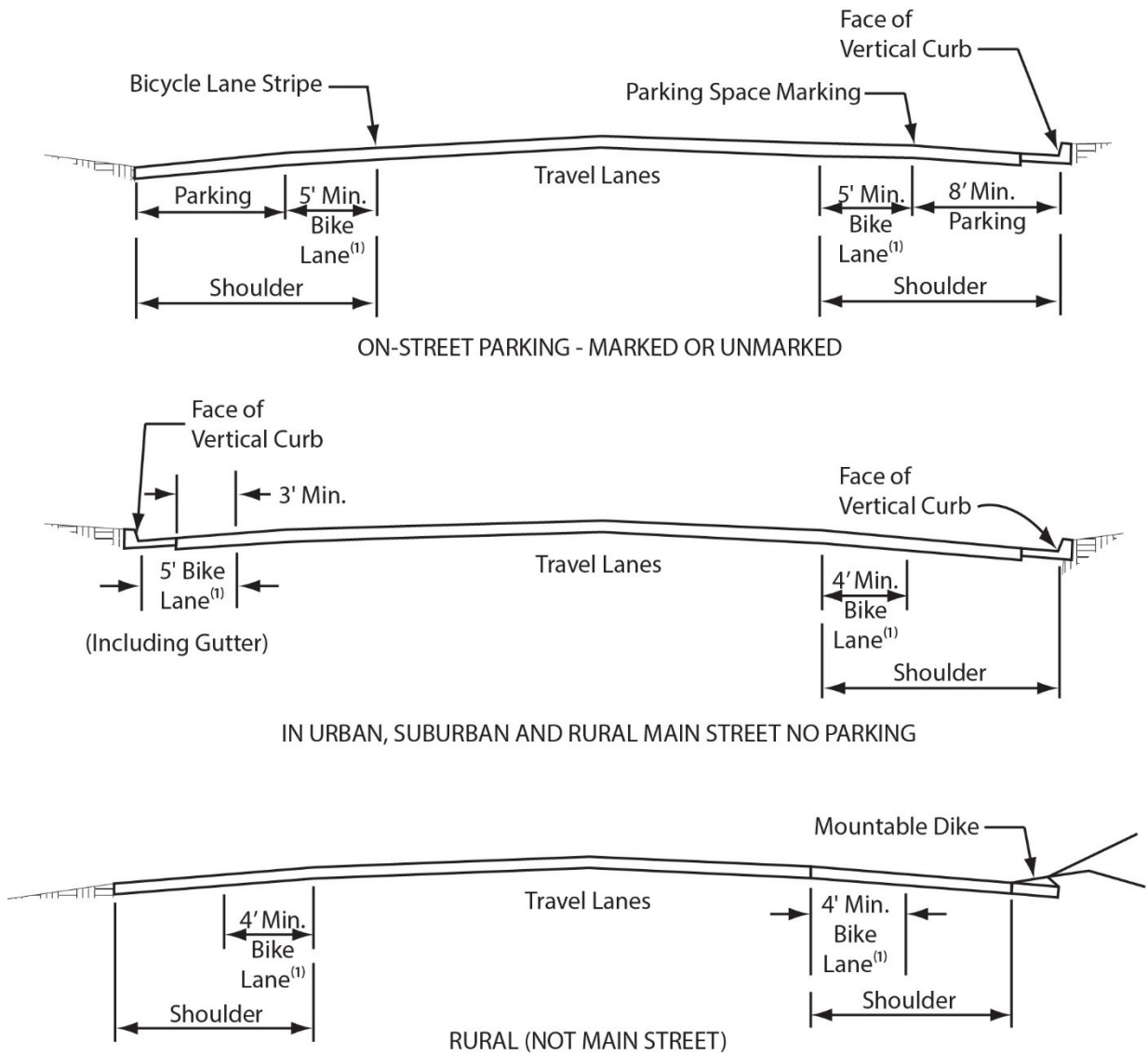

NOTES:

- (1) See Index 301.2 for additional guidance.
- (2) For pavement marking guidance, see the California MUTCD, Section 9C.04.

July 1, 2020

301.3 Cross Slopes

- (1) *General.* The purpose of sloping on roadway cross sections is to provide a mechanism to direct water (usually from precipitation) off the traveled way. Undesirable accumulations of water can lead to hydroplaning or other problems which can increase accident potential. See Topics 831 and 833 for hydroplaning considerations. For roadways with three (3) lanes or more sloped in the same direction, see topic 833.2.
- (2) *Standards.*
- (a) **The standard cross slope to be used for new construction on the traveled way for all types of surfaces shall be 2 percent.**
 - (b) **For resurfacing or widening (only when necessary to match existing cross slope), the minimum shall be 1.5 percent and the maximum shall be 3 percent.** However, the cross slope on 2-lane and multilane HMA highways should be increased to 2 percent if the cost is reasonable.
 - (c) **On unpaved roadway surfaces, including gravel and penetration treated earth, the cross slope shall be 2.5 percent to 5.0 percent.**

On undivided highways with two or more lanes in a normal tangent section, the high point of the crown should be centered on the pavement and the pavement sloped toward the edges on a uniform grade.

For rehabilitation and widening projects, the maximum algebraic difference in cross slope between adjacent lanes of opposing traffic for either 2-lane or undivided multilane highways should be 6 percent. For new construction, the maximum shall be 4 percent.

On divided highway roadbeds, the high point of crown may be centered at, or left of, the center of the traveled way, and preferably over a lane line (tangent sections). This strategy may be employed when adding lanes on the inside of divided highways, or when widening an existing "crowned" 2-lane highway to a 4-lane divided highway by utilizing the existing 2-lane pavement as one of the divided highway roadbeds.

The maximum algebraic difference in cross slope between same direction traffic lanes of divided highway roadbeds should be 4 percent.

The maximum difference in cross slope between the traveled way and the shoulder should not exceed 8 percent. This applies to new construction as well as pavement overlay projects.

At freeway entrances and exits, the maximum difference in cross slope between adjacent lanes, or between lanes and gore areas, should not exceed 5 percent.

Topic 302 – Highway Shoulder Standards

302.1 Width

The shoulder widths given in Table 302.1 shall be the minimum continuous usable width of paved shoulder on highways. Typically, on-street parking areas in urbanized areas is included in the shoulder.

Class II bikeways are typically part of the shoulder width, see Index 301.2. **Where rumble strips are placed in the shoulder, the shoulder shall be a minimum of 4 feet width to the right of the grooved rumble strip when a vertical element, such as curb or guardrails present or a minimum of 3 feet width when a vertical element is not present.** Shoulder rumble strip must not be placed in the Class II bike lane. Consult the District Traffic Safety Engineer during selection of rumble strip options and with the California MUTCD for markings in combination with rumble strip. Also see Standard Plans for rumble strip details.

See DIB 79 for 2R, 3R, certain storm damage, protective betterment, operational, and safety projects on two-lane and three-lane conventional highways.

See Index 308.1 for shoulder width requirements on city streets or county roads. See shoulder definition, Index 62.1(9).

See Index 1102.2 for shoulder width requirements next to noise Barriers.

When shoulders are less than standard width, see Index 204.5(4) for bicycle turnout considerations.

302.2 Cross Slopes

(1) *General* - **When a roadway crosses a bridge structure, the shoulders shall be in the same plane as the adjacent traveled way.**

(2) *Left Shoulders* - **In depressed median sections, shoulders to the left of traffic shall be sloped at 2 percent away from the traveled way.**

In paved median sections, shoulders to the left of traffic shall be designed in the plane of the traveled way. Maintenance paving beyond the edge of shoulder should be treated as appropriate for the site, but consideration needs to be given to the added runoff and the increased water depth on the pavement (see discussion in Index 831.4(5) "Hydroplaning").

(3) *Right Shoulders*- **In normal tangent sections, shoulders to the right of traffic shall be sloped at 2 percent to 5 percent away from the traveled way.**

The above flexibility in the design of the right shoulder allows the designer the ability to conform to regional needs. Designers shall consider the following during shoulder cross slope design:

July 1, 2020

Table 302.1

Boldface Standards for Paved Shoulder Widths on Highways

Highway Type	Paved Shoulder Width (ft)	
	Left ⁽⁸⁾	Right ⁽⁸⁾
Freeways & Expressways		
2 lanes ⁽¹⁾	--	8 ⁽⁶⁾
4 lanes ⁽¹⁾	5	10
6 or more lanes ⁽¹⁾	10	10
Auxiliary lanes	--	10
Freeway-to-freeway connections		
Single and two-lane connections	5	10
Three-lane connections	10	10
Single-lane ramps	4 ⁽²⁾	8
Multilane ramps	4 ⁽²⁾	8 ⁽³⁾
Multilane undivided	--	10
Collector-Distributor	5	10
Conventional Highways		
Multilane divided		
4-lanes	5	8 ⁽⁷⁾
6-lanes or more	8	8 ⁽⁷⁾
Urban areas with posted speeds less than or equal to 45 mph and curbed medians	2 ⁽⁴⁾	8 ⁽⁷⁾
Multilane undivided	--	8 ⁽⁷⁾
2-lane		
RRR	See Index 307.3	
New construction	See Table 307.2	
Slow-moving vehicle lane	--	4 ⁽⁵⁾
Local Facilities		
Frontage roads	See Index 310.1	
Local facilities crossing State facilities	See Index 308.1	

NOTES:

- (1) Total number of lanes in both directions including separate roadways (see Index 305.6). If a lane is added to one side of a 4-lane facility (such as a truck climbing lane) then that side shall have 10 feet left and right shoulders. See Index 62.1.
- (2) May be reduced to 2 feet upon concurrence from the Project Delivery Coordinator that a restrictive situation exists. 4 feet preferred in urban areas and/or when ramp is metered. See Index 504.3.
- (3) May be reduced to 2 feet or 4 feet (4 feet preferred in urban areas) in the 2-lane section of a non-metered ramp, which transitions from a single lane upon concurrence from the Project Delivery Coordinator that a restrictive situation exists. May be reduced to 2 feet in ramp sections having 3 or more lanes. See Index 504.3.
- (4) For posted speeds less than or equal to 35 mph, shoulder may be omitted (see Index 303.5(5)) except where drainage flows toward the curbed median.
- (5) On right side of climbing or passing lane section only. See Index 301.2(1) for minimum width if bike lanes are present.
- (6) 10-foot shoulders preferred.
- (7) Where on-street parking is allowed, 10 feet shoulder width is preferred. Where bus stops are present, 10 feet shoulder width is preferred for the length of the bus stop. If a Class II bikeway is present, minimum shoulder width shall be 8 feet where on street parking is provided plus the minimum required width for the bike lane.
- (8) Shoulders adjacent to abutment walls, retaining walls in cut locations, and noise barriers shall be not less than 10 feet wide. See Index 303.4 for minimum shoulder adjacent to bulbouts. See Index 309.1(4) for minimum shoulder width adjacent to high speed rail facilities.

- In most areas a 5 percent right shoulder cross slope is desired to most expeditiously remove water from the pavement and to allow gutters to carry a maximum water volume between drainage inlets. The shoulders must have adequate drainage interception to control the "water spread" as discussed in Table 831.3 and Index 831.4. Conveyance of water from the total area transferring drainage and rainwater across each lane and the quantity of intercepting drainage shall also be a consideration in the selection of shoulder cross slope. Hydroplaning is discussed in Index 831.4 (5).

In locations with snow removal operations it is desirable for right shoulders to slope away from traffic in the same plane as the traveled way. This design permits the snow plowing crew to remove snow from the lanes and the shoulders with the least number of passes.

- For 2-lane roads with 4-foot shoulders, see Index 307.2.
- If shoulders are Portland cement concrete and the District plans to convert shoulders into through lanes within the 20 years following construction, then shoulders are to be built in the plane of the traveled way and to lane standards for width and structural section. (See Index 603.4).
- Deciding to construct pedestrian facilities and elements, where none exist, is an important consideration. Shoulders are not required to be designed as accessible pedestrian routes although it is legal for a pedestrian to traverse along a highway. In urban, rural main street areas, or near schools and bus stops with pedestrians present, pedestrian facilities should be constructed. In rural areas where few or no pedestrians exist, it would not be reasonable or cost effective to construct pedestrian facilities. This determination should involve the local agency and must be consistent with the design guidance provided in Topic 105 and in Design Information Bulletin 82, "Pedestrian Accessibility Guidelines for Highway Projects" for people with disabilities.

Shoulder slopes for superelevated curves are discussed in Index 202.2.

See Index 307.2 for shoulder slopes on 2-lane roads with 4-foot shoulders.

302.3 Tapered Edge

The tapered edge is a sloped edge that is placed at the edge of the paved roadbed to provide a smooth reentry for vehicles that leave the roadway. Its design is based on research performed by the FHWA.

The tapered edge should be placed on all pavement edges either during new construction or on overlay projects irrespective of pavement types and is most useful:

- On undivided roadways.
- On roadways with unpaved shoulders.
- On roadways with Class II Bikeways.

The tapered edge is not to be placed on roadways:

- Next to curbs, dikes, guardrails, barriers, walls, and landscape paving.
- Where there is not enough room to place the tapered edge without reducing the existing lane width.

July 1, 2020

- Within 3 feet of driveways or intersections.
- Where pavement overlay thickness is less than 0.15 foot.

Tapered edge is optional when the distance between consecutive minor roads or driveways is less than 30 feet. See the Standard Plans for design and construction details regarding tapered edge.

Topic 303 – Curbs, Dikes, and Side Gutters

303.1 General Policy

Curb (including curb with gutter pan), dike, and side gutter all serve specific purposes in the design of the roadway cross section. Curb is primarily used for channelization, access control, separation between pedestrians and vehicles, and to enhance delineation. Dike is specifically intended for drainage and erosion control where stormwater runoff cannot be cost effectively conveyed beyond the pavement by other means. Curb with gutter pan serves the purpose of both curb and dike. Side gutters are intended to prevent runoff from a cut slope on the high side of a superelevated roadway from running across the pavement and is discussed further in Index 834.3.

Aside from their positive aspects in performing certain functions, curbs and dikes can have undesirable effects. In general, curbs and dikes should present the least potential obstruction, yet perform their intended function. As operating speeds increase, lower curb and dike height is desirable. Curbs and dikes are not considered traffic barriers.

On urban conventional highways where right of way is costly and/or difficult to acquire, it is appropriate to consider the use of a “closed” highway cross section with curb, or curb with gutter pan. There are also some situations where curb is appropriate in freeway settings. The following criteria describe typical situations where curb or curb with gutter pan may be appropriate:

- (a) Where needed for channelization, delineation, or other means of improving traffic flow and safety.
- (b) At ramp connections with local streets for the delineation of pedestrian walkways and continuity of construction at a local facility.
- (c) As a replacement of existing curb with gutter pan and sidewalk.
- (d) On frontage roads on the side adjacent to the freeway to deter vehicular damage to the freeway fence.
- (e) When appropriate to conform to local arterial street standards.
- (f) Where it may be necessary to solve or mitigate operational deficiencies through control or restriction of access of traffic movements to abutting properties or traveled ways.
- (g) In freeway entrance ramp gore areas (at the inlet nose) when the gore cross slope exceeds standards.
- (h) At separation islands between a freeway and a collector-distributor to provide a positive separation between mainline traffic and collector-distributor traffic.
- (i) Where sidewalk is appropriate.

(j) To deter vehicular damage of traffic signal standards.

Dike is appropriate where controlling drainage is not feasible via sheet flow or where it is necessary to contain/direct runoff to interception devices. On cut slopes, dike also protects the toe of slope from erosion. Dike may also be necessary to protect adjacent areas from flooding.

The use of curb should be avoided on facilities with posted speeds greater than or equal to 40 miles per hour, except as noted in Table 303.1. For projects where the use of curb is appropriate, it should be the type shown in Table 303.1.

303.2 Curb Types and Uses

Depending on their intended function, one of two general classifications of curb design is selected as appropriate. The two general classifications are vertical and sloped. Vertical curbs are nearly vertical (approximate batter of 1:4) and vary in height from 4 inches to 8 inches. Sloped curbs (approximate batter of 2:3 or flatter) vary in height from 3 inches to 6 inches.

Sloped curbs are more easily mounted by motor vehicles than vertical curbs. Since curbs are not generally adequate to prevent a vehicle from leaving the roadway, a suitable traffic barrier should be provided where redirection of vehicles is needed. A curb may be placed to discourage vehicles from intentionally entering the area behind the curb (e.g., truck offtracking). In most cases, the curb will not prevent an errant vehicle from mounting the curb.

Curb with gutter pan may be provided to enhance the visibility of the curb and thus improve delineation. This is most effective where the adjacent pavement is a contrasting color or material. B2-4 and B4 curbs are appropriate for enhancing delineation. Where curb with gutter pan is intended as delineation and has no drainage function, the gutter pan should be in the same plane as the adjacent pavement.

The curb sections provided on the Standard Plans are approved types to be used as stated below. The following types are vertical curb, (for information on side gutters, see Index 834.3):

- (1) *Types A1-6, A2-6, and A3-6.* These curbs are 6 inches high. Their main function is to provide a more positive deterrent to vehicles than provided by sloped curbs. Specifically, these curbs are used to separate pedestrians from vehicles, to control parking of vehicles, and to deter vehicular damage of traffic signal standards. They may also be used as raised median islands in low speed environments (posted speed \leq 35 miles per hour). These curbs do not constitute a barrier as they can be mounted except at low speeds and flat angles of approach.
- (2) *Types A1-8, A2-8, and A3-8.* These 8-inch high curbs may be used in lieu of 6-inch curbs when requested by local authorities, if the curb criteria stated under Index 303.1 are satisfied and posted speeds are 35 miles per hour or less. This type of curb may impede curbside passenger loading and may make it more difficult to comply with curb ramp design (see Design Information Bulletin Number 82, "Pedestrian Accessibility Guidelines for Highway Projects").
- (3) *Type H Curb.* This type may be used on bridges where posted speeds are 40 miles per hour or less and where it is desired to match the approach roadway curb. Type H

July 1, 2020

curb is often incorporated into bridge barrier/sidewalk combination railings (See Index 208.10(4)).

Table 303.1**Selection of Curb Type**

Location	Posted Speeds (mph)		
	≤ 35	40	≥ 45
Freeways and Expressways			
Collector-distributor Roads	See Index 504.3(11)		
Ramps			
Conventional Highways			
Frontage Roads (1)	A or B-6	B-6	B-4
Traffic Signals	A or B-6	B-6	B-4
Raised Traffic, Median Islands & Pedestrian Refuge Islands (2)	A or B-6	B-6	B-4 or D
Adjacent to Sidewalks	A (3)	A-6	B-6
Bulbouts/curb extensions	A	NA	NA
Bridges (4)	H, A3, or B3	H or B3	B3

NOTES:

- (1) Based on the posted speed along the frontage road.
- (2) See the National Cooperative Highway Research Program Report 672 entitled "Roundabouts: An Informational Guide, 2nd ed." for information on curbs at roundabouts.
- (3) Type A curb includes Types A1-6, A2-6, A1-8, and A2-8.
- (4) Type H curb typically used in conjunction with Type A curbs next to sidewalks on approach roadway. Type A3 curbs typically used with corresponding Type A curbs on median island of approach roadway. Type B3 curbs typically used with corresponding Type B curbs on approach roadway.

These types are sloped curbs:

- (4) *Types B1, B2, and B3 Curbs* Types B1-6, B2-6, and B3-6 are 6 inches high. Type B1-4, B2-4, and B3-4 are 4 inches high. Since all have a 1:1½ slope or flatter on the face, they are mounted more easily than Type A curbs. Typical uses of these curbs are for channelization including raised median islands. B2 curb with gutter pan also serves as drainage control.
- (5) *Type B4 Curb.* Type B4 curb with gutter pan is 3 inches high and is typically used on ramp gores as described in Index 504.3(11). It may also be appropriate where a lower curb is desirable.
- (6) *Type D Curb.* Type D curb is 4 inches or 6 inches high and is typically used for raised traffic islands, collector-distributor separation islands, or raised medians when posted speeds equal or exceed 45 miles per hour.
- (7) *Type E Curb.* This essentially is a rolled gutter used only in special drainage situations.

Curbs with gutter pans, along with the shoulder, may provide the principal drainage system for the roadway. Inlets are provided in the gutter pan or curb, or both.

Gutter pans are typically 2 feet wide but may be 1 foot to 4 feet in width, with a cross slope of typically 8.33 percent to increase the hydraulic capacity. Gutter pan cross slopes often need to be modified at curb ramps in order to meet accessibility requirements. See Design Information Bulletin Number 82, "Pedestrian Accessibility Guidelines for Highway Projects" and Standard Plan A88A.

Curbs and gutter pans are cross section elements considered entirely outside the traveled way, see Index 301.1.

303.3 Dike Types and Uses

Use of dike is intended for drainage control and should not be used in place of curb. Dikes placed adjoining the shoulder, as shown in Figures 307.2, 307.4A, 307.4B, and 307.5, provide a paved triangular gutter within the shoulder area. The dike sections provided on the Standard Plans are approved types to be used as stated below. Dikes should be selected as illustrated in Figure 303.3. Dikes should be designed so that roadway runoff is contained within the limits specified in Index 831.3. For most situations Type E dike is the preferred dike type as discussed below.

- (1) *Type A Dike.* This 6-inch high dike is to be used where dike is necessary for drainage underneath guardrail with 12-inch blockout installation. This dike is placed directly under the face of guardrail. Otherwise, the use of Type A dike should be avoided. For RRR projects, Type A dike may be used in cut sections with slopes steeper than 3:1 and where existing conditions do not allow for construction of the wider Type D or E dikes. Compacted embankment material should be placed behind the back of dike as shown in Figure 303.3.

July 1, 2020

Figure 303.3

Dike Type Selection and Placement⁽¹⁾

CUT SECTIONS

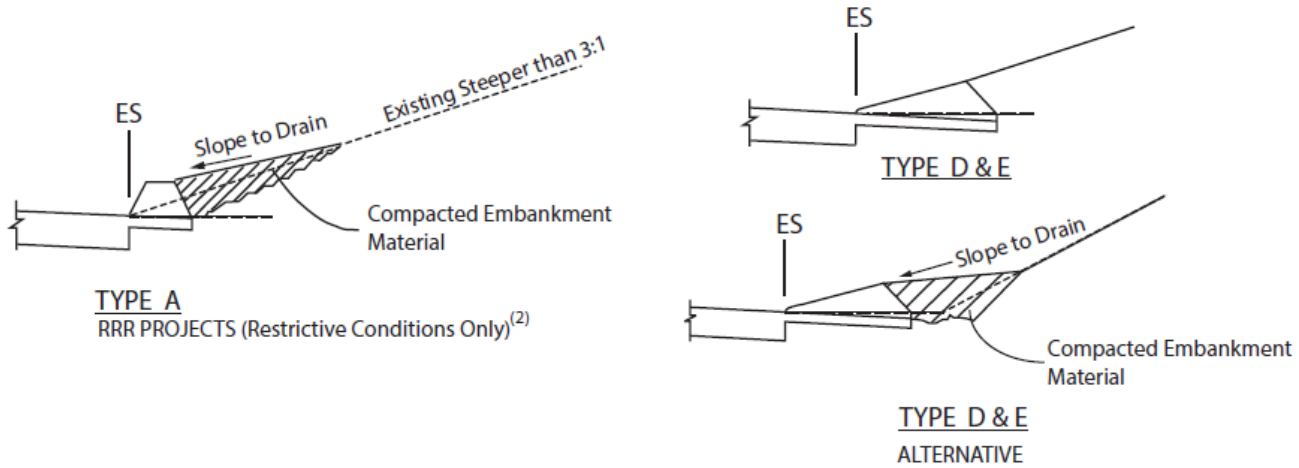

FILL SECTIONS

5' for Type D

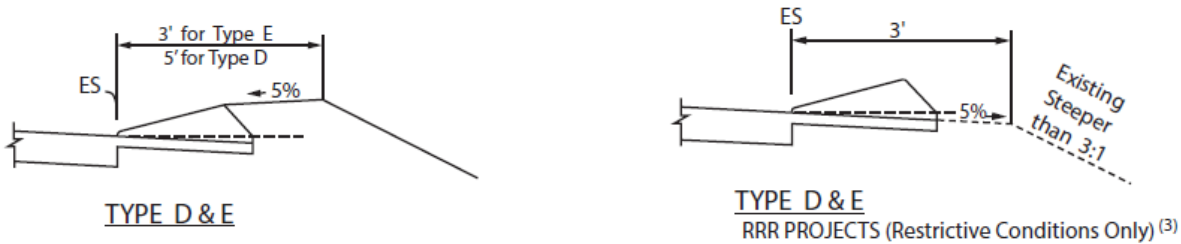

CUT/FILL SECTIONS

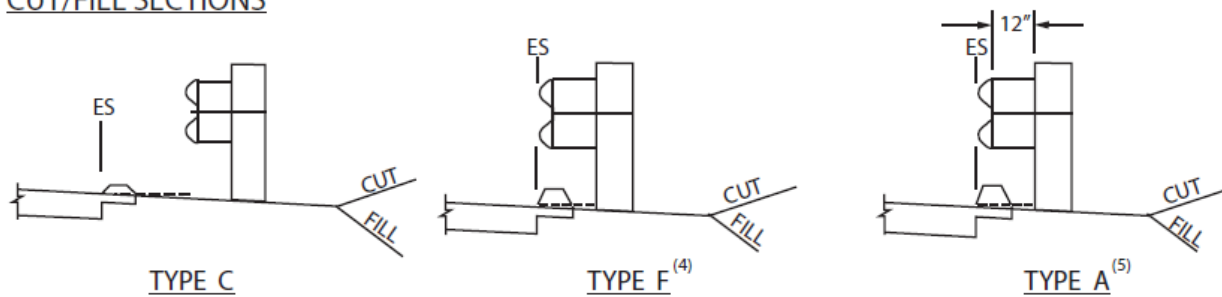

Notes:

- (1) See Standard Plans for additional information and details.
- (2) See Index 303.3(1) for restrictive conditions.
- (3) See Index 303.3(3) and Index 303.3(4) for restrictive conditions for Types D and E respectively.
- (4) Use under guardrail when dike is necessary for drainage control.
- (5) Use under guardrail with 12-inch blockouts when dike is necessary for drainage control.

- (2) *Type C Dike.* This low dike, 2 inches in height, may be used to confine small concentrations of runoff. The capacity of the shoulder gutter formed by this dike is small. Due to this limited capacity, the need for installing an inlet immediately upstream of the beginning of this dike type should be evaluated. This low dike can be traversed by a vehicle and allows the area beyond the surfaced shoulder to be used as an emergency recovery and parking area. The Type C dike is the only dike that may be used in front of guardrail. In such cases, it is not necessary to place compacted embankment material behind Type C dike.
- (3) *Type D Dike.* This 6-inch high dike provides about the same capacity as the Type A dike but has the same shape as the Type E dike. The quantity of material in the Type D dike is more than twice that of a Type E dike. It should only be used where there is a need to contain higher volumes of drainage. Compacted embankment material should be placed behind the back of dike as shown in Figure 303.3. For RRR projects that do not widen pavement, compacted embankment material may be omitted on existing fill slopes steeper than 3:1 when there is insufficient room to place the embankment material.
- (4) *Type E Dike.* This 4-inch high dike provides more capacity than the Type C dike. Because Type E dike is easier to construct than Type D dike, and has greater drainage capacity than Type C dike, it is the preferred dike type for most installations. Compacted embankment material should be placed behind the back of dike as shown in Figure 303.3. For RRR projects that do not widen pavement, compacted embankment material may be omitted on existing fill slopes steeper than 3:1 where there is insufficient room to place the embankment material.
- (5) *Type F Dike.* This 4-inch high dike is to be used where dike is necessary for drainage underneath a guardrail installation. This dike is placed directly under the face of guardrail installations.

303.4 Curb Extensions

- (1) *Bulbouts.* A bulbout is an extension of the sidewalk into the roadway when there is marked on-street parking, see Index 402.3. Bulbouts should comply with the guidance provided in Figures 303.4A and B; noting that typical features are shown and that the specific site conditions need to be taken into consideration. Bulbouts provide queuing space and shorten crossing distances, thereby reducing pedestrian conflict time with mainline traffic. By placing the pedestrian entry point closer to traffic, bulbouts improve visibility between motorists, bicyclists, and pedestrians. They are most appropriate for urban conventional highways and Rural Main Streets with posted speeds 35 miles per hour or less. Curb extensions are not to extend into Class II Bikeways (Bike Lanes). The corner curb radii should be the minimum needed to accommodate the design vehicle, see Topic 404.

When used, bulbouts should be placed at all corners of an intersection. When used at mid-block crossing locations, bulbouts should be used on both sides of the street. The curb face of the bulbout should be setback a minimum of 2 feet as shown in Figures 303.4A and B. See the California MUTCD for on-street parking signs and markings. Landscaping and appurtenant facilities located within a bulbout are to comply per Topic 405.

July 1, 2020

Figure 303.4A

Typical Bulbout with Class II Bikeway (Bike Lane)

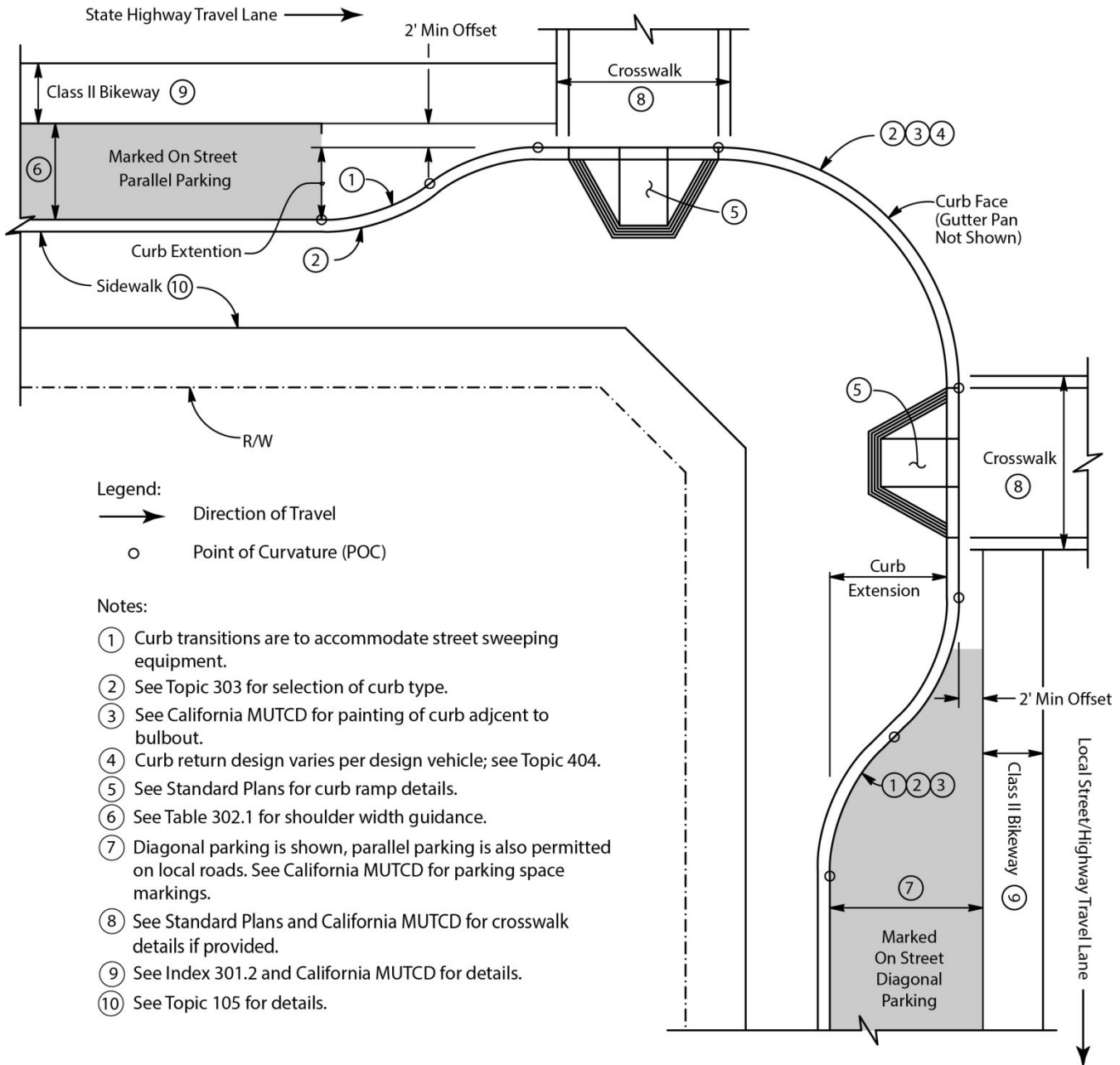
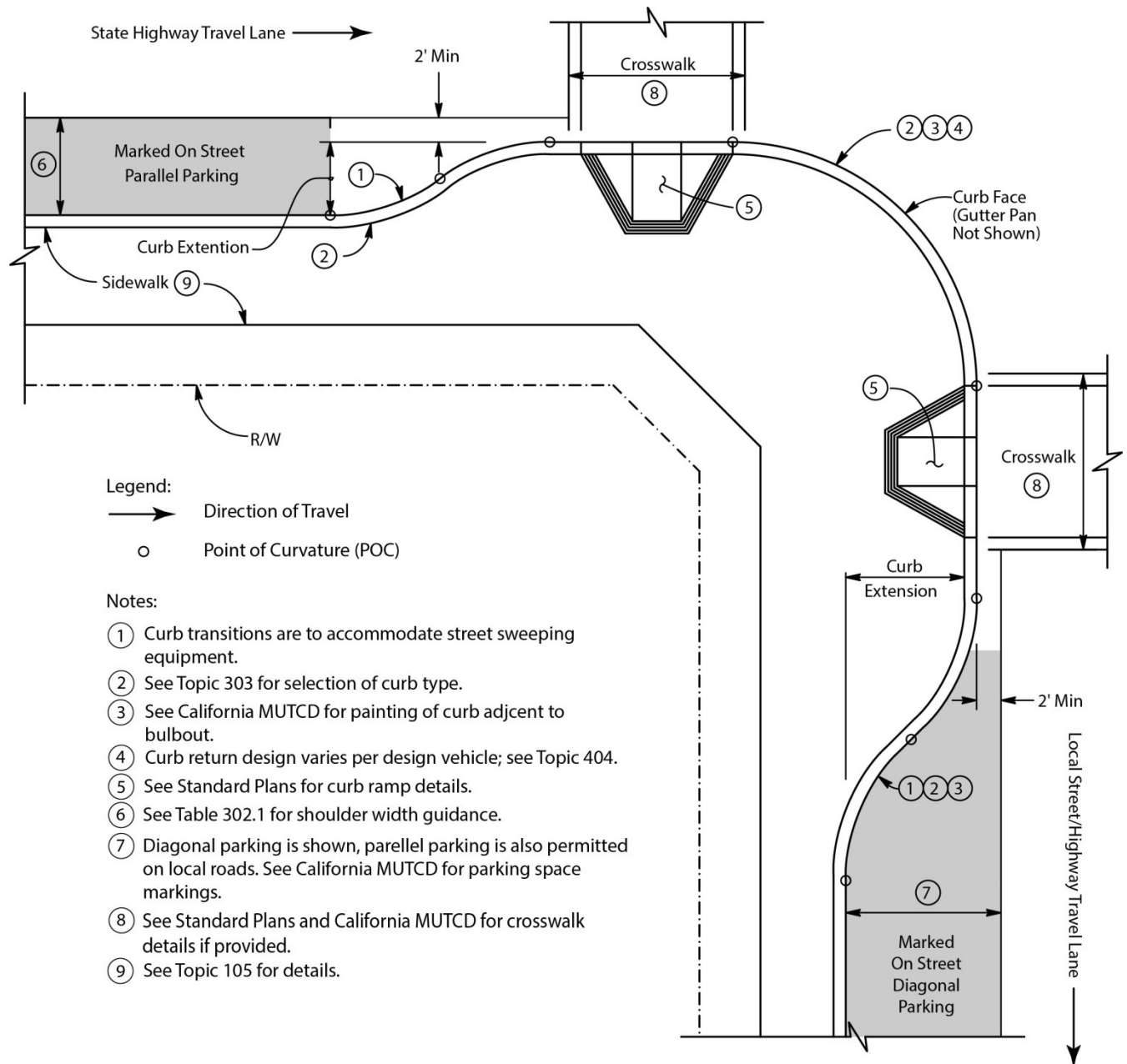

Figure 303.4B

Typical Bulbout without Class II Bikeway (Bike Lane)



July 1, 2020

Bulbouts are considered pedestrian facilities and as such, compliance with DIB 82 is required. Avoid bulbouts on facilities where highway grade lines exceed 5 percent.

(2) *Busbulbs*. A busbulb is a bulbout longer than 25 feet which facilitates bus loading and unloading, and provides for enhanced bus mobility. Busbulbs reduce bus dwell times and provide travel time benefits to transit passengers. However, busbulbs can restrict the mobility of vehicular and bicycle traffic because they allow the bus to stop in their traveled way to load and unload passengers. Therefore, their impact on the mobility of the vehicular and bicycle traffic using the facility must be taken into consideration, and pursuant to the California Vehicle Code, busbulbs or other transit stops which require a transit vehicle to stop in the traveled way require approval from the Department. In lieu of a busbulb, a busbay may be considered which will not impact the mobility of the vehicular and bicycle users of the facility.

(3) *Busbays*. A busbay is an indentation in the curb which allows a bus to stop completely outside of vehicular and bicycle lanes.

Busbays may be created by restricting on street parking.

303.5 Position of Curbs and Dikes

Curbs located at the edge of the traveled way may have some effect on lateral position and speed of moving vehicles, depending on the curb configuration and appearance. Curbs with low, sloped faces may encourage drivers to operate relatively close to them. Curbs with vertical faces may encourage drivers to slow down and/or shy away from them and, therefore, it may be desirable to incorporate some additional roadway width.

All dimensions to curbs (i.e., offsets) are from the near edge of traveled way to bottom face of curb. All dimensions to dikes are from the near edge of traveled way to flow line. Curb and dike offsets should be in accordance with the following:

- (1) *Through Lanes*. The offset from the edge of traveled way to the face of curb or dike flow line should be no less than the shoulder width, as set forth in Table 302.1.
- (2) *Channelization*. Island curbs used to channelize intersection traffic movements should be positioned as described in Index 405.4.
- (3) *Separate Turning Lanes*. Curb offsets to the right of right-turn lanes in urban areas may be reduced to 2 feet if design exception approval for nonstandard shoulder width has been obtained in accordance with Index 82.2. No curb offset is required to the left of left-turn lanes in urban areas unless there is a gutter pan.
- (4) *Median Openings*. Median openings (Figure 405.5) should not be separated with curb unless necessary to delineate areas occupied by traffic signal standards.
- (5) *Urban Conventional Highways*. When the posted speed is less than or equal to 35 miles per hour, no median curb offset is required if there is no gutter pan.
- (6) *Structure Approach Slabs*. When a dike is required to protect the side slope from erosion, it should be placed on the structure approach and sleeper slabs as well as aligned to tie into the end of the structure railing. The guardrail alignment and edge of shoulder govern the positioning of the dike.

When the Type 14 structure approach slab is used, concrete dikes are preferred. Hot mixed asphalt dike will inevitably crack due to expansion and contraction at the approach/sleeper slab joint. A metal dike insert is used to carry the flow across the sealed joint. The insert acts as a water barrier to minimize erosion of the fill slope. Details of the

metal dike insert are shown in the structure approach plans provided by the Division of Engineering Services, (DES).

- (7) *Bridges and Grade Separation Structures.* When both roadbeds of a curbed divided highway are carried across a single structure, the median curbs on the structure should be in the same location as on adjacent roadways.
- (8) *Approach Nose.* The approach nose of islands should also be designed utilizing a parabolic flare, as discussed in Index 405.4.

303.6 Curbs and Dikes on Frontage Roads and Streets

Continuous curbs or dikes are not necessarily required on all frontage roads. Where curbs or dikes are necessary for drainage control or other reasons, they should be consistent with the guidelines established in this topic and placed as shown on Figure 307.4B. Local curb standards should be used when requested by local authorities for roads and streets that will be relinquished to them.

Topic 304 – Side Slopes

304.1 Side Slope Standards

Slopes should be designed as flat as is reasonable. For new construction, widening, or where slopes are otherwise being modified, embankment (fill) slopes should be 4:1 or flatter. Factors affecting slope design are as follows:

- (a) *Safety.* Flatter slopes provide better recovery for errant vehicles that may run off the road. A cross slope of 6:1 or flatter is suggested for high speed roadways whenever it is achievable. Cross slopes of 10:1 are desirable.

Embankment slopes 4:1 or flatter are recoverable for vehicles. Drivers who encroach on recoverable slopes can generally stop or slow down enough to return to the traveled way safely. See Index 309.1(2) for information on clear recovery zones.

A slope which is between 3:1 and 4:1 is considered traversable, but not recoverable. Since a high percentage of vehicles will reach the toe of these slopes, the recovery area should be extended beyond the toe of slope. The AASHTO Roadside Design Guide should be consulted for methods of determining the preferred extent of the runout area.

Embankment slopes steeper than 3:1 should be avoided when accessible by traffic. District Traffic, and the AASHTO Roadside Design Guide should be consulted for methods of determining the preferred treatment.

Regardless of slope steepness, it is desirable to round the top of slopes so an encroaching user remains in contact with the ground. Likewise, the toe of slopes should be rounded to prevent users from nosing into the ground.

- (b) *Erosion Control.* Slope designs steeper than 4:1 must be approved by the District Landscape Architect in order to assure compliance with the regulations affecting Stormwater Pollution contained in the Federal Clean Water Act (see Index 82.4). Slope steepness and length are two of the most important factors affecting the erodibility of a slope. Slopes should be designed as flat as possible to prevent erosion. However, since there are other factors such as soil type, climate, and exposure to the sun, District Landscape Architecture and the District Stormwater Coordinator must be contacted for erosion control requirements. See Topic 906.

December 31, 2020

A Storm Water Data Report (SWDR) documents project information and considerations pertaining to Storm Water Best Management Practices (BMPs) and Erosion Control methods. The SWDR is prepared and signed by key personnel (including the District Landscape Architect) at the completion of each phase of a project. By signing the SWDR, the District Landscape Architect approves compliance with the proposed slope designs.

- (c) *Structural Integrity*. Slopes steeper than 2:1 require approval of District Maintenance. The Geotechnical Design Report (See Topic 113) will recommend a minimum slope required to prevent slope failure due to soil cohesiveness, loading, slip planes and other global stability type failures. There are other important issues found in the Geotechnical Design Report affecting slope design such as the consistency of the soil likely to be exposed in cuts, identification of the presence of ground water, and recommendations for rock fall.
- (d) *Economics*. Economic factors such as purchasing right of way, imported borrow, and environmental impacts frequently play a role in the decision of slope length and steepness. In some cases, the cost of stabilizing, planting, and maintaining steep slopes may exceed the cost of additional grading and right of way to provide a flatter slope.
- (e) *Aesthetics*. Flat, gentle, and smooth, well transitioned slopes are visually more satisfying than steep, obvious cuts and fills. In addition, flatter slopes are more easily revegetated, which helps visually integrate the transportation improvement within its surrounding environment. Contact the District Landscape Architect when preparing a contour grading plan.

Where normal slopes catch in a distance less than 18 feet from the edge of the shoulder, a uniform catch point, at least 18 feet from the edge of the shoulder, should be used. This is done not only to improve errant vehicle recovery and aesthetics, but also to reduce grading costs. Uniform slopes wider than 18 feet can be constructed with large production equipment thereby reducing earthwork costs.

Transition slopes should be provided between adjoining cuts and fills. Such slopes should intersect the ground at the uniform catch point line.

In areas where heavy snowfall can be expected, consideration should be given to snow removal problems and snow storage in slope design. It is considered advisable to use flatter slopes in cuts on the southerly side of the roadway where this will provide additional exposure of the pavement to the sun.

304.2 Clearance From Slope to Right of Way Line

The minimum clearance from the right of way line to catch point of a cut or fill slope should be 10 feet for all types of cross sections. When feasible, at least 15 feet should be provided.

Following are minimum clearances recommended for cuts higher than 30 feet:

- a. Twenty feet for cuts from 30 feet to 50 feet high.
- b. Twenty-five feet for cuts from 50 feet to 75 feet high.
- c. One-third the cut height for cuts above 75 feet, but not to exceed a width of 50 feet.

The foregoing clearance standards should apply to all types of cross sections.

304.3 Slope Benches and Cut Widening

The necessity for benches, their width, and vertical spacing should be finalized only after an adequate materials investigation. Since greater user benefits are realized from widening a cut than from benching the slope, benches above grade should be used only where necessary. Benches above grade should be used for such purposes as installation of horizontal drains, control of surface erosion, or intercepting falling rocks. Design of the bench should be compatible with the geotechnical features of the site.

Benches should be at least 20 feet wide and sloped to form a valley at least 1 foot deep with the low point a minimum of 5 feet from the toe of the upper slope. Access for maintenance equipment should be provided to the lowest bench, and if feasible to all higher benches.

In cuts over 150 feet in height, with slopes steeper than 1½:1, a bench above grade may be desirable to intercept rolling rocks. The Division of Engineering Services – Geotechnical Services (DES-GS) should be consulted for assistance in recommending special designs to contain falling and/or rolling rocks.

Cut widening may be necessary:

- (a) To provide for drainage along the toe of the slope.
- (b) To intercept and store loose material resulting from slides, rock fall, and erosion.
- (c) For snow storage in special cases.
- (d) To allow for planting.

Where the widened area is greater than that required for the normal gutter or ditch, it should be flush with the edge of the shoulder and sloped upward or downward on a gentle slope, preferably 20:1 in areas of no snow; and downward on a 10:1 slope in snow areas.

304.4 Contour Grading and Slope Rounding

Contour grading, slope rounding and topsoil replacement are important factors in roadside design to help make highway improvements compatible with the surrounding environment while comply with National Pollutant Discharge Elimination System permits (NPDES). Smooth, flowing contours that tie gracefully into the existing adjacent roadside and landforms are visually appealing and conducive to safe vehicle recovery (see Index 304.1), reduce the

July 1, 2020

potential for erosion and stormwater runoff, and reduce roadside maintenance activities while contributing to the long term success of revegetation planting.

Contour grading plans are to be prepared to facilitate anticipated roadside treatments and future maintenance activities. These plans should show flattened slopes where right of way permits. The tops and ends of all cut slopes should be rounded. Rock cut slopes should be irregular where possible to provide a natural appearance and the tops and ends should also be rounded. All slope designs should include consideration of an application of local or imported topsoil and duff to promote the growth of vegetation, improve stormwater pollutant filtration and control erosion. The calculation of the final grade for a project needs to take into account the reapplication of topsoil and duff.

Local topsoil and duff material within the grading limits should be identified on the plans, removed or excavated, stockpiled, and reapplied. This is to be performed on all projects that include grading or earthwork unless the materials are determined to be unsuitable. Refer to Index 904.2(2).

Coordinate the development of contour grading plans including, removal, stockpiling, suitability of material and application of topsoil and duff with the District Landscape Architect. See Index 904.2.

304.5 Stepped Slopes

Stepped cut slopes should be used to encourage material revegetation from the adjacent plants. Stepped slopes are a series of small benches 1 foot to 2 feet wide. Generally, stepped slopes can be used in rippable material on slopes 2:1 or steeper. Steps may be specified for slopes as flat as 3:1. Steps are provided to capture loose material, seed, and moisture. Topsoil should be reapplied to stepped slopes to encourage revegetation.

For appearance, steps on small cuts viewed from the roadway should be cut parallel to the road grade. Runoff is minimized on steps cut parallel to roads with grades up to 10 percent, as long as the natural ravel from construction is left on the steps. Steps less than one-half full should not be cleaned.

High cuts viewed from surrounding areas should be analyzed before a decision is made to form steps parallel to the roadway or horizontal. In some cases, horizontal steps may be more desirable. Special study is also necessary when a sag occurs in the vertical alignment within the cut. In all cases at the ends of cuts, the steps should wrap around the rounded transition.

The detail or contract special provisions should allow about a 20 percent variation, expressed in terms of tenths of a foot. Some irregularity will improve the appearance of the slope by making it appear more natural.

In designing step width, the material's weathering characteristics should generally be considered. Widths over approximately 2 feet should be avoided because of prominence and excessive time to achieve a weathered and natural appearance. Contact the DES-GS and the District Landscape Architect for more information about the width of steps.

Topic 305 – Median Standards

305.1 Width

Median width is expressed as the dimension between inside edges of traveled way, including the inside shoulder. This width is dependent upon the type of facility, costs, topography, and right of way. Consideration may be given to the possible need to construct a wider median than prescribed in Cases (1), (2), and (3), below, in order to provide for future expansion to accommodate:

- a. Public Transit (rail and bus).
- b. Traffic needs more than 20 years after completion of construction.

Median width as presented in Case (1) below applies to new construction, projects to increase mainline capacity and to reconstruction projects. Any recommendation to provide additional median width should be identified and documented as early as possible and must be justified in a project initiation document and/or project report. Attention should be given to such items as initial costs, future costs for outside widening, the likelihood of future needs for added mixed flow or High-Occupancy Vehicle (HOV) lanes, traffic interruption, future mass transit needs and right of way considerations. (For instance, increasing median width may add little to the cost of a project where an entire city block must be acquired in any event.)

Median pedestrian refuge areas at intersections lessen the risk of pedestrian exposure to traffic. See Index 405.4(3) and DIB 82 for pedestrian refuge guidance.

If additional width is justified, the minimum median widths provided below should be increased accordingly.

Minimum median widths for the design year (as described below) should be used in order to accommodate the ultimate highway facility (type and number of lanes):

(1) Freeways and Expressways.

- (a) Urban Areas. Where managed lanes (HOV, Express, etc) or transit facilities are planned, the minimum median width should be 62 feet. Where there is little or no likelihood of managed lanes or transit facilities planned for the future, the minimum median width should be 46 feet. However, where physical and economic limitations are such that a 46-foot median cannot be provided at reasonable cost, the

July 1, 2020

minimum median width for freeways and expressways in urban areas should be 36 feet.

(b) Rural Areas. The minimum median width for freeways and expressways in rural areas should be 62 feet.

(2) *Conventional Highways.* Appropriate median widths for non-controlled access highways vary widely with the type of facility being designed. In Urban and Rural Main Street areas, the minimum median width for multilane conventional highways should be 12 feet. However, this width would not provide room for left-turn lanes at intersections with raised curb medians, nor left-turn lanes in striped medians with room for pedestrian refuge areas. Posted speed and left shoulder width can also affect median width. See Table 302.1.

Medians refuge areas at pedestrian crosswalks and bicycle path crossings provide a space for pedestrians and bicyclists. They allow these users to cross one direction of traffic at a time. Where medians are provided, they should allow access through them for pedestrians and bicyclists as necessary. Bicycle crossings through paved medians should line up with the bicycle path of travel and not require bicyclists to utilize the pedestrian crosswalk. See Index 405.4 for additional requirements.

Where medians are provided for proposed future two-way left-turn lanes, median widths up to 14 feet may be provided to conform to local agency standards (see Index 405.2). **In rural areas the minimum median width for multilane conventional highways shall be 12 feet.** This provides the minimum space necessary to accommodate a median barrier and 5-foot shoulders. Whenever possible, and where it is appropriate, this minimum width should be increased to 30 feet or greater.

At locations where a climbing or passing lane is added to a 2-lane conventional highway, a 4-foot median (or "soft barrier") between opposing traffic lanes should be used.

(3) *Facilities under Restrictive Conditions.* Where certain restrictive conditions, including steep mountainous terrain, extreme right of way costs, and/or significant environmental factors are encountered, the basic median widths above may not be attainable. Where such conditions exist, a narrower median, down to the limits given below, may be allowed with adequate justification. (See Index 307.5.)

(a) Freeways and Expressways. **In areas where restrictive conditions prevail the minimum median width shall be 22 feet.**

(b) Conventional Highways. Median widths should be consistent with requirements for two-way left-turn lanes or the need to construct median barriers (as discussed in Index 305.1(2)), but may be reduced or eliminated entirely in extreme situations.

The above stated minimum median widths should be increased at spot locations to accommodate the construction of bridge piers or other planned highway features while maintaining standard cross section elements such as inside shoulder width and horizontal clearance. If a bridge pier is to be located in a tangent section, the additional width should be developed between adjacent horizontal curves; if it is to be located in a curve, then the additional width should be developed within the limits of the curve. Provisions should be made for piers 6 feet wide or wider. Median widths in areas of multilevel interchanges or other major structures should be coordinated with the Division of Engineering Services, Structures Design (DES-SD).

Consideration should also be given to increasing the median width at unsignalized intersections on expressways and divided highways in order to provide a refuge area for large trucks attempting to cross the State route.

In any case, the median width should be the maximum attainable at reasonable cost based on site specific considerations of each project.

See Index 613.5(2)(b) for paved median pavement structure requirements.

305.2 Median Cross Slopes

Unsurfaced medians up to 65 feet wide should be sloped downward from the adjoining shoulders to form a shallow valley in the center. Cross slopes should be 10:1 or flatter; 20:1 being preferred. Slopes as steep as 6:1 are acceptable in exceptional cases when necessary for drainage, stage construction, etc. Cross slopes in medians greater than 65 feet should be treated as separate roadways (see Index 305.6).

Paved medians, including those bordered by curbs, should be crowned at the center, sloping towards the sides at the slope of the adjacent pavement.

305.3 Median Barriers

See Traffic Safety Systems Guidance.

305.4 Median Curbs

See Topic 303 for curb types and usage in medians and Index 405.5(1) for curbs in median openings.

305.5 Paved Medians

(1) *Freeways.*

(a) 6 or More Lanes--Medians 30 feet wide or less should be paved.

(b) 4 Lanes--Medians 22 feet or less in width should be paved. Medians between 22 feet and 30 feet wide should be paved only if a barrier is installed. With a barrier, medians wider than 30 feet should not normally be paved.

Where medians are paved, each half generally should be paved in the same plane as the adjacent traveled way.

(2) *Nonfreeways.* Unplanted curbed medians generally are to be surfaced with minimum 0.15 foot of Portland cement concrete.

For additional information on median cross slopes see Index 305.2.

July 1, 2020

305.6 Separate Roadways

- (1) *General Policy.* Separate grade lines are not considered appropriate for medians less than 65 feet wide (see Index 204.7).
- (2) *Median Design.* The cross sections shown in Figure 305.6 include a clear recovery zone that provides maneuvering room for out-of-control users. See Index 309.1(2).

See Index 302.1 for shoulder widths and Index 302.2 for shoulder cross slopes.

Topic 306 – Right of Way

306.1 General Standards

The right of way widths for State highways, including frontage roads to be relinquished, should provide for installation, operation and maintenance of all cross section elements needed depending upon the type of facility, including median, traffic lanes, bicycle lanes, outside shoulders, sidewalks, recovery areas, slopes, sight lines, outer separations, ramps, walls, transit facilities and other essential highway appurtenances. For minimum clearance from the right of way line to the catch point of a cut or fill slope, see Index 304.2. Fixed minimum widths of right of way, except for 2-lane highways, are not specified because dimensions of cross-sectional elements may require narrow widths, and right of way need not be of constant width. The minimum right of way width on new construction for 2-lane highways should be 150 feet.

306.2 Right of Way Through the Public Domain

Right of way widths to be obtained or reserved for highway purposes through lands of the United States Government or the State of California are determined by laws and regulations of the agencies concerned.

Topic 307 – Cross Sections for State Highways

307.1 Cross Section Selection

The cross section of a State highway is based upon the number of vehicles, including trucks, buses, bicycles, and safety, terrain, transit needs and pedestrians. Other factors such as sidewalks, bike paths and transit facilities, both existing and future should be considered. For 2-lane roads the roadbed width is influenced by the factors discussed under Index 307.2. The roadbed width for multilane facilities should be adequate to provide capacity for the design hourly volume based upon capacity considerations discussed under Index 102.1.

When it becomes necessary to widen an existing cross section, e.g., add or widen the paved shoulder or lane, refer to Index 653.2 and Index 662.3 to ensure proper drainage of both the existing and widening structural sections. See also Chapter 680, Pavement Design for Widening Projects.

Figure 305.6

Optional Median Designs for Freeways with Separate Roadways

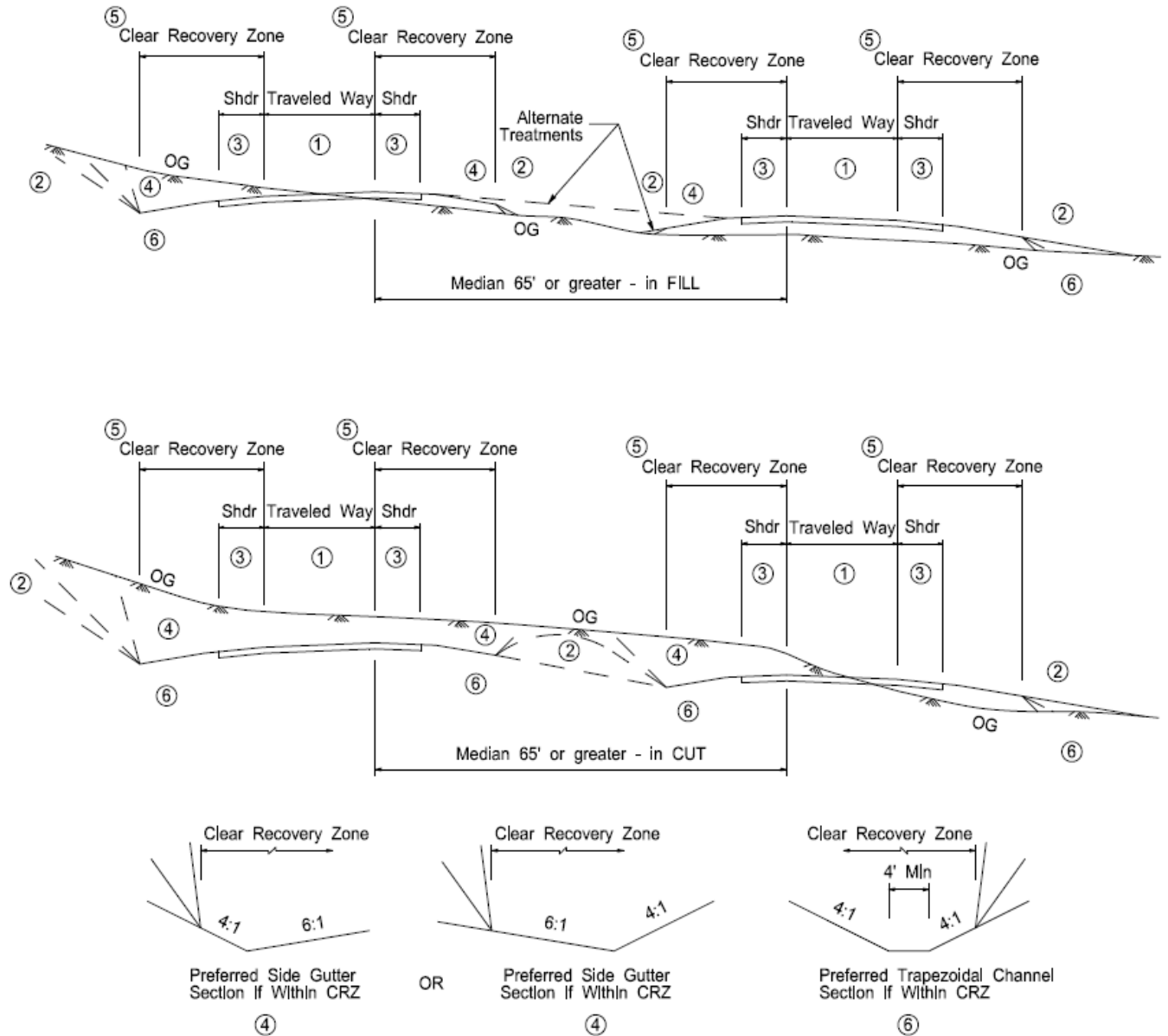

NOTES:

① CROSS SLOPES	See Index 302.2	④ SIDE GUTTERS	See Index 834.3(3)
② SIDE SLOPES	See Index 304.1	⑤ CLEAR RECOVERY ZONE	See Index 309.1(2)
③ SHOULDER WIDTH	See Index 302.1	⑩ ROADSIDE CHANNELS	See Topic 860

July 1, 2020

307.2 Two-lane Cross Sections for New Construction

These standards are to be used for highways on new alignment as well as on existing highways where the width, alignment, grade, or other geometric features are being upgraded.

A 2-lane, 2-way roadbed consists of a 24-foot wide traveled way plus paved shoulders. In order to provide structural support, the minimum paved width of each shoulder should be 2 feet. Shoulders less than 4 feet are not adequate for bicycles. Where 4-foot shoulders are not possible, consideration should be given to providing turnouts for bicycles. See Index 204.5(4) for turnout information. See Topic 1003 and Index 301.2 for information on bicycle design criteria and Figure 307.2 for typical 2-lane cross sections.

Shoulder widths based on design year traffic volumes shall conform to the standards given in Table 307.2.

Table 307.2

Shoulder Widths for Two-lane Roadbed New Construction Projects

Two-way ADT (Design Year)	Shoulder Width ⁽¹⁾ (ft)
Less than 400	4 ⁽²⁾
Over 400	8 ⁽³⁾

NOTES:

- (1) See Index 302.1 for shoulder requirements when bike lanes are present.
- (2) Minimum bridge width is 32 feet (see Index 208.1).
- (3) See Index 405.3(2)(a) for shoulder requirements adjacent to right-turn only lanes.

On 2-lane roads with 4-foot shoulders, the shoulder slope may be increased to 7 percent for additional drainage capacity where a dike is used. A design exception to Index 302.2 will be required to document the decision to increase the slope.

Bicycles are not prohibited on conventional highways: therefore, where the shoulder width is 4 feet, the gutter pan width should be reduced to 1 foot, so 3 feet is provided between the traffic lane and the longitudinal joint at the gutter pan. Whenever possible, grate type inlets should not be located in bicycle paths of travel. See Index 837.2(2) for further grate guidance.

307.3 Two-lane Cross Sections for 2R, 3R, and other Projects

Standards and guidelines for two-lane cross sections on resurfacing and restoration (2R) projects and resurfacing, restoration, and rehabilitation (3R) projects are found in DIB 79 and Index 603.4. DIB 79 also includes screening criteria to determining whether the project fits 2R or 3R.

Figure 307.2

Geometric Cross Sections for Two-lane Highways (New Construction)

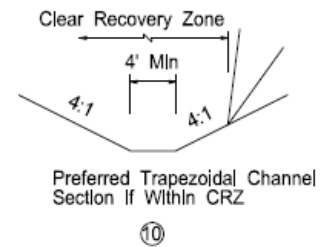
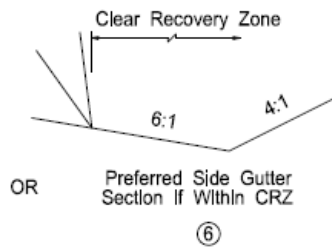
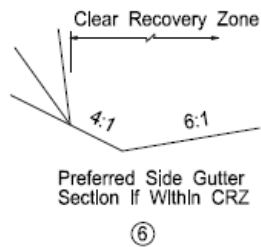
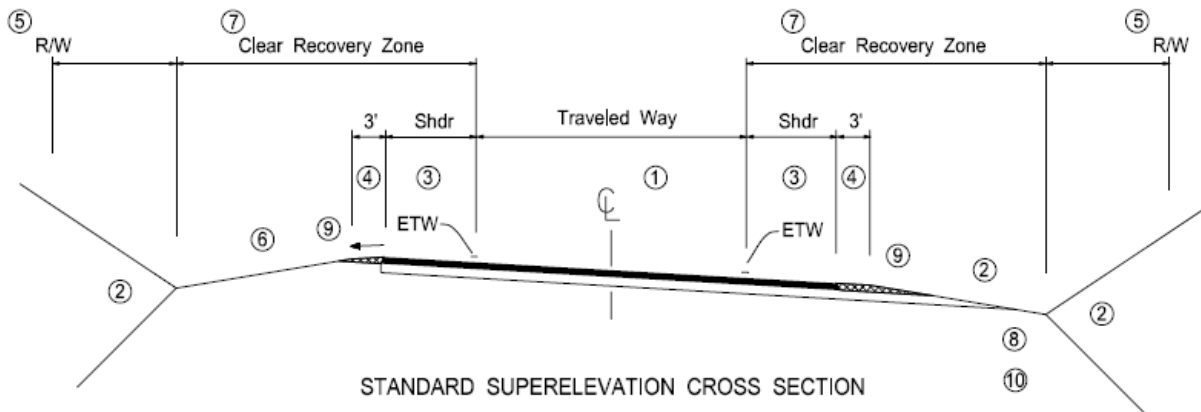
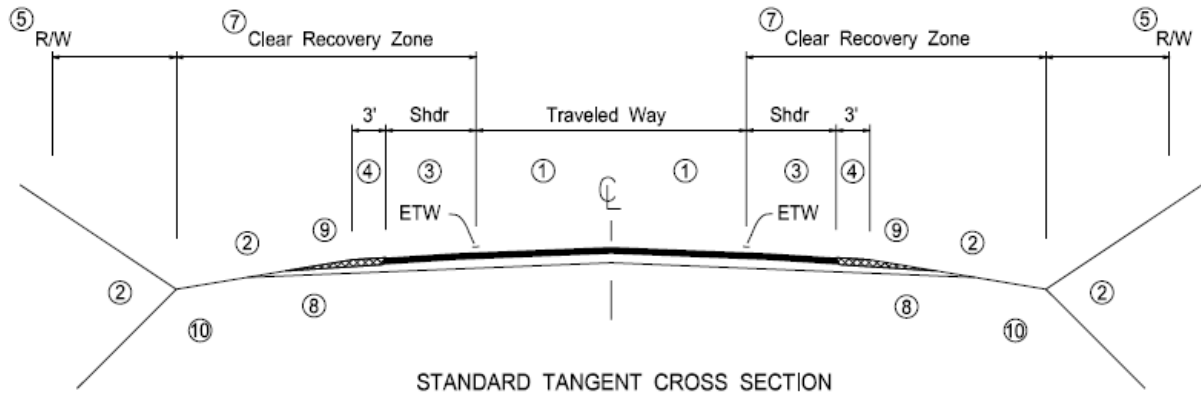

NOTES:					
①	CROSS SLOPES	See Index 302.2	⑥	SIDE GUTTERS	See Index 834,3(3)
②	SIDE SLOPES	See Index 304,1	⑦	CLEAR RECOVERY ZONE	See Index 309,1(2)
③	SHOULDER WIDTH	See Index 302.1	⑧	PAVEMENT DRAINAGE	See Indexes 653,1, 653,2, 662,3
④	DIKE PLACEMENT	See Index 303.3	⑨	SHOULDER BACKING	See Index 672
⑤	RIGHT OF WAY	See Index 306,1 and Index 304,2	⑩	ROADSIDE CHANNELS	See Topic 860

July 1, 2020

3R design criteria apply to all structure and roadway 3R projects on two-lane conventional highways and three-lane conventional highways not classified as multilane conventional highways.

3R design criteria also apply to certain storm damage, protective betterment, operational, and safety nonfreeway improvement projects that are considered spot locations as described in detail in DIB 79.

3R criteria apply to geometric design features such as lane and shoulder widths, horizontal and vertical alignment, stopping sight distance, structure width, cross slope, superelevation, side slope, clear recovery zone, curb ramps, pavement edge drop, dike, curb and gutter, and intersections. They may also apply to such features as bike lanes, sidewalk, and drainage.

307.4 Multilane Divided Cross Sections

The general geometric features of multilane divided cross sections are shown in Figures 307.4A and B.

Divided highways may be designed as two separate one-way roads where appropriate to fit the terrain. Economy, pleasing appearance, and safety are factors to be considered in this determination. The alignment of each roadway may be independent of the other (see Indexes 204.8 and 305.6). Optional median designs may be as shown on Figure 305.6. See Index 309.1 (2) for Clear Recovery Zone.

307.5 Multilane All Paved Cross Sections with Special Median Widths

A multilane cross section with a narrow median is illustrated in Figure 307.5. This section is appropriate in special circumstances where a wider median would not be justified. It should not be considered as an alternative to sections with the median widths set forth under Index 305.1. It may be used under the following conditions:

- (a) Widening of existing facilities.
- (b) Locations where large excavation quantities would result if a multilane roadway cross section with a basic median width were used. Examples are steep mountainous terrain and unstable mountainous areas.
- (c) As an alternate cross section on 2-lane roads having frequent sight distance restrictions.

The median width should be selected in accordance with the criteria set forth in Index 305.1(3).

In general, the outside shoulder should be 8 feet wide (10 feet on freeways and expressways) as mandated in Table 302.1. Where large excavation quantities or other factors generate unreasonable costs, 4-foot shoulders may be considered.

However, a design exception is required except where 4-lane passing sections are constructed on 2-lane highways. Where the roadbed width does not contain 8-foot shoulders, emergency parking areas clear of the traveled way should be provided by using daylighted cuts and other widened areas which develop during construction.

Figure 307.4A

Geometric Cross Sections for Freeways and Expressways

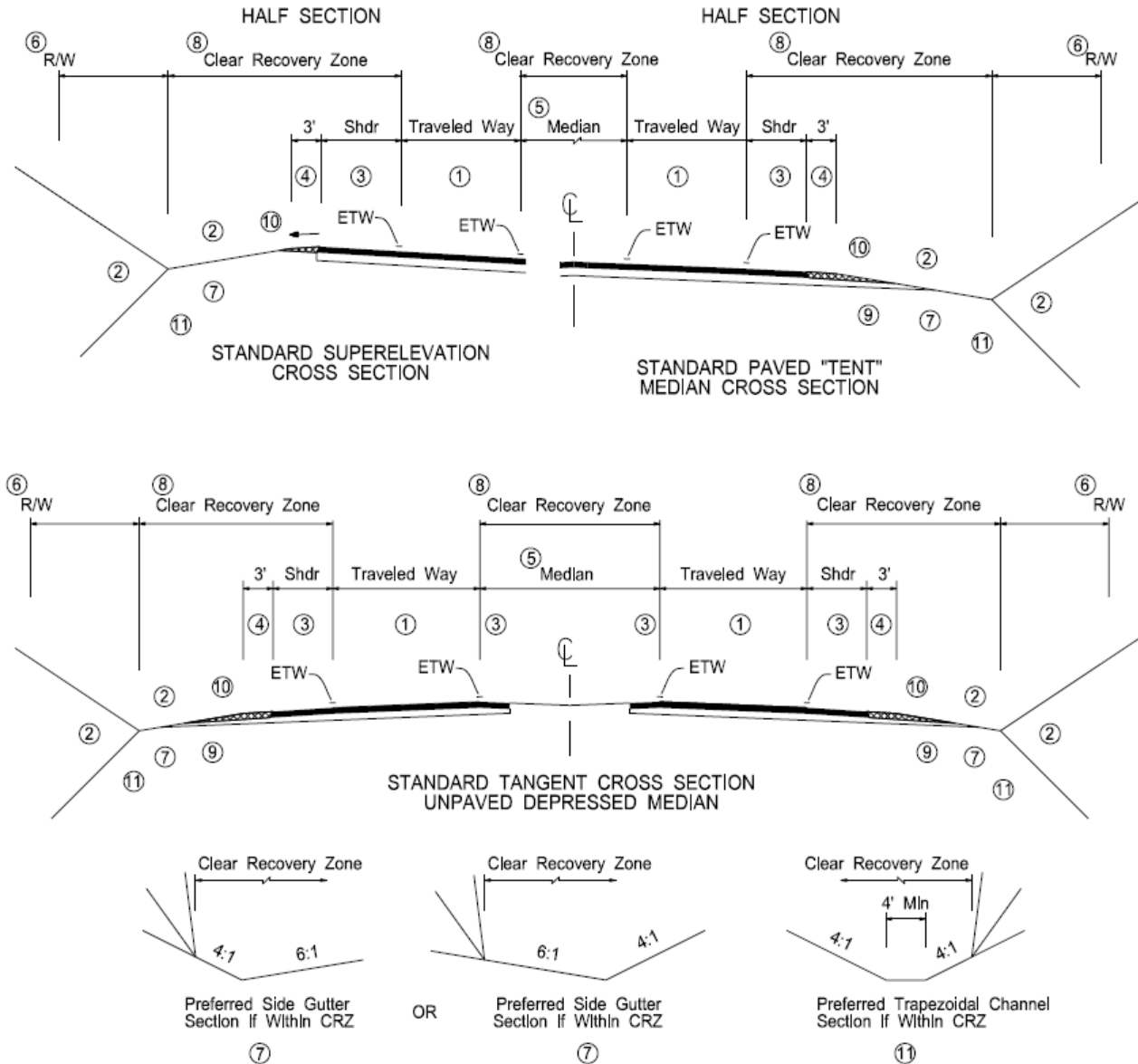

NOTES:

①	CROSS SLOPES	See Index 302.2	⑥	RIGHT OF WAY	See Indexes 306.1, 304.2
②	SIDE SLOPES	See Index 304.1 and Index 304.2	⑦	SIDE GUTTERS	See Index 834.3(3)
③	SHOULDERS WIDTH PAVING	See Index 302.1 and Index 613.5(2)	⑧	CLEAR RECOVERY ZONE	See Index 309.1(2)
④	DIKES	See Index 303.3	⑨	PAVEMENT DRAINAGE	See Indexes 653.1, 653.2, 662.3
⑤	MEDIANS WIDTH SLOPES PAVING SEPARATE ROADWAYS	See Index 305.1 See Index 305.2 See Index 305.5 See Index 305.6	⑩	SHOULDER BACKING	See Index 672
			⑪	ROADSIDE CHANNELS	See Topic 860

July 1, 2020

Figure 307.4B

Geometric Cross Sections for Freeways and Expressways

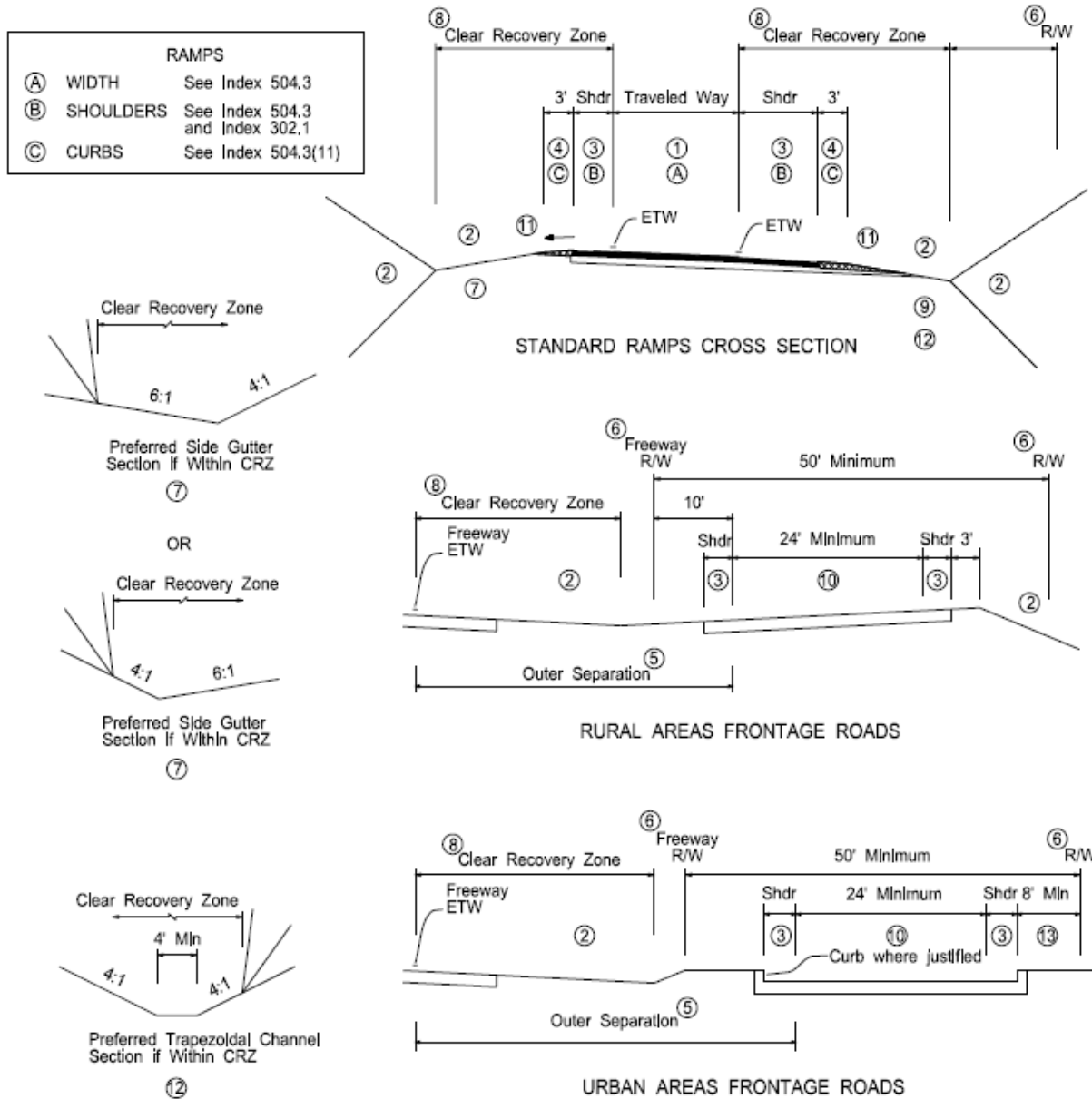

NOTES:			
(1) CROSS SLOPES	See Index 302.2	(6) RIGHT OF WAY	See Indexes 306.1, 304.2
(2) SIDE SLOPES	See Index 304.1 and Index 304.2	(7) SIDE GUTTERS	See Index 834.3(3)
(3) SHOULDERS WIDTH PAVING	See Index 302.1 and Index 613.5(2)	(8) CLEAR RECOVERY ZONE	See Index 309.1(2)
(4) DIKES	See Index 302.2	(9) PAVEMENT DRAINAGE	See Indexes 653.1, 653.2, 662.3
(5) OUTER SEPARATION	See Index 310.2	(10) CROSS SECTION	See Index 310.1
		(11) SHOULDER BACKING	See Index 672
		(12) ROADSIDE CHANNELS	See Topic 860
		(13) SIDEWALKS	See Index 105.2

Figure 307.5

Geometric Cross Sections for All Paved Multilane Highways

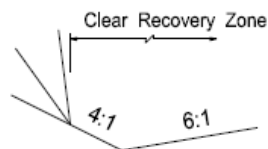
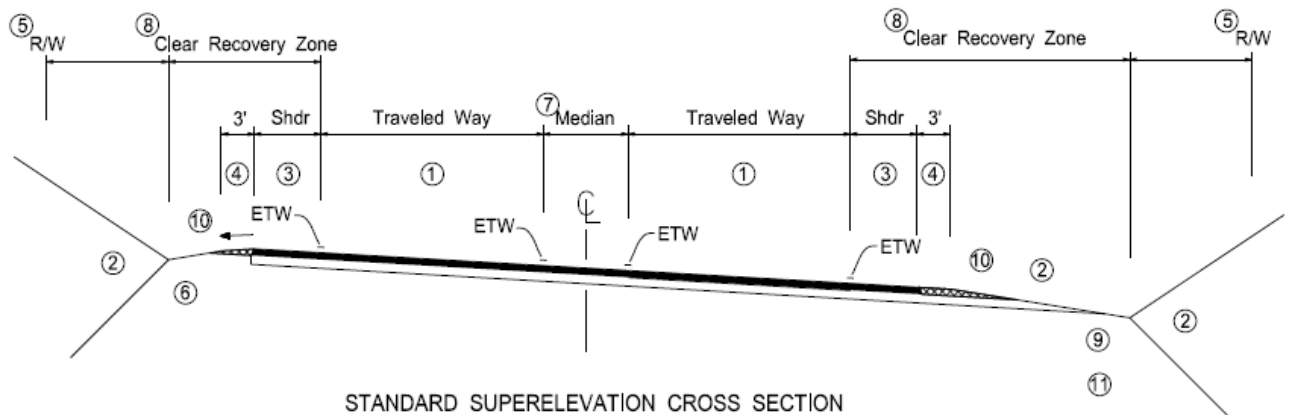
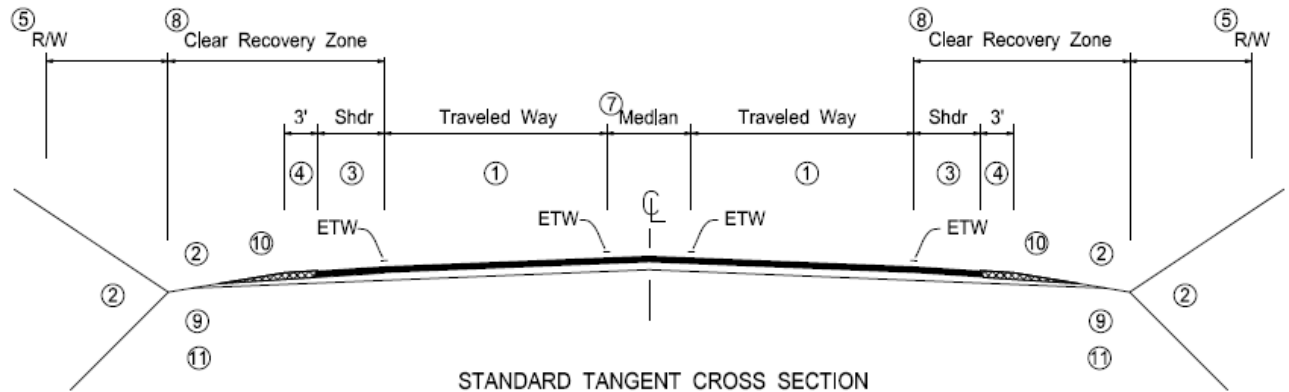

Preferred Side Gutter Section if Within CRZ

⑥

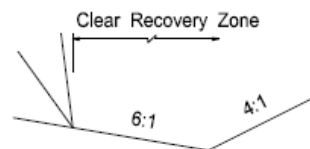

Preferred Side Gutter Section if Within CRZ

⑥

OR

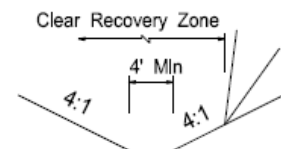

Preferred Trapezoidal Channel Section if Within CRZ

⑪

NOTES:		⑥	⑦	⑧	⑨	⑩	⑪	
①	CROSS SLOPES	See Index 302.2	MEDIANS	See Index 305.1(3)	PAVEMENT DRAINAGE	See Indexes 653.1, 653.2, 662.3	ROADSIDE CHANNELS	See Topic 860
②	SIDE SLOPES	See Index 304.1	CLEAR RECOVERY ZONE	See Index 309.1(2)	SHOULDER BACKING	See Index 672		
③	SHOULDER WIDTH	See Index 302.1						
④	DIKES	See Index 303.3						
⑤	RIGHT OF WAY	See Index 306.1 and Index 304.2						

July 1, 2020

307.6 Multilane Cross Sections for 2R and 3R Projects

3R projects on freeways, expressways, and multilane conventional highways are required to meet new construction standards. See Index 309.1 (2) for Clear Recovery Zone.

For additional information on 2R and 3R projects, see DIB 79.

307.7 Reconstruction Projects

Reconstruction projects on freeways, expressways, and conventional highways are required to meet new construction standards.

Topic 308 – Cross Sections for Roads Under Other Jurisdictions

308.1 City Streets and County Roads

The minimum width of local roads and streets that are to be reconstructed as part of a freeway or expressway project should conform to locally adopted standards except as described below.

Where a local facility, not on the NHS, within the State right of way crosses over or under a freeway or expressway but has no connection to the State facility, the minimum design standards for the cross section of the local facility within the State's right of way shall be the local agency adopted standards. If the local facility is on the NHS, AASHTO standards will apply. If the local agency has standards that exceed AASHTO standards, then the local agency standards can apply. See the Local Assistance Procedures Manual Chapter 11 for information on design guidance and documentation of design decisions for local assistance projects.

AASHTO standards for local roads and streets are given in AASHTO, A Policy on Geometric Design of Highways and Streets. These standards relate to the functional classification and system characteristics of the local roadway system. See Chapter 1 of these standards for information on the functional classification and system characteristics of roadways.

AASHTO, A Policy on Geometric Design of Highways and Streets, gives minimum lane and shoulder widths. When selecting a cross section, the effects on capacity of commercial vehicles and grades should be considered as discussed under Topic 102 and in the Transportation Research Board, Highway Capacity Manual.

The minimum width of 2-lane overcrossing structures shall not be less than 32 feet face of curb to face of curb.

If the local agency has definite plans to widen the local street either concurrently or within 5 years following freeway construction, the reconstruction to be accomplished by the State should generally conform to the widening planned by the local agency. Stage construction should be considered where the planned widening will occur beyond the 5-year period following freeway construction or where the local agency has a master plan indicating an

ultimate width greater than the existing facility. Where an undercrossing is involved, the initial structure construction should provide for ultimate requirements.

Where a local facility crosses over or under a freeway or expressway and connects to the State facility (such as ramp terminal intersections), the minimum design standards for the cross section of the local facility shall be at least equal to those for a conventional highway with the exception that the outside shoulder width shall match the approach roadway, but not less than 4 feet, and as shown below.

Where the 2-lane local facility connects to a freeway within an interchange, the lane width of the local facility shall be 12 feet.

Where a multilane local facility connects to a freeway within an interchange, the outer most lane in each direction of the local facility shall be 12 feet.

Shoulder width shall not be less than 5 feet when railings or other lateral obstructions are adjacent to the right edge of shoulder.

If gutter pans are used, then the minimum shoulder width shall be 3 feet wider than the width of the gutter pan being used.

The minimum width for two-lane overcrossing structures at interchanges shall be 40 feet curb-to-curb.

Topic 309 – Clearances

309.1 Horizontal Clearances for Highways

(1) *General.* The horizontal clearance to all roadside objects should be based on engineering judgment with the objective of maximizing the distance between roadside objects and the edge of traveled way. Engineering judgment should be exercised in order to balance the achievement of horizontal clearance objectives and reduction of maintenance cost and exposure to workers, with the prudent expenditure of available funds.

Certain yielding types of fixed objects, such as sand filled barrels, guardrail, breakaway wood posts, etc. may encroach within the clear recovery zone (see Index 309.1(2)). While these objects are designed to reduce the severity of accidents, efforts should be made to maximize the distance between any object and the edge of traveled way.

Horizontal clearances are measured from the edge of the traveled way to the nearest point on the obstruction (usually the bottom). Consideration should be given to the planned ultimate traveled way width of the highway facility. **Horizontal clearances greater than those cited below under Subsection (3) - "Minimum Clearances" shall be provided where necessary to meet horizontal stopping sight distance requirements.** See subsection (4) for high speed rail clearance guidance. See discussion on "... technical reductions in design speed..." under Topic 101.

(2) *Clear Recovery Zone (CRZ).* The roadside environment can and should be made as safe as practical. A clear recovery zone is an unobstructed, relatively flat (4:1 or flatter) or gently sloping area beyond the edge of the traveled way which affords the drivers of errant vehicles the opportunity to regain control. For embankment slopes, a clear recovery zone of 4:1 or flatter should apply on all highways with distances referenced in Subsection (2)(a), except if guardrail or barrier is provided. Dike, curb and gutter are acceptable within the clear recovery zone, but there are limitations if used with guardrail. See the

July 1, 2020

Traffic Safety Systems Guidance for information on guardrail and barrier placement. The AASHTO Roadside Design Guide provides detailed design guidance for creating a forgiving roadside environment. See also Index 304.1 regarding side slopes.

See DIB 79 for 2R, 3R, certain storm damage, protective betterment, operational, and safety projects on two-lane and three-lane conventional highways.

The following clear recovery zone widths are the minimum desirable for the type of facility indicated. Consideration should be given to increasing these widths based on traffic volumes, operating speeds, terrain (e.g., steeper than 4:1), horizontal curvature, and costs associated with a particular highway facility:

- Freeways and Expressways – 30 feet
- Conventional Highways – 20 feet*

*On conventional highways with posted speeds less than or equal to 35 miles per hour and curbs, clear recovery zone widths do not apply. See minimum horizontal clearance, Index 309.1(3)(c).

(a) Necessary Highway Features.

Fixed objects, when they are necessary highway features, including, but not limited to, bridge piers, abutments, retaining walls, and noise barriers closer to the edge of traveled way than the distances listed above should be eliminated, moved, redesigned to be made yielding, or shielded in accordance with the following guidelines:

- Fixed objects, when they are necessary highway features, should be eliminated or moved outside the clear recovery zone to a location where they are unlikely to be hit.
- If necessary highway features such as sign posts or light standards cannot be eliminated or moved outside the clear recovery zone, they should be made yielding with a breakaway feature.
- If a fixed object, when they are necessary highway features, cannot be eliminated, moved outside the clear recovery zone, or modified to be made yielding, it should be shielded by guardrail, barrier or a crash cushion.

Shielding and breakaway features must be in conformance with the guidance found in Traffic Safety Systems Guidance. For input on the need for shielding at a specific location, consult District Traffic Operations.

Existing above-ground utilities and existing large trees as defined in Index 904.5(1) should conform to the guidance associated with necessary highway features stated above. When the planting of trees is being considered, see the additional discussion and standards in Chapter 900.

(b) Discretionary Fixed Objects.

Discretionary fixed objects are features or facilities that are not necessary for the safety, maintenance or operation of the highway, but may enhance livability and sustainability. These may include, but are not limited to, transportation art, gateway monuments, solar panels, and memorial/historical plaques or markers. See Subsection (4) for high speed rail clearance guidance. When discretionary fixed objects are constructed on freeways, expressways or conventional highways, they should be located beyond the clear recovery zone at a minimum of 52 feet horizontally or 8 feet vertically up-slope from the planned ultimate edge of traveled way. However, if discretionary fixed objects are to be placed less than the 52 feet horizontally or less than the 8 feet vertically up-slope, they should be made breakaway or shielded behind existing guardrail, barrier or other safety device.

Shielding and breakaway features must be in conformance with the guidance found in Traffic Safety Systems Guidance. For input on the need for shielding at a specific location, consult District Traffic Operations.

Where compliance with the guidelines stated in Subsections (2)(a) and (b) are impractical, the minimum horizontal clearance cited in Subsection (3) Minimum Clearances shall apply to the unshielded fixed object. These minimum horizontal clearances apply to yielding objects as well.

(3) *Minimum Clearances.* **The following minimum horizontal clearances shall apply to all objects that are closer to the edge of traveled way than the clear recovery zone distances listed above:**

- (a) **The minimum horizontal clearance to all objects, such as bridge rails and safety-shaped concrete barriers, as well as sand-filled barrels, guardrail, etc., on all freeway and expressway facilities, including auxiliary lanes, ramps, and collector-distributor roads, shall be equal to the standard shoulder width of the highway facility as stated in Table 302.1. A minimum clearance of 4 feet shall be provided where the standard shoulder width is less than 4 feet. Approach rail connections to bridge rail may require special treatment to maintain the standard shoulder width.**
- (b) **The minimum horizontal clearance to walls, such as abutment walls, retaining walls in cut locations, and noise barriers on all facilities, including auxiliary lanes, ramps and collector-distributor roads, shall not be less than 10 feet per Table 302.1.**
- (c) **On conventional highways, frontage roads, city streets and county roads within the State right of way (all without curbs), the minimum horizontal clearance shall be the standard shoulder width as listed in Tables 302.1 and 307.2, except that a minimum clearance of 4 feet shall be provided where the standard shoulder width is less than 4 feet. For RRR projects, widths are provided in DIB 79.**

On conventional highways with curbs, typically in urban conditions, a minimum horizontal clearance of 1 foot 6 inches should be provided beyond the face of curbs to any obstruction. On curbed highway sections, a minimum clearance of 3 feet should be provided along the curb returns of intersections and near the edges of driveways to allow for design vehicle offtracking (see Topic 404). Where sidewalks are located immediately adjacent to curbs, fixed objects should be located beyond the back of sidewalk to provide an unobstructed area for pedestrians.

In areas without curbs, the face of Type 60 concrete barrier should be constructed integrally at the base of any retaining, pier, or abutment wall which faces traffic and is

July 1, 2020

15 feet or less from the edge of traveled way (right or left of traffic and measured from the face of wall). See Index 1102.2 for the treatment of noise barriers.

The minimum width of roadway openings between Temporary Railing (Type K) on bridge deck widening projects should be obtained from the HQ Transportation Permit Program.

The HQ Transportation Permit Program must be consulted on the use of the route by overwidth loads.

See Traffic Safety Systems Guidance for other requirements pertaining to clear recovery zone, guardrail at fixed objects and embankments, and crash cushions.

- (4) *High Speed Rail Clearances.* When a high speed rail corridor is to be constructed longitudinally to a freeway, expressway or a conventional highway with posted speeds over 40 miles per hour, the nearest fixed object or feature associated with the operation of the rail facility should be located a minimum of 52 feet horizontally from the planned ultimate edge of the traveled way. **The minimum shoulder width adjacent to barrier (longitudinal to the high speed rail) shall be 10 feet, in addition to the fixed objects in Table 302.1 Note (8).** See Index 62.10 for the definition of high speed rail. The terrain and the required highway features between the edge of traveled way and the rail facility to be constructed must be evaluated to determine on a case-by-case basis whether or not shielding behind guardrail, barrier or other safety device in conformance with the guidance found in Traffic Safety Systems Guidance is needed. For input on the need for shielding at a specific location, consult District Traffic Operations.

- (5) *Other Transportation Facilities.* Contraflow BRT, light rail facilities, and heavy rail facilities are considered fixed objects and the clearances noted in Index 309.1 apply.

Parallel BRT facilities are preferred to have the following minimum separation between lanes:

- Freeways and Expressways** – 4 feet
- Conventional Highways (see also Index 108.5)
 - Posted Speeds over 40 miles per hour – 4 feet
 - Posted Speeds equal or greater than 25 miles per hour and up to 45 miles per hour in an urban environment –2 feet, with curbed separation, 4 feet with 2-foot curbed separation recommended.

**See “A Guide for HOT Lane Development”, FHWA, and Caltrans High Occupancy Vehicle Guidelines for additional information.

309.2 Vertical Clearances

(1) Major Structures.

- (a) Freeways and Expressways, All construction except overlay projects – **16 feet 6 inches shall be the minimum vertical clearance over the roadbed of the State facility (e.g., main lanes, shoulders, ramps, collector-distributor roads, speed change lanes, etc.).**
- (b) Freeways and Expressways, Overlay Projects – **16 feet shall be the minimum vertical clearance over the roadbed of the State facility.**
- (c) Conventional Highways, Parkways, and Local Facilities, All Projects – **15 feet shall be the minimum vertical clearance over the traveled way and 14 feet 6 inches**

- shall be the minimum vertical clearance over the shoulders of all portions of the roadbed.
- (2) *Minor Structures.* Pedestrian over-crossings shall have a minimum vertical clearance 2 feet greater than the standard for major structures for the State facility in question. Sign structures shall have a vertical clearance of 18 feet over the roadbed of the State facility.
- (3) *Rural Interstates and Single Routing in Urban Areas:* This subset of the Interstate System is composed of all rural Interstates and a single routing in urban areas. Those routes described in Table 309.2B and Figure 309.2 are given special attention in regards to minimum vertical clearance as a result of agreements between the FHWA and the Department of Defense. **Vertical clearance for structures on this system shall meet the standards listed above for freeways and expressways.** In addition to the standards listed above, vertical clearances of less than 16 feet over any portion of this system must be approved by FHWA in coordination with Surface Deployment and Distribution Command Transportation Engineering Agency (SDDCTEA). Documentation in the form of a Design Standard Decision Document must be submitted to FHWA to obtain approval for less than 16 feet of vertical clearance. Vertical clearances of less than 16 feet over any Interstate will require FHWA/SDDCTEA notification. See <http://www.fhwa.dot.gov/design/090415.cfm>
- (4) *General Information.* The standards listed above and summarized in Table 309.2A are the minimum allowable on the State highway system for the facility and project type listed. For the purposes of these vertical clearance standards, all projects on the freeway and expressway system other than overlay projects shall be considered to be covered by the "new construction" standard.

When approved by a design exception (see HDM Index 82.2) clearances less than the values given above may be allowed on a case by case basis given adequate justification based upon engineering judgment, economic, environmental or right of way considerations. Typical instances where lesser values may be approved are where the structure is protected by existing lower structures on either side or where a project includes an existing structure that would not be feasible to modify to the current standard. In no case should vertical clearance be reduced below 15 feet over the traveled way or 14 feet 6 inches over the shoulders over any portion of a State highway facility.

July 1, 2020

Table 309.2A

Minimum Vertical Clearances

	Traveled Way	Shoulder
Freeways and Expressways, New Construction, Lane Additions, Reconstruction and Modification	16½ ft	16½ ft
Freeways and Expressways, Overlay Projects	16 ft	16 ft
All Projects on Conventional Highways and Local Facilities	15 ft	14½ ft
Sign Structures	18 ft	18 ft
Pedestrian, Bicycle Overcrossings, and Minor Structures	Standard + 2 ft See 309.2(2)	
Structures on the Rural and Single Interstate Routing System	See 309.2(3)	

Figure 309.2

Department of Defense Rural and Single Interstate Routes

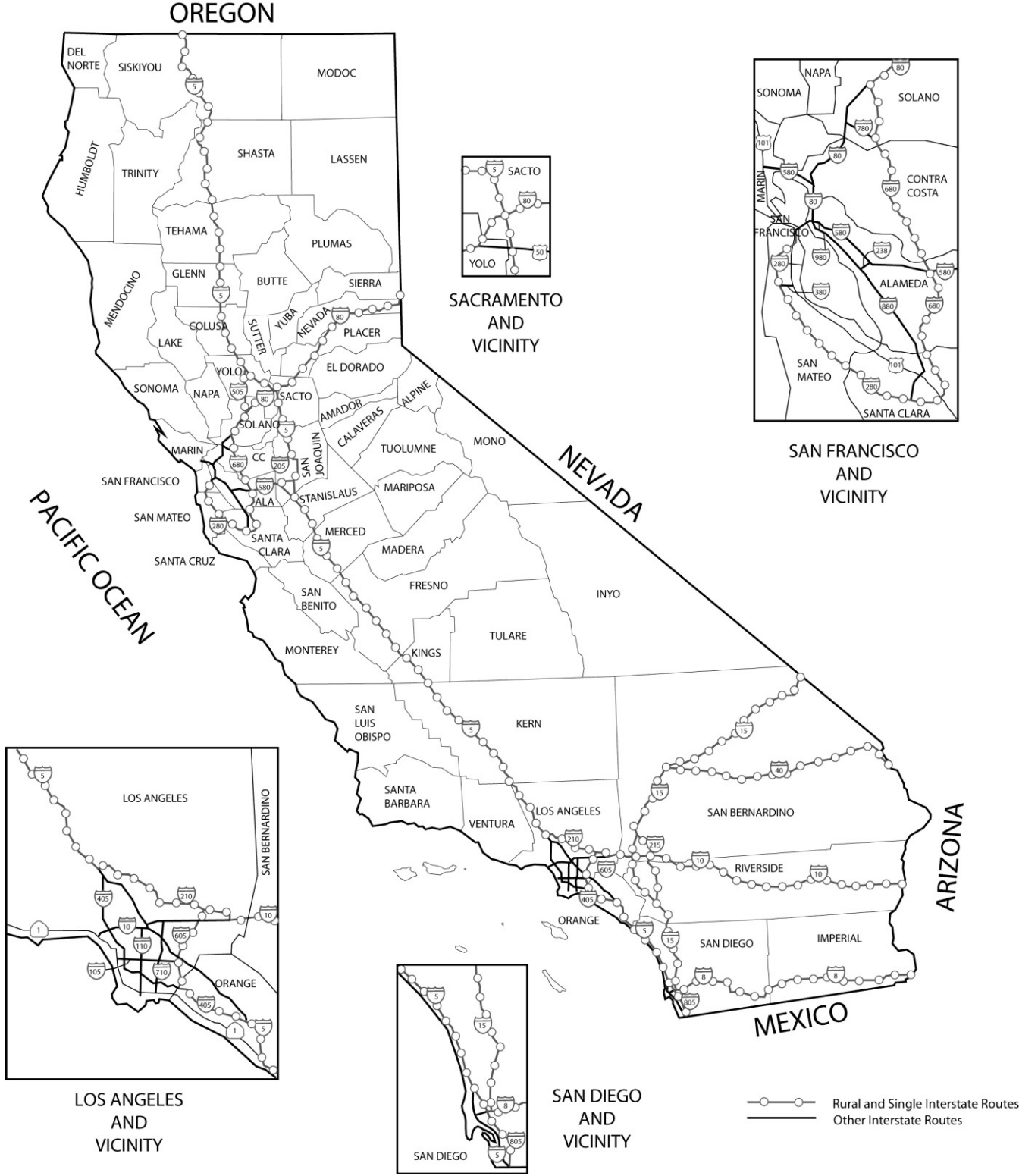

July 1, 2020

Table 309.2B

California Routes on the Rural and Single Interstate Routing System

ROUTE	FROM	TO
I-5	U. S. Border	I-805 just N. of U. S. Border
I-5	I-805 N. of San Diego	I-405 near El Toro
I-5	I-210 N. of Los Angeles	Oregon State Line
I-8	I-805 near San Diego	Arizona State Line
I-10	I-210 near Pomona	Arizona State Line
I-15	I-8 near San Diego	Nevada State Line
I-40	Junction at I-15 near Barstow	Arizona State Line
I-80	I-680 near Cordelia	Nevada State Line
I-205	Junction at I-580	Junction at I-5
I-210	I-5 N. of Los Angeles	I-10 near Pomona
I-215	I-15 near Temecula	I-15 near Devore
I-280	Junction at I-680 in San Jose	At or near south city limits of San Francisco to provide access to Hunter's Point
I-405	I-5 near El Toro	Palo Verde Avenue just N. of I-605
I-505	Junction at I-80	Junction at I-5
I-580	I-680 near Dublin	Junction at I-5
I-605	I-405 near Seal Beach	I-210
I-680	Junction at I-280 in San Jose	I-80 near Cordelia
I-805	I-5 just N. of U. S. Border	I-5 N. of San Diego

Efforts should be made to avoid decreasing the existing vertical clearance whenever possible and consideration should be given to the feasibility of increasing vertical clearance on projects involving structural section removal and replacement. Any project that would reduce vertical clearances below 16 feet 6 inches or lead to an increase in the vertical clearance should be brought to the attention of the Project Delivery Coordinator or District approval authority, depending upon the current District Design Delegation Agreement, the District Permit Engineer and the Regional Permit Manager at the earliest possible date.

The Regional Permit Manager should be informed of any changes (temporary or permanent) in vertical clearance.

(5) *Federal Aid Participation.* Federal-aid participation is normally limited to the following maximum vertical clearances unless there are external controls such as the need to provide for falsework clearance or the vertical clearance is controlled by an adjacent structure in a multi-structure interchange:

(a) Highway Facilities.

- 17 feet over freeways and expressways.
- 15 feet 6 inches over other highways (15 feet over shoulders).
- For pedestrian structures, 2 feet greater than the above values.

(b) Railroad Facilities.

- 23 feet 4 inches over the top of rails for non-electrified rail systems.
- 24 feet 3 inches over the top of rails for existing or proposed 25 kv electrification.
- 26 feet over the top of rails for existing or proposed 50 kv electrification.

These clearances include an allowance for future ballasting of the rail facility. The cost of reconstructing or modifying any existing railroad-highway grade separation structure solely to accommodate electrification will not be eligible for Federal-aid highway fund participation. Where a rail system is not currently electrified, the railroad must have a plan adopted which specifies the intent to electrify the subject rail segment within a reasonable time frame in order to provide clearances in excess of 23 feet 4 inches.

Any exceptions to the clearances listed above should be reviewed with the FHWA early in the design phase to ensure that they will participate in the structure costs. All excessive clearances should be documented in the project files. Documentation must include reasons for exception including the railroad's justification for increased vertical clearance based on an analysis of engineering, operational and/or economic conditions at a specific structure location with appropriate approval by the HQ Right of Way, Railroad Agreement Coordinator and concurrence by the FHWA.

See Index 1003.1(3) for guidance on Class I bikeway vertical clearance.

July 1, 2020

309.3 Tunnel Clearances

Cross sections for tunnels should match the full paved width of the approach roadways, including shoulders. See Topics 301 and 302.

(1) *Horizontal Clearances.* Tunnel construction is so infrequent and costly that the width should be considered on an individual basis. For the minimum horizontal clearance standards for freeway and expressway tunnels see Index 309.1.

A minimum emergency egress walkway width of 4 feet shall be provided on one side. The emergency egress walkway should be elevated a minimum of 6 inches or separated from the roadway with barrier.

In one-way tunnels on conventional highways the minimum side clearance from the edge of the traveled way shall be 4 feet on the left and 6 feet on the right. For two-way tunnels, this clearance shall be 6 feet on each side. This clearance provides space for bicycle lanes or for bicyclists who want to use the shoulder.

(2) *Vertical Clearances.* **For conventional highways the minimum vertical clearance listed in Index 309.2(1)(c) shall be used. On freeways and expressways, the vertical clearance listed in Index 309.2(1)(a) and (b) shall be used.** Cost weighed against the probability of over-height vehicles will be the determining factors.

309.4 Lateral Clearance for Elevated Structures

Adequate clearance must be provided for maintenance, repair, construction, or reconstruction of adjacent buildings and of the structure; to avoid damage to the structure from a building fire or to buildings from a vehicle fire; to permit operation of equipment for fire fighting and other emergency teams. **The minimum horizontal clearance between elevated highway structures, such as freeway viaducts and ramps, and adjoining buildings or other structures shall be 15 feet for single-deck structures and 20 feet for double-deck structures. Spot encroachments on this clearance shall be approved in accordance with Index 82.2.**

309.5 Structures Across or Adjacent to Railroads

Regulations governing clearances on railroads and street railroads with reference to side and overhead structures, parallel tracks, crossings of public roads, highways, and streets are established by the PUC. The PUC requirements are minimums for all grade separated structures. The railroad clearances are much greater due to operational requirements.

(1) *Normal Horizontal and Vertical Clearances.* Although General Order No. 26-D specifies a minimum vertical clearance of 22 feet 6 inches above tracks on which freight cars not exceeding a height of 15 feet 6 inches are transported, a minimum of 23 feet 4 inches should be used in design to allow for reballasting and normal maintenance of track. Railroads on which freight cars are not operated, should have a minimum vertical clearance of 19 feet. See Index 309.2(5)(b) for FHWA maximums. In establishing the grade line, the District should consult the DES to obtain the depth of structures and false work requirements, if any (see Index 204.8(4)).

Horizontal clearance from piers, abutments, and barriers shall be 25 feet minimum to centerline of track. For clearances less than 25 feet, the piers supporting bridges over the railroads are to be heavy construction or are to be protected by a reinforced concrete crash wall. Piers are to be considered heavy construction if they have a cross-sectional

area equal to or greater than that required for the crash wall where the larger of its dimension is parallel to the track.

Crash walls for piers from 12 to 25 feet clearance from the centerline of track are to have a minimum height of 6 feet above the top of rail. Piers less than 12 feet clearance from the centerline of track are to have a minimum crash wall height of 12 feet above the top of rail. Horizontal clearances other than those stated above must be approved by the PUC and concurred by the affected railroad entity. Coordinate early in the design phase of the project with the District Railroad Coordinator when railroad agreements are required.

For future planned track expansion, a minimum horizontal clearance distance of 20 feet between existing and future track centerlines shall be provided for freight tracks and 25 feet for commuter tracks. See Figure 309.5A for typical horizontal railroad clearances and Figure 309.5B for limits of permanent vertical clearance envelope for grade separated structures.

Code of Federal Regulations 646.212(a)(2) provides that if the railroad establishes to the satisfaction of the Department and FHWA that it has definite demand and plans for installation of additional tracks within a reasonable time, for grade separation structures, Federal funds may be used to provide space for more tracks than are in place.

Vertical clearance greater than 23 feet 4 inches may be approved on a site by site basis where justified by the railroad to the satisfaction of the Department and the FHWA. A railroad's justification for increased vertical clearance should be based on an analysis of engineering, operational and/or economic conditions and the need for future tracks at a specific location. Contact the District Railroad Coordinator for further information.

Table 309.5A

Minimum Vertical Clearances Above Highest Rail

Type of Structure	Type of Operation	
	Normal Freight	No Freight Cars Operated
Highway overhead and other structures including through railroad bridges.	23' – 4"	19' – 0"

July 1, 2020

Figure 309.5A

Typical Horizontal Railroad Clearance from Grade Separated Structures

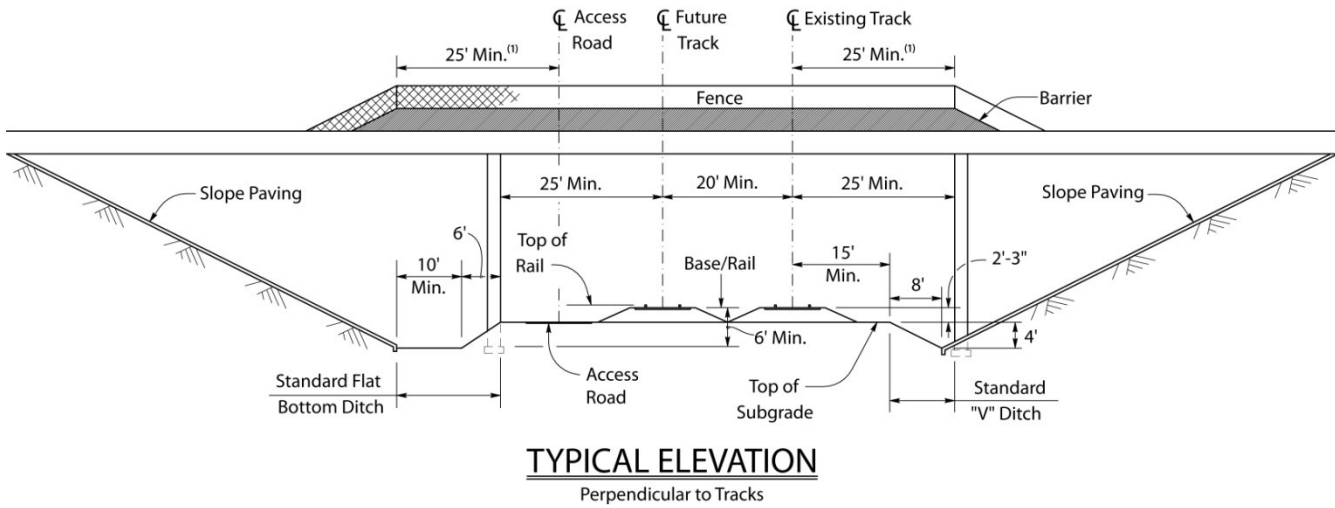

NOTE:

The limits of the fence with barrier rail should extend to the limits of railroad right-of-way or a minimum of 25 feet beyond the centerline of the outermost existing track, future track or access roadway, whichever is greater.

Figure 309.5B
Permanent Railroad Clearance Envelope

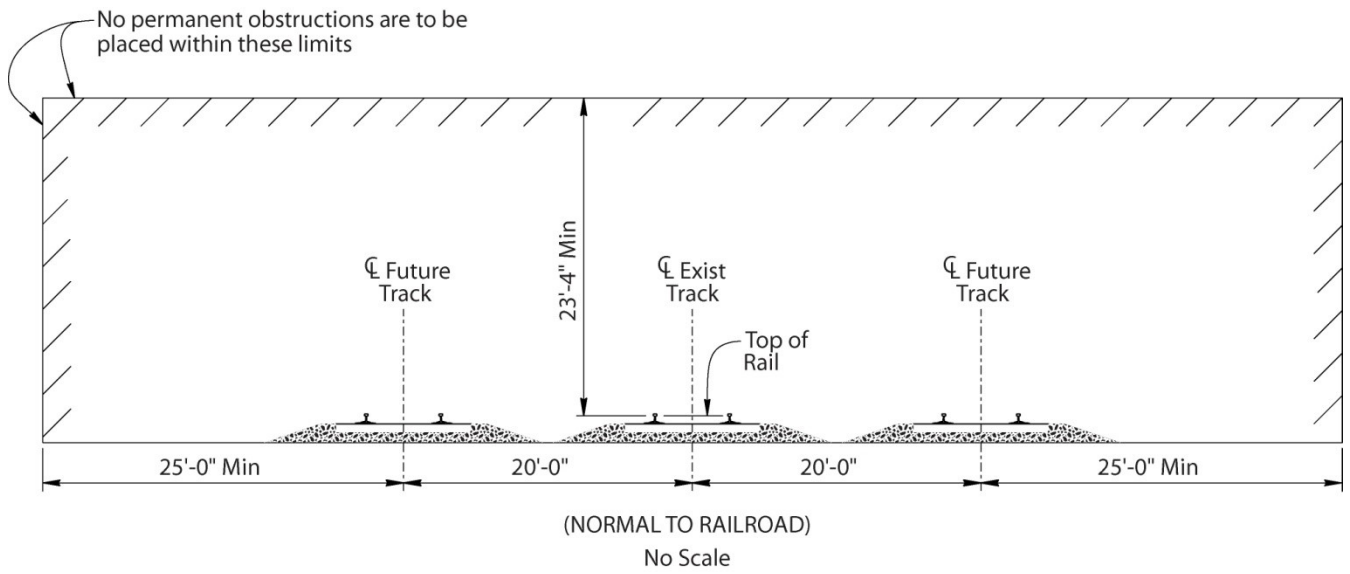

July 1, 2020

Table 309.5B

Minimum Horizontal Clearances to Centerline of Nearest Track

Type of Structure	Off-track Maintenance Clearance	Tangent Track Clearance	Normal Curved Track ⁽¹⁾ Clearance	Curved Track Clearances When Space is Limited ⁽¹⁾	
				Curves of 0° to 12°	Curves of 12° or more
Through rail-road bridge	None	8' – 0" ⁽²⁾⁽⁴⁾	9' – 0" ⁽²⁾⁽⁴⁾		
Highway over-head and other structures	18' – 0" clear to face of pier or abutment on side railroad requires for equipment road.	8' – 6" ⁽⁴⁾	9' – 6" ⁽⁴⁾	8' – 6" (Min.) ⁽³⁾	8' – 6" + ½" ⁽³⁾ per degree of curve.
Curbs		10' – 0"			

NOTES:

- (1) The minimum, in general, is one foot greater than for tangent track.
- (2) With approval of P.U.C.
- (3) Greater clearance necessary if walkway is required.
- (4) Collision walls may be required. See Index 309.5(1).

At underpasses, General Order No. 26-D establishes a minimum vertical clearance of 15 feet above any public road, highway or street. **However, the greater clearances specified under Index 309.2 shall be used.**

For at grade crossings, all curbs, including median curbs, should be designed with 10 feet of clearance from the track centerline measured normal thereto.

- (2) *Off-track Maintenance Clearance.* The 18-foot horizontal clearance is intended for sections of railroad where the railroad company is using or definitely plans to use off-track maintenance equipment. This clearance is provided on one side of the railroad right of way.

On Federal-aid projects, where site conditions are such that off-track maintenance clearance at an overhead is obtained at additional cost, Federal-aid funds may participate in the costs of such overhead designs that provide up to 18 feet 2 inches horizontal clearance on one side of the track. In such cases, the railroad is required to present a statement that off-track maintenance equipment is being used, or is definitely planned to be used, along that section of the railroad right of way crossed by the overhead structure.

- (3) *Walkway Clearances Adjacent to Railroads At Grade.* All plans involving construction adjacent to railroads at grade should be such that there is no encroachment on the walkway adjoining the track. Walkway requirements are set forth in General Order No. 118 of the PUC. Where excavations encroach into walkway areas, the contractor is required to construct a temporary walkway with handrail as set forth in the contract special provisions.

- (4) *Approval.* All plans involving clearances from a railroad track must be submitted to the railroad for approval as to railroad interests. Such clearances are also subject to approval by the PUC.

To avoid delays, early consideration must be given to railroad requirements when the planning phase is started on a project.

Topic 310 – Frontage Roads

310.1 Cross Section

Frontage roads are normally relinquished to local agencies. When Caltrans and a county or city enter into an agreement (cooperative agreement, freeway agreement, or other type of binding agreement), the CTC may relinquish to the county or city any frontage or service road or outer highway within that city or county. The relinquished right of way (called a collateral facility) should be at least 40 feet wide and have been constructed as part of a State highway project. Index 308.1 gives width criteria for city streets and county roads. These widths are also applicable to frontage roads. **However, the minimum paved 2-lane cross section width including 4-foot shoulders without curb and gutter shall be:**

- **32 feet if 12-foot lanes are to be provided;**
- **30 feet if 11-foot lanes are to be provided.**

The minimum paved 2-lane cross section width, including 5-foot shoulders and curb and gutter shall be:

- **34 feet if 12-foot lanes are to be provided;**

July 1, 2020

- 32 feet if 11-foot lanes are to be provided.

310.2 Outer Separation

In urban areas and in mountainous terrain, the width of the outer separation should be a minimum of 26 feet from edge of traveled way to edge of traveled way. A greater width may be used where it is obtainable at reasonable additional cost, for example, on an urban highway centered on a city block and paralleling the street grid.

In rural areas, other than mountainous terrain, the outer separation should be a minimum of 40 feet wide from edge of traveled way to edge of traveled way.

See Figure 307.4B for cross sections of outer separation and frontage road.

310.3 Headlight Glare

Care should be taken when designing new frontage roads to avoid the potential for headlight glare interfering with the vision of motorists, bicyclists, and pedestrians traveling in opposite directions on the frontage roads and in the outer freeway lanes. Consideration should also be given to bike and pedestrians paths. To prevent headlight glare interference on new construction, the preferred measures are for wider outer separations, revised alignment and raised or lowered profiles.

CHAPTER 400 – INTERSECTIONS AT GRADE

Intersections are planned points of conflict where two or more roadways join or cross. At-grade intersections are among the most complicated elements on the highway system, and control the efficiency, capacity, and safety for motorized and non-motorized users of the facility. The type and operation of an intersection is important to the adjacent property owners, motorists, bicyclists, pedestrians, transit operators, the trucking industry, and the local community.

There are two basic types of at grade intersections: crossing and circular. It is not recommended that intersections have more than four legs. Occasionally, local development and land uses create the need for a more complex intersection design. Such intersections may require a specialized intersection design to handle the specify traffic demands at that location. In addition to the guidance in this manual, see Traffic Operations Policy Directive (TOPD) Number 13-02: Intersection Control Evaluation (ICE) for direction and procedures on the evaluation, comparison and selection of the intersection types and control strategies identified in Index 401.5. Also refer to the Complete Streets Intersection Guide for further information.

Topic 401 – Factors Affecting Design

Index 401.1 – General

At-grade intersections must handle a variety of conflicts among users, which includes truck, transit, pedestrians, and bicycles. These recurring conflicts play a major role in the preparation of design standards and guidelines. Arriving, departing, merging, turning, and crossing paths of moving pedestrians, bicycles, truck, and vehicular traffic have to be accommodated within a relatively small area. The objective of designing an intersection is to effectively balance the convenience, ease, and comfort of the users, as well as the human factors, with moving traffic (automobiles, trucks, motorcycles, transit vehicles, bicycles, pedestrians, etc.). The safety and mobility needs of motorist, bicyclist and pedestrians as well as their movement patterns in intersections must be analyzed early in the planning phase and then followed through appropriately during the design phase of all intersections on the State highway. It is Departmental policy to develop integrated multimodal projects in balance with community goals, plans, and values.

The Complete Intersections: A Guide to Reconstructing Intersections and Interchanges for Bicyclists and Pedestrians contains a primer on the factors to consider when designing intersections. It is published by the California Division of Traffic Operations.

401.2 Human Factors

(1) *The Driver.* An appreciation of driver performance is essential to proper highway design and operation. The suitability of a design rests as much on how safely and efficiently drivers are able to use the highway as on any other criterion.

Motorist's perception and reaction time set the standards for sight distance and length of transitions. The driver's ability to understand and interpret the movements and crossing times of the other vehicle drivers, bicyclists, and pedestrians using the intersection is equally

July 1, 2020

important when making decisions and their associated reactions. The designer needs to keep in mind the user's limitations and therefore design intersections so that they meet user expectation.

- (2) *The Bicyclist.* Bicyclist experience, skills and physical capabilities are factors in intersection design. Intersections are to be designed to help bicyclists understand how to traverse the intersection. Chapter 1000 provides intersection guidance for Class I and Class III bikeways that intersect the State highway system. The guidance in this chapter specifically relates to bicyclists that operate within intersections on the State highway system.
- (3) *The Pedestrian.* Understanding how pedestrians will use an intersection is critical because pedestrian volumes, their age ranges, physical ability, etc. all factor in to their startup time and the time it takes them to cross an intersection and thus, dictates how to design the intersection to avoid potential conflicts with bicyclists and motor vehicles. The guidance in this chapter specifically relates to pedestrian travel within intersections on the State highway system. See Topic 105, Pedestrian Facilities, Design Information Bulletin 82 - "Pedestrian Accessibility Guidelines for Highway Projects," the AASHTO Guide for the Planning, Design, and Operation of Pedestrian Facilities, and the California Manual on Uniform Traffic Control Devices (California MUTCD) for additional guidance.

401.3 Traffic Considerations

Good intersection design clearly indicates to bicyclists and motorists how to traverse the intersection (see Figure 403.6A). Designs that encourage merging traffic to yield to through bicycle and motor vehicle traffic are desirable.

The size, maneuverability, and other characteristics of bicycles and motorized vehicles (automobiles, trucks, transit vehicles, farm equipment, etc.) are all factors that influence the design of an intersection. The differences in operating characteristics between bicycles and motor vehicles should be considered early in design.

Table 401.3 compares vehicle characteristics to intersection design elements.

A design vehicle is a convenient means of representing a particular segment of the vehicle population. See Topic 404 for a further discussion of the uses of design vehicles.

Transit vehicles and how their stops interrelate with an intersection, pedestrian desired walking patterns and potential transfers to other transit facilities are another critical factor to understand when designing an intersection. Transit stops and their placement needs to take into account the required maintenance operations that will be needed and usually supplied by the Transit Operator.

401.4 The Physical Environment

In highly developed urban areas, where right of way is usually limited, the volume of vehicular traffic, pedestrians, and bicyclists may be large, street parking exists, and transit stops (for both buses and light rail) are available. All interact in a variety of movements that contribute to and add to the complexity of a State highway and can result in busy intersections.

Industrial development may require special attention to the movement of large trucks.

Rural areas where farming occurs may require special attention for specialized farm equipment. In addition, rural cities or town centers (rural main streets) also require special attention.

Rural intersections in farm areas with low traffic volumes may have special visibility problems or require shadowing of left-turn vehicles from high speed approach traffic.

Table 401.3

Vehicle Characteristics	Intersection Design Element Affected
Length	Length of storage lane
Width	Lane width
Height	Clearance to overhead signs and signals
Wheel base	Corner radius and width of turning lanes
Acceleration	Tapers and length of acceleration lane
Deceleration	Tapers and length of deceleration lane

There are many factors to be considered in the design of intersections, with the goal to achieve a functional, safe and efficient intersection for all users of the facility. The location and level of use by various modes will have an impact on intersection design, and therefore should be considered early in the design process. In addition to current levels of use, it is important to consider future travel patterns for vehicles, including trucks; pedestrian and bicycle demand and the future expansion of transit.

401.5 Intersection Type

Intersection types are characterized by their basic geometric configuration, and the form of intersection traffic control that is employed:

(1) Geometric Configurations

- (a) Crossing-Type Intersections - “Tee” and 4-legged intersections
- (b) Circular Intersections –roundabouts, traffic circles, rotaries; however, only roundabouts are acceptable for State highways.
- (c) Alternative Intersection Designs – various effective geometric alternatives to traditional designs that can reduce crashes and their severity, improve operations, reduce congestion and delay typically by reducing or altering the number of conflict points; these alternatives include geometric design features such as intersections with displaced left-turns or variations on U-turns.

July 1, 2020

(2) *Intersection Control Strategies.* See California MUTCD and Traffic Operations Policy Directive (TOPD) Number 13-02, Intersection Control Evaluation for procedures and guidance on how to evaluate, compare and select from among the following intersection control strategies:

- (a) Two-Way Stop Controlled - for minor road traffic
- (b) All-Way Stop Control
- (c) Signal Control
- (d) Yield Control (Roundabout)

Historically, crossing-type intersections with signal or “STOP”-control have been used on the State highway system. However, other intersection types, given the appropriate circumstances may enhance intersection performance through fewer or less severe crashes and improve operations by reducing overall delay. Alternative intersection geometric designs should be considered and evaluated early in the project scoping, planning and decision-making stages, as they may be more efficient, economical and safer solutions than traditional designs. Alternative intersection designs can effectively balance the safety and mobility needs of the motor vehicle drivers, transit riders, bicyclists and pedestrians using the intersection.

401.6 Transit

Transit use may range from periodic buses, handled as part of the normal mix of vehicular traffic, to Bus Rapid Transit (BRT) or light rail facilities which can have a large impact on other users of the intersection. Consideration of these modes should be part of the early planning and design of intersections.

Topic 402 – Operational Features Affecting Design

402.1 Capacity

Adequate capacity to handle peak period traffic demands is a basic goal of intersection design.

- (1) *Unsignalized Intersections.* The “Highway Capacity Manual”, provides methodology for capacity analysis of unsignalized intersections controlled by “STOP” or “YIELD” signs. The assumption is made that major street traffic is not affected by the minor street movement. Unsignalized intersections generally become candidates for signalization when traffic backups begin to develop on the cross street or when gaps in traffic are insufficient for drivers to yield to crossing pedestrians. See the California MUTCD, for signal warrants. Changes to intersection controls must be coordinated with District Traffic Branch.
- (2) *Signalized Intersections.* See Topic 406 for analysis of simple signalized intersections, including ramps. The analysis of complex and alternative intersections should be referred to the District Traffic Branch; also see Traffic Operations Policy Directive (TOPD) Number 13-02.
- (3) *Roundabout Intersections.* See TOPD Number 13-02 for screening process and the Intersection Control Evaluation(ICE) Process Informational Guide for operational analysis methods and tools.

402.2 Collisions

(1) *General.* Intersections have a higher potential for conflict compared to other sections of the highway because travel is interrupted, traffic streams cross, and many types of turning movements occur.

The type of traffic control affects the type of collisions. Signalized intersections tend to have more rear end and same-direction sideswipes than intersections with “STOP”-control on minor legs. Roundabouts experience few angle or crossing collisions. Roundabouts reduce the frequency and severity of collisions, especially when compared to the performance of signalized intersections in high speed environments. Other alternative intersection types are configurations to consider for minimizing the number of conflict points.

(2) *Undesirable Geometric Features.*

- Inadequate approach sight distance.
- Inadequate corner sight distance.
- Steep grades.
- Five or more approaches.
- Presence of curves within intersections(unless at roundabouts).
- Inappropriately large curb radii.
- Long pedestrian crossing distances.
- Intersection Angle <75 degrees (see Topic 403).

402.3 On-Street Parking

On-street parking generally decreases through-traffic capacity, impedes traffic flow, and increases crash potential. Where the primary service of the arterial is the movement of vehicles, it may be desirable to prohibit on-street parking on State highways in urban and suburban expressways and rural arterial sections. However, within urban and suburban areas and in rural communities located on State highways, on-street parking should be considered in order to accommodate existing land uses. Where adequate off-street parking facilities are not available, the designer should consider on-street parking, so that the proposed highway improvement will be compatible with the land use. On-street parking as well as off-street parking needs to comply with DIB82. See AASHTO, A Policy on Geometric Design of Highways and Streets for additional guidance related to on-street parking.

July 1, 2020

402.4 Consider All Users

Intersections should accommodate all users of the facility, including vehicles, bicyclists, pedestrians and transit. Bicycles have all the rights and responsibilities as motorist per the California Vehicle Code, but should have separate consideration of their needs, even separate facilities if volumes warrant. Pedestrians should not be prohibited from crossing one or more legs of an intersection, unless no other safe alternative exists. Pedestrians can be prohibited from crossing one or more legs of an intersection if a reasonable alternate route exists and there is a demonstrated need to do so. All pedestrian facilities shall be ADA compliant as outlined in DIB 82. Transit needs should be determined early in the planning and design phase as their needs can have a large impact on the performance of an intersection. Transit stops in the vicinity of intersections should be evaluated for their effect on the safety and operation of the intersection(s) under study. See Topic 108 for additional information.

402.5 Speed-Change Areas

Speed-change areas for vehicles entering or leaving main streams of traffic are beneficial to the safety and efficiency of an intersection. Entering traffic merges most efficiently with through traffic when the merging angle is less than 15 degrees and when speed differentials are at a minimum.

Topic 403 – Principles of Channelization

403.1 Preference to Major Movements

The provision of direct free-flowing high-standard alignment to give preference to major movements is good channelization practice. This may require some degree of control of the minor movements such as stopping, funneling, or even eliminating them. These controlling measures should conform to natural paths of movement and should be introduced gradually to promote smooth and efficient operation.

403.2 Areas of Conflict

Large multilane undivided intersection areas are undesirable. The hazards of conflicting movements are magnified when motorists, bicyclists, and pedestrians are unable to anticipate movements of other users within these areas. Channelization reduces areas of conflict by separating or regulating traffic movements into definite paths of travel by the use of pavement markings or traffic islands.

Multilane undivided intersections, even with signalization, are more difficult for pedestrians to cross. Providing pedestrian refuge islands enable pedestrians to cross fewer lanes at a time.

See Index 403.7 for traffic island guidance when used as pedestrian refuge. Curb extensions shorten crossing distance and increase visibility. See Index 303.4 for curb extensions.

403.3 Angle of Intersection

A right angle (90°) intersection provides the most favorable conditions for intersecting and turning traffic movements. Specifically, a right angle provides:

- The shortest crossing distance for motor vehicles, bicycles, and pedestrians.
- Sight lines which optimize corner sight distance and the ability of motorists to judge the relative position and speed of approach traffic.
- Intersection geometry that can reduce vehicle turning speeds so collisions are more easily avoided and the severity of collisions are minimized.
- Intersection geometry that sends a message to turning bicyclists and motorists that they are making a turning movement and should yield as appropriate to through traffic on the roadway they are leaving, to traffic on the receiving roadway, and to pedestrians crossing the intersection.

Minor deviations from right angles are generally acceptable provided that the potentially detrimental impact on visibility and turning movements for large trucks (see Topic 404) can be mitigated. However, large deviations from right angles may decrease visibility, hamper certain turning operations, and will increase the size of the intersection and therefore crossing distances for bicyclists and pedestrians, may encourage high speed turns, and may reduce yielding by turning traffic. When a right angle cannot be provided due to physical constraints, the interior angle should be designed as close to 90 degrees as is practical, but should not be less than 75 degrees. Mitigation should be considered for the affected intersection design features. (See Figure 403.3A). A 75 degree angle does not unreasonably increase the crossing distance or generally decrease visibility. Class II bikeway crossings at railroads follow similar guidance to Class I bikeway crossings at railroads, see Index 1003.5(3), and Figure 403.3B.

A characteristic of skewed intersection angles is that they result in larger intersections.

When existing intersection angles are less than 75 degrees, the following retrofit improvement strategies should be considered:

- Realign the subordinate intersection legs if the new alignment and intersection location(s) can be designed without introducing new geometric or operational deficiencies.
- Provide acceleration lanes for difficult turning movements due to radius or limited visibility.
- Restrict problematic turning movements; e.g. for minor road left turns with potentially limited visibility.
- Provide refuge areas for pedestrians at very long crossings.

For additional guidance on the above and other improvement strategies, consult with the District Design Liaison.

Particular attention should be given to skewed angles on curved alignment with regards to sight distance and visibility. Crossroads skewed to the left have more restricted visibility for drivers of vans and trucks than crossroads skewed to the right. In addition, severely skewed intersection angles, coupled with steep downgrades (generally over 4 percent) can increase the potential for high centered vehicles to overturn where the vehicle is on a downgrade and must make a turn greater than 90 degrees onto a crossroad. These factors should be considered in the design of skewed intersections.

July 1, 2020

403.4 Points of Conflict

Channelization separates and clearly defines points of conflict within the intersection. Bicyclists, pedestrians and motorists should be exposed to only one conflict or confronted with one decision at a time.

Speed-change areas for diverging traffic should provide adequate length clear of the through lanes to permit vehicles to decelerate after leaving the through lanes.

See AASHTO, A Policy on Geometric Design of Highways and Streets for additional guidance on speed-change lanes.

Figure 403.3A

Angle of Intersection (Minor Leg Skewed to the Right)

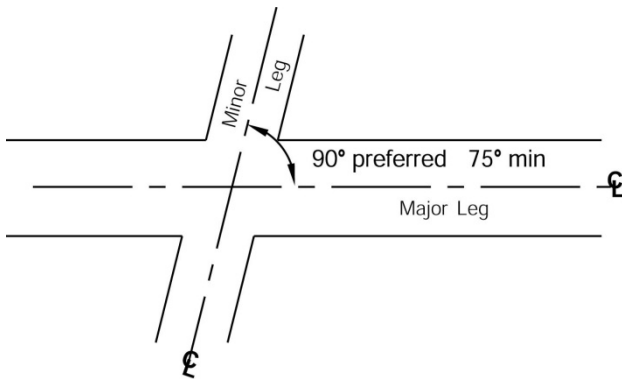
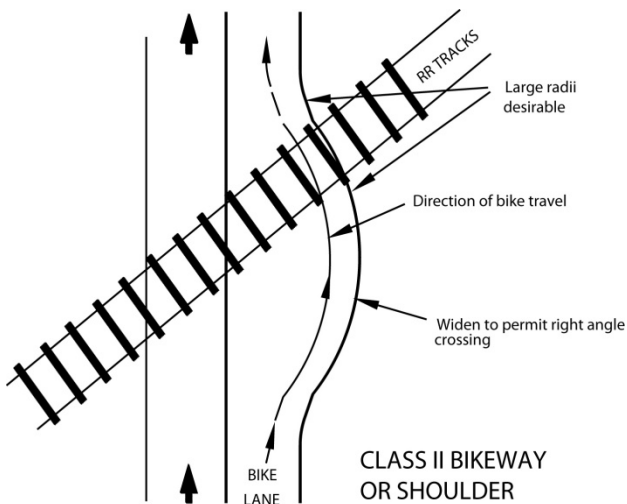

Figure 403.3.B

Class II Bikeway Crossing Railroad



403.5 (Currently Not In Use)

403.6 Turning Traffic

A separate turning lane removes turning movements from the intersection area. Abrupt changes in alignment or sight distance should be avoided, particularly where traffic turns into a separate turning lane from a high-standard through facility.

For wide medians, consider the use of offset left-turn lanes at both signalized and unsignalized intersections. Opposing left-turn lanes are offset or shifted as far to the left as practical by reducing the width of separation immediately before the intersection. Rather than aligning the left-turn lane exactly parallel with and adjacent to the through lane, the offset left-turn lane is separated from the adjacent through lane. Offset left-turn lanes provide improved visibility of opposing through traffic. For further guidance on offset left-turn lanes, see AASHTO, A Policy on Geometric Design of Highways and Streets.

(1) *Treatment of Intersections with Right-Turn-Only Lanes.* Most motor vehicle/bicycle collisions occur at intersections. For this reason, intersection design should be accomplished in a manner that will minimize confusion by motorists and bicyclists, eliminate ambiguity and induce all road users to operate in accordance with the statutory rules of the road in the California Vehicle Code. Right-turn-only lanes should be designed to meet user expectations and reduce conflicts between vehicles and bicyclists.

Figure 403.6A illustrates a typical at-grade intersection of multilane streets without right-turn-only lanes. Bike lanes or shoulders are included on all approaches. Some common movements of motor vehicles and bicycles are shown. A prevalent crash type is between straight-through bicyclists and right-turning motorists, who do not yield to through bicyclists.

Optional right-turn lanes should not be used in combination with right-turn-only lanes on roads where bicycle travel is permitted. The use of optional right-turn lanes in combination with right-turn-only lanes is not recommended in any case where a Class II bike lane is present. This may increase the need for dual or triple right-turn-only lanes, which have

July 1, 2020

Figure 403.6A

Typical Bicycle and Motor Vehicle Movements at Intersections of Multilane Streets without Right-Turn-Only Lanes

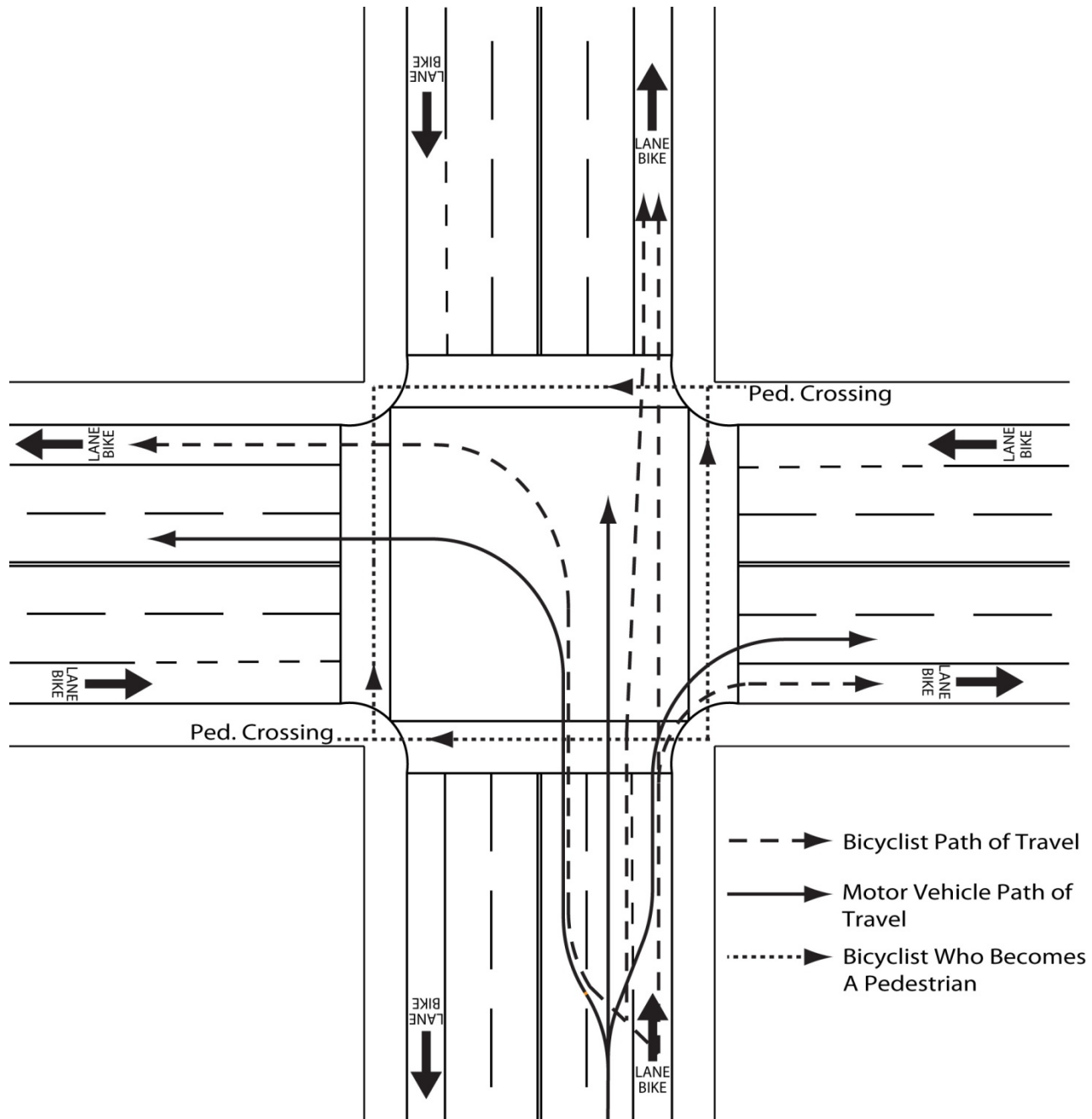

NOTE:

Only one direction is shown for clarity.

challenges with visibility between turning vehicles and pedestrians. Multiple right-turn-only lanes should not be free right-turns when there is a pedestrian crossing. If there is a pedestrian crossing on the receiving leg of multiple right-turn-only lanes, the intersection should be controlled by a pedestrian signal head, or geometrically designed such that pedestrians cross only one turning lane at a time.

Locations with right-turn-only lanes should provide a minimum 4-foot width for bicycle use between the right-turn and through lane when bikes are permitted, except where posted speed is greater than 40 miles per hour, the minimum width should be 6 feet. Configurations that create a weaving area without defined lanes should not be used.

For signing and delineation of bicycle lanes at intersections, consult District Traffic Operations.

Figure 403.6B depicts an intersection with a left-turn-only bicycle lane, which should be considered when bicycle left-turns are common. A left-turn-only bicycle lane may be considered at any intersection and should always be considered as a tool to provide mobility for bicyclists. Signing and delineation options for bicycle left-turn-only lanes are shown in the California MUTCD.

- (2) *Design of Intersections at Interchanges.* The design of at-grade intersections at interchanges should be accomplished in a manner that will minimize confusion of motorists, bicyclists, and pedestrians. Higher speed, uncontrolled entries and exits from freeway ramps should not be used at the intersection of the ramps with the local road. The smallest curb return radius should be used that accommodates the design vehicle. Intersections with interior angles close to 90 degrees reduce speeds at conflict points between motorists, bicyclists, and pedestrians. The intersection skew guidance in Index 403.3 applies to all ramp termini at the local road.

403.7 Refuge Areas

Traffic islands should be used to provide refuge areas for bicyclists and pedestrians. See Index 405.4 for further guidance.

403.8 Prohibited Turns

Traffic islands may be used to direct bicycle and motorized vehicle traffic streams in desired directions and prevent undesirable movements. Care should be taken so that islands used for this purpose accommodate convenient and safe pedestrian and bicycle crossings, drainage, and striping options. See Topic 303.

403.9 Effective Signal Control

At intersections with complex turning movements, channelization is required for effective signal control. Channelization permits the sorting of approaching bicycles and motorized vehicles which may move through the intersection during separate signal phases. Pedestrians may also have their own signal phase. This requirement is of particular importance when traffic-actuated signal controls are employed.

July 1, 2020

Figure 403.6B

Bicycle Left-Turn-Only Lane

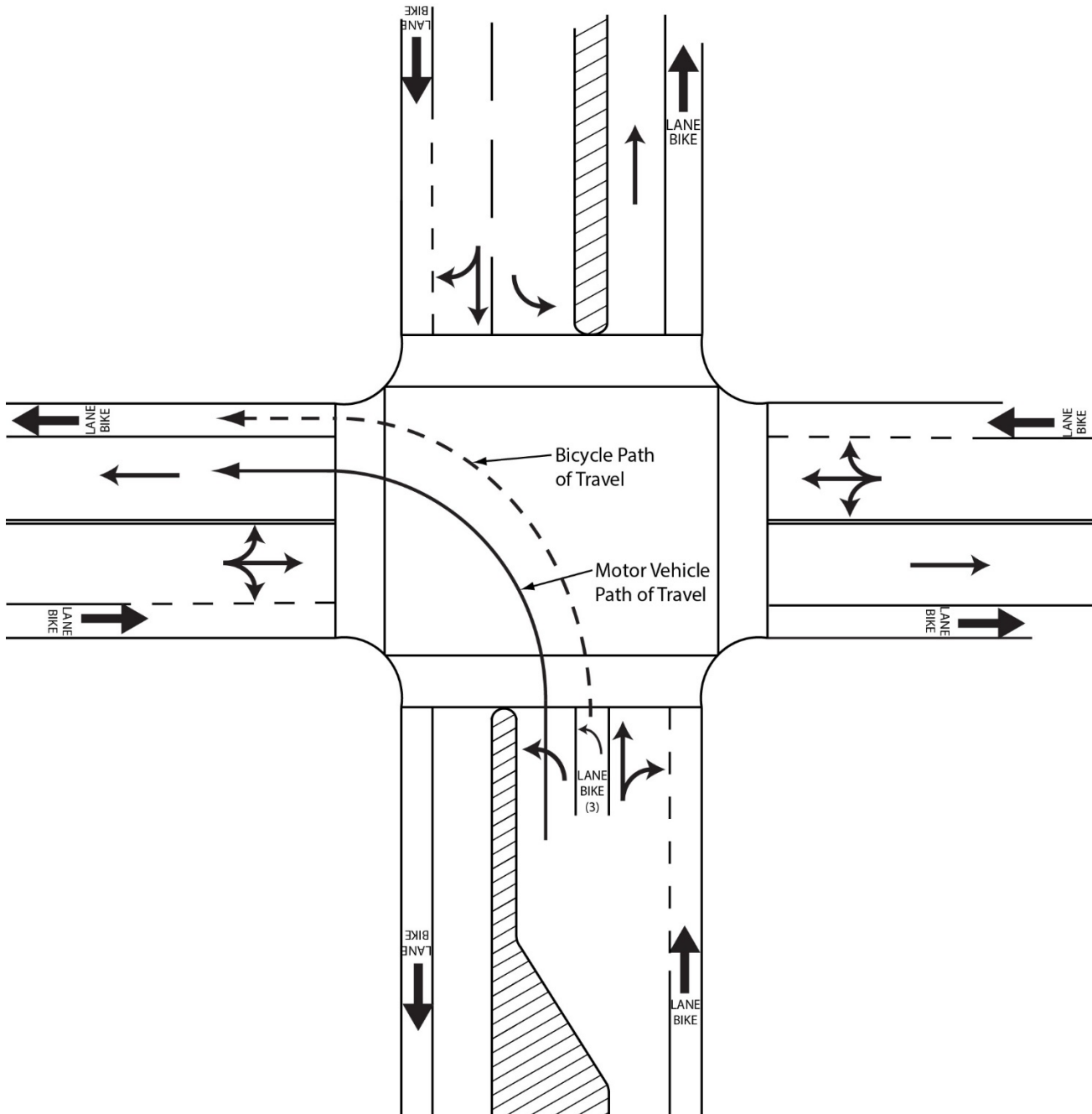

NOTES:

- (1) For bicycle lane markings, see the California MUTCD.
- (2) Bicycle detectors are necessary for signalized intersections.
- (3) Left-turn bicycle lane should have receiving bike lane or shoulder.

The California MUTCD has warrants for the placement of signals to control vehicular, bicycle and pedestrian traffic. Pedestrian activated devices, signals or beacons are not required, but must be evaluated where directional, multilane, pedestrian crossings occur. These locations may include:

- Mid-block street crossings;
- Channelized turn lanes;
- Ramp entries and exits; and
- Roundabouts.

The evaluation, selection, programming and use of a chosen device should be done with guidance from District Traffic Operations.

403.10 Installation of Traffic Control Devices

Channelization may provide locations for the installation of essential traffic control devices, such as “STOP” and directional signs. See Index 405.4 for information about the design of traffic islands.

403.11 Summary

- Give preference to the major move(s).
- Reduce areas of conflict.
- Reduce the duration of conflicts.
- Cross traffic at right angles or skew no more than 75 degrees. (90 degrees preferred.)
- Separate points of conflict.
- Provide speed-change areas and separate turning lanes where appropriate.
- Provide adequate width to shadow turning traffic.
- Restrict undesirable moves with traffic islands.
- Coordinate channelization with effective signal control.
- Install signs in traffic islands when necessary but avoid building conflicts one or more modes of travel.
- Consider all users.

403.12 Other Considerations

- An advantage of curbed islands is they can serve as pedestrian refuge. Where curbing is appropriate, consideration should be given to mountable curbs. See Topic 303 for more guidance.
- Avoid complex intersections that present multiple choices of movement to the motorist and bicyclist.
- Traffic safety should be considered. Collision records provide a valuable guide to the type of channelization needed.

July 1, 2020

Topic 404 – Design Vehicles

404.1 General

Any vehicle, whether car, bus, truck, or recreational vehicle, while turning a curve, covers a wider path than the width of the vehicle. The outer front tire can generally follow a circular curve, but the inner rear tire will swing in toward the center of the curve.

Some terminology is vital to understanding the engineering concepts related to design vehicles. See Index 62.4 Interchanges and Intersection at Grade for terminology.

404.2 Design Considerations

It may not be necessary to provide for design vehicle turning movements at all intersections along the State route if the design vehicle's route is restricted or it is not expected to use the cross street frequently. Discuss with Traffic Operations and the local agency before a turning movement is not provided. The goal is to minimize possible conflicts between vehicles, bicycles, pedestrians, and other users of the roadway, while providing the minimum curb radii appropriate for the given situation.

Both the tracking width and swept width should be considered in the design of roadways for use of the roadway by design vehicles.

Tracking width lines delineate the path of the vehicle tires as the vehicle moves through the turn.

Swept width lines delineate the path of the vehicle body as the vehicle moves through the turn and will therefore always exceed the tracking width. The following list of criteria is to be used to determine whether the roadway can accommodate the design vehicle.

(1) *Traveled way.*

(a) To accommodate turn movements (e.g., at intersections, driveways, alleys, etc.), the travel way width and intersection design should be such that tracking width and swept width lines for the design vehicle do not cross into any portion of the lane for opposing traffic. Encroachment into the shoulder and bike lane is permitted.

(b) Along the portion of roadway where there are no turning options, vehicles are required to stay within the lane lines. **The tracking and swept widths lines for the design vehicle shall stay within the lane as defined in Index 301.1 and Table 504.3.** This includes no encroachment into Class II bike lanes.

(2) *Shoulders.* Both tracking width and swept width lines may encroach onto paved shoulders to accommodate turning. For design projects where the tracking width lines are shown to encroach onto paved shoulders, the shoulder pavement structure should be engineered to sustain the weight of the design vehicle. See Index 613 for general traffic loading considerations and Index 626 for tied rigid shoulder guidance. At corners where no sidewalks are provided and pedestrians are using the shoulder, a paved refuge area may be provided outside the swept width of turning vehicle.

(3) *Curbs and Gutters.* Tires may not mount curbs. If curb and gutter are present and any portion of the gutter pan is likewise encroached, the gutter pan must be engineered to match the adjacent shoulder pavement structure. See Index 613.5(2)(c) for gutter pan design guidance.

- (4) *Edge of Pavement.* To accommodate a turn, the swept width lines may cross the edge of pavement provided there are no obstructions. The tracking width lines must remain on the pavement structure, including the shoulder, provided that the shoulder is designed to support vehicular traffic. If truck volumes are high, consideration of a wider shoulder is encouraged in order to preserve the pavement edge.
- (5) *Bicycle Lanes.* Where bicycle lanes are considered, the design guidance noted above applies. Vehicles are permitted to cross a bicycle lane to initiate or complete a turning movement or for emergency parking on the shoulder. See the California MUTCD for Class II bike lane markings.
- To accommodate turn movements (e.g., intersections, driveways, alleys, etc. are present), both tracking width and swept width lines may cross the broken white painted bicycle lane striping in advance of the right-turn, entering the bicycle lane when clear to do so.
- (6) *Sidewalks.* Tracking width and swept width lines must not encroach onto sidewalks or pedestrian refuge areas, without exception.
- (7) *Obstacles.* Swept width lines may not encroach upon obstacles including, but not limited to, curbs, islands, sign structures, traffic delineators/channelizers, traffic signals, lighting poles, guardrails, trees, cut slopes, and rock outcrops.
- (8) *Appurtenances.* Swept width lines do not include side mirrors or other appurtenances allowed by the California Vehicle Code, thus, accommodation to non-motorized users of the facility and appurtenances should be considered.

If both the tracking width and swept width lines meet the design guidance listed above, then the geometry is adequate for that design vehicle. Consideration should be given to pedestrian crossing distance, motor vehicle speeds, truck volumes, alignment, bicycle lane width, sight distance, and the presence of on-street parking.

Note that the STAA Design Vehicle has a template with a 56-foot (minimum) and a 67-foot (longer) radius and the California Legal Design Vehicle has a template with 50-foot (minimum) and 60-foot (longer) radii. These templates are shown in Figures 404.5A through 404.5D. The longer radius templates are more conservative. The longer radius templates develop less swept width and leave a margin of error for the truck driver. The longer radius templates should be used for conditions where the vehicle may not be required to stop before entering the intersection.

The minimum radius template can be used if the longer radius template does not clear all obstacles. The minimum radius templates demonstrate the tightest turn that the vehicles can navigate, assuming a speed of less than 10 miles per hour.

For offtracking lane width requirements on freeway ramps, see Topic 504.

404.3 Design Tools

District Truck Managers should be consulted early in the project to ensure compliance with the design vehicle guidance contained in Topic 404. Consult local agencies to verify the location of local truck routes. Essentially, two options are available – templates or computer software.

July 1, 2020

- The turning templates in Figures 404.5A through G are a design aid for determining the swept width and/or tracking width of large vehicles as they maneuver through a turn. The templates can be used as overlays to evaluate the adequacy of the geometric layout of a curve or intersection when reproduced on clear film and scaled to match the highway drawings. These templates assume a vehicle speed of less than 10 miles per hour.
- Computer software such as AutoTURN or AutoTrak can draw the swept width and/or tracking width along any design curve within a CADD drawing program such as MicroStation or AutoCAD. Dimensions taken from the vehicle diagrams in Figures 404.5A through G may be inputted into the computer program by creating a custom vehicle if the vehicle is not already included in the software library. The software can also create a vehicle turn template that conforms to any degree curve desired.

404.4 Design Vehicles and Related Definitions

(1) *The Surface Transportation Assistance Act of 1982 (STAA).*

- (a) STAA Routes. STAA allows certain longer trucks called STAA trucks to operate on the National Network. After STAA was enacted, the Department evaluated State routes for STAA truck access and created Terminal Access and Service Access routes which, together with the National Network, are called the STAA Network. Terminal Access routes allow STAA access to terminals and facilities. Service Access routes allow STAA trucks one-mile access off the National Network, but only at identified exits and only for designated services. Service Access routes are primarily local roads. A “Truck Route Map,” indicating the National Network routes and the Terminal Access routes is posted on the Department’s Office of Commercial Vehicle Operations website and is also available in printed form.
- (b) STAA Design Vehicle. The STAA design vehicle is a truck tractor-semitrailer combination with a 48-foot semitrailer, a 43-foot kingpin-to-rear-axle (KPR) distance, an 8.5-foot body and axle width, and a 23-foot truck tractor wheelbase. Note, a truck tractor is a non-load-carrying vehicle. There is also a STAA double (truck tractor-semitrailer-trailer); however, the double is not used as the design vehicle due to its shorter turning radius. The STAA Design Vehicle is shown in Figures 404.5A and B.

The STAA Design Vehicle in Figures 404.5A or B should be used on the National Network, Terminal Access, California Legal, and Advisory routes.

- (c) STAA Vehicle – 53-Footer. Another category of vehicle allowed only on STAA routes has a maximum 53-foot trailer, a maximum 40-foot KPR for two or more axles, a maximum 38-foot KPR for a single axle, and unlimited overall length. This vehicle is not to be used as the design vehicle as it is not the worst case for offtracking due to its shorter KPR. The STAA Design Vehicle should be used instead.

(2) *California Legal.*

- (a) California Legal Routes. Virtually all State routes off the STAA Network are California Legal routes. There are two types of California Legal routes, the regular California Legal routes and the KPR Advisory Routes. Advisory routes have signs posted that state the maximum KPR length that the route can accommodate without the vehicle offtracking outside the lane. KPR advisories range from 30 feet to 38 feet, in 2-foot increments. California Legal vehicles are allowed to use both types of California Legal routes. California Legal vehicles can also use the STAA Network. However, STAA trucks are not allowed on any California Legal routes. The Truck Route Map indicating the California Legal routes is posted on the Department’s Office of Commercial Vehicle Operations website.

- (b) California Legal Design Vehicle. The California Legal vehicle is a truck tractor-semitrailer with the following dimensions: the maximum overall length is 65 feet; the maximum KPRA distance is 40 feet for semitrailers with two or more axles, and 38 feet for semitrailers with a single axle; the maximum width is 8.5 feet. There are also two categories of California Legal doubles (truck tractor-semitrailer-trailer); however, the doubles are not used as the design vehicle due to their shorter turning radii. The California Legal Design Vehicle is shown in Figures 404.5C and D.

The California Legal Design Vehicle in Figures 404.5C and D should only be used when the STAA design vehicle is not feasible and with concurrence from the District Truck Manager.

(3) *40-Foot Bus.*

- (a) 40-Foot Bus Routes. All single-unit vehicles, including buses and motor trucks up to 40 feet in length, are allowed on virtually every route in California.
- (b) 40-Foot Bus Design Vehicle. The 40-Foot Bus Design Vehicle shown in Figure 404.5E is an AASHTO standard. Its 25-foot wheelbase and 40-foot length are typical of city transit buses and some intercity buses. At intersections where truck volumes are light or where the predominate truck traffic consists of mostly 3-axle units, the 40-foot bus may be used. Its wheel path sweeps a greater width than 3-axle delivery trucks, as well as smaller buses such as school buses.

(4) *45-Foot Bus & Motorhome.*

- (a) 45-Foot Bus & Motorhome Routes. The “45-foot bus and motorhome” refers to bus and motorhomes over 40 feet in length, up to and including 45 feet in length. These longer buses and motorhomes are allowed in California, but only on certain routes.

The 45-foot tour bus became legal on the National Network in 1991 and later allowed on some State routes in 1995. The 45-foot motorhome became legal in California in 2001, but only on those routes where the 45-foot bus was already allowed. A Bus and Motorhome Map indicating where these longer buses and motorhomes are allowed and where they are not allowed is posted on the Department’s Office of Commercial Vehicle Operations website.

- (b) 45-Foot Bus and Motorhome Design Vehicle. The 45-Foot Bus & Motorhome Design Vehicle shown in Figure 404.5F is used by Caltrans for the longest allowable bus and motorhome. Its wheelbase is 28.5 feet. It is also similar to the AASHTO standard 45-foot bus. Typically this should be the smallest design vehicle used on a State highway. It may be used where the State highway intersects local streets without commercial or industrial traffic.

The 45-Foot Bus and Motorhome Design Vehicle shown in Figure 404.5F should be used in the design of all interchanges and intersections on all green routes indicated on the Bus and Motorhome Map for both new construction and rehabilitation projects. Check also the longer standard design vehicles on these routes as required – the STAA Design Vehicle and the California Legal Design Vehicle in Indexes 404.4(1) and (2).

July 1, 2020

(5) *60-Foot Articulated Bus.*

(a) 60-Foot Articulated Bus Routes. The articulated bus is allowed a length of up to 60 feet per CVC 35400(b)(3)(A). This bus is used primarily by local transit agencies for public transportation. There is no master listing of such routes. Local transit agencies should be contacted to determine possible routes within the proposed project.

(b) 60-Foot Articulated Bus Design Vehicle. The 60-Foot Articulated Bus Design Vehicle shown in Figure 404.5G is an AASHTO standard. The routes served by these buses should be designed to accommodate the 60-Foot Articulated Bus Design Vehicle.

404.5 Turning Templates & Vehicle Diagrams

Figures 404.5A through G are computer-generated turning templates at an approximate scale of 1"=50' and their associated vehicle diagrams for the design vehicles described in Index 404.3. The radius of the template is measured to the outside front wheel path at the beginning of the curve. Figures 404.5A through G contain the terms defined as follows:

(1) *Tractor Width* - Width of tractor body.

(2) *Trailer Width* - Width of semitrailer body.

(3) *Tractor Track* - Tractor axle width, measured from outside face of tires.

(4) *Trailer Track* - Semitrailer axle width, measured from outside face of tires.

Figure 404.5A

STAA Design Vehicle 56-Foot Radius

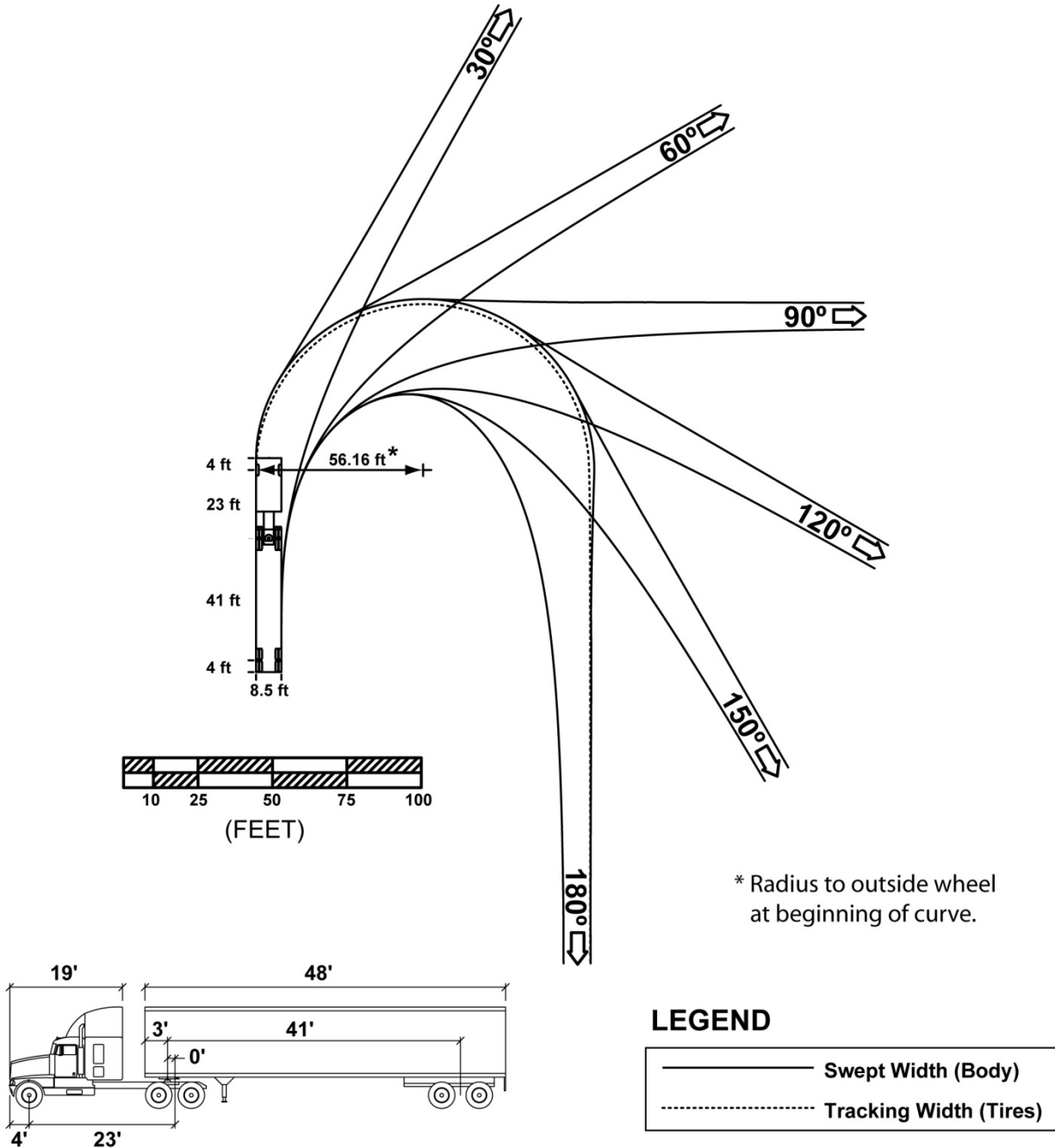

* Radius to outside wheel at beginning of curve.

STAA - STANDARD

- | | | | |
|---------------|--------|---------------------|----------------|
| Tractor Width | : 8.5' | Lock to Lock Time | : 6 seconds |
| Trailer Width | : 8.5' | Steering Lock Angle | : 26.3 degrees |
| Tractor Track | : 8.5' | Articulating Angle | : 70 degrees |
| Trailer Track | : 8.5' | | |

Note: For definitions, see Indexes 404.1 and 404.5.

July 1, 2020

Figure 404.5B

STAA Design Vehicle 67-Foot Radius

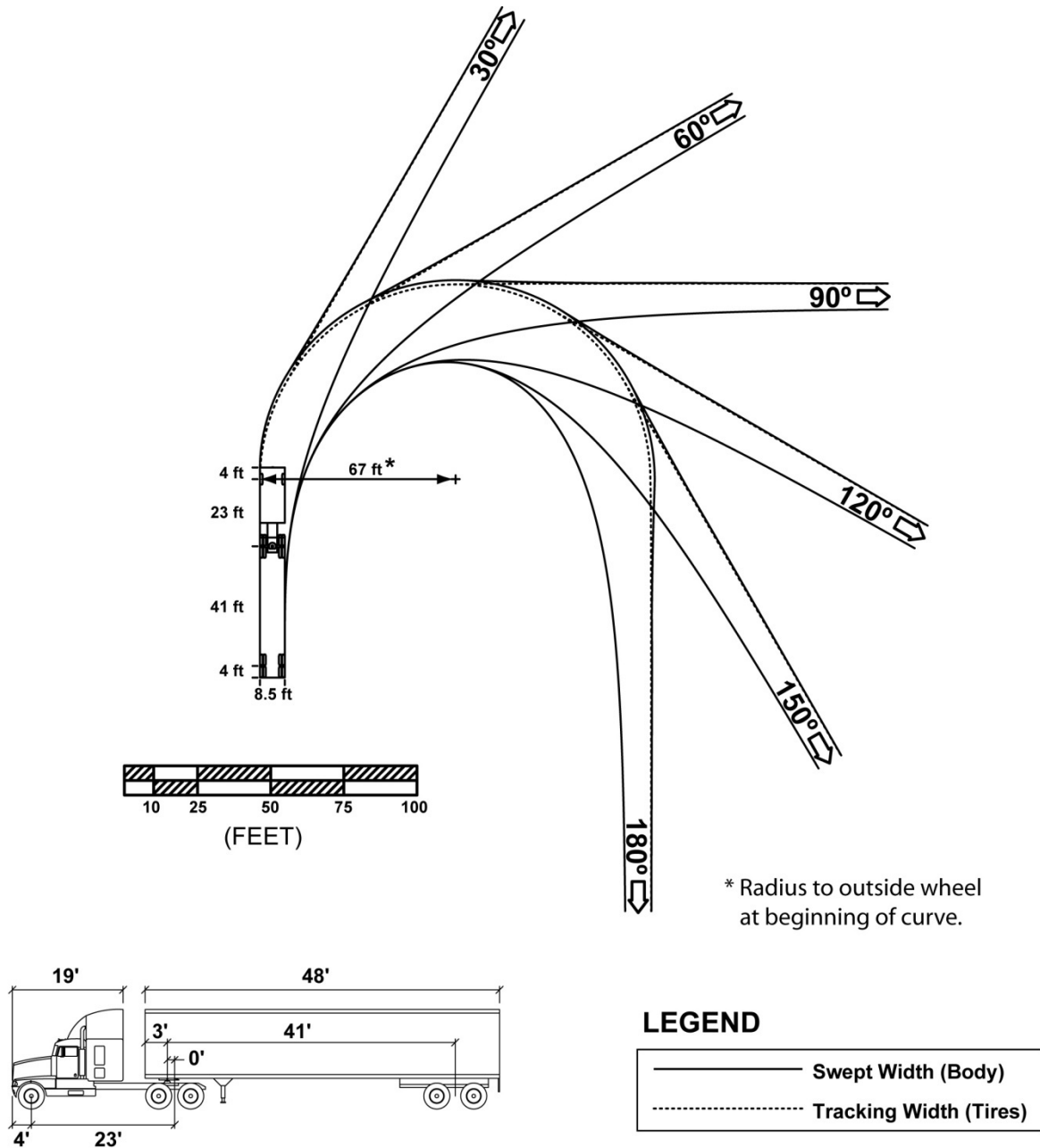

STAA - STANDARD

Tractor Width : 8.5'
 Trailer Width : 8.5'
 Tractor Track : 8.5'
 Trailer Track : 8.5'

Lock to Lock Time : 6 seconds
 Steering Lock Angle : 26.3 degrees
 Articulating Angle : 70 degrees

Note: For definitions, see Indexes 404.1 and 404.5.

Figure 404.5C

California Legal Design Vehicle 50-Foot Radius

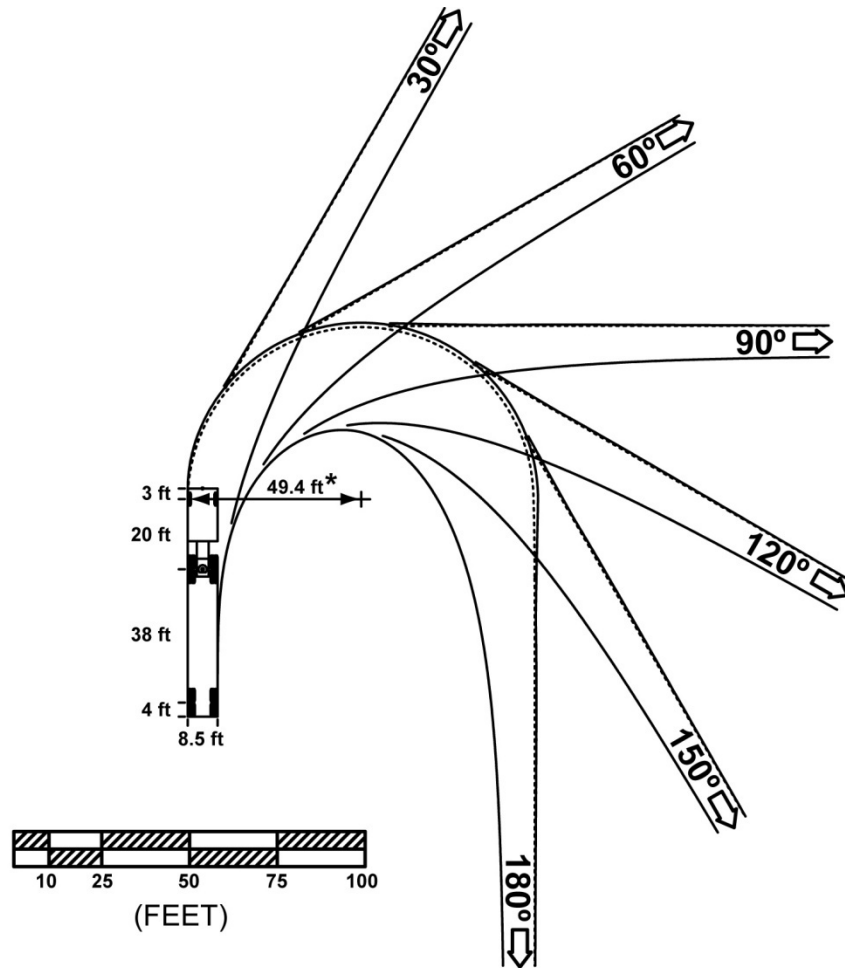

* Radius to outside wheel at beginning of curve.

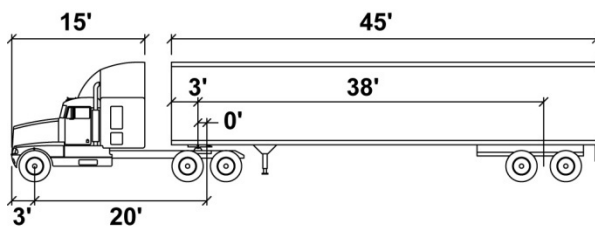

LEGEND

	Swept Width (Body)
	Tracking Width (Tires)

CA LEGAL - 65 FT

Tractor Width	: 8.5'	Lock to Lock Time	: 6 seconds
Trailer Width	: 8.5'	Steering Lock Angle	: 26.3 degrees
Tractor Track	: 8.5'	Articulating Angle	: 70 degrees
Trailer Track	: 8.5'		

Note: For definitions, see Indexes 404.1 and 404.5.

July 1, 2020

Figure 404.5D

California Legal Design Vehicle 60-Foot Radius

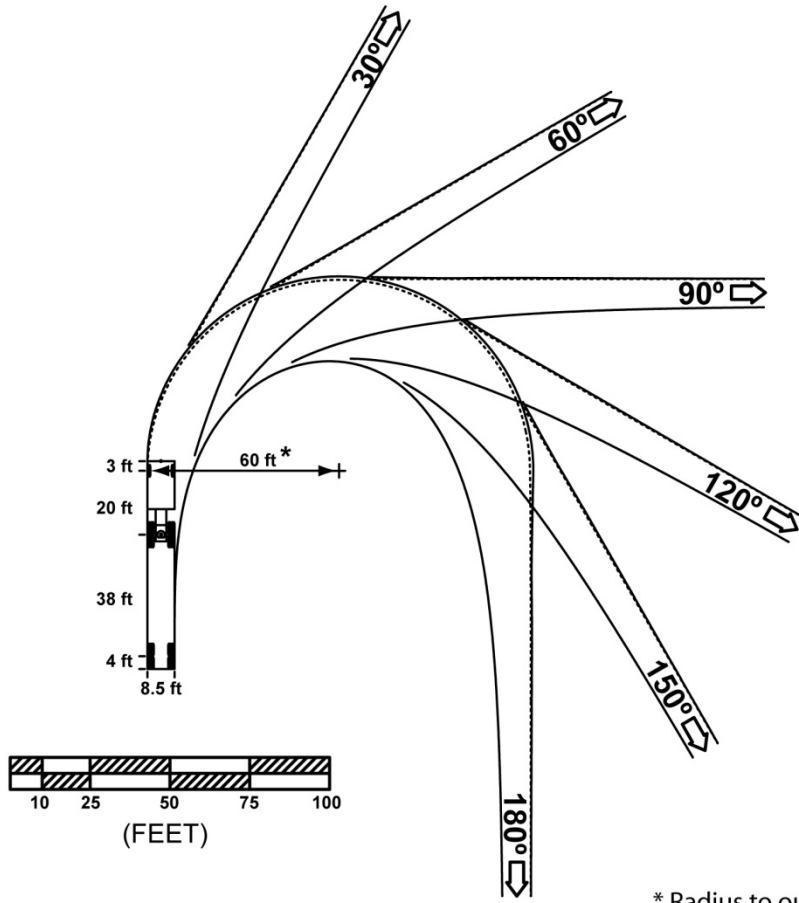

* Radius to outside wheel at beginning of curve.

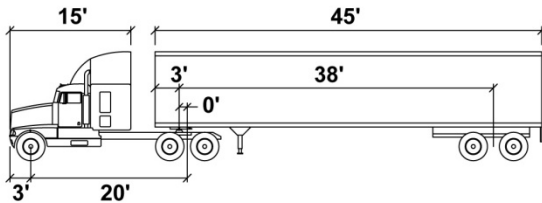

LEGEND

	Swept Width (Body)
	Tracking Width (Tires)

CA LEGAL - 65 FT

Tractor Width	: 8.5'	Lock to Lock Time	: 6 seconds
Trailer Width	: 8.5'	Steering Lock Angle	: 26.3 degrees
Tractor Track	: 8.5'	Articulating Angle	: 70 degrees
Trailer Track	: 8.5'		

Note: For definitions, see Indexes 404.1 and 404.5.

Figure 404.5E

40-Foot Bus Design Vehicle

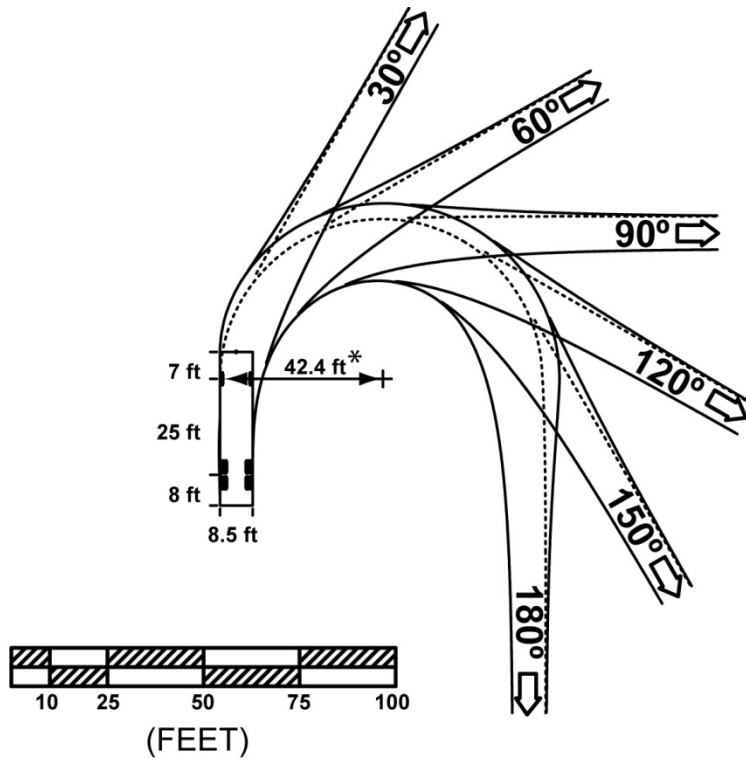

* Radius to outside wheel at beginning of curve.

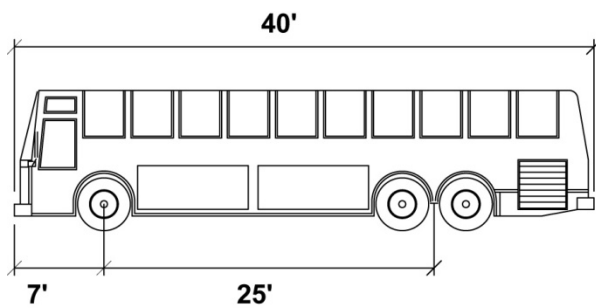

LEGEND

	Swept Width (Body)
	Tracking Width (Tires)

40' BUS

- Width : 8.5'
- Track : 8.5'
- Lock to Lock Time : 6 seconds
- Steering Lock Angle: 41.0 degrees

Note: For definitions, see Indexes 404.1 and 404.5.

July 1, 2020

Figure 404.5F

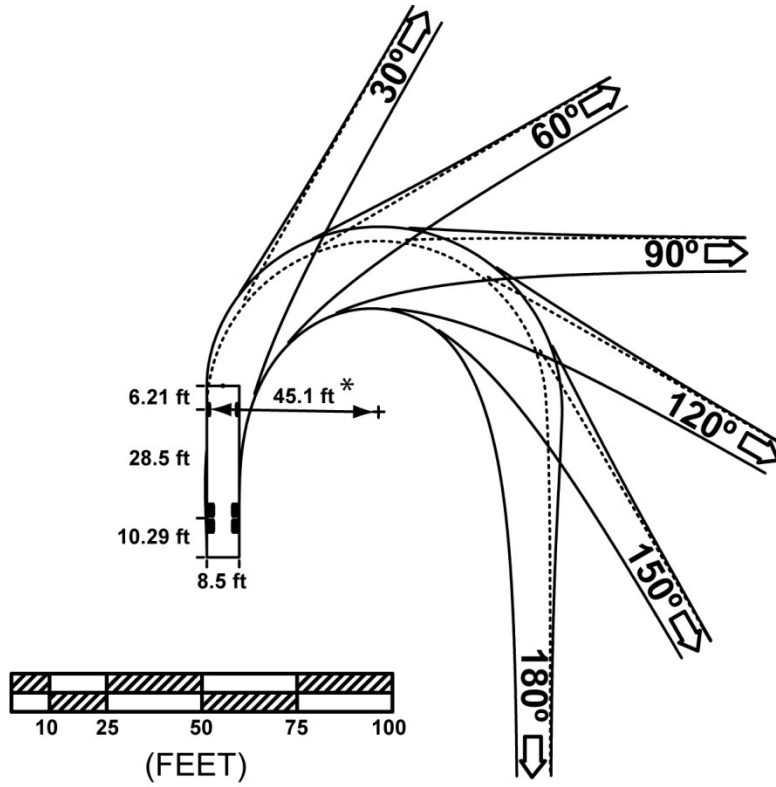

45-Foot Bus & Motorhome Design Vehicle

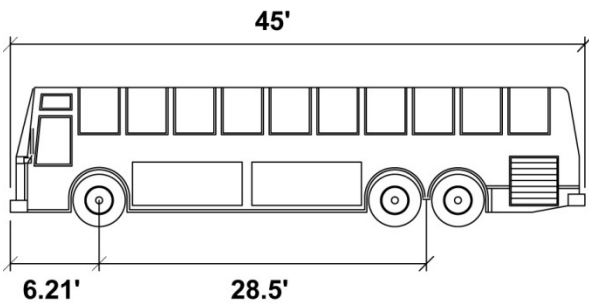

* Radius to outside wheel at beginning of curve.



LEGEND

	Swept Width (Body)
	Tracking Width (Tires)

45' BUS

- Width : 8.5'
- Track : 8.5'
- Lock to Lock Time : 6 seconds
- Steering Lock Angle: 44.3 degrees

Note: For definitions, see Indexes 404.1, and 404.5.

Figure 404.5G

60-Foot Articulated Bus Design Vehicle

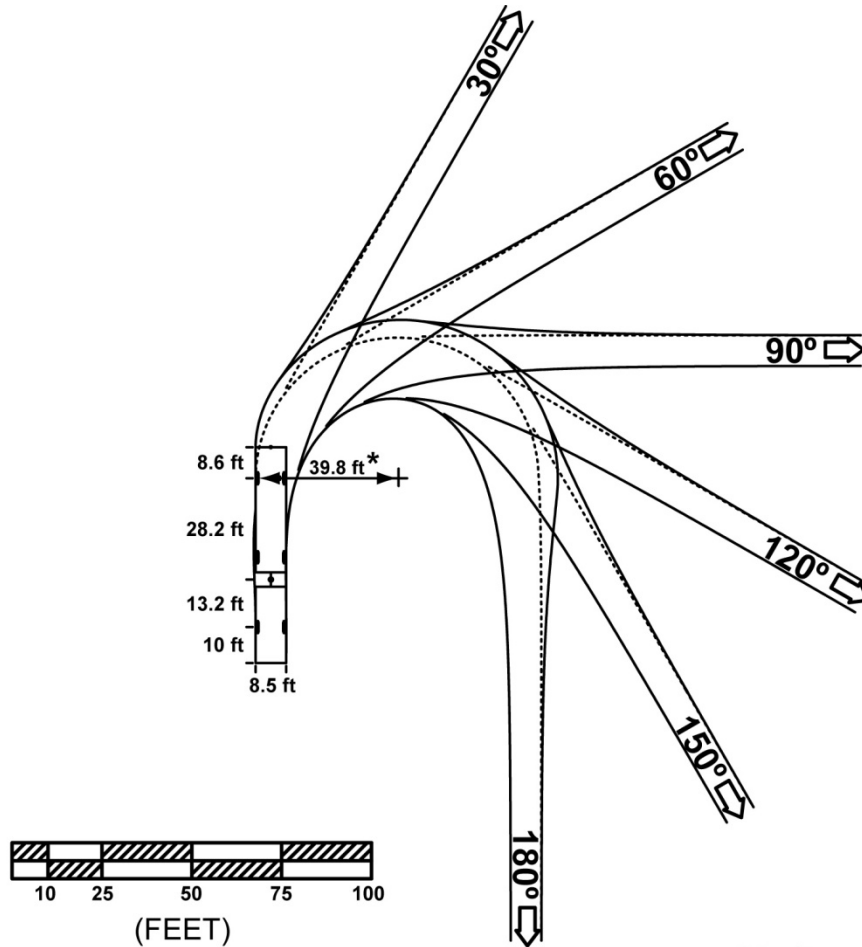

* Radius to outside wheel at beginning of curve.

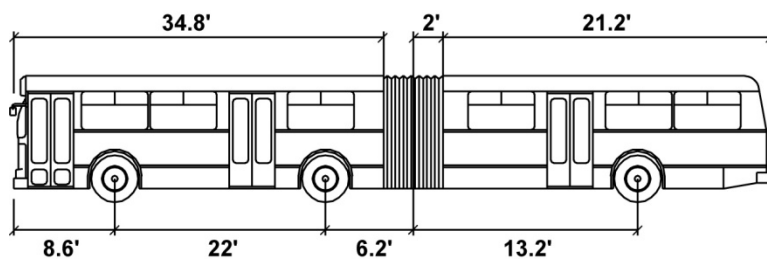

LEGEND

	Swept Width (Body)
	Tracking Width (Tires)

ARTICULATED BUS

- Width : 8.5'
- Track : 8.5'
- Lock to Lock Time : 6 seconds
- Steering Lock Angle: 38.3 degrees
- Articulating Angle : 50.0 degrees

Note: For definitions, see Indexes 404.1 and 404.5.

July 1, 2020

- (5) *Lock To Lock Time* - The time in seconds that an average driver would take under normal driving conditions to turn the steering wheel of a vehicle from the lock position on one side to the lock position on the other side. The default in AutoTurn software is 6 seconds.
- (6) *Steering Lock Angle* - The maximum angle that the steering wheels can be turned. It is further defined as the average of the maximum angles made by the left and right steering wheels with the longitudinal axis of the vehicle.
- (7) *Articulating Angle* - The maximum angle between the tractor and semitrailer.

Topic 405 – Intersection Design Standards

405.1 Sight Distance

- (1) *Stopping Sight Distance*. See Index 201.1 for minimum stopping sight distance requirements.
- (2) *Corner Sight Distance*.

- (a) General. At unsignalized intersections a substantially clear line of sight should be maintained between the driver of a vehicle, bicyclist or pedestrian stopped on the minor road and the driver of an approaching vehicle on the major road that has no stop. Line of sight for all users should be included in right of way, in order to preserve sight lines.

See DIB 79 for 2R, 3R, certain storm damage, protective betterment, operational, and safety projects on two-lane and three-lane conventional highways.

Adequate time should be provided for the stopped vehicle on the minor road to either cross all lanes of through traffic, cross the near lanes and turn left, or turn right, without requiring through traffic to radically alter their speed. The visibility required for these maneuvers form a clear sight triangle with the corner sight distance b and the crossing distance a_1 or a_2 (see Figure 405.1 as an example of corner sight distance at a two-lane, two-way highway). Dimensions a_1 and a_2 are measured from the decision point to the center of the lane. The actual number of lanes will vary on the major and minor roads. There should be no sight obstruction within the clear sight triangle.

The methodology used for the driver on the minor road that is stopped to complete the necessary maneuver while the approaching vehicle travels at the design speed of the major road is based on gap-acceptance behavior. A 7-1/2 second criterion is applied to a passenger car (including pickup trucks) for a left turn from a stop on the minor road. However, this time gap does not account for a single-unit truck (no semitrailer), a combination truck (see Index 404.4 for truck tractor-semi-trailer guidance), a right-turn from a stop, or for a crossing maneuver. See Table 405.1A for the time gap that addresses these situations for the assumed design vehicle making these maneuvers from the minor road.

In determining corner sight distance, a set back distance for the vehicle waiting on the minor road must be assumed as measured from the edge of traveled way of the major road. Set back for the driver of the vehicle on the minor road should be a minimum of 10 feet plus the shoulder width of the major road but not less than 15 feet. The location of the driver's eye for the set back is the decision point per Figure 405.1. Corner sight distance and the driver's eye set back are also illustrated in Figures 405.7 and 504.3I. Line of sight for corner sight distance for passenger cars is to be determined from a 3 and 1/2-foot height at the location of the driver of the vehicle in the center of the minor road lane to a 3 and 1/2-foot object height in the center of the approaching outside lane of the major road. This provides for reciprocal sight by both vehicles. The passenger

car driver's eye height should be applied to all minor roads. In addition, a truck driver's eye height of 7.6 feet should be applied to the minor road where applicable. Additionally, if the major road has a median barrier, a 2-foot object height should be used to determine the median barrier set back. A median that is wide enough to accommodate a stopped vehicle should also provide a clear sight triangle.

The minimum corner sight distance (feet) should be determined by the equation: $1.47V_mT_g$, where V_m is the design speed (mph) of the major road and T_g is the time gap (seconds) for the minor road vehicle to enter the major road. The values given in Table 405.1A should be used to determine T_g based on the design vehicle, the type of maneuver, and whether the stopped vehicle's rear wheels are on an upgrade exceeding 3 percent. The distance from the edge of traveled way to the rear wheels at the minor road stop location should be assumed as: 20 feet for a passenger car, 30 feet for a single-unit truck, and 72 feet for a combination truck.

- (b) Public Road Intersections (Refer to Topic 205 and Index 405.7); corner sight distance applies, see Table 405.1A.

At signalized intersections the corner sight distances should also be applied whenever possible. Even though traffic flows are designed to move at separate times, unanticipated conflicts can occur due to violation of signal, right turns on red, malfunction of the signal, or use of flashing red/yellow mode.

The minimum value for corner sight distance at signalized intersections should be equal to the stopping sight distance as given in Table 201.1, measured as previously described. This includes an urban driveway that forms a leg of the signalized intersection.

- (c) Private Road Intersections (Refer to Index 205.2) and Rural Driveways (Refer to Index 205.4); corner sight distance applies, see Table 405.1A. If signalized, the minimum corner sight distance should be equal to the stopping sight distance as given in Table 201.1, measured as previously described.
- (d) Urban Driveways (Refer to Index 205.3); corner sight distance requirements as described above are not applied to urban driveways unless signalized. See Index 405.1(2)(b) underlined standard. If parking is allowed on the major road, parking should be prohibited on both sides of the driveway per the California MUTCD, 3B.19.
- (3) *Decision Sight Distance.* At intersections where the State route turns or crosses another State route, the decision sight distance values given in Table 201.7 should be used. In computing and measuring decision sight distance, the 3.5-foot eye height and the 0.5-foot object height should be used, the object being located on the side of the intersection nearest the approaching driver.

The application of the various sight distance requirements for the different types of intersections is summarized in Table 405.1B

July 1, 2020

Table 405.1B

Application of Sight Distance Requirements

Intersection Types	Sight Distance		
	Stopping	Corner	Decision
Private Roads	X	X ⁽¹⁾	
Public Streets and Roads	X	X	
Signalized Intersections	X	X ⁽²⁾	
State Route Intersections & Route Direction Changes, with or without Signals	X	X	X

NOTES:

(1) Per Index 405.1(2)(c), the minimum corner sight distance shall be equal to the stopping sight distance as given in Table 201.1. See Index 405.1(2)(a) for setback requirements.

(2) Apply corner sight distance requirements at signalized intersections whenever possible due to unanticipated violations of the signals or malfunctions of the signals. See Index 405.1(2)(b).

(4) *Acceleration Lanes for Turning Moves onto State Highways.* At rural intersections, with "STOP" control on the local cross road, acceleration lanes for left and right turns onto the State facility should be considered. At a minimum, the following features should be evaluated for both the major highway and the cross road:

- divided versus undivided
- number of lanes
- design speed
- gradient
- lane, shoulder and median width
- traffic volume and composition of highway users, including trucks and transit vehicles

Figure 405.1
Corner Sight Distance (b)

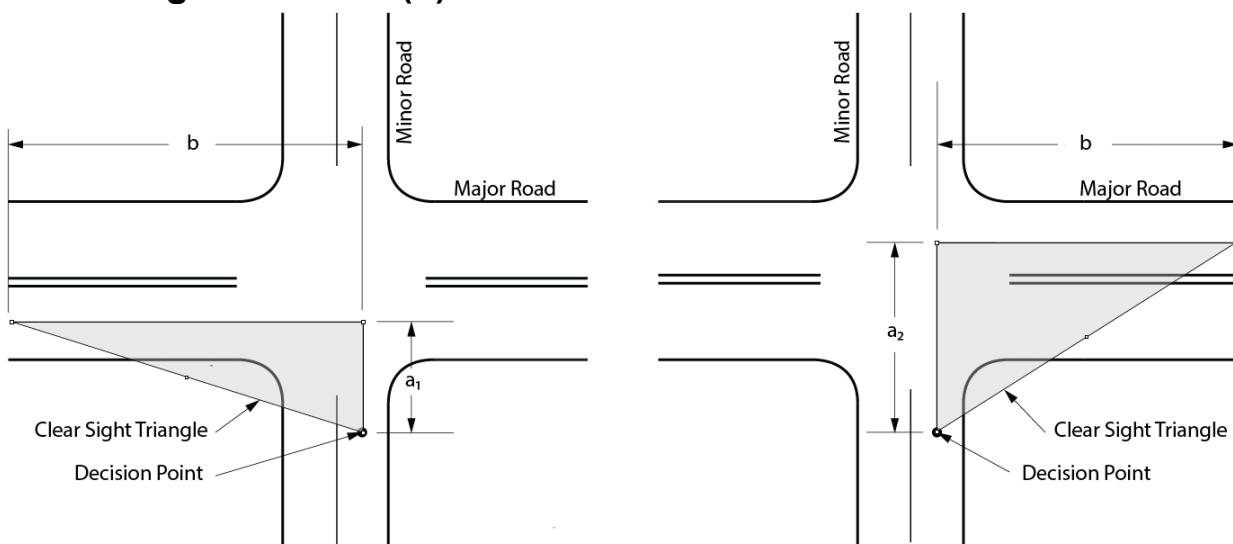

Table 405.1A
Corner Sight Distance Time Gap (T_g) for Unsignalized Intersections

Design Vehicle	Left-turn from Stop (s) ⁽⁴⁾	Right-turn from Stop and Crossing Maneuver (s)
Passenger Car	7½	6½
Private Road Intersection		
Rural Driveway		
Single-Unit Truck	9½	8½
Public Road Intersection		
Combination Truck	11½	10½
Major and Minor Roads on Routes:		
National Network		
Terminal or Service Access		
California Legal		
KPRA Advisory		

Notes: Time gaps are for a stopped vehicle to turn left, right or cross a two-lane highway with no median and with minor road grades of 3 percent or less. The table values should be adjusted as follows:

(1) For multilane highways—When crossing or making a left-turn onto a two-way major road with more than two lanes, add 0.5 s for passenger cars or 0.7 s for trucks for each additional lane to be crossed. Median widths should be converted to an equivalent number of lanes in applying the 0.5 s and 0.7 s criteria. For example, an 18-foot wide median is equivalent to 1.5 lanes; this requires an additional 0.75 s for a passenger car to cross or an additional 1.05 s for a truck to cross.

(2) For minor road approach grades—If the minor road approach grade is an upgrade that exceeds 3 percent and the rear wheels of the design vehicle are on the grade exceeding 3 percent, add 0.2 s for each percent grade for left-turns and crossing maneuvers; or add 0.1 s for each percent grade for right-turns. For example, a passenger car is turning right from a minor road and at the stop location its rear wheels are on a 4 percent upgrade; this requires an additional 0.4 s for the right-turn.

(3) Unique situations may necessitate a different design vehicle for a particular minor road than those listed here (e.g., predominant combination trucks out of a rural driveway). Additionally, for intersections at skewed angles less than 60 degrees, a further adjustment is needed. See the AASHTO “A Policy on Geometric Design of Highways and Streets” for guidance.

(4) Time gap for vehicles approaching from the left can be the same as the right-turn from stop maneuver.

July 1, 2020

- turning volumes
- horizontal curve radii
- sight distance
- proximity of adjacent intersections
- types of adjacent intersections

For additional information and guidance, refer to AASHTO, A Policy on Geometric Design of Highways and Streets, the District Traffic Engineer or designee, the District Design Liaison, and the Project Delivery Coordinator.

405.2 Left-turn Channelization

(1) *General.* The purpose of a left-turn lane is to expedite the movement of through traffic by, controlling the movement of turning traffic, increasing the capacity of the intersection, and improving safety characteristics.

The District Traffic Branch normally establishes the need for left-turn lanes.

(2) *Design Elements.*

(a) Lane Width – **The lane width for both single and double left-turn lanes on State highways shall be 12 feet.**

For conventional State highways with posted speeds less than or equal to 40 miles per hour and AADTT (truck volume) less than 250 per lane that are in urban, city or town centers (rural main streets), the minimum lane width shall be 11 feet.

When considering lane width reductions adjacent to curbed medians, refer to Index 303.5 for guidance on effective roadway width, which may vary depending on drivers' lateral positioning and shy distance from raised curbs.

(b) Approach Taper – On conventional highways without a median, an approach taper provides space for a left-turn lane by moving traffic laterally to the right. The approach taper is unnecessary where a median is available for the full width of the left-turn lane. Length of the approach taper is given by the formula on Figures 405.2A, B and C.

Figure 405.2A shows a standard left-turn channelization design in which all widening is to the right of approaching traffic and the deceleration lane (see below) begins at the end of the approach taper. This design should be used in all situations where space is available, usually in rural and semi-rural areas or in urban areas with high traffic speeds and/or volumes.

Figures 405.2B and 405.2C show alternate designs foreshortened with the deceleration lane beginning at the 2/3 point of the approach taper so that part of the deceleration takes place in the through traffic lane. Figure 405.2C is shortened further by widening half (or other appropriate fraction) on each side. These designs may be used in urban areas where constraints exist, speeds are moderate and traffic volumes are relatively low.

Figure 405.2A
Standard Left-turn Channelization

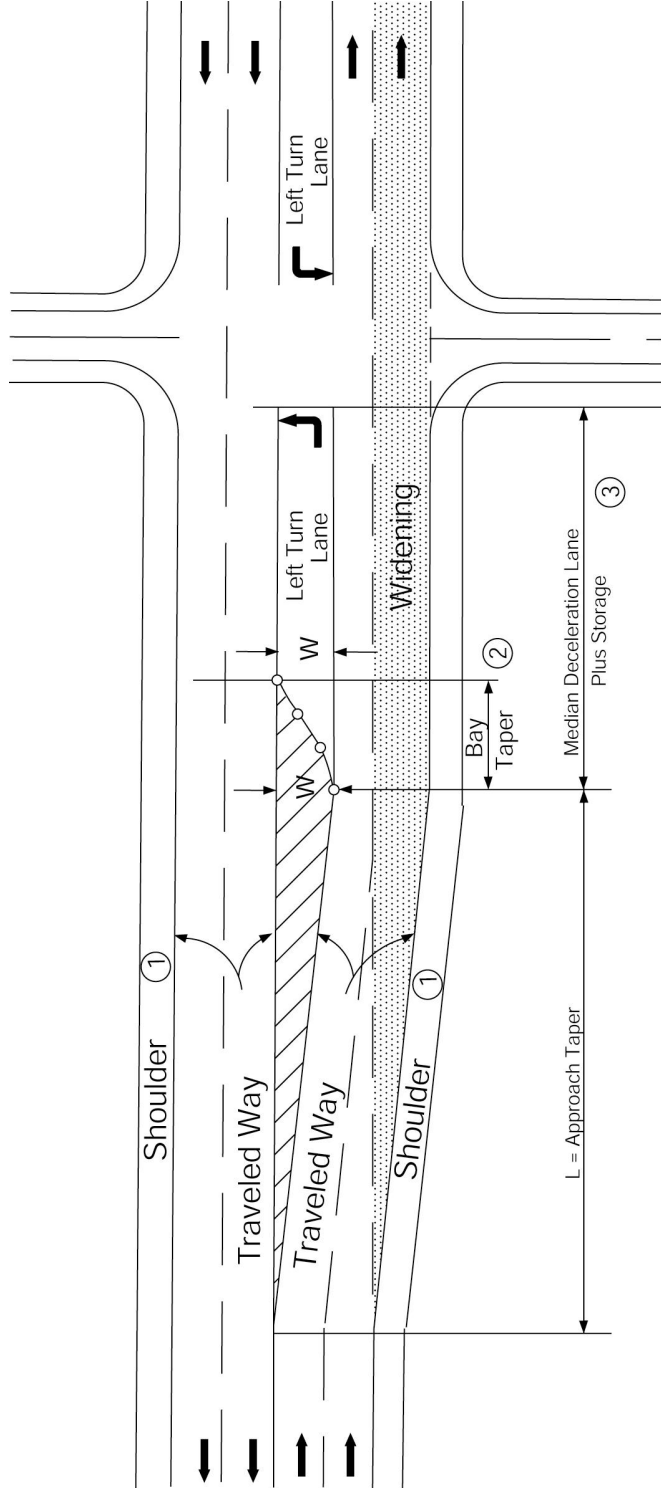

EQUATION: $L = \text{Use } WV, \text{ for } V \geq 45 \text{ mph}$ ④
 Or $WV^2/60, \text{ for } V < 45 \text{ mph}$

Where L = Length of Approach Taper - feet

V = Design Speed - mph

W = Width of Median Lane - feet

NOTES:

- ① Where width is restricted, shoulder width may be reduced and parking restricted with an approved design exception pursuant to Index 82.2. For bicycle use, a minimum 4-foot shoulder is required (5-foot if gutter is present).
- ② Bay taper length = 60 feet to 120 feet. (See Table 405.2A)
- ③ For deceleration lane length see Table 405.2B.
- ④ Where both sides of roadway are widened, use a fraction of "W" that is proportional to widening on each side.

July 1, 2020

Figure 405.2B

Minimum Median Left-turn Channelization (Widening on one Side of Highway)

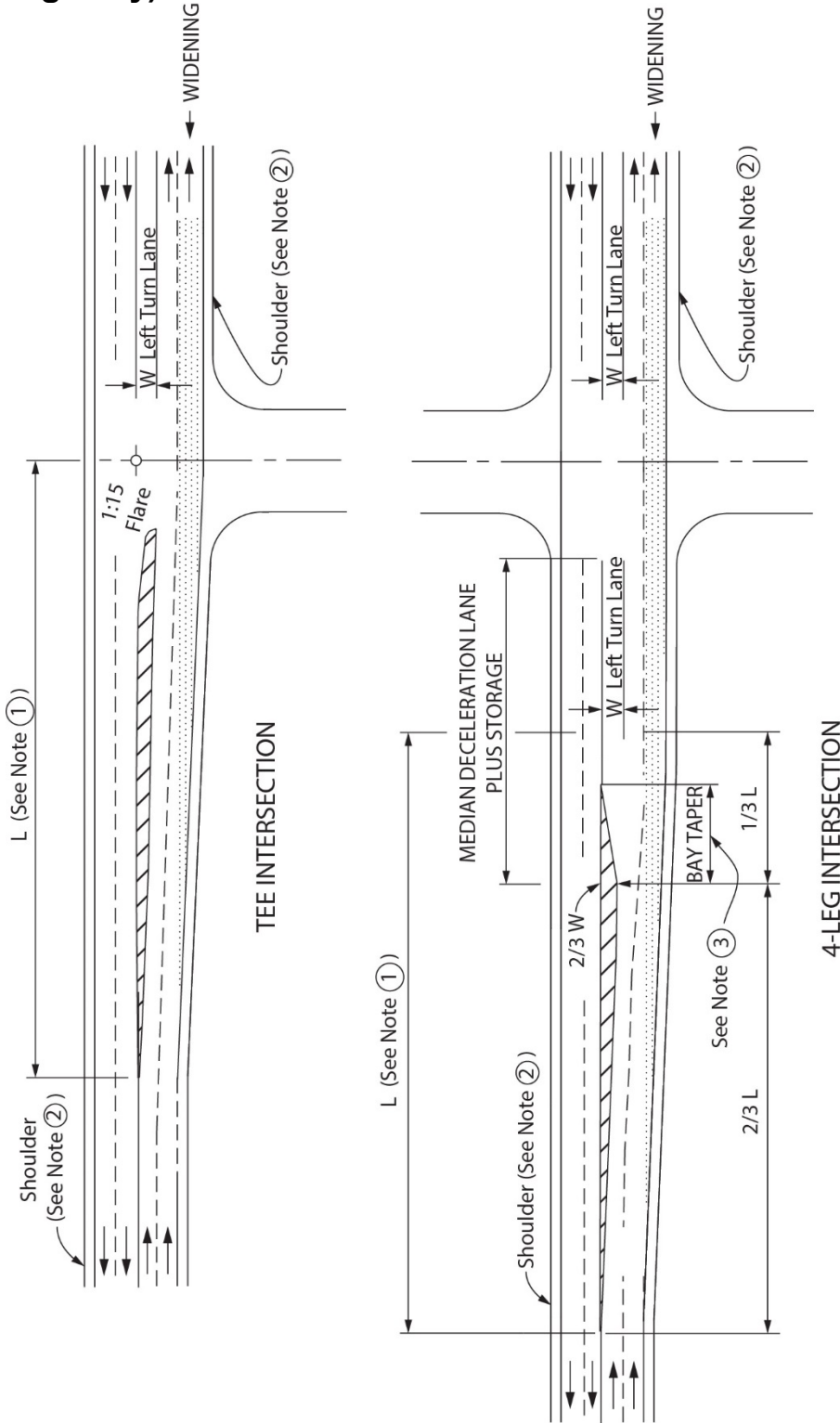

NOTES:

- ① L = 500 feet Maximum
- ② Where width is restricted, shoulder width may be reduced and parking restricted with an approved design exception pursuant to Index 82.2. For bicycle use, a minimum 4-foot shoulder is required (5-foot if gutter is required)
- ③ Bay Taper Length 60 feet to 120 feet (See Table 405.2A)

EQUATION

Use WV , for $V \geq 45$ mph

$$L = \text{Or } WV^2/60, \text{ for } V < 45 \text{ mph}$$

Where:

L = Length of Transition - feet

W = Width of Median Lane - feet

V = Design Speed - mph

Figure 405.2C

Minimum Median Left-turn Channelization (Widening on Both Sides in Urban Areas with Short Blocks)

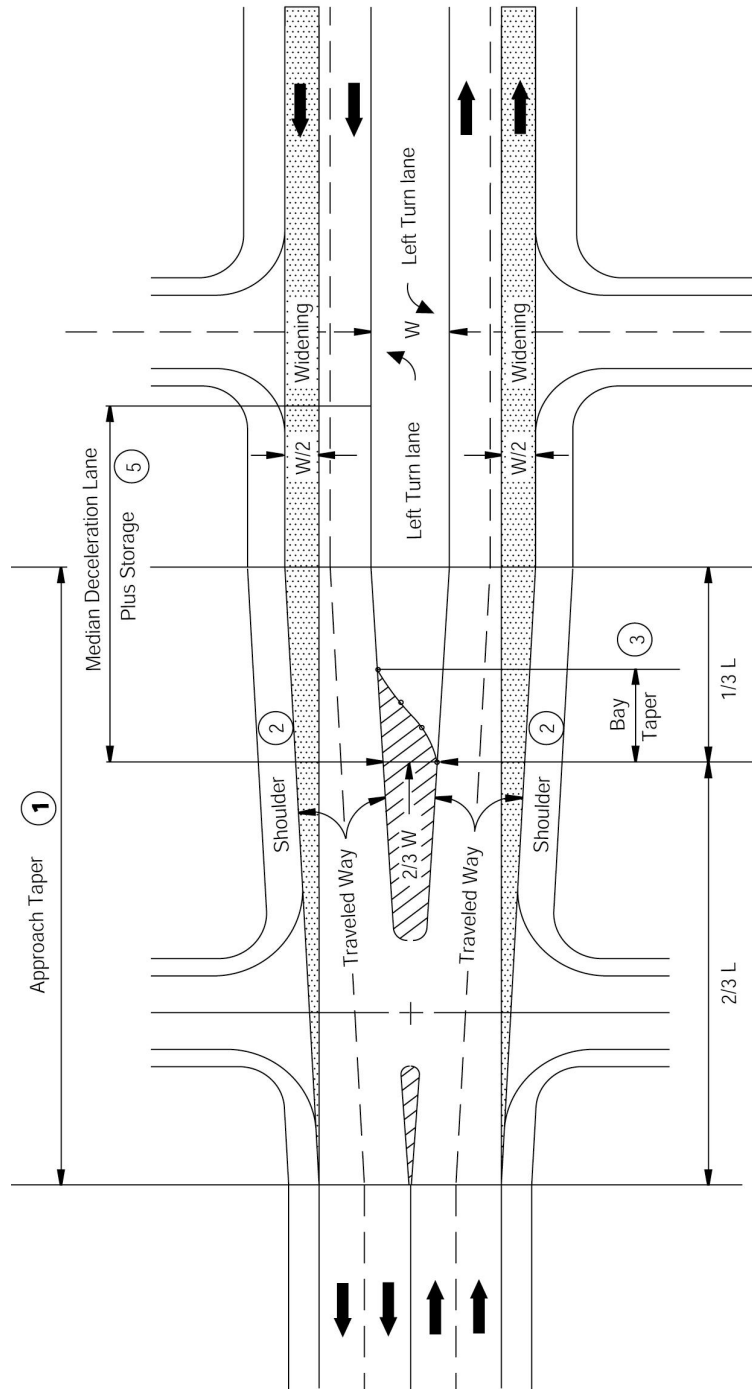

NOTES:

- ① L = 500 feet Maximum
- ② Where width is restricted, shoulder width may be reduced and parking restricted with an approved design exception pursuant to Index 82.2. For bicycle use, a minimum 4 feet shoulder is required (5 feet if gutter is present).
- ③ Bay taper length = 60 feet to 120 feet. (See Table 405.2A)
- ④ Assumes equal widening each side. Where widening is unequal, use a fraction that is proportional to widening on each side.
- ⑤ For deceleration lane length see Table 405.2B.

EQUATION: ④

Use $(1/2)WV$, for $V \geq 45\text{mph}$
 Or $WV^2/120$, for $V < 45\text{mph}$

Where L = Length of Approach Taper - feet
 W = Width of Median Lane - feet
 V = Design Speed - mph

July 1, 2020

- (c) Bay Taper – A reversing curve along the left edge of the traveled way directs traffic into the left-turn lane. The length of this bay taper should be short to clearly delineate the left-turn move and to discourage through traffic from drifting into the left-turn lane. Table 405.2A gives offset data for design of bay tapers. In urban areas, lengths of 60 feet and 90 feet are normally used. Where space is restricted and speeds are low, a 60-foot bay taper is appropriate. On rural high-speed highways, a 120-foot length is considered appropriate.
- (d) Deceleration Lane Length – Design speed of the roadway approaching the intersection should be the basis for determining deceleration lane length. It is desirable that deceleration take place entirely off the through traffic lanes. Deceleration lane lengths are given in Table 405.2B; the bay taper length is included. Where partial deceleration is permitted on the through lanes, as in Figures 405.2B and 405.2C, design speeds in Table 405.2B may be reduced 10 miles per hour to 20 miles per hour for a lower entry speed. In urban areas where cross streets are closely spaced and deceleration lengths cannot be achieved, the District Traffic branch should be consulted for guidance.
- (e) Storage Length – At unsignalized inter-sections, storage length may be based on the number of turning vehicles likely to arrive in an average 2-minute period during the peak hour. At a minimum, space for 2 vehicles should be provided at 25 feet per vehicle. If the peak hour truck traffic is 10 percent or more, space for at least one passenger car and one truck should be provided. Bus usage may require a longer storage length and should be evaluated if their use is anticipated.

At signalized intersections, the storage length may be based on one and one-half to two times the average number of vehicles that would store per signal cycle depending on cycle length, signal phasing, and arrival and departure rates. At a minimum, storage length should be calculated in the same manner as unsignalized intersection. The District Traffic Branch should be consulted for this information.

When determining storage length, the end of the left-turn lane is typically placed at least 3 feet, but not more than 30 feet, from the nearest edge of shoulder of the intersecting roadway. Although often set by the placement of a crosswalk line or limit line, the end of the storage lane should always be located so that the appropriate turning template can be accommodated.

Table 405.2A

Bay Taper for Median Speed-change Lanes

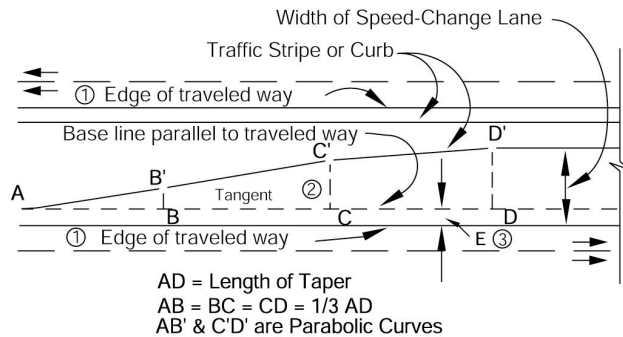

LENGTH OF TAPER - feet			OFFSET DISTANCE			
60	90	120	DD' = 10'	DD' = 11'	DD' = 12'	
Distance From Point "A"						
-	-	-	0.00	0.00	0.00	
5	7.5	10.0	0.16	0.17	0.19	
10	15.0	20.0	0.62	0.69	0.75	
15	22.5	30.0	1.41	1.55	1.69	
B'	20	30.0	40.0	2.50	2.75	3.00
	30	45.0	60.0	5.00	5.50	6.00
C'	40	60.0	80.0	7.50	8.25	9.00
	45	67.5	90.0	8.59	9.45	10.31
	50	75.0	100.0	9.38	10.31	11.25
	55	82.5	110.0	9.84	10.83	11.81
	60	90.0	120.0	10.00	11.00	12.00

NOTES:

- (1) The table gives offsets from a base line parallel to the edge of traveled way at intervals measured from point "A". Add "E" for measurements from edge of traveled way.
- (2) Where edge of traveled way is a curve, neither base line nor taper between B & C will be a tangent. Use proportional offsets from B to C.
- (3) The offset "E" is usually 2 ft along edge of traveled way for curbed medians; Use "E" = 0 ft. for striped medians.

Table 405.2B

Deceleration Lane Length

Design Speed (mph)	Length to Stop (ft)
30	235
40	315
50	435
60	530

July 1, 2020

- (3) *Double Left-turn Lanes.* At signalized intersections on multilane conventional highways and on multilane ramp terminals, double left-turn lanes should be considered if the left-turn demand is 300 vehicles per hour or more. The lane widths and other design elements of left-turn lanes given under Index 405.2(2) applies to double as well as single left-turn lanes.

The design of double left-turn lanes can be accomplished by adding one or two lanes in the median. See "Complete Intersections: A Guide to Reconstructing Intersections and Interchanges for Bicyclists and Pedestrians", published by Headquarters, Division of Traffic Operations, for the various treatments of double left-turn lanes.

- (4) *Two-way Left-turn Lane (TWLTL).* The TWLTL consists of a striped lane in the median of an arterial and is devised to address the special capacity and safety problems associated with high-density strip development. It can be used on 2-lane highways as well as multilane highways. Normally, the District Traffic Operations Branch should determine the need for a TWLTL.

The minimum width for a TWLTL shall be 12 feet (see Index 301.1). The preferred width is 14 feet. Wider TWLTL's are occasionally provided to conform with local agency standards. However, TWLTL's wider than 14 feet are not recommended, and in no case should the width of a TWLTL exceed 16 feet. Additional width may encourage drivers in opposite directions to use the TWLTL simultaneously.

405.3 Right-turn Channelization

- (1) *General.* For right-turning traffic, delays are less critical and conflicts less severe than for left-turning traffic. Nevertheless, right-turn lanes can be justified on the basis of capacity, analysis, and crash experience.

In rural areas a history of high speed rear-end collisions may warrant the addition of a right-turn lane.

In urban areas other factors may contribute to the need such as:

- High volumes of right-turning traffic causing backup and delay on the through lanes.
- Conflicts between crossing pedestrians and right-turning vehicles and bicycles.
- Frequent rear-end and sideswipe collisions involving right-turning vehicles.

Where right-turn channelization is proposed, lower speed right-turn lanes should be provided to reduce the likelihood of conflicts between vehicles, pedestrians, and bicyclists.

- (2) *Design Elements.*

- (a) Lane and Shoulder Width – **Index 301.1 shall be used for right-turn lane width requirements. Shoulder width shall be a minimum of 4 feet.** Although not desirable, lane and shoulder widths less than those given above can be considered for right-turn lanes under the following conditions pursuant to Index 82.2:

- In urban, city or town centers (rural main streets) with posted speeds less than 40 miles per hour in severely constrained situations, if truck or bus use is low, consideration may be given to reducing the right-turn lane width to 10 feet.
- Shoulder widths may also be considered for reduction under constricted situations. Whenever possible, at least a 2-foot shoulder should be provided where the right-turn lane is adjacent to a curb. Entire omission of the shoulder should only be considered in constrained situations and where an 11-foot lane can be constructed.

Gutter pans can be included within a shoulder, but cannot be included as part of the travel lane width. Additional right of way for a future right-turn lane should be considered when an intersection is being designed.

- (b) Curve Radius--Where pedestrians are allowed to cross a free right-turning roadway, the curve radius should be such that the operating speed of vehicular traffic is no more than 20 miles per hour at the pedestrian crossing. See NCHRP Report 672, "Roundabouts: An Informational Guide" for guidance on the determination of design speed (fastest path) for turning vehicles. See Index 504.3(3) for additional information.
 - (c) **Tapers--**Approach tapers are usually unnecessary since main line traffic need not be shifted laterally to provide space for the right-turn lane. If, in some rare instances, a lateral shift were needed, the approach taper would use the same formula as for a left-turn lane. Bay tapers are treated as a mirror image of the left-turn bay taper.
 - (d) **Deceleration Lane Length--**The conditions and principles of left-turn lane deceleration apply to right-turn deceleration. Where full deceleration is desired off the high-speed through lanes, the lengths in Table 405.2B should be used. Where partial deceleration is permitted on the through lanes because of limited right of way or other constraints, average running speeds in Table 405.2B may be reduced 10 miles per hour to 20 miles per hour for a lower entry speed. For example, if the main line speed is 50 miles per hour and a 10 miles per hour deceleration is permitted on the through lanes, the deceleration length may be that required for 40 miles per hour.
 - (e) **Storage Length--**Right-turn storage length is determined in the same manner as left-turn storage length. See Index 405.2(2)(e).
- (3) *Right-turn Lanes at Off-ramp Intersections.* Diamond off-ramps with a free right-turn at the local street and separate right-turn off-ramps around the outside of a loop will likely cause conflict as traffic volumes increase. Serious conflicts occur when the right-turning vehicle must weave across multiple lanes on the local street in order to turn left at a major cross street close to the ramp terminal. Furthermore, free right-turns create sight distance issues for pedestrians and bicyclists crossing the off-ramp, or pedestrians crossing the local road. Also, rear-end collisions can occur as right-turning drivers slow down or stop waiting for a gap in local street traffic. Free right-turns usually end up with "YIELD", "STOP", or signal controls thus defeating their purpose of increasing intersection capacity.

405.4 Traffic Islands

A traffic island is an area between traffic lanes for channelization of bicycle and vehicle movements or for pedestrian refuge. An island may be defined by paint, raised pavement markers, curbs, pavement edge, or other devices. The California MUTCD should be referenced when considering the placement of traffic islands at signalized and unsignalized locations. For splitter island guidance at roundabouts, see Index 405.10(13).

Traffic islands usually serve more than one function. These functions may be:

- (a) Channelization to confine specific traffic movements into definite channels;
- (b) Divisional to separate traffic moving in the same or opposite direction; and
- (c) Refuge, to aid users crossing the roadway.

Generally, islands should present the least potential conflict to approaching or crossing bicycles and vehicles, and yet perform their intended function.

July 1, 2020

(1) *Design of Traffic Islands.* Island sizes and shapes vary from one intersection to another. They should be large enough to command attention. Channelizing islands should not be less than 50 square feet in area, preferably 75 square feet. Curbed, elongated divisional median islands should not be less than 4 feet wide and 20 feet long. All traffic islands placed in the path of a pedestrian crossing must comply with DIB 82. See the Standard Plans for typical island passageway details.

The approach end of each island should be offset 3 feet to the left and 5 feet to the right of approaching traffic, using standard 1:15 parabolic flares, and clearly delineated so that it does not surprise the motorist or bicyclist. These offsets are in addition to the shoulder widths shown in Table 302.1. Table 405.4 gives standard parabolic flares to be used in island design. On curved alignment, parabolic flares may be omitted for small triangular traffic islands whose sides are less than 25 feet long.

The approach nose of a divisional island should be highly visible day and night with appropriate use of signs (reflectorized or illuminated) and object markers. The approach nose should be offset 3 feet from the through traffic to minimize accidental impacts.

(2) *Delineation of Traffic Islands.* Generally, islands should present the least potential conflict to approaching traffic and yet perform their intended function. See Index 303.2 for appropriate curb type. Islands may be designated as follows:

- (a) Raised paved areas outlined by curbs.
- (b) Flush paved areas outlined by pavement markings.
- (c) Unpaved areas (small unpaved areas should be avoided).

On facilities with posted speeds over 40 miles per hour, the use of any type of curb is discouraged. Where curbs are to be used, they should be located at or outside of the shoulder edge, as discussed in Index 303.5.

In rural areas, painted channelization supplemented with raised pavement markers may be more appropriate than a raised curbed channelization. This design is as forgiving as possible and decreases the consequence of a driver's or bicyclist's failure to detect or recognize the curbed island. Consideration for snow removal operations should be determined where appropriate.

In urban areas, posted speeds less than or equal to 40 miles per hour allow more frequent use of curbed islands. Local agency requirements and matching existing conditions are factors to consider.

Table 405.4

Parabolic Curb Flares Commonly Used

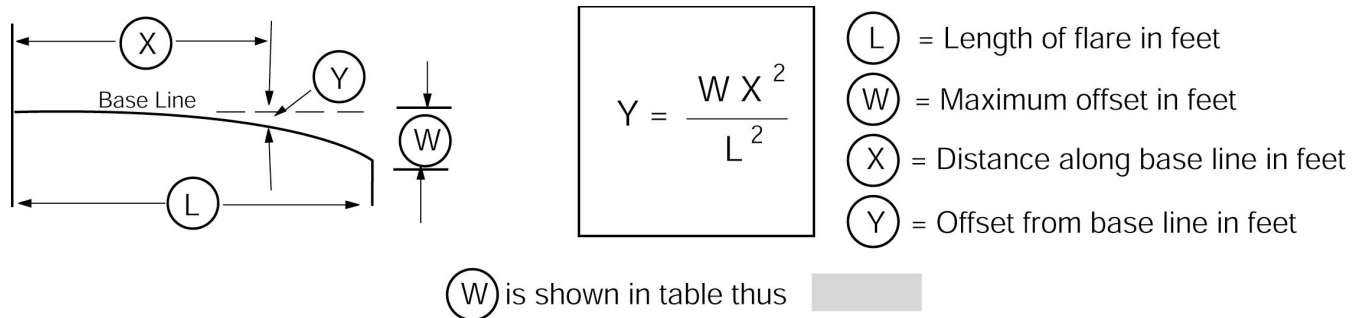

OFFSET IN FEET FOR GIVEN "X" DISTANCE																
0	10	15	20	25	30	40	45	50	60	70	75	80	90	100	110	120
1:5 FLARES																
25	0.8	1.8	3.2	5.0												
50	0.4		1.6		3.6	6.4		10.								
1:10 FLARES																
50	0.2		0.8		1.8	3.2		5.0								
100	0.1		0.4		0.9	1.6		2.5	3.6	4.9		6.4	8.1	10.		
1:15 FLARES																
45	0.1		0.5		1.3	2.3	3.0									
75	0.0		0.3		0.8	1.4		2.2	3.2	4.3	5.0					
90	0.0		0.3		0.6	1.1		1.8	2.6	3.6		4.7	6.0			
120	0.0		0.2		0.5	0.8		1.3	2.0	2.7		3.5	4.5	5.5	6.7	8.0

(3) *Pedestrian Refuge.* Pedestrian refuge islands allow pedestrians to cross fewer lanes at a time while judging conflicts separately. They also provide a refuge so slower pedestrians can wait for a gap in traffic while reducing total crossing distance.

At unsignalized intersections in rural city/town centers (rural main streets), suburban, or urban areas, a pedestrian refuge should be provided between opposing traffic where pedestrians are allowed to cross 2 or more through traffic lanes in one direction of travel, at marked or unmarked crosswalks. Pedestrian islands at signalized crosswalks should be considered, taking into account crossing distance and pedestrian activity. Note that signalized pedestrian crossings must be timed to allow for pedestrians to cross. See the California MUTCD, Chapter 4E, for further guidance.

Traffic islands used as pedestrian refuge are to be large enough to provide a minimum of 6 feet in the direction of pedestrian travel, without exception.

All traffic islands placed in the path of a pedestrian crossing must be accessible, refer to DIB 82 and the Standard Plans for further guidance. An example of a traffic island that serves as a pedestrian refuge is shown on Figure 405.4.

July 1, 2020

405.5 Median Openings

- (1) *General.* Median openings, sometimes called crossovers, provide for crossings of the median at designated locations. Except for emergency passageways in a median barrier, median openings are not allowed on urban freeways.
- (2) *Spacing and Location.* By a combination of interchange ramps and emergency passageways, provisions for access to the opposite side of a freeway may be provided for law enforcement, emergency, and maintenance vehicles to avoid extreme out-of-direction travel. Access should not be more frequent

Figure 405.4

Pedestrian Refuge Island

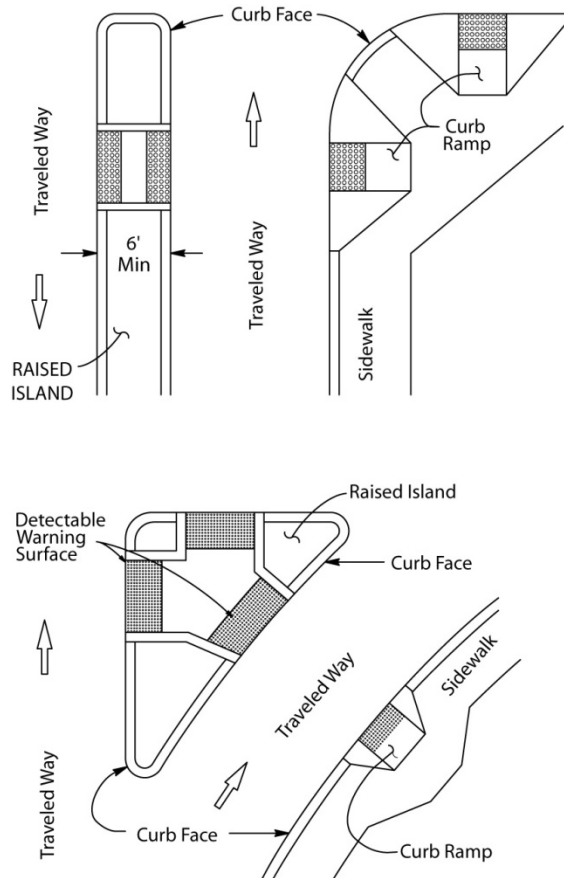

than at three-mile intervals. See Traffic Safety Systems Guidance for additional information on the design of emergency passageways.

Emergency passageways should be located only where decision sight distance is available (see Table 201.7).

Median openings at close intervals on other types of highways create conflicts with high speed through traffic. Median openings should be spaced at intervals no closer than 1600 feet. If a median opening falls within 300 feet of an access opening, it should be placed opposite the access opening.

- (3) *Length of Median Opening.* For any three or four-leg intersection on a divided highway, the length of the median opening should be at least as great as the width of the crossroads pavement, median width, and shoulders. An important factor in designing median openings is the path of the design vehicle making a minimum left turn at 5 miles per hour to 10 miles per hour. The length of median opening varies with width of median and angle of intersecting road.

Usually a median opening of 60 feet is adequate for 90 degree intersections with median widths of 22 feet or greater. When the median width is less than 22 feet, a median opening of 70 feet is needed. When the intersection angle is other than 90 degrees, the length of median opening should be established by using truck turn templates (see Index 404.3).

- (4) *Cross Slope.* The cross slope in the median opening should be limited to 5 percent. Crossovers on curves with super elevation exceeding 5 percent should be avoided. This cross slope may be exceeded when an existing 2-lane roadbed is converted to a 4-lane divided highway. The elevation of the new construction should be based on the 5 percent cross slope requirement when the existing roadbed is raised to its ultimate elevation.
- (5) *References.* For information related to the design of intersections and median openings, "A Policy on Geometric Design of Highways and Streets," AASHTO, should be consulted.

405.6 Access Control

The basic guidance which govern the extent to which access rights are to be acquired at interchanges (see Topic 104, Index 205.1 and 504.8 and the PDPM) also apply to intersections at grade on expressways. Cases of access control which frequently occur at intersections are shown in Figure 405.7. This illustration does not presume to cover all situations. Where required by traffic conditions, access should be extended in order to ensure proper operation of the expressway lanes. Reasonable variations which observe the basic principles referred to above are acceptable.

However, negative impacts on the mobility needs of pedestrians, bicyclists, equestrians, and transit users need to be assessed. Pedestrians and bicyclists are sensitive to additional out of direction travel.

July 1, 2020

Figure 405.5

Typical Design for Median Openings

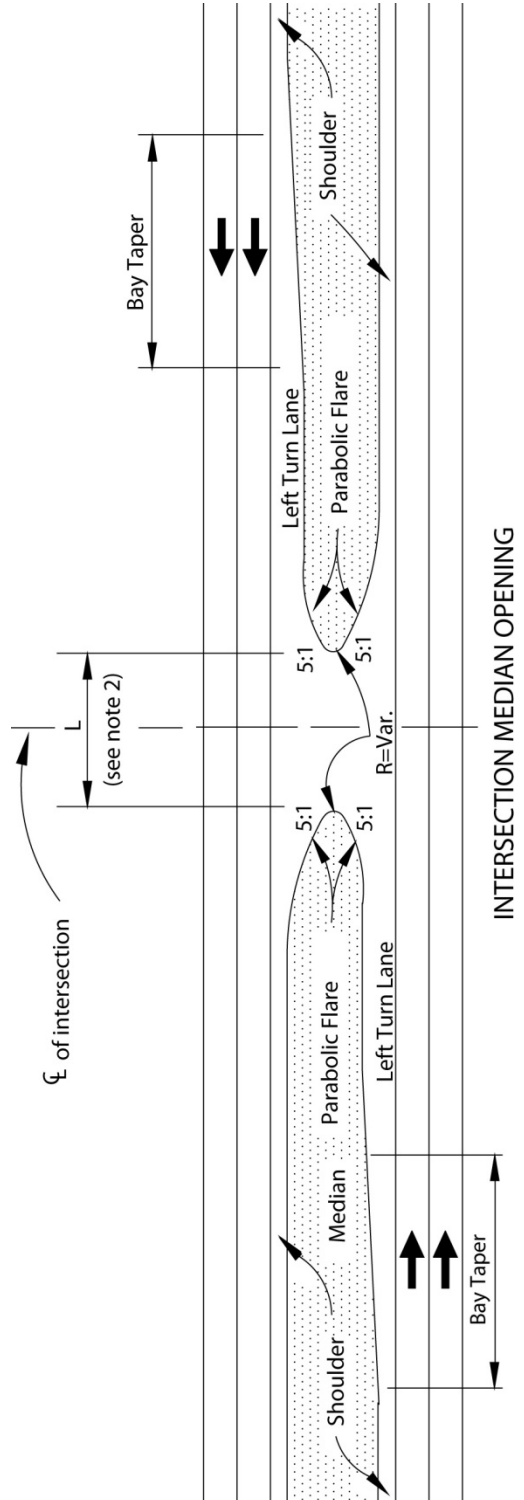

NOTES:

- ① For length of bay taper, see Table 405.2A.
- ② L = Length of median opening: varies with width of median and angle of intersecting road. Usually for 90° intersection, L = 60 feet for median of 22 feet and wider. L = 70 feet for medians narrower than 22 feet.
- ③ See Index 405.2.
- ④ Pedestrian and bicycle features are not shown on figure.

405.7 Public Road Intersections

The basic design to be used at right-angle public road intersections on the State Highway System is shown in Figure 405.7. The essential elements are sight distance (see Index 405.1) and the treatment of the right-turn on and off the main highway. Encroachment into opposing traffic lanes by the turning vehicle should be avoided or minimized.

(1) *Right-turn Onto the Main Highway.* The combination of a circular curve joined by a 2:1 taper on the crossroads and a 75-foot taper on the main highway is designed to fit the wheel paths of the appropriate turning template chosen by the designer.

It is desirable to keep the right-turn as tight as practical, so the “STOP” or “YIELD” sign on the minor leg can be placed close to the intersection.

(2) *Right-turn Off the Main Highway.* The combination of a circular curve joined by a 150-foot taper on the main highway and a 4:1 taper on the crossroads is designed to fit the wheel paths of the appropriate turning template and to move the rear of the vehicle off the main highway. Deceleration and storage lanes may be provided when necessary (see Index 405.3).

(3) *Alternate Designs.* Offsets are given in Figure 405.7 for right angle intersections. For skew angles, roadway curvature, and possibly other reasons, variations to the right-angle design are permitted, but the basic rule is still to approximate the wheel paths of the design vehicle.

A three-center curve is an alternate treatment that may be used at the discretion of the designer.

Intersections are major consideration in bicycle path design as well. See Indexes 403.6 and 1003.1(5) for general bicycle path intersection design guidance. Also see Section 5.3 of the AASHTO Guide for the Planning, Design, and Operation of Bicycle Facilities.

405.8 City Street Returns and Corner Radii

The pavement width and corner radius at city street intersections is determined by the type of vehicle to be accommodated and the mobility needs of pedestrians and bicyclists, taking into consideration the amount of available right of way, the types of adjoining land uses, the place types, the roadway width, and the number of lanes on the intersecting street.

At urban intersections, the California truck or the Bus Design Vehicle template may be used to determine the corner radius. Where STAA truck access is allowed, the STAA Design Vehicle template should be used giving consideration to factors mentioned above. See Index 404.3.

Smaller radii of 15 feet to 25 feet are appropriate at minor cross streets where few trucks or buses are turning. Local agency standards may be appropriate in urban and suburban areas.

Encroachment into opposing traffic lanes must be avoided.

405.9 Widening of 2-lane Roads at Signalized Intersections

Two-lane State highways may be widened at intersections to 4-lanes whenever signals are installed. Sometimes it may be necessary to widen the intersecting road. The minimum design is shown in Figure 405.9. More elaborate treatment may be warranted by the volume and

July 1, 2020

Figure 405.7

Public Road Intersections

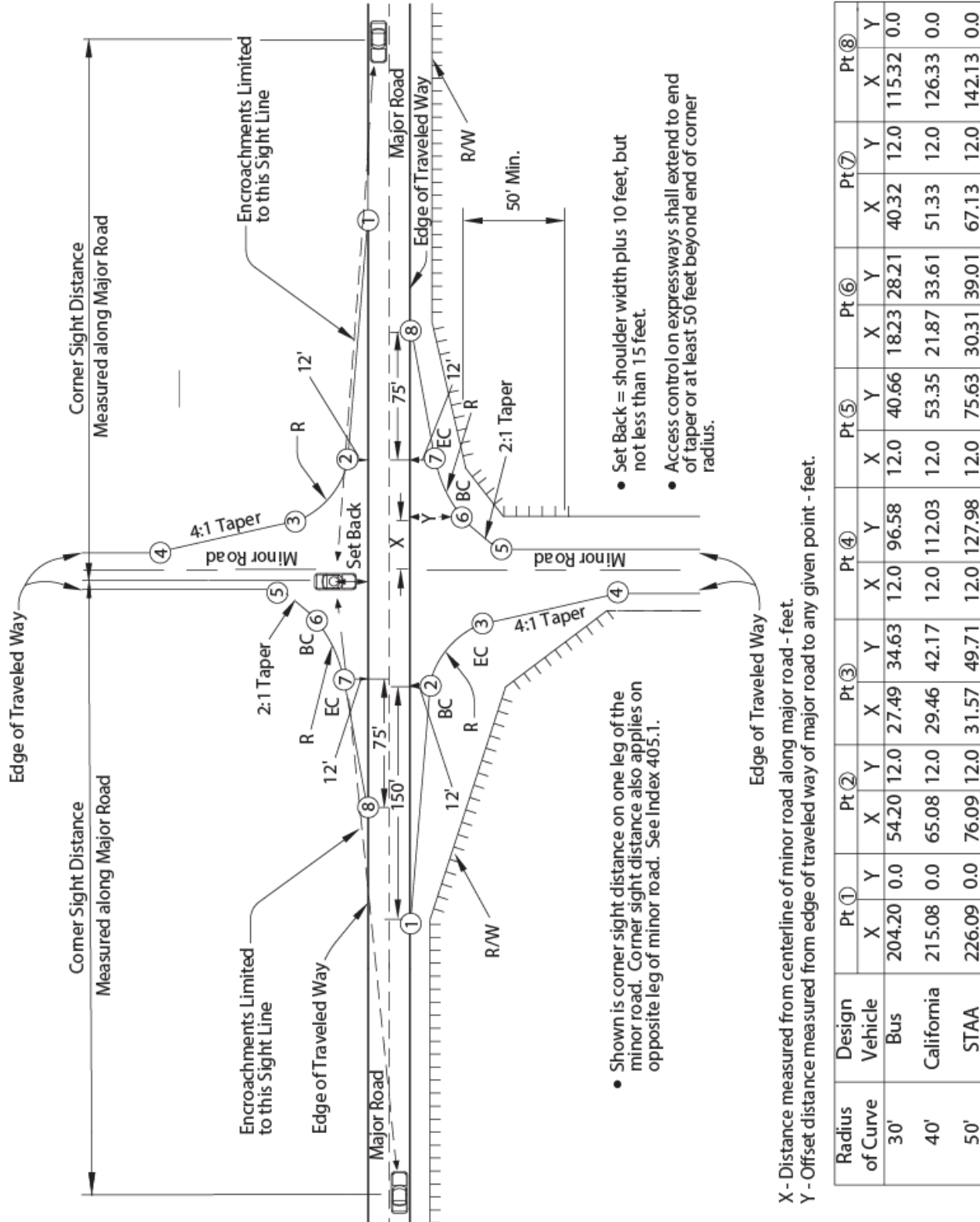

Radius of Curve	Pt ①		Pt ②		Pt ③		Pt ④		Pt ⑤		Pt ⑥		Pt ⑦		Pt ⑧	
	X	Y	X	Y	X	Y	X	Y	X	Y	X	Y	X	Y	X	Y
30'	204.20	0.0	54.20	12.0	27.49	34.63	12.0	96.58	12.0	40.66	18.23	28.21	40.32	12.0	115.32	0.0
40'	215.08	0.0	65.08	12.0	29.46	42.17	12.0	112.03	12.0	53.35	21.87	33.61	51.33	12.0	126.33	0.0
50'	226.09	0.0	76.09	12.0	31.57	49.71	12.0	127.98	12.0	75.63	30.31	39.01	67.13	12.0	142.13	0.0

Figure 405.9

Widening of Two-lane Roads at Signalized Intersections

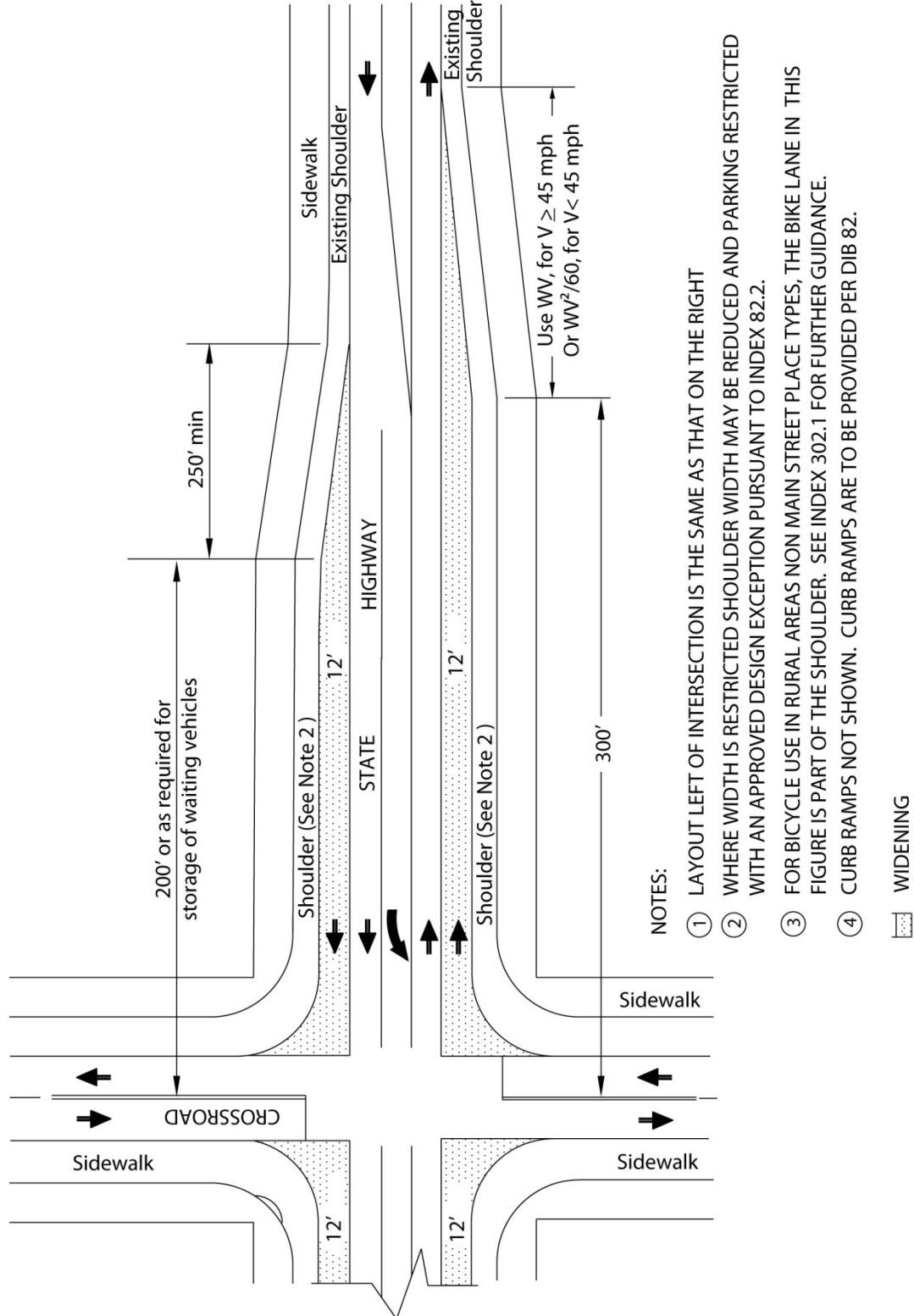

July 1, 2020

pattern of traffic movements. Unusual turning movement patterns may possibly call for a different shape of widening.

The impact on pedestrian and bicycle traffic mobility of larger intersections should be assessed before a decision is made to widen an intersection.

405.10 Roundabouts

Roundabout intersections on the State highway system must be developed and evaluated in accordance with National Cooperative Highway Research Program (NCHRP) Report 672 entitled "Roundabouts: An Informational Guide, 2nd ed." (NCHRP Guide 2) dated October 2010 and Traffic Operations Policy Directive (TOPD) Number 13-02. Also see Index 401.5 for general information and guidance. See Figure 405.10 Roundabout Geometric Elements for nomenclature associated with roundabouts. Signs, striping and markings at roundabouts are to comply with the California MUTCD.

A roundabout is a form of circular intersection in which traffic travels counterclockwise around a central island and entering traffic must yield to the circulating traffic. Roundabouts feature, among other things, a central island, a circulatory roadway, and splitter islands on each approach. Roundabouts rely upon two basic and important operating principles:

- (a) Speed reduction at the entry and through the intersection will be achieved through geometric design and,
- (b) The yield-at-entry rule, which requires traffic entering the intersection to yield to traffic that is traveling in the circulatory roadway.

Benefits of roundabouts are:

- Fewer conflict points typically result in fewer collisions with less severity. Over half of vehicle to vehicle points of conflict associated with intersections are eliminated with the use of a roundabout. Additionally, a roundabout separates the points of conflict which eases the ability of the users to identify a conflict and helps prevent conflicts from becoming collisions.
- Roundabouts are designed to reduce the vehicular speeds at intersections. Lower speeds lessens the vehicular collision severity. Likewise, studies indicate that pedestrian and bicyclist collisions with motorized vehicles at lower speeds significantly reduce their severity.
- Roundabouts allow continuous free flow of vehicles and bicycles when no conflicts exist. This results in less noise and air pollution and reduces overall delays at roundabout intersections.

Except as indicated in this Index, the standards elsewhere in this manual do not apply to roundabouts. For the application of design standards, the approach ends of the splitter islands define the boundary of a roundabout intersection, see Figure 405.10. The design standards elsewhere in this manual apply to the approach legs beyond the approach ends of the splitter islands.

Figure 405.10

Roundabout Geometric Elements

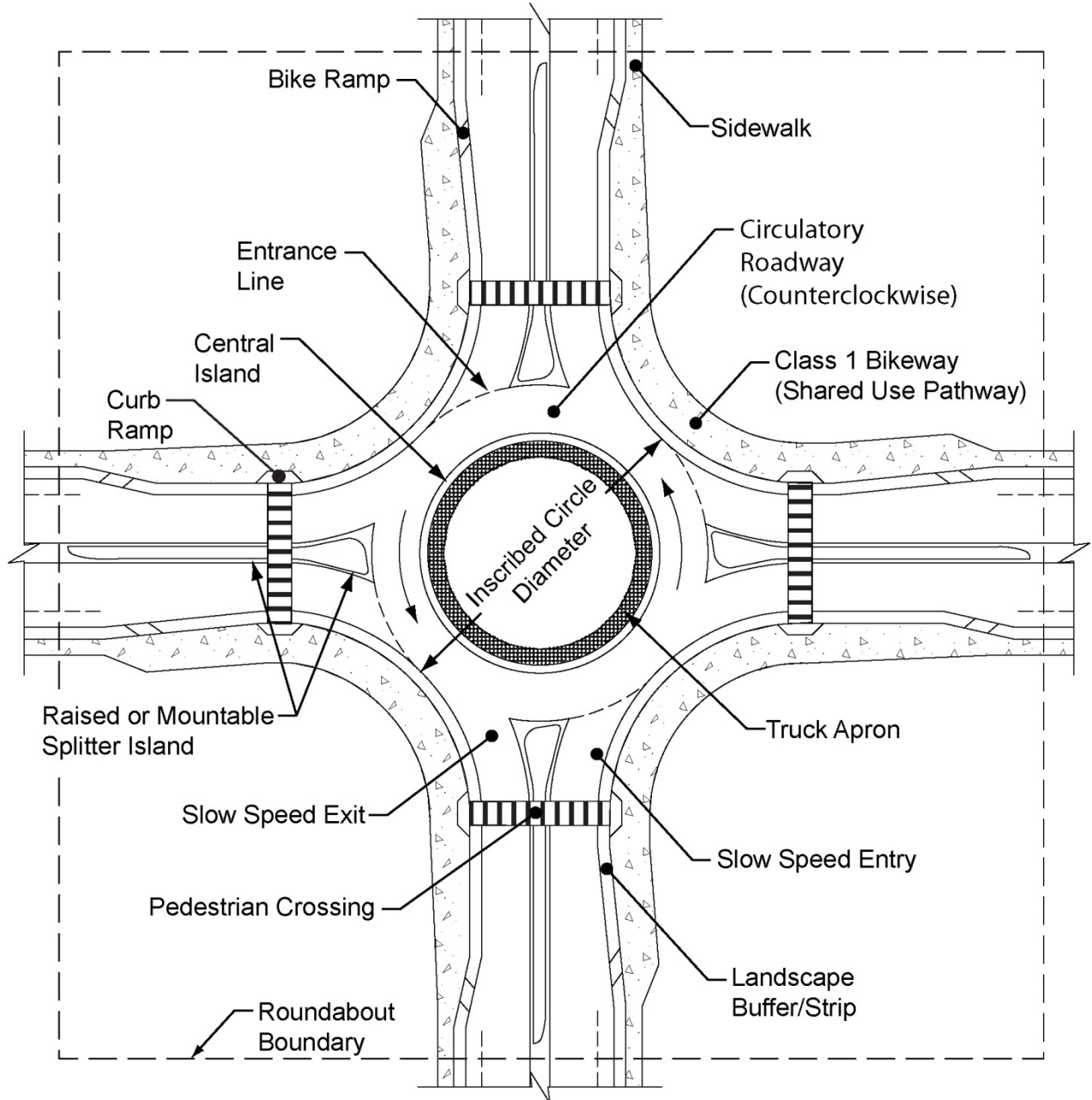

NOTE:

This figure is provided to only show nomenclature and is not to be used for design details.

July 1, 2020

- (1) *Design Period.* First consider the design of a single lane roundabout per the design period guidance in Index 103.2. If a second lane is not needed until 10 or more years, it may be better to phase the improvements. Construct the first phase of the roundabout so at the 20-year design period, an additional lane can be easily added. In order to comply with the 20-year design period, the initial project must provide the right of way needed for utility relocations, a shared-use path designed for a Class I Bikeway, and all other features other than pavement, lighting, and striping in their ultimate locations.

In some locations, it may not be practical to build a single lane roundabout that will operate for 10 years. Geometric constraints and other conflicts may preclude widening to the ultimate configuration. In such cases, other intersection configurations or control strategies addressed in Index 401.5 may need to be considered.

When staging improvements, see NCHRP Guide 2, Section 6.12.

- (2) *Design Vehicles.* See Topic 404. The turning path for the design vehicle, see Index 404.5, dictates many of the roundabout dimensions. The design vehicle tracking and swept width are to be used when designing all the entries and exits, where design vehicles are unrestricted (see Index 404.2), and the circulatory roadway. The percentage of trucks and their lane utilization is an important consideration on multilane roundabouts when determining if the design will allow trucks to stay within their own lane or encroach into the adjacent lane. If permit vehicles larger than the design vehicle occasionally use the proposed roundabout, they can be accommodated by having removable signs or other removable features in the central island or around the circular path to ensure their swept path can negotiate the roundabout. Roundabouts should not be overdesigned for the occasional permit vehicle.

To accurately simulate the design vehicle swept width traveling through a roundabout, the minimum speed of the design vehicle used in computer simulation software (e.g., Auto TURN) should be 10 miles per hour through the roundabout.

- (3) *Inscribed Circle Diameter.* At single lane roundabouts, the size of the inscribed circle is largely dependent upon the turning requirements of the design vehicle. The inscribed circle diameter (ICD) must be large enough to accommodate: (a) the STAA design vehicle for all roundabouts on the National Network and on Terminal Access routes; and, (b) the California Legal design vehicle on all non-STAA route intersections on California Legal routes and California Legal KPRA Advisory routes, while maintaining adequate deflection curvature to ensure appropriate travel speeds for smaller vehicles. The design vehicle is to navigate the roundabout with the front tractor wheels off the truck apron, if one is present. Transit vehicles, fire engines and single-unit delivery vehicles are also to be able to navigate the roundabout without using the truck apron, if one is present. The inscribed circle diameter for a single lane roundabout generally ranges between 105 feet to 150 feet to accommodate the California Legal design vehicle and 130 feet to 180 feet to accommodate the STAA design vehicle.

At multilane roundabouts, the inscribed circle diameter is to achieve adequate alignment of the natural vehicle path while maintaining deflection curvature to ensure appropriate travel speeds. To achieve both of these design objectives requires a slightly larger diameter than used for a single lane roundabout. The inscribed circle diameter for a multilane (2-lane) roundabout generally ranges between 150 feet to 220 feet to accommodate the California Legal design vehicle for non-STAA route intersections on California Legal routes and California Legal KPRA Advisory routes, and 165 feet to 220 feet to accommodate the STAA design vehicle for roundabouts on the National Network and on Terminal Access routes. Similar to a single lane roundabout, the design vehicle is to be able to navigate a multilane roundabout with the front tractor wheels staying off the truck apron, if one is present. Transit

vehicles, fire engines and single-unit delivery vehicles are also to be able to navigate the roundabout without using the truck apron, if one is present.

The inscribed diameter ranges given above are typical values, design may be larger or smaller. Site location constraints and performance checks will determine if the diameter is appropriate for the location.

- (4) *Entry Speeds.* Lowering the speed of vehicles entering and traveling through the roundabout is a primary design objective that is achieved by approach alignment and entry geometry.

The following entry speeds should not be exceeded:

- Single lane entry, 25 miles per hour.
- Multilane entry, 30 miles per hour.

A bypass lane is not included in the number of entry lanes. A bypass prohibits entry into the circulatory roadway.

Entry speeds are to be determined through fastest path analysis. Fastest path is the smoothest, flattest path possible for a single vehicle in the absence of other traffic and ignoring all lane markings. The fastest path analysis should begin at least 165 feet from the inscribed circle diameter and should not bring the path closer than 3 feet from a stripe nor 5 feet from the face of a curb. These distances are minimums and the fastest path may occur further away from the curbs and striping depending on the roundabout configuration. For fastest path evaluation, see NCHRP Guide 2, Section 6.7.1.

- (5) *Exit Design.* Similar to entry design, exit design flexibility is required to achieve the optimal balance between competing design variables and project objectives to provide adequate capacity and, essentially, safety while minimizing excessive property impacts and costs. Thus, the selection of a curved versus tangential design is to be based upon the balance of each of these criteria. Exit design is influenced by the place type, pedestrian demand, bicyclist needs, the design vehicle and physical constraints. The exit curb radii are usually larger than the entry curb radii in order to minimize the likelihood of congestion and crashes at the exits. However, the desire to minimize congestion at the exits needs to be balanced with the need to maintain an appropriate operating speed through the pedestrian crossing. Therefore, the exit path radius should not be significantly greater than the circulating path radius to ensure low speeds are maintained at the pedestrian crossing.
- (6) *Number of Legs Serving the Roundabout.* Intersections with more than four legs are often difficult to manage operationally. Roundabouts are a proven traffic control device in such situations. However, it is necessary to ensure that the design vehicle can maneuver through all unrestricted legs of the roundabout.

July 1, 2020

- (7) *Pedestrian Use.* Sidewalks around the circular roadway are to be designed as shared-use paths, see Index 405.10(8)(c). However, the guidance in Design Information Bulletin (DIB) 82 Pedestrian Accessibility Guidelines for Highway Projects must also be followed when designing these shared-use facilities around a roundabout. If there is a difference in the standards, the guidance in DIB 82 is to be followed. In addition,
- (a) Pedestrian curb ramps need to be differentiated from bike ramps:
 - The detectable warning surface (truncated domes) differentiates a pedestrian curb ramp from a bicycle ramp.
 - Detectable warning surface is required on curb ramps. They are not to be used on a bike ramp.
 - (b) Truck aprons and mountable curbs are not to be placed in the pedestrian crossing areas.
 - (c) See the California MUTCD for the signs and markings used at roundabouts.
 - (d) At pedestrian crossing locations the accessibility design will be treated as a midblock pedestrian street crossing. See DIB 82 for more information.
- (8) *Bicyclist Use.*
- (a) General. Bicyclists may choose to travel in the circular roadway of a roundabout by taking a lane, while others may decide to travel using the shared-use path to bypass the circular roadway. Therefore, the approach and circular roadways, as well as the shared-use path all need to be designed for the mobility needs of bicyclists. See the California MUTCD for the signs and markings used at roundabouts.
 - (b) Bicyclist Use of the Circular Roadway. Single lane roundabouts do not require bicyclists to change lanes in the circular roadway to select the appropriate lane for their direction of travel, so they tend to be comfortable for bicyclists to use. Even two-lane roundabouts, which may have straighter paths of travel that can lead to faster vehicular traveling speeds, appear to be comfortable for bicyclists that prefer to travel like vehicles. Roundabouts that have more than two circular lanes can create complexities in signing and striping (see the California MUTCD for guidance), and their operating speed may cause some bicyclists to decide to bypass the circular roadway and use the bicycle ramp that provides access to the shared-use path around the roundabout.
 - (c) Bicyclists Use of the Shared-Use Path. The shared-use path is to be designed using the guidance in Index 1003.1 for Class I Bikeways and in NCHRP Guide 2 Section 6.8.2.2. However, the accessibility guidance in DIB 82 must also be followed when designing these shared-use facilities around a roundabout. If there is a difference in the standards, the accessibility guidance in DIB 82 is to be followed to ensure the facility is accessible to pedestrians with disabilities.

Bicycle ramps are to be located to avoid confusion as curb ramps for pedestrians. Also see Index 405.10(7) for guidance on how to differentiate the two types of ramps. The design details and width of the ramp are also important to the bicyclist. Bicyclists approaching the bicycle ramp need to be provided the choice of merging left into the lane or moving right to use the bicycle ramp. Bicycle ramps should be placed at a 35 to 45 degree angle to the departure roadway and the sidewalk to enable the bicyclists to use the ramp and discourage bicyclists from entering the shared-use path at a speed that is detrimental to the pedestrians. The shared-use path should be designated as Class I Bikeways; however, appropriate regulatory signs may need to be posted if the local jurisdiction has a law(s) that prohibit bicyclists from riding on a sidewalk.

A landscape buffer or strip between the shared-use/Class I Bikeway and the circular roadway of the roundabout is needed and should be a minimum of 2 feet wide.

Pedestrian crossings may also be used by bicyclists; thus, these shared-use crossings need to be designed for both bicyclist and pedestrian needs.

(9) *Transit Use.* Transit vehicles and buses will not have difficulty negotiating a roundabout when it has been designed using the California Legal design vehicle or the STAA design vehicle. However, to minimize passenger discomfort, a roundabout should be designed such that the transit vehicle or bus does not use the truck apron, if one is present.

(10) *Stopping Sight Distance and Visibility.* See Index 201.1 for stopping sight distance guidance at roundabouts.

A domed or mounded central island, between 3.5 to 6 feet high, is needed to focus attention on the approach and through roundabout alignment. A domed central island provides a visual screen from downstream alignment and other distractions and provides a visual cue for vehicles approaching the roundabout.

In high speed environments, additional lighting of, and vertical elements in the central island (i.e., landscaping and esthetic features) may be needed.

(11) *Speed Consistency.* Consistency in operating speeds between the various movements within the roundabout can minimize collisions between traffic streams. The operating speeds between competing traffic streams and between consecutive geometric elements should be minimized such that the maximum speed differential between them is no more than 15 miles per hour; it is preferred that the operating speed differential be less than 10 miles per hour.

(12) *Path Alignment (Natural Path).* As two traffic streams approach the roundabout in adjacent lanes, drivers and bicyclists will be guided by lane markings up to the entrance line. At the yield point, they will continue along their natural trajectory into the circulatory roadway. The speed and orientation of the design vehicle at the entrance line determines what can be described as its natural path. The geometry of the exits also affects the natural path that the design vehicle travels. The natural path of two vehicles are not to overlap, see NCHRP Guide 2, Section 6.7.2.

(13) *Splitter Islands.* Splitter islands (also called separator islands, divisional islands, or median islands) will be provided on all roundabouts. The purpose is to provide refuge for pedestrians, assist in controlling speeds, guide traffic into the roundabout, physically separate entering and exiting traffic streams, and deter wrongway movements.

The total length of the raised island should be at least 50 feet although 100 feet is desirable. On higher speed roadways, splitter island lengths of 150 feet or more is beneficial. Additionally, the splitter island should extend beyond the end of the exit curve to prevent exiting traffic from crossing into the path of approaching traffic. The splitter island width should be a minimum of 6 feet at the pedestrian crossing to adequately provide refuge for pedestrians.

Posted speeds on the approach roadway greater than or equal to 45 miles per hour require the splitter island length, as measured from the inscribed circle diameter, to be 200 feet. In some instances, a longer splitter island may be desirable. Concrete curb is to be provided on the right side of the approach roadway equal to the length of the splitter island from the inscribed circle diameter.

(14) *Access Control.* The access control standards in Index 504.3(3) and 504.8 apply to roundabouts at interchange ramp intersections. The dimensions shown in Index 504.8 are to be measured from the inscribed circle diameter.

Driveways should not be placed within 100 feet from the inscribed circle diameter.

July 1, 2020

- (15)*Lighting*. Lighting is required at all roundabouts. See NCHRP Report 672 Chapter 8, the Traffic Manual Chapter 9 as well as consult with the District Traffic Safety Engineer.
- (16)*Landscaping*. Landscaping should be designed such that drivers and bicyclists can observe the signing and shape of the roundabout as they approach, allowing adequate visibility for making decisions within the roundabout. The landscaping of the central island can enhance the intersection by making it a focal point, by promoting lower speeds and by breaking the headlight glare of oncoming vehicles or bicycles. It is desirable to create a domed or mounded central island, between 3.5 to 6 feet high, to increase the visibility of the intersection on the approach. Contact the District Landscape Architecture Unit to provide technical assistance in designing the roundabout landscaping. See Chapter 900 for additional Landscape Architecture requirements.
- (17)*Vertical Clearance*. The vertical clearance guidance provided in Index 309.2 applies to roundabouts.
- (18)*Drainage Design*. See Chapter 800 to 890 for further guidance.
- (19)*Maintenance*. Contact the District Maintenance Engineer and appropriate Regional Manager for maintenance strategies and practices including seasonal operations, maintenance resources, and specialized equipment. Maintenance responsibilities may also include multiple state, county, and city agencies where coordination of maintenance efforts and funding is needed.
- Consider maintenance of the central island. Provide a maintenance vehicle pullout within the central island beyond the truck apron, so maintenance vehicles will not conflict with circulating trucks.
- (20)*Snow Areas*. In climate regions where snowfall requires the use of snow removal equipment, consider the equipment to be used. Design ICD's as well as entrance and exit geometry to accommodate snow removal equipment and plow limitations. Check with District Maintenance for their requirements and limitations. Geometric elements to consider that facilitate snow removal are; mountable curb, tapering the ends of curbs down to allow plows to ride over curbs, plowing accommodation in both directions, providing snow storage space within the central island, and providing minimum entry/exit widths to accommodate the plow blade. Mountable curb may be used if sidewalk/shared use path is not contiguous to the curb. Provide a planter or textured pavement between the path and the roadway. Snow storage areas must be designed to prevent snow melt from entering the circulating lanes where it can freeze. Snow storage areas must not block pedestrian paths.
- (21)*Utilities*. Utility access openings (manholes) should not be located within the traveled way within the boundary of the roundabout. Roundabouts do not have shoulders to accommodate traffic while manholes are accessed. Manholes should not be allowed within the circulating roadway to avoid closing down the intersection during access. If a manhole is absolutely necessary within the boundary of the inscribed diameter, place it in the central island and off of the truck apron. Provide a maintenance vehicle pullout to allow access to the manhole without blocking truck traffic.

Topic 406 – Ramp Intersection Capacity Analysis

The following procedure for ramp intersection analysis may be used to estimate the capacity of any signalized intersection where the phasing is relatively simple. It is useful in analyzing the need for additional turning and through traffic lanes. For a more complete analysis refer to the Highway Capacity Manual.

- (a) Ramp Intersection Analysis--For the typical local street interchange there is usually a critical intersection of a ramp and the crossroads that establishes the capacity of the interchange. The capacity of a point where lanes of traffic intersect is 1500 vehicles per hour. This is expressed as intersecting lane vehicles per hour (ILV/hr). Table 406 gives values of ILV/hr for various traffic flow conditions.

If a single-lane approach at a normal intersection has a demand volume of 1000 vph, for example, then the intersecting single-lane approach volume cannot exceed 500 vph without delay.

The three examples that follow illustrate the simplicity of analyzing ramp intersections using this 1500 ILV/hr concept.

- (b) Diamond Interchange--The critical intersection of a diamond type interchange must accommodate demands of three conflicting travel paths. As traffic volumes approach capacity, signalization will be needed. For the spread diamond (Figure 406A), basic capacity analysis is made on the assumption that 3-phase signalization is employed. For the tight diamond (Figure 406B), it is assumed that 4-phase signal timing is used.
- (c) 2 Quadrant Cloverleaf--Because this interchange design (Figure 406C) permits 2-phase signalization, it will have higher capacities on the approach roadways. The critical intersection is shared two ways instead of three ways as in the diamond case.

July 1, 2020

Table 406**Vehicle Traffic Flow Conditions at Intersections at Various Levels of Operation**

<i>ILV/hr</i>	Description
<i>< 1200:</i>	Stable flow with slight, but acceptable delay. Occasional signal loading may develop. Free midblock operations.
<i>1200-1500:</i>	Unstable flow with considerable delays possible. Some vehicles occasionally wait two or more cycles to pass through the intersection. Continuous backup occurs on some approaches.
<i>1500 (Capacity):</i>	Stop-and-go operation with severe delay and heavy congestion ⁽¹⁾ . Traffic volume is limited by maximum discharge rates of each phase. Continuous backup in varying degrees occurs on all approaches. Where downstream capacity is restrictive, mainline congestion can impede orderly discharge through the intersection.

NOTE:

The amount of congestion depends on how much the ILV/hr value exceeds 1500. Observed flow rates will normally not exceed 1500 ILV/hr, and the excess will be delayed in a queue.

Figure 406A

Spread Diamond

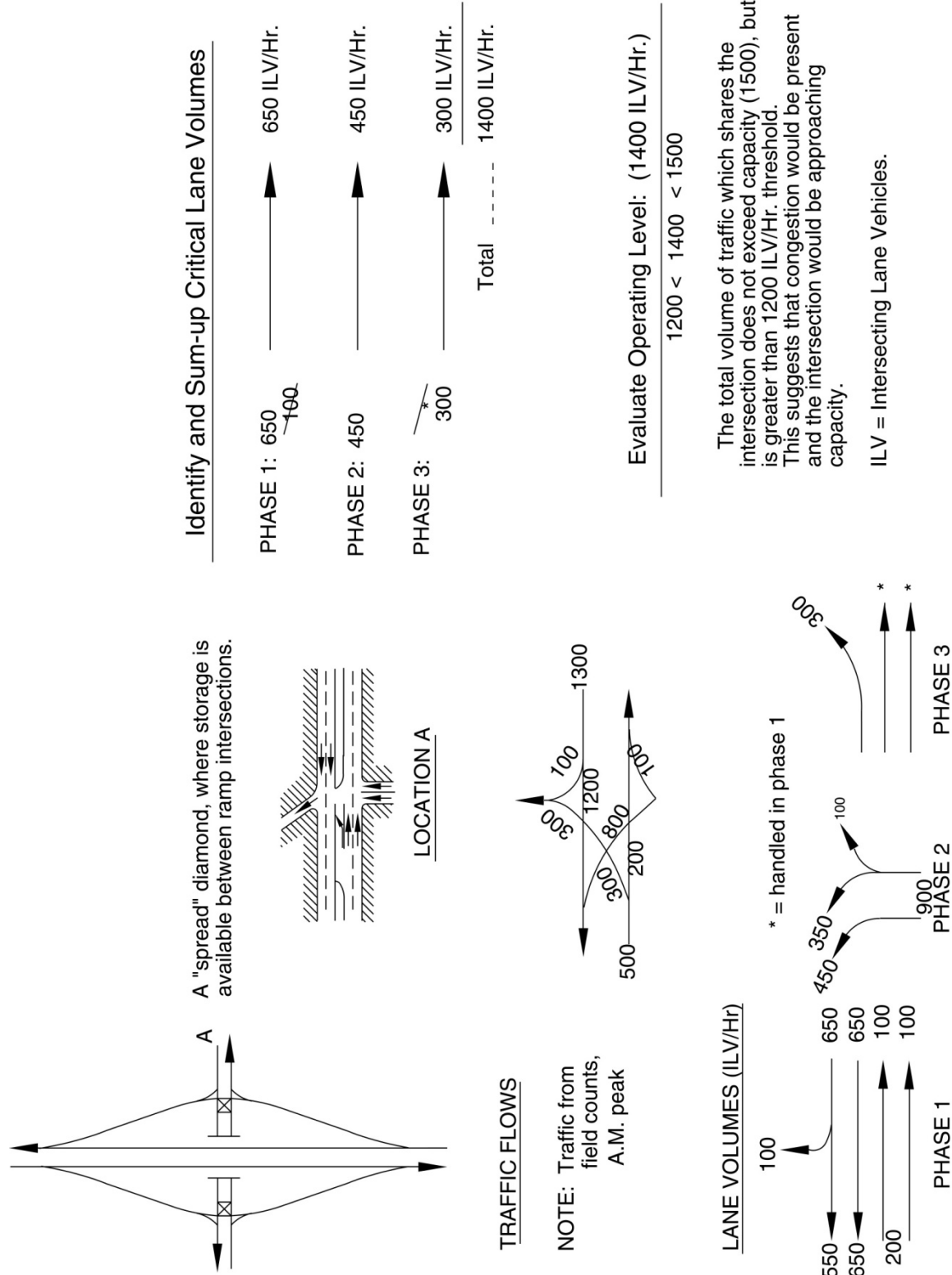

July 1, 2020

Figure 406B

Tight Diamond

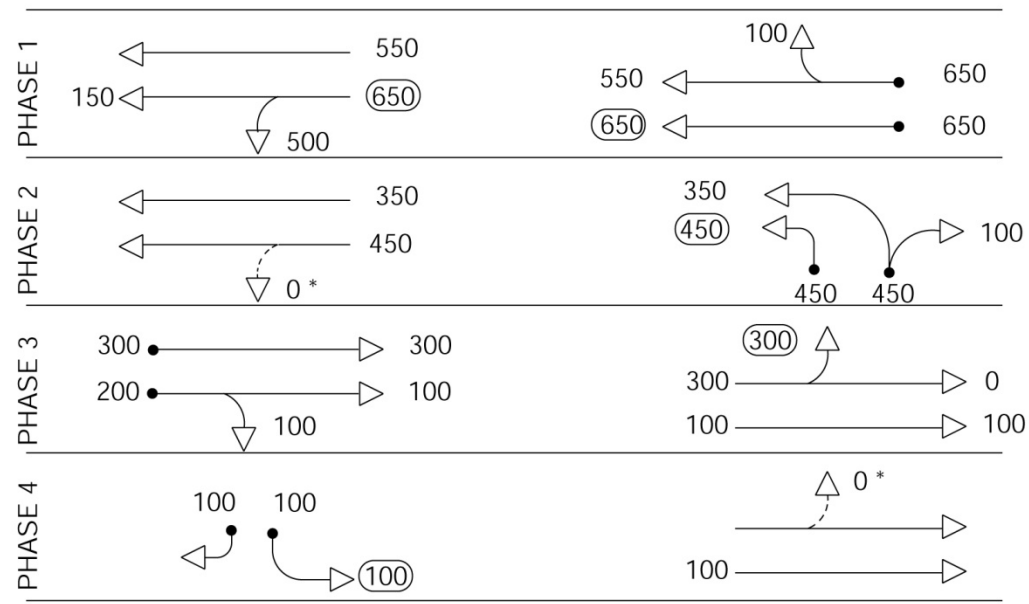
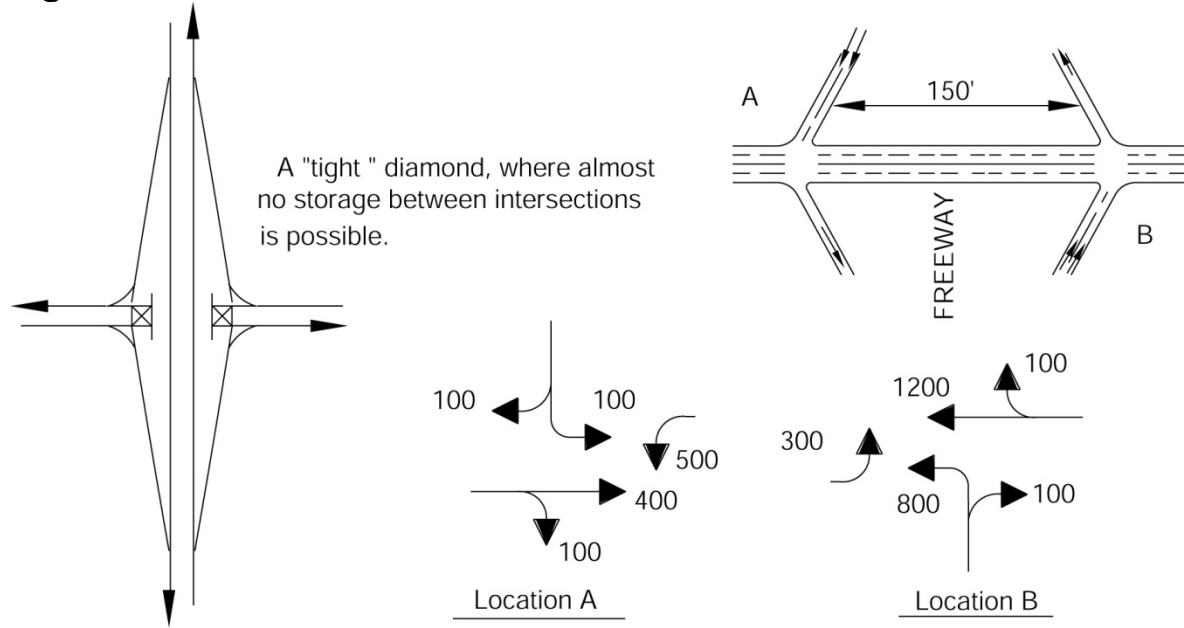

*NOTE: When no storage at all is permitted, left-turn movement is cleared during this phase.

Critical Lane Volumes:	650
	450
	300
ILV=Intersecting Lane Vehicles.	100
	<hr/> 1500 ILV/Hr.

Figure 406C

Two-quadrant Cloverleaf

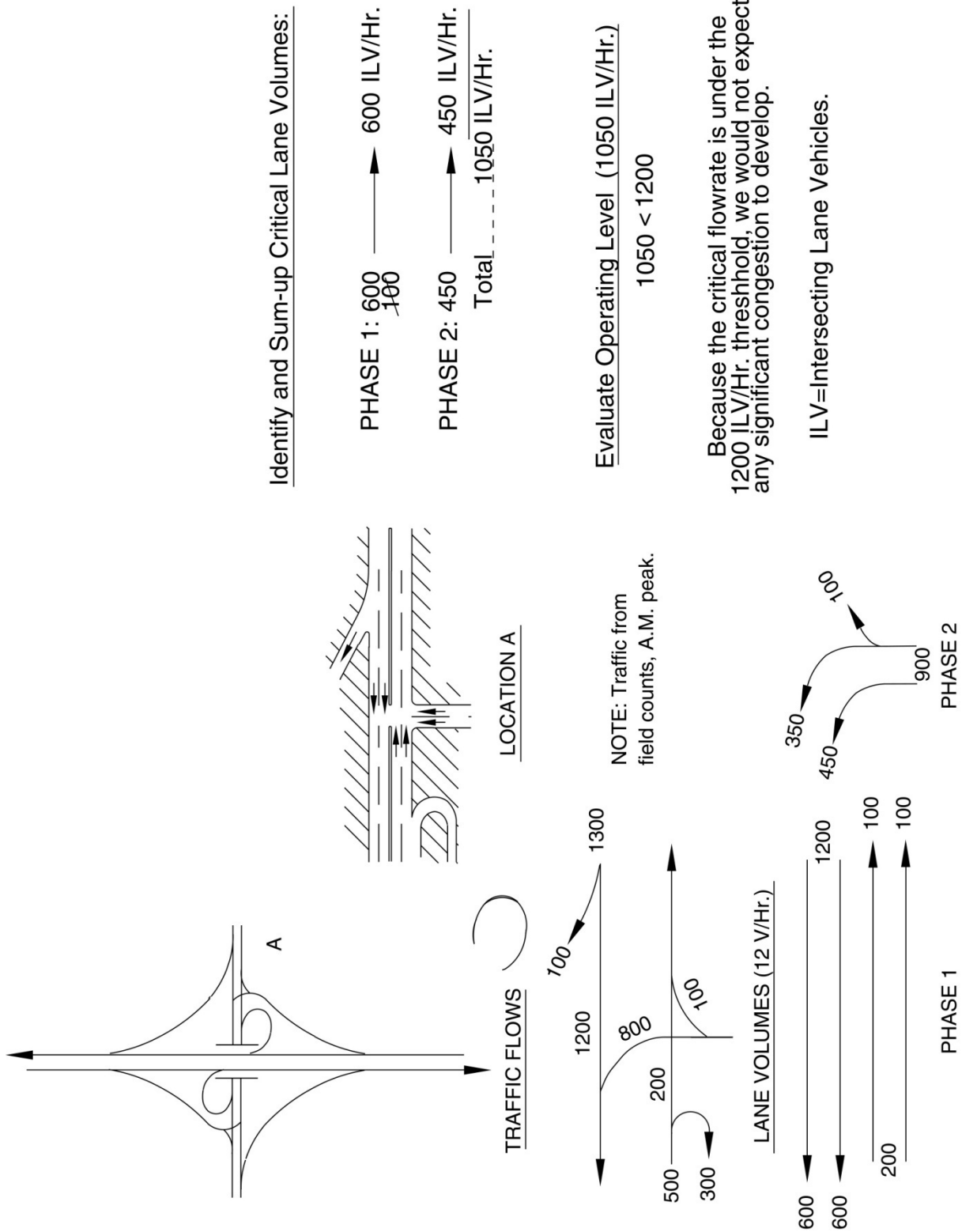

CHAPTER 500 – TRAFFIC INTERCHANGES

Topic 501 – General

Index 501.1 – Concepts

A traffic interchange is a combination of ramps and grade separations at the junction of two or more highways for the purpose of reducing or eliminating traffic conflicts, to improve safety, and increase traffic capacity. Crossing conflicts are reduced by grade separations. Turning conflicts are either eliminated or minimized, depending upon the type of interchange design.

501.2 Warrants

All connections to freeways are by traffic interchanges. An interchange or separation may be warranted as part of an expressway (or in special cases at the junction of two non-access controlled highways), to improve safety or eliminate a bottleneck, or where topography does not lend itself to the construction of an intersection.

501.3 Spacing

The minimum interchange spacing shall be one mile in urban areas, two miles outside of urban areas, and two miles between freeway-to-freeway interchanges and other interchanges. The minimum interchange spacing on Interstates outside of urban areas shall be three miles. These minimum distances are measured between centerlines of adjacent intersecting roadways. To improve operations of closely spaced interchanges the use of auxiliary lanes, grade separated ramps, collector-distributor roads, and/or ramp metering may be warranted.

The standards contained within this Index apply to:

- New interchanges.
- Modifications to existing interchanges including access control revisions for new ramps or the relocation/elimination of existing ramps.
- Projects to increase mainline capacity when existing interchanges do not meet interchange spacing requirements.

See Index 504.7 for additional technical requirements related to interchange spacing. Procedures and documentation requirements are provided in PDPM Chapter 27. See the FHWA publication “Interstate System Access Informational Guide.”

Topic 502 – Interchange Types

502.1 General

The selection of an interchange type and its design are influenced by many factors including the following: speed, volume, and composition of traffic to be served (e.g., trucks, vehicles,

July 1, 2020

bicycles, and pedestrians), number of intersecting legs, and arrangement of the local street system (e.g., traffic control devices, topography, right of way controls), local planning, proximity of adjacent interchanges, community impact, and cost.

The cost of a structure is a considerable investment where the life of a structure may be 50 to 100 years, far beyond that of the project traffic study projections. New or significant modifications to interchanges should take into consideration future needs of the system; the ultimate configuration for the freeway and the potential for local land development well beyond the 20-year traffic study. Choose an interchange type that is compatible with or can easily be modified to accommodate the future growth of the system.

Even though interchanges are designed to fit specific conditions and controls, it is desirable that the pattern of interchange ramps along a freeway follow some degree of consistency. It is frequently desirable to rearrange portions of the local street system in connection with freeway construction in order to affect the most desirable overall plan for mobility and community development.

Interchange types are characterized by the basic shapes of ramps: namely, diamond, loop, directional, hook, or variations of these types. Many interchange designs are combinations of these basic types. Schematic interchange patterns are illustrated in Figure 502.2 and Figure 502.3. These are classified as: (a) Local street interchanges and (b) Freeway-to-freeway interchanges. See AASHTO, A Policy on Geometric Design of Highways and Streets, for additional examples.

502.2 Local Street Interchanges

The Department's philosophy for highway design has evolved over time. DD-64 Complete Streets, DP-22 Context Sensitive Solutions, DP-05 Multimodal Alternatives and other policies and guidance are a result of that evolution in design philosophy. No longer are freeway interchanges designed with only the needs of motorists in mind. Pedestrian and bicycle traffic needs are to be considered along with the motorized traffic. Local road interchanges ramp termini should be perpendicular to the local road. The high speed, shallow angle, ramp termini of the past are problematic for pedestrians and bicyclists to navigate. Vehicle speeds are reduced by the right angle turn, allowing drivers to better respond to bicycle and pedestrian conflicts. For new construction or major reconstruction consideration must be given to orienting ramps at right angles to local streets. For freeways where bicycles are permitted to use the freeway, ramps need to be designed so that bicyclists can exit and enter the freeway without crossing the higher speed ramp traffic. See Index 400 for type, design, and capacity of intersections at the ramp terminus with the local road.

An interchange is expected to have an on- and off-ramp for each direction of travel. If an off-ramp does not have a corresponding on-ramp, that off-ramp would be considered an isolated off-ramp. **Isolated off-ramps or partial interchanges shall not be used because of the potential for wrong-way movements.** In general, interchanges with all ramps connecting with a single cross street are preferred.

Figure 502.2

Typical Local Street Interchanges

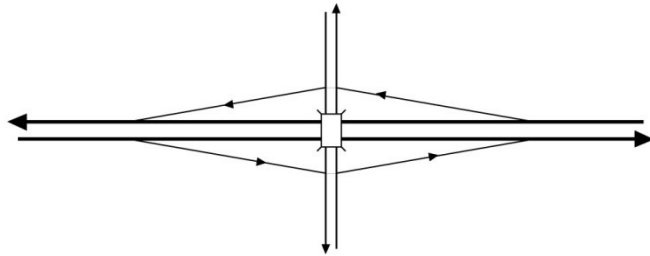

TYPE L-1

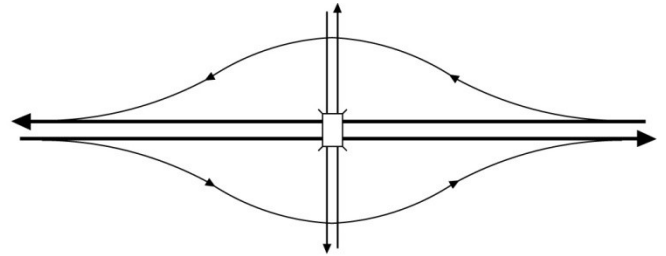

TYPE L-2

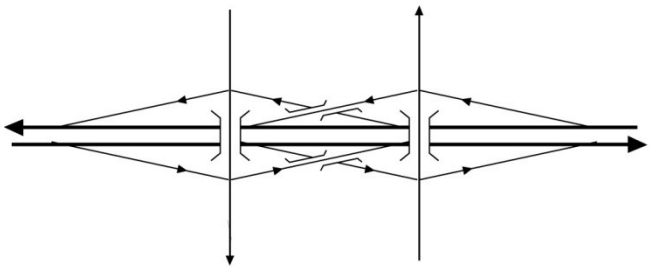

TYPE L-3

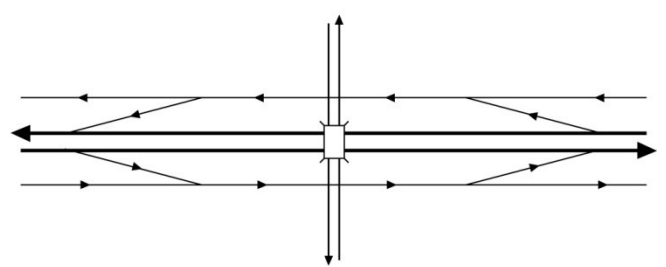

TYPE L-4

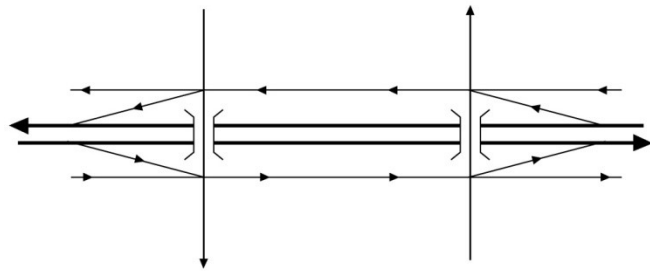

TYPE L-5

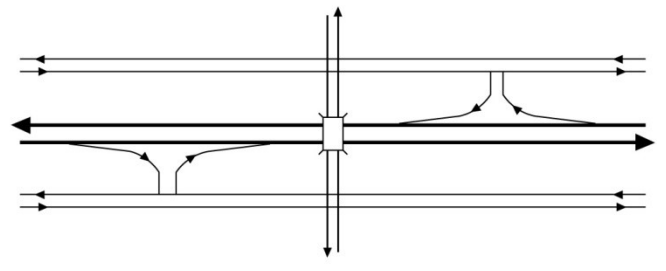

TYPE L-6

July 1, 2020

Figure 502.2

Typical Local Street Interchanges (Cont.)

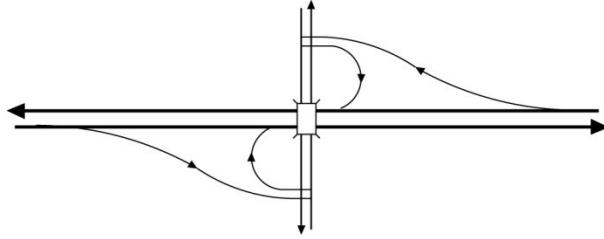

TYPE L-7

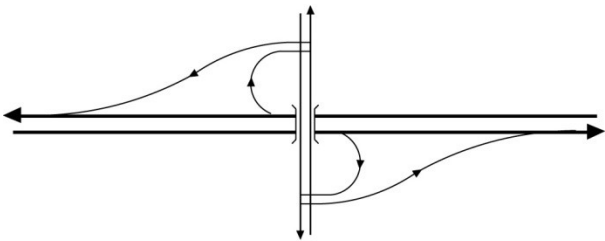

TYPE L-8

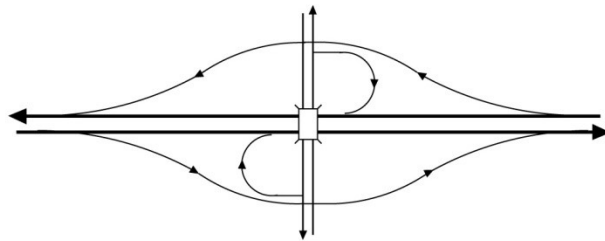

TYPE L-9

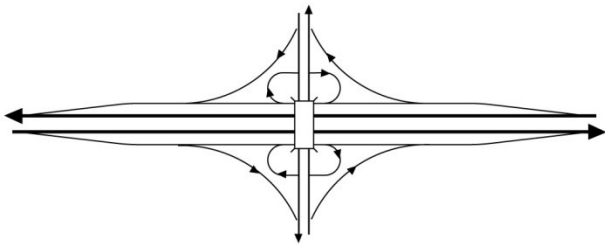

TYPE L-10

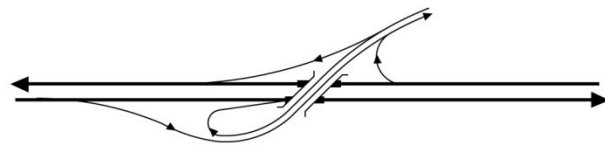

TYPE L-11

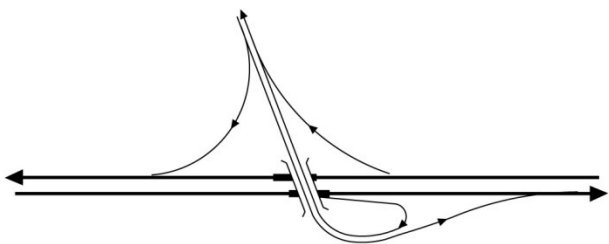

TYPE L-12

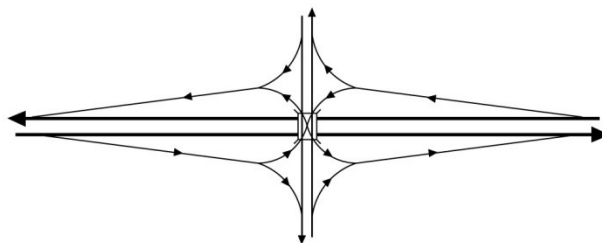

TYPE L-13

At local road interchanges it is preferable to minimize elevation changes on the local road and instead elevate or depress the freeway. Such designs have the least impact on those users most affected by the elevation changes, such as pedestrians and bicyclists.

Class II bikeways designed through interchanges should be accomplished considering the mobility of bicyclists and should be designed in a manner that will minimize confusion by motorists and bicyclists. Designs which allow high speed merges at on- and off-ramps to local streets and conventional highways have a large impact on bicycle and pedestrian mobility and should not be used. Designers should work closely with the Local Agency when designing bicycle facilities through interchanges to ensure that the shoulder width is not reduced through the interchange area. If maintaining a consistent shoulder width is not feasible, the Class II bikeway must end at the previous local road intersection. A solution on how to best provide for bicycle travel to connect both sides of the freeway should be developed in consultation with the Local Agency and community as well as with the consideration of the local bicycle plan.

- (a) Diamond Interchange. The simplest form of interchange is the diamond. Diamond interchanges provide a high standard of ramp alignment, direct turning maneuvers at the crossroads, and usually have minimum construction costs. The diamond type is adaptable to a wide range of traffic volumes, as well as the needs of transit, bicyclists, and pedestrians. The capacity is limited by the capacity of the intersection of the ramps at the crossroad. This capacity may be increased by widening the ramps to two or three lanes at the crossroad and by widening the crossroad in the intersection area. Crossroad widening will increase the length of undercrossings and the width of overcrossings, thus adding to the bridge cost. Roundabouts may provide the necessary capacity without expensive crossroad widening between the ramp termini. Ramp intersection capacity analysis is discussed in Topic 406.

The compact diamond (Type L-1) is most adaptable where the freeway is depressed or elevated and the cross street retains a straight profile. Type L-1's are suitable where physical, geometric or right of way restrictions do not permit a spread diamond configuration. Compact diamonds have the disadvantage of requiring wider overcrossing or longer span undercrossing to provide corner sight distance and have limited capacity between intersections. Once the area around the interchange is developed, Type L-1 is challenging to expand to accommodate growth.

The spread diamond (Type L-2) is adaptable where the grade of the cross street is changed to pass over or under the freeway. The ramp terminals are spread in order to achieve maximum sight distance and minimum intersection cross slope, commensurate with construction and right of way costs, travel distance, and general appearance. A spread diamond has the advantage of flatter ramp grades, greater crossroads left-turn storage capacity, and the flexibility of permitting the construction of future loop ramps if required.

The split diamond with braids (Type L-3) may be appropriate where two major crossroads are closely spaced.

- (b) Interchanges with Parallel Street Systems. Types L-4, L-5 and L-6 are interchange systems used where the freeway alignment is placed between parallel streets. Types L-4 and L-5 are used where the parallel streets will operate with one-way traffic. In Type L-4 slip ramps merge with the frontage street and in Type L-5 the ramps terminate at the intersection of the frontage road with the cross street, forming five-legged intersections. In Type L-6 the freeway ramps connect with two-way parallel streets. The parallel streets in the Types L-4, L-5 and L-6 situation are usually too close to the freeway to permit ramp intersections on the cross street between the parallel frontage streets.

The "hook" ramps of the Type L-6 are often forced into tight situations that lead to less than desirable geometrics. The radius of the curve at the approach to the intersection should

July 1, 2020

exceed 150 feet and a tangent of at least 150 feet should be provided between the last curve on the ramp and the ramp terminal.

Special attention should always be given to exit ramps that end in a hook to ensure that adequate sight distance around the curve, adequate deceleration length prior to the curve or end of anticipated queue, and adequate superelevation for anticipated driving speeds can be developed. Type L-6 can only be considered when all other interchange types are not acceptable.

- (c) Cloverleaf Interchanges. The simplest cloverleaf interchange is the two-quadrant cloverleaf, Type L-7 or Type L-8, or a combination where the two loops are on the same side of the cross street. Type L-7 eliminates the need for left-turn storage lanes, on or under the structure, thus reducing the structure costs. These interchanges should be used only in connection with controls which preclude the use of diamond ramps in all four quadrants. These controls include right of way controls, a railroad track paralleling the cross street, and a short weaving distance to the next interchange.

The Type L-9, partial cloverleaf interchange, provides loop on-ramps in addition to the four diamond-type ramps. This interchange is suitable for large volume turning movements. Left-turn movements from the crossroads are eliminated, thereby permitting two-phase operation at the ramp intersections when signalized. Because of this feature, the Type L-9 interchange usually has capacity to handle the higher volume traffic on the crossroad.

The four-quadrant cloverleaf interchange (Type L-10) offers free-flow characteristics for all movements. It has the disadvantage of a higher cost than a diamond or partial cloverleaf design, as well as a relatively short weaving section between the loop ramps which limits capacity. For this reason this type of interchange is not desirable. Collector-distributor roads should be incorporated in the design of four-quadrant cloverleaf interchanges to separate the weaving conflicts from the through freeway traffic.

- (d) Trumpet Interchanges. A trumpet design, Type L-11 or L-12, may be used when a crossroads terminates at a freeway. This design should not be used if future extension of the crossroads is probable. The diamond interchange is preferable if future extension of the crossroads is expected.
- (e) Single Point Interchange (SPI). The Type L-13 is a concept which essentially combines two separate diamond ramp intersections into one large at-grade intersection. It is also known as an urban interchange. Additional information on SPI's is provided in DIB 92 "Single Point Interchange Guidelines."

Type L-13 requires approximately the same right of way as the compact diamond. However, the construction cost is substantially higher due to the structure requirements. The capacity of the L-13 can exceed that of a compact diamond if long signal times can be provided and left turning volumes are balanced.

This additional capacity may be offset if nearby intersection queues interfere with weaving and storage between intersections. The disadvantages of the L-13 are: 1) future expansion of the interchange is extremely difficult; 2) stage construction for retrofit situations is costly; 3) long structure spans require higher than normal profiles and deeper structure depths; and 4) longer bicycle and pedestrian circulation.

- (f) Other Types of Interchanges. New or experimental interchanges must have the Project Delivery Coordinator and the Headquarters Chief, Division of Traffic Operations concurrence before selection. Concurrence may require additional studies and documentation.

502.3 Freeway-to-Freeway Interchanges

- (1) *General.* The function of the freeway-to-freeway interchange is to link freeway segments together so as to provide the highest level of service in terms of mobility. Parameters such as cost, environment, community values, traffic volumes, route continuity, driver expectation and safety should all be considered. Route continuity, providing for the designated route to continue as the through movement through an interchange, reduces lane changes, simplifies signing, and reduces driver confusion.

Interstate routes shall maintain route continuity. Where both the designated route and heavier traffic volume route are present, the interchange configuration shall keep the designated route to the left through the interchange.

- (2) *Design Considerations.*

- (a) *Cost.* The differential cost between interchange types is often significant. A cost-effective approach will tend to assure that an interchange is neither over nor underdesigned. Decisions as to the relative values of the previously mentioned parameters must be consistent with decisions reached on adjacent main line freeways.
- (b) *System Balance.* The freeway-to-freeway interchange is a critical link in the total freeway system. The level of traffic service provided will have impact upon the mobility and overall effectiveness of the entire roadway system. For instance, traffic patterns will adjust to avoid repetitive bottlenecks, and to the greatest degree possible, to temporary closures, accidents, etc. The freeway-to-freeway interchange should provide flexibility to respond to these needs so as to maximize the cost effectiveness of the total system.
- (c) *Provide for all Traffic Movements.* All interchanges must provide for each of the eight basic movements (or four basic movements in the case of a three-legged interchange), except in the most extreme circumstances. Less than “full interchanges” may be considered on a case-by-case basis for applications requiring special access for managed lanes (e.g., transit, HOVs, HOT lanes) or park and ride lots. Partial interchanges usually have undesirable operational characteristics. If circumstances exist where a partial interchange is considered appropriate as an initial phase improvement, then commitments need to be included in the request to accommodate the ultimate design. These commitments may include purchasing the right of way required during the initial phase improvements.
- (d) *Local Traffic Service.* In metropolitan areas a freeway-to-freeway interchange is usually superimposed over an existing street system. Local and through traffic requirements are often in conflict.

Combinations of local and freeway-to-freeway interchanges can result in designs that are both costly and so complex that the important design concepts of simplicity and consistency are compromised. Therefore, alternate plans separating local and freeway-to-freeway interchanges should be fully explored. Less than desirable local interchange spacing may result; however, this may be compensated for by upgrading the adjacent local interchanges and street system.

Local traffic service interchanges should not be located within freeway-to-freeway interchanges unless geometric standards and level of service will be substantially maintained.

- (e) *Alignment.* It is not considered practical to establish fixed freeway-to-freeway interchange alignment standards. An interchange must be designed to fit into its environment. Alignment is often controlled by external factors such as terrain, buildings, street patterns, route adoptions, and community value considerations. Normally, loops have radii in the range of 150 feet to 200 feet and direct connections should have

July 1, 2020

minimum radii of 850 feet. Larger radii may be proper in situations where the skew or other site conditions will result in minimal increased costs. Direct connection radii of at least 1,150 feet are desirable from a traffic operational standpoint. High alignment and sight distance standards should be provided where possible.

Drivers have been conditioned to expect a certain standard of excellence on California freeways. The designer's challenge is to provide the highest possible standards consistent with cost and level of service.

(3) *Types*. Several freeway-to-freeway interchange design configurations are shown on Figure 502.3. Many combinations and variations may be formed from these basic interchange types.

(a) *Four-Level-Interchange*. Direct connections are appropriate in lieu of loops when required by traffic demands or other specific site conditions. The Type F-1 interchange with all direct connections provides the maximum in mobility and safety. However, the high costs associated with this design require that the benefits be fully substantiated.

The Type F-1 Alternative "A" interchange utilizes a single divergence ramp for traffic bound for the other freeway; then provides a secondary directional split. Each entrance ramp on a Type F-1A interchange is provided separately. The advantages of the Type F-1A are: 1) reduced driver confusion since there is only one exit to the other freeway, and 2) operations at the entrance may be improved since the ramps merge with the mainline one at a time.

The Type F-1 Alternative "B" interchange provides separate directional exit ramps and then merges the entering traffic into a single ramp before converging with the mainline. Since the Type F-1B combines traffic from two ramps before entering the freeway, it is important to verify that adequate weaving capacity is provided beyond the entrance. Separating the directional split of exiting traffic reduces the volume to each of the two ramps and therefore may improve the level of service of the weave section prior to the exit.

Design for a four-level interchange may combine the configuration of the Type F1-A and F1-B interchange to best suit the conditions at a given location.

(b) *Combination Interchanges*. The three-quadrant cloverleaf, Type F-2, with one direct connection may be necessary where a single move carries too much traffic for a loop ramp or where the one quadrant is restricted by environmental, topographic, or right of way controls.

The two-loop, two-direct connection interchange, Type F-3, is often an appropriate solution. The weaving conflicts which ordinarily constitute the most restrictive traffic constraint are eliminated, yet cost and right of way requirements may be kept within reasonable bounds. Consideration should be given to providing an auxiliary lane in advance of the loop off-ramps to provide for vehicle deceleration.

(c) *Four-Quadrant Cloverleaf*. The four-quadrant cloverleaf with collector-distributor roads, Type F-4, is ordinarily the most economical freeway-to-freeway interchange solution when all turning movements are provided. The four-quadrant cloverleaf is generally applicable in situations where turning volumes are low enough to be accommodated in the short weaving sections. It should be designed with collector-distributor roads to separate weaving conflicts from the through freeway traffic.

(d) *Freeway Terminal Junction*. Types F-5, F-6, F-7, and F-8 are examples of interchange designs where one freeway terminates at the junction with another freeway. In general, the standard of alignment provided on the left or median lane connection from the terminating freeway should equal or approach as near as possible that of the terminating

Figure 502.3

Typical Freeway-to-freeway Interchanges

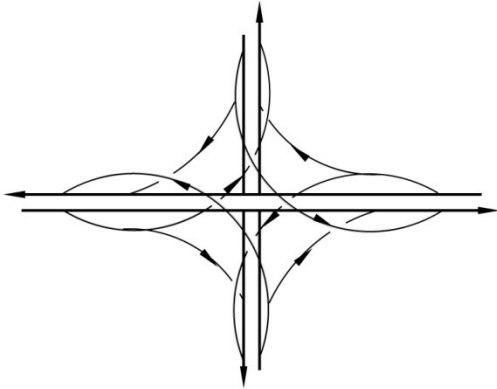

TYPE F-1 (ALT "A")

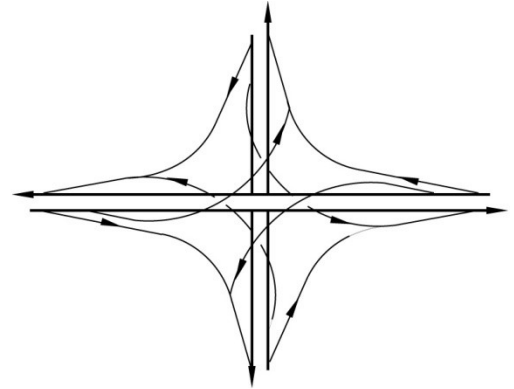

TYPE F-1 (ALT "B")

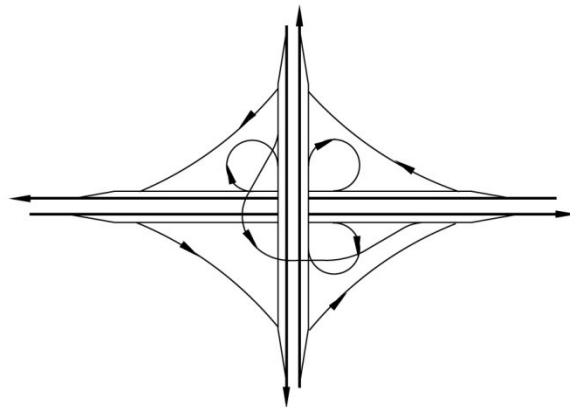

TYPE F-2

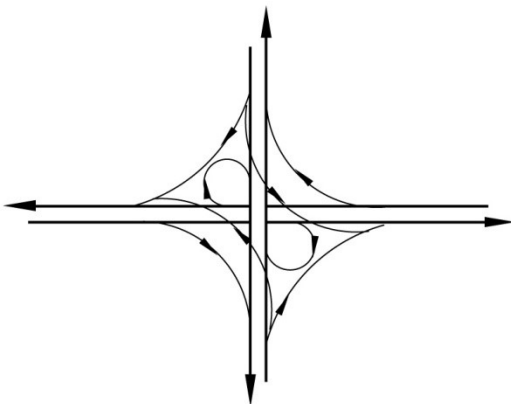

TYPE F-3

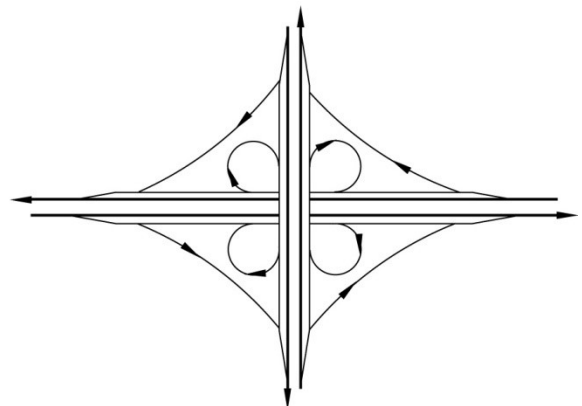

TYPE F-4

July 1, 2020

Figure 502.3

Typical Freeway-to-freeway Interchanges (Cont.)

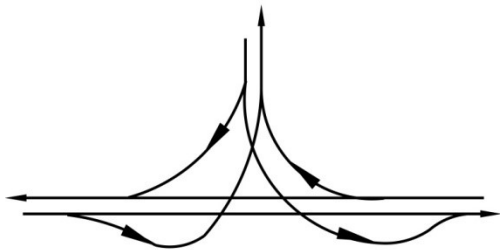

TYPE F-5

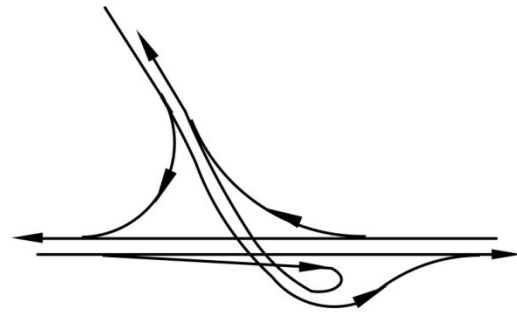

TYPE F-6

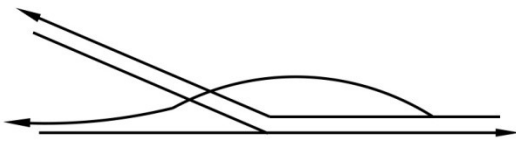

TYPE F-7

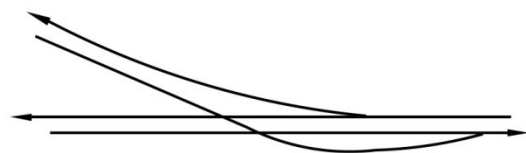

TYPE F-8

freeway. Terminating the median lane on a loop should be avoided. It is preferable that both the designated route and the major traffic volume be to the left at the branch connection diverge. The choice between Types F-7 and F-8 should include considerations of traffic volumes, and route continuity. When these considerations are in conflict, the choice is made on the basis of judgment of their relative merits.

Topic 503 – Interchange Design Procedure

503.1 Basic Data

Data relative to community service, traffic, physical and economic factors, and potential area development which may materially affect design, should be obtained prior to interchange design. Specifically, the following information should be available:

- (a) The location and standards of existing and proposed local streets including types of traffic control.
- (b) Existing, proposed and potential for development of land, including such developments as employment centers, retail services and shopping centers, recreational facilities, housing developments, schools, and other institutions.
- (c) A vehicle traffic flow diagram showing average daily traffic and design hourly volumes, as well as time of day (a.m. or p.m.), anticipated on the freeway ramps and affected local streets or roads.
- (d) Current and future bicycle and pedestrian access through the community.
- (e) The relationship with adjacent interchanges.
- (f) The location of major utilities, railroads, or airports.
- (g) The presence of dedicated lanes and associated ramps and connections, including HOV lanes, Bus (BRT) lanes and Express lanes.
- (h) The planned ultimate build-out for the freeway facility.
- (i) Existing and planned rail facilities.

503.2 Reviews

Interchanges are among the major design features which are to be reviewed by the Project Delivery Coordinator and/or District Design Liaison, District Traffic Engineer or designee, other Headquarters staff, and the FHWA Transportation Engineer, as appropriate. Major design features include the freeway alignment, geometric cross section, geometric design and intersection control of ramp termini, location of separation structures, closing of local roads, frontage road construction, bicycle and pedestrian facilities and work on local roads. Particularly close involvement should occur during preparation of the project initiation document and project report (see the Project Development Procedures Manual). Such reviews can be particularly valuable when exceptions to design standards are being considered and alternatives are being sought. The geometric features of all interchanges or modifications to existing interchanges must be approved by the Project Delivery Coordinator.

Topic 504 – Interchange Design Standards

504.1 General

Topic 504 discusses the standards that pertain to both local service interchanges (various ramp configurations) and freeway-to-freeway connections. The design standards, policies and practices covered in Indexes 504.2, and 504.5 through 504.8 are typically common to both ramp and connector interchange types. Indexes 504.3 and 504.4 separately discuss ramp standards and freeway-to-freeway connector standards, respectively.

504.2 Freeway Entrances and Exits

- (1) **Basic Policy.** All freeway entrances and exits, except for direct connections with median High-Occupancy Vehicle (HOV) lanes, Express Toll lanes or BRT lanes, shall connect to the right of through traffic.

July 1, 2020

- (2) *Standard Designs.* Design of freeway entrances and exits should conform to the standard designs illustrated in Figure 504.2A-B (single lane), and Figure 504.3K (two-lane entrances and exits) and/or Figure 504.4 (diverging branch connections), as appropriate.

The minimum deceleration length shown on Figure 504.2B shall be provided prior to the first curve beyond the exit nose to assure adequate distance for vehicles to decelerate before entering the curve. The same standard should apply for the first curve after the exit from a collector-distributor road. The range of minimum "DL" (distance) vs. "R" (radius) is given in the table in Figure 504.2B. Strong consideration should be given to lengthening the "DL" distance given in the table when the subsequent curve is a descending loop or hook ramp, or if the upstream condition is a sustained downgrade (see AASHTO, A Policy on Geometric Design of Highways and Streets, for additional information).

The exit nose shown on Figure 504.2B may be located downstream of the 23-foot dimension; however, the maximum paved width between the mainline and ramp shoulder edges should be 20 feet. Also, see pavement cross slope requirements in Index 504.2(5).

Contrasting surface treatment beyond the gore pavement should be provided on both entrance and exit ramps as shown on Figures 504.2A, 504.2B, and 504.3K. This treatment can both enhance aesthetics and minimize maintenance efforts. It should be designed so that a driver will be able to identify and differentiate the contrasting surface treatment from the pavement areas that are intended for regular or occasional vehicular use (e.g., traveled way, shoulders, paved gore, etc.).

Consult with the District Landscape Architect, District Materials Engineer, and District Maintenance Engineer to determine the appropriate contrasting surface treatment of the facility at a specific location.

Refer to the HOV Guidelines for additional information specific to direct connections to HOV lanes.

- (3) *Location on a Curve.* Freeway entrances and exits should be located on tangent sections wherever possible in order to provide maximum sight distance and optimum traffic operation. Where curve locations are necessary, the ramp entrance and exit tapers should be curved also. The radius of the exit taper should be about the same as the freeway edge of traveled way in order to develop the same degree of divergence as the standard design (see Figure 504.2C).

On entrance ramps the distance from the inlet nose (14-foot point) to the end of the acceleration lane taper should equal the sum of the distances shown on Figure 504.2A. The 50:1 (longitudinal to lateral) taper may be curved to fit the conditions, and the 3,000-foot radius curve may be adjusted (see Figure 504.2A, note 3).

When an exit must be located where physical restrictions to visibility cannot be corrected by cut widening or object removal, an auxiliary lane in advance of the exit should be provided. The length of auxiliary lane should be a minimum 600 feet, 1,000 feet preferred.

- (4) *Design Speed Considerations.* In the design of interchanges it is important to provide vertical and horizontal alignment standards which are consistent with driving conditions expected on branch connections. Sight distance on crest vertical curves should be consistent with expected approach speeds.

- (a) *Freeway Exit*—The design speed at the exit nose should be 50 miles per hour or greater for both ramps and branch connections.

Figure 504.2A
Single Lane Freeway Entrance

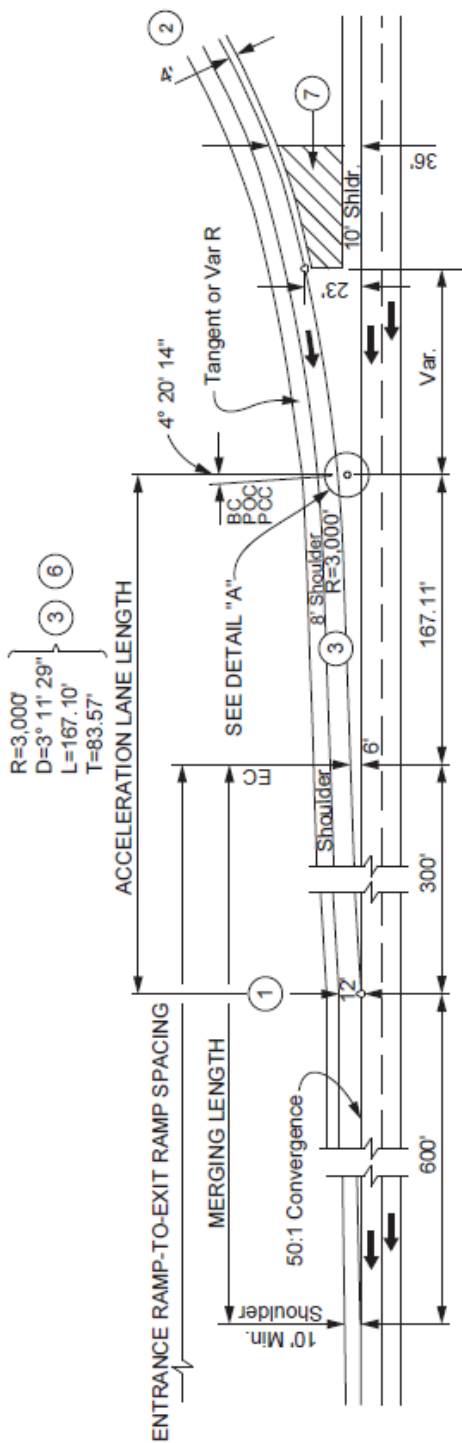

ENTRANCE

NOTES:

- 1 On freeway to freeway connections the right paved shoulder shall be 10' - Table 302.1.
- 2 On single- and two-lane freeway to freeway connections, the left paved shoulder shall be 5' - Table 302.1.
- 3 When freeway is not on tangent alignment, select radius to approximate same degree of convergence (see Index 504.2(3)).
- 4 Locate as if it were to be center of a 1' radius curb nose.
- 5 1:15 (longitudinal to lateral) Flare, 45' long - Table 405.4.
- 6 2% superelevation may be acceptable for the 3,000' radius curve on entrance ramps.
- 7 Contrasting surface treatment (See Index 504.2(2)).
- 8 See Index 504.2(7) for pedestrian and bicycle ramp crossings on freeways where bicycle or pedestrian travel is not prohibited. See Index 302.1 for shoulder width standards.

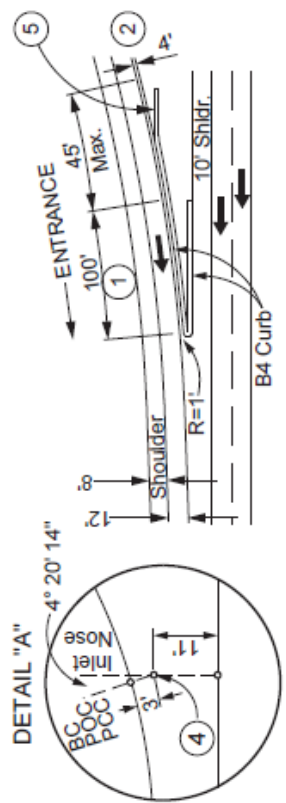

OPTIONAL B4 CURB AT INLET NOSE
(See Index 504.3(11))

INLET NOSE

July 1, 2020

Figure 504.2B

Single Lane Freeway Exit

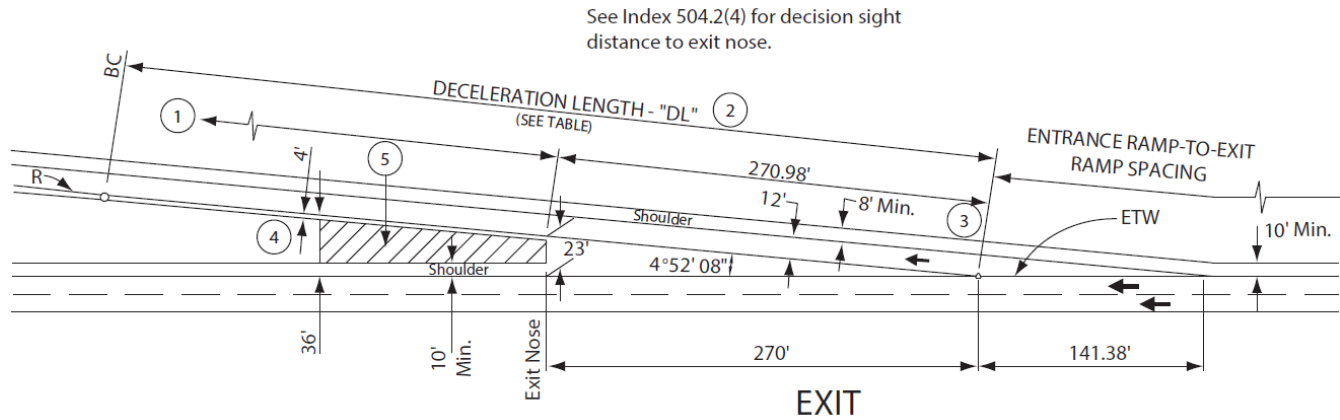

R (ft)	Min. DL (ft) (2)
Less than 300	570
300 - 499	470
500 - 999	420
1,000 & over	270

- NOTES:
- (1) Minimum length between exit nose and end of ramp is 525' for full stop at end of ramp.
 - (2) "DL" distance should be lengthened for descending, short radius curves, or if entered from a sustained downgrade.
 - (3) On freeway to freeway connections the right paved shoulder shall be 10'. - Table 302.1
 - (4) On single- and two-lane freeway to freeway connections the left paved shoulder shall be 5'. - Table 302.1
 - (5) Contrasting surface treatment (See Index 504.2(2))
See Index 302.1 for shoulder width standards.

Figure 504.2C

Location of Freeway Ramps on a Curve

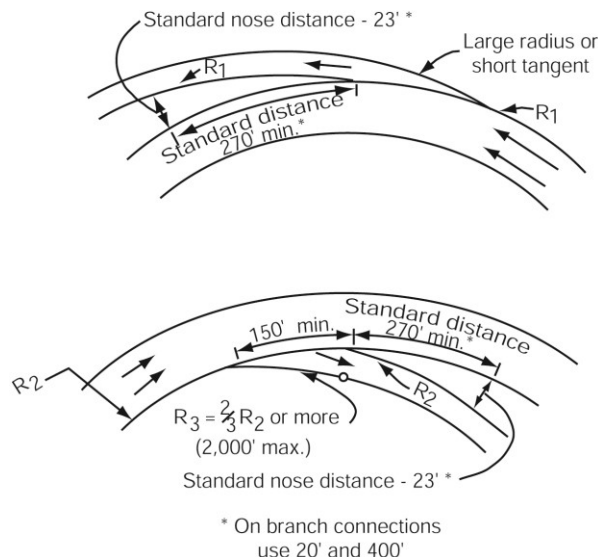

Decision sight distance given in Table 201.7 should be provided at freeway exits and branch connectors. At secondary exits on collector-distributor roads, a minimum of 600 feet of decision sight distance should be provided. In all cases, sight distance is measured to the center of ramp lane right of the nose.

- (b) Freeway Entrance—The design speed at the inlet nose should be consistent with approach alignment standards. If the approach is a branch connection or diamond ramp with high alignment standards, the design speed should be at least 50 miles per hour.
- (c) Ramps—See Index 504.3(1)(a).
- (d) Freeway-to-Freeway Connections—See Index 504.4(2).
- (5) Grades. Grades for freeway entrances and exits are controlled primarily by the requirements of sight distance. Ramp profile grades should not exceed 8 percent with the exception of descending entrance ramps and ascending exit ramps, where a 1 percent steeper grade is allowed. However, the 1 percent steeper grade should be avoided on descending loops to minimize overdriving of the ramp (see Index 504.3 (8)).

Profile grade considerations are of particular concern through entrance and exit gore areas. In some instances the profile of the ramp or connector, or a combination of profile and cross slope, is sufficiently different than that of the freeway through lanes that grade breaks across the gore may become necessary. Where adjacent lanes or lanes and paved gore areas at freeway entrances and exits are not in the same plane, the algebraic difference in pavement cross slope should not exceed 5 percent (see Index 301.3). The paved gore area is typically that area between the diverging or converging edge of traveled ways and the 23-foot point.

In addition to the effects of terrain, grade lines are also controlled by structure clearances (see Indexes 204.6 and 309.2). Grade lines for overcrossing and undercrossing roadways should conform to the requirements of HDM Topic 104 Roads Under Other Jurisdictions.

- (a) Freeway Exits—Vertical curves located just beyond the exit nose should be designed with a minimum 50 miles per hour stopping sight distance. Beyond this point,

July 1, 2020

progressively lower design speeds may be used to accommodate loop ramps and other geometric features.

Ascending off-ramps should join the crossroads on a reasonably flat grade to expedite truck starts from a stopped condition. If the ramp ends in a crest vertical curve, the last 50 feet of the ramp should be on a 5 percent grade or less. There may be cases where a drainage feature is necessary to prevent crossroads water from draining onto the ramp.

On descending off-ramps, the sag vertical curve at the ramp terminal should be a minimum of 100 feet in length.

- (b) Freeway Entrances. Entrance profiles should approximately parallel the profile of the freeway for at least 100 feet prior to the inlet nose to provide intervisibility in merging situations. The vertical curve at the inlet nose should be consistent with approach alignment standards.

Where truck volumes (three-axle or more) exceed 20 vehicles per hour on ascending entrance ramps to freeways and expressways with sustained upgrades exceeding 2 percent, a 1,500-foot length of auxiliary lane should be provided in order to ensure satisfactory operating conditions. Additional length may be warranted based on the thorough analysis of the site specific grades, traffic volumes, and calculated speeds; and after consultation with the District Traffic Safety Engineer or designee and the Project Delivery Coordinator or District Design Liaison. Also, see Index 204.5 "Sustained Grades".

(6) *Bus Stops.* See Index 108.2 and 303.4 for general information.

(7) *Bicycle and Pedestrian Conditions.* On freeways where bicycle or pedestrian travel is not prohibited, provisions need to be made at interchanges to accommodate bicyclists and pedestrians. See Topic 116 and the California MUTCD for additional guidance.

504.3 Ramps

(1) *General.*

- (a) Design Speed. When ramps terminate at an intersection at which all traffic is expected to make a turning movement, the minimum design speed along the ramp should be 25 miles per hour. When a "through" movement is provided at the ramp terminus, the minimum ramp design speed should meet or exceed the design speed of the highway facility for which the through movement is provided. The design speed along the ramp will vary depending on alignment and controls at each end of the ramp. An acceptable approach is to set design speeds of 25 miles per hour and 50 miles per hour at the ramp terminus and exit nose, respectively, the appropriate design speed for any intermediate point on the ramp is then based on its location relative to those two points. When short radius curves with relatively lower design speeds are used, the vertical sight distance should be consistent with approach vehicle speeds. See Index 504.2(4) for additional information regarding design speed for ramps.

- (b) Lane Width. **Ramp lanes shall be a minimum of 12 feet in width. Where ramps have curve radii of 350 feet or less, measured along the outside edge of traveled way for single lane ramps or along the outside lane line for multilane ramps, with a central angle greater than 60 degrees, the single ramp lane, or the lane furthest to the right if the ramp is multilane, shall be widened in accordance with Table 504.3 in order to accommodate large truck wheel paths.** See Topic 404. Consideration may be given to widening more than one lane on a multilane ramp with short radius curves if there is a likelihood of considerable transit or truck usage of that lane.

Table 504.3

Ramp Widening for Trucks

Ramp Radius (ft)	Widening (ft)	Lane Width (ft)
<150	8	20
150 – 179	5	17
180 – 209	4	16
210 – 249	3	15
250 – 299	2	14
-300 – 350	1	13
>350	0	12

(c) Shoulder Width. **Shoulder widths for ramps shall be as indicated in Table 302.1.** Typical ramp shoulder widths are 4 feet on the left and 8 feet on the right.

(d) Lane Drops. Typically, lane drops are to be accomplished over a distance equal to WV. Where ramps are metered, the recommended lane drop taper past the meter limit line is 50 to 1 (longitudinal to lateral). Depending on approach geometry and speed, the lane drop transition between the limit line and the 6-foot separation point should be accomplished with a taper of between 30:1 and 50:1 (longitudinal to lateral). This is further explained in Index 504.3(2)(b) for metered multilane entrance ramps. **However, the lane drop taper past the limit line shall not be less than 15 to 1.**

Lane drop tapers should not extend beyond the 6-foot point without the provision of an auxiliary lane.

(e) Lane Additions Lane additions to ramps are usually accomplished by use of a 120-foot bay taper. See Table 405.2A for the geometrics of bay tapers.

(2) Ramp Metering.

Caltrans Deputy Directive (DD) No. 35-R1, Ramp Metering, contains the statewide policy for ramp metering which delegates responsibility for its implementation in part through the Ramp Metering Design Manual (RMDM). DD 35-R1 specifies that provisions for entrance ramp metering shall be included in any project that proposes additional capacity, modification of an existing interchange, or construction of a new interchange, within the freeway corridors identified in the Ramp Metering Development Plan (RMDP), regardless of funding source. Projects designed for new or existing freeway segments experiencing recurring traffic congestion and/or a high frequency of vehicle collisions may include provisions for entrance ramp metering, whether or not the freeway segment locations are listed in the RMDP.

All geometric designs for ramp metering installations must be discussed with the Project Delivery Coordinator or District Design Liaison. Design features or elements which deviate from design standards require the approvals described in Index 82.2.

See the RMDM for ramp metering guidance, procedures, and policies to be used in conjunction with the guidance in this manual. Where traffic-related ramp metering guidance is noted in this Chapter, reference is made to the RMDM for exception instructions and further information.

July 1, 2020

Geometric ramp design for operational improvement projects which include ramp metering should be based on current peak-hour traffic volume. If this current data is not available it should be obtained before proceeding with design. Peak hour traffic data from the annual Caltrans Traffic Volumes book is not adequate for this application.

The design advice and typical designs that follow should not be directly applied to ramp meter installation projects, especially retrofit designs. Every effort should be made by the designer to exceed the recommended minimum standards provided herein, where conditions are not restrictive.

(a) Metered Freeway Entrance Ramps (1 General Purpose (GP) + 1 HOV Preferential Lane)

According to the RMDM, a High-Occupancy Vehicle (HOV) preferential lane shall be provided where ramp meters are installed, and each HOV preferential lane should be metered. See the RMDM for exception procedures from the Ramp Metering policy. See Figures 504.3A and 504.3B for typical freeway entrance ramp metering (1 GP Lane + 1 HOV Preferential Lane).

Due to the operational benefits of an auxiliary lane, the merge from the metered entrance ramp to the freeway should include an auxiliary lane with a minimum length of 300 feet beyond the ramp convergence point. See Figure 504.3A.

Where truck volumes (3-axle or more) are 5 percent or greater on ascending entrance ramps to freeways with sustained upgrades exceeding 3 percent (i.e., at least throughout the merge area), a minimum 1000-foot length of auxiliary lane should be provided beyond the ramp convergence point.

When ramp volumes exceed 1,500 vph, a 1,000-foot minimum length of auxiliary lane should be provided beyond the ramp convergence point. If an auxiliary lane is included, the ramp lane transition may be extended to the convergence point. However, the proximity of the nearest interchange may warrant weaving analysis to determine the acceptability of extending the ramp lane transition beyond the 6-foot separation point. A longer auxiliary lane should be considered where mainline/ramp gradients and truck volumes warrant additional length.

(b) HOV Preferential Lane.

Ramp meter installations should operate in conjunction with, and complement, other transportation management system elements and transportation modes. As such, ramp meter installations should include preferential treatment of carpools and transit riders. Specific treatment(s) must be tailored to the unique conditions at each ramp location.

Where restrictive conditions, vehicle volumes less than 500 vehicles per hour (vph), or other engineering judgement exist in support of an exception to the HOV preferential lane, see Figures 504.3C and 504.3D. In restrictive conditions, a minimum 500-foot auxiliary lane should be provided beyond the ramp convergence point when truck volumes (3-axle or more) are 5 percent or greater on ascending entrance ramps to freeways with sustained upgrades exceeding 3 percent (i.e., at least throughout the merge area).

Figure 504.3A

Typical Freeway Entrance Loop Ramp Metering (1 GP Lane + 1 HOV Preferential Lane)

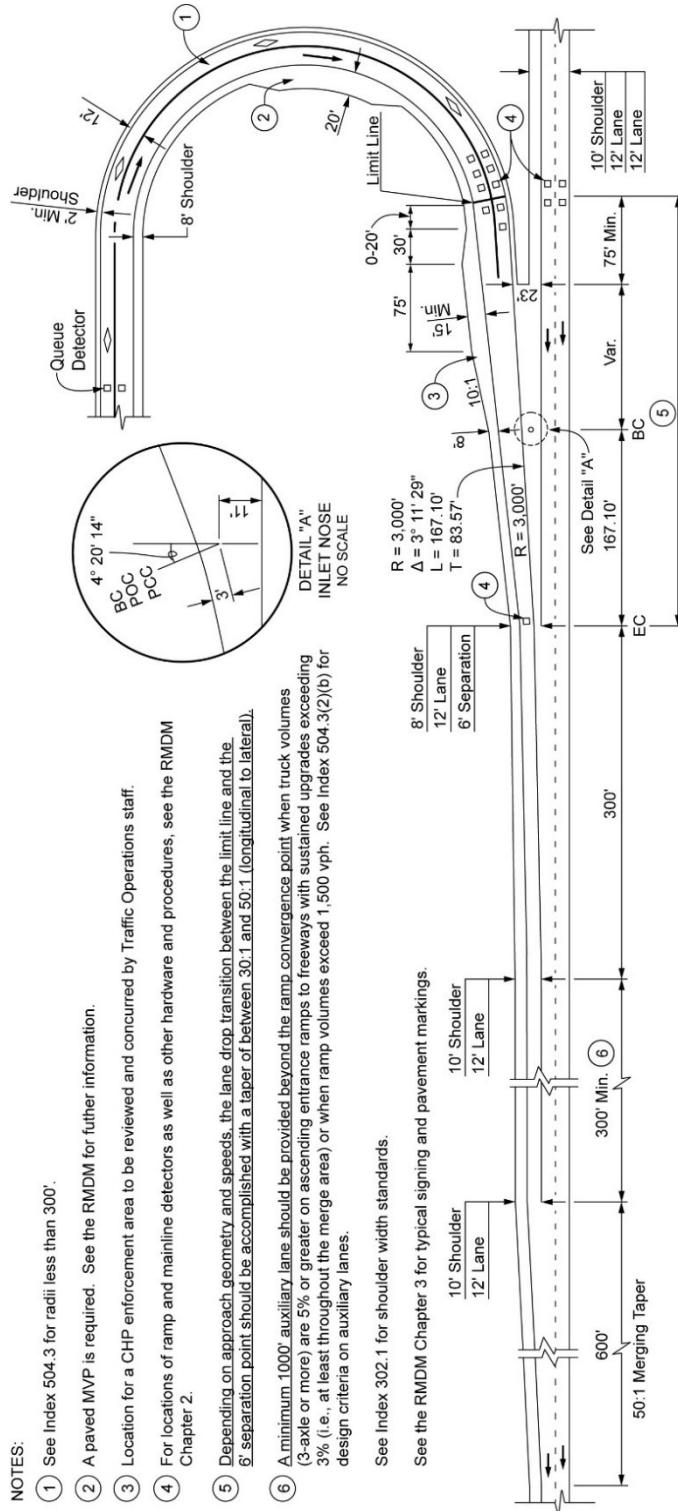

NOTES:

- 1 See Index 504.3 for radii less than 300'.
- 2 A paved MVP is required. See the RMDM for further information.
- 3 Location for a CHP enforcement area to be reviewed and concurred by Traffic Operations staff.
- 4 For locations of ramp and mainline detectors as well as other hardware and procedures, see the RMDM Chapter 2.
- 5 Depending on approach geometry and speeds, the lane drop transition between the limit line and the separation point should be accomplished with a taper of between 30:1 and 50:1 (longitudinal to lateral).
- 6 A minimum 1000' auxiliary lane should be provided beyond the ramp convergence point when truck volumes (3-axle or more) are 5% or greater on ascending entrance ramps to freeways with sustained upgrades exceeding 3% (i.e., at least throughout the merge area) or when ramp volumes exceed 1,500 vph. See Index 504.3(2)(b) for design criteria on auxiliary lanes.

See Index 302.1 for shoulder width standards.

See the RMDM Chapter 3 for typical signing and pavement markings.

July 1, 2020

Figure 504.3B

Typical Successive Freeway Entrance Ramp Metering (1 GP Lane + 1 HOV Preferential Lane)

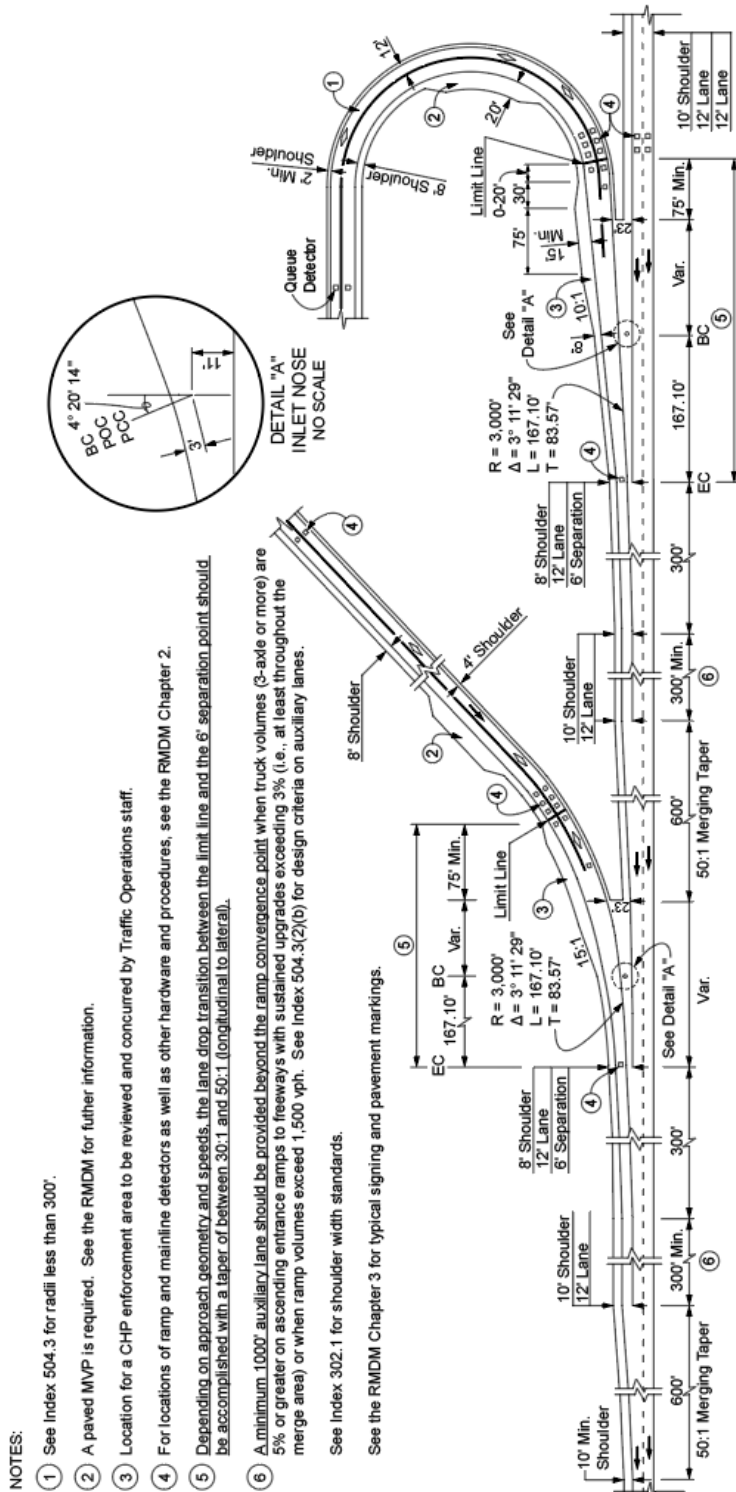

In general, the vehicle occupancy requirement for ramp meter HOV preferential lanes is typically two or more persons per vehicle. At some locations, a higher vehicle occupancy requirement may be necessary. The occupancy requirement should be based on the HOV demand and should match with other HOV facilities in the vicinity.

A HOV preferential lane should typically be placed on the left; however, demand and operational characteristics at the ramp entrance may dictate otherwise. Design of the HOV preferential lane at a metered entrance ramp requires the review and concurrence of the Caltrans District Traffic Operations Branch responsible for ramp metering.

Access to the HOV preferential lane may be provided in a variety of ways depending on interchange type and available storage length for queued vehicles. Where queued vehicles in the general purpose (GP) lane may block access to the HOV preferential lane, consider providing direct or separate access. To avoid trapping GP traffic in an HOV preferential lane, the signing and pavement marking at the ramp entrance should direct motorists into the GP lane(s). See the RMDM, Chapter 3 for signing and pavement markings. Designs should consider pedestrian/bicycle volumes, especially when the entrance ramp is located near a school or the local highway facility includes a designated bicycle lane or route. See Index 403.6 for right-turn-only lane guidance where bicycle travel is permitted. Contact the District Traffic Safety Engineer or designee and the Project Delivery Coordinator or District Design Liaison to discuss the application of specific design and/or general issues related to the design of HOV preferential lane access.

Signing for a HOV preferential lane should be placed to clearly indicate which lane is designated for HOVs. Real-time signing at the ramp entrance, such as an overhead changeable message sign, may be necessary at some locations if pavement delineation and normal signing do not provide drivers with adequate lane usage information. To avoid leading Single-Occupancy Vehicles (SOV) into a HOV preferential lane, pavement delineation at the ramp entrance should lead drivers into the SOV lane.

(c) Metered Multilane Freeway Entrance Ramps.

The number of metered lanes at an entrance ramp is the number of both metered general purpose (GP) and high-occupancy vehicle (HOV) preferential lanes at the limit line. The minimum number of metered GP lanes is determined based on GP traffic demand. The number of metered HOV preferential lanes is determined based on HOV demand using the same guidelines as GP traffic demand, as well as the HOV preferential lane policy.

A multilane ramp segment may be provided to increase vehicle storage within the available ramp length. At on-ramps with peak hour volume between 500 and 900, a two-lane ramp meter may be provided to double the vehicles stored within the available storage area. See RMDM for additional multilane freeway entrance ramp guidance.

Figures 504.3E and 504.3F illustrate typical designs for metered multilane diagonal and loop freeway entrance ramps. On multilane loop ramps, typically only the right lane needs to be widened to accommodate design vehicle off-tracking. See Index 504.3(1)(b).

Three-lane metered ramps are typically needed to serve peak (i.e., commute) hour traffic along urban and suburban freeway corridors. The adverse effects of bus and truck traffic on the operation of these ramps (i.e., off-tracking, sight restriction, acceleration characteristics on upgrades, etc.) is minimized when the ramp alignment is tangential or consists of curve radii not less 300 feet. Proposed three-lane loop and four-lane entrance ramps require the review and approval by the Deputy District Director of Traffic Operations.

July 1, 2020

Figure 504.3C

Restrictive Condition Freeway Entrance Ramp Metering (1 GP Lane)

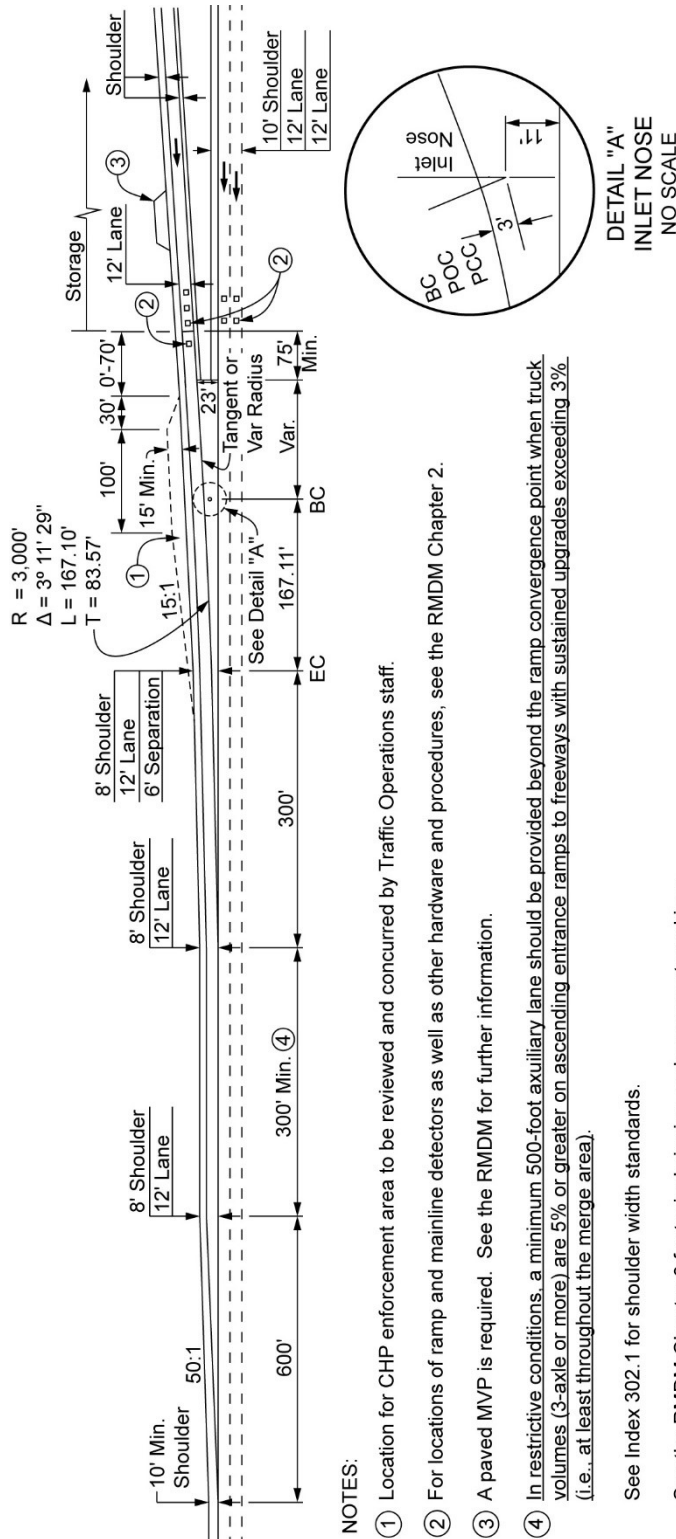
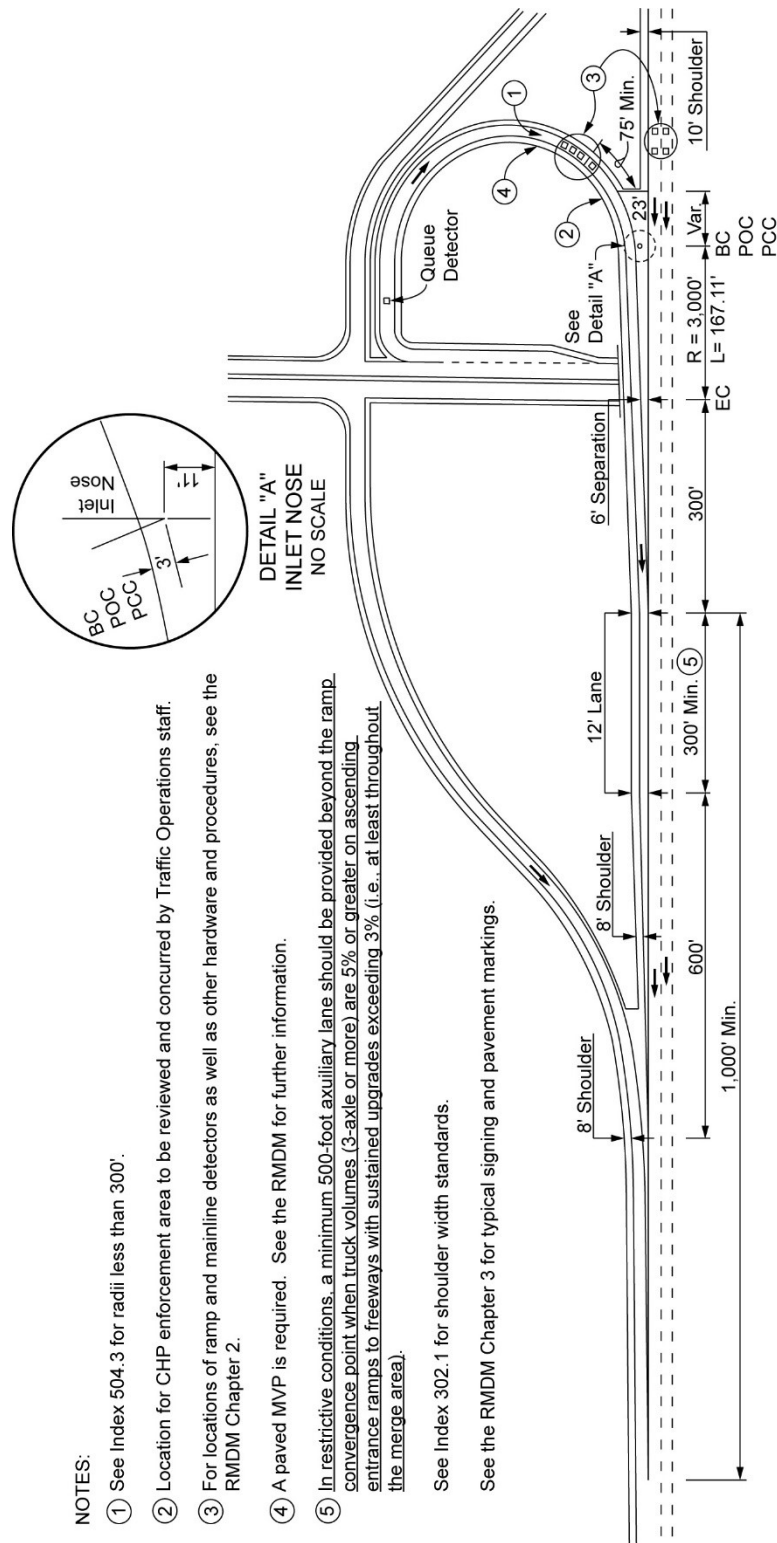

Figure 504.3D

Restrictive Condition Freeway Entrance Loop Ramp Metering (1 GP Lane)



- NOTES:
- ① See Index 504.3 for radii less than 300'.
 - ② Location for CHP enforcement area to be reviewed and concurred by Traffic Operations staff.
 - ③ For locations of ramp and mainline detectors as well as other hardware and procedures, see the RMDM Chapter 2.
 - ④ A paved MVP is required. See the RMDM for further information.
 - ⑤ In restrictive conditions, a minimum 500-foot auxiliary lane should be provided beyond the ramp convergence point when truck volumes (3-axle or more) are 5% or greater on ascending entrance ramps to freeways with sustained upgrades exceeding 3% (i.e., at least throughout the merge area).

See Index 302.1 for shoulder width standards.
See the RMDM Chapter 3 for typical signing and pavement markings.

July 1, 2020

On multi-lane entrance ramps, the multi-lane segment should transition to a single lane width between the ramp meter limit line and the 6-foot separation point (from the mainline edge of traveled way).

The lane drop transition should be accomplished with a taper of 50:1 (longitudinal to lateral) unless a lesser taper is warranted by site and/or project specific conditions which control the ramp geometry and/or anticipated maximum speed of ramp traffic. For example, "loop" entrance ramps would normally not allow traffic to attain speeds which would warrant a 50:1 (longitudinal to lateral) lane drop taper. Also, in retrofit situations, existing physical, environmental or right of way constraints may make it impractical to provide a 50:1 taper, especially if the maximum anticipated approach speed will be less than 50 miles per hour. Therefore, depending on approach geometry and speed, the lane drop transition between the limit line and the 6-foot separation point should be accomplished with a taper of between 30:1 and 50:1 (longitudinal to lateral). **However, the lane drop taper past the limit line shall not be less than 15 to 1.**

The merge from the metered entrance ramp to the freeway should include a 300-foot minimum auxiliary lane beyond the ramp convergence point.

Where truck volumes (3-axle or more) are 5 percent or greater on ascending entrance ramps to freeways with sustained upgrades exceeding 3 percent (i.e. at least throughout the merge area), a minimum 1,000 feet length of auxiliary lane should be provided beyond the ramp convergence point. AASHTO, A Policy on Geometric Design of Highways and Streets, provides additional guidance on acceleration lane length on grades.

When ramp volumes exceed 1,500 vph, a 1,000-foot minimum length of auxiliary lane should be provided beyond the ramp convergence point. If an auxiliary lane is included, the ramp lane transition may be extended to the convergence point. However, the proximity of the nearest interchange may warrant weaving analysis to determine the acceptability of extending the ramp lane transition beyond the 6-foot separation point. A longer auxiliary lane should be considered where mainline/ramp gradients and truck volumes warrant additional length.

(d) Metered Freeway-to-Freeway Connectors.

Freeway-to-freeway connectors may also be metered. The need to meter a freeway-to-freeway connector should be determined on an individual basis. Because connector ramps provide a link between two high speed facilities, drivers do not expect to stop, nor do they expect to approach a stopped vehicle.

The installation of ramp meters on connector ramps shall be limited to those facilities which meet or exceed the following geometric design criteria:

- **Standard lane and shoulder widths.**
- **"Tail light" sight distance, measured from a 3 ½ feet eye height to a 2-foot object height, is provided for a design speed of 50 miles per hour minimum.**

All lane drops on connectors should be accomplished over a distance not less than WV. All lane drop transitions on connectors shall be accomplished with a taper of 50:1 (longitudinal to lateral) minimum, (see Figures 504.3G and 504.3H).

See RMDM Section 1.11 for additional metered freeway-to-freeway connector guidance.

Figure 504.3E

Typical Multilane Freeway Diagonal Entrance Ramp Metering (2 GP Lanes + 1 HOV Preferential Lane)

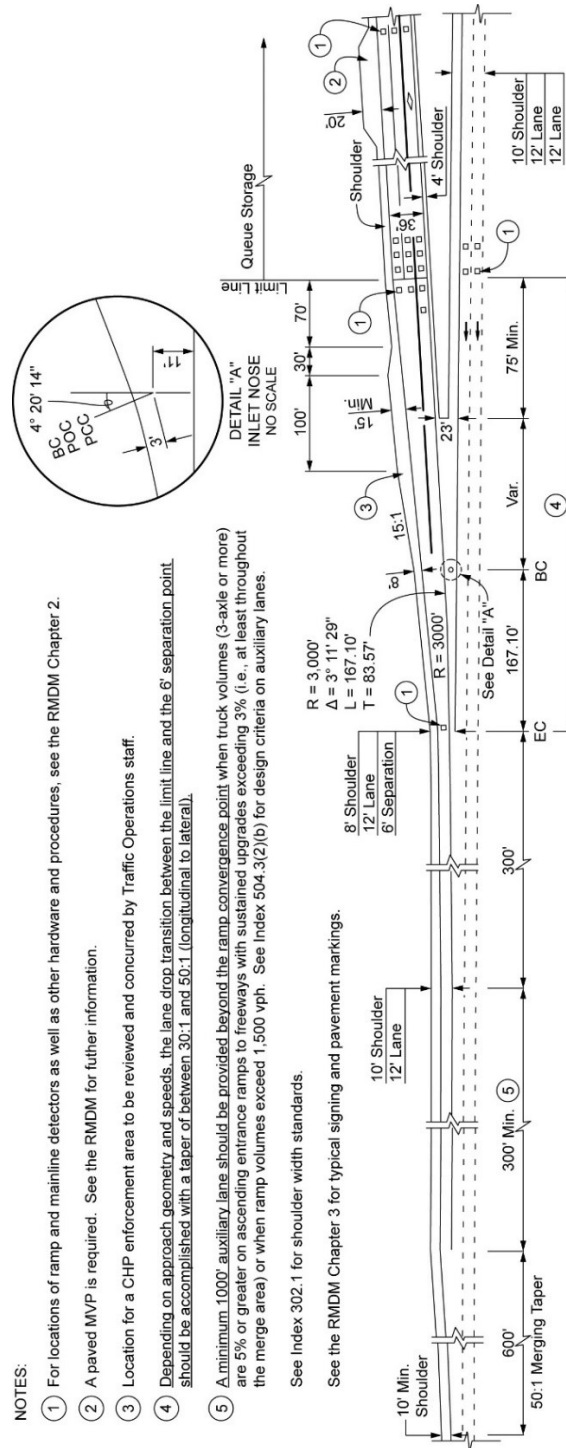

NOTES:

- ① For locations of ramp and mainline detectors as well as other hardware and procedures, see the RMDM Chapter 2.
- ② A paved MVP is required. See the RMDM for further information.
- ③ Location for a CHP enforcement area to be reviewed and concurred by Traffic Operations staff.
- ④ Depending on approach geometry and speeds, the lane drop transition between the limit line and the 6' separation point should be accomplished with a taper of between 30:1 and 50:1 (longitudinal to lateral).
- ⑤ A minimum 1000' auxiliary lane should be provided beyond the ramp convergence point when truck volumes (3-axle or more) are 5% or greater on ascending entrance ramps to freeways with sustained upgrades exceeding 3% (i.e., at least throughout the merge area) or when ramp volumes exceed 1,500 vph. See Index 504.3(2)(b) for design criteria on auxiliary lanes. See Index 302.1 for shoulder width standards.

See the RMDM Chapter 3 for typical signing and pavement markings.

July 1, 2020

Figure 504.3F

Typical Multilane Freeway Loop Entrance Ramp Metering (2 GP Lanes + 1 HOV Preferential Lane)

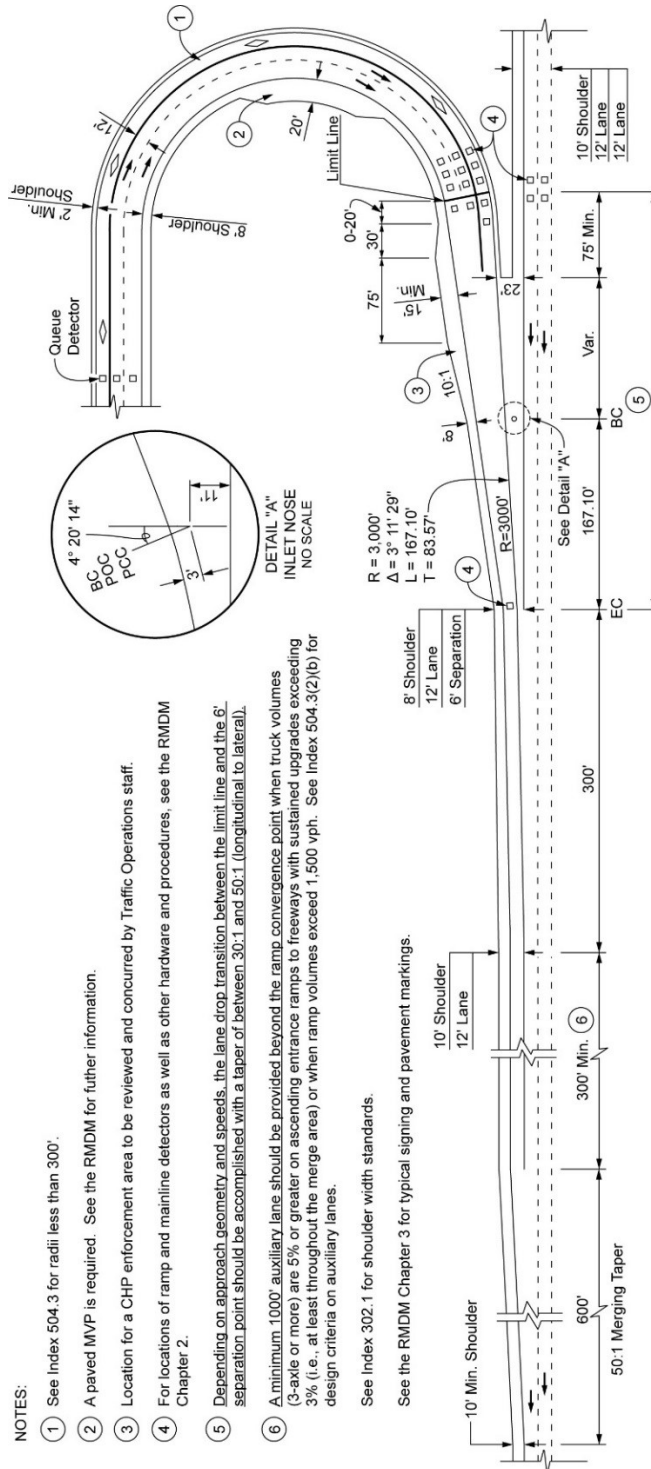

NOTES:

- ① See Index 504.3 for radii less than 300'.
- ② A paved MVP is required. See the RMDM for further information.
- ③ Location for a CHP enforcement area to be reviewed and concurred by Traffic Operations staff.
- ④ For locations of ramp and mainline detectors as well as other hardware and procedures, see the RMDM Chapter 2.
- ⑤ Depending on approach geometry and speeds, the lane drop transition between the limit line and the 6' separation point should be accomplished with a taper of between 30:1 and 50:1 (longitudinal to lateral).
- ⑥ A minimum 1000' auxiliary lane should be provided beyond the ramp convergence point when truck volumes (3-axle or more) are 5% or greater on ascending entrance ramps to freeways with sustained upgrades exceeding 3% (i.e., at least throughout the merge area) or when ramp volumes exceed 1,500 vph. See Index 504.3(2)(b) for design criteria on auxiliary lanes.

See Index 302.1 for shoulder width standards.

See the RMDM Chapter 3 for typical signing and pavement markings.

(e) Queue Storage Length

In order to maximize the effectiveness of operational strategies, an important design consideration for a ramp meter system is providing adequate storage for queues. Storage length design requires the review and concurrence of the Caltrans District Traffic Operations Branch responsible for ramp metering. See RMDM Section 1.4 for detailed queue storage length design guidance.

To minimize the impact on local street operation, every effort should be made to meet the recommended storage length. Wherever feasible, ramp metering storage should be contained on the ramp by either widening or lengthening it. Improvements to the local street system in the vicinity of the ramp should also be thoroughly investigated where there is insufficient storage length on the ramp and the ramp queue will adversely affect local street operation. Note that excessive queue length may also impact the mobility of pedestrians and bicyclists. The storage length that can be provided on the ramp may be limited by the weaving distance to the next off-ramp and/or available right of way. Local street improvements can include widening or restriping the street(s) or intersection(s) to provide additional storage or capacity. Signal timing revisions along the corridor feeding the ramp can also enhance the storage capability. These will require coordination with the local agency consistent with the regional traffic operations strategy.

It is the responsibility of the Department, on Department initiated projects, to mitigate the effect of ramp metering, for initial as well as future operational impacts, to local streets that lead to metered freeway entrance ramps. It is the responsibility of developers and/or local agencies, to mitigate any impact to existing ramp meter facilities, future ramp meter installations, or local streets, when those impacts are attributable to new development and/or local agency roadway improvement projects.

(f) Pavement Structure.

In planning for the possibility of future widening, the pavement structure for the ramp shoulders should be equal to the ramp traveled way pavement structure. In locations where failure of loop detectors due to flexible pavement deterioration is a concern, a Portland Cement Concrete (PCC) pad may be considered on new construction and rehabilitation projects. The concrete pad should cover the metering detector loop area upstream and downstream of the limit line.

(g) Meter Signal Location.

For the location of ramp meter signal standards, see the RMDM, Chapter 2.

(h) Limit Line Location.

The limit line location will be determined by the selected transition taper, but should be a minimum of 75 feet upstream of the 23-foot separation point. See the RMDM Section 1.7 for additional guidance.

(i) Modifications to Existing HOV Preferential Lanes.

Changes in traffic conditions, proposals for interchange modifications, recurrent operational problems affecting the local facility, or the need to further improve mainline operations through more restrictive metering are opportunities to reevaluate the need for a HOV preferential lane. Typically, an existing HOV preferential lane may be considered for conversion to a GP lane if the existing HOV preferential lane is underutilized, there is a need for additional queue storage for the GP lanes, or an alternate entrance ramp HOV preferential lane is available within 1½ miles. See the RMDM for procedures when

July 1, 2020

Figure 504.3G

Typical Freeway-to-Freeway Connector Ramp Metering (1 GP Lane + 1 HOV Preferential Lane)

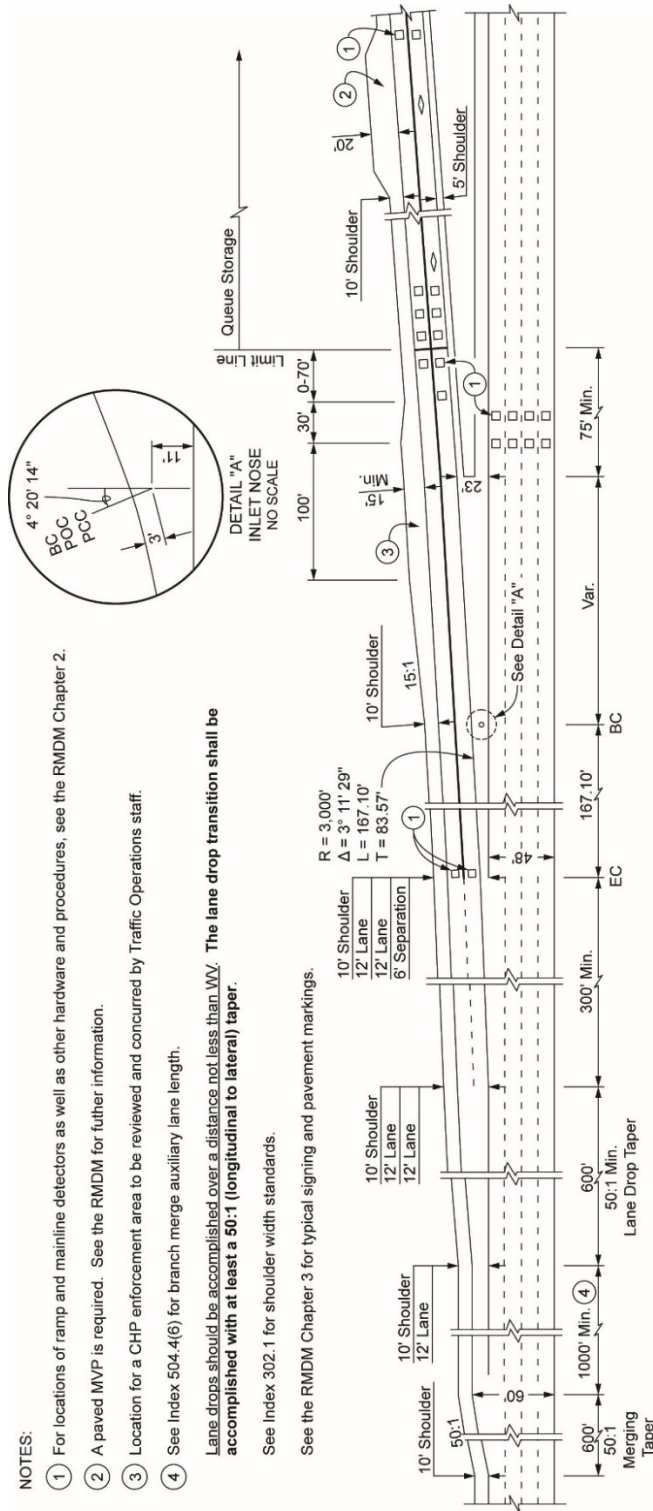

NOTES:

- 1 For locations of ramp and mainline detectors as well as other hardware and procedures, see the RMDM Chapter 2.
- 2 A paved MVP is required. See the RMDM for further information.
- 3 Location for a CHP enforcement area to be reviewed and concurred by Traffic Operations staff.
- 4 See Index 504.4(6) for branch merge auxiliary lane length.

Lane drops should be accomplished over a distance not less than 100'. The lane drop transition shall be accomplished with at least a 50:1 (longitudinal to lateral) taper.

See Index 302.1 for shoulder width standards.

See the RMDM Chapter 3 for typical signing and pavement markings.

Figure 504.3H

Typical Freeway-to-Freeway Connector Ramp Metering (2 GP Lanes + 1 HOV Preferential Lane)

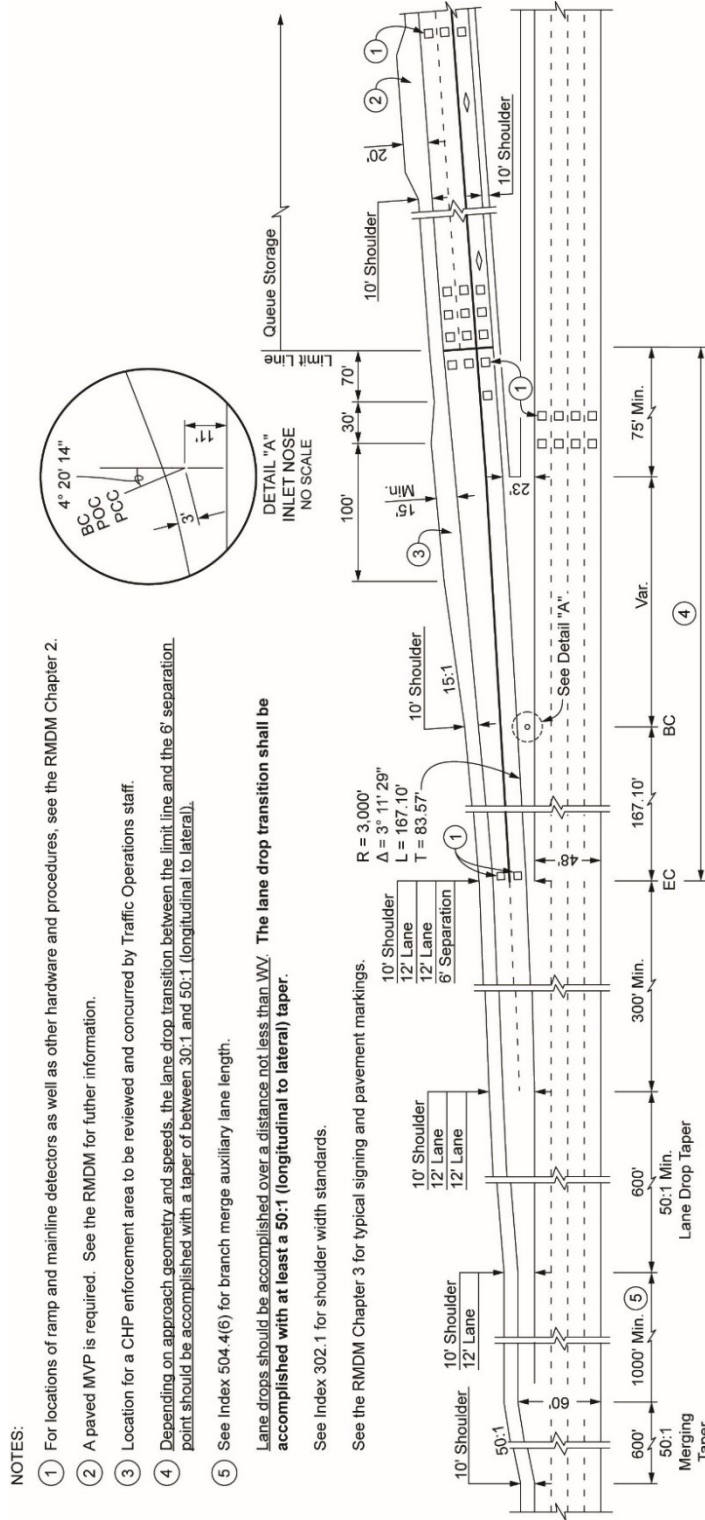

July 1, 2020

considering conversion of a HOV preferential lane to a GP lane at a metered entrance ramp.

(j) Enforcement Areas and Maintenance Pullouts.

Division of Traffic Operations policy requires a paved enforcement area to be provided on all projects that include new or reconstructed metered entrance ramps or connectors.

See the RMDM for exception procedures to this policy.

Enforcement areas are used by the California Highway Patrol (CHP) to enforce minimum vehicle occupancy requirements. The paved enforcement area should be placed on the right side of a metered entrance ramp, downstream of the metering signals, and as close to the limit line as practical to facilitate CHP enforcement. See Figures 504.3A to 504.3H for the typical layout and dimensions of enforcement areas.

The District Traffic Operations Branch responsible for ramp metering must coordinate enforcement issues with the CHP. The CHP Area Commander must be contacted during the development of the project report or PA & ED phase, prior to design, to discuss any variations needed to the CHP enforcement area designs shown in this manual. Variations to enforcement area dimensions or location require the review and concurrence of the CHP and the Caltrans District Traffic Operations Branch responsible for ramp metering.

Division of Traffic Operations policy requires a paved Maintenance Vehicle Pullout (MVP) to be provided at a location for maintenance and operations personnel to access controller cabinets. The MVP should be placed upstream or next to controller cabinets. The MVP and the controller cabinets should be placed on the same side of the entrance ramp. At loop entrance ramps, locate the MVP to the inside of the loop ramp. A paved walkway should be provided between the MVP and the controller cabinets. See RMDM Section 2.4 for controller cabinet placement. See Topic 309, Clearances, for placement guidance of fixed objects such as controller cabinets. Refer to HDM Index 107.2 and the Standard Plans for the layout and pavement structure section details of an MVP. See the RMDM for exception procedures to this policy.

(3) *Location and Design of Ramp Intersections on the Crossroads.*

Factors which influence the location of ramp intersections on the crossroads include sight distance, construction and right of way costs, bicycle and pedestrian mobility, circuitous travel for left-turn movements, crossroads gradient at ramp intersections, storage requirements for left-turn movements off the crossroads, and the proximity of other local road or bicycle path intersections.

Ramp intersections with local roads are intersections at grade. Chapter 400 and the references therein contain general guidance. For ramp intersections, a wrong-way movement onto an off-ramp can have severe consequences. The California MUTCD also contains guidance for signing and striping to deter wrong-way movements.

Interchange Types L-7, L-8, and L-9 are partial cloverleaf designs with ramps at a right angle to the crossroad where the off-ramps and on-ramps are adjacent to each other on the same side of the crossroad that offer benefits for non-motorized travel modes; however, additional design considerations as follows may be appropriate in order to deter wrong-way movements:

- The entrance and exit ramps should be clearly visible from the crossroad. Concrete barrier or guardrail placed between the ramps can block the view from the crossroad. If feasible, the concrete barrier or guardrail channelization feature should be set back from the crossroad edge of shoulder 20 to 50 feet with a raised traffic island placed from the

ramp termini to the begin point of the separation feature. See Index 405.4 for further traffic island guidance. Consult the District Traffic Safety Branch for available options.

- Vehicles turning left onto an on-ramp are to be prevented, to the maximum extent feasible, from turning prematurely onto the off-ramp by placing or extending a curbed median on the crossroad to physically discourage this move. Attention needs to be given to accommodating truck turn templates for design vehicles entering and exiting the freeway. See Index 404.5 for further turning template guidance. Truck aprons could be provided if the size of an intersections becomes too large for an occasional truck. See Index 405.10, Roundabouts, and the references therein for design guidance on truck aprons.

Isolated off-ramps are to be avoided to minimize the potential for wrong-way movements. If the isolated off-ramp is necessary, the leading curb return from the perspective of a vehicle on the crossroad approaching from the same side as the off-ramp is made with a short radius curve of 3 to 5 feet. State or local roads and driveways opposite isolated off-ramps are to be avoided as there is no corresponding on-ramp for cross traffic to take. See this chapter for further interchange and ramp guidance.

Ramp terminals should connect where the grade of the overcrossing is 4 percent or less to avoid potential overturning of trucks.

For left-turn maneuvers from an off-ramp at an unsignalized intersection, the length of crossroads open to view should be according to the corner sight distance criteria in Index 405.1.

When proposing uncontrolled entries and exits from freeway ramps with local roads, see the Design of Intersections at Interchanges guidance in Index 403.6(2).

Corner sight distance restrictions may be caused by bridge railings, bridge piers, or slopes. Corner sight distance is measured along the crossroad between the vehicle in the center of the outside lane of the crossroad approaching the ramp and the eye of the driver of the ramp vehicle that is set back from the edge of traveled way of the crossroad. Figure 504.31 illustrates the relationship of the ramp vehicle that is set back from an overcrossing structure, which is based on the sight distance controlled by the bridge rail location using the corner sight distance criteria. The same relationship exists for sight distance controlled by bridge piers or slopes.

Where the clear sight triangle is unobtainable according to Index 405.1, sight distance should be provided by flaring the end of the overcrossing structures or setting back the piers or end slopes of an undercrossing structure. The sight line should take into account if the bridge railing is see-through or is at a height below the driver's eye height. Note, the bridge railing may have added features, such as chain link railing, tubular hand railing, sound barrier, decorative architectural pedestals, etc.

If signals are warranted within 5 years of construction, consideration may be given to installing signals according to Part 4 of the California MUTCD, 4B.107(CA) and 4C.09.

For additional information on sight distance requirements at signalized intersections, see Index 405.1.

The minimum distance (curb return to curb return) between ramp intersections and local road intersections shall be 400 feet. The preferred minimum distance should be 500 feet. This does not apply to Resurfacing, Restoration and Rehabilitation (3R), ramp widening, restriping or other projects which do not reconfigure the interchange. This standard does apply to projects proposing to realign a local street.

Where intersections are closely spaced, traffic operations are often inhibited by short weave distance, storage lengths, and signal phasing. In addition it is difficult to provide proper

July 1, 2020

signing and delineation. The District Traffic Branch should be consulted regarding traffic engineering studies needed to determine the appropriate signage, delineation, and form of intersection control.

(4) *Superelevation for Ramps.*

The factors controlling superelevation rates discussed in Topic 202 apply also to ramps. As indicated in Index 202.2 use the 12 percent e_{max} rate except where snow and ice conditions prevail. In restrictive cases where the length of curve is too short to develop standard superelevation, the highest obtainable rate should be used (see Index 202.5). If feasible, the curve radius can be increased to reduce the standard superelevation rate. Both edge of traveled way and edge of shoulder should be examined at ramp junctions to assure a smooth transition.

Under certain restrictive conditions the standard superelevation rate discussed above may not be required on the curve nearest the ramp intersection of a ramp. The specific conditions under which lower superelevation rates would be considered must be evaluated on a case-by-case basis and must be discussed with the Project Delivery Coordinator or the District Design Liaison and then documented as required by the Project Delivery Coordinator.

(5) *Single-lane Ramps.*

Single lane ramps are those ramps that either enter into or exit from the freeway as a single lane. These ramps are often widened near the ramp intersection with the crossroads to accommodate turning movements onto or from the ramp. When additional lanes are provided near an entrance ramp intersection, the lane drop should be accomplished over a distance equal to WV . The lane to be dropped should be on the right so that traffic merges left.

Exit ramps in metropolitan areas may require multiple lanes at the intersection with the crossroads to provide additional storage and capacity. If the length of a single lane ramp exceeds 1,000 feet, an additional lane should be provided on the ramp to permit passing maneuvers. Figure 504.3J illustrates alternative ways of transitioning a single lane exit ramp to two lanes. The decision to use Alternate A or Alternate B is generally based on providing the additional lane for the minor movement.

(6) *Two-lane Exit Ramps.*

Where design year estimated volumes exceed 1500 equivalent passenger cars per hour, a 2-lane ramp should be provided. Provisions should be made for possible widening to three or more lanes at the crossroads intersection. Figure 504.3K illustrates the standard design for a 2-lane exit. An auxiliary lane approximately 1,300 feet long should be provided in advance of a 2-lane exit. For volumes less than 1500 but more than 900, a one-lane width exit ramp should be provided with provision for adding an auxiliary lane and an additional lane on the ramp.

(7) *Two-lane Entrance Ramps.* These ramps are discouraged in congested corridors. Early discussion with the Project Delivery Coordinator, District Design Liaison and the District Traffic Engineer or designee is recommended whenever two-lane entrance ramps are being considered.

(8) *Loop Ramps.* Normally, loop ramps should have one lane and shoulders unless a second lane is needed for capacity or ramp metering purposes. Consideration should be given to providing a directional ramp when loop volumes exceed 1500 vehicles per hour. If two lanes are provided, normally only the right lane needs to be widened for trucks. See Topic 404 for additional discussion on lane widths and design of ramp intersections to accommodate the design vehicle. See Index 504.3(1) for a discussion regarding on-ramp widening for trucks.

Figure 504.3I

Location of Ramp Intersections on the Crossroads

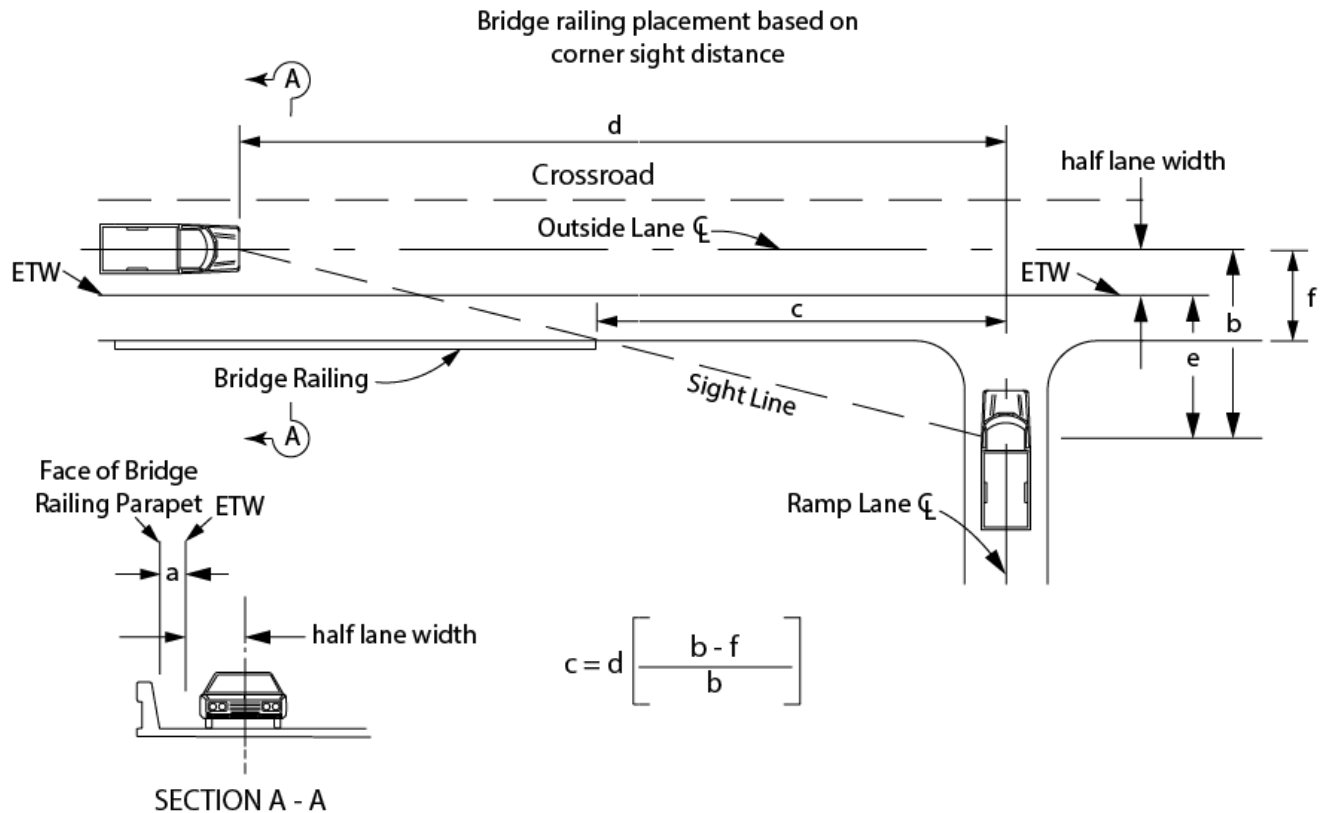

- a = Distance from edge of traveled way (ETW) to bridge railing; includes sidewalk width, if present.
- b = Distance from center of outside lane to assumed eye of ramp vehicle driver.
 $b = \text{half lane width} + e$
- c = Ramp set back from end of bridge railing.
- d = Corner sight distance measured along the crossroad from the intersection. See Index 405.1.
- e = Driver's eye set back: Ramp driver's eye is assumed to be located 10' plus the shoulder width, but not less than 15' from the ETW. See Index 405.1.
- f = half lane width + a

July 1, 2020

Figure 504.3J

Transition to Two-lane Exit Ramp

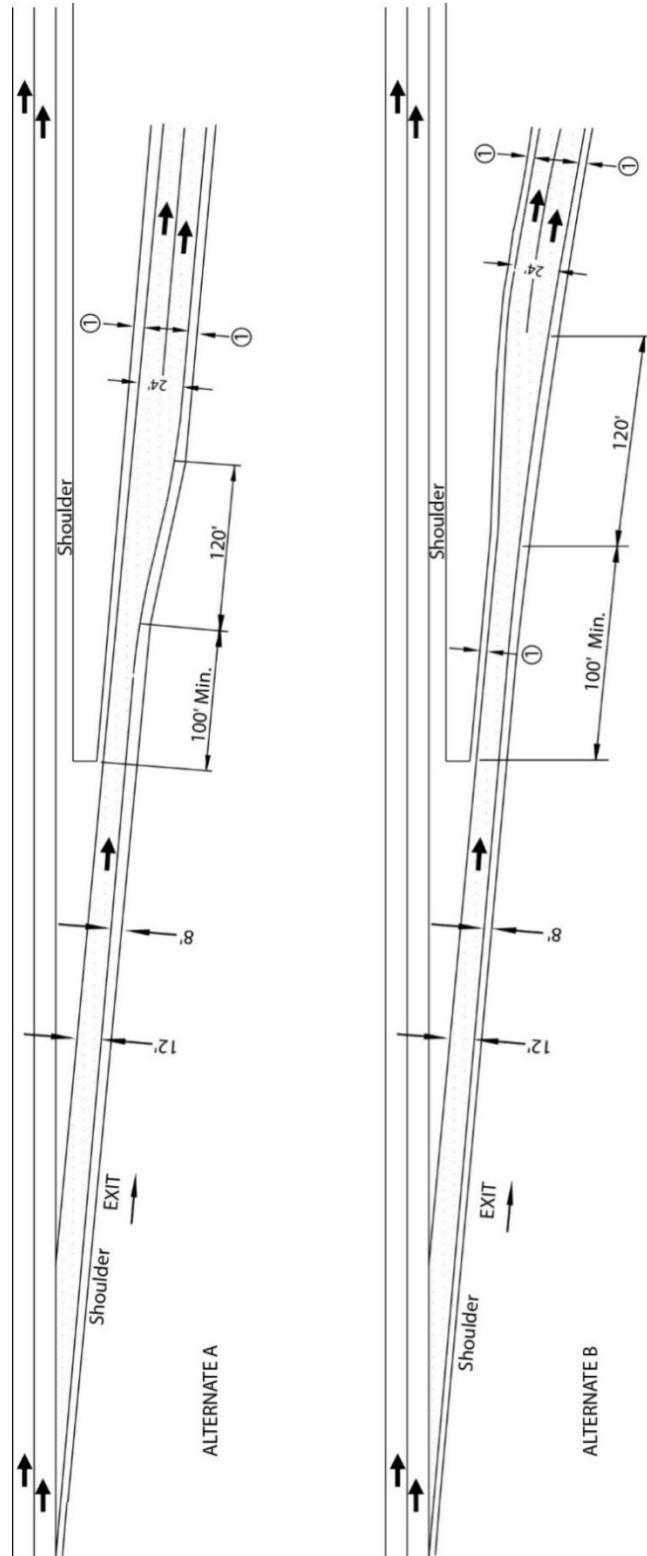

NOTES:

① See Index 302.1 for shoulder width standards. If shoulder reductions occur, see Index 206.3(4) for transitions.

Figure 504.3K

Two-Lane Connectors and Entrance/Exit Ramps

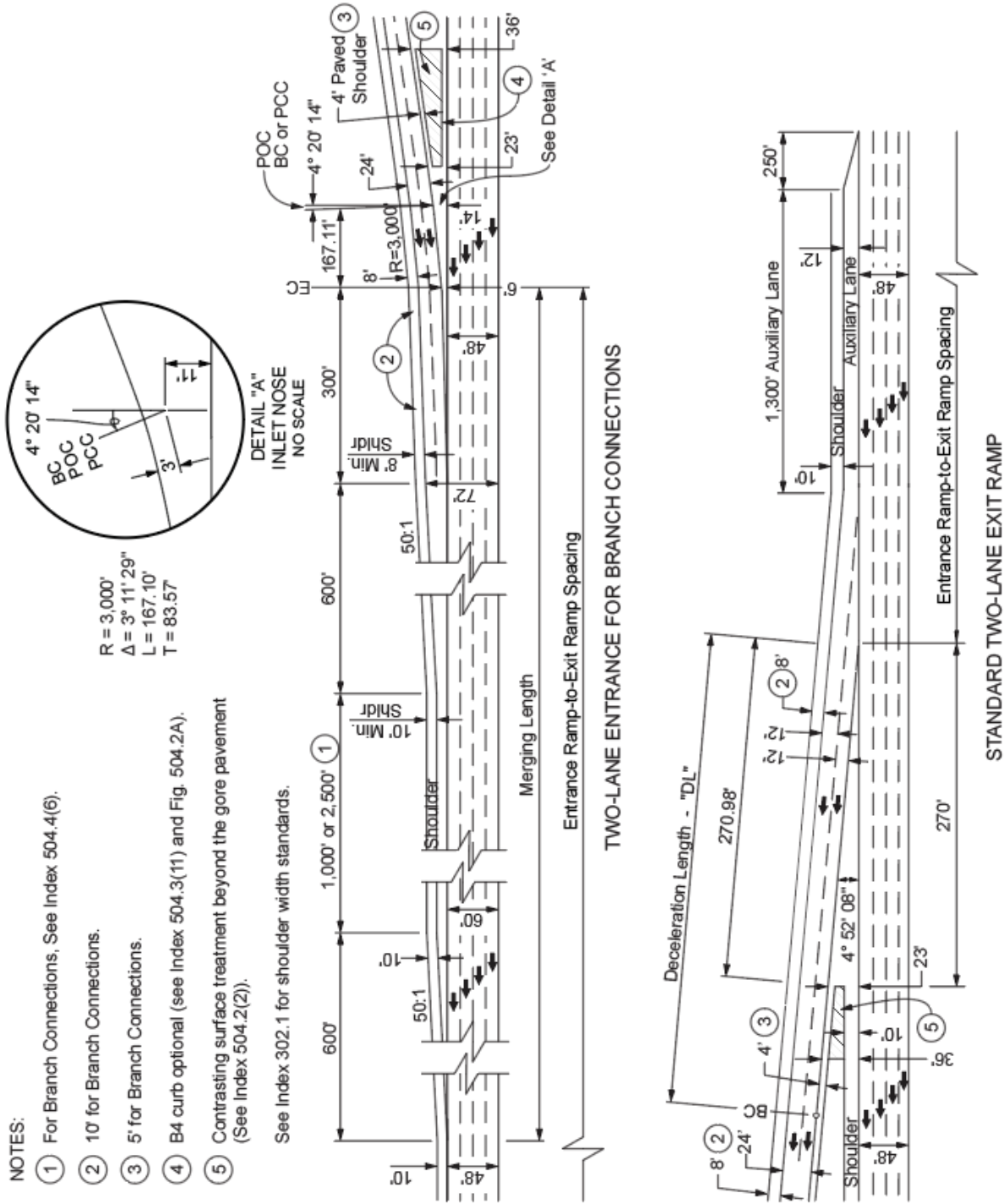

July 1, 2020

Radii for loop ramps should normally range from 150 feet to 200 feet. Increasing the radii beyond 200 feet is typically not cost effective as the slight increase in design speed is usually outweighed by the increased right of way requirements and the increased travel distance. Curve radii of less than 120 feet should also be avoided. Extremely tight curves lead to increased off-tracking by trucks and increase the potential for vehicles to enter the curve with excessive speed. Therefore, consider providing the ramp lane pavement structure on shoulders for curves with a radius less than 300 feet (see Indexes 626.1 and 636.1).

Of particular concern in the design of loop ramps are the constraints imposed on large trucks. Research indicates that trucks often enter loops with excessive speed, either due to inadequate deceleration on exit ramps or due to driver efforts to maintain speed on entrance ramps to facilitate acceleration and merging. Where the loop is of short radius and is also on a steep descent (over 6 percent), it is important to develop the standard 2/3 full superelevation rate by the beginning of the curve (see Index 504.2(5)). When accommodating design vehicles in Rural Developing Corridors that are largely composed of industrial, commercial or retail buildings located separately from housing, the following considerations may be necessary to meet the standard 2/3 full superelevation rate on loop entrance ramps:

- Begin the ramp with a short tangent (75 feet to 100 feet) that diverges from the cross street at an angle of 4 to 9 degrees.
- Provide additional tangent length as site conditions allow.

The Angle of Intersection guidance in Index 403.3 applies to all on-ramps including loops.

(9) *Distance Between Successive On-ramps.* The minimum distance between two successive on-ramps to a freeway lane should be the distance needed to provide the standard on-ramp acceleration taper shown on Figure 504.2A. This distance should be about 1,000 feet unless the upstream ramp adds an auxiliary lane in which case the downstream ramp should merge with the auxiliary lane in a standard 50:1 (longitudinal to lateral) convergence. The distance between on-ramp noses will then be controlled by interchange geometry.

(10) *Distance Between Successive Exits.* The minimum distance between successive exit ramps for guide signing should be 1,000 feet on the freeway and 600 feet on collector-distributor roads.

(11) *Curbs.* Curbs should not be used on ramps except in the following locations:

- (a) A Type D curb or 4-inch Type B curb (see Index 303.2) may be used on both sides of the separation between freeway lanes and a parallel collector-distributor road.
- (b) A B4 curb may be used as shown in Figure 504.2A to control drainage or where the gore cross slope would be greater than allowed in Index 504.2(5). When the optional B4 curb is used at the entrance ramp inlet nose, the shoulder adjacent to the curb should be the same width as the ramp shoulder approaching the curb. The B4 gutter pan can be included as part of the shoulder width. As stated in Index 405.4(2), curbs are typically discouraged where posted speeds are over 40 miles per hour. Curbs at gore areas must be determined on a case-by-case basis.
- (c) Curbs may be used where necessary at the ramp connection with the local street for the protection of pedestrians, for channelization, and to provide compatibility with the local facility.
- (d) The Type E curb may be used only in special drainage situations, for example, where drainage parallels and flows against the face of a retaining wall.

In general, curbs should not be used on the high side of ramps or in off-ramp gore areas except at collector-distributor roads. The off-tracking of trucks should be analyzed when considering curbs on ramps.

(12) *Dikes*. Dikes may be used where necessary to control drainage. For additional information see Index 303.3.

504.4 Freeway-to-Freeway Connections

(1) *General*.

All of the design criteria discussed in Indexes 501.3, 504.2 and 504.3 apply to freeway to freeway connectors, except as discussed or modified below.

(2) *Design Speed*.

The design speed for single lane directional and all branch connections should be a minimum of 50 miles per hour. When smaller radius curves, with lower design speeds, are used the vertical sight distance should be consistent with approaching vehicle speeds. Design speed for loop connectors should be consistent with the radii guidance discussed in Index 504.3(8).

(3) *Grades*.

The maximum profile grade on freeway-to-freeway connections should not exceed 6 percent. Flatter grades and longer vertical curves than those used on ramps are needed to obtain increased stopping sight distance for higher design speeds.

(4) *Shoulder Width*.

(a) Single-lane and Two-lane Connections—**The width of shoulders on single-lane and two-lane (except as described below) freeway-to-freeway connectors shall be 5 feet on the left and 10 feet on the right. A single lane freeway-to-freeway connector that has been widened to two lanes solely to provide passing opportunities and not due to capacity requirements shall have a 5-foot left shoulder and at least a 5-foot right shoulder** (see Index 504.4(5)).

(b) Three-lane Connections—**The width of shoulders on three-lane connectors shall be 10 feet on both the left and right sides.**

(5) *Single-Lane Connections*.

Freeway-to-freeway connectors may be single lane or multilane. Where design year volume is between 900 and 1500 equivalent passenger cars per hour, initial construction should provide a single lane connection with the capability of adding an additional lane. Single lane directional connectors should be designed using the general configurations shown on Figure 504.2A and 504.2B, but utilizing the flatter divergence angle shown in Figure 504.4. Single lane loop connectors may use a diverge angle of as much as that shown on Figure 504.2B for ramps, if necessary. The choice will depend upon interchange configuration and driver expectancy. Single lane connectors in excess of 1,000 feet in length should be widened to two lanes to provide for passing maneuvers (see Index 504.4(4)).

(6) *Branch Connections*.

A branch connection is defined as a multilane connection between two freeways. A branch connection should be provided when the design year volume exceeds 1500 equivalent passenger cars per hour.

Merging branch connections should be designed as shown in Figure 504.3K. Diverging branch connections should be designed as shown in Figure 504.4. The diverging branch

July 1, 2020

connection leaves the main freeway lanes on a flatter angle shown in Figure 504.4 than the standard 2-lane ramp exit connection shown in Figure 504.3K. The standard ramp exit connects to a local street. The diverging branch connection connects to another freeway and has a flatter angle that allows a higher departure speed.

At a branch merge, a 2,500-foot length of auxiliary lane should be provided beyond the merge of one lane of the inlet, except where it does not appear that capacity on the freeway will be reached until five or more years after the 20 year design period. In this case the length of auxiliary lane should be a minimum of 1,000 feet. For diverging connections where less than capacity conditions beyond the design year are anticipated, the length of auxiliary lane in advance of the exit should be 1,300 feet.

(7) Lane Drops.

The lane drop taper on a freeway-to-freeway connector should not be less than WV .

(8) Metering.

Any decision to meter freeway-to-freeway connectors must be carefully considered as driver expectancy on these types of facilities is for high-speed uninterrupted flow. If metering is anticipated on a connector, discussions with the Project Delivery Coordinator and the District Traffic Engineer or designee should take place as early as possible. Issues of particular concern are adequate deceleration lengths to the end of the queue, potential need to widen shoulders if sight distance is restricted (particularly on-ramps with 5-foot shoulders on each side), and the potential for queuing back onto the freeway

504.5 Auxiliary Lanes

In order to ensure satisfactory operating conditions, auxiliary lanes may be added to the basic width of traveled way.

Where an entrance ramp of one interchange is closely followed by an exit ramp of another interchange, the acceleration and deceleration lanes should be joined with an auxiliary lane. Auxiliary lanes are frequently used when the entrance ramp-to-exit ramp spacing, measured as shown in Figure 504.2A, is less than 2,000 feet. Where interchanges are more widely spaced and ramp volumes are high, the need for an auxiliary lane between the interchanges should be determined in accordance with Index 504.7.

Auxiliary lanes may be used for the orientation of traffic at 2-lane ramps or branch connections as illustrated on Figure 504.3K and Figure 504.4. The length and number of auxiliary lanes in advance of 2-lane exits are based on percentages of turning traffic and a weaving analysis.

Auxiliary lanes should be considered on all freeway entrance ramps with significant truck volumes. The grade, volumes and speeds should be analyzed to determine the need for auxiliary lanes. An auxiliary lane would allow entrance ramp traffic to accelerate to a higher speed before merging with mainline traffic, or simply provide more opportunity to merge. See Index 504.2 for specific requirements.

504.6 Mainline Lane Reduction at Interchanges

The basic number of mainline lanes should not be dropped through a local service interchange. The same standard should also be applied to freeway-to-freeway interchanges where less than 35 percent of the traffic is turning (see Figure 504.4). Where more than 35 percent of the freeway traffic is turning, consideration may be given to reducing the number of lanes. No

Figure 504.4
Diverging Branch Connections

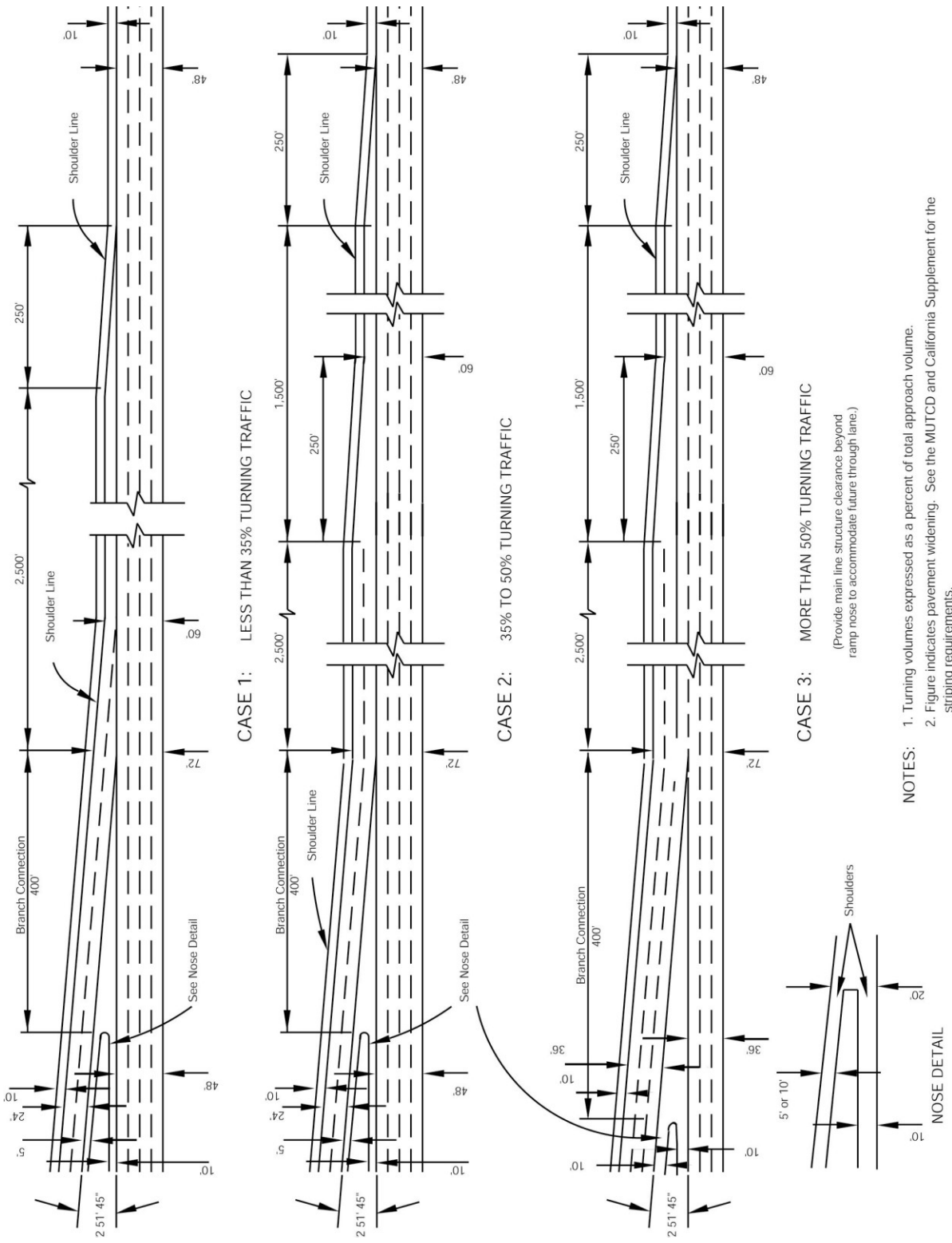

July 1, 2020

decision to reduce the number of lanes should be made without the approval of the District Traffic Operations Unit. Additionally, adequate structure clearance (both horizontal and vertical) should be provided to accommodate future construction of the dropped lane if required.

Where the reduction in traffic volumes is sufficient to warrant a decrease in the basic number of lanes, a preferred location for the lane drop is beyond the influence of an interchange and preferably at least one-half mile from the nearest exit or inlet nose. It is desirable to drop the right lane on tangent alignment with a straight or sag profile so vehicles can merge left with good visibility to the pavement markings in the merge area (see Index 201.7).

504.7 Weaving Sections

A weaving section is a length of one-way roadway where vehicles are crossing paths, changing lanes, or merging with through traffic as they enter or exit a freeway or collector-distributor road. A single weaving section has an inlet at the upstream end and an exit at the downstream end. A multiple weaving section is characterized by more than one point of entry followed by one or more points of exit.

A rough approximation for adequate length of a weaving section is one foot of length per weaving vehicle per hour. This rate will approximately provide a Level of Service (LOS) C.

There are various methods for analyzing weaving sections. Two methods which provide valid results are described below.

The Leisch method, which is usually considered the easiest to use, is illustrated in Figure 504.7A. This method was developed by Jack Leisch & Associates and may be used to determine the length of weaving sections for both freeways and collector-distributor roads. The Leisch weaving charts determine the level of service for the weaving volumes for the length of the weaving section from the first panel on the lower left of the chart. The analysis is dependent on whether the section is balanced or unbalanced, as defined in Figure 504.7B. The level of service for the total volume over all lanes of the weaving section is then found from the panels on the right of the chart. The weaving chart should not be extrapolated.

Pages 234-238 of the 1965 Highway Capacity Manual (HCM) provide a method for determining the adequacy of weaving sections near single lane ramps. It is often referred to as the LOS D method. This method is also documented in Traffic Bulletin 4 which is available from the District Division of Traffic Operations. The LOS D method can be used to project volumes along a weaving section. These volumes can be compared to the capacities along the same weaving section.

Volumes in passenger car equivalents per hour (PCEPH) should be adjusted for freeway grade and truck volumes. Table 504.7C and Figures 504.7D and E are reprinted from the 1965 HCM and provide information regarding vehicle distribution by lane.

The results obtained from Figure 504.7A (the Leisch Method) for single-lane ramps with an auxiliary lane and weaving rates exceeding 2500 PCEPH should be checked using the LOS D method.

Weaving capacity analyses other than those described above should not be used on California highways. Other methods, such as the one contained in the 1994 HCM, may not always produce accurate results.

Figure 504.7A

Design Curve for Freeway and Collector Weaving

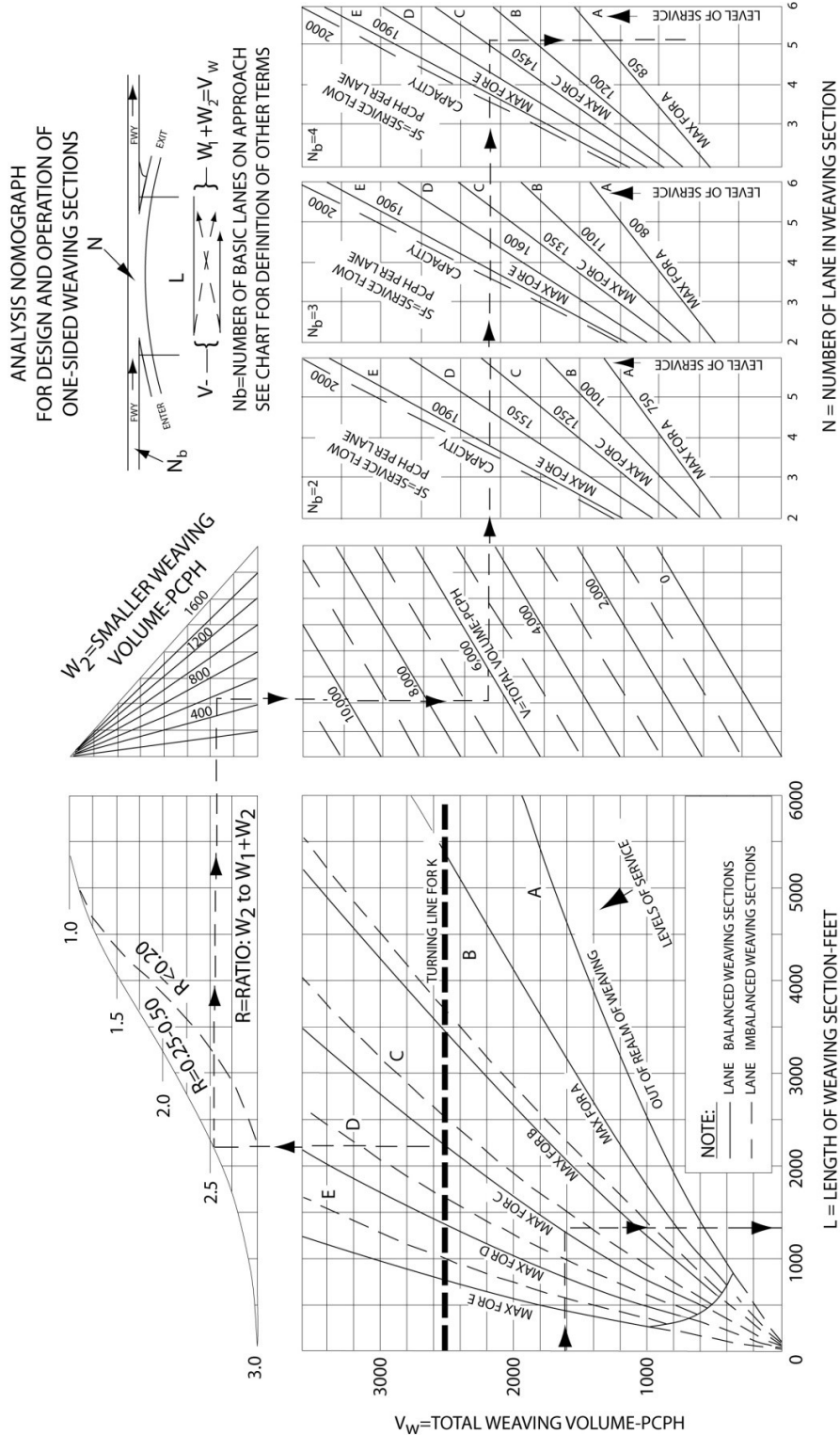

NOTE: EXTRAPOLATION OF CHART BEYOND THE BOUNDARIES GIVEN IS NOT ADVISED.

Example: The nomograph is entered on the left (see dashed line and arrows) with weaving volume, $W_1 + W_2$ (or V_w) followed by projection to the right, intersecting the desired weaving LOS; a vertical drop from this point provides weaving distance $L = 1300$ ft. Returning to first intersection point of V_w with LOS line, an upward projection along the LOS line is intersected with the horizontal, heavy dashed, "turning line for K " from here the solution line is extended vertically to intersect the K values curve, from which a horizontal extension meets the desired W_2 volume. Then a downward turn to total volume, V , from which the line is horizontally projected to the right, intersection (in this case) the desired LOS = C curve having an SF of 1450 (representing the overall or composite operation of the weaving section), from which a downward extension yields a N of 5.2; this would be rounded to $N = 5$ lanes.

July 1, 2020

Figure 504.7B

Lane Configuration of Weaving Sections

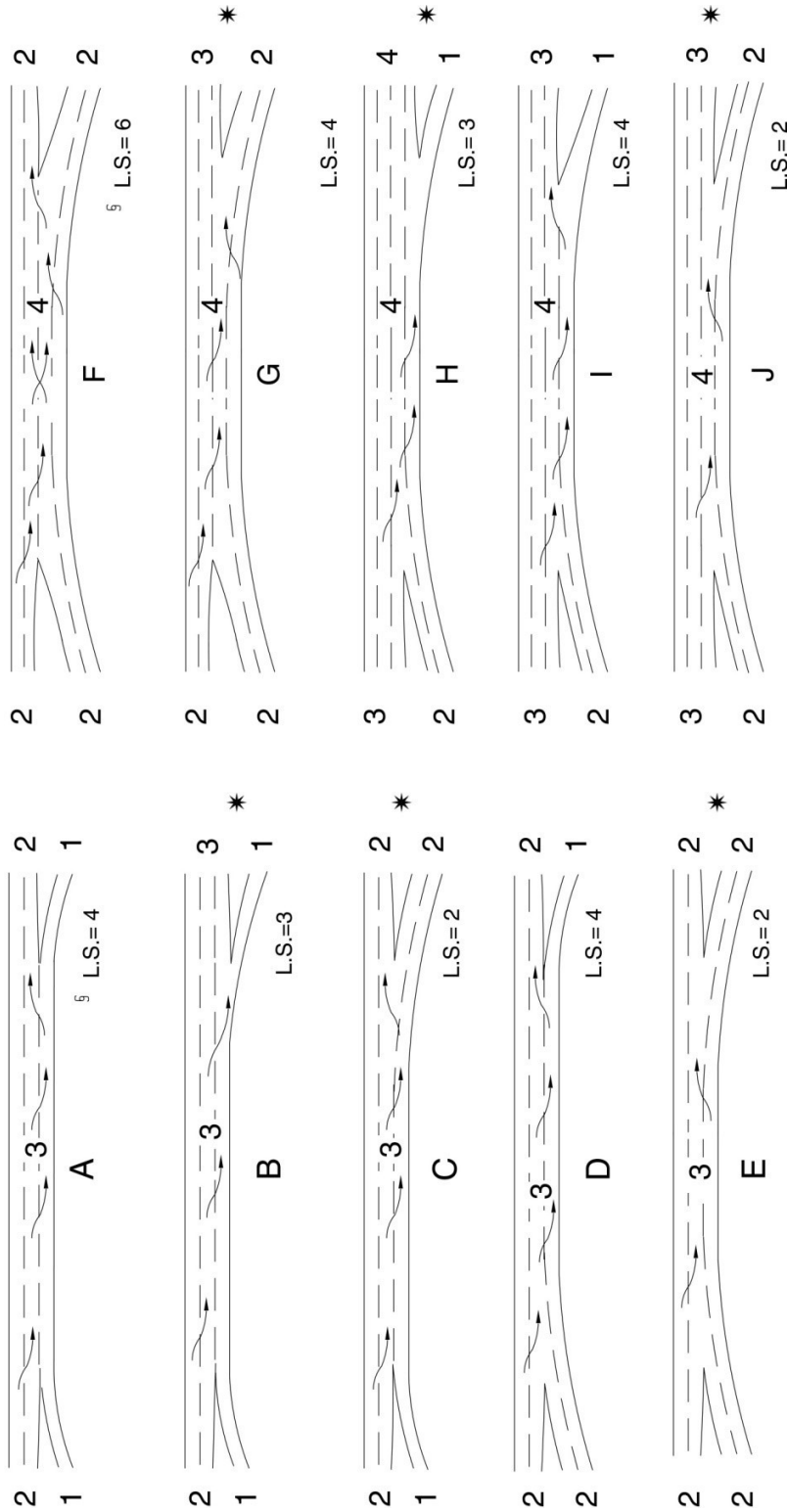

* DENOTE LANE BALANCE - OPTIONAL LANE AT EXIT

⁵L.S.- POTENTIAL LANE SHIFTS, CONSIDERING MAX. OF 2 LANES INVOLVED ON ANY ONE APPROACH

Source: Jack E. Leisch & Associates

Table 504.7C

Percent of Through Traffic Remaining in Outer Through Lane (Level of Service D Procedure)

Total Volume of Through Traffic, One Direction (vph)	Approximate Percentage of Through ⁽¹⁾ Traffic Remaining in the Outer Through Lane in the Vicinity of Ramp Terminals at Level of Service D		
	8-Lane ⁽²⁾ Freeway	6-Lane ⁽³⁾ Freeway	4-Lane ⁽⁴⁾ Freeway
6500 and over	10	-	-
6000 - 6499	10	-	-
5500 - 5999	10	-	-
5000 - 5499	9	-	-
4500 - 4999	9	18	-
4000 - 4499	8	14	-
3500 - 3999	8	10	-
3000 - 3499	8	6	40
2500 - 2999	8	6	35
2000 - 2499	8	6	30
1500 - 1999	8	6	25
Up to 1499	8	6	20

NOTES:

⁽¹⁾Traffic not involved in a ramp movement within 4,000 feet in either direction.

⁽²⁾4 lanes one-way.

⁽³⁾3 lanes one-way.

⁽⁴⁾2 lanes one-way.

July 1, 2020

Figure 504.7D

Percentage Distribution of On- and Off-ramp Traffic in Outer Through Lane and Auxiliary Lane (Level of Service D Procedure)

CASE I - SINGLE - LANE ON- AND OFF-RAMPS WITHOUT AUXILIARY LANE
 (THIS CHART MAY BE USED REGARDLESS OF ACTUAL SPACING BETWEEN ON- AND OFF-RAMPS, BUT AS NOTED BELOW* CAUTION MUST BE EXERCISED IN USING THESE VALUES.)

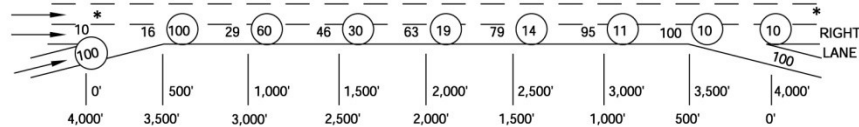

CASE II - SINGLE - LANE - ON- AND OFF-RAMPS WITH AUXILIARY LANE**

(A) L = 1,000'

EXAMPLE:

GIVEN: L = 1,000'
 PORTION OF V₁ THROUGH (FROM TABLE 504.7C = 475 VPH)
 ON-RAMP = 1,000 VPH
 OFF-RAMP = 1,200 VPH
 ON-RAMP TO OFF-RAMP = 0

FIND: V₁ (VOL. IN OUTER THROUGH LANE) @ 500' =
 $475 + (0.80)(1,000) + (0.24)(1,200) = 1,563$ VPH

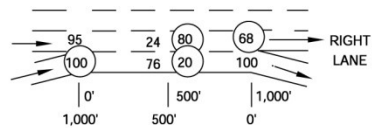

(B) L = 1,500'

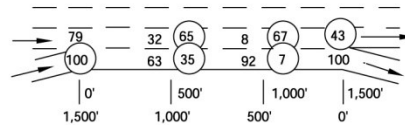

(C) L = 2,000'

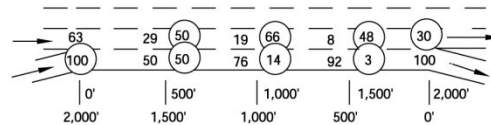

(D) L = 2,500'

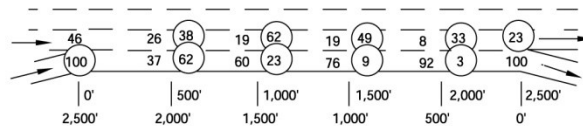

(E) L = 3,000'

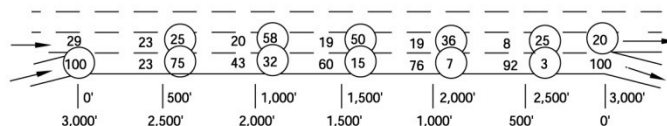

CIRCLED VALUES INDICATE PERCENTAGE OF ON-RAMP TRAFFIC IN LANE SHOWN. UNCIRCLED VALUES INDICATE PERCENTAGE OF OFF-RAMP TRAFFIC IN LANE SHOWN. (REMAINING PORTION OF TRAFFIC IS IN LANE(S) TO LEFT OF OUTER THROUGH LANE.)

THESE PERCENTAGES ARE NOT NECESSARILY THE DISTRIBUTIONS UNDER FREE FLOW OR LIGHT RAMP TRAFFIC, BUT UNDER PRESSURE OF HIGH VOLUMES IN THE RIGHT LANES AT THE POINT BEING CONSIDERED AND WITH ROOM AVAILABLE IN OTHER LANES.

* MINIMUM % IN RIGHT LANE CANNOT BE LESS THAN % OF THROUGH TRAFFIC IN RIGHT LANE AS DETERMINED FROM TABLE 504.7C (SEE NOTE, FIG. 5047E).

** SEE FIGURES 504.2A AND 504.2B FOR METHOD OF MEASURING LENGTH L (WEAVING LENGTH).

Figure 504.7E

Percentage of Ramp Traffic in the Outer Through Lane (No Auxiliary Lane)
(Level of Service D Procedure)

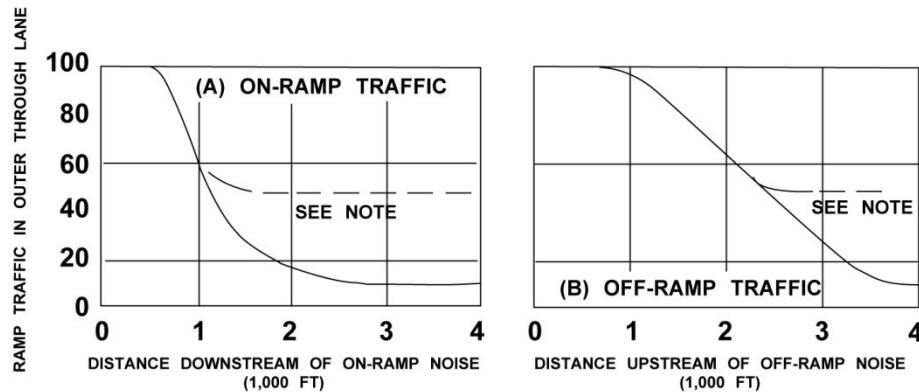

EXAMPLE:

①

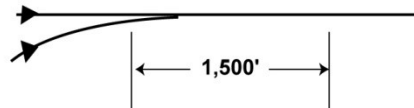

A - NORMAL CALCULATION

2 LANES ONE-WAY

"THROUGH TRAFFIC" = 2,400 VPH

"ON-RAMP" = 800 VPH

AMOUNT IN THE OUTER THROUGH LANE AT ①

THROUGH (FROM TABLE 504.7C)

$$= 0.30 \times 2,400 = 720$$

ON-RAMP (FROM CHART ABOVE)

$$= 0.30 \times 800 = \underline{240}$$

960

B - CHECK CALCULATIONS

BECAUSE % IN THE OUTER THROUGH LANE AT 1,500' IS BELOW DASHED LINE, RECALCULATE ASSUMING ON-RAMP TRAFFIC IS THROUGH TRAFFIC.

AMOUNT IN THE OUTER THROUGH LANE AT ①

THROUGH (FROM TABLE 504.7C) $0.40 \times 3,200 = 1,280$

SINCE CALCULATION B (1,280) IS GREATER THAN

CALCULATION A (960) USE 1,280.

*THESE PERCENTAGES ARE NOT NECESSARILY THE DISTRIBUTIONS UNDER FREE FLOW OR LIGHT RAMP TRAFFIC, BUT UNDER PRESSURE OF HIGH VOLUMES IN THE RIGHT LANES AT THE LOCATION BEING CONSIDERED AND WITH AVAILABLE ROOM IN OTHER LANES.

NOTE:

IF RAMP PERCENTAGE IN THE OUTER THROUGH LANE AT POINT UNDER CONSIDERATION IS BELOW DASHED LINE, THEN AMOUNT IN THE OUTER THROUGH LANE SHOULD BE RECALCULATED ASSUMING RAMP TRAFFIC IS THROUGH TRAFFIC. USE HIGHER VALUE. SEE EXAMPLE ABOVE.

July 1, 2020

The criteria contained within this Index apply to:

- New interchanges.
- Modifications to existing interchanges including access control revisions for new ramps or the relocation/elimination of existing ramps.
- Projects to increase mainline capacity when existing interchanges do not meet interchange spacing requirements.

Weaving sections in urban areas should be designed for LOS C or D. Weaving sections in rural areas should be designed for LOS B or C. Design rates for lane balanced weaving sections where at least one ramp or connector will be two lanes should not result in a LOS lower than the middle of LOS D using Figure 504.7A. Mainline through capacity is optimized when weaving movements operate at least one level of service better than the mainline level of service. In determining acceptable hourly operating volumes, peak hour factors should be used.

Between interchanges, the minimum entrance ramp-to-exit ramp spacing, measured as shown on Figures 504.2A and 504.2B shall be 2,000 feet in urban areas, 5,000 feet outside urban areas, and 5,000 feet between freeway-to-freeway interchanges and other interchanges. The volumes used must be volumes unconstrained by metering regardless of whether metering will be used. It should be noted that a weaving analysis must be considered over an entire freeway segment as weaving can be affected by other nearby ramps.

The District Traffic Operations Branch should be consulted for difficult weaving analysis problems.

504.8 Access Control

Access rights shall be acquired along interchange ramps to their junction with the nearest public road. At such junctions, for new construction, access control should extend 100 feet beyond the end of the curb return or ramp radius in urban areas and 300 feet in rural areas, or as far as necessary to ensure that entry onto the facility does not impair operational characteristics. Access control shall extend at least 50 feet beyond the end of the curb return, ramp radius, or taper.

Typical examples of access control at interchanges are shown in Figure 504.8. These illustrations do not presume to cover all situations or to indicate the most desirable designs for all cases. When there is state-owned access control on both sides of a local road, a maintenance agreement may be needed.

For new construction or major reconstruction, access rights shall be acquired on the opposite side of the local road from ramp terminals to preclude driveways or local roads within the ramp intersection. This access control would limit the volume of traffic and the number of phases at the intersection of the ramp and local facility, thereby optimizing capacity and operation of the ramp. Through a combination of access control and the use of raised median islands along the local facility, right-in/right-out access may be permitted beyond 200 feet from the ramp intersection. The length of access control on both sides of the local facility should match. See Index 504.3(3) for further ramp intersection guidance on the crossroads.

Figure 504.8

Typical Examples of Access Control at Interchanges

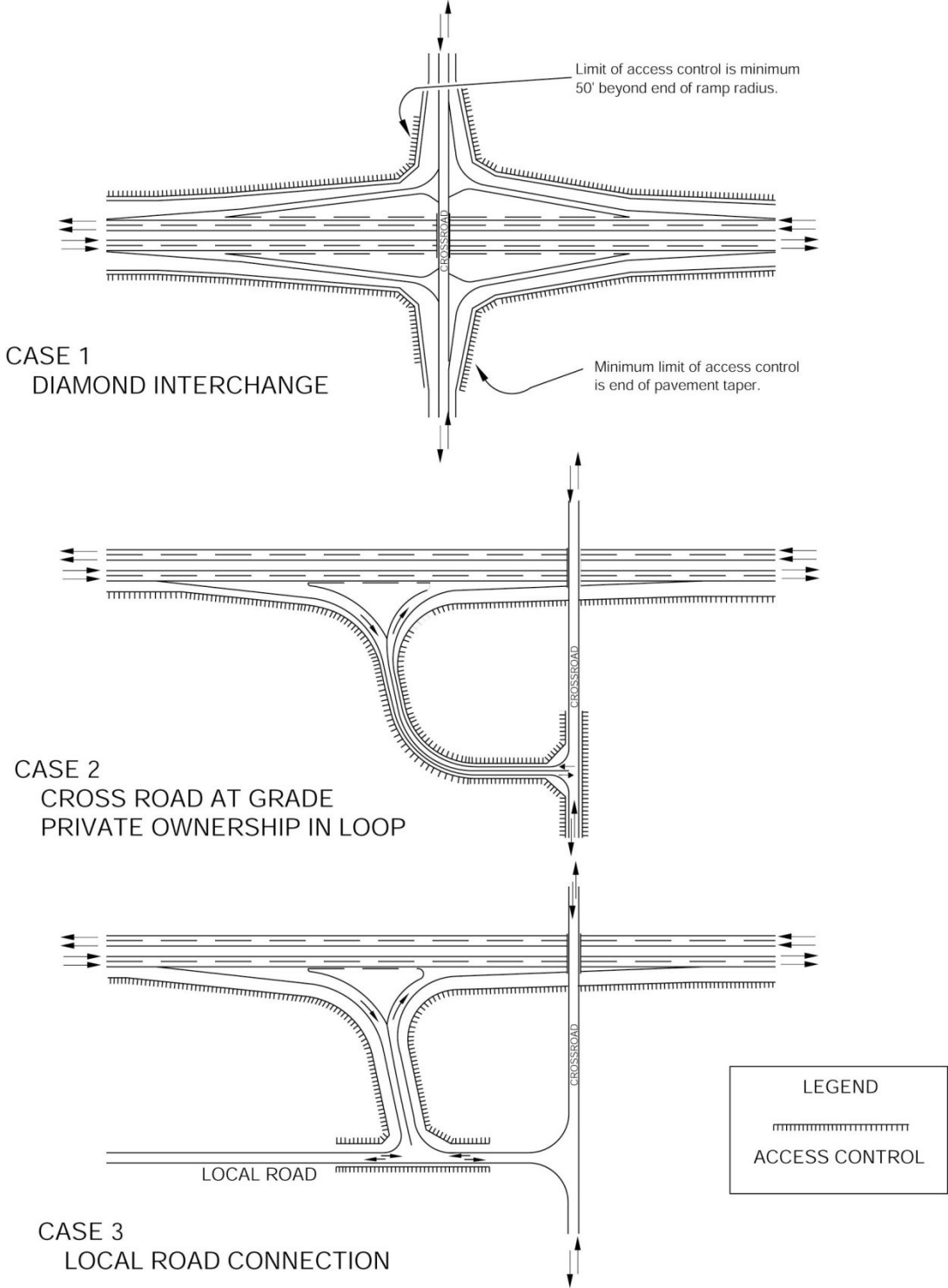
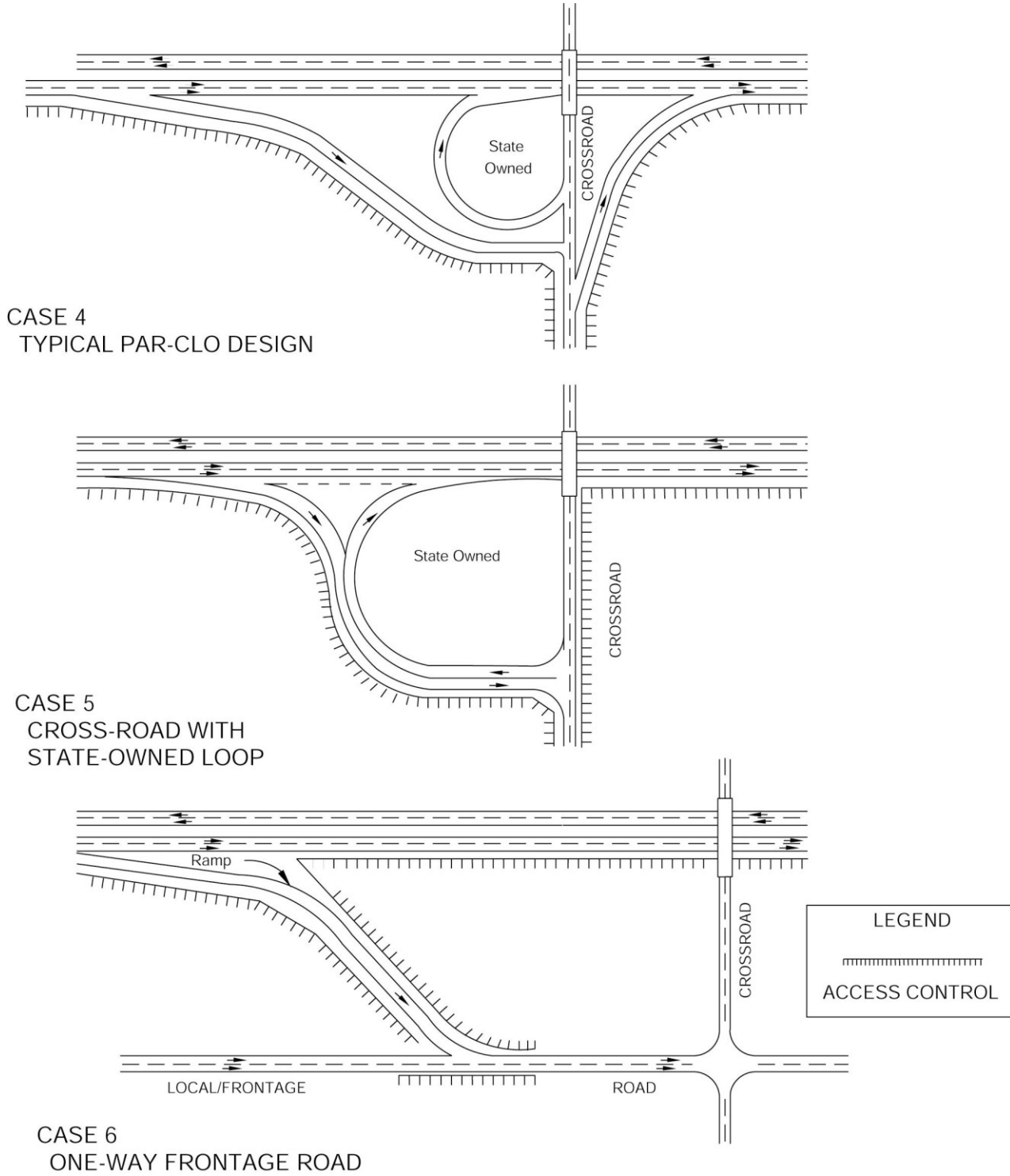

Figure 504.8

Typical Examples of Access Control at Interchanges (Cont.)



In Case 2 consider private ownership within the loop only if access to the property is an adequate distance from the ramp junction to preserve operational integrity.

In Case 3 if the crossroads is near the ramp junction at the local road, full access control should be acquired on the local road from the junction to the intersection with the crossroad.

Case 6 represents a slip ramp design. If the ramp is perpendicular to the local/frontage road refer to Case 3. In Case 6 if the crossroad is near the ramp junction to the local/frontage road, access control should be acquired on the opposite side of the local road from the junction.

CHAPTERS 600 – 670 PAVEMENT ENGINEERING

CHAPTER 600 – GENERAL ASPECTS

Topic 601 – Introduction

Pavement engineering involves the determination of the type and thickness of pavement surface course, base, and subbase layers that in combination are cost effective and structurally adequate for the projected traffic loading, service life, and specific project conditions including climate. This combination of roadbed materials placed in layers above the subgrade (also known as basement soil) is referred to as the "pavement" or the "pavement structure".

The Department guidelines and standards for pavements described in this manual are based on extensive engineering research and field experience, including the following:

- Theoretical concepts in pavement engineering and analysis.
- Data obtained from test track studies and experimental sections.
- Research on materials characteristics, testing methods, and equipment.
- Observation of performance throughout the State and the Nation.

The pavement should be engineered using the standards and guidance described in this manual to ensure consistency throughout the State and provide a pavement structure that will have adequate strength, ride quality, and durability to carry the projected traffic loads for the design life of each project. The final pavement structure for each project should be based on a thorough investigation of specific project conditions including subgrade soils and structural materials, environmental conditions, projected traffic, cost effectiveness, and the performance of other pavements in the same area or similar climatic and traffic conditions. These factors are discussed in Chapter 610 of this manual.

The standards, procedures and requirements found in this manual are best practices and should not preclude engineering judgment based on experience, and knowledge of the local conditions when developing pavement structures for individual projects.

Topic 602 – Pavement Structure Layers

Index 602.1 – Description

Pavement structures are comprised of one or more layers of select materials placed above the subgrade. The basic pavement layers of the roadway are discussed below.

- (1) *Subgrade*. It is the portion of the roadbed consisting of native or treated soil on which surface course, base, subbase, or a layer of any other material is placed. Subgrade may

July 1, 2020

be composed of either in-place material that is exposed from excavation, or embankment borrow material that is placed to elevate the roadway above the surrounding natural ground. Subgrade soil characteristics are discussed in Topic 614.

- (2) *Subbase*. It is the unbound or treated aggregate or granular material that is placed on the subgrade as a foundation or working platform for the base. It functions primarily as structural support but it can also minimize the intrusion of fines from the subgrade into the pavement structure, improve drainage, and minimize frost action damage. The subbase generally consists of lower quality materials than the base but better than the subgrade soils. Subbase may not be needed in areas with high quality subgrade or where it is more cost effective to build a thicker base layer. Further discussion on subbase materials and concepts can be found in Chapter 660.
- (3) *Base*. It is the select, processed, and/or treated aggregate material that is placed immediately below the surface course. It provides additional load distribution and contributes to drainage and frost resistance. Base may be one or multiple layers treated with cement, asphalt or other binder material, or may consist of untreated aggregate. In some cases, the base may include a drainage layer to drain water that seeps into the base. The aggregate in base is typically a higher quality material than that used in subbase. Further discussion on base materials and concepts can be found in Chapter 660.
- (4) *Surface Course*. It represents one or more layers of the pavement structure engineered to accommodate and distribute traffic loads, provide skid resistance, minimize disintegrating effects of climate, reduce tire/pavement noise, improve surface drainage, and minimize infiltration of surface water into the underlying base, subbase and subgrade. Sometimes referred to as the surface layer, the surface course may be composed of a single layer, constructed in one or more lifts of the same material, or multiple layers of different materials. Pavements are generally classified based on the type of surface course, as follows:
 - (a) *Flexible Pavements*. These are pavements in which the surface course is an asphalt bound structural layer underlain with a non-rigid base. This type of pavements is engineered to bend or flex when loaded. Flexible pavements transmit and distribute traffic loads to the underlying layers. The highest quality layer is the surface course, which typically consists of one or more layers of asphalt concrete and may or may not incorporate underlying layers of base and/or subbase. These types of pavements are called "flexible" because the total pavement structure bends (or flexes) to accommodate deflection bending under traffic loads. Procedures for flexible pavements can be found in Chapter 630.
 - (b) *Rigid Pavements*. These are pavements with a rigid surface course typically a slab of Portland cement concrete (or a variety of specialty hydraulic cement concrete mixes used for rapid strength concrete) over underlying layers of stabilized or unstabilized base or subbase materials. These types of pavements rely on the substantially higher stiffness of the concrete slab to distribute the traffic loads over a relatively wide area of underlying layers and the subgrade. Some rigid concrete slabs have reinforcing steel to help resist cracking due to temperature changes and repeated loading. Procedures for rigid pavements can be found in Chapter 620.

- (c) Composite Pavements. These are pavements comprised of both flexible (asphalt concrete) and rigid (cement concrete) layers over underlying layers of stabilized or unstabilized base or subbase materials. In California, composite pavements consist mostly of existing rigid pavements that have been overlaid with hot mix asphalt (HMA), open graded friction course (OGFC), or rubberized hot mix asphalt (RHMA). Refer to Chapter 640 for additional information on composite pavements.
- (5) *Non-Structural Wearing Course*. On some pavements, a non-structural wearing course is placed to protect the surface course from wear and tear from tire/pavement interaction, the weather, and other environmental factors. Examples of non-structural wearing courses include OGFC, various types of surface seals, and added surface course thickness to allow for chain wear or grinding. Non-structural wearing courses are also placed over pavements to reduce noise and improve wet weather condition. Although non-structural wearing courses are not given a structural value in the procedures and tables found in this manual, they will improve the service life of the pavement by protecting it from traffic and environmental effects.
- (6) *Others*. Depending on the type of pavement built and the subgrade or existing soil conditions encountered, additional layers may be included in the pavement. Some of these layers include:
- (a) Interlayers can be used between pavement layers or within pavement layers to reinforce pavement and/or improve resistance of HMA layers to reflective cracking. Interlayers can be geosynthetic type or asphaltic chip seals. Refer to Chapter 630 and Chapter 660 for additional information.
 - (b) Bond Breakers are used to prevent bonding between two pavement layers such as rigid pavement surface course to a cement-stabilized base.
 - (c) Tack Coats are used to bond a layer of asphalt binder mix to underlying existing pavement layers or between layers of asphalt concrete where multiple lifts are required.
 - (d) Prime Coats can be used on aggregate base prior to paving for better bonding and to act as water proofing of the aggregate base.
 - (e) Leveling Courses are used to fill and level surface irregularities and ruts before placing overlays. Hot mix asphalt is commonly used for constructing leveling courses.
 - (f) Working Platform is a layer of granular base, asphalt, or concrete used to support construction equipment. A working platform permits the efficient construction of the treated base and asphalt or concrete structural course.

Topic 603 – Types of Pavement Projects

603.1 New Construction

New construction is the building of a new facility. This includes new roadways, interchanges or grade separation crossings, and new parking lots or safety roadside rest areas.

July 1, 2020

603.2 Widening

Widening projects involve the construction of additional width to improve traffic flow and increase capacity on an existing highway facility. Widening may involve adding lanes (including transit or bicycle lanes), shoulders, pullouts for maintenance/transit traffic; or widening existing lane, shoulder or pullouts.

Additional guidance and requirements on widening existing facilities, including possible options as well as certain circumstances that may justify adding rehabilitation or pavement preservation work to widening, or deferring it, are discussed in Index 612.3.

603.3 Pavement Preservation

Pavement Preservation has two main categories or programs:

(1) *Preventive Maintenance*. Preventive maintenance projects are used to provide preventive treatments to preserve pavements in good condition. These projects are typically done by Department Maintenance forces or through the Major Maintenance Program. The District Maintenance Engineer determines which preventive treatment to apply and when.

Traffic safety and other operational improvements, geometric upgrades, or widening are not included in preventative maintenance projects. Strategies and guidelines on preventive maintenance treatments currently used by the Department are discussed further in Indexes 624.1, 634.1, and 644.1.

(2) *Capital Preventive Maintenance (CAPM)*. Capital Preventive Maintenance (CAPM) is a program of short-term (5 to less than 20 years) repair projects agreed to between the Department and FHWA beginning in 1994. Since the CAPM program is part of pavement preservation, CAPM projects are more closely related to preventive maintenance (Major Maintenance) projects than to roadway rehabilitation projects.

The primary purpose of the CAPM program is to repair pavement exhibiting minor distress as identified in Design Information Bulletin (DIB) 81 under the Flexible and Rigid Selection Criteria, Sections 2.1.1 and 2.1.2, determined by the Pavement Condition Survey (PCS) and the Pavement Management System (PMS). Ride improvement and preservation of serviceability are key elements of this program. Timely application of CAPM treatments will postpone the need for major roadway rehabilitation and is generally more cost effective than having to rehabilitate pavements exhibiting major distress. CAPM provides flexibility to make the most effective use of all funds available in the biennial State Highway Operation and Protection Plan (SHOPP).

Figure 602.1
Basic Pavement Layers of the Roadway

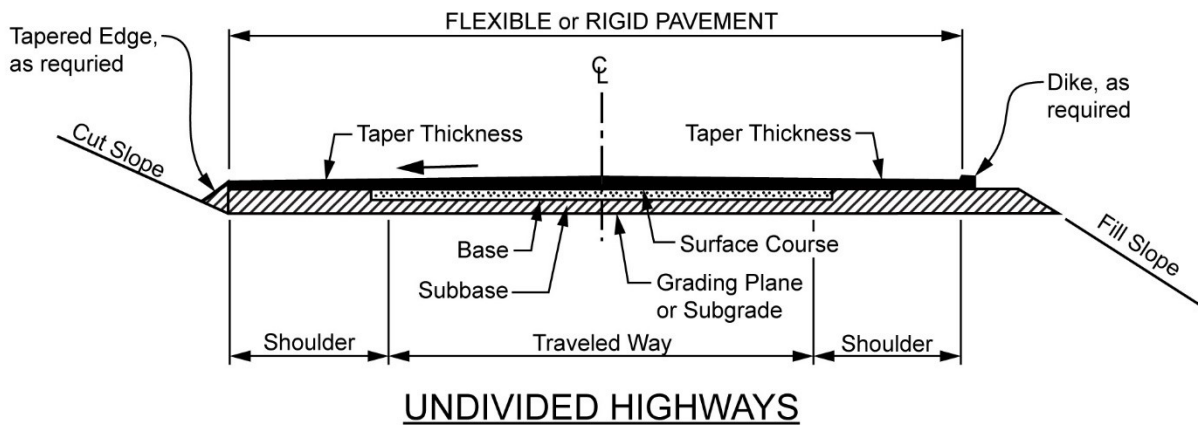
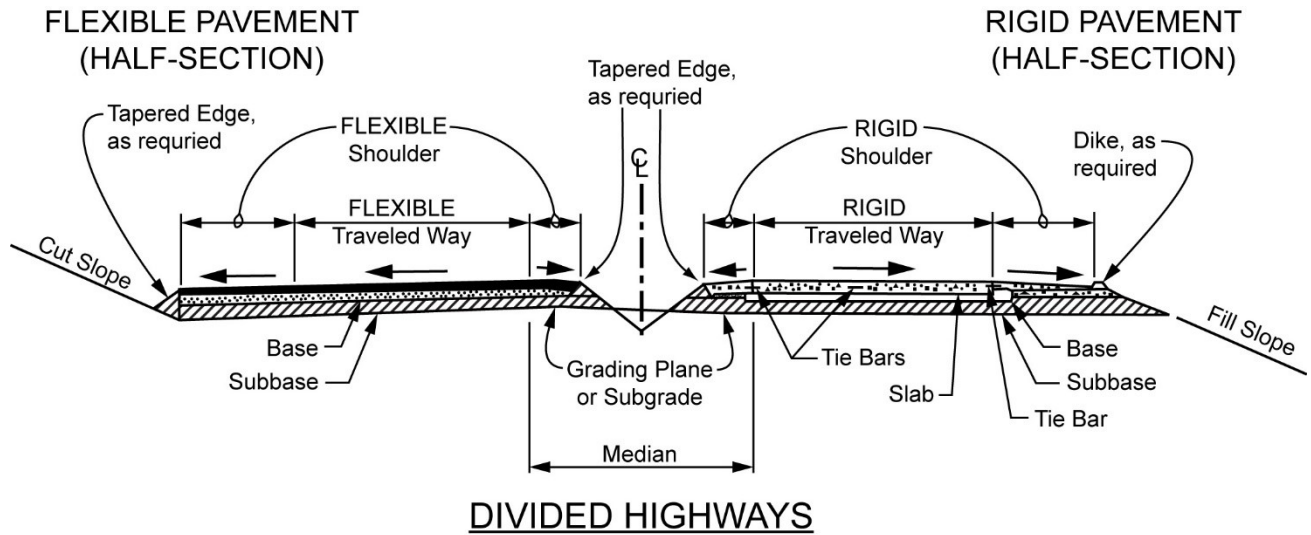

NOTES:

- (1) These illustrations are only to show nomenclature and are not to be used for geometric cross section details. For these, see Chapter 300.
- (2) Pavement drainage design, both on divided and undivided highways, are illustrated and discussed under Chapter 650.
- (3) Only flexible and rigid pavements shown. Composite pavements are the same as rigid pavements with a flexible layer overlay.
- (4) See Index 626.2 for criteria for when and how to use flexible or rigid shoulders.

CAPM projects involve non-structural overlays and repairs, which do not require Traffic Index calculations or deflection studies. CAPM projects include all appropriate items or work necessary to preserve the pavement in good condition for a minimum of 5 years (10 years preferred). The District Maintenance Engineer is responsible for making strategy selections and recommendations for CAPM projects. Information on CAPM strategies is found in Indexes 624.2, 634.2, and 644.2. For further information and other guidance for CAPM projects, see DIB 81 and PDPM Appendix H. See DIB 82 for required work regarding accessibility for persons with disabilities.

July 1, 2020

603.4 Roadway Rehabilitation

The primary purpose of roadway rehabilitation projects is to return roadways that exhibit major structural distress, to good condition. Many of these structural distresses indicate failure of the surface course and underlying base layers. Roadway rehabilitation work is generally regarded as major, non-routine maintenance work engineered to restore the service life as well as provide upgrades to enhance safety where needed. As described in Design Information Bulletin 79, Section 1.2, rehabilitation criteria also apply to minor projects and certain other projects in addition to roadway rehabilitation projects. Roadway rehabilitation is different from pavement preservation that simply preserves or repairs the facility to a good condition.

Roadway rehabilitation projects are divided into 2R (Resurfacing and Restoration) and 3R (Resurfacing, Restoration and Rehabilitation). Roadway rehabilitation projects should address other highway appurtenances such as pedestrian and bicyclist facilities, drainage facilities, lighting, signal controllers, and fencing that are failing, worn out or functionally obsolete. Also, unlike pavement preservation projects, geometric enhancements and operational improvements may be added to roadway rehabilitation work if such work is critical or required by FHWA standards.

Roadway rehabilitation strategies for rigid, flexible and composite pavements are discussed in Topics 625, 635 and 645. Additional information and guidance on roadway rehabilitation, including determining whether the project fits 2R or 3R screening criteria, and other rehabilitation projects may also be found in the Design Information Bulletin, Number 79 - "Design Guidance and Standards for Roadway Rehabilitation Projects" and in the PDPM Chapter 9, Article 5.

603.5 Reconstruction

Pavement reconstruction is the replacement of the entire existing pavement structure by an equivalent or increased new pavement structure, and rebuilding of adjacent operational and roadside features. Reconstruction is typically justified when the roadway has become functionally and structurally obsolete.

Reconstruction features typically include significant change to the horizontal or vertical alignment of the highway, and may include the addition of lanes. Although reconstruction is often done for reasons other than pavement repair, it can be done as an option to rehabilitation when the existing pavement meets the following conditions:

- Is in a substantially distressed condition and rehabilitation strategies will not restore the pavement to a good condition; or
- Existing alignments and clearances are functionally obsolete and need to be upgraded to improve safety and mobility; or
- Life-cycle costs for rehabilitation are greater than those for reconstruction.

Reconstruction differs from lane/shoulder replacement roadway rehabilitation options in that lane/shoulder replacements typically involve replacing portions of the roadway width whereas reconstruction is the removal and replacement of the entire roadway width. Incidental rebuilding of existing pavements for rehabilitation in order to conform to bridges, existing pavement, or meet vertical clearance standards are considered rehabilitation and not reconstruction. Storm or earthquake damage repair (i.e., catastrophic) also are not considered reconstruction projects.

Pavement reconstruction projects are to follow the same standards as “new construction” found in this manual unless noted otherwise.

603.6 Temporary Pavements and Detours

Temporary pavements and detours are constructed to temporarily carry traffic anticipated during construction. These types of pavements should be engineered using the pavement standards and procedures for new construction except where noted otherwise.

603.7 Stage Construction

In some cases, a pavement structure may need to be staged (constructed at different times or over multiple projects.) Stage construction for flexible pavement structures could be done by reducing the surface course thickness with provision for a future overlay to bring the pavement to full design depth. For rigid pavement stage construction, the base and subbase layers could initially be built (if the base is built with asphalt) and then overlaid later with concrete pavement.

Where staging of the pavement structure is needed, the initial stage:

- is to be built to meet or exceed the expected time the initial stage will be used prior to placing the final stage.
- is to meet or exceed what would be required for ultimate pavement structure when final layers are placed.
- show the future placement of pavement on the typical sections.

Life-cycle cost should be considered before using a staging option.

Topic 604 – Roles, Resources, and Proprietary Items

604.1 Roles and Responsibilities for Pavement Engineering

The roles and responsibilities listed below apply only to pavement engineering.

- (1) *Pavement Engineer.* The pavement engineer is the engineer who performs pavement calculations, develops pavement structure recommendations, details, or plans. The pavement engineer can be the Project Engineer, District Materials Engineer, District Maintenance Engineer, consultant, or other staff engineer responsible for this task.

July 1, 2020

- (2) *Project Engineer (PE)*. The PE is the registered civil engineer in responsible charge of appropriate project development documents (i.e., project initiation document, project report, and PS&E) and coordinates all aspects of project development. The PE is responsible for project technical decisions including pavement engineering, quality (quality control, and estimates. This includes collaborating with the District Materials Engineer, District Maintenance Engineer and other subject matter experts regarding pavement details and selecting pavement strategy for new and rehabilitation projects. The PE clearly conveys pavement related decisions and information on the project plans and specifications for a Contractor to bid and build the project.
- (3) *District Materials Engineer (DME)*. The DME is responsible for determining materials information used to develop pavement engineering strategies. The District Materials Unit is responsible for conducting or reviewing the findings of a preliminary soils and other materials investigation to evaluate the quality of the materials available for constructing the project. The DME prepares or reviews the Materials Report when needed for new construction, widening and rehabilitation projects; provides materials recommendations to and in continuous consultation with the PE throughout planning and design, as well as with the PE and Resident Engineer during construction. The DME also coordinates materials information with the Department functional units: Material Engineering and Testing Services (METS), Headquarters functional units, local agencies, industry, and consultants.
- (4) *District Maintenance Engineer*. The District Maintenance Engineer manages and coordinates overall pavement strategies for the District. They are primarily involved in pavement management such as identifying future pavement preservation, rehabilitation and reconstruction needs, prioritizing pavement projects to meet those needs, and recommends pavement preservation strategies. The District Maintenance Engineer establishes pavement projects and reviews planning documents prepared by the PE for consistency with overall District and statewide goals for pavements.
- (5) *Pavement Program (PP)*. The PP, within the Division of Maintenance (DOM) is responsible for statewide standards and guidelines for the pavement engineering process. The DOM Assistant Division Chief for Pavement Program serves as the State Pavement Engineer for the Department.

The PP Office of Concrete Pavement (OCP) and Asphalt Pavements (OAP) are responsible for maintaining pavement engineering standards, specifications, standard plans, design methodologies, design software, and practices that are used state wide. OCP and OAP also provide technical expertise on material properties and products for pavements. OCP and OAP work closely with the District Materials Engineers, Maintenance Engineers, and Resident Engineers to investigate ongoing field and pavement related issues.

- (6) *State Pavement Engineer*. The State Pavement Engineer provides leadership and commitment to ensure safe, effective, and environmentally sensitive highway pavements that improve mobility across California. The State Pavement Engineer is responsible for conveying clear direction and priorities on pavement initiatives, policies, and standards that reflect departmental goals; and for the implementation of pavement policies, standards, and specifications.

(7) *Materials and Geotechnical Services.* The Materials and Geotechnical Services subdivision of the Division of Engineering Services (DES) consists of the Materials unit (formerly Materials Engineering and Testing Services (METS)) and the Geotechnical Services (GS) unit. The Materials unit is responsible for conducting laboratory testing, field testing, specialized field inspections, and maintaining the test method procedures for the Department. The GS unit provides the Districts, Structures, and Headquarters with expertise and guidance in soil related investigations and groundwater issues, GS prepares or reviews Geotechnical Design Reports based upon studies and information supplied by the District.

604.2 Pavement Recommendations

Recommendations for pavement strategies or structures for individual projects should be documented in writing. The project engineer uses the recommendations to determine the best pavement strategy for the project.

Recommendations should include the following information:

- Pavement climate zone or climate data used to prepare the recommendations.
- Design designation.
 - Not needed for non-structural recommendations such as pavement preservation or roadside paving work.
- Multiple alternatives that will accomplish the purpose and need of the project and minimum design/performance standards found in this manual, including life cycle cost analysis.
- Compliance with Section 42703 of the Public Resources Code on use of RHMA alternatives. Asphalt rubber or crumb rubber modified binders should be included for asphalt pavements in accordance with Index 631.3.
- Summary of assumptions such as pavement design life.
- Reference to Materials Report used to prepare report.
- Preparer's name. Include engineering stamp for pavement structure recommendations.

Recommendations for pavement preservation projects are typically prepared by the District Maintenance Engineer. Pavement structure recommendations for new construction, widening, rehabilitation, and other situations where pavement structural requirements need to be met should be made by or reviewed by the District Materials Engineer with input from the District Maintenance Engineer.

604.3 Other Resources

The following resources provide additional standards and guidance related to pavement engineering. Much of this information can be found on the Department Pavement website, see category (5) below.

(1) *Standard Plans.* These are collections of commonly used engineering details intended to provide consistency for contractors, resident engineers and maintenance engineers in

July 1, 2020

defining the scope of work for projects, assist in the bid ability of the project contract plans, and assist maintenance in maintaining the facility. The standard plans were developed based on research and field experience and in consultation with industry. Standard plans for pavement should not be altered or modified without the prior written approval of the Chief, Office of Concrete Pavement and Pavement Foundations. Standard plans for pavements can be found on the Department Pavement website.

- (2) *Standard Specifications and Standard Special Provisions.* The Standard Specifications provide material descriptions, properties and work quality requirements, contract administration requirements, and measurement and payment clauses for items used in the project. The Standard Special Provisions are additional specification standards used to modify the Standard Specifications including descriptions, quality requirements, and measurement and payment for the project work and materials. When no Standard Specification or Standard Special Provision exists for new or proprietary items, the Pavement Program must review and concur with the special provision. For further information, see the Specifications section on the Department Pavement website. *Pavement Technical Guidance.*
- (3) Pavement Technical Guidance is a collection of supplemental guidance and manuals regarding pavement engineering which is intended to assist project engineers, pavement engineers, materials engineers, consultants, construction oversight personnel, and maintenance workers in making informed decisions on pavement structural engineering, constructability and maintainability issues. Information in the Technical Guidance includes, but is not limited to, resources for assistance in decision making, rigid, flexible and composite pavement rehabilitation strategies, pavement preservation strategies, and guidelines for the use of various products and materials. Technical assistance is also available from the Pavement Program to assist with pavements that utilize new materials, methods, and products. These Technical Guidance documents may be accessed on the Department Pavement website.
- (4) *Supplemental District Standards and Guidance.* Some Districts have developed additional written pavement standards and guidance to address local issues. Such guidance adds to or supplements the standards found in this manual, the Standard Plans, the Standard Specifications, and Standard Special Provisions. District guidance does not replace statewide standards unless the State Pavement Engineer has approved an exception. Supplemental District Guidance should be approved by the District Director or as delegated to Deputy or Office Chief. Supplemental District Guidance can be obtained by contacting the District Maintenance Engineer and/or the District Materials Engineer.
- (5) *Department Pavement website.* The Department Pavement website provides a one-stop resource for those seeking to find standards, guidance, reports, approved software, and other resource tools related to pavements. The Department Pavement website can be accessed at http://www.dot.ca.gov/hq/maint/Pavement/Pavement_Program/index.html.
- (6) *Pavement Interactive Guide.* The Pavement Interactive Guide is a reference tool developed by the Department in partnership with other states. It includes discussion and definitions to terms and practices used in pavement engineering that are intended to aid design engineers in obtaining a better understanding of pavements. This document is not a standards manual or guideline. Because of copyright issues, the Pavement

Interactive Guide is only available to Department employees on the Pavement intranet, or internal, website.

- (7) *The AASHTO "Guide for Design of Pavement Structures."* Although not adopted by the Department, the AASHTO "Guide for Design of Pavement Structures" is a comprehensive reference guide that provides background that is helpful to those involved in engineering of pavement structures. This reference is on file in the Pavement Program and a copy should be available in each District.

Topic 605 – Record Keeping

605.1 Documentation

One complete copy of the documentation for the type of pavement selected should be retained in permanent District Project History files as well as subsequent updates of construction changes to the pavement structure. The documentation must contain the following:

- Pavement design life (including both the construction year and design year),
- The Unified Soil Classification of the subgrade soil, and where used, the California R-value,
- The strength properties for the materials selected for the subbase and/or base layers (provide California R-value when used for the design),
- Ride quality data as measured by International Roughness Index (IRI),
- The Traffic Index (TI) and equivalent single axle loads (ESALs) or spectra used to engineer each pavement structure, and
- Life-cycle cost analysis (including the data required for the life-cycle cost analysis) and other factors mentioned in Topic 619.

605.2 Subsequent Revisions

Any subsequent changes in pavement structures must be documented and processed in accordance with the appropriate instructions stated above and with proper reference to the original design.

Topic 606 – Research and Special Designs

606.1 Research and Experimentation

Research and experimentation are undertaken on an ongoing basis to provide improved methods and standards, which take advantage of new technology, materials, and practices. They may involve investigations of new materials, construction methods, and/or new engineering procedures. Submittal of new ideas by Headquarters and District staff, especially those involved in the engineering, construction, maintenance, paving materials, and performance of the pavement, is encouraged. Research proposals should be sent to the

July 1, 2020

Division of Research, Innovation and System Information (DRISI) in Headquarters for review and consideration. Suggestions for research studies and changes in pavement standards may also be submitted to the State Pavement Engineer. The Pavement Program must approve pilot projects and experimental construction features before undertaking such projects. District Maintenance should also be engaged in the discussion involving pilot projects and experimental construction features. Experimental sections must be clearly marked so that District Maintenance can easily locate and maintain such sites.

606.2 Special Designs

“Special” designs must be fully justified and submitted to the Headquarters Pavement Program.. “Special” designs are defined as those designs that meet either or both of the following criteria:

- Involve products, methods, or strategies which either reduce the structural thickness to less than what is determined by the standards and procedures of this manual and accompanying technical guidance, or
- Utilize experimental products or procedures not covered in the engineering tables or methods found in this manual or accompanying technical guidance.

“Special” designs must be submitted to the Headquarters Pavement Program either electronically or as hard copies. Hard copy submittals must be in duplicate. All submittals must include the proposed pavement structure(s) and a location strip map (project title sheet is acceptable). The letter of transmittal should include the following:

- Pavement design life, including both the construction year and design year (See Topic 612).
- The Unified Soil Classification of the subgrade soil(s) and, if used for the design, the California R-value (See Indexes 614.2 and 614.3).
- The strength properties for the materials selected for the subbase and/or base layers (See Tables 663.1A and 663.1B). Provide the California R-value if used for the design.
- The Traffic Index (TI) and ESALs or spectra for each pavement structure (See Indexes 613.3 & 613.4).
- The name of the engineering analysis and methods used in developing the “special” design(s).
- Justification for the “special” design(s).

The relevant Office at the Pavement Program (Office of Concrete Pavement and Pavement Foundation or Office of Asphalt Pavements) will act as the Headquarters’ focal point to obtain concurrence of Pavement Program and other Headquarters functional units as needed prior to granting approval of the “special” designs.

606.3 Mechanistic-Empirical Design

The Mechanistic-Empirical (ME) design method offers a unique special design system that utilizes solid mechanics to mechanistically model the primary responses of the pavement

materials in terms of stresses, strains, and deflections in response to detailed traffic loading and climatic conditions. The ME design process accumulates pavement damage over time and empirically relates accumulated damage over time to pavement surface distresses and ride quality. The primary responses are determined using advanced mechanistic models such as the multilayer elastic theory (MLET) or finite element method (FEM) and these are in turn used in distress prediction models (relationships) to determine pavement performances and related service life. Distress prediction models are calibrated using field data for the same type of pavement structure in similar traffic loading and climatic conditions.

(1) *Application.* The ME design methods are being considered by all State Departments of Transportation as alternative tools to existing empirical methods. On March 10, 2005, the Department committed to developing ME Design to replace the old existing empirical methods. The Department has completed the development of the procedures and criteria for performing ME Design. The following are current applications of ME design for rigid and flexible pavements on the State highway system or other roads maintained by the State.

- (a) Rigid Pavements – The current design catalogs for rigid pavements (see Index 623.1) are based on AASHTOware™ ME software. The design catalogs are to be used for rigid pavement design on State owned and operated highways. Using AASHTOware™ to independently design or refine data from these catalogs is not permissible because the design catalogs take into consideration other factors not currently addressed in the AASHTOware™ ME software.
- (b) Flexible Pavements – The Caltrans ME design procedure for flexible pavement is being implemented on select projects (mostly long life project with 40-year design life) as determined by Districts and HQ Pavement Program. Districts are encouraged to identify candidate projects for ME design and work with the HQ Pavement Program (Office of Asphalt Pavements) to perform the required design and conduct the additional testing needed to develop material specifications. The ME method for flexible pavement design (both new construction and rehabilitation) has been encoded into two programs: CalME and CalBack. Additional information on these two programs is given in Chapter 630. To date, the ME method has been used in the design and construction of four projects: one in southern California, one in Central California, and two in Northern California. The Department is currently fine tuning the ME process particularly with regard to materials testing and selection in preparation for future statewide implementation. Future use of the ME method will not be limited to long-life projects but to all flexible pavement projects on the State highway system or other roads maintained by the State; except for the following types of projects which use predetermined strategies and/or designs:
 - Pavement preservation,
 - Roadside paving (including bikeways and pedestrian pathways), and
 - Parking lots.

Indexes 633.2 and 633.3 provides detailed information on ME design procedures as related to new construction, widening, reconstruction, and rehabilitation of flexible

July 1, 2020

pavements. Additional information on flexible pavement ME design procedures can be found on the “ME Designer’s Corner” on the Pavement Program’s intranet site.

606.4 Proprietary Items

The use of proprietary materials and methods on State highway projects is discussed in Topic 110.10.

CHAPTER 610 – PAVEMENT ENGINEERING CONSIDERATIONS

Topic 611 – Factors In Selecting Pavement Type

Index 611.1 – Pavement Type Selection

The types of pavement generally considered for new construction, widening, reconstruction, and rehabilitation in California are rigid, flexible and composite pavements. Rigid and flexible pavements are considered for all new and reconstructed pavements. For widening and rehabilitation projects, flexible or rigid pavements may be appropriate based on performance, maintainability, and constructability of new and/or existing pavement structure. Composite pavement consisting of a flexible layer placed over a rigid pavement has mostly been used for maintenance and rehabilitation of rigid pavements on State highway facilities.

Life-cycle cost analysis discussed in Topic 619 is a useful tool when selecting optimal pavement structure type for a specific project.

611.2 Selection Criteria

Because physical conditions and other factors considered in selecting pavement type vary significantly from location to location, the Project Engineer must evaluate each project individually to determine the most appropriate and cost-effective pavement type to be used. The evaluation should be based on good engineering judgment utilizing the best information available during the planning and design phases of the project together with a systematic consideration of the following project specific conditions:

- Pavement design life
- Traffic considerations
- Soils characteristics
- Climate
- Existing pavement type and condition
- Availability of materials
- Recycling
- Maintainability
- Constructability
- Life-cycle cost analysis
- Life-cycle assessment

The above factors should be thoroughly investigated when selecting a pavement structure and addressed specifically in all project documents (PID, PR, PS&E, etc.). The final decision

July 1, 2020

on pavement type should be the most economical design based on life-cycle cost analysis (see Topic 619). In addition, the Department is currently developing a tool based on life-cycle assessment that can be valuable in selecting pavement type and rehabilitation strategies while assisting the Department in achieving its sustainability goal (see Topic 620).

The principal factors considered in selecting pavement structures are discussed in Topic 612 through Topic 620.

Topic 612 – Pavement Design Life

612.1 Definition

Pavement design life, also referred to as performance period, is the period of time that a newly constructed or rehabilitated pavement is engineered to perform before reaching any of the performance thresholds in Table 622.2 for concrete pavements or those in Index 632.2 for asphalt pavements. The selected pavement design life varies depending on the characteristics of the highway facility, the objective of the project, and projected traffic volume and loading. The pavement structure selected for any project should provide the minimum pavement design life that meets or exceeds the objective of the project as described in Index 612.2 through Index 612.7.

612.2 New Construction and Reconstruction

The pavement design life for new construction and reconstruction projects shall be no less than 40 years. For roadside facilities such as parking lots and rest areas, 20-year pavement design life may be used. Realignment or other new roadways which fit the definition of spot improvement in DIB 79 are considered to be rehabilitation for purposes of determining pavement design life.

612.3 Widening

Additional consideration is needed when determining the design life for pavement widening. Factors to consider include the remaining service life of the adjacent pavement, planned future projects (including maintenance and rehabilitation), and future corridor plans for any additional widening. **The pavement design life for the mainline traveled way, ramp traveled way, and intersection widening projects shall either be: (a) the remaining pavement service life of the adjacent roadway (but not less than the project design period as defined in Index 103.2), (b) 20 years, or (c) 40 years depending on which pavement design life produces the lowest life-cycle costs.** Design the first 2 feet of new shoulder pavement structure in conjunction with the lane widening, or if the shoulder is expected to be converted to a traffic lane within the pavement design life, design the pavement structure to match the same pavement design life as the adjacent traveled way. All other widening projects including shoulder widening and roadside facilities should be designed to either match the adjacent existing pavement structure or a 20-year design life, depending on the design life that produces the lowest life-cycle cost. Life-cycle cost analysis is discussed in Topic 619.

612.4 Pavement Preservation

- (1) *Preventive Maintenance.* Because preventive maintenance projects involve non-structural overlays, seals, grinds, or repairs, they are not engineered to meet a minimum structural design life like other types of pavement projects. Their intended goal is to extend the service life and maintain ride quality of an existing pavement structure while it is in good condition. On average, the added service life can vary from a couple of years to over 7 years, depending on the strategy being used and the condition of the existing pavement.
- (2) *Capital Preventive Maintenance.* The strategies used for CAPM projects have been engineered to extend the service life and maintain ride quality of a pavement that exhibits minor distress and/or triggered ride issues (International Roughness Index (IRI) greater than 170 inches per mile) by a minimum of 5 years. When properly engineered and placed on pavements that meet CAPM thresholds, CAPM strategies can last 5 to less than 20 years.

612.5 Roadway Rehabilitation

The minimum pavement design life for roadway rehabilitation projects shall be 20 years except for roadways with existing rigid pavements or with a current Annual Average Daily Traffic (AADT) of at least 12,000 vehicles, where the minimum pavement design life shall be either 20 or 40 years depending on which design life has the lowest life-cycle costs. At the discretion of the District, a 40-year pavement design life may be considered and evaluated for all projects with an AADT less than 12,000 using the Department's life-cycle cost analysis procedures. Life-cycle cost analysis is discussed further in Topic 619.

612.6 Temporary Pavements and Detours

Temporary pavements and detours should be engineered to accommodate the anticipated traffic loading that the pavement will experience during the construction period. This period may range from a few months to several years depending on the type, size and complexity of the project. Temporary pavement should not be designed to the same depth as the new traveled way and should not require treated base.

612.7 Non-Structural Wearing Courses

As described in Index 602.1(5), a non-structural wearing course is used on some pavements to ensure that the underlying layers will be protected from wear and tear from tire/pavement interaction and environmental factors for the intended design life of the pavement. Because non-structural wearing courses are not considered to contribute to pavement structural capacity, they are not expected to meet the same design life criteria as the structural layers. However, when selecting materials, mix designs and thickness of these courses, appropriate evaluation and sound engineering judgment should be used to optimize performance and minimize the need for maintenance of the wearing course and the underlying structural layers. Based on experience, a properly engineered non-structural wearing course placed on new or rehabilitated pavement should perform adequately for 10 or more years, and 5 or more years when placed on existing pavement as a part of pavement preservation.

July 1, 2020

Topic 613 – Traffic Considerations

613.1 Overview

Pavements are engineered to carry the truck traffic loads expected during the pavement design life. Truck traffic, which includes transit vehicles, trucks and truck-trailer vehicles, is the primary factor affecting pavement design life and its serviceability. Passenger cars and pickups are considered to have negligible effect when determining traffic loads that damage the pavement.

The Department currently estimates traffic loading required for pavement engineering using the following procedure:

- Estimate projected truck traffic volume for each of four categories of truck and transit vehicle types by axle classification (2-, 3-, 4-, and 5-axles or more).
- Convert the projected truck traffic data into 18-kip equivalent single axle loads (ESALs).
- Convert the total projected ESALs during the pavement design life into a Traffic Index (TI) that is used to determine minimum pavement thickness. Refer to Index 613.3.

Besides projected truck traffic volume, as the Department adopts the Mechanistic – Empirical (ME) pavement design and rehabilitation methods, additional information such as axle configurations (single, tandem, tridem, and quad), axle loads, and number of load repetitions are also needed. This information will be used to estimate pavement loading throughout the design life of the project using the Axle Load Spectra available in the current ME design procedure. Further detail on Axle Load Spectra is given in Index 613.4.

613.2 Traffic Volume Projections

(1) *Traffic Volume and Loading Data.* In order to determine expected traffic loads on a pavement it is first necessary to determine projected traffic volumes during the design life for the facility.

Current traffic volume or loading on State highways can be obtained from the following sources:

- Annual Average Daily Traffic (AADT) counts by axle classification,
- Weigh-In-Motion (WIM) station axle load data by axle classification, or
- Annual Average Daily Truck Traffic (AADTT) volume counts by axle classification.

Both AADT and AADTT on California State Highways are published annually by Headquarters Division of Traffic Operations.

Districts typically have established a unit within Traffic Operations or Planning specifically responsible for providing travel forecast information. The Project Engineer should coordinate with these units in their District early in the project development process to obtain current and projected traffic volumes by vehicle classification for each project in accordance with the procedures found in this Topic.

(2) *Design Year Annual Average Daily Truck Traffic (AADTT)*. A traffic growth factor obtained from the traffic forecasting unit is used to project current AADTT to the design year AADTT for each axle classification. In its simplest form, a straight-line projection is used to project the current one-way AADTT data to the design year AADTT. When using the straight-line projection, the truck traffic data for each axle classification is projected to find the AADTT at the midway of the design life. This represents the average one-way AADTT for each axle classification during the pavement design life.

When other than a straight-line projection of current truck traffic data is used for engineering purposes, the procedure to be followed in developing design year traffic projections will depend on travel forecast information for the region. In such cases, the projections require a coordinated effort from the District's Division of Transportation Planning and Traffic Operations, working closely with the Regional Agencies to establish realistic values for truck traffic growth rates based on travel patterns, land use changes, and other socioeconomic factors. When there is a difference between sources, Caltrans will determine which data and assumptions to use.

613.3 Traffic Index Calculation

The Traffic Index (TI) is determined using the following procedure:

(1) *Determine the Projected Equivalent Single Axle Loads (ESALs)*. The information obtained from traffic projections and Truck Weight Studies is used to develop 18-kip Equivalent Single Axle Load (ESAL) constants (see Table 613.3A). The ESAL constants represent the estimated total cumulative traffic loading for each of the four vehicle types by axle classification during the pavement design life. Due to the relatively low number of buses in comparison to trucks, buses are typically included in the 2-axle and 3-axle truck counts. However, for facilities with high percentage of buses such as high-occupancy vehicle (HOV) lanes and exclusive bus-only lanes, projected bus volumes need to be included in the projection used to determine ESALs. For these facilities and in response to the passing of Assembly Bill 1250 which increases axle weight of transit buses procured through a solicitation process, new ESAL constants must be used for all two-axle and three-axle buses; as shown in Table 613.3A. In a facility where a significant number of buses exists beside trucks, counts for the two- and three-axle trucks must be separated from counts for the two- and three-axle buses. These distinct counts must be used with the corresponding ESAL constants to calculate the total ESALs during the pavement design life.

The ESAL constants in Table 613.3A are used as multipliers of the projected AADTT for each truck type (and bus type) by axle classification to determine the total cumulative ESALs for all truck types during the pavement design life. The total cumulative ESALs for all truck types during the design life for the pavement are in turn used to determine the Traffic Index (TI) as described in Index 613.3(3). Both the total cumulative ESALs and the resulting TI are the same magnitude when engineering flexible, rigid, and composite pavement structures.

The current 10-, 20-, 30-, and 40-year ESAL constants are shown in Table 613.3A. Note that the constants for each axle classification are linearly proportional to design life.

(2) *Lane Distribution Factors*. Traffic on multilane highways normally varies by lane with passenger cars, vans, pickups, and buses generally in the median and HOV lanes, and

July 1, 2020

heavy trucks in the outside lanes. For this reason, the distribution of truck/bus traffic by lanes must be considered in the engineering for all multilane facilities to ensure that traffic loads are appropriately distributed. Because of the uncertainties and the variability of lane distribution of trucks on multilane freeways and expressways, statewide lane distribution factors have been established for pavement engineering of highway facilities in California. These lane distribution factors are shown in Table 613.3B. These factors are also used in the calculation of TI based on the selected design life.

- (3) *Traffic Index (TI) Calculation.* The Traffic Index (TI) is a measure of the number of ESALs expected in the traffic lane over the pavement design life of the facility. The TI does not vary linearly with the ESALs but rather according to the following exponential formula: The TI is rounded up to the nearest 0.5.

$$TI = 9.0 \times \left(\frac{ESAL \times LDF}{10^6} \right)^{0.119}$$

Where:

TI = Traffic Index for a given design life

ESAL = Total number of cumulative 18-kip Equivalent Single Axle Loads for all truck/bus types over the design life of the pavement structure calculated using the ESAL constants given in Table 613.3A

LDF = Lane Distribution Factor (see Table 613.3B)

In lieu of using the above formula, Table 613.3C can be used to determine the TI depending on total ESAL calculated for the design life. In Table 613.3C, the TI is given for a range of ESAL values. The total ESAL values given in Table 613.3C are already adjusted for LDF.

Due to various changes in travel patterns, land use changes, and other socioeconomic factors that may significantly affect design year traffic projections, the TI for facilities with longer service life, such as a 30- or 40-year design life require more effort to determine than for a 20-year design life. For this reason, the Project Engineer should involve District Transportation Planning and/or Traffic Operations in determining a realistic and appropriate TI for each project early in the project development process. In the absence of 30- or 40-year traffic projection data, 20-year projection data may be extrapolated to 30- and 40-year values by applying the 30- and 40-year ESAL constants in Table 613.3A.

613.4 Axle Load Spectra

This Index contains additional requirements and considerations for determining projected traffic loads.

- (1) *Development of Axle Load Spectra.* Axle load spectra analysis is an alternative method of characterizing the distribution of heavy vehicle loads, and is currently under development for the future mechanistic-empirical pavement design methods. Axle load spectra is a representation of normalized axle load distribution developed from weigh-in-motion (WIM) data for each axle type (single, tandem, tridem, and quad) and truck class (FHWA vehicle classes 4 through 13). Axle load spectra do not involve conversion of

Table 613.3A**ESAL Constants**

Vehicle Type (by Axle Classification)	10-Year Constants	20-Year Constants	30-Year Constants	40-Year Constants
Two-axle trucks or buses	690	1,380	2,070	2,760
Three-axle trucks or buses	1,840	3,680	5,520	7,360
Four-axle trucks	2,940	5,880	8,820	11,760
Five or more-axle trucks	6,890	13,780	20,670	27,560
Two-axle buses ⁽¹⁾	1,380	2,760	4,140	5,520
Three-axle buses ⁽¹⁾	6,808	13,616	20,424	27,232

NOTES:

⁽¹⁾ New constants added in in response to recent passing of AB 1250 in October 2015.**Table 613.3B****Lane Distribution Factors for Multilane Highways**

Number of Mixed Flow Lanes in One Direction ⁽²⁾	Factors to be Applied to Projected One-Way Annual Average Daily Truck Traffic (AADTT) ⁽³⁾			
	Mixed Flow Lanes ^{(6), (7)}			
	Lane 1 ⁽¹⁾	Lane 2	Lane 3	Lane 4
One	1.0	-	-	-
Two	1.0	1.0	-	-
Three	0.2 ^{(4), (5)}	0.8	0.8	-
Four	0.2 ^{(4), (5)}	0.2 ^{(4), (5)}	0.8	0.8

NOTES:

⁽¹⁾ Lane 1 is next to the centerline or median.⁽²⁾ For more than four lanes in one direction, use a factor of 0.8 for the outer two lanes plus any auxiliary/collector lanes and, a factor of 0.2 for other mixed flow through lanes, HOV lanes and other inside lanes (non truck lanes).⁽³⁾ Projected one-way AADTT is the truck traffic volume expected to use the lane during the design life for the facility.⁽⁴⁾ TI for non-truck permitted lanes must not exceed 11 for 20-year pavement design life and 12 for 40-year pavement design life.⁽⁵⁾ If HOV or other inside lanes are designated (signage required) for truck use, they must be designed to the same standards as found in this table for the outside lanes.⁽⁶⁾ For lanes devoted exclusively to buses and/or trucks, use a factor of 1.0 based on projected AADTT of mixed-flow lanes for auxiliary and truck lanes, and a separate AADTT based on expected bus traffic for exclusive bus-only lanes.⁽⁷⁾ The lane distribution factors in this table represent minimum factors and, based on knowledge of local traffic conditions and sound engineering judgment, higher values may be used for specific locations when warranted.

July 1, 2020

Table 613.3C
Conversion of ESAL to Traffic Index

ESAL ^{(1), (2)}	TI ⁽³⁾	ESAL ^{(2), (3)}	TI ⁽³⁾
4,710		6,600,000	
	5.0		11.5
10,900		9,490,000	
	5.5		12.0
23,500		13,500,000	
	6.0		12.5
47,300		18,900,000	
	6.5		13.0
89,800		26,100,000	
	7.0		13.5
164,000		35,600,000	
	7.5		14.0
288,000		48,100,000	
	8.0		14.5
487,000		64,300,000	
	8.5		15.0
798,000		84,700,000	
	9.0		15.5
1,270,000		112,000,000	
	9.5		16.0
1,980,000		144,000,000	
	10.0		16.5
3,020,000		186,000,000	
	10.5		17.0
4,500,000		238,000,000	
	11.0		17.5 ⁽⁴⁾
6,600,000		303,000,000	

NOTES:

- (1) For ESALs less than 5,000 or greater than 300,000,000, use the TI equation to calculate design TI, see Index 613.3(3).
- (2) ESAL totals already adjusted for LDF.
- (3) The determination of the TI closer than 0.5 is not justified. No interpolations should be made.
- (4) For TI's greater than 17.5, use the TI equation, see Index 613.3(3).

projected traffic loads into equivalent single axle loads (ESALs), instead traffic load applications for each truck class and axle type are directly characterized by the number of axles within each axle load range.

In order to accurately predict traffic load related damage on a pavement structure, it is important to develop both spatial and temporal axle load spectra for different truck loadings. The following data is needed to develop axle load spectra:

- Truck class (FHWA Class 4 for buses through Class 13 for 7+ axle multi-trailer combinations),
- Axle type (single, tandem, tridem, and quad),
- Axle load range for each axle type and truck class (3 to 102 kips),
- The number of axle load applications within each axle load range by axle type and truck class, and
- The percentage of the total number of axle applications within each axle load range with respect to each axle type, truck class, and year of data. These are the normalized values of axle load applications for each axle type and truck class.

The aforementioned data are obtained from traffic volume counts and WIM data for each vehicle classification, axle type and axle load range. Traffic counts and WIM stations should be deployed widely to ensure that projected volume estimates for each vehicle class and axle type are in line with the actual volumes and growth rates.

(2) *Use of Axle Load Spectra in Pavement Engineering.* Pavement engineering calculations using axle load spectra are generally more complex than those using ESALs or TI because loading cannot be reduced to one equivalent number. However, the load spectra approach of quantifying traffic loads offers a more realistic representation of traffic loading than using ESALs or TI.

Due to its better performance modeling, axle load spectra will be used in the Mechanistic-Empirical (ME) design method currently under development to evaluate traffic loading over the design life for new and rehabilitated pavements. This information will be used to validate original pavement design loading assumptions, and to continuously monitor pavement performance given the loading spectrum. Axle load spectral data will also be used to facilitate effective and pro-active deployment of maintenance efforts and in the development of appropriate strategies to mitigate sudden and unexpected pavement deterioration due to increased traffic volumes or loading patterns.

In this edition of the Highway Design Manual, axle load spectra are not used to engineer pavements.

613.5 Specific Traffic Loading Considerations

(1) *Traveled Way.*

(a) Mainline Lanes. Because each lane for a multilane highway with 3 or more lanes in each direction may have a different load distribution factor (see Table 613.3B), multiple TIs may be generated for the mainline lanes which can result in different pavement thickness for each lane. Such a design with different thickness for each individual lane would create complications for constructing the pavement. Therefore,

July 1, 2020

the decision to use a single or multiple TI's for the pavement engineering of mainline lanes for a multilane highway with 3 or more lanes in each direction should be based on a thorough consideration of constructability issues discussed in Index 618.2 together with sound engineering judgment.

(b) Freeway and Expressway Lanes. TI for all freeway and expressway lanes, including widening and auxiliary lanes must be the greater of either the calculated value, or 11.0 for a 20-year pavement design life, or 12.0 for a 40-year pavement design life. For roadway rehabilitation projects, use the calculated TI.

(c) Ramps and Connectors.

1. Connectors. AADTT and TI's for freeway-to-freeway connectors should be determined the same way as for mainline traffic.
2. Ramps to Weigh Stations. Pavement structure for ramps to weigh stations should be engineered using the mainline ESALs and the load distribution factor of 1.0 for exclusive truck lanes as noted in Table 613.3B.
3. Other Ramps. Estimating future truck traffic on ramps is more difficult than on through traffic lanes. It is typically more difficult to accurately forecast ramp AADTT because of a much greater impact of commercial and industrial development on ramp truck traffic than it is on mainline truck traffic.

If reliable truck traffic forecasts are not available, ramps should be engineered using the 20-, and 40-year TI values given in Table 613.5A for light, medium, and heavy truck traffic ramp classifications, respectively. Design life TI should be the greater of the calculated TI or the TI values in Table 613.5A. Ramp TI should never exceed mainline TI.

The three ramp classifications are defined as follows:

- Light Traffic Ramps - Ramps serving undeveloped or residential suburban areas with light to no truck traffic predicted during the pavement design life.
- Medium Traffic Ramps - Ramps in metropolitan areas, business districts, or where increased truck traffic is likely to develop because of anticipated commercial development within the pavement design life
- Heavy Traffic Ramps - Ramps that will or currently serve industrial areas, truck terminals, truck stops, and/or maritime shipping facilities. The final decision on ramp truck traffic classification rests with the District.

(2) *Shoulders.*

(a) Purpose and Objectives.

Shoulder pavement structures must be designed and constructed to assure that the following performance objectives are met:

- Be safely and economically maintained.
- Enhance the performance of adjacent travel lanes.

Table 613.5A**Traffic Index (TI) Values for Ramps and Connectors**

Ramp Truck Traffic Classification	Minimum Traffic Index (TI)	
	20-Yr Design Life	40-Yr Design Life ⁽¹⁾
Light	8.0	9.0
Medium	10.0	11.0
Heavy	12.0	14.0

NOTE:

(1) Based on straight line extrapolation of 20-year ESALs.

- Be structurally adequate to handle maintenance and emergency vehicles and to serve as emergency parking.
- Accommodate pedestrians and bicyclists as necessary.
- Provide versatility in using the shoulders as temporary detours for construction or maintenance activities in the future.
- Make it easier and more cost-effective to convert into a traffic lane as part of a future widening.
- Simplify the Contractor's operation which leads to reduced working days and lower unit prices.

Shoulders do not need to be designed to traffic lane standards to meet these objectives. To achieve these performance objectives, the following design standards apply for shoulders on the State highway.

(b) New Construction and Reconstruction.

New or reconstructed shoulders shall be designed to match the TI of the adjacent traffic lane when any of the following conditions apply:

- **The shoulder width is less than 5 feet.**
- **The median width is 14 feet or less.** See Index 305.5 for further paved median guidance.
- **On roads with less than two lanes in the direction of travel and there is a sustained (greater than 1 mile in length) grade of over 4 percent without a truck climbing lane.**
- **The shoulders are adjacent to exclusive truck or bus only lanes, or weigh station ramps.** This standard does not apply to mixed use (automobile plus bus) lanes, including high-occupancy vehicle (HOV) and toll (HOT) lanes.

July 1, 2020

The shoulder may also be engineered to match the TI of the adjacent traffic lane provided that:

- There is an identified plan (such as Regional Transportation Plan, Metropolitan Transportation Plan, Interregional Improvement Plan) to convert a shoulder into a traffic lane within the next 20 years.
- The shoulder is designed following the lane width and cross slope guidance in Topic 301.
- Agreement is obtained by the Program Fund Manager or Agency funding the project.

When the above conditions apply and the shoulder and lane will both be constructed as part of the same project, the shoulder pavement structure should match the adjacent traffic lane for ease of construction. For asphalt pavements, the thickness of the shoulder surface course layer may be tapered from the lane surface course thickness to the shoulder pavement edge thickness of no less than 0.35 foot to address different cross slope conditions (see Figure 613.5A).

For all other cases, the following design standards shall apply:

The minimum TI for the shoulder shall match the TI of the adjacent traffic lane for the first 2 feet of the outside shoulder width and 1.0 foot of the inside shoulder measured from the edge of traveled way. See Figure 613.5B.

For the remaining width of the shoulder, the TI shall:

- **be no less than 2 percent of the projected ESAL of the adjacent traffic lane or a TI of 5, whichever is greater.**
- **not to exceed 9.0.**

Do not include treated bases such as lean concrete base underneath the pavement except for treated permeable bases needed to perpetuate an existing treated permeable base under the adjacent lane. Non-permeable treated bases, such as lean concrete base, are not to be included underneath the pavement.

The total depth of the shoulder pavement structure (depth from the surface to the subgrade) shall match the pavement structure grading plane of the adjacent traffic lane.

Matching the total grading plane of the shoulder pavement structure to that of the adjacent traffic lane can be accomplished by increasing the depth of the aggregate base and/or subbase as needed (see Figure 613.5B). This will provide a path for water in the pavement structure to drain away from the lane and into the shoulder. It can also provide a more cost effective means to upgrade the shoulder to a traffic lane in the future. Although using a thinner overall shoulder pavement structure than the traveled way requires less material and may appear to reduce construction costs, the added costs of time and labor to the Contractor to build the step between the traveled way and shoulder can offset any perceived savings from reduced materials.

Figure 613.5A

Shoulder Design for TI Equal to Adjacent Lane TI

Shoulder Pavement Structure is the Same as Traveled Way Structure

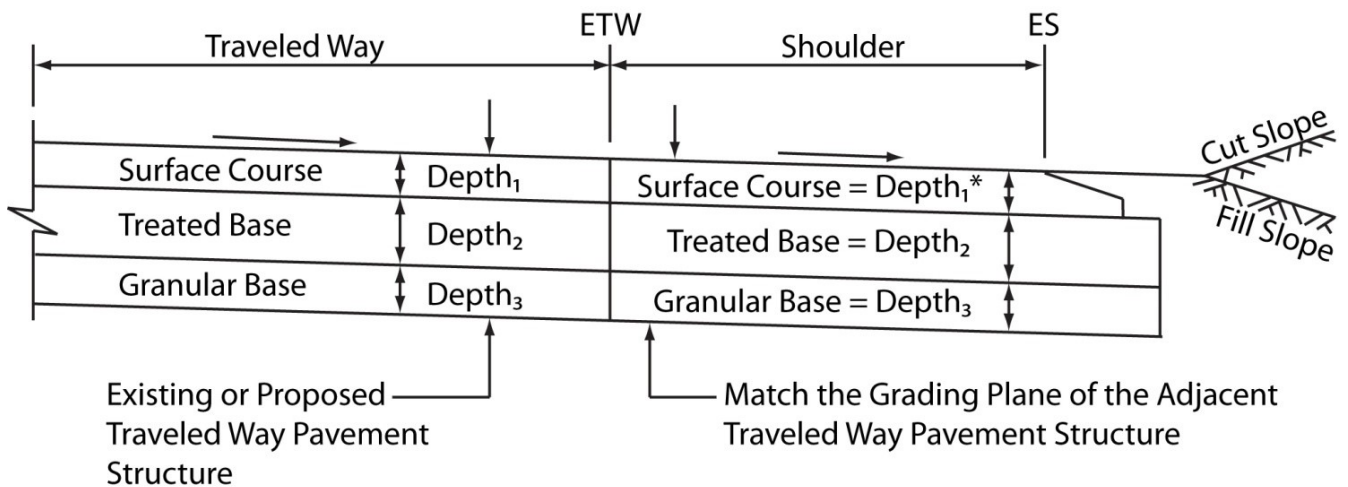

Variable Shoulder Thickness Option for Asphalt Pavement

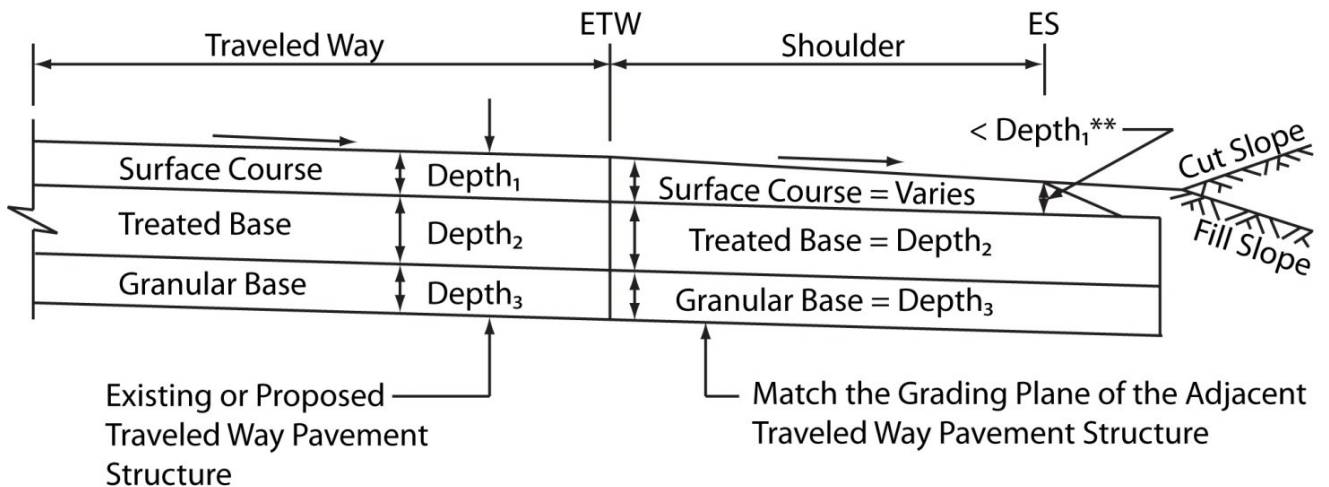

NOTES:

* Applies to concrete and asphalt pavements.

** For asphalt pavement, minimum thickness of surface course $\geq 0.35'$.

July 1, 2020

Figure 613.5B

Shoulder Design for TI Less Than Adjacent Lane TI

Variable Surface Course Option

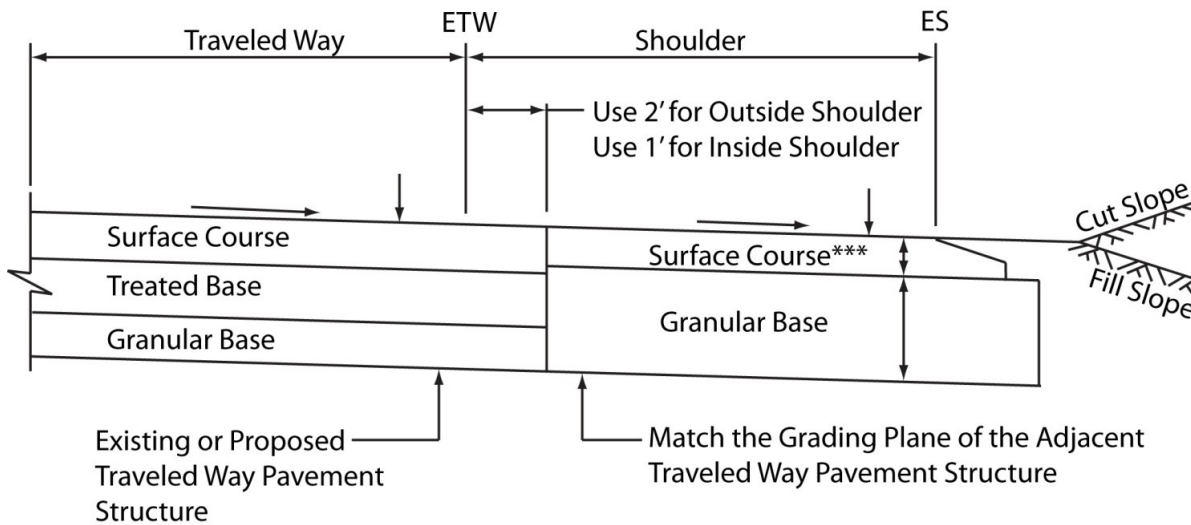

Uniform Surface Course Option

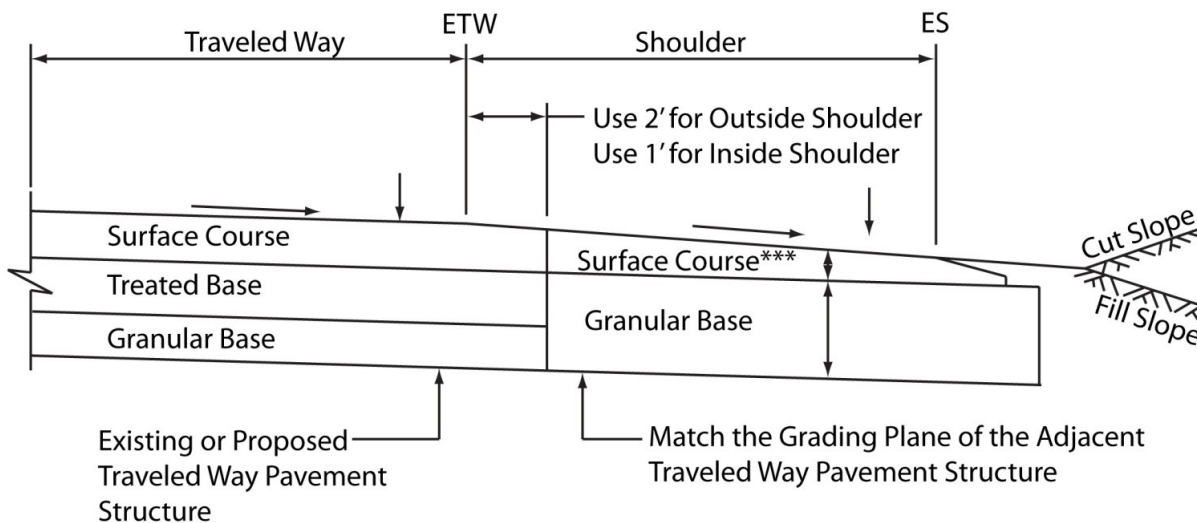

NOTES:

*** For rigid pavement, minimum thickness of surface course is $\geq 0.60'$ ($0.75'$ for High Mountain or High Desert Climate Region)

For flexible pavement, minimum thickness of surface course is ≥ 0.35

For asphalt shoulders, the thickness of the asphalt layer (not including nonstructural wearing surface) should not be less than 0.35 foot or the thickness of the asphalt layer of the adjacent traffic lane, whichever is less.

For concrete shoulders, see Index 626.2 and Table 626.2 for recommended thicknesses.

An alternate shoulder design is to taper the surface course from the surface course thickness of the adjacent traffic lane to no less than 0.60 foot (0.75 foot in High Mountain and High Desert climate regions) for concrete and 0.35 foot for asphalt at the edge of shoulder (see Figure 613.5B).

Bases and subbases for new or reconstructed shoulders should extend at least 1 foot from beyond the edge of shoulder as shown in Figures 613.5A and 613.5B.

(c) Widening. Existing shoulders do not need to be replaced or upgraded to new construction or reconstruction standards as part of a shoulder widening project unless the following conditions exist:

- Adding or widening lanes will require removal of all or a portion of the existing shoulder.
- The existing shoulder of 5 feet or less in width is being widened and the existing shoulder does not meet the current standards for new construction or reconstruction. For shoulders wider than 5 feet, the District and Program Fund Manager/Agency determines whether to reconstruct the entire shoulder to new construction or reconstruction standards, or match the pavement structure of the existing shoulder.
- There is an identified plan that the widened shoulder will be converted or replaced with a traffic lane within 20 years.
- The widened shoulder will be used as a temporary detour as discussed in Index 613.5(2)(f).

For all other cases, widening of the existing shoulder should match the pavement structure of the existing shoulder. For shoulders left in place, repair any existing distresses prior to overlaying.

(d) Pavement Preservation.

Shoulder preservation should be done in conjunction with work on the adjacent traffic lanes to assure that the shoulder pavement structure will meet the performance requirements stated in Index 613.5(2)(a). Shoulders can be preserved by:

- Sealing cracks greater than $\frac{1}{4}$ inch in width,
- Grinding out rolled up sections next to concrete pavement,
- Fog or slurry sealing asphalt surfaces,
- Limited digouts of failed locations.

For CAPM projects, the following additional strategies can be considered if warranted:

- Milling and replacing 0.15 foot of oxidized and cracked surfaces can also be considered either prior to an overlay or as a stand-alone action.
- Grinding of concrete shoulders if the adjacent traffic lane is being ground.

July 1, 2020

Shoulder preservation strategies should be identified and discussed with District Maintenance and the Headquarters Pavement Reviewer during the scoping phase of the project or whenever a change in strategy is proposed.

(e) Roadway Rehabilitation.

The goal of roadway rehabilitation projects is to maintain existing shoulders wherever possible. The TI is not a consideration in choosing the shoulder rehabilitation strategy unless it has been determined that the shoulder needs to be replaced for one of the following reasons:

- The shoulder will be used to temporarily detour traffic during construction and the existing shoulder does not provide adequate structure to handle the expected loads.
- The adjacent lane is being replaced as part of the project. In this situation, if the shoulder is wider than 5 feet, replace only two feet of the outside shoulder (1.0 foot of inside shoulder) adjacent to the traffic lane. For shoulders 5 feet wide or less, replace the entire shoulder.
- The existing shoulder exhibits extensive distress and/or settlement and it is agreed to by the Headquarters Pavement Reviewer that replacement is the only viable option.

For replacements other than temporary traffic detours, use the standards for new construction and reconstruction in Index 613.5(2)(b). For temporary traffic detours, see Index 613.5(2)(f) for further discussion.

Regardless of whether or not the TI is considered, shoulder rehabilitation repairs of the existing shoulder are often necessary and should be done in conjunction with work on the adjacent traffic lanes to assure that the shoulder pavement will meet the performance requirements stated in Index 613.5(2)(a).

Existing asphalt shoulders can typically be maintained as part of a rehabilitation project by milling and replacing 0.15 feet of asphalt surface plus digouts of failed areas to remove oxidized layers. This can be done either prior to an overlay or to maintain the existing surface. Where the existing shoulders have little to no cracking and are older than 3 years from the last treatment, a fog seal or slurry seal with digouts is all that is needed.

Existing concrete shoulders typically only require sealing any unsealed cracks ½ inch or wider or replacing the joint seals. Shoulders should be sealed if the adjacent traffic lanes are sealed. If shoulders are spalled, the spalls should be repaired and any shattered slabs replaced. Grinding should not be done, even if the shoulder is faulted or curled unless the adjacent traffic lane is also being ground.

Shoulder rehabilitation strategies should be identified and discussed with District Maintenance and the Headquarters Pavement Reviewer during the scoping phase of the project or whenever a change in strategy is proposed.

(g) Temporary Detours.

When existing shoulders will be used to stage traffic during construction, the existing shoulder pavement structure should be checked for structural adequacy. If the existing shoulder is not structurally adequate or if it is a new shoulder, calculate the TI based on the actual truck traffic expected to be encountered during construction. Design the shoulder based on the requirements for new or reconstructed shoulders in Index 613.5(2)(b) except in this case the TI may exceed 9. Do not use treated bases for temporary detours. For existing shoulders, remove the surface course layer and replace with a new surface course sufficiently thick enough to support temporary traffic loads.

(h) Conversion to Lane.

If a decision has been made to convert an existing shoulder to a portion of a traffic lane, a deflection study must be performed to determine the structural adequacy of the in place asphalt shoulder. The condition of the existing shoulder must also be evaluated for undulating grade, rolled-up hot mix asphalt at the rigid pavement joint, surface cracking, raveling, brittleness, oxidation, etc.

The converted facility must provide a roadway that is structurally adequate for the proposed pavement design life. This is necessary to eliminate or minimize the likelihood of excessive maintenance or rehabilitation being required in a relatively short time because of inadequate structural strength and deterioration of the existing pavement structure.

If the existing shoulder is determined to be structurally inadequate for the proposed pavement design life, then the shoulder should be upgraded or replaced in accordance with the standards for new construction and reconstruction discussed in Index 613.5(2)(b).

(i) Other.

- Tracking and Sweep Width Lines.

For projects where the tracking width and sweep width lines are shown to encroach onto the paved shoulders, the shoulder pavement structure must be engineered to sustain the weight of the design vehicle. If curb and gutter are present and any portion of the gutter pan is likewise encroached, the gutter pan must be engineered to match the adjacent shoulder pavement structure. See Topic 404 for design vehicle guidance.

- Minimizing Worker Exposure.

Consult with District Maintenance and the Headquarters Program Advisor during the scoping phase on options for minimizing maintenance worker exposure to maintain shoulders.

- Concrete shoulders and asphalt pavement structure.

Do not place concrete shoulders adjacent to asphalt pavement structure.

(3) *Intersections.* Future AADTT and TI's for intersections should be determined for each approach the same way as for mainline traffic. At some intersections, the level of

July 1, 2020

truck/transit traffic from all approaches may add more loads on the pavement than what the mainline pavement was designed for. Separate ESAL/TI or load spectra calculations should be performed at intersections when any of the following criteria apply:

- Two or more State highways intersect (including ramps to/from State highways)
- Truck traffic on the local road exceeds 25 percent of the truck traffic on the State highway.
- Ramp connecting a State highway to a local road is classified as Medium or Heavy as described in Index 613.5(1)(c).

In these cases, combine the traffic counts/ESALs of the approaches to calculate the TI or load spectra for all approaches combined. If the resulting TI or load spectra are higher than what is calculated for the mainline, then the intersections will need to be engineered using the combined TI or load spectra.

For all roundabout designs, look at the traffic projections for each turning movement of each leg of the roundabout, then, sum up the truck/transit traffic volumes using each quadrant of the roundabout. From the total truck traffic volume, generate an ESAL/TI or load spectra for each quadrant. Choose the quadrant with the highest TI or load spectra to design the entire roundabout.

Special attention should be given to truck and transit traffic behavior (turning and stopping) to determine the loading patterns and to select the most appropriate materials.

The limits for engineering pavement at an intersection should include intersection approaches and departures, to the greater of the following distances:

- For signalized intersections, the limits of the approach should extend past the furthest set of signal loop detectors where trucks do the majority of their braking; or
- For "STOP" controlled intersections the limits for the approach should be long enough to cover the distance trucks will be braking and stopping either at the stop bar or behind other trucks and vehicles; or
- 100 feet.

The limits for the intersection departures should match the limits of the approach in the opposing lane to address rutting caused by truck acceleration.

For further assistance on this subject, contact either your District Materials Engineer, or Headquarters Pavement Program – Office of Concrete Pavement and Pavement Foundations.

(4) *Roadside Facilities*. The pavement for safety roadside rest areas, including parking lots, should meet or exceed the TI requirements found in Table 613.5B for a 20-year pavement design life for new/reconstructed or rehabilitated pavements.

Table 613.5B**Minimum TI's for Safety Roadside Rest Areas**

Facility Usage	Minimum TI (20-Year)
Truck Ramps & Roads	8.0 ⁽¹⁾
Truck Parking Areas	6.0 ⁽¹⁾
Auto Roads	5.5
Auto Parking Areas	5.0

NOTE:

- (1) For safety roadside rest areas next to all Interstates and those State Routes with AADTT greater than 12,000 use Table 613.5A medium truck traffic for truck ramps, truck roads, and a minimum TI of 9.0 for truck parking areas.

Topic 614 – Soil Characteristics

614.1 Engineering Considerations

California is a geologically active state with a wide variety of soil types throughout. Thorough understanding of the native soils in a project area is essential to properly engineer or update a highway facility.

Subgrade is the natural soil or rock material underlying the pavement structure. Unlike concrete and steel whose characteristics are fairly uniform, the engineering properties of subgrade soils may vary widely over the length of a project.

Pavements are engineered to distribute stresses imposed by traffic to the subgrade. For this reason, subgrade condition is a principal factor in selecting the pavement structure. Before a pavement is engineered, the structural quality of the subgrade soils must be evaluated to ensure that it has adequate strength to carry the predicted traffic loads during the design life of the pavement. The pavement must also be engineered to limit the expansion and loss of density of the subgrade soil.

614.2 Unified Soil Classification System (USCS)

The USCS classifies soils according to their grain size distribution and plasticity. Therefore, only a sieve analysis and Atterberg limits (liquid limit, plastic limit, and plasticity index) are necessary to classify a soil in this system. Based on grain size distribution, soils are classified as either (1) coarse grained (more than 50 percent retained on the No. 200 sieve), or (2) fine grained (50 percent or more passes the No. 200 sieve). Coarse grained soils are further classified as gravels (50 percent or more of coarse fraction retained on the No. 4 sieve) or sands (50 percent or more of coarse fraction passes the No. 4 sieve); while fine grained soils are classified as inorganic or organic silts and clays and by their liquid limit (equal to or less

July 1, 2020

than 50 percent, or greater than 50 percent). The USCS also includes peat and other highly organic soils, which are compressible and not recommended for roadway construction. Peat and other highly organic soils should be removed wherever possible prior to placing the pavement structure.

The USCS based on ASTM D 2487 is summarized in Table 614.2. Testing frequency will depend on the probability of soil types changing within the project limits. At a minimum, there should be at least one test per mile to verify the soil type. Where changes in soil type occur, additional testing should be done to determine boundaries of the individual soil types.

614.3 California R-Value

The California R-value is the measure of resistance to deformation of the soils under wheel loading and saturated soil conditions. It is used to determine the bearing value of the subgrade. Determination of R-value for subgrade is provided under California Test (CT) 301. Typical R-values used by the Department range from five for very soft material to 80 for treated base material.

When determining R-value for project design, testing should be done at least once per mile (more if area is known to have variable soil properties.) Where noticeable differences in R-value occur between tests, additional tests should be taken to ascertain the boundaries of the various R-values.

The California R-value is determined based on the following separate measurements under CT 301:

- The exudation pressure test determines the thickness of cover or pavement structure required to prevent plastic deformation of the soil under imposed wheel loads.
- The expansion pressure test determines the pavement thickness or weight of cover required to withstand the expansion pressure of the saturated soil.

Because some soils, such as coarse grained gravels and sands, may exhibit a higher California R-value test result than would normally be required for pavement design, the California R-value for subgrade soils used for pavement design should be limited to no more than 50 unless agreed to otherwise by the District Materials Engineer. Local experience with these soils should govern in assigning R-value on subgrade. The California R-value of subgrade within a project may vary substantially but cost and constructability should be considered in specifying one or several California R-value(s) for the project. Engineering judgment should be exercised in selecting appropriate California R-values for the project to ensure a reasonably "balanced design" which will avoid excessive costs resulting from over conservatism. The following should be considered when selecting California R-values for a project:

- If the measured California R-values are in a narrow range with some scattered higher values, the lowest California R-value should be selected for the pavement design.
- If there are a few exceptionally low California R-values and they represent a relatively small volume of subgrade or they are concentrated in a small area, it may be more cost effective to remove or treat these materials.

Table 614.2

Unified Soil Classification System (from ASTM D 2487)

Major Classification Group	Sub-Groups		Classification Symbol	Description
Coarse Grained Soils More than 50% retained on the No. 200 sieve	Gravels 50% or more of coarse fraction retained on the No. 4 sieve	Clean Gravels	GW	Well-graded gravels and gravel-sand mixtures, little or no fines
			GP	Poorly graded gravels and gravel-sand mixtures, little or no fines
		Gravels with Fines	GM	Silty gravels, gravel-sand-silt mixtures
			GC	Clayey gravels, gravel-sand-clay mixtures
	Sands 50% or more of coarse fraction passes the No. 4 sieve	Clean Sands	SW	Well-graded sands and gravelly sands, little or no fines
			SP	Poorly graded sands and gravelly sands, little or no fines
		Sands with Fines	SM	Silty sands, sand-silt mixtures
			SC	Clayey sands, sand-clay mixtures
Fine Grained Soils More than 50% passes the No. 200 sieve	Silts and Clays Liquid Limit 50% or less		ML	Inorganic silts, very fine sands, rock four, silty or clayey fine sands
			CL	Inorganic clays of low to medium plasticity, gravelly/sandy/silty/lean clays
			OL	Organic silts and organic silty clays of low plasticity
	Silts and Clays Liquid Limit greater than 50%		MH	Inorganic silts, micaceous or diatomaceous fine sands or silts, elastic silts
			CH	Inorganic clays of high plasticity, fat clays
			OH	Organic clays of medium to high plasticity
Highly Organic Soils			PT	Peat, muck, and other highly organic soils

Prefix: G = Gravel, S = Sand, M = Silt, C = Clay, O = Organic

Suffix: W = Well Graded, P = Poorly Graded, M = Silty, L = Clay, LL < 50%, H = Clay, LL > 50%

July 1, 2020

- Where changing geological formations and soil types are encountered along the length of a project, it may be cost-effective to design more than one pavement structure to accommodate major differences in R-values that extend over a considerable length. Care should be exercised to avoid many variations in the pavement structure that may result in increased construction costs that exceed potential materials cost savings.

614.4 Expansive soils

With an expansive subgrade (Plasticity Index, PI greater than 12), special engineering or construction considerations will be required. Engineering alternatives, which have been used to address expansive soils include:

- (a) Chemical treatment of expansive soil with lime or other chemical additives to reduce expansion in the presence of water. Lime is often used with highly plastic, fine-grained clayey soils. When mixed and compacted, the plasticity and swelling potential of clay soils are reduced and workability increased, as lime combines with the clay particles. It also increases the California R-value of the subgrade. Soil treated with lime is considered to be lime stabilized soil. Lime stabilized soil is discussed further in Chapter 660.
- (b) Replacing the expansive material with a non-expansive material to a depth where the seasonal moisture content will remain nearly constant.
- (c) Providing a pavement structure of sufficient thickness to counteract the expansion pressure. The expansion pressure is the uplift pressure that an expansive soil layer would exert upon swelling due to saturation. The expansion pressure may be determined experimentally in the laboratory or using correlation equations that relate the pressure to a number of geotechnical properties of the soil and other site conditions such as plasticity index, density, and moisture content.
- (d) Utilizing two-stage construction by placing a base or subbase to permit the underlying material to expand and stabilize before placing leveling and surface courses.
- (e) Stabilizing the moisture content by minimizing the access of water through surface and subsurface drainage and the use of a waterproof membrane (i.e., geomembrane, asphalt saturated fabric, or rubberized asphalt membrane).
- (f) Relocating the project alignment to a more suitable soil condition.

Alternative (e) is considered to be the most effective approach if relocation is not feasible such as in the San Joaquin Delta. The District Materials Engineer determines which alternative(s) is/are practical. For further assurance, more than one alternative may be selected (e.g., alternative (a) and alternative (e)).

614.5 Other Considerations

- (1) *Fill.* Because the quality of excavated material may vary substantially along the project length, the pavement design over a fill section should be based on the minimum Unified Soil Classification or California R-value of the material that is to be excavated as part of the project. If there is any excavated material that should not be used, it should be identified in the Materials Report and noted as appropriate in the PS&E.

(2) *Imported Borrow.* Imported borrow is used in the construction of embankments when sufficient quantity of quality material (R-value > 20) is not available. When imported borrow of desired quality is not economically available or when the entire earthwork consists of borrow, the California R-value specified for the borrow material becomes the design R-value for the pavement project. The minimum R-value specified for borrow material should be at least 20 or the R-value for the native soil, whichever is greater. Since no minimum California R-value is required by the Standard Specifications for imported borrow, a minimum R-value for the imported borrow material placed within 4 feet of the grading plane must be specified in the Materials Report and in the project plans and specifications.

(3) *Compaction.* Compaction is densification of the soil by mechanical means. The Standard Specifications require a relative compaction of at least 95 percent be obtained between the outer edges of shoulders for the greater depth of either 0.5 foot below the grading plane or 2.5 feet below finished grade. The 95 percent relative compaction for the depth of 0.5 foot below the grading plane or 2.5 feet below the finished grade should not be waived for the traveled way, auxiliary lanes, and ramps on State highways.

These specifications sometimes can be waived by special provision with approval from the District Materials Engineer, when any of the following conditions apply:

- A portion of a local road is being replaced with a stronger pavement structure.
- Partial-depth reconstruction is specified.
- Existing buried utilities would have to be moved.
- Interim widening projects are required on low-volume roads, intersection channelization, or frontage roads.

Locations where the 2.5 feet of compaction depth is waived must be shown on the typical cross sections of the project plan. If soft material below this depth is encountered, it must be removed and replaced with suitable excavated material, imported borrow or subgrade enhancement fabric. Location(s) where the Special Provisions apply should be shown on the typical cross section(s).

Topic 615 – Climate

The effects that climate will have on pavement must be considered as part of pavement engineering. Temperatures will cause pavements to expand and contract creating pressures that can cause pavements to buckle or crack. Binders in flexible pavements will also become softer at higher temperatures and more brittle at colder temperatures. Precipitation can increase the potential for water to infiltrate the base and subbase layers, thereby resulting in increased susceptibility to erosion and weakening of the pavement structural strength.

In freeze/thaw environments, the expansion and contraction of water as it goes through freeze and thaw cycles, plus the use of salts, sands, chains, and snow plows, create additional stresses on pavements. Solar radiation can also cause some pavements to oxidize. To help account for the effects of various climatic conditions on pavement performance, the State has been divided into the following nine climate regions primarily based on air temperature and precipitation:

July 1, 2020

- North Coast
- Central Coast
- South Coast
- Low Mountain
- High Mountain
- South Mountain
- Inland Valley
- Desert
- High Desert

Figure 615.1 provides a representation of where these regions are. A more detailed map, along with a detailed list of where State routes fall within each climate region, can be found on the Department Pavement website.

In conjunction with this map, designs, standards, plans, and specifications have been and are being developed to tailor pavement standards and practices to meet each of these climatic conditions.

The standards and practices found in this manual, the Standard Plans, Standard Specifications, and Special Provisions should be considered as the minimum requirements to meet the needs of each climate region. Districts may also have additional requirements based on their local conditions. Final decision for the need for any requirements that exceed the requirements found in this manual, the Standard Plans, Standard Specifications, and Standard Special Provisions rests with the District.

Topic 616 – Existing Pavement Type and Condition

The type and condition of pavement on existing adjacent lanes or facilities should be considered when selecting new pavement structures or rehabilitation/preservation strategies. The selection process and choice made by the engineer is influenced by their experience and knowledge of existing facilities in the immediate area that have given adequate service. Providing continuity of existing pavement type can also ensure consistency in maintenance operations and optimum performance.

In reviewing existing pavement type and condition, the following factors should be considered:

- Type of pavement on existing adjacent lanes or facilities
- Performance of similar pavements in the project area
- Corridor continuity
- Maintaining or changing grade profile
- Existing pavement widening with a similar material

Figure 615.1

Pavement Climate Regions

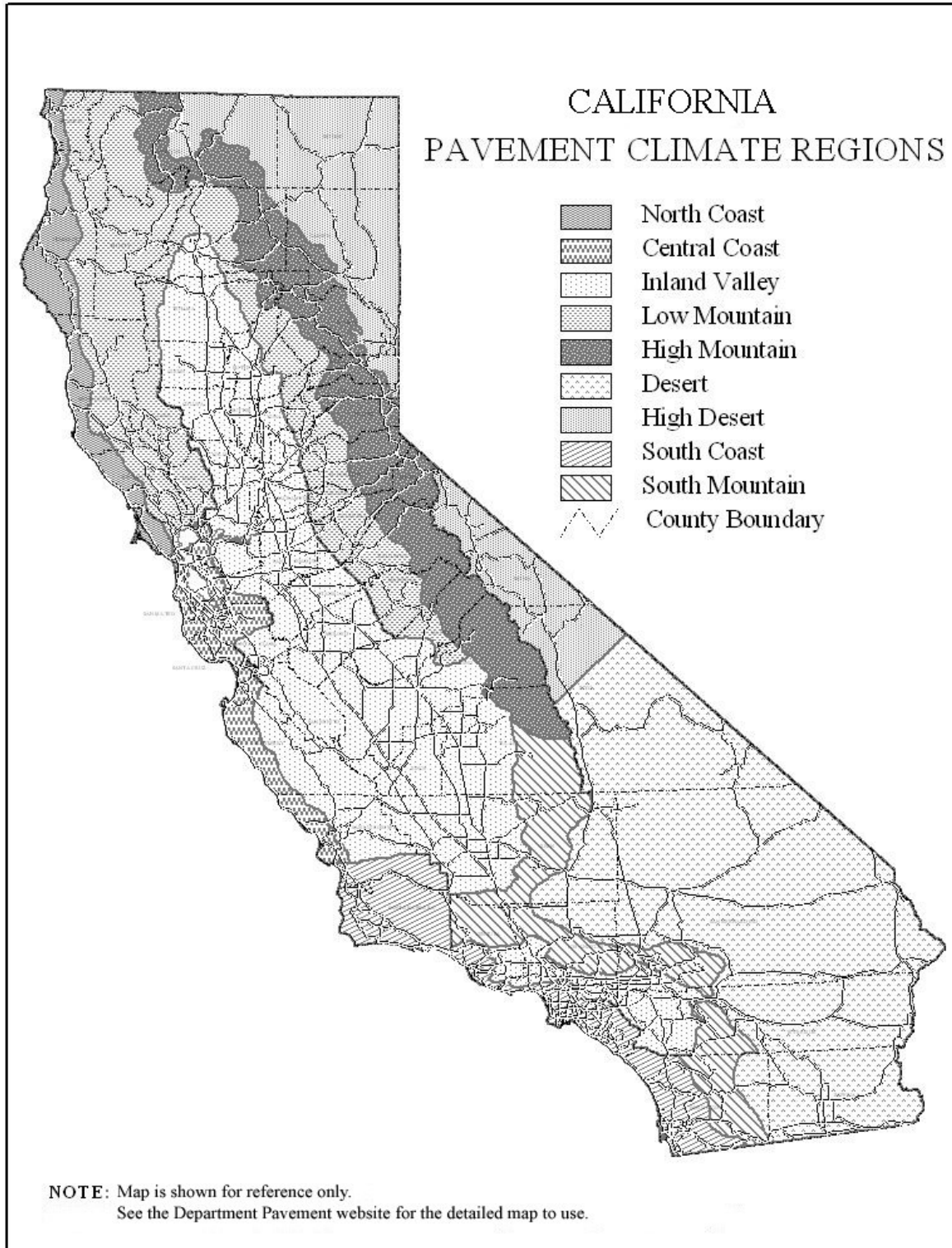

July 1, 2020

- Existing appurtenant features (median barriers, drainage facilities, curbs and dikes, lateral and overhead clearances, and structures which may limit the new or rehabilitated pavement structure).

Topic 617 – Materials

617.1 Availability of Materials

The availability of suitable materials such as subbase and base materials, aggregates, binders, and cements for pavements should be considered in the selection of pavement type. The availability of commercially produced mixes and the equipment capabilities of area contractors may also influence the selection of pavement type, particularly on small widening, reconstruction or rehabilitation projects. Suitable materials that are locally available or require less energy to produce and transport to the project site should be used whenever possible.

617.2 Recycling

The Department encourages and seeks opportunities to utilize recycled materials in construction projects whenever such materials meet the minimum engineering standards and are economically viable. Accordingly, consideration should be given on every project to use materials recycled from existing pavements as well as other recycled materials such as scrap tires. Existing pavements can be recycled for use as subbase and base materials to be surfaced with a flexible structural surface course, or as a partial substitute for aggregate in hot mix asphalt mixes. The decision to use recycled materials should be made based on a thorough evaluation of material properties, performance experience, benefit/cost analysis, and engineering judgment. Additional information on use of recycled pavements is available in Index 110.11 and on the Department Pavement website.

Candidates for recycling flexible pavement surface courses are those with uniform asphalt content. The existence of heavy crack-sealant, numerous patches, open-graded friction course, and heavy seal coats make the new recycled hot mix asphalt design inconsistent thereby resulting in mix properties that are more difficult to control. To avoid this problem and still use the recycling option, for flexible pavement, a minimum of 0.08 foot should be milled off prior to the recycling operation. Light crack sealing (less than 5 percent of the pavement) or a uniform single seal coat does not require milling.

The Department has established a minimum mill depth of 0.15 foot for recycling flexible pavement surface courses. Since existing surface course thickness will have slight variations, the recycling strategy should leave at least the bottom 0.15 foot of the existing flexible surface course in place. This is to insure the milling machine does not loosen base material and possibly contaminate the recycled material. As mentioned in Index 110.11(2), recycling of existing hot mix asphalt must be considered, in all cases, as an alternative to placing 100 percent new hot mix asphalt.

Topic 618 – Maintainability and Constructability

618.1 Maintainability

Maintainability is the ability of a highway facility to be restored in a timely and cost-effective way with minimal traffic exposure to the workers and minimal traffic delays to the traveling public. It is an important factor in the selection of pavement type and pertinent appurtenances. Maintainability issues should be considered throughout the project development process to ensure that maintenance needs are adequately addressed in the engineering and construction of the pavement structure. For example, while a project may be constructible and built in a timely and cost-effective manner, it may create conditions requiring increased worker exposure and increased maintenance effort that is more expensive and labor intensive to maintain. Another example is the pavement drainage systems that need frequent replacement and often do not provide access for cleanout.

Besides the minimum considerations for the safety of the public and construction workers found in this manual, the Standard Specifications, and other Department manuals and guidance, greater emphasis should also be placed on the safety of maintenance personnel and long-term maintenance costs over the service life for the proposed project rather than on constructability or initial costs. Minimizing exposure to traffic through appropriate pavement type selection and sound engineering practices should always be a high priority. The District Maintenance Engineer and Maintenance Supervisor responsible for maintaining the project after it is built should be consulted for recommendations on addressing maintainability.

618.2 Constructability

Construction issues that influence pavement type selection include: size and complexity of the project, stage construction, lane closure requirements, traffic control and safety during construction, construction windows when the project must be completed, adequate work area, and other constructability issues that have the potential of generating contract change orders.

The Project Engineer must be cognizant of the issues involved in constructing a pavement, and provide plans and specifications that both meets performance standards and requirements. The Construction Engineer for the area where the pavement will be built should be consulted regarding constructability during the project development process. The recommendations given by Construction should be weighed against other recommendations and requirements for the pavement. Constructability recommendations should be accommodated where practical, provide minimum performance requirements, safety, and maintainability. Some constructability items that should be addressed in the project include:

July 1, 2020

- Clearance width of paving machines to barriers and hinge points should be provided for good control of paving operation and smoothness. Provide a minimum of 2.5 feet from limits of paving to portable concrete barrier (Type 60K) for paving machine and survey control.
- Access for delivery trucks and construction equipment. Consistent delivery of material is important for the paving machine to operate at a consistent rate to construct smooth and long lasting pavement.
- Public safety and convenience.
- Time and cost of placing multiple thin lifts of different materials as opposed to thicker lifts of a single material. (For example, sometimes it is more efficient and less costly to place one thick lift of aggregate base rather than two thin lifts of aggregate base and subbase).
- The impact of combined lifts of different materials on long-term performance or maintenance of the pavement. For example, although it may seem to be a good idea to combine layers of Portland cement concrete and lean concrete base into a single layer to make it easier to construct, combining these layers has a negative impact on the pavement performance and will lead to untimely failure.
- Distance to material batch plant should be taken into consideration. If one is not accessible to the project site, a staging area no less than 200 by 200 feet should be provided to produce consistent concrete or asphalt mixes and ensure proper moisture levels in aggregate mix as they are essential in creating sound and smooth pavement.
- Maximize lane closure times or utilize detours to provide consistent paving operations. Paving short sections causes more pavement tie-ins and more start-stop operations, both of which create greater potential for pavement roughness and lower durability. In lieu of short duration closures of less than 10 hours, the following traffic handling strategies should be considered for major pavement operations such as widening, rehabilitation, or reconstruction:
 - Extended weekend closures (55-hour, 48-hour, 24-hour, etc.).
 - Median widening to temporarily detour traffic.
 - Diverting some or all traffic to opposite direction (split roadway) and using movable barriers, if needed, to maintain peak traffic flows.
 - Long-term lane closures. Some roads can be at least partially closed for 2 weeks or more during light travel seasons or during entire construction.
- Order of work should be taken into consideration to ensure smooth and durable pavement. For example, diamond grinding should be done after individual slab replacement work is completed. However, for concrete pavement widening, diamond grind the adjacent existing lane prior to beginning the widening work.

Topic 619 – Pavement Life-Cycle

619.1 Life-Cycle Cost Analysis

Life-cycle cost analysis (LCCA) is a useful tool for comparing the value of alternative pavement structures and strategies. LCCA is an economic analysis that compares initial cost, future cost, and user delay cost of different pavement alternatives. LCCA is an integral part of the decision making process for selecting pavement type and design strategy. It can be used to compare life-cycle cost for:

- Different pavement types (rigid, flexible, composite).
- Different rehabilitation strategies.
- Different pavement design lives (e.g., 20 vs. 40).

LCCA comparisons must be made between properly engineered, viable pavement structures that would be approved for construction if selected. The alternatives being evaluated should also have identical improvements. For example, comparing 20-year rehabilitation vs. 40-year rehabilitation or flexible pavement new construction vs. rigid pavement new construction, provide an identical improvement. Conversely, comparing pavement rehabilitation to new construction, or pavement overlay to pavement widening are not identical improvements.

LCCA can also be useful to determine the value of combining several projects into a single project. For example, combining a pavement rehabilitation project with a pavement widening project may reduce overall user delay and construction cost. In such case, LCCA can help determine if combining projects can reduce overall user delay and construction cost for more efficient and cost-effective projects. LCCA could also be used to identify and measure the impacts of splitting a project into two or more projects.

LCCA must conform to the procedures and data in the Life-Cycle Cost Analysis Procedures Manual available on the Department Pavement website. LCCA must be completed for any project with a pavement cost component except for the following:

- Pavement preservation projects (preventative maintenance and CAPM).
- Minor A and Minor B projects.
- Projects using Permit Engineering Evaluation Reports (PEER).
- Maintenance pullouts.
- Landscape.

For the above exempted projects, the Project Manager and the Project Development Team (PDT) will determine on a case-by-case basis if and how a life-cycle cost analysis should be performed and documented. LCCA must be performed and documented in the PID and PA&ED phases. If a change in pavement design is done after the PA&ED, the LCCA must be updated. The Project Engineer is responsible for coordinating all aspects of LCCA and utilizing the information to assure the most efficient use of transportation funds. Information on how to perform and document LCCA can be found in the LCCA Procedures Manual.

July 1, 2020

619.2 Life-Cycle Assessment

Life Cycle Assessment (LCA) is an approach to quantify the environmental impacts of industrial products and processes. The Department is currently developing a framework and a tool for using this concept to conduct life-cycle assessment for pavements. Using this tool, it is possible to quantify the amount of greenhouse gases (GHGs) emissions (in terms of tons of carbon dioxide equivalents) released during the production of the various materials to be used in pavement construction, transport to the job site, and use of these materials on the project, followed by the maintenance and rehabilitation of these materials, recycling, and disposal (i.e., a cradle-to-grave analysis). The tool will be valuable in the decision-making process regarding the selection of pavement type, materials, and rehabilitation strategies and will help the Department in the future achieve its sustainability goals. The tool will complement the LCCA tool in the final selection of pavement materials and strategies to minimize the carbon footprint associated with pavement.

CHAPTER 620 – RIGID PAVEMENT

Topic 621 – Types of Rigid Pavements

Index 621.1 – Continuously Reinforced Concrete Pavement (CRCP)

CRCP uses reinforcement rather than transverse joints for crack control. Longitudinal joints are still used. Transverse random cracks are expected in the slab, usually at 3 to 7-foot intervals (see Figure 621.1). The continuous reinforcement in the pavement holds the cracks tightly together.

CRCP can be used for concrete pavement new construction and concrete overlays for $TI \geq 13.0$ in all climate regions except High Mountain and High Desert. It can also be used for widening and replacement of existing lanes where there is adequate space to construct.

CRCP may cost more initially than other types of cast in place pavement due to the added cost of the reinforcement, but can be more cost-effective over the life of the pavement on high volume routes due to improved long-term performance and reduced maintenance.

Because there are no sawn transverse joints, CRCP should provide better ride quality and less maintenance than Jointed Plain Concrete Pavement (JPCP).

Additional CRCP guidance can be found in the “Concrete Pavement Guide” on the Department’s Pavement website.

621.2 Jointed Plain Concrete Pavement (JPCP)

JPCP is the most common type of rigid pavement used by the Department. JPCP uses longitudinal and transverse joints to control where cracking occurs in the slabs (see Figure 621.1), and does not contain reinforcement other than tie bars and dowel bars (see Index 622.4). Initially JPCP is cheaper to construct than CRCP but CRCP is cost effective over the life of the pavement. JPCP is recommended for lower volume truck routes ($TI < 13.0$), ramps, urban streets, pavements in High Mountain and High Desert climate regions and on widened and rehabilitated pavements where there is not sufficient space to construct CRCP.

Additional guidance for JPCP can be found in the “Guide for Design and Construction of New Jointed Plain Concrete Pavements” on the Department Pavement website.

621.3 Precast Concrete Pavement (PCP)

PCP uses panels that are precast off-site instead of cast in-place, which is basically the only difference between PCP and JPCP. Figure 621.1 does not show PCP because after installing the panels the section views of PCP are same as JPCP. The precast panels are linked together with dowel bars and should have tied bars like JPCP, at least in the outer or inner lanes. PCP offers the following advantages:

- Improved concrete mixing and curing as they are controlled in a precast yard.
- Shorter lane closure times than using conventional concrete for JPCP, which is beneficial when there are short construction windows.

The primary disadvantage of PCP is the high cost of fabrication, transportation and installation. PCP also needs a leveling system at the base underneath the precast panels during construction to even out the loads on the slab and avoid uneven deflections or stresses that could lead to faulting, slab settlement, and/or premature cracking. Although PCP is not currently included in the Standard Specs and Plans, it has been used since 2010 in California and should be considered.

Figure 621.1

Types of Rigid Pavement

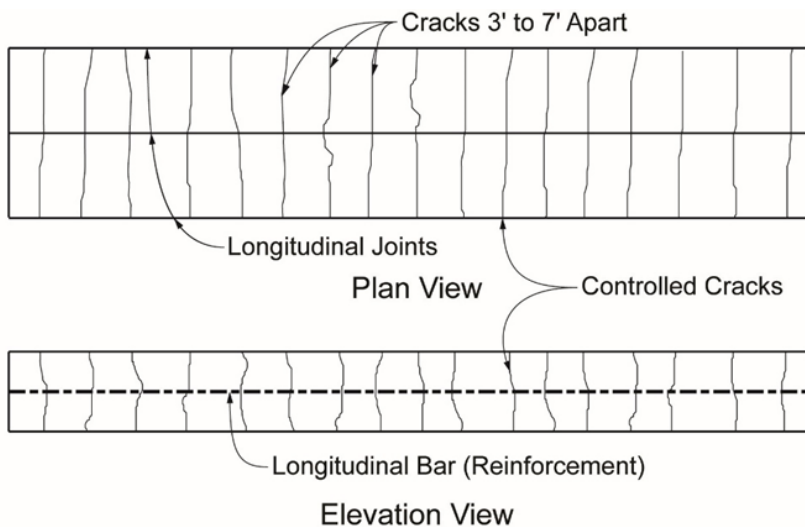

Continuously Reinforced Concrete Pavement (CRCP)

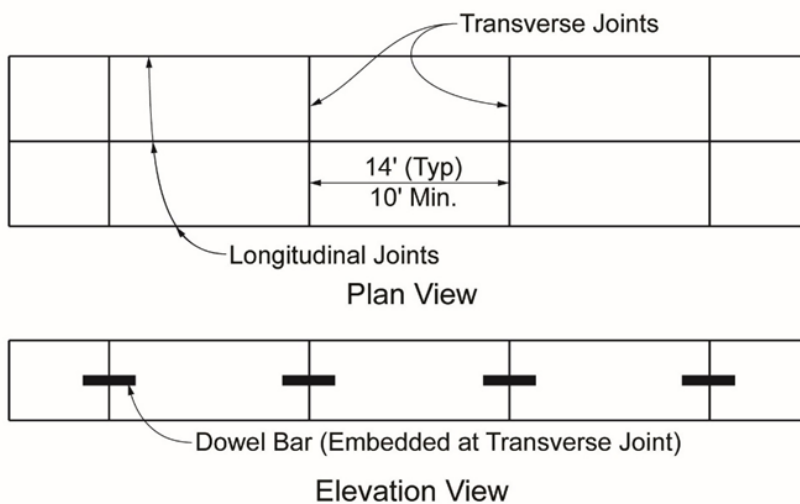

Jointed Plain Concrete Pavement (JPCP)

Topic 622 – Engineering Requirements

622.1 Engineering Properties

The predominant type of concrete used in California for rigid pavement is made of Type II Portland cement. Other types of hydraulic cement are sometimes used for special considerations such as rapid strength concrete (RSC), which can be made of Type III Portland cement, Calcium Sulfoaluminate (CSA) cement, or other proprietary rapid setting cements.

Table 622.1 shows the concrete engineering properties that were used to develop the rigid pavement design catalog in this chapter. The values are based on Department specifications and experience with materials used in California.

622.2 Performance Factors

The end-of-design life performance factors used to develop concrete pavement structure design catalogs found in this chapter are presented in Table 622.2. The design catalogs are intended to ensure that concrete pavements are engineered to meet or exceed the performance factors in Table 622.2 (i.e., the pavement structure will last longer before reaching these thresholds).

622.3 Types of Concrete

(1) *Portland Cement Concrete (PCC)*. Portland cement concrete is the most common concrete used. It is composed of Portland cement, supplementary cementitious materials, aggregate, water and sometimes chemical admixtures. It is typically produced by weighing materials in batches that are charged into a rotary drum mixer. For pavements, the mixer is usually stationary and the concrete is loaded into dump trucks for delivery. The concrete is normally placed and consolidated using a paving machine which incorporates internal vibrators, grade control and the screed among other things. Initial setting of the concrete is normally about 4 to 6 hours; however, accelerators can be added to make the time much shorter. Strength gain allows the pavement to be opened to traffic as early as 3 days and continues to increase for an extended period. Portland cement concrete is designed to resist environmentally induced degradation for over 100 years. Typical use for Portland cement concrete is new pavement, widening, reconstruction and rehabilitation.

December 31, 2020

Table 622.1

Concrete Properties Used in Developing Rigid Pavement Design Catalog

Property	Values
Transverse joint spacing	14 ft
Initial IRI immediately after construction	63 in/mile max
Reliability	90%
Unit weight	150 lb/ft ³
Poisson's ratio	0.20
Coefficient of thermal expansion	5.5 x 10 ⁻⁶ / °F
Thermal conductivity	1.25 $\frac{\text{Btu}}{\text{hr-ft-}^\circ\text{F}}$
Heat capacity	0.28 $\frac{\text{Btu}}{\text{lbm-}^\circ\text{F}}$
Permanent curl/warp effective temperature difference	Top of slab is 10 °F cooler than bottom of slab
Surface layer/base interface	Unbonded
Surface shortwave absorptivity	0.85
Cement type	Type II Portland Cement
Cement material content (cement + flyash)	24 lb/ft ³
Water: cementitious material ratio	0.42
PCC zero-stress temperature	100.9 °F
Ultimate shrinkage at 40% relative humidity	537 microstrain
Reversible shrinkage (% of ultimate shrinkage)	50%
Time to develop ultimate shrinkage	35 days
Modulus of rupture or flexural strength (28 days)	625 psi
Dowel bar diameter	1.5 in (1.25 in for rigid pavement thickness < 0.70 ft)

Table 622.2

Concrete Pavement Performance Factors

Factor	Value
General	
Design Life	Determined per Topic 612
Terminal IRI ⁽¹⁾ at end of design life	170 in/mile max
JPCP only	
Transverse cracking at end of design life	10% of slabs max
Average joint faulting at end of design life	0.10 inch max
CRCP only	
Punchouts at end of design life	10 per mile max

NOTE:

⁽¹⁾The International Roughness Index (IRI) is a nationally recognized method for measuring the smoothness of pavements.

(2) **Rapid Strength Concrete (RSC).** Rapid strength concrete is used in cases where rapid construction (typically 3 days or less) and accelerated opening to traffic is the most important consideration. RSC is either highly accelerated Portland cement concrete without supplementary cementitious materials or concrete made with a proprietary hydraulic cement which sets and gains strength extremely fast. It is produced either by weighing batches that are charged into a rotary drum mixer truck and then accelerated with chemicals at the pavement site or by volumetric proportioning and continuous mixing at the pavement site. The concrete is typically placed into forms or an excavated area and consolidated using hand held vibrators. Finishing is normally done with a roller screed and hand tools. The final finish is typically rougher than Portland cement concrete and grinding to achieve smoothness may be needed. Strength gain allows the pavement to be opened to traffic in hours where it continues to gain strength for several days. Rapid strength concrete is designed for rapid return to service. Because these products are relatively new to pavements, their long-term durability (40 or more years) has yet to be substantiated. Typical use for rapid strength concrete is JPCP replacement, punch-out repair, reconstruction or widening in locations where traffic cannot be diverted for at least 3 days.

(3) **Roller Compacted Concrete (RCC).** Roller compacted concrete is Portland cement concrete that is produced with water content diminished to the point that it must be consolidated with a vibratory roller, similar to asphalt pavement. The initial finish looks similar to an HMA surface. It is typically produced by volumetric proportioning and continuous mixing in a stationary plant and the concrete is loaded into dump trucks for delivery. The concrete is placed and shaped by a paving machine similar to an asphalt paving machine in lifts up to 0.80 ft. The concrete is compacted by a 10 ton vibratory roller. It is not as smooth as pavement placed with concrete paving machines. Strength gain allows the pavement to be opened to light traffic in 24 hours and heavy traffic (trucks) in 3 days. It will continue to gain strength for an extended period. Roller compacted concrete is designed to resist environmentally induced degradation for over 100 years.

December 31, 2020

Roller compacted concrete is only used on State highways for shoulders and temporary detours.

622.4 Pavement Joints

- (1) *Construction.* Construction joints are joints between sections of concrete slabs that result when concrete is placed at different times. Construction joints can be transverse or longitudinal and are constructed in all types of concrete pavements. Except for precast pavement, the joint is formed by placing a metal or wooden header board that is set vertical to the surface and at right angle or parallel to the centerline and it is of sufficient length and height so that it conforms to the cross section of the pavement.

For CRCP, construction joints allow for some paving breaks in the continuous concrete paving operation. On a subsequent paving day the joints are used to extend the pavement in-kind. Transverse construction joints typically include additional longitudinal reinforcement to keep construction cracks from widening. Holes are drilled in the header board to allow the longitudinal reinforcing bars to pass through the header board.

For JPCP, construction joints occur at planned transverse joints and longitudinal joints. They are typically placed by the contractor to facilitate their paving operation. Details and instructions for how to place construction joints in JPCP are found in the Standard Plans and Standard Specifications. Tie bars are typically used at longitudinal construction joints to connect the adjoining slabs together so that the construction joint will be tightly closed. Dowel bars are used at transverse construction joints to provide load transfer.

- (2) *Contraction.* Longitudinal and transverse contraction joints (also known as weakened plane joints) are sawed into new pavement to control the location and geometry of shrinkage, curling, and thermal cracking.

CRCP is constructed without transverse contraction joints. Transverse cracks are allowed to form but are held tightly together with continuous reinforcing steel.

JPCP contains contraction joints that create a weakened line across the slab to control the location of the expected natural cracks. The concrete is supposed to crack at the contraction joints and not elsewhere in the slabs. The Standard Plans show the typical spacing details for transverse contraction joints. For special situations, such as intersections and ramps, spacing layout will be needed. See HDM Index 626.3 for special consideration when engineering a rigid pavement intersection.

- (3) *Isolation.* Isolation joints are used to separate dissimilar pavements/structures in order to reduce compressive stresses that could cause cracking. Examples of dissimilar pavements/structures include different joint patterns, different types of concrete pavement (e.g., CRCP/JPCP), structure foundations, drainage inlets, drainage inlet depressions, manholes and manhole frame and cover. Isolation joints keep cracks from propagating through the joint and are sealed to prevent water/dirt infiltration. Isolation joints are most commonly placed along pavement longitudinal joints. Because of different arrangements for structure foundations, drainage inlets, drainage inlet depressions, and utility frames and covers, isolation joints are necessary to provide isolation to relieve stresses in the abutting faces of dissimilar pavements/structures.

- (4) *Expansion.* Expansion joints are used in CRCP as part of the expansion terminal joint system where there is a need to allow for a large expansion, greater than one half inch, between approach slabs and other types of pavements. They are typically placed in the transverse direction. Like isolation joints, expansion joints are sealed to prevent water and dirt infiltration. For CRCP, expansion joints are typically used where CRCP abuts up to bridges, structure approach slabs or other types of rigid pavements, including an existing CRCP. Expansion joints are typically not used with JPCP.

Typical joint spacing patterns can be found in the Standard Plans. In some cases such as intersections and parking lots, joint spacing patterns need to be engineered and included on project construction details. See Topic 626 for further details.

622.5 Transition Panels, Terminal Joints and End Anchors

Transition panels and end anchors are used at transverse joints to minimize deterioration or faulting of the joint where rigid pavement abuts to flexible pavement, a different type of rigid pavement, or a structure approach. The following types of transition joints and anchors should be used where applicable:

- (1) *Concrete Pavement Transition Panel.* The concrete pavement transition panel is used to provide a smooth transition between concrete and asphalt pavements (see Figure 622.5A) by minimizing distortion of asphalt at the joint. It can also be used as a transition between structure approach slabs and asphalt pavement.

Figure 622.5A

Concrete Pavement to Asphalt Pavement Transition Panel

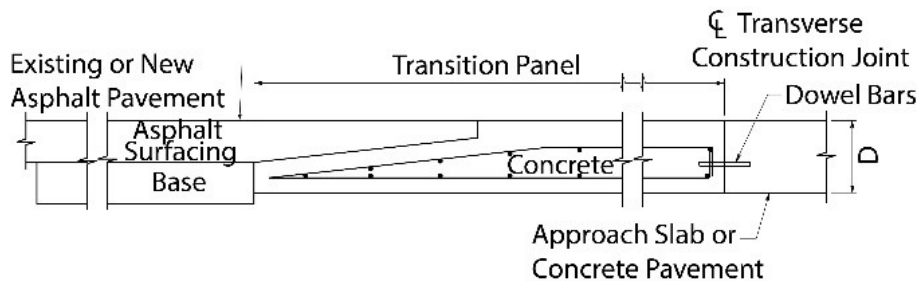

The transition panel is a 12-foot long reinforced concrete panel placed between the existing or new asphalt pavement and the concrete pavement or approach slab. It is not always possible to build this panel due to short construction windows and limited space. Where building this panel is not possible, a JPCP End Anchor or CRCP terminal joint type A or C should be used.

- (a) End Anchor - Use when JPCP abuts to asphalt or composite pavement and Concrete Pavement Transition Panel is not used. Also recommended where JPCP abuts to structure approach slabs. Consists of a 14-foot long end panel which varies in thickness from the designed thickness to 2 feet. Base type and thickness under the end anchor is the same as base under JPCP.
- (2) *Continuously Reinforced Concrete Pavement.* **For CRCP, expansion terminal joint systems (ETJS) shall be used at all transitions to or from structure approach slabs, whereas terminal joint type G shall be used at all transitions with another pavement as shown in Table 622.5.** Where a construction joint is not used to connect two segments of CRCP, a terminal joint G must be used, which includes an expansion joint. As indicated in Table 622.5, use an expansion terminal joint system (ETJS) or a terminal joint type G to accommodate and minimize the movement of the end of a CRCP section when it encounters a structure approach slab, abutment, or another pavement. The Standard Plans include a variety of details for these transitions.

December 31, 2020

Table 622.5**Use of Terminal Joints and Expansion Joints in CRCP**

Type	Structure Approach Slab or Abutment	New or Existing JPCP or Existing CRCP
Terminal Joint Type G	No	Yes
Expansion Terminal Joint System (ETJS) ⁽¹⁾	Yes	No

NOTE:

⁽¹⁾ Includes a Terminal Joint Type F.

Depending on the CRCP terminal type to be used, Figure 622.5B shows the schematic diagrams of Expansion Terminal Joint System between CRCP and existing structure approach slab.

The following types of joints and anchors are used for CRCP:

- (a) Terminal Joints – Terminal joints are used in CRCP to transition to another pavement type or to a structure approach slab. It is found at the beginning and end of all CRCP. Its function is to isolate CRCP and adjacent pavement types or approach slab to prevent damage and faulting at the transverse joint. The following are terminal joint types for CRCP:
- Terminal Joint Type (A) - Use when constructing new CRCP next to existing asphalt pavement and if a concrete pavement transition panel is not viable.
 - Terminal Joint Type (B) - Use when the newly constructed CRCP terminates at future pavement construction. CRCP at the terminus will be supported with a reinforced concrete support slab and backfilled with backing material and later removed when the new pavement will be constructed.
 - Terminal Joint Type (C) - Use when the newly constructed CRCP terminates at a proposed temporary asphalt pavement construction for traffic staging. CRCP at the terminus will be supported with a reinforced concrete support slab.
 - Terminal Joint Type (F) - Use when constructing new CRCP next to a structure approach slab.
 - Terminal Joint Type (G) - Use when constructing new CRCP next to new or existing JPCP, PCP, or existing CRCP.
- (b) Expansion Terminal Joint System (ETJS) - ETJS is a series of two 14-ft reinforced slabs with two full depth, full width transverse expansion joints designed to absorb the pavement expansion without damaging adjacent structures. These two expansion joints are placed on a 24-ft long support slab to provide load transfer (see Figure 622.5B).

Figure 622.5B

Expansion Terminal Joint System Between CRCP and Structure Approach Slab

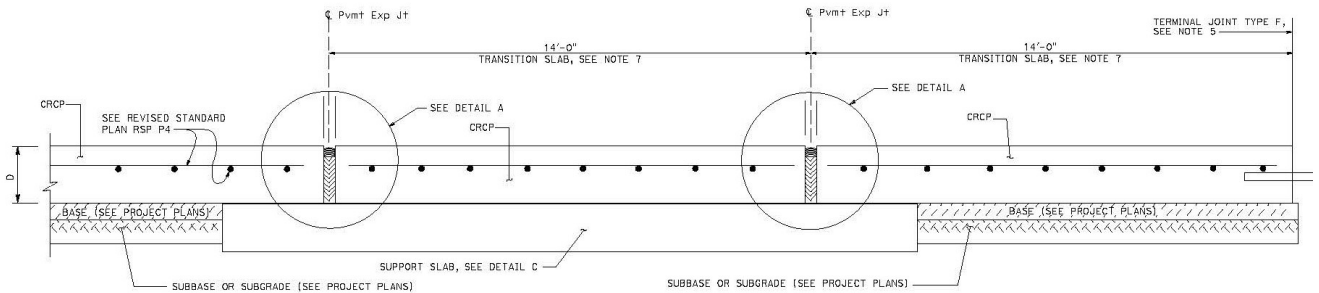

NO SCALE

(3) *Jointed Plain Concrete Pavement.* The following types of transition joints and anchors are used only for JPCP:

- (a) Terminal Joint Type 1 – Use when constructing new JPCP next to existing concrete pavement or structure approach slab. It consists of a transverse construction joint with dowel bars drilled and bonded to existing concrete.
- (b) Terminal Joint Type 2 – Use when constructing new JPCP next to new structure approach slabs or concrete to asphalt transition panel. It consists of a transverse construction joint with dowel bars placed at the joint of new concrete pavement or structure approach slabs and the new concrete.

622.6 Joint Seals

(1) *General.* Joint and crack seals are used to protect wide joints (joints 3/8 inch or wider) from infiltration of surface moisture and intrusion of incompressible materials. Infiltration of surface moisture and intrusion of incompressible materials into joints is minimized when a narrow joint is used.

(2) *New Construction, Widening, and Reconstruction.* Joints are not sealed or filled for new construction, widening, or for reconstruction except for the following conditions:

- isolation joints,
- expansion joints,
- longitudinal construction joints in all desert and mountain climate regions, and
- transverse joints in JPCP in all desert and mountain climate regions.

(3) *Preservation and Rehabilitation.* To be effective, existing joint seals should be replaced every 10 to 15 years depending on the type used. As part of preservation or rehabilitation strategies, existing joint seals should be replaced when the pavement is ground, replaced or dowel bar retrofitted. Previously unsealed joints should be reviewed to determine if joint sealing is warranted. The condition of the existing joints and joint seals should be reviewed with the District Maintenance or District Materials Engineer to determine if joint seal replacement is warranted.

(4) *Selection of Joint Seal Material.* Various products are available for sealing joints with each one differing in cost and service life. The type of joint sealant is selected based on the following criteria:

- Project environment.

In mountain and high desert climate regions where chains are used during winter storms, joint sealants that use backer rods are not recommended. Severe climate conditions (such as in the mountains or deserts) will require more durable sealants and/or more frequent replacement.

- Type of roadway.

Interstate or State highway, and corresponding traffic characteristics including traffic volumes and percentage of truck traffic.

- Condition of existing reservoir.

If the sides of in-place joint faces are variable in condition, do not use preformed compression seal.

- Expected performance.

If suitable for intended use and site conditions, the sealant with the longest service life is preferred.

The joint sealant selected should match the type of existing joint sealant being left in place.

- Cost effectiveness.

Life cycle cost analysis (LCCA) is used to select the appropriate sealant type.

Joint sealants should not last longer than the pavement being sealed.

622.7 Dowel Bars and Tie Bars

(1) Dowel bars are smooth round bars that act as load transfer devices across pavement joints.

Dowel bars shall be placed within the traveled way pavement structure at the following joints:

- **All transverse terminal joints in CRCP at new and existing JPCP or structure approach slabs.**
- **All transverse contraction and construction joints in JPCP.**
- **All transverse construction joints in PCP.**
- **All transverse transition joints regardless of concrete pavement type where concrete pavement abuts to structure approach slabs or other concrete pavement type.**

Dowel bars should not be used on shoulders except within the limits of widened slabs and for tied concrete shoulders that are engineered to be converted to a future lane in conformance with Index 613.5(2). When dowel bars are used, they must meet the same requirements as the traveled way.

For JPCP slab replacements, the placement of dowel bars is determined on a project-by-project basis based on proposed design life, condition or remaining service life of adjacent

slabs, whether original pavement was constructed doweled or undoweled, and other pertinent factors. Details for doweling slab replacements for JPCP can be found in the Standard Plans.

In limited situations, dowel bars are placed across longitudinal joints. See Standard Plans for further details.

(2) *Tie Bars*. Tie bars are deformed bars (i.e., rebar) or connectors that are used to hold the faces of abutting rigid slabs in contact. Tie bars are typically placed across longitudinal joints. **Tie bars shall be placed at longitudinal joints except at the following locations:**

- Adjacent concrete pavement when the spacing of transverse joints of adjacent slabs is not the same.
- Roller compacted concrete.
- Do not tie more than 50 feet width of JPCP together to preclude random longitudinal cracks from occurring due to the pavement acting as one large rigid slab. In order to maintain some load transfer across the longitudinal joint, the Standard Plans include details for placing dowel bars in the longitudinal joint within the travelled way for this situation.
- Individual slab replacements.

Further details regarding tie bars can be found in the Standard Plans.

622.8 Base Interlayer

When concrete pavement is placed on a concrete base without an engineered interlayer (a.k.a. bond breaker) uncontrolled cracking can occur. In areas of bonding, the pavement and base act as a monolithic mass causing sawn joints to be ineffective due to insufficient depth. This causes cracks to occur in the pavement surface in unexpected areas. To prevent bonding and subsequent crack formation, use a base interlayer between concrete pavement and concrete bases, including lean concrete base, cement treated permeable base, and cement treated base.

Several methods are available for using an interlayer including sufficient application of wax curing compound, geosynthetic, or asphalt binder. When using rapid strength concrete, plastic sheeting or paper may also be suitable alternatives. Asphalt pavement interlayers can be used but it is more efficient to use asphalt base for construction than require two separate products. The Standard Specifications and Standard Special Provisions provide the options for the Contractor to select but the designer should specify them on the plans if a specific interlayer is to be used. For design, the engineer needs to identify on the typical sections when the interlayer is to be installed.

622.9 Texturing

Longitudinal tining is the typical texturing for new pavements. Grooving is typically done to rehabilitate existing pavement texture or to improve surface friction. Grinding is typically done to restore a smooth riding surface on existing pavements or for individual slab replacements.

622.10 Pavement Smoothness

Pavement smoothness, which is also referred to as ride quality, is an important surface texture characteristic that affects both long-term pavement performance as well as ride quality. Smoother pavements have lower dynamic loads and provide the following benefits:

- Improved ride quality;
- Extended pavement life;
- Reduced highway travel user costs, such as gas usage and wear and tear; and
- Lower pavement maintenance costs and less work zone activities.

Pavement smoothness, or ride quality, is measured in terms of the International Roughness Index (IRI). For new construction, reconstruction or widening/lane replacement projects, the concrete pavement is engineered and built to have an IRI. For additional information, see the pavement smoothness page on the Department Pavement website.

Topic 623 – Engineering Procedure for New, Widening, and Reconstruction Projects

623.1 Catalog

Tables 623.1B through M contain the minimum thickness for concrete pavement surface layers, base, and subbase of the traveled way for all types of projects. All JPCP structures shown are doweled. The tables are categorized by subgrade soil type and climate regions. Figure 623.1 is used to determine which table to use to select the traveled way pavement structure. For pavement structure types at other locations such as shoulders and parking lots, see Topic 626.

The steps for selecting the appropriate concrete pavement structure are as follows:

- (1) *Determine the Soil Type for the Existing Subgrade.* Soil types for existing subgrade are categorized into Types I, II, and III as shown in Table 623.1A. Soils are classified by the Unified Soil Classification System (USCS). If a soil can be classified in more than one type in Table 623.1A, then the engineer should choose the more conservative design based on the less stable soil. Subgrade is discussed in Topic 614.
- (2) *Determine Climate Region.* Find the location of the project on the Pavement Climate Map. The Pavement Climate Map is discussed in Topic 615.
- (3) *Select the Appropriate Table (Tables 623.1B through M).* Select the table that applies to the project based on subgrade soil type, and climate region. Use Figure 623.1 to determine which table applies to the project.
- (4) *Determine Whether Pavement Has Lateral Support Along Both Longitudinal Joints.* The pavement is considered to have lateral support if any of the following exist:
 - longitudinal joints are tied to an adjacent lane or shoulder,
 - tied rigid shoulders are present, or
 - a widened slab is present.

If lateral support is provided along only one longitudinal joint, then the pavement is considered to have no lateral support. As shown in Tables 623.1B through M, pavement thicknesses are reduced slightly for slabs engineered with lateral support along both longitudinal joints.

(5) *Select Pavement Structure.* Using the Traffic Index provided or calculated from the traffic projections, select the desired pavement structure from the list of alternatives provided.

Note that although the pavement structures listed for each Traffic Index are considered to be acceptable for the climate, soil conditions, and design life desired, they should not be considered as equal designs. Some designs will perform better than others, have lower maintenance/repair costs, and/or lower construction life-cycle costs. For these reasons, the rigid pavement structures in these tables cannot be used as substitutes for the pavement structures shown in approved contract plans.

Figure 623.1

Rigid Pavement Catalog Decision Tree

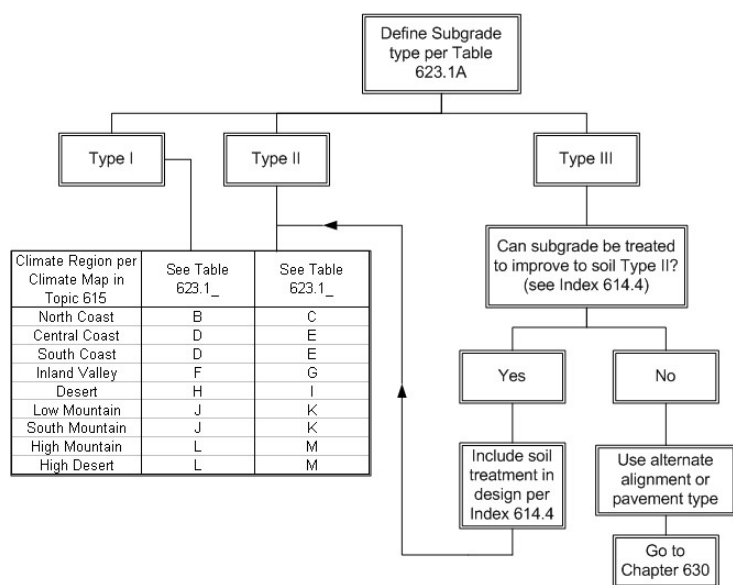

Table 623.1A

Relationship Between Subgrade Type⁽¹⁾

Subgrade Type ⁽²⁾	Unified Soil Classification System (USCS)
I	SC, SP, SM, SW, GC, GP, GM, GW
II	CH (PI ≤ 12), CL, MH, ML
III	CH (PI > 12)

NOTES:

(1) See Topic 614 for further discussion on subgrade and USCS.

(2) Choose more conservative soil type (i.e., use soil with a lower subgrade type) if native soil can be classified by more than one type.

Legend

PI = Plasticity Index

Table 623.1B

Rigid Pavement Catalog (North Coast, Type I Subgrade Soil)^{(1), (2), (3), (4), (5)}

TI	Rigid Pavement Structural Depth					
	With Lateral Support (ft)			Without Lateral Support (ft)		
≤ 9	0.70 JPCP 0.50 AB			0.70 JPCP 0.50 AB		
9.5 to 10	0.75 JPCP 0.60 AB			0.75 JPCP 0.60 AB		
10.5 to 11	0.70 JPCP 0.35 LCB	0.70 JPCP 0.25 HMA-A	0.75 JPCP 0.70 AB	0.75 JPCP 0.35 LCB	0.75 JPCP 0.25 HMA-A	0.80 JPCP 0.70 AB
11.5 to 12	0.75 JPCP 0.35 LCB	0.75 JPCP 0.25 HMA-A	0.75 CRCP 0.25 HMA-A	0.80 JPCP 0.35 LCB	0.80 JPCP 0.25 HMA-A	0.80 CRCP 0.25 HMA-A
12.5 to 13	0.80 JPCP 0.35 LCB	0.80 JPCP 0.25 HMA-A	0.75 CRCP 0.25 HMA-A	0.85 JPCP 0.35 LCB	0.85 JPCP 0.25 HMA-A	0.80 CRCP 0.25 HMA-A
13.5 to 14	0.80 JPCP 0.35 LCB	0.80 JPCP 0.25 HMA-A	0.75 CRCP 0.25 HMA-A	0.90 JPCP 0.35 LCB	0.85 JPCP 0.25 HMA-A	0.80 CRCP 0.25 HMA-A
14.5 to 15	0.85 JPCP 0.35 LCB	0.85 JPCP 0.25 HMA-A	0.80 CRCP 0.25 HMA-A	0.95 JPCP 0.35 LCB	0.95 JPCP 0.25 HMA-A	0.85 CRCP 0.25 HMA-A
15.5 to 16	0.90 JPCP 0.35 LCB	0.90 JPCP 0.25 HMA-A	0.85 CRCP 0.25 HMA-A	1.00 JPCP 0.35 LCB	1.00 JPCP 0.25 HMA-A	0.90 CRCP 0.25 HMA-A
16.5 to 17	0.95 JPCP 0.35 LCB	0.95 JPCP 0.25 HMA-A	0.85 CRCP 0.25 HMA-A	1.05 JPCP 0.35 LCB	1.05 JPCP 0.25 HMA-A	0.95 CRCP 0.25 HMA-A
> 17	1.00 JPCP 0.35 LCB	1.00 JPCP 0.25 HMA-A	0.90 CRCP 0.25 HMA-A	1.10 JPCP 0.35 LCB	1.10 JPCP 0.25 HMA-A	1.00 CRCP 0.25 HMA-A

NOTES:

- (1) Thicknesses shown for JPCP are for doweled pavement only. The thickness shown in these tables are not valid for nondoweled JPCP.
- (2) Includes 0.03 ft sacrificial wearing course for future grinding of JPCP/CRCP.
- (3) Portland cement concrete may be substituted for LCB when justified for constructability or traffic handling. If Portland cement concrete is used in lieu of LCB, it must be placed in a separate lift than JPCP and must not be bonded to the JPCP.
- (4) If ATPB is needed for TIs > 10.0 to perpetuate an existing treated permeable layer, place the ATPB between the surface layer (JPCP or CRCP) and the base layer. No deduction is made to the thickness of the base and subbase layers on account of the ATPB.
- (5) Place an interlayer between JPCP and LCB in all cases

LEGEND:

JPCP = Jointed Plain Concrete Pavement	ATPB = Asphalt Treated Permeable Base
CRCP = Continuously Reinforced Concrete Pavement	AB = Class 2 Aggregate Base
LCB = Lean Concrete Base	TI = Traffic Index
HMA-A = Hot Mix Asphalt (Type A)	

Table 623.1C

Rigid Pavement Catalog (North Coast, Type II Subgrade Soil) (1), (2), (3), (4), (5)

TI	Rigid Pavement Structural Depth					
	With Lateral Support (ft)			Without Lateral Support (ft)		
< 9	0.70 JPCP 1.00 AB			0.70 JPCP 1.00 AB		
9.5 to 10	0.75 JPCP 1.00 AB			0.75 JPCP 1.00 AB		
10.5 to 11	0.70 JPCP 0.35 LCB 0.60 AS	0.70 JPCP 0.25 HMA-A 0.60 AS	0.75 JPCP 1.30 AB	0.75 JPCP 0.35 LCB 0.60 AS	0.75 JPCP 0.25 HMA-A 0.60 AS	0.80 JPCP 1.30 AB
11.5 to 12	0.75 JPCP 0.35 LCB 0.60 AS	0.75 JPCP 0.25 HMA-A 0.60 AS	0.75 CRCP 0.25 HMA-A 0.60 AS	0.80 JPCP 0.35 LCB 0.60 AS	0.80 JPCP 0.25 HMA-A 0.60 AS	0.80 CRCP 0.25 HMA-A 0.60 AS
12.5 to 13	0.80 JPCP 0.35 LCB 0.70 AS	0.80 JPCP 0.25 HMA-A 0.70 AS	0.75 CRCP 0.25 HMA-A 0.70 AS	0.85 JPCP 0.35 LCB 0.70 AS	0.85 JPCP 0.25 HMA-A 0.70 AS	0.80 CRCP 0.25 HMA-A 0.70 AS
13.5 to 14	0.80 JPCP 0.35 LCB 0.70 AS	0.80 JPCP 0.25 HMA-A 0.70 AS	0.75 CRCP 0.25 HMA-A 0.70 AS	0.90 JPCP 0.35 LCB 0.70 AS	0.85 JPCP 0.25 HMA-A 0.70 AS	0.80 CRCP 0.25 HMA-A 0.70 AS
14.5 to 15	0.85 JPCP 0.35 LCB 0.70 AS	0.85 JPCP 0.25 HMA-A 0.70 AS	0.80 CRCP 0.25 HMA-A 0.70 AS	0.95 JPCP 0.35 LCB 0.70 AS	0.95 JPCP 0.25 HMA-A 0.70 AS	0.85 CRCP 0.25 HMA-A 0.70 AS
15.5 to 16	0.90 JPCP 0.35 LCB 0.70 AS	0.90 JPCP 0.25 HMA-A 0.70 AS	0.85 CRCP 0.25 HMA-A 0.70 AS	1.00 JPCP 0.35 LCB 0.70 AS	1.00 JPCP 0.25 HMA-A 0.70 AS	0.90 CRCP 0.25 HMA-A 0.70 AS
16.5 to 17	0.95 JPCP 0.35 LCB 0.70 AS	0.95 JPCP 0.25 HMA-A 0.70 AS	0.85 CRCP 0.25 HMA-A 0.70 AS	1.05 JPCP 0.35 LCB 0.70 AS	1.05 JPCP 0.25 HMA-A 0.70 AS	0.95 CRCP 0.25 HMA-A 0.70 AS
> 17	1.00 JPCP 0.35 LCB 0.70 AS	1.00 JPCP 0.25 HMA-A 0.70 AS	0.90 CRCP 0.25 HMA-A 0.70 AS	1.10 JPCP 0.35 LCB 0.70 AS	1.10 JPCP 0.25 HMA-A 0.70 AS	1.00 CRCP 0.25 HMA-A 0.70 AS

NOTES:

- (1) Thicknesses shown for JPCP are for doweled pavement only. The thickness shown in these tables are not valid for nondoweled JPCP.
- (2) Includes 0.03 ft sacrificial wearing course for future grinding of JPCP/CRCP.
- (3) Portland cement concrete may be substituted for LCB when justified for constructability or traffic handling. If Portland cement concrete is used in lieu of LCB, it must be placed in a separate lift than JPCP and must not be bonded to the JPCP.
- (4) If ATPB is needed for TIs > 10.0 to perpetuate an existing treated permeable layer, place the ATPB between the surface layer (JPCP or CRCP) and the base layer. No deduction is made to the thickness of the base and subbase layers on account of the ATPB.
- (5) Place an interlayer between JPCP and LCB in all cases

LEGEND:

JPCP = Jointed Plain Concrete Pavement
 CRCP = Continuously Reinforced Concrete Pavement
 LCB = Lean Concrete Base
 HMA-A = Hot Mix Asphalt (Type A)

ATPB = Asphalt Treated Permeable Base
 AB = Class 2 Aggregate Base
 AS = Class 2 Aggregate Subbase
 TI = Traffic Index

December 31, 2020

Table 623.1D

Rigid Pavement Catalog (South Coast/Central Coast, Type I Subgrade Soil) (1), (2), (3), (4), (5)

TI	Rigid Pavement Structural Depth					
	With Lateral Support (ft)			Without Lateral Support (ft)		
≤ 9	0.70 JPCP 0.50 AB			0.75 JPCP 0.50 AB		
9.5 to 10	0.75 JPCP 0.60 AB			0.80 JPCP 0.60 AB		
10.5 to 11	0.75 JPCP 0.35 LCB	0.75 JPCP 0.25 HMA-A	0.80 JPCP 0.70 AB	0.80 JPCP 0.35 LCB	0.80 JPCP 0.25 HMA-A	0.85 JPCP 0.70 AB
11.5 to 12	0.80 JPCP 0.35 LCB	0.80 JPCP 0.25 HMA-A	0.80 CRCP 0.25 HMA-A	0.85 JPCP 0.35 LCB	0.85 JPCP 0.25 HMA-A	0.80 CRCP 0.25 HMA-A
12.5 to 13	0.85 JPCP 0.35 LCB	0.85 JPCP 0.25 HMA-A	0.80 CRCP 0.25 HMA-A	0.90 JPCP 0.35 LCB	0.90 JPCP 0.25 HMA-A	0.85 CRCP 0.25 HMA-A
13.5 to 14	0.85 JPCP 0.35 LCB	0.85 JPCP 0.25 HMA-A	0.80 CRCP 0.25 HMA-A	0.95 JPCP 0.35 LCB	0.95 JPCP 0.25 HMA-A	0.90 CRCP 0.25 HMA-A
14.5 to 15	0.90 JPCP 0.35 LCB	0.90 JPCP 0.25 HMA-A	0.85 CRCP 0.25 HMA-A	1.00 JPCP 0.35 LCB	1.00 JPCP 0.25 HMA-A	0.95 CRCP 0.25 HMA-A
15.5 to 16	0.95 JPCP 0.35 LCB	0.90 JPCP 0.25 HMA-A	0.85 CRCP 0.25 HMA-A	1.05 JPCP 0.35 LCB	1.05 JPCP 0.25 HMA-A	0.95 CRCP 0.25 HMA-A
16.5 to 17	1.00 JPCP 0.35 LCB	0.95 JPCP 0.25 HMA-A	0.90 CRCP 0.25 HMA-A	1.10 JPCP 0.35 LCB	1.10 JPCP 0.25 HMA-A	1.00 CRCP 0.25 HMA-A
> 17	1.05 JPCP 0.35 LCB	1.05 JPCP 0.25 HMA-A	0.95 CRCP 0.25 HMA-A	1.15 JPCP 0.35 LCB	1.15 JPCP 0.25 HMA-A	1.00 CRCP 0.25 HMA-A

NOTES:

- (1) Thicknesses shown for JPCP are for doweled pavement only. The thickness shown in these tables are not valid for nondoweled JPCP.
- (2) Includes 0.03 ft sacrificial wearing course for future grinding of JPCP/CRCP.
- (3) Portland cement concrete may be substituted for LCB when justified for constructability or traffic handling. If Portland cement concrete is used in lieu of LCB, it must be placed in a separate lift than JPCP and must not be bonded to the JPCP.
- (4) If ATPB is needed for TIs > 10.0 to perpetuate an existing treated permeable layer, place the ATPB between the surface layer (JPCP or CRCP) and the base layer. No deduction is made to the thickness of the base and subbase layers on account of the ATPB.
- (5) Place an interlayer between JPCP and LCB in all cases

LEGEND:

JPCP =	Jointed Plain Concrete Pavement	ATPB =	Asphalt Treated Permeable Base
CRCP =	Continuously Reinforced Concrete Pavement	AB =	Class 2 Aggregate Base
LCB =	Lean Concrete Base	TI =	Traffic Index
HMA-A =	Hot Mix Asphalt (Type A)		

Table 623.1E

Rigid Pavement Catalog (South Coast/Central Coast, Type II Subgrade Soil) (1), (2), (3), (4), (5)

TI	Rigid Pavement Structural Depth					
	With Lateral Support (ft)			Without Lateral Support (ft)		
≤ 9	0.70 JPCP 1.00 AB			0.75 JPCP 1.00 AB		
9.5 to 10	0.75 JPCP 1.00 AB			0.80 JPCP 1.00 AB		
10.5 to 11	0.75 JPCP 0.35 LCB 0.60 AS	0.75 JPCP 0.25 HMA-A 0.60 AS	0.80 JPCP 1.30 AB	0.80 JPCP 0.35 LCB 0.60 AS	0.80 JPCP 0.25 HMA-A 0.60 AS	0.85 JPCP 1.30 AB
11.5 to 12	0.80 JPCP 0.35 LCB 0.60 AS	0.80 JPCP 0.25 HMA-A 0.60 AS	0.80 CRCP 0.25 HMA-A 0.60 AS	0.85 JPCP 0.35 LCB 0.60 AS	0.85 JPCP 0.25 HMA-A 0.60 AS	0.80 CRCP 0.25 HMA-A 0.60 AS
12.5 to 13	0.85 JPCP 0.35 LCB 0.70 AS	0.85 JPCP 0.25 HMA-A 0.70 AS	0.80 CRCP 0.25 HMA-A 0.70 AS	0.90 JPCP 0.35 LCB 0.70 AS	0.90 JPCP 0.25 HMA-A 0.70 AS	0.85 CRCP 0.25 HMA-A 0.70 AS
13.5 to 14	0.85 JPCP 0.35 LCB 0.70 AS	0.85 JPCP 0.25 HMA-A 0.70 AS	0.80 CRCP 0.25 HMA-A 0.70 AS	0.95 JPCP 0.35 LCB 0.70 AS	0.95 JPCP 0.25 HMA-A 0.70 AS	0.90 CRCP 0.25 HMA-A 0.70 AS
14.5 to 15	0.90 JPCP 0.35 LCB 0.70 AS	0.90 JPCP 0.25 HMA-A 0.70 AS	0.85 CRCP 0.25 HMA-A 0.70 AS	1.00 JPCP 0.35 LCB 0.70 AS	1.00 JPCP 0.25 HMA-A 0.70 AS	0.95 CRCP 0.25 HMA-A 0.70 AS
15.5 to 16	0.95 JPCP 0.35 LCB 0.70 AS	0.90 JPCP 0.25 HMA-A 0.70 AS	0.85 CRCP 0.25 HMA-A 0.70 AS	1.05 JPCP 0.35 LCB 0.70 AS	1.05 JPCP 0.25 HMA-A 0.70 AS	0.95 CRCP 0.25 HMA-A 0.70 AS
16.5 to 17	1.00 JPCP 0.35 LCB 0.70 AS	0.95 JPCP 0.25 HMA-A 0.70 AS	0.90 CRCP 0.25 HMA-A 0.70 AS	1.10 JPCP 0.35 LCB 0.70 AS	1.10 JPCP 0.25 HMA-A 0.70 AS	1.00 CRCP 0.25 HMA-A 0.70 AS
> 17	1.05 JPCP 0.35 LCB 0.70 AS	1.05 JPCP 0.25 HMA-A 0.70 AS	0.95 CRCP 0.25 HMA-A 0.70 AS	1.15 JPCP 0.35 LCB 0.70 AS	1.15 JPCP 0.25 HMA-A 0.70 AS	1.00 CRCP 0.25 HMA-A 0.70 AS

NOTES:

- (1) Thicknesses shown for JPCP are for doweled pavement only. The thickness shown in these tables are not valid for nondoweled JPCP.
- (2) Includes 0.03 ft sacrificial wearing course for future grinding of JPCP/CRCP.
- (3) Portland cement concrete may be substituted for LCB when justified for constructability or traffic handling. If Portland cement concrete is used in lieu of LCB, it must be placed in a separate lift than JPCP and must not be bonded to the JPCP.
- (4) If ATPB is needed for TIs > 10.0 to perpetuate an existing treated permeable layer, place the ATPB between the surface layer (JPCP or CRCP) and the base layer. No deduction is made to the thickness of the base and subbase layers on account of the ATPB.
- (5) Place an interlayer between JPCP and LCB in all cases

LEGEND:

JPCP = Jointed Plain Concrete Pavement	ATPB = Asphalt Treated Permeable Base
CRCP = Continuously Reinforced Concrete Pavement	AB = Class 2 Aggregate Base
LCB = Lean Concrete Base	AS = Class 2 Aggregate Subbase
HMA-A = Hot Mix Asphalt (Type A)	TI = Traffic Index

Table 623.1F

Rigid Pavement Catalog (Inland Valley, Type I Subgrade Soil) (1), (2), (3), (4), (5)

TI	Rigid Pavement Structural Depth					
	With Lateral Support (ft)			Without Lateral Support (ft)		
< 9	0.75 JPCP 0.50 AB			0.80 JPCP 0.50 AB		
9.5 to 10	0.80 JPCP 0.60 AB			0.90 JPCP 0.60 AB		
10.5 to 11	0.75 JPCP 0.35 LCB	0.75 JPCP 0.25 HMA-A	0.85 JPCP 0.70 AB	0.85 JPCP 0.35 LCB	0.90 JPCP 0.25 HMA-A	0.95 JPCP 0.70 AB
11.5 to 12	0.85 JPCP 0.35 LCB	0.85 JPCP 0.25 HMA-A	0.80 CRCP 0.25 HMA-A	0.95 JPCP 0.35 LCB	0.95 JPCP 0.25 HMA-A	0.85 CRCP 0.25 HMA-A
12.5 to 13	0.85 JPCP 0.35 LCB	0.90 JPCP 0.25 HMA-A	0.80 CRCP 0.25 HMA-A	1.00 JPCP 0.35 LCB	1.00 JPCP 0.25 HMA-A	0.90 CRCP 0.25 HMA-A
13.5 to 14	0.95 JPCP 0.35 LCB	0.95 JPCP 0.25 HMA-A	0.85 CRCP 0.25 HMA-A	1.05 JPCP 0.35 LCB	1.05 JPCP 0.25 HMA-A	0.95 CRCP 0.25 HMA-A
14.5 to 15	1.00 JPCP 0.35 LCB	1.00 JPCP 0.25 HMA-A	0.90 CRCP 0.25 HMA-A	1.15 JPCP 0.35 LCB	1.15 JPCP 0.25 HMA-A	1.00 CRCP 0.25 HMA-A
15.5 to 16	1.05 JPCP 0.35 LCB	1.05 JPCP 0.25 HMA-A	0.95 CRCP 0.25 HMA-A	1.20 JPCP 0.35 LCB	1.20 JPCP 0.25 HMA-A	1.05 CRCP 0.25 HMA-A
16.5 to 17	1.10 JPCP 0.35 LCB	1.10 JPCP 0.25 HMA-A	0.95 CRCP 0.25 HMA-A	1.25 JPCP 0.35 LCB	1.25 JPCP 0.25 HMA-A	1.10 CRCP 0.25 HMA-A
> 17	1.15 JPCP 0.35 LCB	1.15 JPCP 0.25 HMA-A	1.00 CRCP 0.25 HMA-A	1.30 JPCP 0.35 LCB	1.30 JPCP 0.25 HMA-A	1.10 CRCP 0.25 HMA-A

NOTES:

- (1) Thicknesses shown for JPCP are for doweled pavement only. The thickness shown in these tables are not valid for nondoweled JPCP.
- (2) Includes 0.03 ft sacrificial wearing course for future grinding of JPCP/CRCP.
- (3) Portland cement concrete may be substituted for LCB when justified for constructability or traffic handling. If Portland cement concrete is used in lieu of LCB, it must be placed in a separate lift than JPCP and must not be bonded to the JPCP.
- (4) If ATPB is needed for TIs > 10.0 to perpetuate an existing treated permeable layer, place the ATPB between the surface layer (JPCP or CRCP) and the base layer. No deduction is made to the thickness of the base and subbase layers on account of the ATPB.
- (5) Place an interlayer between JPCP and LCB in all cases

LEGEND:

JPCP =	Jointed Plain Concrete Pavement	ATPB =	Asphalt Treated Permeable Base
CRCP =	Continuously Reinforced Concrete Pavement	AB =	Class 2 Aggregate Base
LCB =	Lean Concrete Base	TI =	Traffic Index
HMA-A =	Hot Mix Asphalt (Type A)		

Table 623.1G

Rigid Pavement Catalog (Inland Valley, Type II Subgrade Soil)^{(1), (2), (3), (4), (5)}

TI	Rigid Pavement Structural Depth					
	With Lateral Support (ft)			Without Lateral Support (ft)		
≤ 9	0.75 JPCP 1.00 AB			0.80 JPCP 1.00 AB		
9.5 to 10	0.80 JPCP 1.00 AB			0.90 JPCP 1.00 AB		
10.5 to 11	0.75 JPCP 0.35 LCB 0.60 AS	0.75 JPCP 0.25 HMA-A 0.60 AS	0.85 JPCP 1.30 AB	0.85 JPCP 0.35 LCB 0.60 AS	0.90 JPCP 0.25 HMA-A 0.60 AS	0.95 JPCP 1.30 AB
11.5 to 12	0.85 JPCP 0.35 LCB 0.60 AS	0.85 JPCP 0.25 HMA-A 0.60 AS	0.80 CRCP 0.25 HMA-A 0.60 AS	0.95 JPCP 0.35 LCB 0.60 AS	0.95 JPCP 0.25 HMA-A 0.60 AS	0.85 CRCP 0.25 HMA-A 0.60 AS
12.5 to 13	0.85 JPCP 0.35 LCB 0.70 AS	0.90 JPCP 0.25 HMA-A 0.70 AS	0.80 CRCP 0.25 HMA-A 0.70 AS	1.00 JPCP 0.35 LCB 0.70 AS	1.00 JPCP 0.25 HMA-A 0.70 AS	0.90 CRCP 0.25 HMA-A 0.70 AS
13.5 to 14	0.95 JPCP 0.35 LCB 0.70 AS	0.95 JPCP 0.25 HMA-A 0.70 AS	0.85 CRCP 0.25 HMA-A 0.70 AS	1.05 JPCP 0.35 LCB 0.70 AS	1.05 JPCP 0.25 HMA-A 0.70 AS	0.95 CRCP 0.25 HMA-A 0.70 AS
14.5 to 15	1.00 JPCP 0.35 LCB 0.70 AS	1.00 JPCP 0.25 HMA-A 0.70 AS	0.90 CRCP 0.25 HMA-A 0.70 AS	1.15 JPCP 0.35 LCB 0.70 AS	1.15 JPCP 0.25 HMA-A 0.70 AS	1.00 CRCP 0.25 HMA-A 0.70 AS
15.5 to 16	1.05 JPCP 0.35 LCB 0.70 AS	1.05 JPCP 0.25 HMA-A 0.70 AS	0.95 CRCP 0.25 HMA-A 0.70 AS	1.20 JPCP 0.35 LCB 0.70 AS	1.20 JPCP 0.25 HMA-A 0.70 AS	1.05 CRCP 0.25 HMA-A 0.70 AS
16.5 to 17	1.10 JPCP 0.35 LCB 0.70 AS	1.10 JPCP 0.25 HMA-A 0.70 AS	0.95 CRCP 0.25 HMA-A 0.70 AS	1.25 JPCP 0.35 LCB 0.70 AS	1.25 JPCP 0.25 HMA-A 0.70 AS	1.10 CRCP 0.25 HMA-A 0.70 AS
> 17	1.15 JPCP 0.35 LCB 0.70 AS	1.15 JPCP 0.25 HMA-A 0.70 AS	1.00 CRCP 0.25 HMA-A 0.70 AS	1.30 JPCP 0.35 LCB 0.70 AS	1.30 JPCP 0.25 HMA-A 0.70 AS	1.10 CRCP 0.25 HMA-A 0.70 AS

NOTES:

- (1) Thicknesses shown for JPCP are for doweled pavement only. The thickness shown in these tables are not valid for nondoweled JPCP.
- (2) Includes 0.03 ft sacrificial wearing course for future grinding of JPCP/CRCP.
- (3) Portland cement concrete may be substituted for LCB when justified for constructability or traffic handling. If Portland cement concrete is used in lieu of LCB, it must be placed in a separate lift than JPCP and must not be bonded to the JPCP.
- (4) If ATPB is needed for TIs > 10.0 to perpetuate an existing treated permeable layer, place the ATPB between the surface layer (JPCP or CRCP) and the base layer. No deduction is made to the thickness of the base and subbase layers on account of the ATPB.
- (5) Place an interlayer between JPCP and LCB in all cases

LEGEND:

JPCP = Jointed Plain Concrete Pavement	ATPB = Asphalt Treated Permeable Base
CRCP = Continuously Reinforced Concrete Pavement	AB = Class 2 Aggregate Base
LCB = Lean Concrete Base	AS = Class 2 Aggregate Subbase
HMA-A = Hot Mix Asphalt (Type A)	TI = Traffic Index

Table 623.1H

Rigid Pavement Catalog (Desert, Type I Subgrade Soil) (1), (2), (3), (4), (5)

TI	Rigid Pavement Structural Depth					
	With Lateral Support (ft)			Without Lateral Support (ft)		
< 9	0.70 JPCP	0.70 JPCP	0.75 JPCP	0.75 JPCP	0.75 JPCP	0.80 JPCP
	0.35 LCB	0.25 HMA-A	0.50 AB	0.35 LCB	0.25 HMA-A	0.50 AB
9.5 to 10	0.75 JPCP	0.75 JPCP	0.80 JPCP	0.80 JPC	0.85 JPCP	0.90 JPCP
	0.35 LCB	0.25 HMA-A	0.60 AB	0.35 LCB	0.25 HMA-A	0.60 AB
10.5 to 11	0.80 JPCP	0.80 JPCP	0.85 JPCP	0.85 JPCP	0.90 JPCP	0.95 JPCP
	0.35 LCB	0.25 HMA-A	0.70 AB	0.35 LCB	0.25 HMA-A	0.70 AB
11.5 to 12	0.85 JPCP	0.85 JPCP	0.80 CRCP	0.90 JPCP	0.95 JPCP	0.85 CRCP
	0.35 LCB	0.25 HMA-A	0.25 HMA-A	0.35 LCB	0.25 HMA-A	0.25 HMA-A
12.5 to 13	0.95 JPCP	0.95 JPCP	0.85 CRCP	1.05 JPCP	1.05 JPCP	0.95 CRCP
	0.35 LCB	0.25 HMA-A	0.25 HMA-A	0.35 LCB	0.25 HMA-A	0.25 HMA-A
13.5 to 14	1.00 JPCP	1.00 JPCP	0.90 CRCP	1.15 JPCP	1.15 JPCP	1.05 CRCP
	0.35 LCB	0.25 HMA-A	0.25 HMA-A	0.35 LCB	0.25 HMA-A	0.25 HMA-A
14.5 to 15	1.05 JPC	1.05 JPCP	0.95 CRCP	1.20 JPCP	1.20 JPCP	1.10 CRCP
	0.35 LCB	0.25 HMA-A	0.25 HMA-A	0.35 LCB	0.25 HMA-A	0.25 HMA-A
15.5 to 16	1.10 JPCP	1.10 JPCP	1.00 CRCP	1.25 JPCP	1.25 JPCP	1.10 CRCP
	0.35 LCB	0.25 HMA-A	0.25 HMA-A	0.35 LCB	0.25 HMA-A	0.25 HMA-A
16.5 to 17	1.15 JPCP	1.15 JPCP	1.05 CRCP	1.30 JPCP	1.30 JPCP	1.10 CRCP
	0.35 LCB	0.25 HMA-A	0.25 HMA-A	0.35 LCB	0.25 HMA-A	0.25 HMA-A
> 17	1.20 JPCP	1.20 JPCP	1.10 CRCP	1.30 JPCP	1.30 JPCP	1.10 CRCP
	0.35 LCB	0.25 HMA-A	0.25 HMA-A	0.35 LCB	0.25 HMA-A	0.25 HMA-A

NOTES:

- (1) Thicknesses shown for JPCP are for doweled pavement only. The thickness shown in these tables are not valid for nondoweled JPCP.
- (2) Includes 0.03 ft sacrificial wearing course for future grinding of JPCP/CRCP.
- (3) Portland cement concrete may be substituted for LCB when justified for constructability or traffic handling. If Portland cement concrete is used in lieu of LCB, it must be placed in a separate lift than JPCP and must not be bonded to the JPCP.
- (4) If ATPB is needed for TIs > 10.0 to perpetuate an existing treated permeable layer, place the ATPB between the surface layer (JPCP or CRCP) and the base layer. No deduction is made to the thickness of the base and subbase layers on account of the ATPB.
- (5) Place an interlayer between JPCP and LCB in all cases

LEGEND:

JPCP = Jointed Plain Concrete Pavement	ATPB = Asphalt Treated Permeable Base
CRCP = Continuously Reinforced Concrete Pavement	AB = Class 2 Aggregate Base
LCB = Lean Concrete Base	TI = Traffic Index
HMA-A = Hot Mix Asphalt (Type A)	

Table 623.1I

Rigid Pavement Catalog (Desert, Type II Subgrade Soil) (1), (2), (3), (4), (5)

TI	Rigid Pavement Structural Depth					
	With Lateral Support (ft)			Without Lateral Support (ft)		
< 9	0.70 JPCP	0.70 JPCP	0.75 JPCP	0.75 JPCP	0.75 JPCP	0.80 JPCP
	0.35 LCB	0.25 HMA-A	1.00 AB	0.35 LCB	0.25 HMA-A	1.00 AB
	0.50 AS	0.50 AS		0.60 AS	0.60 AS	
9.5 to 10	0.75 JPCP	0.75 JPCP	0.80 JPCP	0.80 JPCP	0.85 JPCP	0.90 JPCP
	0.35 LCB	0.25 HMA-A	1.00 AB	0.35 LCB	0.25 HMA-A	1.00 AB
	0.50 AS	0.50 AS		0.60 AS	0.60 AS	
10.5 to 11	0.80 JPCP	0.80 JPCP	0.85 JPCP	0.85 JPCP	0.90 JPCP	0.95 JPCP
	0.35 LCB	0.25 HMA-A	1.30 AB	0.35 LCB	0.25 HMA-A	1.30 AB
	0.60 AS	0.60 AS		0.60 AS	0.60 AS	
11.5 to 12	0.85 JPCP	0.85 JPCP	0.80 CRCP	0.90 JPCP	0.95 JPCP	0.85 CRCP
	0.35 LCB	0.25 HMA-A	0.25 HMA-A	0.35 LCB	0.25 HMA-A	0.25 HMA-A
	0.60 AS	0.60 AS	0.60 AS	0.60 AS	0.60 AS	0.60 AS
12.5 to 13	0.95 JPCP	0.95 JPCP	0.85 CRCP	1.05 JPCP	1.05 JPCP	0.95 CRCP
	0.35 LCB	0.25 HMA-A	0.25 HMA-A	0.35 LCB	0.25 HMA-A	0.25 HMA-A
	0.70 AS	0.70 AS	0.70 AS	0.70 AS	0.70 AS	0.70 AS
13.5 to 14	1.00 JPCP	1.00 JPCP	0.90 CRCP	1.15 JPCP	1.15 JPCP	1.05 CRCP
	0.35 LCB	0.25 HMA-A	0.25 HMA-A	0.35 LCB	0.25 HMA-A	0.25 HMA-A
	0.70 AS	0.70 AS	0.70 AS	0.70 AS	0.70 AS	0.70 AS
14.5 to 15	1.05 JPCP	1.05 JPCP	0.95 CRCP	1.20 JPCP	1.20 JPCP	1.10 CRCP
	0.35 LCB	0.25 HMA-A	0.25 HMA-A	0.35 LCB	0.25 HMA-A	0.25 HMA-A
	0.70 AS	0.70 AS	0.70 AS	0.70 AS	0.70 AS	0.70 AS
15.5 to 16	1.10 JPCP	1.10 JPCP	1.00 CRCP	1.25 JPCP	1.25 JPCP	1.10 CRCP
	0.35 LCB	0.25 HMA-A	0.25 HMA-A	0.35 LCB	0.25 HMA-A	0.25 HMA-A
	0.70 AS	0.70 AS	0.70 AS	0.70 AS	0.70 AS	0.70 AS
16.5 to 17	1.15 JPCP	1.15 JPCP	1.05 CRCP	1.30 JPCP	1.30 JPCP	1.10 CRCP
	0.35 LCB	0.25 HMA-A	0.25 HMA-A	0.35 LCB	0.25 HMA-A	0.25 HMA-A
	0.70 AS	0.70 AS	0.70 AS	0.70 AS	0.70 AS	0.70 AS
> 17	1.20 JPCP	1.20 JPCP	1.10 CRCP	1.30 JPCP	1.30 JPCP	1.10 CRCP
	0.35 LCB	0.25 HMA-A	0.25 HMA-A	0.35 LCB	0.25 HMA-A	0.25 HMA-A
	0.70 AS	0.70 AS	0.70 AS	0.70 AS	0.70 AS	0.70 AS

NOTES:

- (1) Thicknesses shown are for doweled JPCP only. Not valid for nondoweled JPCP.
- (2) Includes 0.03 ft sacrificial wearing course for future grinding of JPCP/CRCP.
- (3) Portland cement concrete may be substituted for LCB when justified for constructability or traffic handling. If Portland cement concrete is used in lieu of LCB, it must be placed in a separate lift than JPCP and must not be bonded to the JPCP.
- (4) If ATPB is needed for TIs > 10.0 to perpetuate an existing treated permeable layer, place the ATPB between the surface layer (JPCP or CRCP) and the base layer. No deduction is made to the thickness of the base and subbase layers on account of the ATPB.
- (5) Place an interlayer between JPCP and LCB in all cases

LEGEND:

JPCP = Jointed Plain Concrete Pavement	ATPB = Asphalt Treated Permeable Base
CRCP = Continuously Reinforced Concrete Pavement	AB = Class 2 Aggregate Base
LCB = Lean Concrete Base	AS = Class 2 Aggregate Subbase
HMA-A = Hot Mix Asphalt (Type A)	TI = Traffic Index

December 31, 2020

Table 623.1J

Rigid Pavement Catalog (Low Mountain/South Mountain, Type I Subgrade Soil) (1), (2), (3), (4), (5)

TI	Rigid Pavement Structural Depth					
	With Lateral Support (ft)			Without Lateral Support (ft)		
≤ 9	0.75 JPCP 0.50 AB			0.75 JPCP 0.50 AB		
9.5 to 10	0.75 JPCP 0.60 AB			0.85 JPCP 0.60 AB		
10.5 to 11	0.75 JPCP 0.35 LCB	0.75 JPCP 0.25 HMA-A	0.80 JPCP 0.70 AB	0.85 JPCP 0.35 LCB	0.85 JPCP 0.25 HMA-A	0.90 JPCP 0.70 AB
11.5 to 12	0.80 JPCP 0.35 LCB	0.85 JPCP 0.25 HMA-A	0.80 CRCP 0.25 HMA-A	0.90 JPCP 0.35 LCB	0.95 JPCP 0.25 HMA-A	0.85 CRCP 0.25 HMA-A
12.5 to 13	0.90 JPCP 0.35 LCB	0.95 JPCP 0.25 HMA-A	0.85 CRCP 0.25 HMA-A	1.00 JPCP 0.35 LCB	1.05 JPCP 0.25 HMA-A	0.90 CRCP 0.25 HMA-A
13.5 to 14	0.95 JPCP 0.35 LCB	1.00 JPCP 0.25 HMA-A	0.85 CRCP 0.25 HMA-A	1.05 JPCP 0.35 LCB	1.10 JPCP 0.25 HMA-A	0.95 CRCP 0.25 HMA-A
14.5 to 15	1.00 JPCP 0.35 LCB	1.05 JPCP 0.25 HMA-A	0.90 CRCP 0.25 HMA-A	1.15 JPCP 0.35 LCB	1.20 JPCP 0.25 HMA-A	1.05 CRCP 0.25 HMA-A
15.5 to 16	1.05 JPCP 0.35 LCB	1.10 JPCP 0.25 HMA-A	0.95 CRCP 0.25 HMA-A	1.20 JPCP 0.35 LCB	1.25 JPCP 0.25 HMA-A	1.10 CRCP 0.25 HMA-A
16.5 to 17	1.10 JPCP 0.35 LCB	1.15 JPCP 0.25 HMA-A	1.00 CRCP 0.25 HMA-A	1.25 JPCP 0.35 LCB	1.30 JPCP 0.25 HMA-A	1.10 CRCP 0.25 HMA-A
> 17	1.15 JPCP 0.35 LCB	1.20 JPCP 0.25 HMA-A	1.00 CRCP 0.25 HMA-A	1.30 JPCP 0.35 LCB	1.35 JPCP 0.25 HMA-A	1.10 CRCP 0.25 HMA-A

NOTES:

- (1) Thicknesses shown for JPCP are for doweled pavement only. The thickness shown in these tables are not valid for nondoweled JPCP.
- (2) Includes 0.03 ft sacrificial wearing course for future grinding of JPCP/CRCP.
- (3) Portland cement concrete may be substituted for LCB when justified for constructability or traffic handling. If Portland cement concrete is used in lieu of LCB, it must be placed in a separate lift than JPCP and must not be bonded to the JPCP.
- (4) If ATPB is needed for TIs > 10.0 to perpetuate an existing treated permeable layer, place the ATPB between the surface layer (JPCP or CRCP) and the base layer. No deduction is made to the thickness of the base and subbase layers on account of the ATPB.
- (5) Place an interlayer between JPCP and LCB in all cases

LEGEND:

JPCP = Jointed Plain Concrete Pavement

CRCP = Continuously Reinforced Concrete Pavement

LCB = Lean Concrete Base

HMA-A = Hot Mix Asphalt (Type A)

ATPB = Asphalt Treated Permeable Base

AB = Class 2 Aggregate Base

TI = Traffic Index

Table 623.1K

Rigid Pavement Catalog (Low Mountain/South Mountain, Type II Subgrade Soil) (1), (2), (3), (4), (5)

TI	Rigid Pavement Structural Depth					
	With Lateral Support (ft)			Without Lateral Support (ft)		
≤ 9	0.75 JPCP			0.75 JPCP		
	1.00 AB			1.00 AB		
9.5 to 10	0.75 JPCP			0.85 JPCP		
	1.00 AB			1.00 AB		
10.5 to 11	0.75 JPCP	0.75 JPCP	0.80 JPCP	0.85 JPCP	0.85 JPCP	0.90 JPCP
	0.35 LCB	0.25 HMA-A	1.30 AB	0.35 LCB	0.25 HMA-A	1.30 AB
	0.60 AS	0.60 AS		0.60 AS	0.60 AS	
11.5 to 12	0.80 JPCP	0.85 JPCP	0.80 CRCP	0.90 JPCP	0.95 JPCP	0.85 CRCP
	0.35 LCB	0.25 HMA-A	0.25 HMA-A	0.35 LCB	0.25 HMA-A	0.25 HMA-A
	0.60 AS	0.60 AS	0.60 AS	0.60 AS	0.60 AS	0.60 AS
12.5 to 13	0.90 JPCP	0.95 JPCP	0.85 CRCP	1.00 JPCP	1.05 JPCP	0.90 CRCP
	0.35 LCB	0.25 HMA-A	0.25 HMA-A	0.35 LCB	0.25 HMA-A	0.25 HMA-A
	0.70 AS	0.70 AS	0.70 AS	0.70 AS	0.70 AS	0.70 AS
13.5 to 14	0.95 JPCP	1.00 JPCP	0.85 CRCP	1.05 JPCP	1.10 JPCP	0.95 CRCP
	0.35 LCB	0.25 HMA-A	0.25 HMA-A	0.35 LCB	0.25 HMA-A	0.25 HMA-A
	0.70 AS	0.70 AS	0.70 AS	0.70 AS	0.70 AS	0.70 AS
14.5 to 15	1.00 JPCP	1.05 JPCP	0.90 CRCP	1.15 JPCP	1.20 JPCP	1.05 CRCP
	0.35 LCB	0.25 HMA-A	0.25 HMA-A	0.35 LCB	0.25 HMA-A	0.25 HMA-A
	0.70 AS	0.70 AS	0.70 AS	0.70 AS	0.70 AS	0.70 AS
15.5 to 16	1.05 JPCP	1.10 JPCP	0.95 CRCP	1.20 JPCP	1.25 JPCP	1.10 CRCP
	0.35 LCB	0.25 HMA-A	0.25 HMA-A	0.35 LCB	0.25 HMA-A	0.25 HMA-A
	0.70 AS	0.70 AS	0.70 AS	0.70 AS	0.70 AS	0.70 AS
16.5 to 17	1.10 JPCP	1.15 JPCP	1.00 CRCP	1.25 JPCP	1.30 JPCP	1.10 CRCP
	0.35 LCB	0.25 HMA-A	0.25 HMA-A	0.35 LCB	0.25 HMA-A	0.25 HMA-A
	0.70 AS	0.70 AS	0.70 AS	0.70 AS	0.70 AS	0.70 AS
> 17	1.15 JPCP	1.20 JPCP	1.00 CRCP	1.30 JPCP	1.35 JPCP	1.10 CRCP
	0.35 LCB	0.25 HMA-A	0.25 HMA-A	0.35 LCB	0.25 HMA-A	0.25 HMA-A
	0.70 AS	0.70 AS	0.70 AS	0.70 AS	0.70 AS	0.70 AS

NOTES:

- (1) Thicknesses shown for JPCP are for doweled pavement only. The thickness shown in these tables are not valid for nondoweled JPCP.
- (2) Includes 0.03 ft sacrificial wearing course for future grinding of JPCP/CRCP.
- (3) Portland cement concrete may be substituted for LCB when justified for constructability or traffic handling. If Portland cement concrete is used in lieu of LCB, it must be placed in a separate lift than JPCP and must not be bonded to the JPCP.
- (4) If ATPB is needed for TIs > 10.0 to perpetuate an existing treated permeable layer, place the ATPB between the surface layer (JPCP or CRCP) and the base layer. No deduction is made to the thickness of the base and subbase layers on account of the ATPB.
- (5) Place an interlayer between JPCP and LCB in all cases

LEGEND:

JPCP =	Jointed Plain Concrete Pavement	ATPB =	Asphalt Treated Permeable Base
CRCP =	Continuously Reinforced Concrete Pavement	AB =	Class 2 Aggregate Base
LCB =	Lean Concrete Base	AS =	Class 2 Aggregate Subbase
HMA-A =	Hot Mix Asphalt (Type A)	TI =	Traffic Index

December 31, 2020

Table 623.1L

Rigid Pavement Catalog (High Mountain/High Desert, Type I Subgrade Soil) (1), (2), (3), (4), (5)

TI	Rigid Pavement Structural Depth					
	With Lateral Support (ft)			Without Lateral Support (ft)		
≤ 9	0.85 JPCP 0.50 AB			0.90 JPCP 0.50 AB		
9.5 to 10	0.90 JPCP 0.60 AB			0.95 JPCP 0.60 AB		
10.5 to 11	0.90 JPCP 0.35 LCB	0.90 JPCP 0.25 HMA-A	0.95 JPCP 0.70 AB	0.95 JPCP 0.35 LCB	0.95 JPCP 0.25 HMA-A	1.00 JPCP 0.70 AB
11.5 to 12	0.95 JPCP 0.35 LCB	0.95 JPCP 0.25 HMA-A		1.05 JPCP 0.35 LCB	1.05 JPCP 0.25 HMA-A	
12.5 to 13	1.00 JPCP 0.35 LCB	1.05 JPCP 0.25 HMA-A		1.10 JPCP 0.35 LCB	1.15 JPCP 0.25 HMA-A	
13.5 to 14	1.05 JPCP 0.35 LCB	1.10 JPCP 0.25 HMA-A		1.15 JPCP 0.35 LCB	1.20 JPCP 0.25 HMA-A	
14.5 to 15	1.10 JPCP 0.35 LCB	1.15 JPCP 0.25 HMA-A		1.20 JPCP 0.35 LCB	1.25 JPCP 0.25 HMA-A	
15.5 to 16	1.15 JPCP 0.35 LCB	1.20 JPCP 0.25 HMA-A		1.25 JPCP 0.35 LCB	1.30 JPCP 0.25 HMA-A	
16.5 to 17	1.20 JPCP 0.35 LCB	1.25 JPCP 0.25 HMA-A		1.30 JPCP 0.35 LCB	1.35 JPCP 0.25 HMA-A	
> 17	1.25 JPCP 0.35 LCB	1.25 JPCP 0.25 HMA-A		1.35 JPCP 0.35 LCB	1.35 JPCP 0.25 HMA-A	

NOTES:

- (1) Thicknesses shown for JPCP are for doveled pavement only. The thickness shown in these tables are not valid for nondoweled JPCP.
- (2) Includes 0.15 ft sacrificial wearing course for future grinding of JPCP.
- (3) Portland cement concrete may be substituted for LCB when justified for constructability or traffic handling. If Portland cement concrete is used in lieu of LCB, it must be placed in a separate lift than JPCP and must not be bonded to the JPCP.
- (4) If ATPB is needed for TIs > 10.0 to perpetuate an existing treated permeable layer, place the ATPB between the surface layer (JPCP or CRCP) and the base layer. No deduction is made to the thickness of the base and subbase layers on account of the ATPB.
- (5) Place an interlayer between JPCP and LCB in all cases

LEGEND:

- JPCP = Jointed Plain Concrete Pavement
- CRCP = Continuously Reinforced Concrete Pavement
- LCB = Lean Concrete Base
- HMA-A = Hot Mix Asphalt (Type A)
- ATPB = Asphalt Treated Permeable Base
- AB = Class 2 Aggregate Base
- TI = Traffic Index

Table 623.1M

Rigid Pavement Catalog (High Mountain/High Desert, Type II Subgrade Soil) (1), (2), (3), (4), (5)

TI	Rigid Pavement Structural Depth					
	With Lateral Support (ft)			Without Lateral Support (ft)		
≤ 9	0.85 JPCP 1.00 AB			0.90 JPCP 1.00 AB		
9.5 to 10	0.90 JPCP 1.00 AB			0.95 JPCP 1.00 AB		
10.5 to 11	0.90 JPCP 0.35 LCB 0.60 AS	0.90 JPCP 0.25 HMA-A 0.60 AS	0.95 JPCP 1.30 AB	0.95 JPCP 0.35 LCB 0.60 AS	0.95 JPCP 0.25 HMA-A 0.60 AS	1.00 JPCP 1.30 AB
11.5 to 12	0.95 JPCP 0.35 LCB 0.60 AS	0.95 JPCP 0.25 HMA-A 0.60 AS		1.05 JPCP 0.35 LCB 0.60 AS	1.05 JPCP 0.25 HMA-A 0.60 AS	
12.5 to 13	1.00 JPCP 0.35 LCB 0.70 AS	1.05 JPCP 0.25 HMA-A 0.70 AS		1.10 JPCP 0.35 LCB 0.70 AS	1.15 JPCP 0.25 HMA-A 0.70 AS	
13.5 to 14	1.05 JPCP 0.35 LCB 0.70 AS	1.10 JPCP 0.25 HMA-A 0.70 AS		1.15 JPCP 0.35 LCB 0.70 AS	1.20 JPCP 0.25 HMA-A 0.70 AS	
14.5 to 15	1.10 JPCP 0.35 LCB 0.70 AS	1.15 JPCP 0.25 HMA-A 0.70 AS		1.20 JPCP 0.35 LCB 0.70 AS	1.25 JPCP 0.25 HMA-A 0.70 AS	
15.5 to 16	1.15 JPCP 0.35 LCB 0.70 AS	1.20 JPCP 0.25 HMA-A 0.70 AS		1.25 JPCP 0.35 LCB 0.70 AS	1.30 JPCP 0.23 HMA-A 0.70 AS	
16.5 to 17	1.20 JPCP 0.35 LCB 0.70 AS	1.25 JPCP 0.25 HMA-A 0.70 AS		1.30 JPCP 0.35 LCB 0.70 AS	1.35 JPCP 0.25 HMA-A 0.70 AS	
> 17	1.25 JPCP 0.35 LCB 0.70 AS	1.25 JPCP 0.25 HMA-A 0.70 AS		1.35 JPCP 0.35 LCB 0.70 AS	1.35 JPCP 0.25 HMA-A 0.70 AS	

NOTES:

- (1) Thicknesses shown for JPCP are for doweled pavement only. The thickness shown in these tables are not valid for nondoweled JPCP.
- (2) Includes 0.15 ft sacrificial wearing course for future grinding of JPCP.
- (3) Portland cement concrete may be substituted for LCB when justified for constructability or traffic handling. If Portland cement concrete is used in lieu of LCB, it must be placed in a separate lift than JPCP and must not be bonded to the JPCP.
- (4) If ATPB is needed for TIs > 10.0 to perpetuate an existing treated permeable layer, place the ATPB between the surface layer (JPCP or CRCP) and the base layer. No deduction is made to the thickness of the base and subbase layers on account of the ATPB.
- (5) Place an interlayer between JPCP and LCB in all cases

LEGEND:

JPCP = Jointed Plain Concrete Pavement	ATPB = Asphalt Treated Permeable Base
CRCP = Continuously Reinforced Concrete Pavement	AB = Class 2 Aggregate Base
LCB = Lean Concrete Base	AS = Class 2 Aggregate Subbase
HMA-A = Hot Mix Asphalt (Type A)	TI = Traffic Index

Topic 624 – Engineering Procedures for Pavement Preservation

624.1 Preventive Maintenance

Examples of rigid pavement preventive maintenance strategies include the following or combinations of the following:

- Seal random cracks.
- Joint seal, repair/replace existing joint seals.
- Dowel bar retrofit.
- Grinding or grooving to maintain ride quality and/or restore surface texture.
- Special surface treatments (such as methacrylate, hardeners, and others).

Rigid pavement preventive maintenance strategies are discussed further in the Concrete Pavement Guide.

624.2 Capital Pavement Maintenance (CAPM)

A CAPM project is warranted if any of the following criteria is met:

(1) *Continuously Reinforced Concrete Pavement*

- Number of punchouts with high severity cracking is between 1 and 10 percent.

(2) *Jointed Plain Concrete Pavement*

Number of slabs with 3rd stage cracking between 1 and 10 percent of a given travel lane-mile. Note, 3rd stage cracking is any slab with two or more intersecting cracks of at least $\frac{3}{4}$ inch in width.

- Combination of corner, longitudinal, and traverse cracking and/or spalling between 1 and 15 percent of travel lane-miles. Note, corner, longitudinal, or transverse cracks that are at least $\frac{3}{4}$ inch in width. Also note, spalling is regarded as a joint or crack which spalls at least 6 inches wide as measured from centerline of joint or spall.

(3) *All Concrete Pavements*

- International Roughness Index (IRI) is more than 170 with no or minor distress.
- Faulting greater than $\frac{1}{4}$ inch.

CAPM strategies include the following or combinations of the following:

- (a) Individual slab replacement (for JPCP) and punchout repair (for CRCP). The use of rapid strength concrete in the replacement of concrete slabs should be considered to minimize traffic impacts and open the facility to traffic in a minimal amount of time. Individual slab replacements and punchout repair may include replacing existing cement treated base or lean concrete base with rapid setting concrete lean concrete base or rapid strength concrete. For further information (including information on rapid strength concrete) see the Concrete Pavement Guide on the Department Pavement website.

- (b) Spall repair. Spall repair is a corrective maintenance treatment that replaces loss of concrete, typically around joints or cracks, with polyester or fast-setting concrete. Depending on the existing pavement condition, spall repairs can be used as the primary project treatment or in combination with other preventive, corrective, or rehabilitation strategies. Typical cases when spall repair may be needed include repair of spalled joints and cracks on individual slab replacement projects, as a pre-overlay repair of a distress pavement surface, or prior to grinding or joint sealing projects.
- (c) Grinding to correct faulting or poor ride. To improve ride quality, diamond grind the concrete pavement to correct ride smoothness to an acceptable level. If the existing pavement has an IRI > 170 inches per mile, restore ride quality to an IRI that is 40 percent improvement. If individual slab replacement is part of the project, diamond grind the concrete pavement after slab replacement is completed. The pavement must maintain an IRI of less than 170 inches per mile throughout its service life.
- (d) Asphalt overlay strategies for CAPM in Index 635.2 may also apply to concrete pavement where appropriate.

The roadway rehabilitation requirements for overlays (see Index 625.1(2)) and preparation of existing pavement surface (Index 625.1(3)) apply to CAPM projects. Additional information regarding CAPM policies can be found in PDPM Appendix H and Design Information Bulletin (DIB) 81 "Capital Preventive Maintenance Guidelines." Additional details for scoping and designing these strategies can be found in the Concrete Pavement Guide. Both DIB 81 and the Concrete Pavement Guide can be found on the Department Pavement website.

Topic 625 – Engineering Procedures for Pavement Rehabilitation

625.1 Rehabilitation Warrants

A rehabilitation project is warranted if any of the following criteria is met:

Jointed Plain Concrete Pavement

- Number of slabs with 3rd stage cracking between 1 and 10 percent of a given travel lane-mile. Note, 3rd stage cracking is any slab with two or more intersecting cracks of $\frac{3}{4}$ inch in width.
- Combination of corner, longitudinal, and traverse cracking and/or spalling exceeding 15 percent of given travel lane-miles. Note, corner, longitudinal, or transverse cracks are at least $\frac{3}{4}$ inch in width. Also note, spalling is regarded as a joint or crack which spalls at least 6 inches wide as measured from centerline of joint or spall.

When the number of slabs that warrant slab replacement per the above criteria is between 10 and 20 percent, perform a life cycle cost analysis per Topic 619 comparing roadway rehabilitation to CAPM. If CAPM has lower life cycle cost, pursue the project as a CAPM project.

625.2 Rigid Pavement Rehabilitation Strategies

- (1) *Strategies.* An overview of rigid pavement strategies for rehabilitation is discussed in the "Concrete Pavement Guide," which can be found on the Department Pavement website.

December 31, 2020

Some rehabilitation strategies discussed in the guide include the following or combinations of the following:

- (a) Concrete overlay. To determine the thickness of the rigid layer, use the rigid layer thicknesses for new pavement found in Index 623.1. Include a 0.10 foot minimum asphalt interlayer between the concrete overlay and the existing concrete pavement. The interlayer may need to be thicker if it is used temporarily for traffic handling.
- (b) Lane replacement. Lane replacements are engineered using the catalogs found in Index 623.1. Attention should be given to maintaining existing drainage patterns underneath the surface layer, (see Chapter 650 for further guidance). For further information see the Concrete Pavement Guide located on the Department Pavement website.
- (c) Crack, seat, and asphalt overlay. Thicknesses should be engineered using Caltrans mechanistic-empirical method (CalME). See Index 635.2 for further details. Thicknesses for a 20-year and 40-year design life using this strategy have been provided in Table 625.2 for cost estimating purposes in planning documents when calculations are not available.

For crack, seat, and asphalt overlay projects, a nonstructural wearing course may be placed in addition to (but not as a substitute for) the thickness found in Table 625.2 for 20-year design life. A nonstructural wearing course is required for a 40-year design life. Once a rigid pavement has been cracked, seated, and

overlaid with asphalt pavement it is considered to be a composite pavement and subsequent preservation and rehabilitation strategies are determined in accordance with the guidelines found in Chapter 640.

- (d) Asphalt overlay (without crack and seat). If the existing rigid pavement (JPCP) will not be cracked and seated, for a 20-year design life, add an additional 0.10 foot HMA to the minimum standard thicknesses of HMA surface course layer given in Table 625.2. Since the maximum thickness for RHMA-G is 0.20 foot (see Index 631.3), no additional thickness is needed if RHMA-G is used for the overlay. For 40-year design life, if the existing pavement cannot be cracked and seated it will need to be removed or rubberized. The section should be designed as a flexible pavement per Index 633.1(3) or Caltrans mechanistic-empirical method (CalME) in Chapter 630.

(2) *Overlay Limits.* **On overlay projects, the entire traveled way and paved shoulder shall be overlaid.** Not only does this help provide a smoother finished surface, it also benefits bicyclists and pedestrians when they need to use the shoulder.

(3) *Preparation of Existing Pavement.* Existing pavement distresses should be repaired before overlaying the pavement. Cracks 3/8 inch or wider should be sealed; loose pavement removed and patched; spalls repaired; and broken slabs or punchouts replaced. Existing thermoplastic traffic striping and above grade pavement markers should be removed. This applies to both lanes and adjacent shoulders (flexible and rigid). The Materials Report should include a reminder of these preparations. Crack sealants should be placed 1/4 inch below grade to allow for expansion (i.e., recess fill) and to alleviate a potential bump if an overlay is placed. For information and criteria for slab replacements, see the Concrete Pavement Guide located on the Department Pavement website.

(4) *Selection.* The selection of the appropriate strategy should be based upon life-cycle cost analysis, load transfer efficiency of the joints, materials testing, ride quality, safety, maintainability, constructability, visual inspection of pavement distress, and other factors

Table 625.2

Thicknesses for Crack, Seat, and Flexible Overlay

20-year ⁽¹⁾	TI <12.0	0.35' HMA GPI or RPI 0.10' HMA (LC)	0.35' HMA GPI or RPI 0.10' HMA (LC)	0.20' RHMA-G RPI 0.10' HMA (LC)
	TI ≥12.0	0.40' HMA GPI or RPI 0.15' HMA (LC)	0.20' RHMA-G RPI 0.15' HMA (LC)	0.20' RHMA-G 0.15' HMA GPI or RPI 0.10' HMA (LC)
40-year	TI ≥15.0	0.10' HMA-O or RHMA-O 0.20' HMA (PM) 0.50' HMA GPI or RPI 0.10' HMA (LC)		0.10' RHMA-O 0.20' RHMA-G 0.50' HMA GPI or RPI 0.10' HMA (LC)
	TI 12 - 15	0.10' HMA-O or RHMA-O 0.20' HMA (PM) 0.35' HMA GPI or RPI 0.10' HMA (LC)		0.10' RHMA-O 0.20' RHMA-G 0.35' HMA GPI or RPI 0.10' HMA (LC)

NOTE:

⁽¹⁾If the existing rigid pavement is not cracked and seated, add minimum of 0.10 foot HMA over the GPI layer.

Legend:

- HMA = Hot Mix Asphalt
- HMA (LC) = Hot Mix Asphalt Leveling Course
- HMA (PM) = Hot Mix Asphalt Modified Binder
- RHMA-G = Rubberized Hot Mix Asphalt (Gap Graded)
- GPI = Geosynthetic Pavement Interlayer
- RPI = Rubberized Pavement Interlayer

December 31, 2020

listed in Chapter 610. The Materials Report should discuss any historical problems observed in the performance of rigid pavement constructed with aggregates found near the proposed project and subjected to similar physical and environmental conditions.

- (5) *Smoothness*. For rehabilitation projects, restore the ride quality to the IRI specified on the concrete pavement specifications. Additional information on smoothness can be found on the pavement smoothness page on the Department Pavement website.

Topic 626 – Other Considerations

626.1 Traveled Way

- (1) *Mainline*. No additional considerations.
- (2) *Ramps and Connectors*. If tied rigid shoulders or widened slabs are used on the mainline, then the ramp or connector gore area (including ramp traveled way adjacent to the gore area) should also be constructed with rigid pavement (see Figure 626.1). This will minimize deterioration of the joint between the flexible and rigid pavement. When the ramp or connector traveled way is rigid pavement, utilize the same base and thickness for the gore area as that to be used under the ramp shoulders, especially when concrete shoulders are utilized on the mainline. Note that in order to optimize constructability, any concrete pavement structure used for mainline concrete shoulders should still be perpetuated through the gore area. If the base is Treated Permeable Base (TPB) under the ramp's traveled way and shoulder, TPB should still be utilized in the ramp gore areas as well.
- (3) *Ramp Termini*. Rigid pavement is sometimes placed at ramp termini instead of flexible pavement where there is projected heavy truck traffic (as defined in Index 613.5(1)(c)) to preclude pavement failure such as rutting or shoving from vehicular braking, turning movements, and oil dripping from vehicles. Once a design TI is selected for the ramp in accordance with Index 613.5, follow the requirements in Index 623.1 to engineer the rigid pavement structure for the ramp termini. The length of rigid pavement to be placed at the termini will depend on the geometric alignment of the ramp, ramp grades, and the length of queues of stopped traffic. The rigid pavement should extend to the first set of signal loops on signalized intersections. A length of 150 feet should be considered the minimum on unsignalized intersections. Special care should be taken to assure skid resistance in conformance with current standard specifications in the braking area, especially where oil drilage is concentrated. End anchors or transitions should be used at flexible/rigid pavement joints. The Department Pavement website has additional information and training for engineering pavement for intersections and rigid ramp termini.

Figure 626.1

Preferred Limits of Rigid Pavement at Flexible Pavement Ramp or Connector Gore Area

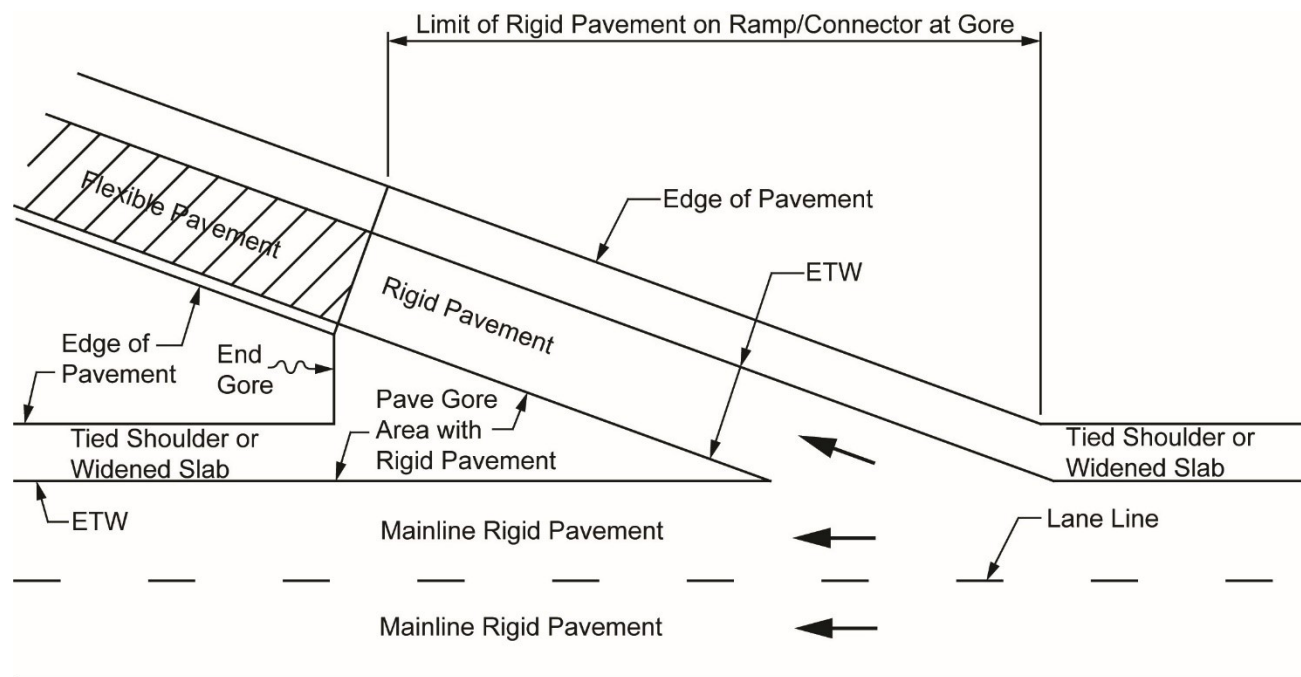

NOTES:

- (1) Not all details shown.
- (2) Off ramp shown. Same conditions apply for on ramps.

626.2 Shoulder

The types of shoulders that are used for rigid pavements can be categorized into the following three types:

(1) *Tied Concrete Shoulders.* These are shoulders that are built with rigid pavement that are tied to the adjacent lane with tie bars. These shoulders provide lateral support to the adjacent lane, which improves the long-term performance of the adjacent lane, reducing the need for maintenance or repair of the lane. To obtain the maximum benefit, these shoulders should be built monolithically with the adjacent lane (i.e., no construction joints). This will create aggregate interlock between the lane and shoulder, which provides increased lateral support.

The pavement structure for the tied rigid shoulder should match the pavement structure of the adjacent traffic lane at the edge of traveled way. Special delineation of concrete shoulders may be required to deter the use of the shoulder as a traveled lane. District Traffic Operations should be consulted to determine the potential need for anything more than the standard edge stripe.

The locations to use tied concrete shoulders is discussed under Selection Criteria of this Index. Tied concrete shoulders are also the most adaptable to future widening and conversion to a lane. Where there is an identified documented plan (such as Regional Transportation Plan, Metropolitan Transportation Plan and Interregional Transportation

December 31, 2020

Plan) to convert the shoulder into a traffic lane within the next 20 years, the shoulder may be built to the same geometric and pavement standards as the lane. See Index 613.5(2) for criteria and requirements.

- (2) *Widened Slab.* Widened slabs involve constructing the concrete panel for the lane adjacent to the shoulder 14-feet wide on the outside and 13-feet wide on the inside in lieu of the prescribed lane width. The additional width becomes part of the shoulder width and provides lateral support to the adjacent lane. Widened slabs are most useful in areas where lateral support is desired but future widening is not anticipated.
- (3) *Untied Shoulders.* Untied shoulders are shoulders that are not tied to the adjacent lane and do not provide lateral support to the adjacent lane. All new construction, reconstruction and rehabilitation shall not have untied shoulders unless a widened lane is constructed.
- (4) *Selection Criteria.* Shoulders should be constructed of the same material as the traveled way pavement (in order to facilitate construction, improve pavement performance, and reduce maintenance cost). Shoulders adjacent to rigid pavement traffic lanes can be rigid with the following conditions:

(a) Tied concrete shoulders shall be used for:

- **rigid pavements constructed in the High Mountain and High Desert climate regions (see climate map in Topic 615).**
- **paved buffers between rigid High-Occupancy Vehicle (HOV) lanes and rigid mixed flow lanes. Same for High-Occupancy Toll (HOT) lanes.**
- **rigid ramps to and from truck inspection stations.**

(b) Either tied concrete shoulders or widened slabs shall be used for:

- **continuously reinforced concrete pavement.**
- **horizontal radii 300 feet or less.**
- **truck and bus only lanes.**
- **desert climate regions. Where widened slabs are used, the remaining shoulder width shall also be concrete pavement.**

Where tied concrete shoulders or widened slabs are used, they shall continue through ramp and gore areas (see Figure 626.2A). Paving the gore area and adjacent ramp with concrete is preferred (see Figure 626.1).

The shoulder pavement structure selected must meet or exceed the pavement design life standards in Topic 612 and meet requirements for shoulders in Index 613.5(2). Table 626.2 and Figure 626.2B show rigid pavement shoulder design thicknesses for widened slabs and untied shoulders which meet these requirements. For untied concrete shoulders and portions of shoulders built within widened lane, use the thicknesses in Table 626.2.

Table 626.2

Shoulder Concrete Pavement Designs (“S” Dimension)

Climate Region	S (Based on $TI \leq 9$, unsupported edge)
North Coast	0.70
South Coast / Central Coast	0.75
Inland Valley	0.80
Desert	0.80
Low Mountain / South Mountain	0.75
High Mountain / High Desert	0.90

Figure 626.2A

Rigid Shoulders Through Ramp and Gore Areas

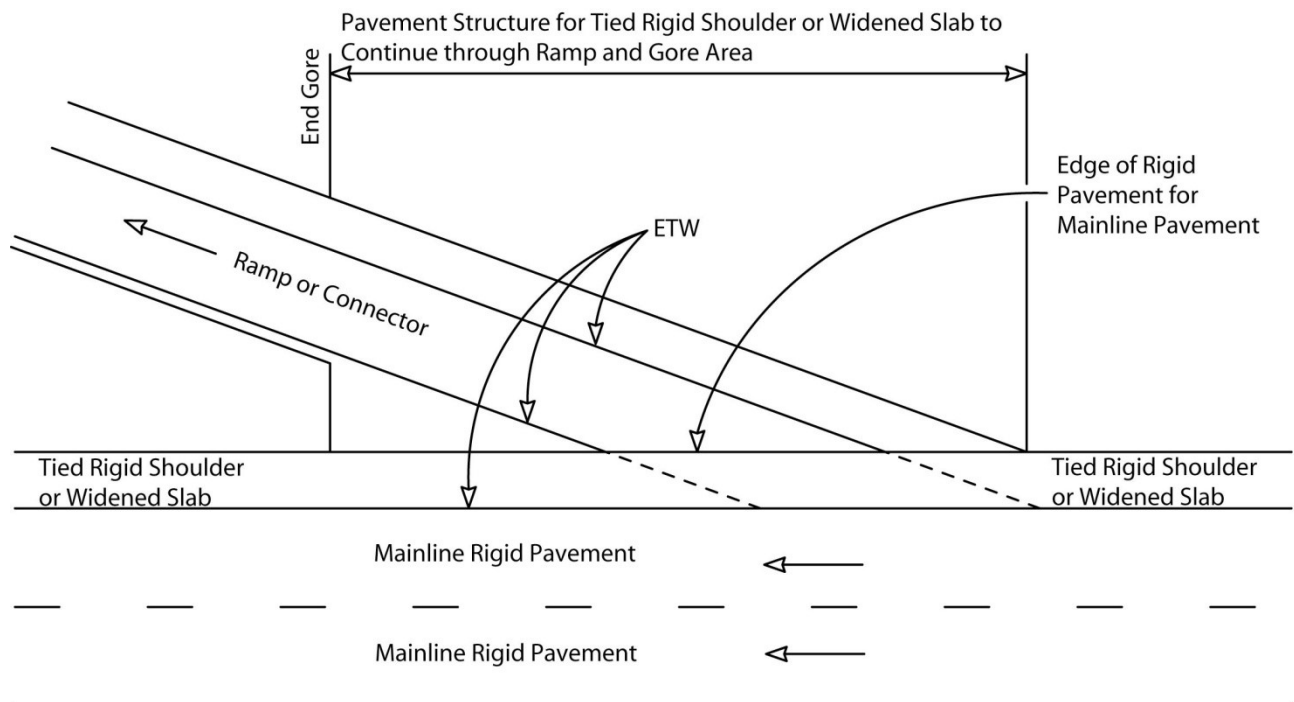

NOTES:

- (1) Not all details shown.
- (2) Off ramp shown. Same conditions apply for on ramps.

Figure 626.2B

Widened Slab Shoulder with Concrete Remainder Designs

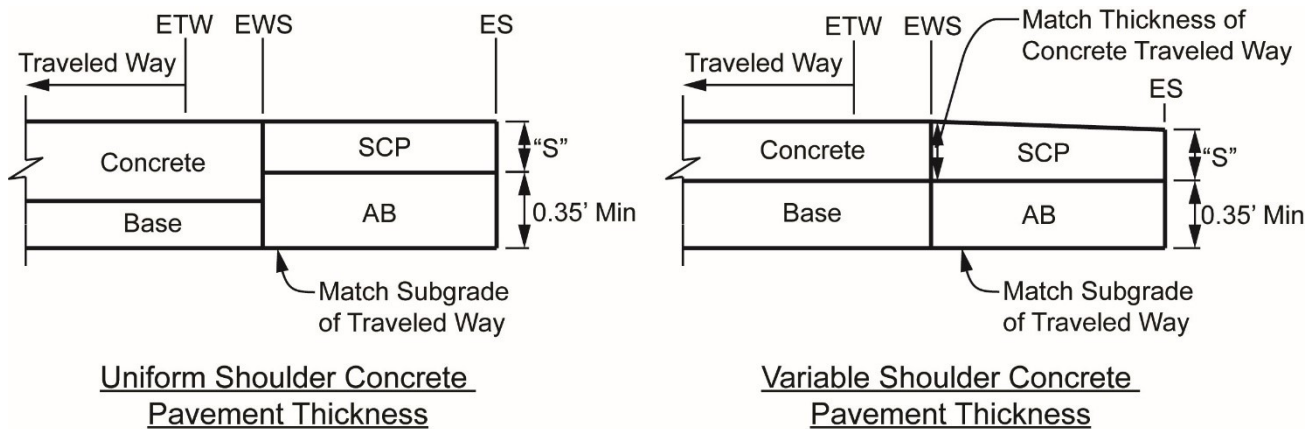

NOTES:

- No Scale
- "S" = Shoulder Concrete Pavement thickness dimension
- SCP = Shoulder Concrete Pavement
- AB = Aggregate Base
- TI = Traffic Index
- ETW = Edge of traveled way
- EWS = Edge of widened slab
- ES = Edge of shoulder

626.3 Intersections

Standard joint spacing patterns found in the Standard Plans do not apply to intersections. Special paving details for intersections need to be included in the project plans. Special consideration needs to be given to the following features when engineering a rigid pavement intersection:

- Intersection limits.
- Joint types and joint spacing.
- Joint patterns.
- Slab dimensions.
- Pavement joints at utilities.
- Dowel bar and tie bar placement.

Additional information and training is available on the Department Pavement website.

626.4 Roadside Facilities

(1) *Safety Roadside Rest Areas and Vista Points.* If rigid pavement is selected for some site-specific reason(s), the pavement structures used should be sufficient to handle projected loads at most roadside facilities. To select the pavement structure, determine the Traffic Index either from traffic studies and projections developed for the project or the values

found in Table 613.5B, whichever is greater. Then select the appropriate pavement structure from the catalog in Index 623.1. Treated bases such as lean concrete base and hot mix asphalt base should not be used for Traffic Indices less than 12.

Joint spacing patterns found in the Standard Plans do not apply to parking areas. Joint patterns should be engineered as square as possible. Relative slab dimensions should be approximately 1:1 to 1:1.25, transverse-to-longitudinal. Transverse and longitudinal joints should be perpendicular to each other. Joints should be doweled in two directions. Special attention should be given to joint patterns around utility covers and manholes.

Use guidelines for intersections in Index 626.3 for further information.

(2) *Bicycle Facilities*. For bicycle facilities independent of the vehicular roadway use local standards where available and where local agencies will be maintaining the facility. Otherwise, for stand-alone bike paths, use the following thicknesses:

- 0.35 foot minor concrete and 0.50 foot aggregate base for bike paths not available to maintenance vehicles, or
- 0.50 foot minor concrete and 0.50 foot aggregate base for bike paths accessible to maintenance vehicles.

Place longitudinal joints at centerline for 2-way bikeways and no more than 8 feet for one way bikeways. Transverse joints should be placed such that the transverse slab dimension relative to longitudinal dimension is between 1:1 and 1:1.25. Construction is similar to sidewalks or pathways so dowel bars and tie bars should not be used.

(3) *Bus Pads*. Bus pads are subjected to similar stresses as intersections; however, it is not practical to engineer rigid bus pads according to the Traffic Index, or according to bus counts. The minimum pavement structure for bus pads should be 0.85 foot JPCP with dowel bars at transverse joints on top of 0.5 foot lean aggregate subbase. Type III soil should be treated in accordance with Index 614.4. Where local standards are more conservative than the pavement structures mentioned above, local standards should govern.

Relative slab dimensions for bus pads should be approximately 1:1 to 1:1.25, transverse-to-longitudinal. The width of the bus pad should be no less than the width of the bus plus 4 feet. If the bus pad extends into the traveled way, the rigid bus pad should extend for the full width of the lane occupied by buses. The minimum length of the bus pad should be 1.5 times the length of the bus(es) that will use the pad at any given time. This will provide some leeway for variations in where the bus stops. Additional length of rigid pavement should be considered for approaches and departures from the bus pad since these locations may be subjected to the same stresses from buses as the pad. A 115-foot length of bus pad (which is approximately 250 percent to 300 percent times the length of typical 40-foot buses) should provide sufficient length for bus approach and departure. The decision whether to use rigid pavement for bus approach and departure to/from bus pads is the responsibility of the District.

A JPCP end anchor is not required, but may improve long-term performance at the flexible-to-rigid pavement transition. Doweled transverse joints should be perpendicular to the longitudinal joint at maximum 14 feet spacing, but consider skewing (at 1:6 typical) entrance/exit transverse flexible-to-rigid transitions, note that since acute corners can fail prematurely, acute corners should be reinforced or rounded (see Figure 626.4). Special care should be taken to assure skid resistance in conformance with current Standard Specifications in the braking area, especially where oil drippage is concentrated.

Figure 626.4

Rigid Bus Pad

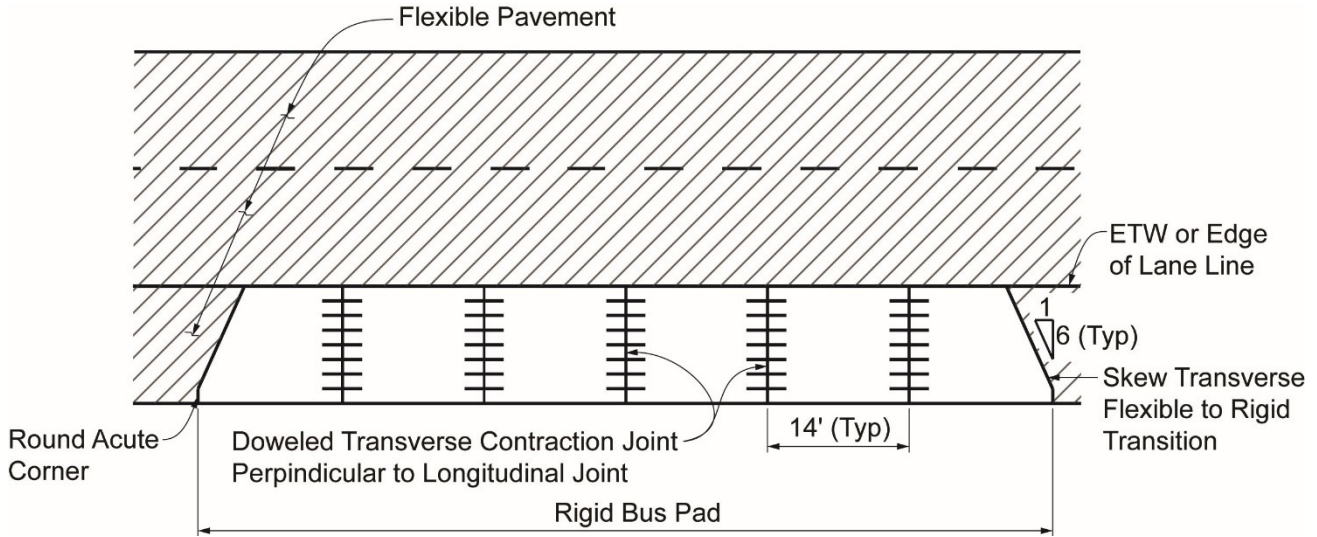

NOTES:

(1) Not all details shown.

CHAPTER 630 – FLEXIBLE PAVEMENT

Topic 631 – Types of Flexible Pavements & Materials

Index 631.1 – Hot Mix Asphalt (HMA)

HMA consists of a mixture of asphalt binder and a graded aggregate ranging from coarse to very fine particles. HMA is classified by type depending on the specified aggregate gradation and mix design criteria appropriate for the project conditions. The Department uses the following types of HMA based on the aggregate gradation: (1) Dense Graded HMA, (2) Gap Graded HMA, and (3) Open Graded Friction Course.

HMA types are found in the Standard Specifications and Standard Special Provisions.

631.2 Dense Graded HMA

Dense graded HMA is the most common mix used as a structural surface course. The aggregate is uniformly graded to provide for a stable and impermeable surface. The aggregate can be treated and the asphalt binder can be modified. HMA could be made from new or recycled material. Examples of recycled asphalt include, but are not limited to reclaimed asphalt pavement and cold in-place recycling. The Department uses one type of dense graded HMA: HMA-Type A.

631.3 Rubberized Hot Mixed Asphalt Gap Graded (RHMA-G)

Gap graded HMA is used to meet Public Resources Code section 42703 that specifies specific amounts of crumb rubber modifier (CRM) usage in HMA. To meet the Public Resources Code, regular asphalt binder is substituted with the asphalt rubber binder (that contains CRM) in pavement products to create rubberized HMA (RHMA) product in which the regular asphalt binder of the HMA is substituted with asphalt rubber binder. Known as the wet process, CRM is mixed with asphalt binder at specified temperature and mixing time to create asphalt rubber binder. The aggregate is gap graded to create space between the aggregate particles to

accommodate asphalt rubber binder. The Department uses only one type of gap graded HMA: Rubberized Hot Mix Asphalt-Gap-graded (RHMA-G). RHMA-G is used as a structural surface course. RHMA is commonly specified to retard reflection cracking, resist thermal stresses created by wide temperature fluctuations and add elasticity to a structural overlay. RHMA-G is used as a structural surface course up to a maximum thickness of 0.20 foot. Because of maximum thickness requirements, if a thicker surface layer or overlay is called for, then a HMA layer of a predetermined thickness should be placed prior to placing the RHMA surface course. The minimum thickness for RHMA-G is 0.10 foot. RHMA layer

July 1, 2020

should only be placed over a HMA or concrete surface course and not on an aggregate base. Do not place conventional HMA over a new RHMA unless it is HMA-O.

631.4 Open Graded Friction Course (OGFC)

OGFC; formerly known as open graded asphalt concrete (OGAC), is a non-structural wearing course placed primarily on asphalt pavement. The aggregate is open graded to provide for high permeability. The primary reason for using OGFC is the improvement of wet weather skid resistance, reduced water splash and spray, reduced night time wet pavement glare, and as a stormwater treatment Best Management Practice (BMP). Secondary benefits include better visibility of pavement delineation (pavement markings and pavement markers) during wet weather conditions. Three types of non-structural OGFC are used on asphalt pavement: Hot Mix Asphalt-Open-graded (HMA-O), Rubberized Hot Mix Asphalt-Open-Graded (RHMA-O), and Rubberized Hot Mix Asphalt-Open-graded-High Binder (RHMA-O-HB). HMA-O is occasionally placed on rigid pavements. The difference between RHMA-O and RHMA-G is in the gradation of the aggregate; while the difference between RHMA-O and RHMA-O-HB is in the amount of binder content. The maximum thickness of RHMA-O or RHMA-O-HB is 0.15 foot.

Rubberized OGFC (RHMA- O or RHMA-O-HB) is recommended unless it is documented that RHMA-O or RHMA-O-HB are not suitable due to availability, cost, constructability, or environmental factors (such as a stormwater treatment BMP for National Pollutant Discharge Elimination System (NPDES) compliance). RHMA-O and RHMA-O-HB are not expected to provide a water quality benefit. The project engineer should balance the competing requirement of recycled crumb rubber goals with those for stormwater treatment and document in the project report. Coordinate with the district pavements engineer and NPDES coordinator to determine if both goals are on target for compliance. It is undesirable to place RHMA-O in areas that will not allow surface water to drain. As an example, a surface that is milled only on the traveled way and not on the shoulder forms a “bathtub” section that can trap water beneath the surface of the traveled way. To prevent this effect, HMA should be placed on the milled surface (traveled way only) and OGFC should be placed over the entire cross section of the road (traveled way and shoulders).

For additional information and applicability of OGFC in new construction and rehabilitation projects refer to OGFC Guideline available on the Department Pavement website. Also, see Maintenance Technical Advisory Guide (MTAG) for additional information and use of OGFC in pavement preservation. If OGFC is proposed as a stormwater treatment BMP, see OGFC Stormwater Treatment BMP Guidance on the Design website.

631.5 Rubberized HMA (RHMA) Use

Currently, three RHMA products are used: gap-graded (RHMA-G), open-graded (RHMA-O), and open-graded-high binder (RHMA-O-HB) mixes.

The minimum thickness for RHMA (any type) should be 0.10 foot for rehabilitation and pavement preservation projects. These RHMA products are considered to be the asphalt pavement surface courses of choice for a project unless it is documented that RHMA is not

suitable due to availability, cost, constructability or environmental factors (Treatment BMP). The following describes situations where RHMA should not be used:

- When RHMA project quantities are 1,000 tons or less or staged construction operations require less than 1,000 tons of RHMA per stage. This is due to the higher costs associated with mobilizing an asphalt rubber blending plant. The 1,000-ton minimum does not apply in Los Angeles/Inland Empire areas due to the availability of several HMA production plants that have full time RHMA blending plants on site.
- When the ambient temperatures forecasted at the time of placement will be below 45°F.
- Where the roadway elevation is above 3,000 feet.
- When the project has a Caltrans NPDES permit requirement for treatment BMPs (only applicable for RHMA-O or RHMA-O-HB exception).

For additional information on and applicability of RHMA in new construction and rehabilitation projects refer to Asphalt Rubber Usage Guide available on the Pavement website.

631.6 Other Types of Flexible Pavement Surface Courses

There are other types of flexible pavement surface courses such as cold mix, Resin Pavement, and Sulphur Extended Hot Mix Asphalt. The other types of pavements are either used for maintenance treatments or not currently used on State highways. For pavement preservation and other maintenance treatments refer to the Caltrans Maintenance Manual and MTAG.

631.7 Warm Mix Asphalt Technology

HMA may be produced using the Warm Mix Asphalt (WMA) technology. The Department has a permissive specification which allows contractors to use WMA technology as compaction aid. The Department has an approved list of WMA additives technology and WMA water injection technology. Ambient and surface temperature requirements for both the WMA additives and WMA water injection technologies are specified in the standard specifications. The designer with reasonable assurance of these ambient and surface temperatures should specify WMA additives technology to avoid unnecessary conflicts and delays with marginal temperatures conditions on actual paving day.

Where ambient and surface temperatures are not issues, WMA may still be specified if other conditions such as long haul and coastal and windy conditions justify its use as compaction aid.

RHMA-G may be placed when ambient air or surface temperature is between 45°F and 49.9°F provided that WMA additives technology is specified.

WMA does not change the design parameters representative of HMA. Therefore, all design methods discussed in this chapter using hot mix asphalt are also applicable to warm mix asphalt products.

July 1, 2020

631.8 Pavement Interlayers

Pavement interlayers are used with asphalt pavement as a means to retard reflective cracks from existing pavement into the new flexible layer, prevent water infiltration deeper into the pavement structure, and enhance pavement structural strength. Two types of pavement interlayers are: Rubberized Pavement Interlayers (RPI); also known as Rubberized Stress Absorbing Membrane Interlayer (SAMI-R); which is simply a rubberized chip seal.

- Geosynthetic Pavement Interlayer (GPI). GPI consists mainly of asphalt-saturated geotextile (also called fabric), but other geosynthetic planar products such as paving grids and paving geocomposites (grid attached to geotextile) are also used. Refer to Standard Specifications for the various GPI types.

Sound engineering judgment is required when considering the use of a pavement interlayers. The following must be considered:

- Consideration should be given to areas that may prohibit surface water from draining out the sides of the overlay, thus forming a “bathtub” section.
- Since pavement interlayer can act as a moisture barrier, it should be used with caution in hot environments where it could prevent underlying moisture from evaporating.
- When placed on an existing pavement, preparation is required to prevent excess stress on the membrane. This includes sealing cracks wider than $\frac{1}{4}$ inch and repairing potholes and localized failures.

A pavement interlayer may be placed between layers of new flexible pavement, such as on an asphalt leveling course, or on the surface of an existing flexible pavement. A GPI should not be placed directly on coarse surfaces such as a chip seal, OGFC, areas of numerous rough patches, or on a pavement that has been cold planed. As an example, coarse surfaces may penetrate the paving fabric and the paving asphalt binder used to saturate the fabric may collect in the voids or valleys leaving areas of the fabric dry. For the GPI to be effective in these areas, use a layer of HMA prior to the placement of the GPI.

GPI is ineffective in the following applications:

- For providing added structural strength when placed in combination with new flexible pavement.
- In the reduction of thermal cracking of the new flexible pavement overlay.

When using a GPI, care must be taken to specify a product that can withstand temperatures of the asphalt placed above it, particularly for RHMA. Detailed information for selecting appropriate type of pavement interlayer to use can be found in the MTAG on the Department Pavement website.

Topic 632 – Asphalt Binder

632.1 Binder Classification

Asphalt binders are most commonly characterized by their physical properties which directly affect asphalt pavement field performance. Although asphalt binder viscosity grading is still common, new binder tests and specifications have been developed to more accurately characterize temperature extremes which pavements in the field are expected to withstand. These tests and specifications are particularly designed to address three specific asphalt pavement distress types: permanent deformation (rutting), fatigue cracking, and low temperature cracking.

In the past, unmodified asphalt binders were classified using viscosity grading based on the Aged Residue (AR) System and Performance Based Asphalt (PBA) binder system. Beginning January 1, 2006, the Department switched to the nationally recognized Performance Grade (PG) System for conventional binders. Effective January 1, 2013, the Department has graded modified binders as Performance Graded Modified (PG-M) binder. Binder modification is achieved using either crumb rubber, polymers, or both.

Performance grading is based on the concept that asphalt binder properties should be related to the conditions under which the binder is used. PG asphalt binders are selected to meet expected climatic conditions as well as traffic speed and volume. Therefore, the PG system uses a common set of tests to measure physical properties of the binder that can be directly related to field performance of the pavement at its service temperatures. For example, a binder identified as PG 64-10 (64 minus 10) must meet certain performance criteria at an average seven-day maximum pavement temperature of 64°C and also at a minimum pavement temperature of -10°C.

Although modified asphalt binder is more expensive than unmodified binder, it can provide improved performance and durability for sensitive climate conditions. While unmodified binder is adequate for most applications, improved resistance to rutting, thermal cracking, fatigue damage, stripping, and temperature susceptibility have led polymer modified binders to be substituted for unmodified asphalt binders in many paving and maintenance applications.

632.2 Binder Selection

Table 632.1 provides the binder grade that is to be used for each climatic region for general application. For HMA, values are given for typical and special conditions. For a few select applications such as dikes and tack coats, PG binder requirements are found in the applicable Standard Specifications or Standard Special Provisions.

For locations of each pavement climate region see Topic 615.

Binder selection based on climate region is crucial for improving the pavement resistance to temperature extremes during its service life; which in turn is critical in controlling thermal cracking and other distress types affected by temperature.

July 1, 2020

Special conditions in Table 632.1 are defined as those roadways or portion of roadways that need additional attention due to conditions such as:

Table 632.1**Asphalt Binder Performance Grade Selection**

Climate Region ⁽⁶⁾	Binder Grade for Hot Mixed Asphalt (HMA) ^{(1), (2)}				
	Dense Graded HMA		Open Graded HMA		Gap and Open Graded Rubberized Hot Mix Asphalt (RHMA)
	Typical	Special ⁽³⁾	Placement Temperature		
			> 70°F	≤ 70°F	
South Coast Central Coast Inland Valley	PG 64-10	PG 70-10 or PG 64-28 M	PG 64-10	PG 58-34 M	PG 64-16
North Coast	PG 64-16	PG 64-28 M	PG 64-16	PG 58-34 M	PG 64-16
Low Mountain South Mountain	PG 64-16	PG 64-28 M	PG 64-16	PG 58-34 M	PG 64-16
High Mountain High Desert	PG 64-28	PG 58-34 M ⁽⁴⁾	PG 64-28	PG 58-34 M	PG 58-22
Desert	PG 70-10	PG 64-28 M	PG 70-10	PG 58-34 M or PG 64-28 M ⁽⁵⁾	PG 64-16

NOTES:

- (1) PG = Performance Grade
- (2) M = Modified (Polymers, crumb rubber, or both)
- (3) PG 76-22 M may be specified for conventional dense graded hot mix asphalt for special conditions in all climate regions when specifically requested by the District Materials Engineer.
- (4) PG 64-28 M may be specified when particularly requested by the District Materials Engineer.
- (5) Consult with the District Materials Engineer for which binder grade to use.
- (6) Refer to Topic 615 for determining climate region for project.

- Heavy truck/bus traffic (over 10 million ESALs for 20 years).
- Truck/bus stopping areas (parking area, rest area, loading area, etc.).
- Truck/bus stop-and-go areas (intersections, metered ramps, ramps to and from Truck Scales, etc.).
- Truck/bus climbing and descending lanes.

The final decision as to whether a roadway meets the criteria for special conditions rests with the District. It should be noted that even though special binder grades help meet the flexible pavement requirements for high truck/bus use areas, they should not be considered as the only measure needed to meet these special conditions. The District Materials Engineer should be consulted for additional recommendations for these locations.

For more detailed information on PG binder selection, refer to the Pavement website.

Topic 633 – Engineering Procedures for New Construction and Reconstruction

633.1 Empirical Method

The empirical procedures and practices found in this chapter are based on research and field experimentation undertaken by Caltrans and AASHTO. These procedures were calibrated for pavement design lives of 10 to 20 years and Traffic Index (TI) ranging from 5.0 to 12. Extrapolations and supplemental requirements were subsequently developed to address longer pavement design lives and higher Traffic Indices. Details on mix design and other requirements for these procedures are provided in the Standard Specifications and Standard Special Provisions. Alterations to the requirements in these documents can impact the performance of the pavement structure and the performance values found in this chapter.

The data needed to engineer a flexible pavement using the Caltrans empirical method are California R-value of the subgrade and the Traffic Index (TI) determined for the desired design life. Engineering of the flexible pavement is based on a relationship between the gravel equivalent (or equivalency) GE of the pavement structural materials, TI, and the California R-value of the underlying material. The relationship was developed by Caltrans through research and field experimentation.

The procedures and rules governing flexible pavement engineering are as follows (Sample calculations are provided on the Department Pavement website):

(1) *Procedures for Engineering Multiple Layered Flexible Pavement.* The Department's empirical method, commonly referred to as the Hveem or R-value method, for determining design thicknesses of the structural layers of flexible pavement structure involves the determination of the following design parameters:

Traffic Index (TI),

- California R-value (R),

July 1, 2020

- Gravel Equivalent (GE), and
- Gravel Factor (G_f).

Once TI, R, GE, and G_f are determined, then the design thickness of each structural layer is determined using the Hveem method. These design parameters and the Hveem design method are discussed in the following paragraphs:

- As discussed in Index 613.3(3), the TI is a measure of the cumulative number of ESALs expected during the design life of the pavement structure. The TI is determined to the nearest 0.5 using the equation given in Index 613.3(3) or from Table 613.3C.
- The California R-value is a measure of resistance of soils to deformation under wheel loading and saturated soils conditions. The California R-value is determined as discussed in Index 614.3.
- The gravel equivalent (GE) of each layer or the entire flexible pavement structure is the equivalent thickness of gravel (aggregate subbase) that would be required to prevent permanent deformation in the underlying layer or layers due to cumulative traffic loads anticipated during the design life of the pavement structure. The GE requirement of the entire flexible pavement or each layer is calculated using the following equation:

$$GE = 0.0032 \times TI \times (100 - R)$$

Where:

GE = Gravel Equivalent in feet,

TI = Traffic Index, and

R = California R-value of the material below the layer or layers for which the GE is being calculated.

The GE requirement of each type of material used in the flexible pavement structure is determined for each structural layer, starting with the surface course and proceeding downward to base and subbase as needed. For pavements that include base and/or subbase, a safety factor of 0.20 foot is added to the GE requirement for the surface course to compensate for construction tolerances allowed by the contract specifications. Since the safety factor is not intended to increase the GE of the overall pavement, a compensating thickness is subtracted from the subbase layer (or base layer if there is no subbase). For pavements that are full depth asphalt, a safety factor of 0.10 foot is added to the required GE of the pavement structure. When determining the appropriate safety factor to be added, Hot Mix Asphalt Base (HMAB) and Asphalt Treated Permeable Base (ATPB) should be considered as part of the surface course.

- The gravel factor (G_f) of pavement structural material is the relative strength of that material compared to gravel (i.e., aggregate subbase). Gravel factor for HMA decreases as TI increases, and also increases with HMA thickness greater than 0.5 foot. The G_f of HMA varies with layer thickness (t) for any given TI as follows:

$t \leq 0.50 \text{ ft}$	$G_f = \frac{5.67}{\text{TI}^{1/2}}$
$t > 0.50 \text{ ft}$	$G_f = 7.00 \times \frac{t^{1/3}}{\text{TI}^{1/2}}$

These equations are valid for TI's ranging from 5 to 15. For TI's greater than 15, use a rigid or composite pavement or contact the Headquarters Division of Maintenance-Pavement Program for special design options. For TI's less than 5, use a TI = 5. For base and subbase materials, G_f is only dependent on the material type. Typical gravel factors for HMA of thickness equal to or less than 0.5 foot, and various types of base and subbase materials, are provided in Table 633.1. Additional information on G_f for base and subbase materials are provided in Table 663.3.

- (e) The design thickness of each structural layer of flexible pavement is obtained either by dividing the GE by the appropriate G_f for that layer material, or from Table 633.1. The layer thickness determined by dividing GE by G_f is rounded up to the next higher value in 0.05-foot increments.

$$\text{Thickness (t)} = \frac{\text{GE}}{G_f}$$

The minimum thickness of any asphalt layer should not be less than three times the maximum aggregate size. Also, the minimum thickness of the dense graded HMA surface course should not be less than 0.15 foot. The limit thicknesses for placing HMA for each TI, and the limit thickness for each type of base and subbase materials are shown in Table 633.1

Base and subbase materials, other than ATPB, should each have a minimum thickness of 0.35 foot. When the calculated thickness of base or subbase material is less than the desired 0.35 foot minimum thickness, either: (a) increase the thickness to the minimum without changing the thickness of the overlying layers, or (b) eliminate the layer and increase the thickness of the overlying layers to compensate for the reduction in GE.

Generally, the layer thickness of Lime Stabilized Soil (LSS) and Cement Stabilized Soil (CSS) should be limited with 0.65 foot as the minimum and 2 feet as the maximum. A surface layer placed directly on the LSS or CSS should have a thickness of at least 0.25 foot.

The thicknesses determined by the procedures outlined in this section are not intended to preclude other combinations and thicknesses of materials. Adjustments to the thickness of the various materials may be made to accommodate construction restrictions or practices, and minimize costs, provided the minimum thicknesses, maximum thicknesses, and minimum GE requirements (including safety factors) of the entire pavement structure and each layer are as specified.

Whereas the empirical method and Table 633.1 do not provide for RHMA-G material, it is possible to substitute the top 0.15 to 0.20 foot of the design HMA thickness with an equal thickness of RHMA-G.

July 1, 2020

Table 633.1

Gravel Equivalents (GE) and Thickness of Structural Layers (ft)

Actual Layer Thickness (ft) ⁽⁵⁾	HMA ^{(1),(2)}											Base and Subbase ^{(3),(4)}					
	Traffic Index (TI)											TI is not a factor					
	5.0	5.5	6.5	7.5	8.5	9.5	10.5	11.5	12.5	13.5	14.5						
	& below	6.0	7.0	8.0	9.0	10.0	11.0	12.0	13.0	14.0	15.0	CTPB;					
												CTB		CTB			
												LCB	(Cl. A)	ATPB	(Cl. B)	AB	AS
G _f (For HMA thickness equal to or less than 0.5 ft, G _f decreases with TI) ⁽⁶⁾											G _f (Constant for any base or subbase material irrespective of TI or thickness)						
2.54	2.32	2.14	2.01	1.89	1.79	1.71	1.64	1.57	1.52	1.46	1.9	1.7	1.4	1.2	1.1	1.0	
GE for HMA layer (ft)											GE for Base or Subbase layer (ft)						
0.10	0.25	0.23	0.21	0.20	0.19	0.18	0.17	0.16	0.16	0.15	0.15	--	--	--	--	--	--
0.15	0.38	0.35	0.32	0.30	0.28	0.27	0.26	0.25	0.24	0.23	0.22	--	--	--	--	--	--
0.20	0.51	0.46	0.43	0.40	0.38	0.36	0.34	0.33	0.31	0.30	0.29	--	--	--	--	--	--
0.25	0.63	0.58	0.54	0.50	0.47	0.45	0.43	0.41	0.39	0.38	0.37	--	--	0.35	--	--	--
0.30	0.76	0.69	0.64	0.60	0.57	0.54	0.51	0.49	0.47	0.45	0.44	--	--	0.42	--	--	--
0.35	0.89	0.81	0.75	0.70	0.66	0.63	0.60	0.57	0.55	0.53	0.51	0.67	0.60	0.49	0.42	0.39	0.35
0.40	1.01	0.93	0.86	0.80	0.76	0.72	0.68	0.65	0.63	0.61	0.59	0.76	0.68	0.56	0.48	0.44	0.40
0.45	1.14	1.04	0.96	0.90	0.85	0.81	0.77	0.74	0.71	0.68	0.66	0.86	0.77	0.63	0.54	0.50	0.45
0.50	1.27	1.16	1.07	1.00	0.94	0.90	0.85	0.82	0.79	0.76	0.73	0.95	0.85	0.70	0.60	0.55	0.50
0.55	1.41	1.29	1.19	1.12	1.05	1.00	0.95	0.91	0.87	0.84	0.81	1.05	0.94	0.77	0.66	0.61	0.55
0.60	1.58	1.45	1.34	1.25	1.18	1.12	1.07	1.02	0.98	0.95	0.91	1.14	1.02	0.84	0.72	0.66	0.60
0.65	1.76	1.61	1.49	1.39	1.31	1.25	1.19	1.14	1.09	1.05	1.02	1.24	1.11	0.91	0.78	0.72	0.65
0.70	--	1.78	1.64	1.54	1.45	1.38	1.31	1.26	1.21	1.16	1.12	1.33	1.19	--	0.84	0.77	0.70
0.75	--	1.95	1.80	1.69	1.59	1.51	1.44	1.38	1.32	1.27	1.23	1.43	1.28	--	0.90	0.83	0.75
0.80	--	2.12	1.96	1.84	1.73	1.64	1.57	1.50	1.44	1.39	1.34	1.52	1.36	--	0.96	0.88	0.80
0.85	--	--	2.13	1.99	1.88	1.78	1.70	1.63	1.56	1.51	1.46	1.62	1.45	--	1.02	0.94	0.85
0.90	--	--	2.30	2.15	2.03	1.92	1.83	1.76	1.69	1.63	1.57	1.71	1.53	--	1.08	0.99	0.90
0.95	--	--	--	2.31	2.18	2.07	1.97	1.89	1.81	1.75	1.69	1.81	1.62	--	1.14	1.05	0.95
1.00	--	--	--	2.47	2.33	2.21	2.11	2.02	1.94	1.87	1.81	1.90	1.70	--	1.20	1.10	1.00
1.05	--	--	--	2.64	2.49	2.36	2.25	2.16	2.07	2.00	1.93	2.00	1.79	--	1.26	1.16	1.05
1.10	--	--	--	--	2.65	2.51	2.40	2.29	2.20	2.12	2.05	--	--	--	--	--	1.10
1.15	--	--	--	--	2.81	2.67	2.54	2.43	2.34	2.25	2.18	--	--	--	--	--	1.15
1.20	--	--	--	--	2.98	2.82	2.69	2.58	2.48	2.39	2.30	--	--	--	--	--	1.20
1.25	--	--	--	--	--	2.98	2.84	2.72	2.61	2.52	2.43	--	--	--	--	--	1.25
1.30	--	--	--	--	--	3.14	2.99	2.87	2.75	2.65	2.56	--	--	--	--	--	1.30
1.35	--	--	--	--	--	3.30	3.15	3.01	2.90	2.79	2.70	--	--	--	--	--	--
1.40	--	--	--	--	--	--	3.31	3.16	3.04	2.93	2.83	--	--	--	--	--	--
1.45	--	--	--	--	--	--	3.46	3.32	3.19	3.07	2.97	--	--	--	--	--	--
1.50	--	--	--	--	--	--	3.62	3.47	3.33	3.21	3.10	--	--	--	--	--	--
1.55	--	--	--	--	--	--	--	3.62	3.48	3.36	3.24	--	--	--	--	--	--
1.60	--	--	--	--	--	--	--	3.78	3.63	3.50	3.38	--	--	--	--	--	--
1.65	--	--	--	--	--	--	--	3.94	3.79	3.65	3.52	--	--	--	--	--	--
1.70	--	--	--	--	--	--	--	--	3.94	3.80	3.67	--	--	--	--	--	--
1.75	--	--	--	--	--	--	--	--	4.09	3.95	3.81	--	--	--	--	--	--
1.80	--	--	--	--	--	--	--	--	4.25	4.10	3.96	--	--	--	--	--	--
1.85	--	--	--	--	--	--	--	--	--	4.25	4.10	--	--	--	--	--	--
1.90	--	--	--	--	--	--	--	--	--	4.40	4.25	--	--	--	--	--	--
1.95	--	--	--	--	--	--	--	--	--	4.56	4.40	--	--	--	--	--	--
2.00	--	--	--	--	--	--	--	--	--	--	4.55	--	--	--	--	--	--

NOTES:

- (1) Open Graded Friction Course (conventional and rubberized) is a non-structural wearing course and provides no structural value.
- (2) Top portion of HMA surface layer (maximum 0.20 ft.) may be replaced with equivalent RHMA-G thickness. See Topic 631.3 for additional details.
- (3) See Table 663.3 for additional information on Gravel Factors (G_f) and California R-values for base and subbase materials.
- (4) When using Hot Mix Asphalt Base (HMAB), the HMAB is considered as part of the HMA layer. Therefore, the HMAB will be assigned the same G_f as the remainder of the HMA in the pavement structure.
- (5) For HMA layer, select TI range, then go down to the appropriate GE and across to the thickness column. For base and subbase layer, select material type, then go down to the appropriate GE and across to the thickness column.

(2) *Procedures for Full Depth Hot Mix Asphalt.* Full depth hot mix asphalt applies when the pavement structure is comprised entirely of a flexible surface layer in lieu of base and subbase. The flexible surface layer may be comprised of a single or multiple types of flexible pavements including HMA, RHMA, interlayers, special asphalt binders, or different mix designs. Considerations regarding worker safety, short construction windows, the amount of area to be paved, or temporary repairs may make it desirable in some instances to reduce the total thickness of the pavement by placing full depth hot mix asphalt. Full depth hot mix asphalt also is less affected by moisture or frost, does not let moisture build up in the subgrade, provides no permeable layers that entrap water, and is a more uniform pavement structure. Use the standard equation in Index 633.1(1) with the California R-value of the subgrade to calculate the GE for the entire pavement structure based on TI and the subgrade R-value. Increase this GE by adding the safety factor of 0.10 foot to obtain the required GE for the flexible pavement. Then refer to Table 633.1, select the closest layer thickness for conventional hot mix asphalt, and determine the adjusted GE that it provides. The GE of the safety factor is not removed in this design. Adjust the final thickness as needed when using other types of materials than hot mix asphalt. The top 0.15 to 0.2 foot of the HMA thickness can be substituted with an equal thickness of RHMA-G.

A Treated Permeable Base (TPB) layer may be placed below full depth hot mix asphalt on widening projects to perpetuate or match, an existing TPB layer for continuity of drainage. Reduce the GE of the surface layer by the amount of GE provided by the TPB. In no case should the initial GE of the surface layer over the TPB be less than 40 percent of the GE required over the subbase as calculated by the standard engineering equation. When there is no subbase, use 50 for the California R-value for this calculation. In cases where a working platform will be used, the GE of the working platform is subtracted from the GE of the surface layer.

The empirical “new construction” and reconstruction design procedure has been encoded in a computer program CalFP available for download on the Department’s website.

(3) *Pavement Design for Design Life Greater than 20 Years.* The above pavement design procedures are based on an empirical method valid for a twenty-year design life. For pavement design lives greater than twenty years, in addition to using a TI for that longer design life, provisions should be made to increase material durability and other appropriate measures to protect pavement layers from degradation.

The following enhancements shall be incorporated into all flexible pavements designed using the empirical method with a design life greater than twenty years:

- (a) Use the design procedure for full depth hot mix asphalt described above to determine the minimum thickness of conventional HMA for flexible pavement. Use the TI for the longer design life in the analysis. If the longer-life TI is greater than 15, the empirical procedure can’t be used. Consult with the Pavement Program for other design methods such as the mechanistic-empirical method or other design options.
- (b) Place subgrade enhancement geotextile (SEGT) on the subgrade for California R-values less than 40. Refer to Chapter Topic 665 for SEGT class selection. If the subgrade requires chemical stabilization using approved stabilizing agent such as lime or cement, the SEGT will not be needed.

July 1, 2020

- (c) Place a minimum 0.50 foot of Class 2 Aggregate Base (AB) layer underneath the flexible pavement. This AB layer acts as a working platform. The AB layer must not be considered part of the pavement structural design and cannot be used to reduce the thickness of the full depth hot mix asphalt layer.
- (d) Use RHMA-G (0.15 to 0.20 foot) or a PG-PM binder (minimum 0.20 foot) at the top of the surface layer. The rubberized or polymer modified HMA must be substituted on an equal thickness basis.
- (e) Use a non-structural wearing course above the surface layer (minimum 0.10 foot). See Index 602.1(5) and Topic 631 for further details.

This procedure does not require advanced performance testing of the hot mix asphalt materials discussed in Index 633.2. Instead the conventional mix design of the HMA and RHMA-G is performed based on Standard Specification (Section 39).

As an alternative to the above design procedure, the mechanistic-empirical (ME) method may be used, offering a wider selection of pavement structures besides full depth structure. Refer to Index 633.2 for more details.

- (4) *Alternate Procedures and Materials.* At times, experimental design procedures and/or alternative materials are proposed as part of the design or construction. See Topic 606 for further discussion. The Mechanistic-Empirical (ME) method can also be used for new pavement design when the empirical procedure is not applicable such as when design life exceeds 20 years, traffic index exceeds 15, and/or when using non-standard materials. Refer to Index 633.2.

633.2 Mechanistic-Empirical Method

- (1) *Application.* For information on Mechanistic-Empirical design application and requirements, see Index 606.3(2)(b).
- (2) *Method.* The Mechanistic-Empirical (ME) method integrates the effect of traffic loading and climate on the various layers of pavement structure at various time increments during the analyzed service life. For “new construction” design, a trial pavement structure comprised of multiple layer types and thicknesses is selected and then analyzed with the ME method over a large number of time steps to determine the time it takes for the pavement to reach fatigue cracking, rutting, and ride quality performance thresholds. This typically requires a vast number of computations requiring fast computers. Therefore, the ME method is more of an analysis than a design procedure. The trial pavement structure may be obtained with the help of the Caltrans empirical R-value procedure discussed in Index 633.1.

Unlike the empirical method, the ME procedure is capable of designing flexible pavement structures for more than 20 years of service. The ME method offers additional benefits over the empirical procedure including:

- Capturing the special performance benefits of materials such as enhanced or modified HMA (e.g., PG grade specifications and polymer modified) that were not available at the time of developing the empirical method.

- Analyzing the effect of future maintenance and rehabilitation treatments on the performance and life extension of the pavement.
- Incorporating detailed traffic loading characteristics by using axle load spectra.
- Accounting for the effect of climate on pavement performance.
- Determining how and when the pavement will develop certain types of distresses or deterioration in ride quality
- The consideration of design reliability by incorporating statistical variabilities associated with construction quality, material properties, climate, and traffic.
- Because the ME procedure can account for project specific information, it generally results in reduced initial cost of design and overall life cycle costs.

The ME method for designing or analyzing flexible pavement for “new construction” or reconstruction requires the following:

- (a) CalME Software – In collaboration with the University of California Pavement Research Center (UCPRC), Caltrans has

developed CalME, the ME software for flexible pavement design and rehabilitation in California. Inputs to the CalME software include:

- Pavement design life,
- Traffic index (TI) corresponding to design life,
- Project location (district, county, route No., post mile limits),
- Trial pavement structure to be analyzed consisting of a number of pre-selected layers, materials, and subgrade soil pertaining to the project,
- HMA materials characterization (material constants) through lab testing or by selection from the CalME database (depending on project testing level discussed in item (b) below),
- Performance criteria or thresholds such as percentage cracking, total rut depth, and International Roughness Index (IRI), and
- Design reliability.

Specifying project location in CalME assigns both climate zone(s) for the project (see Topic 615) and axle load spectrum or spectra (see Index 613.4).

- (b) Project Testing Levels – The project testing level determines the extent of testing required as follows:

- Level AAA – All HMAs (Type A and RHMA-G) planned for use in the pavement structure need to be lab-tested using specialized advanced test methods and ME-related materials parameters obtained and uploaded to CalME.
- Level AA – HMAs to be used in the surface structural layer must be lab-tested and ME-related materials parameters obtained and uploaded to CalME.

July 1, 2020

- Level A – The standard materials library available in CalME can be used for all HMAs. In this case the engineer will consider similarities between the HMA planned for use on the project and the HMAs available in the library and select the closest HMA types.

Note that the above testing requirements represent minimums, that is, the Engineer may consider advanced laboratory testing for all HMAs for a Level A project.

When designing projects using Caltrans' ME procedure, the testing level is selected based on the project Traffic Index (TI) and design life. Table 633.2 provides the criteria for selecting ME testing level. Note that the testing levels shown in Table 633.2 are considered minimum standards. For example, the design engineer may use Level AAA design for a project that only requires Level A.

Table 633.2**Selecting ME Project Testing Level**

Design Life	Corresponding Design Year TI Range	Project Testing Level ⁽¹⁾
20 years	≤11.5	A
	≥12.0	AA
40 years	≤9.0	A
	9.5 to 13.5	AA
	≥14.0	AAA

NOTE:

(a) See Index 633.2(2)(b) for the descriptions of project design and testing levels.

- (c) Performance Criteria – The performance factors are the thresholds for total fatigue cracking (flexural and reflection in the asphalt layer), total rut depth measured at the pavement surface (assumed to be equal to the combined rut depths of all layers), and IRI that must not be exceeded during

the design life of the proposed pavement structure. The pavement is said to have failed as soon as one of these thresholds has been reached. Whereas Caltrans is currently working on developing final values for these factors, the following thresholds should be used in the interim when designing asphalt pavements using the CalME procedure:

- Cracking = 5 percent (or 0.15 ft/ft²),
- Rut depth = 0.4 inch (down rut),
- IRI = 170 in/mile.

- (d) Reliability – All design and analysis using CalME must be performed using the reliability concept. In CalME, reliability analysis is performed with the Monte Carlo Simulation method. A minimum of 100 simulations are needed to determine the minimum reliability of the final design. When evaluating preliminary designs a lower number of simulations may be used (e.g., 10) to expedite the simulations. On average, 10 simulations may take up to one minute using a desktop computer. The reliability for a given project is assigned based on the project testing levels shown in Table 633.3.

Table 633.3

Minimum Reliability Depending on Project Testing Level

Project Design & Testing Level ⁽¹⁾	Minimum Reliability (%)
Level A	95
Level AA	90
Level AAA	85

NOTE:

⁽¹⁾ See Index 633.2(2)(b) for the description of project testing levels.

If the trial design is found to pass all the criteria, then the Engineer may gradually reduce the thickness of one or more layers and re-run the CalME analysis. Several iterations may be done to optimize the pavement structure design.

- (e) Materials Information – The HMA material information may be selected from the CalME standard library or laboratory testing on the HMA is conducted and material parameters relevant to the tested HMA are generated and uploaded to the CalME database. Whether materials parameters are obtained through testing or from existing materials database depends on the project testing level discussed in (b) above.

Unbound materials such as aggregate base, aggregate subbase, subgrades and other chemically stabilized bases and subbases do not at this time require any advanced testing for evaluating their strength and permanent deformation characteristics as needed for ME design and analysis. Selecting these materials in the CalME software will upload recommended resilient modulus and other performance properties needed in the ME analysis. The resilient modulus values of the various pavement materials are given in Chapter 660 (Table 666.1A and Table 666.1B).

- (f) Laboratory Testing – The ME procedure in CalME requires HMA performance be specified. If testing level requires advanced laboratory testing of the HMA materials,

July 1, 2020

the critical performance properties of the HMAs to be used on the project are evaluated from the following two standard laboratory tests:

- AASHTO T 320: “Repetitive shear deformation for asphalt concrete rutting characterization.” This test characterizes the HMA permanent deformation (rutting) performance.
- AASHTO T 321: “Repetitive four-point beam bending for asphalt fatigue characterization.” This test evaluates the HMA fatigue performance and flexural stiffness master curve.

The level of testing selected for the project determines whether testing of all or some of the HMA materials needs to be conducted with these two AASHTO tests or the use of the existing materials database would be sufficient.

The fatigue, rutting and stiffness parameters used in the ME method are derived from the lab test results of the HMA materials by numerical fitting of the test data to ME performance models.

- (g) Additional Guidance – Additional information on the Caltrans ME methodology and guidelines on the use of CalME can be found on the “ME Designer’s Corner” link on the internal Department Pavement website or by contacting the Headquarters Pavement Program Office Chief. Topic 634 - Engineering Procedures for Flexible Pavement Preservation

634.1 Preventive Maintenance

For details regarding preventive maintenance strategies for flexible pavement, see the “Maintenance Technical Advisory Guide” on the Department Pavement website. Deflection studies are not performed for preventive maintenance projects.

634.2 Capital Preventive Maintenance (CAPM)

(1) *Warrants.* A CAPM project is warranted if any of the following criteria are met:

- 11-29 percent Alligator ‘B’ and 0 to 10 percent patching, or
- 1-10 percent Alligator ‘B’ and > 10 percent patching, or
- 0 percent Alligator ‘B’ crack and > 15 percent patching International Roughness Index (IRI) >170 inches per mile with no to minor distress

(2) *Strategies.* CAPM strategies include the following options:

- (a) When the IRI is less than or equal to 170 inches per mile, use 0.20 foot of RHMA-G or 0.20 foot of HMA. The preferred alternative is 0.20 foot of RHMA-G but a 0.25 foot overlay is permissible if 1 inch gradation HMA is to be used on the project.

For CAPM projects with an IRI greater than 170 inches per mile, the standard design is to place a 0.25-foot asphalt overlay in two lifts consisting of 0.10 foot HMA (leveling course) followed by 0.15 foot HMA or preferably 0.15 RHMA-G overlay.

- (b) Cold-in-place recycling (CIR) is an acceptable CAPM strategy for surfaced distressed pavement with little to no base failure regardless of IRI. Cold-in-place and recycle between 0.25 foot and 0.35 foot of the existing asphalt pavement and then cap with 0.15 foot HMA overlay or preferably 0.15 foot RHMA-G overlay.
 - (c) Existing pavement may be milled or cold planed down to the depth of the overlay prior to placing the overlay for any of the above strategies. Situations where milling or cold planing may be beneficial or even necessary are to improve ride quality, maintain profile grade, maintain vertical clearance, or to taper (transition) to match an existing pavement or bridge surface.
 - (d) Non-structural wearing courses such as open graded friction courses, chips seals, or thin overlays not to exceed 0.10 foot (0.12 foot in North Coast Climate Region) in thickness may be added to the strategies listed above.
 - (e) Pavement interlayers may be used in conjunction with the strategies listed above.
 - (f) Partial or full depth replacements (i.e., digouts) not to exceed 20 percent of the CAPM pavement costs may be included as well. Digouts should be designed to provide a minimum of 20 years added service life.
 - (g) Preventive maintenance strategies may be used in lieu of the above strategies when IRI is less than 170 inches per mile and they will extend pavement service life a minimum of 10 years until the next CAPM project is warranted.
 - (h) CAPM strategies for OGFC, HMA-O used as a stormwater treatment BMP should replace in kind.
- (3) *Smoothness.* For an asphalt pavement CAPM project with an IRI less than 170 inches per mile at the time of PS&E, a 0.20 foot or less single lift overlay is used; which should improve ride quality to an IRI of 75 inches per mile or less. RHMA-G overlay is preferred over HMA overlay. For CAPM projects with an IRI greater than 170 inches per mile the standard practice is to use a 0.25 foot overlay placed in two lifts. A 0.25 foot two-lift overlay strategy should restore the ride quality to an IRI of 60 inches per mile or less. It is preferred to place 0.10 foot HMA first followed by 0.15 foot RHMA-G.
- (4) *Testing.* Deflection studies are not required for CAPM projects. The roadway rehabilitation requirements for overlays (see Index 635.2(1)) and preparation of existing pavement surface (Index 635.2(8)) apply to CAPM projects. Additional details and information regarding CAPM policies and strategies can be found in Design Information Bulletin 81 “Capital Preventive Maintenance Guidelines.”

July 1, 2020

Topic 635 – Engineering Procedures for Flexible Pavement Rehabilitation

635.1 Rehabilitation Warrants

Locations where overall Alligator ‘B’ cracking exceeds the thresholds for CAPM are eligible for rehabilitation. When Alligator ‘B’ cracking is less than or equal to 50 percent, perform a life-cycle cost analysis (LCCA) in accordance with the requirements of Topic 619 comparing flexible pavement rehabilitation strategy versus a CAPM strategy. Pursue a CAPM strategy when CAPM has the lowest life-cycle cost.

635.2 Empirical Method

(1) *General.* The methods presented in this topic are based on rehabilitation studies for a ten-year design life with extrapolations for twenty-year design life. For design lives greater than twenty years, use the Mechanistic-Empirical (ME) design method or contact the Headquarters Office of Asphalt Pavements for assistance.

Because there are potential variations in materials and environment that could affect the performance of both the existing pavement and the rehabilitation strategy, it is difficult to develop precise and firm practices and procedures that cover all possibilities for the rehabilitation of pavements. Therefore, the pavement engineer should consult with the District Materials Engineer and other pertinent experts who are familiar with engineering, construction, materials, and maintenance of pavements in the geographical area of the project for additional requirements or limitations than those listed in this manual.

Flexible pavement rehabilitation strategies are divided into four categories:

- Overlay,
- Mill and Overlay,
- Full Depth Reclamation and Overlay, and
- Remove and Replace.

Flexible pavement rehabilitation designs using the empirical method are governed by one of the following three criteria:

- Structural adequacy,
- Reflective crack retardation, or
- Ride quality.

On overlay projects, the entire traveled way and paved shoulder shall be overlaid. Not only does this help provide a smoother finished surface, it also benefits bicyclists and pedestrians when they need to use the shoulder.

(2) *Data Collection.* Developing a rehabilitation strategy using the empirical method requires collecting background data as well as field data. The Pavement Condition Report (PCR)

or other most recent surface distress data collected for the pavements within the project limits such as the automated pavement condition survey (APCS) available on the Department Pavement website. Ground penetrating radar data (iGPR) is also available on the Department Pavement website, as-built plans, and traffic data are some of the important resources needed for developing rehabilitation strategy recommendations. A thorough field investigation of the pavement surface condition, combined with a current deflection study and coring, knowledge of the subsurface conditions, thicknesses and types of existing flexible pavement layers, and a review of drainage conditions are all necessary for developing a set of appropriate rehabilitation strategies.

- (3) *Deflection Studies.* Deflection studies along with core data are essential in evaluating the structural adequacy of the existing pavement. A deflection study is the process of selecting deflection test sections, measuring pavement surface deflections, and calculating statistical deflection values as described in California Test Method 356 for flexible pavement deflection measurements. The test method can be obtained from the Materials Engineering and Testing Services website.

To provide reliable rehabilitation strategies, deflection studies should be done no more than 18 months prior to the start of construction.

The following steps are required to complete a deflection study for use in developing rehabilitation designs of an existing flexible pavement using the empirical method:

- (a) Test Sections:

Test sections are portions of a roadway considered to be representative of roadway conditions being studied for rehabilitation. California Test Method 356 provides information on selecting test sections and different testing devices. Test sections should be determined in the field based on safe operation and true representation of pavement sections. Test sections can be determined either by the test operator or by the pavement engineer in the field.

Occasionally, a return to a project site may be required for additional testing after reviewing the initial deflection data in the office.

Individual deflection readings for each test section should be reviewed prior to determining statistical values. This review may locate possible areas that are not representative of the entire test section. An example would be a localized failure with a very high deflection. It may be more cost effective to repair the various failed sections prior to rehabilitation. Thus, the high deflection values in the repaired areas would not be included when calculating statistical values for the representative test sections.

- (b) Mean and 80th Percentile Deflections:

The mean deflection level for a test section is determined by dividing the sum of individual deflection measurements by the number of the deflections:

$$\bar{D} = \frac{\sum_{i=1}^N D_i}{N}$$

Where:

July 1, 2020

\bar{D} = mean deflection for a test section, in inches,

D_i = an individual measured surface deflection in the test section, in inches, and

N = number of measurements in the test section

The 80th percentile deflection value represents a deflection level at which approximately 80 percent of all deflections are less than the calculated value and 20 percent are greater than the value. Therefore, a strategy based on 80th percentile deflection will provide thicker rehabilitation than using the mean value.

For simplicity, a normal distribution has been used to find the 80th percentile deflection using the following equation:

$$D_{80} = \bar{D} + 0.84 \times s_D$$

Where:

D_{80} = 80th percentile of the measured surface deflections for a test section, in inches, and

s_D = standard deviation of all test points for a test section, in inches

$$s_D = \sqrt{\frac{\sum_{i=1}^N (D_i - \bar{D})^2}{N - 1}}$$

D_{80} is typically calculated as part of the deflection study done by the test operator. The pavement engineer should verify that the D_{80} results provided by the operator are accurate.

(c) Grouping:

Adjacent test sections may be grouped and analyzed together. There may be one or several groups within the project.

A group is a collection of test sections that have similar engineering parameters. Test sections can be grouped if they have all of the following conditions:

- Average D_{80} that vary less than 0.01 inch.
- Average existing total HMA thickness that vary less than 0.10 foot.
- Similar base material.
- Similar TI.

Once groups have been identified, D_{80} and existing surface layer thickness of each group can be found by averaging the respective values of test sections within that group.

An alternative to the grouping method outlined above is to analyze each test section individually and then group them based on the results of analysis. This way, all the test sections that have similar rehabilitation strategies would fall into the same group.

(4) *Procedure for Flexible Overlay on Existing Flexible Pavement.* The overlay thickness is determined to satisfy structural adequacy, reflective cracking retardation, and ride quality criteria. Therefore, for each criterion, the overlay thickness needed is determined, and finally the thickest overlay is selected to satisfy all criteria. The procedure is described below:

(a) *Overlay Thickness to Address Structural Adequacy.* The goal is to find the minimum thickness of overlay necessary to provide structural strength for the pavement to be able to carry the load till the end of design life. Pavement condition, thickness of surface layer, measured deflections, and the project TI provide the majority of the information used for determining structural adequacy of an existing flexible pavement. Structural adequacy is determined using the procedure described in the following paragraphs.

- Determine the Tolerable Deflection at the Surface (TDS). The term “Tolerable Deflection” refers to the level beyond which repeated deflections of that magnitude produce fatigue failure prior to reaching the end of design life. TDS is obtained from Table 635.2A by knowing the existing total thickness of the flexible layer and TI. For existing flexible pavement over a treated base, use TI and the TDS values in the row for Treated Base (TB) found in Table 635.2A
- The existing base is considered treated if it meets all of the following conditions:
 - (1) It is concrete base (including previously built concrete pavement), Lean Concrete Base (LCB), or Class A Cement Treated Base (CTB-A).
 - (2) Its depth is equal to or greater than 0.35 foot.
 - (3) The D_{80} is less than 0.015 inch.
- For each group compare the TDS to the 80th percentile deflection value D_{80} averaged for the group.
- If the average D_{80} is greater than the TDS, determine the required percent reduction in deflection at the surface (PRD) to restore structural adequacy as follows:

$$PRD = \left(\frac{\text{Average } D_{80} - TDS}{\text{Average } D_{80}} \right) \times 100$$

Where:

PRD = Percent Reduction in Deflection required at the surface, as percent

TDS = Tolerable Deflection at the Surface, in inches

Average D_{80} = mean of the 80th percentile of the deflections for each group, in inches.

- Using the calculated PRD and Table 635.2B, determine the GE required to reduce the deflections to less than the tolerable level.
- Divide the GE obtained from Table 635.2B by the appropriate G_r for the overlay material to determine the required thickness of the overlay.

July 1, 2020

Table 635.2A

Tolerable Deflections at the Surface (TDS) in 0.001 inches

Exist. HMA thick (ft)	Traffic Index (TI)											
	5	6	7	8	9	10	11	12	13	14	15	16
0.00	66	51	41	34	29	25	22	19	17	15	14	13
0.05	61	47	38	31	27	23	20	18	16	14	13	12
0.10	57	44	35	29	25	21	19	16	15	13	12	11
0.15	53	41	33	27	23	20	17	15	14	12	11	10
0.20	49	38	31	25	21	18	16	14	13	12	10	10
0.25	46	35	28	24	20	17	15	13	12	11	10	9
0.30	43	33	27	22	19	16	14	12	11	10	9	8
0.35	40	31	25	20	17	15	13	12	10	9	8	8
0.40	37	29	23	19	16	14	12	11	10	9	8	7
0.45	35	27	21	18	15	13	11	10	9	8	7	7
0.50 ⁽¹⁾	32	25	20	17	14	12	11	9	8	8	7	6
TB ⁽²⁾	27	21	17	14	12	10	9	8	7	6	6	5
	5.5	6.5	7.5	8.5	9.5	10.5	11.5	12.5	13.5	14.5	15.5	16.5
0.00	58	45	37	31	27	23	20	18	16	15	13	12
0.05	53	42	34	29	25	21	19	17	15	14	12	11
0.10	50	39	32	27	23	20	18	16	14	13	11	11
0.15	46	36	30	25	21	19	16	14	13	12	11	10
0.20	43	34	28	23	20	17	15	14	12	11	10	9
0.25	40	32	26	22	19	16	14	13	11	10	9	8
0.30	37	29	24	20	17	15	13	12	11	9	9	8
0.35	35	27	22	19	16	14	12	11	10	9	8	7
0.40	32	26	21	18	15	13	11	10	9	8	8	7
0.45	30	24	20	16	14	12	11	9	9	8	7	6
0.50 ⁽¹⁾	28	22	18	15	13	11	10	9	8	7	7	6
TB ⁽²⁾	24	19	15	13	11	10	8	7	7	6	5	5

NOTES:

⁽¹⁾For an HMA thickness greater than 0.50 ft use the 0.50 ft depth.

⁽²⁾Use the TB (treated base) line to represent treated base materials, regardless of the thickness of the HMA layer.

Table 635.2B

Gravel Equivalence Needed to Reduce Surface Deflection

Percent Reduction In Deflection (PRD or PRM) ⁽¹⁾	GE (in feet) For HMA Overlay Design	Percent Reduction In Deflection (PRD or PRM) ⁽¹⁾	GE (in feet) For HMA Overlay Design
5	0.02	46	0.55
6	0.02	47	0.57
7	0.02	48	0.59
8	0.02	49	0.61
9	0.03	50	0.63
10	0.03	51	0.66
11	0.04	52	0.68
12	0.05	53	0.70
13	0.05	54	0.72
14	0.06	55	0.74
15	0.07	56	0.76
16	0.08	57	0.79
17	0.09	58	0.81
18	0.09	59	0.83
19	0.10	60	0.85
20	0.11	61	0.87
21	0.12	62	0.89
22	0.14	63	0.91
23	0.15	64	0.94
24	0.16	65	0.96
25	0.18	66	0.98
26	0.19	67	1.00
27	0.20	68	1.02
28	0.21	69	1.04
29	0.23	70	1.06
30	0.24	71	1.09
31	0.26	72	1.11
32	0.28	73	1.13
33	0.29	74	1.15
34	0.31	75	1.17
35	0.33	76	1.19
36	0.35	77	1.22
37	0.37	78	1.24
38	0.38	79	1.26
39	0.40	80	1.28
40	0.42	81	1.30
41	0.44	82	1.32
42	0.46	83	1.34
43	0.48	84	1.37
44	0.51	85	1.39
45	0.53	86	1.41

Note: ⁽¹⁾PRD is Percent Reduction in Deflection at the surface.
PRM is Percent Reduction in deflection at the Milled depth.

July 1, 2020

$$\text{Thickness (t)} = \frac{GE}{G_f}$$

Commonly used materials and their gravel factors (G_f) for flexible pavement rehabilitation are presented in Table 635.2C.

- RHMA-G is preferred over HMA as the overlay material. RHMA-G could substitute on 1:1 basis up to 0.20 ft of the top HMA overlay thickness designed for structural adequacy.

(b) Overlay Thickness to Address Reflective Cracking Retardation. The goal is to find the minimum thickness of overlay necessary to keep cracks in the existing flexible pavement from reflecting into and propagating upward into the new overlay surface during the pavement design life. Retarding the propagation of cracks is an important factor to consider when engineering flexible pavement overlays

Table 635.2C
Commonly Used G_f for Flexible Pavement Rehabilitation

Material	$G_f^{(1)}$
Hot Mix Asphalt Overlay	1.9
Cold in-Place Recycled Asphalt	1.5
HMA Below the Analytical Depth ⁽²⁾	1.4

NOTES:

(1) For G_f of bases and subbases see Table 663.1B.

(2) Analytical depth is defined in 635.2(6)(a).

The procedures for determining overlay requirement for reflective cracking retardation is based on the following procedure and rules:

- For flexible pavements over untreated bases (e.g., aggregate base, aggregate subbase), the minimum HMA overlay thickness for a twenty-year design life should be no less than 65 percent of the thickness of the existing total asphalt concrete thickness, but does not need to exceed 0.45 foot. These thickness limits are based on the original ten-year limits of the HMA overlay thickness being half of the existing total asphalt concrete thickness up to 0.35 foot, increased by an additional 25 percent to account for the additional 10 years of service.
- For flexible pavements over treated bases (as defined in the previous section on structural adequacy), a minimum HMA overlay of 0.45 foot should be used for a twenty-year design life. An exception is when the underlying material is a thick rigid layer (0.65 foot or more) such as an overlaid jointed plain concrete pavement that was not cracked and seated, a minimum HMA overlay thickness of 0.60 foot should be used for twenty-year design.

The overlay thickness designed to prevent reflective cracking requires extensive engineering judgement to select the necessary thickness for final design. Thicker sections may be warranted. Factors to be considered that might necessitate a thicker overlay are:

- (1) Type, sizes, and amounts of surface cracks.
- (2) Extent of localized failures.
- (3) Existing performance material and age.
- (4) Thickness and performance of previous rehabilitation strategy.
- (5) Environmental factors.
- (6) Anticipated future traffic loads (Traffic Index).

As always, sound engineering judgment will be necessary for final decisions. Final decision for when to use more than the minimum requirements found in this manual rests with the District.

- Adjust overlay thickness for alternative materials. A thickness equivalency of not more than 1:2 is given to the RHMA-G when compared to the HMA for reflective crack retardation. The thickness of the RHMA-G alternative must be based on the HMA thickness determined for reflective crack retardation. The equivalencies are tabulated in Table 635.2D.
 - A Geosynthetic Pavement Interlayer (GPI) placed under HMA that is designed for reflective crack retardation provides the equivalent of 0.10 foot of HMA. This allows the engineer to decrease the new profile grade and also save on HMA materials. The reduced thickness of HMA can be further reduced with the use of RHMA-G as the overlay material using Table 635.2D for converting thicknesses. Ensure that the melting point of the GPI to be used on the project exceeds the RHMA-G placement temperature. Refer to Standard Specifications for selection of GPI.
 - If a rubberized pavement interlayer (RPI) is placed under a non-rubberized hot mix asphalt overlay designed for reflective crack retardation, the equivalence of a RPI in terms of HMA thickness depends upon the type of base material under the existing pavement. When the base is a treated material, an RPI placed under HMA is considered to be equivalent to 0.10 foot of HMA. When the base is an untreated material RPI is equivalent to 0.15 foot of HMA.
 - Wearing courses are not included in the thickness used to address reflective cracking.
- (c) Overlay Thickness to Address Ride Quality. Ride quality is evaluated based on the pavement surface smoothness. The Department records smoothness as part of the Annual Pavement Condition Survey using the International Roughness Index (IRI). According to FHWA, the IRI value that most motorists consider uncomfortable for flexible pavement is 170 inches per mile. When IRI measurements are 170 inches per mile or greater, the engineer must address ride quality. The entire project can be

July 1, 2020

Table 635.2D

Reflective Crack Retardation Equivalencies (Thickness in feet)

HMA ⁽¹⁾	RHMA-G	RHMA-G over RPI
0.15	0.10	X
0.20	0.10	
0.25	0.15	
0.30	0.15	
0.35	<ul style="list-style-type: none"> • 0.15 if crack width <1/8 inch • 0.20 if crack width ≥1/8 inch or underlying material CTB, LCB, or rigid pavement 	<ul style="list-style-type: none"> • N/A for crack width <1/8 inch • 0.10 if crack width ≥1/8 inch and underlying material untreated • 0.15 if crack width ≥1/8 inch and underlying material CTB, LCB, or rigid pavement
0.45	0.15 over 0.15 HMA	0.20

NOTE:

(1) See Index 635.2(5)(b) for minimum and maximum HMA thicknesses recommended by the Department for reflective crack retardation on flexible pavements.

divided into groups of multiple segments that will be individually analyzed for ride quality.

To improve ride quality, place a minimum of 0.25 foot overlay in two lifts. Because this overlay addresses ride quality, it does not matter whether HMA or RHMA-G is used, although the latter is preferred. This could be performed using either:

- the placement of 0.10 foot HMA followed by 0.15 foot HMA, or
- the placement of 0.10 foot HMA first followed by 0.15 foot RHMA-G.

A non-structural wearing course may be included in the ride quality thickness. Pavement interlayers do not have any effect on ride quality.

- (d) Final Overlay Thickness and Governing Criterion. The overlay thickness requirements obtained to address the three design criteria are compared and the greatest thickness is selected as the overlay thickness. The criterion that yielded the greatest thickness is the governing design criterion. It is possible that more than one criterion can govern the design. Ride quality will ultimately govern the rehabilitation strategy if the requirements for structural adequacy and reflective crack retardation are less than 0.25 foot HMA.

It is advised that the comparison is made based on HMA thicknesses before conversion to RHMA-G equivalents or with inclusion of interlayers. Once the greatest HMA thickness was determined, conversion to RHMA-G equivalent and use of interlayers can be done.

Examples of design calculations for flexible overlay thickness on existing flexible pavement are available on the Department Pavement website.

- (5) *Mill and Overlay Rehabilitation Design Procedure for Flexible Pavement.* Mill and Overlay is the removal of part of the surface course of an existing flexible pavement and placement of an overlay. Since existing pavement thicknesses will have slight variations throughout the project length, leave at least the bottom 0.15 foot of the existing surface course intact to ensure the milling machine does not loosen the base material or contaminate the recycled mix if used. If removal of the entire surface course layer and any portion of the base are required, use the procedure in Index 635.2(7).

- (a) Design for Structural Adequacy. The design procedure for determining the structural adequacy for Mill and Overlay strategies are the same as those for basic overlays found in Index 635.2(1), with the exception of the following:

- TDS is determined using the thickness of the existing pavement prior to milling.
- Deflections are measured at the surface and adjusted to the milled depth.

The engineer must consider milling down to the “analytical depth”. The analytical depth is defined as the least of:

- The milled depth where the percent reduction in deflection required at the milled depth (PRM) reaches 70 percent.
- 0.50 foot.
- The depth to the bottom of the existing HMA layer.

July 1, 2020

The percent reduction in deflection required at the milled depth is based on research that determined that the deflection increases by 12 percent for each additional 0.10 foot of milled depth up to the analytical depth. Once the analytical depth is reached, the existing HMA material below it is considered to be of questionable structural integrity and hence is assigned a G_f of 1.4. Since it is not known at what milled depth the 70 percent PRM level or analytical depth will be reached, an iterative type of calculation is required.

Using the thickness of the existing HMA layer, the TI, and base material type, determine the TDS from Table 635.2A. The deflection at the milled depth is found from the equation:

$$DM = D_{80} + \left[12\% \times \left(\frac{\text{Mill Depth}}{0.10 \text{ ft}} \right) \times D_{80} \right]$$

Where:

D_{80} = 80th percentile deflection in inches.

Mill Depth = the depth of the milling in feet.

DM = the calculated deflection at the milled depth in inches.

Then, PRM is calculated from:

$$PRM = \left(\frac{DM - TDS}{DM} \right) \times 100$$

Where:

PRM = Percent Reduction in deflection required at the Milled depth.

TDS = Tolerable Deflection at the Surface in inches.

Utilizing the calculated PRM value, go to Table 635.2B to get the total GE required to be placed on top of the milled pavement surface. The total GE required to reduce the measured deflection to the tolerable level is a combination of:

- The GE determined from the overlay calculations, and
- The GE required to replace the material removed by the milling process.

If the milling goes below the analytical depth, the “Additional GE” that is required to replace the existing HMA below the analytical depth is calculated by multiplying the G_f of 1.4 by the milled depth below the analytical depth:

$$\text{Additional GE} = 1.4 \times \left(\frac{\text{milled depth below}}{\text{the analytical depth}} \right)$$

To determine the total GE for the overlay, the “Additional GE” below the analytical depth is added to the required GE above the analytical depth (found from Table 635.2B). As stated in Index 633.1(1)(d), the required minimum thickness of the overlay is determined by dividing the total GE by the G_f of the new overlay material.

$$\text{Thickness (t)} = \frac{GE}{G_f}$$

Since Cold In-Place Recycled Asphalt (CIR) has low resistance to abrasion, if the milled material is to be replaced with CIR, the CIR layer must be covered with a wearing surface shortly after the recycling process. To determine the required thickness of the cap layer, first determine the GE of the CIR layer:

$$GE_{CIR} = (\text{CIR Thickness}) \times G_{f\text{ CIR}}$$

Where:

GE_{CIR} = Gravel Equivalent of the CIR.

$G_{f\text{ CIR}}$ = Gravel Factor of CIR

= (1.5, see Table 635.2C).

The thickness of the cap layer is determined as follows:

$$\text{Cap Layer Thickness} = \frac{GE_{TOTAL} - GE_{CIR}}{G_f}$$

Where:

GE_{TOTAL} = Total GE requirement of CIR and cap layers.

G_f = Gravel Factor of the cap material.

It is recommended to round up to get the CIR and cap layer thicknesses. If the cap layer is OGFC, its thickness should not be considered in pavement structure design.

- (b) Design for Reflective Cracking Retardation. The minimum thickness for reflective cracking retardation is determined using the same procedures used for reflective cracking for overlays found in Index 635.2(5)(b) except that the thickness is determined based on the remaining surface layer rather than the initial surface layer.
 - (c) Design for Ride Quality. Milling the existing surface and overlaying with new surface of at least 0.25 foot in two lifts is considered sufficient to smooth out a rough pavement. Either HMA or HMA and RHMA-G can be used. Refer to Index 635.2(4)(c) for lift placement.
- (6) *Full Depth Reclamation Rehabilitation Design Procedure for Flexible Pavements.* Full Depth Reclamation (FDR) transforms distressed existing asphalt into stabilized base to receive a new structural surface layer. The FDR process pulverizes existing asphalt and a portion of the underlying material, while simultaneously mixing with additives (cement or foamed asphalt) and water in one pass. After pulverization and mixing, the material is compacted, graded, and overlaid. FDR can treat a variety of project conditions, but is most cost effective for cracked pavement surfaces requiring digouts of 20 percent or more by paving area. The general steps for designing flexible pavement with FDR are as follows:
- (a) Determine the FDR design thickness from the maximum existing asphalt depth and a portion of underlying material (this example assumes AB). Swelling of pulverized material must also be considered.
 - (b) Determine the required gravel equivalent for the entire pavement structure (GE_{Total}) using Index 633.1 based on the TI and subgrade R-value. This requires that the existing pavement structure be known and subgrade soil has been characterized for

July 1, 2020

R-value. The calculated required GE_{Total} must be increased by 0.10 foot to compensate for possible construction tolerances. The GE_{Total} demand must be supplied by the individual gravel equivalent of each structural layer in the final pavement section. Therefore,

$$GE_{Total} = GE_{HMA} + GE_{FDR} + GE_{AB}$$

Where:

GE_{Total} = The total GE required based on TI and R-value of subgrade.

GE_{HMA} = Gravel equivalent provided by the HMA overlay.

GE_{FDR} = Gravel equivalent provided by the FDR layer.

GE_{AB} = Gravel equivalent provided by the remaining AB after recycling all the existing asphalt concrete and portion of the AB layer. If all the existing AB layer has been reclaimed, then this $GE_{AB} = 0$. If there is a subbase layer, then it must be included.

(c) Determine GE_{FDR} with the following equation:

$$GE_{FDR} = (\text{FDR Layer Thickness}) \times G_{fFDR}$$

Where, "FDR Layer Thickness" is the final compacted thickness of the FDR layer, and G_{fFDR} is the gravel factor of the FDR material. The final FDR layer thickness is determined from the initial planned reclamation depth plus an additional 7 percent swell that occurs due to reclamation. As an example, if the initial planned reclamation depth is 0.80 foot, the final FDR depth can be $0.80 \times 1.07 = 0.85$ foot. The G_{fFDR} is dependent on the additive used to stabilize the reclaimed material, as follows:

- If the additive is cement, then the G_{fFDR} is dependent on the unconfined compressive strength (UCS) of the compacted FDR materials. Refer to the equation in Index 663.3 for determining G_{fFDR} based on UCS.

Therefore, G_{fFDR} is dependent on the amount of cement used up to a value of 1.7.

- If the additive is foamed asphalt, then $G_{fFDR} = 1.4$.

(d) Determine the GE_{AB} of the remaining AB layer (if any). The gravel factor of remaining AB (G_{fAB}) is assumed to be equal to 1.0 (a reduction from the typical 1.1 value). This is done as follows:

$$GE_{AB} = (\text{AB Thickness}) \times G_{fAB}$$

The "AB thickness" is the average remaining thickness of the AB layer after FDR is done.

(e) Determine the GE_{HMA} required that would be provided by the structural HMA overlay as follows:

$$GE_{HMA} = GE_{Total} - GE_{FDR} - GE_{AB}$$

(f) Calculate the required HMA overlay thickness to be placed over the FDR layer. This is done using the equation:

$$\text{Thickness (t)} = \frac{GE}{G_f}$$

Where GE_{HMA} is calculated in (5) above, and GE_{fHMA} is determined from Table 633.1 based on the TI. Round up the overlay thickness to the nearest 0.05 foot. Up to 0.20 foot of the top HMA thickness may be substituted with an equivalent thickness of RHMA-G.

(7) *Design Procedure of Rehabilitation of Flexible Pavement with Pulverization.* Pulverization is a roadway rehabilitation strategy that involves in-place transformation, in one pass, of an existing distressed asphalt concrete layer (reclaimed asphalt pavement, RAP) and some of the existing base layer into a uniformly blended, well-graded granular base material suitable for a new flexible pavement structure. The pulverized material mix is often referred to as Pulverized Aggregate Base (PAB) with physical properties comparable to those of new Class 2 AB. The FDR design procedure described in (6) above is used to determine the required HMA overlay thickness. The only difference is in the selection of an appropriate gravel factor representing the PAB materials (G_{fPAB}) which depends on the percentage of RAP in the PAB mix (i.e., depends on pulverization depth). The G_{fPAB} is selected as follows:

- $G_{fPAB} = 1.2$, if RAP \geq 60 percent of the pulverized material mix.
- $G_{fPAB} = 1.1$, if RAP < 60 percent of the mix.
- $G_{fPAB} = 1.2$, if PAB is treated with cement regardless of RAP content.

For more specific information on the pulverization strategy, see the technical guidance on the Department Pavement website.

(8) *Design Procedure for Flexible Pavements Using Remove and Replace.* The “Remove and Replace” strategy consists of removing the entire surface layer and part or all of the base and subbase material. The entire removed depth is then replaced with a new flexible or rigid pavement structure. The Remove and Replace strategy is most often used when:

- It is not possible to maintain the existing profile grade using Mill and Overlay.
- Existing base and or subbase material is failing and needs to be replaced.
- It is the most cost effective strategy based on life-cycle cost analysis.

Remove and Replace covers a variety of strategies. The discussion found here provides some general rules and minimum requirements for Remove and Replace strategies in general. For more specific information see the technical guidance on the Department Pavement website.

Because the existing surface layer is removed, only structural adequacy needs to be addressed for Remove and Replace. The following are available options:

- (a) *Partial Depth Removal.* When only a portion of the existing depth is being removed, consideration needs to be given to the strength of the remaining pavement structure. Because the pavement has been stressed and has been subject to contamination from fines and other materials over time, it does not have the

July 1, 2020

same strength (GE) as new material. Currently, for partial depth removals, the most effective engineering method is to determine the theoretical deflection of the remaining material otherwise known as DM. See Index 635.2(5) for further Mill and Replace strategy information. It should be noted that the greater the depth of removal, the less accurate the determination might be of the calculated deflections.

Using deflections for Remove and Replace strategies is also less accurate if a bulldozer or a scraper is used to remove the material under the pavement instead of a milling machine. This method of removing material disturbs the integrity of the in-place material from which the deflections were measured.

Because of these issues, the DME may require reduced GE from what is found in this manual or additional pavement thickness. Final determination of what GE is used rests with the District.

It is recommended that if the removal depth is more than 1 foot, determine the pavement thickness and layers using the method for new or reconstructed pavements discussed in Index 633.1. If the pavement structure is being replaced with rigid pavement, the resulting total pavement structure (including existing pavement left in place) cannot be less than the minimum values found in the rigid pavement catalog in Topic 623.

The analysis used for partial depth Remove and Replace with flexible pavement is similar to the Mill and Overlay analysis. The procedure is as follows:

- (1) Consider milling down to what is called the analytical depth. This is an iterative type of calculation since it is not known at what milling depth the analytical depth will be reached.
- (2) Use the thickness of the existing HMA layer, the design TI and base material in Table 635.2A to determine the TDS. Then find the DM knowing D_{80} and the mill depth. Use DM and TDS to find the percent reduction in deflection at the milled depth (PRM).
- (3) Utilizing this calculated PRM value go to Table 635.2B to obtain the GE required to be placed on top of the milled surface. When the milled depth reaches the analytical depth, the analysis changes. The GE for the material milled below the analytical depth is added to the GE required at the analytical depth. The GE for each layer is calculated by multiplying G_f by the thickness of the layer milled.
- (4) Determine the required minimum thickness of HMA needed by dividing the sum of the GE's by the G_f of the new HMA (see equation below.)

$$\text{Thickness (t)} = \frac{GE}{G_f}$$

For the Remove and Replace method, use the G_f for the new HMA commensurate with the TI and HMA thickness found in Table 633.1. The total HMA thickness can be solved for each 0.05 foot of material milled until the desired profile is reached. Round the replacement thickness to the nearest 0.05 foot.

- (5) Adjust thicknesses as needed for alternate materials.

- (b) Full Depth Removal. When material is removed all the way to the subgrade, the Remove and Replace strategy should be engineered using the same procedures used for new construction found in Index 633.1.
- (9) *Computer Program.* All the rehabilitation procedures based on deflection testing discussed above have been encoded in a computer program called *CaIAC* that can be downloaded from the Department Pavement website.
- (10) *Procedure for Concrete Overlay on Existing Flexible Pavement.* For concrete overlay strategies (sometimes referred to as whitetopping), only structural adequacy needs to be addressed. To address structural adequacy, use the tables in Index 623.1 to determine the thickness of the rigid layer. Then existing HMA layer may be considered as the base for the concrete overlay. The overlay should be thick enough to be considered a structural layer. Therefore, thin or ultrathin concrete layers (< 0.65 foot) do not qualify as concrete overlay. To provide a smooth and level grade for the concrete overlay surface layer, place a 0.10 foot to 0.15 foot HMA (leveling course) on top of the existing flexible layer.
- (11) *Preparation of Existing Pavement.* Existing pavement distresses should be repaired before overlaying the pavement. Cracks wider than $\frac{1}{4}$ inch should be sealed; loose pavement removed/replaced; and localized failures such as potholes repaired. Localized failure repairs should be designed to provide a minimum design life to match the pavement design life for the project, but no less than 20 years, even for CAPM projects. Undesirable material such as bleeding seal coats or excessive crack sealant should be removed before paving. Existing thermoplastic traffic striping and raised pavement markers should also be removed. Routing cracks before applying crack sealant has been found to be beneficial. The width of the routing should be $\frac{1}{4}$ inch wider than the crack width. The depth should be equal to the width of the routing plus $\frac{1}{4}$ inch. In order to alleviate the potential bump in the overlay from the crack sealant, leave the crack sealant $\frac{1}{4}$ inch below grade to allow for expansion (i.e., recess fill). The Materials Report should include a reminder of these preparations. Additional discussion of repairing existing pavement can be found on the Department Pavement website.
- (12) *Choosing the Rehabilitation Strategy.* The final strategy should be chosen based on pavement life-cycle cost analysis (LCCA). The strategy should also meet other considerations such as constructability, maintenance, and the other requirements found in Chapter 610.

635.3 Rehabilitation of Existing RHMA-G Surfaced Flexible Pavements

The empirical method discussed above was primarily developed for determining rehabilitation requirement for an existing dense-graded HMA surfaced flexible pavement. The concept of tolerable deflection at the pavement surface given in Table 635.2A represents the allowable deflection values necessary for an existing dense-graded HMA surface that the pavement must exhibit to be able to provide the desired service for the remaining service life. The tolerable deflection concept ensures that the asphalt pavement responds “elastically” when subjected to wheel loads; which is a requirement to prevent permanent deformation (rutting) and cracking.

July 1, 2020

Many flexible pavements that received RHMA-G overlays in the past are either due or will be soon due for rehabilitation. These existing pavements with an old RHMA-G surfacing pose a challenge to the pavement designer with regard to the validity of deflection data collected on such surfaces; and thus the validity of the empirical rehabilitation procedure. This is because the tolerable deflection given in Table 635.2A represents values for dense graded HMA surfaces which tend to be denser (and stiffer) than RHMA-G surfaces. Therefore, the validity of using these tolerable deflection values for designing rehabilitation strategies of an existing RHMA-G surfaced flexible pavement may be questionable. Therefore, deflection testing of existing RHMA-G surfaced flexible pavements may not be necessary when the empirical procedure is selected for rehabilitation design.

An alternative design method is based on the ME methodology (Index 635.4). While this method can overcome the empirical validity challenge described above; the designer may be limited in selecting the rehabilitation strategy for the pavement. In this regard, RHMA-G layers are known to be more permeable than dense graded HMA; therefore infiltrating water can reside in them causing stripping and adversely impacting the integrity of the overlay on top. For this reason, the Department prohibits overlaying RHMA-G surfaces. Therefore, the designer must select an RHMA-G overlay instead of HMA overlay on top of an existing RHMA-G surfaced pavement.

The Department has initiated theoretical and field research to better understand the behavior of “old” RHMA-G surfaces. This research will shed more light on two aspects related to old RHMA-G material:

- Whether RHMA-G material stiffness with time thus exhibiting the same elastic characteristics under load as that of an old HMA. This finding would be important because it will validate the use of the tolerable deflection and testing over old RHMA-G surfaced pavement for use in the empirical rehabilitation design method.
- Whether RHMA-G material loses its permeability properties as it ages and thus approaches the same permeability level of an old HMA. This finding is also important since it enables the designer to select any asphaltic overlay material type (HMA or RHMA-G).

As this research has not been completed yet, the ME method may be the only resort for the designer at this time. Alternatively, some engineering judgment may have to be exercised with the empirical procedure to improve its validity. Consult with the Pavement Program, Office of Asphalt Pavements for assistance.

635.4 Mechanistic-Empirical Method

- (1) *Application.* For information on Mechanistic-Empirical (ME) Design application and requirements, see Index 606.3(2)(b).
- (2) *Procedure.* The ME method can be used to engineer rehabilitation strategies for existing flexible pavements. Unlike the empirical design procedure, the ME method is capable of designing rehabilitation strategies for more than 20 years of service.

Other benefits of the ME method over the empirical procedure are discussed in Index 633.2.

The ME procedure for flexible pavement rehabilitation involves the following:

- (a) Engineering Criteria - Similar to “new construction” and reconstruction design, inputs to the ME design procedure for flexible pavement rehabilitation include detailed information on climate, traffic, existing pavement structure, and desired service life.
- (b) Data Collection - Information on the existing pavement structure is obtained from cores, ground penetrating radar (GPR), and as-built records. In addition, Falling Weight Deflectometer (FWD) deflection testing is conducted on the pavement to obtain deflection basin data. The deflection data is used to assess in-situ strength (in terms of resilient modulus) of each of the existing pavement layers (including subgrade) needed for evaluating rehabilitation requirements using the ME method. The numerical back-calculation method used to obtain the resilient moduli of existing pavement layers is briefly discussed in Index 635.3(2)(c).
- (c) In-Situ Resilient Moduli Evaluation Using Back-calculation - The method of back-calculation relies on using the multilayer elastic theory (MLET) and a numerical search algorithm to determine the resilient modulus of each layer of an existing pavement structure based on deflection basin data collected from the pavement. A deflection basin describes the deflection measured on the pavement surface as a function of distance from the applied load. For additional information on the theory of back-calculation and description of CalBack procedures refer to the link “ME Designer’s Corner” located on the internal Department Pavement website or by contacting the Headquarters Pavement Program Office Chief.
 - For a pavement structure with known layer thicknesses, resilient moduli, Poisson’s ratios, load magnitude and pressure, the MLET is typically used to compute the primary responses (stress, strain, and displacement) at any point within the three-dimensional pavement structure. This type of calculation is called “forward” calculation because the resilient modulus of each layer is known and stresses, strains, and displacements are the unknowns that are being calculated.
 - In the back-calculation method, the MLET is used in a “reverse” manner to back-calculate the resilient modulus of each layer. In this method, vertical displacement (deflection) measured with FWD at various locations on the pavement surface caused by a known load magnitude and loading pressure, along with known layer thicknesses at the test locations obtained from cores, GPR, or as-built plans and reasonably assumed Poisson’s ratios for each of the pavement layers are all used in the MLET in a “reverse” manner to calculate the resilient modulus of each layer.
 - A numerical search algorithm is used in the back-calculation process to ensure that the modulus of each layer is determined within a specified error tolerance. In the search algorithm, the resilient modulus of each known layer is initially assumed and the MLET “forward” calculation is performed to calculate surface deflections at various locations along the deflection basin (at the specified deflection sensor locations from the center of the load). The vertical displacements calculated with MLET and the corresponding measured deflections at same locations are then compared, and the error difference (usually percentage difference) is used to adjust the assumed moduli values. This analysis is repeated many times until the

July 1, 2020

calculated surface deflections become close to measured values within the required error tolerance.

- Because the iterative numerical search algorithm cannot be conducted without computers, the Department with its research partner UCPRC has developed a software for in-situ resilient moduli back-calculation (called CalBack). CalBack uses deflection data obtained from FWD testing along with layer information (layer thicknesses and materials types) to back-calculate resilient moduli of all layers including subgrade.
- (d) Mechanistic-Empirical Analysis - The ME method analyzes a proposed rehabilitation treatment for the three performance criteria (total cracking, total rutting, and IRI) discussed in Index 633.2(2)(b). The engineer starts with a trial rehabilitation design (e.g., by specifying overlay material type and thickness) along with the known existing layer configurations and back-calculated layer moduli, then analyzes the design using the ME procedure encoded in the CalME program. Depending on the performances predicted with CalME the engineer adjusts the rehabilitation design and repeatedly re-runs the analysis until an optimal design is reached. The asphalt material data needed in the analysis may be selected from the CalME standard library or based on laboratory testing of the HMA(s) as discussed in Index 633.2(2)(e). The rehabilitation design must achieve the required reliability level for the project as discussed in in Index 633.2(2)(c).

Topic 636 – Other Considerations

636.1 Traveled Way

- (1) *Mainline*. No additional considerations.
- (2) *Ramps and Connectors*. Rigid pavement should be considered for freeway-to-freeway connectors and ramps near major commercial or industrial areas (TI > 14.0), truck terminals, and all truck weighing and inspection facilities.
- (3) *Ramp Termini*. Distress is compounded on flexible pavement ramp termini by the dissolving action of oil drippings combined with the braking of trucks. Separate pavement strategies should be developed for these ramps that may include thicker pavement structures, special asphalt binders, aggregate sizes, or mix designs. Rigid pavement can also be considered for exit ramp termini where there is a potential for shoving or rutting. At a minimum, rigid pavement should be considered for exit ramp termini of flexible pavement ramps where a significant volume of trucks is anticipated (TI > 11.5). For the engineering of rigid pavement ramp termini, see Index 626.1(3).

636.2 Shoulders

The TI for shoulders is given in Index 613.5(2). See Index 1003.5(1) for surface quality guidance for bicyclists.

636.3 Intersections

Where intersections have “STOP” control or traffic signals, special attention is needed to the engineering of flexible pavements to minimize shoving and rutting of the surface caused by trucks braking, and early failure of detector loops. Separate pavement strategies should be developed for these intersections that may include thicker pavement structures, special asphalt binders, aggregate sizes, or mix designs. Rigid pavement is another alternative for these locations. For additional information see Index 626.3. For further assistance on this subject, consult with the District Materials Engineer or Headquarters Division of Maintenance – Pavement Program.

636.4 Roadside Facilities

- (1) *Safety Roadside Rest Areas.* Safety factors for the empirical method should be applied to the ramp pavement but not for the other areas.

For truck parking areas, where pavement will be subjected to truck starting/stopping and oil drippings which can soften asphalt binders, separate flexible pavement structures which may include thicker structural sections, alternative asphalt binders, aggregate sizes, or mix designs should be considered. Rigid pavement should also be considered.

- (2) *Park & Ride Facilities.* Due to the unpredictability of traffic, it is not practical to design a new park and ride facility based on traffic projections. Therefore, standard structures based on typical traffic loads have been adopted. Table 636.4 provides layer thicknesses based on previous practices.

These pavement structures are minimal, but are considered adequate since additional flexible surfacing can be added later, if needed, without the exposure to traffic or traffic-handling problems typically encountered on a roadway. If project site-specific traffic information is available, it should be used with the standard engineering design procedures discussed in Topic 633 and Topic 635 to design a new or rehabilitate existing pavement structures. A design life of 20 years may be selected for roadside facilities. Refer to Topic 612.

- (3) *Bus Pads.* Use rigid or composite pavement strategies for bus pads.

Topic 637 - Engineering Analysis Software

Software programs for designing flexible pavements using the procedures discussed in this chapter can be found on the Department Pavement website. These programs employ the procedures and requirements for flexible pavement engineering enabling the engineer to compare numerous combinations of materials in seeking the most cost effective pavement structure.

July 1, 2020

Table 636.4

Minimum Pavement Structures for Park & Ride Facilities

California R-value of the Subgrade Soil	Thickness of Layers	
	HMA ⁽²⁾ (ft)	AB (ft)
Less than 40 ⁽¹⁾ (two options)	0.25	0
	0.15	0.35
Greater than or equal to 40 but less than 60	0.15	0
Greater than or equal to 60	Penetration Treatment ⁽³⁾	

NOTES:

- (1) Check for expansive soil and possible need for treatment per Index 614.4.
- (2) Place HMA in one lift to provide for maximum density.
- (3) Penetration Treatment is the application of a liquid asphalt or dust palliative on compacted roadbed material. See Standard Specifications.

CHAPTER 640 – COMPOSITE PAVEMENTS

Topic 641 – Types of Composite Pavement

Index 641.1 – Asphalt Over Concrete Composite Pavement

This configuration consists of an asphalt layer over concrete surface layer (typically jointed plain concrete pavement or continuous reinforced concrete pavement) where the asphalt layer is used to protect or enhance the performance of the concrete pavement. (Asphalt layers over lean concrete base or cement treated base are considered to be flexible pavements for the purposes of this manual.) The function of the asphalt layer is to act as a thermal and moisture blanket to reduce the vertical temperature and moisture gradient within the concrete surface layer and decrease the deformation (curling and warping) of concrete slabs. In addition, the asphalt layer acts as a wearing course to reduce wearing effect of wheel loads on the concrete surface layer.

Asphalt over concrete composite pavements are found most often on older pavements that have had asphalt overlay such as hot mix asphalt, open graded friction course, or rubberized hot mix asphalt, placed over previously built jointed plain concrete pavement (JPCP) or continuously reinforced concrete pavement (CRCP.) New or reconstructed composite pavements with asphalt layer over JPCP or CRCP typically have not been built in the past on State highways because they have been viewed as combining the disadvantages of rigid pavements (higher initial cost) and flexible pavements (more frequent maintenance).

Thin flexible layers (i.e. sacrificial wearing course) have sometimes been placed over JPCP or CRCP to improve ride quality or friction of the rigid layer. Because ride quality and friction can also be improved by grooving or diamond grinding the existing concrete layer, the Engineer should perform a life-cycle cost analysis (LCCA) to determine if diamond grinding/grooving or an asphalt nonstructural overlay is more cost effective before deciding which option to select.

Some cases in which the asphalt over concrete composite pavement option is used include:

- To match the existing pavement structure when widening;
- When adding truck lanes to an adjacent flexible pavement;
- To provide a nonstructural surface course to an existing rigid pavement that is still structurally sound but is worn out on the surface.

July 1, 2020

641.2 Concrete Over Asphalt Composite Pavement

Because of the minimum 0.70 foot thickness requirements for concrete surface course, all pavements with concrete surface course are engineered according to the standards and procedures for rigid pavements in Chapter 620.

Topic 642 – Engineering Criteria

642.1 Engineering Properties

The engineering properties found in Index 622.1 for rigid pavement and Index 632.1 for flexible pavement apply to composite pavements. Care should be taken in selecting materials in the asphalt layer to resist reflective crack propagation from the underlying concrete layer and facilitate construction of generally thin asphalt layers.

642.2 Performance Factors

Flexible layers placed over rigid surface layers need to be engineered and use materials that will meet the following requirements:

- (1) *Reflective Cracking*. Joints or cracks from the underlying concrete surface layer should not reflect through the asphalt layer for the service life of the composite pavement.
- (2) *Smoothness*. The asphalt layer should be engineered to provide an initial IRI of 60 inches per mile and maintain an IRI that is less than 170 inches per mile throughout its service life.
- (3) *Bonding*. A major factor in the effectiveness and service life of the composite pavement is the condition of the bond between the asphalt and concrete layers. For a good bond, the thickness of the asphalt layer does not play an important role in its service life.

Therefore, for practical purposes, if there is no thickness requirement from the structural/constructibility point of view, the minimum thickness of the asphalt layer should be based on material factors such as, gradation and aggregate structure, type of binder, etc. To achieve the maximum bond between asphalt and concrete layers, consult the District Materials Engineer or Headquarters Office of Asphalt Pavement for options on effective bonding methods.

642.3 Overlay Limits

On overlay projects, the entire traveled way and paved shoulder shall be overlaid. Not only does this help provide a smoother finished surface, it also benefits bicyclists and pedestrians when they need to use the shoulder.

Topic 643 – Engineering Procedures for New Construction and Reconstruction

643.1 Empirical Method

Before deciding to construct a new composite pavement, a LCCA should be completed to determine whether the composite pavement is more cost effective over the long term than asphalt or concrete pavement alternatives.

At present, there is no comprehensive procedure to engineer a structural layer of asphalt surface course over a concrete surface course layer of JPCP or CRCP. Research is under way to provide guidelines for engineering and construction of composite pavements. When engineering composite pavements using JPCP or CRCP, the rigid pavement structure is engineered using the procedures in Index 623.1. No reduction is made to the thickness of the concrete layer on account of the asphalt overlay layer. The asphalt pavement is treated as a nonstructural wearing course, and thus has no structural value.

When enough information is not available, the thickness requirement for placing an asphalt layer over an existing rigid pavement can be used as a conservative thickness for a new pavement. See Index 625.1 for further details.

643.2 Mechanistic-Empirical Method

For engineering an asphalt on concrete composite pavement using Mechanistic-Empirical Design follow the procedures and requirements in Index 606.3 and 633.2.

Topic 644 – Engineering Procedures for Pavement Preservation

644.1 Preventive Maintenance

Preventive Maintenance is used to maintain the asphalt surface course layer or to replace thin asphalt layers (i.e., non-structural wearing courses) placed over concrete surface course layer. If work is needed to repair the underlying concrete layer, it should be developed as a CAPM (Index 644.2) or roadway rehabilitation (Topic 645) project. Additional information on preventive maintenance of the asphalt layer of a composite pavement is the same as for the flexible pavements, which can be found in the “Maintenance Technical Advisory Guide (MTAG)” available on the Department Pavement website.

644.2 Capital Preventive Maintenance (CAPM)

The CAPM warrants for concrete and asphalt pavements in Index 624.2 and 634.2 apply to composite pavements. The procedures and designs for asphalt over concrete composite pavement CAPM projects are the same as those for flexible pavements (see

July 1, 2020

Index 634.2) except digouts may require concrete slab replacement and/or base repair. In the case of previously constructed crack, seat, and asphalt overlay projects, it may be beneficial to mill a portion of the existing asphalt layer prior to overlaying. Milling will reduce the thickness of the existing cracked pavement and therefore provide added life to the overlay.

The roadway rehabilitation requirements for overlays (see Index 645.1) and preparation of existing pavement surface (Index 645.1(3)) also apply to CAPM projects. Additional details and information regarding CAPM policies and strategies can be found in Index 603.3, PDPM Appendix H, and Design Information Bulletin 81 “Capital Preventive Maintenance Guidelines.”

Topic 645 – Engineering Procedures for Pavement Rehabilitation

645.1 Empirical Method

Procedures for engineering rehabilitation projects for asphalt over concrete composite pavement using empirical methods are as follows:

Because the asphalt surface layer is considered to have no structural value, only reflective cracking and ride quality need to be considered.

(1) *Reflective cracking.* If the asphalt layer is placed over an existing concrete pavement, the thickness is calculated based on the procedure outlined for rigid pavement rehabilitation. The thickness depends on the design life of asphalt surface course, as well as mix gradation, type and percentage of the binder.

For additional information on rehabilitation of composite pavement with rigid surface courses refer to the Concrete Pavement Guide available on the Department Pavement website.

(2) *Ride Quality.* When the smoothness of the existing roadway is 170 inches per mile or greater as measured by the International Ride Index (IRI), a minimum 0.25 foot consisting of 0.10 foot HMA (leveling course) followed by a minimum of 0.15 foot HMA or RHMA surface course layer. A nonstructural wearing course may be placed on top lift. Pavement interlayers between the leveling course and surface course may also be considered. Note that in some cases, existing pavement will need to be repaired to assure the roadway smoothness will remain below 170 inches per mile throughout the life of the overlay.

(3) *Preparation for Placing Asphalt Layer Over Existing Concrete Pavement.* Existing pavement distresses should be repaired before overlaying the pavement. Cracks wider than 3/8 inch should be sealed or repaired. Undesirable material such as bleeding seal coats or excessive crack sealant should be removed before paving. Existing thermoplastic

traffic striping and raised pavement markers also should be removed. Spalls in rigid pavement should be repaired and broken slabs or punchouts replaced. Grind existing concrete pavement as needed to eliminate rough ride and faulting. Consider dowel bar retrofit when it will help keep faulting from re-emerging. Loose asphalt wearing course should be removed and replaced, and potholes and localized failures repaired. Ideally,

existing non-structural wearing courses should be removed and, if needed, underlying pavement repaired prior to placing a new asphalt wearing course. In some cases it may be more practical to overlay over the existing layer. (A LCCA of the two options will help determine which of these options is more cost effective. Note that when doing a LCCA, the need to ultimately remove asphalt layers in the future should be identified and included in the costs for the analysis.)

645.2 Mechanistic-Empirical Method

For information on Mechanistic-Empirical Design and requirements, see Index 606.3]

CHAPTER 650 – PAVEMENT DRAINAGE

Topic 651 – General Considerations

Index 651.1 – Impacts of Drainage on Pavement

Saturation of the pavement or underlying subgrade, or both, generally results in a decrease in strength or ability to support heavy axle loads. Potential problems associated with saturation of the structural section and subgrade include:

- Pumping action.
- Differential expansion (swelling) of expansive subgrade.
- Frost damage in freeze-thaw areas.
- Erosion and piping of fine materials creating voids which result in the loss of subgrade support.
- Icing of pavement surface from upward seepage.
- Stripping of asphalt concrete aggregates.
- Accelerated oxidation of asphalt binder.

Water can enter the pavement as surface water through cracks, joints, and pavement infiltration, and as groundwater from an intercepted aquifer, a high water table, or a localized spring. These sources of water should be considered and provisions should be made to handle both. The pavement structure drainage system, which is engineered to handle surface water inflow, is generally separated from the subsurface drainage system that is engineered to accommodate encroaching subsurface water. This chapter covers surface water drainage while the subsurface drainage system is covered in Chapter 840.

651.2 Drainage System Components and Requirements

The basic components of a pavement structural section drainage system are:

- (1) *Drainage Layer.* A treated permeable base (TPB) drainage layer may be useful where it is necessary to drain water beneath the pavement. A TPB requires the use of edge drains or some other method of draining water out and away from the pavement; otherwise the collected water will become trapped. If a TPB drainage layer is used, it should be placed immediately below the surface layer for interception of surface water that enters the pavement. The drainage layer limits are shown in Figure 651.2A. Further information for TPB can be found in Index 662.3.

When there is concern that the infiltrating surface water may saturate and soften the underlying subbase or subgrade (due either to exposure during construction operations or under service conditions), a filter fabric or other suitable membrane should be utilized and applied to the base, subbase, or subgrade on which the TPB layer is placed to prevent migration of fines and contamination of the TPB layer by the underlying material.

July 1, 2020

When using TPB, special attention should be given to drainage details wherever water flowing in the TPB encounters impermeable abutting pavement layers, a structure approach slab, a sleeper slab, a pavement end anchor/transition, or a pressure relief joint. In any of these cases, a cross drain interceptor should be provided. Details of cross drain interceptors at various locations are shown in Figure 651.2B. The cross drain outlets should be tied into the longitudinal edge drain collector and outlet system with provision for maintenance access to allow cleaning.

In some situations, underground water from landscape irrigation or other sources may tend to saturate the existing slow-draining layers, thereby creating the potential for pumping and pavement damage. In this case, the pavement should be engineered to provide for removal of such water when reconstruction is required.

- (2) *Collector System.* If constraints exist or where it is not practical to drain water out of the pavement by other means, a collector system should be provided to drain water from the drainage layer. Collector systems include a 3-inch slotted plastic pipe edge drain installed in a longitudinal collector trench as shown in Figure 651.2A. In areas where the profile grade is equal to or greater than 4 percent, intermediate cross drain interceptors, as shown in Figure 651.2C should be provided at an approximate spacing of 500 feet. This will limit the longitudinal seepage distance in the drainage layer, minimizing the drainage time and preventing the buildup of a hydrostatic head under the surface layer. Cross drain interceptor trenches must be sloped to drain.

In addition, cross drains need to be provided at the low-end terminal of TPB projects, as shown in Figure 651.2C. Care should be taken to coordinate the cross drains with the longitudinal structural section drainage system. Drainage layers in roadway intersections and interchanges may require additional collector trenches, pipes, and outlets to assure rapid drainage of the pavement.

A standard longitudinal collector trench width of 1 foot has been adopted for new construction to accommodate compaction and consolidation of the TPB alongside and above the 3-inch slotted plastic pipe.

When a superelevation cross slope begins to drain the water through the TPB to the low side of pavement in cut sections, an edge drain system may be considered to direct water to an area where ponding will not occur.

- (3) *Outlets, Vents, and Cleanouts.* Pavements should be engineered to promote free drainage whenever applicable. Alternative strategies are provided, as shown in Figure 651.2A. Incorporation of a TPB daylighting to the edge of embankment may be considered; otherwise, an edge drain collector and outlet system may provide positive drainage of the structural section.

When edge drains are used, plastic pipe (unslotted) outlets should be provided at proper intervals for the pavement drainage system to be free draining. The spacing of outlets (including vents and cleanouts) should be approximately 200 feet (250 feet maximum). Outlets should be placed on the low side of superelevations or blockages such as bridge structures.

Figure 651.2A

Typical Section with Treated Permeable Base Drainage Layer

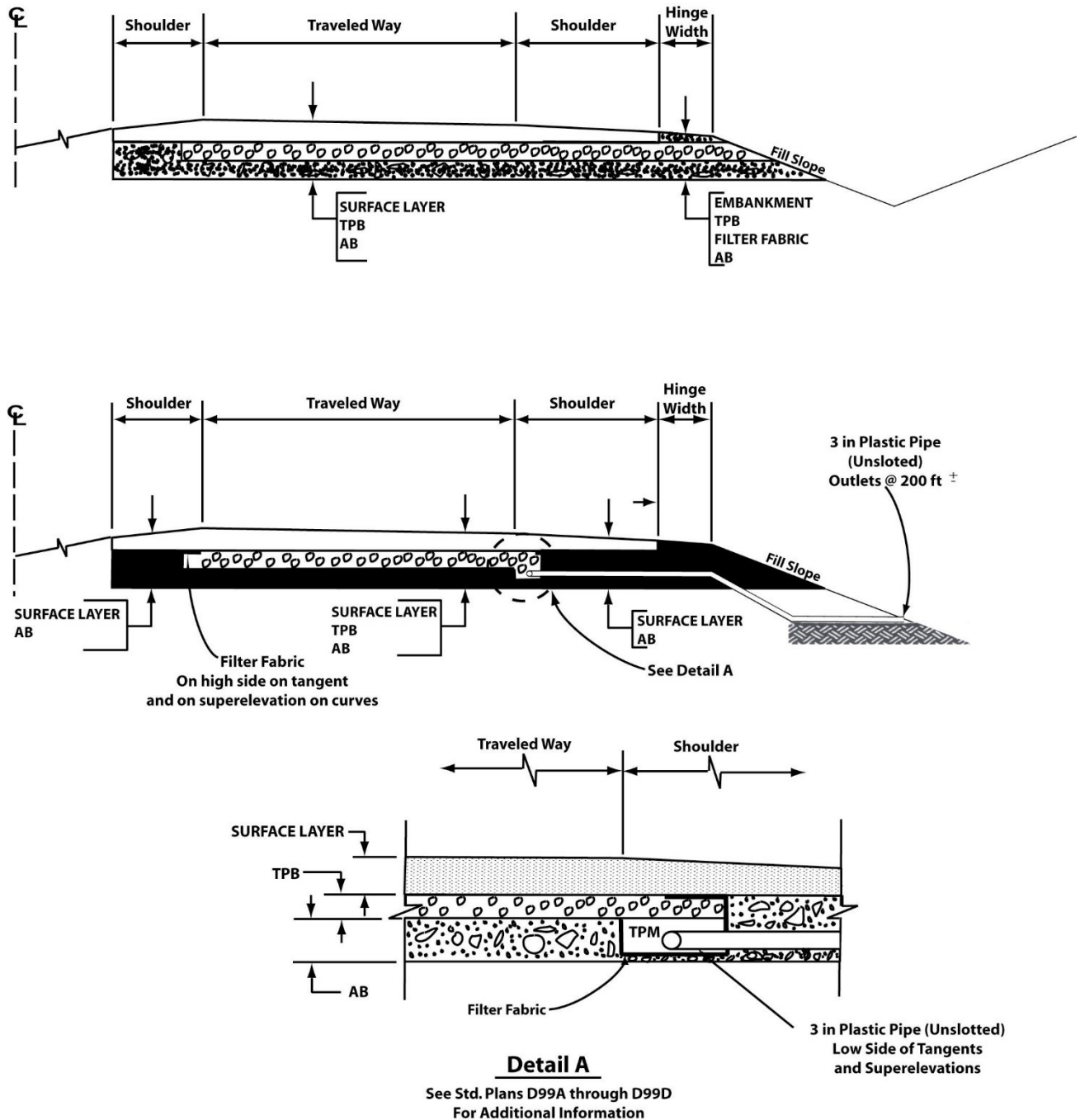

NOTES:

- (1) Section shown is a half-section of a divided highway. An edge drain collector and outlet system should be provided if insufficient Right of Way precludes a retention basin.
- (2) This figure is only intended to show typical pavement details. See the following for further information:
 - (a) Chapter 300 for geometric cross section details.
 - (b) Index 309.1(2) for clear recovery zone guidance.
 - (c) Chapter 680 for widening.

July 1, 2020

Figure 651.2B

Cross Drain Interceptor Details For Use with Treated Permeable Base

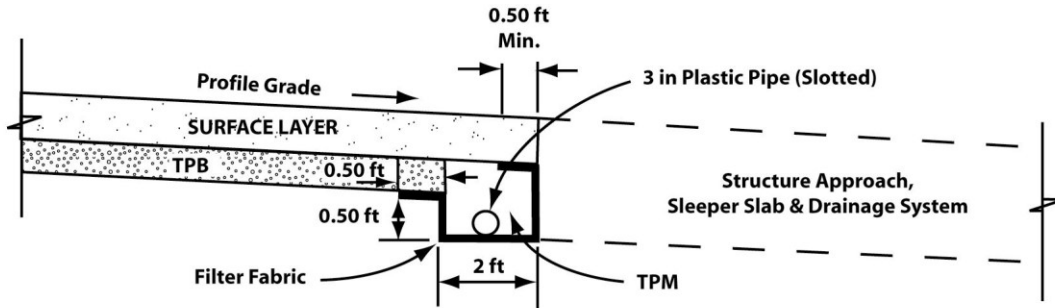

**AT STRUCTURE APPROACH
(LONGITUDINAL SECTION)**

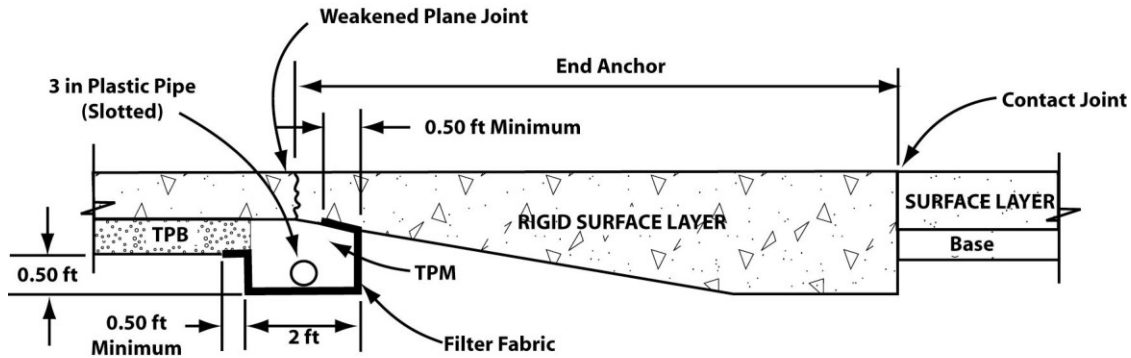

**AT END ANCHOR
(LONGITUDINAL SECTION)**

The trench for the outlet pipe must be backfilled with material of low permeability, or provided with a cut-off wall or diaphragm, to prevent piping. The outlets must be daylighted, connected to culverts or drainage structures, or discharged into gutters or drainage ditches. The area under the exposed end of a daylighted outlet should have a splash block or be paved to prevent erosion and the growth of vegetation, which will impede flows from the outlet. Ready access to outlets, and the provision of intervening cleanouts when outlet spacing exceeds a maximum distance of 250 feet, should be provided to facilitate cleaning of the pavement drainage system. Typical details are shown on the Standard Plans for Edge Drain Outlet and Vent Details.

The end of each outlet pipe should be indicated by an appropriate marker to facilitate location and identification for maintenance purposes and to reduce the likelihood of damage by vehicles and equipment. Consult the District Division of Maintenance for the preferred method of identification. *Filter Fabric.* Filter fabric should be placed as shown in Figures 651.2A and B, respectively, to provide protection against clogging of the treated permeable material (TPM) by intrusion of fines. Filter fabric should be selected based upon project specific materials conditions to ensure continuous flow of water and preclude clogging of the filter fabric openings. Consult with the District Materials Engineer to assist in selecting the most appropriate filter fabric for the project.

Topic 652 – Subsurface Drainage and Storm Water Management

Subsurface drainage (edge drains and underdrains) is to be handled in accordance with the procedures provided in Chapter 890 of the HDM for conveyance and with the procedures in the Storm Water Quality Handbook - Project Planning and Design Guide (PPDG) for storm water compliance. Storm Water Best Management Practices (BMPs) are to be incorporated in the design of projects as prescribed in the PPDG. The PPDG and other information on storm water management can be found at Storm Water page of the Division of Design website.

Topic 653 – Other Considerations

653.1 New Construction Projects

The surface layer should employ materials that will minimize surface water intrusion and any joints should be sealed. If sufficient right of way is available, it is preferable to grade the roadbed to allow for a free draining outlet for the pavement rather than installing edge drain. When a free drainage outlet is used, the TPB and AB layers of the pavement must be daylighted on the low end of the section.

On curvilinear alignments, superelevation of the roadway may create depressions at the low side of pavement where the collected water cannot be drained away. An adjustment to the profile grade may be necessary to eliminate these depressions. Refer to Chapter 200 for superelevation guidelines.

July 1, 2020

Figure 651.2C

Cross Drain Interceptor Trenches

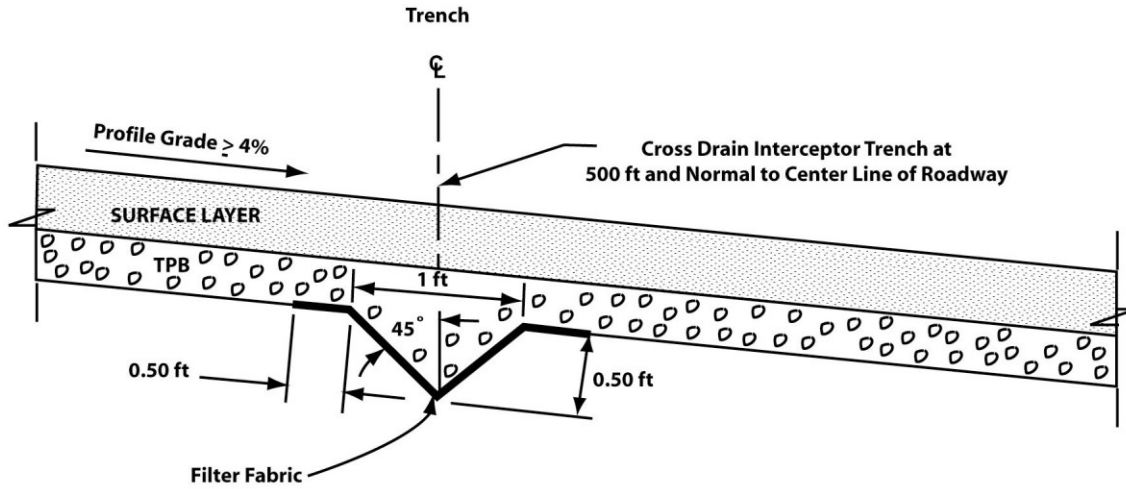

**Intermediate Cross Drain
(Longitudinal Section)**

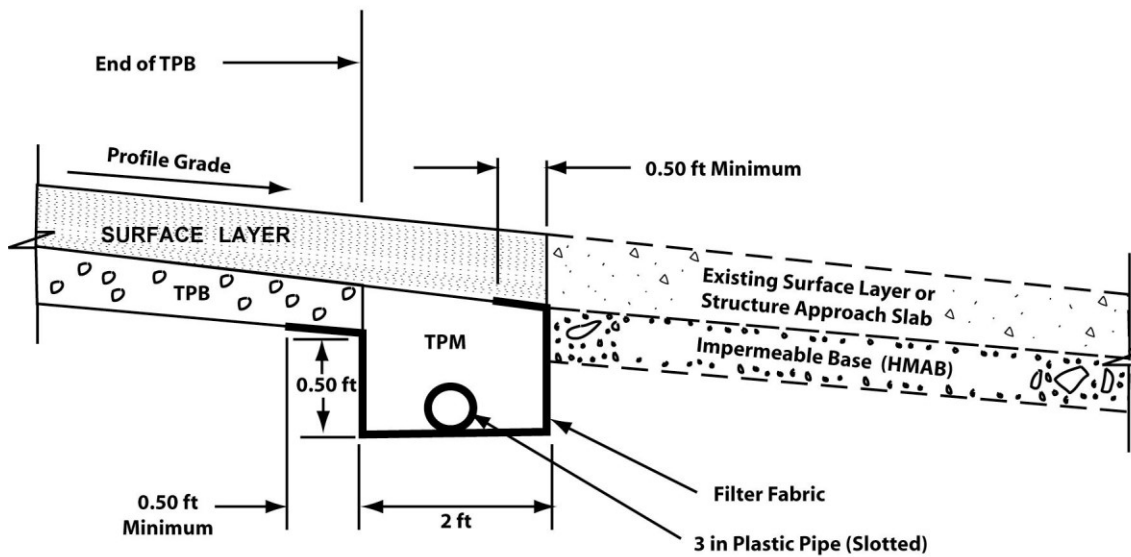

**Terminal Cross Drain
(Longitudinal Section)**

653.2 Widening Projects

The widened pavement layers should be engineered to discharge any existing water collected by the pavement. This may be done by extending any drainage layer of the existing adjacent pavement while still providing sufficient pavement structure to meet the pavement design life requirements in Topic 612. The widened layers should extend the full width of the roadbed to a free outlet, if feasible, as in new construction (See Figure 651.2A).

653.3 Rehabilitation and Reconstruction Projects

The surface of the traveled way and shoulders should employ methods and materials that will help minimize surface water intrusion and any joints should be sealed. Saturation or soft spots should be identified and drainage system should be incorporated to restore or repair the existing pavement, if applicable.

653.4 Ramps

Provisions for positive, rapid drainage of the structural section is very important on ramps as much as main lanes. However, including drainage systems in ramp pavements can sometimes create drainage problems such as accumulation of water in the subgrade of descending ramps approaching local street intersections in flat terrain. Such situations, where there may be no cost effective way to provide positive drainage outlets, call for careful evaluation of local conditions and judgment in determining whether a drainage system should be included or not in each ramp pavement structure.

653.5 Roadside Facilities

The surface of parking areas should be crowned or sloped to minimize the amount of surface water penetrating into the pavement. Drainage facilities for the surface runoff should be provided if flexible pavement is used. A mix using $\frac{3}{8}$ inch or $\frac{1}{2}$ inch maximum aggregate is recommended to provide a relatively low permeability. The flexible pavement should be placed in one lift to provide maximum density.

CHAPTER 660 – PAVEMENT FOUNDATIONS

Topic 661 – Engineering Considerations

Index 661.1 – Description

Pavement foundations typically consist of the following pavement structure layers:

- Base,
- Subbase including stabilized soils, and
- Subgrade or basement soil.

Depending on the type of pavement project and other design considerations, a pavement structure may or may not include base, subbase, or both base and subbase layers. The subbase generally consists of lower quality materials than the base, but better than the subgrade or basement soils. When needed, pavement foundation materials are treated to improve strength. The most common treatment materials are cement, lime, asphalt, and geosynthetics.

661.2 Purpose

Pavement foundations serve as a support for the surface layer and distribute the wheel loads to subgrade material.

In addition to functioning as part of the pavement structure, bases and subbases serve the following functions:

- Slow down the intrusion of fines through upward pumping from the subgrade soil into pavement surface structural layer.
- Minimize the damage caused by frost action.
- Prevent the accumulation of free water within or below the pavement structure.
- Provide a working platform for construction equipment.

Topic 662 – Types of Bases

662.1 Aggregate Base

Aggregate bases consist of a combination of sand, gravel, crushed stone and recycled material. They are classified in accordance with their gradation and the amount of fines. There are two classes of aggregate bases: Class-1 and Class-2. The gradation of the aggregates can affect structural capacity, drainage, and frost susceptibility. The quality of aggregate base material affects the rate of load distribution and drainage.

July 1, 2020

662.2 Treated Base

- (1) *Hot Mix Asphalt Base (HMAB)*. Depending on the quality of aggregate, HMAB is classified as dense-graded Type A or Type B Hot Mix Asphalt, (HMA). Type A is primarily a crushed aggregate, which provides greater stability than Type B. When used with HMA pavement, the HMAB is to be considered as part of the pavement layer. The HMAB will be assigned the same gravel factor, G_f , as the remainder of the HMA in the pavement structure.
- (2) *Concrete Bases*. Concrete base (CB) and Lean concrete base (LCB) are plant-mixed concrete products used as base. CB is essentially unreinforced concrete pavement, constructed with or without reduced joints, used primarily for widening rigid pavement structures that have been or will be surfaced with HMA. CB is finished in anticipation of being paved with HMA. LCB is produced with less cementitious material and allows lower quality aggregates than CB. LCB is primarily intended for concrete pavement structures. Concrete bases can utilize materials that develop strength and/or set quickly. Rapid strength concrete base (RSCB) and lean concrete base rapid setting (LCBRS) have the same applications as CB and LCB, but are usually specified for projects with short construction windows such as individual slab replacement.
- (3) *Treated Bases*. Treated bases are granular materials mixed with asphalt or portland cement to improve the strength or stiffness. Treated bases include cement treated base (CTB) and asphalt treated base (ATB). CTB has shown poor performance under rigid pavement in the past. CTB exhibits excessive pumping, faulting, and cracking. This is most likely due to impervious nature of the base, which traps moisture and yet can break down and contribute to the movement of fines beneath the slab.

662.3 Treated Permeable Base

Treated permeable bases (TPB) provide a strong, highly permeable drainage layer within the pavement structure. The binder material may be either asphalt (ATPB) or portland cement (CTPB). Either of these TPB layers will generally provide greater drainage capacity than is needed. The standard thickness is based primarily on constructability with an added allowance to compensate for construction tolerances. If material other than ATPB and CTPB with a different permeability is used, it is necessary to check the permeability and structural adequacy of the layer thickness. TPB must be used in accordance with a positive sub-drainage system per Index 651.2.

Erosion (water washing away cement paste, and fines) and stripping (water damaging the bond between the asphalt binder and aggregate) can be an issue for TPB. Research conducted in the 1990s at the University of California Pavement Research Center (UCPRC) indicates that the use of ATPB is highly susceptible to stripping. Because of this, the Department recommends use of standard aggregate base (AB), with a compaction of the HMA layer of at least 93 percent of theoretical Rice maximum, instead of ATPB for new pavement structures. When ATPB is needed, such as to ensure continuity of existing ATPB/CTPB layer and/or provide drainage through the pavement structure, special provisions should be made to ensure that it is not subjected to conditions that will lead to premature structural failure. The following guidelines should be followed when using ATPB on State highway pavement projects.

- (1) *Considerations for using ATPB.* The following two conditions warrant consideration to use ATPB layer in the pavement structure:
- (a) When widening or adding lanes adjacent to an existing ATPB layer to ensure continuity of existing ATPB layer.
 - (b) Where there is need to drain excess water through the pavement, such as when the uphill side of pavement does not allow for drainage. However, when practical, it is better in such cases to use sub-surface drainage to carry water to the other side of the roadway rather than drain excess water through an ATPB layer just below the HMA.
- (2) *Added features when using ATPB.* The following features are recommended when using ATPB:
- (a) Use edge drains or daylight the edges (see Figure 651.2A in Chapter 650).
 - (b) If using edge drains, be sure that Maintenance is informed and can budget funds for maintaining edge drains. Developing an estimate of maintenance costs to maintain edge drains and Budget Change Proposals may be required to assure edge drains can be maintained.
 - (c) Try to use permeable backfill in shoulders on sides of edge drain to avoid bathtub effect if edge drain becomes clogged.
 - (d) Increase binder content to 3 percent (maybe higher).
 - (e) Tack coat each layer.
 - (f) Perform moisture sensitivity testing on ATPB.
 - (g) Compaction of the HMA layer should be at least 93 percent of theoretical Rice maximum.

662.4 Subbase

Aggregate subbase is similar to aggregate base but with less restrictive quality requirements. Because of continual depletion of quarry aggregates, most subbases typically consist of recycled pavement materials or quarry products that cannot meet the criteria for aggregate base.

Excavated soil and low quality imported borrow material can be chemically treated with a cementitious binder to improve strength and reduce expansiveness. The most common types of stabilized soils are lime stabilized soil (LSS) and cement stabilized soil (CSS). Other soil stabilization agents include asphalt binder and fly ash or kiln dust, but these are considered experimental alternatives and are not currently supported in the Standard Specifications or guidelines.

Stabilizing the soil does not eliminate or reduce the required aggregate subbase for rigid or composite pavements in the rigid pavements catalog (see Topic 623). However, for flexible pavements, stabilized soil can be used as a substitute for all or part of the required subbase.

July 1, 2020

The District Materials Engineer should be contacted to assist with the selection of the most appropriate method to stabilize soils for individual projects. Final decision as to which stabilization method to use rests with the District.

Topic 663 – Engineering Properties for Base and Subbase Materials

663.1 Selection Criteria

Because different types of treated and untreated base or subbase materials have different capacities for resisting forces imposed by traffic loads, this factor must be considered when determining the thickness of pavement elements. Besides load carrying consideration, the final selection of the bases or subbases for a given project depends on several other factors such as available materials, terrain, climate, economics, and past performance of the pavement under similar project or climate conditions and travel patterns. The District Materials Engineer should be contacted for the latest guidance in base and subbase materials among other related engineering considerations.

663.2 Base and Subbase for Rigid Pavements

For rigid pavements, the capacity of base and subbase materials to resist traffic loads is considered in the design catalogs found in Topic 623. Table 663.2 provides the properties for base and subbase materials used for the Rigid Pavements design catalogs.

663.3 Base and Subbase for Flexible Pavements

For flexible pavements, the capacity of treated or untreated base and subbase materials to resist traffic loads is considered by use of the California R-value and the gravel factor, G_f , which expresses the relative stiffness of various materials when compared to gravel. Table 663.3 provides the California R-value and G_f for base and subbase materials used in the design of flexible pavements using the empirical procedure outlined in Chapter 630.

When the stabilized soil is substituted for aggregate subbase for flexible pavements, as discussed in Index 662.4, the actual thickness of the stabilized soil layer is obtained by dividing the GE by the appropriate G_f . The gravel factor G_f is determined based on unconfined compressive strength (UCS) of the stabilized material as follows:

$$G_f = 0.9 + \frac{UCS(psi)}{1000}$$

This equation is only valid for UCS of 300 psi or higher at 28 days cure. For cement and lime stabilization, UCS is determined by different test methods, but in both cases the 28-day UCS is simulated by curing prepared samples in an oven for 7 days. Refer to the Department Test Method 373. The gravel factor G_f allowed using this equation should range from a minimum of 1.2 to a maximum of 1.7.

Table 663.2

Base and Subbase Material Properties for Rigid Pavement Catalog

HMA Type A Properties	
Aggregate gradation	0% retained on $\frac{3}{4}$ inch sieve 32% retained on $\frac{3}{8}$ inch sieve 52% retained on No. 4 sieve 5.5% passing No. 200 sieve
Asphalt binder type	See Index 632.1(2) and Table 632.1
Reference temperature	70 °F
Poisson's ratio	0.35
Effective binder content	11.662%
Air voids	8%
Total unit weight	149 lb/ft ³
Thermal conductivity	0.657 Btu/hr ft °F
Heat capacity	0.23 Btu/lbm-°F
Base erodibility index ⁽¹⁾	2
LCB / LCBRS ⁽¹⁾ Properties	
Unit weight	150 lb/ft ³
Poisson's ratio	0.20
Elastic modulus	2.00 × 10 ⁶ psi
Thermal conductivity	15 Btu-in/h-ft ² -°F
Heat capacity	0.28 Btu/lbm-°F
Base erodibility index ⁽¹⁾	1
AB / AS Properties	
Poisson's ratio	0.40
Coefficient of lateral pressure, K ₀	0.5
Resilient modulus for AB	43,500 psi
Resilient modulus for AS	29,000 psi
Plasticity Index	1
Passing No. 200	3%
Passing No. 4	20%
D ₆₀ ⁽²⁾	0.315 inch
Base erodibility index ⁽³⁾	4

NOTES:

LCB / LCBRS = Lean Concrete Base / Lean Concrete Base Rapid Setting

- (1) D₆₀ = Particle diameter at which 60 percent of the material sample is finer than or would pass a sieve size of that diameter.
- (2) Base erodibility index is classified as a number from 1 to 5 as follows:
- 1 =Extremely erosion resistant material
 - 2 =Very erosion resistant material
 - 3 =Erosion resistant material
 - 4 =Fairly erodible material
 - 5 =Very erodible material

July 1, 2020

Table 663.3

Gravel Factor and California R-value for Bases and Subbases Used in Flexible Pavement Design

Type of Material	Abbreviation	California R-value	Gravel Factor (G_f)
Aggregate Subbase	AS-Class 1	60	1.0
	AS-Class 2	50	1.0
	AS-Class 3	40	1.0
	AS-Class 4	specify	1.0
	AS-Class 5	specify	1.0
Aggregate Base	AB-Class 2	78	1.1
	AB-Class 3	specify	1.1 ⁽¹⁾
Asphalt Treated Permeable Base	ATPB	NA	1.4
Cement Treated Base	CTB-Class A	NA	1.7
	CTB-Class B	80	1.2
Cement Treated Permeable Base	CTPB	NA	1.7
Lean Concrete Base	LCB	NA	1.9
Lean Concrete Base Rapid Setting	LCBRS	NA	1.9
Hot Mix Asphalt Base	HMAB	NA	(2)
Lime Stabilized Soil	LSS	NA	$0.9+(UCS/1,000)$
Cement Stabilized Soil	CSS	NA	$0.9+(UCS/1,000)$

NOTES:

⁽¹⁾Must conform to the quality requirements of AB-Class 2.

⁽²⁾When used with HMA, the HMAB is to be considered as part of the pavement layer. The HMAB will be assigned the same G_f as the remainder of the HMA in the pavement structure.

Legend:

NA = Not Applicable

UCS = Unconfined Compressive Strength in psi (minimum 300 psi per California Test 373) for lime and ASTM D 1633 (modified) for cement

Because the stabilization of soil may be less expensive than the base material, the calculated base thickness can be reduced and the stabilized soil thickness increased. The base thickness is reduced by the corresponding gravel equivalency provided by the cement or lime stabilized soil. The maximum thickness of lime and cement treated subgrade is limited to 2 feet.

For flexible pavement design with the mechanistic-Empirical (ME) method, the strength of base and subbase materials (as well as subgrade soils) is expressed in terms of the resilient modulus. Refer to Topic 666 for discussion and proposed values of resilient modulus to be used in the ME method.

Topic 664 - Subgrade Enhancement

664.1 Overview

Properties of low quality subgrade can be improved to provide a platform for the construction of subsequent layers and to provide adequate support for the pavement over its design life. The most common methods used in the Department for subgrade improvement include:

- Mechanical stabilization;
- Chemical stabilization; or
- Subgrade enhancement geosynthetics, see Topic 665.

664.2 Mechanical Subgrade Enhancement

Improving strength is usually the primary reason for implementing mechanical stabilization. Mechanical subgrade enhancement includes the following:

- (1) *Compaction*. Sufficient strength can often be achieved on certain subgrade materials that do not quite meet the design requirements by additional compaction usually with a heavier or different type of roller than is normally used. Compaction improves aggregate interlock, and reduces air-void content, pore connectivity, and consequent susceptibility to moisture ingress.
- (2) *Blending*. Blending involves the mixing of materials that have different properties (typically particle size distribution) to form a material with characteristics that improve upon the limitations of the source materials. In most instances, blending will involve adding coarse aggregates to the finer in situ material. Less common in California is the addition of fine material to in situ sandy or coarse aggregates to fill voids and obtain a denser gradation.

664.3 Chemical Stabilization

Low quality in-situ subgrade soil can be improved from Type III to Type II or Type I (see Table 623.1A) by chemical stabilization to a minimum depth of 0.65 foot using an approved stabilizing agent such as lime, cement, asphalt, or fly ash (asphalt and fly ash are not currently supported in the Department's Standard Specifications or guidelines). Chemically treated soil samples should be tested to determine the unconfined strength for the stabilized

July 1, 2020

soil. To ensure long-term stability of the subgrade during the pavement design life the stabilized soil should achieve an initial minimum unconfined strength of 300 psi.

664.4 Subgrade Enhancement Geosynthetics

Subgrade enhancement geosynthetics are geotextile (also called fabric) or geogrid interlayers placed

between the pavement structure and the subgrade (the subgrade is usually untreated). Geosynthetics can be used for temporary improvement of subgrade to provide a platform for equipment during construction, and/or long-term enhancement to improve the ability to sustain traffic loads distributed to the subgrade. Detailed information on subgrade enhancement geosynthetics is provided in Topic 665.

Topic 665 – Subgrade Enhancement Geosynthetic Fabrics

665.1 Purpose

Subgrade Enhancement Geosynthetic (SEG) can be either a Subgrade Enhancement Geotextile (SEG_T) or Subgrade Enhancement Geogrid (SEG_G) placed between the pavement structure and the subgrade (the subgrade is usually untreated). The placement of SEG below the pavement will provide subgrade enhancement by bridging soft areas and, when using SEG_T, provides a separation function between soft subgrade (with a high amount of fines) susceptible to pumping and high quality subbase or base materials. On weak subgrade, the use of SEG_T can also provide a stabilization function (i.e., the coincident function of separation and reinforcement). As the soft soil undergoes deformation, properly placed SEG when stretched will mobilize its tensile strength properties necessary for providing its benefits. Other benefits of using SEG include:

- Prevent premature failure and reduce long-term maintenance costs;
- Potential cost savings:
 - Reduce subbase or aggregate base thickness in some situations,
 - Reduce or eliminate the amount of soft or unsuitable subgrade materials to be removed,
- Increased performance life and reliability of the pavement;
- Prevent contamination of the base materials (when using SEG_T);
- Better performance of a pavement over soils subject to freeze/thaw cycles;
- Reduced disturbance of soft or sensitive subgrade during construction; and
- Ability to install in a wide range of weather conditions.

665.2 Properties of Geosynthetics

- (1) *Subgrade Enhancement Geotextile (SEG_T)*. Mechanical, physical, and other properties of geotextile (SEG_T) used for subgrade enhancement shall meet the requirements in Section 96 of the Standard Specifications.
- (2) *Subgrade Enhancement Geogrid (SEG_G)*. Property requirements for SEG_G are related to performance. The most important geogrid properties for subgrade enhancement related to performance and durability are tensile strength, junction strength, flexural rigidity, and aperture size.

Different types of geogrid can be used for SEG_G provided their stabilizing performance is equivalent to or greater than the values specified in Section 96 of the Standard Specifications.

665.3 Required Tests

The following geotechnical soil laboratory tests are required to evaluate subgrade for the geosynthetic applications:

- Atterberg Limits Tests: CT 204 or alternatively ASTM D 4318 or AASHTO T90.
- R-value Test: CT 301 or alternatively California Bearing Ratio (CBR) test (ASTM D 1883) or AASHTO T 193.
- Sieve Analysis: CT 202 or alternatively ASTM C 136 or AASHTO T27.

665.4 Mechanical Stabilization Using SEG

SEGs (SEG_T and SEG_G) achieve mechanical stabilization through slightly different mechanisms:

- (1) *Subgrade Enhancement Geotextile (SEG_T)*. A geotextile's primary stabilization mechanism is filtration and separation of a soft subgrade and the subbase or base materials. The sheet-like structure provides a physical barrier between these materials to prevent the aggregate and subgrade from mixing. It can also reduce excess pore water pressure through a mechanism of filtration and drainage. Secondary mechanisms of a geotextile are lateral restraint and reinforcement. Lateral restraint is achieved through friction between the surface of the geotextile and the subbase or base materials. Reinforcement mechanism requires deformation of the subgrade and stretching of the geotextile to engage the tensile strength and create a "tensioned membrane."
- (2) *Subgrade Enhancement Geogrid (SEG_G)*. The primary stabilization mechanism of a geogrid is lateral restraint of the subbase or base materials through a process of interlocking the aggregate and the apertures of the geogrid. The level of lateral restraint that is achieved is a function of the type of geogrid and the quality and gradation of the base or subbase material placed on the geogrid. To maximize performance of the geogrid, a well-graded granular base or subbase material should be selected that is sized appropriately for the aperture size of the geogrid. When aggregate is placed over geogrid, it quickly becomes confined within the apertures and is restrained from punching into the soft subgrade and shoving laterally. This results in a "stiffened" aggregate platform over

July 1, 2020

the geogrid. Very little deformation of the geogrid is needed to achieve the lateral restraint and reinforcement. Separation and filtration/vertical drainage are secondary mechanisms of a geogrid. Because the aggregate is confined within the apertures of the geogrid and cannot move under load, separation and filtration can be achieved.

665.5 Selecting Geosynthetic Type and Design Parameters

(1) *Determining SEG Functions.* Subgrade stabilization is the primary function for geogrids installed between an aggregate base and subgrade layer. The primary functions of geotextiles are separation, stabilization, filtration, reinforcement, and drainage.

(2) *Selecting SEG.* SEG can be generally selected based on the following criteria:

- For subgrade R-values greater than 25 but less than 40, SEG_T is recommended to use for its separation function. The requirements for separation function can be found in Section 96 of the Standard Specifications.
- For subgrade R-value between 20 and 25, generally an SEG_G is selected for its stabilization function, depending on natural filter criteria. The stabilization requirements for SEG_G can be found in Section 96 of the Standard Specifications.
- For subgrade R-value less than 20, a designer may choose either SEG_G or SEG_T .
- For subgrade R-value greater than 40, the use of any SEG type may not provide any benefit.

Use the flowchart shown in Figure 665.5 for the optimal selection of the most appropriate type of geotextile or geogrid based on subgrade R-value and gradation of the subgrade and aggregate base materials.

Before selecting SEG, the engineer should investigate the potential engineering and economic benefits of using SEG_T or SEG_G .

665.6 Application of SEG

(1) *Appropriate Applications.* Locations that may require placement of SEG include areas with the following soil characteristics:

- Poor (low strength) soils, which are classified in the Unified Soil Classification System (USCS) as clayey sand (SC), lean clay (CL), silty clay (ML-CL), high plastic clay (CH), silt (ML), high plasticity or micaceous silt (MH), organic soil (OL/OH), and peat (PT);
- Low undrained shear strength: $C_u < 2,000$ psf, and/or other properties stated below in Index 665.6(2);
- High water table and high soil sensitivity

Figure 665.5
Flowchart for SEG Selection

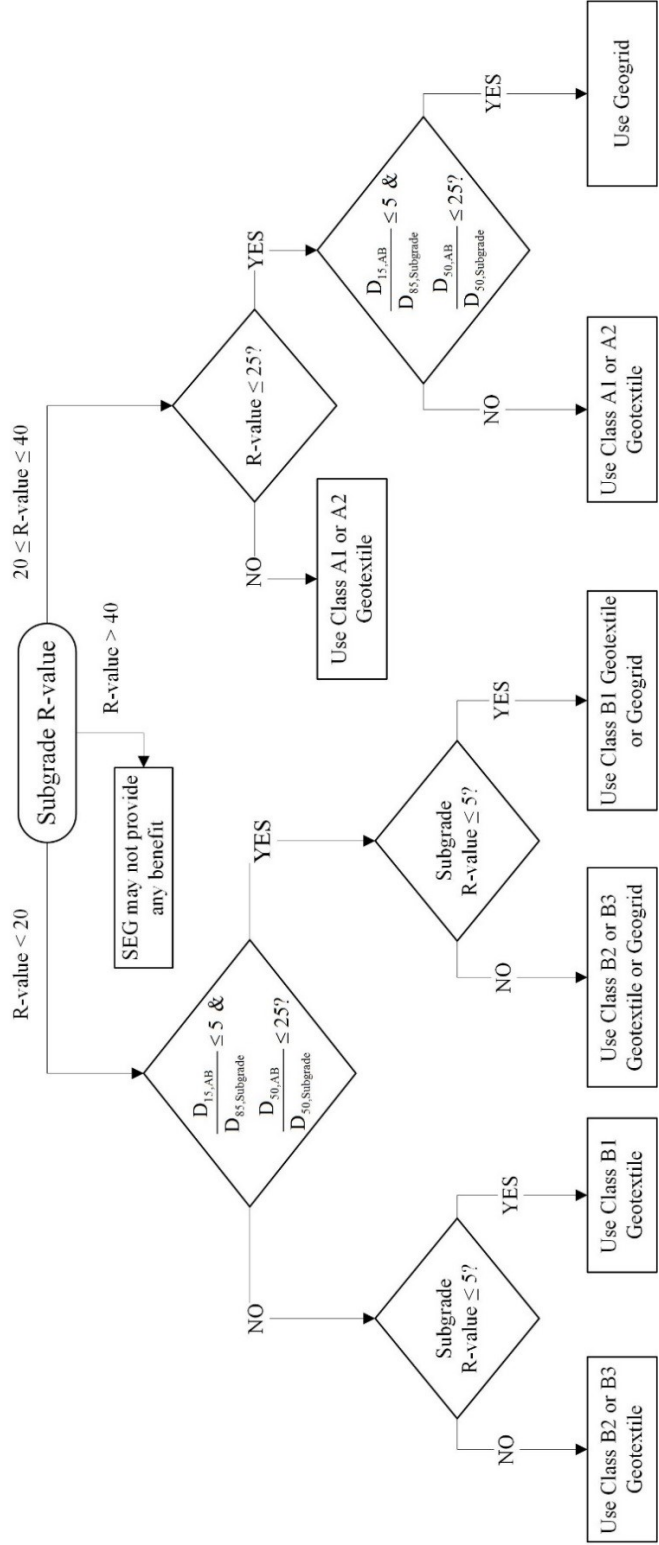

July 1, 2020

(2) Shallow utilities or contaminated soils. *Conditions for Using SEG.*

- SEG_G is most applicable for subgrade R-values < 25 or CBR < 3.5 or resilient modulus $M_r < 5,000$ psi. For R-value between 25 and 40 or CBR between 3.5 and 6.5 or M_r between 5,000 and 9,500 psi the engineer may consider utilizing a geogrid for base reinforcement. Refer to Topic 666 for additional information on resilient modulus.
- SEG_T is most applicable for subgrade R-value < 20 or CBR < 3 or $M_r < 4,500$ psi. For subgrade R-values between 20 and 40 or CBR between 3 and 6.5 or M_r between 4,500 and 9,500 psi, the engineer may consider utilizing a SEG_T as a separator.
- On very soft subgrade conditions (R-value < 10 or CBR < 2 or $M_r < 3,000$ psi), consider placing a thicker initial lift (minimum of 6 inches) of subbase or aggregate base material on top of SEG to effectively bridge the soft soils and avoid bearing capacity failure under construction traffic loading.
- Use of geogrid is not recommended unless the aggregate material meets the following natural filter criteria:
 - $(D_{15} \text{Aggregate Base} / D_{85} \text{Subgrade}) \leq 5$ and $(D_{50} \text{Aggregate Base} / D_{50} \text{Subgrade}) \leq 25$, where D_{15} , D_{85} , and D_{50} are grain sizes of the soil particles for which 15 percent, 85 percent, and 50 percent of the material is smaller than these sieve sizes.
- If the aggregate base material does not meet the above natural filter criteria, geotextiles that meet both separation and stabilization requirements are recommended.
- Do not use geosynthetics for subgrade with R-value > 40 or CBR > 6.5 or $M_r > 9,500$ psi, because stabilization of subgrade is not required and application of geosynthetics will not impart significant benefit to the pavement.

665.7 Other Design Considerations

The following should also be considered by the design engineer when designing pavements involving SEG:

- On soft subgrade soils, the SEG may replace some or all stabilizing material such as lime or cement used solely as a working platform to provide access to construction equipment.
- For information on how to mitigate for expansive subgrade consisting of clay soils with plasticity index (PI) greater than 12, see Index 614.4.
- Consider using SEG for longer life pavement, if not otherwise specified.
- Perform a filter analysis if the soil material types described in Index 665.6(1) are either above or below limits shown in Figure 665.5 when SEG_G is considered to determine whether natural filter criteria are met to control migration of fines into the subbase or aggregate base materials.
- For applications involving drainage and filtration, the design engineer should verify that the permeability of the SEG_T is greater than the permeability of the soil.

- If a SEG_T is to be placed in direct contact with recycled concrete material, SEG_T made of polyester should not be used. Otherwise, a separating layer of thickness greater than 0.3 feet (such as aggregate base) must be placed to separate the geotextile from the recycled concrete material.
- SEG is not necessary if the subgrade is planned for chemical stabilization such as lime or cement treatment.

665.8 Subgrade R-value Enhancement with SEG

Subgrade soils with R-value < 20 are considered poor or weak soils and require SEG to provide reinforcement as the primary function and separation as the secondary function. However, depending on type and treatment of the base layer, pavements constructed over subgrade soils with R-value up to 40 can benefit from separation if the subgrade soil contains an appreciable amount of fines. The SEG when placed with aggregate subbase provides a working platform for access of construction equipment, mainly on subgrade with R-values of 5 to 10.

The use of SEG on weak subgrade (with R-value < 20) can increase the effective R-value of such soils. Therefore, the benefit of using SEG on such weak soils can be realized though using thinner aggregate bases or subbases in flexible pavement design. Likewise, SEG can also affect the design of rigid pavements by providing a stronger subgrade foundation.

The following R-values are recommended when SEG is used on subgrade with low R-value less than 25:

- For subgrade with an R-value of less than 20, a design R-value of 20 can be used if SEG_T is utilized.
- When subgrade has an R-value of less than 25, a design R-value of 25 can be used if SEG_G is utilized. An additional geotextile separator (SEG_T) may be used beneath the SEG_G to provide for the function of filtration and separation unless the aggregate base material meets the natural filter criteria presented in Index 665.6(2).

Additional information on the use of SEG and the selection of the appropriate properties of the SEG based on project specifics are explained in the “Subgrade Enhancement Geosynthetic Design and Construction Guide” available on the Department Pavement website.

665.9 SEG Abbreviations and Definitions

The following is a list of definitions related to subgrade enhancement geosynthetics and their applications:

Apparent Opening Size: A geotextile property that indicates the approximate diameter of the largest soil particle that would effectively pass through the geotextile. Commonly, 95 percent of the geotextile openings are required to have that diameter or smaller as measured using ASTM D 4751.

Aperture Shape: Describes the shape of the geogrid opening.

Aperture Size: Dimension of the geogrid opening.

July 1, 2020

D₁₅: The particle (or grain) size represented by the "15 percent passing" point when conducting a sieve analysis of a soil sample.

D₅₀: The particle (or grain) size represented by the "50 percent passing" point when conducting a sieve analysis of a soil sample.

D₈₅: The particle (or grain) size represented by the "85 percent passing" point when conducting a sieve analysis of a soil sample.

Filtration: The process of allowing water out (perpendicular to plane of geotextile) of a soil mass while retaining the soil.

Geogrid: A geosynthetic formed by a regular network of integrally connected tensile elements with apertures of sufficient size to allow "strike-through" and interlocking with surrounding soil, rock, or earth to improve the performance of the soil structure.

Geosynthetic: A group of synthetic materials made from polymers that are used in many transportation and geotechnical engineering applications.

Geotextile: A permeable sheet-like geosynthetic which, when used in association with soil, has the ability to provide the functions of separation, filtration, reinforcement, and drainage to improve the performance of the soil structure.

Grab Tensile Strength: The maximum force applied parallel to the major axis of a geotextile test specimen of specified dimensions that is needed to tear that specimen using ASTM D 4632.

Nonwoven Geotextile: A planar geotextile typically manufactured by putting small fibers together in the form of a sheet or web, and then binding them by mechanical, chemical and/or solvent means.

Permeability: The permeability of soil or geotextile is the flow rate of water through a soil or geotextile. The permeability of geotextile can be determined by permittivity, which can be measured using ASTM D 4491, multiplied by its effective thickness and the permeability of soil can be measured using ASTM D 2434 or 5084.

Permittivity: It is the volumetric flow rate of water per unit cross-section area of a geotextile, per unit head, in the normal direction through a material as measured using ASTM D 4491.

Puncture Strength: The measure of a geotextile's resistance to puncture determined by forcing a probe through the geotextile at a fixed rate using ASTM D 6241. 10

Reinforcement: The improvement of the soil system by introducing a geosynthetic to enhance lateral restraint, bearing capacity, and/or membrane support.

Separation: A geotextile function that prevents the intermixing between two adjacent dissimilar materials, so that the integrity of the materials on both sides of the geotextile remains intact.

Stabilization: The long-term modification of the soil by the coincident functions of separation, filtration, and reinforcement furnished by a geosynthetic.

Tear Strength: The maximum force required to start or to propagate a tear in a geotextile specimen of specified dimensions using ASTM D 4533.

Ultraviolet Stability: The ability of a geosynthetic to resist deterioration from exposure to the ultraviolet rays of the sun as tested using ASTM D 4355.

Woven Geotextile: Produced by interlacing two or more sets of yarns, fibers, or filaments where they pass each other at right angles.

Topic 666 – Foundation Strength Parameters for Mechanistic-Empirical Design of New Construction and Rehabilitation of Flexible Pavements

666.1 Resilient Modulus

(1) *Use.* Unlike the empirical procedure for flexible pavement design which is based on gravel factors (G_r) and/or R-value of the subgrade, bases, and subbase materials, the mechanistic-empirical (ME) methods for flexible pavement design and rehabilitation require the strength for these foundation materials to be expressed in terms of the resilient modulus, M_r . The resilient modulus is both (1) the input strength parameter in the Department's flexible pavement design methods encoded into the CalME program, and (2) output strength parameter obtained from the back-calculation procedure encoded into CalBack for existing pavement rehabilitation. In the ME method, all layers except the HMA and RHMA-G layers are assigned resilient modulus (different strength parameter is assigned for asphaltic materials that must be derived from advanced laboratory testing). For rehabilitation, the back-calculated resilient moduli of all layers including asphaltic layers are obtained and used in the ME rehabilitation method. Refer to Index 635 for additional information.

(2) *Determination.* The resilient modulus of a material may be found in a number of ways depending on need, whether the material is standard or nonstandard, and whether the design is for new construction or rehabilitation.

- In the laboratory, the resilient modulus of a material (e.g., nonstandard material) is measured under a variety of conditions simulating the physical (e.g., moisture, density, etc.) and stress state conditions of the material subjected to moving wheel loads. Experimentally, it is determined from a relationship between stress and deformation of the material derived using a modified repetitive triaxial testing machine. The loading device in this specialized automated machine is capable of applying repeated cycles of haversine-shaped load pulse of 0.1 second duration followed by a rest period (0.9 seconds for hydraulic loading device and 0.9-3.0 seconds for pneumatic loading device) in accordance with the procedure described in AASHTO T 307, (Standard Method of Test for Determining the Resilient Modulus of Soils and Aggregate Materials). Numerically, it is calculated as the ratio of applied deviator stress (vertical stress less confining pressure) to recoverable or resilient strain. The resilient modulus determined using this procedure represents the elastic modulus of the tested materials recognizing certain nonlinear characteristics. The resilient modulus derived from laboratory experiments conducted on material samples could be used in designing a new flexible pavement using the ME design method.

July 1, 2020

- For new flexible pavement design using the Department's ME method, the resilient modulus of bases, subbases, and subgrade soils are obtained from the standard materials library currently available in CalME.

Table 666.1A provides representative resilient moduli of most standard bases and subbases typically encountered in constructing new pavements along with their Poisson's ratios (ν); a parameter also required for design using the ME methods.

Table 666.1B provides typical resilient modulus values for subgrade soils based on their classification using the Unified Soils Classification System along with their Poisson's ratios (ν). Refer to Table 614.2 for soil classification.

For nonstandard materials, the resilient modulus must be determined experimentally using the AASHTO T 307 test procedure as described above.

For rehabilitation of an existing flexible pavement using the Department's ME method, FWD deflection testing followed by back-calculation analysis described in Index 635.4 are necessary for the determination of in-situ resilient modulus of each layer. The obtained in-situ modulus values must be used in the ME-based rehabilitation method.

Table 666.1A

Typical Resilient Modulus and Poisson's Ratio for Standard Base and Subbase Materials Used in ME-Based Flexible Pavement Design

Material ⁽¹⁾	Resilient modulus, M_r (psi)	Poisson's Ratio, (ν)
AB-Class 2	45,000	0.35
CTB-Class A	1,400,000	0.20
CTB-Class B	1,100,000	0.20
CTPB	1,100,000	0.20
LCB	870,000	0.20
AS-Class 1	35,000	0.35
AS-Class 2	30,000	0.35
AS-Class 3	25,000	0.35
Lime or cement stabilized soil ⁽²⁾	$0.124 \times \text{UCS} + 9.98$	0.20

NOTES:

(1) For definition, see Table 663.3.

(2) UCS is the unconfined compressive strength of the stabilized material in psi measured according to California Test Method 373 with the modification that samples are oven-cured at 105° F for 5 days.

Table 666.1B**Typical Resilient Modulus and Poisson's Ratio for Subgrade Soils Used in ME-Based Flexible Pavement Design**

Soil Classification	Resilient Modulus, M_r (psi)	Poisson's ratio, (ν)
CH	4,000	0.35
CL	9,000	0.35
GC	20,000	0.35
GM	30,000	0.35
GP	29,000	0.35
GW	38,000	0.35
MH	6,000	0.35
ML	11,000	0.35
SC	14,000	0.35
SM	21,000	0.35
SP	17,000	0.35
SW	21,000	0.35

CHAPTER 670 – TAPERS AND SHOULDER BACKING

Topic 671 – Pavement Tapers

Index 671.1 – Background and Purpose

Pavement tapers are a common design detail for asphalt layer overlays and other projects where new pavement surface has a higher profile than existing pavement surface or curbs. The goal of tapers is to provide a smooth unnoticeable transition from pavement to pavement. Tapers are intended to provide a reasonable cost alternative to engineering a profile for every transition. However, in some cases, an engineered profile may be more cost-effective than a taper.

This section provides information on the best design practices for transition tapers that meet geometric, operational, constructability, as well as other pavement surface and drainage standard practices. The tapers presented in this index meet the Caltrans standards and requirements for grade breaks in Index 204.4. The pavement tapers discussed herein do not address every possible situation that can be encountered on projects throughout the State. Good engineering judgment should still be exercised when developing transition taper details for a specific project. This index only addresses permanent pavement transition tapers used on overlay and other pavement projects.

671.2 Engineering Requirements and Considerations

- (1) *Minimum Thickness Requirement.* In order for tapers to be constructable, maintainable and meet performance requirements:
- (a) The minimum thickness for an asphalt pavement taper should be no less than 3 times the maximum aggregate size (example 0.15' for 1/2" aggregate and 0.20' for 3/4" aggregate.)
 - (b) The minimum thickness of the overall surface course layer (existing and new) in the taper should be no less than that of the adjoining existing pavement.
 - (c) When tapering into an existing pavement that was previously overlaid (pavement preservation or rehabilitation), the new taper should overlap the taper of the previous overlay to avoid creating a "dip" or "weak spot" in the pavement (see Figure 671.2A).

July 1, 2020

(2) *Transition Taper Slopes.* The taper slope should be 200:1 or flatter, with taper slope of 400:1 being preferred in highways with design speeds of 65 mph or higher. At locations where taper slopes flatter than 400:1 are desired, engineered profiles should be used because they are often shorter, less expensive, and easier to construct than the pavement taper.

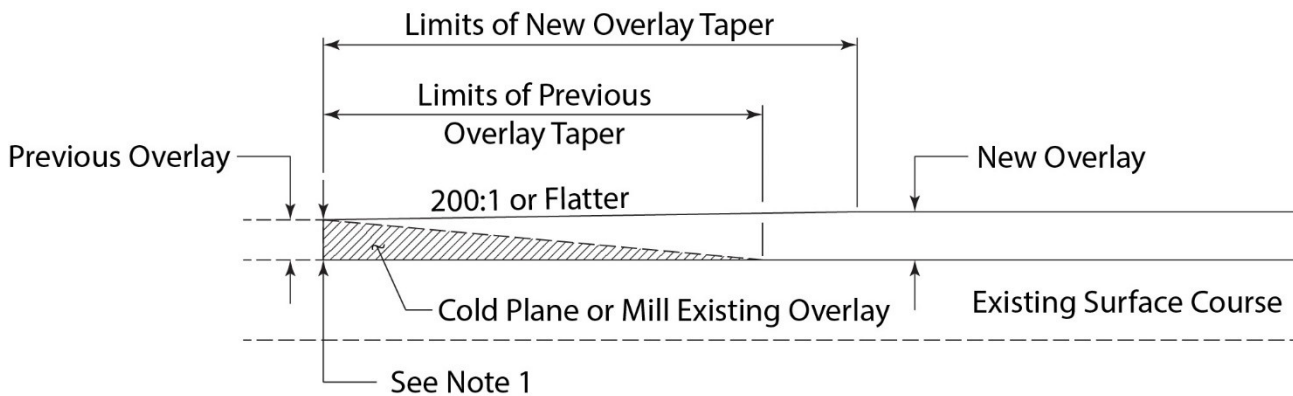
Figure 671.2A**Tapering Into a Previously Overlaid Pavement****NOTES:**

(1) Minimum thickness should match thickness of previous overlay.

(2) No Scale.

(3) *Design Life Requirements for Tapers.* For new construction, widening, and rehabilitation/reconstruction projects, the minimum thickness of the pavement structure (existing plus surface course overlay) for pavement tapers must meet the minimum pavement design life requirements for the project as discussed in Topic 612. This is intended to prevent creating isolated “weak spots” in the pavement that may require additional maintenance and repair in the future. On rehabilitation and reconstruction projects, where the pavement structure of the taper does not meet the pavement design life requirements, the pavement structure or part of it will need to be removed and replaced. Deviations from this requirement or decision not to reconstruct the pavement sections underneath bridges will require a design standard decision document from Headquarters Pavement Program for pavement design life (see Index 612.2 and 612.5). Since pavement preservation projects (preventive maintenance and CAPM projects) are not designed for structural capacity, the minimum thickness of the pavement structure for the pavement taper needs only to match or exceed the existing pavement structure. See Figure 671.2B for further details.

671.3 Tapers into Existing Pavement or Structure

Figures 671.3A to 671.3C provide details on how to construct pavement tapers.

Figure 671.2B

New Structure Approach Pavement Transition Details

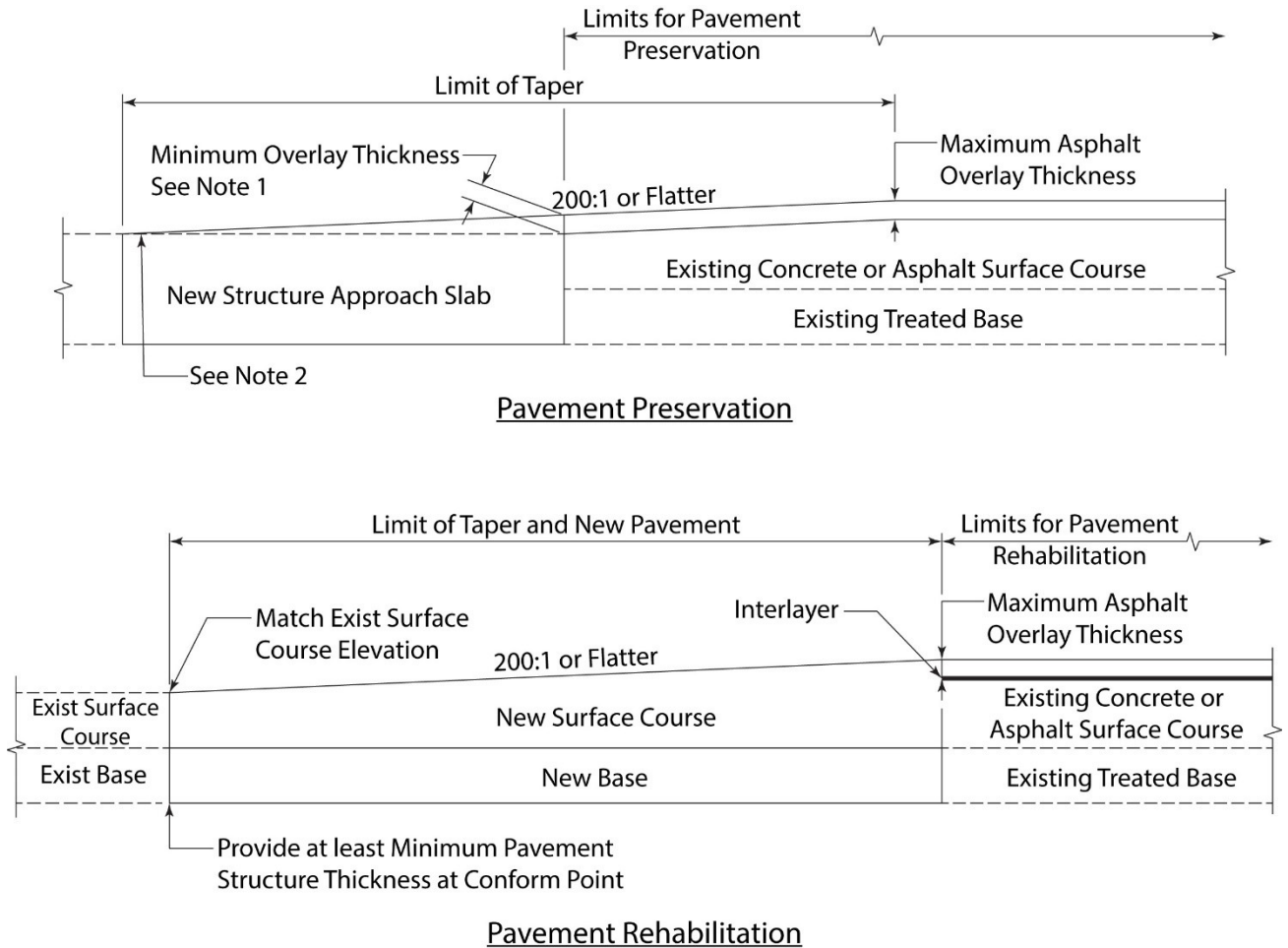

NOTES:

- (1) Use Maximum Overlay Thickness or 3x maximum aggregate size, whichever is less.
- (2) Cold plane as needed to conform overlay with existing pavement.
- (3) No Scale.

July 1, 2020

- (1) *Tapers into an Existing Asphalt Pavement.* Where a new pavement structure or an overlay is tapering into an existing asphalt pavement that is not part of the project, the following apply:
- For preventive maintenance projects (thin asphalt overlays of 0.10' or less), the Design Engineer should follow the taper details in Figure 671.3A.
 - For CAPM projects, taper the overlay using the same details used for OGFC taper to existing OGFC or HMA pavement surface course (See Figure 671.3A)
 - For rehabilitation projects, taper the overlay using the taper details shown in Figure 671.3A for HMA taper to existing HMA surface course.
- (2) *Tapers into an Existing Concrete Pavement.* Where a new pavement structure or an overlay is tapering into an existing pavement that is not part of the project or into/under a structure, grinding existing concrete pavement to create a taper is not recommended because it shortens the life of the concrete pavement. Because it is not always practical to remove and replace concrete pavement for every overlay, the following guidance should be followed regarding tapers for concrete pavement.
- For preventive maintenance projects (thin asphalt overlays of 0.10' or less), the taper should follow the taper details for OGFC overlay over asphalt pavement found in Figure 671.3A or reduce the thickness of overlay to 0.08' at end of taper and roll down edge to minimize raveling. For under structures, existing concrete surface may remain.
 - For CAPM projects, either taper the overlay down using the same details used for OGFC (See Figure 671.3A) or replace the concrete pavement slab. For under structures, the existing concrete surface may remain but should be repaired and ground or rebuilt as needed in accordance with CAPM strategies for concrete pavement in Index 624.2.
 - For rehabilitation projects, do not grind the concrete pavement to accommodate a taper. Instead, remove concrete pavement within the taper section and replace with a new pavement structure that will meet the design life requirements for the project as defined in Topic 612.
 - When grinding concrete pavement, meet the following two conditions:
 - Use a diamond grinder, not a planing machine.
 - Never grind more than 1 inch or reduce the thickness of the concrete pavement slab to less than 0.65 foot.If neither of these conditions can be attained with the taper detail, then remove and replace the concrete pavement slabs and the underlying base as needed for the transition taper section to match the existing pavement surface.
- (3) *Longitudinal Tapers at Shoulders, Curbs, Dikes, Inlets, and Guardrail.* Detailed drawings and information on the best design practices for longitudinal tapers at shoulders, curbs, dikes, inlets, and guardrail are shown in Figure 671.3B.

Figure 671.3A

Transverse Transition Tapers for Pavement Preservation Projects

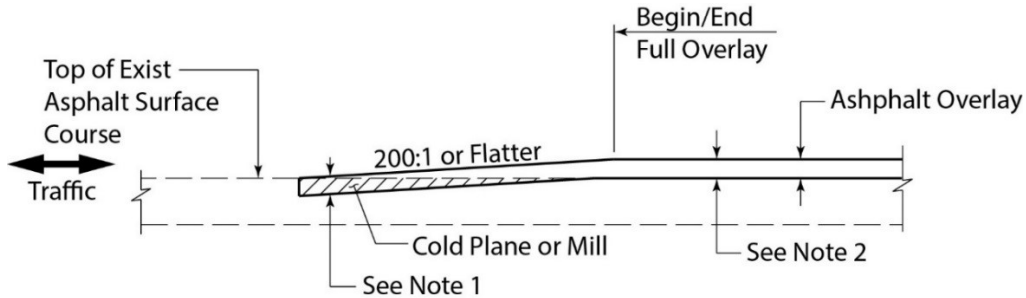

Transverse Asphalt Taper to Existing Asphalt Pavement

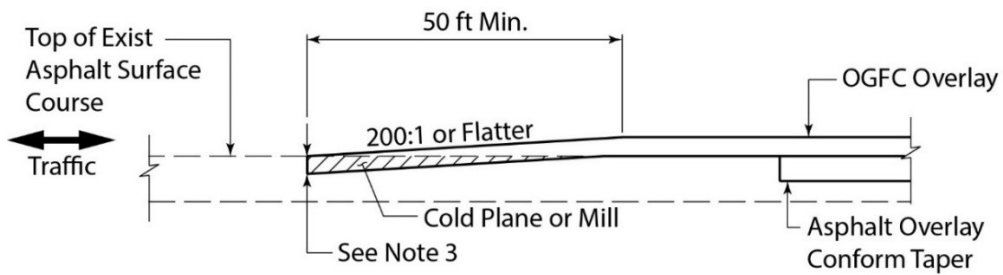

Transverse OGFC Taper to Existing Asphalt Pavement

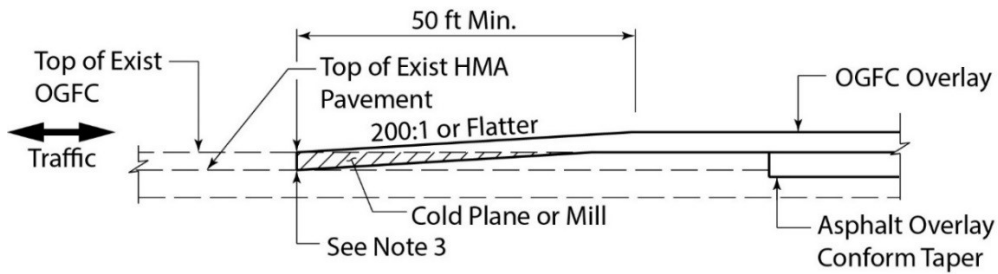

Transverse OGFC Taper to Existing OGFC Pavement

NOTES:

- (1) Minimum thickness should match thickness of the top lift.
- (2) See HDM for minimum thickness.
- (3) Same thickness as OGFC overlay or 0.10', whichever is less.
- (4) Do not use HMA to bring the shoulders up to grade when traveled way is OGFC.

LEGEND:

- HMA = Hot Mix Asphalt
- OGFC = Open Graded Friction Course

July 1, 2020

Figure 671.3B

Longitudinal Tapers at Shoulders, Curbs, Dikes, Inlets, and Guardrail

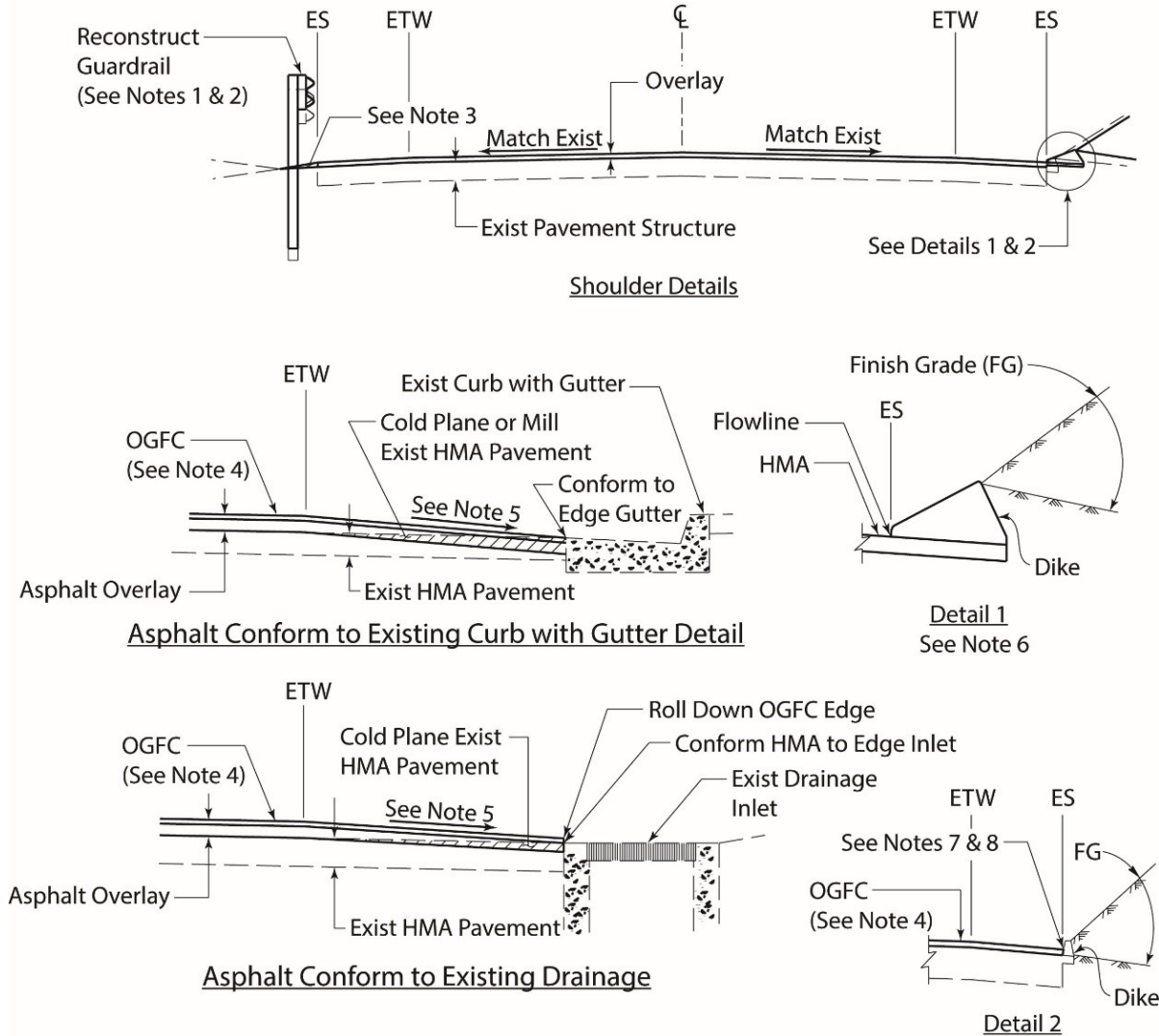

NOTES:

- (1) Additional design and safety criteria may apply for guardrail, for further info, see Traffic Safety Systems Guidance or District Traffic.
- (2) When grinding or paving next to guardrail or obstacle, reconstructing guardrail will be necessary to accommodate grinding machines and compaction equipment.
- (3) Contact District Landscape and Maintenance regarding the appropriate treatment for weed abatement.
- (4) OGFC applies only when used as a surface course, omit details for this course when OGFC is not used.
- (5) See HDM Topic 302 for maximum allowable cross-slopes.
- (6) For additional information on dikes, see HDM Topic 303, and Standard Plan A78B.
- (7) Verify with Hydraulics to see if dike needs to be raised to maintain capacity of gutter.
- (8) Verify with District Hydraulics if additional drainage is required at the conform on the shoulder or at bridge approach slabs in order to avoid ponding.

Figure 671.3C

Transition Taper Underneath Overcrossing/Bridge

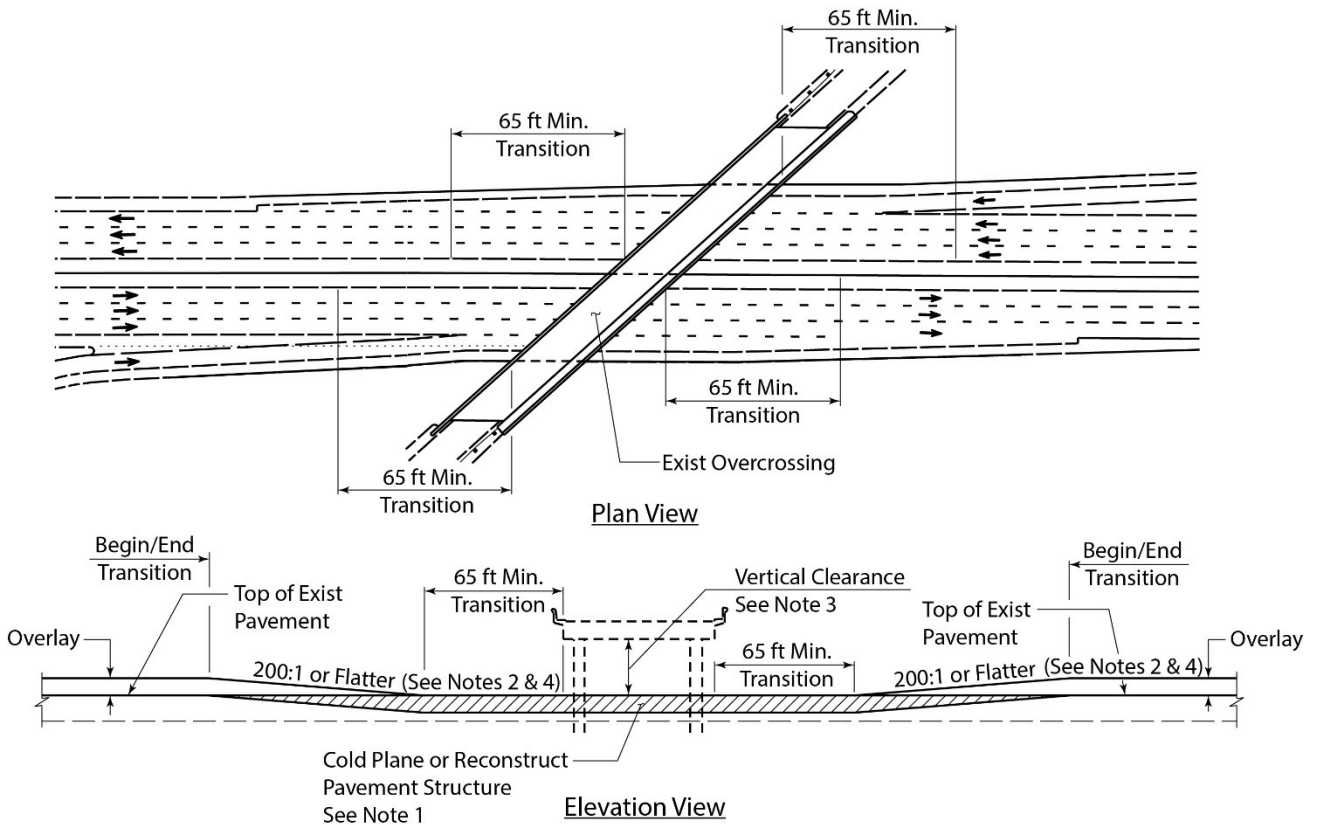

NOTES:

- (1) Pavement structure thickness needs to provide the proposed pavement design life. This may require that the pavement structure be removed and replaced.
 - (2) Verify that the existing drainage facilities will continue to function properly after transition is completed.
 - (3) For minimum vertical clearance requirements, see HDM Index 309.2
 - (4) Creation of a sag may require additional drainage features.
- (4) *Tapers Into or Under Structures.* Figure 671.3C provides a layout and information for transition tapers under an existing structure. The following guidance should be followed when designing tapers underneath over-crossings or into bridges:
- (a) Compare the cost and constructability of very flat tapers (400:1 or flatter) vs. engineered profiles to ensure that the less expensive and easier to construct alternative is used when replacing pavement underneath a structure.
 - (b) The minimum thickness of the pavement structure for transition tapers into or under bridges must meet the minimum design life requirements discussed in Index 671.2(4) for new construction, widening, rehabilitation, and reconstruction projects.

July 1, 2020

Topic 672 – Shoulder Backing

672.1 Background and Purpose

- (1) *Purpose.* Shoulder backing is a thin course of granular material that is used to provide support to the pavement edge by preventing edge cracking and pavement edge loss. Shoulder backing also minimizes pavement edge drop-off heights for overlays.
- (2) *Standards and Requirements.* The placement of shoulder backing requires proper compaction of the shoulder backing material.
- (3) *Application:* Shoulder backing is designed to provide edge support for thin overlays placed on existing pavements. Do not use shoulder backing as embankment material in the following cases:
 - To repair erosion or subsidence in existing slopes (See Figure 672.3C).
 - For side slope reconstruction (See Figure 672.3C).
 - In locations where the overlay thickness is greater than 0.50 ft (See Figure 672.3C).
 - For backfill behind dikes (See Figure 672.3D).
 - To construct the required minimum hinge width (HW) for guardrails, dikes, and barriers.
 - In roadside ditches or gutters (See Figure 672.3E). Since the material used for shoulder backing can be erodible, use non-erodible materials or stabilized base material in roadside ditches or gutters.

Shoulder backing is not be used in the above cases because the material and/or compaction specifications requirements in the Standard Specifications will not provide the desired results. Alternative engineering solutions should be utilized in these situations. Alternative engineering solutions include slope reconstruction, compacted fill, or use of stabilized material. Some alternatives to shoulder backing may require developing a nonstandard special provision.

672.2 Alternate Materials and Admixtures

- (1) *Alternate Materials.* Alternate materials for shoulder backing include imported borrow and asphalt grindings.
 - (a) Imported Borrow: If native material does not meet the specifications for shoulder backing material, utilize imported borrow which meets the specifications for shoulder backing material.
 - (b) Asphalt Grindings: The Deputy Directive on Recycling Asphalt Concrete allows the use of asphalt grindings for shoulder backing; however, there are some limitations to where asphalt grindings can be used. For information on where asphalt grindings cannot be used consult the District Environmental unit. As stated in the Project Development Procedures Manual (PDPM), a Memorandum of Understanding (MOU) dated January 12, 1993 between the Department of Fish and Game (DFG)

and Caltrans, allows Caltrans to use asphalt grindings for shoulder backing where these materials will not enter the water system.

- (2) *Admixtures.* Admixtures may be used if recommended by the District Materials Engineer and their use is permitted in the environmental document and regulatory permits. District Environmental can assist in determining if and where admixtures can be used. Three types of admixtures (lime, cement, and seal coat with an asphaltic emulsion) are approved for use with shoulder backing.
- (a) Lime and Cement Admixtures: Lime and cement are uniformly mixed into the shoulder backing material prior to application.
- (b) Seal Coats: Seal coats with an asphaltic emulsion are applied in situ on top of shoulder backing material. When seal coats are specified, the appropriate seal coat special provisions should be included into the project special provisions. Seal coats are paid for separately from shoulder backing material.

672.3 Design

The limits, slopes, and other design details for shoulder backing need to be documented on the plans. The following design standards apply when designing shoulder backing details:

- (1) Place shoulder backing from the edge of pavement (EP) to hinge point (HP). However, where the horizontal distance from EP to HP is greater than 3 feet, shoulder backing should be placed on a width of at least 2 feet from EP (See Figures 672.3A and 672.3B). The Design Engineer should consult with the District Materials Engineer for conditions where the distance from EP to HP is less than 2 feet and there are minimum hinge width requirements for dike, guardrail and barriers.
- (2) Shoulder backing cross slope should be 10:1 or flatter where possible. Where there is insufficient width for a 10:1 slope, a steeper cross slope can be used but should not be steeper than 6:1 (See Figure 672.3A).
- (3) The minimum hinge width (HW) from EP to new HP should be 2 feet (See Figure 672.3B). Where the existing HW is less than 2 feet, slope reconstruction (See Figure 672.3C) or some other strategy should be used instead of shoulder backing.
- (4) Do not place shoulder backing on existing side slopes where shoulder backing cross slope will be steeper than 6:1 and/or the HW will be less than 2 feet (See Figures 672.3A & 672.3B).
- (5) The maximum thickness for shoulder backing is 0.50 foot (See Figure 672.3B). Where the thickness will exceed 0.50 foot, use alternative strategies that have a combination of more stringent material and compaction requirements
- (6) Where the combined distance for HW and side slope will exceed 5 feet in order to comply with the slope requirement specified in this document, side slope reconstruction is recommended in lieu of shoulder backing (See Figure 672.3C).
- (7) At the option of the District, shoulder backing can be placed up to a thickness of 0.50 foot to cap new construction or reconstructions (See Figures 672.3B & 672.3C).

July 1, 2020

(8) Place shoulder backing to match the pavement surface, even when the surface course layer is open graded friction course (OGFC). This reduces future maintenance needs to replace the shoulder backing as it subsides.

Figures 672.3A through 672.3E show some examples of what should and should not be done when using shoulder backing.

Figure 672.3A

Typical Application of Shoulder Backing

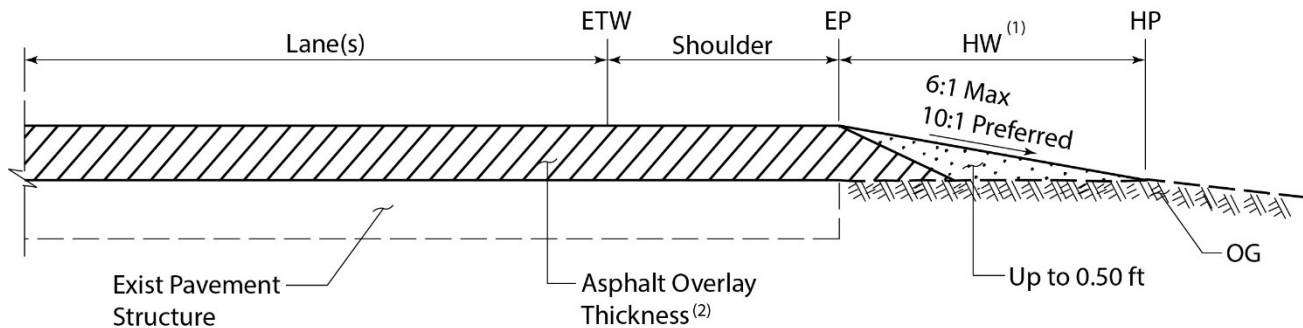
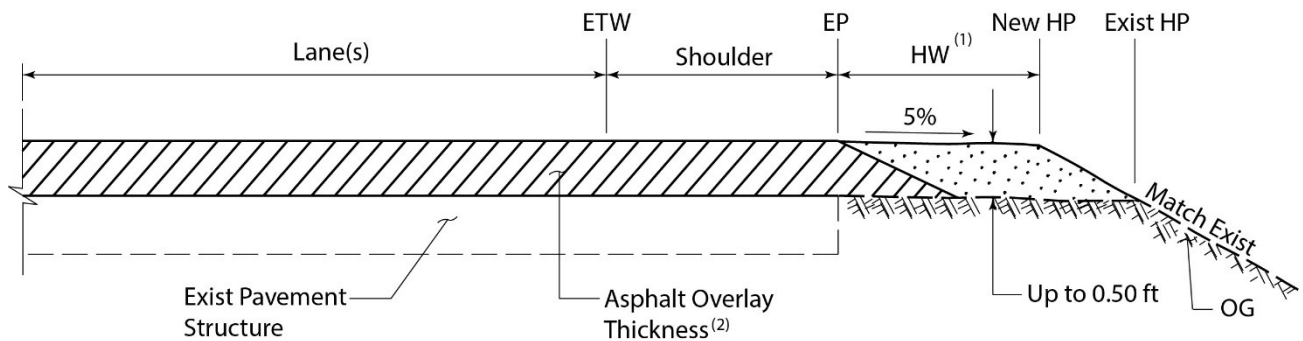

Figure 672.3B

Alternative Placement for Existing Slopes Steeper than 6:1



NOTES:

⁽¹⁾Minimum Hinge Width (HW) is 2 feet. When HW is less than 3 feet, District Materials Engineer should be consulted regarding structural stability due to width reduction.

⁽²⁾Edge treatment shown are for asphalt overlay thickness of 0.45 foot or less. For asphalt thickness of more than 0.45 foot, see Standard Plans for edge treatment details.

Figure 672.3C

Placement of Shoulder Backing Thickness Greater Than 0.50 foot for Slope Repair

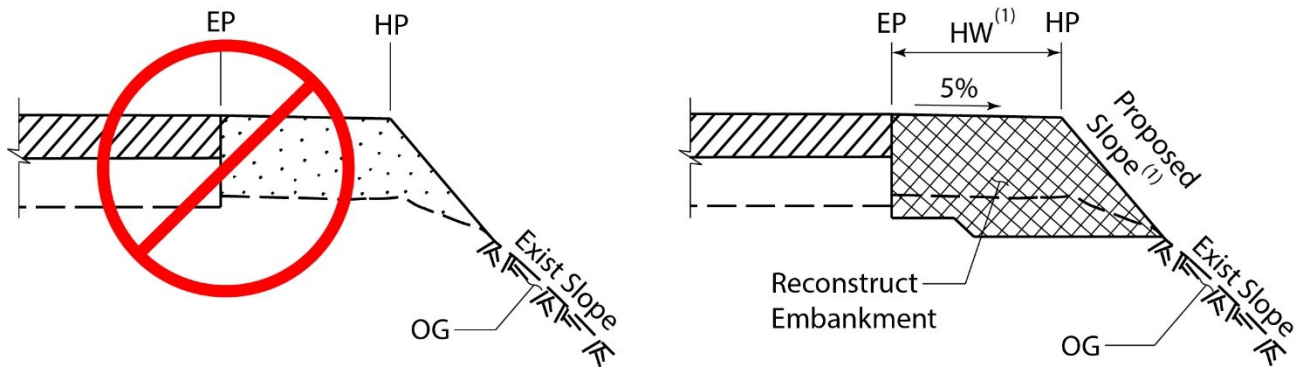

NOTES:

(1)See HDM Topic 304 for additional information on side slopes. See Standard Specifications for additional information on side slope construction. See District Materials Engineer for material recommendations. (Roadway Geotechnical also needs to be consulted for slopes steeper than 2:1.).

Figure 672.3D

Placement of Shoulder Backing Behind Dikes

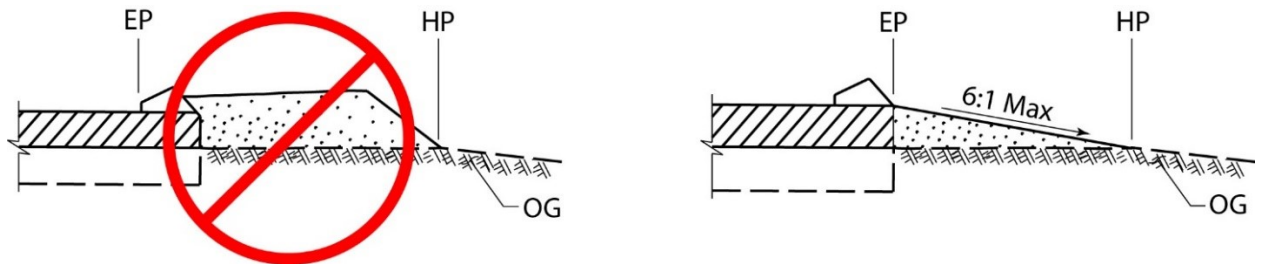

July 1, 2020

Figure 672.3E

Longitudinal Drainage (Roadside Ditches/Gutters)

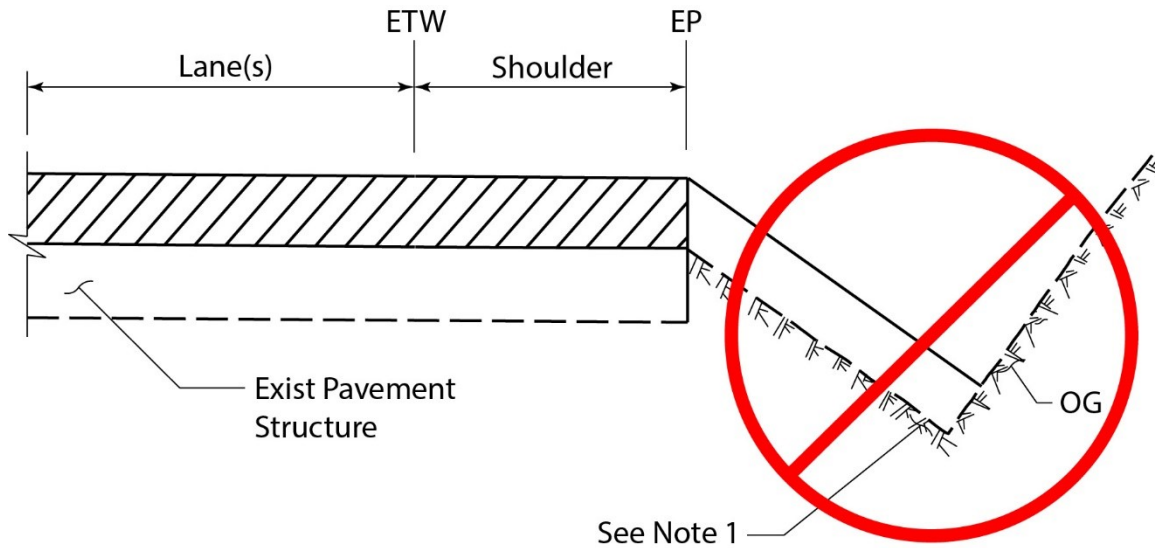

NOTES:

- (1) Consult with area Maintenance personnel and District Materials Engineer regarding erodability of ditch, alternative materials to shoulder backing, slope sloughing, and rockfall catchment in ditch.
Consult with District Hydraulics Engineer regarding acceptable change in ditch capacity.
Consult with District Stormwater Coordinator regarding water quality issues.

CHAPTER 680 – PAVEMENT DESIGN FOR WIDENING PROJECTS

Topic 681 – Pavement Widening Overview

Index 681.1 – Background

(1) *Purpose* - Pavement widening involves the construction of additional width to improve traffic flow and increase capacity on an existing highway facility or to improve existing features such as the inclusion of shoulders, turn lanes, and passing lanes. Pavement widening projects create unique issues for pavement engineers such as what is the best structure to build for the widening and how to tie or build next to existing pavement. This Chapter provides instructions and guidance for selecting pavement type, design standards, and details for pavement widening projects.

(2) *Types of Pavement Widening Projects* - Pavement widening may involve the following types of pavement projects:

- Adding travel lanes (including bus or bicycle lanes), auxiliary lanes, climbing or passing lanes, etc.,
- Adding shoulders, pullouts for maintenance/transit traffic; or
- Widening existing lanes, shoulders or pullouts.

When planning widening projects such as lane or shoulder additions, the existing adjacent pavement condition should be investigated to determine if the measures discussed in Index 682.3 are needed to combine rehabilitation or pavement preservation work with widening.

Topic 682 – Design Considerations

682.1 Standards

Besides pavement engineering discussed in Chapter 610, pavement widening presents additional challenges in pavement design. These include the following:

- A uniform foundation across the new and existing pavement structure to accommodate both pavement drainage and fatigue performance.
- Existing pavement is adequate to sustain traffic loads expected during the design life of the new pavement widening structure.
- Continuity of existing pavement structure drainage system.

Oftentimes, because existing pavements may have been designed decades earlier for lower traffic loads than are currently experienced, their thicknesses may not only be less than those of the new widened pavements but are often worn and in some cases exhibit

July 1, 2020

minor or major distress. These issues could considerably affect the service life and drainage of both the existing and new pavement structures. To ensure both drainage and design life standards are met, drainage conditions and structural capacity of both existing and new pavement structures should be evaluated and taken into account during the planning and scoping phases of a widening project.

682.2 Pre-Design Evaluation

Pavement widening requires a careful evaluation of the existing and proposed new widened pavement structures to ensure adequate performance under expected traffic loads, provide a consistent foundation across new and existing pavements, and perpetuate pavement drainage. The following pre-design evaluations are recommended to ensure that pavement widening projects are designed and constructed to meet these performance requirements.

- Review as-built records of the existing pavement structure such as the as-built material properties, mix designs, and layer thicknesses. In some instances, layer thicknesses from Ground Penetrating Radar (GPR) may also be available.
- Review the current pavement condition survey data.
- Conduct field evaluations including obtaining pavement cores and where applicable performing Falling Weight Deflectometer (FWD) survey to determine the following:
 - (1) Existing material properties and layer thicknesses
 - (2) Layer deflection and moduli (for use in asphalt pavement design)
 - (3) Soil properties including subgrade strength and subgrade moduli, and obtain samples for laboratory investigation if needed.
 - (4) Detection of moisture in the existing base

In instances where the existing pavement is in good condition and does not require rehabilitation, the most essential evaluations are the review of as-built records and current pavement condition survey data.

682.3 Pre-Design Considerations

The following pre-design considerations are recommended when designing a pavement widening project.

- (1) *Consistent and Cost-effective Overall Pavement Structure.* The engineer needs to consider what characteristics are important for both the new and existing pavement in order to provide a consistent, cost-effective, and functioning structure for the overall pavement. This includes taking into account how the new pavement will perform as well as doing a life-cycle cost analysis of how and when the new and existing pavements will be maintained.
- (2) *Rehabilitation or Pavement Preservation of Existing Pavement with the Widening Project.* It is not often cost-effective nor desirable to widen a highway without correcting ride quality and structural distress in adjacent pavement structure when that

work is needed. During planning and scoping of widening projects, it is necessary to thoroughly evaluate the existing adjacent pavement structure to determine if rehabilitation or pavement preservation is needed in conjunction with the widening. This involves a review of the current pavement condition survey data in conjunction with a field investigation of the existing roadway. The review should be done during the project initiation phase and updated during the design phase because the pavement condition may have deteriorated during the intervening time. If rehabilitation or pavement preservation is warranted, combining rehabilitation or pavement preservation work with widening is strongly encouraged.

- (3) *Future Traffic Delay and Long-Term Costs.* Combining widening with rehabilitation or pavement preservation work on existing pavement can minimize future traffic delay and long-term costs. If the adjacent existing lane warrants rehabilitation, the lane should be rehabilitated in conjunction with the widening and brought up to the same life expectancy as the new widened portion of the roadway (see Index 612.3. In certain circumstances, the District may defer the pavement rehabilitation work and program it as a separate project, but this should be done in coordination with Headquarters Pavement Reviewers and the Project Delivery Coordinators (for non-delegated projects per the District Design delegation Agreement). If the adjacent lane does not need to be rehabilitated, an appropriate pavement preservation treatment should be applied to provide a uniform surface for maintenance of existing and widened sections.

Pavement preservation and rehabilitation work that should be included with widening projects for concrete and asphalt pavements are discussed in Index 682.4(1)(b) and 682.4(2)(c) respectively.

682.4 Scoping, Estimating, and Detailing

The following design criteria are provided to aid in scoping, estimating, and detailing pavement widening projects. As per Index 82.1(1), these requirements should be viewed as minimum criteria for determining how much work to do on existing pavements. Because each widening project has different pavement engineering and performance issues, early and frequent involvement of Headquarters Pavement Reviewers is recommended to appropriately address what features to include and how to ensure the following design criteria are met.

- (1) *Pavement Structure Requirements.* The following minimum requirements should apply when designing pavement structures for widening projects.
- (a) If a widening project causes the traffic lanes to lay partially on existing pavement and new pavement, then the engineer should ensure that the pavement type and structure are consistent across the lane. Avoid creating lanes that are partially asphalt, concrete or composite as this will wear at different rates and increase future maintenance costs and worker exposure on the lane.
 - (b) Remove the existing pavement up to the lane line of the existing adjacent truck permitted lane and replace it as part of the new widening pavement structure if:
 - (1) The traffic load capacity of the existing pavement measured in ESALs is more than 90 percent of the predicted need,

July 1, 2020

- (2) The existing pavement is in good condition as identified in the pavement condition survey), and
- (3) The new widening is adding less than 2 lanes and the width of widening the proposed lane is 9 feet or less.

In these situations, the proposed widened pavement structure may match the existing pavement and, where needed, a preservation treatment applied as discussed in Index 682.4(1)(b) and (2)(c). Otherwise, it is preferable to construct new lane(s) to new construction standards and remove existing pavement as needed to accommodate the predicted need.

(2) *Widening of Concrete Roadways.* The following design standards should apply when widening concrete roadways:

- (a) Place longitudinal joints at location of proposed lane lines (or ultimate lane line if project is an interim stage of an ultimate project) except as noted below:
 - (1) Place the longitudinal construction joint between the existing pavement and the new widened section, 0.5 foot from the lane line for truck permitted lanes and from the edge of existing concrete for all other widening in traveled way except for auxiliary lanes next to truck permitted lanes where widening should match existing edge (See Figure 682.4A). Relocating the joint also allows for a clean joint by minimizing spalling and undulations in the existing joint. For truck permitted lanes, relocating the longitudinal joint 0.5 foot outside the lane will provide a uniform section of concrete to distribute truck loads and provide lateral support for the truck lane when longitudinal isolation joint is used. This will assure the performance of the pavement over its design life
 - (2) Additional requirements and details for tying adjacent concrete slabs can be found in Index 622 and the Standard Plans.
 - (3) When existing longitudinal joints and proposed or ultimate lane lines do not line up, it is preferable to construct longitudinal pavement joints between new and existing concrete (particularly isolation joints) in non-truck permitted lanes.
- (b) Do not place or leave slabs less than 8 feet wide in truck permitted lanes or joints within 2 feet of wheel paths. The reduced width of the slab will lead to early cracking of the pavement.
- (c) When widening contiguous to concrete pavement in good condition, a pavement preservation strategy in conjunction with widening is recommended if warranted, including grinding the existing rigid pavement where warranted. This provides a smooth riding surface and can eliminate old striping and pavement markings. Grinding the lane next to the proposed widening is required when the existing International Roughness Index (IRI) exceeds 90 inches per mile in order to provide a smooth platform for the paving machine to construct the adjacent pavement structure. Pavement preservation strategies are discussed in Index 603.3 and in the *Concrete Pavement Guide*. Additional information on procedures for concrete pavement preservation can also be found in Topic 624.

Figure 682.4A

Typical Concrete Pavement Widening Median Lane and Outer Lane

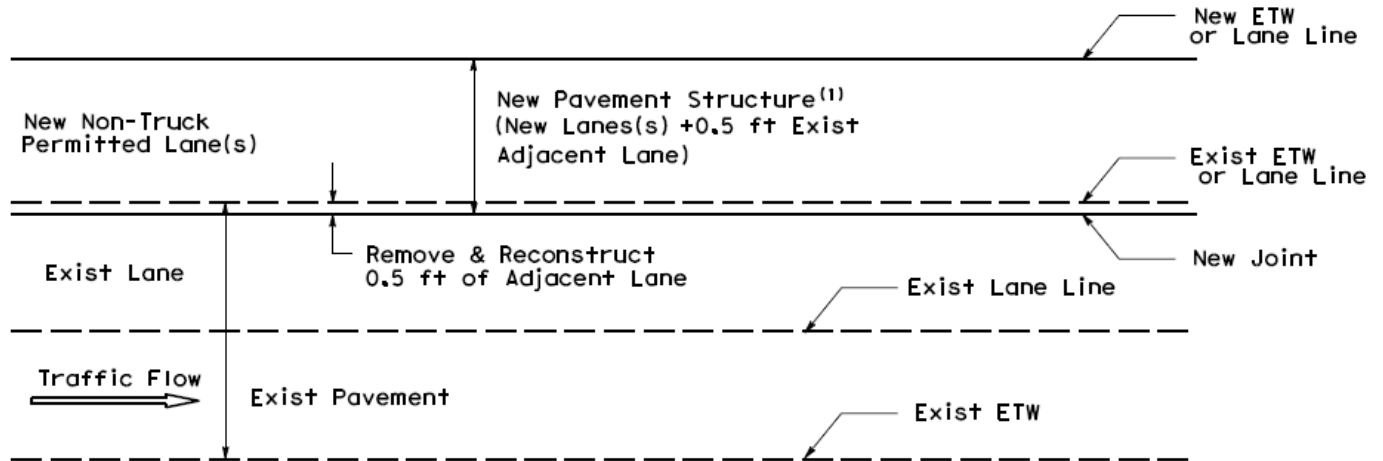

Adding Median Lane

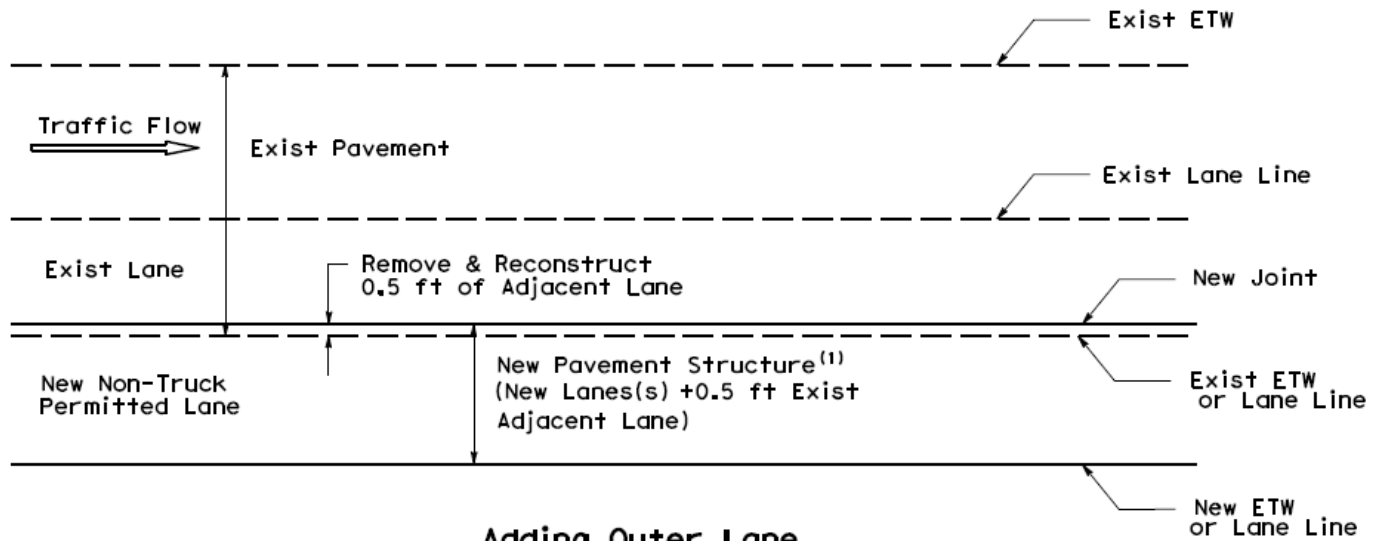

Adding Outer Lane

NOTES:

(1) See Index 623.1 and Tables 623.1B – M for details on concrete pavement structure design.

July 1, 2020

- (d) For concrete pavement that will require rehabilitation within ten years, the widening project should consider future compatibility of the proposed structure with the eventual concrete pavement rehabilitation strategy. Pavement rehabilitation strategies are discussed in Index 603.4 and procedures for concrete pavement rehabilitation can be found in Index 625.1.
 - (e) If the existing adjacent pavement to remain was a previously cracked, sealed, and asphalt overlaid concrete roadway, then the new pavement structure for the widening project should match the structural layers of the existing pavement. This is done by placing asphalt concrete over a concrete base or lean concrete base thick enough to match the concrete layer in the existing pavement. Excluding any cement treated base, the thickness of the new concrete base should not be less than 0.35-feet. Where needed to match existing or add structural capacity, the new pavement structure should include an aggregate base or subbase. To provide a uniform surface for the widening and existing pavement, mill and replace 0.15 foot of the existing asphalt surface course or if the new asphalt concrete surface course required for the new pavement structure is thicker than the existing, the existing shall be overlaid a minimum of 0.15 feet to match the top surface of the new asphalt concrete layer. Figure 682.4B shows a typical pavement widening structure adjacent to existing previously cracked, sealed and asphalt overlaid concrete pavement.
- (3) *Widening of Asphalt Roadways.* The following design standards should apply when widening asphalt roadways:
- (a) When widening asphalt pavement, continuity with the existing pavement should be provided whenever it is economically feasible. At a minimum, the design should use compatible materials and provide for adequate drainage underneath the existing pavement. This may require constructing the top of subgrade for the widening at the same or lower elevation than the existing subgrade, and extending underdrains from the edge of the existing pavement to an outlet beyond the new pavement structure.
 - (b) When widening adjacent to existing asphalt pavement that is in good condition, a pavement preservation strategy in conjunction with widening such as placing a non-structural wearing course over the widening and existing pavement should be done. This provides a surface with a uniform appearance, a surface course with equivalent future maintenance requirements, a clean surface for new striping configurations, as well as elimination of pavement joints which are susceptible to water intrusion and early fatigue failure.

If the new asphalt concrete surface course required for the new pavement structure is thicker than the existing, the existing shall be overlaid a minimum of 0.15 feet to match the top surface of the new asphalt concrete layer.

Figure 682.4B

Widening Previously Cracked, Seated, and HMA Overlay Concrete Pavement in Good Condition

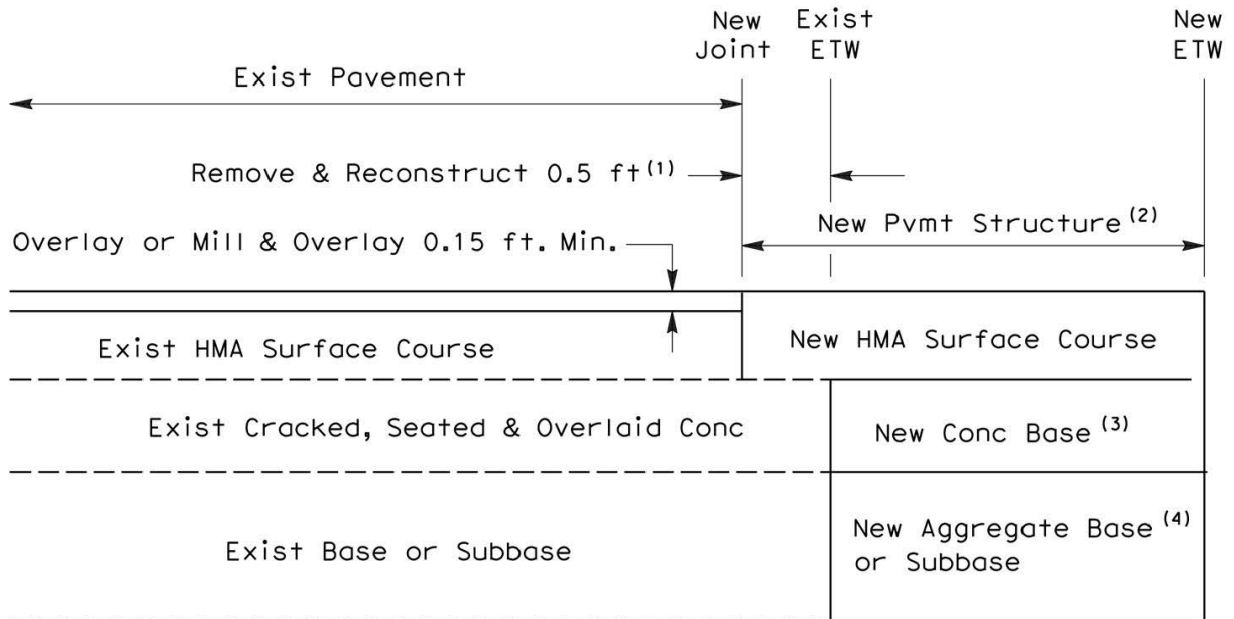

NOTES:

- (1) See Figures 682.4A for additional details.
- (2) Match the structural layers of the existing pavement for situations described in section 682.4 (2) (e).
- (3) Match thickness of adjacent concrete but not less than 0.35 feet.
- (4) When needed to match existing treated base, granular base/sub base, or add structural capacity.

July 1, 2020

If the existing pavement exhibits oxidation, raveling, or minor cracking, it is recommended to mill 0.15 foot of the existing asphalt surface and overlay across the entire existing pavement and new section as shown in Figure 682.4C. The overlay joint should be offset 1.0 foot from the underlying vertical interface between existing and new pavement to improve the impermeability of the interface in the short-term. (The underlying vertical interface at the widening will eventually cause reflective cracking through to the surface.)

Pavement preservation strategies are discussed in Topic 634 and in the Maintenance Technical Advisory Guide (MTAG). Additional information on procedures for asphalt pavement preservation can also be found in Index 603.3.

- (c) For asphalt pavement exhibiting major distress that need rehabilitation work, the widening project should include an appropriate pavement rehabilitation strategy for the existing pavement structure at least in the lane adjacent to the widening to obtain a smooth riding surface. In such cases, project scoping and other engineering decisions should take into account cost as well as other project considerations such as traffic safety to determine whether pavement rehabilitation of the existing roadway should be included with the pavement widening project. Pavement rehabilitation strategies are discussed in Topic 635 and procedures for asphalt pavement roadway rehabilitation can be found in Index 603.4.
- (d) Widening of asphalt roadways with concrete should not be done except in the following cases:
 - (1) Concrete pavement will be placed across all the truck permitted lanes.
 - (2) The concrete pavement joint will be located at the proposed lane line (or ultimate lane line if project is just an interim stage of an ultimate project)
 - (3) There is a funded project to replace the existing lanes with concrete within the next 10 years.

When an asphalt roadway is widened with concrete the existing asphalt pavement should be replaced with concrete and at the same time the entire pavement should be overlaid or, at a minimum, designed to be overlaid with concrete in the future.

- (4) *Drainage of Pavement Widening Structure.* Perpetuate pavement drainage in accordance with Chapter 650. The pavement structure of the widening should be designed where feasible to provide a path for subsurface water drainage to the edge of pavement. If it is not feasible to accomplish this, then consult with Headquarters Pavement Reviewers for other options.

682.5 Other Considerations

In addition to the foregoing design considerations, the following measures should be taken into account when constructing a pavement widening project.

Figure 682.4C

Widening Asphalt Pavement in Good Condition

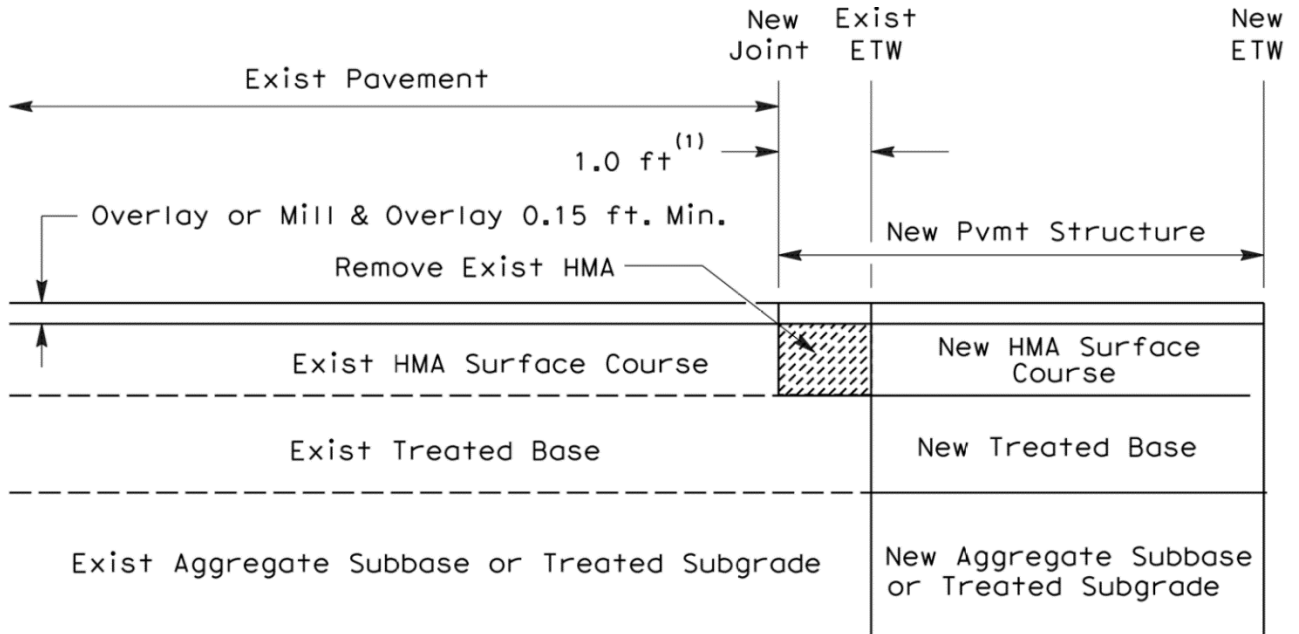

NOTES:

⁽¹⁾Offset overlay joint by 1.0 feet from the underlying vertical interface between existing and new pavement.

July 1, 2020

- (1) *Crack Sealing.* An aggressive crack sealing program will limit the amount of precipitation runoff from entering into the structure. Consideration should be given to using geosynthetic pavement interlayers over the joint between new and existing pavement prior to applying the full-width overlay to delay reflective cracking.
- (2) *Treatment of the Subgrade.* Treatment of the subgrade under the widened section is recommended as an effective strategy to reduce moisture fluctuations at the new pavement edge which in turn should reduce the potential for longitudinal edge cracking. An alternative to treatment of the subgrade may be to use a subgrade enhancement at the subgrade/base interface. Treatment should be accomplished below the level of the old asphalt base.
- (3) *Selection of the Base Material.* Selection of the new base material should be based on laboratory evaluation of both new and existing materials to compare the moisture susceptibility of each. Preferably, the moisture susceptibility of the existing and new base materials should be about the same. A material that is more highly moisture susceptible may draw moisture from both the original section and from outside the structure. A material that is less moisture susceptible may send moisture into the original base, particularly during the original curing process. It should also be noted that premature problems can be experienced when pavements with asphalt bases are widened with different base material, especially cement treated base. Cracks form at the longitudinal joint and moisture ingress often leads to rapid deterioration of the existing section.
- (4) *Treated Base Sections.* Other considerations will closely parallel those discussed in Index 662.2 for treated base materials. There are cases where it may be desirable to use full-depth HMA for the widening to expedite construction, even though the base for the existing pavement was cement-treated material. This strategy should not cause subsurface moisture flow problems (“bath tub” effect) provided that the cement treated base is not moisture susceptible. Laboratory evaluation of core samples will determine the degree of moisture susceptibility of the existing base.

682.6 Life-Cycle Cost Analysis for Widening Projects

In addition to selecting the type of pavement for the widening project, as discussed in Topic 619, life-cycle cost analysis is a key component in determining how best to maintain both new and existing pavements over time and whether it is better to design the widening to match the life of the existing pavement or plan for the upgrading of the existing pavement to match the new pavement. When doing a life-cycle cost analysis for pavement widening, it is often best to perform the life-cycle cost analysis on how best to maintain the existing pavement first since the type and condition of the existing pavement will often influence the engineering of the new pavement. Life-cycle cost analysis is discussed further in Topic 619 and the Life-Cycle Cost Analysis Procedures Manual.

CHAPTER 700 – MISCELLANEOUS STANDARDS

Topic 701 – Fences

Index 701.1 – Type, Intent and Purpose of Fences

- (1) Purpose of Fences. Fences constructed by the Department serve the purposes of either establishing control of access, providing visual demarcation or re-establishing private property lines.

Where the purpose of the fence is access control, installation is intended to establish that access is restricted; such fencing is not intended to serve as a complete physical barrier. The adjacent private property owner will assume responsibility for the construction of any fencing or other facilities necessary to contain their personal property.

- (2) *Type and Intent of Fences.* The type and intent of fences should be as described herein and in the Standard Plans and Standard Specifications.

Fence materials, including gates, installed anywhere within the State right of way are considered Departmental fences and are owned, controlled and maintained by Caltrans forces.

As a right of way consideration, Caltrans may construct fences and gates outside the State right of way. Fences and gates constructed outside the State right of way are considered private fences and are owned, controlled and maintained by the external property owner where Caltrans retains neither rights nor obligations for such fences once constructed.

- (a) Fences for freeway and expressway access control are Departmental fences commonly placed immediately inside the State right of way to help enforce observance of the acquired access rights. See Index 701.2 for more detailed guidance.
- (b) Median fences are Departmental fences constructed to help prevent indiscriminate crossings of the median by vehicles or pedestrians. These fences are a subset of freeway and expressway access control fences. See Index 701.2 for more detailed guidance.
- (c) Private fences may be constructed adjacent to conventional highways if provided via right of way agreement. Placement is typically parallel to the State right of way and outside Caltrans property. See Index 701.3 for more detailed guidance.

Private fences may also be allowed within Caltrans right of way to restrict access to a private facility crossing or as an aesthetic enhancement of Departmental fence. Neither of these situations is common and should be avoided if possible. See Indexes 701.2(3)(e) and 701.3.

- (d) Temporary fences are commonly used during project construction to temporarily control access and/or create a visual screen. Temporary fences are also commonly used during reconstruction of either Departmental or private fences. See Index 701.4 for more detailed guidance.

July 1, 2020

- (e) Environmentally Sensitive Area (ESA) fence is a specialty type of temporary Departmental fence, placed within the limits of a construction project and used to identify the location of sensitive biologic resources while establishing a visible boundary. Orange fabric is used to ensure contractor personnel awareness of the ESA location. See Index 701.5 for more detailed guidance.
- (f) Species protection fences are Departmental fences placed within Caltrans right of way and used to prohibit movement of specific threatened or endangered species onto the highway. These fences are unique in composition to the species being addressed. Species protection fences may be placed for either permanent or temporary applications. See Indexes 701.2(3)(b) and 701.5 for more detailed guidance.
- (g) Enclosure fences are Departmental fences of various types used to secure the perimeter around equipment storage areas from theft or vandalism, provide a perimeter around maintenance stations or other facilities, or otherwise enclose areas intended for Caltrans use. See Index 701.5 for more information.

701.2 Freeway and Expressway Access Control Fence

- (1) **Placement.** Departmental fences shall be provided on freeways and expressways to control access, except as otherwise provided under paragraph (3)(e) below. Freeway fencing or equivalent access control should extend to the limit of the legal access control on local streets at ramp termini.
- (2) **Standard Fence Types.** The standard types of freeway fence are:
 - (a) Chain Link Fencing – Type CL-6 fence or equivalent access control should be used along the right of way and in the outer separation in urban or developed areas.
 - (b) Other Fencing – In rural areas, fences on freeways normally should be either Barbed Wire, (Type BW), or Wire Mesh, (Type WM), on either wood or metal posts. Wood posts may be more aesthetic than metal posts, depending on the surrounding terrain.
 - (c) Median Fencing – Type CL-4 fence, with the distance from the ground to the bottom tension wire increased to 6 inches, should be used where median fencing is required.
- (3) **Exceptions to Standard Fence Types.**
 - (a) If walls or fences equal to or better than the standard fence in durability, maintenance requirements, and dimensions exist along the right of way line, the standard fence may be omitted or removed. To avoid a gap in the access control, standard fences should be securely joined to the existing fence or wall at its terminals, if the access control line extends beyond these points.
 - (b) Fences of special design may be installed where needed for wild animal control.
 - (c) In special cases, where improvements are scattered, the area is aesthetically sensitive, and a lower fence would be in keeping with the height of adjacent property fence, a Type CL-4 fence may be substituted for Type CL-6 along the right of way in locations where Type CL-6 would otherwise be used.
 - (d) Fencing may be omitted in remote areas where access control appears unnecessary.
 - (e) In special cases, nonstandard fencing may be considered at freeway ramp terminals on local streets when the adjacent property either is, or is proposed to be, developed in such a way that the owner feels that standard fencing is aesthetically

objectionable. If it is concluded that the objection is valid, a more compatible facility may be substituted, subject to the following controls:

- Preference should be given to retaining the standard fence along the ramp to the end of the curb return or beginning of the taper on the local road. Where this is not reasonable, there may be substituted a fence or wall of equal or better durability and utility that is at least 4 feet high relative to the grade of freeway right of way line. Walls, ornamental iron fences with closely spaced members, or chain link fences are examples of acceptable possibilities.
- Along the local road, beyond the end of the curb return or the beginning of the taper, a facility of somewhat lower standards may be employed, if considered appropriate. The minimum allowable height is 2.5 feet above the grade at the edge of the right of way. In addition to the fence types suitable for use along the ramp, split rail fences, wooden picket fences, and permanent planter boxes are examples of possibilities. The intent is to delineate the access control line and discourage access violations in an effective manner.
- Generally, all costs for the removal of the existing freeway fence and the installation and future maintenance of a nonstandard fence are to be the property owner's responsibility under the terms of the encroachment permit authorizing the substitution. On new construction, the property owner is to assume similar costs and responsibilities subject to a credit for the value of a standard fence.

(4) *Location of Fences.* Normally, fences on freeways should be placed adjacent to, but on the freeway side of the right of way line.

Fences in the outer separation normally should be placed as shown in Figure 307.4B so that the area outside of the fence may be relinquished to the local agency.

When viewed at a flat angle, chain link fencing restricts sight distance. This fact should be considered in the location of such fencing at intersections. To eliminate hand maintenance, right-angle jogs should be avoided.

(5) *Locked Gates.* Locked gates may be provided in access control fences in special situations. A proposal for a locked gate must address a necessity. Although openings controlled by locked gates do not constitute access openings in the usual sense of access control, they must be shown on the plans. When locked gates are proposed there must be a specific reason for each gate. All gates must be kept locked and secured. Locked gates fall into two categories:

(a) Locked gates to be used exclusively for access by highway maintenance forces do not require FHWA approval and may be approved by the District Director. The integrity and security of this access must always be assured. Maintenance forces must also keep gates locked when not being used for the access of persons or equipment. When locked gates are to be used exclusively by highway maintenance forces, one or more of the following criteria apply:

- A circuitous route would be eliminated.
- The gate access would minimize the exposure of maintenance workers to highway traffic.
- Parking is available outside the gate.
- The gate would allow slow moving equipment to be kept off the highway.
- The site is not accessible to maintenance personal or equipment from the freeway.

July 1, 2020

- (b) Proposals for locked gates to be used by utility companies must be submitted to the District Director for approval. The gate submittal must present all pertinent facts and alternate solutions.

Locked gates to be used by other public agencies or by non-utility entities require FHWA approval if the gate is on an Interstate route.

When proposals for locked gates requiring FHWA approval are included in the plans for new construction, including landscaping projects, FHWA approval of such gates will be included in FHWA approval of the project PS&E. Subsequent installations requiring FHWA approval must be submitted separately to FHWA by the Division of Design after approval by the Chief, Division of Design.

701.3 Private Fences

- (1) *Placement.* Caltrans will construct or pay the cost of fences on private property only as a right of way consideration to mitigate damages. Caltrans' construction of such fences should be limited to:
 - (a) The reconstruction or replacement of existing fences.
 - (b) The construction of fences across property that had been previously enclosed by fences.

These criteria apply to all private as well as public lands.

- (2) *Private Fences Inside the State Right of Way.* Private fences may be constructed within the State right of way via Encroachment Permit to restrict access to facilities (e.g., canals) crossing under or through Department-owned property. A Maintenance Agreement must be executed to provide for future maintenance of the fence and allow access to the private utility.

701.4 Temporary Fences

- (1) *Placement.* Temporary fences are located where necessary in accordance with construction contractor activities and where the right of way rights have been acquired.
- (2) *Types of Fences.* Temporary fence design should conform to the needs of the situation and the length of time to be used. In most access control or demarcation applications the fence fabric will conform to permanent fence standards, while lesser requirements may apply to posts and post footings to more readily accommodate removal when no longer needed.

Temporary fence used during reconstruction of private fences must be of a type adequate to meet the permanent private fence purposes.

701.5 Other Fences

- (1) *ESA and Species Protection Fences.* District Environmental Unit staff must specify the required placement limits and locations for ESA and species protection fences.

ESA fence material requirements are described in Section 14 of the Standard Specifications.

Species protection fences will be uniquely designed to meet the needs of the target species. District Environmental staff will provide information on the necessary design parameters. In many instances, species protection fence will be able to be directly attached to existing freeway or expressway access control fence and thus preclude the

need for separate posts. Where species protection fence is to be constructed along conventional highways, it must be constructed inside the State right of way and should not be attached to any private fence that may exist.

- (2) *Enclosure Fences*. Because these fences are commonly intended to provide security for Caltrans facilities, the facility type and location will often dictate the fence design to be used. Standard chain link (CL-6) fence is most common, but additions (barbed wire extension arms) or alternative designs may be considered. When slats are included as an element of the design, wind forces are considered and a resulting increase in the size and depth of embedment of fence posts as well as an increase in the size of the concrete footing occurs. See the Standard Plans for further details including post size and footing dimensions for various fence heights.

Typically District Maintenance or Traffic Operations will specify any unique design requirements for enclosure fences as they will assume responsibility after construction.

Topic 702 – Miscellaneous Traffic Items

702.1 References

- (1) *Guardrail and Crash Cushions*. See Traffic Safety Systems Guidance.
- (2) *Markers*. See Part 3 of the California Manual on Uniform Traffic Control Devices (California MUTCD).
- (3) *Truck Escape Ramps*. See Traffic Bulletin No. 24, (1986) and the NCHRP Report 178.
- (4) *Mailboxes*. See the AASHTO Roadside Design Guide, 3rd Edition, Chapter 11, “Erecting Mailboxes on Streets and Highways.”

Topic 703 – Special Structures and Installation

703.1 Truck Weighing Facilities

The Division of Traffic Operations coordinates the design and construction of truck weighing facilities with the California Highway Patrol in Sacramento. Typical plans showing geometric details of these facilities are available from the Headquarters Division of Traffic Operations. Districts should refer truck weighing facility maintenance issues to their District maintenance units.

See Index 107.1 for additional details on roadway connections for truck weighing facilities.

703.2 Rockfall Restraining Nets

Rockfall Restraining Nets are protective devices designed to control large rockfall events and prevent rock from reaching the traveled way. The systems consist of rectangular panels of woven wire rope vertically supported by steel posts and designed with frictional brake elements capable of absorbing and dissipating high energies. For additional information on the characteristics and applications for rockfall restraining nets, designers should contact the Division of Engineering Services - Geotechnical Services (DES-GS).

July 1, 2020

Topic 704 – Contrast Treatment

704.1 Policy

In general, delineation should be composed of the standard patterns discussed in Part 3 of the California MUTCD.

Markings include lines and markings applied to the pavement, raised pavement markers, delineators, object markers, and special pavement treatments.

Contrast treatment is designed primarily to provide a black color contrast with an adjacent white surface. Normally, contrast treatment should be used only in special cases such as the following:

- (a) To provide continuity of surface texture for the guidance of drivers through construction areas.
- (b) To provide added emphasis on an existing facility where driver behavior has demonstrated that standard signs and markings have proven inadequate.

When contrast treatment is applied, a slurry seal should be used.

See Part 3 of the California MUTCD for additional information on contrast treatment.

Topic 705 – Materials and Color Selection

705.1 Special Treatments and Materials

Special materials or treatments, such as painted concrete, or vinyl-clad fences, are sometimes proposed for aesthetic reasons, or to comply with special requirements.

The following guidelines are to be used for the selection of these items:

- (a) Concrete should not be painted unless exceptional circumstances exist, due to the continuing and expensive maintenance required. Concrete subject to unintentional staining should be textured during construction to minimize the visibility of stains, if other methods of controlling stain-producing runoff or dripping cannot be accomplished.
- (b) Vinyl-clad fences are sometimes specified for aesthetic reasons. The cost of this material is higher than that of galvanized steel. Special consideration should be given to the life-cycle cost and maintainability of vinyl-clad fencing prior to selection for use. The use of black or green vinyl-clad mesh for access control fencing, safety fencing at the top of retaining walls, and pedestrian overcrossing fencing is acceptable.

705.2 Colors for Steel Structures

Colors for steel bridges and steel sign structures may be green, gray, or neutral tones of brown, tan, or light blue.

Criteria for selection of colors are:

- (a) General continuity along any given route.
- (b) Coordination of color schemes with adjacent Districts for interdistrict routes.

(c) Requests from local agencies for improvement of aesthetics in their community.

Color selection for steel bridges should be mutually satisfactory to the Division of Engineering Services and the District. The Division of Engineering Services (DES) will initiate the color selection process by submitting the proposed color to the District Landscape Architect for review. The color for steel sign structures will be selected by the District Landscape Architect.

Topic 706 – Roadside Management and Vegetation Control

706.1 Roadside Management

Consider the full life-cycle cost of transportation improvements including the long-term cost of maintenance. The design alternative with the lowest initial construction cost may not be the best solution if this approach will include high recurring maintenance costs. Designers should strive to select design approaches that do not require extensive recurring long-term activities.

The design should contribute to the safety of Department maintenance workers by incorporating techniques that eliminate or reduce worker exposure to traffic. See Index 901.2.

The following conditions must be considered in projects:

- Guardrail, including standard railing, terminal system end treatments, guard railing at structure approach and departures, and at fixed objects should include vegetation control. For more detailed information regarding placement of vegetation control consult with both the District Landscape Architect and District Maintenance. See the Standard Plans for vegetation control.
- Thrie beam barrier, including single thrie beam barrier, double thrie beam barrier, at structure approach and at fixed objects should include vegetation control. For more detailed information regarding placement of vegetation control consult with both the District Landscape Architect and District Maintenance. See the Standard Plans for vegetation control.
- Unpaved narrow strips often result from the construction of noise barriers or concrete barriers beyond the paved shoulder edge. Unpaved strips 15 feet or less in width, parallel and immediately adjacent to the roadway, should be paved to the barrier or wall. Paving these areas eliminates the need for manual vegetation control, and allows automated equipment to remove litter and debris. Pavement requirements are consistent with the guidance contained in this manual. Contrasting surface treatment such as markings, delineation, or color may also be provided so drivers can distinguish these areas from those intended for vehicular use. Consult with the District Landscape Architect for contrasting surface selection.
- Unpaved areas greater than 15 feet in width may include vegetation control techniques such as weed control mats, patterned asphalt or stamped concrete paving, or the planting of low maintenance vegetation such as native grasses. Consult the District Landscape Architect and District Maintenance to select an appropriate vegetation control technique.

July 1, 2020

- Noise barriers should be designed with a textured aesthetic treatment and/or planted with vines to reduce maintenance required to control graffiti. Index 904.7 contains information of the planting on noise barriers.
- Unpaved area beyond the gore pavement should be paved as per Index 504.2(2).
- When placing roadside facilities that require recurring maintenance, the designer should strive to include improvements that facilitate safe maintenance access such as maintenance vehicle pullouts, maintenance access paths, walk gates and vehicle gates. It is preferred that access be provided from outside the right-of-way for all facilities that require maintenance access.
- When placing noise barriers in areas with a narrow right of way, the designer should consider locating a concrete safety shape barrier 3 feet from the face of the noise barrier to provide protected maintenance access.

Formal safety reviews for roadside management issues should be accomplished as discussed in Index 110.8. Consult the District Landscape Architect and District Maintenance unit early during design development to identify and address potential roadside management issues, such as avoiding the redundant placement of roadside facilities, or allow for the consolidation of roadside facilities.

706.2 Vegetation Control

Weed control fabric or preemergent chemicals may be placed under pavement to prevent weed growth through medians, traffic islands, and other paved areas.

The Division of Maintenance is responsible for the selection of herbicides. Approval is required for any changes from the currently approved Standard Specifications and Standard Special Provisions for pesticides and herbicides.

Since preemergents may be transported by water, they should be mixed with surfactants to prevent affects on environmentally sensitive areas, habitat, native vegetation, landscape plantings, agricultural crops, adjacent residential, commercial or recreation areas, streams, or water bodies.

Before specifying preemergents, the District Landscape Architect and District Landscape Specialist should be consulted to determine the possibility of future planting.

Topic 707 – Slope Treatment Under Structures

707.1 Policy

Structure end slope should be treated to:

- (a) Protect slopes from erosion.
- (b) Improve aesthetics.
- (c) Reduce long term maintenance costs.

Caltrans maintenance, landscape architecture, materials, design, and other affected units will furnish input to determine slope treatment needed at each site. Local agency input should be obtained for urban undercrossings.

All types of slope treatments require adequate drainage facilities for water from the upper roadway. Inadequate drainage is a major source of slope erosion.

707.2 Guidelines for Slope Treatment

- (a) Full slope paving shall be installed where it is anticipated that erosion by pedestrians, wind, storm water, or other causes will occur. High landscape maintenance costs caused by inadequate moisture, sunlight, instability to establish vegetation etc., may also justify the use of full slope paving in lieu of planting. The District Landscape Architect will provide aesthetic input slope paving and identify irrigation conduit location(s).
- (b) Landscaped structure end slopes may be justified when adjacent slopes are landscaped and when landscaping is compatible with adjacent development. Conditions must exist where plants would have a strong likelihood of survival.
- (c) Bare slopes have minimum initial costs and higher maintenance costs which vary with the site. Bare structure end slopes may be justified at rural sites and other areas where anticipated maintenance activity will be low and there is little likelihood for erosion. Appropriate drainage design is critical when slopes are left bare.
- (d) Adequate drainage facilities must be provided to prevent saturation of abutment foundation materials and damage to slope treatment.
- (e) Additional protection may be required at stream crossings to provide for flow velocity.

707.3 Procedure

Based on consultation with the District Landscape Architect and Structures Bridge Architect and in consideration of economic and aesthetic factors, the District will determine, and set forth with the bridge site plan submittal, the type of slope treatment indicating whether:

- (a) The Division of Engineering Services is to design the slope treatment with the bridge and include the cost in the Structure items; or
- (b) The District will design the slope treatment and include the details with the road plans.

CHAPTERS 800 – 890 HIGHWAY DRAINAGE DESIGN

CHAPTER 800 – GENERAL ASPECTS

Topic 801 – General

Index 801.1 – Introduction

This section is not a textbook, and is not a substitute for fundamental engineering knowledge or experience.

The fields of hydrology and the hydraulics of highway drainage are rapidly evolving and it is the responsibility of the engineer to keep abreast of current design practices. As new practices or procedures are adopted by the Department, this section will be updated.

Instructions for the design of highway drainage features provided are for information and guidance of Department employees. Drainage policies, procedures and standards given are subject to amendment as conditions warrant and are neither intended as, nor do they establish, legal standards. Special situations may call for variations from these requirements, subject to approval of the Division of Design or approval by others as may be specifically referenced.

801.2 Drainage Design Philosophy

Highway drainage design is much more than the mere application of the technical principles of hydrology and hydraulics. Good drainage design is a matter of properly balancing technical principles and data with the environment giving due consideration to other factors such as safety and economics. Such design can only be accomplished through the liberal use of sound engineering judgment. Drainage features to remove runoff from the roadway and to convey surface and stream waters originating upstream of the highway to the downstream side should be designed to accomplish these functions without causing objectionable backwater, excessive velocities, erosion or unduly affecting traffic safety. A goal in highway drainage design should be to perpetuate natural drainage, insofar as practical.

801.3 Drainage Standards

Drainage design criteria should be selected that are commensurate with the relative importance of the highway, associated risks, and possible damage to adjacent property. The objective of drainage design should be to provide optimum facilities considering function versus cost rather than to just meet minimum standards.

Engineers and other professional disciplines using this guide must recognize that hydrologic analysis, as practiced by the highway engineer, has not advanced to a level of precise mathematical expression. All hydrologic analysis methods, whether deterministic

July 1, 2020

or statistical, are based on the information available. A common challenge faced by the highway design engineer is that there may be insufficient flow data or no data at all at the site for which a stream crossing is to be designed. By applying analytical principles and methods it is possible to obtain peak discharge estimates which are functionally acceptable for the design of highway drainage structures and other features.

The design of highway drainage structures and other features must consider the probability of flooding and provide protection which is commensurate with the importance of the highway, the potential for property damage, and traffic safety. Traditionally, the level of assurance for such protection has been specified in terms of the peak rate of flow during passage of a flood or storm of the severity associated with the frequency of occurrence, i.e. a 10-year storm, the 50-year flood, etc. State-of-the-art methods and procedures associated with the necessary hydrologic analysis required to determine the severity and probability of occurrence of possible rare storms and flood events are inherently ambiguous. Therefore, the suggested drainage design criteria relating to frequency of occurrence references in this manual are provided for guidance only and are not intended to establish either legal or design standards which must be strictly adhered to. Rather, they are intended as a starting point of reference for designing the most cost effective drainage structures and facilities considering the importance of the highway, safety, legal obligations, ease of maintenance, and aesthetics.

801.4 Objectives of Drainage Design

Drainage design seeks to prevent the retention of water by a highway and provide for removal of water from the roadway through a detailed analysis considering all pertinent factors.

Specific steps to be taken generally include:

- (a) Estimating the amount and frequency of storm runoff.
- (b) Determining the natural points of concentration and discharge, the limiting elevations of entrance head, and other hydraulic controls.
- (c) Estimating the amount and composition of bedload and its abrasive and bulking effects.
- (d) Determining the necessity for protection from floating trash and from debris moving under water.
- (e) Determining the requirements for energy dissipation and bank protections.
- (f) Determining the necessity of providing for the passage of fish and recognizing other ecological conditions and constraints. Water quality and pollution control are discussed under Index 110.2. Aspects of wetlands protection are covered under Index 110.4.
- (g) Analyzing the deleterious effects of corrosive soils and waters on structures.
- (h) Comparing and coordinating proposed design with existing drainage structures and systems handling the same flows.
- (i) Coordinating, with local agencies, proposed designs for facilities on roads to be relinquished.
- (j) Providing access for maintenance operations.

- (k) Providing for removal of detrimental amounts of water on traveled ways (see Topics 831 and 833).
- (l) Providing for removal of detrimental amounts of subsurface water.
- (m) Designing the most efficient drainage facilities consistent with the factors listed above, economic considerations, the importance of the transportation facility, ease and economy of maintenance, engineering judgment, and aesthetics.
- (n) Checking the structural adequacy of designs by referral to Structures Design or by use of data furnished by Structures Design.
- (o) Preventing water from crossing slopes in concentrated flows.

801.5 Economics of Design

An economic analysis of alternate drainage designs, where a choice is available, should always be made. Non-engineering constraints may severely limit the design alternatives available to the drainage design engineer for a specific project or location. Generally, however, the design engineer has a wide range of materials and products to choose from in selecting the most economical design from available alternatives for highway drainage structures and other features.

The following factors should be considered in the selection of alternative designs and economic comparisons:

- (a) Initial cost of construction and right of way.
- (b) Evaluation of flood related risks to the highway and to adjacent properties including potential liabilities for damage.
- (c) Cost of detours and traffic handling.
- (d) Service life of the highway and of the drainage structure.
- (e) Cost of providing traffic safety features.
- (f) Aesthetics.
- (g) Costs to traveling public for delays or extra travel distance due to road closures.
- (h) Initial cost versus long term maintenance costs for cleanout, repair, traffic control and other pertinent maintenance charges that may be incurred during the life of the facility.
- (i) Safety of required maintenance activities, ability to provide maintenance mechanically and to reduce worker exposure.
- (j) Inlet and outlet treatment.
- (k) Potential for causing erosion and effective water pollution control.

801.6 Use of Drainage References

No attempt has been made herein to detail basic hydrologic and hydraulic engineering techniques.

Various sources of information, including FHWA Hydraulic Engineering Circulars (HEC's); Title 23, Code of Federal Regulations (CFR), Part 650, Subpart A; AASHTO Guidelines; Federal-Aid Policy Guide and numerous hydrology and hydraulics reports and texts have been used to compile this highway drainage guide. Frequent references are made to these publications. Where there is a conflict in information or procedure, engineers must

July 1, 2020

look at all pertinent parameters and use their best judgment, to determine which approach is the most consistent with the objectives of Caltrans drainage design principles and which most closely relates to the specific design problem or project.

Topic 802 – Drainage Design Responsibilities

802.1 Functional Organization

- (1) *Division of Design.* The Office of State Highway Drainage Design in Division of Design performs the following functions under the direction of the Headquarters Hydraulics Engineer:
 - (a) Provide design information, guidance and standards to the Districts for the design of surface and subsurface drainage.
 - (b) Keep informed on the latest data from research, experimental installations, other public agencies, and industry that might lead to improvement in drainage design practices.
 - (c) Promote statewide uniformity of design procedures, and the exchange of information between Districts.
 - (d) Coordinate drainage design practices with other Caltrans Offices.
 - (e) Review special drainage problems and unusual drainage designs on the basis of statewide experience.
 - (f) Act in an advisory capacity to the Districts when requested.
- (2) *Division of Engineering Services (DES).* The DES is responsible for:
 - (a) The hydraulic design of bridges, bridge deck drains, and special culverts.
 - (b) The structural adequacy of all drainage facilities.
 - (c) The adequacy of pumping plant characteristics and temporary storage. Refer to Topic 839 for further discussion on pumping stations.
 - (d) Compliance with Federal-Aid Policy Guide, Transmittal 1, G 6012.1 and submittal of preliminary hydraulic data as outlined under Topic 805.
 - (e) Geotechnical (soil mechanics and foundation engineering) considerations.
- (3) *Legal Division.* The Legal Division provides legal advice and guidance to other Caltrans Offices concerning the responsibilities of the Department and owners of property along State highways with regard to surface water drainage.
- (4) *Districts.* The District Director is responsible for:
 - (a) The hydrology for all drainage features except bridges.
 - (b) The hydraulic adequacy of all drainage features, except bridges and any special culverts and appurtenances designed by the Division of Engineering Services.
 - (c) Consulting with the Division of Engineering Services when it is proposed that an existing bridge be replaced with a culvert.
 - (d) Bank and shore protection designs, including erosion protection measures at ends of bridges and other structures designed by the Division of Engineering Services.
 - (e) Assigning one or more engineers in responsible charge of hydrologic study activities and the hydraulic design of drainage features.

- (f) Compliance with Federal-Aid Policy Guide, Transmittal 1, G 6012.1 for storm drain systems.
- (g) Providing additional staff as necessary with the training and background required to perform the following:
- Accomplish the objectives of drainage design as outlined under Index 801.4
 - Prepare drainage plans or review plans prepared by others.
 - Study drainage problems involving cooperative agreements and make recommendations to the decision makers.
 - Accumulate and analyze hydrologic and hydraulic data reflecting the local conditions throughout the District for use in design.
 - Review drainage changes proposed during construction.
 - Make investigations and recommendations on drainage problems arising from the maintenance of existing State highways.
 - Coordinate drainage design activities with other District Offices and Branches.
 - Coordinate drainage designs with flood control districts and other agencies concerned with drainage by representing the District at meetings and maintaining an active liaison with these agencies at all times.
 - Furnish data as required on special problems, bridges, large culverts, culverts under high fills and pumping plants that are to be designed by the Division of Engineering Services.
 - Make field inspections of proposed culvert sites, existing drainage structures during storms, and storm damage locations.
 - Document condition and file data that might forestall or defend future lawsuits.
 - Review permits for drainage facilities to be constructed by other agencies or private parties within the highway right of way.
 - Investigate and prepare responses to complaints relative to drainage conditions on or adjacent to the right of way.

Assignment of the duties described above will vary between districts. Due to the increasing complexity of hydraulic and hydrologic issues it is imperative that the more complex analyses be performed by experienced hydraulic designers. To provide guidance on those issues where district hydraulic units should become involved, the following list is provided.

- Storm drain design and calculations.
- Drainage basins exceeding 320 acres.
- Hydrograph development or routing.
- Open channel modification or realignment.
- Retention or detention basins.
- Backwater analysis.
- High potential for flood damage litigation.
- Scour analysis or sediment transport (typically forwarded to DOS).
- Culvert designs greater than 36 inches in diameter.
- Encroachments on FEMA designated floodplains.

July 1, 2020

- Modifications to inlet or outlet capacities on existing culverts or drainage inlets (e.g., placement of safety end grates, conversion of side opening inlets to grated inlets, etc.).
- Unique hydraulic design features (e.g., energy dissipator design, pumping stations, siphons, etc.).

This list is not all inclusive, and many additional functions are likely to be performed by hydraulic units. Although various constraints may preclude the hydraulic unit from actively performing the design or analysis of these items, a thorough review by that unit should be performed, at a minimum.

(5) *Materials Engineering and Testing Services*. METS provides advice and guidance to other Caltrans Offices and Branches concerning service life, physical properties, and structural adequacy of materials used in drainage design.

802.2 Culvert Committee

The Caltrans Culvert Committee is composed of nine members representing the Offices of State Highway Drainage Design, Structure Design, Office Engineer, and Materials Engineering and Testing Services, along with the Division of Construction and the Division of Maintenance. The Committee is chaired by the Headquarters Hydraulics Engineer in the Office of Highway Drainage Design. The Committee performs the following functions:

- (a) Investigates new materials and new installation methods that may improve the economic service life of culverts and other drainage facilities.
- (b) Coordinates drainage design practice with other headquarters departments.
- (c) Follows current research and takes steps to implement successful findings.
- (d) Acts as an advisory group to Districts and other Caltrans Offices when requested.
- (e) Serves as Caltrans liaison with manufacturers, suppliers, contractors and industry associations.

The authority of the Committee is advisory only, and recommendations of the Committee are submitted to the Chief, Division of Design for approval and implementation through design guidelines and standards.

Requests for consideration of new materials, methods, or procedures should be directed to the Committee Chairman.

802.3 Bank and Shore Protection Committee

The Caltrans Bank and Shore Protection Committee is composed of representatives from DES Structures Maintenance and Investigation, Office of State Highway Drainage Design, METS, Division of Construction, and Division of Maintenance. It is chaired by the Office of Highway Drainage Design representative. The Committee performs the following functions:

- (a) Acts as a service and an advisory group available to Districts and Caltrans Offices and Branches upon written request for special investigations or study. Requests for special investigation of rock slope protection, channel or bridge protection, major channel changes, etc. should be directed to the Committee Chair.
- (b) Provides conceptual input and acts as approval authority for supplements or modifications to bank and shore protection practice publications as warranted.

- (c) Investigates and provides input toward the development of detailed design criteria for the various types of bank and shore protection.
- (d) Observes performances of existing and/or experimental installations during or following severe exposures. The Districts or Caltrans Offices or Branches are requested to inform the Chair, Bank and Shore Protection Committee, or any available members of the Committee, of damage to installations by flood or high seas.
- (e) Upon submission by the Department's New Products Coordinator, the Committee evaluates new products and processes related to bank and shore protection for possible approval.

Topic 803 – Drainage Design Policies

803.1 Basic Policy

In drainage design, the basic consideration is to protect the department's facilities against damage from storm and subsurface waters, taking into account the effect of the proposed improvement on travelers and property. Unless the State would benefit thereby, or the cost is borne by others, no improvement in the drainage of areas outside the right of way is to be considered on Caltrans projects.

803.2 Cooperative Agreements

The extent of the department's financial participation in cooperative drainage improvement projects must be commensurate with the benefits to the Department and the traveling public.

- (1) *Local Agencies.* Caltrans may participate with Local Agencies, Flood Control Districts or Drainage Assessment Districts on drainage improvement projects. Such projects must be covered by a formal agreement prepared and processed in accordance with instructions in the Caltrans Cooperative Agreement Manual.
- (2) *Federal and State Flood Control Projects.* The cost of upgrading or modifying existing State highway facilities to accommodate Federal and/or State funded flood control projects is normally the responsibility of the agency funding the project. As necessary, Caltrans may enter into agreements containing provisions that the cost of betterments to existing highways, including drainage features, will be paid for by the Department. The Cooperative Agreement Manual contains procedures for preparing interagency agreements.

803.3 Up-Grading Existing Drainage Facilities

- (1) *Rehabilitation and Reconstruction Projects.* The hydraulic adequacy, as well as the structural adequacy of existing drainage facilities should be evaluated early in the project development process on pavement rehabilitation and highway reconstruction projects.

Repair or replacement of structurally deficient drainage structures and up-grading of hydraulically inadequate drainage facilities should, whenever practicable, be included in the work of the proposed project. A thorough investigation of upstream and downstream conditions is often required to reveal what adverse effects there may be with increasing the capacity or velocity of existing cross drainage.

July 1, 2020

A cooperative agreement should be negotiated when the proposed work includes the upgrading of an existing storm drain system under the jurisdiction of a local or other public agency.

- (2) *Proposed Upstream Development.* Unless developers of land in the drainage basin upstream of existing State highways incorporate positive stormwater management practices, such as detention or retention storage basins within their improvement areas, the peak flow from stormwater runoff is nearly always increased. As a practical matter, minor increases in peak flow are usually not objectionable. However, uncontrolled upstream development or diversions can significantly increase the peak flow run-off causing the capacity of downstream drainage systems, including those within the State right of way, to be exceeded.

When reasonable solutions to potential drainage problems associated with such increased flows include the up-grading of drainage facilities within the State highway right-of-way, cooperative agreements with the responsible local agency should be negotiated. The local agency having permit authority has the responsibility for assessing liabilities and seeking commensurate funding for mitigation of run-off impacts from the developers. The local agency should not allow potentially harmful developments to proceed until all issues have been resolved. If it becomes apparent that the District, the local agency and the developer may not amiably reach agreement, the matter should be referred to Caltrans Legal Division before there is an impasse in the negotiations.

Caltrans financial participation in such drainage improvements must be based on the general rule stated in Index 803.2 Cooperative Agreements.

- (3) *Hydraulically Inadequate Facilities.* Land use changes nearly always cause areas to become less pervious and drainage basins to yield greater volumes and increase peak stormwater run-off flows. Even development of a small parcel of land within a drainage basin causes some increase in stormwater run-off. Individually the increase may be negligible. Collectively these incrementally small increases over time may cause the design capacity of an existing culvert to be exceeded.

The up-grading of this category of hydraulically inadequate drainage facilities may be partially or fully financed by Caltrans. Only if the benefit cost (b/c) ratio is equal to or greater than one is up-grading viable for normal Caltrans project funding. When the benefits to the Department and the traveling public do not justify increasing the capacity, up-grading may still be accomplished cooperatively with the local agency in accordance with the general rule for participation under Index 803.2 Cooperative Agreements.

Topic 804 – Floodplain Encroachments

804.1 Purpose

The purpose of these instructions is to provide uniform procedures and guidelines for Caltrans multi-disciplinary evaluation of proposed highway encroachments on floodplains.

804.2 Authority

Title 23, CFR, Part 650, Subpart A, prescribes FHWA's "... policies and procedures for the

location and hydraulic design of highway encroachments on floodplains, ..." The CFR's may be found on-line at: <http://www.access.gpo.gov/nara/cfr/cfr-table-search.html>

804.3 Applicability

The guidance provided herein establishes Caltrans procedures whenever a floodplain encroachment is anticipated. Adherence to these procedures will also ensure compliance with applicable Federal regulations which apply to any Federally approved highway construction, reconstruction, rehabilitation, repair, or improvement project which affects the (100-year) base floodplain. Work outside the limits of the base floodplain should be reviewed to see if it affects the (100-year) base floodplain. The only exception is repairs made during or immediately following a disaster. The premise is that all Federal-aid projects be evaluated and that diligent efforts be made to:

- Avoid significant floodplain encroachments where practicable.
- Minimize the impact of highway actions that adversely affect the base floodplain.
- Be compatible with the National Flood Insurance Program (NFIP) of the Federal Emergency Management Agency (FEMA).

804.4 Definitions

The following definitions of terms are made for the purpose of uniform application in the documentation and preparation of floodplain evaluation reports. Refer to Title 23, CFR, Part 650, Section 650.105 for a complete list of definitions.

- (1) *Base Flood*. The flood or tide having a 1 percent chance of being exceeded in any given year (100-year flood).
- (2) *Base Floodplain*. The area subject to flooding by the base flood. Every watercourse (river, creek, swale, etc.) is subject to flooding and theoretically has a base floodplain.
- (3) *Design Flood*. The peak discharge, volume if appropriate, stage or wave crest elevation of the flood associated with the probability of exceedance selected for the design of a highway encroachment. By definition, the highway will not be inundated from the stage of the design flood.
- (4) *Encroachment*. An action within the limits of the base floodplain. Any construction activity (access road, building, fill slopes, bank or slope protection, etc.) within a base floodplain constitutes an encroachment.
- (5) *Location Hydraulic Study*. A term from 23 CFR, Section 650.111 referring to the preliminary investigative study to be made of base floodplain encroachments by a proposed highway action. The extent of investigation and the discussion content in the required documentation of the "Location Hydraulic Study" is very site specific and need be no more than that which is commensurate with the risk(s) and impact(s) particular to the location under consideration. The information developed, documented (refer to Figure 804.7A) and retained in the project file is the suggested minimum necessary for compliance.
- (6) *Natural and Beneficial Floodplain Values*. This shall include but is not limited to fish, wildlife, plants, open space, natural beauty, scientific study, outdoor recreation, agriculture, forestry, natural moderation of floods, water quality maintenance, and groundwater recharge.

July 1, 2020

- (7) *Overtopping Flood*. The flood described by the probability of exceedance and water surface elevation at which flow occurs over the highway, over the watershed divide, or through structure(s) provided for emergency relief.
- (8) *Regulatory Floodway*. The floodplain area that is reserved in an open manner by Federal, State or local requirements, i.e., unconfined or unobstructed either horizontally or vertically, to provide for the discharge of the base flood so that the cumulative increase in water surface elevation is no more than a designated amount (not to exceed 1 foot as established by the Federal Emergency Management Agency (FEMA) for administering the National Flood Insurance Program).

804.5 Procedures

Floodplain evaluations are essentially an extension of the environmental assessment process and instructions contained in the Environmental Handbook and the Project Development Procedures Manual are to be followed. Early in the planning of a project it is necessary to first determine:

- (a) If a proposed route alternative will encroach on a base floodplain (refer to Index 804.4 (2)) or,
- (b) Where proposed construction on existing highway alignment encroaches on a base floodplain.

A Location Hydraulic Study is used to determine (a) and (b) above. Refer to Index 804.4 (4) and 804.7 (2)(b) for further discussion.

Where National Flood Insurance Program (NFIP) Maps and study reports are available, their use is mandatory in determining whether a highway location alternative will include an encroachment on the base floodplain. Three types of NFIP maps are published which, if available, may be obtained from the District Hydraulics Branch: Flood Hazard Boundary Map (FHBM), Flood Boundary and Floodway Map (FBFM), and Flood Insurance Rate Map (FIRM).

If NFIP Maps are not available, the District Hydraulics Engineer should develop hydrologic data and hydraulic information to estimate the limits of the 100-year base floodplain to determine whether a highway location alternative will include an encroachment.

Projects which involve proposed construction within a regulatory floodplain or floodway need to be analyzed to determine whether it may be necessary to obtain a map revision. A map revision is required when construction in the floodplain increases the base flood elevation (BFE) more than 1 foot. Not all new construction projects require a map revision.

804.6 Responsibilities

The District Project Engineer is generally the responsible party for initiating and coordinating the overall multi-disciplinary team activities of evaluation and documentation of floodplain impacts. Discussion of specific hydraulic and environmental aspects are required by 23 CFR 650, Subpart A. Preparing the project floodplain evaluation report and the summary for the environmental document or project report is normally the responsibility of the Environmental Planning Branch. The District Hydraulics Engineer will, as necessary, develop the hydrological and hydraulic information and provide technical assistance for assessing impacts of floodplain encroachments.

804.7 Preliminary Evaluation of Risks and Impacts for Environmental Document Phase

Virtually all proposed highway improvements that are considered as floodplain encroachments will be designed to have:

- (a) No significant risks associated with implementation and,
 - (b) Negligible environmental impacts on the base floodplain.
- (1) *Risks.* There will always be some potential for property damage and flooding that may affect public safety, associated with highway drainage design. In a majority of cases, a field review with a NFIP or USGS map and the application of good engineering judgment are all that is needed to determine if such risks are significant or acceptable. The detail of study and documentation shall be commensurate with the risk(s) or floodplain impact(s) and, in all cases, should be held to the minimum necessary to address 23 CFR 650.111.
- (2) *Impacts.* The assessment of potential impacts on the floodplain environment will include:
- (a) Impacts on natural and beneficial floodplain values.
 - (b) Support of probable incompatible floodplain development.

Except for the more environmentally sensitive projects, a single visit to the project site by the District Project Engineer, Hydraulics Engineer, and Environmental Planner, to assess and document the risks and environmental impacts associated with the proposed project is generally all that is necessary to obtain enough information for the "Location Hydraulic Study". Any reasonable adaptation of the technical information for "Location Hydraulic Study" form, Figure 804.7A, may be utilized to document and summarize the findings of the "Location Hydraulic Study" when the project is expected to be processed with a categorical exclusion. Items listed in 23 CFR 650.111 as follows must be addressed:

- (a) National Flood Insurance Program (NFIP) maps or information developed by the highway agency, if NFIP maps are not available, shall be used to determine whether a highway location alternative will include an encroachment.
- (b) Location studies shall include evaluation and discussion of the practicability of alternatives to any longitudinal encroachments.
- (c) Location studies shall include discussion of the following items, commensurate with the significance of the risk or environmental impact, for all alternatives containing encroachments and for those actions which would support base floodplain development:
 - (1) The risks associated with implementation of the action,
 - (2) The impacts on natural and beneficial floodplain values,
 - (3) The support of probable incompatible floodplain development,
 - (4) The measures to minimize floodplain impacts associated with the action, and
 - (5) The measures to restore and preserve the natural and beneficial floodplain values impacted by the action.
- (d) Location studies shall include evaluation and discussion of the practicability of alternatives to any significant encroachments or any support of incompatible floodplain development.
- (e) The studies required by Sec. 650.111 (c) and (d) shall be summarized in environmental review documents prepared pursuant to 23 CFR part 771.

July 1, 2020

- (f) Local, State, and Federal water resources and floodplain management agencies should be consulted to determine if the proposed highway action is consistent with existing watershed and floodplain management programs and to obtain current information on development and proposed actions in the affected watersheds.

Figure 804.7A is considered the suggested minimum hydraulic and engineering documentation for floodplain encroachments (bridge, culvert, channel change, slope protection, embankment, etc.). It is intended as a guide tool to help address the items listed in 23 CFR 650.111 and should be prepared jointly by the Project Engineer and Hydraulics Engineer. Since every location is unique, some of the questions may not apply, or additional considerations may need to be added.

For projects requiring an Environmental Impact Statement or Environmental Assessment (EIS/EA) or a finding of no significant impact (FONSI) with alternatives that have permanent features that encroach on the floodplain, a back-up report entitled Floodplain Evaluation is normally prepared by the District Environmental Branch. The technical requirements are typically developed jointly by the District Project Engineer and District Hydraulics Engineer. See Figure 804.7B for the Floodplain Evaluation Report Summary form that is used when an environmental document is to be prepared.

804.8 Design Standards

The design standards for highways encroaching on a floodplain are itemized in 23 CFR, Section 650.115. One requirement often overlooked is the need to assess the costs and risks associated with the overtopping flood for design alternatives in those instances where the overtopping flood exceeds the base flood. The content of design study information to be retained in the project file are described in 23 CFR, Section 650.117.

804.9 Coordination with the Local Community

The responsibility for enforcing National Flood Insurance Program (NFIP) regulations rests with the local community that is participating in the NFIP. It is the community who must submit proposals to Federal Emergency Management Agency (FEMA) for amendments to NFIP ordinances and maps in that community, or to demonstrate that an alternative floodway configuration meets NFIP requirements. However, this responsibility may be borne by the agency proposing to construct the highway crossing. Therefore, the highway agency should deal directly with the community and, through them, deal with FEMA. Determination of the status of a community's participation in the NFIP and review of applicable NFIP maps and study reports are, therefore, essential first steps in conducting location hydraulic studies and preparing environmental documents.

804.10 National Flood Insurance Program

The Flood Disaster Protection Act of 1973 (PL 93-234, 87 Stat. 975) denies Federal financial assistance to flood prone communities that fail to qualify for flood insurance. The Act requires communities to adopt certain land use controls in order to qualify for flood insurance. These land use requirements could impose restrictions on the construction of highways in floodplains and regulatory floodplains in communities which have qualified for flood insurance.

Figure 804.7A

Technical Information for Location Hydraulic Study

Dist. _____ Co. _____ Rte. _____ P.M. _____

EA _____ Bridge No. _____

Floodplain Description

- 1. Description of Proposal (include any physical barriers i.e. concrete barriers, soundwalls, etc. and design elements to minimize floodplain impacts)

- 2. ADT: Current _____ Projected _____

- 3. Hydraulic Data: Base Flood Q_{100} = _____ CFS
 WSE_{100} = _____ The flood of record, if greater than Q_{100} :
 Q = _____ CFS WSE = _____
 Overtopping flood Q = _____ CFS WSE = _____
 Are NFIP maps available? Yes _____ No _____
 Are NFIP studies available? Yes _____ No _____

- 4. Is the highway location alternative within a regulatory floodway?

Yes	No
_____	_____

- 5. Attach map with flood limits outlined showing all buildings or other improvements within the base floodplain.
 Potential Q_{100} backwater damages:
 A. Residences?

_____	_____
-------	-------

 B. Other Bldgs?

_____	_____
-------	-------

 C. Crops?

_____	_____
-------	-------

 D. Natural and beneficial Floodplain values?

_____	_____
-------	-------

July 1, 2020

Figure 804.7A

Technical Information for Location Hydraulic Study (Cont.)

- 6. Type of Traffic:
 - A. Emergency supply or evacuation route? _____
 - B. Emergency vehicle access? _____
 - C. Practicable detour available? _____
 - D. School bus or mail route? _____

- 7. Estimated duration of traffic interruption for 100-year event
 _____ hours.

- 8. Estimated value of Q₁₀₀ flood damages (if any) - moderate risk level.
 - A. Roadway\$ _____
 - B. Property\$ _____
 - Total\$ _____

- 9. Assessment of Level of Risk
 Low ___ Moderate ___ High ___
 For High Risk projects, during design phase, additional Design Study Risk Analysis may be necessary to determine design alternative.

PREPARED BY:

 Signature - Dist. Hydraulic Engineer Date
 (Item numbers 3, 4, 5, 7, 9)

Is there any longitudinal encroachment, significant encroachment, or any support of incompatible Floodplain development? No ___ Yes ___

If yes, provide evaluation and discussion of practicability of alternatives in accordance with 23 CFR 650.113

Information developed to comply with the Federal requirement for the Location Hydraulic Study Shall be retained in the project files.

 Signature - Dist. Project Engineer Date
 (Item numbers 1, 2, 6, 8)

Figure 804.7B

Floodplain Evaluation Report Summary

Dist. _____ Co. _____ Rte. _____ P.M. _____
Project No. _____ Bridge No. _____
Limit _____

Floodplain Description

	Yes	No
1. Is the proposed action a longitudinal encroachment of the base floodplain?	_____	_____
2. Are the risks associated with the implementation of the proposed action significant?	_____	_____
3. Will the proposed action support probable incompatible floodplain development?	_____	_____
4. Are there any significant impacts on natural and beneficial floodplain values?	_____	_____
5. Routine construction procedures are required to minimize impacts on the floodplain. Are there any special mitigation measures necessary to minimize impacts or restore and preserve natural and beneficial floodplain values? If yes, explain.	_____	_____
6. Does the proposed action constitute a significant floodplain encroachment as defined in 23 CFR, Section 650.105(q).	_____	_____
7. Are Location Hydraulic Studies that document the above answers on file? If not explain.	_____	_____

PREPARED BY:

Signature - Dist. Hydraulic Engineer Date _____

Signature - Dist. Environmental Branch Chief Date _____

Signature - Dist. Project Engineer Date _____

July 1, 2020

The National Flood Insurance Act of 1968, as amended (42 U.S.C. 4001-4127) requires that communities adopt adequate land use and control measures to qualify for insurance. To implement this provision, the following Federal criteria contains requirements which may affect certain highways:

- In riverine situations, when the Administrator of the Federal Insurance Administration has identified the flood prone area, the community must require that, until a floodway has been designated, no use, including land fill, be permitted within the floodplain area having special flood hazards for which base flood elevations have been provided, unless it has been demonstrated that the cumulative effect of the proposed use, when combined with all other existing and reasonably anticipated uses of similar nature, will not increase the water surface elevation of the 100-year flood more than 1 foot at any point within the community.
- After the floodplain area having special flood hazards has been identified and the water surface elevation for the 100-year flood and floodway data have been provided, the community must designate a floodway which will convey the 100-year flood without increasing the water surface elevation of the flood more than 1 foot at any point and prohibit, within the designated floodway, fill, encroachments and new construction and substantial improvements of existing structures which would result in any increase in flood heights within the community during the occurrence of the 100-year flood discharge.
- The participating cities and/or counties agree to regulate new development in the designated floodplain and floodway through regulations adopted in a floodplain ordinance. The ordinance requires that development in the designated floodplain be consistent with the intent, standards and criteria set by the National Flood Insurance Program.

804.11 Coordination with FEMA

There should be Caltrans coordination with FEMA in situations where administrative determinations are needed involving a regulatory floodway or where flood risks in NFIP communities are significantly impacted. The circumstances which would ordinarily require coordination with FEMA include the following.

- When a proposed crossing encroaches on a regulatory floodway and, as such, would require an amendment to the floodway map.
- When a proposed crossing encroaches on a floodplain where a detailed study has been performed but no floodway designated and the maximum 1 foot increase in the base flood elevation would be exceeded.
- When a local community is expected to enter into the regular program within a reasonable period and detailed floodplain studies are under way.
- When a local community is participating in the emergency program and the base FEMA flood elevation in the vicinity of insurable buildings is increased by more than 1 foot. Where insurable buildings are not affected, it is sufficient to notify FEMA of changes to the base flood elevations as a result of highway construction.

The draft (EIS/EA) should indicate the NFIP status of affected communities, the encroachments anticipated and the need for floodway or floodplain ordinance amendments. If a determination by FEMA would influence the selection of an alternative, a commitment from FEMA should be obtained prior to the final environmental impact Statement (FEIS) or FONSI.

More information regarding FEMA can be found on-line at: <http://www.fema.gov/nfip/>.

FEMA has developed a comprehensive listing of all numerical models that are accepted for NFIP usage. These models can be accessed online at: http://www.fema.gov/mit/tsd/EN_modl.htm.

Topic 805 – Preliminary Plans

805.1 Required FHWA Approval

Current Federal policy requires the review and approval of plans for unusual structures. (See Indices 805.2 - 805.6) by FHWA. FHWA will no longer review and approve major structures (those with greater than 125,000 square feet of deck area) or pumping plants with greater than 20 CFS design discharge. Submittal of plans for unusual structures for review applies only to new construction on the Interstate system. The responsibility for the oversight of unusual structures on other Federal-aid and non-Federal-aid highways will be assumed by the state.

Federal review and approval may take place at either their Division Office or FHWA Headquarters in Washington, D.C. Early submission of necessary data is critical in order to receive a timely approval.

805.2 Bridge Preliminary Report

A Bridge Preliminary Report will be prepared by Structures Design, in the Division of Engineering Services and submitted to the California FHWA Division Office in Sacramento for approval of unusual bridges and structures.

An unusual bridge involves difficult or unique foundation problems, new or complex designs involving unique design or operational features, longer than normal spans or bridges for which the design procedures depart from current acceptable practice. Examples include cable stayed, suspension, arch, segmental concrete bridges, trusses and other bridges which deviate from AASHTO Standard Specifications or Guide Specifications for Highway Bridges, bridges requiring abnormal dynamic analysis for seismic design, bridges designed using a three-dimensional computer analysis, bridges with spans exceeding 500 feet, and bridges which include ultra high strength concrete or steel.

805.3 Storm Drain Systems

The District will submit preliminary plans and hydraulic data for unusual storm drain systems to the California FHWA Division Office in Sacramento for storm drain systems that carry more than 200 CFS or have an accumulated surface detention storage system of more than five acre-feet.

805.4 Unusual Hydraulic Structures

The District will submit preliminary plans and hydraulic data for unusual hydraulic structures to the California FHWA Office in Sacramento. For projects on the interstate system, FHWA Headquarters Office of Bridge Technology approval is required for

July 1, 2020

hydraulic structures involving unusual stream stability countermeasures or unique design techniques. The Division of Engineering Services will submit preliminary plans and hydraulic data to the California FHWA Division Office in Sacramento for unusual structures such as tunnels, complex or unique geotechnical structures and complex or unique hydraulic structures.

805.5 Levees and Dams Formed by Highway Fills

The District will submit preliminary plans and other supportive data to the California FHWA Division Office in Sacramento for approval of:

- (a) Highway fills which will function as a levee and serve the purpose of reducing the flooding of adjacent areas.
- (b) Dams formed by highway fills which will permanently impound water more than 25 feet in depth or 50 acre-feet in volume. See Index 829.9 Dams, for legal definition of a dam and regulations relative to approval by the California Department of Water Resources.

805.6 Geotechnical

The District shall submit preliminary plans and technical data for major or unusual geotechnical features to the California FHWA Division Office for approval. Major geotechnical features include unusually deep cuts or high fills where the site geology is potentially unstable, landslide corrections, and large retaining walls (cantilever, permanent ground anchor, and soil reinforcement). FHWA Headquarters Bridge Division approval is required for unusual geotechnical features, such as new or complex retaining wall systems or ground improvement systems.

805.7 Data Provided by the District

The following items of supportive information must be provided with requests for FHWA approval:

- (a) Preliminary plans and profiles:
 - Approach layouts.
 - Drainage plans.
- (b) Hydraulic design studies:
 - Design Q and frequency.
 - Hydraulic grade lines.
 - Inflow - Outflow hydrographs.
 - Capacity of reservoirs or pump storage systems.
 - Pump capacity.
 - Stream velocities.
 - Water surface profiles.
 - Slope protection, toe and top elevations.
- (c) Proposed specifications.
- (d) Estimated cost.
- (e) Foundation report:

- Embankment design for fills functioning as dams.
- (f) Subsurface investigations.
- (g) Coordination with Federal, state and local agencies.
- (h) Other pertinent data.

The FHWA requires that three copies of supportive information be submitted to the California FHWA Division Office when approval by FHWA Headquarters Bridge Division is required. Four copies of supportive information are to be furnished to the Division of Engineering Services to prepare the FHWA approval requests for bridges.

Topic 806 – Definitions of Drainage Terms

806.1 Introduction

These definitions are for use with Sections 800 through 890 of this manual and the references cited. They are not necessarily definitions as established by case or statutory law.

806.2 Drainage Terms

Accretion. Outward growth of bank or shore by sedimentation. Increase or extension of boundaries of land by action of natural forces.

Action. Any highway construction, reconstruction, rehabilitation, repair, or improvement.

Aggradation. General and progressive raising of a stream bed by deposition of sediment. Modification of the earth's surface in the direction of uniformity of grade, or slope, by deposition as in a river bed.

Aggressive. Refers to the corrosive properties of soil and water.

Alluvial. Referring to deposits of silts, sands, gravels and similar detrital material which have been transported by running water.

Alluvium. Stream-borne materials deposited in and along a channel. *Apron.* (1) A paved area (usually depressed) around a drainage inlet. (2) A floor or lining of concrete between wingwalls at the end of a culvert to prevent scour. (3) A lining of the bed of the channel upstream or downstream from a lined or restricted waterway. (4) A floor or lining of concrete, rock, etc., to protect a surface from erosion such as the pavement along the toe of bank protection.

Aqueduct. (1) A major conduit. (2) The entire transmission main for a municipal water supply which may consist of a succession of canals, pipes, tunnels, etc. (3) Any conduit for water; especially one for a large quantity of flowing water. (4) A structure for conveying a canal over a river or hollow.

Aquifer. Water-bearing geologic formations that permit the movement of ground water.

Armor. Artificial surfacing of bed, banks, shore or embankment to resist erosion or scour.

Arroyo. Waterway of an ephemeral stream deeply carved in rock or ancient alluvium.

July 1, 2020

Artesian Waters. Percolating waters confined below impermeable formations with sufficient pressure to spring or well up to the surface.

Articulated. Made flexible by hinging particularly of small rigid slabs adapted to revetment.

Avulsion. (1) A forcible separation; also, a part torn off. (2) The sudden removal of land from the estate of one man to that of another, as by a sudden change in a river, the property thus separated continuing in the original owner. (3) A sudden shift in location of channel.

Backing Layer. A layer of graded rock between rock riprap and underlying engineering fabric or filter layer to prevent extrusion of the soil or filter layer material through the riprap.

Backshore. The zone of the shore or beach lying between the foreshore and the coastline and acted upon by waves only during severe storms, especially when combined with exceptionally high water.

Backwater. An unnaturally high stage in stream caused by obstruction or confinement of flow, as by a dam, a bridge, or a culvert. Its measure is the excess of unnatural over natural stage, not the difference in stage upstream and downstream from its cause.

Baffle. Concrete or metal panels mounted in a series on the floor and/or wall of a culvert to increase boundary roughness and thereby reduce the average water velocity while increasing flow depth in the culvert.

Bank. The lateral boundary of a stream confining water flow. The bank on the left side of a channel looking downstream is called the left bank, etc.

Bankfull Stage. Stage at which a stream first overflows its natural banks into the floodplain. If the floodplain is absent or poorly defined, other indicators may identify bankfull. These include the height of depositional features, a change in vegetation, slope or topographic breaks along the bank, a change in the particle size of bank material, undercuts in the bank, and stain lines or the lower extent of lichens and moss on boulders. Corresponds to the stage at which channel maintenance is most effective, that is, the discharge at which the stream is moving sediment, forming or removing bars, forming or changing bends and meanders, and generally doing work that results in the average morphologic characteristics of channels. Generally applies to mature streams in more alluvial conditions rather than in mountainous conditions where the "bank" might be hundreds of feet above the incised channel. In incised channels, where the previous floodplain surface has become a terrace, the bankfull stage can be identified as the lowermost limit of establishing woody-riparian vegetation.

Bank Protection. Revetment, or other armor protecting a bank of a stream from erosion, includes devices used to deflect the forces of erosion away from the bank.

Bar. An elongated deposit of alluvium within a channel or across its mouth.

Barrier. A low dam or rack built to control flow of debris.

Base Flood. The flood or tide having a 1 percent chance of being exceeded in any given year (100-year flood). The "base flood" is commonly used as the "standard flood" in Federal flood insurance studies. (see Regulatory Flood).

Base Floodplain. The area subject to flooding by the base flood.

Basin. (1) The surface of the area tributary to a stream or lake. (2) Space above or below ground capable of retaining or detaining water or debris.

Bay. An indentation of bank or shore, including erosional cuts and slipouts, not necessarily large.

Beach. The zone of sedimentary material that extends landward from the low water line to the place where there is marked change in material or form, or to the line of permanent vegetation (usually the effective limit of storm waves). The seaward limit of a beach, unless otherwise specified, is the mean low water line. A beach includes foreshore and backshore.

Bed. The earth below any body of water, limited laterally by bank or shore.

Bedding. The foundation under a drainage structure.

Bed Load. Sediment that moves by rolling, sliding, or skipping along the bed and is essentially in contact with the stream bed.

Berm. (1) A bench or terrace between two slopes. (2) A nearly horizontal part of the beach or backshore formed at the high water line by waves depositing material. Some beaches have no berms, others have one or several.

Block. Precast prismatic unit for riprap structure.

Bluff. A high, steep bank composed of erodible materials.

Boil. Turbulent break in a water surface by upwelling.

Boom. Floating log or similar element designed to dampen surface waves or control the movement of drift.

Bore. A transient solitary wave in a narrow or converging channel advancing with a steep turbulent front; product of flash floods or incoming tides.

Boulder. Largest rock transported by a stream or rolled in the surf; typically heavier than 25 pounds and larger than 8 inches in diameter.

Braided Stream. A stream in which flow is divided at normal stage by small islands. This type of stream has the aspect of a single large channel with which there are subordinate channels.

Breaker. A collapsing wave meeting a shore, reef, sandbar, or rock.

Breakwater. A fixed or floating structure that protects a shore area, harbor, anchorage, or basin from intercepting waves.

Bulkhead. A steep or vertical structure placed on a bank, bluff, or embankment to retain or prevent sliding of the land and protect the inland area from damage.

Bulking. The increase in volume of flow due to air entrainment, debris, bedload, or sediment in suspension.

Buoyancy. Uplift force on a submerged body equal to the mass of water displaced times the acceleration of gravity.

July 1, 2020

Camber. An upward adjustment of the profile of a drainage facility under a heavy loading (usually a high embankment) and poor soil conditions, so that as the drainage facility settles it approaches the design profile.

Canal. An artificial open channel.

Canyon. A large deep valley; also the submarine counterpart.

Cap. Top layer of stone protective works.

Capacity. The effective carrying ability of a drainage structure. Generally measured in cubic feet per second.

Capillarity. The attraction between water and soil particles which cause water to move in any direction through the soil mass regardless of gravitational forces.

Capillary Water. Water which clings to soil particles by capillary action. It is normally associated with fine sand, silt, or clay, but not normally with coarse sand and gravel.

Catch Basin. A drainage structure which collects water. May be either a structure where water enters from the side or through a grating.

Causeway. A raised embankment or trestle over swamp or overflow areas.

Cavitation. Erosion by suction, especially in the partial vacuum of a diverging jet.

Celerity. Velocity of a moving wave, as distinguished from velocity of particles oscillating in the wave.

Channel. An open conduit either naturally or artificially created which periodically or continuously contains moving water, or which forms a connecting link between two bodies of water. River, creek, run, branch, anabranch, and tributary are some of the terms used to describe natural channels. Natural channels may be single or braided (see Braided Stream). Canal and "floodway" are some of the terms used to describe artificial channels.

Check. A sill or weir in a channel to control stage or velocity.

Check Dam. A small dam generally placed in steep ditches for the purpose of reducing the velocity in the ditch.

Cienega. A swamp formed by water rising to the surface at a fault.

Cleanout. An access opening to a roadway drainage system. Usually consists of a manhole shaft, a special chamber or opening into a shallow culvert or drain.

Cliff. A high, steep face of rock; a precipice.

Cloudburst. Rain storm of great intensity usually over a small area for a short duration.

Coast. (1) The strip of land, of indefinite width (up to several miles), that extends from the shoreline inland to the first major change in terrain features. (2) As a combining form, "upcoast" is northerly and "downcoast" is southerly.

Cobble. Rock smaller than a boulder and larger than gravel; typically 1 pound to 25 pounds, or 3 inches to 8 inches in diameter.

Coefficient of Runoff. Percentage of gross rainfall which appears as runoff.

Composite Hydrograph. A plot of mean daily discharges for a number of years of record on a single year time base for the purpose of showing the occurrence of high and low flows.

Concentrated Flow. Flowing water that has been accumulated into a single fairly narrow stream.

Concentration. In addition to its general sense, means the unnatural collection or convergence of waters so as to discharge in a narrower width, and at greater depth or velocity.

Conduit. Any pipe, arch, box or drain tile through which water is conveyed.

Cone. Physiographic form of sediment deposit washed from a gorge channel onto an open plain; a debris cone, also called an alluvial fan.

Confluence. A junction of streams.

Constriction. An obstruction narrowing a waterway.

Contraction. The reduction in cross sectional area of flow.

Control. (1) A section or reach of an open conduit or stream channel which maintains a stable relationship between stage and discharge. (2) For flood, erosion, debris, etc., remedial means or procedure restricting damage to a tolerable level.

Conveyance. A measure of the water carrying capacity of a stream or channel.

Core. Central zone of dike, levee, rock groin, jetty, etc.

Corrasion. Erosion or scour by abrasion in flowing water.

Corrosion. Erosion by chemical action.

Cradle. (1) A concrete base generally constructed to fit the shape of a structure which is to be forced through earthen material by a jacking operation. The cradle is constructed to line and grade. (2) Wood support for rigid culverts on yielding embankment subgrade. Then the pipe rides on the cradle as it is worked through the given material by jacking and tunneling methods. Also serves as bedding for pipes in trenches in special conditions.

Creek. A small stream, usually active.

Crest. (1) Peak of a wave or a flood. (2) Top of a levee, dam, weir, spillway or other water barrier or control.

Crib. An open-frame structure loaded with earth or stone ballast to act as a baffle in bank protection.

Critical Depth. (Depth at which specific energy is a minimum) - The depth of water in a conduit at which under certain other conditions the maximum flow will occur. These other conditions are the conduit is on the critical slope with the water flowing at its critical velocity and there is an adequate supply of water. The depth of water flowing in an open channel or a conduit partially filled, for which the velocity head equals one-half the hydraulic mean depth.

Critical Flow. That flow in open channels at which the energy content of the fluid is at a minimum. Also, that flow which has a Froude number of one.

July 1, 2020

Critical Slope. That slope at which the maximum flow will occur at the minimum velocity. The slope or grade that is exactly equal to the loss of head per foot resulting from flow at a depth that will give uniform flow at critical depth; the slope of a conduit which will produce critical flow.

Critical Velocity. Mean velocity of flow when flow is at critical depth.

Culvert. A closed conduit which allows water to pass under a highway. The following three conditions constitute a culvert;

1. Single Barrel - span measured along centerline of road 20 feet or less.
2. Multi-Barrels - total of the individual spans measured along centerline of road is 20 feet or less.
3. Multi-Barrels - total of the individual spans measured along centerline of road is 20 feet or greater, but the distance between individual culverts is more than one-half the culvert diameter.

Current. Flow of water, both as a phenomenon and as a vector. Usually qualified by adjectives like downward, littoral, tidal, etc. to show relation to a pattern of movement.

Current Meter. An instrument for measuring the velocity of a current. It is usually operated by a wheel equipped with vanes or cups which is rotated by the action of the impinging current. An indicating or recording device is provided to indicate the speed of rotation which is correlated with the velocity of the current.

Cutoff Wall. A wall at the end of a drainage structure, the top of which is an integral part of the drainage structure. This wall is usually buried and its function is to prevent undermining of the drainage structure if the natural material at the outlet of the structure is dug out by the water discharging from the end of the structure. Cutoff walls are sometimes used at the upstream end of a structure when there is a possibility of erosion at this point.

Debris. Any material including floating woody materials and other trash, suspended sediment, or bed load moved by a flowing stream.

Debris Barrier. A deflector placed at the entrance of a culvert upstream, which tends to deflect heavy floating debris or boulders away from the culvert entrance during high-velocity flow.

Debris Basin. Any area upstream from a drainage structure utilized for the purpose of retaining debris in order to prevent clogging of drainage structures downstream.

Debris Rack. A straight barrier placed across the stream channel which tends to separate light and medium floating debris from stream flow and prevent the debris from reaching the culvert entrance.

Degradation. General and progressive lowering of the longitudinal profile of a channel by erosion.

Delta. System of channels thru an alluvial plain at the mouth of a stream.

Deposit. An earth mass of particles settled or stranded from moving water or wind.

Depth. Vertical distance, (1) from surface to bed of a body of water. (2) From crest or crown to invert of a conduit.

Design Capacity. The size required of a drainage facility which allows it to pass the design discharge without detrimental impacts.

Design Channel Capacity. Expressed as a rate of flow, usually in cubic feet per second, it is the level to which a facility is designed. Based upon slope, geometry, flow regime, frictional coefficients, etc., it is the sizing of a drainage facility which allows it to pass the design discharge. Freeboard or other safety factors which are added to the final facility dimensions are not a part of the design capacity.

Design Discharge. The quantity of flow that is expected at a certain point as a result of a design storm. Usually expressed as a rate of flow in cubic feet per second.

Design Flood. The peak discharge (when appropriate, the volume, stage, or wave crest elevation) of the flood associated with the probability of exceedance selected for the design of a highway encroachment. By definition, the highway will not be inundated by the design flood. In a FEMA floodplain, see 23 CFR, Part 650, Subpart A, for definitions of "overtopping flood" and "base flood."

Design Frequency. The recurrence interval for hydrologic events used for design purposes. As an example, a design frequency of 50 years means a storm of a magnitude that would be expected to recur on the average of every 50 years. (See Probability of Exceedance.)

Design High Water. The flood stage or tide crest elevation adopted for design of drainage and bank protection structures. (See Design Flood and High Water).

Design Storm. That particular storm which contributes runoff which the drainage facilities were designed to handle. This storm is selected for design on the basis of its probability of exceedance or average recurrence interval (See Probability of Exceedance.)

Detention Storage. Surface water moving over the land is in detention storage. Surface water allowed to temporarily accumulate in ponds, basins, reservoirs or other types of holding facility and which is ultimately returned to a watercourse or other drainage system as runoff is in detention storage. (See Retention Storage)

Detritus. Loose material such as; rock, sand, silt, and organic particles.

Dike. (1) Usually an earthen bank alongside and parallel with a river or open channel or an AC dike along the edge of a shoulder. (See Levee) (2) An AC dike along the edge of a shoulder.

Dike, Finger. Relatively short embankments constructed normal to a larger embankment, such as an approach fill to a bridge. Their purpose is to impede flow and direct it away from the major embankment.

Dike, Toe. Embankment constructed to prevent lateral flow from scouring the corner of the downstream side of an abutment embankment. Sometimes referred to as training dikes.

Dike, Training. Embankments constructed to provide a transition from the natural stream channel or floodplain, both to and from a constricting bridge crossing.

Discharge. A volume of water flowing out of a drainage structure or facility. Measured in cubic feet per second.

July 1, 2020

Dissipate. Expend or scatter harmlessly, as of energy of moving water.

Ditch. Small artificial channel, usually unlined.

Diversion. (1) The change in character, location, direction, or quantity of flow of a natural drainage course (a deflection of flood water is not a diversion). (2) Draft of water from one channel to another. (3) Interception of runoff by works which discharge it thru unnatural channels.

D-Load (Cracking D-Load). A term used in expressing the strength of concrete pipe. The cracking D-load represents the test load required to produce a 0.01 inch crack for a length of 12 inches.

Downdrain. A prefabricated drainage facility assembled and installed in the field for the purpose of transporting water down steep slopes.

Downdrift. The direction of predominant movement of littoral materials.

Drain. Conduit intercepting and discharging surplus ground or surface water.

Drainage. (1) The process of removing surplus ground or surface water by artificial means. (2) The system by which the waters of an area are removed. (3) The area from which waters are drained; a drainage basin.

Drainage Area (Drainage Basin) (Basin). That portion of the earth's surface upon which falling precipitation flows to a given location. With respect to a highway, this location may be either a culvert, the farthest point of a channel, or an inlet to a roadway drainage system.

Drainage Course. Any path along which water flows when acted upon by gravitational forces.

Drainage Divide. The rim of a drainage basin. A series of high points from which water flows in two directions, to the basin and away from the basin.

Drainage Easement (See Easement).

Drainage System. Usually a system of underground conduits and collector structures which flow to a single point of discharge.

Drawdown. The difference in elevation between the water surface elevation at a constriction in a stream or conduit and the elevation that would exist if the constriction were absent. Drawdown also occurs at changes from mild to steep channel slopes and weirs or vertical spillways.

Drift. (1) Floating or non-mineral burden of a stream. (2) Deviation from a normal course in a cross current, as in littoral drift.

Drop. Controlled fall in a stream to dissipate energy.

Dry Weather Flows. A small amount of water which flows almost continually due to lawn watering, irrigation or springs.

Dune. A sand wave of approximately triangular cross section (in a vertical plane in the direction of flow) formed by moving water or wind, with gentle upstream slope and steep downstream slope and deposition on the downstream slope.

Easement. Right to use the land of others.

Ebb. Falling stage or outward flow, especially of tides.

Eddy. Rotational flow around a vertical axis.

Eddy Loss. The energy lost (converted into heat) by swirls, eddies, and impact, as distinguished from friction loss.

Embankment. Earth structure above natural ground.

Embayment. Indentation of bank or shore, particularly by progressive erosion.

Encroachment. Extending beyond the original, or customary limits, such as by occupancy of the river and/or floodplain by earth fill embankment.

Endwall. A wall placed at the end of a culvert. It may serve three purposes; (1), to hold the embankment away from the pipe and prevent sloughing into the pipe outlet channel; (2), to provide a wall which will prevent erosion of the roadway fill; and (3), to prevent flotation of the pipe.

Energy. Potential or kinetic, the latter being expressed in the same unit (feet) as the former.

Energy Dissipator. A structure for the purpose of slowing the flow of water and reducing the erosive forces present in any rapidly flowing body of water.

Energy Grade Line. The line which represents the total energy gradient along the channel. It is established by adding together the potential energy expressed as the water surface elevation referenced to a datum and the kinetic energy (usually expressed as velocity head) at points along the stream bed or channel floor.

Energy Head. The elevation of the hydraulic grade line at any section plus the velocity head of the mean velocity of the water in that section.

Entrance. The upstream approach transition to a constricted waterway.

Entrance Head. The head required to cause flow into a conduit or other structure; it includes both entrance loss and velocity head.

Entrance Loss. The head lost in eddies and friction at the inlet to a conduit or structure.

Ephemeral. Of brief duration, as the flow of a stream in an arid region.

Equalizer. A drainage structure similar to a culvert but different in that it is not intended to pass a design flow in a given direction. Instead it is often placed level so as to permit passage of water in either direction. It is used where there is no place for the water to go. Its purpose is to maintain the same water surface elevation on both sides of the highway embankment.

Erosion. The wearing away of natural (earth) and unnatural (embankment, slope protection, structure, etc.) surfaces by the action of natural forces, particularly moving water and materials carried by it. In the case of drainage terminology, this term generally refers to the wearing away of the earth's surface by flowing water.

Erosion and Scour. The cutting or wearing away by the forces of water of the banks and bed of a channel in horizontal and vertical directions, respectively.

July 1, 2020

Erosion and Accretion. Loss and gain of land, respectively, by the gradual action of a stream in shifting its channel by cutting one bank while it builds on the opposite bank. Property is lost by erosion and gained by accretion but not by *avulsion* when the shift from one channel to another is sudden. Property is gained by *reliction* when a lake recedes.

Estuary. That portion of a river channel occupied at times or in part by both sea and river flow in appreciable quantities. The water usually has brackish characteristics.

Evaporation. A process whereby water as a liquid is changed into water vapor, typically through heat supplied from the sun.

Face. The outer layer of slope revetment.

Fan. A portion of a cone, but sometimes used to emphasize definition of radial channels. Also reference to spreading out of water or soils associated with waters leaving a confined channel (e.g., alluvial fan).

Fetch. The unobstructed distance across open water through which wind acts to generate waves.

Filter. A porous article or mass (as of fabric or even-graded mineral aggregate) through which water will freely pass, but which will block the passage of soil particles.

Filter Fabric (RSP fabric). An engineering fabric (geotextile) placed between the backfill and supporting or underlying soil through which water will pass and soil particles are retained.

Filter Layer. A layer of even-graded rock between rock riprap and underlying soil to prevent extrusion of the soil thru riprap.

Flap Gate. This is a form of valve that is designed so that a minimum force is required to push it open but when a greater water pressure is present on the outside of the valve, it remains shut so as to prevent water from flowing in the wrong direction. Construction is simple with a metal cover hanging from an overhead rod or pinion at the end of a culvert or drain.

Flood Frequency. Also referred to as exceedance interval, recurrence interval or return period; the average time interval between actual occurrences of a hydrological event of a given or greater magnitude; the percent chance of occurrence is the reciprocal of flood frequency, e.g., a 2 percent chance of occurrence is the reciprocal statement of a 50-year flood. (See Probability of Exceedance.)

Floodplain. Normally dry land areas subject to periodic temporary inundation by stream flow or tidal overflow. Land formed by deposition of sediment by water; alluvial land.

Floodplain Encroachment. An action within the limits of the base floodplain.

Flood Plane. The position occupied by the water surface of a stream during a particular flood. Also, loosely, the elevation of the water surface at various points along the stream during a particular flood.

Floodproof. To design and construct individual buildings, facilities, and their sites to protect against structural failure, to keep water out or reduce the effects of water entry.

Flood Stage. The elevation at which overflow of the natural banks of a stream begins to cause damage in the reach in which the elevation is measured. The elevation of the lowest bank of the reach. The term "lowest bank" is, however, not to be taken to mean an unusually low place or break in the natural bank through which the water inundates an unimportant and small area.

Flood Waters. Former stream waters which have escaped from a watercourse (and its overflow channel) and flow or stand over adjoining lands. They remain as such until they disappear from the surface by infiltration, evaporation, or return to a natural watercourse. They do not become surface waters by mingling with such waters, nor stream waters by eroding a temporary channel.

Flow. A term used to define the movement of water, silt, sand, etc.; discharge; total quantity carried by a stream.

Flow Line. A term used to describe the line connecting the low points in a watercourse.

Flow Regime. The system or order characteristic of streamflow with respect to velocity, depth, and specific energy.

Flow, steady. Flow at constant discharge.

Flow, unsteady. Flow on rising or falling stages.

Flow, varied. Flow in a channel with variable section.

Foreshore. The part of the shore lying between the ordinary high water mark or upper limit of wave wash traversed by the runup and return of waves and the water's edge at the low water.

Freeboard. (1) The vertical distance between the water surface elevation usually corresponding to the design flow and a point of interest such as a bridge beam, levee top or specific location on the roadway grade. (2) The distance between the normal operating level and the top of the sides of an open conduit; the crest of a dam, etc., designed to allow for wave action, superelevation, floating debris, or any other condition or emergency, without overtopping the structure. Freeboard is provided to ensure that the desired degree of protection will not be reduced by unaccounted factors such as the accumulation of silt, trash, or aquatic growth in the channel; unforeseen embankment settlement, erratic hydrologic phenomena and variation of resistance or other coefficients from those assumed in design.

Free Outlet. A condition under which water discharges with no interference such as a pipe discharging into open air.

Free Water. Water which can move through the soil by force of gravity.

French Drain. A trench loosely backfilled with stones, the largest stones being placed in the bottom with the size of stones decreasing towards the top. The interstices between the stones serve as a passageway for water.

Friction. Energy-dissipating conflict among turbulent water particles disturbed by irregularities of channel surface.

Froude Number. A dimensionless expression of the ratio of inertia forces to gravity forces, used as an index to characterize the type of flow in a hydraulic structure in which gravity

July 1, 2020

is the force producing motion and inertia is the resisting force. It is equal to a characteristic flow velocity (mean, surface, or maximum) of the system divided by the square root of the product of a characteristic dimension (as diameter or depth) and the gravity constant (acceleration due to gravity) all expressed in consistent units.

$$F_r = V/(gy)^{1/2}$$

Gabion. A wire basket or cage filled with stone and placed as, or as part of, a bank-protection structure.

Gaging Station. A location on a stream where measurements of stage or discharge are customarily made. The location includes a reach of channel through which the flow is uniform, a control downstream from this reach and usually a small building to house the recording instruments.

Gorge. A narrow deep valley with steep or vertical banks.

Grade. Elevation of bed or invert of a channel.

Grade to Drain. A construction note often inserted on a plan for the purpose of directing the Contractor to slope a certain area in a specific direction, so that the surface waters will flow to a designated location.

Gradient (Slope). The rate of ascent or descent expressed as a percent or as a decimal as determined by the ratio of the change in elevation to the length.

Gradually Varied Flow. In this type of flow, changes in depth and velocity take place slowly over large distances, resistance to flow dominates and acceleration forces are neglected.

Grate. A framework of bars, usually cast iron or welded steel, used as a screen to cover the intake of a drainage inlet. See Standards Plans and Standard Specifications for requirements.

Ground Water. That water which is present under the earth's surface. Ground water is that situated below the surface of the land, irrespective of its source and transient status. Subterranean streams are flows of ground waters parallel to and adjoining stream waters, and usually determined to be integral parts of the visible streams.

Grouted. Bonded together with an inlay or overlay of cement mortar.

Guide Bank. An appendage to the highway embankment at or near a bridge abutment to guide the stream through the bridge opening.

Gulch. A relatively young, well-defined and sharply cut erosional channel.

Gully. Diminutive of gulch.

Head. Represents an available force equivalent to a certain depth of water. This is the motivating force in effecting the movement of water. The height of water above any point or plane of reference. Used also in various compound expressions, such as energy head, entrance head, friction head, static head, pressure head, lost head, etc.

Headcutting. Progressive scouring and degrading of a streambed at a relatively rapid rate in the upstream direction, usually characterized by one or a series of vertical falls.

High Water. Maximum flood stage of stream or lake; periodic crest stage of tide. Historic HW is stage recorded or otherwise known.

Hydraulic. Pertaining to water in motion and the mechanics of the motion.

Hydraulic Gradient. A line which represents the relative force available due to the potential energy available. This is a combination of energy due to the height of the water and the internal pressure. In any open channel, this line corresponds to the water surface. In a closed conduit, if several openings were placed along the top of the pipe and open tubes inserted, a line connecting the water surface in each of these tubes would represent the hydraulic grade line.

Hydraulic Jump (or Jump). Transition of flow from the rapid to the tranquil state. A varied flow phenomenon producing a rise in elevation of water surface. A sudden transition from supercritical flow to the complementary subcritical flow, conserving momentum and dissipating energy.

Hydraulic Mean Depth. The area of the flow cross section divided by the water surface width.

Hydraulic Radius. The cross sectional area of a stream of water divided by the length of that part of its periphery in contact with its containing conduit; the ratio of area to wetted perimeter.

Hydrograph. A graph showing stage, flow, velocity, or other property of water with respect to time.

Hydrographic. Pertaining to the measurement or study of bodies of water and associated terrain.

Hydrography. Water Surveys. The art of measuring, recording, and analyzing the flow of water; and of measuring and mapping watercourses, shore lines, and navigable waters.

Hydrologic. Pertaining to the cyclic phenomena of waters of the earth; successively as precipitation, runoff, storage and evaporation, and quantitatively as to distribution and concentration.

Hydrology. The science dealing with the occurrence and movement of water upon and beneath the land areas of the earth. Overlaps and includes portions of other sciences such as meteorology and geology. The particular branch of Hydrology that a design engineer is generally interested in is surface runoff which is the result of excess precipitation.

Hydrostatic. Pertaining to pressure by and within water due to gravitation acting thru depth.

Hyetograph. Graphical representation of rainfall intensity against time.

Impinge. To strike and attack directly, as in curvilinear flow where the current does not follow the curve but continues on tangent into the bank on the outside of bend in the channel.

July 1, 2020

Incised Channel. Those channels which have been cut relatively deep into underlying formations by natural processes. Characteristics include relatively straight alignment and high, steep banks such that overflow rarely occurs, if ever.

Infiltration. The passage of water through the soil surface into the ground.

Inlet Time. The time required for storm runoff to flow from the most remote point, in flow time, of a drainage area to the point where it enters a drain or culvert.

Inlet Transition. A specially shaped entrance to a box or pipe culvert. It is shaped in such a manner that in passing from one flow condition to another, the minimum turbulence or interference with flow is permitted.

Inundate. To cover with a flood.

Invert. The bottom of a drainage facility along which the lowest flows would pass.

Invert Paving. Generally applies to metal pipes where it is desirable to improve flow characteristics or prevent corrosion at low flows. The bottom portion of the pipe is paved with an asphaltic material, concrete, or air-blown mortar.

Inverted Siphon. A pipe for conducting water beneath a depressed place. A true inverted siphon is a culvert which has the middle portion at a lower elevation than either the inlet or the outlet and in which a vacuum is created at some point in the pipe. A sag culvert is similar, but the vacuum is not essential to its operation.

Isohyetal Line. A line drawn on a map or chart joining points that receive the same amount of precipitation.

Isohyetal Map. A map containing isohyetal lines and showing rainfall intensities.

Isovel. Line on a diagram of a channel connecting points of equal velocity.

Jack (or Jack Straw). Bank protection element consisting of wire or cable strung on three mutually perpendicular struts connected at their centers.

Jacking Operations. A means of constructing a pipeline under a highway without open excavation. A cutting edge is placed on the first section of pipe and the pipe is forced ahead by hydraulic jacks. As the leading edge pushes ahead, the material inside the pipe is dug out and transported outside the pipe for disposal.

Jam. Wedged collection of drift in a constriction of a channel, such as a gorge or a bridge opening.

Jet. An effluent stream from a restricted channel, including a fast current through a slower stream.

Jetty. An elongated, artificial obstruction projecting into a stream or the sea from bank or shore to control shoaling and scour by deflection of strength of currents and waves.

Jump. Sudden transition from supercritical flow to the complementary subcritical flow, conserving momentum and dissipating energy; the hydraulic jump.

Kolk. Rotational flow about a horizontal axis, induced by a reef and breaking the surface in a boil.

Lake. A water filled basin with restricted or no outlet. Includes reservoirs, tidal ponds and playas.

Lag. Variously defined as time from beginning (or center of mass) of rainfall to peak (or center of mass) of runoff.

Laminar Flow. That type of flow in which each particle moves in a direction parallel to every other particle and in which the head loss is approximately proportional to the velocity (as opposed to turbulent flow).

Lateral. In a roadway drainage system, a drainage conduit transporting water from inlet points to the main drain trunk line.

Levee. An embankment on or along the bank of a stream or lake to protect outer lowlands from inundation. (See Dike)

Lining. Protective cover of the perimeter of a channel.

Littoral. Pertaining to or along the shore, particularly to describe currents, deposits, and drift.

Littoral Drift. The sedimentary material (sand) moved along the shoreline under the influence of waves and currents.

Littoral Transport. The movement of littoral drift along the shoreline by waves and currents. Includes movement parallel (longshore transport) and perpendicular (on-offshore transport) to the shore.

Local Depression. A low area in the pavement or in the gutter established for the special purpose of collecting surface waters on a street and directing these waters into a drainage inlet.

Longshore. Parallel to and near the shoreline.

Marginal. Within a borderland area; more general and extensive than riparian.

Marsh. An area of soft, wet, or periodically submerged land, generally treeless and usually characterized by grasses and other low vegetation.

Mature. Classification for streams which have established flat gradients not subject to further scour.

Maximum Historical Flood. The maximum flood that has been recorded or experienced at any particular highway location.

Mean Annual Flood. The flood discharge with a recurrence interval of 2.33 years.

Mean Depth. For a stream at any stage, the wetted normal section divided by the surface width. Hydraulic mean depth.

Meander. In connection with streams, a winding channel usually in an erodible, alluvial valley. A reverse or S-shaped curve or series of curves formed by erosion of the concave bank, especially at the downstream end, characterized by curved flow and alternating shoals and bank erosions. Meandering is a stage in the migratory movement of the channel, as a whole, down the valley.

July 1, 2020

Meander Plug (Clay Plug). Deposits of cohesive materials in old channel bendways. These plugs are sufficiently resistant to erosion to serve as essentially semi-permanent geological controls to advancing channel migrations.

Meander Scroll. Evidence of historical meander patterns in the form of lines visible on the inside of meander bends (particularly on aerial photographs) which resemble a spiral or convoluted form in ornamental design. These lines are concentric and regular forms in high sinuosity channels and are largely absent in poorly developed braided channels.

Mesh. Woven wire or other filaments used alone as revetment, or as retainer or container of masses of gravel or cobble.

Mud Flow. A well-mixed mass of water and alluvium which, because of its high viscosity, and low fluidity as compared with water, moves at a much slower rate, usually piling up and spreading out like a sheet of wet mortar or concrete.

Natural and Beneficial Floodplain Values. Includes but are not limited to fish, wildlife, plants, open space, natural beauty, scientific study, outdoor recreation, agriculture, aquaculture, forestry, natural moderation of floods, water quality maintenance, and groundwater recharge.

Natural Channel Capacity. The maximum rate of flow in cubic feet per second that can pass through a channel without overflowing the banks

Navigable Waters. Those stream waters lawfully declared or actually used as such. Navigable Waters of the State of California are those declared by Statute. Navigable Waters of the United States are those determined by the Corps of Engineers or the U.S. Coast Guard to be so used in interstate or international commerce. Other streams have been held navigable by courts under the common law that navigability in fact is navigability in law.

Negative Projecting Conduits. A structure installed in a trench with the top below the top of trench, then covered with backfill and embankment. See Positive Projecting Conduit

Nonuniform Flow. A flow in which the velocities vary from point to point along the stream or conduit, due to variations in cross section, slope, etc.

Normal Depth. The depth at which flow is steady and hydraulic characteristics are uniform.

Normal Water Surface (Natural Water Surface). The free surface associated with flow in natural streams.

"n" Value. The roughness coefficient in the Manning formula for determination of the discharge coefficient in the Chezy formula,

$$V = C(RS)^{1/2}, \text{ where } C = \left(\frac{1.49}{n} \right) R^{1/6}$$

Nourishment. The process of replenishing a beach. It may be brought about naturally, by accretion due to the longshore transport, or artificially, by the deposition of dredged materials.

Off-Site Drainage. The handling of that water which originates outside the highway right of way.

On-Site Drainage. The handling of that water which originates inside the highway right of way.

Open Channel. Any conveyance in which water flows with a free surface.

Ordinary High Water Mark. The line on the shore established by the fluctuation of water and physically indicated on the bank (1.5 ± years return period).

Outfall. Discharge or point of discharge of a culvert or other closed conduit.

Outwash. Debris transported from a restricted channel to an unrestricted area where it is deposited to form an alluvial or debris cone or fan.

Overflow. Discharge of a stream outside its banks; the parallel channels carrying such discharge.

Overtopping Flood. The flood described by the probability of exceedance and water surface elevation at which flow occurs over the highway, over the watershed divide, or through structure(s) provided for emergency relief.

Peak Flow. Maximum momentary stage or discharge of a stream in flood. Design Discharge.

Pebble. Stone 0.5 inch to 3-inch in diameter, including coarse gravel and small cobble.

Perched Water. Ground water located above the level of the water table and separated from it by a zone of impermeable material.

Percolating Waters. Waters which have infiltrated the surface of the land and move slowly downward and outward through devious channels (aquifers) unrelated to stream waters, until they reach an underground lake or regain and spring from the land surface at a lower point.

Permeability. The property of soils which permits the passage of any fluid. Permeability depends on grain size, void ratio, shape and arrangement of pores.

Permeable. Open to the passage of fluids, as for (1) pervious soils and (2) bank-protection structures.

Physiographic Region. A geographic area whose pattern of landforms differ significantly from that of adjacent regions.

Pier. Vertical support of a structure standing in a stream or other body of water. Used in a general sense to include bents and abutments.

Pile. A long, heavy timber or section of concrete or metal that is driven or jetted into the earth or bottom of a water body to serve as a structural support or protection.

Piping. The action of water passing through or under an embankment and carrying some of the finer material with it to the surface at the downstream face.

Plunge. Flow with a strong downward component, as in outfall drops, overbank falls, and surf attack on a beach.

Point of Concentration. That point at which the water flowing from a given drainage area concentrates. With reference to a highway, this would generally be either a culvert entrance or some point in a roadway drainage system.

July 1, 2020

Poised Stream. A term used by river engineers applying to a stream that over a period of time is neither degrading or aggrading its channel, and is nearly in equilibrium as to sediment transport and supply.

Positive Projecting Conduit. A structure installed in shallow trench with the top of the conduit projecting above the top of the trench and then covered with embankment. See Negative Projecting Conduit.

Potamology. The hydrology of streams.

Practicable. Capable of being done within reasonable natural, social, and economic constraints.

Precipitation. Discharge of atmospheric moisture as rain, snow or hail, measured in depth of fall or in terms of intensity of fall in unit time.

Prescriptive Rights. The operation of the law whereby rights may be established by long exercise of their corresponding powers or extinguished by prolonged failure to exercise such powers.

Preserve. To avoid modification to the functions of the natural floodplain environment or to maintain it, as closely as practicable, in its natural state.

Probability. The chance of occurrence or recurrence of a specified event within a unit of time, commonly expressed in 3 ways. Thus a 10-year flood has a chance of 0.1 per year and is also called a 10 percent-chance flood.

Probability of Exceedance. The statistical probability, expressed as a percentage, of a hydrologic event occurring or being exceeded in any given year. The probability (p) of a storm or flood is the reciprocal of the average recurrence interval (N).

Probable Maximum Flood. The flood discharge that may be expected from the most severe combination of critical meteorological and hydrological conditions that are reasonably possible in the region.

Pumping Plant. A complete pumping installation including a storage box, pump or pumps, standby pumps, connecting pipes, electrical equipment, pumphouse and outlet chamber.

Rack. An open upright structure, such as a debris rack.

Rainfall. Point Precipitation: That which registers at a single gauge. Area Precipitation: Adjusted point rainfall for area size.

Rainwash. The creep of soil lubricated by rain.

Range. Difference between extremes, as for stream or tide stage.

Rapidly Varied Flow. In this type of flow, changes in depth and velocity take place over short distances, acceleration forces dominate, and energy loss due to friction is minor.

Rapids. Swift turbulent flow in a rough steep reach.

Reach. The length of a channel uniform with respect to discharge, depth, area, and slope. More generally, any length of a river or drainage course.

Recession. Retreat of shore or bank by progressive erosion.

Reef. Generally, any solid projection from the bed of a stream or other body of water.

Regime. The system or order characteristic of a stream; its behavior with respect to velocity and volume, form of and changes in channel, capacity to transport sediment, amount of material supplied for transportation, etc.

Regimen. The characteristic behavior of a stream during ordinary cycles of flow.

Regulatory Floodway. The open floodplain area that is reserved in by Federal, State, or local requirements, i.e., unconfined or unobstructed either horizontally or vertically, to provide for the discharge of the base flood so that the cumulative increase in water surface elevation is no more than a designated amount (not to exceed 1 foot as established by the Federal Emergency Management Agency (FEMA) for administering the National Flood Insurance Program (NFIP)).

Reliction. Pertaining to being left behind. For example: that area of land is left behind by reliction when the water surface of a lake is lowered.

Repose. The stable slope of a bank or embankment, expressed as an angle or the ratio of horizontal to vertical projection.

Restore. To reestablish a setting or environment in which the functions of the natural and beneficial floodplain values adversely impacted by the highway agency can continue to operate.

Restriction. Artificial or natural control against widening of a channel, with or without construction.

Retard. Bank-protection structure designed to check the riparian velocity and induce silting or accretion.

Retarding Basin. Either a natural or man made basin with the specific function of delaying the flow of water from one point to another. This tends to increase the time that it takes all the water falling on the extremities of the drainage basin to reach a common point, resulting in a reduced peak flow at that point.

Retention Storage. Water which accumulates and ponds in natural or excavated depressions in the soil surface with no possibility for escape as runoff. (See Detention Storage)

Retrogression. Reversal of stream grading; i.e., aggradation after degradation, or vice versa.

Revetment. Bank protection to prevent erosion.

Riparian. Pertaining to the banks of a stream.

Riprap. A layer, facing, or protective mound of rubble or stones randomly placed to prevent erosion, scour, or sloughing of a structure or embankment; also, the stone used for this purpose.

Ripple. (1) The light fretting or ruffling of a water caused by a breeze. (2) Undulating ridges and furrows, or crests and troughs formed by action of the flow.

July 1, 2020

Risk. The consequences associated with the probability of flooding attributable to an encroachment. It includes the potential for property loss and hazard to life during the service life of the highway.

Risk Analysis. An economic comparison of design alternatives using expected total costs (construction costs plus risk costs) to determine the alternative with the least expected cost to the public. It must include probable flood-related costs during the service life of the facility for highway operation, maintenance, and repair, for highway aggravated flood damage to other property, and for additional or interrupted highway travel.

Riser. In mountainous terrain where much debris is encountered, the entrance to a culvert sometimes becomes easily clogged. Therefore, a corrugated metal pipe or a structure made of timber or concrete with small perforations, called a riser, is installed vertically to permit entry of water and prohibit the entry of mud and debris. The riser may be increased in height as the need occurs.

River. A large stream, usually active when any streams are flowing in the region.

Rock. (1) Cobble, boulder or quarry stone as a construction material. (2) Hard natural mineral, in formation as in piles of talus.

Rounded Inlet. The edges of a culvert entrance that are rounded for smooth transition which reduces turbulence and increases capacity.

RSP Fabric. (See Filter Fabric).

Rubble. Rough, irregular fragments of rock or concrete.

Runoff. (1) The surface waters that exceed the soil's infiltration rate and depression storage. (2) The portion of precipitation that appears as flow in streams. Drainage or flood discharge which leaves an area as surface flow or a pipeline flow, having reached a channel or pipeline by either surface or subsurface routes.

Runup. The rush of water up a beach or structure, associated with the breaking of a wave. The amount of runup is measured according to the vertical height above still water level that the rush of water reaches.

Sag Culvert (or Sag Pipe). A pipeline with a dip in its grade line crossing over a depression or under a highway, railroad, canal, etc. The term inverted siphon is common but inappropriate as no siphonic action is involved. The term "sag pipe" is suggested as a substitute.

Sand. Granular soil coarser than silt and finer than gravel, ranging in diameter from 0.002 inch to 0.2 inch.

Scour. The result of erosive action of running water, primarily in streams, excavating and carrying away material from the bed and banks. Wearing away by abrasive action.

Scour, General. The removal of material from the bed and banks across all or most of the width of a channel, as a result of a flow contraction which causes increased velocities and bed shear stress.

Scour, Local. Removal of material from the channel bed or banks which is restricted to a minor part of the width of a channel. This scour occurs around piers and embankments and is caused by the actions of vortex systems induced by the obstruction to the flow.

Scour, Natural. Removal of material from the channel bed or banks which occurs in streams with the migration of bed forms, shifting of the thalweg and at bends and natural contractions.

Sea. Ocean or other body of water larger than a lake; state of agitation of any large body of water.

Seawall. A structure separating land and water areas, primarily designed to prevent erosion and other damage due to wave action. (See bulkhead).

Sediment. Fragmentary material that originates from weathering of rocks and is transported by, suspended in, or deposited by water.

Sedimentation. Gravitational deposit of transported material in flowing or standing water.

Seepage. Percolation of underground water thru the banks and into a stream or other body of water.

Seiche. A standing wave oscillation of an enclosed waterbody that continues, pendulum fashion, after the cessation of the originating force, which may have been either seismic or atmospheric.

Seismic Wave. A gravity wave caused by an earthquake.

Sheet Flow. Any flow spread out and not confined; i.e., flow across a flat open field.

Sheet Pile. A pile with a generally slender, flat cross-section that is driven into ground or bottom of a water body and meshed or interlocked with like members to form a wall or bulkhead.

Shoal. A shallow region in flowing or standing water, especially if made shallow by deposition.

Shoaling. Deposition of alluvial material resulting in areas with relatively shallow depth.

Shore. The narrow strip of land in immediate contact with the water, including the zone between high and low water lines. See backshore, foreshore, onshore, offshore, longshore, and nearshore.

Significant Encroachment. A highway encroachment and any direct support of likely base floodplain development that would involve one or more of the following construction or flood related impacts:

- A significant potential for interruption or termination of a transportation facility which is needed for emergency vehicles or provides a community's only evacuation route.
- A significant risk, or
- A significant adverse impact on natural and beneficial floodplain values.

Silt. (1) *Water-Borne Sediment.* Detritus carried in suspension or deposited by flowing water, ranging in diameter from 0.0002 inch to 0.002 inch. The term is generally confined to fine earth, sand, or mud, but is sometimes both suspended and bedload.

(2) *Deposits of Water-Borne Material.* As in a reservoir, on a delta, or on floodplains.

Sinuosity. The ratio of the length of the river thalweg to the length of the valley proper.

July 1, 2020

Skew. When a drainage structure is not normal (perpendicular) to the longitudinal axis of the highway, it is said to be on a skew. The skew angle is the smallest angle between the perpendicular and the axis of the structure.

Slide. Gravitational movement of an unstable mass of earth from its natural position.

Slipout. Gravitational movement of an unstable mass of earth from its constructed position. Applied to embankments and other man-made earthworks.

Slope. (1) Gradient of a stream. (2) Inclination of the face of an embankment, expressed as the ratio of horizontal to vertical projection; or (3) The face of an inclined embankment or cut slope. In hydraulics it is expressed as percent or in decimal form.

Slough. (1) Pronounced SLU. A side or overflow channel in which water is continually present. It is stagnant or slack; also a waterway in a tidal marsh. (2) Pronounced SLUFF. Slide or slipout of a thin mantle of earth, especially in a series of small movements.

Slugflow. Flow in culvert or drainage structure which alternates between full and partly full. Pulsating flow -- mixed water and air.

Soffit. The bottom of the top -- (1) With reference to a bridge, the low point on the underside of the suspended portion of the structure. (2) In a culvert, the uppermost point on the inside of the structure.

Specific Energy. The energy contained in a stream of water, expressed in terms of head, referred to the bed of a stream. It is equal to the mean depth of water plus the velocity head of the mean velocity.

Spur Dike. A structure or embankment projecting a short distance into a stream from the bank and at an angle to deflect flowing water away from critical areas.

Stage. The elevation of a water surface above its minimum; also above or below an established "low water" plane; hence above or below any datum of reference; gage height.

Standing Wave. The motion of swiftly flowing stream water, that resembles a wave, but is formed by decelerating or diverging flow that does not quite produce a hydraulic jump. A term which when used to describe the upper flow regime in alluvial channels, means a vertical oscillation of the water surface between fixed nodes without appreciable progression in either an upstream or downstream direction. To maintain the fixed position, the wave must have a celerity (velocity) equal to the approach velocity in the channel, but in the opposite direction.

Steady Flow. A flow in which the flow rate or quantity of fluid passing a given point per unit of time remains constant.

Stone. Rock or rock-like material; a particle of such material, in any size from pebble to the largest quarried blocks.

Storage. Detention, or retention of water for future flow, naturally in channel and marginal soils or artificially in reservoirs.

Storage Basin. Space for detention or retention of water for future flow, naturally in channel and marginal soils, or artificially in reservoirs.

Storm. A disturbance of the ordinary, average conditions of the atmosphere which, unless specifically qualified, may include any or all meteorological disturbances, such as wind, rain, snow, hail, or thunder.

Storm Drain. That portion of a drainage system expressly for collecting and conveying former surface water in an enclosed conduit. Often referred to as a "storm sewer", storm drains include inlet structures, conduit, junctions, manholes, outfalls and other appurtenances.

Storm Water Management. The recognition of adverse drainage resulting from altered runoff and the solutions resulting from the cooperative efforts of public agencies and the private sector to mitigate, abate, or reverse those adverse results.

Strand. (1) To lodge on bars, banks, or overflow plain, as for drift. (2) Bar of sediment connecting two regions of higher ground.

Stream. Water flowing in a channel or conduit, ranging in size from small creeks to large rivers.

Stream Power. An expression used in predicting bed forms and hence bed load transport in alluvial channels. It is the product of the mean velocity, the specific weight of the water-sediment mixture, the normal depth of flow and the slope.

Stream Response. Changes in the dynamic equilibrium of a stream by any one, or combination of various causes.

Stream Waters. Former surface waters which have entered and now flow in a well defined natural watercourse, together with other waters reaching the stream by direct precipitation or rising from springs in bed or banks of the watercourse. They continue as stream waters as long as they flow in the watercourse, including overflow and multiple channels as well as the ordinary or low-water channel.

Strutting. Elongation of the vertical axis of pipe prior to installing in a trench. After the backfill has been placed around the pipe and compacted, the wires or rods holding the pipe in its distorted shape are removed. Greater side support from the earth is developed when the pipe tends to return to its original shape. Generally used on pipes which because of size or thinness of the metal would tend to deform during construction operations. Arches are strutted diagonally per standard or special plan.

Subcritical Flow. In this state, gravity forces are dominant, so that the flow has a low velocity and is often described as tranquil and streaming. Also, that flow which has a Froude number less than one.

Subdrain. A conduit for collecting and disposing of underground water. It generally consists of a pipe, with perforations in the bottom through which water can enter.

Subsidence. General lowering of land surface by consolidation or removal of underlying soil.

Sump. In drainage, any low area which does not permit the escape of water by gravity flow.

Supercritical Flow. In this state, inertia forces are dominant, so that flow has a high velocity and is usually described as rapid, shooting and torrential. Also, that flow which has a Froude number greater than one.

July 1, 2020

Support Base Floodplain Development. To encourage, allow, serve, or otherwise facilitate additional base floodplain development. Direct support results from an encroachment, while indirect support results from an action out of the base floodplain.

Surf. The breaking of waves and swell on the foreshore and offshore shoals.

Surface Runoff. The movement of water on earth's surface, whether flow is over surface of ground or in channels.

Surface Waters. Surface waters are those which have been precipitated on the land from the sky or forced to the surface in springs, and which have then spread over the surface of the ground without being collected into a definite body or channel. They appear as puddles, sheet or overland flow, and rills, and continue to be surface waters until they disappear from the surface by infiltration or evaporation, or until by overland or vagrant flow they reach well-defined watercourses or standing bodies of water like lakes or seas.

Surge. A sudden swelling of discharge in unsteady flow.

Suspended Load. Sediment that is supported by the upward components of turbulent currents in a stream and that stay in suspension for appreciable amount of time.

Swale. A shallow, gentle depression in the earth's surface. This tends to collect the waters to some extent and is considered in a sense as a drainage course, although waters in a swale are not considered stream waters.

Swamp. An area of shallow pondage or saturated surface, the water being fresh or acidic and the area usually covered with rank vegetation.

Swell. Waves generated by a distant storm, usually regular and fully harmonic.

Talus. Loose rocks and debris disintegrated from a steep hill or cliff standing at repose along the toe.

Tapered Inlet. A transition to direct the flow of water into a channel or culvert. A smooth transition to increase hydraulic efficiency of an inlet structure.

Terrace. Berm or bench-like earth embankment, with a nearly level plain bounded by rising and falling slopes.

Tetrahedron. Bank protection element, basically composed of 6 steel or concrete struts joined like the edges of a triangular pyramid, together with subdividing struts and tie wires or cables.

Tetrapod. Bank protection element, precast of concrete, consisting of 4 legs joined at a central block, each leg making an angle of 109.5 degrees with the other three, like rays from the center of a tetrahedron to the center of each face.

Texture. Arrangement and interconnection of surface and near-surface particles of terrain or channel perimeter.

Thalweg. The line following the lowest part of a valley, whether under water or not. Usually the line following the deepest part of the bed or channel of a river.

Thread. The central element of a current, continuous along a stream.

Tide. The periodic rising and falling of the ocean and connecting bodies of water that results from gravitational attraction of the moon and sun acting on the rotating earth.

Time of Concentration. The time required for storm runoff to flow from the most remote point, in flow time, of a drainage area to the point under consideration. It is usually associated with the design storm.

Topping. The top layer on horizontal revetments or rock structures; also capping or cap stones.

Training. Control of direction of currents.

Transition. A relatively short reach or conduit leading from one waterway section to another of different width, shape, or slope.

Transport. To carry solid material in a stream in solution, suspension, saltation, or entrainment.

Trash Rack. A grid or screen across a stream designed to catch floating debris.

Trough. Space between wave crests and the water surface below it.

Trunk (or Trunk Line). In a roadway drainage system, the main conduit for transporting the storm waters. This main line is generally quite deep in the ground so that laterals coming from fairly long distances can drain by gravity into the trunk line.

Tsunami. A gravity wave caused by an underwater seismic disturbance (such as sudden faulting, landsliding or volcanic activity).

Turbulence. A state of flow wherein the water is agitated by cross-currents and eddies, as opposed to a condition of flow that is quiet and laminar.

Turbulent Flow. That type of flow in which any particle may move in any direction with respect to any other particle, and in which the head loss is approximately proportional to the square of the velocity.

Undercut. Erosion of the low part of a steep bank so as to compromise stability of the upper part.

Underflow. The downstream flow of water through the permeable deposits that underlie a stream. (1) Movement of water through a pervious subsurface stratum, the flow of percolating water; or water under ice, or under a structure. (2) The rate of flow or discharge of subsurface water.

Undertow. Current outward from a wave-swept shore carrying solid particles swept or scoured from the beach or foreshore.

Unsteady Flow. A flow in which the velocity changes with respect to space and time.

Updrift. The direction opposite that of the predominant movement of littoral materials.

Uplift. Upward hydrostatic pressure on base of an impervious structure.

Velocity. The rate of motion of objects or particles, or of a stream of particles.

Velocity Head. A term used in hydraulics to represent the kinetic energy of flowing water. This "head" is represented by a column of standing water equivalent in potential energy to the kinetic energy of the moving water calculated as $(V^2/2g)$ where the "V" is the velocity.

July 1, 2020

represents the velocity in feet per second and "g" represents the potential acceleration due to gravity, in feet per second per second.

Vernal Pools. Seasonally flooded landscape depressions that support distinctive (and many times rare) plant and animal species adapted to periodic or continuous inundation during the wet season, and the absence of either ponded water or wet soil during the dry season.

Wash. Floodplain or active channel of an ephemeral stream, usually in recent alluvium.

Watercourse. A definite channel with bed and banks within which water flows, either continuously or in season. A watercourse is continuous in the direction of flow and may extend laterally beyond the definite banks to include overflow channels contiguous to the ordinary channel. The term does not include artificial channels such as canals and drains, except natural channels trained or restrained by the works of man. Neither does it include depressions or swales through which surface or errant waters pass.

Watershed. The area that contributes surface water runoff into a tributary system or water course.

Water Table. The surface of the groundwater below which the void spaces are completely saturated.

Waterway. (1) That portion of a watercourse which is actually occupied by water (2) A navigable inland body of water.

Wave. (1) An oscillatory movement of water on or near the surface of standing water in which a succession of crests and troughs advance while particles of water follow cyclic paths without advancing. (2) Motion of water in a flowing stream so as to develop the surficial appearance of a wave.

Wave Height. The vertical distance between a wave crest and the preceding trough.

Wave Length. The horizontal distance between similar points on two successive waves (e.g., crest to crest or trough to trough), measured in the direction of wave travel.

Wave Period. The time in which a wave crest travels a distance equal to one wave length. Can be measured as the time for two successive wave crests to pass a fixed point.

Weephole. A hole in a wall, invert, apron, lining, or other solid structure to relieve the pressure of groundwater.

Weir. A low overflow dam or sill for measuring, diverting, or checking flow.

Well. (1) Artificial excavation for withdrawal of water from underground storage. (2) Upward component of velocity in a stream.

Wetland. Those areas that are inundated or saturated by surface or ground water at a frequency and duration sufficient to support, and that under normal circumstances do support a prevalence of vegetation typically adapted for life in saturated soil conditions. Wetlands generally include swamps, marshes, bogs, and similar areas.

Windbreak. Barrier fence or trees to break or deflect the velocity of wind.

Windwave. A wave generated and propelled by wind blowing along the water surface.

Young. Immature, said of a stream on a steep gradient actively scouring its bed toward a more stable grade.

Topic 807 – Selected Drainage References

807.1 Introduction

Hydraulic and drainage related reference publications listed are grouped as to source.

807.2 Federal Highway Administration Hydraulic Publications

Copies of publications identified with an NTIS or GPO number may be ordered as follows:

NTIS - Send a check to:

National Technical Information Service
5285 Port Royal Road
Springfield, VA 22161
(703) 487-4650

GPO - Send a check to:

Superintendent of Documents
Government Printing Office
Washington, D.C. 20402
(202) 783-3238

(1) *Hydraulic Engineering Circulars (HEC).*

HEC No.	Title	Date	FHWA # NTIS #
9	Debris-Control Structures	2005	IF-04-016
14	Hydraulic Design of Energy Dissipators for Culverts and Channels	2006	NHI-06-086
15	Design of Roadside Channels with Flexible Linings	2005	IF-05-114
17	The Design of Encroachments on Flood Plains Using Risk Analysis	1981	EPD-86-112 PB86-182110/AS
18	Evaluating Scour at Bridges	2012	HIF-12-003
20	Stream Stability at Highway Structures	2012	HIF-12-004

July 1, 2020

HEC No.	Title	Date	FHWA # NTIS #
21	Bridge Deck Drainage Systems	1993	SA-92-010 PB94-109584
22	Urban Drainage Design Manual	2009	NHI-10-009
23	Bridge Scour and Stream Instability Countermeasures	2009	NHI-09-111 NHI-09-012
24	Highway Stormwater Pump Station Design	2001	NHI-01-007
25	Highways in the Coastal Environment	2008	NHI-07-096
26	Culvert Designer Aquatic Organism Passage	2010	HIF-11-008

(2) Hydraulic Design Series (HDS).

HDS No.	Title	Date	FHWA # NTIS #
2	Highway Hydrology	2002	NHI-02-001
3	Design Charts for Open-Channel Flow	1961	EPD-86-102 PB86-179249/AS
4	Introduction to Highway Hydraulics	2008	NHI-08-090
5	Hydraulic Design of Highway Culverts (GPO 050-001-00298-1)	2012	HIF-12-026
6	River Engineering for Highway Encroachments	2001	NHI-01-004
7	Hydraulic Design for Safe Bridges	2012	HIF-12-018

(3) Implementation Publications.

Title	Date	FHWA # NTIS #
Structural Design Manual for Improved Inlets and Culverts	1983	IP-83-6 PB84- 153485
Culvert Inspection Manual	1986	IP-86-2 PB87- 151809

807.3 American Association of State Highway and Transportation Officials (AASHTO)

(1) Highway Drainage Guidelines

The Drainage Guidelines is a collection of the guides previously published as individual volumes. These are:

- I. - Hydraulic Considerations in Highway Planning and Location
- II. - Hydrology
- III. - Erosion and Sediment Control in Highway Construction
- IV. - Hydraulic Design of Culverts
- V. - The Legal Aspects of Highway Drainage
- VI. - Hydraulic Analysis and Design of Open Channels
- VII. - Hydraulic Analysis for the Location and Design of Bridges
- VIII. - Hydraulic Aspects in Restoration and Upgrading of Highways
- IX. - Storm Drain Systems
- X. - Evaluating Highway Effects on Surface Water Environments
- XI. - Highways along Coastal Zones and Lakeshores
- XII. - Stormwater Management
- XIII. - Hydraulics Engineer Training and Career Development
- XIV. - Culvert Inspection and Rehabilitation
- XV. - Guidelines for Selecting and Utilizing Hydraulics Engineering Consultants

The current edition may be purchased through AASHTO, 444 North Capitol St., N.W., Suite 225, Washington D.C. 20001.

July 1, 2020

(2) AASHTO Model Drainage Manual

The Model Drainage Manual (MDM) is a comprehensive document covering a wide variety of transportation related hydraulic design issues. Developed for use by Federal, State, and local agencies, the MDM is a practice oriented document that allows the user agency to adopt the recommended values shown in the manual, or insert their own specific design policies and procedures.

807.4 California Department of Transportation

The following publications are available from the Caltrans Publications Unit, 1900 Royal Oaks Dr., Sacramento, CA 95815. Information on ordering and price can be checked by calling (916) 445-3520.

- Bridge Design Practice Manual
- Manual of Test - Volumes 1, 2, and 3
- Standard Plans
- Standard Specifications

807.5 U.S. Department of Interior - Geological Survey (USGS)

- Magnitude and Frequency of Floods in California - Water Resources Investigation 77-21.
- Methods for Estimating Magnitude and Frequency of Floods in the Southwestern United States - Water-Supply Paper 2433.
- Guide For Determining Flood Flow Frequency - Bulletin #17B.
- Water Resources Data for California, Part 1, Volumes 1 and 2.
- Rock Riprap Design for Protection of Stream Channels Near Highway Structures (1987) Volumes 1 and 2 (1987).
- Regional Skew for California, and Flood Frequency for Selected Sites in the Sacramento-San Joaquin River Basin, Based on Data through Water Year 2006 - Scientific Investigations Report 2010-5260.

807.6 U.S. Department of Agriculture - Natural Resources Conservation Service (NRCS)

- Engineering Design Standards.
- Urban Hydrology for Small Watersheds -Technical Release 55

807.7 California Department of Water Resources

The California Department of Water Resources provides intensity, duration, and frequency data from the California Department of Water Resources network of rain gauges at the following website: <http://www.water.ca.gov/floodmgmt/hafoo/hb/csm/engineering/>.

807.8 University of California - Institute of Transportation and Traffic Engineering (ITTE)

- Street and Highway Drainage - Course Notes, Volumes 1 and 2.

807.9 U.S. Army Corps of Engineers

Publications and computer programs, too numerous to list, are available from the Water Resources Support Center. A publication catalog may be obtained by contacting the Hydrologic Engineering Center of the Corp, 609 Second St., Davis, CA 95616. The U. S. Army Corps of Engineers publications website address is: <http://www.usace.army.mil/inet/usace-docs/>.

Topic 808 – Selected Computer Programs

Table 808.1 below presents a software vs. capabilities matrix for hydrologic/hydraulic software packages that have been reviewed and deemed compatible with Departmental procedures. Where Caltrans drainage facilities connect or impact facilities that are owned by others, the affected Local Agency may require the Department to use a specific program that is not listed below. When the use of other computer programs is requested, a comparison with the results using the appropriate program from Table 808.1 should be made. However, when work is performed on projects under Caltrans' jurisdiction, either internally, or by others, if a program not listed in Table 808.1 is used, it should be demonstrated that the computations are based on the same principles that are used in the programs listed in Table 808.1. For information on Local Agency hydraulic computer program requirements, the District Hydraulics Branch should be contacted. It is the responsibility of the user to ensure that the version of the program being used from Table 808.1 is current.

July 1, 2020

Table 808.1

Summary of Related Computer Programs and Web Applications

	Storm Drains	Hydrology	Water Surface Profiles	Culverts	Roadside /Median Channels	Pavement Drainage	Pond Routin g
FHWA Hydraulic Toolbox					x	x	
TR-55		x					
HEC-HMS ⁽²⁾		x					x
HY-8				x			
HEC-RAS ⁽¹⁾			x				
FESWMS			x				
WMS		x		x			x
NOAA Atlas 14		x					
USGS StreamStats		x					
AutoDesk Civil 3D/Hydraflow	x	x				x	x

NOTES:

⁽¹⁾The data that was used by FEMA to establish water surface elevations (usually HEC-2) must be used to develop a duplicate effective model for FEMA floodplain analysis. For more information contact FEMA or the Local Agency.

⁽²⁾HEC-1 has been superseded by HEC-HMS by the U.S. Army Corps of Engineers.

Special circumstances may dictate the use of alternative methods/programs. Any such use should be performed under direction and with approval of the District Hydraulics Engineer.

CHAPTER 810 – HYDROLOGY

Topic 811 – General

Index 811.1 – Introduction

Hydrology is often defined as: "A science dealing with the properties, distribution, and circulation of water on the surface of the land, in the soil and underlying rocks, and in the atmosphere." This is a very broad definition encompassing many disciplines relating to water. The highway engineer is principally concerned with surface hydrology and controlling surface runoff. Controlling runoff includes the hydraulic design of drainage features for both cross highway drainage (Chapter 820) and removal of runoff from the roadway (Chapter 830).

The runoff of water over land has long been studied and some rather sophisticated theories and methods have been proposed and developed for estimating flood flows. Most attempts to describe the process have been only partially successful at best. This is due to the complexity of the process and interactive factors. The random nature of rainfall, snowmelt, and other sources of water further complicate the process.

It should be understood that there are no exact methods for hydrologic analysis. Different methods that are commonly used may produce significantly different results for a specific site and particular situation.

Although hydrology is not an exact science, it is possible to obtain solutions which are functionally acceptable to form the basis for design of highway drainage facilities.

More complete information on the principles and engineering techniques pertaining to hydrology for transportation and highway engineers may be found in FHWA Hydraulic Design Series (HDS) No. 2, Highway Hydrology.

This chapter will focus primarily on the hydrologic analyses that are conducted for peak flow facilities for both transportation facility and cross drainage. In many cases, these peak flow facilities serve dual purposes and receive and convey storm water flows while meeting water quality criteria and other flow criteria independent of Chapter 810. Information related to the designer's responsibility for the hydrologic design of storm water flow facilities is contained in the Department's Project Planning and Design Guide. See:

<http://www.dot.ca.gov/hq/oppd/stormwtr/ppdg.htm>

811.2 Objectives of Hydrologic Analysis

Regardless of the size or cost of the drainage feature the most important step prior to hydraulic design is estimating the discharge (rate of runoff) or volume of runoff that the drainage facility will be required to convey or control.

While some hydrologic analysis is necessary in establishing the quantity of surface water that must be considered in the design of all highway drainage facilities, the extent of such

July 1, 2020

studies are to be commensurate with the importance of the highway, the potential for damage to the highway, loss of property, and hazard to life associated with the facilities.

The choice of analytical method must be a conscious decision made as each problem arises. To make an informed decision, the highway engineer must determine:

- What level of hydrologic analysis is justified.
- What data are available or must be collected.
- What methods of analysis are available including the relative strengths and weaknesses in terms of cost and accuracy.

Cross drainage design, Chapter 820, normally requires more extensive hydrologic analysis than is necessary for roadway drainage design, Chapter 830. The well known and relatively simple "Rational Method" (see Index 819.2) is generally adequate for estimating the rate or volume of runoff for the design of on-site roadway drainage facilities and removal of runoff from highway pavements.

811.3 Peak Discharge

Peak discharge is the maximum rate of flow of water passing a given point during or after a rainfall event. Peak discharge, often called peak flow, occurs at the momentary "peak" of the stream's flood hydrograph. (See Index 816.5, Flood Hydrograph.)

Design discharge, expressed as the quantity (Q) of flow in cubic feet per second (CFS), is the peak discharge that a highway drainage structure is sized to handle. Peak discharge is different for every storm and it is the highway engineer's responsibility to size drainage facilities and structures for the magnitude of the design storm and flood severity. The magnitude of peak discharge varies with the severity of flood events which is based on probability of exceedance (see Index 811.4). The selection of design storm frequency and flood probability are more fully discussed under Topic 818, Flood Probability and Frequency.

811.4 Flood Severity

Flood severity is usually stated in terms of:

- Probability of Exceedance, or
- Frequency of Recurrence.

Modern concepts tend to define a flood in terms of probability. Probability of exceedance, the statistical odds or chance of a flood of given magnitude being exceeded in any year, is generally expressed as a percentage. Frequency of recurrence is expressed in years, on the average, that a flood of given magnitude would be predicted. Refer to Topic 818 for further discussion of flood probability and frequency.

811.5 Factors Affecting Runoff

The highway engineer should become familiar with the many factors or characteristics that affect runoff before making a hydrologic analysis. The effects of many of the factors known to influence surface runoff only exist in empirical form. Extensive field data, empirically determined coefficients, sound judgment, and experience are required for a quantitative

analysis of these factors. Relating flood flows to these causative factors has not yet advanced to a level of precise mathematical expression.

Some of the more significant factors which affect the hydraulic character of surface water runoff are categorized and briefly discussed in Topics 812 through 814. It is important to recognize that the factors discussed may exist concurrently within a watershed and their combined effects are very difficult to quantify.

Topic 812 – Basin Characteristics

812.1 Size

The size (area) of a drainage basin is the most important watershed characteristic affecting runoff. Determining the size of the drainage area that contributes to flow at the site of the drainage structure is a basic step in a hydrologic analysis regardless of the method used to evaluate flood flows. The drainage area typically expressed in acres or square miles, is frequently determined from digital elevation maps (DEMs), field surveys, topographic maps, or aerial photographs. Automated watershed delineation is included within several of the software programs indicated under the “Hydrology” column of Table 808.1, e.g., USGS StreamStats and WMS. See Figure 812.1.

Figure 812.1

Automated Watershed Delineation

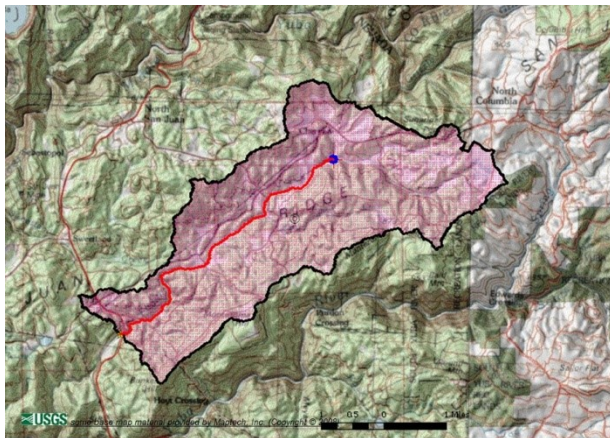

812.2 Shape

The shape, or outline formed by the basin boundaries, affects the rate at which water is supplied to the main stream as it proceeds along its course from the runoff source to the site of the drainage structure. Long narrow watersheds generally give lower peak discharges than do fan or pear shaped basins.

July 1, 2020

812.3 Slope

The slope of a drainage basin is one of the major factors affecting the time of overland flow and concentration of rainfall (see Index 816.6, Time of Concentration). Steep slopes tend to result in shorter response time and increase the discharge while flat slopes tend to result in longer response time and reduce the discharge. Automated basin slope calculation is included within several of the software programs indicated under the "Hydrology" column of Table 808.1, e.g., USGS StreamStats and WMS.

812.4 Land Use

Changes in land use nearly always cause increases in surface water runoff. Of all the land use changes, urbanization is the most dominant factor affecting the hydrology of an area.

Land use studies may be necessary to define present and future conditions with regard to urbanization or other changes expected to take place within the drainage basin.

Valuable information concerning land use trends is available from many sources such as:

- State, regional or municipal planning organizations.
- U.S. Geological Survey.
- U.S. Department of Agriculture Economic Research Service.

Within each District there are various organizations that collect, publish or record land use information. The District Hydraulics Engineer should be familiar with these organizations and the types of information they have available.

A criterion of good drainage design is that future development and land use changes which can reasonably be anticipated to occur during the design life of the drainage facility be considered in the hydraulic analysis and estimation of design discharge.

812.5 Soil and Geology

The type of surface soil which is characteristic of an area is an important consideration for any hydrologic analysis and is a basic input to the National Resources Conservation Service (NRCS) method. Rock formations underlying the surface soil and other geophysical characteristics such as volcanic, glacial, and river deposits can have a significant effect on run-off.

The major source of soil information is the National Resources Conservation Service (NRCS) of the U.S. Department of Agriculture.

Use the following link to access soil information at the NRCS Web Soil Survey website:
<http://websoilsurvey.nrcs.usda.gov/app/>.

812.6 Storage

Interception and depression storage are generally not important considerations in highway drainage design and may be ignored in most hydrologic analysis. Interception storage is rainfall intercepted by vegetation and never becomes run-off. Depression storage is rainfall

lost in filling small depressions in the ground surface, storage in transit (overland or channel flow), and storage in ponds, lakes or swamps.

Detention storage can have a significant effect in reducing the peak rate of discharge, but this is not always the case. There have been rare instances where artificial storage radically redistributes the discharges and higher peak discharges have resulted than would occur had the storage not been added.

The effect of flood-control reservoirs should be considered in evaluating downstream conditions, flood peaks, and river stages for design of highway structures. The controlling public agency or the owner should be contacted for helpful information on determining the effects, if any, on downstream highway drainage structures.

It is not uncommon for flood control projects to be authorized but never constructed because funds are not appropriated. Therefore a flood control project should exist or be under construction if its effects on a drainage system are to be considered.

812.7 Elevation

The mean elevation of a drainage basin and significant variations in elevation within a drainage basin may be important characteristics affecting run-off, particularly with respect to precipitation falling as snow. Elevation is a basic input to some of the USGS Regional Regression Equations (see Index 819.2(2)).

812.8 Orientation

The amount of runoff can be affected by the orientation of the basin. Where the general slope of the drainage basin is to the south it will receive more exposure to the heat of the sun than will a slope to the north. Such orientation affects transpiration, evaporation, and infiltration losses. Snowpack and the rate at which snow melts will also be affected. A basin's orientation with respect to the direction of storm movement can affect a flood peak. Storms moving upstream produce lower peaks than storms tending to move in the general direction of stream flow.

Topic 813 – Channel and Floodplain Characteristics

813.1 General

Streams are formed by the gathering together of surface waters into channels that are usually well defined. The natural or altered condition of the channels can materially affect the volume and rate of runoff and is a significant consideration in the hydrological analysis for cross drainage design.

A useful reference relative to issues associated with transverse and longitudinal highway encroachments upon river channels and floodplains is the FHWA Hydraulic Design Series (HDS) No. 6 "River Engineering for Highway Encroachments."

July 1, 2020

813.2 Length and Slope

The longer the channel the more time it takes for water to flow from the beginning of the channel to the site under consideration. Channel length and effective channel slope are important parameters in determining the response time of a watershed to precipitation events of given frequency.

In the case of a wide floodplain with a meandering main channel the effective channel length will be reduced during flood stages when the banks are overtopped and flow tends more toward a straight line.

813.3 Cross Section

Flood peaks may be estimated by using data from stream gaging stations and natural channel cross section information.

Although channel storage is usually ignored in the hydrologic analysis for the design of highway drainage structures, channel cross section may significantly affect discharge, particularly in wide floodplains with heavy vegetation.

If channel storage is considered to be a significant factor, the assistance of an expert in combining the analysis of basin hydrology and stream hydraulics should be sought. The U.S. Army Corps of Engineers has developed HEC-HMS Flood Hydrograph Package and HEC-RAS, Water Surface Profiles, for this type of analysis. For modeling complex water surface profiles, where one-dimensional models fail, the Finite Element Surface Water Modeling System Two Dimensional Flow in a Horizontal Plane (SMS) was developed by others.

813.4 Hydraulic Roughness

Hydraulic roughness represents the resistance to flows in natural channels and floodplains. It affects both the time response of a drainage channel and channel storage characteristics. The lower the roughness, the higher the peak discharge and the shorter the time of the resulting hydrograph. The total volume of runoff however is virtually independent of hydraulic roughness.

Streamflow is frequently indirectly computed by using Manning's equation, see Index 866.3(4). Procedures for selecting an appropriate coefficient of hydraulic roughness, Manning's "n", may be found in the FHWA report, "Guide for Selecting Manning's Roughness Coefficient for Natural Channels and Flood Plains". See <http://www.fhwa.dot.gov/bridge/wsp2339.pdf>

813.5 Natural and Man-made Constrictions

Natural constrictions, such as gravel bars, rock outcrops and debris jams as well as artificial constrictions such as diversion and storage dams, grade-control structures, and other water-use facilities may control or regulate flow. Their effect on the flood peak may be an important consideration in the hydrologic analysis.

813.6 Channel Modifications

Channel improvements such as channel-straightening, flood control levees, dredging, bank clearing and removal of obstructions tend to reduce natural attenuation and increase downstream flood peaks.

813.7 Aggradation - Degradation

Aggradation, deposited sediments, may lessen channel capacity and increase flood heights causing overflow at a lower discharge. Degradation, the lowering of the bed of a stream or channel, may increase channel capacity and result in a higher peak discharge.

The validity of hydrologic analysis using observed historical highwater marks may be affected by aggradation or degradation of the streambed. The effects of aggradation and degradation are considerations in selecting an effective drainage system design to protect highways and adjacent properties from damage. For more information refer to the FHWA report entitled, "Stream Channel Degradation and Aggradation: Causes and Consequences to Highways." See <http://isddc.dot.gov/OLPFiles/FHWA/009471.pdf>.

813.8 Debris

The quantity and size of solid matter carried by a stream may affect the hydrologic analysis of a drainage basin. Bulking due to mud, suspended sediment and other debris transported by storm runoff may significantly increase the volume of flow, affect flow characteristics, and can be a major consideration in the hydraulic design of drainage structures. In particular, bulking factors are typically a consideration in determining design discharges for facilities with watersheds that are located within mountainous regions subject to fire and subsequent soil erosion (see Figure 813.1), or in arid regions when the facility is in the vicinity of alluvial fans (see Index 819.7(2) and Index 872.3(5) for special considerations given to highways located across desert washes).

Debris control methods, structures, and design considerations are discussed in Topic 822, Debris Control.

The District Hydraulics Engineer should be consulted for any local studies that may be available. If both stream gage data and local studies are available, a determination of whether post-fire peak flows are included within the data record should be made. Consideration should be given to treating a significant post-fire peak as the design discharge in lieu of the peak discharge obtained through gage analysis for a given probability flood event. Records of stream discharge from burned and long-unburned (unburned for 40 years or more years) areas have showed peak discharge increases from 2 to 30 times in the first year after burning. In mountainous regions subject to fire with no local studies available, the U.S. Forest Service should be contacted for fire history in order to determine if there is a significant post-fire peak within the stream records.

July 1, 2020

Figure 813.1

Post-Fire Debris



Alamos Canyon, Ventura County, post-fire debris and plugged culvert barrels (Highway 118)

Topic 814 – Meteorological Characteristics

814.1 General

Meteorology is the science dealing with the earth's atmosphere, especially the weather. As applied to hydrology for the highway designer the following elements of meteorological phenomena are considered the more important factors affecting runoff and flood predictions.

814.2 Rainfall

Rainfall is the most common factor used to predict design discharge. Unfortunately, due to the many interactive factors involved, the relationship between rainfall and runoff is not all that well defined. Intuitively, engineers know and studies confirm, that runoff increases in proportion to the rainfall on a drainage basin. Highway design engineers are cautioned about assuming that a given frequency storm always produces a flood of the same frequency. There are analytical techniques for ungauged watersheds that are based on this assumption.

A statistical analysis of extensive past rainfall records should be made before such a correlation is accepted.

Rainfall event characteristics which are important to highway drainage design are:

- Intensity (rate of rainfall)
- Duration (time rainfall lasts)
- Frequency (statistical probability of how often rainfall will occur)
- Time Distribution (intensity hyetograph)
- Storm Type (orographic, convective or cyclonic)
- Storm Size (localized or broad areal extent)
- Storm Movement (direction of storm)

814.3 Snow

Much of the precipitation that falls in the mountainous areas of the state falls as frozen water in the form of snow, hail, and sleet. Since frozen precipitation cannot become part of the runoff until melting occurs it is stored as snowpack until thawed by warmer weather.

Rain upon an accumulation of snow can cause a much higher peak discharge than would occur from rainfall alone. The parameters of snow which may need to be considered in quantifying peak flood runoff are:

- Mean annual snowfall
- Water content of snowpack
- Snowmelt rate

814.4 Evapo-transpiration

Evaporation and transpiration are two natural processes by which water reaching the earth's surface is returned to the atmosphere as vapor. The losses due to both phenomena are important to long term hydrology and water balance in the watershed and are usually ignored in the hydrologic analysis for the design of highway drainage facilities.

814.5 Tides and Waves

The combined effect of upland runoff and tidal action is a primary consideration in the design of highway drainage structures and shore protection facilities along the coastlines, on estuaries, and in river delta systems.

The time and height of high and low water caused by the gravitational attraction of the sun and moon upon the earth's oceans are precisely predictable. Information on gravitational tides and tidal bench marks for the California Coastline is available from the following report: http://www.slc.ca.gov/reports/ca_marine_boundary_program_final_report.pdf or from the following web-site: <http://co-ops.nos.noaa.gov/sitemap.html>.

July 1, 2020

One of the most devastating forces affecting the coastline occurs when an astronomical high tide and a storm of hurricane proportion arrive on the land at the same time. This is also true of the effect of a tsunami. A tsunami is a wave caused by an earthquake at sea. If shore protection were designed to withstand the forces of a tsunami, it would be extremely costly to construct. Since it would be so costly and the probability of occurrence is so slight, such a design may not be justified.

Wind-waves directly affect coastal structures and cause dynamic changes in coastal morphology. The U.S. Corps of Engineers collects and publishes data which may be used to predict size of Pacific Coast wind-waves. Information pertaining to the California coastline from the Mexican border north to Cape San Martin can be obtained from:

U.S. Army Corps of Engineers
Los Angeles District
915 Wilshire Blvd., Suite 1101
Los Angeles, CA 90017
(213) 452-3333

For information from Cape San Martin to the Oregon border from:

U.S. Army Corps of Engineers
San Francisco District
1455 Market Street
San Francisco, CA 94103-1398
(415) 503-6804

Also see the following website for USGS Coastal Storm Modeling System (CoSMoS) for detailed predictions of storm-induced coastal flooding, erosion and cliff failures over large geographic scales: http://walrus.wr.usgs.gov/coastal_processes/cosmos/

Wind-waves are also generated on large inland bodies of water and their effect should be considered in the design of shoreline highway facilities.

Topic 815 – Hydrologic Data

815.1 General

The purpose for which a hydrologic study is to be made will determine the type and amount of hydrologic data needed. The accuracy necessary for preliminary studies is usually not as critical as the desirable accuracy of a hydrologic analysis to be used for the final design of highway drainage structures. If data needs can be clearly identified, data collection and compilation efforts can be tailored to the importance of the project.

Data needs vary with the methods of hydrologic analysis. Highway engineers should remember that there is no single method applicable to all design problems. They should make use of whatever hydrologic data that has been developed by others whenever it is available and applicable to their needs.

Frequently there is little or no data available in the right form for the project location. For a few locations in the State, so much data has been compiled that it is difficult to manage, store, and retrieve the information that is applicable to the project site.

815.2 Categories

For most highway drainage design purposes there are three primary categories of hydrologic data:

- (1) *Surface Water Runoff.* This includes daily and annual averages, peak discharges, instantaneous values, and highwater marks.
- (2) *Precipitation.* Includes rainfall, snowfall, hail, and sleet.
- (3) *Drainage Basin Characteristics.* Adequate information may not be readily available but can generally be estimated or measured from maps, field reviews or surveys. See Topic 812 for a discussion of basin characteristics.

Other special purpose categories of hydrologic data which may be important to specific problems associated with a highway project are:

- Sediment and debris transport
- Snowpack variations
- Groundwater levels and quantity
- Water quality

815.3 Sources

Hydrologic data necessary for the design of cross drainage (stream crossings) are usually obtained from a combination of sources.

- (1) *Field Investigations.* A great deal of the essential information can only be obtained by visiting the site. Except for extremely simple designs or the most preliminary analysis, a field survey or site investigation should always be made.

To optimize the amount and quality of the hydrologic data collected, the field survey should be well planned and conducted by an engineer with general knowledge of drainage design. Data collected are to be documented. When there is reason to believe that sensitive resources or unusual site conditions may exist, preparation of a written report with maps and photographs may be appropriate. See Topic 804 for Floodplain Encroachments. Index 3.1.1 of HDS No. 2 discusses site investigations and field surveys. Typical data collected in a field survey are:

- Highwater marks
- Performance and condition of existing drainage structures
- Stream alignment
- Stream stability and scour potential
- Land use and potential development
- Location and nature of physical and cultural features
- Vegetative cover
- Upstream constraints on headwater elevation
- Downstream constraints
- Debris potential

- (2) *Federal Agencies.* The following agencies collect and disseminate stream flow data:

July 1, 2020

- Geological Survey (USGS)
- Corps of Engineers (COE)
- Bureau of Reclamation (USBR)
- National Resources Conservation Service (NRCS)
- Forest Service (USFS)
- Bureau of Land Management (BLM)
- Federal Emergency Management Agency (FEMA)
- Environmental Protection Agency (EPA)

The USGS is the primary federal agency charged with collecting and maintaining water related data. Stream-gaging station data and other water related information collected by the USGS is published in Water Supply Papers and through the USGS Office of Surface Water website. The USGS web-based tool StreamStats provides streamflow statistics, drainage-basin characteristics, and other information for user-selected sites on streams. See <http://water.usgs.gov/osw/streamstats>.

- (3) *State Agencies.* The primary state agency collecting stream-gaging and precipitation (rain-gage and snowfall) data is the California Department of Water Resources (DWR). The California Data Exchange Center (CDEC) installs, maintains, and operates an extensive hydrologic data collection network including automatic snow reporting gages and precipitation and river stage sensors. See <http://cdec.water.ca.gov/index.html>.
- (4) *Local Agencies.* Entities such as cities, counties, flood control districts, or local improvement districts study local drainage conditions and are often a valuable source of hydrologic data.
- (5) *Private Sector.* Water using industries or utilities, railroads and local consultants frequently have pertinent hydrologic records and studies available.

815.4 Stream Flow

Once surface runoff water enters into a stream, it becomes "stream flow". Stream flow is the only portion of the hydrologic cycle in which water is so confined as to make possible reasonably accurate measurements of the discharges or volumes involved.

The two most common types of stream flow data are:

- Gaging Stations – data generally based on recording gage station observations with detailed information about the stream channel cross section. Current meter measurements of transverse channel velocities are made to more accurately reflect stream flow rates.
- Historic – data based on observed high water mark and indirect stream flow measurements.

Stream flow data are usually available as mean daily flow or peak daily flow. Daily flow is a measurement of the rate of flow in cubic feet per second (CFS) for the 24-hour period from midnight to midnight.

"Paleoflood" (ancient flood) data has been found useful in extending stream gaging station records. (See Topic 817 for further discussion on measuring stream flow)

815.5 Precipitation

Precipitation data is collected by recording and non-recording rain gages. Precipitation collected by vertical cylindrical rain gages is designated as "point rainfall".

Regardless of the care and precision used, precipitation measurements from rain gages have inherent and unavoidable shortcomings. Snow and wind problems frequently interrupt rainfall records. Extreme precipitation data from recording rain gage charts are generally underestimated.

Rain gage measurements are seldom used directly by highway engineers. The statistical analysis which must be done with precipitation measurements is nearly always performed by qualified hydrologists and meteorologists.

NOAA's Atlas 14 is an example of precipitation data that has been converted into formats usable by designers. See <http://hdsc.nws.noaa.gov/hdsc/pfds/>.

815.6 Adequacy of Data

All hydrologic data that has been collected must be evaluated and compiled into a usable format. Experience, knowledge and judgment are an important part of data evaluation. It must be ascertained whether the data contains inconsistencies or other unexplained anomalies which might lead to erroneous calculations and conclusions that could result in the over design or under design of drainage structures.

Topic 816 – Runoff

816.1 General

The process of surface runoff begins when precipitation exceeds the requirements of:

- Vegetal interception.
- Infiltration into the soil.
- Filling surface depressions (puddles, swamps and ponds). As rain continues to fall, surface waters flow down slope toward an established channel or stream.

816.2 Overland Flow

Overland flow is surface waters which travel over the ground as sheet flow, in rivulets and in small channels to a watercourse.

816.3 Subsurface Flow

Waters which move laterally through the upper soil surface to streams are called "interflow" or "subsurface flow". For the purpose of highway drainage hydrology, where peak design discharge (flood peaks) are the primary interest, subsurface flows are considered to be insignificant. Subsurface flows travel slower than overland flow.

July 1, 2020

While groundwater and subsurface water may be ignored for runoff estimates, their detrimental effect upon highway structural section stability cannot be overstated. See Chapter 840, Subsurface Drainage.

816.4 Detention and Retention

Water which accumulates and ponds in low points or depressions in the soil surface with no possibility for escape as runoff is in retention storage. Where water is moving over the land it is in detention storage. Detained water, as opposed to retained water, contributes to runoff.

816.5 Flood Hydrograph and Flood Volume

In response to a rainstorm the quantity of water flowing in a stream increases. The water level rises and may continue to do so after rainfall ceases. The response of an affected stream, during and after a storm event, can be pictured by plotting discharge against time to produce a flood hydrograph. The principal elements of a typical flood hydrograph are shown in Figure 816.5.

Figure 816.5

Typical Flood Hydrograph

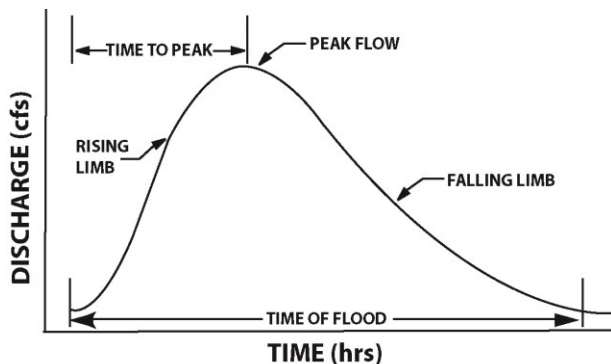

Flood volume is the area under the flood hydrograph. Although flood volume is not considered in the design for all highway drainage facilities, it is an essential design parameter when storage must be evaluated.

Comprehensive guidance on flood hydrographs and methods to estimate the hydrograph may be found in Chapters 6, 7 and 8 of HDS No. 2, Hydrology, and in Chapters 4, 5, 6, 7 and 8 of the user guide for HEC-HMS. See: [http://www.hec.usace.army.mil/software/hec-hms/documentation/HEC-HMS_Technical%20Reference%20Manual_\(CPD-74B\).pdf](http://www.hec.usace.army.mil/software/hec-hms/documentation/HEC-HMS_Technical%20Reference%20Manual_(CPD-74B).pdf)

See Index 819.4 for a general discussion of hydrograph methods.

816.6 Time of Concentration (T_c) and Travel Time (T_t)

Time of concentration is defined as the time required for storm runoff to travel from the hydraulically most remote point of the drainage basin to the point of interest.

An assumption made in some of the hydrologic methods for estimating peak discharge, such as the Rational and NRCS Methods (Index 819.2), is that maximum flow results when rainfall of uniform intensity falls over the entire watershed area and the duration of that rainfall is equal to the time of concentration. Time of concentration (T_c) is typically the cumulative sum of three travel times, including:

- Sheet flow
- Shallow concentrated flow
- Channel flow

For all-paved watersheds (e.g., parking lots, roadway travel lanes and shoulders, etc.) it is not necessary to calculate a separate shallow concentrated flow travel time segment. Such flows will typically transition directly from sheet flow to channel flow or be intercepted at inlets with either no, or inconsequential lengths of, shallow concentrated flow.

In many cases a minimum time of concentration will have to be assumed as extremely short travel times will lead to calculated rainfall intensities that are overly conservative for design purposes. For all-paved areas, slopes steeper than 10H:1V, or where there is a limited opportunity for surface storage, a minimum T_c of 5 minutes should be assumed. For rural or undeveloped areas, it is recommended that a minimum T_c of 10 minutes be used for most situations.

Designers should be aware that maximum runoff estimates are not always obtained using rainfall intensities determined by the time of concentration for the total area. Peak runoff estimates may be obtained by applying higher rainfall intensities from storms of short duration over a portion of the watershed.

(1) *Sheet flow travel time.* Sheet flow is flow of uniform depth over plane surfaces and usually occurs for some distance after rain falls on the ground. The maximum flow depth is usually less than 0.8 inches – 1.2 inches. For unpaved areas, sheet flow normally exists for a distance less than 80 feet – 100 feet. An upper limit of 300 feet is recommended for paved areas.

A common method to estimate the travel time of sheet flow is based on kinematic wave theory and uses the Kinematic Wave Equation:

$$T_t = \frac{0.93L^{3/5}n^{3/5}}{i^{2/5}S^{3/10}}$$

where

T_t = Travel time in minutes.

L = Length of flow path in feet.

S = Slope of flow in feet per feet.

n = Manning's roughness coefficient for sheet flow (see Table 816.6A).

i = Design storm rainfall intensity in inches per hour.

July 1, 2020

If T_t is used (as part of T_c) to determine the intensity of the design storm from the IDF curves, application of the Kinematic Wave Equation becomes an iterative process: an assumed value of T_t is used to determine i from the IDF curve; then the equation is used to calculate a new value of T_t which in turn yields an updated i . The process is repeated until the calculated T_t is the same in two successive iterations.

To eliminate the iterations, use the following simplified form of the Manning's kinematic solution:

$$T_t = \frac{0.42L^{4/5}n^{4/5}}{P_2^{1/2}s^{2/5}}$$

where P_2 is the 2-year, 24-hour rainfall depth in inches (ref. NOAA Atlas 14, <http://hdsc.nws.noaa.gov/hdsc/pfds/>).

The use of flow length alone as a limiting factor for the Kinematic wave equation can lead to circumstances where the underlying assumptions are no longer valid. Over prediction of travel time can occur for conditions with significant amounts of depression storage, where there is a high Manning's n -value or for flat slopes. One study suggests that the upper limit of applicability of the Kinematic wave equation is a function of flow length, slope and Manning's roughness coefficient. This study used both field and laboratory data to propose an upper limit of 100 for the composite parameter of $nL/s^{1/2}$. It is recommended that this criteria be used as a check where the designer has uncertainty on the maximum flow length to which the Kinematic wave equation can be applied to project conditions.

Where sheet flow travel distance cannot be determined, a conservative alternative is to assume shallow concentrated flow conditions without an independent sheet flow travel time conditions. See Index 816.6(2).

Table 816.6A

Roughness Coefficients For Sheet Flow

Surface Description	n
Hot Mix Asphalt	0.011- 0.016
Concrete	0.012- 0.014
Brick with cement mortar	0.014
Cement rubble	0.024
Fallow (no residue)	0.05
<i>Grass</i>	
Short grass prairie	0.15
Dense grass	0.24
Bermuda Grass	0.41
<i>Woods</i> ⁽¹⁾	
Light underbrush	0.40
Dense underbrush	0.80

⁽¹⁾ Woods cover is considered up to a height of 1 inch, which is the maximum depth obstructing sheet flow.

(2) *Shallow concentrated flow travel time.* After short distances, sheet flow tends to concentrate in rills and gullies, or the depth exceeds the range where use of the Kinematic wave equation applies. At that point the flow becomes defined as shallow concentrated flow. The Upland Method is commonly used when calculating flow velocity for shallow concentrated flow. This method may also be used to calculate the total travel time for both the sheet flow and the shallow concentrated flow segments under certain conditions (e.g., where use of the Kinematic wave equation to predict sheet flow travel time is questionable, or where the designer cannot reasonably identify the point where sheet flow transitions to shallow concentrated flow).

Average velocities for the Upland Method can be taken directly from Figure 816.6 (Source NRCS, National Engineering Handbook part 650) or may be calculated from the following equation:

$$V = (3.28) kS^{1/2}$$

Where S is the slope in percent and k is an intercept coefficient depending on land cover as shown in Table 816.6B. It is assumed that the depth range is 0.1 to 0.2 feet, except for grassed waterways, where the depth range is 0.1 to 0.4 feet,

Table 816.6B

Intercept Coefficients for Shallow Concentrated Flow

Land cover/Flow regime	k
Forest with heavy ground litter; hay meadow	0.076
Trash fallow or minimum tillage cultivation; contour or strip cropped; woodland	0.152
Short grass pasture	0.213
Cultivated straight row	0.274
Nearly bare and untilled alluvial fans	0.305
Grassed waterway	0.457
Pavement and small upland gullies	0.620

The travel time can be calculated from:

$$T_t = \frac{L}{60V}$$

where T_t is the travel time in minutes, L the length in feet, and V the flow velocity in feet per second.

(3) *Channel flow travel time.* When the channel characteristics and geometry are known the preferred method of estimating channel flow time is to divide the channel length by the channel velocity obtained by using the Manning's equation, assuming bankfull conditions. See Index 866.3(4), for further discussion of Manning's equation.

Appropriate values for "n", the coefficient of roughness in the Manning's equation, may be found in most hydrology or hydraulics texts and reference books. Table 866.3A gives some "n" values for lined and unlined channels, gutters, and medians. Procedures for selecting an appropriate hydraulic roughness coefficient may be found in the FHWA report, "Guide for Selecting Manning's Roughness Coefficient for Natural Channels and Flood Plains." See <http://www.fhwa.dot.gov/bridge/wsp2339.pdf>. Generally, the channel roughness factor will be much lower than the values for overland flow with similar surface appearance.

July 1, 2020

Figure 816.6

Velocities for Upland Method of Estimating Travel Time for Shallow Concentrated Flow

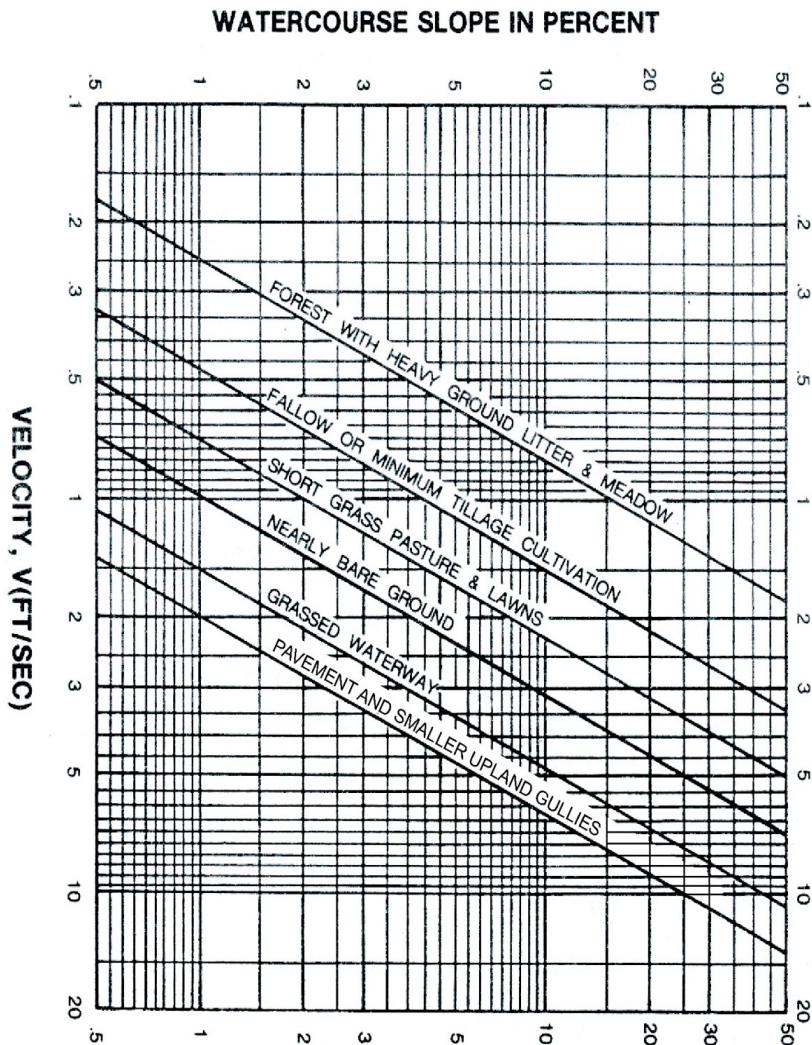

(4) *Culvert or Storm Drain Flow.* Flow velocities in a short culvert are generally higher than they would be in the same length of natural channel and comparable to those in a lined channel. In most cases, including short runs of culvert in the channel, flow time calculation will not materially affect the overall time of concentration (T_C). When it is appropriate to separate flow time calculations, such as for urban storm drains, Manning's equation may be used to obtain flow velocities within pipes.

The TR-55 library of equations for sheet flow, shallow concentrated flow and open channel flow is incorporated into the Watershed Modeling System (WMS) for Time of Concentration Calculations using Triangulated Irregular Networks (TINs) and Digital Elevation Maps (DEMs). See Figure 816.7.

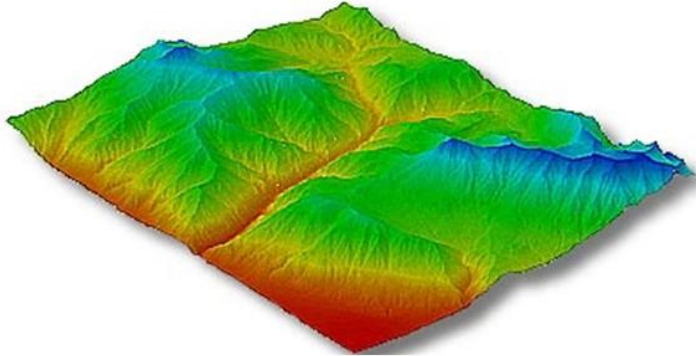
Figure 816.7**Digital Elevation Map (DEM)****Topic 817 – Flood Magnitude****817.1 General**

The determination of flood magnitude from either measurements made during a flood or after peak flow has subsided requires knowledge of open-channel hydraulics and flood water behavior. There are USGS Publications and other technical references available which outline the procedures for measuring flood flow. However, it is only through experience that accurate measurements can be obtained and/or correctly interpreted.

817.2 Measurements

(1) *Direct.* Direct flood flow measurements are those made during flood stage. The area and average velocity can be approximated and the estimated discharge can be calculated, from measurements of flow depth and velocity made simultaneously at a number of points in a cross section.

Discharges calculated from continuous records of stage gaging stations are the primary basis for estimating the recurrence interval or frequency of floods. See Figure 817.2.

(2) *Indirect.* Indirect flood flow measurements are those made after the flood subsides. From channel geometry measurements and high water marks the magnitude of a flood can be calculated using basic open channel hydraulic equations given in Chapter 860. This method of determining flood discharges for given events is a valuable tool to the highway engineer possessing a thorough knowledge and understanding of the techniques involved. See Figure 817.3.

July 1, 2020

Figure 817.2

Gaging Station



Smith River Stage Gaging Station at Dr. Fine Bridge

Figure 817.3

High Water Marks



Topic 818 – Flood Probability And Frequency

818.1 General

The estimation of peak discharges of various recurrence intervals is the most common and important problem encountered in highway engineering hydrology. Since the hydrology for the sizing of highway drainage facilities is concerned with future events, the time and magnitude of which cannot be precisely forecast, the highway engineer must resort to probability statistics to define the design discharge.

Modern hydrologists tend to define floods in terms of probability, as expressed in percentage rather than in terms of return period (recurrence interval). Return period, the "N-year flood", and probability (p) are reciprocals, that is, $p = 1/N$. Therefore, a flood having a 50-year return frequency (Q_{50}) is now commonly expressed as a flood with the probability of recurrence of 0.02 (2 percent chance of being exceeded) in any given year.

There are certain other terminologies which are frequently used and understood by highway engineers but which might have a slight variation in meaning to other engineering branches. For convenience and example, the following definition of terms have been excerpted from Topic 806, Definition of Drainage Terms.

- (1) *Base Flood*. "The flood, tide, or a combination of the two having a 1 percent chance of being exceeded in any given year". The "base flood" is used as the standard flood by FEMA and has been adopted by many agencies for flood hazard analysis to comply with regulatory requirements. See Topic 804, Floodplain Encroachments.
- (2) *Overtopping Flood*. "The flood described by the probability of exceedance and water surface elevation at which flow occurs over the highway, over the watershed divide, or through structure(s) provided for emergency relief". The "overtopping flood" is of particular interest to highway drainage engineers because it may be the threshold where the relatively low profile of the highway acts as a flood relief mechanism for the purpose of minimizing upstream backwater damages. See Figure 818.1. On Interstate highways, CFR 650 states "The design flood for encroachments by through lanes of Interstate highways shall not be less than the flood with a 2-percent chance of being exceeded in any given year. No minimum design flood is specified for Interstate highway ramps and frontage roads or for other highways."
- (3) *Design Flood*. "The peak discharge (when appropriate, the volume, stage, or wave crest elevation) of the flood associated with the probability of exceedance selected for the design of a highway encroachment". Except for the rare situation where the risks associated with a low water crossing are acceptable, the highway will not be inundated by the "design flood".
- (4) *Maximum Historical Flood*. "The maximum flood that has been recorded or experienced at any particular highway location". This information is very desirable and where available is an indication that the flood of this magnitude may be repeated at the project site. Hydrologic analysis may suggest that the probability for recurrence of the "maximum historical flood" is very small, less than 1 percent. Nevertheless consideration should be given to sizing drainage structures to convey the "maximum historical flood". See Figure 818.2.
- (5) *Probable Maximum Flood*. "The flood discharge that may be expected from the most severe combination of critical meteorological and hydrological conditions that are reasonably possible in the region". The "probable maximum flood" is generally not applicable to highway projects. The possibility of a flood of such rare magnitude, as used by the Corps of Engineers, is applicable to projects such as major dams, when consideration is to be given to virtually complete security from potential floods.

July 1, 2020

Figure 818.1

Overtopping Flood



Figure 818.2

Maximum Historic Flood



818.2 Establishing Design Flood Frequency

There are two recognized alternatives to establishing an appropriate highway drainage design frequency. That is, by policy or by economic analysis. Both alternatives have merit and may be applied exclusively or jointly depending upon general conditions or specific constraints.

Application of traditional predetermined design flood frequencies implies that an acceptable level of risk was considered in establishing the design standard. Modern design concepts, on the other hand, recommend that a range of peak flows be considered and that the design flood be established which best satisfies the specific site conditions and associated risks. A preliminary evaluation of the inherent flood-related risks to upstream and downstream properties, the highway facility, and to the traveling public should be made. This evaluation

will indicate whether a predetermined design flood frequency is applicable or additional study is warranted.

Highway classification is one of the most important factors, but not the sole factor, in establishing an appropriate design flood frequency. Due consideration should be given to all the other factors listed under Index 801.5. If the analysis is correct, the highway drainage system will occasionally be overtaxed. The alternative of accommodating the worst possible event that could happen is usually so costly that it may not be justified.

Highway engineers should understand that the option to select a predetermined design flood frequency is generally only applicable to new highway locations. Because of existing constraints, the freedom to select a prescribed design flood frequency may not exist for projects involving replacement of existing facilities. Caltrans policy relative to up-grading of existing drainage facilities may be found in Index 803.3.

Although the procedures and methodology presented in HEC 17, Design of Encroachments on Flood Plains Using Risk Analysis, are not fully endorsed by Caltrans, the circular is an available source of information on the theory of "least total expected cost (LTEC) design". Highway engineers are cautioned about applying LTEC methodology and procedures to ordinary drainage design problems. The Headquarters Hydraulics Engineer in the Division of Design should be consulted before committing to design by the LTEC method since its use can only be justified and recommended under extra-ordinary circumstances.

818.3 Stationarity and Climate Variability

In Index 818.1, the assumption behind flood probability and frequency analysis is that climate is stationary. Stationarity assumes that hydrology varies within an unchanging envelope of natural variability, so that the past accurately represents the future. It has been a basic assumption used for many years in the planning and design of bridges and culverts and continues to represent the current state of practice that serves the engineering community well.

Climate change as well as better understanding of climate variability have presented a challenge to the validity of this assumption.

Today, there is growing recognition that, despite its successful application in the past, the assumption of stationarity may not accurately represent the future. However, until a multi-disciplinary consensus is reached on future trends that can be expected, stationarity will continue to be utilized with current procedures.

To minimize uncertainty, designers should continue to utilize existing hydrologic tools with the most current datasets available for rainfall and runoff. Observed trends can then be quantified and placed in the context of the uncertainty associated with the frequency estimates themselves.

July 1, 2020

(1) *Nonstationarity and Climate Variability.* Changes in land use, changing groundwater levels, and urbanization are examples of nonstationarity within a watershed that can affect hydrologic response. The Intergovernmental Panel on Climate Change (IPCC) has stated that “Climate change challenges the traditional assumption that past hydrological experience provides a good guide to future conditions”. Although the assumption of stationarity is being challenged, there is no consensus within the scientific or engineering community on a viable replacement.

Topic 819 – Estimating Design Discharge

819.1 Introduction

Before highway drainage facilities can be hydraulically designed, the quantity of run-off (design Q) that they may reasonably be expected to convey must be established. The estimation of peak discharge for various recurrence intervals is therefore the most important, and often the most difficult, task facing the highway engineer. Refer to Table 819.5A for a summary of methods for estimating design discharge.

In Topic 819, various design recommendations are given for both general and region-specific areas of California.

819.2 Empirical Methods

Because the movement of water is so complex, numerous empirical methods have been used in hydrology. Empirical methods in hydrology have great usefulness to the highway engineer. When correctly applied by engineers knowledgeable in the method being used and its idiosyncrasies, peak discharge estimates can be obtained which are functionally acceptable for the design of highway drainage structures and other features. Some of the more commonly used empirical methods for estimating runoff are as follows.

(1) *Rational Methods.* Undoubtedly, the most popular and most often misused empirical hydrology method is the Rational Formula:

$$Q = CiA$$

Q = Design discharge in cubic feet per second.

C = Coefficient of runoff.

i = Average rainfall intensity in inches per hour for the selected frequency and for a duration equal to the time of concentration. See <http://hdsc.nws.noaa.gov/hdsc/pfds/>

A = Drainage area in acres.

Rational methods are simple to use, and it is this simplicity that has made them so popular among highway drainage design engineers. Design discharge, as computed by these methods, has the same probability of occurrence (design frequency) as the frequency of the rainfall used. Refer to Topic 818 for further information on flood probability and frequency of recurrence.

An assumption that limits applicability is that the rainfall is of equal intensity over the entire watershed. Because of this, Rational Methods should be used only for estimating runoff from small simple watershed areas, preferably no larger than 320 acres. Even where the

watershed area is relatively small but complicated by a mainstream fed by one or more significant tributaries, Rational Methods should be applied separately to each tributary stream and the tributary flows then routed down the main channel. Flow routing can best be accomplished through the use of hydrographs discussed in Index 819.4. Since Rational Methods give results that are in terms of instantaneous peak discharge and provide little information relative to runoff rate with respect to time, synthetic hydrographs should be developed for routing significant tributary inflows. Several relatively simple methods have been established for developing hydrographs, such as transposing a hydrograph from another hydrologically homogeneous watershed. The stream hydraulic method, and upland method are described in HDS No. 2. These, and other methods, are adequate for use with Rational Methods for estimating peak discharge and will provide results that are acceptable to form the basis for design of highway drainage facilities.

It is clearly evident upon examination of the assumptions and parameters which form the basis of the equation that much care and judgment must be applied with the use of Rational Methods to obtain reasonable results.

- The runoff coefficient "C" in the equation represents the percent of water which will run off the ground surface during the storm. The remaining amount of precipitation is lost to infiltration, transpiration, evaporation and depression storage. "C" is a volumetric coefficient that relates the peak discharge to the "theoretical peak" or 100 percent runoff, occurring when runoff matches the net rain rate. Hence "C" is also a function of infiltration and other hydrologic abstractions.

Values of "C" may be determined for un-developed areas from Figure 819.2A by considering the four characteristics of: relief, soil infiltration, vegetal cover, and surface storage.

The designer must use judgment to select the appropriate "C" value within the range. Generally, larger areas with permeable soils, flat slopes and dense vegetation should have the lowest "C" values. Smaller areas with dense soils, moderate to steep slopes, and sparse vegetation should be assigned the highest "C" values.

Some typical values of "C" for developed areas are given in Table 819.2B. Should the basin contain varying amounts of different cover, a weighted runoff coefficient for the entire basin can be determined as:

$$C = \frac{C_1A_1 + C_2A_2 + \dots}{A_1 + A_2 + \dots}$$

- To properly satisfy the assumption that the entire drainage area contributes to the flow; the rainfall intensity, (i) in the equation expressed in inches per hour, requires that the storm duration and the time of concentration (t_c) be equal. Therefore, the first step in estimating (i) is to estimate (t_c). Methods for determining time of concentration are discussed under Index 816.6.
- Once the time of concentration, (t_c), is estimated, the rainfall intensity, (i), corresponding to a storm of equal duration, may be obtained from available sources such as intensity-duration-frequency (IDF) curves. For IDF curve generating software, see <http://hdsc.nws.noaa.gov/hdsc/pfds/>.

The runoff coefficients given in Figure 819.2A and Table 819.2B are applicable for storms of up to 5 or 10 year frequencies. Less frequent, higher intensity storms usually require modification of the coefficient because infiltration, detention, and other losses have a proportionally smaller effect on the total runoff volume. The adjustment of the rational method for use with major storms can be made by multiplying the coefficient by a

July 1, 2020

frequency factor, $C(f)$. Values of $C(f)$ are given below. Under no circumstances should the product of $C(f)$ times C exceed 1.0.

Frequency (yrs)	$C(f)$
25	1.1
50	1.2
100	1.25

(2) *Regional Analysis Methods.* Regional analysis methods utilize records for streams or drainage areas in the vicinity of the stream under consideration which would have similar characteristics to develop peak discharge estimates. These methods provide techniques for estimating annual peak stream discharge at any site, gaged or ungaged, for probability of recurrence from 50 percent (2years) to 1 percent (100 years). Application of these methods is convenient, but the procedure is subject to some limitations.

Regional Flood - Frequency equations developed by the U.S. Geological Survey for use in California are given in Table 819.2C and Table 819.7A. These equations are based on regional regression analysis of data from stream gauging stations. The equations in Table 819.2C were derived from data gathered and analyzed through 2006, while the regions covered by Table 819.7A are reflective of a 1994 study of the Southwestern U.S., which has been supplemented by a more recent 2007 Study of California Desert Region Hydrology. Information on use and development of this method may be found in "Methods for Determining Magnitude and Frequency of Floods in California Based on Data through Water Year 2006" by the U.S. Department of the Interior, Geological Survey.

The Regional Flood-Frequency equations are applicable only to sites within the flood-frequency regions for which they were derived and on streams with virtually natural flows. The equations are not directly applicable to streams in urban areas affected substantially by urban development. In urban areas the equations may be used to estimate peak discharge values under natural conditions and then by use of the techniques described in the publication or HDS No. 2, adjust the discharge values to compensate for urbanization. A method for directly estimating design discharges for some gaged and ungaged streams is also provided in HDS No. 2. The method is applicable to streams on or nearby those for which study data are available.

(3) *Flood Frequency Analysis*

- (a) If there are two gaged sites with similar watershed characteristics but one has a short record and the other has a longer record of peak flows, a two-station comparison analysis can be conducted to extend the equivalent length of record at the shorter gaged site.
- (b) Flood-frequency relations at sites near gaged sites on the same stream (or in a similar watershed) can be estimated using a ratio of drainage area for the ungaged and gaged sites.
- (c) At a gaged site, weighted estimates of peak discharges based on the station flood-frequency relation and the regional regression equations are considered the best estimates of flood frequency and are used to reduce the time-sampling error that may occur in a station flood-frequency estimate.

Figure 819.2A

Runoff Coefficients for Undeveloped Areas Watershed Types

	Extreme	High	Normal	Low
Relief	.28 -.35 Steep, rugged terrain with average slopes above 30%	.20 -.28 Hilly, with average slopes of 10 to 30%	.14 -.20 Rolling, with average slopes of 5 to 10%	.08 -.14 Relatively flat land, with average slopes of 0 to 5%
Soil Infiltration	.12 -.16 No effective soil cover, either rock or thin soil mantle of negligible infiltration capacity	.08 -.12 Slow to take up water, clay or shallow loam soils of low infiltration capacity, imperfectly or poorly drained	.06 -.08 Normal; well drained light or medium textured soils, sandy loams, silt and silt loams	.04 -.06 High; deep sand or other soil that takes up water readily, very light well drained soils
Vegetal Cover	.12 -.16 No effective plant cover, bare or very sparse cover	.08 -.12 Poor to fair; clean cultivation crops, or poor natural cover, less than 20% of drainage area over good cover	.06 -.08 Fair to good; about 50% of area in good grassland or woodland, not more than 50% of area in cultivated crops	.04 -.06 Good to excellent; about 90% of drainage area in good grassland, woodland or equivalent cover
Surface Storage	.10 -.12 Negligible surface depression few and shallow; drainageways steep and small, no marshes	.08 -.10 Low; well defined system of small drainageways; no ponds or marshes	.06 -.08 Normal; considerable surface depression storage; lakes and pond marshes	.04 -.06 High; surface storage, high; drainage system not sharply defined; large floodplain storage or large number of ponds or marshes
Given	An undeveloped watershed consisting of;		Solution:	
	1) rolling terrain with average slopes of 5%;		Relief	0.14
	2) clay type soils,		Soil Infiltration	0.08
	3) good grassland area, and		Vegetal Cover	0.04
	4) normal surface depressions.		Surface Storage	<u>0.06</u>
			C =	0.32
Find	The runoff coefficient, C, for the above watershed.			

July 1, 2020

Table 819.2B

Run off Coefficients for Developed Areas⁽¹⁾

Type of Drainage Area	Runoff Coefficient
Business:	
Downtown areas	0.70 - 0.95
Neighborhood areas	0.50 - 0.70
Residential:	
Single-family areas	0.30 - 0.50
Multi-units, detached	0.40 - 0.60
Multi-units, attached	0.60 - 0.75
Suburban	0.25 - 0.40
Apartment dwelling areas	0.50 - 0.70
Industrial:	
Light areas	0.50 - 0.80
Heavy areas	0.60 - 0.90
Parks, cemeteries:	0.10 - 0.25
Playgrounds:	0.20 - 0.40
Railroad yard areas:	0.20 - 0.40
Unimproved areas:	0.10 - 0.30
Lawns:	
Sandy soil, flat, 2%	0.05 - 0.10
Sandy soil, average, 2-7%	0.10 - 0.15
Sandy soil, steep, 7%	0.15 - 0.20
Heavy soil, flat, 2%	0.13 - 0.17
Heavy soil, average, 2-7%	0.18 - 0.22
Heavy soil, steep, 7%	0.25 - 0.35
Streets:	
Asphaltic	0.70 - 0.95
Concrete	0.80 - 0.95
Brick	0.70 - 0.85
Drives and walks	0.75 - 0.85
Roofs:	0.75 - 0.95

NOTES:

(1) From HDS No. 2.

Table 819.2C

Regional Flood-Frequency Equations

NORTH COAST (REGION 1)	LAHONTAN (REGION 2)	SIERRA NEVADA (REGION 3)
$Q_2 = 1.82A^{0.904}P^{0.983}$ $Q_5 = 8.11A^{0.887}P^{0.772}$ $Q_{10} = 14.8A^{0.880}P^{0.696}$ $Q_{25} = 26.0A^{0.874}P^{0.628}$ $Q_{50} = 36.3A^{0.870}P^{0.589}$ $Q_{100} = 48.5A^{0.866}P^{0.556}$	$Q_2 = 0.0865A^{0.736}P^{1.59}$ $Q_5 = 0.182A^{0.733}P^{1.58}$ $Q_{10} = 0.260A^{0.734}P^{1.59}$ $Q_{25} = 0.394A^{0.733}P^{1.58}$ $Q_{50} = 0.532A^{0.733}P^{1.58}$ $Q_{100} = 0.713A^{0.731}P^{1.56}$	$Q_2 = 2.43A^{0.924}E^{-0.646}P^{2.06}$ $Q_5 = 11.6A^{0.907}E^{-0.566}P^{1.70}$ $Q_{10} = 17.2A^{0.896}E^{-0.486}P^{1.54}$ $Q_{25} = 20.7A^{0.885}E^{-0.386}P^{1.39}$ $Q_{50} = 21.1A^{0.879}E^{-0.316}P^{1.31}$ $Q_{100} = 20.6A^{0.874}E^{-0.250}P^{1.24}$
CENTRAL COAST (REGION 4)	SOUTH COAST (REGION 5)	<p>Q=Peak discharge in CFS, subscript indicates recurrence interval, in years A=Drainage area, in square miles P=Mean annual precipitation, in inches (Use link to Table 2) http://pubs.usgs.gov/sir/2012/5113/ E=Mean basin elevation, in feet</p>
$Q_2 = 0.00459A^{0.856}P^{2.58}$ $Q_5 = 0.0984A^{0.852}P^{1.97}$ $Q_{10} = 0.460A^{0.846}P^{1.66}$ $Q_{25} = 2.13A^{0.842}P^{1.34}$ $Q_{50} = 5.32A^{0.840}P^{1.15}$ $Q_{100} = 11.0A^{0.840}P^{0.994}$	$Q_2 = 3.60A^{0.672}P^{0.753}$ $Q_5 = 7.43A^{0.739}P^{0.872}$ $Q_{10} = 6.56A^{0.783}P^{1.07}$ $Q_{25} = 4.71A^{0.832}P^{1.32}$ $Q_{50} = 3.84A^{0.864}P^{1.47}$ $Q_{100} = 3.28A^{0.891}P^{1.59}$	

Region	Drainage Area (A), mi ²	Mean Annual Precipitation (P), in.	Mean Basin Elevation (E), ft.
North Coast	0.04 – 3200	20 – 125	-
Lahontan ⁽¹⁾	0.45 – 1500	13 – 85	-
Sierra Nevada	0.07 – 2000	15 – 100	90 – 11,000
Central Coast	0.11 – 4600	7 – 46	-
South Coast	0.04 – 850	10 – 45	-
Desert ⁽²⁾	N/A	N/A	-

NOTES:

(1) See Index 819.7 for hydrologic procedures for those portions of the Northeast Region classified as desert.

(2) USGS equations not recommended. See Index 819.7.

July 1, 2020

Figure 819.2C

Regional Flood-Frequency Regions

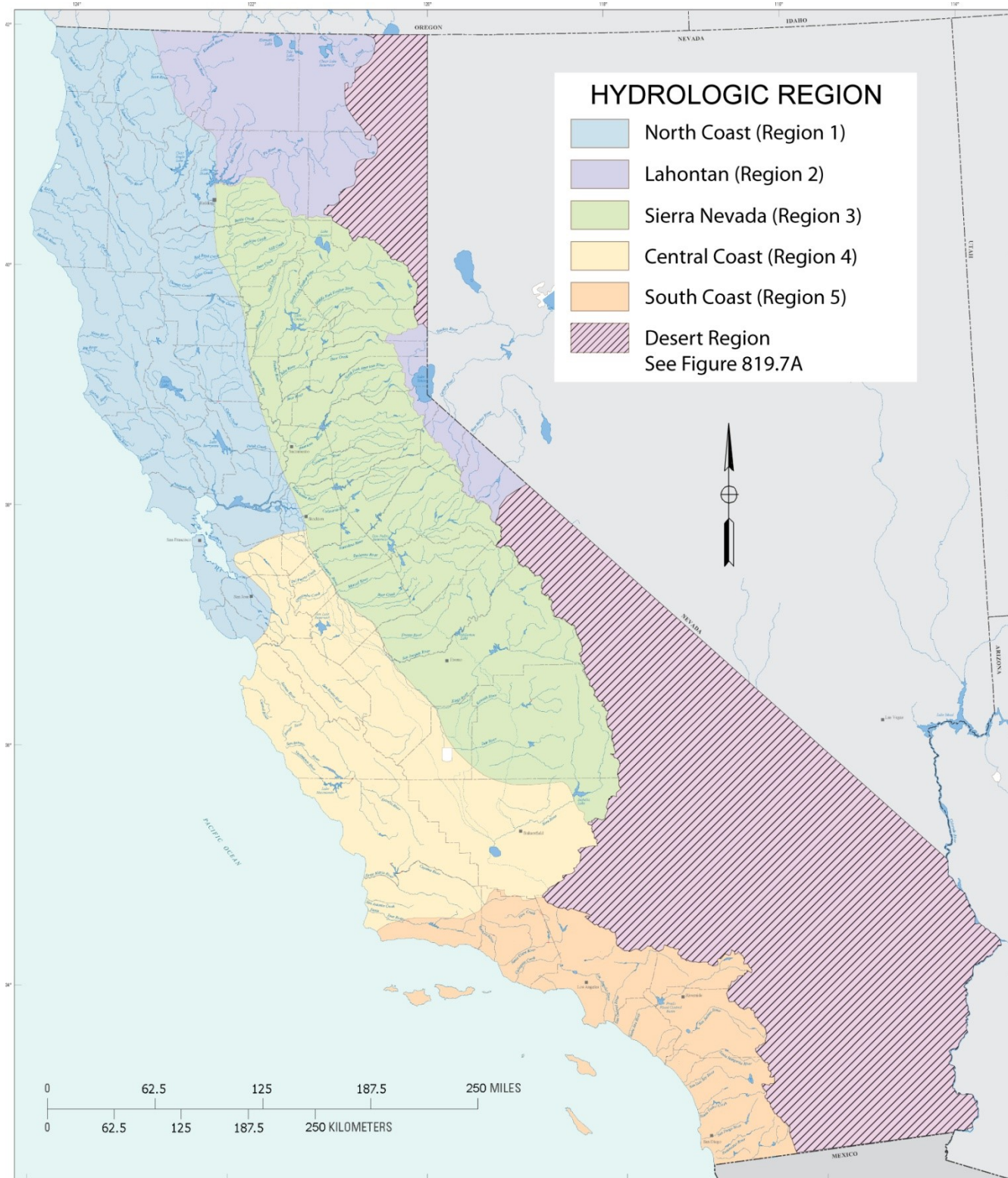

- (d) The flood-frequency flows and the maximum peak discharges at several stations in a region should be used whenever possible for comparison with the peak discharge estimated at an ungaged site using a rainfall-runoff approach or regional regression equation. The watershed characteristics at the ungaged and gaged sites should be similar.
- (4) *National Resources Conservation Service (NRCS) Methods.* The Soil Conservation Service's SCS (former title) National Engineering Handbook, 1972, and their 1975, "Urban Hydrology for Small Watersheds", Technical Release 55 (TR-55), present a graphical method for estimating peak discharge. Most NRCS equations and curves provide results in terms of inches of runoff for unit hydrograph development and are not applicable to the estimation of a peak design discharge unless the design hydrograph is first developed in accordance with prescribed NRCS procedures. NRCS methods and procedures are applicable to drainage areas less than 3 square miles (approx. 2,000 acres) and result in a design hydrograph and design discharge that are functionally acceptable to form the basis for the design of highway drainage facilities.

819.3 Statistical Methods

Statistical methods of predicting stream discharge utilize numerical data to describe the process. Statistical methods, in general, do not require as much subjective judgment to apply as the previously described deterministic methods. They are usually well documented mathematical procedures which are applied to measured or observed data. The accuracy of statistical methods can also be measured quantitatively. However, to assure that statistical method results are valid, the method and procedures used should be verified by an experienced engineer with a thorough knowledge of engineering statistics.

Analysis of gaged data permits an estimate of the peak discharge in terms of its probability or frequency of recurrence at a given site. This is done by statistical methods provided sufficient data are available at the site to permit a meaningful statistical analysis to be made. Water Resources Council Bulletin 17B, 1981, suggests at least 10 years of record are necessary to warrant a statistical analysis. The techniques of inferential statistics, the branch of statistics dealing with the inference of population characteristics, are described in HDS No. 2.

Before data on the specific characteristics to be examined can be properly analyzed, it must be arranged in a systematic manner. Several computer programs are available which may be used to systematically arrange data and perform the statistical computations.

Some common types of data groupings are as follows:

- Magnitude
- Time of Occurrence
- Geographic Location

Several standard frequency distributions have been studied extensively in the statistical analysis of hydrologic data. Those which have been found to be most useful are:

- (1) *Log-Pearson Type III Distribution.* The popularity of the Log-Pearson III distribution is simply based on the fact that it very often fits the available data quite well, and it is flexible enough to be used with a wide variety of distributions. Because of this flexibility, the U.S. Water Resources Council recommends its use by all U.S. Government agencies as the standard distribution for flood frequency studies.

July 1, 2020

The three parameters necessary to describe the Log-Pearson III distribution are:

- Mean flow
- Standard deviation
- Coefficient of skew

Log-Pearson III distributions are usually plotted on log-normal probability graph paper for convenience even though the plotted frequency distribution may not be a straight line.

It should be noted Log-Pearson III analysis is not typically appropriate for desert regions where flood-frequency analysis is complicated due to short annual peak-flow records (usually less than 20 years) and numerous zero flows and (or) low outliers for many stream gages.

(2) *Log-normal Distribution.* The characteristics of the log-normal distribution are the same as those of the classical normal or Gaussian mathematical distribution except that the flood flow at a specified frequency is replaced with its logarithm and has a positive skew. Positive skew means that the distribution is skewed toward the high flows or extreme values.

(3) *Gumbel Extreme Value Distribution.* The characteristics of the Gumbel extreme value distribution (also known as the double exponential distribution of extreme values) are that the mean flood occurs at the return period of $T_r = 2.33$ years and that it has a positive skew.

Special probability paper has been developed for plotting log-normal and Gumbel distributions so that sample data, if it is distributed according to prescribed equations, will plot as a straight line.

(4) *L-Moments.* L-moments provide an alternative way of describing frequency distributions to traditional product moments (conventional moments) or maximum likelihood approach. They are less susceptible to the presence of outliers in the data than conventional moments and are well suited for the analysis of data that exhibit significant skewness. See overview of methodology used for NOAA Atlas 14 (Index 4.6.1); http://www.nws.noaa.gov/oh/hdsc/PF_documents/Atlas14_Volume6.pdf

819.4 Hydrograph Methods

Hydrograph methods of estimating design discharge relate runoff rates to time in response to a design storm. When storage must be considered, such as in reservoirs, natural lakes, and detention basins used for drainage or sediment control, the volume of runoff must be known. Since the hydrograph is a plot of flow rate against time, the area under the hydrograph represents volume. If streamflow and precipitation records are available for a particular design site, the development of the design hydrograph is a straight forward procedure. Rainfall records can be readily analyzed to estimate unit durations and the intensity which produces peak flows near the desired design discharge.

It often becomes necessary to develop a hydrograph when watersheds have complex runoff characteristics, such as in urban and desert areas or when storage must be evaluated.

Hydrograph methods apply for watersheds in which the time of concentration is longer than the duration of peak rainfall intensity of the design storm. Precipitation applied to the watershed model is uniform spatially, but varies with time. The hydrograph method accounts for losses (e.g., soil infiltration) and transforms the remaining (excess) rainfall into a runoff

hydrograph at the outlet of the watershed. There is no size limitation for watershed area. See HDS No. 2; Figure 2-13, for the relationship of discharge and area and effects of basin characteristics on the flood hydrograph.

Hydrographs are also useful for determining the combined rates of flow for two drainage areas which peak at different times. Hydrographs can also be compounded and lagged to account for complex storms of different duration and varying intensities.

See Index 819.7(1)(d) for a detailed discussion on rainfall-runoff simulation for California's Desert regions. The same four general concepts are applicable elsewhere. Other considerations may include:

- Development of a rainfall hyetograph
- Base flow separation
- Direct runoff hydrograph derivation
- Unit hydrograph derivation; and
- Other synthetic unit hydrographs (e.g., Snyder's or Clark's methods)

Successful application of most hydrograph methods requires the designer to:

- Define the temporal and spatial distribution of the desired design storm.
- Specify appropriate losses within the model to compute the amount of precipitation lost to other processes, such as infiltration that does not run off the watershed.
- Specify appropriate parameters to compute runoff hydrograph resulting from excess (not lost) precipitation.
- If necessary for the application, specify appropriate parameters to compute the lagged and attenuated hydrograph at downstream locations. Basic steps to developing and applying a rainfall-runoff model for predicting the required design flow are illustrated in Figure 819.4A.

Several methods of developing hydrographs are described in HDS No. 2. For basins without data, two of the most widely used methods described in HDS No. 2 for developing synthetic hydrographs are:

- Unit Hydrograph (UH)
- SCS Triangular Hydrograph

Both methods however tend to be somewhat inflexible since storm duration is determined by empirical relations.

For basins with data, HEC-HMS includes the following direct runoff models:

- User specified UH
- Parametric and Synthetic UH
- Snyder's UH
- Clark's UH
- ModClark Model
- Kinematic-wave Model

July 1, 2020

For more information see; Chapters 4, 5, 6, 7 and 8 of the user guide for HEC-HMS. See: [http://www.hec.usace.army.mil/software/hec-hms/documentation/HEC-HMS_Technical%20Reference%20Manual_\(CPD-74B\).pdf](http://www.hec.usace.army.mil/software/hec-hms/documentation/HEC-HMS_Technical%20Reference%20Manual_(CPD-74B).pdf)

819.5 Transfer of Data

Often the highway engineer is confronted with the problem where stream flow and rainfall data are not available for a particular site but may exist at points upstream or in an adjacent or nearby watersheds.

Figure 819.4

Basic Steps to Developing and Applying a Rainfall-runoff Model for Predicting the Required Design Flow

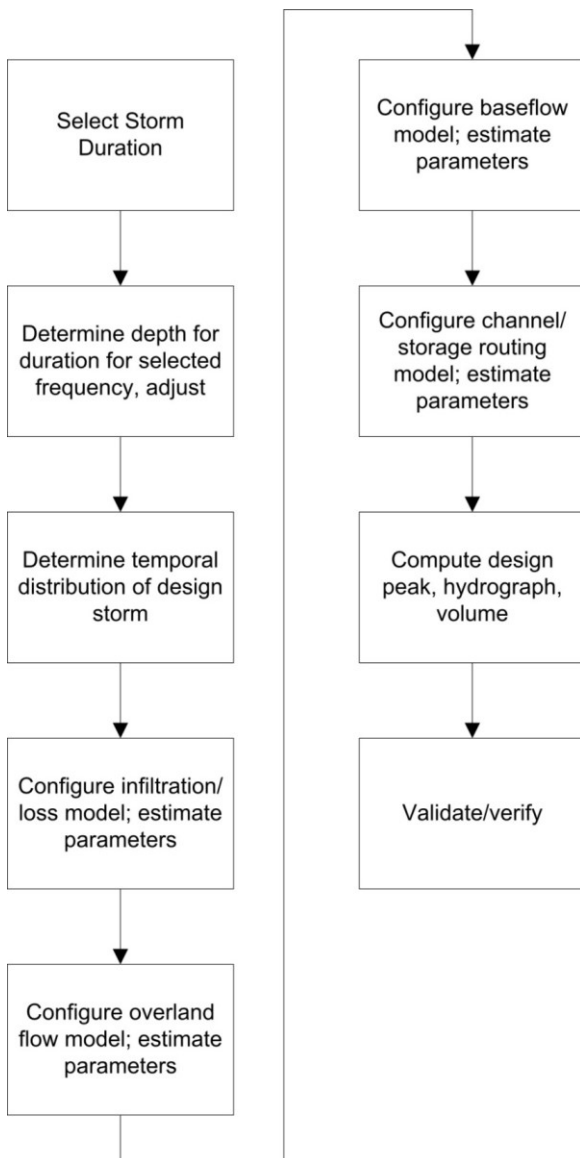

Table 819.5A

Summary of Methods for Estimating Design Discharge

METHOD	ASSUMPTIONS	DATA NEEDS
Rational	<ul style="list-style-type: none"> • Small catchment (< 320 acres) • Concentration time < 1 hour • Storm duration >or = concentration time • Rainfall uniformly distributed in time and space • Runoff is primarily overland flow • Negligible channel storage 	Time of Concentration Drainage area Runoff coefficient Rainfall intensity (http://hdsc.nws.noaa.gov/hdsc/pfds/)
USGS Regional Regression Equations: USGS Water-Resources Investigation 77-21* Improved Highway Design Methods for Desert Storms	<ul style="list-style-type: none"> • Catchment area limit varies by region • Basin not located on floor of Sacramento or San Joaquin Valleys • Peak discharge value for flow under natural conditions unaffected by urban development and little or no regulation by lakes or reservoirs • Ungaged channel 	Drainage area Mean annual precipitation Altitude index
NRCS (TR55)	<ul style="list-style-type: none"> • Small or midsize catchment (< 3 square miles) • Concentration time range from 0.1-10 hour (tabular hydrograph method limit < 2 hour) • Runoff is overland and channel flow • Simplified channel routing • Negligible channel storage 	24-hour rainfall Rainfall distribution Runoff curve number Concentration time Drainage area
Unit Hydrograph (Gaged data) Synthetic Unit Hydrograph SCS Unit Hydrograph S-Graph Unit Hydrograph	<ul style="list-style-type: none"> • Midsize or large catchment (0.20 square miles to 1,000 square miles) • Uniformity of rainfall intensity and duration • Rainfall-runoff relationship is linear • Duration of direct runoff constant for all uniform-intensity storms of same duration, regardless of differences in the total volume of the direct runoff. • Time distribution of direct runoff from a given storm duration is independent of concurrent runoff from preceding storms • Channel-routing techniques used to connect streamflows 	Rainfall hyetograph and direct runoff hydrograph for one or more storm events Drainage area and lengths along main channel to point on watershed divide and opposite watershed centroid (Synthetic Unit Hydrograph)
Statistical (gage data) Log-Pearson Type III Bulletin #17B – U.S. Department of the Interior	<ul style="list-style-type: none"> • Midsized and large catchments with stream gage data • Appropriate station and/or generalized skew coefficient relationship applied • Channel storage 	10 or more years of gaged flood records
Basin Transfer of Gage Data	<ul style="list-style-type: none"> • Similar hydrologic characteristics • Channel storage 	Discharge and area for gaged watershed Area for ungaged watershed

*Magnitude and Frequency of Floods in California

July 1, 2020

- (a) If the site is on the same stream and near a gaging station, peak discharges at the gaging station can be adjusted to the site by drainage area ratio and application of some appropriate power to each drainage area. The USGS may be helpful in suggesting appropriate powers to be used for a specific hydrologic region.
- (b) If a design hydrograph can be developed at an upstream point in the same watershed, the procedure described in HDS No. 2 can be used to route the design hydrograph to the point of interest.
- (c) IDF curve generating software, such as NOAA's Atlas 14, have internal routines that provide interstation interpolation that accounts not only for distance from gauge stations, but other factors, such as elevation. No additional effort is required by the designer to address distance/location effects.

819.6 Hydrologic Software

Most simulation models require a significant amount of input data that must be carefully examined by a competent and experienced user with an understanding of the mathematical nuances of the model and the hydrologic nuances of the particular catchment to assure reliable results.

See Table 808.1 for hydrologic software packages that have been reviewed and deemed compatible with Departmental procedures.

A summary of hydrologic software is listed in Table 808.1. Several of those listed are described below.

Watershed Modeling System (WMS) is a comprehensive environment for hydrologic analysis. It was developed by the Engineering Computer Graphics Laboratory of Brigham Young University in cooperation with the U.S. Army Corps of Engineers Waterways Experiment Station (WES).

WMS merges information obtained from terrain models and GIS with industry standard hydrologic analysis models such as HEC-HMS and TR-55.

Terrain models can obtain geometric attributes such as area, slope and runoff distances. Many display options are provided to aid in modeling and understanding the drainage characteristics of terrain surfaces.

WMS uses three primary data sources for model development:

- (1) Geographic Information Systems (GIS) Data
- (2) Digital Elevation Models (DEMs) published by the U.S. Geological Survey (USGS) at both 1:24,000 and 1:250,000 for the entire U.S. (the 1:24,000 data coverage is not complete)
- (3) Triangulated Irregular Networks (TINs)

Automated basin delineation, slope calculation, and basin characteristics are some of the many features available within USGS StreamStats. See; <http://water.usgs.gov/osw/streamstats/>.

AutoDesk Civil 3D/Hydraflow uses NRCS, Rational and Modified Rational methods to generate runoff hydrographs, however, HEC-HMS provides more comprehensive modeling options for runoff and channel flow.

Two other hydrologic software models that are commonly used are the Army Corps of Engineers' HEC-HMS and the National Resources Conservation Service's TR-20 Method.

The NOAA Atlas 14 product is the preferred IDF tool for State highway projects. See <http://hdsc.nws.noaa.gov/hdsc/pfds/>.

819.7 Region-Specific Analysis

(1) *Desert Hydrology*. Figure 819.7A shows the different desert regions in California, each with distinct hydrological characteristics that will be explained in this section.

(a) Storm Type

Summer Convective Storms – In the southern desert regions (Owens Valley/Mono Lake, Mojave Desert, Sonoran Desert and the Colorado Desert), the dominant storm type is the local thunderstorm, specifically summer convective storms. These storms are characterized by their short duration, over a relatively small area (generally less than 20 mi²), and intense rainfall, which may result in flash floods. These summer convective storms may occur at any time during the year, but are most common and intense during the summer. General summer storms can also occur over these desert regions, but are rare, and usually occur from mid-August to early October. The rainfall intensity can vary from heavy rainfall to heavy thunderstorms.

General Winter Storm – In the Antelope Valley and Northern Basin and Range regions, the dominant storm type is the general winter storm. These storms are characterized by their long duration, 6 hours to 12 hours or more, and possibly intermittently for 3 days to 5 days over a relatively large area. General winter storms produce the majority of large peaks in the northern desert areas; the majority of the largest peaks discharge greater than or equal to 20 cfs/mi² occurred during the winter and fall months in the Owens Valley/Mono Lake and Northern Basin and Range regions. At elevations above 6,000 ft, much of the winter precipitation falls as snow; however, snowfall doesn't play a significant role in flood-producing runoff in the southern desert regions (Colorado Desert, Sonoran Desert, Antelope Valley and Mojave Desert). In the northern desert regions (Owens Valley/Mono Lake and Northern Basin and Range), more floods from snowmelt occur at lower elevations; more than 50 percent of runoff events occurred in spring, most likely snowmelt, but did not produce large floods.

(b) Regional Regression

Newly developed equations for California's Desert regions are shown on Table 819.7A.

While the regression equations for the Northern Basin and Range region provide more accurate results than previous USGS developed equations, there is some uncertainty associated with them. Therefore, the development of a rainfall-runoff model may be preferable for ungaged watersheds in this region.

July 1, 2020

Figure 819.7A

Desert Regions in California

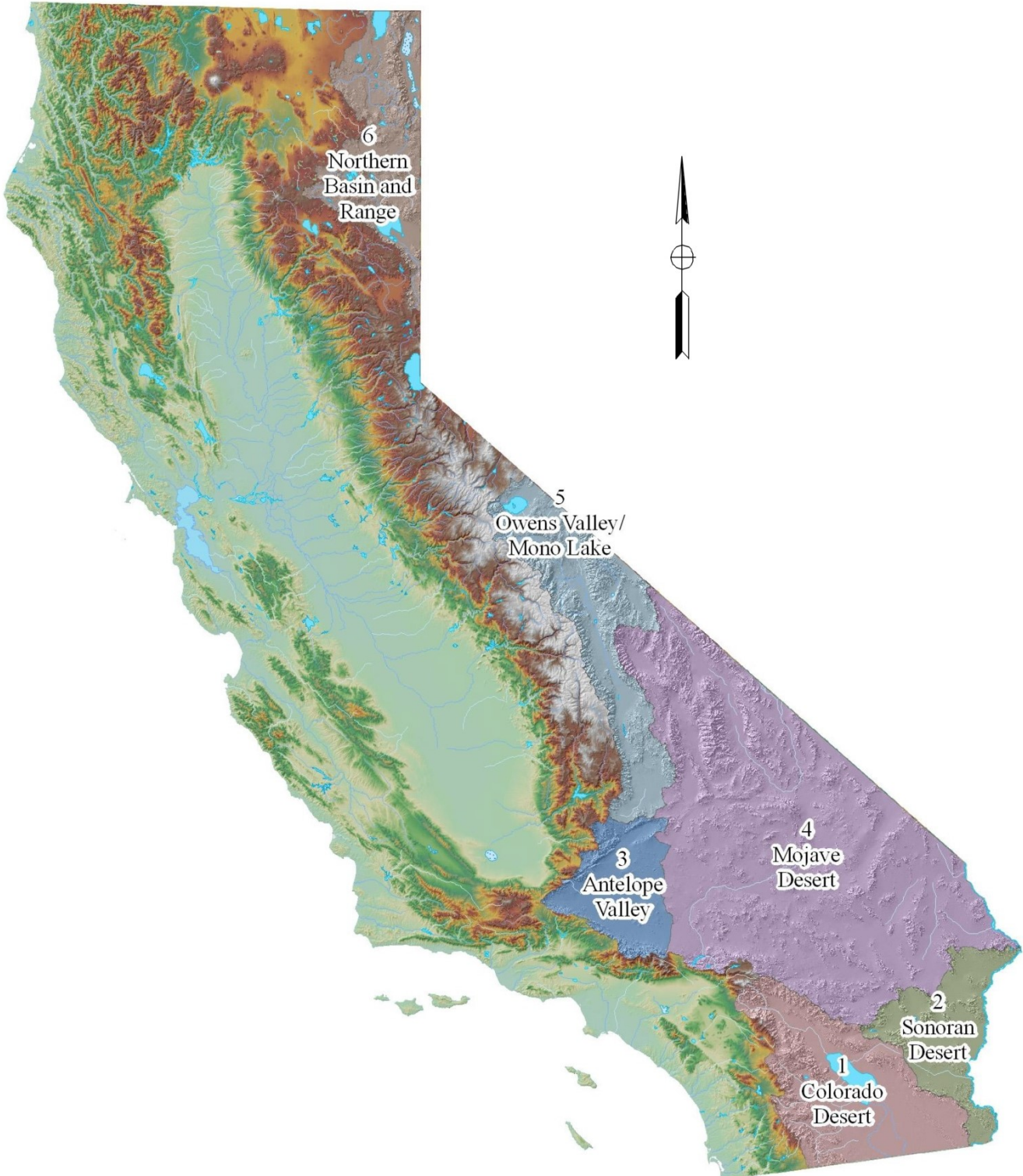

Table 819.7A

Regional Regression Equations for California’s Desert Regions

Region(s)	Associated Regression Equations
Colorado Desert Sonoran Desert Antelope Valley Mojave Desert	$Q_2 = 8.57A^{0.5668} \qquad Q_{25} = 291.04A^{0.5939}$ $Q_5 = 80.32A^{0.541} \qquad Q_{50} = 397.82A^{0.6189}$ $Q_{10} = 146.33A^{0.549} \qquad Q_{100} = 557.31A^{0.6619}$
Owens Valley / Mono Lake	$Q_2 = 0.007A^{1.839} \left[\frac{ELEV}{1000} \right]^{1.485} \left[\frac{LAT - 28}{10} \right]^{-0.680}$ $Q_5 = 0.212A^{1.404} \left[\frac{ELEV}{1000} \right]^{0.882} \left[\frac{LAT - 28}{10} \right]^{-0.030}$ $Q_{10} = 1.28A^{1.190} \left[\frac{ELEV}{1000} \right]^{0.531} \left[\frac{LAT - 28}{10} \right]^{0.525}$ $Q_{25} = 9.70A^{0.962} \left[\frac{ELEV}{1000} \right]^{0.107} \left[\frac{LAT - 28}{10} \right]^{1.199}$ $Q_{50} = 34.5A^{0.829} \left[\frac{ELEV}{1000} \right]^{-0.170} \left[\frac{LAT - 28}{10} \right]^{1.731}$ $Q_{100} = 111A^{0.707} \left[\frac{ELEV}{1000} \right]^{-0.429} \left[\frac{LAT - 28}{10} \right]^{2.241}$
Northern Basin & Range	$Q_2 = 5.320A^{0.415} \left[\frac{H}{1000} \right]^{0.928}$ $Q_5 = 29.71A^{0.360} \left[\frac{H}{1000} \right]^{0.296}$ $Q_{10} = 85.76A^{0.314} \left[\frac{H}{1000} \right]^{-0.109}$ $Q_{25} = 275.5A^{0.253} \left[\frac{H}{1000} \right]^{-0.555}$ $Q_{50} = 616.9A^{0.281} \left[\frac{H}{1000} \right]^{-0.867}$ $Q_{100} = 1293A^{0.166} \left[\frac{H}{1000} \right]^{-1.154}$

July 1, 2020

(c) Rational Method

The recommended upper limit for California's desert regions is 160 acres (0.25 mi²).

Table 819.7B lists common runoff coefficients for Desert Areas. These coefficients are applicable for storms with 2-year to 10-year return intervals, and should be adjusted for larger, less frequent storms by multiplying the coefficient by an appropriate frequency factor, C(f), as stated in Index 819.2(1) of this manual. The frequency factors, C(f), for 25-year, 50-year and 100-year storms are 1.1, 1.2 and 1.25, respectively. Under no circumstances should the product of C(f) times the runoff coefficient exceed 1.0. It is recommended not to use a value that exceeds 0.95.

(d) Rainfall-Runoff Simulation

A rainfall-runoff simulation approach uses a numerical model to simulate the rainfall-runoff process and generate discharge hydrographs. It has four main components: rainfall; rainfall losses; transformation of effective rainfall; and channel routing.

(1) Rainfall

(a) Design Rainfall Criteria

The selection of an appropriate storm duration depends on a number of factors, including the size of the watershed, the type of rainfall-runoff approach and hydrologic characteristics of the study watershed. Watershed sizes are analyzed below and are applied to California's Desert regions in Table 819.7C.

Drainage Areas ≤ 20 mi² – Drainage areas less than 20 mi² are primarily representative of summer convective storms, and usually occur in the southern desert regions (Colorado Desert, Sonoran Desert, Antelope Valley and Mojave Desert regions). Since these storms usually result in intense rainfall, over a small drainage area and are generally less than 6 hours, it is recommended that a 6-hour local design storm be utilized.

Drainage Areas > 20 mi² & ≤ 100 mi² – For drainage areas between 20 mi² and 100 mi², the critical storm can be a summer convective storm or a general thunderstorm. For these drainage areas, it is recommended that both 6-hour and 24-hour design storm be analyzed, and the storm that produces the largest peak discharge be chosen as the design basis.

Drainage Areas > 100 mi² – Since general storms usually cover a larger area and have a longer duration, for drainage areas greater than 100 mi², a 24-hour design storm is recommended.

(b) Depth-Duration-Frequency Characteristics

In 2011, NOAA published updated precipitation-frequency estimates for all of California including the desert regions, often cited as NOAA Atlas 14. This information is available online, via the Precipitation Frequency Data Server at <http://hdsc.nws.noaa.gov/hdsc/pfds/>. NOAA Atlas 14 supersedes NOAA's previous effort, NOAA Atlas 2, the 2004 Atlas 14 which covered the Southwestern U.S., and California's Department of Water Resources (DWR) Bulletin No. 195, where their coverages overlap.

Table 819.7B**Runoff Coefficients for Desert Areas**

Type of Drainage Area	Runoff Coefficient
Undisturbed Natural Desert or Desert Landscaping (without impervious weed barrier)	0.30 – 0.40
Desert Landscaping (with impervious weed barrier)	0.55 – 0.85
Desert Hillslopes	0.40 – 0.55
Mountain Terrain (slopes greater than 10%)	0.60 – 0.80

Table 819.7C**Watershed Size for California Desert Regions**

Desert Region	Duration (based on Watershed size)
Southern Regions (Colorado Desert, Sonoran Desert, Antelope Valley and Mojave Desert)	6-hour local storm ($\leq 20 \text{ mi}^2$) 6-hour local storm and 24-hour general storm (between 20 mi^2 & 100 mi^2); use the larger peak discharge 24-hour general storm ($> 100 \text{ mi}^2$)
Northern Regions (Owens Valley/Mono Lake and Northern Basin and Range)	24-hour general storm

July 1, 2020

NOAA Atlas 14 provides a vast amount of information, which includes:

- Point Estimates
- ESRI shapefiles and ArcInfo ASCII grids
- Color cartographic maps: all possible combination of frequencies (2-year to 1,000-year) and durations (5-minute to 60-day)
- Associated Federal Geographic Data Committee-compliant metadata
- Data series used in the analysis: annual maximum series and partial duration series
- Temporal distributions of heavy precipitation (6-hour, 12-hour, 24-hour and 96-hour)
- Seasonal exceedance graphs: counts of events that exceed the 1 in 2, 5, 10, 25, 50 and 100 annual exceedance probabilities for the 60-minute, 24-hour, 48-hour and 10-day durations

(c) Depth-Area Reduction

Depth-area reduction is the method of applying point rainfall data from one or several gaged stations within a watershed to that entire watershed. NOAA Atlas 14 provides high resolution depth-duration frequency point data which can then be computed with other depth-duration frequency data in that cell to obtain an average depth-duration frequency over a watershed. However, as this data is available as point data, the average calculated depth-duration frequency may not represent an entire watershed. To convert this point data into watershed area, a conversion factor may be applied, of which, two methods are available: applying a reduction factor; or applying depth-area reduction curves.

NOAA is currently working on updating the reduction factors, thus, until then, the depth-area reduction curves are recommended. Two depth-area reduction curves are available: (1) the depth curves in National Weather Service's HYDRO-40

http://www.nws.noaa.gov/oh/hdsc/PF_related_studies/TechnicalMemorandum_HYDRO40.pdf; and (2) the depth curves in NOAA Atlas 2. The general consensus is that the depth curves from HDRO-40 better represent the desert areas of California, and are recommended for the southern desert regions (Colorado Desert, Sonoran Desert, Antelope Valley and the Mojave Desert). For the upper regions (Owens Valley/Mono Lake and Northern Basin and Range), the curves from NOAA Atlas 2 are recommended.

The variables needed to apply depth area reduction curves to a watershed are a storm frequency (i.e., a 100-year storm), storm duration (i.e., a 30-minute storm), and the area of a watershed. For example, if a 100-year storm with a duration of 60-minute were to be analyzed over a desert watershed of 25 mi², then using Figure 819.7B, the Depth-Area Ratio would be 0.64.

Figure 819.7B

Example Depth-Area Reduction Curve

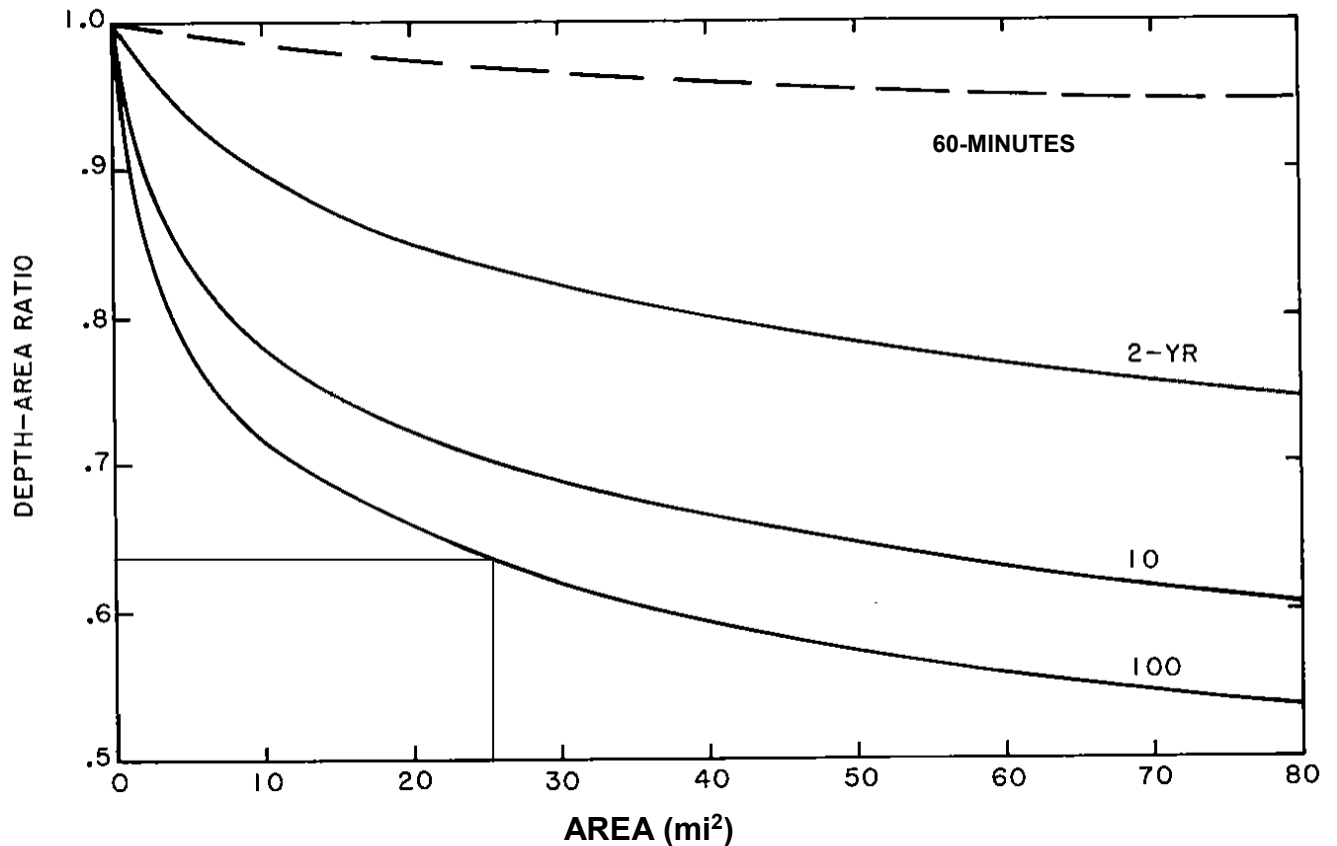

This ratio would then be multiplied by the averaged point- rainfall data, which would then result in the rainfall over the entire watershed.

Point rainfall data is available from NOAA Atlas 14, which must then be converted to area rainfall data. Conversions are available in two forms: (1) the National Weather Service's HYDRO-40, and (2) NOAA Atlas 2. The National Weather Service's HYDRO-40 is recommended for the southern desert regions (Colorado Desert, Sonoran Desert, Antelope Valley and Mojave Desert.) NOAA Atlas 2 is recommended for the northern desert regions (Owens Valley/Mono Lake and Northern Basin and Range).

(2) Rainfall Losses

Antecedent Moisture Condition – The Antecedent Moisture Condition (AMC) is the amount of moisture present in the soil before a rainfall event, or conversely, the amount of moisture the soil can absorb before becoming saturated (Note: the AMC is also referred to as the Antecedent Runoff Condition [ARC]). Once the soil is saturated, runoff will occur. Generally, the AMC is classified into three levels:

- AMC I – Lowest runoff potential. The watershed soils are dry enough to allow satisfactory grading or cultivation to take place.

July 1, 2020

- AMC II – Moderate runoff potential. AMC II represents an average study condition.
- AMC III – Highest runoff potential. The watershed is practically saturated from antecedent rainfall.

Because of the different storm types present in California's desert regions, AMC I is recommended as design criteria for local thunderstorms, and AMC II is recommended as design criteria for general storms.

Curve Number – The curve number was developed by the then Soil Conservation Service (SCS), which is now called the National Resource Conservation Service (NRCS). The curve number is a function of land use, soil type and the soil's AMC, and is used to describe a drainage area's storm water runoff potential. The soil type(s) are typically listed by name and can be obtained in the form of a soil survey from the local NRCS office. The soil surveys classify and present the soil types into 4 different hydrological groups, which are shown in Table 819.7D. From the hydrological groups, curve numbers are assigned for each possible land use-soil group combinations, as shown in Table 819.7E. The curve numbers shown in

Table 819.7D**Hydrologic Soil Groups**

Hydrologic Soil Group	Soil Group Characteristics
A	Soils having high infiltration rates, even when thoroughly wetted and consisting chiefly of deep, well to excessively-drained sands or gravels. These soils have a high rate of water transmission.
B	Soils having moderate infiltration rates when thoroughly wetted and consisting of moderately deep to deep, moderately fine to moderately coarse textures. These soils have a moderate rate of water transmission.
C	Soils having slow infiltration rates when thoroughly wetted and consisting chiefly of soils with a layer that impedes downward movement of water, or soils with moderately fine to fine texture. These soils have a slow rate of water transmission.
D	Soils having very slow infiltration rates when thoroughly wetted and consisting chiefly of clay soils with a high swelling potential, soils with a permanent high water table, soils with a claypan or clay layer at or near the surface, and shallow soils over nearly impervious material. These soils have a very slow rate of water transmission.

Table 819.7E are representative of AMC II, and need to be converted to represent AMC I, and AMC III, respectively. The following equations to convert an AMC II curve number to an AMC I or AMC III curve number, using a five-day period as the minimum for estimating the AMC's:

$$CN_{AMCI} = \frac{4.2CN_{AMCII}}{10 - 0.058CN_{AMCII}}$$

$$CN_{AMCIII} = \frac{23CN_{AMCII}}{10 + 0.13CN_{AMCII}}$$

Note: The AMC of a storm area may vary during a storm; heavy rain falling on AMC I soil can change the AMC from I to II or III during the storm.

(3) Transformation

Total runoff can be characterized by two types of runoff flow: direct runoff and base flow. Direct runoff is classified as storm runoff occurring during or shortly after a storm event. Base flow is classified as subsurface runoff from prior precipitation events and delayed subsurface runoff from the current storm. The transformation of precipitation runoff to excess can be accomplished using a unit hydrograph approach. The unit hydrograph method is based on the assumption that a watershed, in converting precipitation excess to runoff, acts as a linear, time-invariant system.

Unit Hydrograph Approach:

A unit hydrograph for a drainage area is a curve showing the time distribution of runoff that would result at the concentration point from one inch of effective rainfall over the drainage area above that point.

The unit hydrograph method assumes that watershed discharge is related to the total volume of runoff, that the time factors that affect the unit hydrograph shape are invariant, and that watershed rainfall-runoff relationships are characterized by watershed area, slope and shape factors.

(a) SCS Unit Hydrograph

The SCS dimensionless unit hydrograph is based on averages of unit hydrographs derived from gaged rainfall and runoff for a large number of small rural basins throughout the U.S. The definition of the SCS unit hydrograph normally only requires one parameter, which is lag, defined as the time from the centroid of precipitation excess to the time of the peak of the unit hydrograph. For ungaged watersheds, the SCS suggests that the unit hydrograph lag time, t_{lag} , may be related to time of concentration t_c , through the following relation:

$$t_{lag} = 0.6t_c$$

The time of concentration is the sum of travel time through sheet flow, shallow concentrated flow, and channel flow segments. A typical SCS Unit Hydrograph is similar to Figure 816.5.

A unit hydrograph can be derived from observed rainfall and runoff, however either may be unavailable. In such cases, a synthetic unit hydrograph can be developed using the S-graph method.

July 1, 2020

Table 819.7E

Curve Numbers for Land Use-Soil Combinations

Description	Average % Impervious	Curve Number by Hydrological Soil Group				Typical Land Uses
		A	B	C	D	
Residential (High Density)	65	77	85	90	92	Multi-Family, Apartments, Condos, Trailer Parks
Residential (Medium Density)	30	57	72	81	86	Single-Family, Lot Size ¼ to 1 acre
Residential (Low Density)	15	48	66	78	83	Single-Family, Lot Size 1 acre or greater
Commercial	85	89	92	94	95	Strip Commercial, Shopping Centers, Convenience Stores
Industrial	72	81	88	91	93	Light Industrial, Schools, Prisons, Treatment Plants
Disturbed / Transitional	5	76	85	89	91	Gravel Parking, Quarries, Land Under Development
Agricultural	5	67	77	83	87	Cultivated Land, Row Crops, Broadcast Legumes
Open Land – Good	5	39	61	74	80	Parks, Golf Courses, Greenways, Grazed Pasture
Meadow	5	30	58	71	78	Hay Fields, Tall Grass, Ungrazed Pasture
Woods (Thick Cover)	5	30	55	70	77	Forest Litter and Brush adequately cover soil
Woods (Thin Cover)	5	43	65	76	82	Light Woods, Woods-Grass Combination, Tree Farms
Impervious	95	98	98	98	98	Paved Parking, Shopping Malls, Major Roadways
Water	100	100	100	100	100	Water Bodies, Lakes, Ponds, Wetlands

(b) S-graph

An S-graph is a summation hydrograph of runoff that would result from the continuous generation of unit storm effective rainfall over the area (1-inch per hour continuously). The S-graph method uses a basic time-runoff relationship for a watershed type in a form suitable for application to ungaged basins, and is based upon percent of ultimate discharge and percent of lag time. Several entities, including local and Federal agencies, have developed location-specific S-Graphs that are applicable to California's desert regions.

The ordinate is expressed in percent of ultimate discharge, and the abscissa is expressed in percent of lag time. Ultimate discharge, which is the maximum discharge attainable for a given intensity, occurs when the rate of runoff on the summation hydrograph reaches the rate of effective rainfall.

Lag for a watershed is an empirical expression of the hydrologic characteristics of a watershed in terms of time. It is defined as the elapsed time (in hours) from the beginning of unit effective rainfall to the instant that the summation hydrograph for the point of concentration reaches 50 percent of ultimate discharge. When the lags determined from summation hydrographs for several gaged watersheds are correlated to the hydrologic characteristics of the watersheds, an empirical relationship is usually apparent. This relationship can then be used to determine the lags for comparable ungaged drainage areas for which the hydrologic characteristics can be determined, and a unit hydrograph applicable to the ungaged watersheds can be easily derived.

Figure 819.7C is a sample illustration of a San Bernardino County S-Graph, while Figure 819.7D shows an example S-Graph from USBR.

Recommendations:

For watersheds with mountainous terrain/high elevations in the upper portions, the San Bernardino County Mountain S-Graph (<http://www.sbcounty.gov/dpw/floodcontrol/pdf/HydrologyManual.pdf>) is recommended. For watersheds in the southern desert regions with limited or no mountainous terrain/high elevations, the San Bernardino County Desert S-Graph (<http://www.sbcounty.gov/dpw/floodcontrol/pdf/HydrologyManual.pdf>) is recommended. The U.S. Bureau of Reclamation (USBR) S-Graph (http://www.usbr.gov/pmts/hydraulics_lab/pubs/manuals/SmallDams.pdf) is recommended for watersheds in the Northern Basin and Range.

As an alternative to the above mentioned S-Graphs, the SCS Unit Hydrograph may also be used.

(4) Channel Routing

Channel routing is a process used to predict the temporal and spatial variation of a flood hydrograph as it moves through a river reach. The effects of storage and flow resistance within a river reach are reflected by changes in hydrograph shape and timing as the flood wave moves from upstream to downstream. The four commonly used methods are the kinematic wave routing, Modified Puls routing, Muskingum routing, and Muskingum-Cunge routing. The advantages and disadvantages for each method are described in Table 819.7F. Table 819.7G provides guidance for selecting an appropriate routing method. The Muskingum-Cunge routing method can handle a wide range of flow conditions with the exception of significant backwater. The Modified Puls routing can model backwater effects. The kinematic wave routing method is often applied in urban areas with well defined channels.

July 1, 2020

Figure 819.7C

San Bernardino County Hydrograph for Desert Areas

Discharge in Percent of Ultimate Discharge (K)

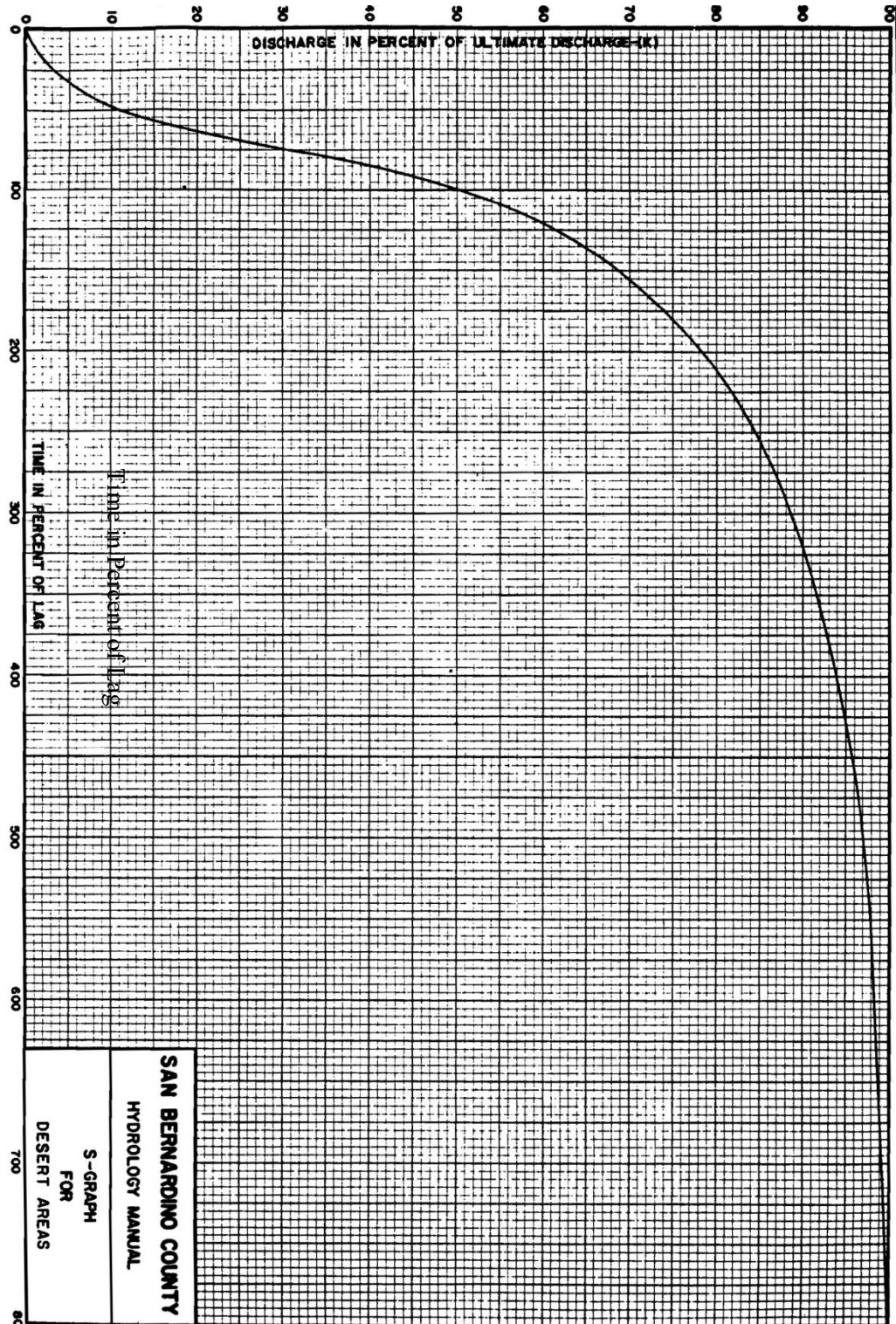
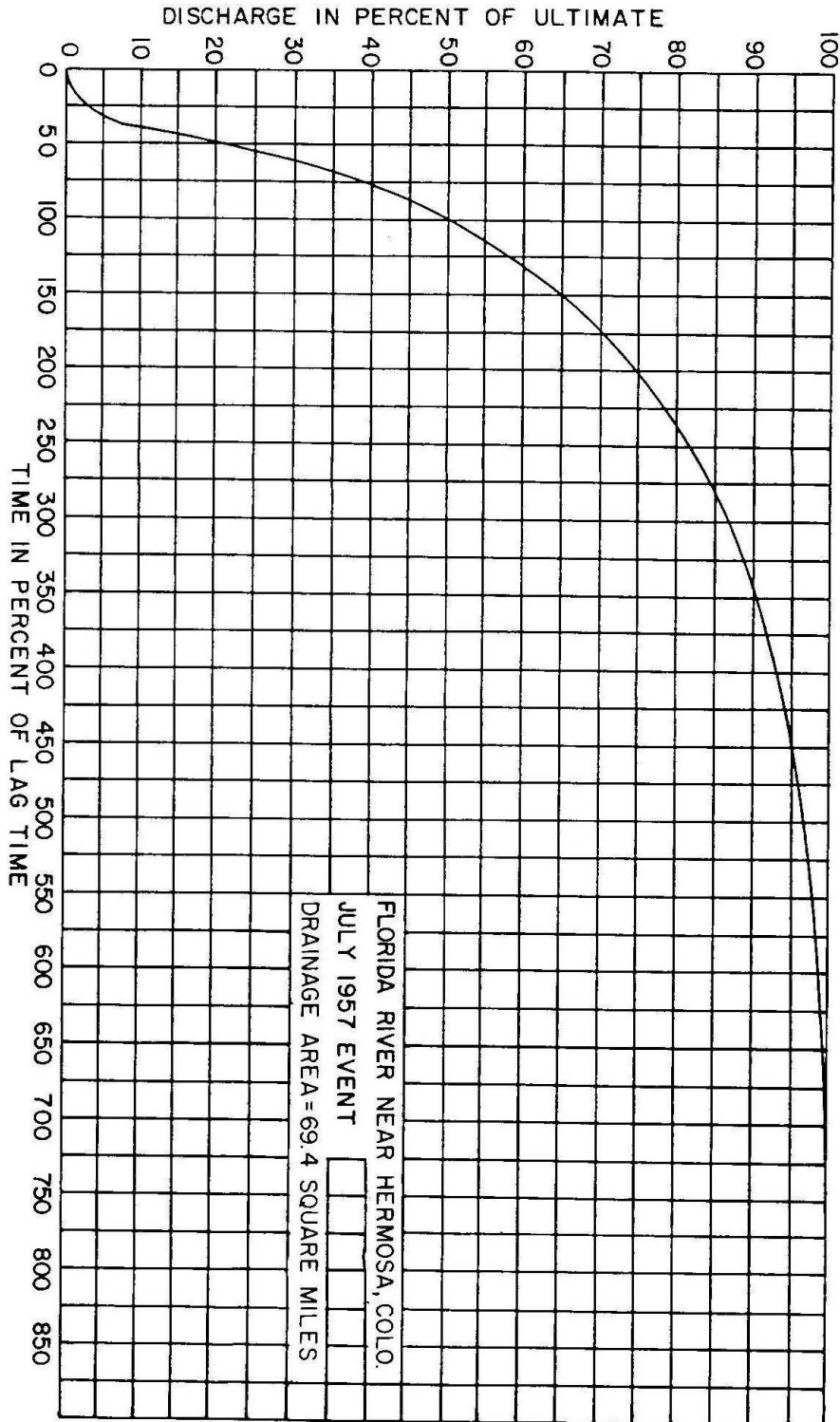

Figure 819.7D

USBR Example S-Graph



July 1, 2020

(5) Storm Duration and Temporal Distribution

Temporal distribution is the time-related distribution of the precipitation depth within the duration of the design storm. Temporal distribution patterns of design storms are based on the storm duration. The temporal distribution pattern for short-duration storms represents a single cloudburst and is based on rainfall statistics. The temporal distribution for long-duration storms resembles multiple events and is patterned after historic events. Since the storm events in California's desert regions are made up of two distinct separate storm types, the summer convective storm and the general winter storm, the design storm durations should be adjusted accordingly. For California's desert regions, the 100-year 6-hour storm is recommended for the convective storms, and the 100-year 24-hour storm is recommended for the winter storms. Table 819.7H summarizes the design storm durations for the different desert regions throughout California.

(2) Sediment/Debris Bulking

The process of increasing the water volume flow rate to account for high concentrations of sediment and debris is defined as bulking. Debris carried in the flow can be significant and greatly increase flow volume conveyed from a watershed. This condition occurs frequently in mountainous areas subject to wildfires with soil erosion, as well as arid regions around alluvial fans and other geologic activity. By bulking the flow through the use of an appropriate bulking factor, bridge openings and culverts can be properly sized for areas that experience high sediment and debris concentration.

(a) Bulking Factor

Bulking factors are applied to a peak (clear-water) flow to obtain a total or bulked peak flow, which provides a safety factor in the sizing of hydraulic structures. For a given watershed, a bulking factor is typically a function of the historical concentration of sediment in the flow.

(b) Types of Sediment/Water Flow

The behavior of flood flows will vary depending on the concentration of sediment in the mixed flow, where the common flow types are normal stream flow, hyperconcentrated flow, and debris flow.

(1) Normal Stream Flow

During normal stream flow, the sediment load minimally influences flow behavior or characteristics. Because sediment has little impact, this type of flow can be analyzed as a Newtonian fluid and standard hydraulic methods can be used. The upper limit of sediment concentration by volume for normal stream flow is 20 percent and bulking factors are applied cautiously because of the low concentration. (See Table 819.7I) The small amount of sediment is conveyed by conventional suspended load and bed-load.

(2) Hyperconcentrated Flow

Hyperconcentrated flow is more commonly known as mud flow. Because of potential for large volumes of sand in the water column, fluid properties and transport characteristics change and the mixture does not behave as a Newtonian fluid. However, basic hydraulic methods and models are still generally accepted and used for up to 40 percent sediment concentration by volume. For hyperconcentrated flow, bulking factors vary between 1.43 and 1.67 as shown in Table 819.7I.

Table 819.7F

Channel Routing Methods

Routing Method	Pros	Cons
Kinematic Wave	<ul style="list-style-type: none"> ▪ A conceptual model assuming a uniform flow condition. ▪ In general, works best for steep (10 ft/mile or greater), well defined channels. ▪ It is often applied in urban areas because the routing reaches are generally short and well-defined. 	<ul style="list-style-type: none"> ▪ Cannot handle hydrograph attenuation, significant overbank storage, and backwater effects.
Modified Puls	<ul style="list-style-type: none"> ▪ Known as storage routing or level-pool routing. ▪ Can handle backwater effects through the storage-discharge relationship. 	<ul style="list-style-type: none"> ▪ Need to use hydraulic model to define the required storage-outflow relationship.
Muskingum	<ul style="list-style-type: none"> ▪ Directly accommodates the looped relationship between storage and outflow. ▪ A linear routing technique that uses coefficients to account for hydrograph timing and diffusion. 	<ul style="list-style-type: none"> ▪ The coefficients cannot be used to model a range of floods that may remain in bank or go out of bank. Therefore, not applicable to significant overbank flows.
Muskingum-Cunge	<ul style="list-style-type: none"> ▪ A nonlinear coefficient method that accounts for hydrograph diffusion based on physical channel properties and the inflowing hydrograph. ▪ The parameters are physically based. ▪ Has been shown to compare well against the full unsteady flow equations over a wide range of flow conditions. 	<ul style="list-style-type: none"> ▪ It cannot account for backwater effects. ▪ Not very applicable for routing a very rapidly rising hydrograph through a flat channel.

July 1, 2020

Table 819.7G

Channel Method Routing Guidance

IF THIS IS TRUE...	... THEN THIS ROUTING MODEL MAY BE CONSIDERED.
No observed hydrograph data available for calibration	Kinematic wave; Muskingum-Cunge
Significant backwater will influence discharge hydrograph	Modified Puls
Flood wave will go out of bank, into floodplain.	Modified Puls; Muskingum-Cunge with 8-point cross section
Channel slope > 0.002 and $\frac{TS_o u_o}{d_o} \geq 171$	Any
Channel slopes from 0.002 to 0.0004 and $\frac{TS_o u_o}{d_o} \geq 171$	Muskingum-Cunge; Modified Puls; Muskingum
Channel slope < 0.0004 and $TS_o \left(\frac{g}{d_o}\right)^{1/2} \geq 30$	Muskingum-Cunge
Channel slope < 0.0004 and $TS_o \left(\frac{g}{d_o}\right)^{1/2} < 30$	None

Notes:

- T = hydrograph duration
- u_o = reference mean velocity
- d_o = reference flow depth
- S_o = channel slope

Table 819.7H

Design Storm Durations

Drainage Area	Desert Region	100-year, 6-hour Convective Storm (AMC I)	100-year, 24-hour General Storm (AMC II)	Regional Regression Equations
< 20 mi ²	Colorado Desert	X		
	Sonoran Desert	X		
	Mojave Desert	X		
	Antelope Valley Desert	X		
> 20 mi ²	Colorado Desert	X*	X*	
	Sonoran Desert	X*	X*	
	Mojave Desert	X*	X*	
	Antelope Valley Desert	X*	X*	
	Owens Valley/Mono Lake			X**
	Northern Basin & Range		X	

*For watersheds greater than 20 mi² in the southern desert regions, both the 6-hour Convective Storm (AMC I) and the 24-hour General Storm (AMC II) should be analyzed and the larger of the two peak discharges selected.

**The use of regional regression equations is recommended where streamgauge data are not available; otherwise, hydrologic modeling could be performed with snowmelt simulation.

July 1, 2020

(3) Debris Flow

In debris flow state, behavior is primarily controlled by the composition of the sediment and debris mixture, where the volume of clay can have a strong influence in the yield strength of the mixture.

During debris flow, which has an upper limit of 50 percent sediment concentration by volume, the sediment/debris/water mixture no longer acts as a Newtonian fluid and basic hydraulic equations do not apply. If detailed hydraulic analysis or modeling of a stream operating under debris flow is needed, FLO2DH is the recommended software choice given its specific debris flow capabilities. HEC-RAS is appropriate for normal stream flow and hyperconcentrated flow, but cannot be applied to debris flow.

For a typical debris flow event, clear-water flow occurs first, followed by a frontal wave of mud and debris. Low frequency events, such as the 100-year flood, most likely contain too much water to produce a debris flow event. Normally, smaller higher frequency events such as 10-year or 25-year floods actually have a greater probability of yielding a debris flow event requiring a higher bulking factor.

As outlined in Table 819.7I, bulking factors for debris flow vary between 1.67 and 2.00.

(c) Sediment/Debris Flow Potential

(1) Debris Hazard Areas

Mass movement of rock, debris, and soil is the main source of bulked flows. This can occur in the form of falls, slides, or flows. The volume of sediment and debris from mass movement can enter streams depending upon hydrologic and geologic conditions.

The location of these debris-flow hazards include:

- (a) At or near the toe of slope 2:1 or steeper
- (b) At or near the intersection of ravines and canyons
- (c) Near or within alluvial fans
- (d) Soil Slips

Soil slips commonly occur at toes of slope between 2:1 and 3:1. Flowing mud and rocks will accelerate down a slope until the flow path flattens. Once energy loss occurs, rock, mud, and vegetation will be deposited. Debris flow triggered by soil slips can become channelized and travel distances of a mile or more. Figure 819.7E shows the potential of soil slip versus slope angle. As seen in this Figure, the flatter the slope angle, the less effect on flow speed and acceleration.

(2) Geologic Conditions

In the Transverse Ranges that include the San Gabriel and San Bernardino Mountains along the southern and southwestern borders of the Antelope Valley (Region 3) and Mojave Desert (Region 4), their substrate contains sedimentary rocks, fractured basement rocks, and granitic rocks. This type of geology has a high potential of debris flow from the hillsides of these regions.

While debris flow potential is less prevalent, it is possible to have this condition in the Peninsula Ranges that include the San Jacinto, Santa Rosa, and Laguna Mountains along the western border of the Colorado Desert (Region 1).

Table 819.7I

Bulking Factors & Types of Sediment Flow

Sediment Flow Type	Bulking Factor	Sediment Concentration by Weight	Sediment Concentration by Volume
		(100% by WT = 1 x 10 ⁶ ppm)	(specific gravity = 2.65)
Normal Streamflow	0	0	0
	1.11	23	10
	1.25	40	20
Hyperconcentrated Flow	1.43	52	30
	1.67	53	40
Debris Flow	2.00	72	50
Landslide	2.50	80	60
	3.33	87	70

Figure 819.7E

Soil Slips vs. Slope Angle

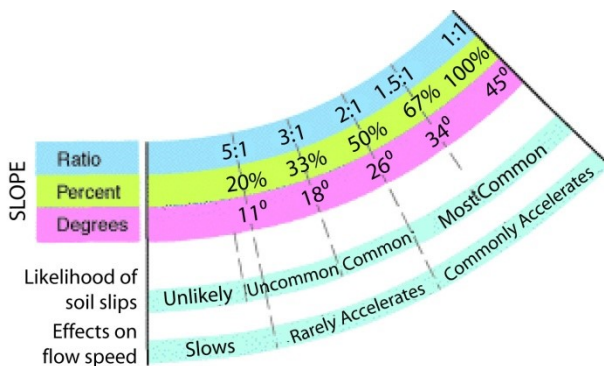

(d) Alluvial Fans

An alluvial fan is a landform located at the mouth of a canyon, formed in the shape of a fan, and created over time by deposition of alluvium. With the apex of the fan at the mouth of a canyon, the base of the fan is spread across lower lying plains below the apex. Over time, alluvial fans change and evolve when sediment conveyed by flood flows or debris flows is deposited in active channels, which creates a new

July 1, 2020

channel within the fan. Potentially, alluvial fan flood and debris flows travel at high velocity, where large volumes of sediment can be eroded from mountain canyons down to the lower fan surface. Given this situation, the alignments of the active channels and the overall footprint of an alluvial fan are dynamic. Also, the concentration of sediment /debris volume is dynamic, ranging from negligible to 50 percent.

Alluvial fans can be found on soil maps, geologic maps, topographic maps, and aerial photographs, in addition to the best source which is a site visit. An example of an alluvial fan, shown in plan view, is in Figure 819.7F and Figure 872.3.

(e) Wildfire and Debris Flow

After fires have impacted a watershed, sediment/debris flows are caused by surface erosion from rainfall runoff and landsliding due to rainfall infiltration into the soil. The most dominant cause is the runoff process because fire generally reduces the infiltration and storage capacity of soils, which increases runoff and erosion.

Figure 819.7F

Alluvial Fan

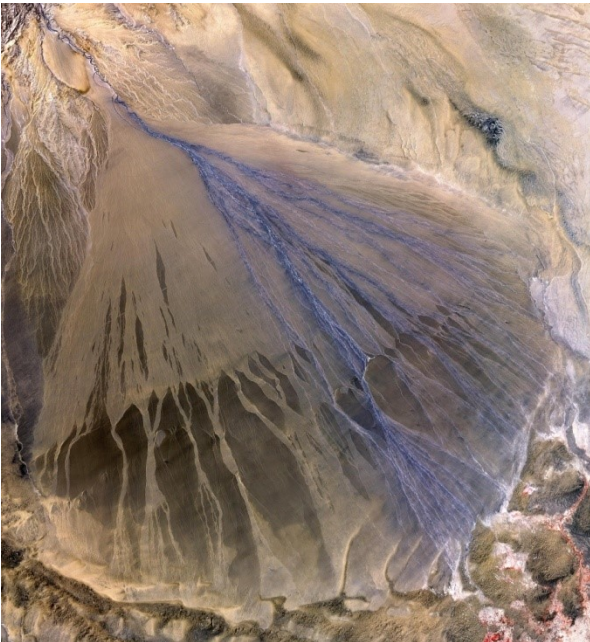

(1) Fire Impacts

Arid regions do not have the same density of trees and vegetation as a forested area, but the arid environment still falls victim to fires in a similar manner. Prior to a fire, the arid region floor can contain a litter layer (leaves, needles, fine twigs, etc.), as well as a duff layer (partially decomposed components of the litter layer). These layers absorb water, provide storage of rainfall, and protect hillsides. Once these layers are burned, they become ash and charcoal particles that seal soil pores and decrease infiltration potential of the soil, which ultimately increases runoff and erosion.

In order to measure the burn severity of watersheds with respect to hydrologic function, classes of burn severity have been created. These classes are simply stated as high, moderate, low, and unburned. From moderate and high burn severity slopes, the generated sediment can reach channels and streams causing bulked water flows during storm events. Generally speaking, the denser the vegetation in a watershed prior to a fire and the longer a fire burns within this watershed, the greater the effects on soil hydrologic function. This occurs due to the fire creating a water repellent layer at or near the soil surface, the loss of soil structural stability, which all results in more runoff and erosion. After a one or two-year period, the water repellent layer is usually washed away.

(f) Local Agency Methods For Predicting Bulking Factors

(1) San Bernardino County

Instead of conducting a detailed analysis, San Bernardino Flood Control District uses a set value for bulking of 2 (i.e., 100 percent bulking) for any project where bulking flows may be anticipated. This bulking factor of 2 can also be expressed as a 50 percent sediment concentration by volume, which is about the upper limit of debris flow. A higher percentage of sediment concentration would be considered a landslide instead of debris flow. Basically, the San Bernardino County method assumes debris flow conditions for all types of potential bulking.

(2) Los Angeles County

The Los Angeles (LA) County method uses a watershed-specific bulking factor. The LA County Sedimentation Manual, which is located at <http://ladpw.org/wrd/publication>, divides the county into three basins: LA Basin, Santa Clara River Basin, and Antelope Valley, where only the latter is located in the Caltrans desert hydrology regions. The production of sediment from these basins is dependent upon many factors, including rainfall intensity, vegetative cover, and watershed slope. For each of the LA County basins, Debris Potential Area (DPA) zones have been identified.

The Design Debris Event (DDE) is associated with the 50-year, 24-hour duration storm, and produces the quantity of sediment from a saturated watershed that is recovered from a burn. For example, a DPA 1 zone sediment rate of 120,000 cubic yards per square mile has been established as the DDE for a 1-square mile drainage area. This sediment rate is recommended for areas of high relief and granitic formation found in the San Gabriel Mountains. In other mountainous areas in LA County, lower sediment rates have been assigned based on differences in topography, geology, and precipitation. For the Antelope Valley basin, eight debris production curves have been generated, and can be found in Appendix B of the LA County Sedimentation Manual along with curves for the other basins.

In addition to sediment production rates, a series of peak bulking factor curves are presented for each LA County basin in Appendix B of the LA manual. The peak bulking factor can be estimated using these curves based on the watershed area and the DPA. Within the Antelope Valley basin, maximum peak bulking factors range from 1.2 in DPA Zone 11 to 2.00 in DPA Zone 1.

(3) Riverside County

For Riverside County, a bulking factor is calculated by estimating a sediment/debris yield rate for a specific storm event, and relating it to the largest expected sediment yield of 120,000 cubic yards per square mile for a 1-square mile watershed from the LA County procedure. This sediment rate from LA County

July 1, 2020

is based on the DPA Zone 1 corresponding to the highest expected bulking factor of 2.00.

The bulking factor equation from the Riverside County Hydrology Manual (<http://www.floodcontrol.co.riverside.ca.us/downloads/planning/>) is as follows:

$$BF = 1 + \frac{D}{120,000}$$

BF = Bulking Factor

D = Design Storm Sediment/Debris Production Rate For Study Watershed (cubic yards/square mile)

(4) U.S. Army Corps of Engineers- LA District

This method, located at <http://www.spl.usace.army.mil/resreg/htdocs/Publications.html>, was originally developed to calculate unit sediment/debris yield values for an "n-year" flood event, and applied to the design and analysis of debris catching structures in coastal Southern California watersheds. The LA District method considers frequency of wildfires and flood magnitude in its calculation of unit debris yield. Even though its original application was intended for coastal-draining watersheds, this method can also be used for desert-draining watersheds for the same local mountain ranges.

The LA District method can be applied to watershed areas between 0.1 and 200 mi² that have a high proportion of their total area in steep, mountainous topography. This method is best used for watersheds that have received significant antecedent rainfall of at least 2 inches in 48 hours. Given this criteria, the LA District method is more suited for general storms rather than thunderstorms.

As shown below, this method specifies a few equations to estimate unit debris yield dependent upon the areal size of the watershed. These equations were developed by multiple regression analysis using known sediment/debris data.

For watersheds between 3 and 10 mi², the following equations can be used:

$$\log D_y = 0.85 \log Q + 0.53 \log RR + 0.04 \log A + 0.22 FF$$

D_y = Unit Debris Yield (cubic yards/square mile)

RR= Relief Ratio (foot/mile), which is the difference in elevation between the highest and lowest points on the longest watercourse divided by the length of the longest watercourse

A = Drainage Area (acres)

FF = Fire Factor

Q = Unit Peak Runoff (cfs/square mile)

In order to account for increase in debris yield due to fire, a non-dimensional fire factor (FF) is a component in the equation above. The FF varies from 3.0 to 6.5, with a higher factor indicating a more recent fire and more debris yield. This factor is 3.0 for desert watersheds because the threat and effects from fire are minimal.

Because the data used to develop the regression equation was taken from the San Gabriel Mountains, an Adjustment and Transposition (A-T) factor needs to be applied to debris yields from the study watersheds. The A-T factor can be determined using Table 819.7J by finding the appropriate subfactor for each of the

four groups (Parent Material, Soils, Channel Morphology, and Hillside Morphology) and summing the subfactors. This sum is the total A-T factor, and it must be multiplied by the sediment/debris yield. Once the sediment/debris yield value has been determined based on the unit yield, a bulking factor can be calculated using a series of equations. The first equation provides a translation of the clear-water discharge to a sediment discharge. This clear-water discharge should be developed using a hydrograph method and a hydrologic modeling program, such as HEC-HMS.

$$Q_s = aQ_w^n$$

Q_s = Sediment Discharge (cfs)

Q_w = 100-Year Clear-Water Discharge (cfs)

a = Bulking Constant

For a majority of sand-bed streams, the value of “n” is between 2 and 3. When n=2, the bulking factor is linearly proportional to the clear-water discharge. As for the coefficient “a”, it is determined with the following equation:

$$a = \frac{V_s}{\Delta t \sum Q_w^2}$$

V_s = Total Sediment Volume (cubic feet)

Δt = Computation Time Interval Used In Developing Hydrograph From Hydrologic Model (e.g. HEC-HMS)

Finally, the bulking factor equation is expressed as follows:

$$BF = \frac{Q_w - Q_s}{Q_s} = 1 + aQ_w^{n-1}$$

(g) Recommended Approach For Developing Bulking Factors

A flow chart outlining the recommended bulking factor process is provided in Figure 819.7H, which considers all bulking methods presented in Topic 819.

As shown in Steps 4 and 5 on Figure 819.7H, a bulking factor can be found by:

- (1) Identifying the type of flow within a watershed and selecting the corresponding bulking factor, or
- (2) Using one of the agency methods to calculate the bulking factor.

If the type of flow cannot be identified or the project site does not fall within the recommended boundaries from Figure 819.7H, use the LA District Method because it is the most universal given its use of the Adjustment-Transposition factor based on study watershed properties.

July 1, 2020

Table 819.7J

Adjustment-Transportation Factor Table

	A-T SUBFACTOR				
	0.25	0.20	0.15	0.10	0.05
PARENT MATERIAL	SUBFACTOR GROUP 1				
Folding	Severe		Moderate		Minor
Faulting	Severe		Moderate		Minor
Fracturing	Severe		Moderate		Minor
Weathering	Severe		Moderate		Minor
SOILS	SUBFACTOR GROUP 2				
Soils	Non-cohesive		Partly Cohesive		Highly Cohesive
Soil Profile	Minimal Soil Profile		Some Soil Profile		Well-developed Soil Profile
Soil Cover	Much Bare Soil in Evidence		Some Bare Soil in Evidence		Little Bare Soil in Evidence
Clay Colloids	Few Clay Colloids		Some Clay Colloids		Many Clay Colloids
CHANNEL MORPHOLOGY	SUBFACTOR GROUP 3				
Bedrock Exposures	Few Segments in Bedrock		Some Segments in Bedrock		Many Segments in Bedrock
Bank Erosion	> 30% of Banks Eroding		10 – 30% of Banks Eroding		< 10% of Banks Eroding
Bed and Bank Materials	Non-cohesive Bed and Banks		Partly Cohesive Bed and Banks		Mildly Cohesive Bed and Banks
Vegetation	Poorly Vegetated		Some Vegetation		Much Vegetation
Headcutting	Many Headcuts		Few Headcuts		No Headcutting
HILLSLOPE MORPHOLOGY	SUBFACTOR GROUP 4				
Rills and Gullies	Many and Active		Some Signs		Few Signs
Mass Movement	Many Scars Evident		Few Signs Evident		No Signs Evident
Debris Deposits	Many Eroding Deposits		Some Eroding Deposits		Few Eroding Deposits
The A-T Factor is the sum of the A-T Subfactors from all 4 Subfactor Groups.					

Figure 819.7H

Recommended Bulking Factor Selection Process

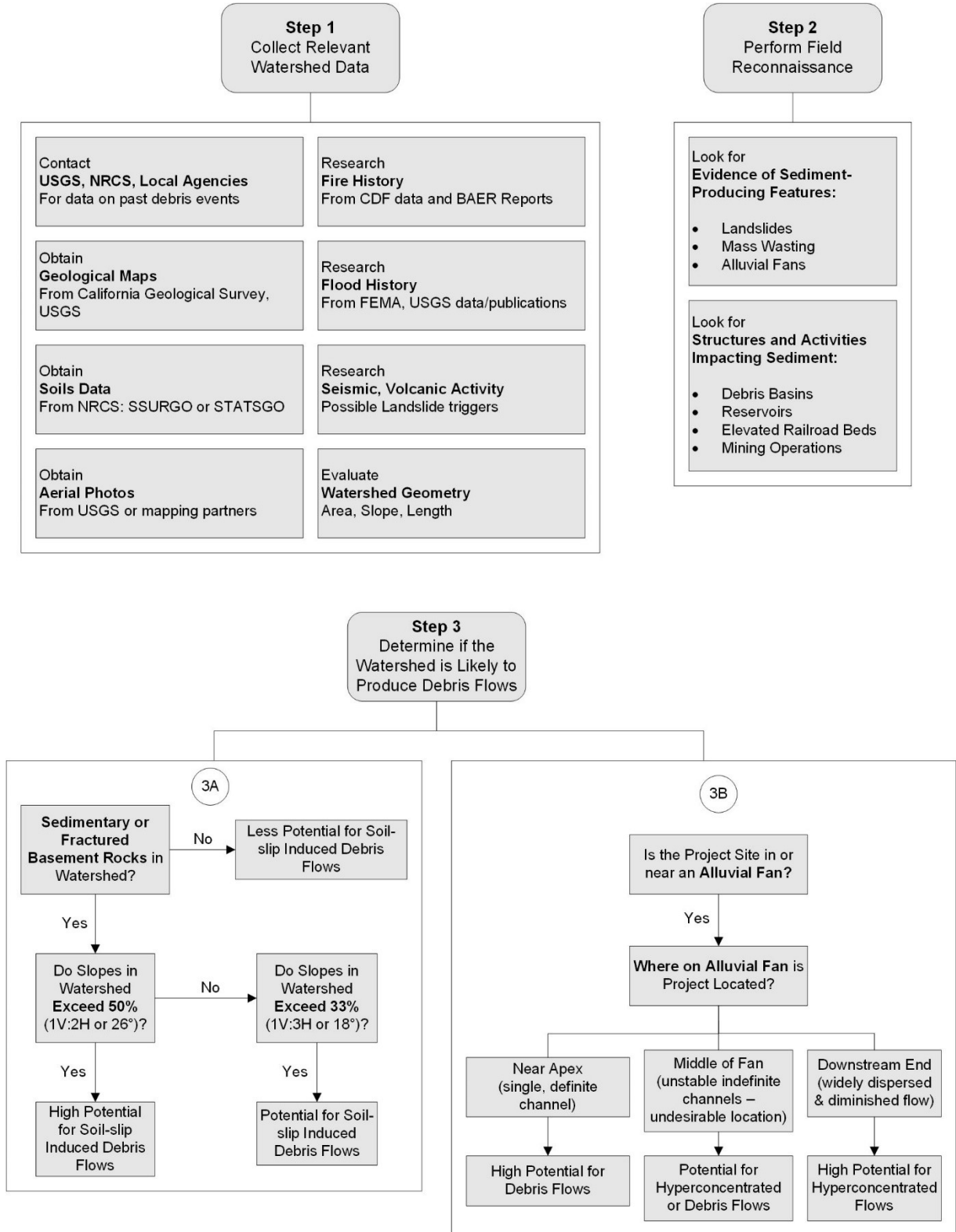

July 1, 2020

Figure 819.7H

Recommended Bulking Factor Selection Process (Cont'd)

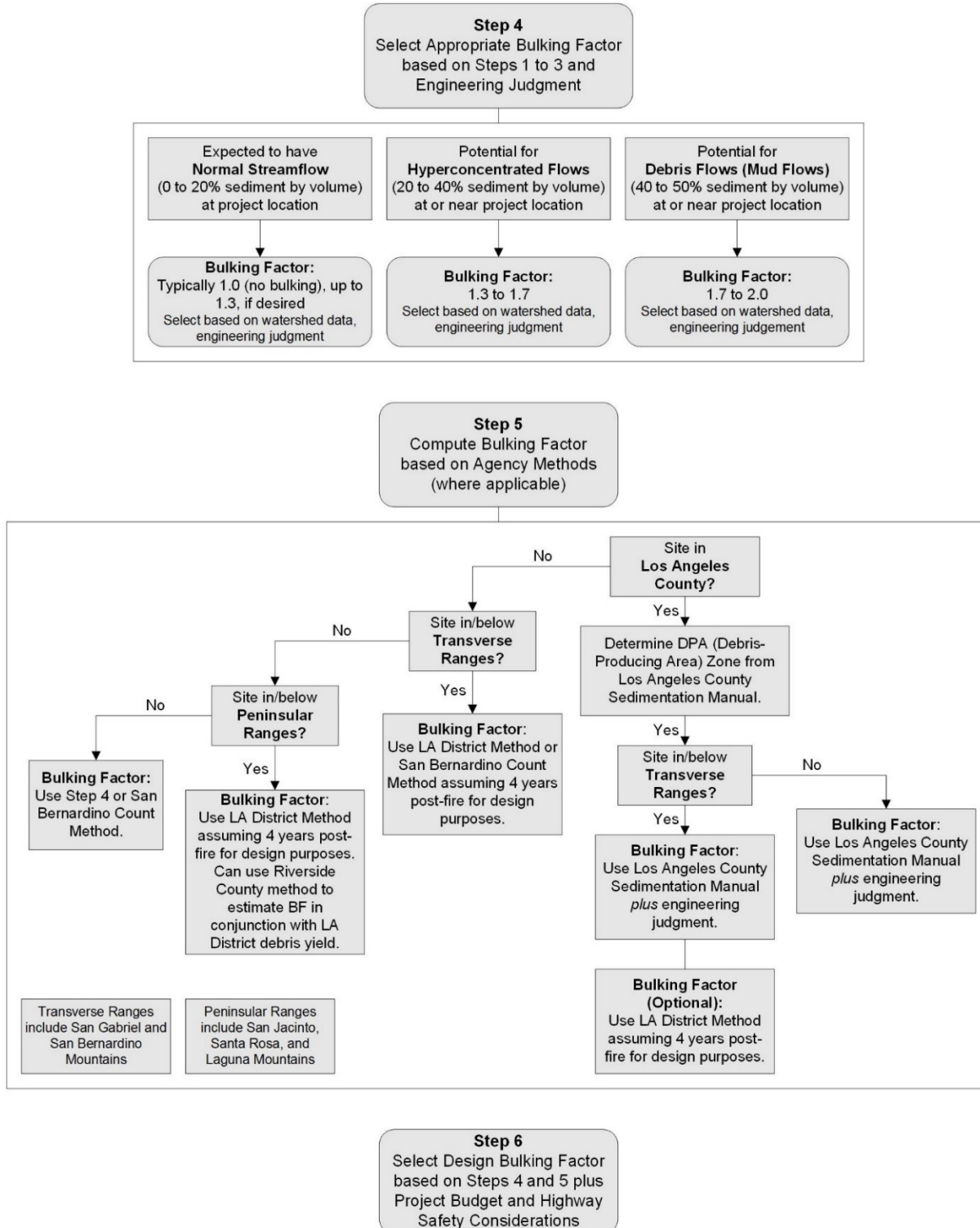

CHAPTER – 820 CROSS DRAINAGE

Topic 821 – General

Index 821.1 – Introduction

Cross drainage involves the conveyance of surface water and stream flow across or from the highway right of way. This is accomplished by providing either a culvert or a bridge to convey the flow from one side of the roadway to the other side or past some other type of flow obstruction.

In addition to the hydraulic function, a culvert must carry construction and highway traffic and earth loads. Culvert design, therefore, involves both hydraulic and structural design. This section of the manual is basically concerned with the hydraulic design of culverts. Both the hydraulic and structural designs must be consistent with good engineering practice and economics. An itemized listing of good drainage design objectives and economic factors to be considered are listed in Index 801.4. Information on strength requirements, height of fill tables, and other physical characteristics of alternate culvert shapes and materials may be found in Chapter 850, Physical Standards.

More complete information on hydraulic principles and engineering techniques of culvert design may be found in the FHWA Hydraulic Design Series No. 5, "Hydraulic Design of Highway Culverts". Key aspects of culvert design and a good overview of the subject are more fully discussed in the AASHTO Highway Drainage Guidelines.

Structures measuring more than 20 feet along the roadway centerline are conventionally classified as bridges, assigned a bridge number, and maintained and inspected by the Division of Structures. However, some structures classified as bridges are designed hydraulically and structurally as culverts. Some examples are certain multi-barreled box culverts and arch culverts. Culverts, as distinguished from bridges, are usually covered with embankment and have structural material around the entire perimeter, although some are supported on spread footings with the streambed serving as the bottom of the culvert.

Bridges are not designed to take advantage of submergence to increase hydraulic capacity even though some are designed to be inundated under flood conditions. For economic and hydraulic efficiency, culverts should be designed to operate with the inlets submerged during flood flows, if conditions permit. At many locations, either a bridge or a culvert will fulfill both the structural and hydraulic requirements of the stream crossing. Structure choice at these locations should be based on construction and maintenance costs, risk of failure, risk of property damage, traffic safety, and environmental and aesthetic considerations.

July 1, 2020

Culverts are usually considered minor structures, but they are of great importance to adequate drainage and the integrity of the highway facility. Although the cost of individual culverts is relatively small, the cumulative cost of culvert construction constitutes a substantial share of the total cost of highway construction. Similarly, the cost of maintaining highway drainage features is substantial, and culvert maintenance is a large share of these costs. Improved service to the public and a reduction in the total cost of highway construction and maintenance can be achieved by judicious choice of design criteria and careful attention to the hydraulic design of each culvert.

821.2 Hydrologic Considerations

Before the hydraulic design of a culvert or bridge can begin, the design discharge, the quantity (Q) of water in cubic feet per second, that the facility may reasonably be expected to convey must be estimated. The most important step is to establish the appropriate design storm or flood frequency for the specific site and prevailing conditions. Refer to Chapter 810, Hydrology and specifically Topics 818 and 819 for useful information on hydrological analysis methods and considerations.

When empirical methods are used to estimate the peak rate of runoff, design Q, for important culverts, it is recommended that at least two methods be tried. By comparing results a more reliable discharge estimate for the drainage basin may be obtained. This is more important for large basins having areas in excess of 320 acres than for small basins.

821.3 Selection of Design Flood

As discussed in Index 818.2, there are two recognized alternatives to selecting the design flood frequency (probability of exceedance) in the hydraulic design of bridges and culverts. They are:

- By policy - using a preselected recurrence interval.
- By analysis - using the recurrence interval that is most cost effective and best satisfies the specific site conditions and associated risks.

Although either of these alternatives may be used exclusive of the other, in actual practice both alternatives are often considered and used jointly to select the flood frequency for hydraulic design. For culverts and bridges, apply the following general rules for first consideration in the process for ultimate selection of the design flood.

- (1) *Bridges*. The basic rule for the hydraulic design of bridges (but not including those culvert structures that meet the definition of a bridge) is that they should pass a 2 percent probability flood (50-year). Freeboard, vertical clearance between the lowest structural member and the water surface elevation of the design flood, sufficient to accommodate the effects of bedload and debris should be provided. Alternatively, a waterway area sufficient to pass the 1 percent probability flood without freeboard should be provided. Two feet of freeboard is often assumed for preliminary bridge designs. The effects of bedload and debris should be considered in the design of the bridge waterway.

(2) *Culverts*. There are two primary design frequencies that should be considered:

- A 10% probability flood (10-year) without causing the headwater elevation to rise above the inlet top of the culvert and,
- A 1% probability flood (100-year) with-out headwaters rising above an elevation that would cause objectionable backwater depths or outlet velocities.

The designer must use discretion in applying the above criteria. Design floods selected on this basis may not be the most appropriate for specific project site locations or conditions. The cost of providing facilities to pass peak discharges suggested by these criteria need to be balanced against potential damage to the highway and adjacent properties upstream and downstream of the site. The selection of a design flood with a lesser or greater peak discharge may be warranted and justified by economic analysis. A more frequent design flood than a 4% probability of exceedance (25-year) should not be used for the hydraulic design of culverts under freeways and other highways of major importance. Alternatively, where predictive data is limited, or where the risks associated with drainage facility failure are high, the greatest flood of record or other suitably large event should be evaluated by the designer.

When channels or drainage facilities under the jurisdiction of local flood control agencies or Corps of Engineers are involved, the design flood must be determined through negotiations with the agencies involved.

821.4 Headwater and Tailwater

(1) *Headwater*. The term, headwater, refers to the depth of the upstream water surface measured from the invert of the culvert entrance. Any culvert which constricts the natural stream flow will cause a rise in the upstream water surface.

It is not always economical or practical to utilize all the available head. This applies particularly to situations where debris must pass through the culvert, where a headwater pool cannot be tolerated, or where the natural gradient is steep and high outlet velocities are objectionable.

The available head may be limited by the fill height, damage to the highway facility, or the effects of ponding on upstream property. The extent of ponding should be brought to the attention of all interested functions, including Project Development, Maintenance, and Right of Way.

Full use of available head may develop some vortex related problems and also develop objectionable velocities resulting in abrasion of the culvert itself or in downstream erosion. In most cases, provided the culvert is not flowing under pressure, an increase in the culvert size does not appreciably change the outlet velocities.

(2) *Tailwater*. The term, tailwater, refers to the water located just downstream from a structure. Its depth or height is dependent upon the downstream topography and other influences. High tailwater could submerge the culvert outlet.

July 1, 2020

821.5 Effects of Tide and Storm

Culvert outfalls and bridge openings located where they may be influenced by ocean tides require special attention to adequately describe the 1% probability of exceedance event.

Detailed statistical analysis and use of unsteady flow models, including two-dimensional models, provide the most accurate approach to describing the combined effects of tidal and meteorological events. Such special studies are likely warranted for major hydraulic structures (See HEC-25, Volume 2, October 2014 - "Highways in the Coastal Environment: Assessing Extreme Events"), but would typically be too costly and time consuming for lesser facilities. If the risk factors and costs associated with a failure of the drainage facility (such as, bridge or culvert) located in a tidal environment do not support conducting such a detailed analysis, the following guidance can be used to select ocean or bay water levels and flood events to adequately estimate the 1% Annual Exceedance Probability (AEP). However, the effect of climate change or sea-level rise is not included in this analysis. Sea-level rise needs to be evaluated for all coastal facilities using Section 883.2 ("Design High Water, Design Wave Height and Sea-Level Rise") of this manual or any other appropriate method.

The daily maximum ocean water levels vary significantly on a fortnightly basis with the spring-neap cycle, where the highest daily maximum water levels occur during spring tides and the lowest daily maximum water levels occur during neap tides. The annualized probability of the daily maximum ocean water level \hat{h}_T , with a return period T year, that may exceed a certain elevation can be expressed using a stage-frequency relationship. Such a relationship has been developed using the water level data received from the National Oceanic and Atmospheric Administration (NOAA) tide gauge stations located in the California coast. These gauge stations typically record water levels every six minutes, and those measurements account for all the combined astronomical, meteorological and climatic effects that have influenced the water levels in the coastal regions of California. The NOAA has periodically verified those ocean water levels for multi-decadal periods which are referred to as "tidal epochs." The basis for developing the Annual Exceedance Probability (AEP) for ocean water levels reaching or exceeding a particular elevation in a day is first, finding the ratio of the total number of daily maximums water levels that reach or exceed that elevation over the total number of daily maximum water level measurements in each year and then averaging the result over the years that make up the period of record of that tide gauge. Finally, these processes are repeated for a range of elevations to develop a continuous relationship with the corresponding AEP. Figure 821.1 shows an example of the continuous distribution where the daily maximum ocean water level for outer San Francisco Bay is plotted against the AEP expressed in percentage. This curve has been derived based on NOAA tide gauge station 9414290 for period of record June 30, 1854 to present. AEP for some tidal datums are also shown here. For this location, the annual probability of the daily maximum ocean water level exceeding the Mean High Water (MHW) is 73%. It is to be noted that all tidal datums in this analysis are based on the tidal epoch 1983 to 2001.

Daily maximum ocean water levels are primarily determined by the astronomic ocean tides which again are controlled by the orbital mechanics of the earth, moon, and sun. These astronomic processes are completely independent of rainfall, snowmelt or watershed management practices that directly influence streamflow. Since the ocean water level and flood are two statistically independent variables, the annual compound probability would be the product of the probabilities of these two events, as shown below:

$$P(Q_T, \hat{\eta}_T) = P(\hat{\eta}_T) \cdot P(Q_T)$$

- $P(\hat{\eta}_T)$ is the annual exceedance probability of the daily maximum ocean water level
- $P(Q_T)$ is the annual exceedance probability of the daily maximum streamflow
- $P(Q_T, \hat{\eta}_T)$ is the annual exceedance probability of these two events that may occur simultaneously at a specific location
- T is the return period, also known as recurrence interval, of each of the above probabilities expressed in year

Since the compound probability of 1% is of interest, then

$$0.01 = P(\hat{\eta}_T) \cdot P(Q_T).$$

The annual exceedance probability of streamflow $P(Q_T)$ is the reciprocal of the corresponding return period expressed in year, or $\frac{1}{T}$. Using the above equation, a compound probability of 1% would occur when:

$$P(\hat{\eta}_T) = 0.01 \times T \text{ or } T\%$$

In other words, when an 1% AEP of these two events is jointly achieved, the numeric value of the flood recurrence interval expressed in year is the same as the annual exceedance probability of the daily maximum ocean water level expressed in percentage. Therefore, if the return period of any flood event is selected using the numeric value in the X-axis of Figure 821.1, the value in the Y-axis of the curve would represent the tailwater level such that the compound probability of these two events to occur concurrently in a year has a 1% chance of exceedance. Likewise, if any water level is chosen from the Y-axis, the corresponding value in the X-axis would represent the return period of the flood expressed in year, where the compound AEP is 1%.

July 1, 2020

Figure 821.1

Annual exceedance probability (AEP) of daily maximum ocean water level

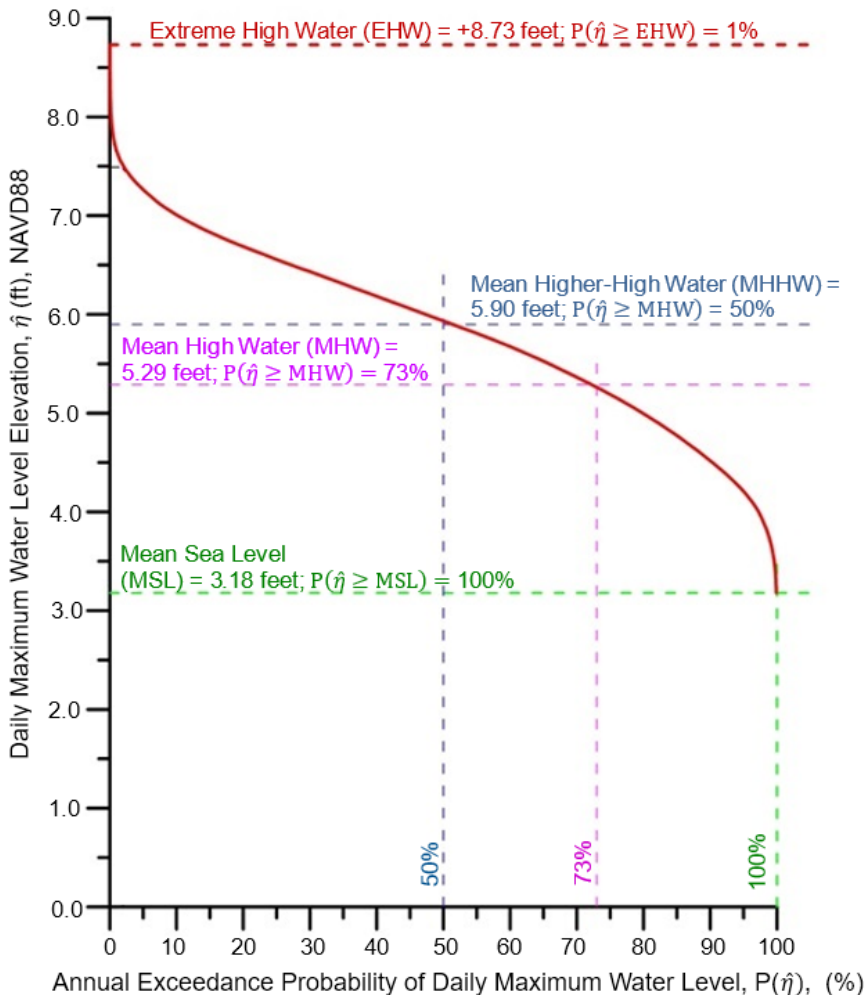

For instance, when determining the backwater effect by a hydraulic structure near outer San Francisco Bay, any of the following pairs of boundary conditions obtained from Figure 821.1 would represent the compound probability exceedance of 1%:

- 100-year flow and a tailwater level of 3.18 feet
- 73-year flow and a tailwater level of 5.29 feet
- 50-year flow and a tailwater level of 5.90 feet

Figure 821.1 can also be interpreted as the one-percent compound frequency curve for this location, if we consider the numeric value of the X-axis as the flood recurrence period in year, instead of % AEP of the water levels.

There exists a wide variation in ocean water levels across the State of California, particularly when comparing water levels on the exposed open coastline with those in the bays, estuaries and semi-enclosed water bodies. Consequently, there is a great deal of variation among the

one-percent compound frequency curves calculated from tide gauge stations on the open coast versus those in the bays. Figure 821.2 identifies a map of open coast and bayfront water level provinces and corresponding NOAA tide gauge stations for the state of California. For the purpose of this analysis, it has been considered that the available NOAA gauge data in each province reflect the tidal conditions at the geographic centroid of that province. The length of a province along the coast and the location of its boundaries are independent of the proximity of the gauge station in the host province, but rather is determined by the spacings between co-tidal lines. Co-tidal lines are the lines of constant tidal phase or lines joining points at which a given tidal phase (such as, mean high water or mean low water) would occur simultaneously. There is approximately a 2-hour tidal phase interval between the California/Mexican border and the California/Oregon border. The province boundaries are designated up-coast and down-coast, as proceeding from north to south or west to east on the open coast; and from outer-bay to inner-bay along the bayfront coasts. The extent of an open coast province has been determined in such a way that the tidal phase interval between the up-coast and down-coast boundary is 15-minute. For the bayfront coastlines, divisions between provinces inside of San Francisco Bay were determined by hydrodynamic tidal simulations (Barnard, et al., 2013; Elias et al, 2013)¹; and inside San Diego Bay, tidal exchange modeling by Largier, (1995)² and Chadwick (1997)³ were used to establish province boundaries. For each water level province shown in Figure 821.2, a one-percent compound frequency curve has been generated using the tidal level data of the corresponding gauge station. There are eight water level provinces (such as 1, 2, 2a, 3, 4, 5, 6 and 7) on the open coastline of California, and six additional provinces (such as 8, 9, 9a, 10, 11, & 12) on bayfront coastlines and estuaries in San Francisco Bay and in San Diego Bay. The corresponding one-percent compound frequency (or 1% compound AEP) curves are shown in Figure 821.3A through Figure 821.3N.

Table 821.1 lists the latitude and longitude of the boundaries of the water-level provinces and the controlling gauge stations. For each water-level province, the last column in Table 821.1 provides a characteristic length scale λ , and a distance-averaging length scale L . The characteristic length of each province represents the tidal propagation path length based on a 15-minute tidal phase interval. The distance averaging length scale L nominally represents the distance from the coastal centroid of the province to its boundaries. It is important to note that these distances are measured as the gross running length of shoreline (exclusive of the interior perimeter of minor embayments) for provinces on the open coast, or the distance along the axis of a bay between the end-points or apexes of provinces distributed around the shorelines of the semi-enclosed bays; such as, San Francisco Bay and San Diego Bay.

¹ Barnard, P.L., Jaffe, B.E., Schoellhamer, D.H., 2013. Preface for Special Issue of Marine Geology. Marine Geology Special Issue on Sediment Transport and Geomorphic Evolution in the San Francisco Bay Coastal System, 345, 1-2. <https://doi.org/10.1016/j.margeo.2013.09.010>.

Elias, E., Hansen, J., and Erikson, L.H. 2013. "San Francisco Bay Basic Tide Model", doi: 10.5066/F7DN4330.

² Largier, J., 1995, "A study of the circulation of water in San Diego Bay for the purpose of assessing, monitoring and managing the transport and potential accumulation of pollutants and sediment in San Diego Bay", submitted to California Water Resources Control Board, 19 pp. + app.

³ Chadwick, D.B. 1997. Tidal Exchange at the Bay-Ocean Boundary. Ph.D. diss., University of California, San Diego.

July 1, 2020

Table 821.1

Boundaries, Locations and Length Scales of Water-level Provinces

Province	Up-Coast Boundary ¹	Down-Coast Boundary ²	Location of Controlling Gauge Station	Length Scale ³ , miles
Province 1	lat: 41°59'45.33"N long: 124°12'43.62"W	lat: 41°32'9.90"N long: 124°4'55.46"W	lat: 41°44'37.19"N long: 124°11'52.59"W	λ = 36 L = 18
Province 2	lat: 41°32'9.90"N long: 124°4'55.46"W	lat: 38°17'38.86"N long: 122°59'57.35"W	lat: 40°44'28.90"N long: 124°12'54.10"W	λ = 255 L = 127.5
Province 2a (San Francisco Bay Coastal)	lat: 38°17'38.86"N long: 122°59'57.35"W	lat: 37°7'8.27"N long: 122°19'39.53"W	lat: 37°48'22.04"N long: 122°28'35.29"W	λ = 105 L = 52.3
Province 3	lat: 37°7'8.27"N long: 122°19'39.53"W	lat: 35°14'43.93"N long: 120°54'10.12"W	lat: 36°36'27.43"N long: 121°53'31.85"W	λ = 189 L = 94.5
Province 4	lat: 35°14'43.93"N long: 120°54'10.12"W	lat: 34°25'55.54"N long: 119°57'29.38"W	lat: 35°10'27.20"N long: 120°44'4.86"W	λ = 106 L = 53
Province 5	lat: 34°25'55.54"N long: 119°57'29.38"W	lat: 34°5'2.13"N long: 119°3'41.57"W	lat: 34°24'15.93"N long: 119°41'33.24"W	λ = 62 L = 31
Province 6	lat: 34°5'2.13"N long: 119°3'41.57"W	lat: 33°44'16.64"N long: 118°6'54.40"W	lat: 33°43'10.11"N long: 118°16'0.81"W	λ = 77 L = 38.5
Province 7	lat: 33°44'16.64"N long: 118°6'54.40"W	lat: 32°31'42.37"N long: 117°7'25.39"W	lat: 32°52'1.21"N long: 117°15'26.68"W	λ = 109 L = 54.5
Province 8	lat: 37°56'15.75"N long: 122°27'9.39"W	lat: 37°43'19.90"N long: 122°15'2.10"W	lat: 37°47'15.14"N long: 122°15'56.10"W	λ = 24.6 (East) λ = 9.2 (West) L = 12.3 (East) L = 4.6 (West)
Province 9	lat: 38°8'31.45"N long: 122°23'57.87"W	lat: 37°56'15.75"N long: 122°27'9.39"W	lat: 38°0'40.21"N long: 122°21'55.35"W	λ = 27.6 (North) λ = 15.2 (South) L = 13.8 (North) L = 7.6 (South)
Province 9a (Sacramento River Delta)	lat: 38°3'31.02"N long: 122°15'51.88"W	lat: 38°3'45.65"N long: 121°47'53.96"W	lat: 38°3'31.75"N long: 122°0'48.71"W	λ = 66.6 L = 33.3
Province 10	lat: 37°42'55.22"N long: 122°21'48.55"W	lat: 37°26'49.58"N long: 122°1'6.19"W	lat: 37°30'45.72"N long: 122°12'35.64"W	λ = 65.8 L = 32.9
Province 11	lat: 32°43'27.47"N long: 117°13'36.47"W	lat: 32°40'36.43"N long: 117°9'14.13"W	lat: 32°42'57.65"N long: 117°10'25.25"W	λ = 7.2 (East), λ = 5.4 (West) L = 3.6 (East) L = 2.7 (West)
Province 12	lat: 32°40'36.43"N long: 117°9'14.13"W	lat: 32°35'57.83"N long: 117°6'56.35"W	lat: 32°35'57.83"N long: 117°6'56.35"W	λ = 15.6 L = 7.8

Notes:

¹On open coastlines, Up-Coast refers to the northern boundary; in bays, Up-Coast refers to the outer bay.

²On open coastlines, Down-Coast refers to the southern boundary; in bays, Down-Coast refers to inner bay.

³On open coastlines, λ = gross running length of province coastline exclusive of the interior perimeter of minor embayment; in bays, λ = tidal propagation length of the province; L = weighted averaging distance.

Figure 821.2

California Open Coast and Bayfront Water Level Province Map



Note: Province 2a is a sub-cell of Province 2 and covers the coastal area around the entrance to San Francisco Bay, as well as the outer Bay; while Province 9a covers the Sacramento Delta east of the Carquinez Bridge.

July 1, 2020

Figure 821.3A

One-Percent Compound Frequency Curve for Province 1, (Based on NOAA # 9419750, Crescent City)

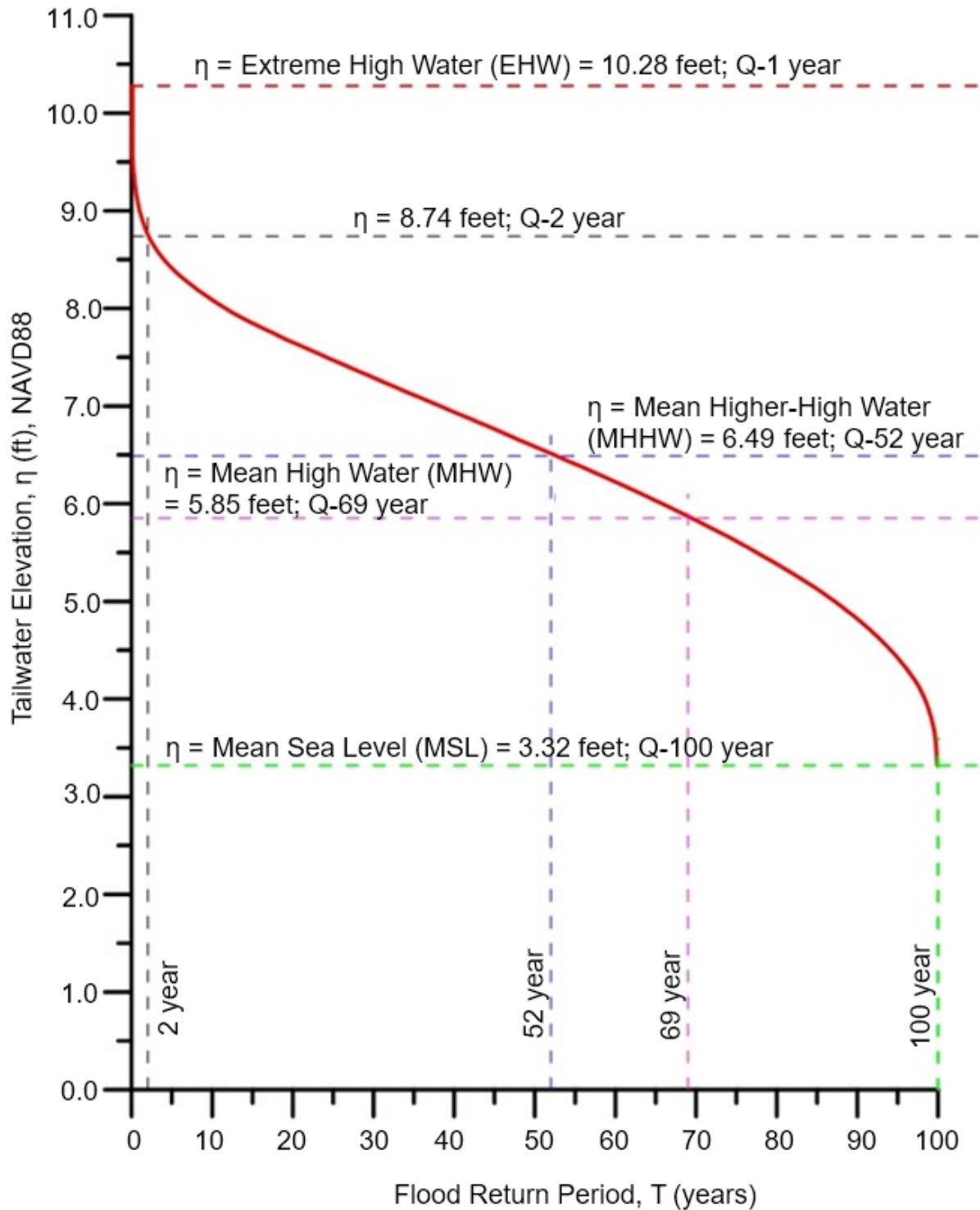
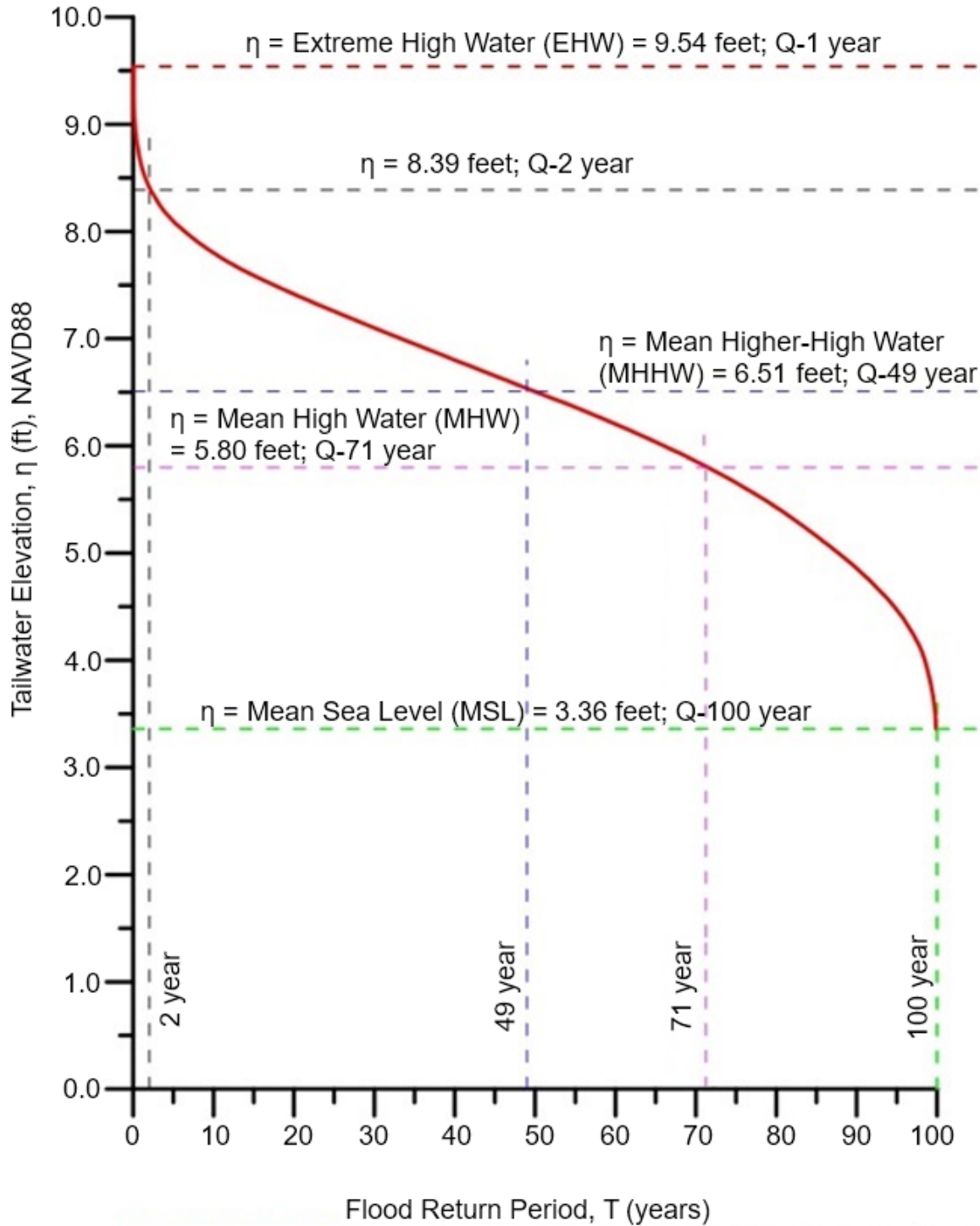

Figure 821.3B

One-Percent Compound Frequency Curve for Province 2, (Based on NOAA # 9418767, North Spit, Humboldt)



July 1, 2020

Figure 821.3C

One-Percent Compound Frequency Curve for Province 2a, (Based on NOAA # 9414290, Golden Gate Bridge)

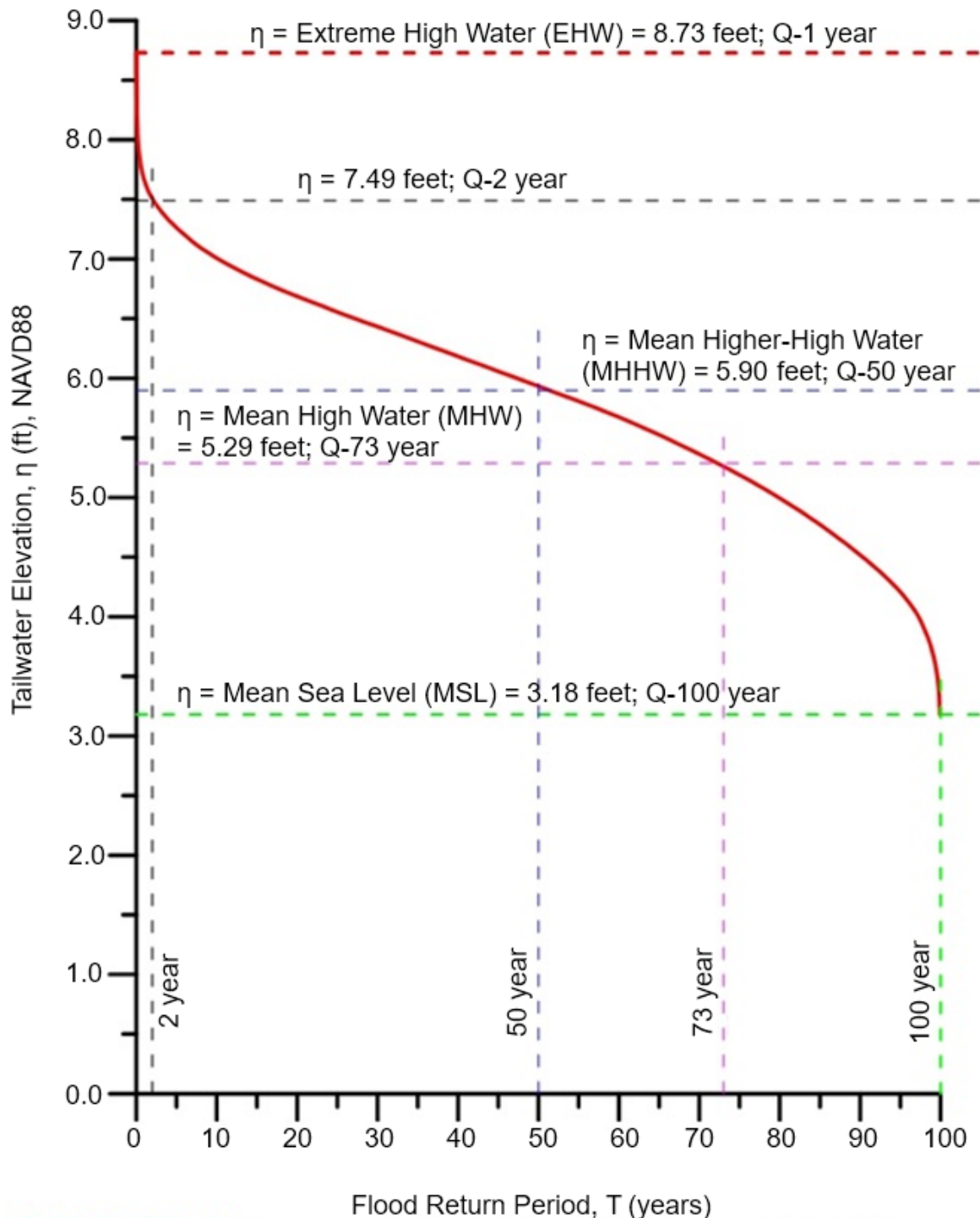
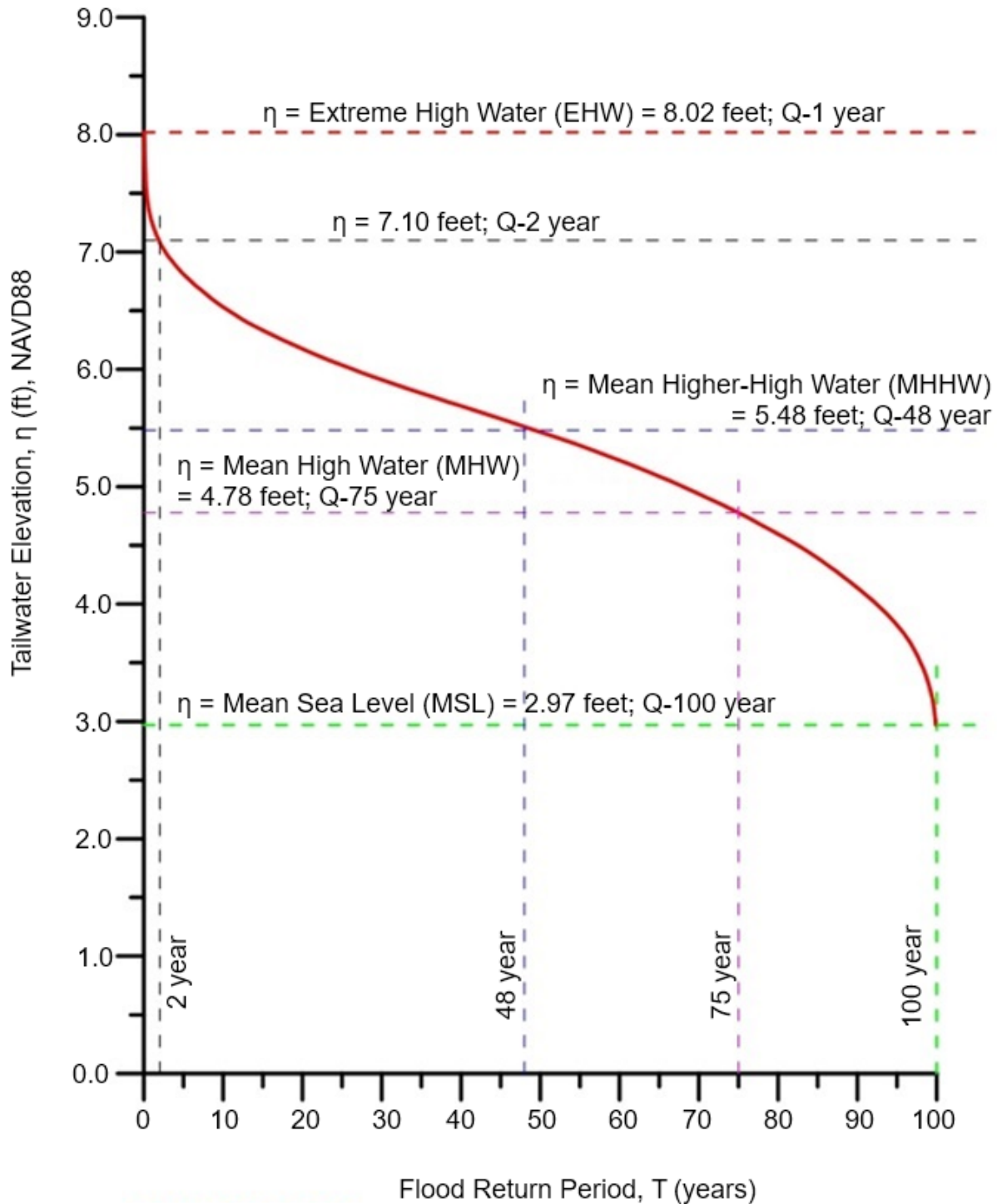

Figure 821.3D

One-Percent Compound Frequency Curve for Province 3, (Based on NOAA # 9413450, Monterey)



July 1, 2020

Figure 821.3E

One-Percent Compound Frequency Curve for Province 4, (Based on NOAA # 9412110, Port San Luis)

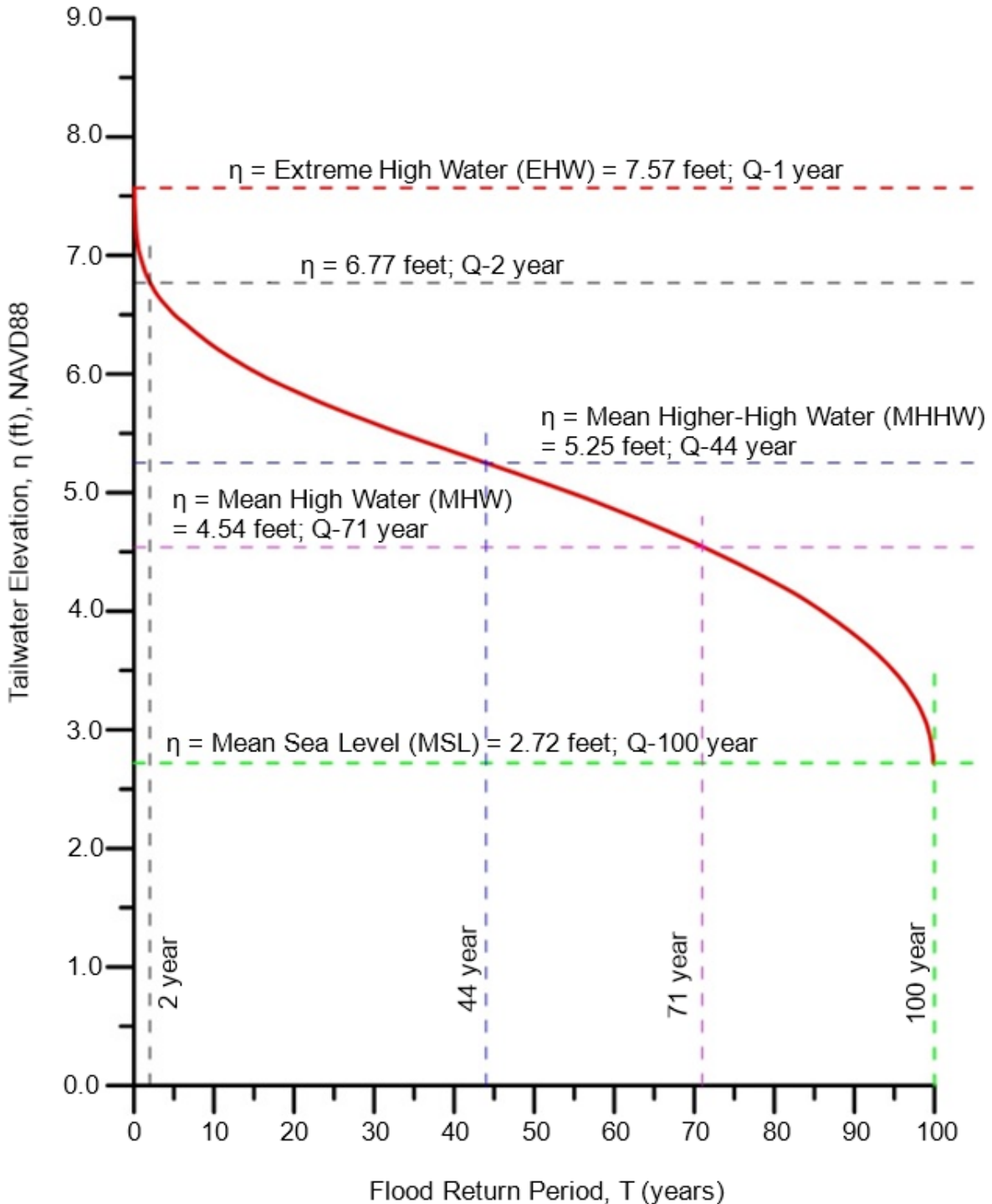
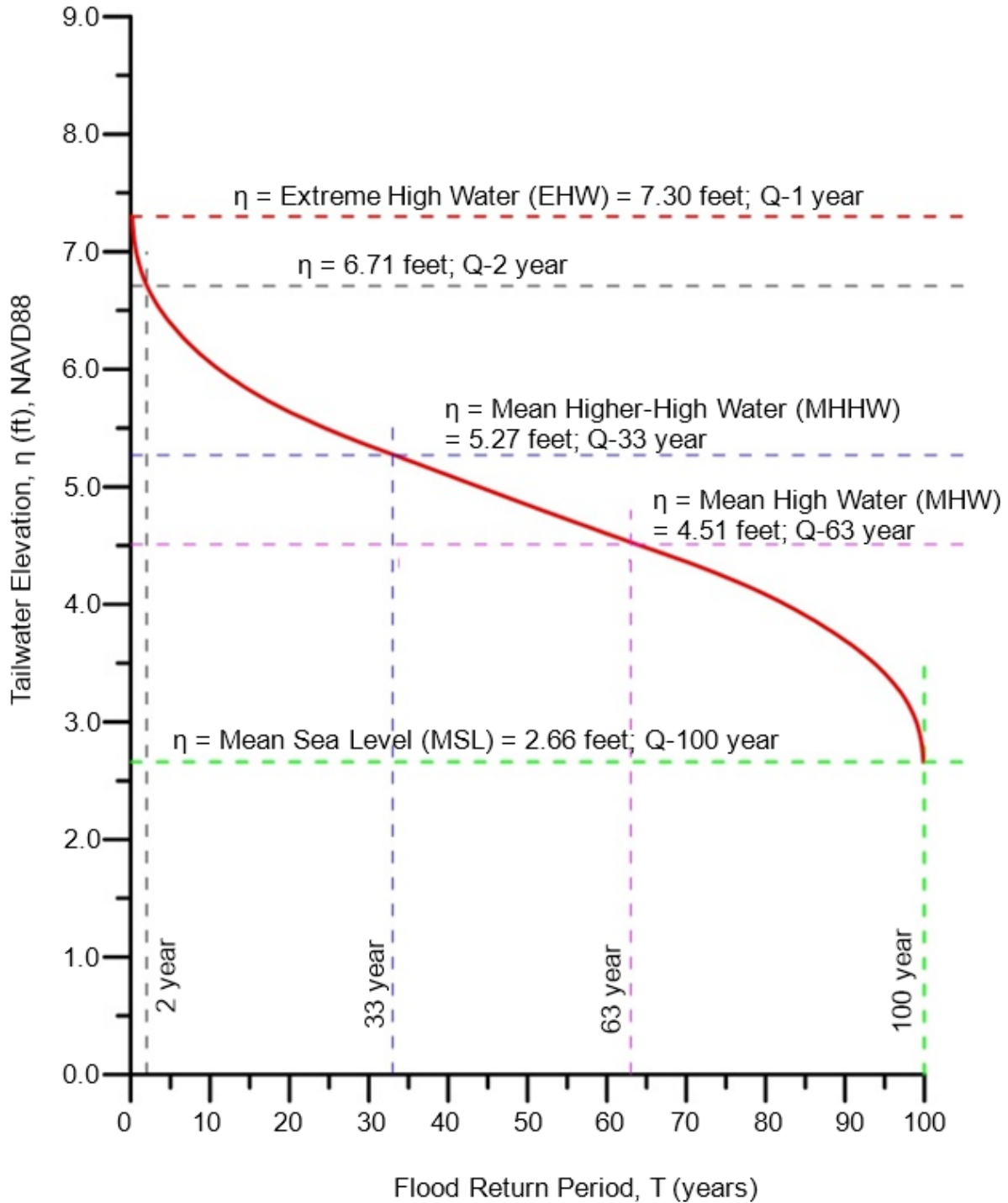

Figure 821.3F

One-Percent Compound Frequency Curve for Province 5, (Based on NOAA # 9411340, Santa Barbara)



July 1, 2020

Figure 821.3G

One-Percent Compound Frequency Curve for Province 6, (Based on NOAA # 9410660, Los Angeles)

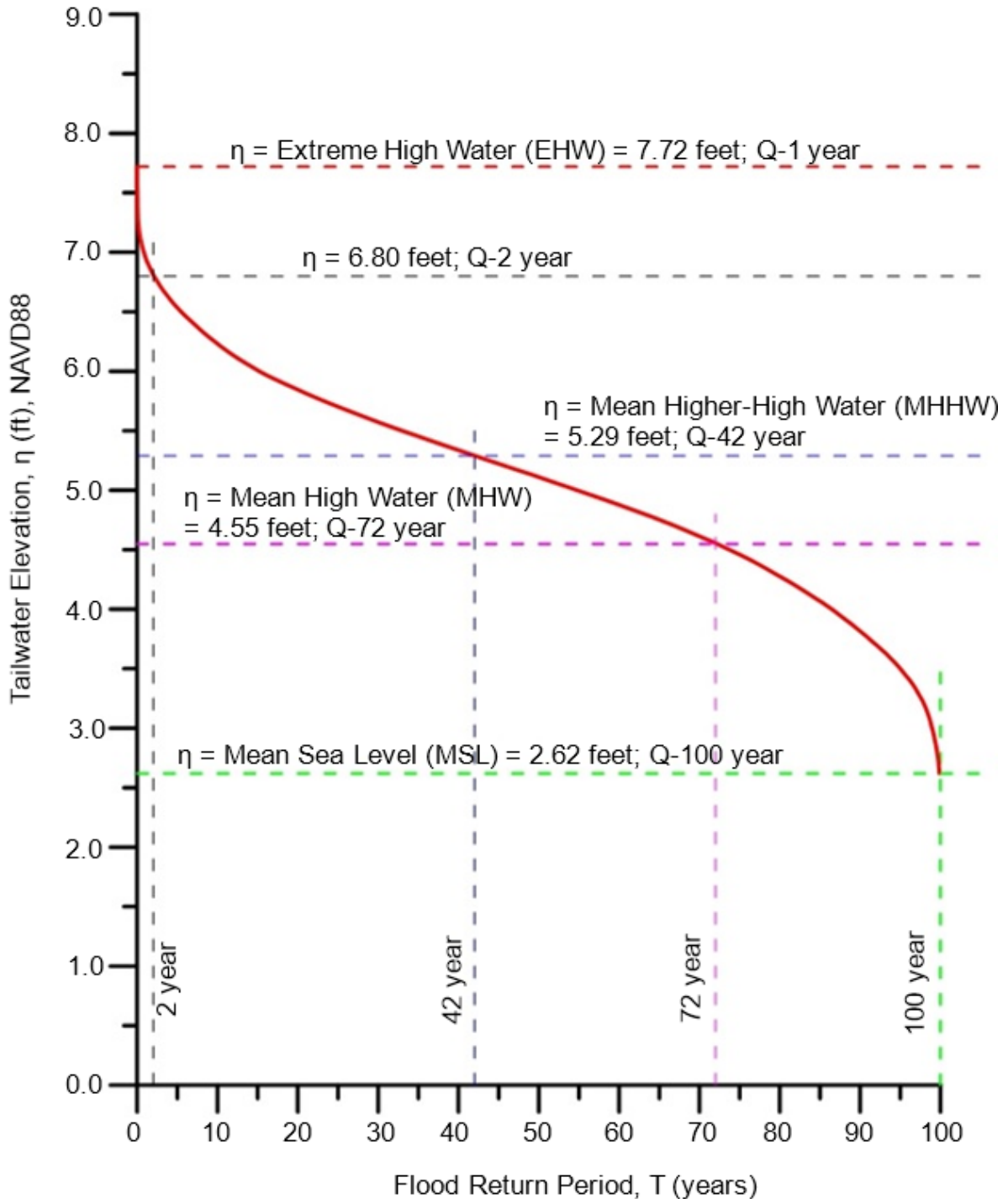
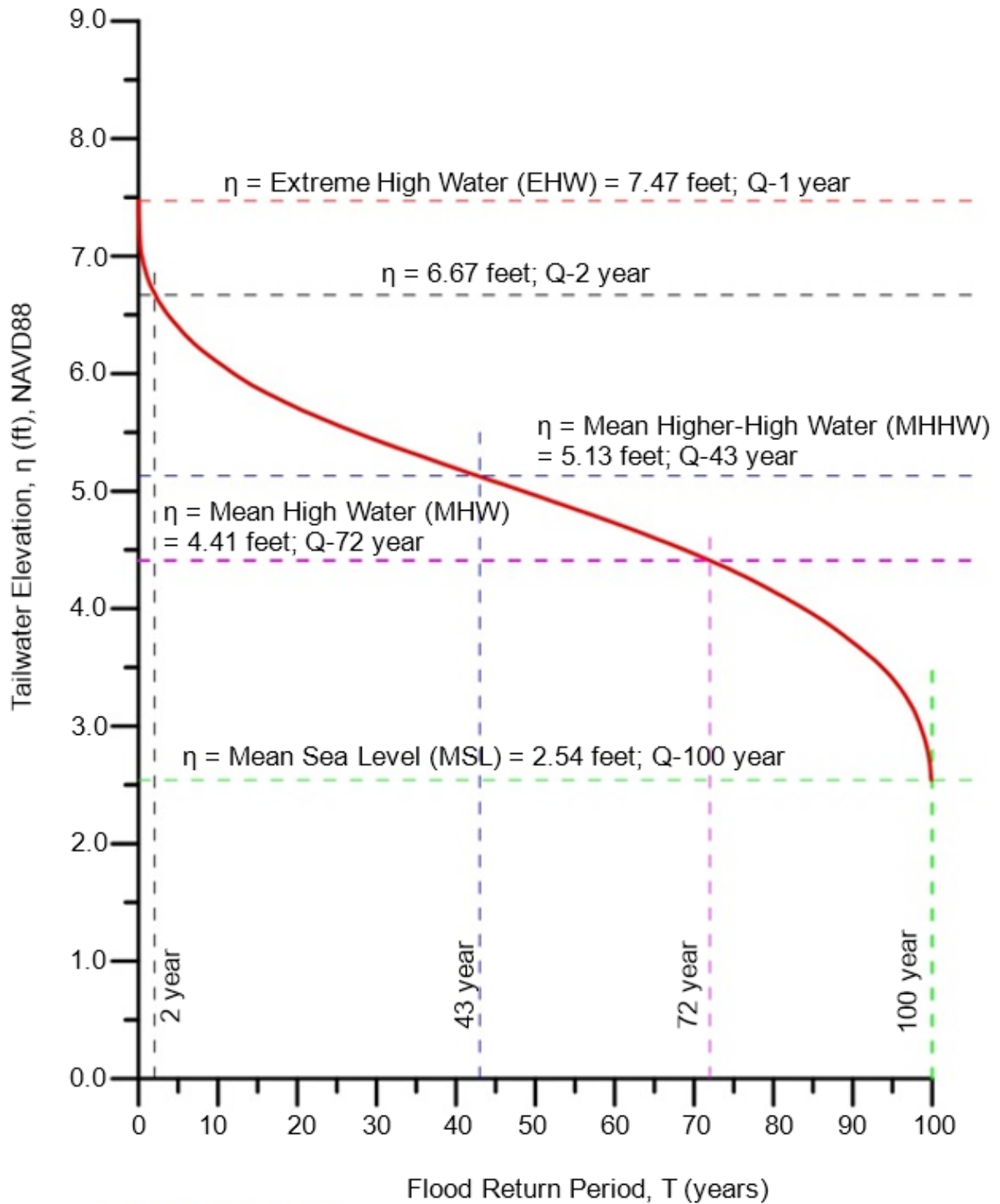

Figure 821.3H

One-Percent Compound Frequency Curve for Province 7, (Based on NOAA # 9410230, La Jolla Scripps Pier)



July 1, 2020

Figure 821.3I

One-Percent Compound Frequency Curve for Province 8, (Based on NOAA # 9414750, Alameda)

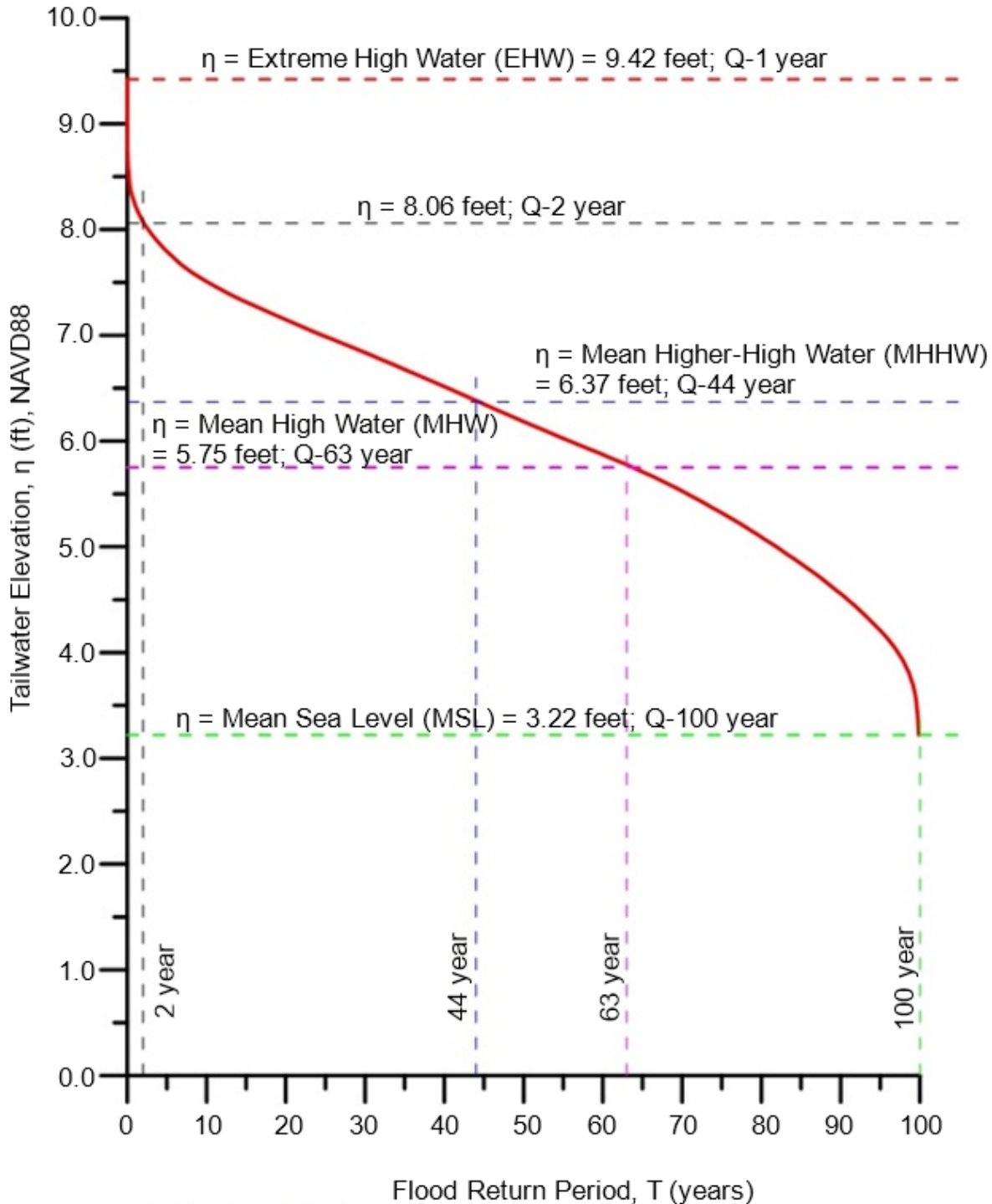
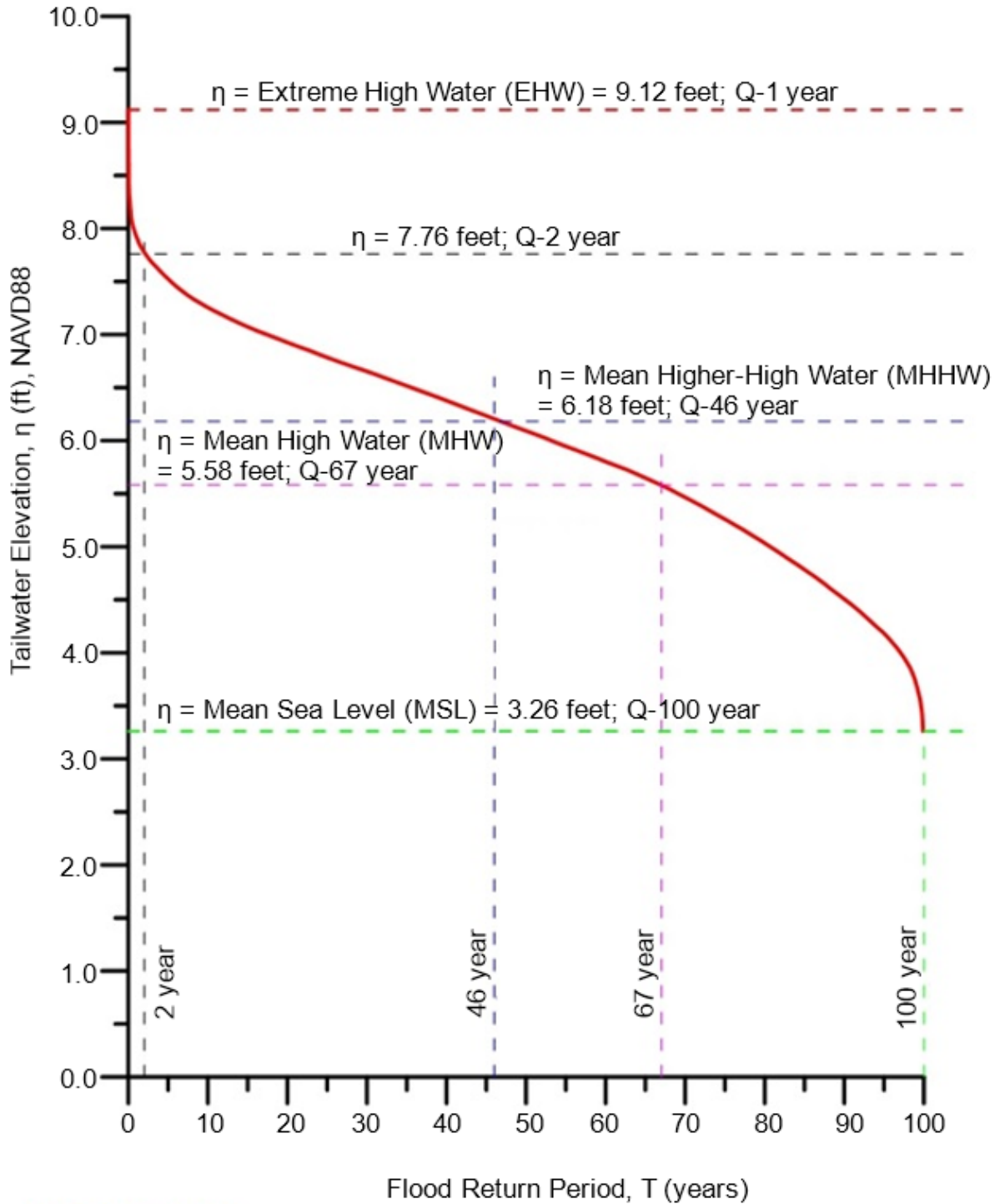

Figure 821.3J

One-Percent Compound Frequency Curve for Province 9, (Based on NOAA # 9415056, Pinole Point, San Pablo Bay)



July 1, 2020

Figure 821.3K

One-Percent Compound Frequency Curve for Province 9a, (Based on NOAA # 9415144, Port Chicago)

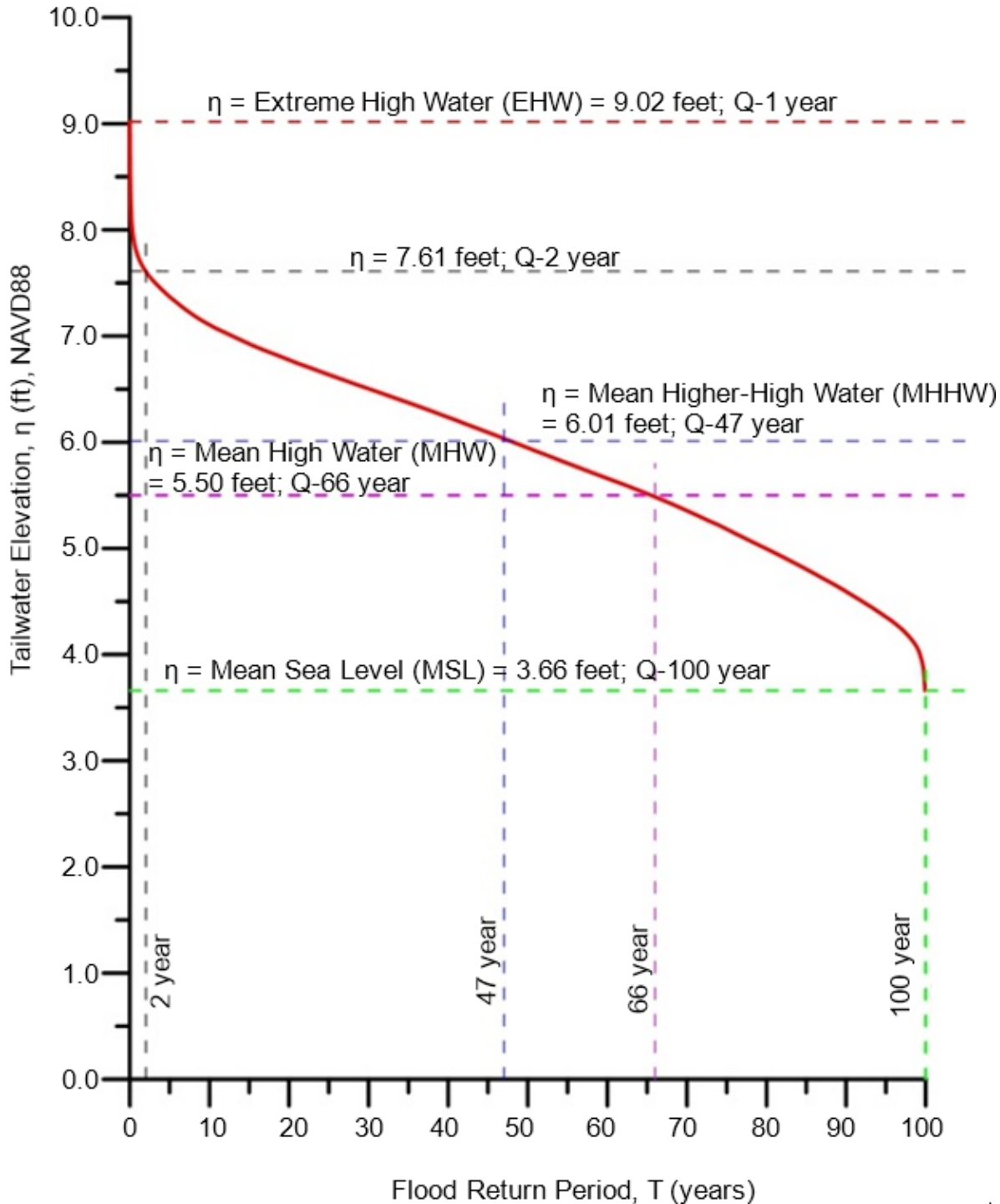
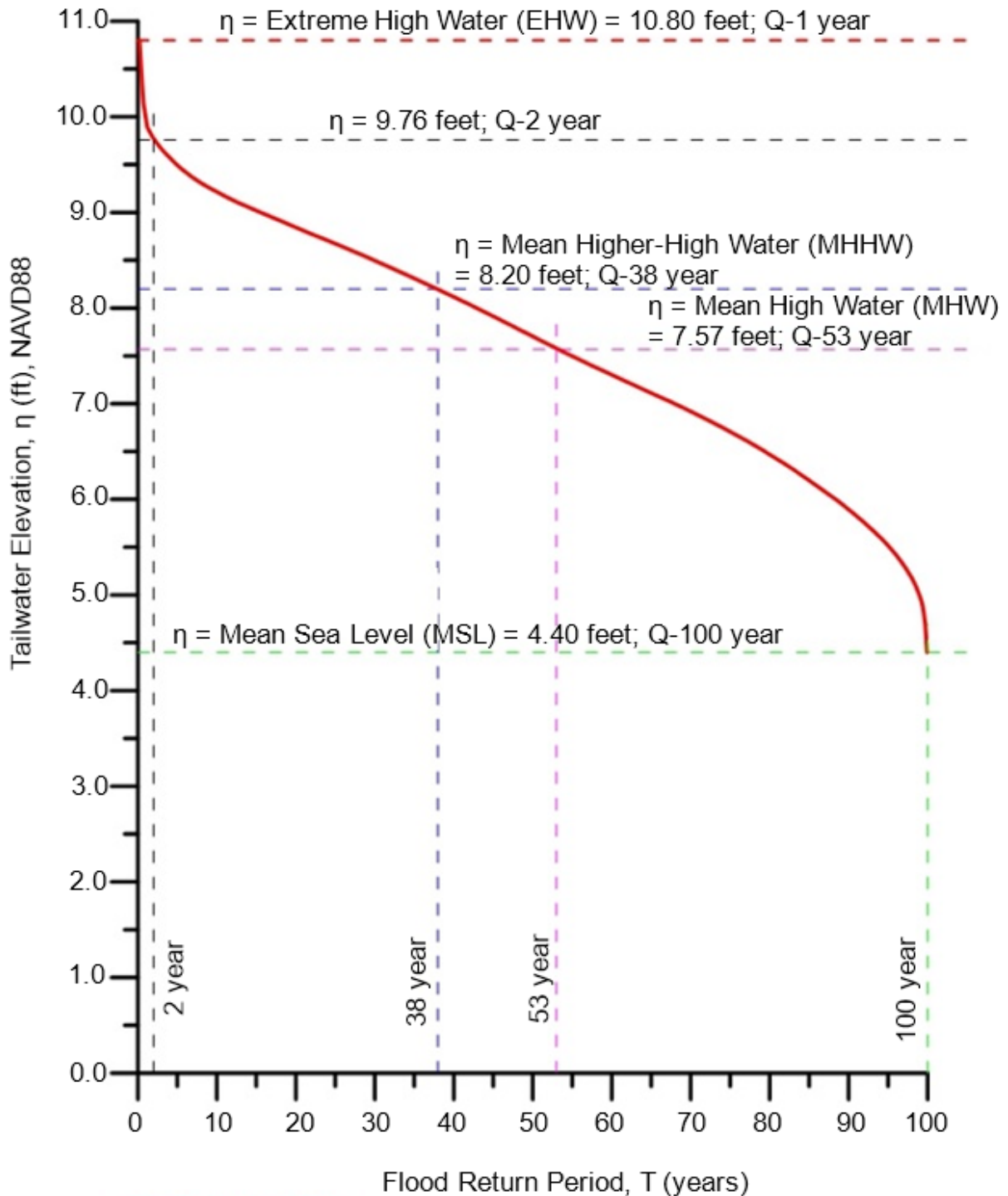

Figure 821.3L

One-Percent Compound Frequency Curve for Province 10, (Based on NOAA # 9414523, Redwood City)



July 1, 2020

Figure 821.3M

One-Percent Compound Frequency Curve for Province 11, (Based on NOAA # 9410170, San Diego Bay, Navy Pier)

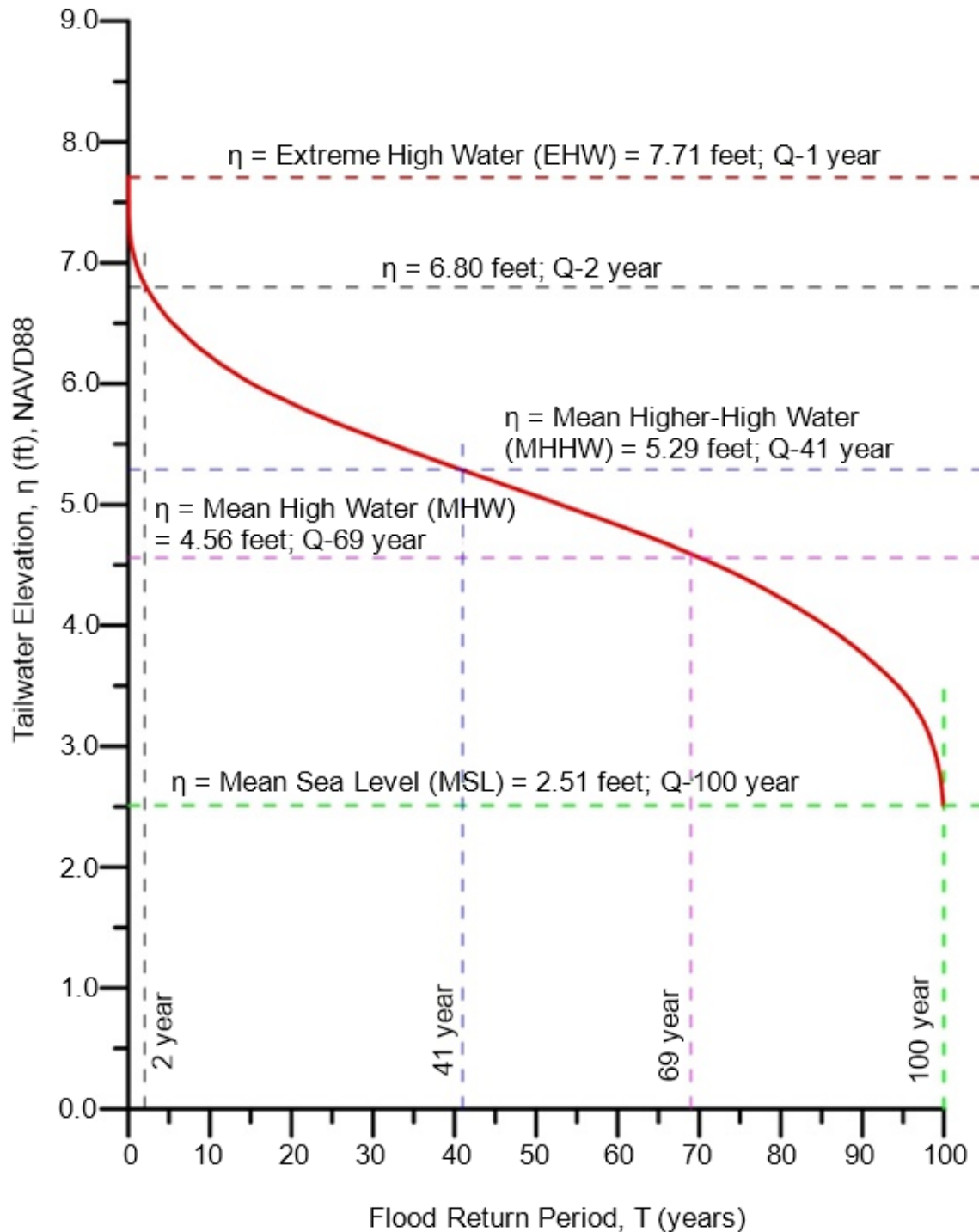
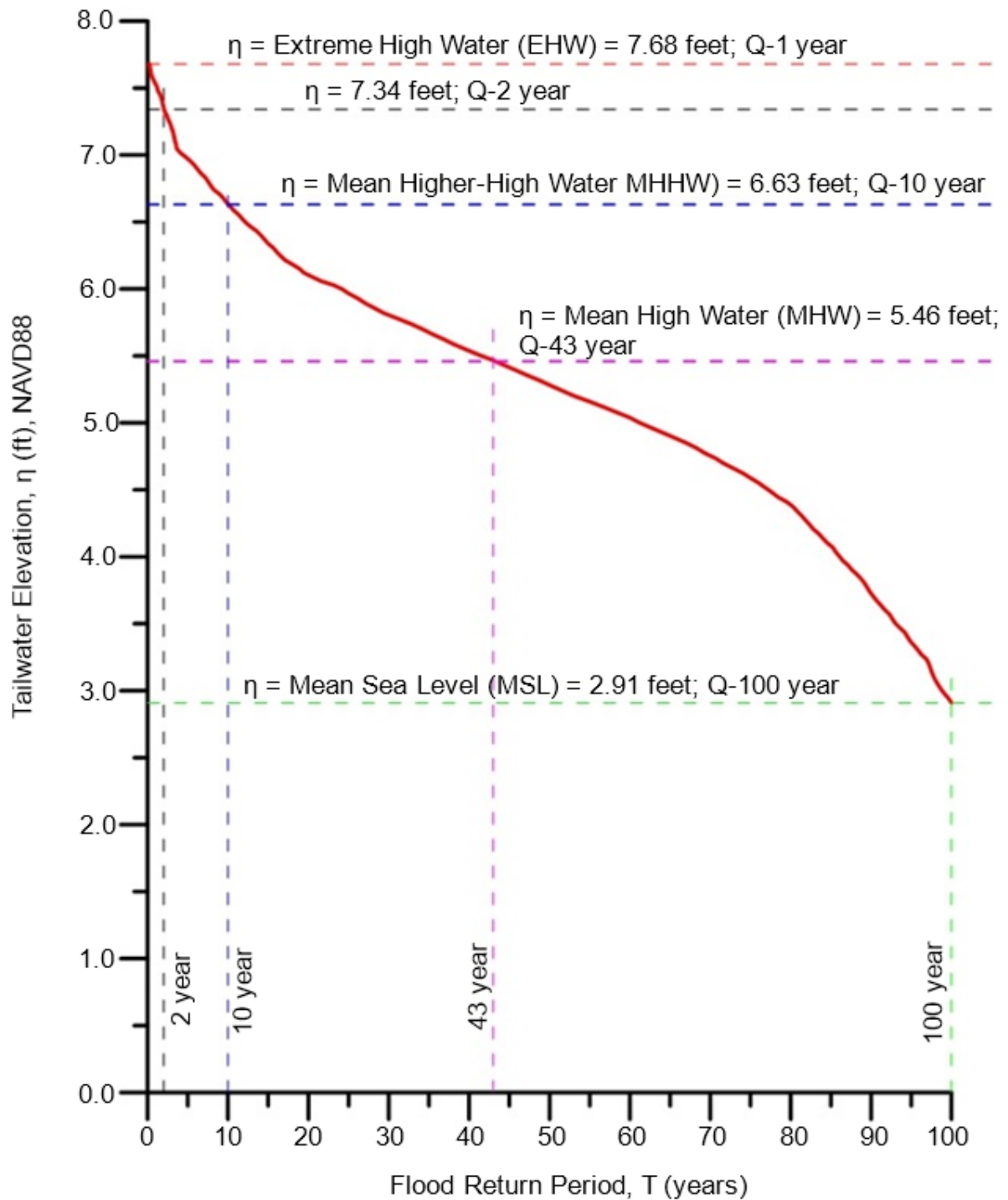

Figure 821.3N

One-Percent Compound Frequency Curve for Province 12, (Based on Otay River Sonde)



July 1, 2020

The following provides guidance on how the tailwater level at a project location can be determined based on the one-percent compound frequency curves described above. Let us consider, Province A and Province B are two neighboring provinces, and the distance from the centroid of the province to the boundary is L_A and L_B , respectively, as shown in Figure 821.4. The project site is located at a distance X_A from the boundary within Province A.

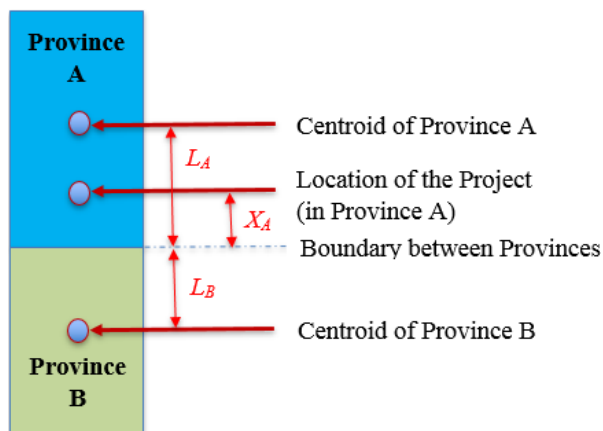
Figure 821.4**Distances needed to guide interpolation**

Depending on the proximity of the project site to the centroid of the host province and to the province boundary, either of the following approaches may be used to determine the tailwater level at the project site:

- If the project site is relatively far from the neighboring province boundary and close to the centroid of the host province, i.e. $X_A > \frac{3}{4}L_A$, the one-percent compound frequency curve of only the host province (in this case Province A) will be considered.
- If the project site is relatively closer to the boundary and further away from the centroid of the host province, i.e. $X_A \leq \frac{3}{4}L_A$, the one-percent curves of both the host province and the neighboring province will be used. If for a particular streamflow event the tailwater level for these two provinces obtained from the curves is η_A and η_B , respectively, then the tailwater level at the project site, $\bar{\eta}$, is determined using the following equation of distance-weighted interpolation:

$$\bar{\eta} = K_x \eta_A + (1 - K_x) \eta_B$$

Here, the term K_x is the distance weighted factor, which is determined from the non-dimensional distance of the project site from the nearest province boundary or $\frac{X_A}{L_A}$, using Figure 821.5 or the following equation:

$$K_x = 0.5086205534 + 0.8853233677 \frac{X_A}{L_A} - 0.3871675236 \left(\frac{X_A}{L_A} \right)^2$$

If a project is located closed to the province boundary the term K_x approaches to 0.5 and the distance-weighted average solution becomes the arithmetic mean of η_A , and η_B . As the project site becomes further away from the province boundary and closer to the centroid of the host province, K_x approaches to 1.0, the solution converges on that of the host province, ($\bar{\eta} \rightarrow \eta_A$).

Figure 821.5

Weighting factor, K_x for interpolation

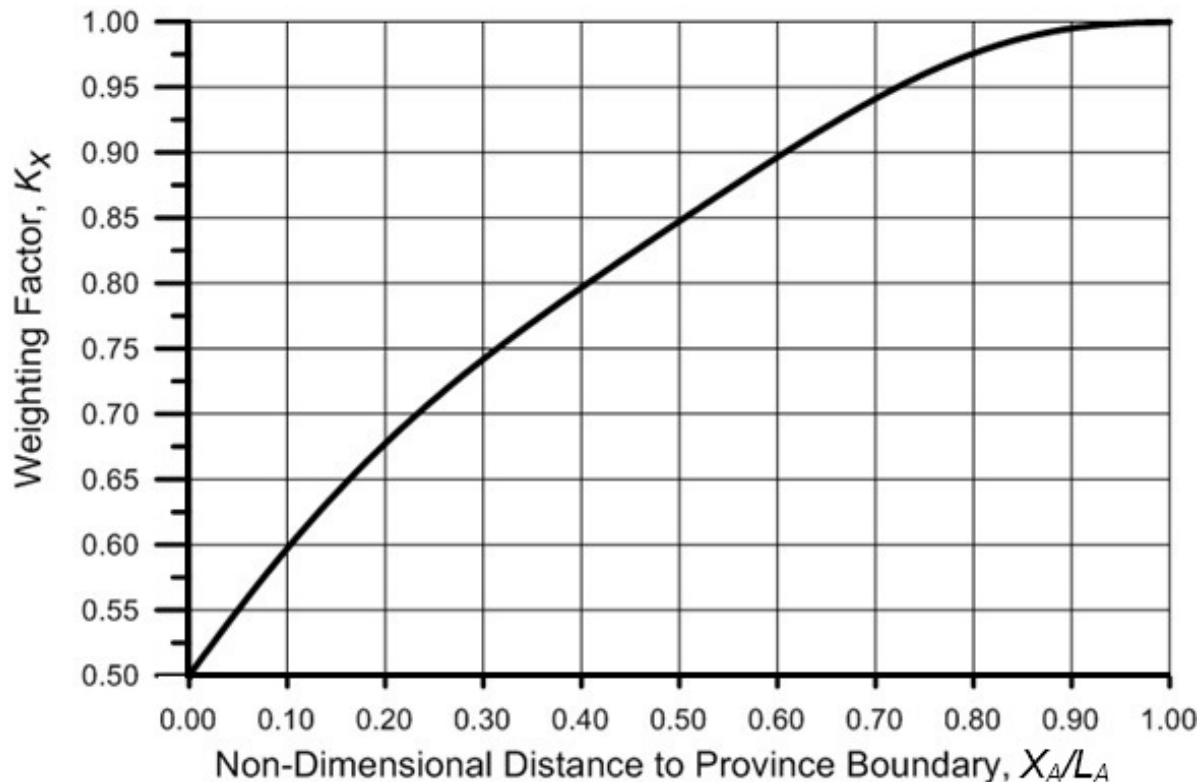

Two examples are provided below, which are loosely based on reality, the reader should be aware of that aspects of the example data are fictional and have been created for instructional purposes only. In general, the discharge in a stream at different return periods can be easily estimated using StreamStats or other methods described in Topic 819 of this manual. In a tidal environment, for a certain flow event, the corresponding tailwater can be obtained using the above-described method, where the compound annual exceedance probability would be 1%. Any set of flow and tailwater data can be used as boundary conditions to determine the upstream water level and the flow velocity. For the hydraulic analysis of a culvert or bridge, at least two sets of boundary conditions, such as 100-year and 50-year discharges should be considered, and the design should be based on the worst-case scenario. The designer must use discretion in selecting the return periods of the discharge. The tailwater levels in these examples do not include sea-level rise (SLR) which needs to be evaluated for all facilities in a coastal environment. The estimated SLR should be added to the tailwater level during the design process.

July 1, 2020

(1) Example 1

A straight culvert with no inlet depression needs to be designed on Highway 1 in San Luis Obispo County. The following hydrology data (using StreamStats or U.S.G.S Regional Regression Equation (see Index 819.2(2)) and site specifications were provided:

- 50-year Discharge = 251 cfs
- 100-year Discharge = 315 cfs

The maximum allowable upstream water level elevation or headwater level (HW) = 12.5 feet (NAVD88). The coordinates of the upstream toe line are = 35°25'02.01" N and 120°52'30.80" W.

The figure below shows the profile of the culvert.

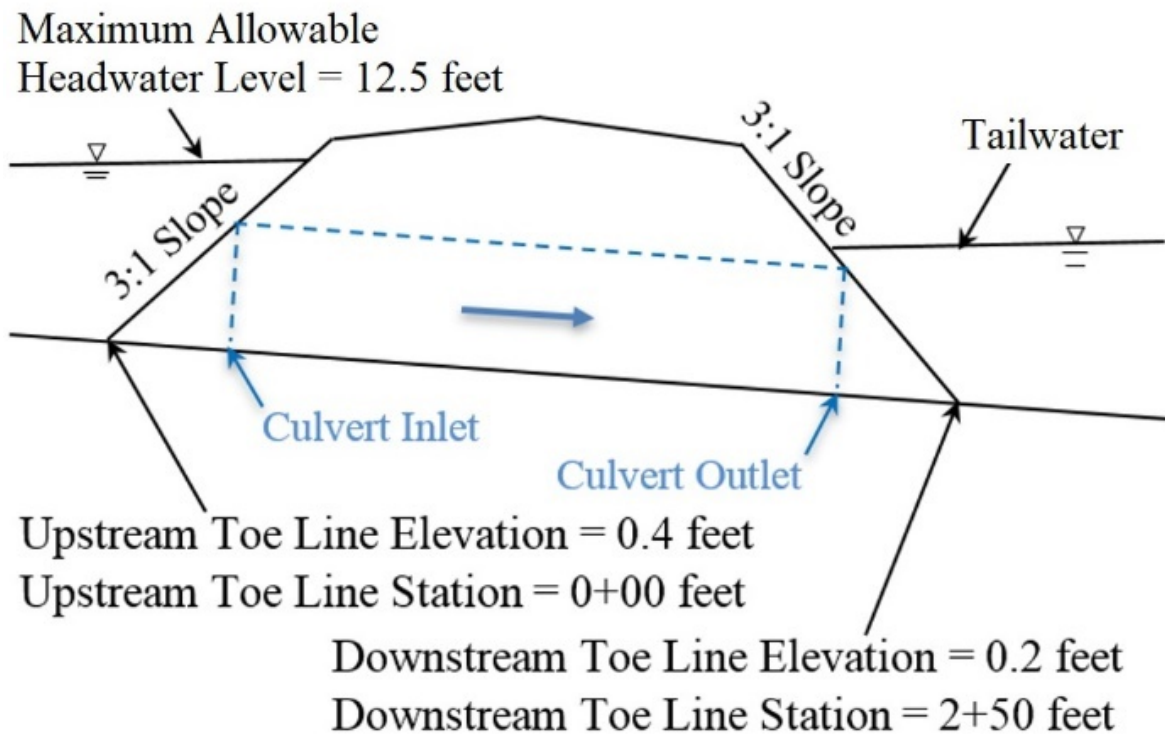

Step 1: Obtain the Tailwater Depth for the corresponding discharge to represent a 1% probability of exceedance event

The project site is in Province 3, near the boundary with Province 4 as shown in the following figure.



The distance from the centroid of the Province 3 and the boundary between Provinces 3 and 4 (L_3) is 94.5 miles (From Table 821.1). The province boundary points could be loaded in a mapping software, such as Google Earth® or ArcGIS®, to measure the running distance along the coastline. It is to be noted that, while measuring distance, the distance path should be relatively smooth and small interior of embayments in the coastlines should be ignored. The distance from the project site to the boundary (X_3) is about 12 miles. Here, $\frac{X_3}{L_3} = \frac{12}{94.5} = 0.127$.

Since $X_3 < \frac{3}{4}L_3$, the project location can be considered as close to the province boundary. Therefore, an interpolation of the tailwater levels (η values) between Province 3 and Province 4 is needed. The tailwater elevation of both provinces for each discharge scenario is obtained based on the corresponding one-percent compound frequency curve per Figure 821.3D and Figure 821.3E (as shown in the following two figures).

July 1, 2020

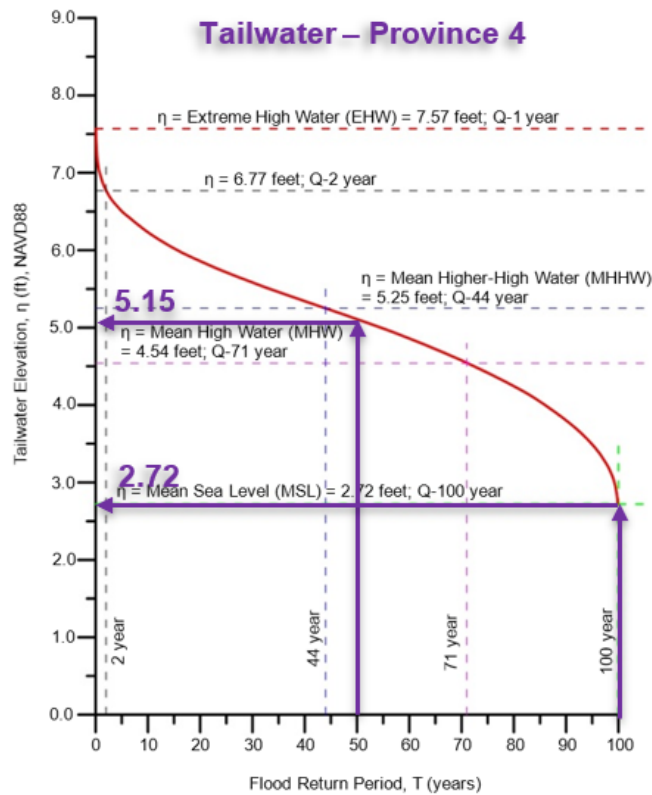
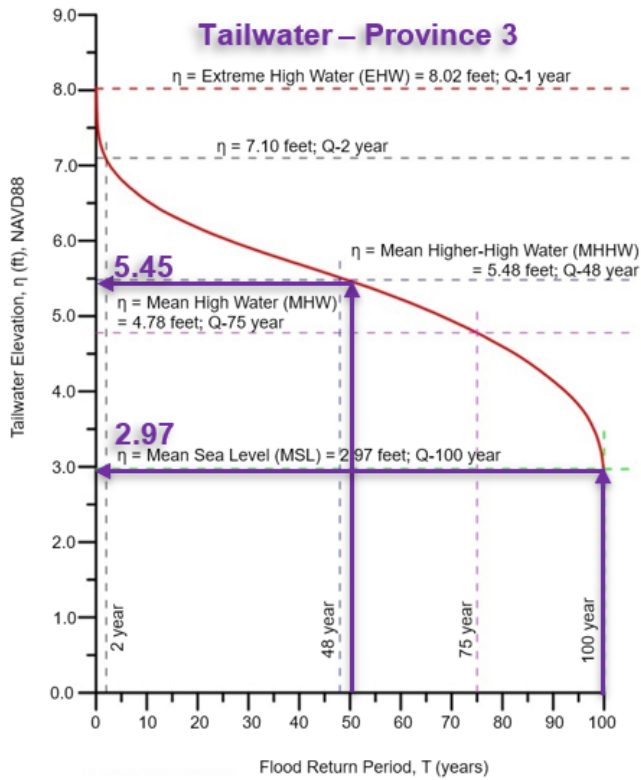

Using $\frac{X_3}{L_3} = 0.127$ in the equation for distance-weighted factor or Figure 821.5, we get $K_x = 0.615$.

Once K_x is determined, the tailwater at the project location for each discharge event can be calculated using the equation of distance-weighted interpolation (as below):

$$\bar{\eta} (50 - \text{year}) = 0.615 \times 5.45 + (1 - 0.615) \times 5.15 = 5.33 \text{ feet}$$

$$\bar{\eta} (100 - \text{year}) = 0.615 \times 2.97 + (1 - 0.615) \times 2.72 = 2.87 \text{ feet}$$

To summarize the above findings, at the project site, either of the two scenarios of boundary conditions shown in the following table would have a compound probability of exceedance of one percent.

Scenario 1		Scenario 2	
50-year Discharge	251 cfs	100-year Discharge	315 cfs
Tailwater Elevation (TW)	5.33 feet, NAVD88	Tailwater Elevation (TW)	2.87 feet, NAVD88

Step 2: Using Standard Plans, select a primary culvert shape, material, size, and entrance configuration.

Trial 1: Use a single barrel Precast Reinforced Concrete Pipe of 6 feet inner diameter. Let us assume the entrance of the culvert has a beveled edge (1:1).

Step 3: Calculate the Station and Elevation at Culvert Inlet and Outlet

The Station at the Culvert Inlet = Upstream Toe Line Station + Culvert Diameter \times Embankment Slope = $0 + 6 \times 3 = 18$ feet

The Station at the Culvert Outlet = Downstream Toe Line Station – Culvert Diameter \times Embankment Slope = $250 - 6 \times 3 = 232$ feet

The slope of Culvert = Difference in elevation between upstream and downstream toe line/Distance between upstream and downstream toe line = $\frac{(0.2-0.4)}{250} = -0.0008$

Culvert Inlet Elevation = Upstream Toe Line Elevation – Culvert Slope \times (Culvert Diameter + Thickness of the Headwall) = $0.4 - 0.0008 \times (6 + 0.5) \approx 0.4$ feet

Culvert Outlet Elevation = Downstream Toe Line Elevation + Culvert Slope \times (Culvert Diameter + Thickness of the Headwall) = $0.2 + 0.0008 \times (6 + 0.5) \approx 0.2$ feet

Step 4: Enter data into a Culvert Software (e.g. HY-8): Enter the data into a culvert software (e.g. HY-8), repeat Steps 2 through 3 for several other culvert configurations and use that software to calculate Headwater (HW) for each scenario of 1% probability of exceedance. The calculated HW is then checked against the maximum allowable HW. If the calculated hydraulic

July 1, 2020

condition for any scenario exceeds the allowable conditions, the configuration must be rejected and a larger size culvert and/or an efficient inlet should be considered to achieve a suitable hydraulic condition. Following table shows the culvert configuration in each trial, and the corresponding headwater and outlet velocity computed using HY-8. Final configuration could change after adding the SLR to the tailwater level.

Trials	Culvert Configuration	Calculated Headwater and Outlet Velocity		
		Scenario 1 (Q ₅₀ = 251 cfs, Tailwater Elevation = 5.33 feet, NAVD88)	Scenario 2 (Q ₁₀₀ = 315 cfs, Tailwater Elevation = 2.87 feet, NAVD88)	Comments
Trial 1	6.0 feet diameter RCP, beveled edge (1:1)	Headwater Elevation 7.63 ft, Velocity 9.75 ft/sec, (Inlet Control)	Headwater 8.95 feet, Velocity 12.89 ft/sec, (Outlet Control)	Much below the Allowable HW
Trial 2	5.0 feet diameter RCP, beveled edge (1:1)	Headwater 10.06 ft, Velocity 12.78 ft/sec, (Outlet Control)	Headwater 12.81 ft, Velocity 16.40 ft/sec (Inlet Control)	Exceeded Allowable HW for Scenario 2
Trial 3	5.5 feet diameter RCP, beveled edge (1:1)	Headwater 8.46 feet, Velocity 10.84 ft/sec, (Outlet Control)	Headwater 10.33 feet, Velocity 14.20 ft/sec, (Inlet Control)	Selected

Following figure shows the HY-8 input data.

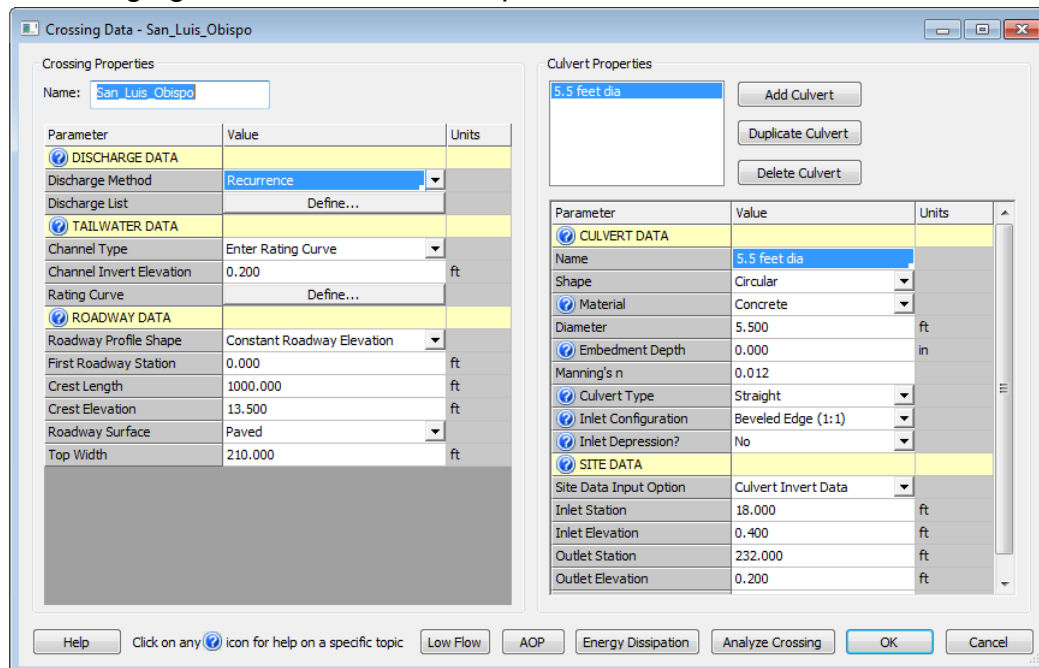

Following figure shows the output profile of the configuration that is selected in the current design.

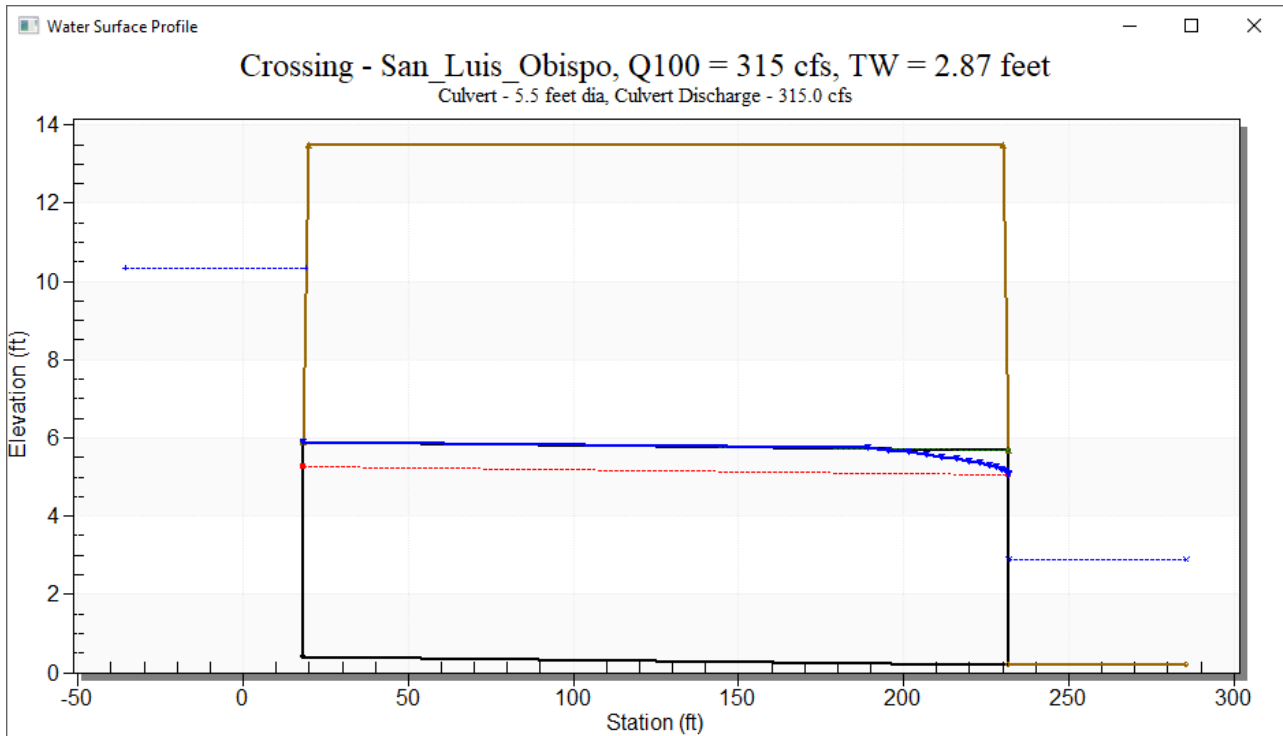

(2) Example 2

A straight culvert with no inlet depression needs to be designed on State Route 101 in San Mateo County. The following hydrology data using StreamStats or U.S.G.S Regional Regression Equation (see Index 819.2(2)) and site specifications were provided.

- 50-year Discharge = 29.3 cfs
- 100-year Discharge = 35.7 cfs

The maximum allowable upstream water level elevation or headwater level = 11.20 feet (NAVD88).

The coordinates of the upstream toe line are = 37°41'53.57"N and 122°23'34.79"W.

July 1, 2020

Following figure shows the profile of the culvert.

Maximum Allowable
Headwater Level = 11.2 feet

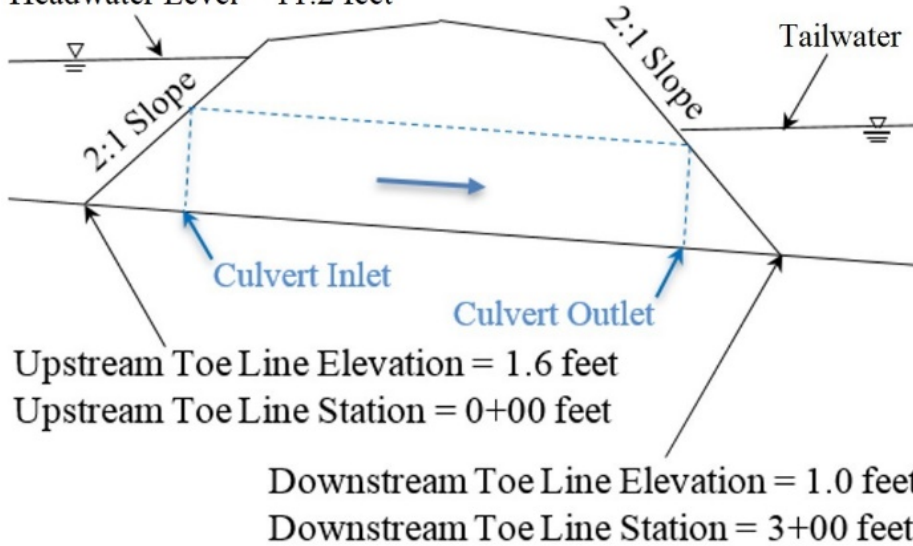

Step 1: Obtain the Tailwater Depth for the corresponding discharge to represent a 1% probability of exceedance event.

The project site is in Province 10, near the boundary with Province 2a as shown in the following figure.



The tailwater elevation for these two provinces at each discharge event is obtained based on the corresponding one-percent compound frequency curve per Figure 821.3C and Figure 821.3L as shown in the following two figures.

Tailwater – Province 10

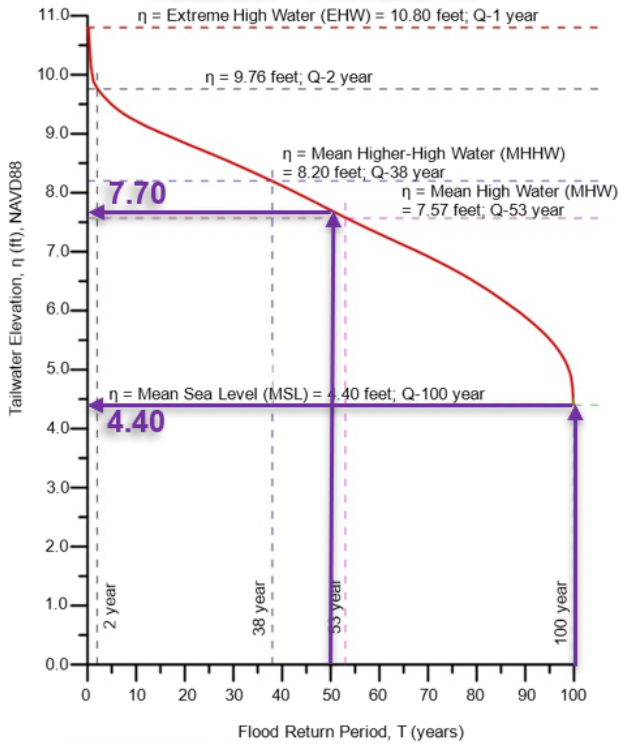

Tailwater – Province 2a

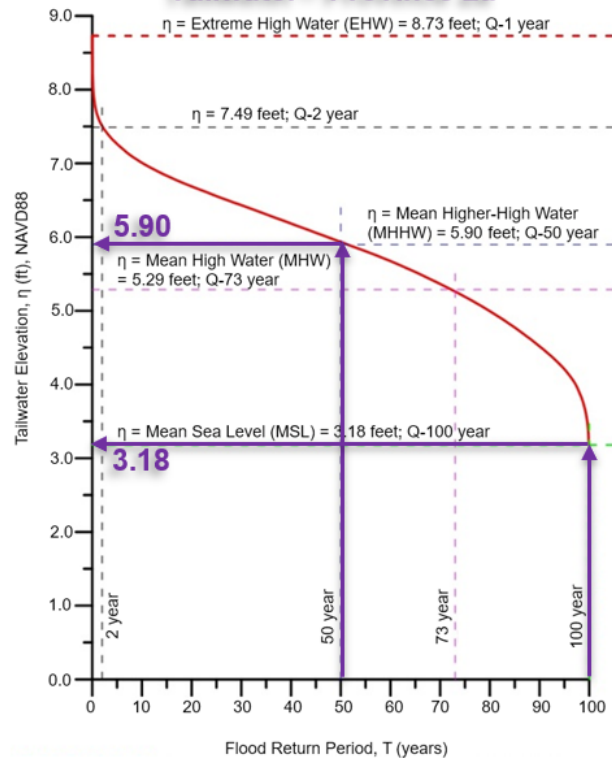

July 1, 2020

The distance from the centroid of the Province 10 and the boundary between Province 10 and Province 2a (L_{10}) is 32.9 miles (From Table 821.1). The distance measured from the project site to the boundary (X_{10}) is 2 miles.

Here, $\frac{X_{10}}{L_{10}} = \frac{2}{32.9} = 0.061$. Since $X_{10} < \frac{3}{4}L_{10}$, the project location can be considered as close to the province boundary. An interpolation of the tailwater levels (η values) between Province 10 and Province 2a is needed.

Using $\frac{X_{10}}{L_{10}} = 0.061$ in the equation for distance-weighted factor or Figure 821.5, we get $K_x = 0.562$. Once K_x is determined, the tailwater at the project location for each discharge event can be calculated using the equation of distance-weighted interpolation (as below):

$$\bar{\eta} (50 - \text{year}) = 0.562 \times 7.70 + (1 - 0.562) \times 5.90 = 6.91 \text{ feet}$$

$$\bar{\eta} (100 - \text{year}) = 0.562 \times 4.40 + (1 - 0.562) \times 3.18 = 3.87 \text{ feet}$$

To summarize the above findings, at the project site, either of the two scenarios of boundary conditions, as shown in the following table, would have a compound probability of exceedance of one percent.

Scenario 1		Scenario 2	
50-year Discharge	29.3 cfs	100-year Discharge	35.7 cfs
Tailwater Elevation (TW)	6.91 feet, NAVD88	Tailwater Elevation (TW)	3.87 feet, NAVD88

Step 2: Using Standard Plans, select a primary culvert shape, material, size, and entrance configuration.

Trial 1: Use a single corrugated steel Pipe of 3 feet inner diameter. Let us assume the entrance of the culvert has a square edge with headwall.

Step 3: Calculate the Station and Elevation at Culvert Inlet and Outlet

The Station at the Culvert Inlet = Upstream Toe Line Station + Culvert Diameter \times Embankment Slope = $0 + 3 \times 2 = 6$ feet

Station at the Culvert Outlet = Downstream Toe Line Station – Culvert Diameter \times Embankment Slope = $300 - 3 \times 2 = 294$ feet

The slope of Culvert = Difference in elevation between upstream and downstream toe line/Distance between upstream and downstream toe line = $\frac{(1.0-1.6)}{300} = -0.002$

Culvert Inlet Elevation = Upstream Toe Line Elevation – Culvert Slope × (Culvert Diameter + Thickness of the Headwall) = $1.6 - 0.002 \times (3 + 0.5) \approx 1.6$ feet

Culvert Outlet Elevation = Downstream Toe Line Elevation + Culvert Slope × (Culvert Height + Thickness of the Headwall) = $1.0 + 0.002 \times (3 + 0.5) \approx 1.0$ feet

Step 4: Enter data in to a Culvert Software (e.g. HY-8)

Similar to the previous example, enter the data in a culvert software (e.g. HY-8), repeat Steps 2 through 3 for several other culvert configurations and use that software to calculate Headwater (HW) for each scenario of 1% probability of exceedance. The calculated HW is then checked against the maximum allowable Headwater. If the calculated hydraulic condition for any scenario exceeds the allowable conditions, the configuration must be rejected, and a larger size culvert and/or an efficient inlet should be considered to achieve a suitable hydraulic condition. Following table shows the culvert configuration in each trial and the corresponding headwater and outlet velocity computed using HY-8. Final configuration could change after adding the SLR to the tailwater level.

Trials	Culvert Configuration	Calculated Headwater and Outlet Velocity		
		Scenario 1 (Q ₅₀ = 29.3 cfs, Tailwater Elevation = 6.91 feet)	Scenario 2 (Q ₁₀₀ = 35.7 cfs, Tailwater Elevation = 3.87 feet)	Comments
Trial 1	3 feet diameter HDPE, square edge with headwall	Headwater Elevation 7.78 ft, Velocity 4.15 ft/sec, (Outlet Control)	Headwater 5.09 feet, Velocity 5.13 ft/sec, (Outlet Control)	Much below the Allowable HW
Trial 2	2.0 feet diameter HDPE, square edge with headwall	Headwater 13.03 ft, Velocity 9.33 ft/sec, (Outlet Control)	Headwater 12.95 ft, Velocity 11.36 ft/sec (Outlet Control)	Exceeded Allowable HW
Trial 3	2.5 feet diameter HDPE, square edge with headwall	Headwater 8.99 feet, Velocity 5.97 ft/sec, (Outlet Control)	Headwater 6.95 feet, Velocity 7.27 ft/sec, (Outlet Control)	Selected

July 1, 2020

Figure below shows the HY-8 input data.

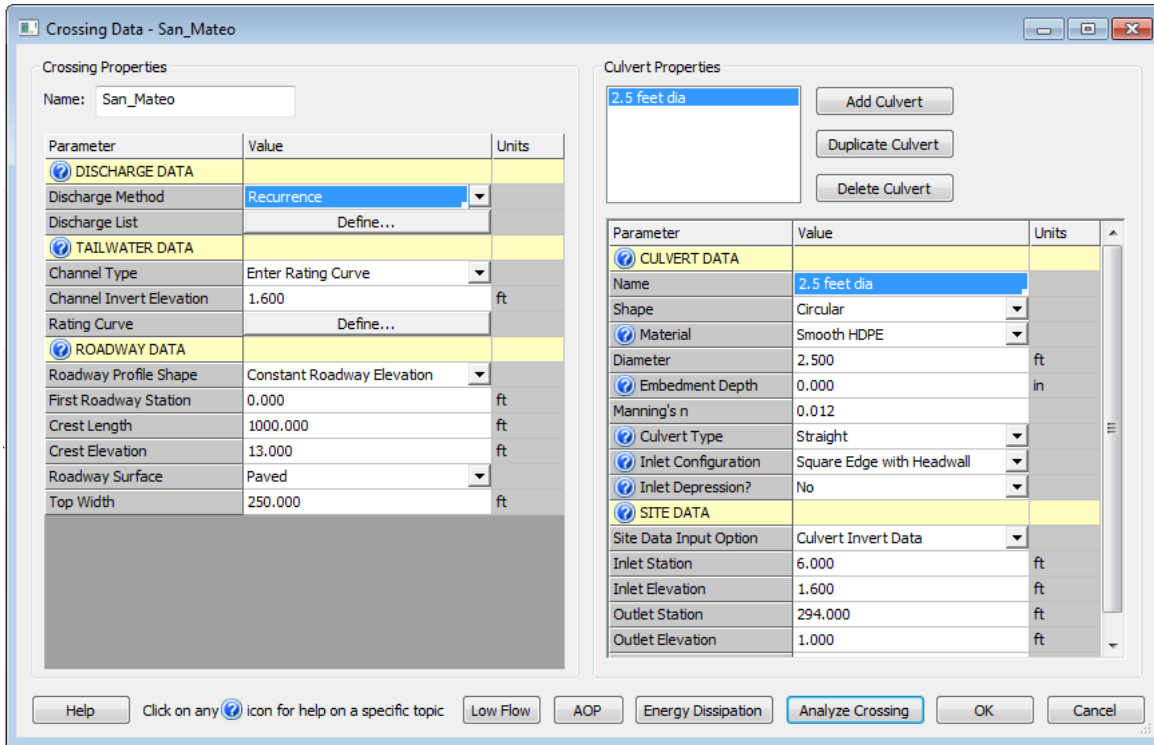

Following figure shows the output profile of the configuration that is selected in the current design.

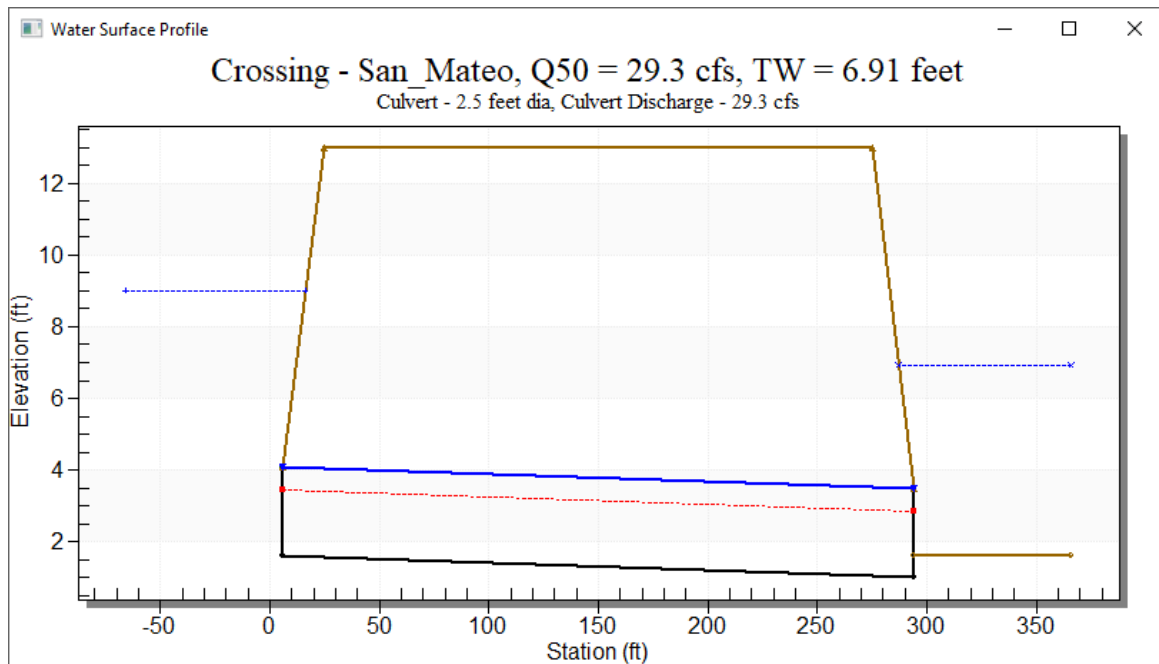

Topic 822 – Debris Control

822.1 Introduction

Debris, if allowed to accumulate either within a culvert or at its inlet, can adversely affect the hydraulic performance of the facility. Damage to the roadway and to upstream property may result from debris obstructing the flow into the culvert. Coordination with district maintenance forces can help in identifying areas with high debris potential and in setting requirements for debris removal where necessary.

The use of any device that can trap debris must be thoroughly examined prior to its use. In addition to the more common problem of debris accumulation at the culvert entrance, the use of safety end grates or other appurtenances can also lead to debris accumulation within the culvert at the outlet end. Evaluation of this possibility, and appropriate preventive action, must be made if such end treatment is proposed.

822.2 Debris Control Methods

There are two methods of handling debris:

- (1) **Passing Through Culvert.** If economically feasible, culverts should be designed to pass debris. Culverts which pass debris often have a higher construction cost. On the other hand, retaining solids upstream from the entrance by means of a debris control structure often involves substantial maintenance cost and could negatively affect fish passage. An economic comparison which includes evaluation of long term maintenance costs should be made to determine the most reasonable and cost effective method of handling.
- (2) **Interception.** If it is not economical to pass debris, it should be retained upstream from the entrance by means of a debris control structure or the use of a debris basin when the facility is located in the vicinity of alluvial fans.

If drift and debris are retained upstream, a riser or chimney may be required. This is a vertical extension to the culvert which provides relief when the main entrance is plugged. The increased head should not be allowed to develop excessive velocities or cause pressure which might induce leakage in the culvert.

If debris control structures are used, access must be provided for maintenance equipment to reach the site. This can best be handled by coordination and field review with district maintenance staff. Details of a pipe riser with debris rack cage are shown on Standard Plan D93C. See FHWA Hydraulic Engineering Circular No. 9, "Debris-Control Structures" for further information.

The use of an upstream debris basin and downstream concrete lined channels, has often been used by Local Agencies for managing flood flows on alluvial fans in urbanized areas. Experience has shown that this approach is effective, however, the costs of building and maintaining such facilities is high with a potential for sediment inflows greater than anticipated.

The District Hydraulics Engineer should be consulted if a debris basin is being considered for interception in the vicinity of an alluvial fan.

July 1, 2020

822.3 Economics

Debris problems do not occur at all suspected locations. It is often more economical to construct debris control structures after problems develop. An assessment of potential damage due to debris clogging if protection is not provided should be the basis of design.

822.4 Classification of Debris

In order to properly determine methods for debris control, an evaluation of the characteristics of debris within flood flows must be made. Debris can be either floating, suspended in the flood flow, or dragged/rolled along the channel bottom. Typically, a flood event will deposit debris from all of these types.

The FHWA Hydraulic Engineering Circular No. 9 contains a debris classification system to aid the designer in selecting the appropriate type of debris control structure.

822.5 Types of Debris Control Structures

The FHWA Hydraulic Engineering Circular No. 9, "Debris-Control Structures", shows types of debris control structures and provides a guide for selecting the type of structure suitable for various debris classifications.

Topic 823 – Culvert Location

823.1 Introduction

The culvert usually should be located so that the thalweg of the stream to be accommodated, approaches and exits at the approximate centerline of the culvert. However, for economic reasons, as a general rule, small skews should be eliminated, moderate skews retained and large skews reduced.

Since the culvert typically acts as a constriction, local velocities will increase through the barrel and in the vicinity of the outlet. The location and design must be also sensitive to the environment (fish passage etc).

As a general rule, flood waters should be conducted under the highway at first opportunity minimizing scour of embankment and entrapment of debris. Therefore, culverts should be placed at each defined swale to limit carryover of drainage from one watershed to another.

823.2 Alignment and Slope

The ideal culvert placement is on straight alignment and constant slope. Variations from a straight alignment should be only to accommodate unusual conditions. Where conditions require deviations from the tangent alignment, abrupt changes in direction or slope should be avoided in order to maintain the hydraulic efficiency, and avoid excessive maintenance. Angle points may be permissible in the absence of abrasives in the flow; otherwise, curves should be

used. When angle points are unavoidable, maintenance access may be necessary. See Index 838.5 for manhole location criteria.

Curvature in pipe culverts is obtained by a series of angle points. Whenever conditions require these angle points in culvert barrels, the number of angle points must be specified either in the plans or in the special provisions. The angle can vary depending upon conditions at the site, hydraulic requirements, and purpose of the culvert. The angle point requirement is particularly pertinent if there is a likelihood that structural steel plate pipe will be used. The structural steel plate pipe fabricator must know what the required miters are in order for the plates to be fabricated satisfactorily. Manufacturers' literature should be consulted to be sure that what is being specified can be fabricated without excessive cost.

Ordinarily the grade line should coincide with the existing streambed. Deviations from this practice are permissible under the following conditions:

- (a) On flat grades where sedimentation may occur, place the culvert inlet and outlet above the streambed but on the same slope. The distance above the streambed depends on the size length and amount of sediment anticipated.

If possible, a slope should be used that is sufficient to develop self-cleaning velocities.

- (b) Under high fills, anticipate greater settlement under the center than the sides of the fill. Where settlement is anticipated, provisions should be made for camber.
- (c) In steep sloping areas such as on hillsides, the overfill heights can be reduced by designing the culvert on a slope flatter than natural slope. However, a slope should be used to maintain a velocity sufficient to carry the bedload. A spillway or downdrain can be provided at the outlet. Outlet protection should be provided to prevent undermining. For the downdrain type of installation, consideration must be given to anchorage. This design is appropriate only where substantial savings will be realized.

Topic 824 – Culvert Type Selection

824.1 Introduction

A culvert is a hydraulically short conduit which conveys stream flow through a roadway embankment or past some other type of flow obstruction. Culverts are constructed from a variety of materials and are available in many different shapes and configurations. Culvert selection factors include roadway profiles, channel characteristics, flood damage evaluations, construction and maintenance costs, and estimates of service life.

824.2 Shape and Cross Section

- (1) Numerous cross-sectional shapes are available. The most commonly used shapes include circular, box (rectangular), elliptical, pipe-arch, and arch. The shape selection is based on the cost of construction, the limitation on upstream water surface elevation, roadway embankment height, and hydraulic performance.
- (2) *Multiple Barrels.* In general, the spacing of pipes in a multiple installation, measured between outside surfaces, should be at least half the nominal diameter with a minimum of 2 feet.

July 1, 2020

See Standard Plan D89 for multiple pipe headwall details.

Additional clearance between pipes is required to accommodate flared end sections. See Standard Plans, D94A & B for width of flared end sections.

Topic 825 – Hydraulic Design of Culverts

825.1 Introduction

After the design discharge, (Q), has been estimated, the conveyance of this water must be investigated. This aspect is referred to as hydraulic design.

The highway culvert is a special type of hydraulic structure. An exact theoretical analysis of culvert flow is extremely complex because the flow is usually non-uniform with regions of both gradually varying and rapidly varying flow. Hydraulic jumps often form inside or downstream of the culvert barrel. As the flow rate and tailwater elevations change, the flow type within the barrel changes. An exact hydraulic analysis therefore involves backwater and drawdown calculations, energy and momentum balance, and application of the results of hydraulic studies.

An extensive hydraulic analysis is usually impractical and not warranted for the design of most highway culverts. The culvert design procedures presented herein and in the referenced publications are accurate, in terms of head, to within plus or minus 10 percent.

825.2 Culvert Flow

The types of flow and control used in the design of highway culverts are:

- Inlet Control - Most culverts operate under inlet control which occurs when the culvert barrel is capable of carrying more flow than the inlet will accept. Supercritical flow is usually encountered within the culvert barrel. When the outlet is submerged under inlet control, a hydraulic jump will occur within the barrel.
- Outlet Control - Outlet control occurs when the culvert barrel is not capable of conveying as much flow as the inlet will accept. Culverts under outlet control generally function with submerged outlets and subcritical flow within the culvert barrel. However, it is possible for the culvert to function with an unsubmerged outlet under outlet control where flow passes through critical depth in the vicinity of the outlet.

For each type of control, different factors and formulas are used to compute the hydraulic capacity of a culvert. Under inlet control, the cross sectional area of the culvert, inlet geometry, and elevation of headwater at entrance are of primary importance. Outlet control involves the additional consideration of the tailwater elevation of the outlet channel and the slope, roughness and length of the culvert barrel. A discussion of these two types of control with charts for selecting a culvert size for a given set of conditions is included in the FHWA Hydraulic Design Series No. 5, "Hydraulic Design of Highway Culverts."

825.3 Computer Programs

Numerous calculator and computer programs are available to aid in the design and analysis of highway culverts. The major advantages of these programs over the traditional hand calculation method are:

- Increased accuracy over charts and nomographs.
- Rapid comparison of alternative sizes and inlet configurations.

Familiarity with culvert hydraulics and traditional methods of solution is necessary to provide a solid basis for designers to take advantage of the speed, accuracy, and increased capabilities of hydraulic design computer programs.

The hydraulic design calculator and computer programs available from the FHWA are more fully described in HDS No. 5, "Hydraulic Design of Highway Culverts."

The HY8 culvert hydraulics program provides interactive culvert analysis. Given all of the appropriate data, the program will compute the culvert hydraulics for circular, rectangular, elliptical, arch, and user-defined culverts.

The logic of HY8 involves calculating the inlet and outlet control headwater elevations for the given flow. The elevations are then compared and the larger of the two is used as the controlling elevation. In cases where the headwater elevation is greater than the top elevation of the roadway embankment, an overtopping analysis is done in which flow is balanced between the culvert discharge and the surcharge over the roadway. In the cases where the culvert is not full for any part of its length, open channel computations are performed.

825.4 Coefficient of Roughness

Suggested Manning's n values for culvert design are given in Table 852.1.

Topic 826 – Entrance Design

826.1 Introduction

The size and shape of the entrance are among the factors that control the level of ponding at the entrance. Devices such as rounded or beveled lips and expanded entrances help maintain the velocity of approach, increase the culvert capacity, and may lower costs by permitting a smaller sized culvert to be used.

The inherent characteristics of common entrance treatments are discussed in Index 826.4. End treatment on large culverts is an important consideration. Selecting an appropriate end treatment for a specific type of culvert and location requires the application of sound engineering judgment.

The FHWA Hydraulic Design Series No. 5, "Hydraulic Design of Highway Culverts" combines culvert design information previously contained in HEC No. 5, No. 10, and No. 13. The hydraulic performance of various entrance types is described in HDS No. 5.

July 1, 2020

826.2 End Treatment Policy

The recommended end treatment for small culverts is the prefabricated flared end section. For safety, aesthetic, and economic reasons, flared end sections should be used at both entrance and outlet whenever feasible instead of headwalls.

End treatment, either flared end section or headwall, is required for circular culverts 60 inches or more in diameter and for pipe arches of equivalent size.

826.3 Conventional Entrance Designs

The inlet edge configuration is one of the prime factors influencing the hydraulic performance of a culvert operating in inlet control. The following entrance types are frequently used.

- (1) *Projecting Barrel.* A thin edge projecting inlet can cause a severe contraction of the flow. The effective cross sectional area of the barrel may be reduced to about one half the actual available barrel area.

The projecting barrel has no end treatment and is the least desirable hydraulically. It is economical but its appearance is not pleasing and use should be limited to culverts with low velocity flows where head conservation, traffic safety, and appearance are not important considerations.

Typical installations include an equalizer culvert where ponding beyond the control of the highway facility occurs on both sides of the highway or where the flow is too small to fill the minimum culvert opening.

The projecting entrance inhibits culvert efficiency. In some situations, the outlet end may project beyond the fill, thus providing security against erosion at less expense than bank protection work.

Projecting ends may prove a maintenance nuisance, particularly when clearance to right of way fence is limited.

- (2) *Flared End Sections.* This end treatment provides approximately the same hydraulic performance as a square-edge headwall and is used to retain the embankment, improve the aesthetics, and enhance safety. Because prefabricated flared end sections provide better traffic safety features and are considered more attractive than headwalls they are to be used instead of headwalls whenever feasible.

Details of prefabricated flared end sections for circular pipe in sizes 12 inches through 84 inches in diameter and pipe arches of equivalent size are shown on Standard Plans D94A & B.

- (3) *Headwalls and Wingwalls.* This end treatment may be required at the culvert entrance for the following reasons:

- To improve hydraulic efficiency.
- To retain the embankment and reduce erosion of slopes.
- To provide structural stability to the culvert ends and serve as a counterweight to offset buoyant or uplift forces.

- (4) *Rounded Lip.* This treatment costs little, smoothes flow contraction, increases culvert capacity, and reduces the level of ponding at the entrance. The box culvert and pipe headwall standard plans include a rounded lip. The rounded lip is omitted for culverts less

than 48 inches in diameter; however, the beveled groove end of concrete pipe at the entrance produces an effect similar to that of a rounded lip.

- (5) *Mitered End*. A mitered culvert end is formed when the culvert barrel is cut to conform with the plane of the embankment slope. Mitered entrances are not to be used. They are hydraulically less efficient than either flared end sections or headwalls, and they are structurally unstable.
- (6) *Entrance Risers*. At a location where the culvert would be subject to plugging, a vertical pipe riser should be considered. Refer to Index 822.2 for discussion on debris-control structures.

826.4 Improved Inlet Designs

Entrance geometry refinements can be used to reduce the flow contraction at the inlet and increase the capacity of culverts operating under inlet control without increasing the headwater depth. The following entrance types improve culvert inlet performance and can be provided at reasonable cost.

- (1) *Expanded Entrances*. Headwalls with straight flared wingwalls or warped wingwalls offer a more highly developed entrance appropriate for large culverts, regardless of type or shape of barrel. The effect of such entrances can be approximated more economically by a shaped entrance using air blown mortar, concreted riprap, sacked concrete or slope paving.

Straight flared wingwalls and warped wingwalls aid in maintaining the approach velocity, align and guide drift, and funnel the flow into the culvert entrance. To insure enough velocity to carry drift and debris through the culvert or increase the velocity and thereby increase the entrance capacity, a sloping drop down apron at the entrance may be used. To minimize snagging drift, the standard plans require wingwalls to be flush with the culvert barrel. The flare angle may range from 30 to 75 degrees; the exact angle is based on the alignment of the approach channel banks and not the axis of the culvert. Greater efficiency is obtained when the top of the wingwall is the same elevation as the headwall.

Whether warped or straight flared wingwalls are used depends on the shape of the approach channel. Straight flared wingwalls are appropriate for well defined channels with steep banks. Warped wingwalls are more suited to shallow trapezoidal approach channels.

Usually it is more economical to transition between the stream section and the culvert by means of straight flared wingwalls or warped wingwalls than to expand the culvert barrel at entrance. For a very wide channel, this transition may be combined with riprap, dikes, or channel lining extending upstream to complete the transition.

- (2) *Transitions*. Elaborate transitions and throated openings for culverts may be warranted in special cases. Generally a highly developed entrance is unnecessary if the shape of the culvert fits the approach channel. In wide flat channels where ponding at entrance must be restricted, a wide shallow structure or multiple conduit should be used if drift and debris are not a problem.

Throated or tapered barrels at entrance are more vulnerable to clogging by debris. They are not economical unless they are used for corrective measures; for example, where there is a severe restriction in right of way width and it is necessary to increase the capacity of an existing culvert structure.

For further information refer to HEC-9, "Debris-Control Structures" and HDS 5, "Hydraulic Design of Highway Culverts"

July 1, 2020

Topic 827 – Outlet Design

827.1 General

The outlet velocity of highway culverts is usually higher than the maximum natural stream velocity. This higher velocity can cause streambed scour and bank erosion for a limited distance downstream from the culvert outlet.

The slope and roughness of the culvert barrel are the principle factors affecting outlet velocity. The shape and size of a culvert seldom have a significant effect on the outlet velocity. When the outlet velocity is believed to be excessive and it cannot be satisfactorily reduced by adjusting the slope or barrel roughness, it may be necessary to use some type of outlet protection or energy dissipator. A method of predicting and analyzing scour conditions is given in the FHWA publication "Scour at Culvert Outlets in Mixed Bed Materials", FHWA/RD - 82/011.

When dealing with erosive velocities at the outlet, the effect on downstream property should be evaluated.

827.2 Embankment Protection

Improved culvert outlets are designed to restore natural flow conditions downstream. Where erosion is to be expected, corrective measures such as bank protection, vertical flared wingwalls, warped wingwalls, transitions, and energy dissipators may be considered. See Chapter 870, "Channel and Shore Protection-Erosion Control", FHWA Hydraulic Engineering Circulars No. 11, "Design of Riprap Revetment", No. 14, "Hydraulic Design of Energy Dissipators for Culverts and Channels", and No. 15, "Design of Roadway Channels with Flexible Linings", and "Hydraulic Design of Stilling Basins and Energy Dissipators", Engineering Monograph No. 25 by the U. S. Department of Interior, Bureau of Reclamation, 1964 (revised 1978). HY-8, within the Hydrain Integrated Computer Program System, provides designs for energy dissipators and follows the HEC-14 method for design.

Culvert outlet design should provide a transition for the 100-year flood or design event from the culvert outlet to a section in the natural channel where natural stage, width, and velocity will be restored, or nearly so, with consideration of stability and security of the natural channel bed and banks against scour.

If an outfall structure is required for transition, typically it will not have the same design as the entrance.

Wingwalls, if intended for an outlet transition (expansion), generally should not flare at an angle (in degrees) greater than 150 divided by the outlet velocity in feet per second. However, transition designs fall into two general categories: those applicable to culverts in outlet control (subcritical flow) or those applicable to culverts in inlet control (supercritical). The procedure outlined in HEC-14 for subcritical flow expansion design should also be used for supercritical flow expansion design if the culvert exit Froude number (Fr) is less than 3, if the location where the flow conditions desired is within 3 culvert diameters of the outlet, and if the slope is less than

10 percent. For supercritical flow expansions outside these limits, the energy equation can be used to determine flow conditions leaving the transition.

Warped endwalls can be designed to fit trapezoidal or U-shaped channels, as transitions for moderate-to-high velocity (10 feet per second – 18 feet per second).

For extreme velocity (exceeding 18 feet per second) the transition can be shortened by using an energy-dissipating structure.

Topic 828 – Diameter and Length

828.1 Introduction

From a maintenance point of view the minimum diameter of pipe and the distance between convenient cleanout access points are important considerations.

The following instructions apply to minimum pipe diameter and the length of pipe culvert.

828.2 Minimum Diameter

The minimum diameter for cross culverts under the roadway is 18 inches. For other than cross pipes, the minimum diameter is 12 inches. For maintenance purposes, where the slope of longitudinal side drains is not sufficient to produce self-cleaning velocities, pipe sizes of 18 inches or more in diameter should be considered.

The minimum diameter of pipe to be used is further determined by the length of pipe between convenient cleanout access points. If pipe runs exceed 100 feet between inlet and outlet, or intermediate cleanout access, the minimum diameter of pipe to be used is 24 inches. When practicable, intermediate cleanout points should be provided for runs of pipe 24 inches in diameter that exceed 300 feet in length.

If a choice is to be made between using 18-inch diameter pipe with an intermediate cleanout in the highway median or using 24-inch diameter pipe without the median access, the larger diameter pipe without the median access is preferred.

828.3 Length

The length of pipe culvert to be installed is determined as follows:

- (a) Establish a theoretical length based on slope stake requirements making allowance for end treatment.
- (b) Adjust the theoretical length for height of fill by applying these rules:
 - For fills 12 feet or less, no adjustment is required.
 - For fills higher than 12 feet, add 1 foot of length at each end for each 10 foot increment of fill height or portion thereof. The additional length should not exceed 6 feet on each end.
 - In cases of high fills with benches, the additional length is based on the height of the lowest bench.

July 1, 2020

- (c) Use the nearest combination of commercial lengths which equal or exceed the length obtained in (b) above.

Topic 829 – Special Considerations

829.1 Introduction

In addition to the hydraulic design, other factors must be considered to assure the integrity of culvert installations and the highway.

829.2 Bedding and Backfill

The height of overfill a culvert will safely sustain depends upon foundation conditions, method of installation, and its structural strength and rigidity.

Uniform settlement under both the culvert and the adjoining fill will not overstress flexible and segmental rigid culverts. Unequal settlement, however, can result in distortion and shearing action in the culvert. For rigid pipes this could result in distress and disjuncting of the pipe. A flexible culvert accommodates itself to moderate unequal settlements but is also subject to shearing action. Monolithic culverts can tolerate only a minimal amount of unequal settlement, and require favorable foundation conditions. Any unequal settlement would subject a monolithic culvert to severe shear stresses.

- (1) *Foundation Conditions.* A slightly yielding foundation under both the culvert and adjoining fill is the foundation condition generally encountered. The maximum height of cover tables given in Chapter 850 are based on this foundation condition.

Unyielding foundation conditions can produce high stresses in the culverts. Such stresses may be counteracted by subexcavation and backfill.

The Standard Plans show details for shaped, sand, and soil cement bedding treatments.

Foundation materials capable of supporting pressures between 1.0 tons per square foot and 8.0 tons per square foot are required for culverts with cast-in-place footing or inverts, such as reinforced concrete boxes, arches, and structural plate arches. When culvert footing pressures exceed 1.5 tons per square foot or the diameter or span exceeds 10 feet, a geology report providing a log of test boring is required.

Adverse foundation and backfill conditions may require a specially designed structure. The allowable overfill heights for concrete arches, structural plate arches, and structural plate vehicular undercrossings are based on existing soil withstanding the soil pressures indicated on the Standard Plans. A foundation investigation should be made to insure that the supporting soils withstand the design soil pressures for those types of structures.

- (2) *Method of Installation.* Under ordinary conditions, the methods of installation described in the Standard Specifications and shown on the Standard Plans should be used. For any predictable settlement, provisions for camber should be made.

Excavation and backfill details for circular concrete pipe, reinforced box and arch culverts, and corrugated metal pipe and arch culverts are shown on Standard Plans A62-D, A62DA, A62-E, and A62-F respectively.

(3) *Height of Cover.* There are several alternative materials from which acceptable culverts may be made. Tables of maximum height of cover recommended for the more frequently used culvert shapes, sizes, corrugation configurations, and types of materials are given in Chapter 850. Not included, but covered in the Standard Plans, are maximum earth cover for reinforced concrete box culverts, reinforced concrete arches, and structural plate vehicular undercrossing.

For culverts where overfill requirements exceed the limits shown on the tables a special design must be prepared. Special designs are to be submitted to the Division of Structures for review, or the Division of Structures may be directly requested to prepare the design.

Under any of the following conditions, the Division of Structures is to prepare the special design:

- Where foundation material will not support footing pressure shown on the Standard Plans for concrete arch and structural plate vehicular undercrossings.
- Where foundation material will not support footing pressures shown in the Highway Design Manual for structural plate pipe arches or corrugated metal pipe arches.
- Where a culvert will be subjected to unequal lateral pressures, such as at the toe of a fill or adjacent to a retaining wall.

Special designs usually require that a detailed foundation investigation be made.

(4) *Minimum Cover.* When feasible, culverts should be buried at least 1 foot. For construction purposes, a minimum cover of 6 inches greater than the thickness of the structural cross section is desirable for all types of pipe. The minimum thickness of cover for various type culverts under rigid or flexible pavements is given in Table 856.5.

829.3 Piping

Piping is a phenomenon caused by seepage along a culvert barrel which removes fill material, forming a hollow similar to a pipe. Fine soil particles are washed out freely along the hollow and the erosion inside the fill may ultimately cause failure of the culvert or the embankment.

The possibility of piping can be reduced by decreasing the velocity of the seepage flow. This can be reduced by providing for watertight joints. Therefore, if piping through joints could become a problem, consideration should be given to providing for watertight joints.

Piping may be anticipated along the entire length of the culvert when ponding above the culvert is expected for an extended length of time, such as when the highway fill is used as a detention dam or to form a reservoir. Headwalls, impervious materials at the upstream end of the culvert, and anti-seep or cutoff collars increase the length of the flow path, decrease the hydraulic gradient and the velocity of flow and thus decreases the probability of piping developing. Anti-seep collars usually consist of bulkhead type plate or blocks around the entire perimeter of the culvert. They may be of metal or concrete, and, if practical, should be keyed into impervious material.

Piping could occur where a culvert must be placed in a live stream, and the flow cannot be diverted. Under these conditions watertight joints should be specified.

July 1, 2020

829.4 Joints

The possibility of piping being caused by open joints in the culvert barrel may be reduced through special attention to the type of pipe joint specified. For a more complete discussion of pipe joint requirements see Index 854.1.

The two pipe joint types specified for culvert installations are identified as "standard" and "positive". The "standard" joint is adequate for ordinary installations and "positive" joints should be specified where there is a need to withstand soil movements or resist disjoining forces. Corrugated metal pipe coupling band details are shown on Standard Plan sheets D97A through D97G and concrete pipe joint details on sheet D97H.

If it is necessary for "standard" or "positive" joints to be watertight they must be specifically specified as such. Rubber "O" rings or other resilient joint material provides the watertight seal. Corrugated metal pipe joints identified as "downrain" are watertight joint systems with a tensile strength specification for the coupler.

829.5 Anchorage

Refer to Index 834.4(5) for discussion on anchorage for overside drains.

Reinforced concrete pipe should be anchored and have positive joints specified if either of the following conditions is present:

- (a) Where the pipe diameter is 60 inches or less, the pipe slope is 33 percent or greater, and the fill over the top of the pipe less than 1.5 times the outside diameter of the pipe measured perpendicular to the slope.
- (b) Where the pipe diameter is greater than 60 inches and the pipe slope is 33 percent or greater, regardless of the fill over the top of the pipe.

Where the slopes have been determined by the geotechnical engineer to be potentially unstable, regardless of the slope of the pipe, as a minimum, the pipes shall have positive joints. Alternative pipes/anchorage systems shall be investigated when there is a potential for substantial movement of the soil.

Where anchorage is required, there should be a minimum of 18 inches cover measured perpendicular to the slope.

Typically buried flexible pipe with corrugations on the exterior surface will not require anchorage, however, a special detail will be required for plastic pipe without corrugations on the exterior surface.

829.6 Irregular Treatment

- (1) *Junctions.* (Text Later)
- (2) *Bends.* (Text Later)

829.7 Siphons and Sag Culverts

- (1) *General Notes.* There are two kinds of conduits called siphons: the true siphon and the inverted siphon or sag culvert. The true siphon is a closed conduit, a portion of which lies above the hydraulic grade line. This results in less than atmospheric pressure in that portion. The sag culvert lies entirely below the hydraulic grade line; it operates under pressure without siphonic action. Under the proper conditions, there are hydraulic and economic advantages to be obtained by using the siphon principle in culvert design.
- (2) *Sag Culverts.* This type is most often used to carry an irrigation canal under a highway when the available headroom is insufficient for a normal culvert. The top of a sag culvert should be at least 4.5 feet below the finished grade where possible, to ensure against damage from heavy construction equipment. The culvert should be on a straight grade and sumps provided at each end to facilitate maintenance. Sag culverts should not be used:
 - (a) When the flow carries trash and debris in sufficient quantity to cause heavy deposits,
 - (b) For intermittent flows where the effects of standing water are objectionable, or
 - (c) When any other alternative is possible at reasonable cost.
- (3) *Types of Conduit.* Following are two kinds of pipes used for siphons and sag culverts to prevent leakage:
 - (a) Reinforced Concrete Pipe - Reinforced concrete pipe with joint seals is generally satisfactory. For heads over 20 feet, special consideration should be given to hydrostatic pressure.
 - (b) Corrugated Metal Pipe - corrugated metal pipe must be of the thickness and have the protective coatings required to provide the design service life. Field joints must be watertight. The following additional treatment is recommended.
 - When the head is more than 10 feet and the flow is continuous or is intermittent and of long duration, pipe fabricated by riveting, spot welding or continuous helical lockseam should be soldered.
Pipe fabricated by a continuous helical welded seam need not be soldered.
 - If the head is 10 feet or less and the flow is intermittent and lasts only a few days, as in storm flows, unsoldered seams are permissible.

829.8 Currently Not In Use

829.9 Dams

Typically, proposed construction which is capable of impounding water to the extent that it meets the legal definition of a dam must be approved by the Department of Water Resource (DWR), Division of Safety of Dams. The legal definition is described in Sections 6002 and 6003 of the State Water Code. Generally, any facility 25 feet or more in height or capable of impounding 50 acre-feet or more would be considered a dam. However, any facility 6 feet or less in height, regardless of capacity, or with a storage capacity of not more than 15 acre-feet, regardless of height, shall not be considered a dam. Additionally, Section 6004 of the State Water Code states ". and no road or highway fill or structure shall be considered a dam." Therefore, except for large retention or detention facilities there will rarely be the need for involvement by the DWR in approval of Caltrans designs.

July 1, 2020

Although most highway designs will be exempt from DWR approval, caution should always be exercised in the design of high fills that could impound large volumes of water. Even partial plugging of the cross drain could lead to high pressures on the upstream side of the fill, creating seepage through the fill and/or increased potential for piping.

The requirements for submitting information to the FHWA Division Office in Sacramento as described in Index 805.6 are not affected by the regulations mentioned above.

829.10 Reinforced Concrete Box Modifications

- (1) *Extensions.* Where an existing box culvert is to be lengthened, it is essential to perform an on-site investigation to verify the structural integrity of the box. If signs of distress are present, the Division of Structures must be contacted prior to proceeding with the design.
- (2) *Additional Loading.* When significant additional loading is proposed to be added to an existing reinforced concrete box culvert the Division of Structures must be contacted prior to proceeding with the design. Overlays of less than 6 inches in depth, or widenings that do not increase the per unit loading on the box are not considered to be significant. Designers should also check the extent that previous projects might have increased loading on box culverts, even if the current project is not adding a significant amount of loading.

CHAPTER 830 – TRANSPORTATION FACILITY DRAINAGE

Topic 831 – General

Index 831.1 – Basic Concepts

Roadway drainage involves the collection, conveyance, removal, and disposal of surface water runoff from the traveled way, shoulders, sidewalks, and adjoining areas defined in Index 62.1(7) as comprising the roadway. Roadway drainage is also concerned with the handling of water from the following additional sources:

- Surface water from outside the right of way and not confined to channels that would reach the traveled way if not intercepted.
- Crossroads or streets.
- Irrigation of landscaped areas.

The design of roadway drainage systems often involves consideration of the problems associated with inadequate drainage of the adjacent or surrounding area. Cooperative drainage improvement projects with the responsible local agency may offer the best overall solution. Cooperative agreements are more fully discussed under Index 803.2

Some of the major considerations of good roadway drainage design are:

- Facility user safety.
- Convenience to vehicular, bicycle and pedestrian traffic.
- Aesthetics.
- Flooding of the transportation facility and adjacent property.
- Subgrade infiltration.
- Potential erosion, pollution and other environmental concerns.
- Economy of construction.
- Economy of maintenance.

This section involves the hydraulic design fundamentals necessary for properly sizing and locating standard highway drainage features such as:

- Asphalt dikes and gutters.
- Concrete curbs and gutters.
- Median drains.
- Roadside ditches
- Overside drains.
- Drop inlets.

July 1, 2020

- Storm drains.

Removal of storm water from highway pavement surfaces and median areas is more fully discussed in FHWA Hydraulic Engineering Circular No. 22, "Urban Drainage Design Manual". HEC 22 includes discussion of the effects of roadway geometry on pavement drainage; the philosophy of design storm frequency and design spread selection; storm runoff estimating methods; pavement and bridge deck inlets; and flow in gutters. Charts and procedures are provided for the hydraulic analysis and design of roadway drainage features.

831.2 Highway Grade Line

In flat terrain, roadway drainage considerations often control the longitudinal grade line of the highway. A grade line that assures the desirable goal of keeping the traveled way free of flooding can usually be established for new freeway projects and rural conventional highways.

For multilane urban highways with nearly continuous dike or curb along the shoulder or parking area, it is seldom practical to design the highway with a gutter section which will contain all of the runoff even from frequent rains. For this reason the gutter and shoulder combination, and often partial or full width of the traveled way, are used to convey the runoff to inlets.

831.3 Design Storm and Water Spread

Before the hydraulic adequacy of roadway drainage facilities can be analyzed, the quantity of water (design Q) that the facility may reasonably be expected to convey must be estimated. The most important, and often the most difficult phase of this task is the selection of an appropriate design storm frequency for the specific project, location or site under consideration. In order for a design frequency to be meaningful criteria for roadway drainage design, it must be tied to an acceptable tolerance of flooding. Design water spread, encroachment upon the roadbed or adjacent property, is the tolerance of flooding directly related to roadway drainage design. Allowing too little spread is uneconomical in design and too much spread may result in unsafe driving conditions.

To optimize economy in roadway drainage, the allowable water spread should vary, depending on the type of project being designed. Because of the effect of splash and spray on motorist visibility and vehicle control, high volume roads with high speed traffic cannot tolerate as much water spread as urban streets. Likewise, the allowable water spread should be minimized on urban streets where a large number of pedestrians use adjacent sidewalks and pedestrian crosswalks. Consideration should be given to the element of motorist surprise when encountering intermittent puddles rather than a continuous encroachment of water on the driving lane. Eccentric forces are exerted on a vehicle when one side encounters water in the lane and the other side does not.

The probability of exceedance of the design storm and the acceptable tolerance to flooding depends on the importance of the highway and risks involved. Selection of the design storm and water spread parameters on rehabilitation and reconstruction are generally controlled by existing constraints.

In addition to the major roadway drainage considerations previously listed, the following more specific factors are to be considered in establishing the project design storm:

- Highway type
- Traffic volume
- Design speed
- Local standards

The following geometric and design features of the highway directly affect establishment of the project design water spread:

- Cross slope
- Longitudinal slope
- Number of lanes
- Width of shoulders
- Height of curb and dike
- Parking lanes
- Bus/Transit pullouts and loading areas

Desirable limits for water spread with respect to design storm probability of exceedance are given in Table 831.3. The parameters shown are considered minimum roadway drainage design standards for new freeway construction and for all State highways with depressed sections which require pumping. Local conditions may justify less stringent criteria than the table parameters for conventional highways. Exceptions should be documented by memo to the project file.

It is often advantageous, to both the State and the local agency, for highway drainage and street drainage to be compatible. This is particularly true in urban areas and rapidly developing suburban areas where a conventional highway is, or will become, part of the street network. Street drainage criteria adopted by a local agency are generally based on the hydrologic events peculiar to a geographical area. Local drainage standards that satisfy the needs of the community, usually provide reasonable traffic safety and flood risk considerations commensurate with those normally expected for conventional highways in urban areas.

831.4 Other Considerations

- (1) *Sheet Flow.* Concentrations of sheet flow across roadways are to be avoided. As a general rule, no more than 0.10 cubic feet per second should be allowed to concentrate and flow across a roadway. Particular attention should be given to reversal points of superelevation where shoulder and gutter slopes may direct flows across the roadway and gore areas.
- (2) *Stage Construction.* All permanent features of roadway drainage systems should be designed and constructed for the ultimate highway facility.
- (3) *Landscaping.* Runoff from existing or proposed landscaping, including excess irrigation water runoff, must be considered.
- (4) *Groundwater.* Groundwater is subsurface water within a permeable strata. Depending upon recharge and withdrawal rates the level of the groundwater table can fluctuate greatly, over a period of a few months or over periods of many years. Consideration should be

July 1, 2020

Table 831.3

Desirable Roadway Drainage Guidelines

HIGHWAY Type/Category/Feature	DESIGN STORM		DESIGN WATER SPREAD		
	4% (25 yrs)	10% (10 yrs)	Shldr or Parking Lane	1/2 Outer Lane	Local Standard
FREEWAYS					
Through traffic lanes, branch connections, and other major ramp connections.	X	--	X	--	--
Minor ramps.	--	X	X	--	--
Frontage roads.	--	X	--	--	X
CONVENTIONAL HIGHWAYS					
High volume, multilane Speeds over 45 mph.	X	--	X	--	--
High volume, multilane Speeds 45 mph and under.	--	X	--	X	--
Low volume, rural Speeds over 45 mph.	X	--	X	--	--
Urban Speeds 45 mph and under.	--	X	--	--	X
ALL STATE HIGHWAYS					
Depressed Sections That Require Pumping:					
Use a 2% (50 yrs) design storm for freeways and conventional State highways. Design water spread at depressed sections should not exceed that of adjacent roadway sections. A 4% (25 yr) design storm may be used on local streets or road undercrossings that require pumping.					

given to recent history (several years of abnormally wet or dry conditions) as well as the possibility of revised practices by local water districts (either increased pumping or increased recharge).

Pipes located in areas where contact with groundwater within their design life is likely should have watertight joints. If groundwater contact is likely and the surrounding soils are highly erodible (fine grained sand, silty sand and sandy silt/silt of limited cohesion) consideration should be given to wrapping the pipe joint with filter fabric. The fabric should cover a length of 4 feet along the pipe, centered on the joint. Groundwater at or above the drainage system elevation will lead to infiltration. Where this is undesirable, either joint systems capable of resisting the hydrostatic pressure, or dewatering measures, should be incorporated into the design. The design of groundwater control measures must be coordinated with Geotechnical Services in the Division of Engineering Services.

(5) *Hydroplaning.* Hydroplaning is the separation of the tire from the road surface by a thin layer of liquid (usually water) on the pavement. The liquid separates the tire from the pavement because of viscosity (viscous hydroplaning), dynamic lift (dynamic hydroplaning), or a combination of the two. Since water offers little shear resistance, the tire loses its tractive ability and the driver has a loss of control of the vehicle. At locations where there is a potential for hydroplaning, a careful review of the wet weather accident rates should be made using information obtained from the District Traffic Branch. Typical situations that should be evaluated for hydroplaning potential are:

- Where three (3) lanes or more are sloped in the same direction (see Topic 833).
- Where the longitudinal grade and or cross slope are less than minimum (Refer to Index 204.3 for minimum grade and Indexes 301.2 and 302.2 for cross slope).
- Where there are poor pavement conditions (rutting, depressions, inadequate roughness).
- Where water is allowed to concentrate prior to being directed across the travel lanes (see Index 831.4(1)).
- Where re-striping projects will reduce shoulder widths where dike, curb or concrete barrier are present.

These situations may also be present on median widening projects or projects involving pavement rehabilitation and or lane addition on multi-lane highways or freeways.

Speed and tire pressure appear to be a significant factor in the occurrence of hydroplaning, therefore, it is considered to be the driver's responsibility to exercise prudence and caution when driving during wet conditions (California Basic Speed Law).

Designers do not have control over all of the factors involved in hydroplaning. However, remedial measures may be included in development of a project to reduce hydroplaning potential. The following is provided as guidance for the designer as practical measures to consider:

(1) Pavement Sheet Flow

- Maximize transverse slope (see Topic 833)
- Maximize pavement roughness
- Use of graded course (porous pavements)

July 1, 2020

(2) Gutter Flow

- Limit water spread to Table 831.3
- Maximize interception of gutter flow above superelevation transitions (see Index 837.3)

(3) Sag Areas

- Limit pond duration and depth (see Topic 833)

(4) Overtopping

- Avoid overtopping at cross culverts using appropriate freeboard and/or headwater elevation (see Topic 821)

Where suitable measures cannot be implemented to address conditions such as those identified above, or an identified existing problem area, coordination should be made with the Safety Review Committee per Index 110.8.

831.5 Computer Programs

There are many computer programs available to aid highway design engineers with estimating runoff and ensuing hydraulic design and analysis of roadway drainage facilities.

Refer to Table 808.1 for guidance on selecting appropriate software programs for specific analysis needs.

Familiarity with the fundamentals of hydraulics and traditional methods of solution are necessary to assure that the results obtained are reasonable. There is a tendency for inexperienced engineers to accept computer output as valid without verifying the reasonableness of input and output data.

Topic 832 – Hydrology

832.1 Introduction

The philosophy and principles of hydrology are discussed in Chapter 810. Additional information on methods of estimating storm runoff may be found in FHWA's HEC 22.

832.2 Rational Method

With few exceptions, runoff estimates for roadway drainage design are made by using Rational Methods described under Index 819.2(1). In order to make use of these methods, information on the intensity, duration, and frequency of rainfall for the locality of the project must be established. Refer to Index 815.3(3) for further information on precipitation intensity-duration-frequency (IDF) curves that have been developed for many locations in California.

832.3 Time of Concentration

Refer to Index 816.6 for information on time of concentration.

Topic 833 – Roadway Cross Sections

833.1 Introduction

The geometric cross section of the roadway affects drainage features and hydraulic considerations. Cross slope and width of pavement and shoulders as well as other roadway geometry affect the rate of runoff, width of tolerable spread, and hydraulic design considerations. The cross section of drainage features such as, depressed medians, curbs and gutters, dikes, and side ditches is often controlled by an existing roadway geometric cross section or the one selected for new highway construction.

833.2 Grade, Cross Slope and Superelevation

The longitudinal slope or grade is governed by the highway grade line as discussed under Index 831.2. Refer to Index 204.3 for minimum grade and Indexes 301.3 and 302.2 for cross slope. Where three (3) lanes or more are sloped in the same direction, it is desirable to counter the resulting increase in flow depth by increasing the cross slope of the outermost lanes. The two (2) lanes adjacent to the crown line should be pitched at the normal slope, and successive lane pairs, or portions thereof outward, should be increased by about 0.5 to 1 percent. The maximum pavement cross slope should be limited to 4 percent. However, exceptions to the design criteria for cross slope in Index 302.2 must be formally approved in accordance with the requirements Index 82.2, "Approvals for Nonstandard Design." For projects where lanes will be added on the inside of divided highways, or when widening an existing "crowned" 2-lane highway to a 4-lane divided highway, consideration should be given to the use of a "tent section" in order to minimize the number of lanes sloping in the same direction. Refer to Index 301.2. Consideration should be given to increasing cross slopes in sag vertical curves, crest vertical curves, and in sections of flat longitudinal grades. Superelevation is discussed in Topic 202. Refer to Index 831.4 for Hydroplaning considerations.

Topic 834 – Roadside Drainage

834.1 General

Median drainage, ditches and gutters, and overside drains are some of the major roadside drainage facilities.

834.2 Median Drainage

(1) *Drainage Across the Median.* When it is necessary for sheet flow to cross flush medians, it should be intercepted by the use of slotted drains or other suitable alternative facilities. See Standard Plan D98-B for slotted drain details.

Where floodwaters are allowed to cross medians, designers must consider the impacts of railings, barrier or other obstructions to both the depth and spread of flow. Designers should consult their district hydraulic unit for assistance.

(2) *Grade and Cross Slope.* The longitudinal slope or grade for median drainage is governed by the highway grade line as discussed under Index 831.2. Refer to Index 204.3 for

July 1, 2020

minimum grade and Indexes 305.2 and 405.5(4) for standards governing allowable cross slope of medians.

Existing conditions control median grades and attainable cross slope on rehabilitation projects. The flattest desirable grade for earth medians is 0.25 percent and 0.12 percent for paved gutters in the median.

- (3) *Erosion*. When velocities are excessive for soil conditions, provisions for erosion control should be provided. See Table 865.2 for recommended permissible velocities for unlined channels.

Economics and aesthetics are to be taken into consideration in the selection of median erosion control measures. Under the less severe conditions, ground covers of natural or synthetic materials which render the soil surface stable against accelerated erosion are adequate. Under the more severe conditions, asphalt or concrete ditch paving may be required.

Whenever median ditch paving is necessary, consideration should be given to the use of cement or lime treatment of the soil. The width treated will depend on the capacity needed to handle the drainage. A depth of 6 inches is generally satisfactory. The amount of cement or lime to be used should be based on laboratory tests of the in-place material to be tested, and normally varies from 6 percent to 10 percent. If a clear or translucent curing compound is used, the completed area is unobtrusive and aesthetically pleasing.

Asphalt concrete ditch paving and soil cement treatments cured with an application of liquid asphalt are highly visible and tend to become unsightly from streaks of eroded material. Cobbles, though effective for erosion control, are not satisfactory in a recovery area for out of control vehicles. See Topic 872 for further discussion on erosion protection and additional types of ditch linings. Erosion control references are given under Index 871.3.

- (4) *Economy in Design*. Economy in median drainage can be achieved by locating inlets to utilize available nearby culverts or the collector system of a roadway drainage installation. The inlet capacity can be increased by placing it in a local depression. Use of slotted pipe at sag points where a local depression might be necessary may be an alternative solution to a grate catch basin.

834.3 Ditches and Gutters

- (1) *Grade*. The flattest grade recommended for design is 0.25 percent for earth ditches and 0.12 percent for paved ditches.
- (2) *Slope Ditches*. Slope ditches, sometimes called surface, brow, interception, or slope protection ditches, should be provided at the tops of cuts where it is necessary to intercept drainage from natural slopes inclined toward the highway.

When the grade of a slope ditch is steep enough that erosion would occur, the ditch should be paved. Refer to Table 865.2 for permissible velocities for unlined channels in various types of soil. When the ditch grade exceeds a 4:1 slope, a downdrain is advisable. Slope ditches may not be necessary where side slopes in favorable soils are flatter than 2:1 or where positive erosion control measures are to be instituted during construction.

- (3) *Side Gutters*. These are triangular gutters adjoining the shoulder as shown in Figures 307.2 and 307.5. The main purpose of the 3 feet wide side gutter is to prevent runoff from the cut slopes on the high side of superelevation from flowing across the roadbeds. The use of side gutters in tangent alignment should be avoided where possible. Local drainage conditions, such as in snow areas, may require their use on either tangent or curved alignment in cut sections. In snow areas it may be necessary to increase the width of side gutters from 3 feet to 6 feet. The slope from the edge of the shoulder to the bottom of the

gutter should be no steeper than 6:1. The structural section for paved side gutters should be adequate to support maintenance equipment loads.

- (4) *Side Gutters within the Clear Recovery Zone (CRZ).* Foreslopes parallel to the flow of traffic are considered to be recoverable if the slope is 4:1 or flatter. Side gutter sections located within the CRZ should have a foreslope and backslope combination of either 6:1 and 4:1, or 4:1 and 6:1 (refer to Figures 305.6, 307.2, 307.4A, 307.4B, and 307.5). See Figure 834.3.

When side gutters are included within the CRZ the depth of flow in the gutter section should be determined for the appropriate design storm. The depth of flow for the design storm may be used to design the structural section of the channel capable of supporting errant vehicles. The side gutter cross-section should satisfy hydraulic conveyance as well as support the load of errant vehicles without the wheels sinking into saturated soil in the channel section. Design criteria for concrete lined channels may be referenced from the US Army Corps Publication "Structural Design of Concrete Lined Flood Control Channels, EM 1110-2-2007".

Figure 834.3

Side Gutter and Trapezoidal Channel

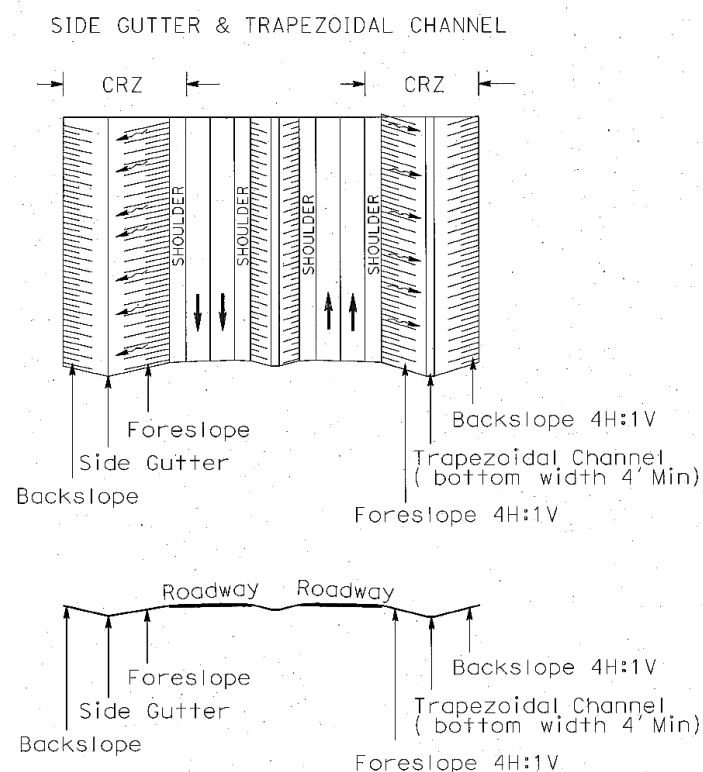

- (5) *Dikes.* Dikes placed adjoining the shoulder, as shown in Figures 307.2, 307.4A, 307.4B and 307.5, provide a paved triangular gutter within the shoulder area. For conditions governing their use, see Index 303.3.
- (6) *Chart Solutions.* Charts for solutions to triangular channel flow problems are contained in FHWA Hydraulic Engineering Circular No. 22, "Urban Drainage Design Manual".

July 1, 2020

834.4 Overside Drains

The purpose of overside drains, sometimes called slope drains, is to protect slopes against erosion. They convey down the slope drainage which is collected from the roadbed, the tops of cuts, or from benches in cut or fill slopes. They may be pipes, flumes or paved spillways.

(1) *Spacing and Location.* The spacing and location of overside drains depend on the configuration of the ground, the highway profile, the quantity of flow and the limitations on flooding stated in Table 831.3. When possible, overside drains should be positioned at the lower end of cut sections. Diversion from one watershed to another should be avoided. If diversion becomes necessary, care should be used in the manner in which this diverted water is disposed.

Overside drains which would be conspicuous or placed in landscaped areas should be concealed by burial or other means.

(2) *Type and Requirement.* Following are details of various types of overside drains and requirements for their use:

(a) *Pipe Downdrains.* Metal and plastic pipes are adaptable to any slope. They should be used where side slopes are 4:1 or steeper. Long pipe downdrains should be anchored.

The minimum pipe diameter is 8 inches but large flows, debris, or long pipe installations may dictate a larger diameter.

Watertight joints are necessary to prevent leakage which causes slope erosion. Economy in long, high capacity downdrains is achieved by using a pipe taper in the initial reach. Pipe tapers should insure improved flow characteristics and permit use of a smaller diameter pipe below the taper. See Standard Plan D87-A for details.

(b) *Flume Downdrains.* These are rectangular corrugated metal flumes with a tapered entrance. See the Standard Plan D87-D for details. They are best adapted to slopes that are 2:1 or flatter but if used on 1.5:1 slopes, lengths over 60 feet are not recommended. Abrupt changes in alignment or grade should be avoided. Flume downdrains should be depressed so that the top of the flume is flush with the fill slope.

(c) *Paved Spillways.* Permanent paved spillways should only be used when the side slopes are flatter than 4:1. On steeper slopes a more positive type of overside drain such as a pipe downdrain should be used.

Temporary paved spillways are effective in preserving raw fill slopes that are 6:1 or flatter in friable soils during the period when protective growth is being established. Paved spillways should be spaced so that a dike 2 inches high placed at the outer edge of the paved shoulder will effectively confine drainage between spillways. When it is necessary to place a spillway on curved alignment, attention must be given to possible overtopping at the bends. See Index 868.2(3) for discussion of superelevation of the water surface.

(3) *Entrance Standards.* Entrance tapers for pipes and flume downdrains are detailed on the Standard Plans. Pipe entrance tapers should be depressed at least 6 inches.

The local depressions called "paved gutter flares" on the Standard Plans are to be used at all entrance tapers. See Standard Plans D87-A and D87-D for details and Index 837.5 for further discussion on local depressions.

In areas where local depressions would decrease safety the use of flush grate inlets or short sections of slotted drain for entrance structures may be necessary.

- (4) *Outlet Treatment.* Where excessive erosion at an overside drain outlet is anticipated, a simple energy dissipater should be employed. Preference should be given to inexpensive expedients such as an apron of broken concrete or rock, a short section of pipe placed with its axis vertical with the lowermost 6 inches filled with coarse gravel or rock, or a horizontal tee section which is usually adequate for downdrain discharges.
- (5) *Anchorage.* For slopes flatter than 3:1 overside drains do not need to be anchored. For slopes 3:1 or steeper overside drains should be anchored with 6 foot pipe stakes as shown on the Standard Plans to prevent undue strain on the entrance taper or pipe ends. For drains over 150 feet long, and where the slope is steeper than 2:1, cable anchorage should be considered as shown on the Standard Plans. Where the cable would be buried and in contact with soil, a solid galvanized rod should be used the buried portion and a cable, attached to the rod, used for the exposed portion. Beyond the buried portion, a slip joint must be provided when the installation exceeds 60 feet in length. Regard-less of pipe length or steepness of slope, where there is a potential for hillside movement cable anchorage should be considered.
- When cable anchorage is used as shown on the Standard Plans, the maximum allowable downdrain lengths shall be 200 feet for a slope of 1.5:1 and 250 feet for a slope of 2:1. For pipe diameters greater than 24 inches, or downdrains to be placed on slopes steeper than 1.5:1, special designs are required. Where there is an abrupt change in direction of flow, such as at the elbow or a tee section downstream of the end of the cable anchorage system, specially designed thrust blocks should be considered.
- (6) *Drainage on Benches.* Drainage from benches in cut and fill slopes should be removed at intervals ranging from 300 feet to 500 feet.
- (7) *Selection of Types.* Pipe and flume downdrains may consist of either corrugated steel, corrugated aluminum, or any other approved material that meets the minimum design service life required under Chapter 850. Refer to Index 855.2 for additional discussion on limitations of abrasive resistance of aluminum pipe culverts.

Topic 835 – Dikes and Berms

835.1 General

Dikes and berms are to be used only as necessary to confine drainage and protect side slopes susceptible to erosion.

835.2 Earth Berms

(Text Later)

835.3 Dikes

Details of dikes are shown on Standard Plan A87. See Topic 303 for a detailed discussion on the types and placement considerations for dikes.

July 1, 2020

Topic 836 – Curbs and Gutters

836.1 General

The primary reason for constructing curbs and gutters may be for delineation or pedestrian traffic rather than for drainage considerations. Refer to Topic 303 for further discussion and Standard Plan A87 for details on concrete curbs and gutters.

Whatever the justification for constructing curbs and gutters, they will usually have an effect on surface water runoff and result in becoming a roadway drainage design consideration.

836.2 Gutter Design

(1) *Capacity.* Gutters and drainage facilities are to be designed to keep flooding within the limits given in Table 831.3. Easy solutions to gutter flow problems can be obtained by using the charts contained in FHWA Hydraulic Engineering Circular No. 22, "Urban Drainage Design Manual" which applies to triangular channels and other shapes illustrated in the charts. Parked cars reduce gutter capacity and also can cause water to shoot over the curb. The downstream ends of driveway ramps can also cause water to flow over the curb. As a rule of thumb, gutter capacity should be determined on a depth equal to 0.5 the curb height for grades up to 10 percent and 0.4 the curb height for grades over 10 percent in locations where parking is allowed or where driveways are constructed.

(2) *Grade and Cross Slope.* The longitudinal grade of curbs and gutters is controlled by the highway grade line as discussed under Index 831.2.

The cross slope of standard gutters is typically 8.33 percent toward the curb. Pavement slopes on superelevated roadways extend the full width of the gutter, except that gutter slopes on the low side should be not less than 8.33 percent. Because they cut down gutter capacity and severely reduce inlet efficiency, cross slopes flatter than 8.33 percent should be avoided, except where gutters are adjacent to curb ramps where ADA requirements limit the slope to a maximum of 5 percent.

(3) *Curbed Intersections.* If pedestrian traffic is a ruling factor, intersection drainage presents the following alternatives to be weighed as to effectiveness and economy.

(a) Intercept the whole flow upstream of the crosswalk.

(b) Intercept a part of the water and allow the overflow to cross the intersection. The width of flow should be controlled so that pedestrian traffic is not unduly hampered.

(c) If flow is small, pass the entire flow across the intersecting street in a valley gutter.

(4) *Valley Gutters.* Valley gutters across the traveled way of the highway should not be used. Valley gutters may be used across intersecting streets and driveways, however, at intersections with high traffic volumes on all approaches, it is desirable to intercept all gutter flow upstream of the intersection and avoid the use of valley gutters. Valley gutters are also undesirable along streets where speeds are relatively high. In locations of frequent intermittent low flows, the use of valley gutters with slotted drains should be considered. In general, the total width of gutters should not exceed 6 feet and cross slopes should not exceed 3 percent. Two percent is suggested where more than nominal speeds are involved.

Topic 837 – Inlet Design

837.1 General

The basic features of standard storm drain inlets are shown in Figure 837.1. Full details appear on Standard Plan D72 through D75, D98-A and D98-B. The variety of standard designs available is considered sufficient to any drainage situation; hence, the use of nonstandard inlets should be rare.

837.2 Inlet Types

From an operating standpoint, there are five main groups of inlets; these are:

- (1) *Curb-Opening.* Curb opening inlets have an opening parallel to the direction of flow in the gutter. This inlet group is adapted to curb and gutter installations. The curb opening is most effective with flows carrying floating debris. As the gutter grade steepens, their interception capacity decreases. Hence, they are commonly used on grades flatter than 3 percent.

When curb opening inlets are used on urban highways other than fenced freeways, a 3/4 inch plain round protection bar is placed horizontally across any curb or wall opening whose height is 7 inches or more. The unsupported length of bar should not exceed 7 feet. Use of the protection bar on streets or roads under other jurisdiction is to be governed by the desires of the responsible authorities.

The Type OS and OL inlets are only used with Type A or B curbs. A checkered steel plate cover is provided for maintenance access.

The Type OS inlet has a curb opening 3.5 feet long. Since a fast flow tends to overshoot such a short opening, it should be used with caution on grades above 3 percent.

The Type OL inlet is a high capacity unit in which the length of curb opening ranges from 7 feet to 21 feet.

- (2) *Grate.* Grate inlets provide a grate opening in the gutter or waterway. As a class, grate inlets perform satisfactorily over a wide range of gutter grades. Their main disadvantage is that they are easily clogged by floating trash and should not be used without a curb opening where total interception of flow is required. They merit preference over the curb opening type on grades of 3 percent or more. Gutter depressions, discussed under Index 837.5, increase the capacity of grate inlets. Grate inlets may also be used at locations where a gutter depression is not desirable. See the Standard Plans for grate details.

Locate grate inlets away from areas where bicycles or pedestrians are anticipated whenever possible. Grate designs that are allowed where bicycle and pedestrian traffic occurs have smaller openings and are more easily clogged by trash and debris and are less efficient at intercepting flow. Additional measures may be necessary to mitigate the increased potential for clogging.

The grate types depicted on Standard Plan D77B must be used if bicycle traffic can be expected. Many highways do not prohibit bicycle traffic, but have inlets where bicycle traffic would not be expected to occur (e.g., freeway median). In such instances, the designer may consider use of grates from Standard Plan D77A. The table of final pay weights on Standard Plan D77B indicates the acceptable grate types to be used for each listed type of inlet.

July 1, 2020

Figure 837.1

Storm Drain Inlet Types

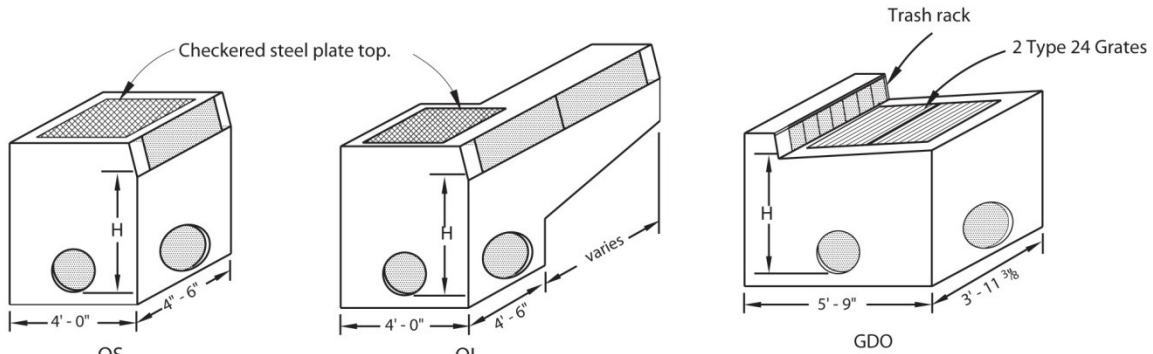

OS
Curb opening 3' - 6" long.
Use only with Type A and B curbs.

OL
Curb opening lengths 7', 10', 14' and 21'. Use only with Type A and B curbs.

GDO
Trash rack provided when needed. Use with Types A and B curbs and Type A dike, or recessed in a cut slope.

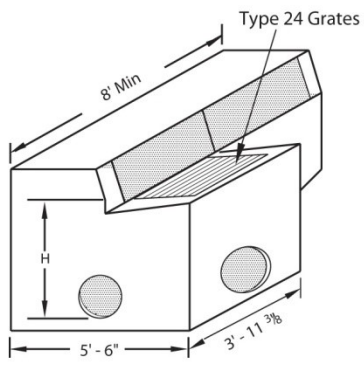

GOL
Curb opening lengths 7' and 10'.
Use with Types A and B curbs.

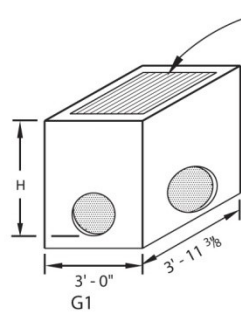

G1
Used when height of inlet is 6' - 0" or less.

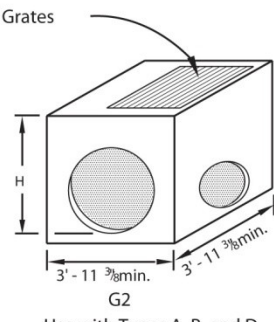

G2
Use with Types A, B, and D dikes when outlet pipe O.D. exceeds 24".

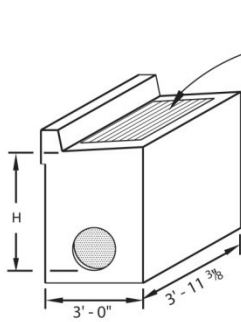

G3
Use with Types A and B curbs when height of inlet is 6' - 0" or less.

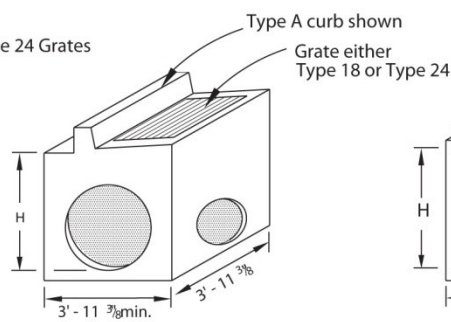

G4
Use with Types A and B curbs when outlet pipe O.D. exceeds 24".

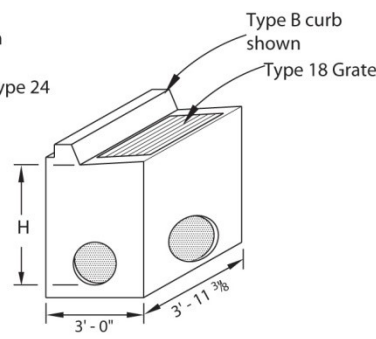

G5
Use with Types A and B curbs when height of inlet is 6' - 0" or less.

- NOTES:
1. All dimensions are outside dimensions based on 6" wall thickness.
 2. For full details on uses according to type, see Index 837.2.
 3. H = height of inlet.
 4. See Standard Plans for Details.
 5. Grates shown are not bicycle proof nor ADA compliant.

Figure 837.1

Storm Drain Inlet Types (Cont.)

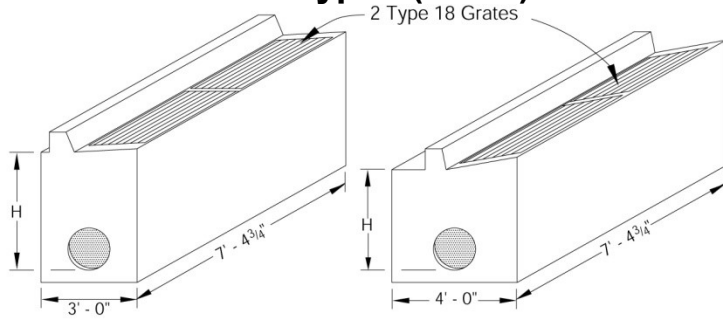

GT1

Use with Types A and B curbs when height of inlet is 6' or less.

GT2

Use with Types A and B curbs when outlet pipe O.D. exceeds 24".

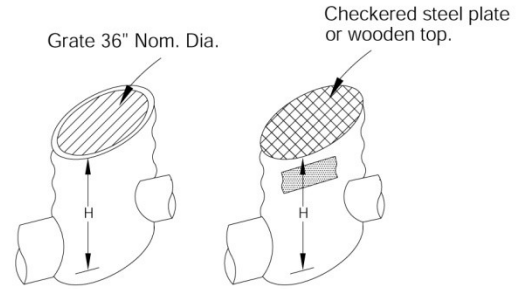

GMP

36" Diameter Metal Pipe.

OMP

36" Diameter Metal Pipe.

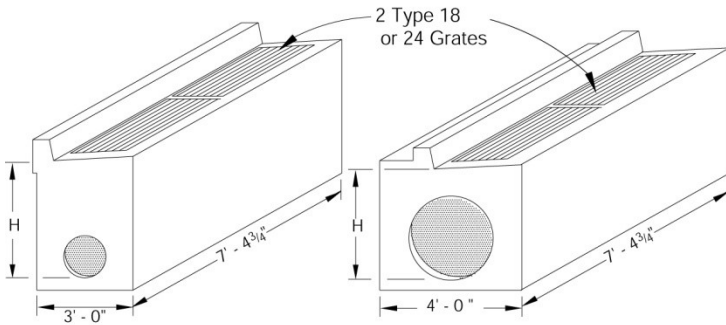

GT3

Use with Types A and B curbs when height of inlet is 6' - 0" or less.

GT4

Use with Types A and B curbs when outlet pipe O.D. exceeds 24".

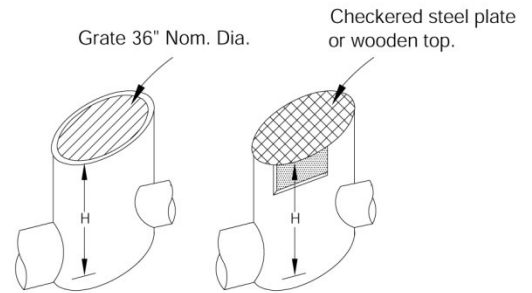

GCP

36" Diameter Concrete Pipe.

OCP

36" Diameter Concrete Pipe.

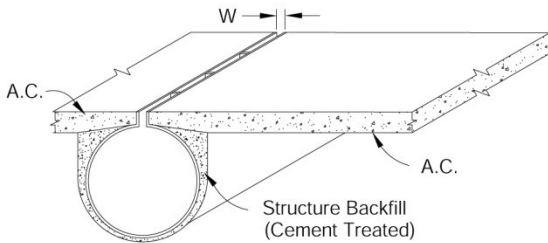

SLOTTED DRAIN INLET

12" to 24" Diameter Corrugated Metal Pipe. $W = 1 \frac{3}{4}"$

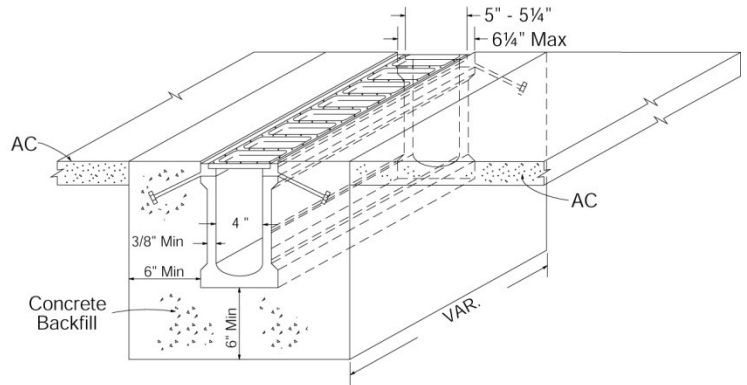

GRATED LINE DRAIN

Precast with non-integral frame

- NOTES: 1. All dimensions are outside dimensions based on 6" wall thickness.
2. For full details on uses according to type, see Index 837.2.
3. H = height of inlet.
4. See Standard Plans for Details.

July 1, 2020

If grate inlets must be placed within a pedestrian path of travel, the grate must be compliant with the Americans with Disabilities Act (ADA) regulations which limit the maximum opening in the direction of pedestrian travel to no more than 0.5 inch. Presently, the only standard grating which meets such restrictive spacing criterion is the slotted corrugated steel pipe with heel guard, as shown in the Standard Plans. Because small openings have an increased potential for clogging, a minimum clogging factor of 50 percent should be assumed; however, that factor should be increased in areas prone to significant debris. Other options which may be considered are grated line drains with specialty grates (see the Standard Plans for grated line drain details, and refer to manufacturers catalogs for special application grates) or specially designed grates for standard inlets. The use of specially designed grates is a nonstandard design that must be approved by the Office of State Highway Drainage Design prior to submittal of PS&E.

- (3) *Combination*. Combination inlets provide both a curb opening and a grate. These are high capacity inlets which make use of the advantages offered by both kinds of openings.
- (a) Type GO and GDO. These types of inlets have a curb opening directly opposite the grate. The GDO inlet has two grates placed side by side and is designed for intercepting a wide flow. A typical use of these inlets would be in a sag location either in a curb and gutter installation or within a shoulder fringed by a dike. When used as the surface inlet for a pumping installation, the trash rack shown on the Standard Plan D74B is provided.
- (b) Type GOL. This is called a sweeper inlet because the curb opening precedes the grate. It is particularly useful as a trash interceptor during the initial phases of a storm. When used in a grade sag, the sweeper inlet can be modified by providing a curb opening on both sides of the grate.
- (4) *Pipe*. Pipe drop inlets are made of a commercial pipe section of concrete or corrugated metal. As a class, they develop a high capacity and are generally the most economical type. This type of inlet is intended for uses outside the roadbed at locations that will not be subjected to normal highway wheel loads.
- Two kinds of inlets are provided; a wall opening and a grate top. The wall opening inlet should only be used at protected locations where it is unlikely to be hit by an out of control vehicle.
- (a) Wall Opening Intake. This opening is placed normal to the direction of surface flow. It develops a high capacity unaffected by the grade of the approach waterway. The inlet capacity is increased by depressing the opening; also by providing additional openings oriented to intercept flows from different directions. When used as the surface intake to a pumping installation, a trash rack across the opening is required. See Standard Plans for pipe inlet details. Because this type of inlet projects above grade, its use should be avoided in areas subject to traffic leaving the roadway.
- (b) Grate Intake. The grate intake intercepts water from any direction. For maximum efficiency, however, the grate bars must be in the direction of greatest surface flow. Being round, it is most effective for flows that are deepest at the center, as in a valley median.
- (5) *Slotted Drains*. This type of inlet is made of corrugated metal or polyethylene pipe with a continuous slot on top. This type of inlet can be used in flush, all paved medians with superelevated sections to prevent sheet flow from crossing the centerline of the highway. Short sections of slotted drain may be used as an alternate solution to a grate catch basin in the median or edge of shoulder.

(a) Drop inlets or other type of cleanout should be provided at intervals of about 100 feet.

- (6) *Grated Line Drains.* This type of inlet is made of monolithic polymer concrete with a ductile iron frame and grate on top. This type of inlet can be used as an alternative at the locations described under slotted drains, preferably in shoulder areas away from traffic loading. However, additional locations may include localized flat areas of pavement at private and public intersections, superelevation transitions, along shoulders where widening causes a decrease to allowable water spread, tollbooth approaches, ramp termini, parking lots and on the high side of superelevation in snow and ice country to minimize black ice and sheet flow from snow melt. Removable grates should not be placed where subject to traffic.

Short sections of grated line drain may be used in conjunction with an existing drainage inlet as a supplement in sag locations. However, based on the depth of the water, the flow condition will be either weir or orifice. The transition between weir and orifice occurs at approximately 7 inches depth of flow. The HEC-22 method of design for slotted pipe is recommended as the basis for grated line drain design. It should be noted that this is inlet interception/capacity design, not the carrying capacity of the product as a conduit.

Furthermore, the grated line drain has a smaller cross sectional area than slotted pipe, and therefore typically less carrying capacity.

Grated line drains are recommended as an alternative to slotted pipe at locations susceptible to pipe clogging from sediments and debris. Self-cleaning velocities can usually be generated from their smooth interior surface, or if necessary by specifying the optional pre-sloped sections.

Grated line drains may also be useful where there is a potential for utility conflicts with slotted drains, which are generally installed at a greater depth.

At locations where clean out access is needed, removable grates can be specified. In areas with pedestrian traffic, special grates which meet the Americans with Disabilities Act (ADA) requirements are mandatory. This type of grate is susceptible to clogging, therefore removable grates are recommended at these locations, and they should only be specified when placement directly within the pedestrian path of travel is unavoidable.

- (7) *Scuppers.* This type of inlet consists of a low, rectangular slot cut through the base of a barrier. Similar to but smaller than curb opening inlets (See Index 837.2(1)), scuppers are prone to clogging by sediment and debris and require enhanced maintenance attention. Scupper interception efficiency decreases with increased longitudinal gradient and scupper design is not typically compatible with construction of an inlet depression. Scuppers are typically considered only when other inlet options are infeasible.

837.3 Location and Spacing

- (1) *Governing Factors.* The location and spacing of inlets depend mainly on these factors:
- (a) The amount of runoff,
 - (b) The longitudinal grade and cross slope,
 - (c) The location and geometrics of interchanges and at-grade intersections,
 - (d) Tolerable water spread, see Table 831.3,
 - (e) The inlet capacity,
 - (f) Accessibility for maintenance and inspection,
 - (g) Volume and movements of motor vehicles, bicycles and pedestrians,
 - (h) Amount of debris, and
 - (i) The locations of public transit stops.

July 1, 2020

(2) *Location.* There are no ready rules by which the spacing of inlets can be fixed; the most effective and economical installation should be the aim.

The following are locations where an inlet is nearly always required:

- Sag points
- Points of superelevation reversal
- Upstream of ramp gores
- Upstream and downstream of bridges – bridge drainage design procedure assumes no flow onto bridge from approach roadway, and flow off bridge to be handled by the district.
- Intersections
- Upstream of pedestrian crosswalks
- Upstream of curbed median openings

In urban areas, the volume and movements of vehicles, bicyclists, and pedestrians constitute an important control. For street or road crossings, the usual inlet location is at the intersection at the upstream end of the curb or pavement return and clear of the pedestrian crosswalk. Where the gutter flow is small and vehicular, bicycle, and pedestrian traffic are not important considerations, the flow may be carried across the intersection in a valley gutter and intercepted by an inlet placed downstream. See Index 836.2(4).

At depressed grade lines under structures, care must be taken to avoid bridge pier footings. See Index 204.6.

Safety of location for maintenance purposes is an important consideration. Wall opening inlets should not be placed where they present an obstacle to maintenance equipment and to vehicles that leave the traveled way. Grate top inlets should be installed in such locations.

Placement of inlets within the traveled way is discouraged. Inlets should typically be relocated when roadways are widened or realigned. Any proposal to leave an existing or construct a new inlet within the traveled way should be discussed with District Maintenance to verify that future access is feasible.

(3) *Spacing.* Arbitrary spacing of inlets should be avoided. The distance between inlets should be determined by a rational analysis of the factors mentioned above. Detailed procedures for determining inlet spacing are given in FHWA Hydraulic Engineering Circular No. 22, "Urban Drainage Design Manual". In a valley median, the designer should consider the effect of inlet spacing on flow velocities where the soil is susceptible to erosion. To economize on disposal facilities, inlets are often located at culverts or near roadway drainage conduits.

(4) *Inlets in Series.* Where conditions dictate the need for a series of inlets, the recommended minimum spacing should be approximately 20 feet to allow the bypass flow to return to the curb face.

837.4 Hydraulic Design

(1) *Factors Governing Inlet Capacity.* Inlet capacity is a variable which depends on:

- (a) The size and geometry of the intake opening,
- (b) The velocity and depth of flow and the gutter cross slope just upstream from the intake, and
- (c) The amount of depression of the intake opening below the flow line of the waterway.

(2) *General Notes.*

- (a) **Effect of Grade Profile.** The grade profile affects both the inlet location and its capacity. The gutter grade line exerts such an influence that it often dictates the choice of inlet types as well as the gutter treatment opposite the opening. See Index 831.2.

Sag vertical curves produce a flattening grade line which increases the width of flow at the bottom. To reduce ponding and possible sedimentation problems, the following measures should be considered:

- Reduce the length of vertical curve.
- Use a multiple installation consisting of one inlet at the low point and one or more inlets upstream on each side. Refer to HEC 22 for further discussion and design procedures for locating multiple inlets.

Short sections of slotted or grated line drains on either side of the low point may be used to supplement drop inlets.

- (b) **Cross Slope for Curbed Gutters.** Make the cross slope as steep as possible within limits stated under Index 836.2(2). This concentrates the flow against the curb and greatly increases inlet capacity.
- (c) **Local Depressions.** Use the maximum depression consistent with site conditions; for further details see Index 837.5.
- (d) **Trash.** The curb-opening type inlet, when the first in a series of grate inlets, may intercept trash and improve grate efficiency. In a grade sag, one trash interceptor should be used on each side of the sump.
- (e) **Design Water Surface Within the Inlet.** The crown of the outlet pipe should be low enough to allow for pipe entrance losses plus a freeboard of 0.75 feet between the design water surface and the opening at the gutter intake. This allows sufficient margin for turbulence losses, and the effects of floating trash.
- (f) **Inlet Floor.** The inlet floor should generally have a substantial slope toward the outlet. In a shallow drain system where conservation of head is essential, or any system where the preservation of a nonsilting velocity is necessary, the half round floor shown on the Standard Plan D74C should be used when a pipe continues through the inlet.
- (g) **Partial Interception.** Economies may be achieved by designing inlets for partial interception with the last one or two inlets in series intercepting the remaining flow. See Hydraulic Engineering Circular No. 22.

- (3) ***Curb-Opening Inlets.*** Gutter depressions should be used with curb-opening inlets. The standard gutter depressions for curb-opening inlets, shown on Standard Plan D78 are 0.1 foot and 0.25 foot deep.

Curb-opening inlets are most economical and effective if designed and spaced to intercept only 85 to 90 percent of the flow. This provides for an increased flow depth at the curb face.

Figure 4-11, "Comparison of Inlet Interception Capacity, Slope Variable", and Figure 4-12, "Comparison of Inlet Interception Capacity, Flow Rate Variable" of Hydraulic Engineering Circular No. 22 can be used to obtain interception capacities for various longitudinal grades, cross slopes, and gutter depressions. Charts for determining interception capacities under sump conditions are also available in HEC No. 22.

- (4) ***Grate Inlets.*** The grate inlet interception capacity is equal to the sum of the frontal flow (flow over the grate) interception and the side flow interception. The frontal flow interception will constitute the major portion of the grate interception. In general, grate inlets will intercept all of the frontal flow until a velocity is reached at which water begins to splash over the grate.

July 1, 2020

Charts provided in HEC 22 can be used to compute grate interception capacities for the various grates contained therein. Grate depressions will greatly increase inlet capacity.

The HEC 22 charts neglect the effects of debris and clogging on inlet capacity. In some localities inlet clogging from debris is extensive, while in other locations clogging is negligible. Local experience should dictate the magnitude of the clogging factor, if any, to be applied. In the absence of local experience, design clogging factors of 33 percent for freeways and 50 percent for city streets may be assumed.

Grate type inlets are most economical and effective if designed and spaced to intercept only 75 to 80 percent of the gutter flow.

(5) *Combination Inlets.*

- (a) Type GO and GDO Inlet. For design purposes, only the capacity of the grates need be considered. The auxiliary curb opening, under normal conditions, offers little or no increase in capacity; but does act as a relief opening should the grate become clogged. Since the grates of Type GDO are side by side, the inlet capacity is the combined capacity of the two grates.
- (b) Type GOL Inlet. The interception capacity of this inlet, a curb-opening upstream of a grate, is equal to the sum of the capacities for the two inlets except that the frontal flow and thus interception capacity of the grate is reduced by interception at the curb opening.

(6) *Pipe Drop Inlets.*

- (a) Wall Opening Intake. The standard intake opening 2 feet wide and 8 inches to 12 inches deep provides a capacity of approximately 6.0 CFS when the water surface is 1 foot higher than the lip of the opening. Where the flow is from more than one direction, two or more standard openings may be provided. Higher capacity openings larger than standard may be provided but are of a special design.
- (b) Grate Intake. The choice between inlets with a round grate (Types GCP and GMP) and those with a rectangular grate (Type G1) hinges largely on hydraulic efficiency. In a waterway where the greatest depth of flow is at the center, both grates are equally effective. In a waterway where the cross slope concentrates the flow on one side of the grate, the rectangular shape is preferred. For rectangular grates, the charts contained in HEC 22 can be used to compute flow intercept. Round grates (Type 36R) with 0.5 foot of depression develop a capacity of 12 CFS to 15 CFS.

837.5 Local Depressions

- (1) *Purpose.* A local depression is a paved hollow in the waterway shaped to concentrate and direct the flow into the intake opening and increases the capacity of the inlet. In a gutter bordered by a curb, it is called a gutter depression.
- (2) *Requirements.* Local depressions generally consist of a paved apron or transition of a shape which serves the purpose. Local depressions should meet the following requirements:
 - (a) Valley Medians. In medians on a grade, the depression should extend a minimum of 10 feet upstream, 6 feet downstream and 6 feet laterally, measured from the edge of the opening. In a grade sag, the depression should extend a minimum of 10 feet on all sides. No median local depression, however should be allowed to encroach on the shoulder area.

The normal depth of depression is 4 inches.
 - (b) Paved Gutter Flares. The local depression which adjoins the outer edge of shoulder at the entrance to overside downdrains and spillways is labeled "paved gutter flare" on

Standard Plans D87-A and D87-D. The flow line approaching the inlet is depressed to increase capacity and minimize water spread on the roadbed. Within a flare length of 10 feet the gutter flow line is depressed a minimum of 6 inches at the inlet. Recommended flare lengths for various gutter flow line depression depths are given on the Standard Plans. When conditions warrant, these flare lengths may be exceeded.

Traffic safety should not be compromised for hydraulic efficiency. Any change in the shape of the paved gutter flare that will result in a depression within the shoulder area should not be made. The Type 2 entrance taper and paved gutter flare is intended for use on divided highways where gutter grades exceed 2 percent and flow is in the opposite direction of traffic.

- (c) Roadside Gutter and Ditch Locations. Regardless of type of intake, the opening of a drop inlet in a roadside gutter or ditch should be depressed from 4 inches to 6 inches below the flow line of the waterway with 10 feet of paved transition upstream.
- (d) Curb and Gutter Depressions. This type of depression is carefully proportioned in length, width, depth, and shape. To best preserve the design shape, construction normally is of concrete. Further requirements for curb and gutter depressions are:
 - Length - As shown on Standard Plan D78.
 - Width - Normally 4 feet, but for wide flows or a series of closely spaced inlets, 6 feet is authorized.
 - Depth - Where traffic considerations govern, the depth commonly used is 0.1 foot. Use the maximum of 0.25 foot wherever feasible at locations where the resulting curb height would not be objectionable.
- (e) Type of Pavement. Local depressions outside the roadbed are usually surfaced with asphalt concrete 0.15 foot thick.

(3) *General Notes on Design.* Except for traffic safety reasons, a local depression is to be provided at every inlet even though the waterway is unpaved. Where the size of intake opening is a question, a depression of maximum depth should be considered before deciding on a larger opening. For traffic reasons, the gutter depression should be omitted in driveways and median curb and gutter installations.

It is permissible to omit gutter depressions at sump inlets where the width of flow does not exceed design water spread.

Topic 838 – Storm Drains

838.1 General

The total drainage system which conveys runoff from roadway areas to a positive outlet including gutters, ditches, inlet structures, and pipe is generally referred to as a storm drain system. In urban areas a highway storm drain often augments an existing or proposed local drainage plan and should be compatible with the local storm drain system.

This section covers the hydraulic design of the pipe or enclosed conduit portion of a storm drain system.

July 1, 2020

838.2 Design Criteria

To adequately estimate design storm discharges for a storm drain system in urban areas involving street flooding it may be necessary to route flows by using hydrograph methods. Hydrographs are discussed under Index 816.5 and further information on hydrograph methods may be found in Chapters 6 and 7 of HDS No.2, Highway Hydrology.

838.3 Hydraulic Design

Closed conduits should be designed for the full flow condition. They may be allowed to operate under pressure, provided the hydraulic gradient is 0.75 foot or more below the intake lip of any inlet that may be affected. The energy gradient should not rise above the lip of the intake. Allowances should be made for energy losses at bends, junctions and transitions.

To determine the lowest outlet elevation for drainage systems which discharge into leveed channels or bodies of water affected by tides, consideration should be given to the possibilities of backwater. The effect of storm surges (e.g., winds and floods) should be considered in addition to the predicted tide elevation.

Normally, special studies will be required to determine the minimum discharge elevation consistent with the design discharge of the facility.

838.4 Standards

- (1) *Location and Alignment.* Longitudinal storm drains are not to be placed under the traveled way of highways. Depending upon local agency criteria, storm drains under the traveled way of other streets and roads may be acceptable. A manhole or specially designed junction structure is usually provided at changes in direction or grade and at locations where two or more storm drains are joined. Refer to Index 838.5 for further discussion on manholes and junction structures.
- (2) *Pipe Diameter.* The minimum pipe diameter to be used is given in Table 838.4.
- (3) *Slope.* The minimum longitudinal slope should be such that when flowing half full, a self cleaning velocity of 3 feet per second is attained.
- (4) *Physical Properties.* In general, the considerations which govern the selection of culvert type apply to storm drain conduits. Alternative types of materials, overfill tables and other physical factors to be considered in selecting storm drain conduit are discussed under Chapter 850.
- (5) *Storage.* In developing the most economical installation, the designer should not overlook economies obtainable through the use of pipeline storage and, within allowable limits, the ponding of water in gutters, medians and interchange areas. Inlet capacity and spacing largely control surface storage in gutters and medians; inlet capacity governs in sump areas.

Table 838.4**Minimum Pipe Diameter for Storm Drain Systems**

Type of Drain	Minimum Diameter (in)
Trunk Drain	18
Trunk Laterals	15 ⁽¹⁾
Inlet Laterals	15 ⁽¹⁾

NOTE:

⁽¹⁾18 minimum if wholly or partly under the roadbed.

Specific subjects for special consideration are:

- **Bedding and Backfill.** Bedding and backfill consideration are discussed under Index 829.2. Maximum height of cover tables are included in Chapter 850 and minimum thickness of cover is given in Table 856.5.
- **Roughness Factor.** The roughness factor, Manning's n value, generally assumes greater importance for storm drain design than it does for culverts. Suggested Manning's n values for various types of pipe materials are given in Table 852.1.

(6) *Floating Trash.* Except at pumping installations, every effort should be made to carry all floating trash through the storm drain system. Curb and wall opening inlets are well suited for this purpose. In special cases where it is necessary to exclude trash, as in pumping installations, a standard trash rack must be provided across all curb and wall openings of tributary inlets. See the Standard Plans for details.

(7) *Median Flow.* In estimating the quantity of flow in the median, consideration should be given to the effects of trash, weeds, and plantings.

838.5 Appurtenant Structures**(1) Manholes.**

(a) **General Notes.** The purpose of a manhole is to provide access to a storm drain for inspection and maintenance. Manholes are usually constructed out of cast in place concrete, pre-cast concrete, or corrugated metal pipe. They are usually circular and approximately three or four feet in diameter to facilitate the movement of maintenance personnel.

There is no Caltrans Standard Plan for manholes. Relocation and reconstruction of existing storm drain facilities, owned by a city or county agency, is often necessary. Generally the local agency has adopted manhole design standard for use on their facilities. Use of the manhole design preferred by the responsible authority or owner is appropriate.

Commercial precast manhole shafts are effective and usually more economical than cast in place shafts. Brick or block may also be used, but only upon request and justification from the local agency or owner.

July 1, 2020

(b) Location. Following are common locations for manholes:

- Where two or more drains join,
- At locations and spacing which facilitate maintenance,
- Where the drain changes in size,
- At sharp curves or angle points in excess of 10 degrees,
- Points where an abrupt flattening of the grade occurs, and
- On the smaller drains, at the downstream end of a sharp curve.

Manholes are not required if the conduit is large enough to accommodate a man, unless spacing criteria govern. Manholes should not be placed within the traveled way. Exceptions are frontage roads and city streets, but intersection locations should be avoided.

(c) Spacing. In general, the larger the storm drain, the greater the manhole spacing. For pipe diameter of 48 inches or more, or other shapes of equal cross sectional area, the manhole spacing ranges from 700 feet to 1200 feet. For diameters of less than 48 inches, the spacing may vary from 300 feet to 700 feet. In the case of small drains where self-cleaning velocities are unobtainable, the 300 feet spacing should be used. With self-cleaning velocities and alignments without sharp curves, the distance between manholes should be in the upper range of the above limits.

(d) Access Shaft. For drains less than 48 inches in diameter, the access shaft is to be centered over the drain. When the drain diameter exceeds the shaft diameter, the shaft should be offset and made tangent to one side of the pipe for better location of the manhole steps. For drains 48 inches or more in diameter, where laterals enter from both sides of the manhole, the offset should be toward the side of the smaller lateral. See Standard Plan D93A for riser connection details.

(e) Arrangement of Laterals. To avoid unnecessary head losses, the flow from laterals which discharge opposite each other should converge at an angle in the direction of flow. If conservation of head is critical, a training wall should be provided.

(2) *Junction Structures.* A junction structure is an underground chamber used to join two or more conduits, but does not provide direct access from the surface. It is designed to prevent turbulence in the flow by providing a smooth transition. This type of structure is usually needed only where the trunk drain is 42 inches or more in diameter. A standard detail sheet of a junction structure is available for pipes ranging from 42 inches to 84 inches in diameter at the following Office Engineer web site address: http://www.dot.ca.gov/hq/esc/structures_cadd/XS_sheets/Metric/dgn/. The XS sheet reference is XS 4-26. Where required by spacing criteria, a manhole should be used.

(3) *Flap Drainage gates.* When necessary, backflow protection should be provided in the form of flap drainage gates. These gates offer negligible resistance to the release of water from the system and their effect upon the hydraulics of the system may be neglected.

If the outlet is subject to floating debris, a shelter should be provided to prevent the debris from clogging the flap drainage gate. Where the failure of a flap drainage gate to close would cause serious damage, a manually controlled gate in series should be considered for emergencies.

Topic 839 – Pumping Stations

839.1 General

Drainage disposal by pumping should be avoided where gravity drainage is reasonable. Because pumping installations have high initial cost, maintenance expense, power costs, and the possibility of failure during a storm, large expenditures can be justified for gravity drainage. In some cases, this can be accomplished with long runs of pipe or continuing the depressed grade to a natural low area.

Whenever possible, drainage originating outside the depressed areas should be excluded. District and Division of Structures cooperation is essential in the design of pumping stations, tributary storm drains, and outfall facilities. This is particularly true of submerged outlets, outlets operating under pressure, and outlets of unusual length.

839.2 Pump Type

Horizontal pumps in a dry location are generally specified for ease of access, safety, and standardization of replacement parts.

Only in special cases is stand-by power for pumping plants a viable consideration. All proposals for stand-by power are to be reviewed by and coordinated with the Division of Structures.

839.3 Design Responsibilities

When a pumping station is required, responsibility for design between the District and the Division of Structures is as follows:

- (1) *Districts*. The District designs the collector and the outfall facilities leading from the chamber into which the pumps discharge. This applies to outfalls operating under gravity and with a free outlet. Refer to Topic 838.

Details of pumping stations supportive information to be submitted by the District to the Division of Structures is covered under Index 805.8 and Chapter 3-3.1(4) of the Drafting and Plans Manual.

- (2) *Division of Structures*. The Division of Structures will prepare the design and contract plans for the pumping station, the storage box and appurtenant equipment, considering the data and recommendations submitted by the District.

The Division of Structures will furnish the District a preliminary plan based on data previously submitted by the District. It will show the work to be covered by the Division of Structures plans, including a specific location for the pumping plant and storage box, the average and maximum pumping rates and the power required.

839.4 Trash and Debris Considerations

Storm drain systems leading to pumping plants are to be designed to limit the inflow of trash and debris, as these may cause damage to the pump impellers and create a maintenance removal nuisance. Standard grate designs are effective at ensuring that trash and debris are screened out of the inflow, but where side opening or curb opening inlets are constructed, trash racks must be added to the inlet design. The only Standard Plan detail for curb opening designs

July 1, 2020

is shown on Standard Plan D74B and is used in conjunction with Type GDO inlets. On those occasions where pipe risers with side opening inlets are part of the system, refer to Standard Plan D93C for appropriate trash rack design details.

839.5 Maintenance Consideration

Access to the pumping plant location for both maintenance personnel and maintenance vehicles is generally provided by way of paved access road or city street. One parking space minimum is to be provided in the vicinity of the pumping plant. An area light is generally provided when it is determined that neither the highway lighting nor the street lighting is adequate. Access to the pumping plant for maintenance from the top of the cut slope generally consists of a stairway located adjacent to the pumping plant. The stairway generally extends from the top of cut slope to the toe of cut slope. Access to the pump control room should be through a vertical doorway with the bottom above flood level, and never through a hatch.

839.6 Groundwater Considerations

As the lowest point in the storm drain system, pumping plants are particularly susceptible to problems associated with rises in groundwater tables. Where the foundation of pump houses or associated storage boxes are at an elevation where they would be subjected to existing or future groundwater tables, sealing around the base of the foundation is necessary. The use of bentonite or other impervious material is typically sufficient in keeping groundwater from welling up through the relatively pervious structure backfill.

Sealing requirements will typically be specified by the Division of Structures during the pump plant design. However, the district should provide any information relative to historical groundwater levels or fluctuations which would be of importance, or known plans by local or regional water districts to modify recharge patterns in a manner that could impact the design.

CHAPTER 840 – SUBSURFACE DRAINAGE

Topic 841 – General

Index 841.1 – Introduction

Saturation of the structural section or underlying foundation materials is a major cause of premature pavement failures. In addition, saturation can lead to undesirable infiltration into storm drain systems and, where certain soil types are below groundwater, liquefaction can occur due to seismic forces. Subsurface drainage systems designed to rapidly remove and prevent water from reaching or affecting the roadbed are discussed in this chapter.

The solution for subsurface drainage problems often calls for a knowledge of geology and the application of soil mechanics. The Project Engineer should request assistance from Geotechnical Services in the Division of Engineering Services for projects involving cuts, sections depressed below the original ground surface, or whenever the presence of groundwater is likely. Geotechnical Services can also provide assistance related to the design of features to relieve hydrostatic pressure at bridge abutments. The designer should consider the potential for large fluctuations in groundwater levels. Wet periods after several years of drought, or changes to recharge practices can lead to considerable rises in groundwater levels.

For tunnel, structure abutments, or other structure projects which might require relief of hydrostatic pressures, contact Geotechnical Services.

The basis for design will generally be the Geotechnical Design Report. This report will include findings on subsurface conditions and recommendations for design. Refer to Topic 113 for more information on Geotechnical Design Reports.

There are many variables and uncertainties as to the actual subsurface conditions. In general, the more obvious subsurface drainage problems can be anticipated in design; the less obvious are frequently uncovered during construction. Extensive exploration and literature review may be required to obtain the design variables with reasonable accuracy.

841.2 Subsurface (Groundwater) Discharge

Groundwater, as distinguished from capillary water, is free water occurring in a zone of saturation below the ground surface. Subsurface discharge, the rate at which groundwater and infiltration water can be removed depends on the effective hydraulic head and on the permeability, depth, slope, thickness and extent of the water-bearing formation (the aquifer). The discharge can be obtained by analytical methods. Such methods, however, are usually cumbersome and unsatisfactory; field explorations will yield better results.

July 1, 2020

841.3 Preliminary Investigations

Field investigations may include:

- Soils, geological, and geophysical studies.
- Borings, pits, or trenches to find the elevation, depth, and extent of the aquifer.
- Inspection of cut slopes in the immediate vicinity.
- Measurement of groundwater discharge.

Preliminary investigations should be as thorough as possible, recognizing that further information is sometimes uncovered during construction. Where an existing road is part of new construction, the presence and origin of groundwater is often known or easily detected. Personnel responsible for maintenance of the existing road are an excellent source of such information and should be consulted. Explorations, therefore, are likely to be lesser in scope and cost than explorations for a project on new alignment. In slope stability questions, and other problems of equal importance, an extensive knowledge of subsurface conditions is required. The District should ask for the assistance of Geotechnical Services in such cases.

841.4 Exploration Notes

In general, explorations should be made during the rainy season or after the melting of snow in regions where snow cover is common. An exception would be where seepage occurs from irrigation sources.

Groundwater difficulties frequently stem from water perched on an impermeable layer some distance above the actual water table. Perched water problems can often be solved with horizontal drains. See Index 841.5.

Pumped water supply wells often give unreliable indications of the water table and such data should be used with caution.

841.5 Category of System

Depending upon the scope and complexity of the problem, an appropriate solution may require the installation of one or a combination of different types of subsurface drainage systems. The type of subsurface drainage system initially considered is usually an underdrain.

The standard underdrain is the pipe underdrain. A pipe underdrain consists of a perforated pipe near the bottom of a narrow trench lined with filter fabric and backfilled with permeable material.

Pipe underdrains are discussed in more detail under Topic 842.

"French Drains" have proven to be unreliable underdrains. A "French drain" consists of a trench backfilled with rock. They are not to be used where a permanent solution is needed. Exceptions may be made for special cases such as where depth of the underdrain and soil conditions would conflict with industrial safety regulations. Under such circumstances a design that includes a filter fabric liner and permeable material backfill, without the perforated pipe may be used.

In addition to pipe underdrains, the following special purpose categories of subsurface drains are used to intercept, collect, and discharge groundwater.

- *Structural Section and Edge Drains.* Subsurface drainage systems that are primarily designed for the rapid removal of surface water infiltration from treated or untreated pavement structural section materials are called structural section drains or more typically edge drains. A 3-inch slotted plastic pipe with 3 rows of slots is the standard for structural section drains. Refer to Chapter 650, Pavement Drainage for more information on the drainage of the pavement structural section.
- *Horizontal Drains.* Horizontal drains are 1 1/2 inch perforated or slotted pipes placed in drilled holes bored into the aquifer or water bearing formations. They are installed in cut slopes and under fills more to guard against slides by relieving hydrostatic pressure than to prevent saturation of the roadbed. They may be used in varying lengths up to 1,000 feet on grades that range from 0 to 25 percent. A collection system to remove the intercepted water from the area is generally also required.
- *Prefabricated Geocomposite Drains.* Available in sheets or rolls, geocomposite drains provide a cost effective solution to subsurface drainage behind bridge abutments, wingwalls and retaining walls. Prefabricated subsurface drainage systems consist of a plastic drain core covered on one or both sides with a filter fabric.
- *Stabilization Trenches.* This category of subsurface drainage system is constructed in swales, ravines, and under sidehill fills to stabilize water logged fill foundations. The Geotechnical Design Report should contain depth and width of trench recommendations. Stabilization trenches may be only a few feet in width requiring a backhoe or similar type of excavation equipment, or they may be large enough for earth moving equipment such as dozers and scrapers to operate. Trenches wide enough to permit the use of earth moving equipment should be considered wherever feasible. A 1:1 side slope is commonly used.

The excavated trench, including the side slopes, is covered with a thick blanket of permeable material. One or more perforated drain pipes, usually 8 inches to 12 inches in diameter, are placed at the bottom of the trench depending on the quantity of groundwater, type of material, and area to be stabilized.

The alignment of the trench and collector pipe are often made parallel to the highway centerline. Conditions may be such that trench alignment on a skew or with tee, wye, or herringbone configurations are a better design.

Lining the trench with filter fabric is recommended. The usual 3 feet or more thickness of permeable material may be reduced and a less expensive gradation may be specified if a filter fabric is used. Assistance in selecting filter fabric and permeable material specifications should be requested from Geotechnical Services.

- *Drainage Galleries.* Drainage galleries consist of a row or rows of closely spaced wells 36 inches to 48 inches in diameter bored with power augers to the depth required to intercept the aquifer. They are a variation of the stabilization trench principle and may afford a more cost effective solution under certain conditions.

Drainage galleries are a viable option where the depth of the aquifer exceeds the economical or practical limits for open trench excavation. Because of potential cave-ins or slides, open trench excavation may not be practical.

The bottom of the bored wells should be interconnected and a suitable collector and outlet system must be provided. The wells may be interconnected by bellling out at the bottoms, tunneling between wells, drilled-in-place outlets, or horizontal drains.

The wells are backfilled with permeable material. The Geotechnical Design Report should contain well spacing and depth recommendations. Assistance in selecting permeable material and other specifications pertinent to drainage galleries should be requested from Geotechnical Services.

July 1, 2020

Topic 842 – Pipe Underdrains

842.1 General

As stated under Index 841.5, the standard underdrain treatment is the perforated pipe underdrain. Pipe underdrain systems consist of a 6-inch or 8-inch diameter perforated pipe placed near the bottom of a narrow trench. The trench is usually lined with filter fabric prior to placement of the perforated pipe and permeable material backfill.

Two standard cross sections for pipe underdrains are shown on Standard Plan D102. The one with the permeable material carried to the top of the grading plane is used under paved areas. The other, with a topping of earth backfill over the permeable material, is used under unpaved areas.

842.2 Single Installations

A single pipe underdrain is commonly used in these cases:

- Along the toe of a cut slope to intercept seepage when slope stability is not a problem.
- Along the toe of a fill on the side from which groundwater originates.
- Across the roadway at the downhill end of a cut.

842.3 Multiple Installations

Multiple underdrain installations may be used in a herringbone or other effective pattern in situations such as the following:

- Under the roadway structural section when a permeable blanket is required.
- To stabilize fill foundation areas.

Refer to Table 842.4 for a guide to selecting depth and spacing of multiple pipe underdrain installations.

842.4 Design Criteria

- *Size and Length.* For pipe underdrains of 500 feet or less in length, the standard perforated pipe size is 6 inches in diameter. As a rule, the 6-inch diameter is adequate for collectors and laterals in most soils. For lengths exceeding 500 feet, the minimum diameter of pipe is 8 inches.
- *Surface Runoff.* Surface drainage should be prevented from discharging into underdrain systems.
- *Outlets.* Underdrain outlets should be provided at intervals of not more than 1,000 feet.

Underdrain systems may be designed to discharge directly into a storm drain or culvert as long as the underdrain outlet is not subjected to hydrostatic pressures that could cause backflow damage.

- *Cleanouts.* Terminal and intermediate risers may be placed for the convenience of the maintenance forces cleaning the system. When practical, a terminal riser should be placed at the upper end of an underdrain. Intermediate cleanout risers may be placed at intervals of 500 feet and at sharp angle points greater than 10 degrees.

The diameter of risers should be the same as the pipe underdrain. Details of underdrain risers are shown on Standard Plan D102.

- *Grade.* If possible, pipe underdrains should be placed on grades steeper than 0.5 percent. Minimum grades of 0.2 percent for laterals and 0.25 percent for mains are acceptable.
- *Depth and Spacing.* The depth of the underdrain depends on the permeability of the soil, the elevation of the water table, and the amount of drawdown needed to ensure stability. Whenever practicable, an underdrain pipe should be set in the impervious zone below the aquifer. Additionally, consideration should be given to the depth and proximity of storm drains. Typically, the underdrain should be placed at a depth sufficient to keep the storm drain above the groundwater table.

Table 842.4 gives suggested depths and spacing of underdrains according to soil types. It is only a guide and should not be considered a substitute for field observations or local experience.

842.5 Types of Underdrain Pipe

The aim of any underdrain installation is long term effectiveness. This aim is associated with filtering ability, durability, strength, and cost of conduit, mainly in that order. In choosing between pipes of different types, the key considerations are filtering ability and durability. Pipe cost assumes secondary importance because it is a minor part of the underdrain investment.

Pipes for underdrains are perforated and may be made of steel, aluminum, polyvinyl chloride (PVC) or polyethylene, all with corrugated profiles, or smooth wall PVC. All of the listed types are acceptable for either shallow or deep burial situations. Where plastic pipe underdrains are proposed and burial depths would exceed 30 feet, the Underground Structures Unit in the Division of Engineering Services should be contacted for approval.

842.6 Design Service Life

Refer to Chapter 850 for further discussion and criteria relative to design service life of pipe materials used in underdrain installations.

Experience with underdrains has shown that they are not subject to corrosion in an environment that lacks an adequate supply of air and oxygen entrained in the water. Subsurface waters that may be inclined to be corrosive chemically do not tend to become so as long as they are not exposed to oxygen. However, subsurface water may become corrosive after it has surfaced and been exposed to oxygen. Furthermore, there is evidence that indicates there is little oxygen available in long lengths of the small diameter pipe normally used in a subsurface drainage system.

Although tests may indicate that corrosive salts are present in the soil solution, corrosion will not take place without the presence of oxygen. Therefore, when it is anticipated that the

July 1, 2020

Table 842.4

Suggested Depth and Spacing of Pipe Underdrains for Various Soil Types

Soil Class	Soil Composition			Drain Spacing (ft)			
	Percent Sand	Percent Silt	Percent Clay	3 feet Deep	4 feet Deep	5 feet Deep	6 feet Deep
Clean Sand	80-100	0-20	0-20	110-150	150-200	--	--
Sandy Loam	50-80	0-50	0-20	50-100	100-150	--	--
Loam	30-50	30-50	0-20	30-60	40-80	50-100	60-120
Clay Loam	20-50	20-50	20-30	20-40	25-50	30-60	40-80
Sandy Clay	50-70	0-20	30-50	15-30	20-40	25-50	3-60
Silty Clay [*]	0-20	50-70	30-50	10-25	15-30	20-40	25-50
Clay [*]	0-50	0-50	30-100	15 (max)	20 (max)	25 (max)	40 (max)

*Drainage blankets or stabilization trenches should be considered.

underdrain will be placed to intercept groundwater under the above conditions, it will not be necessary to allow for metal pipe corrosion.

When the above conditions do not prevail, the design service life of metal pipe is determined from pH and resistivity tests covered in California Test 643. This information is shown in the Geotechnical Design Report. The design service life of steel pipe may be increased by a bituminous coating as indicated in Table 855.2C.

The guide values contained in the tables mentioned above may be modified where field observation of existing installations dictates.

842.7 Pipe Selection

In cases where more than one material meets the foregoing requirements, alternatives should be specified on the basis of optional selection by the contractor. The selection of a single type of underdrain may be appropriate due to other related factors. This selection should be supported by complete analysis of factors and documentation placed on file in the District.

CHAPTER 850 – PHYSICAL STANDARDS

Topic 851 – General

Index 851.1 – Introduction

This chapter deals with the selection of drainage facility material type and sizes including pipes, pipe liners, pipe linings, drainage inlets and trench drains.

851.2 Selection of Material and Type

The choice of drainage facility material type and size is based on the following factors:

- (1) *Physical and Structural Factors.* Of the many physical and structural considerations, some of the most important are:
 - (a) Durability.
 - (b) Headroom.
 - (c) Earth Loads.
 - (d) Bedding Conditions.
 - (e) Conduit Rigidity.
 - (f) Impact.
 - (g) Leak Resistance.
- (2) *Hydraulic Factors.* Hydraulic considerations involve:
 - (a) Design Discharge.
 - (b) Shape, slope and cross sectional area of channel.
 - (c) Velocity of approach.
 - (d) Outlet velocity.
 - (e) Total available head.
 - (f) Bedload.
 - (g) Inlet and outlet conditions.
 - (h) Slope.
 - (i) Smoothness of conduit.
 - (j) Length.

Suggested values for Manning's Roughness coefficient (n) for design purposes are given in Table 851.2 for each type of conduit. See Index 866.3 for use of Manning's formula.

Table 851.2

Manning "n" Value for Alternative Pipe Materials⁽¹⁾

Type of Conduit		Recommended Design Value	"n" Value Range
Corrugated Metal Pipe ⁽²⁾			
(Annular and Helical) ⁽³⁾			
2 $\frac{2}{3}$ " x 1/2"	corrugation	0.025	0.022 - 0.027
3" x 1"	"	0.028	0.027 - 0.028
5" x 1"	"	0.026	0.025 - 0.026
6" x 2"	"	0.035	0.033 - 0.035
9" x 2 $\frac{1}{2}$ "	"	0.035	0.033 - 0.037
Concrete Pipe			
Pre-cast		0.012	0.011 - 0.017
Cast-in-place		0.013	0.012 - 0.017
Concrete Box		0.013	0.012 - 0.018
Plastic Pipe (HDPE and PVC)			
Smooth Interior		0.012	0.010 - 0.013
Corrugated Interior		0.022	0.020 - 0.025
Spiral Rib Metal Pipe			
3/4" (W) x 1" (D) @ 11 $\frac{1}{2}$ " o/c		0.013	0.011 - 0.015
3/4" (W) x 3/4" (D) @ 7 $\frac{1}{2}$ " o/c		0.013	0.012 - 0.015
3/4" (W) x 1" (D) @ 8 $\frac{1}{2}$ " o/c		0.013	0.012 - 0.015
Composite Steel Spiral Rib Pipe		0.012	0.011 - 0.015
Steel Pipe, Ungalvanized		0.015	--
Cast Iron Pipe		0.015	--
Clay Sewer Pipe		0.013	--
Polymer Concrete Grated Line Drain		0.011	0.010 - 0.013

Notes:

- ⁽¹⁾ Tabulated n-values apply to circular pipes flowing full except for the grated line drain. See Note 5.
- ⁽²⁾ For lined corrugated metal pipe, a composite roughness coefficient may be computed using the procedures outlined in the HDS No. 5, Hydraulic Design of Highway Culverts.
- ⁽³⁾ Lower n-values may be possible for helical pipe under specific flow conditions (refer to FHWA's publication Hydraulic Flow Resistance Factors for Corrugated Metal Conduits), but in general, it is recommended that the tabulated n-value be used for both annular and helical corrugated pipes.
- ⁽⁴⁾ For culverts operating under inlet control, barrel roughness does not impact the headwater. For culverts operating under outlet control barrel roughness is a significant factor. See Index 825.2 Culvert Flow.
- ⁽⁵⁾ Grated Line Drain details are shown in Standard Plan D98C and described under Index 837.2(6) Grated Line Drains. This type of inlet can be used as an alternative at the locations described under Index 837.2(5) Slotted Drains. The carrying capacity is less than 18-inch slotted (pipe) drains.

Topic 852 – Pipe Materials

852.1 Reinforced Concrete Pipe (RCP)

(1) *Durability.* RCP is generally precast prior to delivery to the project site. The durability of reinforced concrete pipe can be affected by abrasive flows or acids, chlorides and sulfate in the soil and water. See Index 855.2 Abrasion, and Index 855.4 Protection of Concrete Pipe and Drainage Structures from Acids, Chlorides and Sulfates.

The following measures increase the durability of reinforced concrete culverts:

(a) *Cover Over Reinforcing Steel.* Additional cover over the reinforcing steel should be specified where abrasion is likely to be severe as to appreciably shorten the design service life of a concrete culvert. This extra cover is also warranted under exposure to corrosive environments, see Index 855.4 Protection of Concrete Pipe and Drainage Structures from Acids, Chlorides and Sulfates. Extra cover over the reinforcing steel does not necessarily require extra wall thickness, as it may be possible to provide the additional cover and still obtain the specified D-load with standard wall thicknesses.

(b) Increase cement content.

(c) Reduce water content.

(d) Invert paving/plating.

(2) *Indirect Design Strength Requirements.*

(a) *Design Standards.* The “D” load strength of reinforced concrete pipe is determined by the load to produce a 0.01 inch crack under the “3-edge bearing test” called for in AASHTO Designations M 170, M 207M/M 207, and M 206M/M 206 for circular reinforced pipe, oval shaped reinforced pipe, and reinforced concrete pipe arches, respectively.

(b) *Height of Fill.* See Topic 856.

(3) *Shapes.* Reinforced concrete culverts are available in circular and oval shapes. Reinforced Concrete Pipe Arch (RCPA) shapes have been discontinued by West Coast manufacturers.

In general, the circular shaped is the most economical for the same cross-sectional area. Oval shapes are appropriate for areas with limited head or overfill or where these shapes are more appropriate for site conditions. A convenient reference of commercially available products and shapes is the AASHTO publication, “A Guide to Standardized Highway Drainage Products”.

(4) *Non-Reinforced Concrete Pipe Option.* Non-reinforced concrete pipe may be substituted at the contractor’s option for reinforced concrete pipe for all sizes 36 inches in diameter and smaller as long as it conforms to Section 65 of the Standard Specifications. Non-Reinforced concrete pipe is not affected by chlorides or stray currents and may be used in lieu of RCP in these environments without coating or the need to provide extra cover over reinforcement.

(5) *Direct Design Method – RCP.* (Contact DES - Structures Design)

852.2 Concrete Box and Arch Culverts

(1) *Box Culverts.* Single and multiple span reinforced concrete box culverts are completely detailed in the Standard Plans. For cast-in-place construction, strength classifications are shown for 10 feet and 20 feet overfills. Precast reinforced concrete box culverts require a minimum of 1 foot of overfill and are not to exceed 12 feet in span length. Special details are necessary if precast boxes are proposed as extensions for existing box culverts. Where

the use of precast box culverts is applicable, the project plans should include them as an alternative to cast-in-place construction. Because the standard measurement and payment clauses for precast RCB's differ from cast-in-place construction, precast units must be identified as an alternative and the special provision must be appropriately modified.

The standard plan sheets for precast boxes show details which require them to be laid out with joints perpendicular to the centerline of the box. This is a consideration for the design engineer in situations which require stage construction and when the culvert is to be aligned on a high skew. This situation will require either a longer culvert than otherwise may have been needed, or a special design allowing for skewed joints. Prior to selecting the latter option DES - Structures Design should be consulted.

- (2) *Concrete Arch Culverts.* Technical questions regarding concrete arch culverts should be directed to the Underground Structures Branch of DES - Structures Design.
- (3) *Three-Sided Concrete Box Culverts* Design details for cast-in-place (CIP) construction three-sided bottomless concrete box culverts in 2-foot span increments from 12 feet to < 20 feet, inclusive, with strength classifications shown for 10 feet and 20 feet overfills are available upon request from DES - Structures Design. CIP Bottomless Culvert XS-sheets 17-050-1, 2, 3, 4 and 5 may be obtained electronically. Precast three-sided box culverts are an acceptable alternative to CIP designs, where contractors may submit such designs for approval. Both precast and CIP designs must be placed on a foundation designed specifically for the project site.
- (4) *Corrosion, Abrasion, and Invert Protection.* Refer to Index 855.2 Abrasion, and Index 855.4 Protection of Concrete Pipe and Drainage Structures from Acids, Chlorides and Sulfates for corrosion, abrasion and invert protection of concrete box and arch culverts.

852.3 Corrugated Steel Pipe, Steel Spiral Rib Pipe and Pipe Arches

Corrugated steel pipe, steel spiral rib pipe and pipe arches are available in the diameters and arch shapes as indicated on the maximum height of cover tables. For larger diameters, arch spans or special shapes, see Index 852.5. Corrugated steel pipe and pipe arches are available in various corrugation profiles with helical and annular corrugations. Corrugated steel spiral rib pipe is available in several helical corrugation patterns.

- (1) *Hydraulics.* Annular and helical corrugated steel pipe configurations are applicable in the situations where velocity reduction is important or if a culvert is being designed with an inlet control condition. Spiral rib pipe, on the other hand, may be more appropriate for use in stormdrain situations or if a culvert is being designed with an outlet control condition. Spiral rib pipe has a lower roughness coefficient (Manning's "n") than other corrugated metal pipe profiles.
- (2) *Durability.* The anticipated maintenance-free service life of corrugated steel pipe, steel spiral rib pipe and pipe arch installations is primarily a function of the corrosivity and abrasiveness of the environment into which the pipe is placed. Corrosion potential must be determined from the pH and minimum resistivity tests covered in California Test 643. Abrasive potential must be estimated from bed material that is present and anticipated flow velocities. Refer to Index 855.1 for a discussion of maintenance-free service life and Index 855.2 Abrasion, and Index 855.3 Corrosion.

The following measures are commonly used to prolong the maintenance-free service life of steel culverts:

- (a) Galvanizing. Under most conditions plain galvanizing of steel pipe is all that is needed; however, the presence of corrosive or abrasive elements may require additional protection.
- Protective Coatings – The necessity for any coating should be determined considering hydraulic conditions, local experience, possible environmental impacts, and long-term economy. Approved protective coatings are bituminous asphalt, asphalt mastic and polymeric sheet, which can be applied to the inside and/or outside of the pipe; and polyethylene for composite steel spiral ribbed pipe which is a steel spiral ribbed pipe externally pre-coated with a polymeric sheet, and internally polyethylene lined. All of these protective coatings are typically shop-applied prior to delivery to the construction site. Polymeric sheet coating provides much improved corrosion resistance over bituminous coatings and can be considered to typically allow achievement of a 50-year maintenance-free service life without need to increase thickness of the steel pipe. To ensure that a damaged coating does not lead to premature catastrophic failure, the base steel thickness for pipes that are to be coated with a polymeric sheet must be able to provide a minimum 10-year service life prior to application of the polymeric material. In addition, a bituminous lining or bituminous paving can be applied over a bituminous coating primer on the inside of the pipe for extra corrosion or abrasion protection (see Section 66 of the Standard Specifications).

Citing Section 5650 of the Fish and Game Code, the Department of Fish and Game (DFG) may restrict the use of bituminous coatings on the interior of pipes if they are to be placed in streams that flow continuously or for an extended period (more than 1 to 2 days) after a rainfall event. Their concern is that abraded particles of asphalt could enter the stream and degrade the fish habitat. Where abrasion is unlikely, DFG concerns should be minimal. DFG has indicated that they have no concerns regarding interior application of polymeric sheet coatings, even under abrasive conditions.

Where the materials report indicates that soil side corrosion is expected, a bituminous asphalt coating which is hot-dipped to cover the entire inside and outside of the pipe or an exterior application of polymeric sheet, as provided in the Standard Specifications, combined with galvanizing of steel, is usually effective in forestalling accelerated corrosion on the backfill side of the pipe. Where soil side corrosion is the only, or primary, factor leading to deterioration, the bituminous asphalt protection layer described above is typically expected to add up to 25 years of service life to an uncoated (i.e., plain galvanized) pipe. A polymeric sheet coating is typically expected to provide up to 50 years of service life to an uncoated pipe. For locations where water side corrosion and/or abrasion is of concern, protective coatings, or protective coatings with pavings, or protective coatings with linings, in combination with galvanizing will add to the culvert service life to a variable degree, depending upon site conditions and type of coating selected. Refer to Index 855.2 Abrasion, and Index 855.3 Corrosion. If hydraulic conditions at the culvert site require a lining on the inside of the pipe or a coating different than that indicated in the Standard Specifications, then the different requirements must be described in the Special Provisions.

- Extra Metal Thickness. – Added service life can be achieved by adding metal thickness. However, this should only be considered after protective coatings and pavings have been considered. Since 0.052 inch thick steel culverts is the minimum steel pipe Caltrans allows, it must be limited to locations that are nonabrasive.

See Table 855.2C for estimating the added service life that can be achieved by coatings and invert paving of steel pipes based upon abrasion resistance characteristics.

- (b) Aluminized Steel (Type 2). Evaluations of aluminized steel (type 2) pipe in place for over 40 years have provided data that substantiate a design service life with respect to corrosion resistance equivalent to aluminum pipe. Therefore, for pH values between 5.5 and 8.5, and minimum resistivity values in excess of 1500 ohm-cm, 0.064 inch aluminized steel (type 2) is considered to provide a 50 year design service life. Where abrasion is of concern, aluminized steel (type 2) is considered to be roughly equivalent to galvanized steel. Bituminous coatings are not recommended for corrosion protection, but may be used in accordance with Table 855.2C for abrasion resistance. A concrete invert may also be considered where abrasion is of concern.

For pH ranges outside the 5.5 and 8.5 limits or minimum resistivity values below 1500 ohm-cm, aluminized steel (type 2) should not be used. In no case should the thickness of aluminized steel (type 2) be less than the minimum structural requirements for a given diameter of galvanized steel. Refer to Index 855.2 Abrasion, and Index 855.3 Corrosion.

The AltPipe Computer Program is also available to help designers estimate service life for various corrosive/abrasive conditions. See <https://dot.ca.gov/programs/design/hydraulics-stormwater/bsa-alternative-pipe-culvert-selection-altpipe>.

- (3) *Strength Requirements*. The strength requirements for corrugated steel pipes and pipe arches, fabricated under acceptable methods contained in the Standard Specifications, are given in Tables 856.3A, B, C, & D. For steel spiral rib pipe see Tables 856.3E, F & G.

(a) Design Standards.

- Corrugation Profiles – Corrugated steel pipe and pipe arches are available in 2 $\frac{2}{3}$ " x $\frac{1}{2}$ ", 3" x 1", and 5" x 1" profiles with helical corrugations, and 2 $\frac{2}{3}$ " x $\frac{1}{2}$ " profiles with annular corrugations. Corrugated steel spiral rib pipe is available in a $\frac{3}{4}$ " x $\frac{3}{4}$ " x 7 $\frac{1}{2}$ " or $\frac{3}{4}$ " x 1" x 11 $\frac{1}{2}$ " helical corrugation pattern. For systems requiring large diameter and/or deeper fill capacity a $\frac{3}{4}$ " x 1" x 8 $\frac{1}{2}$ " helical corrugation pattern is available. Composite steel spiral rib pipe is available in a $\frac{3}{4}$ " x $\frac{3}{4}$ " x 7 $\frac{1}{2}$ " helical ribbed profile.

Metal Thickness - Corrugated steel pipe and pipe arches are available in the thickness as indicated on Tables 856.3A, B, C & D. Corrugated steel spiral rib pipe is available in the thickness as indicated on Tables 856.3E, F & G. Where a maximum overfill is not listed on these tables, the pipe or arch size is not normally available in that thickness. All pipe sections provided in Table 856.3 meet handling and installation flexibility requirements of AASHTO LRFD. Composite steel spiral rib pipe is available in the thickness as indicated on Table 856.3G.

- Height of Fill – The allowable overfill heights for corrugated steel and corrugated steel spiral rib pipe and pipe arches for the various diameters or arch sizes and metal thickness are shown on Tables 856.3A, B, C, & D. For corrugated steel spiral rib pipe, overfill heights are shown on Tables 856.3E, F & G. Table 856.3G gives the allowable overfill height for composite steel spiral rib pipe.

- (4) *Shapes*. Corrugated steel pipe, steel spiral rib pipe and pipe arches are available in the diameters and arch shapes as indicated on the maximum height of cover tables. For larger diameters, arch spans or special shapes, see Index 852.5.

- (5) *Invert Protection*. Refer to Index 855.2 Abrasion. Invert protection should be considered for corrugated steel culverts exposed to excessive wear from abrasive flows or corrosive water. Severe abrasion usually occurs when the flow velocity exceeds 12 feet per second to 15

feet per second and contains an abrasive bedload of sufficient volume. When severe abrasion or corrosion is anticipated, special designs should be investigated and considered. Typical invert protection includes invert paving with portland cement concrete with wire mesh reinforcement, and invert lining with metal plate. The paving limits for invert linings are site specific and should be determined by field review. Additional metal thickness will increase service life. Reducing the velocity within the culvert is an effective method of preventing severe abrasion. Index 853.6 provides additional guidance on invert paving with concrete.

- (6) *Spiral Rib Steel.* Galvanized steel spiral rib pipe is fabricated using sheet steel and continuous helical lock seam fabrication as used for helical corrugated metal pipe. The manufacturing complies with Section 66, "Corrugated Metal Pipe," of the Standard Specifications, except for profile and fabrication requirements. Spiral rib pipe is fabricated with either: three rectangular ribs spaced midway between seams with ribs 3/4" wide x 3/4" high at a maximum rib pitch of 7-1/2 inches, two rectangular ribs and one half-circle rib equally spaced between seams with ribs 3/4" wide x 1" high at a maximum rib pitch of 11-1/2 inches with the half-circle rib diameter spaced midway between the rectangular ribs, or two rectangular ribs equally spaced between seams with ribs 3/4" wide x 1" high at a maximum rib pitch of 8-1/2 inches.

Aluminized steel spiral rib pipe, type 2 (ASSRP) is available in the same sizes as galvanized steel spiral rib and will support the same fill heights (the aluminizing is simply a replacement coating for zinc galvanizing that allows thinner steel to be placed in certain corrosive environments. See Figure 855.3A for the acceptable pH and resistivity ranges for placement of aluminized steel pipes). Tables 856.3E, F & G give the maximum height of overfill for steel spiral rib pipe constructed under the acceptable methods contained in the Standard Specifications and essentials discussed in Index 829.2.

852.4 Corrugated Aluminum Pipe, Aluminum Spiral Rib Pipe and Pipe Arches

Corrugated aluminum pipe, aluminum spiral rib pipe and pipe arches are available in the diameters and arch shapes as indicated on the maximum height of cover tables. For larger diameters, arch spans or special shapes see Index 852.6. Corrugated aluminum pipe and pipe arches are available in various corrugation profiles with helical and annular corrugations. Helical corrugated pipe must be specified if anticipated heights of cover exceed the tabulated values for annular corrugated pipe. Non-standard pipe diameters and arch sizes are also available. Aluminum spiral rib pipe is similar to spiral rib steel and is available in several helical corrugation patterns.

- (1) *Hydraulics.* Corrugated aluminum pipe comes in various corrugated profiles. Annular and helical corrugated aluminum pipe configurations are applicable in the situations where velocity reduction is important or if a culvert is being designed with an inlet control condition. Spiral rib pipe, on the other hand, may be more appropriate for use in stormdrain situations or if a culvert is being designed with an outlet control condition. Spiral rib pipe has a lower roughness coefficient (Manning's "n") than other corrugated metal pipe profiles.
- (2) *Durability.* Aluminum culverts or stormdrains may be specified as an alternate culvert material. When a 50-year maintenance-free service life of aluminum pipe is required the pH and minimum resistivity, as determined by California Test Method 643, must be known and the following conditions met:
- (a) The pH of the soil, backfill, and effluent is within the range of 5.5 and 8.5, inclusive. Bituminous coatings are not recommended for corrosion protection or abrasion resistance. However, a concrete invert lining may be considered. Abrasive potential

must be estimated from bed material that is present and anticipated flow velocities. Refer to Index 855.1 for a discussion of maintenance-free service life and Index 855.2 Abrasion, and Index 855.3 Corrosion prior to selecting aluminum as an allowable alternate.

- (b) The minimum resistivity of the soil, backfill, and effluent is 1500 ohm-cm or greater.
- (c) Aluminum culverts should not be installed in an environment where other aluminum culverts have exhibited significant distress, such as extensive perforation or loss of invert, for whatever reason, apparent or not.
- (d) Aluminum may be considered for side drains in environments having the following parameters:
 - When pH is between 5.5 and 8.5 and the minimum resistivity is between 500 and 1500 ohm-cm.
 - When pH is between 5.0 and 5.5 or between 8.5 and 9.0 and the minimum resistivity is greater than 1500 ohm-cm.

For these conditions, the Corrosion Technology Branch in METS should be contacted to confirm the advisability of using aluminum on specific projects.

- (e) Aluminum must not be used as a section or extension of a culvert containing steel sections.

(3) *Strength Requirements.* The strength requirements for corrugated aluminum pipe and pipe arches fabricated under the acceptable methods contained in the Standard Specifications, are given in Tables 856.3H, I & J. See Table 856.3K and Table 856.3L for aluminum spiral rib pipe. Tables 856.3H through L are based on the material properties of H-32 temper aluminum. Additional cover heights can be achieved for an aluminum section when H-34 temper material is used. Contact DES-Structures Design for a special design using H-34 temper material.

(a) Design Standards.

- Corrugation Profiles - Corrugated aluminum pipe and pipe arches are available in 2 $\frac{2}{3}$ " x $\frac{1}{2}$ " and 5" x 1" profiles with helical or annular corrugations. Aluminum spiral rib pipe is available in a $\frac{3}{4}$ " x $\frac{3}{4}$ " x 7 $\frac{1}{2}$ " or a $\frac{3}{4}$ " x 1" x 11 $\frac{1}{2}$ " helical corrugation profile.
- Metal thickness - Corrugated aluminum pipe and pipe arches are available in the thickness as indicated on Tables 856.3H, I & J. Where a maximum overfill is not listed on these tables, the pipe or pipe arch is not normally available in that thickness. All pipe sections provided in Table 856.3 meet handling and installation flexibility requirements of AASHTO LRFD. Aluminum spiral rib pipe are available in the thickness as indicated on Tables 856.3K & L.
- Height of Fill - The allowable overfill heights for corrugated aluminum pipe and pipe arches for various diameters and metal thicknesses are shown on Tables 856.3H, I & J. For aluminum spiral rib pipe, overfill heights are shown on Tables 856.3K, & L.

(4) *Shapes.* Corrugated aluminum pipe, aluminum spiral rib pipe and pipe arches are available in the diameters and arch shapes as indicated on the maximum height of cover tables. Helical corrugated pipe must be specified if anticipated heights of cover exceed the tabulated values for annular corrugated pipe.

For larger diameters, arch spans or special shapes, see Index 852.5. Non-standard pipe diameters and arch sizes are also available.

(5) *Invert Protection.* Invert protection of corrugated aluminum is not recommended.

(6) *Spiral Rib Aluminum.* Aluminum spiral rib pipe is fabricated using sheet aluminum and continuous helical lock seam fabrication as used for helical corrugated metal pipe. The manufacturing complies with Section 66, "Corrugated Metal Pipe," of the Standard Specifications, except for profile and fabrication requirements. Aluminum spiral rib pipe is fabricated with either: three rectangular ribs spaced midway between seams with ribs 3/4" wide x 3/4" high at a maximum rib pitch of 7-1/2 inches or two rectangular ribs and one half-circle rib equally spaced between seams with ribs 3/4" wide x 1" high at a maximum rib pitch of 11-1/2 inches with the half-circle rib diameter spaced midway between the rectangular ribs. Figure 855.3A should be used to determine the limitations on the use of spiral rib aluminum pipe for the various levels of pH and minimum resistivity.

852.5 Structural Metal Plate

(1) *Pipe and Arches.* Structural plate pipes and arches are available in steel and aluminum for the diameters and thickness as shown on Tables 856.3M, N, O & P.

(2) *Strength Requirements.*

(a) Design Standards.

- Corrugation Profiles – Structural plate pipe and arches are available in a 6" x 2" corrugation for steel and a 9" x 2½" corrugation profile for aluminum.
- Metal Thickness – structural plate pipe and pipe arches are available in thickness as indicated on Tables 856.3M, N, O & P.
- Height of Fill – The allowable height of cover over structural plate pipe and pipe arches for the available diameters and thickness are shown on Tables 856.3M, N, O & P.

Where a maximum overfill is not listed on these tables, the pipe or arch size is not normally available in that thickness. All pipe sections provided in Table 856.3 conform to handling and installation flexibility requirements of AASHTO LRFD. Strutting of culverts, as depicted on Standard Plan D88A, is typically necessary if the pipe is used as a vertical shaft or if the backfill around the pipe is being removed in an unbalanced manner.

(b) Basic Premise. To properly use the above mentioned tables, the designer should be aware of the premises on which the tables are based as well as their limitations. The design tables presuppose:

- That bedding and backfill satisfy the terms of the Standard Specifications, the conditions of cover, and pipe or arch size required by the plans and the essentials of Index 829.2.
- That a small amount of settlement will occur under the culvert, equal in magnitude to that of the adjoining material outside the trench.

(c) Limitations. In using the tables, the following restrictions should be kept in mind.

- The values given for each size of structural plate pipe or arch constitute the maximum height of overfill or cover over the pipe or arch for the thickness of metal and kind of corrugation.
- The thickness shown is the structural minimum. For steel pipe or pipe arches, where abrasive conditions are anticipated, additional metal thickness for the invert plate(s) or a paved invert should be provided when required to fulfill the design service life requirements. Table 855.2C may be used. See Index 855.2 Abrasion and Tables 855.2A, 855.2D and 855.2F.

- Where needed, adequate provisions for corrosion resistance must be made to achieve the required design service life called for in the references mentioned herein.
- (d) Tables 856.3M & P show the limit of heights of cover for structural plate arches based on the supporting soil sustaining a bearing pressure of 3 tons per square foot at the corners. Special Designs. If the height of overfill exceeds the tabular values, or if the foundation investigation reveals that the supporting soil will not develop the bearing pressure on which the overfill heights for structural plate pipe or pipe arches are based, a special design prepared by DES - Structures Design is required.
- (3) *Arches*. Design details with maximum allowable overfills for structural plate arches, with cast in place concrete footings may be obtained from DES - Structures Design.
- (4) *Vehicular Underpasses*. Design details with maximum allowable overfills for structural plate vehicular underpasses with spans from 12 feet 2 inches to 20 feet 4 inches, inclusive, are given in the Standard Plans. These designs are based on “factored” bearing soil pressures from 2.5 tons per square foot to 11 tons per square foot.
- (5) *Special Shapes*.
- (a) Long Span.
- Arch
 - Low Profile Arch
 - High Profile Arch
- (b) Ellipse. (Text Later)
- Vertical
 - Horizontal
- (6) *Tunnel Liner Plate*. The primary applications for tunnel liner plate include lining large structures in need of a structural repair, or culvert installations through an existing embankment that can be constructed by conventional tunnel methods. Typically, tunnel liner plate is not used for direct burial applications where structural metal plate pipe is recommended. DES - Structures Design will prepare designs upon request. See Index 853.7 for structural repairs.

852.6 Plastic Pipe

Plastic pipe is a generic term which currently includes two independent materials; the Standard Specifications states plastic pipe shall be made of either high density polyethylene (HDPE) or polyvinyl chloride (PVC) material. See Index 852.6(2)(a) Strength Requirements for allowed materials and wall profile types. *Durability*. Caltrans standards regarding the durability of plastic pipe are based on the long term performance of its material properties. Both forms of plastic pipe culverts (HDPE and PVC) exhibit good abrasion resistance and are virtually corrosion free. See Index 855.2 Abrasion and Index 855.5 Material Susceptibility to Fire. Also, see Tables 855.2A, 855.2E and 855.2F. The primary environmental factor currently considered in limiting service life of plastic materials is ultraviolet (UV) radiation, typically from sunlight exposure. While virtually all plastic pipes contain some amount of UV protection, the level of protection is not equal. Polyvinyl chloride resins used for pipe rarely incorporate UV protection (typically Titanium Dioxide) in amounts adequate to offset long term exposure to direct sunlight. Therefore, frequent exposure (e.g., cross culverts with exposed ends) can lead to brittleness and such situations should be avoided. Conversely, testing performed to date on HDPE

products conforming to specification requirements for inclusion of carbon black have exhibited adequate UV resistance. PVC pipe exposed to freezing conditions can also experience brittleness and such situations should be avoided if there is potential for impact loadings, such as maintenance equipment or heavy (3" or larger) bedload during periods of freeze. Plastic pipes can also fail from long term stress that leads to crack growth and from chemical degradation. Improvements in plastic resin specifications and testing requirements has led to increased resistance to slow crack growth. Inclusion of anti-oxidants in the material formulation is the most common form of delaying the onset of chemical degradation, but more thorough testing and assessment protocols need to be developed to more accurately estimate long term performance characteristics and durability.

(1) *Strength Requirements.*

(a) Design Standards

- Materials - Plastic pipe shall be either Type C (corrugated exterior and interior) corrugated polyethylene pipe, Type S (corrugated exterior and smooth interior) corrugated polyethylene pipe, or corrugated polyvinyl chloride pipe.
- Height of Fill - The allowable overfill heights for plastic pipe for various diameters are shown in Tables 856.4 and 856.5.

852.7 Special Purpose Types

(1) *Smooth Steel.* Smooth steel (welded) pipe can be utilized for drainage facilities under conditions where corrugated metal or concrete pipe will not meet the structural or design service life requirements, or for certain jacked pipe operations (e.g., auger boring).

(2) *Composite Steel Spiral Rib Pipe.* Composite steel spiral rib pipe is a smooth interior pipe with efficient hydraulic characteristics. See Table 851.2.

Composite steel spiral rib pipe with its interior polyethylene liner exhibits good abrasion resistance and also resists waterside corrosion found in a typical stormdrain or culvert environment. The exterior of the pipe is protected with a polyethylene film, which offers resistance to corrosive backfills. The pipe will meet a 50-year maintenance-free service life under most conditions. See Table 856.3G for allowable height of cover.

(3) *Proprietary Pipe.* See Index 110.10 for further discussion and guidelines on the use of proprietary items.

Topic 853 – Pipe Liners and Linings for Culvert Rehabilitation

853.1 General

This topic discusses alternative pipe liner and pipe lining materials specifically intended for culvert repair and does not include materials used for Trenchless Excavation Construction (e.g., pipe jacking, pipe ramming, auger boring), joint repair, various types of grouting, or standard pipe materials that are presented elsewhere in Chapter 850 and in the Standard Plans and Standard Specifications.

Many new products and techniques have been developed that often make complete replacement with open cut as shown in the Standard Plans unnecessary. When used

appropriately, these new products and techniques can benefit the Department in terms of increased mobility, cost, and safety to both the public and contractors. Design Information Bulletin 83 (DIB 83) outlines a collection of procedures that are cost-effective for their location and that will meet the needs of their particular area, supplementing Topic 853. Use the following link: <https://dot.ca.gov/-/media/dot-media/programs/design/documents/dib83-04-a11y.pdf> for further information.

853.2 Caltrans Host Pipe Structural Philosophy

In general, if the host (i.e., existing) pipe cannot be made capable of sustaining design loads, it should be replaced rather than rehabilitated. This is a conservative approach and when followed eliminates the need to make a detailed evaluation of the liner's ability to effectively accept and support dead and live loads. Prior to making the decision whether or not to rehabilitate the culvert and/or which method to choose, a determination of the structural integrity of the host pipe must be made. If rehabilitation of the culvert is determined to be a feasible option, existing voids within the culvert backfill or in the base material under the existing culvert identified either by Maintenance (typically as part of their culvert management system) or already noted in the Geotechnical Design Report, should be filled with grout to re-establish its load carrying capability. Therefore, structural considerations for pipe liners are generally limited to their ability to withstand construction handling and/or grouting pressures. When a structural repair is needed, contact Underground Structures within DES – Structures Design. See Index 853.7.

853.3 Problem Identification and Coordination

Before various alternatives for liners or linings can be selected, the first step following a site investigation which may include taking soil and water samples and pipe wall thickness measurements, is to determine the actual cause of the problem. Relative to Caltrans host pipe structural philosophy, the host pipe may be in need of stabilization, rehabilitation or replacement. Further, it will need to be determined if the structure is at the end of its maintenance-free service life, whether it has been damaged by mechanical abrasion, or corrosion (or both) and if there are any changes to the hydrology or habitat (e.g. fish passage). To make these determinations, the Project Engineer should coordinate with the District Maintenance Culvert Inspection team, Hydraulics and Environmental units. Further assistance may be needed from Geotechnical Design, the Corrosion Technology Branch within DES, Underground Structures and/or Structures Maintenance within DES. Prior to a comprehensive inspection either by trained personnel or camera, it may also be necessary to first clean out the culvert. Problem identification and assessment, and coordination with Headquarters and DES, is discussed in greater detail in DIB 83. Use the following link; <https://dot.ca.gov/-/media/dot-media/programs/design/documents/dib83-04-a11y.pdf>.

853.4 Alternative Pipe Liner Materials

Similar to the basic policy in Topic 857.1 for alternative pipes, when two or more liner materials meet the design service life and minimum thickness requirements for various materials that are outlined under Topic 855, as well as hydraulic requirements, the plans and specifications should provide for alternative pipe liners to allow for optional selection by the contractor. A table of

allowable alternative pipe liner materials for culverts and drainage systems is included as Table 853.1A. This table also identifies the various diameter range limitations and whether annular space grouting is needed. Sliplining consists of sliding a new culvert inside an existing distressed culvert as an alternative to total replacement. See DIB No 83; <https://dot.ca.gov/-/media/dot-media/programs/design/documents/dib83-04-a11y.pdf>.

The plastic pipeliners listed in the notes under Table 853.1A are installed as slipliners, however, other standard pipe types that are described in Topic 852 (e.g., metal), may be equally viable as material options to be added as sliplining alternatives.

Table 853.1A

Allowable Alternative Pipe Liner Materials

Allowable Alternatives	Diameter Range ⁽¹⁾	Annular Space Grouting
PP ⁽²⁾	15" – 120"	Yes
CIPP	8" – 96"	No
MSWPVCPLFD	6" – 30"	No
SWPVCPLFD	21" – 108"	Yes

Abbreviations:

- PP – Plastic Pipe (sliplining)
- CIPP – Cured in Place Pipe
- SWPVCPLFD – Spiral Wound PVC Pipe Liner (Fixed Diameter)
- MSWPVCPLFD – Machine Spiral Wound PVC Pipe Liner (Expandable Diameter)

Note:

⁽¹⁾Headquarters approval needed for pipe liner diameters 60 inches or larger. Diameter range represents liners only, not Caltrans standard pipe.

⁽²⁾The designer must edit the following plastic pipeliner list within SSP 15-6.10 to suit the work:

- Type S corrugated high density polyethylene (HDPE) pipe conforming to the provisions in Section 64, "Plastic Pipe," of the Standard Specifications; or
- Standard Dimension Ratio (SDR) 35 polyvinyl chloride (PVC) pipe conforming to the requirements in AASHTO Designation: M 278 and ASTM Designation: F 679; or
- Polyvinyl chloride (PVC) closed profile wall pipe conforming to the requirements in ASTM Designation: F 1803, F 794 (Series 46); or
- Polyvinyl chloride (PVC) dual wall corrugated pipe conforming to the requirements in ASTM Designation: F 794 (Series 46), and ASTM Designation F 949; or
- High density polyethylene (HDPE) solid wall pipe conforming to the requirements in AASHTO M 326 and ASTM Designation: F 714; or
- Large diameter high density polyethylene (HDPE) closed profile wall pipe conforming to the requirements in ASTM Designation: F 894.

Table 853.1B provides a guide for plastic pipeliner selection in abrasive conditions to achieve a 50-year maintenance-free service life.

For further information on sliplining using plastic pipe liners including available dimensions and stiffness, see DIB 83. Use the following link: <https://dot.ca.gov/-/media/dot-media/programs/design/documents/dib83-04-a11y.pdf>.

853.5 Cementitious Pipe Lining

This method may be used to line corroded corrugated steel pipes ranging from 12 inches to a maximum of 36 inches diameter and involves lining an existing culvert with concrete, shotcrete or mortar using a lining machine. If the bedload is abrasive, alternative cementitious materials such as calcium aluminate mortar or geopolymer mortar may be selected from the Authorized Materials list for cementitious pipeliners. See Table 855.2F and Section 15-6.14 of the Standard Specifications for specifications. Regardless of type of cementitious material used, the resulting lining is a minimum of one inch thick when measured over the top of corrugation crests and has a smooth surface texture. As with other liners, the pipes must first be thoroughly cleaned and dried. For diameters between 12 and 24 inches, the cement mortar is applied by robot. The mortar is pumped to a head, which rotates at high speed using centrifugal force to place the mortar on the walls. A conical-shaped trowel attached to the end of the machine is used to smooth the walls. The maximum recommended length of small-diameter pipe that can be lined using this method is approximately 650 feet. Although this method will line larger diameter pipes, it is mostly appropriate for non-human entry pipes (less than 30 inches). Generally, most problems with steel pipe are limited to the lower 180 degrees, therefore, in larger diameter metal pipes where human entry is possible, invert paving may be all that is required. See Index 853.6.

853.6 Invert Paving with Concrete

(1) *Existing Corrugated Metal Pipe (CMP)*. One of the most effective ways to rehabilitate corroded and severely deteriorated inverts of CMP that are large enough for human entry (with equipment) is by paving them with reinforced concrete shotcrete or authorized cementitious material. Standard Specification Section 15-6.04 includes specifications for preparing the surface of the culvert invert, installing bar reinforcement and anchorage devices, and paving the invert with concrete, shotcrete or authorized cementitious material. For most non-abrasive sites, concrete may comply with the requirements for minor concrete or shotcrete. See index 110.12 Tunnel Safety Orders. Generally, this method is feasible for pipes 48 inches in diameter and larger. If abrasion is present, see Table 855.2F for minimum

Table 853.1B

Guide for Plastic Pipeliner Selection in Abrasive Conditions⁽²⁾ to Achieve 50 Years of Maintenance-Free Service Life

MATERIAL		Abrasion Level ⁽¹⁾		
		4	5	6
Type S corrugated polyethylene pipe		-	-	-
Standard Dimension Ratio (SDR) 35 PVC ⁽³⁾	(46 psi)	4" – 48"	12" – 48"	36" – 48"
	(75 psi)	18" – 48"	18" – 48"	30" – 48"
	(115 psi)	18" – 48"	18" – 48"	27" – 48"
Standard Dimension Ratio (SDR) PVC ⁽⁴⁾ (AWWA C900 & C905)	SDR 41	30" – 36"	30" – 36"	-
	SDR 32.5	30" – 36"	30" – 36"	30" – 36"
	SDR 25	4" – 36"	8" – 36"	24" – 36"
	SDR 21	14" – 24"	14" – 24"	20" – 24"
	SDR 18	4" – 24"	6" – 24"	18" – 24"
	SDR 14	4" – 12"	4" – 12"	-
PVC closed profile wall (ASTM F 1803)		18" – 60"	42" – 60"	-
Corrugated PVC (ASTM F 794 & F 949)	(46 psi)	18" – 36"	-	-
	(115 psi)	15"	-	-
Standard Dimension Ratio (SDR) HDPE ⁽³⁾ (AASHTO M 326 and ASTM Designation F 714)	SDR 41	10" – 63"	36" – 63"	-
	SDR 32.5	8" – 63"	30" – 63"	-
	SDR 26	6" – 63"	24" – 63"	-
	SDR 21	5" – 63"	20" – 63"	54" – 63"
	SDR 17	5" – 55"	16" – 55"	42" – 55"
	SDR 15.5	5" – 48"	14" – 48"	42" – 48"
	SDR 13.5	5" – 42"	12" – 42"	34" – 42"
	SDR 11	5" – 36"	10" – 36"	28" – 36"
	SDR 9	5" – 24"	8" – 24"	22"
Polyethylene (PE) large diameter profile wall sewer and drain pipe (ASTM F 894)	RSC ⁽⁵⁾ 160	18" – 120"	120"	-
	RSC ⁽⁵⁾ 250	33" – 108"	96" – 108"	-

NOTES:

⁽¹⁾ See Tables 855.2A and 855.2F for Abrasion Level Descriptions and minimum thickness.

⁽²⁾ No restrictions for Abrasion Levels 1 through 3.

⁽³⁾ Measured pipe designated SDR is measured to outside diameter.

⁽⁴⁾ Measured to inside diameter.

⁽⁵⁾ RSC = Ring Stiffness Class

material thickness of concrete or authorized material. Concrete should have a minimum compressive strength of 6,000 psi at 28 days and the aggregate source should be harder material than the streambed load and have a high durability index (consult with District Materials Branch for sampling and recommendation). The maximum grading specified (1.5 inch) for coarse aggregate may need to be modified if the concrete must be pumped. The abrasion resistance of cementitious materials is affected by both its compressive strength and hardness of the aggregate. There is a correlation between decreasing the water/cement ratio, increasing compressive strength and increasing abrasion resistance. Therefore, where abrasion is a significant factor, the lowest practicable water/cement ratios and the hardest available aggregates should be used.

Paving thickness will range from 2 inches to 13 inches depending on abrasiveness of site based on Table 855.2A, and paving limits typically vary from 90 to 120 degrees for the internal angle. See Index 855.2 and Table 855.2F. Note that in Table 855.2F cementitious concrete is not recommended for extremely abrasive conditions (Level 6 in Table 855.2A). For extremely abrasive conditions alternative materials are recommended such as abrasion resistant concrete (calcium aluminate), steel plate or adding RSP. Calcium aluminate abrasion resistant concrete or mortar may be selected from the Authorized Materials list for concrete invert paving. If hydraulically feasible, a flattened invert design may be warranted.

Consult the District Hydraulic Branch for a recommendation.

Where there is significant loss of the pipe invert, it may be necessary to tie the concrete to more structurally sound portions of the pipe wall in order to transfer compressive thrust of culvert walls into the invert slab to create a "mechanical" connection using welding studs, angle iron or by other means. When a mechanical connection is used, paving limits may vary up to 180 degrees for the internal angle. These types of repairs should be treated as a special design and consultation with the Headquarters Office of Highway Drainage Design within the Division of Design and the Underground Structures unit of Structures Design within the Division of Engineering Services (DES) is advised. Depending on the size of the culvert being paved, pipes with significant invert loss often also have a significant loss of structural backfill with voids present. Where large voids are present, consultation with Geotechnical Services within the Division of Engineering Services (DES) is advised to develop a grouting plan.

See DIB 83 for some invert paving case studies using the following link:
<http://www.dot.ca.gov/hq/oppd/dib/dib83-01-12.htm#h>

- (2) *Existing RCB and RCP.* For existing reinforced concrete boxes (RCB) and reinforced concrete pipes (RCP) with worn inverts and exposed reinforcing steel (generally from abrasive bedloads), the same paving thickness considerations outlined under Index 853.6(1) will apply. However, depending on the structural condition, the existing steel reinforcement may need to be augmented. Consultation with Structures Maintenance and Underground Structures within DES is recommended.
- (3) *Existing Plastic Pipe.* Generally, concrete invert paving is not feasible for plastic pipes because the cement will not adhere to plastic. However, it may be possible to create a "mechanical" connection by other means but these types of repairs should be treated as a special design and consultation with the Headquarters Office of Highway Drainage Design within the Division of Design and the Underground Structures unit of Structures Design within the Division of Engineering Services (DES) is advised.

853.7 Structural Repairs with Steel Tunnel Liner Plate

Cracks in RCP greater than 0.1 inch in width and flexible metal pipes with deflections beyond 10 – 12 percent may indicate a serious condition. When replacement is not an option for existing human entry pipes in need of structural repair, an inspection by Structures Maintenance and a structural analysis by Underground Structures within DES are recommended. Further assistance may be needed from Geotechnical Design and/or the Corrosion Unit within DES.

Two flange or four flange steel tunnel liner plate can be specially designed by Underground Structures within DES as a structural repair to accommodate all live and dead loads. The flange plate lap joints facilitate internal bolt connections (structural metal plate requires access to both sides). After the rings have been installed, the annular space between the liner plates and the host pipe is grouted.

Topic 854 – Pipe Connections

854.1 Basic Policy

The Standard Specifications set forth general performance requirements for transverse field joints in all types of culvert and drainage pipe used for highway construction.

Table 857.2 indicates the alternative types of joints that are to be specified for different arch and circular pipe installations with regard to joint strength. The two joint strength types specified for culvert and drainage systems are identified as “standard” and “positive.”

(1) *Joint Strength.* Joint strength is to be designated on the culvert list.

- (a) **Standard Joints.** The “standard” joint is usually for pipes or arches not subject to large soil movement or disjuncting forces. These “standard” joints are satisfactory for ordinarily installations, where tongue and groove or simple slip type joints are typically used. The “standard” joint type is generally adequate for underdrains. **Positive Joints.** “Positive” joints are for more adverse conditions such as the need to withstand soil movements or resist disjuncting forces. Examples of these conditions are steep slopes, sharp curves, and poor foundation conditions. See Index 829.2 for additional discussion. “Positive” joints should always be designated on the culvert list for siphon installations.
- (b) **Downdrain Joints.** Pipe “downdrain” joints are designed to withstand high velocity flows, and to prevent leaking and disjuncting that could cause failure.
- (c) **Joint Strength Properties.** A description of the specified joint strength properties tabulated in Section 61 “Culvert and Drainage Pipe Joints” of the Standard Specifications is as follows:
 - **Shear Strength.** The shear strength required of the joint is expressed as a percentage of the calculated shear strength of the pipe at a transverse section remote from the joint. All joints, including any connections must be capable of transferring the required shear across the joint.
 - **Moment Strength.** The moment strength required of the joint is expressed as a percent of the calculated moment capacity of the pipe on a transverse section remote from the joint.
 - **Tensile Strength.** The tensile strength is that which resist the longitudinal force which tends to separate (disjoint) adjacent pipe sections.

- Joint Overlap.

Integral Preformed Joint. The Joint overlap is the amount of protection of one culvert barrel into the adjacent culvert barrel by the amount specified for the size of pipe designated. The amount of required overlap will vary based on several factors (material type, diameter, etc.) and is designated on the Standard Plans and/or Standard Specifications.

Any part of an installed joint that has less than ¼ inch overlap will be considered disjointed. Whenever the plans require that the culvert be constructed on a curve, specially manufactured sections of culvert will be required if the design joint cannot meet the minimum ¼ inch overlap requirement after the culvert section is placed on the specified curve.

- Sleeve Joints. The joint overlap is the minimum sleeve width (typically defined by the width of a coupling band) required to engage both the culvert barrels which are abutted to each other.

(2) *Joint Leakage.* The ability of a pipe joint to prevent the passage of either soil particles or water defines its soiltightness or watertightness. These terms are relative and do not mean that a joint will be able to completely stop the movement of soil or water under all conditions. Any pipe joint that allows significant soil migration (piping) will ultimately cause damage to the embankment, the roadway, or the pipe itself. Therefore, site conditions, such as soil particle size, presence of groundwater, potential for pressure flow, etc., must be evaluated to determine the appropriate joint requirement. Other than solvent or fusion welded joints, almost all joints can exhibit some amount of leakage. Joint performance is typically defined by maximum allowable opening size in the joint itself or by the ability to pass a standardized pressure test. The following criteria should be used, with the allowable joint type(s) indicated on the project plans:

- Normal Joint. Many pipe joint systems are not defined as either soiltight or watertight. However, for the majority of applications, such as culverts or storm drains placed in well graded backfill and surrounding soils containing a minimum of fines; no potential for groundwater contact; limited internal pressure, hydraulic grade line below the pavement grade, etc., this type of joint is acceptable. All currently accepted joint types will meet or exceed “Normal Joint” requirements. The following non-gasketed joint types should not be used beyond the “Normal Joint” criteria range:

CMP -Annular
 -Hat
 -Helical
 -Hugger
 -2-piece Integral Flange
 -Universal

PLASTIC -Split Coupler
 -Bell/Spigot

- Soiltight Joint. This category includes those joints which would provide an enhanced level of security against leakage and soil migration over the normal joint. One definition of a soiltight joint is contained in Section 26.4.2.4(e) of the AASHTO Standard Specifications for Highway Bridges. In part, this specification requires that if the size of the opening through which soil might migrate exceeds 1/8 inch, the length of the channel (length of path along which the soil particle must travel, i.e., the coupling length) must exceed 4 times the size of the opening. Alternatively, AASHTO allows the joint to pass

a hydrostatic test (subjected to approx. 4.6 feet of head) without leaking to be considered soiltight. Typical pipe joints that can meet this criteria are:

RCP and NRCP

- Flared Bell
- Flushed Bell
- Steel Joint-Flush Bell
- Single or Double Offset Design (Flared or Flushed Bell)
- Double Gasket
- Tongue and Groove*
- Self-Centering T & G*

CMP and SSRP

- Annular w/gasket
- Hat w/gasket
- Helical w/gasket
- Hugger w/gasket
- 2-piece Int. Fl. w/gasket
- Universal w/gasket

CSSRP -Cuffed end w/gasket

PLASTIC -Split Coupler w/gasket
(premium)-Bell/Spigot w/gasket

* Where substantial differential settlement is anticipated, would only meet Normal Joint criteria.

Where soil migration is of concern, but leakage rate is not, a soiltight joint can be achieved in most situations by external wrapping of the joint area with filter fabric (see Index 831.4). Joints listed under both the normal joint and soiltight joint categories, with a filter fabric wrap, would be suitable in these conditions and would not require a gasket or sealant. In many cases, fabric wrapping can be less expensive than a rubber gasket or other joint sealant. Coordination with the District Materials Unit is advised to ensure that the class of filter fabric will withstand construction handling and screen fine soil particles from migrating through the joint.

- **Watertight Joint.** Watertight joints are specified when the potential for soil erosion or infiltration/exfiltration must be restricted, such as for downdrains, culverts in groundwater zones, etc. Watertight joint requirements are typically met by the use of rubber gasket materials as indicated in the Standard Specifications. The watertight certification test described in Standard Specification Section 61 requires that no leakage occur when a joint is tested for a period of 10 minutes while subjected to a head of 10 feet over the crown of the pipe. This is a test that is typically performed in a laboratory under optimal conditions not typical of those found in the field. Where an assurance of water tightness is needed, a field test should be specified. Designers should be aware that field tests can be relatively expensive, and should only be required if such assurance is critical. A field leakage rate in the range of 700 gallons to 1,000 gallons per inch of nominal diameter per mile of pipe length per day, with a hydrostatic head of 6 feet above the crown of the pipe, is not unusual for joints that pass the watertight certification test, and is sufficiently watertight for well graded, quality backfill conditions. Where conditions are more sensitive, a lower rate should be specified. Rates below 50 to 100 gallons per inch per mile per day are difficult to achieve and would rarely be necessary. For example, sanitary sewers are rarely required to have leakage rates below 200 gallons per inch per mile per day, even though they have stringent health and environmental restrictions. Field hydrostatic tests are typically conducted over a period of 24 hours or more to

establish a valid leakage rate. Designers should also be aware that non-circular pipe shapes (CMP pipe arches, RCP oval shapes, etc.) should not be considered watertight even with the use of rubber gaskets or other sealants due to the lack of uniform compression around the periphery of the joint. Additionally, watertight joints specified for pressure pipe or siphon applications must meet the requirements indicated in Standard Specification Sections 65 and 66. Pipe joints that meet Standard Specification Section 61 water-tightness performance criteria are:

<u>RCP and NRCP</u>	-Flared Bell -Flushed Bell -Steel Joint-Flush Bell -Single or Double Offset Design (Flared or Flushed Bell) -Double Gasket
<u>CMP and SSRP</u>	-Hugger Bands (H-10, 12) w/gasket and double bolt bar -Annular Band w/gasket -Two Piece Integral Flange w/sleeve-type gasket*
<u>PLASTIC</u>	-Bell/Spigot w/gasket

* Acceptable as a watertight pipe only in downdrain applications and in 6, 8 and 10 inch diameters. Factory applied sleeve-type gaskets are to be used instead of O-ring or other sealants.

Table 854.1 provides information to help the designer select the proper joint under most conditions.

Topic 855 – Design Service Life

855.1 Basic Concepts

The prediction of design service life of drainage facilities is difficult because of the large number of variables, continuing changes in materials, wide range of environments, and use of various protective coatings. The design service life of a drainage facility is defined as the expected maintenance-free service period of each installation. After this period, it is anticipated major work will be needed for the facility to perform as originally designed for further periods.

For all metal pipes and arches that are listed in Table 857.2, maintenance-free service period, with respect to corrosion, abrasion and/or durability, is the number of years from installation until the deterioration reaches the point of perforation at any location on the culvert (See Figures 855.3A, 855.3B, and Tables 855.2D and 855.2F). AltPipe can be used to estimate service life of all circular metal pipe. See Index 857.2 Alternative Pipe Culvert Selection Procedure Using AltPipe.

Table 854.1

Joint Leakage Selection Criteria

<u>JOINT TYPE</u> ⇒ ⇓ <u>SITE CONDITIONS</u>	“NORMAL” JOINT	“SOIL TIGHT” JOINT	“WATER TIGHT” JOINT
<u>SOIL FACTORS</u>			
Limited potential for soil migration (e.g., gravel, medium to coarse sands, cohesive soil)	X	X	X
Moderate potential for soil migration (e.g., fine sands, silts)	X ⁽¹⁾	X	X
High potential for soil migration (e.g., very fine sands, silts of limited cohesion)		X ⁽¹⁾	X ⁽¹⁾
<u>INFILTRATION / EXFILTRATION</u>			
No concern over either infiltration or exfiltration.	X	X	X
Infiltration or exfiltration not permitted (e.g., potential to contaminate groundwater, contaminated plume could infiltrate)			X ⁽²⁾
<u>HYDROSTATIC POTENTIAL</u>			
Installation will rarely flow full. No contact with groundwater.	X	X	X
Installation will occasionally flow full. Internal head no more than 10 feet over crown. No potential groundwater contact.		X	X X
Installation may or may not flow full. Internal head no more than 10 feet over crown. May contact groundwater.			X ⁽²⁾
Possible hydrostatic head (internal or external) greater than 10 feet, but less than 25 ft ⁽³⁾ .			

Notes:

“X” indicates that joint type is acceptable in this application. The designer should specify the most cost-effective option.

⁽¹⁾ Designer should specify filter fabric wrap at joint. See Index 831.4.

⁽²⁾ Designer should consider specifying field watertightness test.

⁽³⁾ Pipe subjected to hydrostatic heads greater than 25 ft should have joints designed

For reinforced concrete pipe (RCP), box (RCB) and arch (RCA) culverts, maintenance-free service period, with respect to corrosion, abrasion and/or durability, is the number of years from installation until the deterioration reaches the point of exposed reinforcement at any point on the culvert. AltPipe can be used to estimate service life of reinforced concrete pipe (RCP), but not RCB, RCA or NRCP. See Index 857.2 Alternative Pipe Culvert Selection Procedure Using AltPipe.

For non-reinforced concrete pipe culverts (NRCP), maintenance-free service period, with respect to corrosion, abrasion and/or durability, is the number of years from installation until the deterioration reaches the point of perforation or major cracking with soil loss at any point on the culvert.

For plastic pipe, maintenance-free service period, with respect to corrosion, abrasion, and long term structural performance, is the number of years from installation until the deterioration reaches the point of perforation at any location on the culvert or until the pipe material has lost structural load carrying capacity typically represented by wall buckling or excessive deflection/deformation. AltPipe can be used to estimate service life of all plastic pipe. See Index 857.2 Alternative Pipe Culvert Selection Procedure Using AltPipe. All types of culverts are subject to deterioration from corrosion, or abrasion, or material degradation.

Corrosion may result from active elements in the soil, water and/or atmosphere. Abrasion is a result of mechanical wear and depends upon the frequency, duration and velocity of flow, and the amount and character of bedload. Material degradation may result from material quality, UV exposure, or long term material structural performance.

To assure that the maintenance-free service period is achieved, alternative metal pipe may require added thickness and/or protective coatings. Concrete pipe may require extra thickness of concrete cover over the steel reinforcement, high density concrete, using supplementary cementitious materials, epoxy coated reinforcing steel, and/or protective coatings. Means for estimating the maintenance-free service life of pipe, and techniques for extending the useful life of pipe materials are discussed in more detail in Topic 852.

The design service life for drainage facilities for all projects should be as follows:

(1) Culverts, Drainage Systems, and Side Drains.

- (a) Roadbed widths greater than 28 feet - 50 years.
- (b) Greater than 10 feet of cover - 50 years.
- (c) Roadbed widths 28 feet or less and with less than 10 feet of cover - 25 years.
- (d) Installations under interim alignment - 25 years.

(2) Overside Drains.

- (a) Buried more than 3 feet- 50 years.
- (b) All other conditions, such as on the surface of fill slopes - 25 years.

(3) Subsurface Drains.

- (a) Underdrains within roadbed - 50 years.
- (b) Underdrains outside of roadbed - 25 years.
- (c) Stabilization trench drains - 50 years.

In case of conflict in the design service life requirements between the above controls, the highest design service life is required except for those cases of interim alignment with more than 10 feet of cover. For temporary construction, a lesser design service life than that shown above is acceptable.

Where the above indicates a minimum design service life of 25 years, 50 years may be used. For example an anticipated change in traffic conditions or when the highway is considered to be on permanent alignment may warrant the higher design service life.

855.2 Abrasion

All types of pipe material are subject to abrasion and can experience structural failure around the pipe invert if not adequately protected. Abrasion is the wearing away of pipe material by water carrying sands, gravels and rocks (bed load) and is dependent upon size, shape, hardness and volume of bed load in conjunction with volume, velocity, duration and frequency of stream flow in the culvert. For example, at independent sites with a similar velocity range, bedloads consisting of small and round particles will have a lower abrasion potential than those with large and angular particles such as shattered or crushed rocks. Given different sites with similar flow velocities and particle size, studies have shown the angularity and/or volume of the material may have a significant impact to the abrasion potential of the site. Likewise, two sites with similar site characteristics, but different hydrologic characteristics, i.e., volume, duration and frequency of stream flow in the culvert, will probably also have different abrasion levels.

In Table 855.2A six abrasion levels have been defined to assist the designer in quantifying the abrasion potential of a site. The designer is encouraged to use the guidelines provided in Table 855.2A in conjunction with Table 855.2B “Bed Materials Moved by Various Flow Depths and Velocities” and the abrasion history of a site (if available) to achieve the required service life for a pipe, coating or invert lining material. Sampling of the streambed materials generally is not necessary, but visual examination and documentation of the size, shape and volume of abrasive materials in the streambed and estimating the average stream slope will provide the designer data needed to determine the expected level of abrasion. Where an existing culvert is in place, the condition of the invert and estimated combined wear rate due to abrasion and corrosion based on remaining pipe thickness measurements or if it is known approximately when first perforation occurred (steel pipe only), should always be used first. Figure 855.3B should be used to estimate the expected loss due to corrosion for steel pipe.

The descriptions of abrasion levels in Table 855.2A are intended to serve as general guidance only, and not all of the criteria listed for a particular abrasion level need to be present to justify defining a site at that level. For example, the use of one of the three lower abrasion levels in lieu of one of the upper three abrasion levels is encouraged where there are minor bedload volumes, regardless of the gradation. See Figure 855.1.

Table 855.2C constitutes a guide for estimating the added service life that can be achieved by coatings and invert paving of steel pipes based upon abrasion resistance characteristics. However, the table does not quantify added service life of coatings and paving of steel pipe based upon corrosion protection. In heavily abrasive situations, concrete inverts or other lining alternatives outlined in Table 855.2A should be considered. The guide values for years of added service life should be modified where field observations of existing installations show that

other values are more accurate. The designer should be aware of the following limitations when using Table 855.2C:

- Channel Materials: If there is no existing culvert, it may be assumed that the channel is potentially abrasive to culvert if sand and/or rocks are present. Presence of silt, clay or heavy vegetation may indicate a non-abrasive flow.
- Flow velocities: The velocities indicated in the table should be compared to those generated by the 2-5 year return frequency flood.
- The abrasion levels represent all six abrasion levels presented in Table 855.2A however, levels 2 and 3 have been combined.

Figure 855.1

Minor Bedload Volume



Large, round bedload (top) and RCP with minimal wear and minor bedload volume with moderate to high velocity.

Table 855.2D constitutes a guide for anticipated wear (in mils/year) to metal pipe by abrasive channel materials. No additional abrasion wear is anticipated for steel for the lower three abrasion levels defined in Table 855.2A, because it is assumed that there is some degree of abrasion incorporated within California Test 643 and Figure 855.3B. Figure 855.3B, "Chart for

Estimating Years to Perforation of Steel Culverts,” is part of a Standard California Department of Transportation Test Method derived from highway culvert investigations. This chart alone is not used for determining service life because it does not consider the effects of abrasion or overfill; it is for estimating the years to the first corrosion perforation of the wall or invert of the CSP. Additional gauge thickness or invert protection may be needed if the thickness for structural requirements (i.e., for overfill) is inadequate for abrasion potential.

Table 855.2E indicates relative abrasion resistance properties of pipe and lining materials and summarizes the findings from “Evaluations of Abrasion Resistance of Pipe and Pipe Lining Materials Final Report FHWA /CA/TL-CA01-0173 (2007)”. This report may be viewed at the following web address: <https://rosap.ntl.bts.gov/view/dot/27517>. See Figure 855.2.

Figure 855.2

Abrasion Test Panels



Various culvert material test panels shown in Figure 855.2 after 1 year of wear at site with moderate to severe abrasion (velocities generally exceed 13 ft/s with heavy bedload).

Table 855.2F is based on Tables 855.2D and 855.2E and constitutes a guide for selecting the minimum material thickness of abrasive resistant invert protection for various materials to achieve 50 years of maintenance-free service life.

Structural metal plate pipe and arches provide a viable option for large diameter pipes (60 inches or larger) in abrasive environments because increased thickness can be specified for the lower 90 degrees or invert plates. If the thickness for structural requirements is inadequate for abrasion potential, it is recommended to apply the increased thickness to the lower 90 degrees of the pipe only. Arches, which have a relatively larger invert area than circular pipe, generally will provide a lower abrasion potential from bedload being less concentrated.

July 1, 2020

Table 855.2A

Abrasion Levels and Materials

Abrasion Level	General Site Characteristics	Allowable Pipe Materials and Lining Alternatives
Level 1	<ul style="list-style-type: none"> Bedloads of silts and clays or clear water with virtually no abrasive bed load. No velocity limitation. 	<p>All pipe materials listed in Table 857.2 allowable for this level.</p> <p>No abrasive resistant protective coatings listed in Table 855.2C needed for metal pipe.</p>
Level 2	<ul style="list-style-type: none"> Moderate bed loads of sand or gravel Velocities ≥ 1 ft/s and ≤ 5 ft/s (See Note 1) 	<p>All allowable pipe materials listed in Table 857.2 with the following considerations:</p> <ul style="list-style-type: none"> Generally, no abrasive resistant protective coatings needed for steel pipe. Polymeric, or bituminous coating or an additional gauge thickness of metal pipe may be specified if existing pipes in the same vicinity have demonstrated susceptibility to abrasion and thickness for structural requirements is inadequate for abrasion potential.
Level 3	<ul style="list-style-type: none"> Moderate bed load volumes of sands, gravels and small cobbles. Velocities > 5 ft/s and ≤ 8 ft/s (See Note 1) 	<p>All allowable pipe materials listed in Table 857.2 with the following considerations:</p> <ul style="list-style-type: none"> Steel pipe may need one of the abrasive resistant protective coatings listed in Table 855.2C or additional gauge thickness if existing pipes in the same vicinity have demonstrated susceptibility to abrasion and thickness for structural requirements is inadequate for abrasion potential. Aluminum pipe may require additional gauge thickness for abrasion if thickness for structural requirements is inadequate for abrasion potential. Aluminized steel (type 2) not recommended without invert protection or increased gauge thickness (equivalent to galv. Steel) where pH < 6.5 and resistivity $< 20,000$. <p>Lining alternatives:</p> <ul style="list-style-type: none"> PVC, Corrugated or Solid Wall HDPE, CIPP

Note:

(1) If bed load volumes are minimal, a 50% increase in velocity is permitted.

Table 855.2A

Abrasion Levels and Materials (Cont.)

Abrasion Level	General Site Characteristics	Allowable Pipe Materials and Lining Alternatives
Level 4	<ul style="list-style-type: none"> • Moderate bed load volumes of angular sands, gravels, and/or small cobbles/rocks. (See Note 1) • Velocities > 8 ft/s and ≤ 12 ft/s 	<p>All allowable pipe materials listed in Table 857.2 with the following considerations:</p> <ul style="list-style-type: none"> • Steel pipe will typically need one of the abrasive resistant protective coatings listed in Table 855.2C or may need additional gauge thickness if thickness for structural requirements is inadequate for abrasion potential. • Aluminum pipe not recommended. • Aluminized steel (type 2) not recommended without invert protection or increased gauge thickness (wear rate equivalent to galv. steel) where pH < 6.5 and resistivity < 20,000 if thickness for structural requirements is inadequate for abrasion potential. • Increase concrete cover over reinforcing steel for RCB (invert only). RCP generally not recommended. • Corrugated HDPE (Type S) limited to ≥ 48" min. diameter. Corrugated HDPE Type C not recommended. • Corrugated PVC limited to ≥ 18" min. diameter <p>Lining alternatives:</p> <ul style="list-style-type: none"> • Closed profile or SDR 35 PVC (corrugated and ribbed PVC limited to ≥ 18" min. diameter. • SDR HDPE • CIPP (min. thickness for abrasion specified) • Concrete and authorized cementitious pipeliners and invert paving. See Table 855.2F.

Note:

(1) For minor bed load volumes, use Level 3.

Table 855.2A

Abrasion Levels and Materials (Cont.)

Abrasion Level	General Site Characteristics	Allowable Pipe Materials and Lining Alternatives
Level 5	<ul style="list-style-type: none"> • Moderate bed load volumes of angular sands and gravel or rock (See Note 1). • Velocities > 12 ft/s and ≤ 15 ft/s 	<ul style="list-style-type: none"> • Aluminized steel (type 2) not recommended without invert protection or increased gauge thickness (wear rate equivalent to galv. steel) where pH < 6.5 and resistivity < 20,000 if thickness for structural requirements is inadequate for abrasion potential. • For steel pipe invert lining additional gauge thickness is recommended if thickness for structural requirements is inadequate for abrasion potential. See lining alternatives below. • Increase concrete cover over reinforcing steel for RCB (invert only). RCP generally not recommended <p>Lining alternatives:</p> <ul style="list-style-type: none"> • Closed profile (≥ 42 in) or SDR 35 PVC (PVC liners not recommended when freezing conditions are often encountered and cobbles or rocks are present) • SDR HDPE • CIPP (with min. thickness for abrasion specified) • Concrete and authorized cementitious pipeliners and invert paving. See Table 855.2F.

Note:

(1) For minor bed load volumes, use Level 3.

Table 855.2A

Abrasion Levels and Materials (Cont.)

Abrasion Level	General Site Characteristics	Allowable Pipe Materials and Lining Alternatives
Level 6	<ul style="list-style-type: none"> • Moderate bed load volumes of angular sands and gravel or rock (See Note 1). • Velocities > 15 ft/s and ≤ 20 ft/s <p>or</p> <ul style="list-style-type: none"> • Heavy bed load volumes of angular sands and gravel or rock (See Note 1). • Velocities > 12 ft/s 	<ul style="list-style-type: none"> • Aluminized steel (type 2) not recommended without invert protection or increased gauge thickness (wear rate equivalent to galv. steel) where pH < 5.5 and resistivity < 20,000. • None of the abrasive resistant protective coatings listed in Table 855.2C are recommended for protecting steel pipe. • Invert lining and additional gauge thickness is recommended. See lining alternatives below. • Corrugated HDPE not recommended. Corrugated and closed profile PVC pipe not recommended. • RCP not recommended. Increase concrete cover over reinforcing steel recommended for RCB (invert only) for velocities up to 15 ft/s. RCB not recommended for velocities greater than 15 ft/s unless invert lining is placed (see lining alternatives below). <p>Lining/replacement alternatives:</p> <ul style="list-style-type: none"> • ≥ 27 in SDR 35 PVC (PVC liners not recommended when freezing conditions are often encountered and cobbles or rocks are present) or HDPE SDR (minimum wall thickness 2.5") • CIPP (with min. thickness for abrasion specified), • Concrete with embedded aggregate (e.g. cobbles or RSP (facing)): (for all bed load sizes a larger, harder aggregate than the bed load, decreased water cement ratio and an increased concrete compressive strength should be specified). • Alternative invert linings may include steel plate, rails or concreted RSP, and abrasion resistant concrete (Calcium Aluminate). See authorized cementitious pipeliners and invert paving in Table 855.2F. • For new/replacement construction, consider “bottomless” structures.

Note:

(1) For minor bed load volumes, use Level 3.

July 1, 2020

Table 855.2B

Bed Materials Moved by Various Flow Depths and Velocities

Bed Material	Grain Dimensions (inches)	Approximate Nonscour Velocities (feet per second)			
		Mean Depth (feet)			
		1.3	3.3	6.6	9.8
Boulders	more than 10	15.1	16.7	19.0	20.3
Large cobbles	10 – 5	11.8	13.4	15.4	16.4
Small cobbles	5 – 2.5	7.5	8.9	10.2	11.2
Very coarse gravel	2.5 – 1.25	5.2	6.2	7.2	8.2
Coarse gravel	1.25 – 0.63	4.1	4.7	5.4	6.1
Medium gravel	0.63 – 0.31	3.3	3.7	4.1	4.6
Fine gravel	0.31 – 0.16	2.6	3.0	3.3	3.8
Very fine gravel	0.16 – 0.079	2.2	2.5	2.8	3.1
Very coarse sand	0.079 – 0.039	1.8	2.1	2.4	2.7
Coarse sand	0.039 – 0.020	1.5	1.8	2.1	2.3
Medium sand	0.020 – 0.010	1.2	1.5	1.8	2.0
Fine sand	0.010 – 0.005	0.98	1.3	1.6	1.8
Compact cohesive soils					
Heavy sandy loam		3.3	3.9	4.6	4.9
Light		3.1	3.9	4.6	4.9
Loess soils in the conditions of finished settlement		2.6	3.3	3.9	4.3

Notes:

- (1) Bed materials may move if velocities are higher than the nonscour velocities.
- (2) Mean depth is calculated by dividing the cross-sectional area of the waterway by the top width of the water surface. If the waterway can be subdivided into a main channel and an overbank area, the mean depths of the channel and the overbank should be calculated separately. For example, if the size of moving material in the main channel is desired, the mean depth of the main channel is calculated by dividing the cross-sectional area of the main channel by the top width of the main channel.

Under similar conditions, aluminum culverts will abrade between one and a half to three times faster than steel culverts. Therefore, aluminum culverts are not recommended where abrasive materials are present, and where flow velocities would encourage abrasion to occur. Culvert flow velocities that frequently exceed 5 feet per second where abrasive materials are present should be carefully evaluated prior to selecting aluminum as an allowable alternate. In a corrosive environment, Aluminum may display less abrasive wear than steel depending on the volume, velocity, size, shape, hardness and rock impact energy of the bed load. However, if it is deemed necessary to place aluminum pipe in abrasion levels 4 through 6 in Table 855.2C, contact Headquarters Office of State Highway Drainage Design for assistance.

Aluminized Steel (Type 2) can be considered equivalent to galvanized steel for abrasion resistance and therefore does not have the same limitations as aluminum in abrasive environments.

Concrete pipes typically counter abrasion through increased minimum thickness over the steel reinforcement, i.e., by adding additional sacrificial material. See Table 855.2F. However, there are significantly fewer limitations involved in increasing the invert thickness of RCB in the field verses increasing minimum thickness over the steel reinforcement of RCP in the plant. Therefore, RCP is typically not recommended in abrasive flows greater than 10 feet per second but may be considered for higher velocities if the bedload is insignificant (e.g. storm drain systems and most.

Table 855.2C

Guide for Anticipated Service Life Added to Steel Pipe by Abrasive Resistant Protective Coating ⁽²⁾

Flow Velocity (ft/s)	Channel Materials	Bituminous Coating (yrs.) (hot-dipped)	Bituminous Coating & Paved Invert (yrs.)	Polymeric Sheet Coating (yrs.)	Polyethylene (CSSRP) (yrs.)
	Non-Abrasive	8	15	*	*
≥ 1 – ≤ 8 ⁽¹⁾	Abrasive	6-0	15-2	30-5	*
> 8 – ≤ 12	Abrasive	0	2-0	5-0	70-35
> 12 – ≤ 15	Abrasive	**	**	**	35-8 ^{***}
> 12 – ≤ 20	Abrasive & heavy bedloads	****	****	****	****

- * Provides adequate abrasion resistance to meet or exceed a 50-year design service life.
- ** Abrasive resistant protective coatings not recommended, increase steel thickness to 10 gage.
- *** Not recommended above 14 fps flow velocity.
- **** Contact District Hydraulics Branch. See Table 855.2F.

Notes:

- (1) Where there are increased velocities with minor bedload volumes, much higher velocities may be applicable.
- (2) Range of additional service life commensurate with flow velocity range.

July 1, 2020

Table 855.2D**Guide for Anticipated Wear to Metal Pipe by Abrasive Channel Materials**

Flow Velocity (ft/s)	Channel Materials	Anticipated Wear (mils/yr)		
		Plain Galvanized	Aluminized Steel (Type 2)	Aluminum**
	Non-Abrasive	0*	0*	0
$\geq 1 - \leq 8$	Abrasive	0*	0*	0 – 1.5
$> 8 - \leq 12$	Abrasive	0.5 – 1	0.5 – 1	1.5 – 3
$> 12 - \leq 15$	Abrasive	1 – 3.5	1 – 3.5	3 – 10.5
$> 12 - \leq 20$	Abrasive & Heavy bedloads	2.5 – 10	2.5 – 10	7.5 – 30

* Refer to California Test 643 and Figure 855.3B.

** Refer to Figure 855.3A.

Note:

1 mil = 0.001"

Table 855.2E**Relative Abrasion Resistance Properties of Pipe and Lining Materials***

Material	Relative Wear (dimensionless)
Steel	1
Aluminum	1.5 – 3
PVC	2
Polyester Resin (CIPP)	2.5 – 4
HDPE	4 – 5
Concrete (RCP 4000 – 7000 psi)	75 – 100
Calcium Aluminate (Mortar)	30-40
Calcium Aluminate (Concrete)	20 – 25
Basalt Tile	1
Polyethylene (CSSRP)	1 – 2

* Evaluation of Abrasion Resistance of Pipe and Pipe Lining Materials Final Report FHWA/CA/TL-CA01-0173 (2007).

Table 855.2F

Guide for Minimum Material Thickness of Abrasive Resistant Invert Protection to Achieve 50 Years of Maintenance-Free Service Life

Abrasion Level & Flow Velocity (ft/s)	Channel Materials	Concrete ⁽⁴⁾ (in)	Steel Pipe & Plate (in)	Aluminum Pipe & Plate (in)	PVC (in)	HDPE (in)	CIPP (in)	Calcium Aluminate Abrasion Resistant Concrete ⁽⁵⁾ (in)	Mortar ⁽⁵⁾	
									Calcium Aluminate (in)	Geopolymer (in)
Level 4 > 8 – ≤ 12	Abrasive	2 – 4	0.052	0.075 – 0.164	0.1	0.125 – 0.25	0.1 – 0.3	⁽⁶⁾	1-2	2-4
Level 5 > 12 – ≤ 15	Abrasive	4 – 13	0.052 – 0.18	⁽²⁾	0.1 – 0.35	0.25 – 0.875	0.3 – 0.70	3 ⁽⁶⁾	2-5	4-13
Level 6 > 12 – ≤ 20	Abrasive & Heavy bedloads	⁽¹⁾	0.109 – 0.5	⁽²⁾	0.25 – 1.0 ⁽³⁾	0.625 – 2.5	0.5 – 2	3 – 5	5-8	⁽¹⁾

Notes:

- ⁽¹⁾For flow velocity > 12 ft/s ≤ 14 ft/s use 9" – 15". For > 14 ft/s use CRSP or other abrasion resistant layer special design with, or in lieu of concrete or geopolymer mortar.
- ⁽²⁾Not recommended without invert protection.
- ⁽³⁾PVC liners not recommended when freezing conditions are often encountered and cobbles and rocks are present.
- ⁽⁴⁾Values shown based on RCP abrasion test results. See Table 855.2E. Results may differ from concrete specified under 15-6.04 for invert paving which must have a minimum compressive strength of 6,000 psi at 28 days and 1 ½-inch maximum grading.
- ⁽⁵⁾See Authorized Materials List for Cementitious Pipeliners and Concrete Invert Paving: <https://dot.ca.gov/programs/engineering-services/authorized-materials-lists>. Standard Mortar (Section 51-1.02F of the Standard Specifications) not recommended for Abrasion Level 4 or higher.
- ⁽⁶⁾Minimum thickness recommended is 3". Not practical or economically viable for Level 4. Consider calcium aluminate mortar or standard concrete (Section 90 of the Standard Specifications) for lower range of Level 5.

culverts smaller than 30 inches or larger diameters with insignificant abrasive bedload volumes). Abrasion resistance for any concrete lining is dependent upon the thickness, quality, strength, and hardness of the aggregate and compressive strength of the concrete as well as the velocity of the water flow coupled with abrasive sediment content and acidity. Abrasion resistant concrete or mortar made from calcium aluminate provides much improved abrasion resistance over cementitious concrete and should be considered as a viable countermeasure in extremely abrasive conditions (i.e., velocity greater than 15 feet per second with heavy bedload). See Table 855.2F.

Plastic materials typically exhibit good abrasion resistance but service life is constrained by the manufactured thickness of typical pipe profiles. Both PVC and HDPE corrugated pipe are limited for their use in moderate and heavy bedload abrasion conditions by the combined manufactured inner liner and corrugated wall thicknesses. For culvert rehabilitation, PVC and HDPE pipe slip lining products (e.g. solid wall HDPE) are viable options for applications in moderate and heavy bedload abrasion conditions (see Table 855.2A).

Table 855.2A can be used as a “preliminary estimator” of abrasion potential for material selection to achieve the required service life, however, it incorporates only three of the primary abrasion factors; bedload volume, bedload type and flow velocity and the general assumption is the materials are angular, hard and abrasive. As discussed above, the other factors that are not used in the table should also be carefully considered. For example, under similar hydraulic conditions, heavy volumes of hard, angular sand may be more abrasive than small volumes of relatively soft, large or rounded rocks. Furthermore, two sites with similar site characteristics, but different hydrologic characteristics, i.e., volume, duration and frequency of stream flow in the culvert, will likely also have different abrasion levels. Table 855.2B can be used as a guide with Table 855.2A to determine the maximum size of material that can be moved through a pipe. Field observations of channel bed material both upstream and downstream from the pipe are extremely important for estimating the size range of transportable material in the channel.

855.3 Corrosion

Corrosion is the destructive attack on a pipe by a chemical reaction with the materials surrounding the pipe. Corrosion problems can occur when metal pipes are used in locations where the surrounding materials have excess acidity or alkalinity. The relative acidity of a substance is often expressed by its pH value. The pH scale ranges from 1 to 14, with 1 representing extreme acidity, and 14 representing extreme alkalinity, and 7 representing a neutral substance. The closer the pH value is to 7, the less potential the substance has for causing corrosion.

Corrosion is an electrolytic process and requires an electrolyte (generally moisture) and oxygen to proceed. As a result, it has the greatest potential for causing damage in soils that have a relative high ability to pass electric current. The ability of a soil to convey current is expressed as its resistivity in ohm-cm, and a soil with a low resistivity has a greater ability to conduct electricity. Very dry areas (e.g., desert environments) have a limited availability of electrolyte, and totally and continuously submerged pipes have limited oxygen availability. These extreme conditions (among others) are not well represented by AltPipe, and some adjustment in the estimated service life for pipes in these conditions should be made. See Index 857.2

Corrosion can also be caused by excessive acidity in the water conveyed by the pipe. Water pH can vary considerably between watersheds and seasons.

Because failure can occur at any point along the length of the pipe (e.g. tidal zones), the designer must look at the conditions and how they may vary along the pipe length - and select for input into AltPipe those conditions that represent the most severe situation along the length.

AltPipe operates based on some fairly basic assumptions for corrosion and minimum resistivity that are part of California Test 643. Altpipe will list all viable alternatives for achieving design service life. Where enhanced soilside corrosion protection is needed, aluminum or aluminized pipe (if within acceptable pH/min. resistivity ranges), bituminous coatings or polymeric sheet coating should be considered.

Aluminum, and the aluminum coating provided by Aluminized Steel (Type 2) pipe, corrodes differently than steel and will provide adequate durability to meet the 50-year service life criterion within the acceptable pH range of 5.5-8.5 and minimum resistivity greater than 1500 ohm-cm without need for specifying a thicker gauge or additional coating, whereas under the same range galvanized steel may need a protective coating or an increase in thickness to provide a 50-year maintenance-free service life (with respect to corrosion). Figure 855.3A should be used to determine the limitations on the use of corrugated aluminum pipe for various levels of pH and minimum resistivity. The minimum thickness (0.060 inch) of aluminum pipe obtained from the chart only satisfies corrosion requirements. Overfill requirements for minimum metal thickness must also be satisfied. The metal thickness of corrugated aluminum pipe should satisfy both requirements.

Figure 855.3A should be used to determine the minimum thickness and limitation on the use of corrugated steel and spiral rib pipe for various levels of pH and minimum resistivity. For example, given a soil environment with pH and minimum resistivity levels of 6.5 and 15,000 ohm-cm, respectively, the minimum thicknesses for the various metal pipes are: 1) 0.109 inch (12 gage) galvanized steel, 2) 0.064 inch (16 gage) aluminized steel (type 2) and 3) 0.060 inch (16 gage) aluminum. The minimum thickness of metal pipe obtained from the figure only satisfies corrosion requirements. Overfill requirements for minimum metal thickness must also be satisfied. The metal thickness of corrugated pipe and steel spiral rib pipe that satisfies both requirements should be used.

Figure 855.3B, "Chart for Estimating Years to Perforation of Steel Culverts," is part of a Standard California Department of Transportation Test Method derived from highway culvert investigations. This chart alone is not used for determining service life because it does not consider the effects of abrasion or overfill; it is for estimating the years to the first corrosion perforation of the wall or invert of the CSP.

855.4 Protection of Concrete Pipe and Drainage Structures from Acids, Chlorides and Sulfates

Table 855.4A indicates the limitation on the use of concrete by acidity of soil and water. Table 855.4A is also a guide for designating cementitious material restrictions and water content

July 1, 2020

Figure 855.3A

Minimum Thickness of Metal Pipe for 50-Year Maintenance-Free Service Life ⁽²⁾

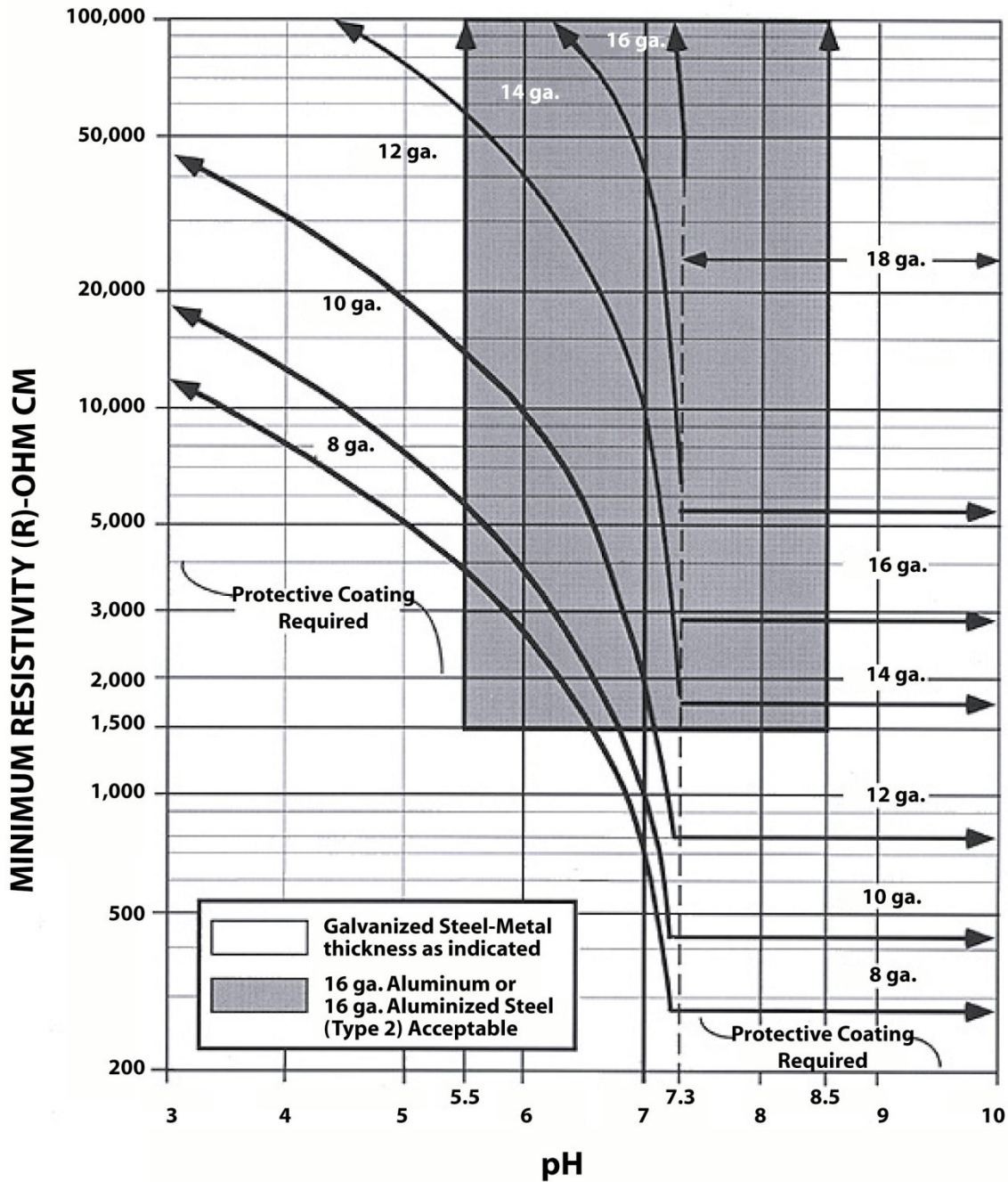

Notes:

- (1) For pH and aluminum resistivity levels not shown refer to Fig. 855.3B steel pipes. (California Test 643)
- (2) Service life estimate are for various corrosive conditions only.
- (3) Refer to Index 852.3(2) and 852.4(2) for appropriate selection of metal thickness and protection coating to achieve service life requirements.

Figure 855.3B

Chart for Estimating Years to Perforation of Steel Culverts

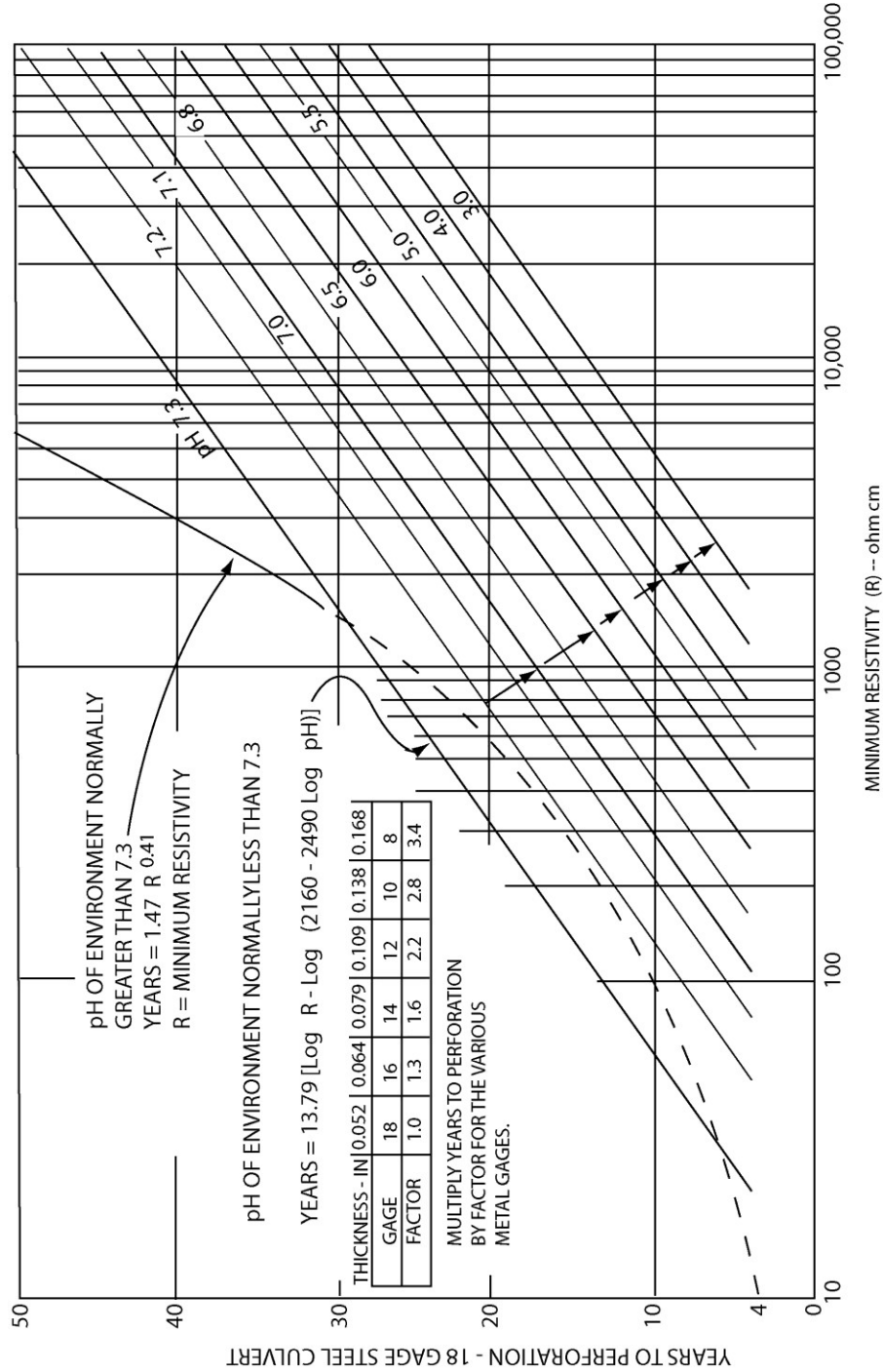

July 1, 2020

Table 855.4A

Guide for the Protection of Cast-In-Place and Precast Reinforced and Unreinforced Concrete Structures⁽⁵⁾ Against Acid and Sulfate Exposure Conditions^{(1),(2)}

Soil or Water pH	Sulfate Concentration of Soil or Water (ppm)	Cementitious Material Requirements ⁽³⁾	Water Content Restrictions
7.1 to 14	0 to 1,499	Standard Specifications Section 90	No Restrictions
5.6 to 7.0	1,500 to 1,999	Standard Specifications Section 90	Maximum water-to-cementitious material ratio of 0.45
3 to 5.5 ⁽⁴⁾	2,000 to 15,000 ⁽⁴⁾	675 lb/cy minimum: Type II or Type V portland cement and required supplementary cementitious materials per Standard Specification 90-1.02H	Maximum water-to-cementitious material ratio of 0.40

Notes:

- ⁽¹⁾ Recommendations shown in the table for the cementitious material requirements and water content restrictions should be used if the pH and/or the sulfate conditions in Column 1 and/or Column 2 exists. Sulfate testing is not required if the minimum resistivity is greater than 1,000 ohm-cm.
- ⁽²⁾ The table lists soil/water pH and sulfate concentration in increasing level of severity starting from the top of the table. If the soil/water pH and the sulfate concentration are at different levels of severity, the recommendation for the more severe level will apply. For example, a soil with a pH of 4.0, but with a sulfate concentration of only 1,600 ppm would require a minimum of 675 lb/cy of cementitious material. The maximum water-to-cementitious material ratio would be 0.40.
- ⁽³⁾ Cementitious material shall conform to the provisions in Section 90 of the Standard Specifications.
- ⁽⁴⁾ Additional mitigation measures will be needed for conditions where the pH is less than 3 and/or the sulfate concentration exceeds 15,000 ppm. Mitigation measures may include additional concrete cover and/or protective coatings. For additional assistance, contact the Corrosion Technology Branch of Materials Engineering and Testing Services (METS) at 5900 Folsom Boulevard Sacramento, CA. 95819.
- ⁽⁵⁾ Does not include RCP.

Table 855.4B**Guide for Minimum Cover Requirements for Cast-In-Place and Precast Reinforced Concrete Structures⁽³⁾ for 50-Year Design Life in Chloride Environments**

Chloride Concentration (ppm)			
500 to 2000	2001 to 5000	5001 to 10000	10000 +
1.5 in. ⁽¹⁾	2.5 in. ⁽¹⁾	3 in. ⁽¹⁾	4 in. ⁽¹⁾
1.5 in. ⁽²⁾	1.5 in. ⁽²⁾	2 in. ⁽²⁾	3 in. ⁽²⁾

Notes:

- ⁽¹⁾Supplementary cementitious materials are required. Typical minimum requirement consists of 675#/cy minimum cementitious material with 75% by weight of Type II or Type V portland cement and 25% by weight of either fly ash or natural pozzolan. A maximum w/cm ratio of 0.40 is specified. Fly ash or natural pozzolan may have a CaO content of up to 10%. Section 90-1.02B(3) of the Standard Specifications provides requirements.
- ⁽²⁾Additional supplementary cementitious materials per the requirements of Section 90-1.02B(3) of the Standard Specifications are required in order to achieve the listed reduction in concrete cover.
- ⁽³⁾Does not include RCP.

restrictions for various ranges of sulfate concentrations in soil and water for all cast in place and precast construction of drainage structures.

For pH ranging between 7.0 and 3.0 and for sulfate concentrations between 1500 and 15,000 ppm, concrete mix designs conforming to the recommendations given in Table 855.4A should be followed. Higher sulfate concentrations or lower pH values may preclude the use of concrete or would require the designer to develop and specify the application of a complete physical barrier. Reinforcing steel can be expected to respond to corrosive environments similarly to the steel in CSP.

Table 855.4B provides a guide for minimum concrete cover requirements for various ranges of chloride concentrations in soil and water for all precast and cast in place construction of drainage structures.

- (1) *RCP*. In relatively severe acidic, chloride or sulfate environments (either in the soil or water) as identified in the project Materials Report, the means for offsetting the effects of the corrosive elements is to either increase the cover over the reinforcing steel, increase the cementitious material content, or reduce the water/ cementitious material ratio. The identified constituent concentration levels should be entered into AltPipe to verify what combinations of increased cover (in 1/4-inch intervals from 1 inch to a maximum of 1-1/2 inches), increased cementitious material content (in increments of 47 pounds from 470 pounds to a maximum of 564 pounds), will provide the necessary service life (typically 50 years). Per an agreement with Industry, the water to cementitious material ratio is set at 0.40. AltPipe is specifically programmed to provide RCP mix and cover designs that are compatible with industry practice, and are based on their agreements with Caltrans. For corrosive condition installations such as low pH (<4.5), Chlorides (>2,000 ppm) or Sulfates

(> 2,000 ppm), the following service life (SL) equation provides the basis for RCP design in AltPipe:

$$SL = 10^3 \times 1.107^{C_c} \times C_c^{0.717} \times D_c^{1.22} \times (K + 1)^{-0.37} \\ \times W^{-0.631} - 4.22 \times 10^{10} \times pH^{-14.1} - 2.94 \times 10^{-3} \\ \times S + 4.41$$

Where: S= Environmental sulfate content in ppm.

C_c = Sacks of cement (94 lbs each) per cubic yard of concrete.

D_c = Concrete cover in inches.

K = Environmental chloride concentration in ppm.

W = Water by volume as percentage of total mix.

pH = The measure of relative acidity or alkalinity of the soil or water. See Index 855.3.

Where the measured concentration of chlorides exceeds 2000 ppm for RCP that is placed in brackish or marine environments and where the high tide line is below the crown of the invert, the AltPipe input for chloride concentration will default to 25,000 ppm.

Contact the District Materials unit or the Corrosion Technology Branch in DES for design recommendations when in extremely corrosive conditions. Non-Reinforced concrete pipe is not affected by chlorides or stray currents and may be used in lieu of RCP with additional concrete cover and/or protective coatings for sizes 36" in diameter and smaller. See Index 852.1(4) and Table 855.4A. Where conditions occur that RCP designs as produced by AltPipe will not work, the Office of State Highway Drainage Design within the Division of Design should be contacted.

855.5 Material Susceptibility to Fire

Fire can occur almost anywhere on the highway system. Common causes include forest, brush or grass fires that either enter the right-of-way or begin within it. Less common causes include spills of flammable liquids that ignite or vandalism. Storm drains, which are completely buried would typically be impacted by spills or vandalism. Because these are such low probability events, prohibitions on material placement for storm drains are not typically warranted.

Cross culverts and exposed overside drains are the placement types most subject to burning or melting and designers should consider either limiting the alternative pipe listing to non-flammable pipe materials or providing a non-flammable end treatment to provide some level of protection.

Plastic pipe and pipes with coatings (typically of bituminous or plastic materials) are the most susceptible to damage from fire. Of the plastic pipe types which are allowed, PVC will self extinguish if the source of the fire is eliminated (i.e., if the grass or brush is consumed or removed) while HDPE can continue to burn as long as an adequate oxygen supply is present. Based on testing performed by Florida DOT, this rate of burning is fairly slow, and often self extinguished if the airflow was inhibited (i.e., pipe not aligned with prevailing wind or ends sheltered from air flow).

Due to the potential for fire damage, plastic pipe is not recommended for overside drain locations where there is high fire potential (large amounts of brush or grass or areas with a history of fire) and where the overside drain is placed or anchored on top of the slope.

Where similar high fire potential conditions exist for cross culverts, the designer may consider limiting the allowable pipe materials indicated on the alternative pipe listing to non-flammable material types, use concrete endwalls that eliminate exposure of the pipe ends, or require that the end of flammable pipe types be replaced with a length of non-flammable pipe material.

Topic 856 – Height of Fill

An essential aspect of pipe selection is the height of fill/cover over the pipe. This cover dissipates live loads from traffic, both during construction and after the facility is open to the public.

856.1 Construction Loads

See Standard Plan D88 for table of minimum cover for construction loads.

856.2 Concrete Pipe, Box and Arch Culverts

(1) *Reinforced Concrete Pipe.* See Standard Plan A62D and A62DA for the maximum height of overfill for reinforced concrete pipe, up to and including 120-inch diameter (or reinforced oval pipe and reinforced concrete pipe arch with equivalent cross-sectional area), using the backfill method or type shown. For oval shaped reinforced concrete pipe fill heights, see Standard Plan A62D and Indirect Design D-Load (Marsten/Spangler Method). Allowable cover for oval shaped reinforced concrete pipe is determined by using Method 2 (Note 8). See Standard Plan D79 and D79A for pre-cast reinforced concrete pipe Direct Design Method (pertains to circular pipe only).

The designer should be aware of the premises on which the tables on Standard Plan A62D, A62DA, D79 and D79A are computed as well as their limitations. The cover presupposes:

- That the bedding and backfill satisfy the terms of the Standard Specifications, the conditions of cover and pipe size required by the plans, and take into account the essentials of Index 829.2.
- That a small amount of settlement will occur under the culvert equal in magnitude to that of the adjoining material outside the trench.
- Subexcavation and backfill as required by the Standard Specifications where unyielding foundation material is encountered.

If the height of overfill exceeds the tabular values on Standard Plan A62D and A62DA a special design is required; see Index 829.2.

(2) *Concrete Box and Arch Culverts.* Single and multiple span reinforced concrete box culverts are completely detailed in the Standard Plans. For cast-in-place construction, strength classifications are shown for 10 feet and 20 feet overfills. See Standard Plan numbers D80, D81 and D82. Pre-cast reinforced concrete box culverts require a minimum of 1 foot overfill and limit fill height to 12 feet maximum. See Standard Plans D83A, D83B and A62G. For fill height design criteria for CIP Bottomless 3-sided rigid frame culverts see XS-Sheets 17-050-1, 2, 3, 4 and 5. Cast-in-place reinforced concrete arch culverts are no longer economically feasible structures and last appeared in the 1997 Standard Plans. Questions

regarding fill height for concrete arch culverts or extensions should be directed to the Underground Structures Branch of DES - Structures Design.

856.3 Metal Pipe and Structural Plate Pipe

Basic Premise - To properly use the fill height design tables, the designer should be aware of the premises on which the tables are based as well as their limitations. The design tables presuppose:

- That bedding and backfill satisfy the terms of the Standard Specifications and Standard Plan A62F, the conditions of cover, and pipe size required by the plans and the essentials of Index 829.2.
- That a small amount of settlement will occur under the culvert, equal in magnitude to that of the adjoining material outside the trench.

Limitations - In using the tables, the following restrictions must be kept in mind:

- The values given for each size of pipe constitute the maximum height of overfill or cover over the pipe for the thickness of metal and kind of corrugation.
- The thickness shown is the structural minimum. Where abrasive conditions are anticipated, additional metal thickness or invert treatments as stated under Index 852.4(5) and Index 852.6(2)(c) should be provided when required to fulfill the design service life requirements of Topic 855.
- Where needed, adequate provisions for corrosion resistance must be made to achieve the required design service life called for in the references mentioned herein.
- Table 856.3D shows the limit of heights of cover for corrugated steel pipe arches based on the supporting soil sustaining a factored bearing pressure varying between 3.38 tons per square feet to 3.55 tons per square feet. Table 856.3J shows similar values for corrugated aluminum pipe arches.
- The values given for each size of structural plate pipe or arch constitute the maximum height of overfill or cover over the pipe or arch for the thickness of metal and kind of corrugation.
- Tables 856.3N & P show the limit of heights of cover for structural plate arches based on the supporting soil sustaining a factored bearing pressure of 6 tons per square foot at the corners.

Special Designs.

- If the height of overfill exceeds the tabular values, or if the foundation investigation reveals that the supporting soil will not develop the bearing pressure on which the overfill heights for pipe arches are based, a special design prepared by DES - Structures Design is required. See index 829.2.
- Non-standard pipe diameters and arch sizes are available. Loading capacity of special designs needs to be verified with the Underground Structures Branch of DES - Structures Design.
- Aluminum pipe fill height tables are based on use of H-32 temper aluminum. If use of aluminum is necessary and greater structural capacity is required, H-34 temper can be specified. Contact Underground Structures branch of DES-Structures Design for calculation of allowable fill height.

(1) *Corrugated Steel Pipe and Pipe Arches, Steel Spiral Rib Pipe, Structural Steel Plate Pipe and Structural Steel Plate Pipe Arches.* The allowable overfill heights for corrugated steel

pipe and pipe arches for the various diameters or arch sizes and metal thickness are shown on Tables 856.3A, B, C & D. For steel spiral rib pipe, overfill heights are shown on Tables 856.3E, F, G & H. Table 856.3G gives the allowable overfill height for composite steel spiral rib pipe.

For structural steel plate pipe and structural steel plate pipe arches, overfill heights are shown on Tables 856.3M & N. For maximum height of fill over structural steel plate vehicular undercrossings, see Standard Plan B14-1.

(2) *Corrugated Aluminum Pipe and Pipe Arches, Aluminum Spiral Rib Pipe and Structural Aluminum Plate Pipe and Structural Aluminum Plate Pipe Arches.* The allowable overfill heights for corrugated aluminum pipe and pipe arches for various diameters and metal thickness are shown on Tables 856.3H, I & J. For aluminum spiral rib pipe, overfill heights are shown on Tables 856.3K & L.

For structural aluminum plate pipe and structural aluminum plate pipe arches, overfill heights are shown on Tables 856.3O, & P.

856.4 Plastic Pipe

The allowable overfill heights for plastic pipe for various diameters are shown in Tables 856.4 and 856.5. To properly use the plastic pipe height of fill table, the designer should be aware of the basic premises on which the table is based as well as their limitations. The design tables presuppose:

- That bedding and backfill satisfy the terms of the Standard Specifications and Standard Plan A62F, the conditions of cover, and pipe size required by the plans and the essentials of Index 829.2.
- That corrugated high density polyethylene (HDPE) pipe that is greater than 48" in size shall be backfilled with cementitious (slurry cement, CLSM or concrete) backfill.
- That where cementitious or flowable backfill is used for structural backfill, the backfill shall be placed to a level not less than 12 inches above the crown of the pipe.
- That a small amount of settlement will occur under the culvert, equal in magnitude to that of the adjoining material outside the trench.
- That the average water table elevation is at or below the pipe springline.
- Corrugated HDPE pipe, Type C is recommended for placement only outside the roadbed where vehicular loading is unlikely (e.g., overside drains, medians) unless cementitious backfill is specified.

856.5 Minimum Height of Cover

Table 856.5 gives the minimum thickness of cover required for design purposes over pipes and pipe arches. For construction purposes, a minimum cover of 6 inches greater than the roadway structural section is desirable for all types of pipe.

Table 856.3A

Corrugated Steel Pipe Helical Corrugations

Diameter (in)	MAXIMUM HEIGHT OF COVER (ft)					
	Metal Thickness (in)					
	0.052 (18 ga.)	0.064 (16 ga.)	0.079 (14 ga.)	0.109 (12 ga.)	0.138 (10 ga.)	0.168 (8 ga.)
	2²/₃" x 1/2" Corrugations					
12-15	118	148	177	--	--	--
18	99	124	148	207	--	--
21	85	106	132	177	--	--
24	74	93	116	155	200	245
30	59	74	93	130	160	195
36	49	62	77	108	139	163
42	42	53	66	93	119	139
48	--	46	58	81	104	128
54	--	--	51	72	93	113
60	--	--	--	65	83	102
66	--	--	--	--	76	93
72	--	--	--	--	70	85
78	--	--	--	--	--	75
84	--	--	--	--	--	65
	3" x 1" Corrugations					
48	--	53	67	93	120	147
54	--	47	59	83	107	131
60	--	42	53	75	96	118
66	--	39	48	68	87	107
72	--	35	44	62	80	98
78	--	33	41	57	74	91
84	--	30	38	53	69	84
90	--	28	35	50	64	78
96	--	--	33	47	60	74
102	--	--	31	44	56	69
108	--	--	--	41	53	65
114	--	--	--	39	50	62
120	--	--	--	37	48	59

Table 856.3B

Corrugated Steel Pipe Helical Corrugations

Diameter (in)	MAXIMUM HEIGHT OF COVER (ft)			
	Metal Thickness (in)			
	0.064 (16 ga.)	0.079 (14 ga.)	0.109 (12 ga.)	0.138 (10 ga.)
	5" x 1" Corrugations			
48	47	59	83	--
54	42	53	74	95
60	38	47	66	86
66	34	43	60	78
72	31	39	55	71
78	29	36	51	66
84	27	34	47	61
90	25	31	44	57
96	--	29	41	53
102	--	28	39	50
108	--	--	37	47
114	--	--	35	45
120	--	--	33	43

July 1, 2020

Table 856.3C

Corrugated Steel Pipe 2 $\frac{2}{3}$ " x $\frac{1}{2}$ " Annular Corrugations

Diameter (in)	MAXIMUM HEIGHT OF COVER (ft)				
	Metal Thickness (in)				
	0.064 (16 ga.)	0.079 (14 ga.)	0.109 (12 ga.)	0.138 (10 ga.)	0.168 (8 ga.)
18	54	--	--	--	--
21	46	--	--	--	--
24	40	44	--	--	--
30	32	35	--	--	--
36	27	29	38	--	--
42	30	41	65	68	--
48	26	36	57	59	62
54	--	32	50	53	55
60	--	--	45	47	50
66	--	--	--	43	45
72	--	--	--	39	41
78	--	--	--	--	38
84	--	--	--	--	35

Table 856.3D

Corrugated Steel Pipe Arches 2²/₃" x 1/2" Helical or Annular Corrugations

Span-Rise (in)	Factored Bearing Demand (tons/ft ²)	Minimum Corner Radius (in)	MAXIMUM HEIGHT OF COVER (ft)			
			Metal Thickness (in)			
			0.079 (14 ga.)	0.109 (12 ga.)	0.138 (10 ga.)	0.168 (8 ga.)
21 x 15	3.50	4 1/8	10	--	--	--
24 x 18	3.38	4 7/8	10	--	--	--
28 x 20	3.49	5 1/2	10	--	--	--
35 x 24	3.49	6 7/8	10	--	--	--
42 x 29	3.49	8 1/4	10	--	--	--
49 x 33	3.49	9 5/8	10	--	--	--
57 x 38	3.55	11	--	10	--	--
64 x 43	3.54	12 3/8	--	10	--	--
71 x 47	3.54	13 3/4	--	--	10	--
77 x 52	3.49	15 1/8	--	--	--	10
83 x 57	3.45	16 1/2	--	--	--	10

Note:

(1) Cover limited by corner soil bearing pressure as shown.

Table 856.3E

Steel Spiral Rib Pipe $\frac{3}{4}$ " x 1" Ribs at 11 $\frac{1}{2}$ " Pitch

Diameter (in)	MAXIMUM HEIGHT OF COVER (ft)		
	Metal Thickness (in)		
	0.064 (16 ga.)	0.079 (14 ga.)	0.109 (12 ga.)
24	44	62	105
30	36	50	84
36	30	42	70
42	25	36	60
48	22	31	53
54	20	28	47
60	--	25	42
66	--	22	38
72	--	21	35
78	--	--	32
84	--	--	30
90	--	--	28
96	--	--	--

Table 856.3F

Steel Spiral Rib Pipe $\frac{3}{4}$ " x 1" Ribs at 8 $\frac{1}{2}$ " Pitch

Diameter (in)	MAXIMUM HEIGHT OF COVER (ft)		
	Metal Thickness (in)		
	0.064 (16 ga.)	0.079 (14 ga.)	0.109 (12 ga.)
24	59	83	137
30	48	66	110
36	40	55	92
42	34	47	78
48	30	41	69
54	26	37	61
60	24	33	55
66	21	30	50
72	20	27	46
78	--	25	42
84	--	23	39
90	--	--	36
96	--	--	34
102	--	--	32
108	--	--	30
114	--	--	--

Table 856.3G

Steel Spiral Rib Pipe $\frac{3}{4}$ " x $\frac{3}{4}$ " Ribs at 7 $\frac{1}{2}$ " Pitch

Diameter (in)	MAXIMUM HEIGHT OF COVER (ft)			
	Metal Thickness (in)			
	0.064 (16 ga.)	0.079 (14 ga.)	0.109 (12 ga.)	0.138 (10 ga.)
24	61	85	141	205
30	49	68	113	164
36	40	57	94	137
42	35	48	81	117
48	30	42	71	103
54	27	38	63	91
60	--	34	57	82
66	--	31	51	75
72	--	--	47	68
78	--	--	43	63
84	--	--	40	59
90	--	--	--	55

Table 856.3H

Corrugated Aluminum Pipe Annular Corrugations

Diameter (in)	MAXIMUM HEIGHT OF COVER (ft)				
	Metal Thickness (in)				
	0.060 (16 ga.)	0.075 (14 ga.)	0.105 (12 ga.)	0.135 (10 ga.)	0.164 (8 ga.)
2²/₃" x 1/2" Corrugations					
12	43	43	--	--	--
15	35	34	60	--	--
18	29	29	50	--	--
21	25	25	43	--	--
24	21	21	37	39	--
30	--	17	30	31	--
36	--	14	25	26	--
42	--	--	43	45	--
48	--	--	38	40	41
54	--	--	34	35	36
60	--	--	--	32	33
66	--	--	--	--	30
72	--	--	--	--	27
3" x 1" Corrugations					
30	32	40	54	81	--
36	26	33	45	68	88
42	23	28	39	58	75
48	20	25	34	51	66
54	17	22	30	45	59
60	16	20	27	41	53
66	14	18	24	37	48
72	13	16	22	34	44
78	--	15	21	31	40
84	--	--	19	29	38
90	--	--	18	27	35
96	--	--	17	25	33
102	--	--	--	24	31
108	--	--	--	22	29
114	--	--	--	--	28
120	--	--	--	--	26

July 1, 2020

Table 856.3I

Corrugated Aluminum Pipe Helical Corrugations

Diameter (in)	MAXIMUM HEIGHT OF COVER (ft)				
	Metal Thickness (in)				
	0.060 (16 ga.)	0.075 (14 ga.)	0.105 (12 ga.)	0.135 (10 ga.)	0.164 (8 ga.)
	2²/₃" x 1¹/₂" Corrugations				
12	112	140	--	--	--
15	90	112	156	--	--
18	75	93	130	--	--
21	64	80	112	--	--
24	56	70	98	126	--
30	--	56	78	101	--
36	--	47	65	84	--
42	--	--	56	72	--
48	--	--	49	63	77
54	--	--	43	56	68
60	--	--	--	46	58
66	--	--	--	--	47
72	--	--	--	--	37
	3" x 1" Corrugations				
30	51	65	90	121	--
36	43	54	75	101	118
42	37	46	64	86	102
48	32	40	56	76	89
54	28	36	50	67	79
60	26	32	45	60	71
66	23	29	41	55	65
72	21	27	37	50	59
78	--	25	35	46	55
84	--	--	32	43	51
90	--	--	30	40	47
96	--	--	28	38	44
102	--	--	--	35	42
108	--	--	--	33	39
114	--	--	--	--	36
120	--	--	--	--	32

Table 856.3J

Corrugated Aluminum Pipe Arches 2²/₃" x 1/2" Helical or Annular Corrugations

Span-Rise (in)	Factored Bearing Demand (tons/ft ²)	Minimum Corner Radius (in)	MAXIMUM HEIGHT OF COVER (ft)				
			Metal Thickness (in)				
			0.060 (16 ga.)	0.075 (14 ga.)	0.105 (12 ga.)	0.135 (10 ga.)	0.164 (8 ga.)
17 x 13	3.34	3 1/2	10	--	--	--	--
21 x 15	3.49	4 1/8	10	--	--	--	--
24 x 18	3.38	4 7/8	10	--	--	--	--
28 x 20	3.49	5 1/2	--	10	--	--	--
35 x 24	3.49	6 7/8	--	10	--	--	--
42 x 29	3.49	8 1/4	--	--	10	--	--
49 x 33	3.49	9 5/8	--	--	10	--	--
57 x 38	3.55	11	--	--	--	10	--
64 x 43	3.54	12 3/8	--	--	--	10	--
71 x 47	3.54	13 3/4	--	--	--	--	10

Note:

(1) Cover is limited by corner soil bearing pressure as shown.

Table 856.3K

Aluminum Spiral Rib Pipe $\frac{3}{4}$ " x 1" Ribs at 11 $\frac{1}{2}$ " Pitch

Diameter (in)	MAXIMUM HEIGHT OF COVER (ft)		
	Metal Thickness (in)		
	0.060 (16 ga.)	0.075 (14 ga.)	0.105 (12 ga.)
24	22	31	50
30	18	24	40
36	15	20	33
42	--	17	29
48	--	--	25
54	--	--	22
60	--	--	20
66	--	--	--
72	--	--	--

Table 856.3L

Aluminum Spiral Rib Pipe $\frac{3}{4}$ " x $\frac{3}{4}$ " Ribs at 7 $\frac{1}{2}$ " Pitch

Diameter (in)	MAXIMUM HEIGHT OF COVER (ft)		
	Metal Thickness (in)		
	0.60 (16 ga.)	0.075 (14 ga.)	0.105 (12 ga.)
24	30	41	66
30	24	33	53
36	20	27	44
42	--	23	38
48	--	--	33
54	--	--	29
60	--	--	26
66	--	--	--
72	--	--	--

Table 856.3M

Structural Steel Plate Pipe 6" x 2" Corrugations

Diameter (in)	MAXIMUM HEIGHT OF COVER (ft)							
	Metal Thickness (in)							
	0.110 (12 ga.)	0.140 (10 ga.)	0.170 (8 ga.)	0.218 (5 ga.)	0.249 (3 ga.)	0.280 (1 ga.)	0.318 (0 ga.)	0.380 (000 ga.)
60	42	60	79	105	128	140	223	268
66	38	55	71	99	116	127	203	243
72	35	50	65	91	107	116	186	223
77	32	47	61	85	100	109	174	209
84	30	43	56	78	92	100	160	192
90	28	40	52	72	85	93	149	179
96	26	37	49	68	80	87	140	168
102	24	35	46	64	75	82	132	158
108	23	33	44	60	71	78	124	149
114	22	31	41	57	67	74	118	141
120	21	30	39	54	64	70	112	134
126	20	28	37	52	61	67	107	128
132	19	27	36	49	58	63	102	122
138	18	26	34	47	56	61	91	117
144	17	25	33	45	53	58	93	112
150	16	24	31	43	51	56	89	108
156	16	23	30	42	49	54	86	103
162	15	22	29	40	47	52	83	100
168	15	21	28	39	46	50	80	96
174	14	20	27	37	44	48	77	93
180	14	20	26	36	43	46	75	90
186	13	19	25	35	41	45	72	87
192	--	18	24	34	40	44	70	84
198	--	18	24	33	39	42	68	81
204	--	17	23	32	38	41	66	79
210	--	17	22	31	36	40	64	77
216	--	--	22	30	35	39	62	75
222	--	--	21	29	34	38	60	73
228	--	--	20	28	34	37	59	71
234	--	--	20	28	33	36	57	69
240	--	--	--	27	32	35	56	67
246	--	--	--	26	31	34	54	65
252	--	--	--	26	30	33	53	64

Table 856.3N

Structural Steel Plate Pipe Arches 6" x 2" Corrugations

MAXIMUM HEIGHT OF COVER (ft)				
Span	Rise	Factored Corner Soil Bearing – 6 tons/ft ²		
		Metal Thickness (in)		
		0.110 (12 ga.)	0.140 (10 ga.)	
18" Corner Radius				
6'-1"	4'-7"	21		--
7'-0"	5'-1"	18		--
7'-11"	5'-7"	16		--
8'-10"	6'-1"	14		--
9'-9"	6'-7"	13		--
10'-11"	7'-1"	12		--
31" Corner Radius				
13'-3"	9'-4"	17		--
14'-2"	9'-10"	16		--
15'-4"	10'-4"	13		--
16'-3"	10'-10"	12		--
17'-2"	11'-4"	12		--
18'-1"	11'-10"	11		--
19'-3"	12'-4"	--		10
19'-11"	12'-10"	--		10
20'-7"	13'-2"	--		10

NOTES:

- (1) For intermediate sizes, the depth of cover may be interpolated.
- (2) The 31-inch corner radius arch should be specified when conditions will permit its use.

Table 856.30

Structural Aluminum Plate Pipe 9" x 2½" Corrugations

Diameter (in)	MAXIMUM HEIGHT OF COVER (ft)						
	Metal Thickness (in)						
	0.100	0.125	0.150	0.175	0.200	0.225	0.250
60	27	40	52	62	71	81	90
66	24	36	48	56	65	73	82
72	22	33	44	51	59	67	75
77	21	31	41	48	55	63	70
84	19	28	37	44	51	58	64
90	18	26	35	41	47	54	60
96	17	25	33	38	44	50	56
102	16	23	31	36	42	47	53
108	15	22	29	34	39	45	50
114	14	21	27	32	37	42	47
120	13	20	26	31	35	40	45
126	13	19	25	29	34	38	43
132	12	18	24	28	32	36	41
138	11	17	23	27	31	35	39
144	--	16	22	25	29	33	37
150	--	16	21	24	28	32	36
156	--	15	20	23	27	31	35
162	--	--	19	23	26	30	33
168	--	--	18	22	25	29	32
174	--	--	18	21	24	28	31
180	--	--	--	20	23	27	30
186	--	--	--	20	23	26	29
192	--	--	--	--	22	25	28
198	--	--	--	--	21	24	27
204	--	--	--	--	--	23	26
210	--	--	--	--	--	23	26
216	--	--	--	--	--	22	25
222	--	--	--	--	--	--	24
228	--	--	--	--	--	--	23

Table 856.3P

Structural Aluminum Plate Pipe Arches 9" x 2½" Corrugations

Span	Rise	MAXIMUM HEIGHT OF COVER (ft)					
		Factored Corner Soil Bearing – 6 tons/ft ²					
		Metal Thickness (in)					
		0.100	0.125	0.150	0.175	0.200	0.225
6'-7"	5'-8"	20	--	--	--	--	--
7'-9"	6'-0"	17	--	--	--	--	--
8'-10"	6'-4"	15	--	--	--	--	--
9'-11"	6'-8"	13	--	--	--	--	--
10'-3"	6'-9"	13	19	--	--	--	--
11'-1"	7'-0"	12	18	20	--	--	--
12'-3"	7'-3"	11	16	18	--	--	--
12'-11"	7'-6"	10	15	17	--	--	--
13'-1"	8'-2"	10	15	17	--	--	--
13'-11"	8'-5"	9	14	16	--	--	--
14'-0"	8'-7"	9	14	16	--	--	--
14'-8"	9'-8"	--	13	15	--	--	--
15'-7"	10'-2"	--	12	13	--	--	--
16'-1"	10'-4"	--	12	13	--	--	--
16'-9"	10'-8"	--	--	12	--	--	--
17'-9"	11'-2"	--	--	--	11	--	--
18'-8"	11'-8"	--	--	--	11	--	--
19'-10"	12'-1"	--	--	--	--	10	--
20'-10"	12'-7"	--	--	--	--	--	9
21'-6"	12'-11"	--	--	--	--	--	9

Note:
(1)31 inch Corner Radius

Table 856.4**Thermoplastic Pipe Fill Height Tables****High Density Polyethylene (HDPE) Corrugated Pipe – Type S**

Size (in)	Maximum Height of Cover (ft)
12	15
15	15
18	15
24	15
30	15
36	15
42	15
48	15
54	15
60	15

High Density Polyethylene (HDPE) Corrugated Pipe – Type C

Size(in)	Maximum Height of Cover (ft)
12	5
15	5
18	5
24	5

Polyvinyl Chloride (PVC) Corrugated Pipe with Smooth Interior

Size (in)	Maximum Height of Cover (ft)
12	35
15	35
18	35
21	35
24	35
30	35
36	35

Where cover heights above culverts are less than the values shown in Table 856.5, stress reducing slab details available from the Headquarters Design drainage detail library using the following web address may be used: <https://design.onramp.dot.ca.gov/drainage-detail-library>.

Where cover heights are less than the values shown in the stress reducing slab details, contact Office of State Highway Drainage Design or the Underground Structures Branch of DES - Structures Design.

Table 856.5

Minimum Thickness of Cover for Culverts

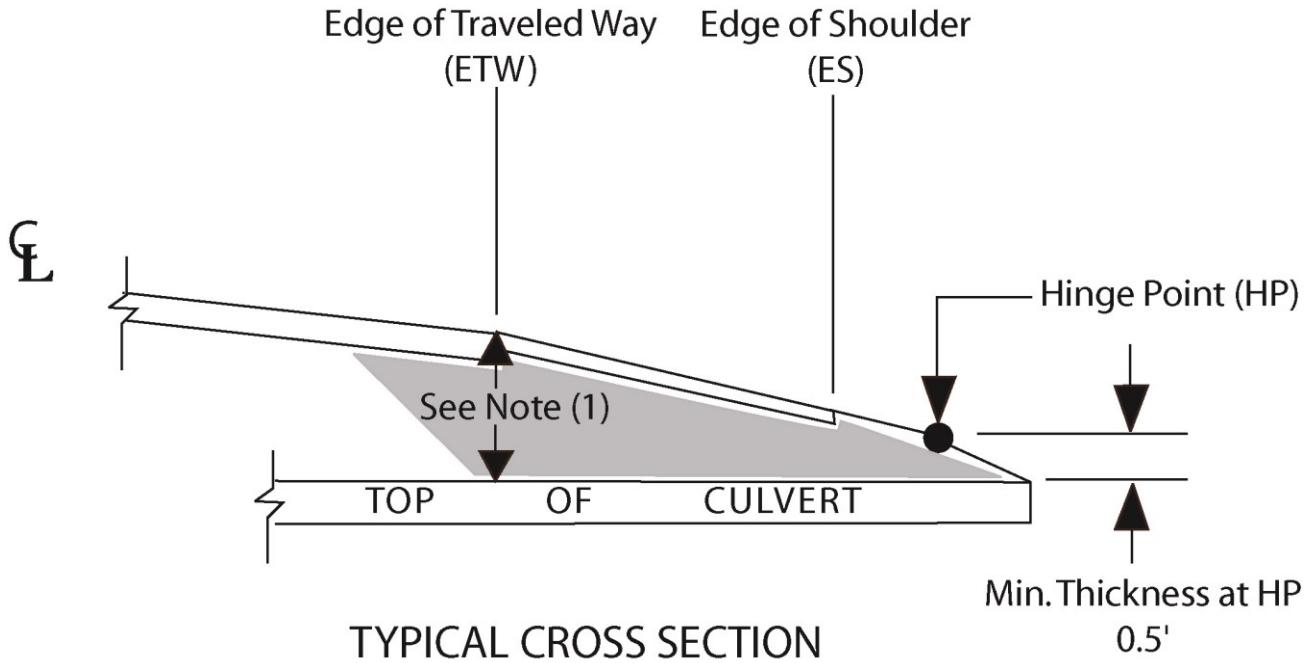

MINIMUM THICKNESS OF COVER AT ETW							
Corrugated Metal Pipes and Pipe Arches	Steel Spiral Rib Pipe	Aluminum Spiral Rib Pipe, S ≤ 48"	Aluminum Spiral Rib Pipe, S > 48"	Structural Plate Pipe	Reinforced Concrete Pipe (RCP) Under Rigid Pavement	RCP Under Flexible Pavement or Unpaved	Plastic Pipes
S/8 or 24" Min.	S/4 or 24" Min.	S/2 or 24" Min.	S/2.75 or 24" Min.	S/8 or 24" Min.	12" Min.	(Max Outside Dimension) /8 or 24" Min.	S/2 or 24" Min.

Notes:

- (1) Minimum thickness of cover is measured at ultimate or failure edge of traveled way.
- (2) Table is for HL-93 live load conditions only.
- (3) "S" in the table is the maximum inside diameter or span of a section.

Topic 857 – Alternate Materials

857.1 Basic Policy

When two or more materials meet the design service life, and structural and hydraulic requirements, the plans and specifications must provide for alternative pipes, pipe arches, overside drains, and underdrains to allow for optional selection by the contractor. See Index 114.3 (2).

- (1) *Allowable Alternatives.* A table of allowable alternative materials for culverts, drainage systems, overside drains, and subsurface drains is included as Table 857.2. This table also identifies the various joint types described in Index 854.1(1) that should be used for the different types of installations.
- (2) *Design Service Life.* Each pipe type selected as an alternative must have the appropriate protection as outlined in Topic 852 to assure that it will meet the design service life requirements specified in Topic 855. The maximum height of cover must be in accordance with the tables included in Topic 856.
- (3) *Selection of a Specific Material Type.* In the cases listed below, the selection of a specific culvert material must be supported by a complete analysis based on the foregoing factors. All pertinent documentation should be placed on file in the District.
 - Where satisfactory performance for a life expectancy of 25 or 50 years, as defined under design service life, cannot be obtained with certain materials by reason of highly corrosive conditions, severe abrasive conditions, or critical structural and construction requirements.
 - For individual drainage systems such as roadway drainage systems or culverts which operate under hydrostatic pressure or culverts governed by hydraulic considerations and which would require separate design for each culvert type.
 - When alterations or extensions of existing systems are required, the culvert type may be selected to match the type used in the existing system.

857.2 Alternative Pipe Culvert Selection Procedure Using AltPipe

These instructions are general guidelines for alternative pipe culvert selection using the AltPipe computer program that is located on the Headquarters Division of Design alternative pipe culvert selection website at the following web address: <https://dot.ca.gov/programs/design/hydraulics-stormwater/bsa-alternative-pipe-culvert-selection-altpipe>.

AltPipe is a web-based tool that may be used to assist materials engineers and designers in the appropriate selection of pipe materials for culvert and storm drain applications. The computations performed by AltPipe are based on the procedures and California Test Methods described in this Chapter. AltPipe is not a substitute for the appropriate use of engineering judgment as conditions and experience would warrant. AltPipe establishes uniform procedures to assist the designer in carrying out the majority of the alternative pipe culvert selection functions of the Department, and is neither intended as, nor does it establish, a legal standard for these functions. Implementation of the results and output of this program is solely at the discretion of the user. The user is encouraged to first read the two informational links on the website titled 'Get More Information' and 'How to use Altpipe' prior to using the program.

July 1, 2020

Each alternative material selected for a drainage facility must provide the required design service life based on physical and structural factors, be of adequate size to satisfy the hydraulic design, and require the minimum of maintenance and construction cost for each site condition.

Step 1. Obtain the results of soil and water pH, resistivity, sulfate and chloride tests, proposed design life of culverts and make determination if any of the outfalls are in salty or brackish water. The Materials Report should include proposed design life and recommendations for pipe material alternatives. See Indexes 114.2 (3) and 114.3 (2).

Step 2. Obtain hydraulic studies and location data for pipe minimum sizes, and expected Q2-5 flow velocities. For pipes operating under outlet control, a critical element of pipe selection is the Manning's internal roughness value used in the hydraulic design. It is important to independently verify the roughness used in the design is applicable for the selected alternate materials from AltPipe. Rougher pipes may require larger sizes to provide adequate hydraulic capacities and need steeper slopes to produce desired cleaning velocities, usually however, pipe slope is maintained, and the only variable provided on the plans is pipe size.

Step 3. Determine the abrasion level from Table 852.2A from the maximum size of material that can be moved through a pipe, the expected Q2-5 flow velocities, and Table 855.2B. Field observations of channel bed material both upstream and downstream are recommended.

Step 4. Determine the maximum fill height.

Step 5. Using the AltPipe computer program that is located on the Headquarters Division of Design alternative pipe culvert selection website enter:

- Pipe diameter
- Maximum fill height
- Design service life
- pH
- Minimum resistivity
- Sulfate concentration
- Chloride concentration (for values greater than 2000, check boxes if end of culvert is exposed to brackish conditions and high tide line is below the crown of the culvert)
- Abrasion level
- 2-5-year Storm Flow Velocity (ft/sec)

Repeat step 5 as necessary and save each pipe in worksheet as needed and go to the final summary upon completion.

Table 857.2

Allowable Alternative Materials

Type of Installation	Service Life (yrs) ¹	Allowable Alternatives	Joint Type Standard Positive Downdrain		
Culverts & Drainage Systems	50	ASSRP, ASRP, CAP, CASP, CSSRP, CIPCP, CSP, NRCP, SAPP, SSPP, SSRP, RCP, RCB, PPC	X	X	--
Overside Drains	50	CAP, CASP, CSP, PPC	--	--	X
Underdrains	50	PAP, PSP, PPET, PPVCP	X	--	--
Arches (Culverts & Drainage Systems)	50	ACSPA, CAPA, CSPA, RCA, SAPP, SSPPA, SSPA	X	X	--

LEGEND

- ACSPA - Aluminized Corrugated Steel Pipe Arch
- ASSRP - Aluminized Steel Spiral Rib Pipe
- ASRP - Aluminum Spiral Rib Pipe
- CAP - Corrugated Aluminum Pipe
- CAPA - Corrugated Aluminum Pipe Arch
- CSSRP - Composite Steel Spiral Rib Pipe
- CASP - Corrugated Aluminized Steel Pipe, Type 2
- CIPCP - Cast-in-Place Concrete Pipe
- CSP - Corrugated Steel Pipe
- CSPA - Corrugated Steel Pipe Arch
- NRCP - Non-Reinforced Concrete Pipe
- PAP - Perforated Aluminum Pipe
- PPC - Plastic Pipe Culvert
- PPET - Perforated Polyethylene Tubing
- PPVCP - Perforated Polyvinyl Chloride Pipe
- PSP - Perforated Steel Pipe
- RCA - Reinforced Concrete Arch
- RCB - Reinforced Concrete Box
- RCP - Reinforced Concrete Pipe
- SAPP - Structural Aluminum Plate Pipe
- SAPP - Structural Aluminum Plate Pipe Arch
- SSPA - Structural Steel Plate Arch
- SSPP - Structural Steel Plate Pipe
- SSPPA - Structural Steel Plate Pipe Arch
- SSRP - Steel Spiral Rib Pipe
- X - Permissible Joint Type for the Type of installation Indicated

NOTE:

⁽¹⁾The design service life indicated for the various types of installations listed in the table may be reduced to 25 years in certain situations. Refer to Index 855.1 for a discussion of service life requirements.

July 1, 2020

Step 6. The following alternatives are not included in AltPipe and will not be provided in the output Alternative pipe list: all non-circular shapes (arches, boxes, etc.), non reinforced concrete pipe (NRCP) and non-standard new products. Check Materials and Hydraulics reports and verify if any of these alternatives were recommended and supplement the AltPipe final summary accordingly. For reinforced concrete pipe (RCP), box (RCB) and arch (RCA) culverts, maintenance-free service life, with respect to corrosion, abrasion and/or durability, is the number of years from installation until the deterioration reaches the point of exposed reinforcement at any point on the culvert. Changes in the design may be required in relatively severe acidic, chloride or sulfate environments. The levels of these constituents (either in the soil or water) will need to be identified in the project Materials or Geotechnical Design Report. The adopted procedure consists of a formula that the constituent concentrations are entered into in order to determine a pipe service life. The means for offsetting the affects of the corrosive elements is to increase the cover over the reinforcing steel, increase the cement content, or reduce the water/cement ratio.

Step 7. Table 855.2C constitutes a guide for abrasive resistant coatings in low to moderate abrasive conditions for metal pipe (i.e., Levels 1 through 5 in Table 855.2A) and is included in AltPipe. Table 855.2F constitutes a guide for minimum material thickness of abrasive resistant invert protection to achieve 50 years of maintenance-free service life in moderate to highly abrasive conditions (i.e., Levels 4 through 6 in Table 855.2A) and was not programmed into AltPipe. If pipe material thickness does not meet service life due to abrasive conditions, consideration for invert protection should be made using Table 855.2F as a guide.

857.3 Alternative Pipe Culvert (APC) and Pipe Arch Culvert List

Because of the difference in roughness coefficients between various materials, it may be necessary to specify a different size for each allowable material at any one location. In this event, it is recommended that the material with the smallest dimension be listed as the alternative size. Refer to Plans Preparation Manual for standard format to be used.

There may be situations where there is a different set of alternatives for the same nominal size of alternative drainage facilities. In this case the different sets of the same nominal size should be further identified by different types, for example, 18-inch alternative pipe culvert (Type A), 18-inch alternative pipe culvert (Type B), etc. No attempt to correlate type designation between projects is necessary. The first alternative combination for each culvert size on each project should be designated as Type A, second as Type B, etc.

Since the available nominal sizes for pipe arches vary slightly between pipe arch materials, it is recommended that the listed alternative pipe arch sizes conform to those sizes shown for corrugated steel pipe arches shown on Table 856.3D. The designer should verify the availability of reinforced concrete pipe arches. If reinforced concrete pipe arches are not available, oval shaped reinforced concrete pipe of a size necessary to meet the hydraulic requirements may be used as an alternative.

CHAPTER 860 – ROADSIDE CHANNELS

Topic 861 – General

Index 861.1 – Introduction

Chapter 860 addresses the design of small open channels called roadside channels that are constructed as part of a highway drainage system. See Figure 861.1.

Figure 861.1

Small Roadside Channel



An open channel is a conveyance in which water flows with a free surface. Although closed conduits such as culverts and storm drains function as open channels when flowing partially full, the term is generally applied to natural and improved watercourses, gutters, ditches, and channels. While the hydraulic principles discussed in this chapter are valid for all drainage structures, the primary consideration is given to roadside channels.

In addition to performing its hydraulic function, the roadside channel should be economical to construct and maintain. Some roadside channels serve as dual purpose channels which concurrently function as infiltration swales for stormwater purposes. See Index 861.11, “Water Quality Channels”. Roadside channel design should consider errant vehicles leaving the traveled way, be pleasing in appearance, convey collected water without damage to the transportation facility or adjacent property and minimize environmental impacts. These considerations are usually so interrelated that optimum conditions cannot be met for one without compromising one or more of the others. The objective is to achieve a reasonable balance, but the importance of traveler safety must not be underrated. See Index 861.4, “Safety Considerations”.

Roadside channels play an important role in the highway drainage system as the initial conveyance for highway runoff. Roadside channels are often included as part of the typical roadway section. Therefore, the geometry of roadside channels depends on available right-of-

July 1, 2020

way, flow capacity requirements, and the alignment and profile of the highway. Most roadside channels capture sheet flow from the highway pavement and cut slope and convey that runoff to larger channels or to culverts within the drainage system. See Figure 861.2.

Figure 861.2

Roadside Channel Outlet to Storm Drain at Drop Inlet



This initial concentration of runoff may create hydraulic conditions that are erosive to the soil that forms the channel boundary. To perform reliably, the roadside channel is often stabilized against erosion by placing a protective lining over the soil. This chapter presents two classes of channel linings called rigid and flexible linings that are well suited for construction of small roadside channels.

861.2 Hydraulic Considerations

An evaluation of hydraulic considerations for the channel design alternatives should be made early in the project development process. The extent of the hydrologic and hydraulic analysis should be commensurate with the type of highway, complexity of the drainage facility, and associated costs, risks, and impacts. Most of the roadside channels and swales discussed in this chapter convey design flows less than 50 cubic feet per second and generally do not require detailed hydrologic and hydraulic analyses beyond developing the parameters required for the Rational Formula (see Index 819.2(1)), Manning's Equation, and the shear stress equations presented within this Chapter and Hydraulic Engineering Circular (HEC) No. 15, "Design of Roadway Channels with Flexible Linings". The hydraulic design of an open channel consists of developing a channel section to carry the design discharge under the controlling conditions, adding freeboard as needed and determining the type of channel protection required to prevent erosion. In addition to erosion protection, channel linings can be used to increase the hydraulic capacity of the channel by reducing the channel roughness.

The hydraulic capacity of a roadside channel is dependent on the size, shape, slope and roughness of the channel section. For a given channel, the hydraulic capacity becomes greater as the grade or depth of flow increases. The channel capacity decreases as the channel surface becomes rougher. A rough channel can sometimes be an advantage on steep slopes where it is desirable to keep flow velocities from becoming excessively high. See Topics 866 and 867.

(1) *Flood Control Channels*. Flood control channels are typically administered by a local agency and present extreme consequences should failure occur. Therefore, when channels or drainage facilities under the jurisdiction of local flood control agencies or Corps of Engineers are involved, the design must be coordinated via negotiations with the District Hydraulic Engineer and the agencies involved. See Index 861.7, "Coordination with other Agencies" and Index 865.2.

For flood control purposes, a good open channel design within the right of way minimizes the effect on existing water surface profiles. Open channel designs which lower the water surface elevation can result in excessive flow velocities and cause erosion problems. A planned rise in water surface elevation can cause:

- Objectionable flooding of the roadbed and adjacent properties or facilities;
- An environmental and maintenance problem with sedimentation due to reduced flow velocities.

Additional hydraulic considerations may include: movable beds, heavy bedloads and bulking during flood discharges. A detailed discussion of sediment transport and channel morphology is contained in the FHWA's HDS No. 6 River Engineering for Highway Encroachments.

Reference is made to Volume VI of the AASHTO Highway Drainage Guidelines for a general discussion on channel hydraulic considerations.

861.3 Selection of "Design Flood"

As with other drainage facilities, the first step in the hydraulic design of roadside channels is to establish the range of peak flows which the channel section must carry. The recommended design flood and water spread criteria for roadway drainage type installations are presented in Table 831.3.

For flood control and cross drainage channels within the right of way, see Index 821.3, "Selection of Design Flood". Empirical and statistical methods for estimating design discharges are discussed in Chapter 810, "Hydrology".

861.4 Safety Considerations

An important aspect of transportation facility drainage design is that of traffic safety.

The shape of a roadside channel section should minimize vehicular impact and provide a traversable section for errant traffic leaving the traveled way. The ideal channel section, from a traversability standpoint, will have flattened side slopes and a curved transition to the channel bottom. When feasible, it is recommended that channels be constructed outside the clear recovery zone.

July 1, 2020

Figure 861.3

Damaged Channel



861.5 Maintenance Considerations

Design of open channels and roadside ditches should recognize that periodic maintenance inspection and repair is required. Provisions should be incorporated into the design for access to a channel by maintenance personnel and equipment. Consideration should be given to the size and type of maintenance equipment required when assessing the need for permanent or temporary access easements for entrance ramps and gates through the right of way fences.

Damaged channels can be expensive to repair and interfere with the safe and orderly movement of traffic.

Minor erosion damage within the right of way should be repaired immediately after it occurs and action taken to prevent the recurrence. Conditions which require extensive repair or frequently recurring maintenance may require a complete redesign rather than repetitive or extensive reconstruction. The advice of the District Hydraulics Engineer should be sought when evaluating the need for major restoration.

The growth of weeds, brush, and trees in a drainage channel can effectively reduce its hydraulic efficiency. See Figure 861.4. The result being that a portion of the design flow may overflow the channel banks causing flooding and possible erosion.

Accumulation of sediment and debris may destroy vegetative linings leading to additional erosion damage.

Channel work on some projects may be completed several months before total project completion. During this interim period, the contractor must provide interim protection measures. Per Index 865.3(3), the design engineer should include temporary channel linings to assure that minor erosion will not develop into major damage. As needed, the District Project Engineer may obtain vegetative recommendations from the District Landscape Architect. The Project Engineer must verify vegetative component compatibility with the final design.

Figure 861.4**Concrete Lined Channel with Excessive Weed Growth****861.6 Economics**

Economical drainage design is achieved by selecting the design alternative which best satisfies the established design criteria at the lowest cost.

The economic evaluation of design alternatives should be commensurate with the complexity and importance of the facility. Analysis of the channel location, shape, size, and materials involved may reveal possibilities for reducing construction costs, flood damage potential, maintenance problems and environmental impacts.

861.7 Coordination with Other Agencies

There are many Federal, State and local agencies and private entities engaged in water related planning, construction and regulation activities whose interests can affect the design of some highway drainage channels (e.g., flood control channels described under Index 861.2(1)). Such agencies may request the channel design satisfy additional and perhaps governing design criteria. Early coordination with these agencies may help avoid delays in the project development process and post-project conflicts. Early coordination may also reveal opportunities for cooperative projects which may benefit both Caltrans and the water resources agency. For information on cooperative agreements refer to Index 803.2.

861.8 Environment

Many of the same principles involved in sound highway construction and maintenance of open channels parallel environmental considerations. Environmental problems can arise if riparian species inhabit the channel. Erosion, sedimentation, water quality, and aesthetics should be of prime concern to the highway design engineer. Refer to Index 110.2 and the Project Planning and Design Guide for discussion on control of water pollution.

861.9 Unlined Channels

Whenever feasible, roadside channels should be designed with natural bottoms. Use linings only when warranted.

July 1, 2020

Refer to Table 865.2 for typical permitted shear stress and velocity for bare soil and vegetation.

861.10 Lined Channels

The main purposes of channel linings are:

- (a) To prevent erosion damage.
- (b) To increase velocity for prevention of excessive sedimentation
- (c) To increase capacity.

See Topic 865 for design concepts.

861.11 Water Quality Channels

Biofiltration swales are vegetated channels, typically configured as trapezoidal or v-shaped channels (trapezoidal recommended where feasible) that receive and convey stormwater flows while meeting water quality criteria and other flow criteria independent of Chapter 860. Pollutants are removed by filtration through the vegetation, sedimentation, absorption to soil particles, and infiltration through the soil. Strips and swales are effective at trapping litter, total suspended solids (soil particles), and particulate metals. In most cases, flow attenuation is also provided.

Refer to Appendix B, Table B-1 of the Project Planning and Design Guide for a summary of preliminary design factors for biofiltration strips and swales:

<http://www.dot.ca.gov/hq/oppd/stormwtr/ppdg/swdr2012/PPDG-May-2012.pdf>

See HDM Table 816.6A and Index 865.5 for Manning's roughness coefficients used for travel time calculations for the rational formula based on water quality flow (WQF) to check swale performance against biofiltration criteria at WQF, i.e., a Hydraulic Residence Time of 5 minutes or more; a maximum velocity of 1.0 ft/s; and a maximum depth of flow of 0.5 ft. See Bio-Strips and Bio-Swales under Biofiltration Design Guidance at:

http://www.dot.ca.gov/hq/oppd/storm1/caltrans_20090729.html

861.12 References

More complete information on hydraulic principles and engineering techniques of open channel design may be found in FHWA's Hydraulic Design Series No. 3, "Design Charts for Open Channel Flow", Hydraulic Design Series No. 4, "Introduction to Highway Hydraulics", Hydraulic Engineering Circular No. 15 (HEC No. 15), "Design of Roadway Channels with Flexible Linings" and Hydraulic Engineering Circular No. 22 (HEC No. 22), Chapter 5, "Urban Drainage Design Manual – Roadside and Median Channels". For a general textbook discussion of open channel hydraulics, reference is made to "Open-Channel Hydraulics" by Ven Te Chow. In addition, many helpful design aids are included in "Handbook of Hydraulics", by Brater and King.

Topic 862 – Roadside Drainage Channel Location

862.1 General

Assuming adequate functional design, the next most important design consideration is channel location. Locations that avoid poorly drained areas, unstable soil conditions, and frequently flooded areas can greatly reduce drainage related problems. Refer to Index 110.4 for discussion on wetlands protection.

Typically drainage and open channel considerations are not considered the primary decision factors in the roadway location; however they are factors which will often directly or indirectly affect many other considerations. Often minor alignment adjustments can avoid serious drainage problems.

If a channel can be located far enough away from the highway, the concerns of traffic safety and aesthetics can be significantly mitigated. See Figure 862.1. The cost of additional right of way may be offset somewhat by the reduced cost of erosion control, traffic protection, and landscaping.

Figure 862.1

Small-Rock Lined Channel Outside of Clear Recovery Zone



862.2 Alignment and Grade

Ordinarily, the highway drainage channel must be located where it will best serve its intended purpose, using the grade and alignment obtainable at the site. Insofar as practicable, abrupt changes in alignment and grade should be avoided. A sharp change in alignment presents a point of attack for flowing water, and abrupt changes in grade can result in possible scour when the grade is steepened or deposition of transported material when the grade is flattened.

Ideally, a drainage channel should have flow velocities that neither erode nor cause deposition in the channel. This optimum velocity is dependent on the size and slope of channel, the quantity of flowing water, the material used to line the channel, the nature of the bedding soil and the sediment being transported by the flow. Refer to Table 865.2 for recommended permissible flow

July 1, 2020

velocities in unlined channels. Realignment considerations for channels within the right of way are discussed in Index 867, Channel Changes.

862.3 Point of Discharge

The point of discharge into a natural watercourse requires special attention. Water entering a natural watercourse from a highway drainage channel should not cause eddies with attendant scour of the natural watercourse. In erodible embankment soils, if the flow line of the drainage channel is appreciably higher than that of the watercourse at the point of discharge, then the use of a spillway may be advisable to prevent erosion of the channel.

Topic 863 – Channel Section

863.1 Roadside and Median Channels

Roadside and median channels are open-channel systems which collect and convey stormwater from the pavement surface, roadside, and median areas. These channels may outlet to a storm drain piping system via a drop inlet (see Figure 861.2), to a detention or retention basin or other storage component, or to an outfall channel. Roadside and median channels are normally triangular or trapezoidal in cross section and are lined with grass or other protective lining.

Reference is made to the FHWA publication HEC No. 22, Chapter 5.

The shape of a channel section is generally determined by considering the intended purpose, terrain, flow velocity and quantity of flow to be conveyed.

863.2 Triangular

The triangular channel or V-ditch is intended primarily for low flow conditions such as in median and roadside ditches. V-shaped ditches are susceptible to erosion and will require lining when shear stress and velocity exceed the values given for bare soil in Table 865.2. It is good practice to round the bottom of a V-ditch. See Figure 862.1 and Figure 863.1.

863.3 Trapezoidal

The most common channel shapes is the trapezoidal section.

Trapezoidal channels are easily constructed by machinery and are often the most economical.

When a wide trapezoidal section is proposed, both traffic safety and aesthetics can be improved by rounding all angles of the channel cross section with vertical curves. The approximate length of these vertical curves can be determined by the formula:

$$L = \frac{40}{X}$$

where:

L = Length of vertical curve in feet

Figure 863.1**Small-Rock Lined Triangular Channel with Rounded Bottom**

X = Horizontal component of side slopes expressed as x, y coordinates with y = 1
For narrow channels, L, is limited to the bottom width.

863.4 Rectangular

Rectangular channels are used to convey large flows in areas with limited right of way. At some locations, guardrail or other types of positive traffic barrier may be necessary between the traveled way and the channel.

Though rectangular channels are relatively expensive to construct, since the walls must be designed as earth retaining structures, the construction costs can be somewhat offset by the reduced costs associated with right of way, materials, and channel excavation. See Index 865.2 for the design of concrete lined flood control channels.

Topic 864 – Channel Stability Design Concepts**864.1 General**

The gradient of roadside channels typically parallels the grade of the highway. Even at relatively mild highway grades, highly erosive hydraulic conditions can exist in adjacent roadside channels. Consequently, designing a stable conveyance becomes a critical component in the design of roadside channels.

The need for erosion prevention is not limited to the highway drainage channels; it extends throughout the right-of-way and is an essential feature of adequate drainage design. Erosion and maintenance are minimized largely by the use of flat side slopes rounded and blended with natural terrain, drainage channels designed with due regard to location, width, depth, slopes, alignment, and protective treatment, proper facilities for groundwater interception, dikes, berms, and other protective devices, and protective ground covers and planting.

July 1, 2020

864.2 Stable Channel Design Procedure

For most highway drainage channels bed and side slope instability cannot be tolerated and stable channel design must be based on the concepts of static equilibrium, including the use of a lining material if necessary. The permissible tractive force (shear stress) procedure requires that the shear stresses on the channel bottom and sides do not exceed the allowable amounts for the given channel boundary. Based on the actual physical processes involved in maintaining a stable channel, specifically the stresses developed at the interface between flowing water and materials forming the channel boundary, the tractive force procedure is a more realistic model and was adopted as the preferred design procedure for HEC No. 15, which is the primary reference for stable channel design.

The maximum shear stress along the channel bottom may be estimated by the following equation:

$$\tau_d = \gamma d S$$

where:

τ_d = Shear stress in channel at maximum depth, lb/ft²

γ = Specific weight of water

d = Maximum depth of flow in channel for the design discharge, ft

S = Slope of channel, ft/ft

When the permissible shear stress is greater than or equal to the computed shear stress, the lining is considered acceptable:

$$\tau_p \geq SF \tau_d$$

where:

τ_p = Permissible shear stress for the channel lining, lb/ft

SF = Safety factor

The safety factor provides for a measure of uncertainty, as well as a means for the designer to reflect a lower tolerance for failure by choosing a higher safety factor. A safety factor of 1.0 is appropriate in many cases and may be considered the default. However, safety factors from 1.0 to 1.5 may be appropriate, subject to the designer's discretion, where one or more of the following conditions may exist:

- (a) critical or supercritical flows are expected
- (b) climatic regions where vegetation may be uneven or slow to establish
- (c) significant uncertainty regarding the design discharge
- (d) consequences of failure are high

The relationship between permissible shear stress and permissible velocity for a lining can be found by substituting the equation for maximum shear stress and continuity equation into Manning's equation:

$$V_p = \frac{\alpha}{n\sqrt{\gamma d}} R^{1/6} \tau_p^{1/2}$$

where:

V_p = Permissible velocity, ft/s

τ_p = Permissible shear stress, lb/ft²

α = Unit conversion constant, 1.49

As a guide, Table 865.2 provides typical values of permissible velocity and permissible shear stress for selected lining types.

The basic procedure for designing a flexible lining consists of the following steps.

Step 1. Determine a design discharge, Q , and select the channel slope and channel shape.

Step 2. Select a trial lining type. Initially, the Engineer may need to determine if a long-term lining is needed and whether or not a temporary or transitional lining is required. For determining the latter, the trial lining type could be chosen as the native material (unlined), typically bare soil. For example, it may be determined that the bare soil is insufficient for a long-term solution, but vegetation is a good solution. For the transitional period between construction and vegetative establishment, analysis of the bare soil will determine if a temporary lining is prudent. Per Index 865.1, District Landscape should be consulted to provide feasible long-term vegetation recommendations. The Engineer and the Landscape Architect should discuss the compatibility of any living materials (temporary, transitional or permanent) with the proposed lining material and verify impacts to conveyance before the Engineer finalizes the design.

Step 3. Estimate the depth of flow, d_i in the channel and compute the hydraulic radius, R . The estimated depth may be based on physical limits of the channel, but this first estimate is essentially a guess. Iterations on Steps 3 through 5 may be required.

Step 4. Estimate Manning's n and the discharge implied by the estimated n and flow depth values. Calculate the discharge (Q_i).

Step 5. Compare Q_i with Q . If Q_i is within 5 percent of the design, Q , then proceed on to Step 6. If not, return to Step 3 and select a new estimated flow depth, d_{i+1} . This can be estimated from the following equation or any other appropriate method.

$$d_{i+1} = d_i \left(\frac{Q}{Q_i} \right)^{0.4}$$

Step 6. Calculate the shear stress at maximum depth, τ_d , determine the permissible shear stress, τ_p , according to the methods described in HEC No. 15 and select an appropriate safety factor (i.e., 1 to 1.5).

Step 7. Compare the permissible shear stress to the calculated shear stress from Step 6 using:

$$\tau_p \geq SF\tau_d$$

If the permissible shear stress is adequate then the lining is acceptable. If the permissible shear is inadequate, then return to Step 2 and select an alternative lining type with greater permissible shear stress from Table 865.2. As an alternative, a different channel shape may be selected

July 1, 2020

that results in a lower depth of flow. The selected lining is stable and the design process is complete. Other linings may be tested, if desired, before specifying the preferred lining.

Direct solutions for Manning's equation for many channels of trapezoidal, rectangular, triangular and circular cross sections can be found within the Channel Analysis subcomponent FHWA's Hydraulic Toolbox software program.

864.3 Side Slope Stability

Shear stress is generally reduced on the channel sides compared with the channel bottom. The maximum shear on the side of a channel is given by the following equation:

$$\tau_s = K_1 \tau_d$$

where:

τ_s = Side shear stress on the channel, lb/ft²

K_1 = Ratio of channel side to bottom shear stress

τ_d = Shear stress in channel at maximum depth, lb/ft²

The value K_1 depends on the size and shape of the channel. For parabolic or V-shape with rounded bottom channels there is no sharp discontinuity along the wetted perimeter and therefore it can be assumed that shear stress at any point on the side slope is related to the depth at that point using the shear stress equation from Index 864.2:

$$\tau_d = \gamma d S$$

For trapezoidal and triangular channels, the following K_1 values may be applied:

$$K_1 = 0.77 \quad Z \leq 1.5$$

$$K_1 = 0.066Z + 0.67 \quad 1.5 < Z < 5$$

$$K_1 = 1.0 \quad 5 \leq Z$$

The Z value represents the horizontal dimension 1:Z (V:H). Use of side slopes steeper than 1:3 (V:H) is not encouraged for flexible linings because of the potential for erosion of the side slopes. Steep side slopes are allowable within a channel if cohesive soil conditions exist. Channels with steep slopes should not be allowed if the channel is constructed in non-cohesive soils.

For channels lined with gravel or small-rock slope protection, the maximum suggested side slope is 1 V : 3 H, and flatter slopes are encouraged. If steeper side slopes are required, see Chapter 6 of HEC No. 15 for design procedures.

Topic 865 – Channel Linings

865.1 Flexible Verses Rigid

Lining materials may be classified as flexible or rigid. Flexible linings are able to conform to changes in channel shape and can sustain such changes while maintaining the overall integrity of the channel. In contrast, rigid linings cannot change shape and tend to fail when a portion of the channel lining is damaged. Channel shape may change due to frost-heave, slumping, piping,

etc. Typical flexible lining materials include grass or small-rock slope protection, while typical rigid lining materials include hot mixed asphalt or Portland cement concrete. Flexible linings are generally less expensive, may have a more natural appearance, permit infiltration and exfiltration and are typically more environmentally acceptable. Vegetative channel lining is also recognized as a best management practice for storm water quality design in highway drainage systems. A vegetated channel helps to deposit highway runoff contaminants (particularly suspended sediments) before they leave the highway right of way and enter streams. See Index 861.11 'Water Quality Channels' and Figure 865.1.

On steep slopes, most vegetated flexible linings are limited in the erosive forces they can sustain without damage to the channel and lining unless the vegetative lining is combined with another more erosion-resistant long-term lining below, such as a cellular soil confinement system. See Figure 865.1 and Index 865.3(1). The District Landscape Architect should be contacted to provide viable vegetation alternatives within the District, however all design responsibilities belong to the Project Engineer.

Figure 865.1

Steep-Sloped Channel with Composite Vegetative Lining

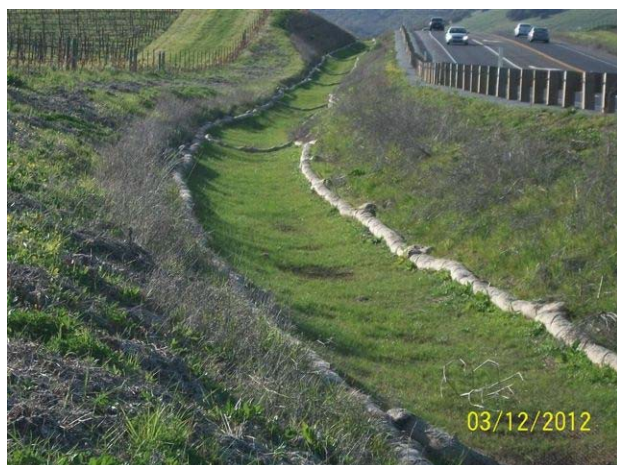

Vegetative flexible lining placed on top of cellular soil confinement system on a steep-sloped channel.

865.2 Rigid

A rigid lining can typically provide higher capacity and greater erosion resistance and in some cases may be the only feasible alternative.

Rigid linings are useful in flow zones where high shear stress or non-uniform flow conditions exist, such as at transitions in channel shape or at an energy dissipation structure.

The most commonly used types of rigid lining are hot mixed asphalt and Portland cement concrete. Hot mixed asphalt is used mainly for small ditches, gutters and overside drains (see Standard Plan D87D) because it cannot withstand hydrostatic pressure from the outside.

Table 865.1 provides a guide for Portland cement concrete and air blown mortar roadside channel linings. See photo below Table 865.1 for example.

July 1, 2020

For the design of concrete lined flood control channels discussed in Index 861.2 (1), see U.S. Army Corps of Engineers publication; "Structural Design of Concrete Lined Flood Control Channels", EM 1110-2-2007:

<http://planning.usace.army.mil/toolbox/library/EMs/em1110.2.2007.pdf>

Table 865.1

Concrete⁽²⁾ Channel Linings

Abrasion Level ⁽¹⁾	Thickness of Lining (in)		Minimum Reinforcement
	Sides	Bottom	
1 - 3	5	5	6 x 6- W2.9 x W2.9 welded wire fabric

NOTES:

⁽¹⁾See Table 855.2A.

⁽²⁾Portland Cement Concrete or Air Blown Mortar

Figure 865.2

Concrete Lined Channel



For large flows, consideration should be given to using a minimum bottom width of 12 feet for construction and maintenance purposes, but depths of flow less than one foot are not recommended. Despite the non-erodible nature of rigid linings, they are susceptible to failure from foundation instability and abrasion. The major cause of failure is undermining that can occur in a number of ways.

Trapezoidal Channel Within the Clear Recovery Zone (CRZ): Foreslopes and backslopes of trapezoidal channel constructed within the CRZ should not be steeper than 4:1. Trapezoidal channel sections located within the CRZ should have foreslopes matching the slopes of the CRZ slopes but should not be steeper than 4:1 (refer to Figures 305.6, 307.2, 307.4A, 307.4B, and 307.5). The backslope should not be steeper than 4:1. The bottom width of the channel should not be less than 4 feet (see Figure 834.3). The trapezoidal channel cross-section should satisfy hydraulic conveyance as well as support the load of errant vehicles without the wheels sinking into saturated soil in the channel section. Design criteria for concrete lined channels may be referenced from the US Army Corps Publication “Structural Design of Concrete Lined Flood Control Channels, EM 1110-2-2007”.

865.3 Flexible

Flexible linings can be long-term, transitional or temporary. Long-term flexible linings are used where the channel requires protection against erosion for the design service life of the channel. Per Index 861.12, more complete information on hydraulic principles and engineering techniques of flexible channel lining design may be found in HEC No. 15 and Chapter 5 of HEC No. 22.

Flexible linings act to reduce the shear stress on the underlying soil surface. Therefore, the erodibility of the underlying soil is a key factor in the performance of flexible linings. Erodibility of non-cohesive soils (plasticity index less than 10) is mainly due to particle size, while cohesive soil erodibility is a function of cohesive strength and soil density. Vegetative and rolled erosion control product lining performance relates to how well they protect the underlying soil from shear stress, and so these lining types do not have permissible shear stresses independent of soil type. The soil plasticity index should be included in the Materials or Geotechnical Design Report.

In general, when a lining is needed, the lowest cost lining that affords satisfactory protection should be used. This may include vegetation used alone or in combination with other types of linings. Thus, a channel might be grass-lined on the flatter slopes and lined with more resistant material on the steeper slopes. In cross section, the channel might be lined with a highly resistant material (e.g., cellular soil confinement system – see Index 865.3(1) *Long Term*) within the depth required to carry floods occurring frequently and lined with grass above that depth for protection from the rare floods.

(1) *Long Term*. Long-term lining materials include vegetation, rock slope protection, gabions (wire-enclosed rock), and turf reinforcement mats with enhanced UV stability. Standard Specification Section 72-4 includes specifications for constructing small-rock slope protection for gutters, ditches or channels and includes excavating and backfilling the footing trench, placing RSP fabric and placing small rocks (cobble, gravel, crushed gravel, crushed rock, or any combination of these) on the slope. Where the channel design includes a requirement for runoff infiltration to address stormwater needs, the designer may need to consider installation of a granular filter in lieu of RSP fabric if it is anticipated that the RSP fabric would become clogged with sediment. See following link to HEC No. 23, Volume 2, Design Guideline 16, Index 16.2.1, for information on designing a granular filter:

<http://www.fhwa.dot.gov/engineering/hydraulics/pubs/09112/page16.cfm>

Standard Specification Section 72-16 includes specifications for constructing gabion structures. Gabions consist of wire mesh baskets that are placed and then filled with rock. Gabion basket wires are susceptible to corrosion and are most appropriate for use as a channel lining where corrosion potential is minimized, such as desert or other arid locations.

July 1, 2020

Cellular soil confinement systems may be used as an alternative for steep channels with a variety of infills available including soil and gravel. Soil confinement systems consist of sheet polyethylene spot welded to form a system of individual confinement cells. See Figure 865.3.

Figure 865.3**Long-Term Flexible Lining**

Placing a polyethylene cellular soil confinement system on a steep-sloped channel.

Per Index 865.1, these systems may be combined with other vegetated flexible linings, e.g., turf reinforcement mats.

- (2) *Transitional*. Transitional flexible linings are used to provide erosion protection until a long-term lining, such as grass, can be established. For mild slopes, these may include jute netting (depending on environmental, i.e., wildlife, parameters) or turf reinforcement. Turf reinforcement can serve either a transitional or long-term function by providing additional structure to the soil/vegetation matrix. Typical turf reinforcement materials include gravel/soil mixes and turf reinforcement mats (TRM's). A TRM is a non-degradable rolled erosion control product (RECP) processed into a three-dimensional matrix. For examples see following link:

<http://www.dot.ca.gov/hq/LandArch/ec/recp/trm.htm>

The design for transitional products should be based on a flood event with an exceedance probability at least equal to the expected product service life (i.e., 12 to 36 months).

- (3) *Temporary*. Temporary channel linings are used without vegetation to line channels that might be part of a construction site or some other short-term channel situation.

Standard Specification Section 21-1 was developed primarily to address slope erosion products, however, it includes specifications for constructing turf reinforcing mats, netting and rolled erosion control products (RECP's – see Index 865.6) which may also be applied to channels as temporary and transitional linings. See Index 865.1 for coordinating vegetative recommendation with District Landscape Architecture.

865.4 Composite Lining Design

The procedure for composite lining design is based on the stable channel design procedure presented in Index 864.2 with additional sub-steps to account for the two lining types. Specifically, the modifications are:

- Step 1. Determine design discharge and select channel slope and shape. (No change.)
- Step 2. Need to select both a low flow and side slope lining. (See Table 866.3A.)
- Step 3. Estimate the depth of flow in the channel and compute the hydraulic radius. (No change.)
- Step 4. After determining the Manning's n for the low flow and side slope linings, calculate the effective Manning's n:

$$n_e = \left[\frac{P_L}{P} + \left(1 - \frac{P_L}{P} \right) \left(\frac{n_s}{n_L} \right)^{3/2} \right]^{2/3} n_L$$

where:

- n_e = Effective Manning's n value for the composite channel
- P_L = Low flow lining perimeter, ft
- P = Total flow perimeter, ft
- n_s = Manning's n value for the side slope lining
- n_L = Manning's n value for the low flow lining

- Step 5. Compare implied discharge and design discharge. (No change.)
- Step 6. Determine the shear stress at maximum depth, τ_d ($\tau_d = \gamma dS$), and the shear stress on the channel side slope, τ_s (see Index 864.2).
- Step 7. Compare the shear stresses, τ_d and τ_s , to the permissible shear stress, τ_p , for each of the channel linings. If τ_d or τ_s is greater than the τ_p for the respective lining, a different combination of linings should be evaluated. See Table 865.2.

865.5 Bare Soil Design and Grass Lining

Per Index 865.1, the District Landscape Architect should be contacted to recommend vegetation alternatives (including vegetation for transitional products, if needed) and the same procedure for the stable channel design procedure presented in Index 864.2 should be followed by the Project Engineer. See Figure 865.4 for grass lining example in a median channel. For slope stability when constructing embankment (4:1 and steeper), 85-90% relative compaction is desired. Although not optimal for best plant growth, compaction of up to 90% is not a major constraint for grass establishment. Prior to seeding, scarification to a depth of 1 inch of the compacted soil surface is recommended for improving initial runoff absorption and ensuring the seed is incorporated into the soil. A temporary degradable erosion control blanket (ECB) (e.g., single net straw) can then be installed on top.

The permissible shear stress for the vegetation is based on the design flood (Table 831.3). If the calculated shear for any given vegetation method is inadequate, then an alternative vegetation

July 1, 2020

type with greater shear stress must be selected and/or a different channel shape may be selected that results in a lower depth of flow.

Figure 865.4

Grass-Lined Median Channel



The permissible shear stress for rolled erosion control products should be based on a flood event with an exceedance probability no less than the expected product service life (i.e., 12 to 36 months). The maximum shear stresses for channel applications shown in Erosion Control Technology Council Rolled Erosion Control Products Specification Chart must be lower than the permissible shear stresses indicated in Table 865.2. See: <https://www.ectc.org/specifications>.

The Manning's roughness coefficient for grass linings varies depending on grass properties and shear stress given that the roughness changes as the grass stems bend under flow. The equation describing the n value for grass linings is:

$$n = \alpha C_n \tau_0^{-0.4}$$

where:

τ_0 = Average boundary shear stress, lb/ft²

α = Unit conversion constant, 0.213

C_n = Grass roughness coefficient (use 0.20 or Tables 4.3 and 4.4 from HEC-15)

The remaining shear at the soil surface is termed the effective shear stress. When the effective shear stress is less than the allowable shear for the soil surface, then erosion of the soil surface will be controlled. The effective shear at the soil surface is given by the following equation.

$$\tau_e = \tau_d (1 - C_f) \left(\frac{n_s}{n} \right)^2$$

where:

τ_e = Effective shear stress on the soil surface, lb/ft²

τ_d = Design shear stress, lb/ft²

C_f = Grass cover factor (use 0.6 to 0.8 or Table 4.5 from HEC-15)

n_s = Soil grain roughness

n = Overall lining roughness

The soil grain roughness, n_s , is 0.016 when $D_{75} < 0.05$ in. For larger grained soils the soil grain roughness is

$$n_s = \alpha(D_{75})^{1/6}$$

where:

n_s = Soil grain roughness ($D_{75} > 1.3$ (0.05 in))

D_{75} = Soil size where 75 percent of the material is finer, in

α = Unit conversion constant, 0.026

The permissible soil shear stress for fine-grained, non-cohesive soils ($D_{75} < 0.05$ in. is relatively constant and is conservatively estimated at 0.02 lb/ft². For coarse grained, non-cohesive soils (0.05 in. $< D_{75} < 2$ in.) the following equation applies.

$$\tau_{p,soil} = \alpha D_{75}$$

where:

$\tau_{p,soil}$ = Permissible soil shear stress, lb/ft²

D_{75} = Soil size where 75 percent of the material is finer, in

α = Unit conversion constant, 0.4

A simplified approach for estimating the permissible shear stress for cohesive soils (based on Equation 4.6 in Chapter 4 of HEC No. 15) is illustrated in Figure 4.1 of Chapter 4 in HEC No. 15. The combined effects of the soil permissible shear stress and the effective shear stress transferred through the vegetative lining results in a permissible shear stress for the given conditions. Table 865.2 provides typical values of permissible shear stress and permissible velocity for cohesive soils and selected lining types. Representative values for different soil, vegetation and lining types are based on the methods found in Chapter 4 of HEC No. 15 while those for gravel, rock gabions and rock slope protection are based on methods found in Chapters 6 and 7 of HEC No. 15. The permissible shear stress values shown for soil confinement systems are based on testing by others, however, the maximum permissible velocity shown in Table 865.2 for all boundary types has been limited to 12 feet per second based on the following assumptions:

- The upper limit of flow rate is 50 cfs
- The longitudinal slope is 10 percent maximum
- The maximum side slope is 2H:1V
- The maximum storm duration is one hour

July 1, 2020

Table 865.2

Permissible Shear and Velocity for Selected Lining Materials⁽²⁾

Boundary Category	Boundary Type	Permissible Shear Stress (lb/ft ²)	Permissible Velocity (ft/s)
Soils ⁽¹⁾	Fine colloidal sand	0.03	1.5
	Sandy loam (noncolloidal)	0.04	1.75
	Clayey sands (cohesive, PI ≥ 10)	0.095	2.6
	Inorganic silts (cohesive, PI ≥ 10)	0.11	2.7
	Silty Sands (cohesive, PI ≥ 10)	0.072	2.4
	Alluvial silt (noncolloidal)	0.05	2
	Silty loam (noncolloidal)	0.05	2.25
	Finer than coarse sand - D ₇₅ < 0.05 in. (non-cohesive)	0.02	1.3
	Firm loam	0.075	2.5
	Fine gravels	0.075	2.5
	Fine gravel (non-cohesive, D ₇₅ = 0.3 in, PI<10)	0.12	2.8
	Gravel (D ₇₅ = 0.6 in) (non-cohesive, D ₇₅ = 0.6 in, PI<10)	0.24	3.7
	Inorganic clays (cohesive, PI ≥ 20)	0.14	2.9
	Stiff clay	0.25	4.5
	Alluvial silt (colloidal)	0.25	3.75
	Graded loam to cobbles	0.38	3.75
	Graded silts to cobbles	0.43	4
Shales and hardpan	0.67	6	
Vegetation	Class A turf (Table 4.1, HEC No. 15)	3.7	8
	Class B turf (Table 4.1, HEC No. 15)	2.1	7
	Class C turf (Table 4.1, HEC No. 15)	1.0	3.5
	Long native grasses	1.7	6
	Short native and bunch grass	0.95	4

Table 865.2

Permissible Shear and Velocity for Selected Lining Materials⁽²⁾ (cont.)

Boundary Category	Boundary Type	Permissible Shear Stress (lb/ft ²)	Permissible Velocity (ft/s)
Rolled Erosion Control Products (RECPs)			
Temporary Degradable Erosion Control Blankets (ECBs)	Single net straw	1.65	3
	Double net coconut/straw blend	1.75	6
	Double net shredded wood	1.75	6
Open Weave Textile (OWT)	Jute	0.45	2.5
	Coconut fiber	2.25	4
	Vegetated coconut fiber	8	9.5
	Straw with net	1.65	3
Non Degradable Turf Reinforcement Mats (TRMs)	Unvegetated	3	7
	Partially established	6.0	12
	Fully vegetated	8.00	12
Rock Slope Protection, Cellular Confinement and Concrete			
Rock Slope Protection	Small-Rock Slope Protection (4-inch Thick Layer)	0.8	6
	Small-Rock Slope Protection (7-inch Thick Layer)	2	8
	No. 2	2.5	10
	Facing	5	12
Gabions	Gabions	6.3	12
Cellular Confinement: Vegetated infill	71 in ² cell and TRM	11.6	12
Cellular Confinement: Aggregate Infill	1.14 - in. D ₅₀ (45 in ² cell)	6.9	12
	3.5" D ₅₀ (45 in ² cell)	15.1	11.5
	1.14" D ₅₀ (71 in ² cell)	13.2	12
	3.5" D ₅₀ (71 in ² cell)	18	11.7
	1.14" D ₅₀ (187 in ² cell)	10.92	12
	3.5" D ₅₀ (187 in ² cell)	10.55	12
Cellular Confinement: Concrete Infill	(71 in ² cell)	2	12
Hard Surfacing	Concrete	12.5	12

NOTES:

(1)PI = Plasticity Index (From Materials or Geotechnical Design Report)

(2)Some materials listed in Table 856.2 have been laboratory tested at shear stresses/velocities above those shown. For situations that exceed the values listed for roadside channels, contact the District Hydraulic Engineer.

July 1, 2020

When the permissible shear stress is greater than or equal to the computed shear stress, the lining is considered acceptable. If the computed velocity exceeds the permissible velocity, or any of the above-listed assumptions are exceeded, contact the District Hydraulic Engineer for support.

865.6 Rolled Erosion Control Products

- (1) *General.* Manufacturers have developed a variety of rolled erosion control products (RECPs) for erosion protection of channels.

RECPs consist of materials that are stitched or bound into a fabric. Vegetative and RECP lining performance relates to how well they protect the underlying soil from shear stresses so these linings do not have permissible shear stresses independent of soil types. Chapters 4 (vegetation) and 5 (RECPs) of HEC No. 15 describe the methods for analyzing these linings. Standard Specification Section 21-1 was developed primarily to address slope erosion products, however, the specifications for constructing turf reinforcing mats (TRM's), open weave textiles and erosion control blankets may also be applied to channels as temporary and transitional linings, and some TRM's may be used as permanent linings.

- (2) *Non-Hydraulic Design Considerations.* The long-term performance of TRMs has traditionally been evaluated using hydraulic testing performance within controlled flume environments, or laboratory testing of specific parameters, usually conforming to ASTM or other industry standards. In recent years additional important design factors have been identified, from damages due to insect infestation to drainage problems or soil conditions resulting in poor vegetative establishment. Table 5.5 within Chapter 5 of HEC No. 15 provides a detailed TRM protocol checklist.

Six broad categories of stressors or potential damages to RECPs are listed below that can cause decrease in performance, considered as a function of specific properties of these lining materials.

- (a) Environmental stress – tensile stresses that exceed the mechanical strength of the material accelerated by other stresses in the exposure environment.

Many manufacturer-reported values for maximum velocity or shear stress are based on short duration testing, however, longer duration flows – hours to days – more closely represent field conditions. Erosive properties of soils change with saturation, vegetation becomes stressed or damaged, and properties of some lining materials change with long periods of inundation or hydraulic stress. The result is that maximum reported shear stress and velocity may overestimate actual field performance of the full range of channel lining materials in the event of longer duration flows (Table 865.2). See Index 865.5 for safety factor discussion.

- (b) Mechanical damage – localized damage due to externally applied loads such as debris or machinery, often during installation but also due to operation and maintenance activities
- (c) Oxidation – due to exposure to air and water, a chemical reaction with a specific chemical group in a constituent polymer that leads to damage at a molecular level and changes in physical properties. Other chemical stresses can include acidity, corrosives, salinity, ozone and other air pollutants.
- (d) Photo degradation – change in chemical structure due to exposure to UV wavelengths of sunlight, most often occurring during installation, prior to full vegetation establishment or inadequate vegetation establishment and coverage over time.

UV-Resistance per ASTM D-4355 should conform to the following for the specified type of TRM and design life:

- Temporary or transitional TRM – 90% tensile strength retained at 500 hr for the TRM product to be considered up to a 5-year design life.
 - Long-term TRM – 90% tensile strength retained at 5,000 hr for the TRM product to be considered up to a 50-year design life.
- (e) Temperature instability – changes in appearance, weight, dimension or other properties as a result of low, high, or cyclic temperature exposure.

As TRM or other materials are degrading, the vegetative component of a project is simultaneously becoming established, presumably leading to an overlap in effectiveness of each component. The engineer must carefully evaluate published performance data for specific materials with anticipated degradation, consider specific performance added by vegetative components, and apply a factor of safety in choosing materials that may provide enough strength initially to bridge the gap. Per Index 865.6(1), the District Landscape Architect should be consulted to provide viable long-term and compatible transitional vegetation recommendations (if required by the designer).

Topic 866 – Hydraulic Design of Roadside Channels

866.1 General

Open channel hydraulic design is of particular importance to highway design because of the interrelationship of channels to most highway drainage facilities.

The hydraulic principles of open channel flow are based on steady state uniform flow conditions, as defined in Index 866.2. Though these conditions are rarely achieved in the field, generally the variation in channel properties is sufficiently small that the use of uniform flow theory will yield sufficiently accurate results for most roadside channels.

866.2 Flow Classifications

- (1) *Steady vs. Unsteady Flow.* The flow in an open channel can be classified as steady or unsteady. The flow is said to be steady if the depth of flow at a section, for a given discharge, is constant with respect to time. The flow is considered unsteady if the depth of flow varies with respect to time.
- (2) *Uniform Flow.* Steady flow can further be classified as uniform or nonuniform. The flow is said to be uniform if the depth of flow and quantity of water are constant at every section of the channel under consideration. Uniform flow can be maintained only when the shape, size, roughness and slope of the channel are constant. Under uniform flow conditions, the depth and mean velocity of flow is said to be normal. Under these conditions the water surface and flowlines will be parallel to the stream bed and a hydrostatic pressure condition will exist, the pressure at a given section will vary linearly with depth.

As previously mentioned, uniform flow conditions are rarely attained in the field, but the error in assuming uniform flow in a channel of fairly constant slope, roughness and cross section is relatively small when compared to the uncertainties of estimating the design discharge.

- (3) *Non-uniform Flow.* There are two types of steady state non-uniform flow:
- Gradually varied flow.

July 1, 2020

Gradually varied flow is described as a steady state flow condition where the depth of water varies gradually over the length of the channel. Under this condition, the streamlines of flow are practically parallel and therefore, the assumption of hydrostatic pressure distribution is valid and uniform flow principles can be used to analyze the flow conditions.

- Rapidly varied flow.

With the rapidly varied flow condition, there is a pronounced curvature of the flow streamlines and the assumption of hydrostatic pressure distribution is no longer valid, even for the continuous flow profile. A number of empirical procedures have been developed to address the various phenomena of rapidly varied flow. For additional discussion on the topic of rapidly varied flow, refer to "Open-Channel Hydraulics" by Chow.

866.3 Open Channel Flow Equations

The equations of open channel flow are based on uniform flow conditions. Some of these equations have been derived using basic conservation laws (e.g. conservation of energy) whereas others have been derived using an empirical approach.

(1) *Continuity Equation.* One of the fundamental concepts which must be satisfied in all flow problems is the continuity of flow. The continuity equation states that the mass of fluid per unit time passing every section in a stream of fluid is constant. The continuity equation may be expressed as follows:

$$Q = A_1V_1 = A_2V_2 = \dots = A_nV_n$$

Where Q is the discharge, A is the cross-sectional flow area, and V is the mean flow velocity. This equation is not valid for spatially varied flow, i.e., where flow is entering or leaving along the length of channel under consideration.

(2) *Bernoulli Equation.* Water flowing in an open channel possesses two kinds of energy: (1) potential energy and (2) kinetic energy. Potential energy is due to the position of the water surface above some datum. Kinetic energy is due to the energy of the moving water. The total energy at a given section as expressed by the Bernoulli equation is equal to:

$$H = z + d + \frac{V^2}{2g}$$

where:

- H = Total head, in feet of water
- z = Distance above some datum, in feet
- d = Depth of flow, in feet
- $\frac{V^2}{2g}$ = Velocity head, in feet
- g = Acceleration of gravity
= 32.2 feet per second squared

(3) *Energy Equation.* The basic principle used most often in hydraulic analysis is conservation of energy or the energy equation. For uniform flow conditions, the energy equation states that the energy at one section of a channel is equal to the energy at any downstream section

plus the intervening energy losses. The energy equation, expressed in terms of the Bernoulli equation, is:

$$z_1 + d_1 + \frac{V_1^2}{2g} = z_2 + d_2 + \frac{V_2^2}{2g} + h_L$$

where:

h_L = Intervening head losses, in feet

- (4) *Manning's Equation.* Several equations have been empirically derived for computing the average flow velocity within an open channel. One such equation is the Manning Equation. Assuming uniform and turbulent flow conditions, the mean flow velocity in an open channel can be computed as:

$$V = \frac{1.486}{n} R^{2/3} S^{1/2}$$

where:

V = Mean velocity, in feet per second

n = Manning coefficient of roughness

S = Channel slope, in foot per foot

R = Hydraulic Radius, in feet

= A/WP

where:

A = Cross sectional flow area, in square feet

WP = Wetted perimeter, in feet

Commonly accepted values for Manning's roughness coefficient, n, based on materials and workmanship required in the Standard Specifications, are provided in Table 866.3A. The tabulated values take into account deterioration of the channel lining surface, distortion of the grade line due to unequal settlement, construction joints and normal surface irregularities. These average values should be modified to satisfy any foreseeable abnormal conditions. See Chapters 4 and 6 in HEC No. 15 for Manning's roughness equations for grass linings, RSP, cobble and gravel linings. Refer to Index 861.11 for a discussion of Manning's roughness coefficients for water quality channels.

Direct solutions for Manning's equation for many channels of trapezoidal, rectangular, triangular and circular cross sections can be found within the Channel Analysis subcomponent FHWA's Hydraulic Toolbox software program.

- (5) *Conveyance Equation.* Often it is convenient to group the properties peculiar to the cross section into one term called the conveyance factor, K. The conveyance factor, as expressed by the Manning's equation, is equal to:

$$K = \frac{1.486}{n} AR^{2/3}$$

For the non-pressure, full flow condition, the geometric properties and conveyance of a channel section can be computed. Then for a given channel slope the discharge capacity can be easily determined.

July 1, 2020

(6) *Critical Flow.* A useful concept in hydraulic analysis is that of "specific energy". The specific energy at a given section is defined as the total energy, or total head, of the flowing water with respect to the channel bottom. For a channel of small slope;

$$E = d + \frac{V^2}{2g}$$

Table 866.3A**Average Values for Manning's Roughness Coefficient (n)**

Type of Channel	n value
Unlined Channels:	
Clay Loam	0.023
Sand	0.020
Gravel	0.030
Rock	0.040
Lined Channels:	
Portland Cement Concrete	0.014
Air Blown Mortar (troweled)	0.012
Air Blown Mortar (untroweled)	0.016
Air Blown Mortar (roughened)	0.025
Asphalt Concrete	0.016-0.018
Sacked Concrete	0.025
Pavement and Gutters:	
Portland Cement Concrete	0.013-0.015
Hot Mix Asphalt Concrete	0.016-0.018
Depressed Medians:	
Earth (without growth)	0.016-0.025
Earth (with growth)	0.050
Gravel ($d_{50} = 1$ in. flow depth ≤ 6 in.)	0.040
Gravel ($d_{50} = 2$ in. flow depth ≤ 6 in.)	0.056

NOTES:

For additional values of n, see HEC No. 15, Tables 2.1 and 2.2, and "Introduction to Highway Hydraulics", Hydraulic Design Series No. 4, FHWA Table 14.

where:

E = Specific energy, in feet

d = Depth of flow, in feet

$$\frac{V^2}{2g} = \text{Velocity head, in feet}$$

When the depth of flow is plotted against the specific energy, for a given discharge and channel section, the resulting plot is called a specific energy diagram (see Figure 866.3C). The curve shows that for a given specific energy there are two possible depths, a high stage and a low stage. These flow depths are called alternate depths. Starting at the upper right of the curve with a large depth and small velocity, the specific energy decreases with a decrease in depth, reaching a minimum energy content at a depth of flow known as critical depth. A further decrease in flow depth results in a rapid increase in specific energy.

Flow at critical depth is called critical flow. The flow velocity at critical depth is called critical velocity. The channel slope which produces critical depth and critical velocity for a given discharge is the critical slope.

Figure 866.3C

Specific Energy Diagram

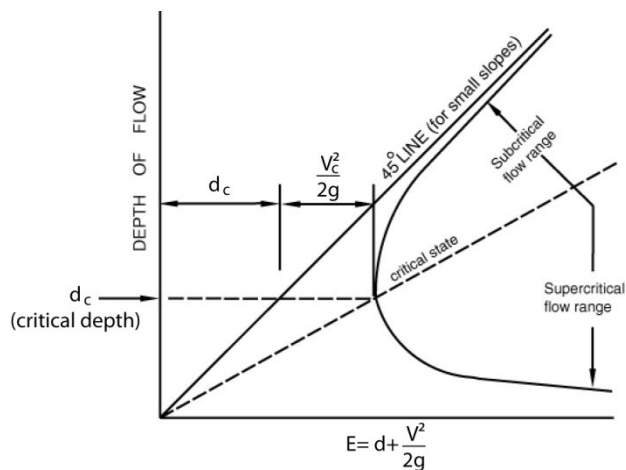

Uniform flow within approximately 10 percent of critical depth is unstable and should be avoided in design, if possible. The reason for this can be seen by referring to the specific energy diagram. As the flow approaches critical depth from either limb of the curve, a very small change in energy is required for the depth to abruptly change to the alternate depth on the opposite limb of the specific energy curve. If the unstable flow region cannot be avoided in design, the least favorable type of flow should be assumed for the design.

When the depth of flow is greater than critical depth, the velocity of flow is less than critical velocity for a given discharge and hence, the flow is subcritical. Conversely, when the depth of flow is less than critical depth, the flow is supercritical.

When velocities are supercritical, air entrainment may occur. This produces a bulking effect which increases the depth of flow. For concrete lined channels, the normal depth of flow with bulking can be computed by using a Manning's "n" value of 0.018 instead of the 0.014 value given in Table 866.3A. Air entrainment also causes a reduction in channel friction with a resulting increase in flow velocity. A Manning's "n" value of about 0.008 is recommended for computing the velocity and specific energy of flow in concrete-lined channels carrying supercritical flow

July 1, 2020

Critical depth is an important hydraulic parameter because it is always a hydraulic control. Hydraulic controls are points along the channel where the water level or depth of flow is limited to a predetermined level or can be computed directly from the quantity of flow. Flow must pass through critical depth in going from subcritical flow to supercritical flow. Typical locations of critical depth are at:

- (a) Abrupt changes in channel slope when a flat (subcritical) slope is sharply increased to a steep (supercritical) slope,
- (b) A channel constriction such as a culvert entrance under some conditions,
- (c) The unsubmerged outlet of a culvert on subcritical slope, discharging into a wide channel or with a free fall at the outlet, and
- (d) The crest of an overflow dam or weir.

Critical depth for a given channel is dependent on the channel geometry and discharge only, and is independent of channel slope and roughness.

When flow occurs at critical depth the following relationship must be satisfied

$$\frac{A^3}{T} = \frac{Q^2}{g}$$

Where:

A = Cross sectional area, ft²

T = Top width of water surface, ft

Q = Discharge, CFS

g = Acceleration of gravity, 32.2 ft/s²

Critical depth formulas, based on the above equation, for various channel cross-sections include:

- Rectangular sections,

$$d_c = \left(\frac{q^2}{g} \right)^{1/3}$$

Where:

q = Flow per unit width, CFS

- Trapezoidal sections. The tables in King's "Handbook of Hydraulics" provide easy solutions for critical depth for channels of varying side slopes and bottom widths.
- Circular sections. The tables in King's "Handbook of Hydraulics" can be used for obtaining easy solutions for critical depth.

(7) *Froude Number*. The Froude number is a useful parameter which uniquely describes open flow. The Froude number is a dimensionless value:

$$Fr = \frac{V}{(gD)^{1/2}}$$

Where:

D = A/T = Hydraulic depth, in feet

- Fr < 1.0 ==> Subcritical flow
- Fr = 1.0 ==> Critical flow
- Fr > 1.0 ==> Supercritical flow

866.4 Water Surface Profiles

Depending on the site conditions, accuracy required, and risks involved, a single section analysis may be sufficient to adequately describe the channel stage discharge relationship. The basic assumptions to a single section analysis are uniform cross section, slope, and Manning's "n" values which are generally applicable to most roadside and median channels. The condition of uniform flow in a channel at a known discharge is computed using the Manning's equation combined with the continuity equation:

$$Q = \frac{1.49}{n} AR^{2/3} S^{1/2}$$

The depth of uniform flow is solved by rearranging Manning's Equation to the form the given below. This equation is solved by trial and error by varying the depth of flow until the left side of the equation is zero:

$$\frac{Qn}{1.49S^{1/2}} - AR^{2/3} = 0$$

Per Index 866.3 (4), direct solutions for Manning's equation for many channels of trapezoidal, rectangular, triangular and circular cross sections can be found within the Channel Analysis subcomponent FHWA's Hydraulic Toolbox software program.

Where uniform flow conditions do not adequately describe the actual flow conditions (e.g., natural channels) or where additional accuracy is desired, the computation of complete water surface profiles for each discharge value may be necessary using detailed backwater analysis methods. Per Index 802.1(4)(g) contact the District Hydraulic Engineer for support.

Topic 867 – Channel Changes

867.1 General

Chapter 860 primarily addresses the design of small man-made open channels called roadside channels (gutters, ditches, swales etc.) that are constructed as part of a highway drainage system. However, both the terms 'open channel' or 'channel' may be applied to any natural or improved watercourse as well as roadside channels. See Index 861.1.

A channel change is any realignment or change in the hydraulic characteristics of an existing channel. Per Index 802.1(4)(g), contact the District Hydraulic Engineer for support.

The main reasons for channel changes to either natural or improved watercourses (flood control channels, irrigation channels etc.) within the right of way are to:

- Permit better drainage
- Improve flow conditions
- Protect the highway from flood damage

July 1, 2020

- Reduce right of way requirements

The guidelines in Topic 823 (Culvert Location) generally recommend alignment of the thalweg of the stream with the centerline of the culvert, however, for economic reasons, small skews should be eliminated, moderate skews retained and large skews reduced. Road crossings requiring fish passage are strongly encouraged to retain the natural alignment of the stream, regardless of the skew. Alignment of the culvert centerline with the channel approach angle aids debris passage during storm flows and minimizes hydraulic turbulence which may impede fish passage.

Sometimes a channel change may be to its vertical alignment. For example, inverted siphons or sag culverts may be used to carry irrigation channels crossing the right of way via vertical realignment entirely below the hydraulic grade line. However, maintenance concerns include sediment build-up and potential leakage problems with full-flow barrel(s). See Index 829.7(2) and Index 867.2 below.

867.2 Design Considerations

Channel changes should be designed with extreme caution and coordinated with District Hydraulics. Careful study of the channel characteristics upstream and downstream as well as within the channel change area is required to achieve a safe and effective design.

Channel changes may result in a decreased surface roughness or increased channel slope. As a result the following may occur:

- Higher velocities which result in damage due to scour
- Sedimentation and meandering at downstream end of channel change
- A flattened downstream gradient which progresses upstream undercutting the channel banks or highway fill
- Flattened downstream gradient or channel restrictions may create undesirable backwater conditions.

A channel change perched above the bottom of an old flood stage stream bed may cause the stream to return to its old channel during a subsequent flood. In addition, the designer should consult with Geotechnical Services to ensure that infiltration through the bank would not be problematic.

Topic 868 – Freeboard Considerations

868.1 General

Freeboard is the extra height of bank above the design depth where overflow is predicted to cause damage. Freeboard allowances will vary with each situation.

868.2 Height of Freeboard

(1) *Straight Alignment.* In channels where overflow may cause substantial damage, a guide for freeboard height for channels on a straight alignment, is provided in Table 868.2

Table 868.2

Guide to Freeboard Height

Shape of Channel	Subcritical Flow	Supercritical Flow
Rectangular	0.1 He	0.20 d
Trapezoidal	0.2 He	0.25 d

Where:

He = Energy head, in feet

d = Depth of flow, in feet for a straight alignment

- (2) *Critical Flow.* An unstable zone of flow occurs where the flow is near critical state. This is characterized by random waves. An allowance for waves should be added to the normal depth when the slope of the channel is between $0.7 S_c$ and $1.3 S_c$.

$$H_w = 0.25d_c \left[1 - 11.1 \left(\frac{S}{S_c} - 1 \right)^2 \right]$$

Where:

H_w = height of wave, in feet

d_c = critical depth, in feet

S = slope of channel, in foot per foot

S_c = critical slope, in foot per foot

- (3) *Superelevation.* The height of freeboard discussed above does not provide for superelevation of the water surface on curved alignments.

Flow around a curve will result in a rise of the water surface on the outside of the curve and extra lining is necessary to guard against overtopping.

Additional freeboard is necessary in bends and can be calculated use the following equation:

$$\Delta d = \frac{V^2 T}{g R_c}$$

where:

Δd = Additional freeboard required because of superelevation, feet

V = Average channel velocity, ft/s

T = Water surface top width, ft

G = Acceleration due to gravity, ft/s²

R_c = Radius of curvature of the bend to the channel centerline, ft

See HEC No. 15, Chapter 3, for shear stress considerations around bends.

CHAPTER 870 – BANK PROTECTION – EROSION CONTROL

Topic 871 – General

Index 871.1 – Introduction

Highways, bikeways, pedestrian facilities and appurtenant installations are often attracted to parallel locations along man-made channels, streams, and rivers. These locations may be affected from the action of flowing water, and may require protective measures.

Bank protection can be a major element in the design, construction, and maintenance of highways. This section deals with procedures, methods, devices, and materials commonly used to mitigate the damaging effects of flowing water on transportation facilities and adjacent properties. Potential sites for such measures should be reviewed in conjunction with other features of the project such as long and short term protection of downstream water quality, aesthetic compatibility with surrounding environment, and ability of the newly created ecological system to survive with minimal maintenance. See Index 110.2 for further information on water quality and environmental concerns related to erosion control. See Chapter 880 for shore protection along coastal zones and lake shores that are subjected to wave attack.

Refer to Index 806.2 for definitions of drainage terms.

871.2 Design Philosophy

In each district there should be a designer or advisor, usually the District Hydraulic Engineer, knowledgeable in the application of bank protection principles and the performance of existing works. Information is also available from headquarters specialists in the Division of Design and Structures Design in the Division of Engineering Services (DES). The most effective designs result from involvement with Design, Environmental, Landscape Architecture, Structures, Construction, and Maintenance (for further discussion on functional responsibilities see Topic 802). For channel and habitat characterization and assessment relative to design and obtaining project specific permits, the designer may also require input from fluvial geomorphologists (or engineers with geomorphology training), geologists and biologists. The District Hydraulic Engineer will typically be able to assist with flood analysis, water surface elevations/profiles, shear stress computations, scour analysis, and hydraulic analysis for placement of in-stream structures. A geomorphologist can provide input regarding characterization of channel form and dominant geomorphic processes and hydraulic geometry relationships such as an analysis of lateral and longitudinal channel adjustment. The geomorphologist can also make an identification of the processes responsible for forming and maintaining key habitats and assist in making an assessment of the long-term project effects.

There are a number of ways to deal with the problem of bank erosion as follows:

- Although not always feasible or economical, the simplest way and generally the surest of success and permanence, is to locate the facility away from the erosive forces. Locating

July 1, 2020

the facility to higher ground or solid support should be considered, even when it requires excavation of solid rock, since excavated rock may serve as a valuable material for bank protection.

- The most commonly used method of bank protection is with a more resistant material like rock slope protection. Other protection methods (e.g., training systems) are discussed in Index 873.4 and summarized in Table 872.1.
- A third method is to reduce the force of the attacking water. This is often done by various plantings such as willows. Plantings once established not only reduce stream velocity near the bank during heavy flows, but their roots add structure to the bank material.
- Another method is to re-direct flows away from the embankment. In the case of stream attack, a new channel can be created or the stream can be diverted away from the embankment by the use of baffles, deflectors, or spurs.

Combinations of the above four methods may be used. Even protective works destroyed in floods have proven to be effective and cost efficient in minimizing damage to transportation facilities.

Design of protective features should be governed by the importance of the facility and appropriate design principles. Some of the factors which should be considered are:

- *Roughness.* Revetments generally are less resistant to flow than the natural channel bank. Channel roughness can be significantly reduced if a rocky vegetated bank is denuded of trees and rock outcrops. When a rough natural bank is replaced by a smooth revetment, the current is accelerated, increasing its power to erode, especially along the toe and downstream end of the revetment. Except in narrowed channels, protective elements should approximate natural roughness and simulate the effect of trees and boulders along natural banks and in overflow channels.
- *Undercutting.* Particular attention must be paid to protecting the toe of revetments against undercutting caused by the accelerated current along smoothed banks, since this is the most common cause of bank failure.
- *Standardization.* Standardization should be a guide but not a restriction in designing the elements and connections of protective structures.
- *Expendability.* The primary objective of the design is the security of the transportation facility, not security of the protective structure. Less costly replaceable protection may be more economical than expensive permanent structures.
- *Dependability.* An expensive structure is warranted primarily where transportation facilities carry high traffic volumes, where no reasonable detour is available, or where facility replacement is very expensive.
- *Longevity.* Short-lived structures or materials may be economical for temporary situations. Expensive revetments should not be placed on banks likely to be buried in widened embankments, nor on banks attacked by transient meander of mature streams.
- *Rock Materials.* Optimum use should be made of local materials, considering the cost of special handling. Specific gravity of stone is a major factor in bank protection and the specified minimum should not be lowered without increasing the mass of stones. See Index 873.3(3)(a)(2)(b) for equation to estimate rock size.
- *Selection.* Selection of class and type of protection should be guided by the intended function of the installation.

- *Limits.* Horizontal and vertical limits of protection should be carefully designed. The bottom limit should be secure against toe scour. The top limit should not arbitrarily be at high-water mark, but above it if overtopping would cause excessive damage and below it if floods move slowly along the upper bank. The end limits should reach and conform to durable natural features or be secure with respect to design parameters.

Table 872.1

Guide to Selection of Protection

Location	Armor										Training										
	Flexible					Rigid					Guide Banks				Bendway Weirs and Spurs			Check Dams			
	Vegetation	Rip Rap	Mattresses			Grouted	Conc. Rock	Conc. Lined	Cribs	Bulk Heads	Earth	Rock	Piling	Other	Rock	Grouted	Piling	Other	Drop	Piling	Rock
Cross Channel																					
Young Valley		X				X	X		X	X											
Mature Valley		X				X	X		X	X	X		X	X				X			X
Parallel Encroachment																					
Young Valley		X				X	X		X	X											
Mature Valley	X	X				X	X		X	X	X		X	X	X	X	X	X			X
Desert-wash																					
Top debris cone		X				X	X			X	X										
Center debris cone		X				X	X												X		X
Bottom debris cone		X				X	X											X			X
Overflow and Floodplain	X	X				X					X		X	X							
Artificial Channel or Roadside Ditch (Ch. 860)	X	X	X	X		X		X													
Culvert																					
Inlet		X				X				X											
Outlet		X				X				X											
Bridge																					
Abutment		X				X		X													
Upstream		X				X					X	X	X	X							
Downstream		X				X					X	X	X	X					X	X	X

871.3 Selected References

Hydraulic and drainage related publications are listed by source under Topic 807. References specifically related to slope protection measures are listed here for convenience.

- (a) FHWA Hydraulic Engineering Circulars (HEC) – The following seven circulars were developed to assist the designer in using various types of slope protection and channel linings:

July 1, 2020

- HEC 14, Hydraulic Design of Energy Dissipators for Culverts and Channels (2006)
 - HEC 15, Design of Roadside Channels with Flexible Linings (2005).
 - HEC 18, Evaluating Scour at Bridges (2012)
 - HEC 20, Stream Stability at Highway Structures (2012)
 - HEC 23, Bridge Scour and Stream Instability Countermeasures (2009)
 - HEC 25, Highways in the Coastal Environment (2008 with 2014 supplement)
 - HEC 26, Culvert Design for Aquatic Organism Passage (2010)
- (b) FHWA Hydraulic Design Series (HDS) No. 6, River Engineering for Highway Encroachments (2001) – A comprehensive treatise of natural and man-made impacts and responses on the river environment, sediment transport, bed and bank stabilization, and countermeasures.
- (c) AASHTO Highway Drainage Guidelines – General guidelines for good erosion control practices are covered in Volume III - Erosion and Sediment Control in Highway Construction
- (d) AASHTO Drainage Manual (2014) – Refer to Chapters; 11 – Energy Dissipators; 16 – Erosion and Sediment Control; 17 – Bank Protection. The manual provides guidance on engineering practice in conformance with FHWA’s HEC and HDS publications and other nationally recognized engineering policy and procedural documents.
- (e) U.S. Army Corps of Engineers EM 1110-2-1601 Hydraulic Design of Flood Control Channels Manual.
- (f) California Department of Fish and Wildlife – California Salmonid Stream Habitat Restoration Manual.

Topic 872 – Planning and Location Studies

872.1 Planning

The development of sustainable, cost effective and environmentally friendly protective works requires careful planning and a good understanding of both the site location and habitat within the stream reach and overall watershed. Planning begins with an office review followed by a site investigation.

Google Earth can be a useful tool for determining site location, changes to stream planform (pattern), bend radius to channel width ratio (to estimate rock size per Index 873.3(3)(a)(2)(b), and location within the overall watershed. USGS StreamStats will facilitate simple watershed delineation and provide basin characteristics such as area, cover and percentage of impervious cover, average elevation, stream slope, mean annual precipitation, and peak flow from regression equations. When more detailed watershed delineation is required, United States Geological Survey (USGS) 7.5-minute quadrangle maps are used to trace the tributary area and sub-basins. The USGS maps are found in graphic image form, such as TIFF and JPEG, and are also found in the form of a Digital Elevation Model (DEM). A DEM contains x-y-z topographic data point usually at 10 or 30-meter grid intervals, where “x” and “y” represent horizontal position coordinates of a topographic point and “z” is its elevation. These data files and the USGS 7.5-minute quadrangle image files can be imported into software programs, including the Watershed Modeling System (WMS), AutoCAD Civil 3D, and ArcGIS.

Nearby bridges that are located along the same stream reach should be reviewed for site history and changes in stream cross-section. All bridge files are located in the Division of Maintenance, Office of Structures Maintenance.

District biologist staff should be consulted early on during the project planning phase for subject matter expertise regarding fisheries, habitat, and wildlife and to perform an initial stream habitat assessment.

Contact information for Department biologists can be accessed through the CalBioRoster.

For channel and habitat characterization and preliminary assessment relative to design and acquisition of project specific permits, the initial site investigation team should include the project engineer, the district hydraulic engineer, and a biologist. Depending on the complexity of the project, it may be necessary to include Caltrans staff that are trained to perform a geomorphic assessment and/or a geologist during the site investigation.

The selection of the type of protection can be determined during or following the site investigation. For some sites the choice is obvious; at other sites several alternatives or combinations may be applicable. See the FHWA's HDS No. 6, River Engineering for Highway Encroachments for a complete and thorough discussion of hydraulic and environmental design considerations associated with hydraulic structures in moveable boundary waterways.

Some specific site conditions that may dictate selection of a type of protection different from those shown in Table 872.1 are:

- Available right of way.
- Available materials.
- Possible damage to other properties through streamflow diversion or increased velocity.
- Environmental concerns.
- Channel capacity or conveyance.
- Conformance to new or existing structures.
- Provisions for side drainage, either surface waters or intersecting streams or rivers.

The first step is to determine the limits of the protection with respect to length, depth and the degree of security required. For more detailed stream reconnaissance considerations, see HEC 20, Index 4.2.1 (Appendix C and D) and the FHWA's HDS No. 6, River Engineering for Highway Encroachments (Table 8.1).

Considerations at this stage are:

- The severity of stream attack.
- The present alignment of the stream or river and potential meander changes.
- The ratio of cost of highway replacement versus cost of protection.
- Whether the protection should be permanent or temporary.
- Analysis of foundation and materials explorations.
- Access for construction.
- Bank slope (H:V).
- Bed and bank material gradations.

July 1, 2020

- Stream stability (lateral and vertical). Caltrans Hydromodification Requirements Guidance Storm Water Best Management Practices Rapid Assessment of Stream Crossings Higher Level Stream Stability Analysis presents 13 channel characteristics that are indicators of present stream stability. See Index 4.1.
- Local stream profile.
- Vegetation type and location.
- Physical habitat (temperature, shade, pools, riffles, sediment supply).
- Toe scour/bank failure mode (see Table 872.2).
- Thalweg location.
- Hardpoint location(s).
- Total length of protection needed.

The second step is the selection and layout of protective elements in relation to the highway facility.

872.2 Class and Type of Protection

Protective devices are classified according to their function. They are further categorized as to the type of material from which they are constructed or shape of the device. For additional information on specific material types and shapes see Topic 873, Design Concepts.

There are two basic classes of protection, armor treatment and training works. Table 872.1 relates different location environments to these classes of protection.

872.3 Geomorphology and Site Consideration

The determination of the lengths, heights, alignment, and positioning of the protection are affected to a large extent by the facility location environment.

An evaluation is required for any proposed highway construction or improvement that encroaches on a floodplain. See Topic 804, Floodplain Encroachments for detailed procedures and guidelines.

(1) *Geomorphology.* An understanding of stream morphology is important for identifying both stream instability and associated habitat problems at highway-stream locations. A study of the plan and profile of a stream is very useful in understanding stream morphology. Plan view appearances of streams are varied and result from many interacting variables. Small changes in a variable can change the plan view and profile of a stream, adversely affecting a highway crossing or encroachment. This is particularly true for alluvial streams. Conversely, a highway crossing or encroachment can inadvertently change multiple variables such as Manning's "n-value", channel width, and average velocity, which may adversely affect the stream.

Chapter 2 in HEC 20 presents an overview of general landform and channel evolutionary processes to illustrate the dynamics of alluvial channel systems. It discusses lateral stability, factors effecting bed elevation changes, and the sediment continuity principle to provide an introduction to alluvial channel response to natural and human-induced change.

River morphology and river response is discussed in detail in Chapter 5 of FHWA's HDS No. 6, River Engineering for Highway Encroachments.

(2) *Stream Processes.* Prior to the current interest in ecology, water quality, and the environment, few engineers involved with highway crossings and encroachments considered the short-term and long-term changes that were possible or the many problems that humans can cause to streams. It is imperative that anyone working with rivers, either on localized areas or entire systems, have an understanding of the many factors involved, and of the potential for change within the river system. Highway construction can have significant general and local effects on the geomorphology and hydraulics of river systems. Hence, it is necessary to consider induced short-term and long-term effects of erosion and sedimentation on the surrounding landscape and the river. The biological response of the river system should also be considered and evaluated. Certain species of fish can only tolerate large quantities of suspended sediment for relatively short periods of time. This is particularly true of the eggs and fry. It is useful for the project engineer to understand what is important for regulators. Some of the most common topics include:

- Site geomorphology and stream stability
- Stressors to historic aquatic organism habitat
- Locations of hydraulic constrictions

Only with such knowledge can the project engineer develop the necessary arguments to make the case that erosion control measures must be designed to avoid significant deterioration of the stream environment not only in the immediate vicinity of the highway encroachment or crossing, but in many instances for great distances downstream.

Fluvial geomorphology is the science dealing with the shape of stream channels and includes the study of physical processes within river systems, such as bank erosion, sediment transport, and bed material sorting.

This section is intended to give the engineer background, perspective, and respect of stream processes and their dynamics when designing and constructing bank protection for natural streams and to lay the groundwork for application of the concepts of open-channel flow, fluvial geomorphology, sediment transport, and river mechanics to the design, maintenance, and environmental challenges associated with highway crossings and encroachments. Encroachment is any occupancy of the river and floodplain for highway use. Encroachments usually present no issues during normal stages, but require special protection against floods. Classifying the regions requiring protection, the possible types of protection, the possible flow conditions, the possible channel shapes, and the various geometric conditions aids the engineer in selecting the design criteria for the conditions encountered.

(a) *Types of Encroachment.* In the vicinity of rivers, highways generally impose a degree of encroachment. In some instances, particularly in mountainous regions or in river gorges and canyons, river crossings can be accomplished with absolutely no encroachment on the river. The bridge and its approaches are located far above and beyond any possible flood stage. More commonly, the economics of crossings require substantial encroachment on the river and its floodplain, the cost of a single span over the entire floodplain tends to be prohibitive. The encroachment can be in the form of earth fill bridge approach embankments on the floodplain or into the main channel itself, reducing the required bridge length; or in the form of piers and abutments or culverts in the main channel of the river. Longitudinal encroachments may exist that are not connected with river crossings. Floodplains often appear to provide an attractive low cost alternative for highway location, even when the extra cost of flood protection is included. As a consequence, highways, including interchanges, often encroach on a floodplain over long distances. In some regions, such as mountainous regions, river valleys (or canyons) provide the only feasible route for highways. This is true in areas where a floodplain does not exist. In many locations the highway encroaches on the main channel itself and the channel is partly filled to allow room for the roadway. See Figure 872.4. In some

July 1, 2020

instances, this encroachment becomes severe, particularly as older highways are upgraded and widened.

(b) Effects of River Development Works. These works may include water diversions to and from the river system, dams, cutoffs (channel straightening), levees, navigation works, and the mining of sand and gravel. It is essential to consider the probable long-term plans of all agencies and groups as they pertain to a river when dealing with the river in any way. For example, dams serve as traps for the sediment normally flowing through the river system. With sediment trapped in the reservoir, essentially clear water is released downstream of the dam site. This clear water has the capacity to transport more sediment than may be immediately available. Consequently the channel begins to supply this deficit with resulting degradation of the bed or banks. The degraded or widened main channel causes steeper gradients on tributary streams in the vicinity of the main channel. The result is degradation in the tributary streams. It is entirely possible, however, that the additional sediments supplied by the tributary streams would ultimately offset the degradation in the main channel. Thus, it must be recognized that downstream of storage structures the channel may either aggrade or degrade (most common) and the tributaries will be affected in either case.

(c) Alluvial Streams. Most streams that highways cross or encroach upon are alluvial; that is, the streams are formed in materials that have been and can be transported by the stream. In alluvial stream systems, it is the rule rather than the exception that banks will erode; sediments will be deposited; and floodplains, islands, and side channels will undergo modification with time. Alluvial channels continually change position and shape as a consequence of hydraulic forces exerted on the bed and banks. These changes may be gradual or rapid and may be the result of natural causes or human activities. At any location in a stream, the cross-sectional shape is dependent upon the volume flow-rate (flow), the composition of sediment transported through a section, and the integrity or gradation of the bed and bank materials. As water flows through the stream channel, it exerts a fluid shear stress on the bed and banks. For a constant and stable cross-sectional shape for a given flow at a specific location, the resisting bed and bank material shear stress must be equal to the fluid stress at every point in the stream cross section perimeter. In this state, a stream is in the threshold condition where each point along the perimeter is at the threshold of movement or incipient motion. This condition also indicates a dynamic equilibrium with scour and deposition of sediment being equal. As flow, velocity, and fluid shear stress increase, the amount of scour and sediment deposition will change, which will also change the stream cross section for a given bed/bank gradation.

Alluvial streams are commonly trapezoidal in cross section through their straight reaches and become asymmetric through their bends. When streams incise in response to possible instability, their depth increases and the stream takes on a more rectangular cross-sectional shape. Also, streams with very large flows may become rectangular as the bed width increases to convey the large flows, especially if bedrock outcroppings are present on the banks preventing them from flattening.

(d) Non-Alluvial Streams. Some streams are not alluvial. The bed and bank material is very coarse, and except at extreme flood events, do not erode. These streams are classified as sediment supply deficient, i.e., the transport capacity of the streamflow is greater than the availability of bed material for transport. The bed and bank material of these streams may consist of cobbles, boulders, or bedrock. In general these streams are stable, but should be carefully analyzed for stability at large flows. A study of the plan and profile of a stream is useful in understanding stream morphology. Plan view appearances of streams are varied and result from many interacting variables. Small changes in a variable can change the plan view and profile of a stream, adversely affecting a highway

crossing or encroachment. This is particularly true for alluvial streams. Conversely, a highway crossing or encroachment can inadvertently change a variable, adversely affecting the stream.

- (e) Dynamics of Natural Streams. Long-term climatic and tectonic fluctuations have caused major changes of river morphology, but rivers can display a remarkable propensity for change of position and morphology in time periods of a century. For shorter time periods river channels will shift through erosion and deposition at bends and may form chutes, islands or oxbow lakes. Lateral migration, erosion and deposition rates are not linear; i.e., a river may maintain a stable position for several years and then experience rapid movement. At low flow the bed of a sand bed stream can be dunes, but at large flows the bed may become plane or have antidune flow. With dunes, resistance to flow is large and bed material transport is low. Whereas, with plane bed or antidune flow the resistance to flow is small and the bed material transport is large. Much, therefore, depends on flood events, bank stability, permanence of vegetation on banks and the floodplain and watershed land use.

In summary, archaeological, botanical, geological, and geomorphic evidence supports the conclusion that most rivers are subject to constant change as a normal part of their morphologic evolution. Therefore, stable or static channels are the exception in nature.

If an engineer modifies a river channel locally, this local change may cause unintended modification of channel characteristics both up and down the stream. The response of a river to human-induced changes often occurs in spite of attempts by engineers to keep the anticipated response under control. The points that should be stressed are that a river through time is dynamic and that human-induced change frequently sets in motion a response that can be propagated upstream or downstream for long distances.

In spite of their complexity, all rivers are governed by the same basic forces. The design engineer must understand, and work with these natural forces:

- Geological factors, including soil and seismic conditions.
 - Hydrologic factors, including possible changes in flows, runoff, and the hydrologic effects of changes in land use.
 - Geometric characteristics of the stream, including the probable geometric alterations that will be activated by the changes a project and future projects will impose on the channel.
 - Hydraulic characteristics such as depths, slopes, and velocity of streams and what changes may be expected in these characteristics in space and time.
 - Sea level rise may also cause river instability, particularly when the 75-year design life of a bridge is considered.
- (f) Basic Stream Pattern. The three basic stream patterns are straight, braided, and meandering as seen in aerial or plan view. Pattern is one way of classifying a stream and generalizing its behavior, another is sediment load. See Figure 872.1.

Commonly, stream patterns are identified by sinuosity, which is defined as channel length divided by valley (floodplain) length. For straight and braided streams, sinuosity varies between 1.0 and 1.5, while meandering streams have sinuosity greater than 1.5. These different patterns and their associated gradients contribute to changes and adjustments in streams, and specifically influence flow resistance that effects sediment transport and formation of cross-sectional shape. Engineers using any stream

July 1, 2020

Figure 872.1

Stream Classification

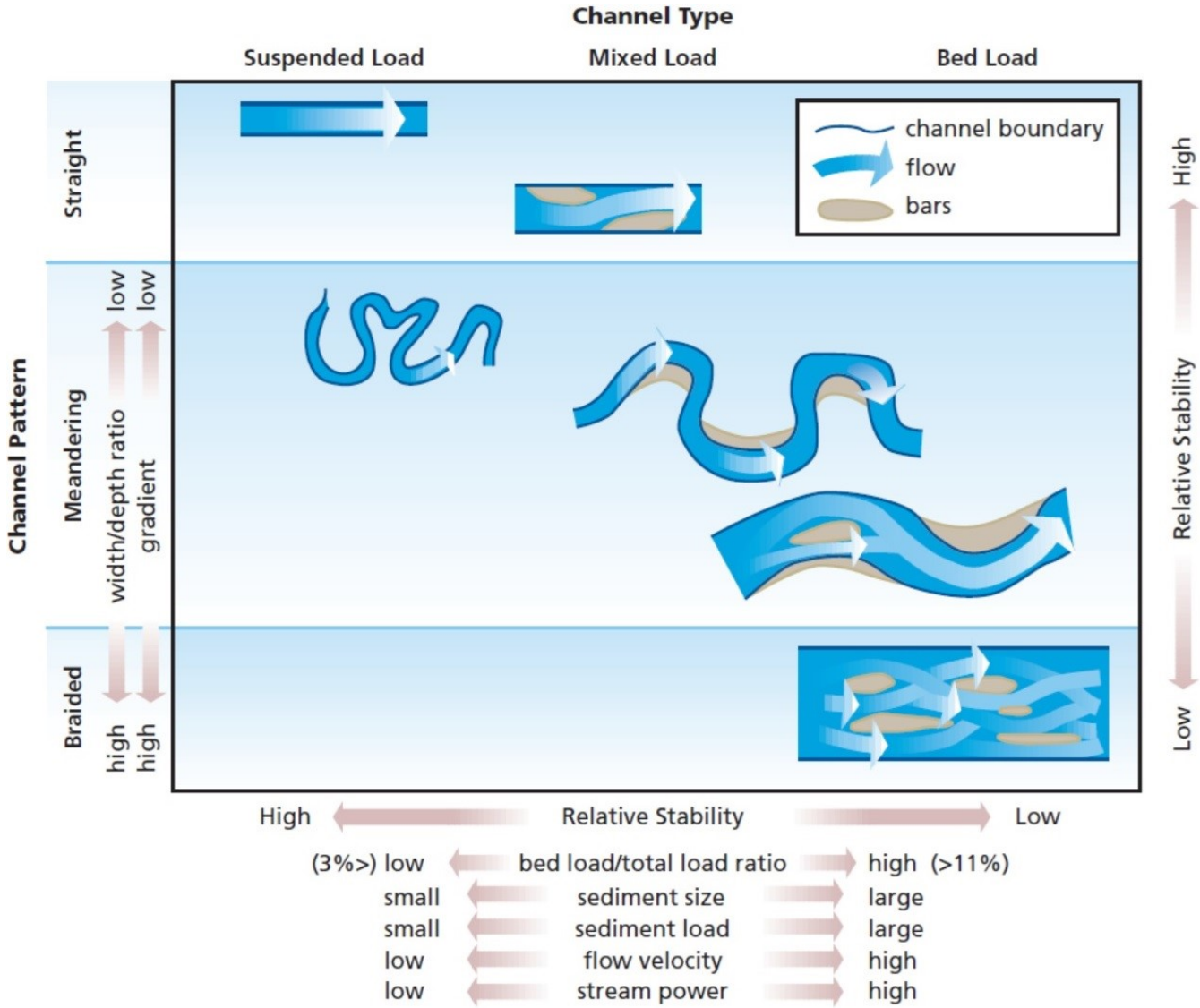

classifications should be aware that they are artificial constructs, and no strict science laws or principles of classification (such as used in biology) are possible. Although we may assign channel reaches to discrete categories based on arbitrary thresholds of slope, sinuosity, bed material size, sediment load, width-depth ratio, etc., these quantities vary continuously, and channels tend to behave in rather individualistic fashion. Different types of streams occur within a given subregion. Index 3.9 of Caltrans Hydromodification Requirements Guidance presents the various stream forms within each of the physiographic subregions of California available at the following website:

<http://www.dot.ca.gov/hq/oppd/stormwtr/guidance/CT-Hydromodification-Requirements-Guidance.pdf>

- (g) **Straight Streams.** Straight river channels can be of two types. The first forms on a low-gradient valley slope, has a low width-depth ratio channel, and is relatively stable. The first type of straight channel may contain alternate islands or bars that result in a sinuous thalweg (flow path connecting deepest points in successive cross sections) within the straight channel. It may seem that the first type of straight stream is very stable because of low slope and energy, but alternating sediment deposits can cause lateral instability. In general, it is more natural for a stream to meander than to have a straight stream pattern, therefore it is difficult to find low-gradient straight streams in the field, especially long reaches.

The second type is a steep gradient, high width-depth ratio, high energy river that has many islands or bars, and at low flow is braided. It is relatively active.

In general, the designer should not attempt to develop straight channels fully protected with riprap. In a straight channel the alternate islands or bars and the thalweg are continually changing; thus, the current is not uniformly distributed through the cross-section but is deflected toward one bank and then the other.

- (h) **Braided Streams.** Similar to straight streams, streams with braided pattern have low sinuosity, but have the highest gradient of any of the stream patterns. Braided streams have many sub-channels within the main stream channel that interweave and crisscross. The sub-channels are separated by islands or bars which are visible during low flows and normally submerged under high flows. Because braided streams have steep slopes, they possess the higher energy necessary to erode and transport sediment that comprises the bars and islands. Even though braided streams have high energy, these streams will deposit their coarser and larger material that cannot be physically transported by the stream's average velocity and shear stress. In other words, the process of braiding occurs during flood events as a stream adjusts in response to the larger sediment and debris loads that cannot be sustained while trying to find dynamic equilibrium. This deposition of larger material creates the bars and islands. See Figure 872.2. As flow and velocity fluctuate during a flood event, it is common to see movement and re-creation of bars, islands, and sub-channels.

Figure 872.2

Diagram of a Braided River Channel

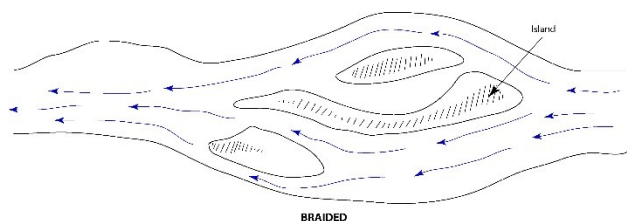

July 1, 2020

- (i) Meandering Streams. Meandering is the most common stream pattern, having a series of alternating curves or bends, and is associated with flatter valleys. Meandering stream types have the highest sinuosity because of their longer stream length, due to several alternating curves, with respect to valley length, see Figure 872.6. One way that streams seek dynamic equilibrium is to dissipate energy through erosion of their banks, creating meandering patterns. When meanders are created, overall stream length is increased, and energy is released through the work necessary to scour its banks, which brings a stream closer to dynamic equilibrium. Streambank revetments are often constructed through these meanders to prevent excessive erosion that may cause instability of nearby or adjacent transportation facilities.

Once curves have been created in a stream's alignment, velocity increases as the flow of water moves through the outside bank of a bend caused by secondary circulation currents. Given the geometry of a curve, velocity is resolved into three components described in the longitudinal, width-wise, and vertical directions, contrary to straight reaches of stream.

As flow moves through a curve, the circulation currents and their turbulence are influenced by radius of curvature, stream bottom width, flow depth, curve deflection angle, and Reynolds Number. As often occurs, turbulence is magnified by counter-circulating currents from an upstream bend merging with circulating currents of an immediate downstream bend. The increased turbulence usually increases the amount of scour at the outside bend, and the transported material is deposited on the inside bend at the downstream reversing curve creating a point island or bar.

Another characteristic of flow through a curve is that the top of the water surface will superelevate along the outside bank of a curve as it is pulled by centrifugal forces while the bottom water surface at the bed is being pulled toward the inside of a bend. These two actions will cause skewing of the circulating current contributing to increased erosion around a bend.

- (j) Sediment Transport. For engineering purposes, the two sources of sediment transported by a stream are: (1) bed material that makes up the stream bed; and (2) fine material that comes from the banks and the watershed (washload). Geologically both materials come from the watershed, but for the engineer, the distinction is important because the bed material is transported at the capacity of the stream and is functionally related to measurable hydraulic variables. The washload is not transported at the capacity of the stream. Instead, the washload depends on availability and is not functionally related to measurable hydraulic variables.

The division size between washload and bed sediment load is sediment size finer than the smallest 10 percent of the bed material. It is important to note that in a fast flowing mountain stream with a bed of cobbles the washload may consist of coarse sand sizes. For these conditions, the transport of sand sizes is supply limited. In contrast, if the bed of a channel is silt, the rate of bed load transport of the silt sizes is less a question of supply than of capacity.

When a river reaches equilibrium, its transport capacities for water and sediment are in balance with the rates supplied. In fact, most rivers are subject to some kind of control or disturbance, natural or human-induced that gives rise to non-equilibrium conditions.

HDS No. 6, Index 4.3.2, states total sediment load can be expressed by three equations:

1. By type of movement

$$L_T = L_b + L_s$$

2. By method of measurement

$$L_T = L_m + L_u$$

3. By source of sediment

$$L_T = L_w + L_{bm}$$

Where:

L_T = Total load;

L_b = Bed load which is defined as the transport of sediment particles that are close to or maintain contact with the bed;

L_s = Suspended load defined as the suspended sediment passing through a stream cross-section above the bed layer;

L_m = Measured sediment;

L_u = Unmeasured sediment that is the sum of bed load and a fraction of suspended load below the lowest sampling elevation;

L_w = Wash load which is the fine particles not found in the bed material ($D_s < D_{10}$), and originates from available bank and upstream supply;

L_{bm} = Capacity limited bed material load.

Streams are unique from other hydraulic conveyance facilities, such as engineered channels and pipes, in that its boundaries are mobile, and they move sediment within their water column or along the bed by skipping and rolling, which is a complicated interrelationship. The suspended sediment load is carried through the flow by turbulence and is typically fine sand, silt, and clay. Bedload is coarser possibly as large as boulders, and moves along the bed by fluid stress action, see Figure 872.3. Sediment supply and its movement are the life of a stream that can become unstable when this process is interrupted if supply becomes limited or if a stream is unable to transport its excess downstream.

Instability can be seen through channel incision, where the stream bed degrades and banks over steepen, excessive meandering, or large alignment shifts as a stream attempts to control energy as it searches for dynamic equilibrium. The ability of a stream to control and manage its sediment is not the only influence on stream stability, but one of the more important factors.

Within a stream bed, immersed sediment particles resting on the stream bed over other particles exert their effective weight in the form of a vertical force, which can be divided into normal and tangential components based on the stream bed slope. Simply stated, in order for sediment particles to become mobile, a force greater than their normal weight must be applied to them. This force that causes mobility is a drag force or fluid stress acting on the particle as water flows over them. The fluid stress can be expressed as an average boundary shear stress acting on a stream bed considering steady, uniform flow:

$$\sigma_0 = gDS_f$$

Where:

σ_0 = Shear stress = Force per unit area in flow direction;

July 1, 2020

g = Specific weight of water;

D = Flow-depth;

S_f = Friction slope.

Particle movement can be further expressed at a specific point in a stream bed as incipient motion, which is the initial movement of a particle. The calculation of a critical shear stress or critical velocity can be performed at the threshold movement condition that assumes active hydraulic forces are equal to particle resistant forces. At the point of critical shear stress or critical velocity, a particle is just about to move. This means that values of shear stress or velocity greater than critical shear stress or critical velocity cause particles to be in motion, while particles will be at rest with values of shear stress and velocity lower than critical shear stress and velocity. An incipient motion calculation can provide an indication of erosion potential and stream stability. Fischenich (2001) provides a variation of the widely accepted and industry standard Shields equation for approximated critical shear stress considering different materials:

Clays:

$$\sigma_{cr} = 0.5d(g_s - g_w) \tan F$$

Silts & Sands:

$$\sigma_{cr} = 0.25d_0 - 0.6d(g_s - g_w) \tan F$$

Gravels & Cobbles:

$$\sigma_{cr} = 0.06d(g_s - g_w) \tan F$$

Where:

$$d_0 = d[(G - 1)g\nu^{-2}]^{1/3};$$

σ_{cr} =Critical shear stress;

F = Soil grain angle of repose;

Figure 872.3

Bed Load and Suspended Load

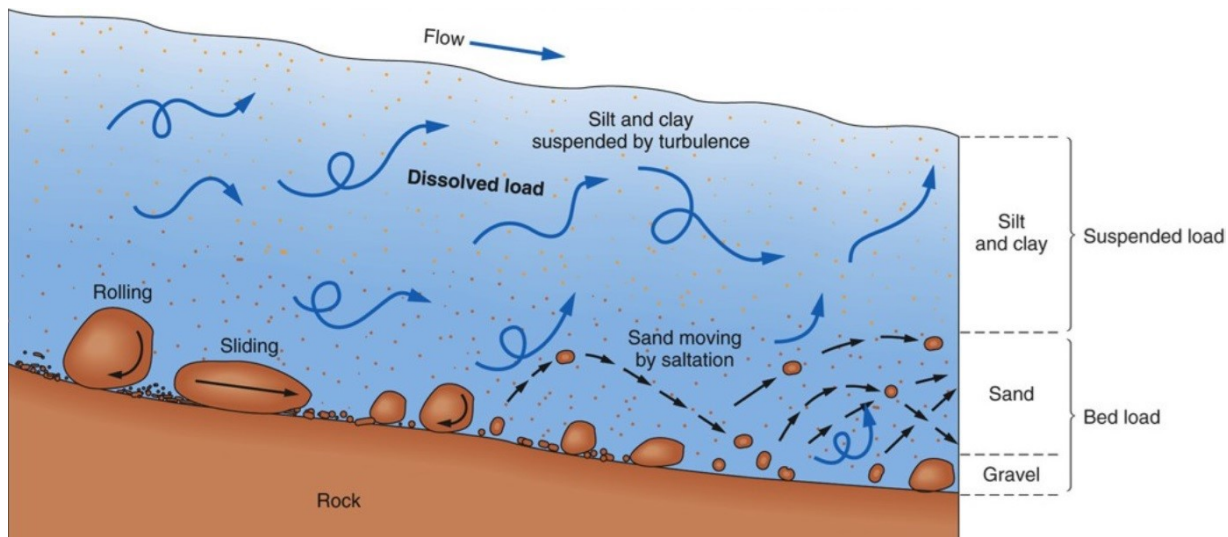

Figure 872.4**Longitudinal Encroachments**

Highway 49, North Fork Yuba River (Near Downieville) and Highway 190, Furnace Creek, (Death Valley)

d = Soil diameter;

g_s = Sediment unit weight;

g_w = Water unit weight;

G = Sediment specific gravity;

g = Gravity;

ν = Water/sediment mixture kinematic viscosity.

The Shields equation and the beginning of motion is described in more detail in Index 3.5 of HDS No. 6.

Modeling of a stream reach, although complex, can be performed in order to predict sediment transport potential on a larger scale, transport rates, volume, and capacity modeling. Several empirical sediment transport functions used in modeling have been developed and named after their creators, such as Einstein, Acker and White, Laursen-Copeland, Meyer-Peter Muller, and Yang. These functions are complex and notoriously

July 1, 2020

data intensive. Three classic sediment transport formulae are discussed in detail in Index 4.5 of HDS No. 6 to illustrate sediment transport processes. While not often, resource agencies and flood control districts may request this type of analysis during the permit review process. If sediment modeling is necessary, HEC-RAS v4.1 (or higher), the Army Corps of Engineers' river and stream modeling software, contains sediment transport modeling capabilities using these transport functions and others.

(k) Stream Channel Form. Major factors affecting alluvial stream channel forms are:

- stream discharge, viscosity, temperature;
- sediment discharge;
- longitudinal slope;
- bank and bed resistance to flow;
- vegetation;
- geology, including types of sediments and;
- human activity.

At any location in a stream, the cross-sectional shape is dependent upon the volume flow-rate (flow), the composition of sediment transported through a section, and the integrity or gradation of the bed and bank materials. As water flows through the stream channel, it exerts a fluid shear stress on the bed and banks. For a constant and stable cross-sectional shape for a given flow at a specific location, the resisting bed and bank material shear stress must be equal to the fluid stress at every point in the stream cross section perimeter. In this state, a stream is in the threshold condition where each point along the perimeter is at the threshold of movement or incipient motion. This condition also indicates a dynamic equilibrium with scour and deposition of sediment being equal. As flow, velocity, and fluid shear stress increase, the amount of scour and sediment deposition will change, which will also change the stream cross section for a given bed/bank gradation.

The form and appearance of a stream can also be influenced by features within the stream profile, such as riffles and pools because of their effects on the acting fluid shear stress and velocity. Riffles are longitudinal sections of streams with higher velocity, where lower flow-depth usually caused by obstructions, such as gravels, cobbles, and boulders created by island or bar development. On the contrary, pools have higher flow-depth and lower velocity, and are typically comprised of finer silts and sands compared to a riffle. These bed materials associated with pools and riffles have an effect on resisting bed shear stress that will influence stream shape and stability. The alternating pool and riffle sequence is common for nearly all perennial streams that have gravel to boulder size bed formations. Different types of streams occur within a given subregion. Index 3.9 of Caltrans Hydromodification Requirements Guidance presents the various stream forms within each of the physiographic subregions of California, see:

<http://www.dot.ca.gov/hq/oppd/stormwtr/guidance/CT-Hydromodification-Requirements-Guidance.pdf>

(l) Floodplain Form. From a geomorphic perspective, floodplains are flatter lands adjacent to a river main channel that are dry until larger flows force water out of the stream channel into these overbank lands during significant flood events. Floodplains typically include the following features: the main stream channel itself, point islands or bars, oxbows and lakes, natural raised berms (levees) above floodplain surface, terraces, sloughs and depressions, overbank fine and coarse sediment deposition, scattered debris, and vegetation.

When water exceeds the capacity of the main channel, the conveyance of flow through the floodplain overbanks will differ from the main channel due to uniqueness of form (shape), gradient, alignment, and likely the flow resistance (roughness) of the floodplain versus the stream channel. Therefore, water will move and deposit varying sediment types differently, also at different frequency, creating a separate floodplain form. Once sediment is moved to the floodplain, coarser sediment is generally deposited along the streambanks forming levees, while finer sediment is dropped between the valley walls and the levees on the floodplain floor. Sediment is stored and becomes dormant until larger flows return to the floodplain that may convey the sediment down-valley.

Similar to the stream channel, floodplain form is directly linked to the sediment transport process, as well as floodplain stability affected by sediment supply and its movement. Fluid shear stress and velocity control the sediment/debris degradation and deposition properties within the floodplain that impact its form, landscape, and appearance. Because the floodplain can be dormant for considerable time depending on watershed hydrology, its form can remain relatively constant and preserved for extended periods, as well as be less dynamic than the stream channel.

- (m) Streambank Erosion. Simply defined, streambank erosion occurs when the soil resisting strength is less than the driving forces acting on the bank. It can occur through bank-toe scour below the water line and bank mass failure from above. This erosion occurs first as a geotechnical failure followed by the hydraulic action that removes the failed soil and sediment by fluid shear stress. The hydraulic action further causes lateral scour of the bank and is the principal contributor to bank-toe failure. This is a natural process for both stable and unstable streams, but is exaggerated in the latter case. The degree of erosion can be influenced by impervious development in the watershed, agricultural use, and changes in climate. With or without these influences and whether a stream is stable or unstable, streambank erosion will take place at some level. Therefore, scour must be reduced at critical locations to protect highway structures and preserve public safety, although restraint needs to be exercised during the project development process so that a stream does not greatly change its morphology in response to the protection measures.

The driving and resisting forces for streambank erosion, mentioned above, are controlled by a series of factors. The factors that influence the calculation of the driving (active) forces within geotechnical failure are soil saturated unit weight, pore pressure, bank height, and angle of repose, as well as object surcharges within and above the bank such as vegetation. The effects of driving forces are commonly seen through soil saturation as a result of intense precipitation with subsequent increase in pore pressure and bank soil saturated unit weight that can cause mass bank failure. The forces that will resist and give soil its strength from geotechnical type failure are dependent upon effective soil cohesion, normal stress, pore pressure, and soil effective angle of friction.

During streambank erosion, the bank soil can fail by different modes. Generally speaking, steep slopes present slab-type or toppling failures where large slabs (blocks of soil) of the bank break away from the top and fall into the stream, while mild slopes show a rotational failure that begins at the bank toe causing soil to slide from above into the stream. Once the eroded soil reaches flowing water, it is usually transported downstream depending upon its size and composition.

As for bank-toe scour, its main influences are derived from bank soil composition and gradation, volume of sediment in transport, stream flow and stream gradient. These factors and the principles of scour and sediment movement from hydraulic forces are a reoccurring theme in fluvial geomorphology. The following paragraphs summarize the characteristics of unstable and stable banks;

July 1, 2020

- (1) Unstable banks with moderate to high erosion rate occur when the slope angle of unstable banks typically exceed 30 percent, where a cover of woody vegetation is rarely present. At a bend, the point island or bar opposite of an unstable cut bank is likely to be bare at normal stage, but it may be covered with annual vegetation and low woody vegetation, particularly willows. Where very rapid erosion is occurring, the bankline may have irregular indentations. Fissures, which represent the boundaries of actual or potential slump blocks along the bankline indicate the potential for rapid bank erosion.
- (2) Unstable banks with slow to moderate erosion rate occur when a bank is partly graded (smooth slope) and the degree of instability is difficult to assess where reliance is placed mainly on vegetation. The grading of a bank typically begins with the accumulation of slumped material at the base such that a slope is formed and progresses by smoothing of the slope and the establishment of vegetation.
- (3) Stable banks with very slow erosion rate occur where banks tend to be graded to a smooth slope and the slope angle is usually less than about 30 percent. In most regions, the upper parts of stable banks are vegetated, but the lower part may be bare at normal stage, depending on bank height and flow regime of the stream. Where banks are low, dense vegetation may extend to the water's edge at normal stage. Mature trees on graded bank slopes are particularly convincing evidence for bank stability. Where banks are high, occasional slumps may occur on even the most stable graded banks. Shallow mountain streams that transport coarse bed sediment tend to have stable banks.

For a more detailed discussion of bank stability and the mechanics of bank failure see HEC 20.

- (n) Young Valley. Typically young valleys are narrow V-shaped valleys with streams on steep gradients. Relief elevation greater than 1,000 ft is regarded as mountainous, while relief in the elevation range of 100 to 1,000 ft is regarded as hilly. Streams in mountainous regions are likely to have steep slopes, coarse bed materials (gravel or cobble-boulder), narrow floodplains, and have nonalluvial characteristics (i.e., supply-limited sediment transport rates). At flood stage, the stream flow covers all or most of the valley floor. The usual situation for such locations is a structure crossing a well-defined channel in which the design discharge will flow at a moderate to high velocity.
- (1) Cross-Channel Location. A cross channel location is a highway crossing a stream on normal or skewed alignment. The erosive forces of parallel flow associated with a normal crossing are generally less of a threat than the impinging and eddy flows associated with a skewed crossing. The effect of constriction by projection of the roadway embankment into the channel should be assessed.

Characteristics to be considered include:

- Stream velocity.
- Scouring action of stream.
- Bank stability.
- Channel constrictions (artificial or natural).
- Nature of flow (tangential or curvilinear).
- Areas of impingement at various stages.
- Security of leading and trailing edges.

Common protection failures occur from:

- Undermining of the toe (inadequate depth/size of foundation), see Figure 872.5 and Table 872.2.
- Local erosion due to eddy currents.
- Inadequate upstream and downstream terminals or transitions to erosion-resistant banks or outcrops.
- Structural inadequacy at points of impingement overtopping.
- Inadequate rock size, see Table 872.2.
- Lack of proper gradation/ layering/ RSP fabric, leading to loss of embankment, see Table 872.2.

Any of the more substantial armor treatments can function properly in such exposures providing precautions are taken to alleviate the probable causes of failure. If the foundation is questionable for concreted-rock or other rigid types it would not be necessary to reject them from consideration but only to provide a more acceptable treatment of the foundation, such as heavy rock or sheet piling.

Whether the highway crosses a stream channel on a bridge or over a culvert, economic considerations often lead to constriction of the waterway. The most common constriction is in width, to shorten the structure. Next in frequency is obstruction by piers and bents of bridges or partitions of multiple culverts.

Figure 872.5

Slope Failure Due to Loss of Toe



July 1, 2020

Table 872.2

Failure Modes and Effects Analysis for Riprap Revetment

Failure Modes	Effects on Other Components	Effects on Whole System	Detection Methods	Compensating Provisions
Translational slope or slump (slope failure)	Disruption of armor layer	Catastrophic failure	<ul style="list-style-type: none"> • Mound of rock at bank toe • Unprotected upper bank 	<ul style="list-style-type: none"> • Reduce bank slope • Use more angular or smaller rock • Use granular filter rather than geotextile fabric
Particle erosion (rock undersized)	Loss of armor layer, erosion of filter	Progressive failure	<ul style="list-style-type: none"> • Rock moved downstream from original location • Exposure of filter 	<ul style="list-style-type: none"> • Increase rock size • Modify rock gradation
Piping or erosion beneath armor (improper filter)	Displacement of armor layer	Progressive failure	<ul style="list-style-type: none"> • Scalloping of upper bank • Bank cutting • Void beneath and between rocks 	<ul style="list-style-type: none"> • Use appropriate granular or geotextile filter
Loss of toe or key (under designed)	Displacement or disruption of armor layer	Catastrophic failure	<ul style="list-style-type: none"> • Slumping of rock • Unprotected upper bank 	<ul style="list-style-type: none"> • Increase size, thickness, depth or extent of toe or key

The risk of constricting the width of the waterway is closely related to the relative conveyance of the natural waterway obstructed, the channel scour, and to the channel migration. Constricting the width of flow at structures has the following effects:

- Increase in the upstream water surface elevation (backwater profile).
- Increase in flow velocity through the structure opening (waterway).
- Causes eddy currents around the upstream and downstream ends of the structure.

Unless protection is provided the eddy currents can erode the approach roadway embankment and the accelerated flow can cause scour at bridge abutments. The effects of erosion can be reduced by providing transitions from natural to constricted and back to natural sections, either by relatively short wingwalls or by relatively long training embankments or structures.

Channel changes, if properly designed, can improve conditions of a crossing by reducing skew and curvature and enlarging the main channel. Unfortunately, there are "side effects" which actually increase erosion potential. Velocity is almost always increased by the channel change, both by a reduction of channel roughness and increase of slope due to channel shortening. In addition, channel changes affecting stream gradient may have upstream and/or downstream effects as the stream adjusts in relation to its sediment load.

At crossing locations, lateral erosion can be controlled by positive protection, such as armor on the banks, rock spurs to deflect currents away from the banks, retards to reduce riparian velocity, or vertical walls or bulkheads. The life cycle cost of such devices should be considered in the economic studies to choose a bridge length which minimizes total cost.

Accurate estimates of anticipated scour depths are a prerequisite for safe, cost effective designs. Design criteria require that bridge foundations be placed below anticipated scour depths. For this reason, the design of protection to control scour at such locations is seldom necessary for new construction. However, if scour may undercut the toes of dikes or embankments positive methods including self-adjusting armor at the toe, jetties or retards to divert scouring currents away from the toe, or sill-shaped baffles interrupting transport of bedloads should be considered.

There is the potential for instability from saturated or inundated embankments at crossings with embankments projecting into the channel. Failures are usually reported as "washouts", but several distinct processes should be noted:

- Saturation of an embankment reduces its angle of repose. Granular fills with high permeability may "dissolve" steadily or slough progressively. Cohesive fills are less permeable, but failures have occurred during falling stages.
- As eddies carve scallops in the embankment, saturation can be accelerated and complete failure may be rapid. Partial or total losses can occur due to an upstream eddy, a downstream eddy, or both eddies eroding toward a central conjunction. Training devices or armor can be employed to prevent damage.
- If the fill is pervious and the pavement overtopped, the buoyant pressure under the slab will exceed the weight of slab and shallow overflow by the pressure head of the hydraulic drop at the shoulder line. A flat slab of thickness, t , will float when the upstream stage is $4t$ higher than the top of the slab. Thereafter the saturated fill usually fails rapidly by a combination of erosion and sloughing. This problem can occur or be increased when curbs, dikes, or emergency sandbags maintain a

July 1, 2020

differential stage at the embankment shoulder. It is increased by an impervious or less pervious mass within the fill. Control of flotation, insofar as bank protection is concerned, should be obtained by using impervious armor on the upstream face of the embankment and a pervious armor on the downstream face.

Culvert problem locations generally occur in and along the downstream transition. Sharp divergence of the high velocity flow develops outward components of velocity which attack the banks directly by impingement and indirectly by eddies entrained in quieter water. Downward components and the high velocity near the bed cause the scour at the end of the apron.

Standard plans of warped wingwalls have been developed for a smooth transition from the culvert to a trapezoidal channel section. A rough revetment extension to the concrete wingwalls is often necessary to reduce high velocity to approximate natural flow. Energy dissipaters may be used to shorten the deceleration process when such a transition would be too long to be economical. Bank protection at the end of wingwalls is more cost effective in most cases.

- (2) Parallel Location. With parallel locations the risk of erosion damage along young streams increases where valleys narrow and gradients steepen. The risk of erosion damage is greatest along the outer bend of natural meanders or where highway embankment encroaches on the main channel.

The *encroaching* parallel location is very common, especially for highways following mountain streams in narrow young valleys or canyons. Much of the roadway is supported on top of the bank or a berm and the outer embankment encroaches on the channel in a zone of low to moderate velocity. Channel banks are generally stable and protection, except at points of impingement, is seldom necessary.

The *constricting* parallel location is an extreme case of encroaching location, causing such impairment of channel that acceleration of the stream through the constriction increases its attack on the highway embankment requiring extra protection, or additional waterway must be provided by deepening or widening along the far bank of the stream.

In young valleys, streams are capable of high velocity flows during flood stages that may be damaging to adjacent highway facilities. Locating the highway to higher ground or solid support is always the preferred alternative when practical.

Characteristics to be considered include:

- High velocity flow.
- Narrow confined channels.
- Accentuated impingement.
- Swift overflow.
- Disturbed flow due to rock outcrops on the banks or within the main channel.
- Alterations in flow patterns due to the entrance of side streams into the main channel.

Protective methods that have proven effective are:

- Rock slope protection.
- Concreted-rock slope protection.
- Walls of masonry and concrete.

- Articulated concrete block revetments.
 - Sacked concrete.
 - Cribs walls of various materials.
- (o) Mature Valley. Typically mature valleys are broad V-shaped valleys with associated floodplains. See Figure 872.6. The gradient and velocity of the stream are low to moderate. Streams in regions of lower relief are usually alluvial and exhibit more problems because of lateral erosion in the channels. Vegetative cover, land use, and flow depth on the floodplain are also significant factors in stream channel stability. Changes in channel geometry with time are particularly significant during periods when alluvial channels are subjected to high flows, and few changes occur during relatively dry periods. Erosive forces during high-flow periods may have a capacity as much as 100 times greater than those forces acting during periods of intermediate and low-flow rates.

Figure 872.6**Mature Valley with Meandering Stream**

Russian River near Geyserville

When considering the stability of alluvial streams, in most instances it can be shown that approximately 90 percent of all changes occur during that small percentage of the time when the flow equals or exceeds dominant discharge. A discussion of dominant discharge may be found in Hydraulic Design Series No. 6, but the bankfull flow condition is recommended for use where a detailed analysis of dominant discharge is not feasible. In addition to the general information previously given, the following applies to mature valleys:

- (1) Cross-Channel Location. The usual situation is a structure crossing a braided or meandering normal flow channel. The marginal area subject to overflow is usually traversed by the highway on a raised embankment and may have long approaches extending from both banks.

Characteristics to be considered include:

- Shifting of the main channel.
- Skew of the stream to the structure.
- Foundation in deep alluvium.
- Erodible embankment materials.
- Channel constrictions, either artificial or natural, which may affect or control the future course of the stream.

July 1, 2020

- Variable flow characteristics at various stages.
- Stream acceleration at the structure.

Armor protection has proven effective to prevent erosion of road approach embankments, supplemented, if necessary, by stream training devices such as guide dikes, permeable retards or jetties to direct the stream through the structure. The abutments should not depend on the training dikes to protect them from erosion and scour. At bridge ends one of the more substantial armor types may be required, but bridge approach embankments affected only by overflow seldom require more than a light revetment, such as a thin layer of rocky material, vegetation, or a fencing along the toe of slope. For channel flow control upstream, the size and type of training system ranges from pile wings for high velocity, through permeable jetties for moderate velocity, to the earth dike suitable for low velocity.

The more common failures in this situation occur from:

- Lack of upstream control of channel alignment.
- Damage of unprotected embankments by overflow and return flow.
- Undercut foundations.
- Formation of eddies at abrupt changes in channel.
- Stranding of drift in the converging channel.

- (2) **Parallel Location.** Parallel highways along mature rivers are often situated on or behind levees built, protected and maintained by other agencies. Along other streams, rather extensive protective measures may be required to control the action of these meandering streams.

Channel change is an important factor in locations parallel to mature streams. The channel change may be to close an embayment, to cut off an oxbow, or to shift the alignment of a long reach of a stream. In any case, positive means must be adopted to prevent the return of the stream to its natural course. For a straight channel, the upstream end is critical, usually requiring bank protection equivalent to the facing of a dam. On a curved channel change, all of the outer bend may be critical, requiring continuous protection. Continuous and resistive bank protection measures, such as riprap and longitudinal rock toes are primarily used to armor outer bends or areas with impinging flows. These continuous and concentrated high velocity areas will generally result in reduced aquatic habitat. Since streambank protection designs that consist of riprap, concrete, or other inert structures alone may be unacceptable for lack of environmental and aesthetic benefits. Resource agencies have increased interest in designs that combine vegetation and inert materials into living systems that can reduce erosion while providing environmental and aesthetic benefits.

- (3) **Desert Wash Locations.** Particular consideration should be given to highway locations that traverse natural geographical features of desert washes, sand dunes, and other similar regions.

Desert washes are a prominent feature of the physiography of California. Many long stretches of highway are located across a succession of outwash cones. Infrequent discharge is typically wide and shallow, transporting large volumes of solids, both mineral and organic. Rather than bridge the natural channels, the generally accepted technique is to concentrate the flow by a series of guide dikes leading like a funnel to a relatively short crossing.

An important consideration at these locations is instability of the channel, see Figure 872.7. For a location at the top of a cone (Line A), discharge is maximum, but the single channel emerging from the uplands is usually stable. For a location at the bottom of the cone (Line C), instability is maximum with poor definition of the channel, but discharge is reduced by infiltration and stream dispersion. The energy of the stream is usually dissipated so that any protection required is minimal. The least desirable location is midway between top and bottom (Line B), where large discharge may approach the highway in any of several old channels or break out on a new line. Control may require dikes continuously from the top of the cone to such a mid-cone site with slope protection added near the highway where the converging flow is accelerated. See Figure 872.8, which depicts a typical alluvial fan.

Also common are roadway alignments which longitudinally encroach, or are fully within the desert wash floodplain, see Figure 872.9. Re-alignment to a stable location should be the first consideration, but restrictions imposed by federal or state agencies (National Park Service, USDA Forest Service, etc.) may preclude that option, somewhat similar to transverse crossings. The designer may need to consider allowing frequent overtopping and increased sediment removal maintenance since an "all weather design" within these regimes can often lead to large scale roadway washout.

Figure 872.7

Alternative Highway Locations Across Debris Cone

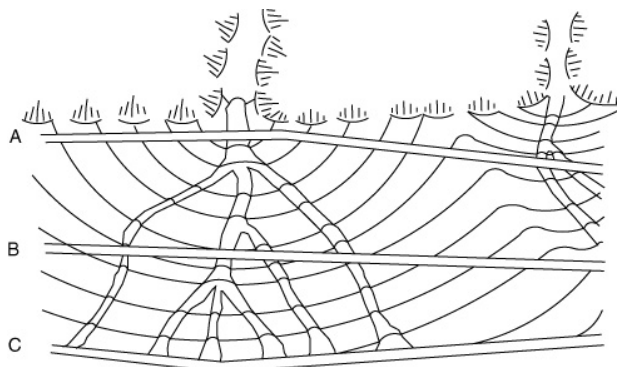

- A. Cross at a single definite channel
- B. A series of unstable indefinite channels and
- C. A widely dispersed and diminished flow

Characteristics to be considered include:

- The intensity of rainfall and subsequent run-off.
- The relatively large volumes of solids that are carried in such run-off.
- The lack of definition and permanence of the channel.
- The scour depths that can be anticipated.
- The lack of good foundation.

Effective protective methods include armor along the highway and at structures and the probable need for baffles to control the direction and velocity of flow. Installations of rock, fence, palisades, slope paving, and dikes have been successful.

July 1, 2020

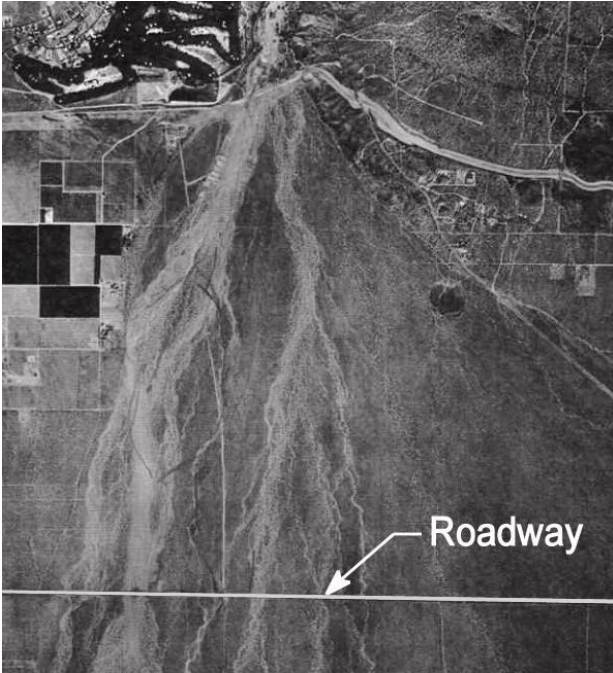
Figure 872.8**Alluvial Fan**

Typical multi-channel stream threads on alluvial fan.
Note location of roadway crossing unstable channels.

Figure 872.9**Desert Wash Longitudinal Encroachment**

Road washout due to longitudinal location in desert wash channel

The Federal Emergency Management Agency (FEMA) Flood Hazard Mapping website contains information on recognizing alluvial fan landforms and methods for defining active and inactive areas. See their “Guidelines for Determining Flood Hazards on Alluvial Fans” at https://www.fema.gov/media-library-data/20130726-1546-20490-5256/ft_afqd.pdf.

(4) *Construction, Easements, Access and Staging.* A primary site consideration for any bank protection design is its constructability. This may include the need for supplemental plans

and temporary construction easements for stage construction to accommodate equipment access. See Figure 872.10.

Figure 872.10

Stage Construction



(5) *Biodiversity*. The riparian area provides one of the richest habitats for large numbers of fish and wildlife species, which depend on it for food and shelter. Many species, including coho and Chinook salmon, steelhead, yellow-billed cuckoo, and the red-legged frog, are threatened or endangered in California. Natural riparian habitat also includes the assortment of native plants that occur adjacent to streams, creeks and rivers. These plants are well adapted to the dynamic and complex environment of streamside zones. A key threat to fish species in any migrating corridor therefore will include loss of riparian habitat and instream cover affecting juvenile rearing and outmigration.

For channel and habitat characterization and preliminary assessment relative to designing and obtaining project specific permits, District biologist staff should be consulted early on within the project planning phase for subject matter expertise regarding fisheries, habitat, and wildlife. District biologist staff can also perform an initial stream habitat assessment. Contact information for Department biologists can be accessed through the CalBioRoster.

Numerous State and Federal agencies are responsible for fish management in California - including California Department of Fish and Wildlife, the National Marine Fisheries Service and the United States Army Corps of Engineers. Each agency has its own guidelines and jurisdiction. For example, detailed information on the requirements for fish habitat in riparian corridors may be found in Volume One and Two of the California Salmonid Stream Habitat Restoration Manual: <http://www.dfg.ca.gov/fish/Resources/HabitatManual.asp>

872.4 Data Needs

The types and amount of data needed for planning and analysis of channel protection varies from project to project depending upon the class and extent of the proposed protection, site location environment, and geographic area. See Index 872.1. The data that is collected and developed including preliminary calculations, and alternatives considered should be documented in project development reports (Environmental Document, Project Report, etc.) or as a minimum in the project file. These records serve to guide the detailed designs, and provide reference background for analysis of environmental impacts and other needs such as permit

July 1, 2020

applications and historical documentation for any litigation which may arise. See Index 873.3(3)(a)(2)(b) for rock sizing equation parameters.

Recommendations for data needs can be requested from the District Hydraulics Engineer or determined from Chapter 8 of FHWA's HDS No. 6, for a more complete discussion of data needs for highway crossings and encroachments on rivers. Further references to data needs are contained in Chapter 810, Hydrology and FHWA's HDS No. 2, Highway Hydrology and HEC 20, Stream Stability at Highway Structures.

872.5 Rapid Assessment

The National Pollutant Discharge Elimination System (NPDES) permit mandates a risk-based approach to be employed during planning and design for assessing stream stability at highway crossings. This approach involves conducting a rapid pre-project assessment of the vertical and lateral stability of the receiving stream channel related to an existing or planned highway crossing structure. If the rapid stability assessment (RSA) indicates potential problems, more detailed engineering analyses are required to determine if countermeasures are needed to stabilize the crossing to prevent the release of sediment. Therefore, if available, stream stability assessments for nearby highway crossings should be included in the site consideration for channel protection.

Section 3 of Caltrans Hydromodification Requirements Guidance Storm Water Best Management Practices Rapid Assessment of Stream Crossings Higher Level Stream Stability Analysis is an excellent resource for understanding the concepts of basic geomorphology and California earth science.

Table 8 of Assessing Stream Channel Stability at Bridges in Physiographic Regions (FHWA-HRT-05-072) presents an extensive listing of factors affecting stream stability.

Topic 873 – Design Concepts

873.1 Introduction

No attempt will be made here to describe in detail all of the various devices that have been used to protect embankments against scour. Methods and devices not described may be used when justified by economic analysis. Not all publicized treatments are necessarily suited to existing conditions for a specific project.

A set of plans and specifications must be prepared to define and describe the protection that the design engineer has in mind. These plans should show controlling factors and an end product in such detail that there will be no dispute between the construction engineer and contractor. To serve the dual objectives of adequacy and economy, plans and specifications should be precise in defining materials to be incorporated in the work, and flexible in describing methods of construction or conformance of the end product to working lines and grades.

Recommendations on channel lining, slope protection, and erosion control materials can be requested from the District Hydraulic Engineer, the District Materials Branch and the Office of Highway Drainage and Water Quality Design in Headquarters. The District Landscape Architect will provide recommendations for temporary and permanent erosion and sediment control

measures. The Caltrans Bank and Shore Protection Committee is available on request to provide advice on extraordinary situations or problems and to provide evaluation and formal approvals for acceptable non-standard designs. See Index 802.3 for further information on the organization and functions of the Committee.

Combinations of armor-type protection can be used, the slope revetment being of one type and the foundation treatment of another. The use of rigid, non-flexible slope revetment may require a flexible, self-adjusting foundation for example: concreted-rock on the slope with heavy rock foundation below, or PCC slope paving with a steel sheet-pile cutoff wall for foundation.

Bank protection may be damaged while serving its primary purpose. Lower cost replaceable facilities may be more economical than expensive permanent structures. However, an expensive structure may be economically warranted for highways carrying large volumes of traffic or for which no detour is available.

Cost of stone is extremely sensitive to location. Variables are length of haul, efficiency of the quarry in producing acceptable sizes, royalty to quarry and, necessity for stockpiling and rehandling. On some projects the stone may be available in roadway excavation.

873.2 Design High Water and Hydraulics

The most important, and often the most perplexing obligation, in the design of bank and shore protection features is the determination of the appropriate design high water elevation to be used. The design flood stage elevation should be chosen that best satisfies site conditions and level of risk associated with the encroachment. The basis for determining the design frequency, velocity, backwater, and other limiting factors should include an evaluation of the consequences of failure on the highway facility and adjacent property. Stream stability and sediment transport of a watercourse are critical factors in the evaluation process that should be carefully weighted and documented. Designs should not be based on an arbitrary storm or flood frequency.

A suggested starting point of reference for the determination of the design high water level is that the protection withstands high water levels caused by meteorological conditions having a recurrence interval of one-half the service life of the protected facility. For example, a modern highway embankment can reasonably be expected to have a service life of 100 years or more. It would therefore be appropriate to base the preliminary evaluation on a high water elevation resulting from a storm or flood with a 2 percent probability of exceedance (50 year frequency of recurrence). The first evaluation may have to be adjusted, either up or down, to conform with a subsequent analysis which considers the importance of the encroachment and level of related risks which may include consideration of historic high water marks and climate change. Scour countermeasures protecting structures designed by the Division of Engineering Services (DES) may include consideration of floods greater than a 1 percent probability of exceedance (100 year frequency of recurrence).

There is always some risk associated with the design of protection features. Special attention must be given to life threatening risks such as those associated with floodplain encroachments. Significant floodplain risks are classified as those having probability of:

- Catastrophic failure with loss of life.
- Disruption of fire and ambulance services or closing of the only evacuation route available to a community.

July 1, 2020

Refer to Topic 804, Floodplain Encroachments, for further discussion on evaluation of risks and impacts.

(1) *Streambank Locations.* The velocity along the banks of watercourses with smooth or uniformly rough tangent reaches may only be a small percentage of the average stream velocity. However, local irregularities of the bank and streambed may cause turbulence that can result in the bank velocity being greater than that of the central thread of the stream. The location of these irregularities is not always permanent as they may be caused by local scour, deposition of rock and sand, or stranding of drift during high water changes. It is rarely economical to protect against all possibilities and therefore some damage should always be anticipated during high water stages.

Essential to the design of streambank protection is sufficient information on the characteristics of the watercourse under consideration. For proper analysis, information on the following types of watercourse characteristics must be developed or obtained:

- Design Discharge
- Design High Water Level
- Flow Types
- Channel Geometry
- Flow Resistance
- Sediment Transport

Refer to Chapter 810, Hydrology, for a general discussion on hydrologic analysis and specifically to Topic 817, Flood Magnitudes; Topic 818, Flood Probability and Frequency; and Topic 819, Estimating Design Discharge. For a detailed discussion on the fundamentals of alluvial channel flow, refer to Chapter 3, HDS No. 6, and to Chapter 4, HDS No. 6, for further information on sediment transport.

(2) *Ocean & Lake Shore Locations.* Refer to Chapter 880 for information needed to design shore protection.

873.3 Armor Protection

(1) *General.* Armor is the artificial surfacing of bed, banks, shore or embankment to resist erosion or scour. Armor devices can be flexible (self-adjusting) or rigid.

Hard armoring of stream banks, primarily with rock slope protection (RSP), has been the most common means of providing long-term protection for transportation facilities, and most importantly, the traveling public. With many years of use, dozens of formal studies and thousands of constructed sites, RSP is the armor type for which there exists the most quantifiable data on performance, constructability, maintainability and durability, and for which there exist several nationally recognized design methods.

Due to the above factors, RSP is the general standard against which other forms of armoring are compared.

The results of internal research led to the publication of Report No. FHWA-CA-TL-95-10, "California Bank and Shore Rock Slope Protection Design". Within that report, the methodology for RSP design adopted as the Departmental standard for many years, was the California Bank and Shore, (CaBS), layered design. The CaBS layered design methodology and its associated gradations have become obsolete. For reference only, the full report is available at the following website:

<http://www.dot.ca.gov/hq/oppd/hydrology/hydroidx.htm>.

FHWA Hydraulic Engineering Circular No. 23 (HEC 23) presents guidelines for RSP for a range of applications, including: RSP on streams and river banks, bridge piers and abutments, and bridge scour countermeasures such as guide banks and spurs. These guidelines were formally adopted by the Caltrans Bank and Shore Protection Committee with a modified version of HEC 23 gradations. See Tables 873.3A and 873.3B as well as HEC 23, Volume 1, Chapter 5 and Design Guideline 4, 5, 11, 12, 15 and 16 from Volume 2. Section 72 of the Standard Specifications provides all construction and material specifications for RSP designs. While standards (i.e., Standard Plans, Standard Specifications and/or SSP's) do exist for some other products discussed in this Chapter (most notably for gabions, but also for certain rolled or mat-style erosion control products), their primary application is for relatively flat slope or shallow ditch erosion control (gabions are also used as an earth retaining structure, see Topic 210 for more details).

Rigid and other armor types listed below are viable and may be considered where conditions warrant. Although the additional step of headquarters approval of any nonstandard designs is required, designers are encouraged to consider alternative designs, particularly those that incorporate vegetation or products naturally present in stream environments. The District Landscape Architect can provide design assistance together with specifications and details for the vegetative portion of this work.

(a) Flexible Types.

- Rock slope protection.
- Gabions, Standard Plan D100A and D100B.
- Precast concrete articulated blocks.

(b) Rigid Types.

- Concreted-rock slope protection.
- Partially-grouted rock slope protection.
- Sacked concrete slope protection.
- Concrete filled cellular mats.

(2) *Bulkheads*. The bulkhead types are steep or vertical structures, like retaining walls, that support natural slopes or constructed embankments which include the following:

- Gravity or pile supported concrete or masonry walls.
- Crib walls
- Sheet piling

(a) General Design Criteria. In selecting the type of flexible or rigid armor protection to use the following characteristics are important design considerations.

- (1) The lower limit, or toe, of armor should be below anticipated scour or on bedrock. If for any reason this is not economically feasible, a reasonable degree of security can be obtained by placement of additional quantities of heavy rock at the toe which can settle vertically as scour occurs.
- (2) In the case of slope paving or any expensive revetment which might be seriously damaged by overtopping and subsequent erosion of underlying embankment, extension above design high water may be warranted. The usual limit of extension for streambank protection above design high water is 1 foot to 2 feet in unconstricted reaches and 2 feet to 3 feet in constricted reaches.

July 1, 2020

- (3) The upstream terminal can be determined best by observation of existing conditions and/or by measuring velocities along the bank. The terminal should be located to conform to outcroppings of erosion-resistant materials, trees, shrubs or other indications of stability.

In general, the upstream terminal on bends in the stream will be some distance upstream from the point of impingement or the beginning of curve where the effect of erosion is no longer damaging.

- (4) When possible, the downstream terminal should be made downstream from the end of the curve and against outcroppings, erosion-resistant materials, or returned securely into the bank so as to prevent erosion by eddy currents and velocity changes occurring in the transition length.
- (5) The encroachment of embankment into the stream channel must be considered with respect to its effect on the conveyance of the stream and possible damaging effect on properties upstream due to backwater and downstream due to increased stream velocity or redirected stream flow.
- (6) A smooth surface will generally accelerate velocity along the bank, requiring additional treatment (e.g., extended transition, cut-off wall, etc.) at the downstream terminal. Rougher surfaces tend to keep the thread of the stream toward the center of the channel.
- (7) Heavy-duty armor used in exposures along the ocean shore may be influenced or dictated by economics, or the feasibility of handling heavy individual units.

(3) *Flexible Revetments.*

(a) Streambank Rock Slope Protection.

- (1) General Features. This kind of protection, commonly called riprap, consists of rock courses placed upon the embankment or the natural slope along a stream. Rock, as a slope protection material, has a number of desirable features which have led to its widespread application.

It is usually the most economical type of revetment where stones of sufficient size and quality are available, it also has the following advantages:

- It is flexible and is not impaired nor weakened by slight movement of the embankment resulting from settlement or other minor adjustments.
- Local damage or loss is easily repaired by the addition of similar sized rock where required.
- Construction is not complicated and special equipment or construction practices are not usually necessary. (Note that Method A placement of very large rock may require large cranes or equipment with special lifting capabilities).
- Appearance is natural, and usually acceptable in recreational and scenic areas.
- If exposed to fresh water, vegetation may be induced to grow through the rocks adding structural value to the embankment material and restoring natural roughness. See Index 873.3(3)(a)(2)(d) for further vegetative rock slope protection information.
- Additional thickness (i.e., mounded toe design) can be provided at the toe to offset possible scour when it is not feasible to found it upon bedrock or below anticipated scour.
- It is salvageable, may be stockpiled and reused if necessary.

In designing the rock slope protection for a given embankment the following determinations are to be made for the typical section.

- Depth at which the stones are founded (bottom of toe trench).
- Elevation at the top of protection.
- Thickness of protection.
- Need for geotextile or rock filter material.
- Face slope.

(a) *Placement*. Two different methods of placement for rock slope protection are allowed under Section 72 of the Standard Specifications: Placement under Method A requires considerable care, judgment, and precision and is consequently more expensive than Method B. Method A should be specified primarily where large rock is required, but also for relatively steeper slopes.

(b) *Foundation Treatment*. The foundation excavation must afford a stable base on bedrock or extend below anticipated scour.

Terminals of revetments are often destroyed by eddy currents and other turbulence because of nonconformance with natural banks. Terminals should be secured by transitions to stable bank formations, or the end of the revetment should be reinforced by returns of thickened edges.

While a significant amount of research is currently being conducted, few methods exist for estimating scour along stream banks. One of the few is the method contained in HEC 23 Volume 1, Index 4.3.5 and the CHANLPRO Program developed by the U.S.

Army Corps of Engineers. Based on the flume studies at the Corps' Waterways Experiment Station, the program is primarily used by the Corps for RSP designs on streams with 2 percent or lesser gradients, but contains an option for scour depth estimates in bends for sand channels. CHANLPRO is available at the following USACE website: <https://apps.dtic.mil/dtic/tr/fulltext/u2/a351838.pdf> along with a user guide containing equations, charts, assumptions and limitations to the method and example problems.

(c) *Embankment Considerations*. Embankment material is not normally carried out over the rock slope protection so that the rock becomes part of the fill. With this type of construction fill material can filter down through the voids of the large stones and that portion of the fill above the rocks could be lost. If it is necessary to carry embankment material out over the rock slope protection a geotextile is required to prevent the losses of fill material.

The embankment fill slope is usually determined from other considerations such as the angle of repose for embankment material, or the normal 1V:4H specified for high-standard roads. If the necessary size of rock for the given exposure is not locally available, consideration should be given to flattening of the embankment slope to allow a smaller size stone, or substitution of other types of protection. On high embankments, alternate sections on several slopes should be compared, practically and economically; flatter slopes require smaller stones in thinner sections, but at the expense of longer slopes, a lower toe elevation, increased embankment, and perhaps additional right of way.

Where the roadway alignment is fixed, slope flattening will often increase embankment encroachment into the stream. When such an encroachment is environmentally or technically undesirable, the designer should consider various

July 1, 2020

vertical, or near vertical, wall type alternatives to provide adequate stream width, allowing natural channel migration and the opportunity for enhancing habitat.

- (d) *Rock Slope Protection Fabric.* Rock Slope Protection fabrics are described in Standard Specification Section 96. The RSP fabric placement ensures that fine soil particles do not migrate through the RSP due to hydrostatic forces and, thus, eliminate the potential for bank failure. The use of RSP fabric provides an inexpensive layer of protection retaining embankment fines in lieu of placing a gravel filter of small, well graded materials. See Index 873.3(3)(a)(1)(e) "Gravel Filter."

Stronger and heavier RSP fabrics than those listed in the Standard Specifications are manufactured. They are used in special designs for larger than standard RSP sizes, or emergency installations where placement of large RSP must be placed directly on the fabric. These heavy weight fabrics have unit weights of up to 16 ounces per square yard. Contact the Headquarters Hydraulic Engineer for assistance regarding usage applications of heavy weight RSP fabrics.

- (e) *Gravel Filter.* Generally, RSP fabric should always be used unless there is a permit requirement that precludes the placement of fabric. Where RSP fabric cannot be placed, such as in stream environments where CA Fish & Wildlife and NOAA Fisheries strongly discourage the use of RSP Fabric, a gravel filter is usually necessary with most native soil conditions to stop fines from bleeding through the typical RSP classes. A gravel filter will be specified and placed between the native base soil and RSP for hybrid revetments to avoid conflicts associated with planting vegetation and placing RSP fabric together. A universal gravel filter gradation is presented in Design Information Bulletin No. 87 (see Table H, Index 7.1.2), which should work for many stream sites in California and eliminate the need for a site-specific gravel filter design for every project.

When a gravel filter is to be placed, the designer is advised to work with the District Materials Office to get a recommendation for the necessary gradation to work effectively with both the native backfill and the base layer of the RSP that is being placed. Among the methods available for designing the gravel filter are the Terzaghi method, developed exclusively for situations where the native backfill is sand, and the Cisten-Ziems method, which is often used for a broad variety of soil types and recommended in HEC 23. Where streambanks must be significantly rebuilt and reconfigured with imported material before RSP placement, the designer must ensure that the imported material will not bleed through the designed gravel filter. See HEC 23 Volume 2, Design Guideline 16, Index 16.2.1 Granular Filter Design Procedure and 16.3.1 Granular filter (design example).

- (a) *Streambank Protection Design.* In the lower reaches of larger rivers wave action resulting from navigation or wind blowing over long reaches may be much more serious than velocity. A 2 foot wave, for example, is more damaging than direct impingement of a current flowing at 10 feet per second. Therefore, consideration of a wave attack based design may be necessary. See Chapter 880 for further information.

Well designed streambank rock slope protection should:

- Assure stability and compatibility of the protected bank as an integral part of the channel as a whole.
- Connect to natural bank, bridge abutments or adjoining improvements with transitions designed to ease differentials in alignment, grade, slope and roughness of banks.

- Eliminate or ease local embayments and capes so as to streamline the protected bank.
 - Consider the effects of backwater above constrictions, superelevations on bends, as well as tolerance of occasional overtopping.
 - Not be placed on a slope steeper than 1.5H:1V. Flatter slopes use lighter stones in a thinner section and encourage overgrowth of vegetation, but may not be permissible in narrow channels.
 - Use stone of adequate weight to resist erosion, derived from Index 873.3(3)(a)(2)(b).
 - Prevent loss of bank materials through interstitial spaces of the revetment. Rock slope protection fabric should be used.
 - Rest on a good foundation on bedrock or extend below the depth of probable scour. If questionable, use heavy bed stones and provide a wide base section with a reserve of material to slough into local scour holes (i.e., mounded toe).
 - Reinforce critical zones on outer bends subject to impinging flow, using heavier stones, thicker section, and deeper toe.
 - Be constructed of rock of such shape as to form a stable protection structure of the required section. Rounded boulders or cobbles must not be used on prepared ground surfaces having slopes steeper than 2.5H:1V.
- (a) *Stone Shape*. The shape of a stone can be generally described by designating three axes of measurement: major, intermediate, and minor, also known as the “A, B, and C” axes, as shown in Figure 873.3A.

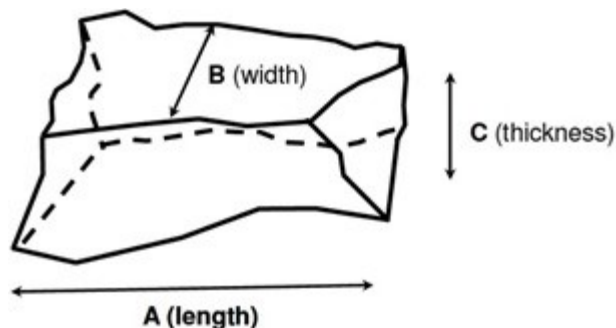
Figure 873.3A**Stone Shape**

Riprap stones should not be thin and platy, nor should they be long and needle-like. Therefore, specifying a maximum allowable value of the ratio A/C , also known as the shape factor, provides a suitable measure of particle shape, since the B axis is intermediate between the two extremes of length A and thickness C. A maximum allowable value for A/C of 3.0 is recommended.

Based on field studies, the recommended relationship between stone size and weight is given by:

July 1, 2020

Table 873.3A

RSP Class by Median Particle Size⁽³⁾

Nominal RSP Class by Median Particle Size ⁽³⁾		d ₁₅		d ₅₀		d ₁₀₀	Placement
Class ⁽¹⁾ , (2)	Size (in)	Min	Max	Min	Max	Max	Method
I	6	3.7	5.2	5.7	6.9	12.0	B
II	9	5.5	7.8	8.5	10.5	18.0	B
III	12	7.3	10.5	11.5	14.0	24.0	B
IV	15	9.2	13.0	14.5	17.5	30.0	B
V	18	11.0	15.5	17.0	20.5	36.0	B
VI	21	13.0	18.5	20.0	24.0	42.0	A or B
VII	24	14.5	21.0	23.0	27.5	48.0	A or B
VIII	30	18.5	26.0	28.5	34.5	48.0	A or B
IX	36	22.0	31.5	34.0	41.5	52.8	A
X	42	25.5	36.5	40.0	48.5	60.5	A
XI	46	28.0	39.4	43.7	53.1	66.6	A

NOTES:

⁽¹⁾Rock grading and quality requirements per Standard Specifications.

⁽²⁾RSP-fabric Type of geotextile and quality requirements per Section 96 Rock Slope Protection Fabric of the Standard Specifications. For RSP Classes I thru VIII, use Class 8 RSP-fabric which has lower weight per unit area and it also has lower toughness (tensile x elongation, both at break) than Class 10 RSP-fabric. For RSP Classes IX thru XI, use Class 10 RSP-fabric.

⁽³⁾Intermediate, or B dimension (i.e., width) where A dimension is length, and C dimension is thickness.

Table 873.3B

RSP Class by Median Particle Weight⁽³⁾

Nominal RSP Class by Median Particle Weight		W ₁₅		W ₅₀		W ₁₀₀	Placement
Class ^{(1),} ₍₂₎	Weight	Min	Max	Min	Max	Max	Method
I	20 lb	4	11	15	27	140	B
II	60 lb	14	39	50	94	470	B
III	150 lb	32	94	120	220	1,100	B
IV	300 lb	63	180	250	440	2,200	B
V	1/4 ton	110	300	400	700	3,800	B
VI	3/8 ton	180	520	650	1,100	6,000	A or B
VII	1/2 ton	250	750	1000	1,700	9,000	A or B
VIII	1 ton	520	1,450	1,900	3,300	9,000	A or B
IX	2 ton	870	2,500	3,200	5,800	12,000	A
X	3 ton	1,350	4,000	5,200	9,300	18,000	A
XI	4 ton	1,800	5,000	6,800	12,200	24,000	A

NOTES:

(1)Rock grading and quality requirements per Standard Specifications.

(2)RSP-fabric Type of geotextile and quality requirements per Section 96 Rock Slope Protection Fabric of the Standard Specifications. For RSP Classes I thru VIII, use Class 8 RSP-fabric which has lower weight per unit area and it also has lower toughness (tensile x elongation, both at break) than Class 10 RSP-fabric. For RSP Classes IX thru XI, use Class 10 RSP-fabric.

(3)Values shown are based on Table 873.3A dimensions and an assumed specific gravity of 2.65. Weight will vary based on density of rock available for the project.

July 1, 2020

$$W = 0.85(\gamma_s d^3)$$

Where:

W = Weight of stone, lb;

d = Size of intermediate ("B") axis, ft;

 γ_s = Density of stone, lb/ft³;

$$= S_g \gamma_w$$

Where:

$$\gamma_w = 62.4 \text{ lb/ft}^3;$$

 S_g = Specific gravity of stone.

Tables 873.3A and 873.3B provide recommended gradations for eleven standard classes of riprap based on median particle size d_{50} as determined by the dimension of the intermediate ("B") axis. The D or W refers to size or weight, respectively. The number is the percent finer by weight. Tables 873.3A and 873.3B are modified versions of Tables 4.1 and 4.2 in HEC 23, Volume 2, Design Guideline 4, which provide recommended gradations for ten standard classes of riprap and conform to those recommended in NCHRP Report 568 (Lagasse et al. 2006). The gradation criteria in Table 873.3A are based on a nominal or "target" d_{50} . See Index 873.3(3)(a)(2)(b) for equations to calculate d_{30} and d_{50} . The most significant modifications to Tables 873.A and 873.B from the gradations shown in Tables 4.1 and 4.2 are to the $d_{100\max}$ and $W_{100\max}$ gradation for classes VIII through XI, which have been truncated for practicality. An additional class XI is included in Tables 873.3A and 873.3B. Contact the Headquarters Hydraulic Engineer if more information is needed on the modification to the HEC 23 gradations.

Based on the recommended relationship between size and weight, which assumes the volume of the stone is 85% of a cube, Table 873.3B provides the equivalent particle weights for the same eleven classes as Table 873.3A using a specific gravity of 2.65 for the particle density.

- (b) *Stone Size.* Where stream velocity governs, rock size may be estimated from the following formula, which can be used with uniform or gradually varying flow. Coefficients are included to account for the desired safety factor for design, specific gravity of the riprap stone, bank slope, and bendway character;

$$d_{30} = y(S_f C_S C_V C_T) \left[\frac{V_{des}}{\sqrt{K_1(S_g - 1)gy}} \right]^{2.5}$$

Where:

 d_{30} = Particle size for which 30% is finer by weight, ft;

y = Local depth of flow, ft;

 S_f = Safety factor (typically = 1.1);

C_S =Stability coefficient (for blanket thickness $1.5d_{50}$ or d_{100} , whichever is greater) = 0.30 for angular rock;

C_V =Velocity distribution coefficient;

=1.0 for straight channels or the inside of bends;

= $1.283 - 0.2 \log(R_c/W)$ for the outside of bends (1.0 for $R_c/W > 26$);

=1.25 downstream from concrete channels;

=1.25 at the end of dikes;

C_T =Blanket thickness coefficient = 1.0;

S_g =Specific gravity of stone (2.5 minimum);

g =Acceleration due to gravity, 32.2 ft/s²;

V_{des} =Characteristic velocity for design, defined as the depth-averaged velocity at a point 20% upslope from the toe of the revetment, ft/s;

For natural channels,

$$V_{des} = V_{avg} (1.74 - 0.52 \log(R_c/W))$$

$$V_{des} = V_{avg} \text{ for } R_c/W > 26$$

For trapezoidal channels,

$$V_{des} = V_{avg} (1.71 - 0.78 \log(R_c/W))$$

$$V_{des} = V_{avg} \text{ for } R_c/W > 8$$

Where:

R_c = Centerline radius of curvature of channel bend, ft;

W = Width of water surface at upstream end of channel bend, ft;

V_{avg} = Channel cross-sectional average velocity, ft/s;

K_1 = Side slope correction factor;

$$K_1 = \sqrt{1 - \left[\frac{\sin(\theta - 14^\circ)}{\sin 32^\circ} \right]^{1.6}}$$

Where:

θ = is the bank angle in degrees.

The flow depth "y" used in the above equation is defined as the local flow depth. The flow depth at the toe of slope is typically used for bank revetment applications; alternatively, the average channel depth can be used. The smaller of these values will result in a slightly larger computed d_{30} size, since riprap size is inversely proportional to ($y^{0.25}$). The blanket thickness coefficient (C_T) is 1.0 for standard riprap applications where the thickness is equal to $1.5d_{50}$ or d_{100} , whichever is greater. Because limited data is available for selecting lower values of C_T when greater thicknesses of riprap are used, a value of 1.0 is reasonable for all applications. The recommended Safety Factor S_f is 1.1 for bank revetment. Greater values should be considered where there is significant potential for ice or impact from large debris, freeze-thaw degradation that would significantly decrease particle size, or large uncertainty in the design variables, especially velocity. The specific gravity (S_g) of stone is commonly taken as 2.65 for planning

July 1, 2020

purposes, however, this will result in a less conservative design than utilizing a 2.5 specific gravity assumption, which would be the minimum accepted in the field. Therefore, the designer should contact the District Materials Engineer in the project's area and determine if there is any history of RSP materials used in that region. Where such information or history is unavailable, use of a 2.5 specific gravity within the design should be considered.

The d_{30} size of the riprap is related to the recommended median (d_{50}) size by:

$$d_{50} = 1.20d_{30}$$

Using standard sizes the appropriate gradation can be achieved by selecting the next larger size class, thereby creating a slightly over-designed structure, but economically a less expensive one. For example, if a riprap sizing calculation results in a required d_{50} of 16.8 inches, Class V riprap should be specified because it has a nominal d_{50} of 18 inches. See Table 873.3A.

A limitation to the rock size equation above is that the longitudinal slope of the channel should not be steeper than 2.0% (0.02 ft/ft). For steeper channels, the riprap sizing approach for overtopping flows presented in HEC 23, Volume 2, Design Guideline 5 should be considered and the results compared with the rock size equation above .

Where wave action is dominant, design of rock slope protection should proceed as described for shore protection, see Chapter 880.

- (c) *Design Height.* The top of rock slope protection along a stream bank should be carried to the elevation of the design high water plus some allowance for freeboard. Cost and severity of damage if overtopped as well as the importance of the facility should also be considered. The goal for the design high water is based on the 50-year (2% probability) flow, but can be modified using engineering judgment which may include consideration of historic high water marks and climate change. This stage may be exceeded during infrequent floods, usually with little or no damage to the upper slope. See Hybrid RSP cross section in Figure 873.3D for an example showing the top of rock slope protection.

When determining freeboard, or the height above design high water from which the RSP is to extend, one should consider: the size and nature of debris in the flow; the resulting potential for damage to the bank, the potential for streambed aggradation; and the confidence in data used to estimate design highwater. Freeboard may also be affected by regulatory or local agency requirements. Freeboard may be more generous on the outside bends of channels, or around critical bridges.

The 50-year design high water plus freeboard goal should be followed whenever possible, but the biggest exception to this goal occurs when the design height exceeds the main channel top of bank. Because floodplain overbank areas can be wide and extensive, the footprint of the RSP could grow exponentially if extended above and beyond the top of bank. This increased footprint would bring higher costs and permitting challenges that could make a project no longer viable. Given this possibility, the RSP vertical limit (height) should typically end at the main channel top of bank; however, a vegetation component may extend above and beyond the top of bank.

For cases where significant erosion has occurred above the main channel top of bank into its overbank(s), contact the District Hydraulic Engineer to discuss alternatives for repair and protection.

Design Example – The following example reflects the HEC 23 method for designing RSP. The designer is encouraged to review Design Guideline 4, Riprap Revetment from HEC 23, Volume 2. The following example assumes that the designer has conducted the appropriate site assessments and resulting calculations to establish average stream velocity, flow depth at bank toe, estimated depth of scour, stream alignment (i.e., parallel or impinging flow), width of channel, radius of bend (if impinging flow), length and side slope of stream bank to be protected and locations of natural hard points (e.g., rock outcroppings). Field reviews and discussions with maintenance staff familiar with the site are critical to the success of the design.

Given for example:

- Average stream velocity for design event of 9.8 feet per second
- Flow depth of 11.4 feet at bank toe
- Estimated scour depth – 3.5 feet
- Length of bank requiring protection – 550 feet
- Bank slope – 2:1
- Specific gravity of rock used for RSP – 2.54 (based on data from local quarry)
- Embankment is on outside of stream bend of 100 ft wide natural channel on a bend that has a centerline radius (R_c) of 500 ft. The radius of curvature divided by width (R_c/W) is 5.0.
- A desired factor of safety (S_f) of 1.2.

Determine the target d_{50} , select appropriate RSP class from Table 873.3A and determine the blanket thickness:

Step 1: Compute the side slope correction factor:

$$\begin{aligned}
 K_1 &= \sqrt{1 - \left(\frac{\sin(\theta - 14^\circ)}{\sin 32^\circ} \right)^{1.6}} \\
 &= \sqrt{1 - \left(\frac{\sin(26.6^\circ - 14^\circ)}{\sin 32^\circ} \right)^{1.6}} \\
 &= 0.87
 \end{aligned}$$

Step 2: Select the appropriate stability coefficient for riprap: C_s (for blanket thickness $1.5d_{50}$ or d_{100} , whichever is greater) = 0.30 for angular rock

Step 3: Compute the vertical velocity factor (C_v) for $R_c/W = 5.0$:

$$\begin{aligned}
 C_v &= 1.283 - 0.2 \log(R_c/W) \\
 &= 1.283 - 0.2 \log(5.0) \\
 &= 1.14
 \end{aligned}$$

Step 4: Compute local velocity on the side slope (V_{des}) for a natural channel with $R_c/W = 5.0$:

$$\begin{aligned}
 V_{des} &= V_{avg} [1.74 - 0.52 \log(R_c/W)] \\
 &= 9.8 [1.74 - 0.52 \log(5.0)] \\
 &= 13.5 \text{ ft/s}
 \end{aligned}$$

July 1, 2020

Step 5: Compute the d_{30} size using stone size equation from Index 873.2(2)(a)(2)(b):

$$d_{30} = S_f C_s C_v y \left[\frac{V_{des}}{\sqrt{(Sg - 1) K_1 g y}} \right]^{2.5}$$

$$= (1.2)(0.3)(1.14)(11.4) \times \left[\frac{13.5}{\sqrt{(2.54 - 1)(0.87)(32.2)(11.4)}} \right]^{2.5}$$

$$= 1.35 \text{ ft}$$

Step 6: Compute the d_{50} size = $1.2d_{30}$ = $1.2(1.35)$
 = 1.62 ft = 19 inches.

Note: Use next larger size class (see Table 873.3A)

Step 7: Select Class VI riprap from Table 873.3A: d_{50} = 21 inches

Step 8: Blanket thickness = $1.5d_{50}$ or d_{100} , whichever is greater

$$1.5d_{50} = 1.5(21 \text{ inches})$$

$$= 31.5 \text{ inches}$$

$$d_{100} = 42 \text{ inches, therefore, use 42 inches}$$

Step 9: Determine the depth of riprap embedment below the streambed at the toe of the bank slope:

Since toe scour is expected to be 3.5 ft, the 2H:1V slope should be extended below the ambient bed level 7 ft horizontally out from the toe to accommodate this scour. Alternatively, a mounded riprap toe 3.5 ft high could be established at the base of the slope and allowed to self-launch when toe scour occurs, see Figure 873.3D.

Step 10: Assess Stream Impact Due to Revetment. In some cases, the thickness of the completed RSP revetment creates a narrowing of the available stream channel width, to the extent that stream velocity or stage at the design event is increased to undesirable levels, or the opposite bank becomes susceptible to attack. In these cases, the bank upon which the RSP is to be placed must be excavated such that the constructed face of the revetment is flush with the original embankment.

Step 11: Exterior Edges of Revetment. The completed design must be compatible with existing and future conditions. Freeboard and top edge of revetments were covered in Index 873.3(2)(a)(2)(c) "Design Height." For depth of toe, the estimated scour was given as 3.5 feet. This is the minimum toe depth to be considered. Again, based on site conditions and discussions with maintenance staff and others, determine if any long-term conditions need to be addressed. These could include streambed degradation due to local aggregate mining or headcutting. Regardless of the condition, the toe must be founded below the lowest anticipated elevation that could become exposed over the service life of the embankment or roadway facility. As for the upstream and downstream ends, the given length of revetment is 550 feet. Again, this will typically be a minimum, as the designer should seek natural rock outcroppings, areas of quiescent stream flow, or other inherently stable bank segments to end the RSP.

(d) *Vegetated Rock Slope Protection.* The use of vegetation in streambank stabilization has positive attributes on stream integrity, such as improving stream ecology, increasing soil strength, and providing flow resistance, but vegetation can also have negative impacts on stream integrity by altering conveyance

characteristics of the stream, affecting soil characteristics, in addition to being unpredictable in its long term establishment and performance.

Streams with stable vegetation typically have good water quality, as well as good biological and chemical health due in part to the ability of the vegetation to filter pollutants including nitrates and phosphates through their uptake of moisture in the soil. Vegetation will also promote good fish, wildlife, and aquatic organism habitat by providing cover, reducing stream temperature and controlling temperature fluctuations, and supplying an organic food source. In addition to ecological improvements, vegetation can strengthen the underlying soils. It can create additional cohesion and binding properties through its roots. The fibrous woody roots are strong in tension, but weak in compression, which is the opposite case for soil. Therefore, roots and soil working in tandem can complement the other providing a material that has both tension and compression resistance. Vegetation can also improve soil strength by lowering pore-water pressure through its soil moisture extraction.

These benefits of the vegetation root system also carry some negative effects. Their additional mass and surcharge can increase slope failure potential under saturated conditions where the magnitude of saturation can actually be compounded because of root development. Another positive effect of vegetation use in revetments is its ability to improve flow resistance creating higher roughness that will dissipate energy, shear stress, and velocity. The vegetation deflects velocity upwards away from the streambank, which reduces the influence of drag and lift. For example, willows planted on a streambank have the capacity to deflect and resist velocities up to 10 feet/second in their mature state, which would equate to a 12-inch to 18-inch rock (RSP Class III to IV) having similar permissive velocity. To reach this point, it may take three to five years. In the first few years after planting, the vegetation is providing little resistance. During this establishment period, the streambanks can be subject to scour and erosion because of the lack of flow resistance without some other means of protection. Even after vegetation reaches maturity and beyond, potential exists for it to succumb to drought conditions or to yield to large flows/velocities and break apart rendering the vegetation ineffective to dissipating velocity and hydraulic forces. Because the stages of vegetation growth can be dynamic as it is affected by drought or high flows, the vegetation may go through a reestablishment process, and the *n*-value and velocity/flow resistance will also be dynamic making revetment performance unpredictable. Even though the use of vegetation in bank stabilization may have negative effects, its ecological benefits generally outweigh them.

The design premise is to use rock and vegetation together in a streambank revetment in such a way that will highlight their positive attributes while also addressing and managing their negative impacts. In the design of hybrid revetments, mounded toes referenced in Index 873.3(3)(a)(1) are not recommended because of their encroachment into the middle of the channel, which can impact cross-sectional area and capacity. With the use of vegetation on the bank and possible projection toward the middle of the channel, cross-sectional area could possibly be impacted as well. A mounded toe used with bank vegetation would only exacerbate this issue, therefore an embedded toe is chosen for hybrid revetment application. See Figure 873.3D for an example cross section of hybrid RSP with an embedded toe. For hybrid revetment design, the 50-year (2% probability) flood event should be used. Per Index 873.2, depending on the importance of the encroachment and level of related risks, subsequent analysis may consider historic high water marks and climate change for design. In order

July 1, 2020

to manage possible negative impacts from vegetation use, planting needs to be performed in a controlled manner. Placement of vegetation within the bank-toe zone and the main channel is highly discouraged to keep turbulence intensity in check that could cause excessive sediment accumulation. Plant mortality must be considered during the initial planting and establishment period. Overplanting must be avoided so that high density and projection does not occur causing increased sediment deposition and capacity/conveyance reduction. Given these issues, plant density in the design of a hybrid revetment and consideration of natural plant density is critical to the performance of the hybrid revetment. The goal for design should be medium density, where horizontal projection and cross-sectional area reduction at maturity are minimal. See Figure 873.3B. For woody vegetation, medium density is described as mature trees or shrubs with full foliage on a streambank, where preferably individual canopies or outer layers retain some free space between them, but may have minimal overlapping without being interwoven.

Figure 873.3B**Medium Density Vegetation**

Lower limit of medium vegetation density

Pre-construction and post-construction hydraulic modelling and hybrid revetment design are discussed in more detail in Design Information Bulletin No. 87. For rock sizing, Index 7.1.1.2 should be substituted with Index 873.3(3)(a)(2)(b) of this manual.

- (e) *Gabions*. Gabion revetments consist of rectangular wire mesh baskets filled with stone. See Standard Plan D100A and D100B for gabion basket details and the Standard Specifications for requirements.

Gabions are formed by filling commercially fabricated and preassembled wire baskets with rock. There are two types of gabions, wall type and mattress type. In wall type the empty cells are positioned and filled in place to form walls in a

stepped fashion. Mattress type baskets are positioned on the slope and filled. See HEC 23, Volume II, Design Guideline 10 and Figure 873.3B. Wall type revetment is not fully self-adjusting but has some flexibility. The mattress type is very flexible and well suited for man-made roadside channels (with uniform flow) discussed in Chapter 860 and as overside drains that are constructed on steep, unstable slopes. For some stream locations, gabions may be more aesthetically acceptable than rock riprap or may be considered when larger stone sizes are not readily available and flows are nonabrasive. Due to abrasion, corrosion and vandalism concerns and difficulty of repairs, caution is advised regarding in-stream placement of gabions. In addition, the California Department of Fish and Wildlife recommends against using gabions as weirs in streams. If gabions are placed in-stream, some form of abrasion protection in the form of wooden planks or other facing will typically be necessary for wall type, see Figure 873.3C. Maintenance-free design service life in most environments is generally under 20 years.

Figure 873.3C

Gabion Lined Streambank



Gabion wall with timber facing to protect wires from abrasive flow.

- (f) *Articulated Precast Concrete*. This type of revetment consists of pre-cast concrete blocks which interlock with each other, are attached to each other, or butted together to form a continuous blanket or mat. A number of block designs are commercially available. They differ in shape and method of articulation, but share common features of flexibility and rapid installation. Most provide for establishment of vegetation within the revetment.

The permeable nature of these revetments permits free draining of the embankment and their flexibility allows the mat to adjust to minor changes in bank geometry. Pre-cast concrete block revetments may be economically justified where suitable rock for slope protection is not readily available. They are generally more aesthetically pleasing than other types of revetment, particularly after vegetation has become established.

July 1, 2020

Figure 873.3D

Rock Slope Protection

Hybrid RSP with Embedded Toe

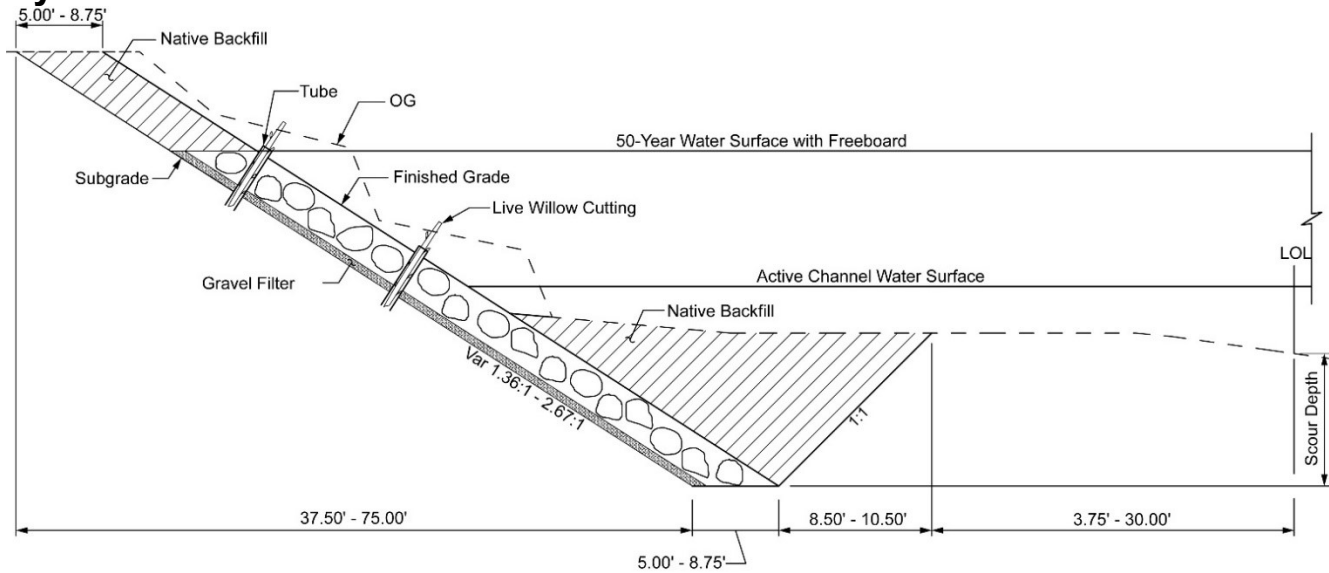

Rock Slope Protection

Embedded Toe RSP

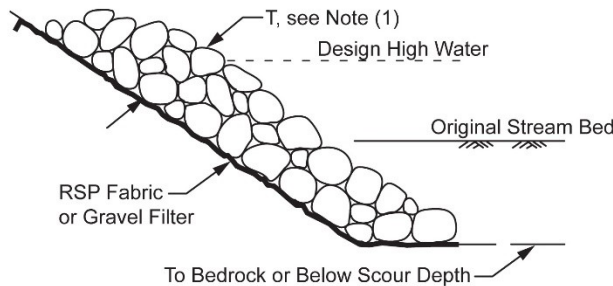

Mounded Toe RSP (as constructed)

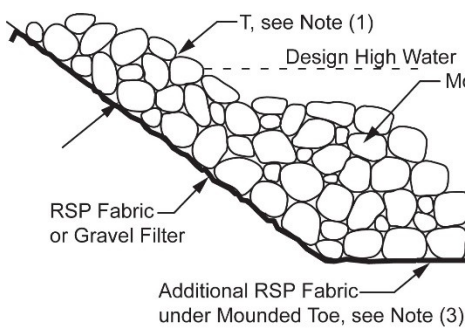

Mounded Toe RSP (after launching of Mounded Toe)

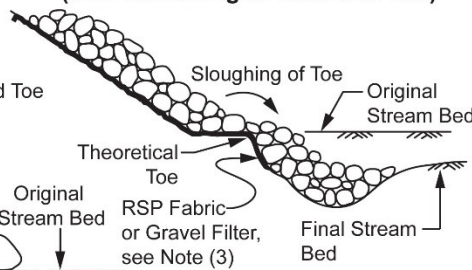

NOTES:

- (1) Thickness "T" = 1.5 d50 or d100, whichever is greater.
- (2) Face stone size is determined from Index 873.3(2)(a)(2)(a).
- (3) RSP fabric not to extend more than 20 percent of the base width of the Mounded Toe past the Theoretical Toe.

Individual blocks are commonly joined together with steel cable or synthetic rope, to form articulated block mattresses. Pre-assembled in sections to fit the site, the mattresses can be used on slopes up to 2:1. They are anchored at the top of the revetment to secure the system against slippage.

Pre-cast block revetments that are formed by butting individual blocks end to end, with no physical connection, should not be used on slopes steeper than 3:1. An engineering fabric is normally used on the slope to prevent the migration of the underlying embankment through the voids in the concrete blocks.

Refer to HEC 11, Design of Riprap Revetment, Section 6.2, and HEC 23, Bridge Scour and Stream Instability Countermeasures, Design Guideline 4, for further discussion on the use of articulated concrete blocks.

(4) Rigid Revetments.

(a) Concreted-Rock Slope Protection.

(1) General Features. This type of revetment consists of rock slope protection with interior voids filled with PCC to form a monolithic armor. A typical section of this type of installation is shown in Figure 873.3E.

It has application in areas where rock of sufficient size for ordinary rock slope protection is not economically available.

(2) Design Concepts. Concreting of RSP is a common practice where availability of large stones is limited, or where there is a need to reduce the total thickness of a RSP revetment. Inclusion of the concrete, and the labor required to place it, makes concreted RSP installations more expensive per unit area than non-concreted installations.

Figure 873.3E

Concreted-Rock Slope Protection

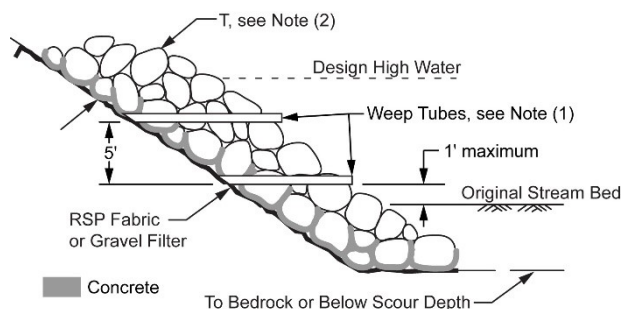

NOTES:

- (1) If needed to relieve hydrostatic pressure.
- (2) $1.5d_{50}$ or d_{100} , whichever is greater from Table 873.3A for section thickness.

Dimensions and details should be modified as required.

Design procedures for concreted RSP revetments are similar to that of non-concreted RSP. Start by following the design example provided in Index 873.3(3)(a)(2)(c) to select a stable rock class for a non-concreted design based on the d_{50} and the next larger class in Table 873.3A. This non-concreted rock size is divided by a factor of roughly four or five to arrive at the appropriate d_{50} size rock for a concreted revetment. The factor is based on observations of previously constructed facilities and

July 1, 2020

represents the typical sized pieces that stay together even after severe cracking (i.e., failed revetments will still usually have segments of four to five rocks holding together). As with the non-concreted design procedures, use the rock size derived from this calculation to enter Table 873.3A (i.e., round up to the next larger d_{50} rock to select the appropriate RSP Class.

As this type of protection is rigid without high strength, support by the embankment must be maintained. Slopes steeper than the angle of repose of the embankment are risky, but with rocks grouted in place, little is to be gained with slopes flatter than 1.5:1. Precautions to prevent undermining of embankment are particularly important, see Figure 873.3F. The concreted-rock must be founded on solid rock or below the depth of possible scour. Ends should be protected by tying into stable rock or forming smooth transitions with embankment subjected to lower velocities. As a precaution, cutoff stubs may be provided. If the embankment material is exposed at the top, freeboard is warranted to prevent overtopping.

Figure 873.3F

Toe Failure – Concreted RSP



Toe of concreted RSP that has been undermined.

The design intent is to place an adequate volume of concrete to tie the rock mass together, but leave the outer face roughened with enough rock projecting above the concrete to slow flow velocities to more closely approximate natural conditions.

The volume of concrete required is based on filling roughly two-thirds of the void space of the rock layer, as shown in Figure 873.3E. The concrete is rodded or vibrated into place leaving the outer stones partially exposed. Void space for the various RSP gradations ranges from approximately 30 percent to 35 percent for Method A placed rock to 40 percent to 45 percent for Method B placed rock of the total volume placed.

Specifications. Quality specifications for rock used in concreted-rock slope protection are usually the same as for rock used in ordinary rock slope protection. However, as the rocks are protected by the concrete which surrounds them, specifications for specific gravity and hardness may be lowered if necessary. The concrete used to fill the voids is normally 1 inch maximum size aggregate minor concrete. Except for freeze-thaw testing of aggregates, which may be waived in the contract special provisions, the concrete should conform to the provisions of Standard Specification Section 90.

Size and grading of stone and concrete penetration depth are provided in Standard Specification Section 72.

- (b) Partially Grouted Rock Slope Protection. Partially grouted rock slope protection (PGRSP) is a viable alternative to larger rock or concreted rock slope protection where either the availability of large material is limited, or site limitations regarding placement of large material (e.g., no excavation below spread footing base) would lead the designer to consider using some form of smaller rock held together with a cementitious material. With partially grouted rock slope protection, there are no relationships per se for selecting the size of rock, other than the practical considerations of proper void size, gradation, and adequate stone-to-stone contact area. The intent of partial grouting is to "glue" stones together to create a conglomerate of particles. Each conglomerate is therefore significantly larger than the d_{50} stone size, and typically is larger than the d_{100} size of the individual stones in the matrix. The proposed gradation criteria are based on a nominal or "target" d_{50} and only stones with a d_{50} ranging from 9 inches to 15 inches may be used with the partial grouting technique. See rock classes II, III and IV in Table 873.3A. In HEC 23, PGRSP is presented as a pier scour countermeasure, but it may be also used for bridge abutment protection, as well as for bed/bank protection for short localized areas with high velocities and shear stresses that require a smaller rock

footprint than a non-grouted design. Both Headquarters Office of Highway Drainage Design and District biologist staff should be consulted early on during the planning phase for subject matter expertise relative to design and obtaining project specific permits. For more guidance, see HEC 23, Volume 2, Design Guideline 12.

- (c) Sacked-Concrete Slope Protection. This method of protection consists of facing the embankment with sacks filled with concrete. It is expensive, but historically was a much used type of revetment. Much hand labor is required but it is simple to construct and adaptable to almost any embankment contour. Use of this method of slope protection is generally limited to replacement or repair of existing sacked concrete facilities, or for small, unique situations that lend themselves to hand-placed materials.

Tensile strength is low and as there is no flexibility, the installation must depend almost entirely upon the stability of the embankment for support and therefore should not be placed on face slopes much steeper than the angle of repose of the embankment material. Slopes steeper than 1:1 are rare; 1.5:1 is common. The flatter the slope, the less is the area of bond between sacks. From a construction standpoint it is not practical to increase the area of bond between sacks; therefore for slopes as flat as 2:1 all sacks should be laid as headers rather than stretchers.

Integrity of the revetment can be increased by embedding dowels in adjoining sacks to reinforce intersack bond. A No. 3 deformed bar driven through a top sack into the underlying sack while the concrete is still fresh is effective. At cold joints, the first course of sacks should be impaled on projecting bars that were driven into the last previously placed course. The extra strength may only be needed at the perimeter of the revetment.

Most failures of sacked concrete are a result of stream water eroding the embankment material from the bottom, the ends, or the top.

The bottom should be founded on bedrock or below the depth of possible scour.

If the ends are not tied into rock or other nonerosive material, cutoff returns are to be provided and if the protection is long, cutoff stubs are built at 30-foot intervals, in order to prevent or retard a progressive failure.

Protection should be high enough to preclude overtopping. If the roadway grade is subject to flooding and the shoulder material does not contain sufficient rock to prevent

July 1, 2020

erosion from the top, then pavement should be carried over the top of the slope protection in order to prevent water entering from this direction.

Class 8 RSP fabric as described in Standard Specification Section 96 should be placed behind all sacked concrete revetments. For revetments over 4 feet in height, weep tubes should also be placed, see Figure 873.3E.

For good appearance, it is essential that the sacks be placed in horizontal courses. If the foundation is irregular, corrective work such as placement of entrenched concrete or sacked concrete is necessary to level up the foundation. Refer to HDS No. 6, Section 6.6.5, for further discussion on the use of sacked concrete slope protection.

(5) *Bulkheads.* A bulkhead is a steep or vertical structure supporting a natural slope or constructed embankment. As bank protection structures, bulkheads serve to secure the bank against erosion as well as retaining it against sliding. As a retaining structure, conventional design methods for retaining walls, cribs and laterally loaded piles are used.

Bulkheads are usually expensive, but may be economically justified in special cases where valuable riparian property or improvements are involved and foundation conditions are not satisfactory for less expensive types of slope protection. They may be used for toe protection in combination with other revetment types of slope protection. Some other considerations that may justify the use of bulkheads include:

- Encroachment on a channel cannot be tolerated.
- Retreat of highway alignment is not viable.
- Right of Way is restricted.
- The force and direction of the stream can best be redirected by a vertical structure.

The foundation for bulkheads must be positive and all terminals secure against erosive forces. The length of the structure should be the minimum necessary, with transitions to other less expensive types of slope protection when possible. Eddy currents can be extremely damaging at the terminals and transitions. If overtopping of the bulkheads is anticipated, suitable protection should be provided.

Along a stream bank, using a bulkhead presumes a channel section so constricted as to prohibit use of a cheaper device on a natural slope. Velocity will be unnaturally high along the face of the bulkhead, which must have a fairly smooth surface to avoid compounding the restriction. The high velocity will increase the threat of scour at the toe and erosion at the downstream end. Allowance must be made for these threats in selecting the type of foundation, grade of footing, penetration of piling, transition, and anchorage at downstream end. Transitions at both ends may appropriately taper the width of channel and slope of the bank. Transition in roughness is desirable if attainable. Refer to HDS No. 6, Section 6.4.8, for further discussion on the use of bulkheads to prevent streambank erosion or failure.

- (a) *Concrete or Masonry Walls.* The expertise and coordination of several engineering disciplines is required to accomplish the development of PS&E for concrete walls serving the dual purpose of slope protection and support. The Division of Structures is responsible for the structural integrity of all retaining walls, including bulkheads.
- (b) *Crib walls.* Timber and concrete cribs can be used for bulkheads in locations where some flexibility is desirable or permissible. Metal cribs are limited to support of embankment and are not recommended for use as protection because of vulnerability to corrosion and abrasion. The design of crib walls is essentially a determination of line, foundation grade, and height with special attention given to potential scour and possible loss of backfill at the base and along the toe. Concrete crib walls used as bulkheads and exposed to salt water require special provisions specifying the use of coated rebars and special high density concrete. Recommendations from METS Corrosion Technology

Branch should be requested for rebar protection and type of concrete. DES Structures Design should be consulted with the physical, structural design of a crib wall.

- (c) Sheet Piling. Timber, concrete and steel sheet piling are used for bulkheads that depend on deep penetration of foundation materials for all or part of their stability. High bulkheads are usually counterforted at upper levels with batter piles or tie back systems to deadmen. Any of the three materials is adaptable to sheet piling or a sheathed system of post or column piles.

Excluding structural requirements, design of pile bulkheads is essentially as follows:

- Recognition of foundation conditions suitable to or demanding deep penetration. Penetration of at least 15 feet below scour level, or into soft rock, should be assured.
- Choice of material. Timber is suitable for very dry or very wet climates, for other situations economic comparison of preliminary designs and alternative materials should be made.
- Determination of line and grade. Fairly smooth transitions with protection to high-water level should be provided.

- (6) *Vegetation*. Vegetation is the most natural method for stabilization of embankments and channel bank protection. Vegetation can be relatively easy to maintain, visually attractive and environmentally desirable. The root system forms a binding network that helps hold the soil. Grass and woody plants above ground provide resistance to the near bank water flow causing it to lose some of its erosive energy.

Erosion control and revegetation mats are flexible three-dimensional mats or nets of natural or synthetic material that protect soil and seeds against water erosion prior to establishment of vegetation. They permit vegetation growth through the web of the mat material and have been used as temporary channel linings where ordinary seeding and mulching techniques will not withstand erosive flow velocities. The designer should recognize that flow velocity estimates and a particular soils resistance to erosion are parameters that must be based on specific site conditions. Using arbitrarily selected values for design of vegetative slope protection without consultation with the District Hydraulic Unit and/or the District Landscape Architect Unit is not recommended. However, a suggested starting point of reference is Table 865.2 in which the resistance of various unprotected soil classifications to flow velocities are given. Under near ideal conditions, ordinary seeding and mulching methods cannot reasonably be expected to withstand sustained flow velocities above 4 feet per second. If velocities are in excess of 4 feet per second, a lining maybe needed, see Table 865.2.

Temporary channel liners are used to establish vegetative growth in a drainage way or as slope protection prior to the placement of a permanent armoring. Some typical temporary channel liners presented in Table 865.2 are:

- Single net straw
- Double net coconut/straw blend
- Double net shredded wood

Vegetative and temporary channel liners are suitable for conditions of uniform flow and moderate shear stresses.

Permanent soil reinforcing mats and rock riprap may serve the dual purpose of temporary and permanent channel liner. Some typical permanent channel liners are:

- Small rock slope protection
- Geosynthetic mats

July 1, 2020

- Polyethylene cells or grids
- Gabion Mattresses (see Index 873.3(3)(a)(2)(e))

However, geosynthetics and plastic (polyethylene, polypropylene, polyamide, etc.) based mats with no enhanced UV resistance must be installed in a fashion where there will be no potential for long-term sunlight exposure, as these products will degrade due to UV radiation.

Composite designs are often used where there are sustained low flows of high to moderate velocities and intermediate high water flows of low to moderate velocities. Brush layering is a permanent type of erosion control technique that may also have application for channel protection, particularly as a composite design.

Additional design information on vegetation, and temporary and permanent channel liners is given in Chapter IV, HEC 15, Design of Roadside Channels and Flexible Linings and in Chapter 860 of this manual.

873.4 Training Systems

(1) *General.* Training systems are structures, usually within a channel, that act as countermeasures to control the direction, velocity, or depth of flowing water. When training systems are used, they generally straighten the channel, shorten the flow line, and increase the local velocity within the channel. Any such changes made in the system that cause an increase in the gradient may cause an increase in local velocities. The increase in velocity increases local and contraction scour with subsequent deposition downstream, where the channel takes on its normal characteristics. If significant lengths of the river are trained and straightened, there can be a noticeable decrease in the elevation of the water surface profile for a given discharge in the main channel. Tributaries emptying into the main channel in such reaches are significantly affected. Having a lower water level in the main channel for a given discharge means that the tributary streams entering in that vicinity are subjected to a steeper gradient and higher velocities which can cause degradation in the tributary streams. In extreme cases, degradation can be induced of such magnitude as to cause failure of structures such as bridges, culverts or other encroachments on the tributary systems. In general, any increase in transported materials from the tributaries to the main channel causes a reduction in the quality of the environment within the river.

(a) *Bendway Weirs.* Bendway weirs, also referred to as stream barbs, bank barbs, and reverse sills are low elevation stone sills used to improve lateral stream stability and flow alignment problems at river bends and highway crossings on streams and smaller rivers.

They are placed at an angle with the embankment in meandering streams for the purpose of directing or forcing the current away from the embankment, see Figure 873.4A. They also encourage deposition of bed material and growth of vegetation. When the purpose is to deposit material and promote growth, the weirs are considered to have fulfilled their function and are expendable when this occurs.

Figure 873.4A**Thalweg Redirection Using Bendway Weirs**

Bendway weirs in conjunction with rock slope protection.

Bendway weirs are similar in appearance to stone spurs, but have significant functional differences. Spurs are typically visible above the flow line and are designed so that flow is either diverted around the structure, or flow along the bank line is reduced as it passes through the structure. Bendway weirs are normally not visible, especially at stages above low water, and are intended to redirect flow by utilizing weir hydraulics over the structure. Flow passing over the bendway weir is redirected such that it flows perpendicular to the axis of the weir and is directed towards the channel centerline. See Figure 873.4B for typical cross section and layout. Similar to stone spurs, bendway weirs reduce near bank velocities, reduce the concentration of currents on the outer bank, and can produce a better alignment of flow through the bend and downstream crossing. Experience with bendway weirs has indicated that the structures do not perform well in degrading or sediment deficient reaches.

Material sizing should be based on the Isbash equation plotted in Figure 873.4C. Riprap stone size is designed using the critical velocity near the boundary where the riprap is placed. Typically the size ranges between 1 and 3 ft and should be approximately 20% greater than that computed from the rock sizing formula presented in Index 873.3(3)(a)(2)(b). The minimum rock size should not be less than the D_{100} of the streambed material. See Tables 873.3A and 873.3B to determine rock class.

See HEC 23 Volume 2, Design Guideline 1 for detailed guidance on weir height, length, angle, location and spacing,

- (b) Spurs. A spur can be a pervious or impervious structure projecting from the streambank into the channel. Similar to bendway weirs, spurs are used to halt meander migration at a bend and channelize wide, poorly defined streams into well-defined channels by reducing flow velocities in critical zones near the streambank to prevent erosion and establish a more desirable channel alignment or width. The main function of spurs is to reduce flow velocities near the bank, which in turn, encourages sediment deposition due to these reduced velocities. Increased protection of banks can be achieved over time, as more sediment is deposited behind the spurs. Because of this, spurs may protect a streambank more effectively and at less cost than revetments. Furthermore, by moving the location of any scour away from the bank, partial failure of the spur can often be repaired before damage is done to structures along and across the stream.

July 1, 2020

In braided streams, the use of spurs to establish and maintain a well-defined channel location, cross section, and alignment can decrease the required bridge length, thus decreasing the cost of bridge construction and maintenance.

Spur types are classified based upon their permeability as retarder spurs, retarder/deflector spurs, and deflector spurs. The permeability of spurs is defined simply as the percentage of the spur surface area facing the streamflow that is open. Deflector spurs are impermeable spurs which function by diverting the primary flow currents away from the bank. Retarder/deflector spurs are more permeable and function by retarding flow velocities at the bank and diverting flow away from the bank. Retarder spurs are highly permeable and function by retarding flow velocities near the bank.

These structures should be designed not to overtop. Therefore, for permeable spurs, the rock sizing formula presented in Index 873.3(3)(a)(2)(b) may be used and a C_v value of 1.25 is recommended. Where overtopping the spur is unavoidable, the riprap size may be determined by equations 5.2 (for slopes $> 25\%$) or 5.3 (for slopes $< 25\%$) in HEC 23 Volume 2, Design Guideline 5. Since these equations are for free flow down the slope, always check to see if the structure is actually drowned (submerged) by high tailwater. If that is the case, then use the rock sizing formula presented in Index 873.3(3)(a)(2)(b) for sizing riprap on a stream bank should be used. See Tables 873.3A and 873.3B to determine rock class.

In general a top width equal to the width of a dump truck can be used. The side slopes of the spur should be 2H:1V or flatter. Rock riprap should be placed on the upstream and downstream faces as well as on the nose of the spur to inhibit erosion of the spur.

Figure 873.4B

Bendway Weir Typical Cross Section and Layout

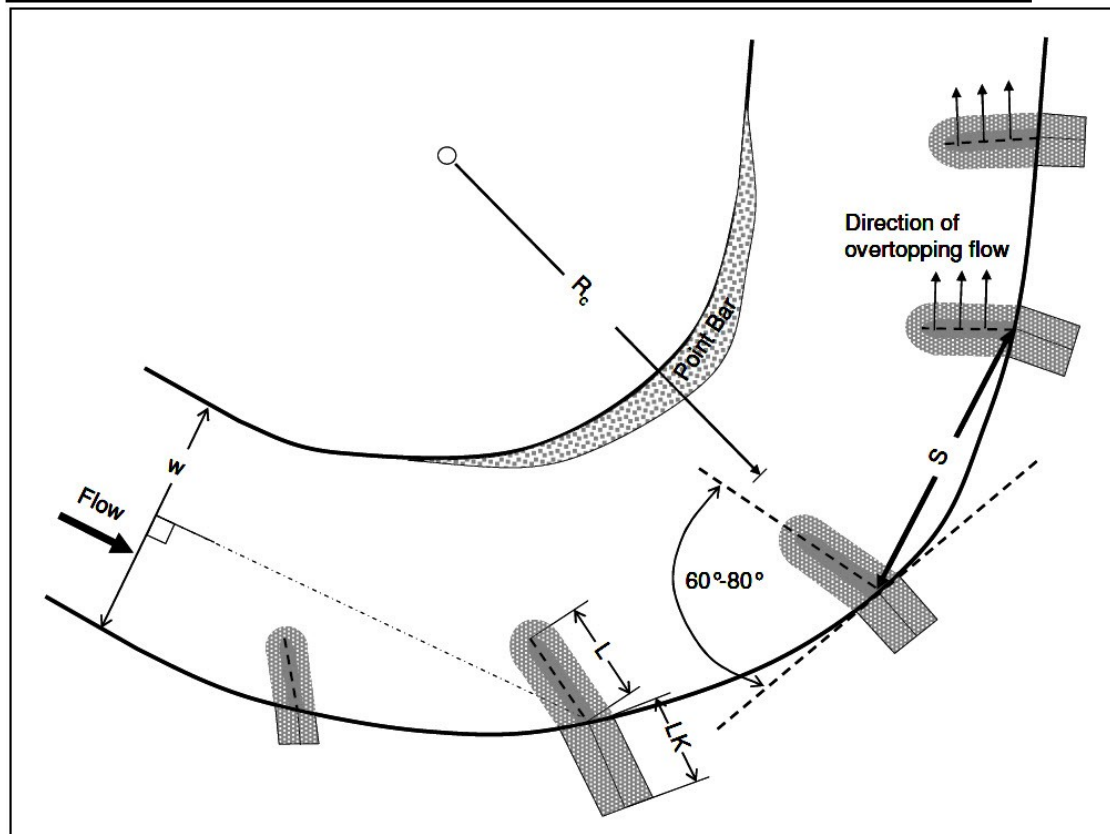
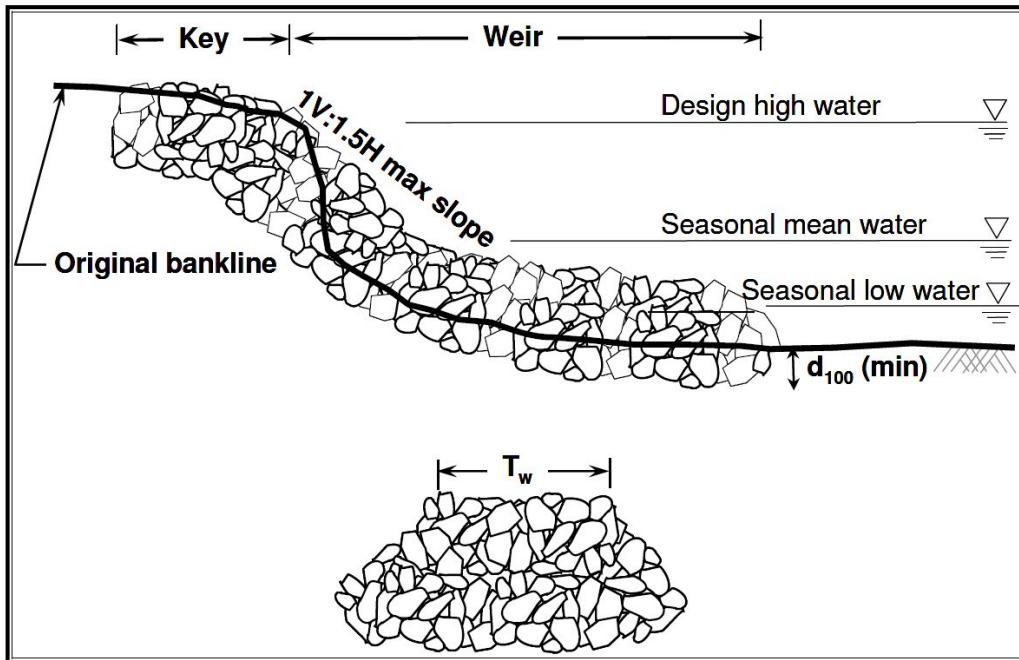

July 1, 2020

Figure 873.4C

Bendway Weir Rock Size Chart

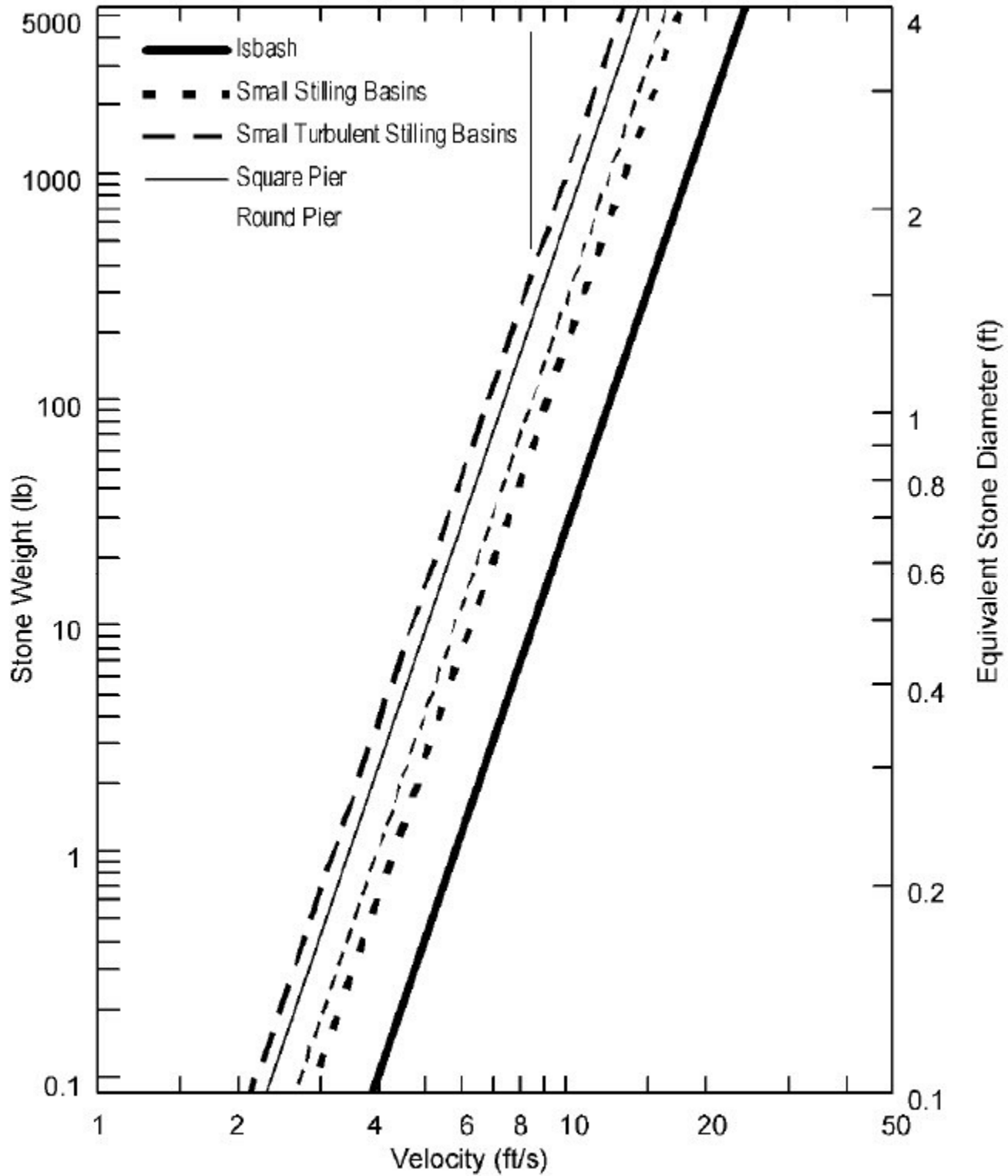

Depending on the embankment material being used, a gravel, sand, or geotextile filter may be required. It is recommended that riprap be extended below the bed elevation to the combined long-term degradation and contraction scour depth. Riprap should also extend to the crest of the spur, in cases where the spur would be submerged at design flow, or to 2 feet above the design flow, if the spur crest is higher than the design flow depth. Additional riprap should be placed around the nose of the spur, so that spur will be protected from scour.

See Figure 873.4D for example of spur design and HEC 23 Volume 2, Design Guideline 2, for detailed guidance on spur height, length, shape, angle, permeability, location and spacing.

Figure 873.4D

Example of Spur Design

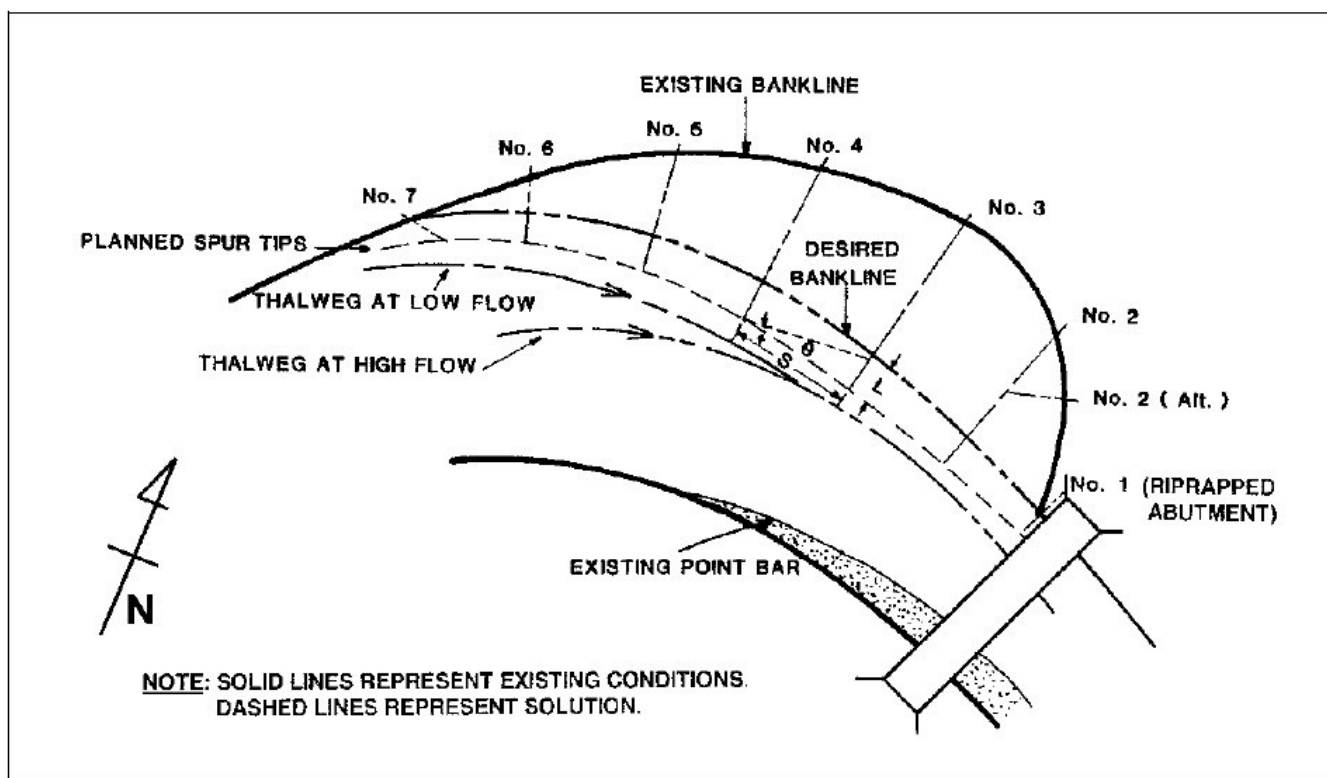

- (c) Guide Dikes/Banks. Guide banks are appendages to the highway embankment at bridge abutments, see Figure 873.4E. They are smooth extensions of the fill slope on the upstream side. When embankments encroach on wide floodplains to attain an economic length of bridge, the flows from these areas must flow parallel to the approach embankment to the bridge opening. These flows can cause a severe flow contraction at the abutment with damaging eddy currents that can scour away abutment and pier foundations, erode the approach embankment, and reduce the effective bridge opening. Guide banks can be used in these cases to prevent erosion of the approach embankments by cutting off the flow adjacent to the embankment, guiding streamflow through a bridge opening, and transferring scour away from abutments to prevent damage caused by abutment scour. The two major enhancements guide banks bring to bridge design are (1) reduce the separation of flow at the upstream abutment face and

July 1, 2020

thereby maximize the use of the total bridge waterway area, and (2) reduce the abutment scour due to lessening turbulence at the abutment face. Guide banks can be used on both sand and gravel-bed streams.

Guide banks are usually earthen embankment faced with rock slope protection. Optimum shape and length of guide dikes will be different for each site. Field experience has shown that an elliptical shape with a major to minor axis ratio of 2.5:1 is effective in reducing turbulence. The length is dependent on the ratio of flow diverted from the floodplain to flow in the first 100 feet of waterway under the bridge. If the use of another shape dike, such as a straight dike, is required for practical reasons more scour should be expected at the upstream end of the dike. The bridge end will generally not be immediately threatened should a failure occur at the upstream end of a guide dike.

Toe dikes are sometimes needed downstream of the bridge end to guide flow away from the structure so that redistribution in the floodplain will not cause erosion damage to the embankment due to eddy currents. The shape of toe dikes is of less importance than it is with upstream guide banks.

Principal factors to be considered when designing guide banks, are their orientation to the bridge opening, plan shape, upstream and downstream length, cross-sectional shape, and crest elevation.

It is apparent from the Figure 873.4E that without this guide bank, overbank flows would return to the channel at the bridge opening, which can increase the severity of contraction and scour at the abutment. With installation of guide banks the scour holes which normally would occur at the abutments of the bridge are moved upstream away from the abutments. Guide banks may be designed at each abutment, as shown, or singly, depending on the amount of overbank or floodplain flow directed to the bridge by each approach embankment.

Figure 873.4E

Bridge Abutment Guide Banks

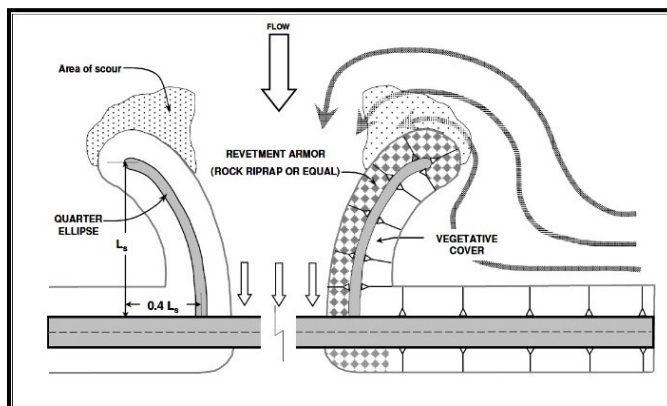

The goal in the design of guide banks is to provide a smooth transition and contraction of the streamflow through the bridge opening. Ideally, the flow lines through the bridge opening should be straight and parallel. As in the case with other countermeasures, the designer should consider the principles of river hydraulics and morphology, and exercise sound engineering judgment.

The Division of Engineering Services (DES) and Structures Maintenance and Investigations (SMI) Hydraulics Branches are responsible for the hydraulic design of

bridges, therefore, for protection at bridge abutments and approaches, the District is responsible for consulting with them to verify the design parameters and also obtaining the bridge hydraulic model. See Index 873.6 "Coordination with the Division of Engineering Services and Structures Maintenance and Investigations."

For further detailed information on guide bank design procedures, refer to HEC 23, Volume 2, Design Guidelines 14 and 15. See Tables 873.3A and 873.3B to determine rock class.

- (d) Further Information and Other Countermeasures for Lateral Stream Instability. General design considerations and guidance for evaluating scour and stream stability at highway bridges is contained in HEC 18, HEC 20, and HEC 23.

For further information on other countermeasures such as retarder structures, longitudinal dikes and bulkheads, see HEC 23 Volume 1, Chapter 8.

- (e) Check Dams and Drop Structures. Drop structures or check dams are an effective means of gradient control. They may be constructed of rock, gabions, concrete, treated timber, sheet piling or combinations of any of the above. They are most suited to locations where bed materials are relatively impervious otherwise underflow must be prevented by cutoffs. Rock riprap and timber pile construction have been most successful on channels having small drops and widths less than 100 ft. Sheet piles, gabions, and concrete structures are generally used for larger drops on channels with widths ranging up to 300 ft. Check dams can initiate erosion of banks and the channel bed downstream of the structure as a result of energy dissipation and turbulence at the drop. This local scour can undermine the check dam and cause failure. The use of energy dissipators downstream of check dams can reduce the energy available to erode the channel bed and banks. In some cases it may be better to construct several consecutive drops of shorter height to minimize erosion. Lateral erosion of channel banks just downstream of drop structures is another adverse result of check dams and is caused by turbulence produced by energy dissipation at the drop, bank slumping from local channel bed erosion, or eddy action at the banks. The usual solution to these problems is to place rock slope protection on the streambank adjacent to the drop structure or check dam. Erosion of the streambed can also be reduced by placing rock riprap in a preformed scour hole downstream of the drop structure. A row of sheet piling with top set at or below streambed elevation can keep the riprap from moving downstream. Because of the problems associated with check dams, the design of these countermeasures requires designing the check dams to resist scour by providing for dissipation of excess energy and protection of areas of the bed and the bank which are susceptible to erosive forces. Refer to HEC 23 Volume 2, Design Guideline 3 and HDS No. 6, Section 6.4.11, for further discussion on the use of check dams and drop structures.

873.5 Summary and Design Check List

The designer should anticipate the more significant problems that are likely to occur during the construction and maintenance of channel protection facilities. So far as possible, the design should be adjusted to eliminate or minimize those potential problems.

The logistics of the construction activity such as access to the site, on-site storage of construction materials, time of year restrictions, environmental concerns, project specific permits and sequence of construction should be carefully considered during the project design. See Index 872.1, Planning, Index 872.3(6), Construction, Easements, Access and Staging, and Index 872.3(7), Biodiversity. The stream morphology and its response to construction activities

July 1, 2020

is an integral part of the planning process. Communication between the designer and those responsible for construction administration as well as maintenance are important.

Channel protection facilities require periodic maintenance inspection and repair. Where practicable, provisions should be made in the facility design to provide access for inspection and maintenance.

The following check list has been prepared for both the designer and reviewer. It will help assure that all necessary information is included in the plans and specifications. It is a comprehensive list for all types of protection. Items pertinent to any particular type can be selected readily and the rest ignored.

(1) Location and staging of the planned work with respect to:

- The highway.
- The stream, its morphology, biodiversity and project specific permits.
- Right of way. See Index 872.1 and 872.3 for construction easements and examination of stream behavior far upstream and downstream.

(2) Datum control of the work, and relation of that datum to gage datum on streams.

(3) A typical cross section indicating dimensions, slopes, arrangement and connections.

(4) Quantity of materials (per foot, per protection unit, or per job).

(5) Relation of the foundation treatment with respect to the existing ground.

(6) Relation of the top of the proposed protection to design high water (historic, with date; or predicted, with frequency).

(7) The limits of excavation and backfill as they may affect measurement and payment.

(8) Construction details such as weep holes, rock slope protection fabrics, geocomposite drains and associated materials.

(9) Location and details of construction joints, cut-off stubs and end returns.

(10) Restrictions to the placement of reinforcement.

(11) Connections and bracing for framing of timber or steel.

(12) Splicing details for timber, pipe, rails and structural shapes.

(13) Anchorage details, particularly size, type, location, and method of connection.

(14) Size, shape, and special requirements of units such as precast concrete shapes and other manufactured items.

(15) Number and arrangement of cables and details of fastening devices.

(16) Size, mass per unit area, mesh spacing and fastening details for wire-fabric or geosynthetic materials.

(17) On timber pile construction the number of piles per bent, number of bents, length of piling, driving requirements, cut-off elevations, and framing details.

(18) The details of gabions and the filling material. See Standard Plan D100A and D100B and the Standard Specifications.

(19) The size of articulated blocks, the placement of steel, and construction details relating to fabrication.

(20) The corrosion considerations that may dictate specialty concretes, coated reinforcing, or other special requirements.

873.6 Coordination with the Division of Engineering Services and Structures Maintenance and Investigations

(1) *The Division of Engineering Services and Structures Maintenance and Investigations Hydraulics Branches.* The Division of Engineering Services (DES) and Structures Maintenance and Investigations (SMI) Hydraulics Branches are responsible for the hydraulic design of bridges. Therefore, for protection at bridge piers, abutments and approaches, the District is responsible for consulting with them to verify the design parameters (i.e., water surface elevations, freeboard requirements, water velocities, scour recommendations etc.) used and also obtaining the bridge hydraulic model.

Figure 873.6A

Bridge Abutment Failure Example



Bridge Abutment Failure at Tex Wash on I-10 after a Flood Larger Than the Design Flood

The DES Hydraulics branch performs all hydraulic designs for new bridges or replacement bridges that meet the National Bridge Inventory (NBI) bridge definition. Modifications to an existing bridge or constructing a new bridge require obtaining permits from the regulatory agencies. The DES Hydraulics branch should coordinate with the District to perform conceptual designs for permit approval. The DES Hydraulics branch is essentially a consultant/designer to the District Design Offices.

The SMI Hydraulics branch within the Division of Maintenance is responsible for the hydraulic analyses, repair and monitoring of in-service bridges. Typical maintenance challenges include scour, flooding, and lateral migration. Maintenance related impacts to a bridge will trigger a hydraulic report for that specific bridge. The hydraulic report recommendations are used by the District in determining the scope of hydraulic improvements to the bridge projects. For countermeasure design at bridge abutments and piers (e.g., rock slope protection, guide banks, check dams, structural repairs etc.) the magnitude of the discharge used is the 100-year flood. This standard is independent of the design flood used by the District for protecting the channel bank or the bridge approach embankment (see Index 873.2).

Since the mid 1990's, new bridges have been designed so that the top of the pile cap is at the bottom of anticipated scour (long-term degradation, contraction and local scour) for the

July 1, 2020

100-year flood using the hypothesis that by designing the foundations lower than recommended in HEC 18 for the 100-year flood, there would be ample safety factor inherent to withstand the 200-year scour check flood. Bridges that were designed prior to the first edition of HEC 18 in 1991 may be more vulnerable to the possible effects of climate change or floods larger than the 100-year flood. See Figure 873.6A.

Depending on location, site considerations may include constructability and biodiversity, see Index 872.3(4) and Index 872.3(5). During the planning and environmental phases on environmentally sensitive projects (e.g., bridge structures that require permits for fish passage design under California Fish and Wildlife jurisdiction – see Figure 873.3B), the District should initiate contact with resource agencies early to propose conceptual design, identify impacts and any necessary mitigation as part of the permitting process. The overriding issue of concern is the difference in timing of detailed analyses (e.g., hydraulics, geotechnical, foundation) that takes place on the District side of the project development process versus what takes place in DES prior to project approval during the environmental phase.

Prematurely approved projects and environmental documents prior to permit approval can, and do, result in costly major re-work during the design phase. On environmentally sensitive projects the District should consider the need to shift resources to the environmental phase so that a more advanced bridge foundation design can be incorporated into the Advanced Planning Study (APS) and the Environmental Document (ED) to facilitate permit approval consistent with the Project Approval (PA) and to minimize rework.

Figure 873.6B

Habitat Enhancement Example



Longitudinal Peaked Stone Toe Protection (LPSTP) with Rock Vanes for Chinook Salmon Habitat Enhancement, Route 128, Russian River Bridge in Geyserville

(2) *Geotechnical Design and Geology.* The Project Engineer must review the Project Initiation Document and Preliminary Geotechnical Design Report, if any, to ascertain the scope of geotechnical involvement for a project.

For all projects that involve designs for cut slopes, embankments, earthwork, landslide remediation, retaining walls, groundwater studies, erosion control features, subexcavation and any other studies involving geotechnical investigations and engineering geology, a

Geotechnical Design Report (GDR) is to be prepared by the Roadway Geotechnical Engineering Branches of the Division of Engineering Services, Geotechnical Services (DES-GS).

Coordination with Geotechnical Design and Geology within DES may be initiated by the designer when any of the following determinations need to be made:

- Scour potential of channel material.
- Natural erosion potential of stream banks that may affect project features. See Figure 873.6C.
- The performance of existing cut, fill and natural slopes including the slope soil/rock composition.
- Slope stability analysis and need for earth retaining systems including crib walls and gabion walls.
- Embankment constructability and impact to nearby structures or bridge abutments. See following link to the Geotechnical Manual and Figure 873.6D: http://www.dot.ca.gov/hq/esc/geotech/geo_manual/page/Embankments_Dec2014.pdf

Figure 873.6C

Lateral Stream Migration Within a Canyon Setting Example



Figure 873.6D

Conceptual Geotechnical Failures Resulting from Abutment Scour

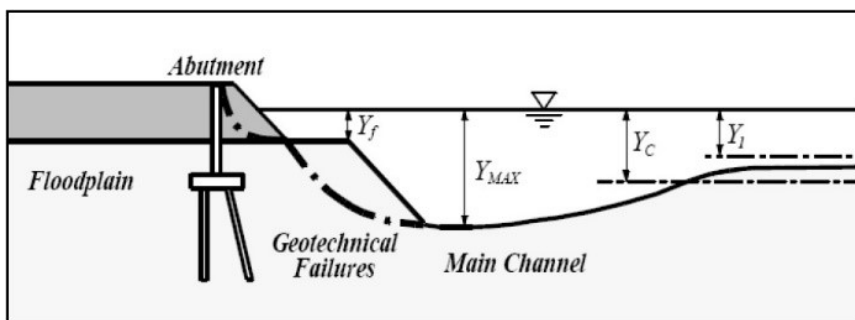

CHAPTER 880 – SHORE PROTECTION

Topic 881 – General

Index 881.1 – Introduction

Highways, bikeways, pedestrian facilities and appurtenant installations are often attracted to parallel locations along lakes and coastal zones. These locations are under attack from the action of waves and may require protective measures.

Shore protection along coastal zones and lake shores that are subjected to wave attack can be a major element in the design, construction, and maintenance of highways. Chapter 880 deals with procedures, methods, devices, and materials commonly used to mitigate the damaging effects of wave action on transportation facilities and adjacent properties. The primary focus is on quantifying exposure of these locations to sea level rise, storm surge, and wave action. The practice of coastal engineering is still much of an art. This is for a variety of reasons including that the physical processes are so complex, often too complex for adequate theoretical description, and the design level of risk is often high.

Refer to Index 806.2 for definitions of drainage terms.

881.2 Design Philosophy

In each district there should be a designer or advisor, usually the District Hydraulic Engineer, knowledgeable in the application of shore protection principles and the performance of existing works at coastal and lake shore locations vulnerable to wave attack.

Information is also available from headquarters specialists in the Division of Design and Structures Design in the Division of Engineering Services (DES). The most effective designs result from involvement with Design, Environmental, Landscape Architecture, Structures, Construction, and Maintenance (for further discussion on functional responsibilities see Topic 802). For habitat characterization and assessment relative to design and obtaining project specific permits, the designer may also require input from biologists. The District Hydraulic Engineer will typically be able to

assist with selecting storm scenarios for design wave heights, the design of high water level (including sea or lake level change estimates) using coastal surge and wave models, flood analysis, water surface elevations/profiles, shear stress computations, scour analysis and hydraulic analysis for placement of coastal structures.

There are a number of ways to deal with the problem of wave action and shore erosion.

- Where avoidance is not feasible, the simplest way and generally the surest of success and permanence, is to locate the facility away from the erosive forces. This is not always feasible or economical, but should be the first consideration. Locating the facility to higher ground or solid support should never be overlooked, even when it requires excavation of solid rock, since excavated rock may serve as a valuable material for protection at other points of attack.
- The most commonly used method is to armor the shore with a more resistant material like rock slope protection. FHWA Hydraulic Engineering Circular 25 (HEC 25), Volume

July 1, 2020

1, presents general issues and approaches in coastal highway design. Types of revetments for wave attack and coastal structures are covered in Indexes 6.1 and 7.6.

- *Rock Materials*. Optimum use should be made of local materials, considering the cost of special handling. Specific gravity of stone is a major factor in shore protection and the specified minimum should not be lowered without increasing the mass of stones. See Index 873.3(3)(a)(2)(b) for equations to estimate rock size.

881.3 Selected References

Hydraulic and drainage related publications are listed by source under Topic 807. References specifically related to shore protection measures are listed here for convenience.

- (a) FHWA Hydraulic Engineering Circulars (HEC) – The following circulars were developed to assist the designer in using various types of slope protection and channel linings:
- HEC 14, Hydraulic Design of Energy Dissipators for Culverts and Channels (2006)
 - HEC 18, Evaluating Scour at Bridges (2012)
 - HEC 20, Stream Stability at Highway Structures (2012)
 - HEC 23, Bridge Scour and Stream Instability Countermeasures (2009)
 - HEC 25, Highways in the Coastal Environment (2008 with 2014 supplement – Assessing Extreme Events)
- (b) AASHTO Highway Drainage Guidelines – General guidelines for good erosion control practices are covered in Volume III – Erosion and Sediment Control in Highway Construction, and Volume XI - Guidelines for Highways Along Coastal Zones and Lakeshores.
- (c) AASHTO Drainage Manual (2014) – Refer to Chapters; 11 – Energy Dissipators; 16 – Erosion and Sediment Control; 17 – Bank Protection; and 18 – Coastal Zone. The MDM provides guidance on engineering practice in conformance with FHWA’s HEC and HDS publications and other nationally recognized engineering policy and procedural documents.
- (d) Shore Protection Manual (SPM) (1984) – Comprehensive two volume guidance on wave and shore processes and methods for shore protection. No longer in publication but still referenced pending completion of the Coastal Engineering Manual.
- (e) Design of Coastal Revetments, Seawalls, and Bulkheads. Engineering Manual 1110-2-1614 (1995) – Supersedes portions of Volume 2 of the Shore Protection Manual (SPM).
- (f) Coastal Engineering Manual. Engineer Manual (EM) 1110-2-1100 (2002) – Published in six parts plus an appendix, this set of documents supersedes the SPM and EM 1110-2-1614.

Topic 882 – Planning and Location Studies

882.1 Planning

The development of sustainable, cost effective and environmentally friendly protective works requires careful planning and a good understanding of both the site location and habitat within the shore or coastal zone subject to wave attack. Planning begins with an office review followed by a site investigation.

Google Earth can be a useful tool for determining site location and recent changes to the coastal zone.

Nearby bridges should be reviewed for site history and changes in stream cross-section. All bridge files belong to Structure Maintenance within the Division of Maintenance.

Coastal highways traverse bays, estuaries, beaches, dunes and bluffs which are some of the most unique and treasured habitats for humans as well as the habitats of a variety of plants and animals. The list of endangered species requiring these coastal habitats for survival includes numerous sea turtles, birds, mammals, rodents, amphibians and fish. District biologist staff should be consulted early on during the project planning phase for subject matter expertise to perform an initial habitat assessment. Contact information for Department biologists can be accessed through the CalBioRoster.

For habitat characterization and preliminary assessment relative to design and obtaining project specific permits, the initial site investigation team should include the project engineer, the district hydraulic engineer, and a biologist.

The selection of the type of protection can be determined during or following site investigation. For some sites the choice is obvious; at other sites several alternatives or combinations may be applicable.

Considerations at this stage are:

- Design life and whether the protection need be permanent or temporary.
- The severity of wave attack.
- The coastal water level and future sea level.
- Littoral drift of the beach sands.
- Seasonal shifts of the shore.
- The ratio of cost of highway replacement versus cost of protection.
- Analysis of foundation and materials explorations.
- Access for construction
- Slope (H:V)
- Vegetation type and location
- Physical habitat
- Failure mode (see Table 872.2)
- Total length of protection needed

The second step is the selection and layout of protective elements in relation to the highway facility.

882.2 Class and Type of Protection

Protective devices are classified according to their function. They are further categorized as to the type of material from which they are constructed or shape of the device.

July 1, 2020

882.3 Site Consideration

The determination of the lengths, heights, alignment, and positioning of the protection is affected to a large extent by the facility location environment.

An evaluation is required for any proposed highway construction or improvement that encroaches on a floodplain. See Topic 804, Floodplain Encroachments for detailed procedures and guidelines.

(1) *Lakes and Tidal Basins.* Highways adjacent to lakes or basins may be at risk from wave generated erosion. All bodies of water generate waves. Height of waves is a function of fetch and depth. Erosion along embankments behind shallow coves is reduced because the higher waves break upon reaching a shoal in shallow water. The threat of erosion in deep water at headlands or along causeways is increased. Constant exposure to even the rippling of tiny waves may cause severe erosion of some soils.

Older lakes normally have thick beds of precipitated silt and organic matter. Bank protection along or across such lakes must be designed to suit the available foundation. It is usually more practical to use lightweight or self-adjusting armor types supported by the soft bed materials than to excavate the mud to stiffer underlying soils. See Index 883.3 for further information on armor protection.

In fresh waters, effective protection can often be provided by the establishment of vegetation, but planners should not overlook the possibility of moderate erosion before the vegetative cover becomes established. A light armor treatment should be adequate for this transitional period.

(2) *Ocean Front Locations.* Wave action is the erosive force affecting the reliability of highway locations along the coast. The corrosive effect of salt water is also a major concern for hydraulic structures located along the coastline. Headlands and rocks that have historically withstood the relentless pounding of tide and waves can usually be relied on to continue to protect adjacent highway locations founded upon them. The need for shore protection structures is, therefore, generally limited to highway locations along the top or bottom of bluffs having a history of sloughing and along beach fronts.

Beach protection considerations include:

- Attack by waves.
- Littoral drift of the beach sands.
- Seasonal shifts of the shore.
- Foundation for protective structures.

Wave attack on a beach is less severe than on a headland, due to the gradual shoaling of the bed which trips incoming waves into a series of breakers called a surf.

Littoral drift of beach sands may either be an asset or a liability. If sand is plentiful, a new beach will be built in front of the highway embankment, reducing the depth of water at its toe and the corresponding height of the waves attacking it. If sand supply is less plentiful or subject to seasonal variations, the new beach can be induced or retained by groins.

If sand is in scant supply, backwash from a revetment tends to degrade the beach or bed even more than the seasonal variation, and an allowance should be made for this scour when designing the revetment, both as to weight of stones and depth of foundation. Groins may be ineffective for such locations; if they succeeded in trapping some littoral drift, downcoast beaches would recede from undernourishment.

Seasonal shifts of the shore line result from combinations of:

- Ranges of tide.
- Reversal of littoral currents.
- Changed direction of prevailing onshore winds.
- Attack by swell.

Generally the shift is a recession, increasing the exposure of beach locations to the hazard of damage by wave action. On strands or along extensive embayments, recession at one end may result in deposition at the other. Observations made during location assessment should include investigation of this phenomenon. For strands, the hazard may be avoided by locating the highway on the backshore facing the lagoon.

Foundation conditions vary widely for beach locations. On a receding shore, good bearing may be found on soft but substantial rock underlying a thin mantle of sand. Bed stones and even gravity walls have been founded successfully on such foundations. Spits and strands, however, are radically different, often with softer clays or organic materials underlying the sand. Sand is usually plentiful at such locations, subsidence is a greater hazard than scour, and location should anticipate a "floating" foundation for flexible, self-adjusting types of protection.

In planning ocean-front locations, the primary decision is a choice of (1) alignment far enough inshore to avoid wave attack, (2) armor on the embankment face, or (3) off shore devices like groins to aggrade the beach at embankment toe.

Topic 883 – Design

883.1 Introduction

A set of plans and specifications must be prepared to define and describe the protection that the design engineer has in mind. See Index 873.1.

Recommendations on slope protection, and erosion control materials can be requested from the District Hydraulic Engineer, the District Materials Branch and the Office of State Highway Drainage and Water Quality Design in Headquarters. The District Landscape Architect will provide recommendations for temporary and permanent erosion and sediment control measures.

The Caltrans Bank and Shore Protection Committee is available on request to provide advice on extraordinary situations or problems and to provide evaluation and formal approvals for acceptable non-standard designs. See Index 802.3 for further information on the organization and functions of the Committee.

883.2 Design High Water, Design Wave Height and Sea-Level Rise

Information needed to design shore protection is:

- Design High Water Level
- Design Wave Height

(1) Design High Water Level

Designs should not be based on an arbitrary storm, high tide or flood frequency.

July 1, 2020

Per Index 873.2, a suggested starting point of reference for the determination of the design high water level is that the protection withstands high water levels caused by meteorological conditions having a recurrence interval of one-half the service life of the protected facility. Depending on the type of facility, it may be appropriate to base the preliminary evaluation on a high water elevation resulting from a storm or flood with a 2 percent probability of exceedance (50 year frequency of recurrence). The first evaluation may have to be adjusted to conform with a subsequent analysis which considers the level of related risks, local historic high water marks, sea level rise and climate change. Scour countermeasures protecting structures designed by the Division of Engineering Services (DES) may include consideration of floods greater than a 1 percent probability of exceedance (100 year frequency of recurrence). See Index 873.6.

There is always some risk associated with the design of protection features. Significant risks are classified as those having probability of:

- Catastrophic failure with loss of life.
- Disruption of fire and ambulance services or closing of the only evacuation route available to a community.

Refer to Topic 804, Floodplain Encroachments, for further discussion on evaluation of risks and impacts.

(a) Lake Shore Locations. The flood stage elevation on a lake or reservoir is usually the result of inflow from upland runoff. If the water stored in a reservoir is used for power generation, flood control, or irrigation, the design high water elevation should be based on the owner's schedule of operation.

(b) Coastal Locations.

Except for inland tidal basins effected by wind tides, floods and seiches, the static or still-water level used for design of shore protection is the highest tide. In tide tables, this is the stage of the highest tide above "tide-table datum" at MLLW. To convert this to MSL datum there must be subtracted a datum equation (2.5 feet to 3.9 feet) factor. If datum differs from MSL datum, a further correction is necessary. These steps should be undertaken with care and independently checked. Common errors are:

- Ignoring the datum equation.
- Adding the factor instead of subtracting it.
- Using half the diurnal range as the stage of high water.

To clarify the determination of design high-water, Fig. 883.2A shows the *Highest Tide* in its relation to an extreme-tide cycle and to a hypothetical average-tide cycle, together with nomenclature pertinent to three definitions of tidal range. Note that the cycles have two highs and two lows. The average of all the higher highs for a long period (preferably in multiples of the 19-yr. metonic cycle) is MHHW, and of all the *lower* lows, MLLW. The vertical difference between them is the *diurnal range*.

Particularly on the Pacific coast where MLLW is datum for tide tables, the stage of MHHW is numerically equal to diurnal range.

The average of all highs (indicated graphically as the mean of higher high and lower high) is the MHW, and of all the lows, MLW. Vertical difference between these two stages is the *mean range*.

See Index 814.5, Tides and Waves, for information on where tide and wave data may be obtained. See HEC 25, Volume 1, for a discussion on tidal and survey datums.

Figure 883.2A

Nomenclature of Tidal Ranges

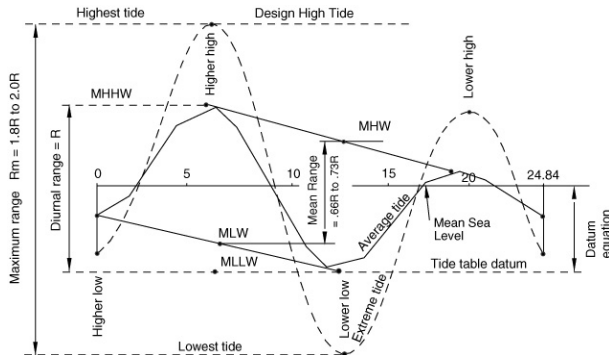

NOTES:

- (1) Because of the great variation of tidal elements, Figure 883.2A was not drawn to scale.
- (2) The elevation of the design high tide may be taken as mean sea level (MSL) plus one-half the maximum tidal range (Rm).

(2) Design Wave Heights.

- (a) General. Even for the simplest of cases, the estimation of water levels caused by meteorological conditions is complex. Elaborate numerical models requiring the use of a computer are available. See HEC 25, Volume 2, Index 2.4.2. Simplified techniques may be used to predict acceptable wind wave heights for the design of highway protection facilities along the shores of embayments, inland lakes, and reservoirs. The Coastal Engineering Manual provides a simplified wave prediction method which is suitable for most riprap sizing applications. The method is described in HEC 23, Volume 2, Index 17.2.2 of Design Guideline 17. It is recommended that for ocean shore protection designs the assistance of the U.S. Army Corp of Engineers be requested.

Shore protection structures are generally designed to withstand the wave that induces the highest forces on the structure over its economic service life. The design wave is analogous to the design storm considerations for determining return frequency. A starting point of reference for shore protection design is the maximum significant wave height that can occur once in about 20-years. Economic and risk considerations involved in selecting the design wave for a specific project are basically the same as those used in the analysis of other highway drainage structures.

- (b) Wave Distribution Predictions. Wave prediction is called hindcasting when based on past meteorological conditions and forecasting when based on predicted conditions. The same procedures are used for hindcasting and forecasting. The only difference is the source of the meteorological data. Reference is made to the Army Corps of Engineers, Coastal Engineering Manual – Part II, for more complete information on the theory of wave generation and predicting techniques.

The prediction of wave heights from boat generated waves must be estimated from observations.

The surface of any large body of water will contain many waves differing in height, period, and direction of propagation. A representative wave height used in the design of bank and shore protection is the significant wave height, H_s . The significant wave height is the average height of the highest one-third of all the waves in a wave train

July 1, 2020

for the time interval (return frequency) under consideration. Thus, the design wave height generally used is the significant wave height, H_s , for a 20-year return period.

Other design wave heights can also be designated, such as H_{10} and H_1 . The H_{10} design wave is the average of the highest 10 percent of all waves, and the H_1 design wave is the average of the highest 1 percent of all waves. The relationship of H_{10} and H_1 to H_s can be approximated as follows:

$$H_{10} = 1.27 H_s \text{ and } H_1 = 1.67 H_s$$

Economics and risk of catastrophic failure are the primary considerations in designating the design wave average height.

(c) Wave Characteristics. Wave height estimates are based on wave characteristics that may be derived from an analysis of the following data:

- Wave gage records
- Visual observations
- Published wave hindcasts
- Wave forecasts
- Maximum breaking wave at the site

(d) Predicting Wind Generated Waves. The height of wind generated waves is a function of fetch length, windspeed, wind duration, and the depth of the water.

(1) Hindcasting – The U.S. Army Corp of Engineers has historical records of onshore and offshore weather and wave observations for most of the California coastline. Design wave height predictions for coastal shore protection facilities should be made using this information and hindcasting methods. Deep-water ocean wave characteristics derived from offshore data analysis may need to be transformed to the project site by refraction and diffraction techniques. As mentioned previously, it is strongly advised that the Corps technical expertise be obtained so that the data are properly interpreted and used.

(2) Forecasting – Simplified wind wave prediction techniques may be used to establish probable wave conditions for the design of highway protection on bays, lakes and other inland bodies of water. Wind data for use in determining design wind velocities and durations is usually available from weather stations, airports, and major dams and reservoirs. The following assumptions pertain to these simplified methods:

- The fetch is short, 75 miles or less
- The wind is uniform and constant over the fetch.

It should be recognized that these conditions are rarely met and wind fields are not usually estimated accurately. The designer should therefore not assume that the results are more accurate than warranted by the accuracy of the input and simplicity of the method. Good, unbiased estimates of all wind generated wave parameters should be sought and the cumulative results conservatively interpreted. The individual input parameters should not each be estimated conservatively, since this may bias the result.

The applicability of a wave forecasting method depends on the available wind data, water depth, and overland topography. Water depth affects wave generation and for a given set of wind and fetch conditions, wave heights will be smaller and wave

periods shorter if the wave generation takes place in transitional or shallow water rather than in deep water.

The height of wind generated waves may also be fetch-limited or duration-limited. Selection of an appropriate design wave may require a maximization procedure considering depth of water, wind direction, wind duration, wind speed, and fetch length.

Procedures for predicting wind generated waves are complex and our understanding and ability to describe wave phenomena, especially in the region of the coastal zone, is limited. Many aspects of physics and fluid mechanics of wave energy have only minor influence on the design of shore protection for highway purposes. Designers interested in a more complete discussion on the rudiments of wave mechanics should consult the U.S. Army Corps of Engineers' Coastal Engineering Manual – Part II.

An initial estimate of wind generated significant wave heights can be made by using Figure 883.2B. If the estimated wave height from the nomogram is greater than 2 feet, the procedure may need to be refined. It is recommended that advice from the Army Corps of Engineers be obtained to refine significant wave heights, H_s , greater than 2 feet.

- (e) **Breaking Waves.** Wave heights derived from hindcasts or any forecasting method should be checked against the maximum breaking wave that the design stillwater level depth and nearshore bottom slope can support. The design wave height will be the smaller of either the maximum breaker height or the forecasted or hindcasted wave height.

The relationship of the maximum height of breaker which will expend its energy upon the protection, H_b , and the depth of water at the slope protection, d_s , which the wave must pass over are illustrated in Figure 883.2C.

The following diagram, with some specific references to the SPM, summarizes an overly simplified procedure that may be used for highway purposes to estimate wind generated waves and establish a design wave height for shore protection.

- (f) **Wave Run-up.** Run-up is the extent, measured vertically, that an incoming wave will rise on a structure. An estimate of wave run-up, in addition to design wave height, will typically be needed and is required by policy for projects subject to California Coastal Commission (CCC) jurisdiction (see CCC guidance document "Beach Erosion and Response," December 1999). Procedures for estimating wave run-up for rough surfaces (e.g., RSP) are contained in the U.S. Army Corps of Engineers manual, Design of Coastal Revetments, Seawalls, and Bulkheads, (EM 1110-2-1614) published in 1995.

Procedures for estimating wave run-up for smooth surfaces (e.g., concrete paved slopes) and for vertical and curved face walls are contained in the U.S. Army Corps of Engineers, Shore Protection Manual, 1984. See Figure 873.2D for estimating wave run-up on smooth slopes for wave heights of 2 feet or less.

In protected bays and estuaries, waves generated by recreational or commercial boat traffic and other watercraft may dominate the design over wind generated waves. Direct observation and measurements during high tidal cycles may provide the designer the most useful tool for establishing wave run-up for these situations.

- (g) **Littoral Processes.** See Index 882.3(2). Littoral processes result from the interaction of winds, waves, currents, tides, and the availability of sediment. The rates at which sediment is supplied to and removed from the shore may cause excessive accretion

July 1, 2020

Determining Design Wave

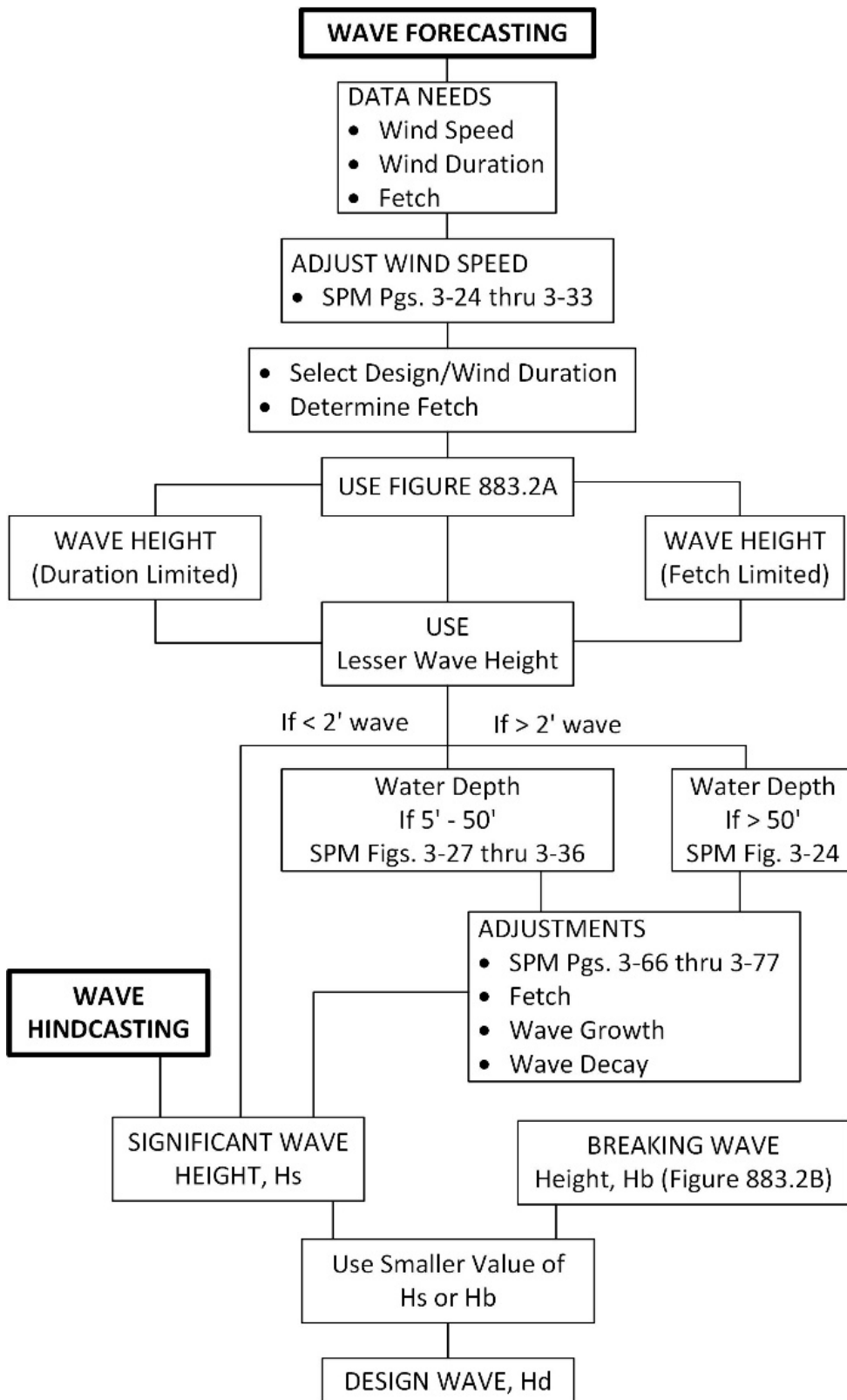
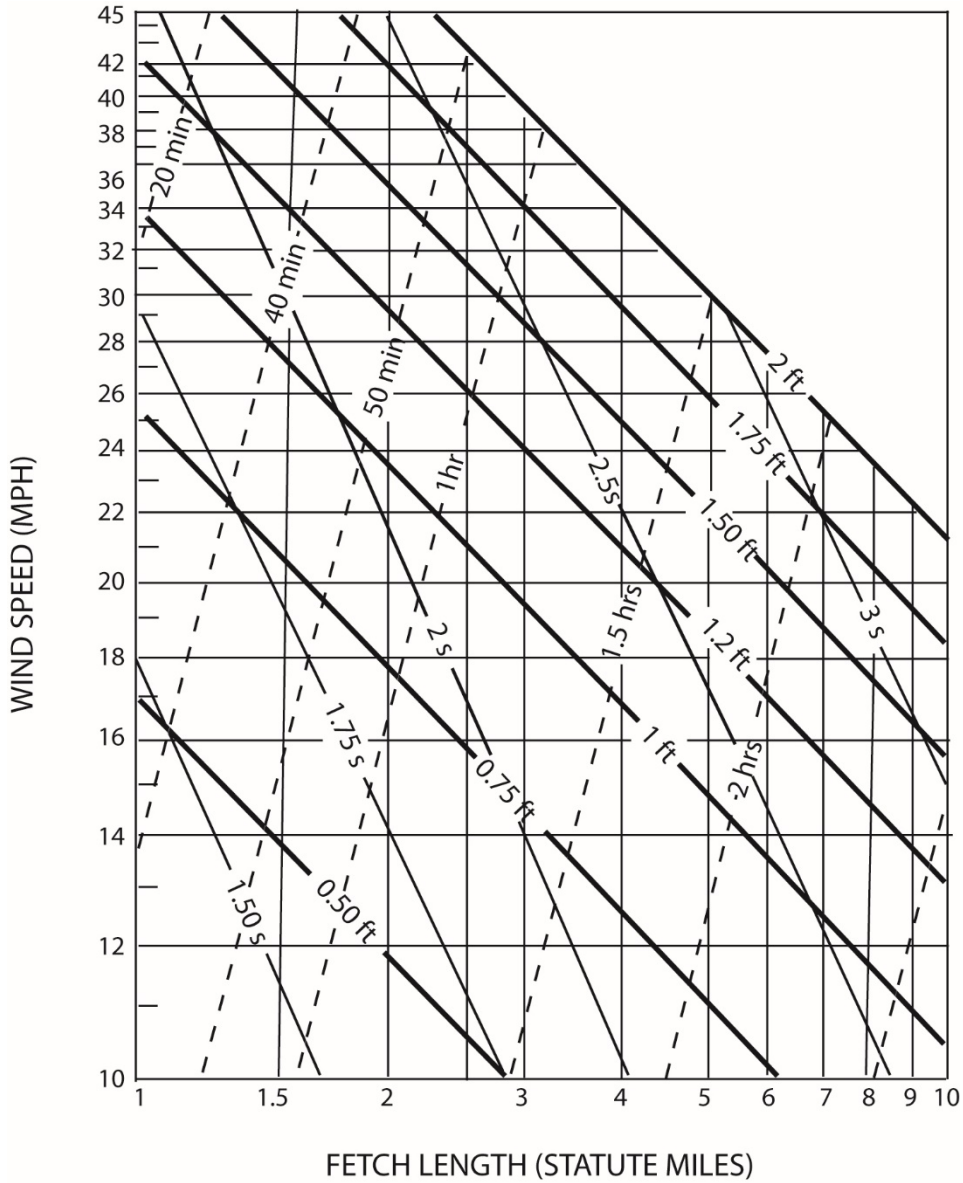

Figure 883.2B

Significant Wave Height Prediction Nomograph



- SIGNIFICANT HT. (ft)
- - - PEAK SPECTRAL PERIOD (s)
- . . . MIN. DURATION (min, hr)

July 1, 2020

Figure 883.2C

Design Breaker Wave

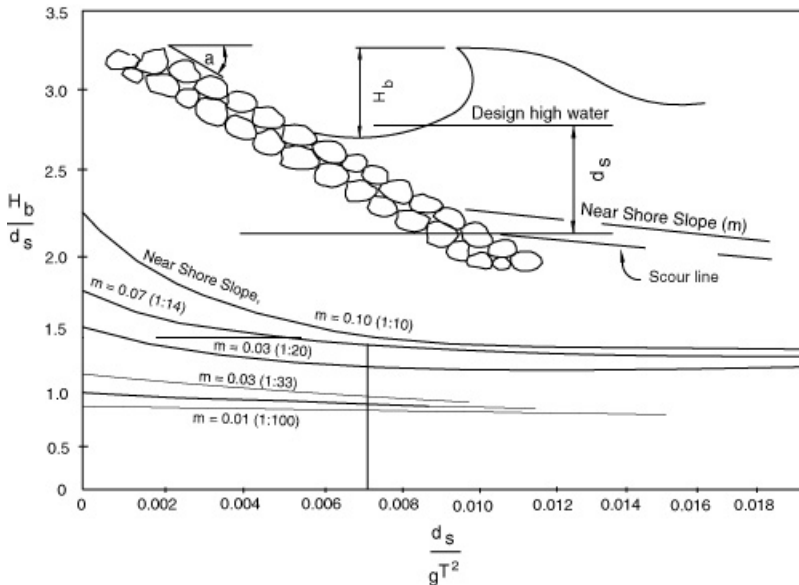
Example:

By using hindcast methods, the significant wave height (H_s) has been estimated at 4 feet with a 3 second period. Find the design wave height (H_d) for the slope protection if the depth of water (d) is only 2 feet and the nearshore slope (m) is 1:10.

Solution:

$$\frac{d_s}{gT^2} = \frac{2 \text{ ft}}{(32.2 \text{ ft/sec}^2) \times (3 \text{ sec})^2} = 0.007$$

From Graph) - $H_b/d_s = 1.4$

$$H_b = 2 \times 1.4 = 2.8 \text{ ft}$$

Answer:

Since the maximum breaker wave height, H_b , is smaller than the significant deepwater wave height, H_s , the design wave height H_d is 2.8 feet.

T = Wave Period (SPM)

or erosion that can affect the structural integrity of shore protection structures or functional usefulness of a beach. The aim of good shore protection design is to maintain a stable shoreline where the volume of sediment supplied to the shore balances that which is removed. Designers interested in a more complete discussion on littoral processes should consult the U.S. Army Corps of Engineers' Coastal Engineering Manual (CEM) – Part III.

(3) *Sea Level Rise.* The California Ocean Protection Council (OPC) has developed sea-level rise guidance for use by state and local governments to assess the associated risks with sea-level rise and incorporate sea-level rise into planning, permitting and investment decisions. The "State of California Sea-Level Rise Guidance 2018" provides estimates of sea-level rise based upon the best available science. A step-by step approach to

selecting a value for sea-level rise based on OPC 2018 Guidance is provided in the steps below. This method of evaluating sea-level rise could be revised and updated in the future based on the most current guidance provided by OPC or other responsible agencies.

Step 1. Identify the nearest tide gauge. The rates of sea-level rise along the California coast is dependent on land elevations resulting from tectonic activity as well as land subsidence. There are 12 active tide gauges along the California coast and sea-level rise projections vary across the tide gauges based on trends in tectonic activity and land subsidence.

Identify the tide gauge nearest to the project site. If the project is located equidistant between two tide gauges it would be appropriate to interpolate between the two gauges or average the two gauges. The 12 tide gauges along the California coast are identified in Figure 883.2 D.

Step 2. Evaluate the project lifespan: Determine the project lifespan for selection of appropriate year for associated sea-level rise. The California Transportation Commission has adopted asset classes associated with the State Highway System and the Primary Asset Classes are defined as: (a) Pavement, (b) Bridges, (c) Culverts, and (d) Transportation Management Systems. In the absence of a designated project lifespan, the design life associated with an asset class may be used to determine the year associated with the projected sea-level rise. Design lives of pavement projects are referenced in Section 612, and maintenance free service life of culverts (typically 50-years) referenced in chapter 850 of this manual. Bridge Design Life (per AASHTO LRFD Bridge Design Specifications 8th Edition Sec. 1.3.2.2) is 75 years.

Emissions Scenarios: Prior to 2050 the differences in sea-level rise projected values across multiple emissions scenarios are not significant since sea-level rise till 2050 is locked-in by past greenhouse gas emissions. After 2050 sea-level rise is dependent on the severity of greenhouse gas emissions, low emissions represented by Representative Concentration Pathway (RCP) 2.6 and the high emissions scenario represented by RCP 8.5. Sea-level rise is evaluated for both high and low emissions scenarios associated with multiple risk aversions. A H++ scenario is also included and is considered to be an extreme scenario not associated with any probability. The H++ scenario may be considered for projects and its impact on potential projects may be documented but may not necessarily be used for design purposes. Feasibility and costs associated with the H++ scenario should be evaluated and included in the justification for the acceptance/rejection of the H++ scenario for design purposes.

Jurisdictional agencies (such as the California Coastal Commission) may require an evaluation of sea-level rise under the RCP 8.5 as well as the H++ scenarios. However, project design may not necessarily include incorporation of the highest value of sea-level rise selected. Factors such as project costs and feasibility, may require a negotiated agreement with the agencies to develop a modular approach to design using a value associated with a shorter time frame than the selected design life of the project with the understanding that successive projects over time would build upon the proposed design to ultimately provide a resilient infrastructure.

Step 3. Identify range of Sea-Level Rise Projections: Vulnerability of people, communities, natural resources, infrastructure and properties should be considered for developing a range of sea-level rise projections. Sea-level rise projections for various risk aversions including a low risk aversion (66% probability sea-level rise lies within this range), a medium risk aversion (1 in 20 chance), a medium high-risk aversion (1 in 200 chance), an extreme risk aversion (H++ scenario) should be studied against impacts of potential sea-level rise on people, communities, natural resources, infrastructure, and properties.

July 1, 2020

Figure 883.2D

California 12 Tide Gauges



Low risk aversion represents a condition where an asset has a 17% chance of being adversely impacted by sea-level rise. Examples of a low risk aversion may include a parking lot within the coastal area, or a constructed trail leading down towards a beach. Should such assets be damaged or destroyed, they may be relatively easy to repair or replace.

Medium risk aversion represents a condition where an asset has a 5% chance of being adversely impacted by sea-level rise. Such risk may be exercised for a segment of roadway that if inaccessible would not jeopardize public safety or public health. Additionally, such a risk may be adopted if an asset would be cost effective to repair/replace as opposed to major resiliency redesign, and whose inaccessibility would not negatively impact natural resources or properties. Another example may be culvert outfalls that may tend to be inundated by sea-level rise on a coastal highway. Medium risk aversion may be assumed if a contingency plan exists to retrofit the culvert outfalls with tidal flap gates to prevent backflow.

Medium-high risk aversion represents a condition where an asset has a 0.5% chance of being inundated and is expected to be needed for public health/safety. The likelihood that sea-level rise may meet or exceed this value is low. A highway expected to be used as an emergency evacuation route for people/communities, as access to and from hospitals, as a major route for support of local/regional economies, may be evaluated for sea-level rise under the medium-high risk aversion scenarios.

Extreme risk scenario represented by H++ may be used for projects that have little to no adaptive capacity, that are essential for public safety and health, that is cost prohibitive to replace or repair, and with a design life well beyond 2050. An example would be a major bridge connecting communities with access to hospitals and economic interests and spanning a water body directly impacted by sea-level rise, and where freeboard requirements are necessary for passage of ships, boats or other crafts. Such situations with project design lives extending into the 22nd century where a minimum freeboard is required for passage of watercraft may require consideration of the H++ scenario.

Sea-level rise projections for each tide gauge are provided in the ‘State of California Sea Level Rise Guidance 2018 Update’ Appendix 3 and may be accessed at: http://www.opc.ca.gov/webmaster/ftp/pdf/agenda_items/20180314/Item3_Exhibit-A OPC SLR Guidance-rd3.pdf.

Step 4. Evaluate potential impacts and adaptive capacity across a range of sea-level rise projections and emissions scenarios: Evaluate the potential impacts of sea-level rise on the project in terms of vulnerable communities, critical infrastructure, and economic burden.

Step 5. Select sea-level rise projections based on risk tolerance and incorporate appropriate resiliency into design. Contingency plans may be included in case sea-level rise exceeds design projections. Evaluate impacts of sea-level rise by using sea-level rise mapping tools (sea-level rise) viewer available at: <https://coast.noaa.gov/slr/#/layer/slr/0/13566681.667176013/4585243.78640795/9/satellite/none/0.8/2050/interHigh/midAccretion>.

NOAA’s sea-level rise viewer evaluates the impacts of sea-level rise at water surface elevations derived from adding the selected value of sea-level rise to the mean higher high water (MHHW) elevation of the sea in the vicinity of the project. MHHW values for various stations may be obtained from <https://tidesandcurrents.noaa.gov/stations.html?type=Datums>. Select appropriate station and datum from website. Add selected value of sea-level rise to MHHW to obtain water surface elevation for design. An example for selection of sea-level rise for a hypothetical project near Crescent City, Del Norte County is provided below. Project Scope: A segment of SR 101 is to be reconstructed south of Crescent City. A parking lot for access to the beach is also included in the scope of the project as shown in Figure 883.2E.

Assumed project scope includes reconstruction of segment of SR-101 south of Crescent City. A parking lot is to be constructed for beach access for recreational purposes. Consideration of sea-level rise for proposed project is as follows:

The nearest tide gauge is Crescent City. The data for sea-level rise at Crescent City is provided in Table 883.1B. Per HDM Index 612.2, pavement design life of parking lots is 20 years; reconstruction projects is 40 years. Applicable sea-level rise for the parking lot will be for year 2040. Applicable sea-level rise for roadway reconstruction will be for year 2060.

July 1, 2020

Consider range of sea-level rise for varying risk and emissions conditions. For the parking lot, sea-level rise for projects prior to 2050 reflect only a high emissions scenario. Refer to Table 883.1B for information:

- Sea-level rise associated with a low risk aversion for year 2040 ranges from 0.1 to 0.4 feet. Select the higher value in the range, i.e. 0.4-foot.
- Sea-level rise associated with a medium risk aversion (5% probability sea level rise meets or exceeds) for the year 2040 is 0.6 feet.
- Sea-level rise associated with the medium-high risk aversion (0.5% probability sea-level rise meets or exceeds) for the year 2040 is 0.9 feet.

Figure 883.2E

Crescent City Example



Now evaluate the impact of the potential loss of the parking lot.

- The loss of the parking lot is not expected to have a significant impact on public health and safety. The loss would be expected to have an insignificant economical impact on any community.
- When there is no significant economical loss, no threat to public safety, public health or transportation resulting from the loss of the parking lot, an evaluation of the costs of construction, repair and replacement should determine the risk factor to be adopted for selection of an appropriate value for sea-level rise.

- Although sea-level rise associated with a low risk aversion may be justified, however, costs of construction, future repair or replacement should be examined. For the parking lot the differences between sea-level rise values associated with the low risk, medium risk and the medium-high risk is very small (ranges from 5 inches to 11 inches) and based on costs an appropriate risk aversion may be selected.

For highway reconstruction, sea-level rise projections for projects with design life extending beyond 2050 are provided for low emissions as well as high emissions scenarios. With a 40-year design life for pavement reconstruction projects sea-level rise for year 2060 may be considered. Refer to Table 883.1B for information. Review sea-level rise projection for both low as well as high emissions scenarios for low risk, medium risk as well as medium-high risk aversions. The comparisons for year 2060 are provided Table 883.1A.

Table 883.1A

Crescent City Example Comparison for 2060

Emissions	Low Risk Aversion	Medium Risk Aversion	Medium-High Risk Aversion
Low (RCP 2.6)	0.1 to 0.7-foot	1.0-foot	1.8-foot
High (RCP 8.5)	0.2 to 0.9-foot	1.3-foot	2.1-foot

July 1, 2020

Table 883.1B

Projected Sea-Level Rise (feet) at Crescent City

Emissions Scenario	Year	Median	Likely Range	1 – In – 20 Chance	1 – In – 200 Chance	H++ Scenario
		50% probability sea-level rise meets or exceeds	66% probability sea-level rise is between	5% probability sea-level rise meets or exceeds	0.5% probability sea-level rise meets or exceed	Not associated with any probability
			Low Risk Aversion	Medium Risk Aversion	Medium – High Risk Aversion	Extreme Risk Aversion
High Emissions	2030	0.1	0.0 – 0.3	0.4	0.5	0.8
High Emissions	2040	0.3	0.1 – 0.4	0.6	0.9	1.4
High Emissions	2050	0.4	0.2 – 0.7	0.9	1.5	2.3
Low Emissions	2060	0.4	0.1 – 0.7	1.0	1.8	
High Emissions	2060	0.6	0.2 – 0.9	1.3	2.1	3.3
Low Emissions	2070	0.5	0.1 – 0.9	1.3	2.4	
High Emissions	2070	0.8	0.4 – 1.2	1.7	2.8	4.5
Low Emissions	2080	0.6	0.1 – 1.1	1.6	3.1	
High Emissions	2080	1.0	0.5 – 1.6	2.2	3.7	5.9
Low Emissions	2090	0.7	0.1 – 1.3	1.9	3.9	
High Emissions	2090	1.2	0.6 – 2.0	2.8	4.7	7.4
Low Emissions	2100	0.7	0.1 – 1.5	2.3	4.8	
High Emissions	2100	1.5	0.7 – 2.5	3.4	5.9	9.3
Low Emissions	2110	0.8	0.2 – 1.5	2.4	5.3	
High Emissions	2110	1.5	0.9 – 2.5	3.4	6.2	11.0
Low Emissions	2120	0.8	0.1 – 1.7	2.8	6.3	
High Emissions	2120	1.8	1.0 – 3.0	4.1	7.4	13.1
Low Emissions	2130	0.9	0.1 – 1.9	3.2	7.3	
High Emissions	2130	2.1	1.1 – 3.4	4.8	8.7	15.3
Low Emissions	2140	1.0	0.1 – 2.2	3.6	8.4	
High Emissions	2140	2.3	1.2 – 3.9	5.5	10.1	17.8
Low Emissions	2150	1.0	0.0 – 2.4	4.2	9.6	
High Emissions	2150	2.6	1.3 – 4.4	6.2	11.6	20.6

Determine impact of potential loss of this segment of highway on communities:

- Will the loss of this segment impact transport of patients to and from a hospital?
- Will the loss of this segment impact response times for emergency vehicle?
- Will the loss of this segment impact freight and deliveries resulting in economic losses?
- Can traffic be detoured easily around this segment?

The value of sea-level rise for designing the roadway may be selected after evaluating relevant issues such as mentioned above. The difference between the low and high emissions scenarios is less than 4-inches. Based on the small difference

between the emissions scenarios, the high emissions scenario RCP 8.5 may be appropriate. If the highway segment is important for public safety/health and local economy, the medium-high risk value of 2.1 feet may be selected. The design would not only incorporate a higher elevation of the roadway but would also include measures for protecting the roadway (Armoring sea approach to roadway embankment).

Although the project does not have to be designed for the H++ scenario, it may be considered. Sea-level rise associated with the H++ scenario is 3.3 feet. A plan for future modular adaptation may be included should it become apparent at some time in future that sea levels are heading towards the H++ projections. The plan may include raising the profile of the highway and associated protection measures against the 3.3 feet projected sea-level rise.

Determine MHHW elevation from:

<https://tidesandcurrents.noaa.gov/datums.html?id=9419750>. Figure 883.2F shows the results.

Add MHHW to projected sea-level rise:

For the roadway project add 2.1 feet to 6.49 feet. Elevation of water surface including seal level rise associated with high emissions and medium-high risk aversion is 8.59 feet. Evaluate impact of sea-level rise on project by using NOAA sea-level rise viewer at: <https://coast.noaa.gov/slr/>.

- (4) *Assessing Extreme Events and Climate Change*. Chapter 4 of HEC 25, Volume 2 presents guidance on specific methodologies for assessing exposure of coastal transportation infrastructure to extreme events and climate change. For all projects, as a minimum, the use of existing data and resources should be utilized through the use of existing inundation (FEMA) or tsunami hazard maps to determine the exposure of infrastructure under selected sea (lake) level change scenarios, and sensitivity to depth-limited wave or wave runup processes. See HEC 25, Volume 2, Indexes 4.1.1 and 4.5.1 Level of Effort 1: Pacific Coast – Storms.

July 1, 2020

Figure 883.2F

Crescent City MHHW

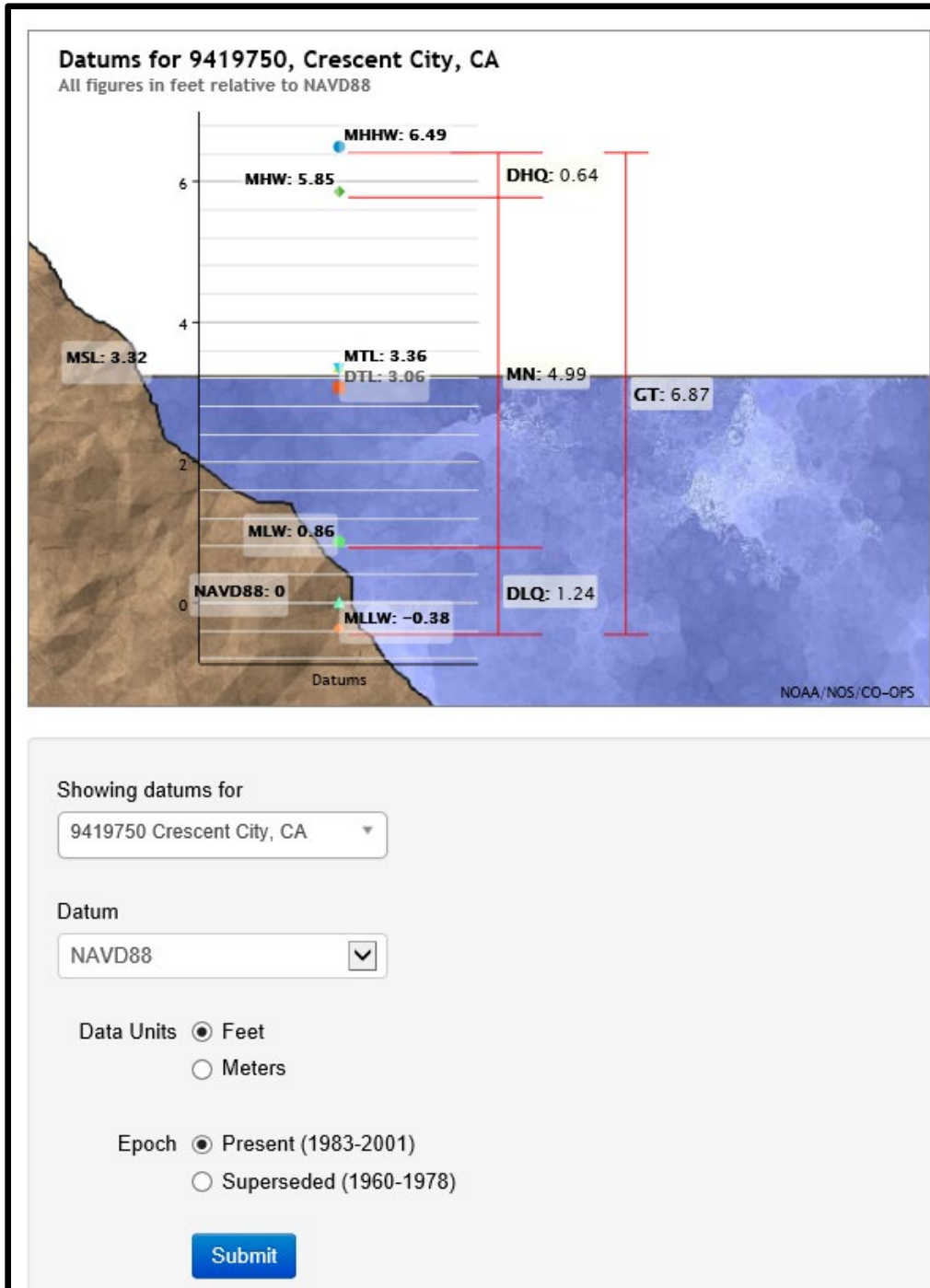

883.3 Armor Protection

(1) *General.* Armor is the artificial surfacing of shore or embankment to resist erosion or scour. Armor devices can be flexible (self-adjusting) or rigid. The distinction between revetments (layers of rock or concrete), seawalls, and bulkheads is one of functional purpose. Revetments usually consist of rock slope protection on the top of a sloped surface to protect the underlying soil. Seawalls are walls designed to protect against large wave forces. Bulkheads are designed primarily to retain the soil behind a vertical wall in locations with less wave action. Design issues such as tie-backs, depth of sheets are primarily controlled by geotechnical issues. The use of each one of the three types of coastal protection depends on the relationship between wave height and fetch (distance across the water body). Bulkheads are most common where fetches and wave heights are small. Seawalls are most common where fetches and wave heights are large. Revetments are often common in intermediate situations such as on bay or lake shorelines.

(2) *Revetments.*

(a) Rock Slope Protection (RSP). Hard armoring of shorelines, primarily with RSP, has been the most common means of providing long-term protection for transportation facilities, and most importantly, the traveling public. With many years of use, dozens of formal studies and thousands of constructed sites, RSP is the armor type for which there exists the most quantifiable data on performance, constructability, maintainability and durability, and for which there exist several nationally recognized design methods.

Due to the above factors, RSP is the general standard against which other forms of armoring are compared.

The results of internal research led to the publication of Report No. FHWA-CA-TL-95-10, "California Bank and Shore Rock Slope Protection Design". Within that report, the methodology for RSP design adopted as the Departmental standard for many years, was the California Bank and Shore, (CABS), layered design. The CABS layered design methodology and its associated gradations are now obsolete. For reference only, the full report is available at the following website: https://www.fs.fed.us/biology/nsaec/fishxing/fplibrary/Racin_2000_California_bank_and_shore_rock_slope_protection.pdf.

For RSP designs along coastal and lake shores, for wave heights five feet or less, the methodology presented in HEC 23, Volume 2, Design Guideline 17- Riprap Design for Wave Attack has been formally adopted by the Caltrans Bank and Shore Protection Committee. Section 72 of the Standard Specifications provides all construction and material specifications.

Rock is usually the most economical type of revetment where stones of sufficient size and quality are available. It also has the following advantages:

- Wave run-up is less than with smooth types (See Figure 883.2G).
- It is salvageable, may be stockpiled and reused if necessary.

July 1, 2020

Figure 883.2G

Wave Run-up on Smooth Impermeable Slope

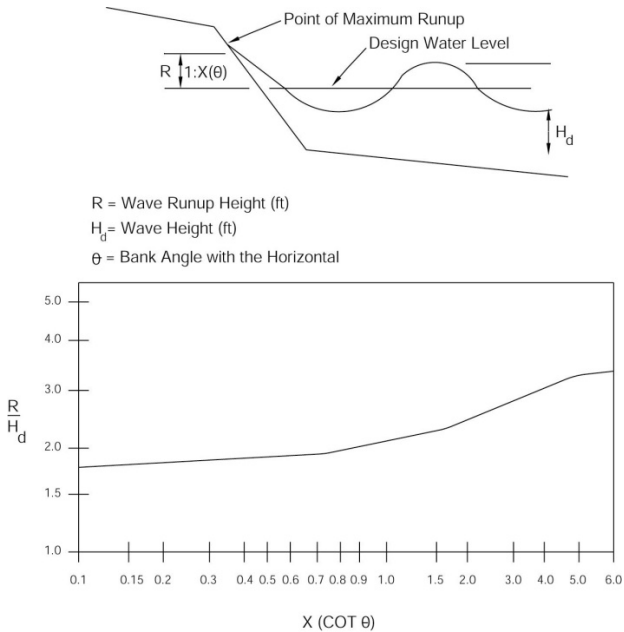

Figure 883.2H

RSP Lined Ocean Shore



In designing the rock slope protection for a shore location, the following determinations are to be made for the typical section.

- Depth at which the stones are founded (bottom of toe trench. See Figure 883.2I and Figure 17.2 in HEC 23, Volume 2, Design Guideline 17).
- Elevation at the top of protection.
- Rock size, specific gravity and section thickness.
- Need for geotextile or rock filter material.
- Face slope.

Well designed coastal rock slope protection should:

- Assure stability and compatibility of the protected shore as an integral part of the shoreline as a whole.
 - Not be placed on a slope steeper than 1.5H:1V.
 - Use stone of adequate weight to resist erosion, derived from Index 883.3(2)(a)(2)(1).
 - Prevent loss of bank materials through interstitial spaces of the revetment. Rock slope protection fabric or a filter layer should be used.
 - Rest on a good foundation on bedrock or extend below the depth of probable scour. If questionable, use heavy bed stones and provide a wide base section with a reserve of material to slough into local scour holes (i.e., mounded toe).
 - Be constructed of rock of such shape as to form a stable protection structure of the required section. See Index 873.3(3)(a)(2)(a).
- (1) General Features – See Index 873.3(3)(a)(1)(a) through (e) for discussions on methods of placement, foundation treatment, rock slope protection fabrics and gravel filters.
- (2) Stone Size – Two methods for determining riprap size for stability under wave action are presented in HEC 23, Volume 2, Design Guideline 17: (1) the Hudson method, and (2) the Pilarczyk method.
- (a) The Hudson Method. Applications of Hudson's equation in situations with a design significant wave height of H=5 feet or less have performed well. This range of design wave heights encompasses many coastal revetments along highway embankments. When design wave heights get large and the design water depths get large, problems with the performance of rubble-mound structures can occur. A more conservative design approach should use a more conservative H statistic. The proper input wave height statistic is required and discussed in Section 6.3 of HEC 25, Volume 1. RSP with design wave heights much greater than H=5 feet require more judgment and more experience and input from a trained, experienced coastal engineer. Therefore, when design wave heights are much greater than H=5 feet, contact the District Hydraulic Engineer. The Hudson method considers wave height, riprap density, and slope of the bank or shoreline to compute a required weight of a median-size riprap particle.

$$W_{50} = \frac{\gamma_r H^3 (\tan \theta)}{K_d (S_r - S_w)^3}$$

Where:

W_{50} = weight of median riprap particle size, (lb)

γ_r = unit weight of riprap, (lb/ft³)

H = design wave height, (ft) (Note: Minimum recognized value for use with the Hudson equation is the 10 percent wave, $H_{0.10} = 1.27H_s$)

K_d = empirical coefficient equal to 2.2 for riprap

S_r = specific gravity for riprap

S_w = specific gravity for water (1.0 for fresh water, 1.3 for sea water)

θ = angle of slope inclination

The median weight W_{50} can be converted to an equivalent particle size d_{50} by the following relationship:

July 1, 2020

$$d_{50} = \sqrt[3]{\frac{W_{50}}{0.85\gamma_r}}$$

- (b) The Pilarczyk Method. Compared to the Hudson method, the Pilarczyk method considers additional variables associated with particle stability in different wave environments, and therefore should more thoroughly characterize the rock stability threshold. The hydraulic processes that influence rock revetment stability are directly related to the type of wave that impacts the slope, as characterized by the breaker parameter. The breaker parameter is a dimensionless quantity that relates the bank slope, wave period, wave height, and wave length to distinguish between the types of breaking waves. This parameter is defined as:

$$\xi = \frac{\tan \theta}{\sqrt{H_s/L_o}} = \tan \theta \frac{K_u T}{\sqrt{H_s}}$$

Where:

ξ = dimensionless breaker parameter

θ = angle of slope inclination

L_o = wave height, (ft)

H_s = significant wave height, (ft)

T = wave period, (sec)

K_u = coefficient equal to 2.25 for wave height, (ft)

The wave types corresponding to the breaker parameter are listed in Table 883.2 and illustrated schematically below.

Table 883.2

Dimensionless Breaker Parameter and Wave Types

Value of the Dimensionless Breaker Parameter ξ	Type of Wave
$\xi < 0.5$	Spilling
$0.5 < \xi < 2.5$	Plunging
$2.5 < \xi < 3.5$	Collapsing
$\xi < 3.5$	Surging

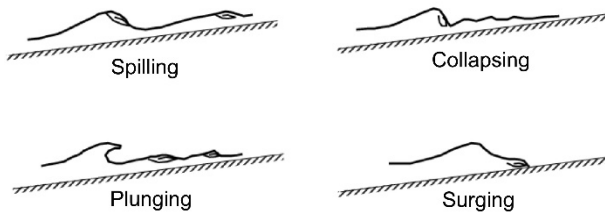

The Pilarczyk method, like the Hudson method, uses a general empirical relationship for particle stability under wave action. When design wave heights are much greater than $H=5$ feet, contact the District Hydraulic Engineer. The Pilarczyk equation is:

$$\frac{H_s}{\Delta D} \leq \psi_u \phi \frac{\cos \theta}{\xi^b}$$

Where:

H_s = significant wave height, (ft)

Δ = relative unit weight of riprap, $\Delta = (\gamma_r - \gamma_w) / \gamma_w$

D = armor size thickness, (ft)

ψ_u = stability upgrade factor (1.0 for good riprap)

ϕ = stability factor (1.5 for good quality, angular riprap)

θ = angle of slope inclination

ξ = dimensionless breaker parameter

b = exponent (0.5 for riprap)

Rearranging the Pilarczyk equation to solve for the required stone size, and inserting the recommended values for riprap with a specific gravity of 2.65 and a fresh water specific gravity of 1.0 yields the following equation for sizing rock riprap for wave attack:

$$d_{50} \geq \frac{2}{3} \left(\frac{H_s \xi^{0.5}}{1.64 \cos \theta} \right)$$

For salt water locations (specific gravity = 1.03), substitute 1.57 for 1.64 into the denominator of the above equation.

Using standard sizes the appropriate gradation can be achieved by selecting the next larger size class, thereby creating a slightly over-designed structure, but economically a less expensive one. For example, if a riprap sizing calculation results in a required d_{50} of 16.8 inches, Class V riprap should be specified because it has a nominal d_{50} of 18 inches. See Table 873.3A.

Worked examples of the Pilarczyk and the Hudson method are presented in HEC 23, Design Guideline 17. Compared with the Hudson method, the Pilarczyk method is more complicated and includes the consideration of wave period, storm duration, clearly-defined damage level and permeability of structure. The choice of the appropriate formula is dependent on the design purpose (i.e. preliminary design or detailed design).

- (3) Design Height – The recommended vertical extent of riprap for wave attack includes consideration of high tide elevation, storm surge, wind setup, wave height, and wave runoff. Details can be found in HEC 25, Volume 1, and HEC 23, Volume 2, Index 17.3.2.

July 1, 2020

(3) *Bulkheads*. The bulkhead types are steep or vertical structures, like retaining walls, that support natural slopes or constructed embankments which include the following:

- Gravity or pile supported concrete or masonry walls.
- Crib walls
- Sheet piling

(a) Concrete or Masonry Walls. The expertise and coordination of several engineering disciplines is required to accomplish the development of PS&E for concrete walls serving the dual purpose of slope protection and support. The Division of Structures is responsible for the structural integrity of all retaining walls, including bulkheads.

(b) Crib walls. Timber and concrete cribs can be used for bulkheads in locations where some flexibility is desirable or permissible.

Figure 883.2I

Rock Slope Protection

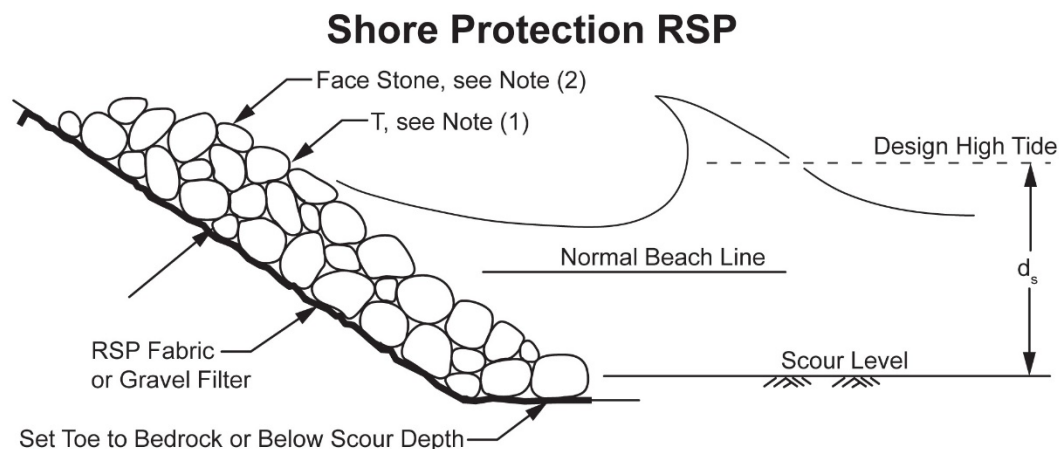

NOTES:

- (1) Thickness "T" = 1.5 d₅₀
- (2) Face stone size is determined from Index 883.3(2)(b).
- (3) RSP fabric not to extend more than 20 percent of the base width of the Mounded Toe past the Theoretical Toe.

Metal cribs are limited to support of embankment and are not recommended for use as protection because of vulnerability to corrosion and abrasion.

The design of crib walls is essentially a determination of line, foundation grade, and height with special attention given to potential scour and possible loss of backfill at the base and along the toe. Concrete crib walls used as bulkheads and exposed to salt water require special provisions specifying the use of coated rebars and special high density concrete. Recommendations from METS Corrosion Technology Branch should be requested for rebar protection and type of concrete. DES Structures Design should be consulted with the physical, structural design of a crib wall.

- (c) **Sheet Piling.** Timber, concrete and steel sheet piling are used for bulkheads that depend on deep penetration of foundation materials for all or part of their stability. High bulkheads are usually counterforted at upper levels with batter piles or tie back systems to deadmen. Any of the three materials is adaptable to sheet piling or a sheathed system of post or column piles

Excluding structural requirements, design of pile bulkheads is essentially as follows:

- Recognition of foundation conditions suitable to or demanding deep penetration. Penetration of at least 15 feet below scour level, or into soft rock, should be assured.
 - Choice of material. Timber is suitable for very dry or very wet climates, for other situations economic comparison of preliminary designs and alternative materials should be made.
 - Determination of line and grade. Fairly smooth transitions with protection to high-water level should be provided.
- (4) **Sea Walls.** Sea walls are structures, often concrete or stone, built along a portion of a coast to prevent erosion and other damage by wave action. Seawalls can be rigid structures or rubble-mound structures specifically designed to withstand large waves. Often they retain earth against the shoreward face. A seawall is typically more massive and capable of resisting greater wave forces than a bulkhead. Index 6.1 of HEC 25, Volume 1 provides several examples of seawall designs.
- (5) **Groins.** A groin is a relatively slender barrier structure usually aligned to the primary motion of water designed to trap littoral drift, retard bank or shore erosion, or control movement of bed load.

These devices are usually solid; however, upon occasion to control the elevation of sediments they may be constructed with openings. Groins typically take the following forms of construction:

- Rock mound.
- Concreted-rock dike.
- Sand filled plastic coated nylon bags.
- Single or double lines of sheet piling.

The primary use of groins is for ocean shore protection. When used as stream channel protection to retard bank erosion and to control the movement of streambed material they are normally of lighter construction than that required for shore installation.

In its simplest or basic form, a groin is a spur structure extending outward from the shore over beach and shoal. A typical layout of a shore protection groin installation is shown in Figure 883.2J.

Assistance from the U.S. Army Corp of Engineers is necessary to adequately design a slope protection groin installation. For a more complete discussion on groins, designers should consult Volume II, Chapter 6, Section VI, of the Corps' Shore

Protection Manual until Part VI of the Coastal Engineering Manual is published. Preliminary studies can be made by using basic information and data available from USGS quadrangle sheets, USC & GS navigation charts, hydrographic charts on currents for the Northeast Pacific Ocean and aerial photos of the area.

July 1, 2020

Factors pertinent to design include:

- (a) Alignment. Factors which influence alignment are effectiveness in detaining littoral drift, and self-protection of the groin against damage by wave action.

A field of groins acts as a series of headlands, with beaches between each pair aligned in echelon, that is, extending from outer end of the downdrift groin to an intermediate point on the updrift groin, see Figure 883.2K. The offset in beach line at each groin is a function of spacing of groins, volume of littoral drift, slope of sea bed and strength of the sea, varying measurably with the season. Length and spacing must be complementary to assure continuity of beach in front of a highway embankment.

A series of parallel spurs normal to the beach extending seaward would be correct for a littoral drift alternating upcoast and downcoast in equal measure. However, if drift is predominantly in one direction the median attack by waves contributes materially to the longshore current because of oblique approach. In that case the groin should be more effective if built oblique to the same degree. Such an alignment will warrant shortening of the groin in proportion to the cosine of the obliquity, see Figure 883.2K.

Conformity of groin to direction of approach of the median sea provides an optimum ratio of groin length to spacing, and the groin is least vulnerable to storm damage. Attack on the groin will be longitudinal during a median sea and oblique on either side in other seas.

- (b) Grade. The top of groins should be parallel to the existing beach grade. Sand may pass over a low barrier. The top of the groin should be established higher than the existing beach, say 2 feet as a minimum for moderate exposure combined with an abundance of littoral drift, to 5 feet for severe exposure and deficiency of littoral drift.

The shore end should be tapered upward to prevent attack of highway embankment by rip currents, and the seaward end should be tapered downward to match the side slope of the groin in order to diffuse the direct attack of the sea on the end of the groin.

- (c) Length and Spacing. The length of groin should equal or exceed the sum of the offset in shoreline at each groin plus the width of the beach from low water (LW) to high water (HW) line, see Figure 883.2I. The offset is approximately the product of the groin spacing and the obliquity (in radians) of the entrapped beach. The width of beach is the product of the slope factor and the range in stage. The relation can be formulated:

$$L = ab + rh$$

Where:

L = Length of groin, feet

a = obliquity of entrapped beach in radians

b = beach width between groins, feet

r = reciprocal of beach slope

h = range in stage, feet

For example, with groins 400 feet apart, obliquity up to 20 degrees, on a beach sloping 10:1 with a tidal range of 11 feet,

$$L = 0.35 \times 400 + 10 \times 11 = 250 \text{ feet}$$

The same formula would have required L = 390 feet for 800-foot spacing, reducing the aggregate length of groins but increasing the depth of water at the outer ends and

the average cost per foot. For some combination of length and spacing the total cost will be a minimum, which should be sought for economical design.

If groins are too short, the attack of the sea will still reach the highway embankment with only some reduction of energy. Some sites may justify a combination of short groins with light revetment to accommodate this remaining energy.

- (d) Section. The typical section of a groin is shown in Figure 883.2L. The stone may be specified as a single class, or by designating classes to be used as bed, core, face and cap stones.

Face stone may be chosen one class below the requirement for revetment. Full mass stone should be specified for bed stones, for the front face at the outer end of the groin, and for cap stones exposed to overrun. Core stones in wide groins may be smaller.

Width of groin at top should be at least 1.5 times the diameter of cap stones, or wider if necessary for operation of equipment. Side slopes should be 1.5:1 for optimum economy and ordinary stability. If this slope demands heavier stone than is available, side slope can be flattened or the cap and face stones bound together with concrete as shown in Figure 883.2L.

Figure 883.2J

Typical Groin Layout with Resultant Beach Configuration

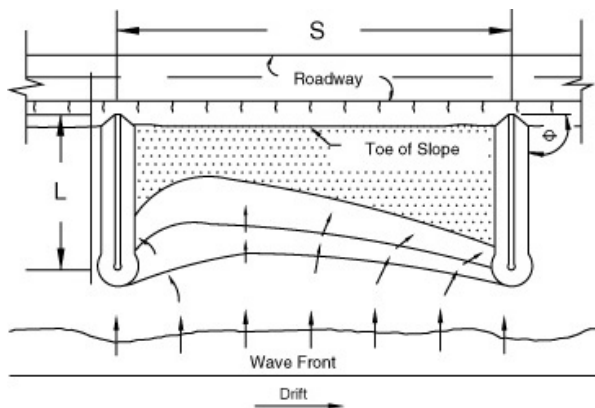

Long Groins Without Revetment

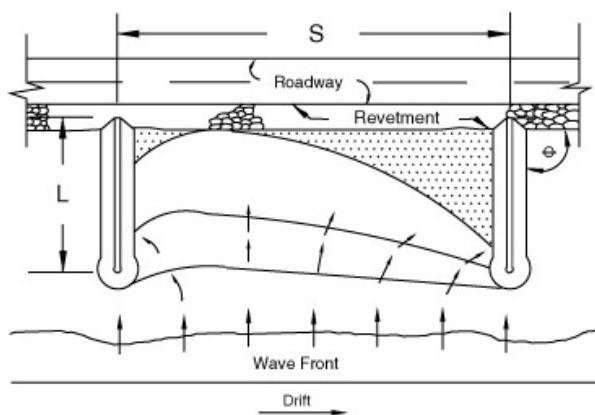

Short Groins With Light Stone Revetment

NOTES: "S", "L" and "θ" are determined by conditions at site.

July 1, 2020

Figure 883.2K

Alignment of Groins to an Oblique Sea Warrants Shortening Proportional to Cosine of Obliquity

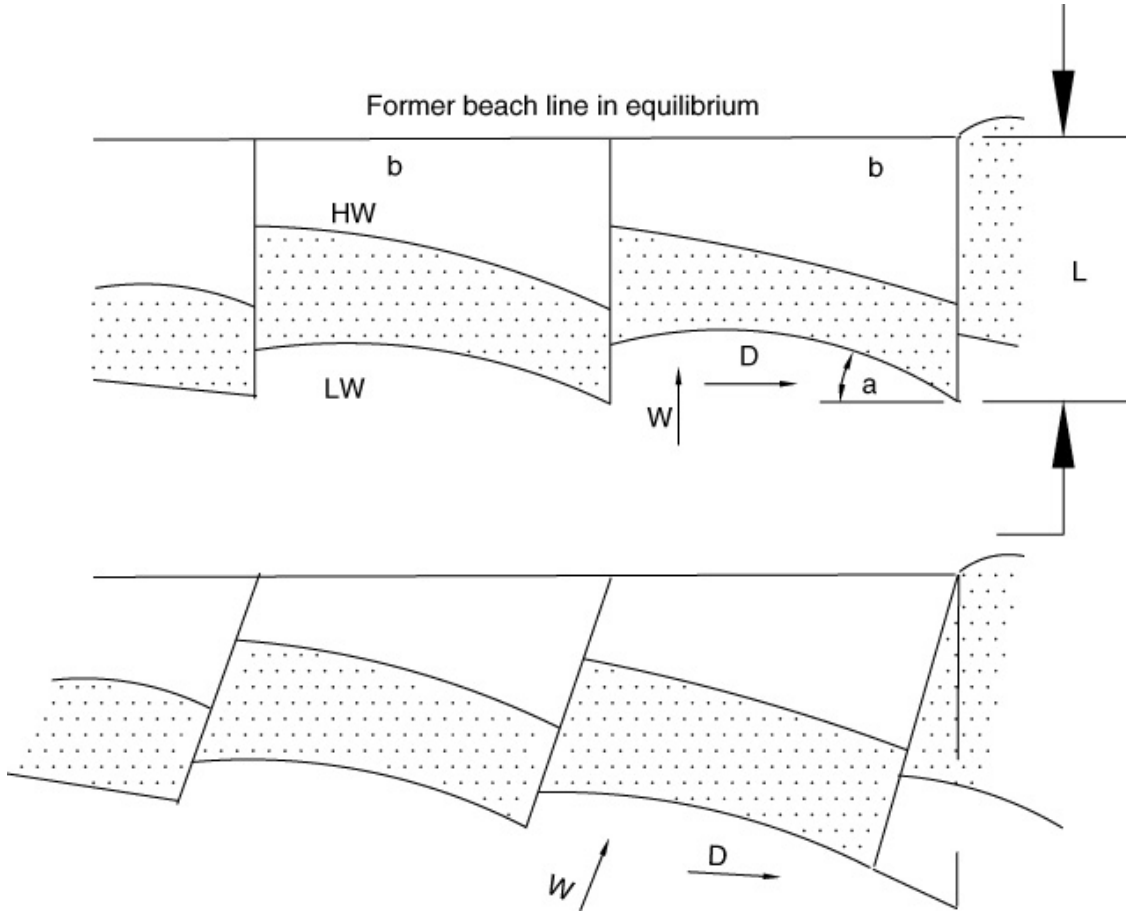
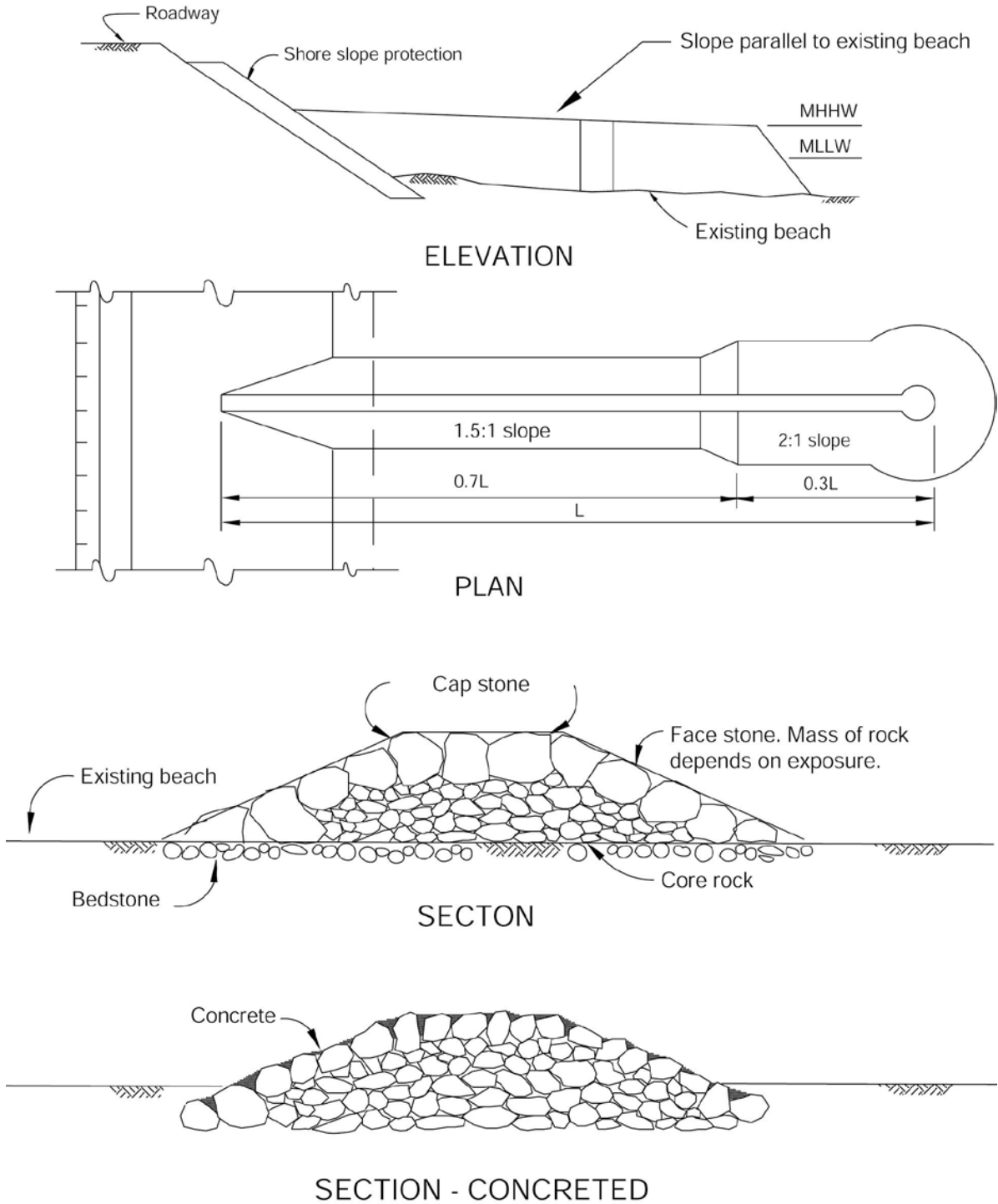

Figure 883.2L

Typical Stone Dike Groin Details



NOTES:

- (1) This is not a standard design.
- (2) Dimensions and details should be modified as required.

CHAPTER 890 – STORM WATER MANAGEMENT

Topic 891 – General

Index 891.1 – Introduction

The term “storm water management” refers to the cooperative efforts of public agencies and the private sector to mitigate, abate, or reverse the adverse results, both in water quantity and water quality, associated with the altered runoff phenomena that typically accompanies urbanization. Storm water management encompasses a number of control measures, which may be either structural or non-structural (including policy and procedural measures) in nature.

This chapter will focus primarily on the management of storm water runoff quantity. Information related to the designer’s responsibility for the management of storm water runoff quality is contained in the Department’s Project Planning and Design Guide.

891.2 Philosophy

When runoff impacts result from a Department project, then the cost of mitigating these impacts is a legitimate part of the project cost. Since transportation funds are increasingly limited, and because mitigation of runoff problems can be expensive, it is important to identify the causative factors and responsible parties. When runoff impacts are caused by others, avenues for assigning these costs to the responsible party should be evaluated. The local agencies responsible for land use in the area are a good place to begin this evaluation, as many of these local agencies have enacted land use regulations in an effort to control flooding. These regulations often require that developers limit changes in the volume and rate of discharge between the pre- and post-development site conditions. In addition, many local agencies must be responsive to their own storm water permits which require that they implement programs to control the quality of storm water discharges within their jurisdiction. When runoff impacts are caused jointly by the Department and others, it may be possible to develop cooperative agreements allowing joint impact mitigation. See Indexes 803.2 and 803.3 for further discussion on cooperative agreements and up-grading of existing highway drainage facilities.

Topic 892 – Storm Water Management Strategies

892.1 General

Quantity / Quality Relationship. Management of storm water quality often requires the assessment of relatively small runoff producing events. As much as 80 percent of average

July 1, 2020

annual rainfall is produced by storms with return periods of less than 2 years. As a result, water quality facilities are typically sized to address relatively small runoff volumes. Conversely, storm water quantity management is typically directed at reducing the peak flow rate on storms with a 10-year or greater return period, and water quantity control facilities must be sized accordingly.

In order to achieve both water quantity and quality benefits, it may be necessary to use a combination of strategies or control measures. For example, placement of a relatively small detention basin or filtration immediately upstream of a quantity attenuating detention basin can provide sediment capture, while allowing larger flows to be mitigated by the major basin. Some types of water quality control measures will need to incorporate bypass features so that the smaller, more frequent, runoff events can be treated while still allowing larger flows to be routed away from the traveled way.

892.2 Types of Strategies

There are various storm water management strategies which may be used to mitigate the effects of storm water runoff problems. They vary from very simple to very complex techniques depending upon specific site conditions and regulatory requirements which must be satisfied.

The Department Storm Water Quality Handbook, "Planning and Design Staff Guide" provides both design guidance on specific water quality control measures as well as a more general discussion of how and when to incorporate water quality control measures into projects.

In addition to the measures described in the Storm Water Quality Handbook, the following measures may provide relief in dealing with the water quantity side of storm water management.

- (1) *Detention & Retention Basins.* The detention and retention basin designs provided in the Storm Water Quality Handbook are based upon water quality control, not quantity control. Refer to the Department training course manual "Storm Water Management Design" for information related to design considerations for peak flood reduction through the use of detention and retention basins. Also, refer to HEC No.22, Chapter 8.
- (2) *Groundwater Recharge.* In some locations highly permeable underground strata may allow percolation of excess runoff into the ground. Benefits include recharge of underground aquifers and the possible reduction or elimination of conveyance systems along with pollutant removal. Special care must be exercised in areas of high groundwater to avoid potential contamination of the aquifer.
- (3) *Drainage Easements.* In areas where right of way is inexpensive it may be possible to purchase flood easements. These areas are typically used for agriculture and are subject to flooding at any time during specified times of the year. Cooperative agreements with local agencies or flood control districts will typically be necessary.

892.3 Design Considerations

The items presented below describe some of the issues to be considered prior to, and during, the design of any storm water management facility. General issues common to most storm water management strategies that need to be evaluated are:

- Access for maintenance must be provided, and the facility must be maintainable. Storm water control facilities must not become regarded as wetlands themselves, which would require special permits for routine maintenance.
- Facilities should be designed to “blend in” with their surroundings to the greatest extent possible. The district landscape architecture unit should be contacted for assistance.
- The effects of the proposed facility on channel capacities and existing floodways require evaluation. Care must be taken to evaluate the effects related to the delayed release from detention facilities since an increase in downstream peak discharges may result (see Figure 892.3).
- The effects of releasing sediment free “hungry” water into channels and the potential for increased erosion rates downstream must be determined.
- Evaluate the effects of depriving downstream water users (human, aquatic or vegetative) of runoff due to retention, percolation or other diversion.

Storm water management techniques involving on-site and off-site storage may offer the highway design engineer the more reasonable and responsive solution to problems relative to the handling of excess runoff. The cooperation of other jurisdictions is generally a prerequisite to applying these strategies and a cooperative agreement is almost always necessary. See Chapter 12 of the AASHTO Model Drainage Manual for additional design criteria for storage facilities.

892.4 Mixing with Other Waste Streams

Storm water runoff from State highways will usually be carried to a receiving body of water without being combined with waste water. Although some combined storm and sanitary sewers do exist, their use should be avoided.

The most common areas of waste stream mixing have been at maintenance stations. These facilities may have combined storm water and wash rack systems. Because of wash water and rinse water, maintenance stations present unique water quality problems from concentrated levels of pollutant loadings. The preferable design has a separate system for the wash rack so that it is not mixed with storm water and rinse water. For additional advice on treatment of concentrated waste streams at maintenance stations, contact the Water/Waste Water Unit in the Division of Engineering Services – Structures Design.

July 1, 2020

Figure 892.3

Example of Cumulative Hydrograph With and Without Detention

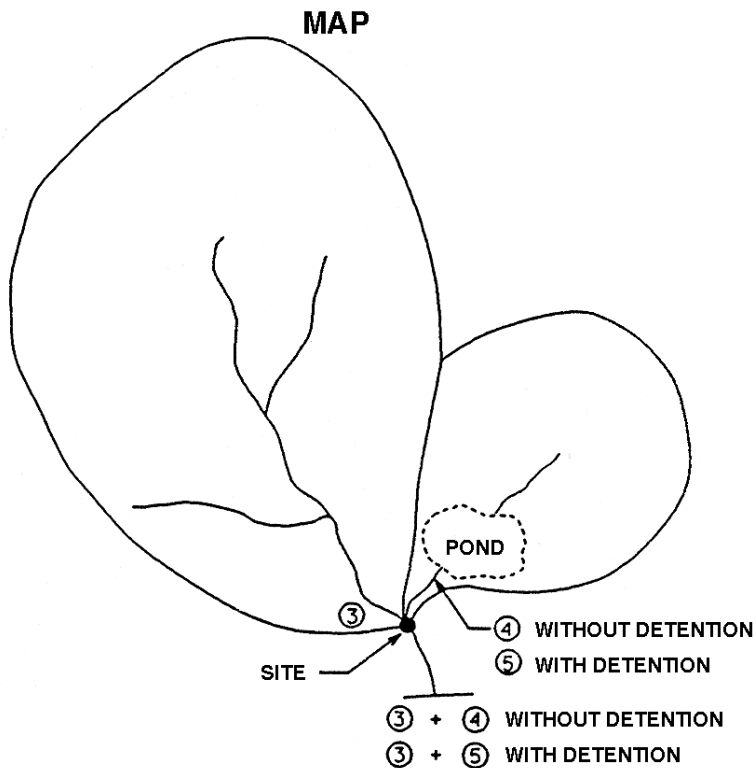
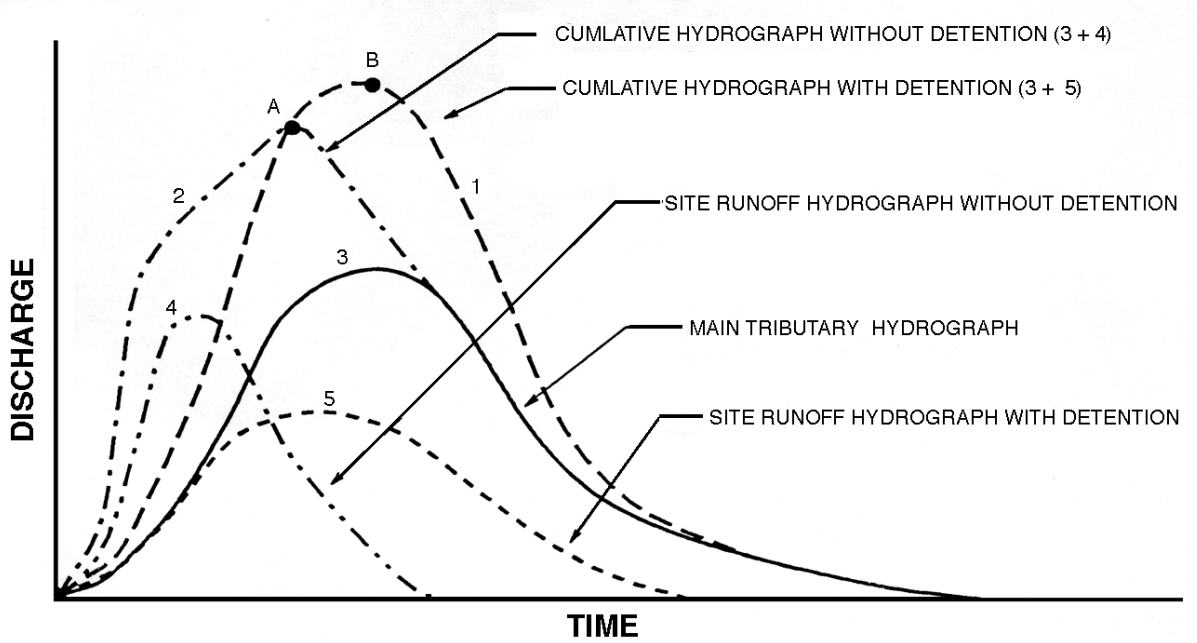

Topic 893 – Maintenance Requirements for Storm Water Management Features

893.1 General

As mentioned previously, the ability and the commitment to maintain storm water management facilities is necessary for their proper operation. The designer must consider the maintenance needs, and the type of maintenance that will take place, in order to provide for adequate access to and within the facility site.

Additionally, the designer should initiate both verbal and written contact with District maintenance to verify the availability of resources to provide proper maintenance and to keep them aware of potential high maintenance items that will be constructed. Initial estimates of how often sediment removal should be performed should be provided by the designer based upon estimated design loadings. Other types of maintenance, such as periodic inspections of embankments, inlet/outlet structures, debris removal, etc. should also be discussed. Due to the large capital investment required for constructing storm water management facilities, proper maintenance cannot be overlooked.

By definition, detained water contributes to runoff and therefore detention ponds or basins must have an outlet and outfall system (see Index 816.4). A gravity outfall should be used whenever feasible. Pumping should only be used where there is no other practical way of handling the excess runoff. See Topic 839 for further discussion on pumping stations.

CHAPTER 900 – LANDSCAPE ARCHITECTURE – ROADSIDES

Topic 901 – Landscape Architecture General

Index 901.1 – Landscape Architecture Program

The Landscape Architecture Program is responsible for the development of policies, programs, procedures, standards, and guidance for all aspects of the California Highway System Roadside Program including planting, irrigation, permanent erosion control, mainstreet livability, structure aesthetics, roadside safety features, and landform grading.

The Landscape Architecture Program also serves as the coordinator for Safety Roadside Rest Areas, Vista Points, Scenic Highways, Classified Landscaped Freeways, Blue Star Memorial Highways and Landscape Administration Facilities such as Transportation Art, Gateway Monuments, and Community Identification.

Guidance in the Chapter 900 series is the responsibility of the Landscape Architecture Program and represents minimum standards.

901.2 Landscape Architecture Design Standards

Design roadsides to maximize sustainability and livability benefits through context-sensitive design solutions. Sustainable design solutions are those that consider balanced and long-term benefits to social, economic, and ecological well-being.

Sustainable landscape architecture designs:

- improve safety for workers and travelers
- improve the quality of the public realm
- conserve water and natural resources
- sequester carbon and improve ecosystem resiliency
- address fire safety
- preserve or improve visual quality and aesthetics
- reduce unnecessary maintenance activities
- employ cost-effective solutions
- consider life-cycle costs and benefits.

Attention should be given to the following considerations:

- (1) *Worker Safety.* Design roadsides for the safety of highway workers and the public by considering the following:
 - Site new roadside features outside of the clear recovery zone and away from gore areas and driver decision points.

July 1, 2020

- Provide access for workers including maintenance vehicle pullouts, maintenance access roads and gates.
- Design solutions that facilitate the use of mechanical equipment to reduce worker activities on foot including the use of new technology.
- Select design solutions that eliminate maintenance activities.
- Relocate existing roadside elements to accessible areas outside the clear recovery zone or to protected locations.

Incorporate the above design considerations when designing roadsides. For example, provide access gates from local streets and frontage roads for maintenance personnel; coordinate with District Maintenance managers for preferred access points. Provide paved maintenance vehicle pullout areas away from traffic on high-volume highways where access cannot be made from local streets and roads. Consider providing maintenance access roads to the center of loop areas or other open, flat areas. Pave narrow areas and areas beyond freeway gore entrances and exits to reduce the need for maintenance. See Index 504.2(2) for contrasting surface treatment guidance.

- (2) *Maintainability*. Field observations with maintenance personnel should be performed during project development, Pre-PID through PS&E. Ongoing communication between designers, landscape specialists, landscape maintenance personnel, and construction inspectors will ensure that maintenance concerns are addressed.

Design roadsides to minimize routine and ongoing roadside maintenance and to accommodate:

- graffiti control and removal.
- homeless encampment removal.
- mowing and weeding.
- litter, debris, and/or dead vegetation removal.
- exotic or "volunteer" vegetation control.
- pesticide and/or fertilizer application.
- pruning or removal of vegetation.
- irrigation and waterline break repair.
- irrigation scheduling for water budgeting.
- replacement of plants and repairs to inert materials.
- maintenance requirements of permanent stormwater pollution prevention treatment BMPs.

- (3) *Livability*. Livability describes the degree to which the built environment improves human quality of life. Designs that improve livability are those that consider how the public realm and roadside can support travel and local community goals. Livable transportation systems connect people to opportunity and promote public health and safety, ecological quality, economic development, community vitality, social equity and interaction, multimodal travel, sense of place, and human health.

Create a state highway public realm through designs that improve community visual quality, provide inviting public spaces, and encourage active transportation. Encourage and support Landscape Architecture Administered Facilities such as Transportation Art, Gateway

Monuments, and Community Identification to enhance livability. Livable roadside facilities often include:

- connectivity of active transportation and complete streets facilities.
 - site furnishings such as benches, bicycle racks, and trash and recycling receptacles.
 - Street trees and other vegetation that provide shade and a separation for vehicles and pedestrians
- (4) *Visual Quality and Aesthetics.* Design roadsides to integrate the facility with the adjacent community or natural surroundings. Buffer objectionable views of the highway facility from adjacent homes, schools, and parks. Soften visual impacts of large structures and graded slopes. Screen objectionable or distracting views. Frame or enhance good views. Provide visually attractive roadsides, entrances to communities, and mainstreets.
- (5) *Ecological Function.* Design roadsides to incorporate native and climate appropriate vegetation, with attention to supporting pollinators, and facilitating stormwater infiltration on-site. Improve soil with compost to build healthy soils, sequester carbon and mitigate greenhouse gas emissions.
- (6) *Water and Resource Conservation.* Roadsides must comply with State water conservation requirements including the Model Water Efficient Landscape Ordinance (MWELO). Comply with local water ordinances. In addition, design landscapes to conserve water by designing efficient irrigation systems and appropriate planting designs that:
- use non-potable or recycled water.
 - use soil amendments to build healthy soils and increase water holding capacity.
 - use drought tolerant, climate appropriate plants.
 - use large groupings of spreading plants.
 - use topical mulches to reduce evapotranspiration.
 - use automated "smart" irrigation controllers.
 - use moisture, wind, and rain sensors.
 - use point source irrigation and tree well assemblies.
 - minimize use of overhead irrigation.
- (7) *Fire Safety.* Consider the risk of fire when designing landscape architecture projects. Consider the following in high fire risk areas:
- Create fire-resistant zones and defensible spaces to minimize the spread of wildfire
 - Remove dead and dying vegetation
 - Minimize or eliminate vegetative fire ladders
 - Select plants with low sap or resin content and high moisture content
 - Select plants with prostrate growth and minimal fuel volume
 - Select nonflammable or low fuel inert materials for ground surface cover
- (8) *Cost-effectiveness.* The design should maximize short and long-term benefits for the costs involved by:
- Optimizing scheduling, performance, constructability, maintainability, and material life cycle costs.

July 1, 2020

- Specify commercial/industrial quality materials and methods to improve cost-effectiveness.
- Utilize long-lived plant species.

901.3 Landscape Architecture Administered Facilities

Landscape Architecture administers local projects related to Transportation Art, Gateway Monuments, Community Identification, and Blue Star Memorial Highways. These projects are typically installed through an encroachment permit project.

When a project will impact an existing Landscape Architecture Administration Facility, coordinate with the local agency charged with maintaining the facility to move it if the facility cannot be preserved and protected. Refer to the LAP website and the PDPM for additional information.

Topic 902 – Sight Distance and Clear Recovery Zone Standards

902.1 Landscape Sight Distance and Clear Recovery Zone Standards

Three considerations affect the placement of new landscape features:

- (1) *Sight Distance*. To keep the continuous length of highway ahead visible to the driver. Sight distances for safety surpass aesthetic considerations. Applicable minimum sight distance standards are set forth in Topic 201 – Sight Distance, and Topic 405 – Intersection Design Standards.
- (2) *Clear Recovery Zone (CRZ)*. To keep the CRZ free of discretionary fixed objects. Refer to Index 309.1(2).
- (3) *Maintenance Access*. To provide worker access without the need for lane or shoulder closure to perform routine maintenance.

Topic 903 – Landscape Site Design

Landscape site design for roadsides involves landform grading and the placement of landscape elements, such as boulders, or other site furnishings for aesthetic or functional purposes.

903.1 Landscape Site Analysis

Landscape site analysis is the study of the site's ability to address Department, corridor, and project goals. Landscape site analysis identifies opportunities and constraints on the site that may have physical, social, fiscal or environmental impacts. Landscape site analysis helps evaluate competing needs and to determine which design decisions will bring the greatest return of investment. Emphasis should be given to design solutions which provide benefits in multiple areas, within a reasonable project schedule and life cycle cost.

Areas typically evaluated include:

- built features, such as existing infrastructure and adjacent land uses
- natural features, such as land form, slopes, soil type, erosion
- community characteristics that may influence design decisions, such as the presence of underserved communities, scenic highways, or other aspects
- travel conditions, such as multimodal access to connections and opportunities to include complete streets features
- existing visual quality and aesthetic conditions
- opportunities to improve livability on mainstreets

903.2 Landscape Site Layout

Landscape site design involves the layout of landscape architectural areas such as planting/irrigation areas, erosion control areas, inert landscape groundcovers and main street elements such as, pedestrian pathways, bicycle paths, tree grates, ornamental pedestrian paving, bus shelters, bollards, benches, tables, trash/recycling receptacles, and bicycle racks.

Landscape site design should start with site analysis that evaluates the optimum location for landscape areas. Consider natural drainage, natural landform, existing vegetation, slope, pedestrian and bicycle circulation patterns (existing and planned), microclimate and any other element that may affect the landscape site layout.

Layout landscape architectural elements to optimize existing site conditions and respond to site constraints.

903.3 Roadside Amenities

Inert landscape features or facilities, that are not necessary for the safety, maintenance, or operation of the highway may be considered discretionary fixed objects. See Index 309.1 for more information. Examples of these objects include but are not limited to boulders placed for decorative purposes, gateway monuments, and transportation art.

903.4 Additional Roadside Site Design Considerations

Consider site features and elements that minimize impacts to natural resources.

- (1) *Low Impact Development.* Consider including low impact development features. Low Impact Development mimics natural processes to capture and infiltrate stormwater runoff.
- (2) *Landscape Grading.* Integrate highway improvements into the existing environment using contour grading to preserve existing natural topographic features and plant material. Refer to Index 304.4 and 304.5.

Topic 904 – Planting Design

904.1 Planting Design General

Planting provides vegetation for aesthetic, environmental, mitigation, stormwater pollution prevention, and erosion control purposes. Successful planting requires soil that will provide an

July 1, 2020

appropriate growing medium. Protection of existing vegetation, selection and location of the appropriate plant material, and an appropriate plant establishment period must be considered.

Planting contributes to climate resiliency with:

- carbon sequestration
- air quality benefits
- reduced fire risk
- heat island reduction
- habitat restoration
- revegetation
- stormwater treatment
- mitigation
- windbreak protection

Planting provides improvements to visual quality by:

- Integrating the highway into the local community
- graffiti reduction
- screening
- aesthetics

Ensure work within any existing Classified Landscape Freeway maintains the status of the Landscaped Freeway. Refer to the Business and Professions Code Sections 5216 and 5440.

In areas subject to illegal activities, provide open visibility to the roadside. In many areas, this may mean limiting landscape to planting trees and groundcover only.

Review the entire planting design with the District Coordinator, District Landscape Specialist, and Maintenance Landscape Supervisor.

904.2 Site Preparation

(1) *Preserve Existing Vegetation.* Preserving existing vegetation minimizes the disturbance of existing vegetation and soil. Preserving existing site vegetation is more effective at erosion control than removing and planting new vegetation. Where possible, minimize disturbed areas within areas impacted by construction. Consider temporary exclusionary fencing during construction to demarcate and retain significant existing vegetation.

(2) *Soil Health.* Healthy topsoil is needed to ensure successful vegetation establishment. The preservation of existing topsoil or amending poor topsoil is necessary to provide favorable growing conditions. Agronomic soil tests may be necessary to verify soil texture, pH, percent organic content, electrical conductivity, sodium content, the availability of Nitrogen, Phosphorus and Potassium, and other local soil deficiencies.

(a) *Preserve Existing Topsoil and Duff.* The best approach to soil health is to preserve the existing topsoil and duff.

Excavate existing soil and store, on-site during construction, and then replace it at select locations prior to seeding or planting. Care must be taken to ensure that topsoil stockpiles are protected and kept in an aerobic and de-compacted state. Stockpiles in

shallow windrows planted with temporary hydroseed will preserve the native seed bank and beneficial microorganisms. Consider the use of exclusionary fencing and signage to identify topsoil stockpiles.

Duff is partly decayed organic matter such as leaves, bark, pine needles, and twigs which have fallen to the ground. Duff is removed along with existing plants and shrubs from an identified area during clearing and grubbing or roadside clearing operations. Duff is then chipped or ground, stockpiled, and reapplied after completion of final grading. Duff may be reapplied within one year of stockpiling. Consider using duff in natural areas where existing organic material is plentiful and preferred for revegetation success.

Mix preserved existing topsoil and duff to maximize natural and organic matter in the soil.

Coordinate with the Design Project Engineer, Environmental, Right of Way, and Construction for acceptable stockpile locations.

- (b) Amending Soil. Soil amendments are necessary to improve water holding capacity, soil nutrient availability, microbial activity, and texture.
- *Compost*. Compost is manufactured through the controlled aerobic biological decomposition of biodegradable materials. Compost is used to improve soil health by increasing organic content, water holding capacity, and adding nutrients. When feasible, use compost in lieu of fertilizer.
 - *Organic Mulch*. Typically, mulch is comprised of tree bark, wood chips, pine needles, shredded bark, or a combination of these.
- (c) Imported Topsoil. When there is insufficient topsoil, preserving topsoil is infeasible, or the existing topsoil is not able to support vegetation establishment, imported topsoil may be considered. Imported topsoil is obtained from outside the project limits.
- (d) Soil Texture Rehabilitation. Improve soil texture when compaction restricts air or water movement and inhibits vegetation growth.
- *Cultivation*. Soil can be cultivated or ripped to de-compact the soil.
 - *Incorporate Materials*. Incorporate materials is the process of tilling topsoil with amendments. It improves soil health by providing nutrients and biotic activity for vegetation growth and establishment. Use incorporate materials to increase infiltration or when existing soils are compacted or low in nutrients.

904.3 Plant Selection

Plants should be well suited to local environmental conditions such as sun exposure, aspect, climate, annual precipitation, temperature extremes, wind, soil type, and recycled water quality.

Plants should be selected for their anticipated ability to adapt to changing climatic conditions such as extreme temperature, wind or other weather events.

Select plants with a growth rate, longevity, size, and appearance appropriate for their intended use. Select plants that minimize ongoing maintenance requirements.

Select drought tolerant plants that will survive if supplemental water is discontinued. To minimize the risk of pest and disease infestation, select a diverse mix of plant species. Consider using no more than 33 percent of one species.

Whenever possible, select native plant species. Include species with a wide range of bloom times to enhance pollinator habitat.

July 1, 2020

Consider carbon sequestration rates of species selected.

In fire prone areas select plants that will minimize fire risks. Refer to local fuel modification plans for recommended plants for the specific area.

When selecting plants also consider species availability.

Landscaping projects with federal funding shall include California native wildflowers and grasses in the planting design. Refer to Chapter 29 of the Project Development Procedures Manual for wildflower requirements.

To ensure maintainability of plant selections, consult with your District Landscape Specialist, and Maintenance Landscape Supervisor.

(1) *Tree Selection.* When proposing large trees, the mature size, form, and growth characteristics of the species should be considered. Select tree species that will not require regular pruning at maturity to maintain clearances. Review species selections with the District Landscape Specialist and Tree Crew Supervisor.

(2) *Other Considerations.* Consider avoiding:

- short lived plant species.
- restricted plants listed as noxious or invasive on the Federal or California Noxious Weed List managed by the U.S. Department of Agriculture (USDA) or the California Invasive Plant Inventory Database managed by the California Department of Fish and Wildlife (CDFW).
- restricted plants by the State or local County Agriculture agencies for agricultural purposes.
- plants with edible or attractive fruits, berries or nuts.
- plants with thorns or stiff branches that may capture litter.
- plants that are known to be poisonous to humans and animals.
- trees that may be brittle, susceptible to disease, or that increase in size by suckering.

904.4 Locating Plants

Locate plants as appropriate for the adjacent existing or planned environment. Arrange plants to be visually and culturally compatible with local indigenous plant communities.

Place plants according to the perspective of the viewer and their traveling speed. For example, compositions viewed by freeway motorists should be simplified and large scale. Compositions primarily viewed by pedestrians may be designed with greater detail.

Plants with similar water requirements are to be grouped together to conserve water.

Wherever feasible, trees should be used to create the main structure of the planting composition.

Median planting should not be installed on freeways. See Index 305.1(2) for median guidance on conventional highways.

Planting must not interfere with the function of safety devices (e.g., barriers, guardrail), traffic control devices (e.g., signals and signs), shoulders, utilities and facilities.

In areas subject to frost and snow, plantings should not be located where they will cast shade and create patches of ice on vehicle and pedestrian thoroughfares.

Without exception, locate plants to maintain visibility to legal off-premise and on-premise outdoor advertising displays. Typical visibility viewsheds are as shown in the Encroachment Permits Manual 509.4.

- (1) *Maintenance Considerations.* Consider the safety of maintenance workers and the traveling public when locating plants. Evaluate the mature size, form, and characteristics of the species, and long-term maintenance requirements.

Locate plants so that pruning will not be required.

Groundcover should be located so it will not extend onto shoulder backing, into drainage channels, or through fencing.

Minimize worker exposure to traffic and reduce the need for shoulder or lane closures. Locate vegetation away from shoulder, gore, and narrow island areas between ramps and the traveled way to reduce the need for shoulder or lane closures to perform pruning or other maintenance operations.

Refer to the Maintenance Manual and Roadside Vegetation Management Handbook for additional considerations.

904.5 Locating Trees

Trees must be located to not visually restrict existing roadside signs and signals.

Locate trees to maintain a minimum vertical clearance of 17 feet from the pavement to the lower foliage of overhanging branches over the traveled way and shoulder. Locate trees to maintain a minimum vertical clearance of 8 feet from sidewalks or walkways to the lower foliage of overhanging branches for pedestrian passage.

For sidewalks and pedestrian plazas, design tree wells with a minimum of 2 feet from the tree trunk to the edge of the tree well to protect pavement from tree root displacement. Include root barriers to protect the pavement surrounding the tree well. Allow for an appropriate soil volume when designing tree wells.

Without exception, do not plant large trees over gas lines or under overhead utilities and/or structures. Coordinate with local utility provider or District Utility Engineering for guidance.

- (1) *Large Trees.* Large trees are defined as plants which at maturity have trunks 4 inches or greater in diameter, measured 4 feet above the ground. Examples of large tree species are Coast Redwood (*Sequoia sempervirens*), Coast Live Oak (*Quercus agrifolia*), and Deodar Cedar (*Cedrus deodara*).
- (2) *Small trees.* Small trees are defined as smaller trees or plants usually considered shrubs but trained in tree form that will develop up to a 4-inch diameter trunk at maturity. Examples of small trees are Crape Myrtle (*Lagerstroemia indica*), and Bottlebrush (*Callistemon sp.*) trained in standard form.
- (3) *Clear Recovery Zone (CRZ).* Locate trees to be outside the CRZ. The CRZ provides an area for errant vehicles the opportunity to regain control. Refer to Index 309.1(2) for additional information and requirements of the CRZ.

Setbacks are measured from the edge of traveled way to the face of tree trunk. Situate trees to accommodate the anticipated mature tree size.

December 31, 2020

- (a) Freeways and Expressways. On freeways and expressways, including interchange areas, there should be 40 feet or more of clearance between the edge of traveled way and large trees; but, a minimum clearance of 30 feet must be provided where trees may become a fixed object to errant vehicles. However, large trees may be planted within the 30-foot limit if they cannot be reached by an errant vehicle. For example, on cut slopes above a retaining wall, in areas shielded behind concrete barriers, metal beam guardrail, thrie beam, etc. which has been placed for reasons other than tree planting. Additionally, exceptions to the 30-foot setback may also be considered on cut slopes which are 2:1 or steeper. The minimum tree setback in these cases should be 25 feet from the edge of traveled way.

Special considerations should be given to providing additional clearance in potential recovery areas. Setback distances greater than 30 feet should be provided at locations such as on the outside of horizontal curves and near ramp gores.

Large trees should not be planted in unprotected areas of freeway medians or expressway medians except for separated roadways with medians of sufficient width to meet the plant setback requirements for tree planting.

Where freeway or expressway right of way intersects a conventional highway or local facility, follow conventional highway requirements for large tree placement.

- (b) Conventional Highways. When locating large trees on conventional highways comply with the requirements in Table 904.5.

904.6 Locating Plants in Conformance with Sight Distances

Sight distance requirements restrict the height of plants or the horizontal distance of plants from the traveled way. Low growing plants may be planted if the requirements for sight distance are met as discussed in Topic 201 – Sight Distance. Refer to Index 405.1(2) for corner sight distance requirements at intersections and driveways. Locate plants to maintain sight distance.

Sight distance limits are measured from the edge of traveled way to the outside edge of the mature growth. Locate plants to meet sight distance requirements when the plant reaches mature size. Preserve views of pedestrians and bicyclists at intersections and other conflict points.

Proposed mature planting should maintain sight distance required by the design speed of the facility, including planting along geometric curvature for horizontal sight distance. In cases where, due to geometric restrictions, the existing freeway facility does not provide optimum sight distance, no further reduction should be caused by planting.

When locating plantings at interchanges, provide ramp and collector-distributor road sight distance equal to or greater than that required by the design speed criteria. At points within an interchange area where ramp connections or channelization are provided, keep plantings clear of the shoulders and sight line shown in Figure 504.31, Location of Ramp Intersections on the Crossroads.

Ensure clear recovery and sight distances are retained for vehicles, bicycles and pedestrians on the inside of curves in interchange loops, in median areas, on the ends of ramps, and on cut slopes. Generally, in interchange areas, a 50-foot horizontal clearance from the edge of traveled way, within the loops, is considered the sight distance plant setback for plants that grow above a 2-foot height.

Table 904.5

Large Tree Setback Requirements on Conventional Highways

ROADSIDE ⁽²⁾		
Condition	Posted Speed (mph)	
	≤ 35	≥ 40
With curb	18" min. from curb face, without exception	<u>30' min. from ETW</u> , and 18" min. from curb face, without exception
With barrier	<u>Min. deflection distance from barrier face (barrier type specific)</u> , and 18" min. from face of barrier, without exception	
Without curb or barrier	<u>30' min. from ETW</u>	
MEDIAN ^{(1), (2)}		
Condition	Posted Speed (mph)	
	≤ 35	≥ 40
With curb	<u>5' min. from curb face</u> , and 18" min. from curb face, without exception	<u>30' min. from ETW</u> , and 18" min. from curb face, without exception
With barrier	<u>Min. deflection distance from barrier face (barrier type specific)</u> , and 18" min. from face of barrier, without exception	
Without curb or barrier	30' min. from ETW, without exception	

Notes:

⁽¹⁾Trees in the median should be located at least 20 feet from manholes.

⁽²⁾Place trees in accordance with sight distance criteria.

July 1, 2020

904.7 Vine Planting

(1) *Vine Planting on Barriers.* Vine planting should be considered with all noise barriers to reduce the potential for graffiti and to soften the appearance of the barrier. If retaining walls or noise barriers are located within the clear recovery zone (see Index 309.1(2)), plants may be placed behind the walls and be allowed to grow over (or through) the barrier, plants placed in front of a noise barrier must be behind a safety shaped barrier. Plants are not permitted on concrete safety shaped barriers unless an exception is granted from the Division of Traffic Operations and all the following requirements are met:

- Only vines which have a natural tendency to cling to noise barriers or retaining walls may be planted on barriers. Support structures on barriers are prohibited. Vine species selected must readily adhere to the barriers. Do not select vines with a habit of peeling off hard surfaces at maturity.
- Each plant should be individually irrigated.
- Plants should not encroach onto the shoulder or create sight distance problems.

Consult with the District Landscape Specialist and Maintenance Landscape Supervisor when considering planting vines on barriers. See Index 1102.7 for maintenance considerations in noise barrier design.

(2) *Planting of Vines on Bridge Structures.* Vines should not be planted where they might grow over any portion of the bridge structure. When the regular inspection of bridge structures is required and where rapid visual inspection of these structures is required in areas of high seismic activity, the planting of vines on bridge structures or columns is prohibited, without exception. There are certain conditions such as low average daily traffic, high redundancy in the substructure, etc. where exceptions from Structure Maintenance may be granted to plant vines.

904.8 Planting in the Vicinity of Airports and Heliports

All plants selected must comply with the height restriction standards contained in Topic 207 – Airway-Highway Clearances. Mature plant height must be used to determine if there is an obstruction to navigable airspace.

904.9 Plant Establishment

Plant Establishment is the period of time necessary that allows newly installed plant material to reach a state of maturity and ensures the operability of the irrigation system, to minimize future maintenance. The plant establishment period typically includes the following:

- replacement of dead or damaged plant material
- weed, rodent, and pest control
- litter removal
- irrigation operation and repair
- activities required to ensure the long-term survival of plant material

Depending on the type of project, there may be different requirements for plant establishment.

For Highway Planting within the right-of-way of all federally funded highways, plant establishment periods must be of a sufficient duration for establishment within the highway

environment. This period is used for identification and resolution of problems, and to minimize long-term maintenance requirements.

When planting is installed as a separate contract provide a three-year plant establishment period. When planting is installed as part of a highway construction project provide a one-year plant establishment period.

Projects with less than 5,000 square feet of planting or irrigation should have a plant establishment period of at least six months.

Mitigation planting may require longer plant establishment periods. Refer to specific permit requirements.

Topic 905 – Irrigation Design

905.1 Irrigation Design General

Irrigation systems should be designed to conserve water, minimize maintenance, minimize worker exposure to traffic, and sustain the planting. The design should be simple and efficient.

Irrigation systems that use recycled, non-potable, or untreated water must comply with State and local regulations.

Permanent irrigation systems are to be designed for automatic operation.

Review the entire irrigation design with the District Water Manager, District Landscape Specialist, and Maintenance Landscape Supervisor.

905.2 Water Supply

Use recycled or non-potable water for permanent irrigation systems. Designers should be familiar with the provisions of the California Streets and Highways Code, Section 92.3.

When the irrigation system is being installed as part of a separate contract install the water supply connection with the parent highway construction project.

Temporary irrigation systems may use potable water.

Coordinate water connections with the local water purveyor, follow water purveyor requirements for MWELo requirements, water meters, and cross contamination requirements.

905.3 Irrigation Conduit

Irrigation conduits should be provided on highway construction projects under new roadways and ramps, and on new bridge structures when future irrigated planting is anticipated. Extend existing conduits, as needed, on highway construction projects when widening or modifying roadways and ramps or modifying bridge structures.

Irrigation conduit consists of a conduit with a water supply line and sprinkler control conduit with a pull tape.

Coordinate with the District Landscape Architect to determine irrigation conduit needs, sizes, and locations.

December 31, 2020

(1) *Conventional Highways, Freeways, and Expressways.* Consider the following when sizing and locating irrigation conduits under roadways or ramps:

- Irrigation conduit consists of a minimum size of 8-inch diameter conduit, with a 3-inch water supply line and a 2-inch diameter sprinkler control conduit with pull tape. Consider sizing conduits and water supply lines larger when using nonpotable water.
- Irrigation conduits are typically spaced 1,000 feet apart on freeways. Consider using undercrossings for alternative crossing opportunities.
- Keep drainage facilities and irrigation conduit separate.

(2) *Bridge Structures.* Coordinate with Structures for location and placement of irrigation conduit in new bridge structures.

Consider the following when designing irrigation conduits for bridge structures:

- Generally, locate the irrigation conduit on the side of the bridge closest to the water source.
- Consider the maximum water demand and number of irrigation controller stations. The water supply line should be a minimum 3-inch diameter and conduit for the sprinkler control conduit should be a minimum 2-inch diameter and contain a pull wire.
- Ductile iron pipe is required for potable water supply line for pipes 4-inch diameter or larger because of its superior strength and flexible joints.

905.4 Irrigation System Equipment

Use standard, commercially available irrigation components. Nonstandard features may be used to address unique site conditions.

Select “smart” irrigation equipment and controllers to minimize worker exposure and conserve water.

Consider security measures, such as locking cabinets, enclosures and valve boxes.

When selecting irrigation components, consider water quality, such as sediment, salinity, and increased particulate content often found in recycled, and non-potable water sources. Include an appropriate filtration system when the recycled water quality contains undesirable suspended particles.

Place irrigation components that require regular maintenance as far from traffic as possible, outside the clear recovery zone, or behind safety devices. Place irrigation components in areas easily accessible by maintenance forces.

Consider potential damage from pedestrians or vehicles when locating irrigation equipment. Minimize exposure to traffic and reduce the need for shoulder or lane closures, irrigation equipment must be located far away from shoulder areas, gore areas, driver decision points, and narrow island areas between ramps and the traveled way.

Review the proposed location of backflow preventers and irrigation controllers in the field with the District Maintenance Supervisor and the District Water Manager.

(1) *Backflow Preventer Assembly.* The use of a reduced pressure principle backflow device is required for permanent irrigation systems using potable water. Include an enclosure with backflow preventer assemblies.

Use master remote control valves directly downstream of the backflow preventer assembly.

- (2) *Booster Pump System.* When water pressure is insufficient, a Variable Frequency Drive (VFD) booster pump may be required in the irrigation design. Determine booster pump specifications by conducting calculations to determine the horsepower and electrical power input requirements. Coordinate with Division of Engineering Services Office of Electrical, Mechanical, Water and Wastewater Engineering. If necessary, consult with an irrigation pump manufacturer for assistance.

Coordinate with the District Electrical Design and Maintenance field personnel to coordinate power supply specifications and location.

- (3) *Irrigation Controller.* Use the district specific “smart” irrigation controller that automatically adjusts water application rates based upon weather conditions. Include a vandal resistant cabinet. Coordinate with the District Maintenance Water Manager for irrigation controller information.

Locate irrigation controllers where they are easily accessible, protected from vehicular traffic, and in an area away from shoulders. Locate the irrigation controller cabinet so maintenance personnel will be able to see oncoming traffic in the nearest traffic lane when accessing the controller. Locate controllers away from dense shrubbery, in an area with good lighting, and out of the spray from sprinklers.

- (4) *Sprinklers.* Select sprinklers appropriate for local wind and soil conditions. Include swing joints with sprinklers. Consider check valves, flow shutoff devices and other water conservation measures when selecting sprinklers. Install sprinklers on fixed risers only in areas away from the roadway.

Overhead irrigation systems should be limited to irrigating low shrub masses, ground cover or establishing native grasses.

Individually water trees and shrubs spaced farther apart than 10 feet on center. Trees in overhead irrigated ground cover areas should receive basin water with a separate irrigation valve using tree well assemblies.

When possible, locate sprinkler heads outside the clear recovery zone. Design irrigation to spray towards the roadway, but not on the pavement. Protect sprinklers by locating them away from areas where damage from vehicles, bicyclists, or pedestrians may take place.

- (5) *Flow Sensor.* Select a flow sensor that can be used in conjunction with the irrigation controller and has capability to monitor low flow, excess flow, and communicate learned flow to the irrigation controller.

- (6) *Valves.* Select industrial grade plastic valves to deter theft.

Remote control valves, including master valves should be normally closed to minimize water loss if a break occurs.

Cluster remote control valves and consolidate manifolds whenever possible. Install a ball valve or gate valve up stream of the manifold.

Locate valves adjacent to access paths or in locations accessible from outside the right of way via access gates.

Install gate valves on each side of irrigation conduits. To minimize the risk of water hammer do not use ball valves at irrigation conduits.

- (7) *Sprinkler Protectors.* Use sprinkler protectors around pop-up sprinklers and quick coupling valves adjacent to the roadway, bicycle paths, or walkways and sidewalks.

July 1, 2020

905.5 Temporary Irrigation

Native and drought tolerant plants may require temporary irrigation for successful establishment. Consider using a temporary irrigation system if establishment of non-irrigated vegetation will be difficult.

Manual, battery, or solar operated valves and controllers may be used when systems are temporary.

The use of drip irrigation systems or on grade irrigation system may be considered with a temporary irrigation system.

Temporary irrigation systems should be removed once they are no longer needed.

Topic 906 – Erosion Control

906.1 Erosion Control General

Permanent erosion and sediment control are required when surface soils are disturbed by construction activities. Erosion control prevents erosion by water, wind, or gravity from moving soil particles away from their original location.

Establishing non-irrigated vegetation is the preferred permanent erosion control measure. Permanent erosion control is accomplished with a combination of soil surface protection (mulches and blankets) and planting techniques.

Steep slope applications and stormwater treatment biofiltration areas may require the application of specialized techniques to ensure the establishment of permanent erosion control.

Sediment control is the interception of eroded soil particles from moving offsite when they become dislodged. Sediment control is accomplished by installing interruption devices on slopes and at concentrated flow locations. Examples include fiber rolls and check dams.

Refer to the LAP website Erosion Control Toolbox and the California Stormwater Quality Handbook: Project Planning and Design Guide (PPDG).

906.2 Soil Surface Protection

Soil surface protection is a necessary component of the erosion control strategy to ensure that soil is protected.

Soil surface protection includes application of the following measures:

- (1) *Organic Material*. Locally obtained or imported organic material applied to the soil surface. Duff, wood chips, and mulch applied topically.
- (2) *Inorganic Material*. Inert mulches such as rock gravel can be applied to protect soil surface erosion.
- (3) *Straw*. Natural fiber stalks from wheat, rice, or native grasses applied to the soil surface. Straw may be stabilized mechanically (punched straw) or with hydromulch and tackifiers.
- (4) *Hydraulic Erosion Control Products (HECPs)*. Temporary, degradable, pre-packaged fibrous mulch materials which are mixed with water into a slurry and hydraulically applied to

the soil surface. HECs include hydromulch, and bonded fiber matrix (BFM), and other hydraulically applied materials.

- (5) *Rolled Erosion Control Products (RECPs)*. RECPs are a blanket that is typically an open weave, degradable material composed of processed natural (jute mesh) or polymer yarns woven into a matrix. RECPs may be applied to the soil surface where vegetation alone will not sustain expected flow conditions and/or provide sufficient erosion protection. RECPs include netting, blanket, and turf reinforcement mat (TRM).

Short term cover measures are intended as transitional soil protection until establishment of vegetation is achieved. Short term cover includes organic material, straw, hydromulch, RECP (Blanket), and RECP (Jute Mesh). Short term cover generally lasts between 1 and 18 months.

Long term cover measures provide immediate and long-term erosion protection where establishing vegetation may be difficult. Long term cover includes RECP (Netting), RECP (Blanket), and RECP (Turf Reinforcing Mat). Long term cover generally lasts 24 months.

906.3 Planting

Planting for erosion control purposes is typically accomplished with seeding, liner plants, seedling plants, and/or native grass sod. Coordinate with the District Biologist to determine specific permit requirements. Contract growing of site specific and genetically appropriate plant materials may be required.

- (1) *Seeding*. Do not specify seeds that have a short shelf life. Seeds may be applied as hydraulically applied seed, drill seed, or dry seed.
- (a) *Hydraulically applied seed*. This method uses hydroseed equipment to mix seed, fiber, tackifiers, and/or other materials with water into a slurry which is hydraulically applied to the soil surface. Hydromulch and bonded fiber matrix are HECs used to hydraulically apply seed. Consider hydraulically applied seed for slopes 2:1 or flatter and larger than half an acre.
 - (b) *Drill Seed*. This method involves sowing seed into the soil using a drill seeder. Consider this method in areas 3:1 or flatter due to drill seeding equipment limitations. This method should not be used to provide temporary cover.
 - (c) *Dry Seed*. This method applies seed and amendments by hand to small areas. Consider this method in areas less than half an acre.
- (2) *Liner and Seedling Plants*. Consider using small nursery grown perennial and woody plants for erosion control and mitigation purposes. These are usually native species. Liners are containerized. Seedlings are bare root without a container.
- (3) *Native Grass Sod*. Consider using native grass sod whenever immediate and complete plant coverage is required. Consider the use of native grass sod in biofiltration strips and swales or for low impact development water quality control projects. Consider including temporary irrigation with native grass sod.
- (4) *Brush Layering*. Consider brush layering when there is adequate soil moisture for the cuttings to grow; use temporary irrigation when brush layering is not installed near a seep, spring or waterway. Locally harvested cuttings from existing cottonwood or willow stands either on site or from an adjacent site are embedded in horizontal layers parallel to the contours of a slope. Consider using in areas 2:1 or flatter. Consult with Geotechnical for slopes steeper than 2:1.

July 1, 2020

906.4 Sediment Control

Linear sediment controls are utilized to slow and spread runoff, reduce concentrated flow, and limit the movement of sediment. Linear sediment control products are manufactured 3-dimensional tubes of a specified filler material encapsulated within a flexible containment material.

- (1) *Fiber Roll*. Consider placing fiber rolls on the contour of the slope. Place along slope faces at regular intervals to minimize sediment loss while permanent vegetation is becoming established.
- (2) *Compost Sock*. Consider placing compost socks on the contour of the slope. Place along slope faces at regular intervals to minimize sediment loss while permanent vegetation is becoming established. Compost socks will also provide biofiltration and organic content to the existing soil.

906.5 Permanent Erosion Control Establishment

Permanent Erosion Control Establishment (PECE) extends the contract period beyond the completion of the highway construction phase requiring the Contractor to be available to perform permanent erosion control repairs prior to "Contract Acceptance." This ensures that adequate vegetation cover and slope stabilization is attained prior to construction contract acceptance.

Having the Contractor available during the PECE period will hasten any repair work that may be needed, such as after severe weather events, and will reduce the workload on the Maintenance Division. PECE provides an additional 250 working days after completion of all other construction activity to assess the success of the erosion control work and meet the project's slope stabilization goals.

Include Permanent Erosion Control Establishment when slopes are steeper than 2:1, where poor soil conditions may inhibit vegetation establishment, erosion control elements are expected to need maintenance while vegetation is being established during construction, or there is the potential of direct discharge of sediment into 303D listed receiving waters.

CHAPTER 910 – LANDSCAPE ARCHITECTURE – ROADSIDE SITES

Topic 911 – General

Index 911.1 Roadside Sites General

The guidance in this chapter refers directly to roadside sites such as Safety Roadside Rest Areas, Vista Points and Park & Ride facilities. Design requirements for roadside site Planting, Irrigation, and Erosion Control can be found in Chapter 900.

Topic 912 – Roadside Sites Design

Landscape site design for roadside sites involves landform grading, building and structure placement, parking design, and the placement of landscape elements, such as boulders or other site furnishings for aesthetic or functional purposes.

912.1 Roadside Sites Layout

Landscape site features and elements should be designed to minimize impacts to natural resources. Buildings, roads, parking areas, shade structures, amenities, and associated earthwork define the site layout. Building locations, roads and parking areas should be arranged to fit the terrain, views, site constraints, and opportunities. If the site has few physical constraints, roads and parking areas should be designed with generous curves and curvilinear parking. Keep pedestrian and parking circulation separate. If the site is heavily wooded, roads and parking should be designed to retain existing trees and tree groupings.

Design roadside sites with adequate lighting, accessible walking surfaces, and open visibility through the site to provide adequate pedestrian security.

- (1) *Low Impact Development.* Consider including low impact development features. Refer to Index 903.4(1).
- (2) *Site Grading.* Grading designs should integrate the required development with as little disturbance to the site as practical. Grading should be harmonious with natural landforms and follow the direction of existing slopes and drainage patterns. Cuts and fills should be shaped and rounded to blend with existing land forms, and the designed terrain should complement the layout of parking areas and sidewalks.
- (3) *Ingress, Egress and Circulation.* Vehicular ingress, egress, and circulation should be simple, direct and obvious to the traveler. See Topic 403 – Principles of Channelization.

Travelers entering a site should be directed to the proper parking area for the type of vehicle driven-automobiles (cars, vans, motorcycles), bicycles, or long-vehicles.

Where practical, provide ample ramps and transitions, good sight distance, and well-placed signs and pavement markings preceding the point where vehicle types separate. Place potential distractions (non-traffic-control signs, plantings, vehicle pullouts, dumpsters, etc.) after this point.

July 1, 2020

Consider the speed and angle at which the various traffic types (long vehicle traffic, bicycle, and automobile traffic) will merge prior to egress. Avoid configurations where one type of traffic can gain excessive speed preceding a merge with slow moving traffic.

Curvilinear road layout, narrow road width and placement of landscape elements can be used to manage traffic so that merging is done at slow and similar speeds.

The design of roads, aisles, parking spaces and parking lot islands should ensure that commercial truck maneuvers can be accommodated without damage to curbs, sidewalks, pavement edges, or parked vehicles. See Topic 404 – Design Vehicles, for truck and bus turning template guidance.

Maintain clear sight lines for all users when locating planting, signs, and other landscape elements.

Provide paved service roads to allow access for maintenance and service to facilities and to protect vegetation, soil and water quality. Service roads should be 10 feet to 12 feet wide.

- (4) *Roadway Connections*. The design of roadway connections to roadside sites should be in accordance with Index 107.1.

Roadside sites designed for freeways shall have standard freeway exit and entrance ramps, in accordance with Chapter 500. Roadside sites on expressways and conventional highways should be designed with standard public road connections and median left-turn lanes, according to Topic 405 – Intersection Design Standards.

Projects to rehabilitate or modify existing ramps, roads, and parking lots should address any requirements to upgrade geometrics to current design standards.

The District Design Liaison should be involved in reviewing the geometric features for the design roadway connections for a roadside site.

Consider including a gate at roadway connections for roadside installations if temporary closures will be required.

- (5) *Pedestrian Circulation*. Walkways should be a minimum of 10 feet wide. When possible, make grade changes with ADA accessible slopes and avoid steps. Sidewalks in front of automobile parking spaces should be a minimum of 12 feet wide to compensate for the overhang of automobiles or provide wheel stops. Locate primary walkways that direct users from automobile, bicycle, and long-vehicle parking areas to facilities.

Clearly defined accessible paths of travel to restrooms, picnic shelters, picnic tables, benches, drinking fountains, telephones, vending machines, information kiosks, interpretive displays, and viewing areas are required. The path of travel from designated accessible parking to accessible facilities should be as short and direct as practical, must have an even surface, and must include curb ramps, marked aisles and crosswalks, and other features as required to facilitate circulation of visitors with wheelchairs, walkers and other mobility aids.

See DIB 82 for further information on accessibility requirements.

The Division of Engineering Services, Structures Design – Office of Transportation Architecture should be consulted when proposing aesthetic treatments to pedestrian features.

912.2 Parking Area Design

Parking areas should be designed to encourage orderly traffic movement and parking.

Parking facilities are to be designed accessible to all modes of travel and are to conform to California MUTCD and DIB 82 guidance. See Table 912.2. Designated accessible parking spaces must be provided for automobiles and vans.

Parking areas should be well defined and include the use of concrete curbs and striping, where appropriate.

- (1) *Low Impact Development.* Include low impact development features, such as porous pavement, curb cut outs, planted bio-strips, planted bioswales, cisterns, or other types of low impact development, into the parking area design to treat stormwater runoff from paved parking surfaces. Refer to Index 903.4(1).
- (2) *Shade Requirements.* Include planting and irrigation for shade trees, when appropriate. Design tree planting areas to shade auto parking areas. Provide 50% shade within 15 years on all impervious driving surfaces (including parking stalls and all driving and maneuvering areas within the parking area.) Trees may receive 25%, 50%, 75% or 100% shade credit based on planted location and the amount of canopy shading paved surfaces. Shade overlap is not counted twice. Follow Planting and Irrigation requirements in Topics 904 – Planting Design and 905 - Irrigation Design.
- (3) *Pavement.* Pavement for parking should be designed in accordance with Chapters 600 through 670. Parking lots may be constructed of flexible or rigid pavement. Rigid pavement has the advantage of being resistant to deterioration from dripping fuel and antifreeze. Consider the use of pervious pavement.

Table 912.2

Vehicle Parking Stall Standards

Vehicle Type	Min Stall Width (ft)	Aisle Width (ft)	Aisle Location
1 Auto	9	5	Passenger side
2 Autos	9	5	Between stalls
1 Van	9	8	Passenger side
1 Van/ 1 Auto	9	8	Between stalls
1 long vehicle	12	8	Passenger side
2 long vehicles	12	8	Between stalls

July 1, 2020

912.3 Site Furnishings

Amenities including trash and recycling facilities, pedestrian signs, pet areas, drinking fountains, shade structures, kiosks, benches, seat walls, bicycle racks, picnic tables, and other site appropriate features should be included. Landscape areas should be provided and may include areas for monuments, artwork, interpretive facilities, and informal exercise and play facilities.

Pedestrian amenities must be designed and constructed to be accessible to persons with disabilities in accordance with all applicable State and Federal law.

(1) *Bicycle Facilities at Roadside Sites.* Where bicycling is allowed, bicycle parking should be considered at roadside sites. Bicycle parking should be in an open area. Consult the District Bicycle Coordinator for information on placement, capacity, and design requirements for bicycle parking.

(2) *Signage.* Non-traffic signs may be of customized design, provided they are easy to maintain or replace should they be damaged or stolen.

(a) *Required Signage.* Place standard reflectorized signs along the roadside to inform and direct travelers as they approach roadside sites.

Directional, regulatory, and warning signs must conform to the California MUTCD.

(b) *Interpretive Areas.* Provide interpretive displays and signage within the pedestrian area of roadside sites. The display or sign should be appropriate to the site in design and content and should be accessible; see DIB 82 for exhibit guidance. Display structures or signs should blend into the site, and be placed at the proper location for viewing the attraction.

Information should pertain to local environmental, ecological, or historical features. It should inform the public while inspiring stewardship in site visitors and strengthen awareness of cultural and natural resources.

Historical plaques, monuments, vicinity maps, and directions to other public facilities are examples of other appropriate interpretive items.

Topic 913 – Safety Roadside Rest Areas

913.1 Safety Roadside Rest Areas General

Safety roadside rest areas typically include restrooms, vehicle parking, bicycle parking, shade shelters, sidewalks, picnic tables, telephones, water, landscape, pet areas, tourist and traveler service information, and vending machines.

Designers should be familiar with the provisions of the California Streets and Highways Code, Article 7 Sections 218 through 226.5.

Comply with State and Federal codes and regulations that address buildings, electrical work, plumbing, lighting, drinking water, wastewater treatment discharge, grading, stormwater discharge, hazardous material containment and disposal, resource conservation, accessibility for persons with disabilities, and environmental protection and mitigation.

Design safety roadside rest areas for cost effective and efficient maintenance. Use high quality, durable and easily cleanable materials to accommodate the heavy use that safety roadside rest

areas receive. Select replaceable components, such as mirrors, sinks, signs, and lighting fixtures that will be readily available during the lifetime of the facility.

Safety roadside rest area expansion should not diminish the scenic and environmental qualities of the existing site.

Determine capacity from the current Safety Roadside Rest Area System Master Plan or site-specific traffic and user counts. Safety roadside rest area parking and restroom capacity should be designed to accommodate the anticipated demand in the design year (20 years from construction completion). When feasible, the design may allow the parking area to be expanded by 25 percent beyond the 20-year design period. Consider future expansion needs for the restroom, parking, water, and wastewater facility beyond the design year.

(1) *Wayside stops.* Include parking areas and restrooms provided by or jointly developed and operated by partners (such as existing or new truck stops, or other highway oriented commercial development). These are for longer-duration stops and overnight parking, primarily for commercial vehicle operators. These facilities are located outside of state right of way, within one-half mile of the freeway. The freeway interchange should accommodate, or be improved to accommodate, the volume and geometric movements of anticipated traffic.

913.2 Safety Roadside Rest Area Site Selection

(1) *Need.* Locations for new or replacement safety roadside rest areas and wayside stops should be consistent with the Safety Roadside Rest Area System Master Plan. Proposed locations identified on the Safety Roadside Rest Area System Master Plan are approximate only. Actual sites may be located within several miles in either direction from the location indicated on the Safety Roadside Rest Area System Master Plan. More than one alternate site should be identified and analyzed before selecting a preferred site. When offering potential sites for wayside stop proposals, it is best to allow for as many acceptable alternative sites as possible.

(2) *Access.* Safety roadside rest areas located on a freeway or a highway of four or more lanes, should be planned as a pair of units, each unit serving a separate direction of traffic.

(3) *Right of Way Requirements.* A safety roadside rest area unit may require 10 to 15 acres of right of way. Potential negative impacts to prime agricultural land, native vegetation, natural terrain, water quality, and drainage features should be considered when identifying potential sites for rest areas. Consider sites where natural vegetation has already been disturbed and where rest area development may facilitate restoration.

913.3 Safety Roadside Rest Area Layout

Refer to Topic 912 – Landscape Site Design for additional information.

(1) *Ingress and Egress.* Access (ingress/egress) should be by means of direct on and off ramps from the freeway or highway. See Index 912.1 for additional roadside site ingress/egress and roadway connection information.

When a rest area or wayside stop facility is developed outside the freeway right of way at an interchange location, the interchange ramps, bridges, and geometric design should accommodate the volume of traffic anticipated and the turning movements of commercial trucks.

July 1, 2020

- (2) *Restroom Location.* Locate the restroom building in a prominent location with appropriate access from parking areas. Entrances to restrooms should be visible from the parking area. They should be well lit and clearly identified with signs and/or graphics. Vegetation, walls, recesses and other areas that allow concealment should not be located near restroom entrances. Restroom entrances should not be in areas of dead-end circulation. Facilities intended for public use should not be located near restroom entrances.
- (3) *Public Information Displays and Telephones.* Locate public information displays, commercial advertising displays, and telephones in pedestrian areas that are well lit and protected from rain, snow, and wind. Information should be placed near telephones and public information displays indicating local emergency numbers and indicating the rest area name and location.
- (4) *Service Facilities.* Service facilities including crew rooms, equipment storage rooms, dumpster enclosures, service yards, and utility equipment, can be distracting and unattractive to safety roadside rest area users. Service facilities should be aesthetically attractive, separated, and oriented away from view of public-use areas (restrooms, pedestrian core, and picnic areas).
- (5) *Fencing.* Fences should be provided only for access control, traffic control, or safety purposes. Fencing should be designed to be as unobtrusive as practical.

A minimum 4-foot high fence must be provided between freeways and safety roadside rest areas. Perimeter fencing should be of the minimum height and design necessary. Where adjacent property is developed, more substantial fencing or screening may be required. Fencing in rural or natural areas may be required to control or protect wildlife or livestock. Refer to Topic 701 – Fences.
- (6) *Pet Area.* Provide a pet relief area. When placing pet areas, consider location and size, some safety roadside rest areas may require multiple pet relief areas. Consider locating pet relief area near auto parking areas to accommodate pet usage. Consider including fencing, signage, trash receptacles, dog watering fountain, waste bags and dispensers. Remove vegetation with thorns or burrowing seeds and consider replacing with turf, artificial turf, mulch, or decomposed granite.

913.4 Safety Roadside Rest Area Buildings and Structures

Safety roadside rest area structures include restrooms, storage rooms, equipment rooms, crew rooms, CHP drop-in offices, picnic shelters, utility enclosures, dumpster enclosures, kiosks, arbors and other architectural elements. Safety roadside rest area structures should be designed for a service life of at least 20 years. Attention to quality architectural design, construction and maintenance is warranted. Building forms, rooflines, construction materials (stone, timber, steel, etc.), colors and detailing should express the local context including history, cultural influences, climate, topography, geology and vegetation.

Structures must be designed and constructed to be accessible to persons with disabilities in accordance with all applicable State and Federal law. Any building upgrade, even minor projects, must address accessibility and building code deficiencies. Refer to the California Building Code for additional information.

Lockable steel doors should be provided for entrances to rest rooms, storage rooms, crew rooms and CHP drop-in offices.

- (1) *Restrooms.* When existing restrooms are replaced as part of rehabilitation projects, it is preferable that the 20-year design need be constructed, even when expansion of parking facilities is deferred.

Two restrooms should be provided for each gender to allow for uninterrupted public access to facilities during janitorial cleaning operations. At least one unisex/family-assisted/all-gender restroom is required; these facilities are not considered part of the total capacity used.

Restroom fixture counts (water closets, urinals for men's rooms, and lavatories) are developed by the Division of Engineering Services-Transportation Architecture and based upon average daily visitor and peak hour visitor data provided by the District. The quantity of fixtures provided for men's restrooms should be divided equally among water closets, urinals and lavatories. The quantity of water closets for women's restrooms should be 1 to 1.5 times the combined quantity of toilets and urinals provided for men.

Each men's, women's, and unisex/family-assisted/all gender restroom must have a baby diaper changing station.

Entrance doors to unisex/family-assisted/all-gender restrooms must be lockable from the inside and outside of the restroom.

Privacy screens at restroom entrances should allow visibility from the ground to a height of 12 inches to 18 inches above the ground.

Maintenance access must be provided to plumbing, sewer, electrical, and equipment to facilitate inspection and repair.

- (2) *California Highway Patrol (CHP) Drop-in Office.* Consult with the local CHP to determine need. Drop-in Office consist of a dedicated office and restroom for use by the CHP. The office should be located adjacent to the pedestrian core and near the dedicated CHP parking stall. The CHP office should be designed to allow access by CHP only. The office should be located and designed to provide maximum visibility by officers to, from, and within the facility.
- (3) *Maintenance.* Provide crew rooms and storage space for cleaning supplies, tools, and equipment.
- (a) *Crew Room.* Provide a maintenance crew room separate from equipment and supply storage at safety roadside rest areas in compliance with the California Occupational Safety and Health Act (Cal-OSHA) requirements. When appropriate, a single crew room may be provided for a pair of safety roadside rest area units. The crew room should be heated and air-conditioned. Conduits or wiring for telephone service, (by others) may be provided.
- (b) *Storage Rooms or Buildings.* Storage rooms or buildings should be provided to house maintenance equipment, tools and supplies. Janitorial cleaning supplies and tools should be near the restrooms, and reasonably close to parking for maintenance service vehicles. Provide shelving for paper goods, cleaning supplies and other materials. Grounds-maintenance equipment and supplies should be located outside of public-use areas and views.

913.5 Safety Roadside Rest Area Utilities and Facilities

Utility and facility systems must be designed in conformance with Title 24 Energy Requirements of the California Code of Regulations (State Building Code), and other applicable State and Federal requirements.

July 1, 2020

- (1) *Electrical Service.* Design electrical power systems to accommodate the demands of outdoor lighting (ramps, parking areas, pedestrian walkways and plazas), water supply systems (pumps, pressure tanks, irrigation controllers), restrooms (lighting, hand dryers), pedestrian facilities (lighting, water chillers, telephones, text telephones (TTY), wireless internet, kiosks), crew room (lighting, heating, air conditioning, refrigerator, microwave), CHP drop-in office (lighting, heating, air conditioning), and vending (lighting, vending machines, change machine, storage-room air conditioning).

Primary electrical power sufficient for basic safety needs should be supplied by conventional power providers. Supplemental power may be provided using innovative technologies such as solar panels, wind generation, or conventional means, such as backup generators. Consider security, public safety and environmental protection when determining the type of fuel and fuel storage facilities for electrical generation. Provide vehicular access to fuel storage facilities for refueling; include fencing and gates as necessary to prevent access by the public.

- (2) *Lighting.* For functionality and safety, rest areas should be lit for 24-hour-a-day use. Lighting should be automatically controlled and include manual-shutoff capability. Restroom entrances and the interiors of restrooms, utility corridors, CHP drop-in offices, crew rooms, storage rooms or buildings, pedestrian plazas, primary sidewalks, crosswalks, ramps, picnic areas, kiosks, bicycle parking, and interpretive displays should be brightly illuminated. Lighting should illuminate walking surfaces and minimize strong shadows. Peripheral areas of the site should be lighted only where nighttime pedestrian use is anticipated. Non-pedestrian areas of the site do not require lighting. Comply with local zoning ordinances for lighting restrictions. Refer to the Traffic Manual, Chapter 9 for additional Highway Lighting guidance.

- (3) *Water.* Water supply systems should be designed to accommodate the 20-year design need and to handle the peak flow required for restroom fixtures and landscape irrigation. Enclosures should be provided for water supply equipment to discourage vandalism and minimize the appearance of clutter. Water lines beneath parking areas, pedestrian plazas and the highway should be placed in conduits. Maintain appropriate distance between wells and wastewater disposal facilities (applicable laws should be followed). Install a water meter at facilities using a well as a water source to track and report on groundwater usage. Potable water must be provided to sinks, drinking fountains, exterior faucet assemblies and pet-watering stations. Untreated or non-potable water may be used for toilets and landscape irrigation. Irrigation systems should be isolated from the general water system using a backflow prevention device.

- (4) *Wastewater Disposal.* Wastewater disposal facilities should be designed to accommodate the 20 year-design need and to handle the peak sewage demand. Waterborne sewage disposal systems should be provided. Division of Engineering Services Structure Design will arrange for soil analysis and percolation tests, and upon completion of testing will obtain approval of the proposed sewage treatment system from the Regional Water Quality Control Board.

Recreational vehicle waste disposal stations may be provided at rest areas where there is a recognized need and commercial disposal stations are not available.

- (5) *Telephones.* **Provide public pay telephone(s) and associated conduit and wiring at each safety roadside rest area.** To comply with accessibility laws and regulations, at least one telephone must be wheelchair accessible, at least one telephone must allow for audio amplification, and at least one telephone must include text messaging for the hearing impaired. Whenever possible, all telephones should allow for audio amplification.

Telephones should be wall or pedestal mounted.

Conduits and pull wires should be provided from the telephone service point to the maintenance crew room and to the California Highway Patrol (CHP) drop-in office. Provide telephone service for maintenance contractors and the CHP.

- (6) *Call Boxes*. Call Boxes generally are not placed in safety roadside rest areas.
- (7) *Wireless Internet Facilities*. Wireless internet facilities may be installed in safety roadside rest areas with funding borne by the provider or others.
- (8) *Telecommunications Equipment and Transmission Towers*. Consider future safety roadside rest area expansion, and, when possible, locate facilities outside of areas planned for future development. The Department seeks revenue from placement of wireless telecommunications facilities on State-owned right of way. Transmission towers and associated equipment, structures and fencing should be located outside of pedestrian use areas and views. Telecommunications equipment and transmission towers should be aesthetically integrated into the site.
- (9) *Water Holding Tanks for Fire Suppression*. Provide a system for water holding when required for fire suppression.

913.6 Safety Roadside Rest Area Parking

See Index 912.2 for additional parking area design requirements.

- (1) *Parking Area Size*. The maximum parking capacity for a safety roadside rest area unit should be 120 total vehicular parking spaces. Site conditions may limit the amount of parking that is practical to build. If construction or enlargement of parking areas to meet anticipated demand will significantly diminish the environmental character of the site, the quantity of parking should be reduced as appropriate.
- (2) *Layout*. The maximum walking distance from the most remote parking space to restrooms should be 350 feet.

One accessible parking space for long vehicles may be provided at each rest area unit.

If a California Highway Patrol (CHP) drop-in office is planned, provide one dedicated parking space for use by CHP. The CHP space should be in an area that provides maximum visibility to the public. The CHP space should also be visible from the office location. Provide a sign and pavement markings to designate the CHP space.

913.7 Safety Roadside Rest Area Signage

Freestanding signs should be placed in safety roadside rest areas only to provide traveler direction. This signage should provide clear instructions for travelers as they approach and depart the rest area.

Refer to Index 912.1(3) for additional signage information.

- (1) *Roadside Signs*. A roadside sign should be placed one mile in advance of each safety roadside rest area that indicates the distance to that rest area and to the next rest area beyond. In remote areas an additional sign may be placed in advance of a safety roadside rest area indicating the distance to the facility. Additional panels may be included on or near this sign to inform travelers of the availability of vending machines, recreational vehicle waste disposal stations, traveler information, wireless internet or other special services. A directional sign should be placed at the safety roadside rest area ingress ramp. Standard reflectorized traffic control signs should be used within the rest area for all traffic guidance. These signs may be enhanced with aesthetic backing or frames.

July 1, 2020

A sign advising “Patrolled by Highway Patrol” should be placed on the freeway exit sign preceding each rest area.

- (2) *Length of Stay Signage.* Provide length of Stay parking regulation signs for autos and long vehicles per the MUTCD. Provide a “8 Hour Parking” sign at the entrance to the parking area for autos. Provide a “10 Hour Parking Commercial Motor Vehicles” sign at the entrance to the parking area for long vehicles.
- (3) *Welcome Signage.* A welcome sign indicating the safety roadside rest area name may be placed within the pedestrian portion of the rest area. Welcome signs must be placed away from traffic decision points and outside the clear recovery zone of the highway or ramps.
- (4) *Restroom Signage.* Signs identifying the entrance to each restroom should be clearly visible from the parking area. A sign, in English and Braille, should be placed on the building wall or on the privacy screen at each restroom entrance to identify the gender. Signs may also be provided in other languages as appropriate. A standard sign is required near the entrance to each restroom advising that, a person of the opposite sex may accompany a person with a disability into the restroom. A sign should be installed near the restroom doors advising that State law prohibits smoking in restrooms and the area within 20 feet of the restroom doors. To deter vandalism, signs should be made of metal or other durable material and should be recessed into, or securely mounted on a wall.
- (5) *Pet Area Signage:* Provide a sign with the rules of the pet area. Rules may include:
 - keep pets leashed
 - pick up and dispose of pet waste

913.8 Public Information Display

At least 96 square feet of lighted display space should be provided at each safety roadside rest area for display of public information, such as rest area use regulations, maps, road conditions, rest area closures, safety tips, missing children posters, anti-litter regulations, nonpotable water use, maintenance crew presence/hours, proximity/use of agricultural crops, scenic highways designation, environmental features, etc. Space should consist of wall-mounted cases or freestanding kiosks designed for pedestrian viewing (see DIB 82 for guidance on exhibits).

913.9 Vending Facilities

- (1) *Vending Machine Facilities.* Consider accommodations for vending machines when designing safety roadside rest areas.

Existing vending machine facilities should only be replaced with a project if the existing Vending Machine Facility requires removal.

New vending machine facilities may be installed if initiated, designed, and funded by the California Department of Rehabilitation, Business Enterprise Program (BEP).

When BEP does not install a vending machine facility with a project, provide a vending machine facility location for future vending machine facilities. Provide conduits from the electrical service panel to the planned/future vending machine facility location.

A storage room may be provided by BEP within 150 feet of the vending machines for storage of vended products. The safety roadside rest area project should provide conduits from the electrical service panel to the vending storage room for possible installation of air conditioning by BEP.

- (2) *Newspaper and Traveler Coupon Booklets.* This type of vending machine is owned by others and may be placed in safety roadside rest areas by an encroachment permit.
- (3) *Coin Operated Binoculars.* Coin operated binocular viewing as authorized by law is provided privately through a competitively awarded revenue-generating agreement.

Topic 914 – Vista Points

914.1 Vista Points General

Refer to Topic 912 – Landscape Site Design. A vista point might be a vista point, scenic overlook, wildlife viewing, trailhead access area, or other place specifically for the traveling public to stop and view the local landscape.

Vista points provide a place where motorists and bicyclists can observe the view from outside their vehicles and off their bicycles.

For vista points designed for exiting a vehicle see Index 912.2 for additional parking area design requirements.

Preserve and highlight existing vegetation, rock outcroppings, and other natural features. Removal or pruning of existing plants to frame the view should be minimal. Earth mounding and contour grading may be employed to restore and naturalize the site. Provide planting, including erosion control, to revegetate graded areas. Use plants that thrive without permanent irrigation.

914.2 Vista Point Site Selection

Site selection is based on the following criteria:

- (1) *Quality.* A site should have views and scenery of outstanding merit or beauty. Locations on designated scenic highways or in areas of historical or environmental significance should be given special emphasis. A site should provide the best viewing opportunities compared to other potential locations within the vicinity.
- (2) *Compatibility.* A site should be located on State highway right of way or on right of way secured by easement or agreement with another public agency. A site should be obtainable without condemnation. Select sites away from or adjacent to developed property or property where development is anticipated.
- (3) *Access.* A site should be accessible from a State highway or intersecting road.
- (4) *Adequate Space.* A site should be of adequate size to accommodate the necessary features and facilities. Development of a site shall preserve or improve the scenic quality of the area. Adequate space should be available for earth mounding and planting to minimize the visual impact of larger facilities. Adequate space for future expansion may be desirable.

914.3 Vista Point Amenities

In general, select items that facilitate the viewing of the scenic attraction or blend the vista point into its surroundings.

- (1) *Maintenance.* Coordinate review of the vista point design with the Maintenance Landscape Supervisor to verify all site amenities are appropriately located for maintenance access.

July 1, 2020

- (2) *Barriers*. Railings, bollards, or other appropriate barriers should be used to protect pedestrians and discourage entry into sensitive or hazardous areas. The design of such barriers should be sensitive to pedestrian scale and reflect the scenic character of the site.
- (3) *Trash/Recycling Receptacles*. Provide trash and recycling receptacles at each vista point. As a guide, provide one receptacle for every four cars, provide a minimum of two receptacles per vista point. Do not locate dumpsters at a vista point.
- (4) *Water*. Potable water may be provided at a reasonable cost. Non-potable water should not be provided in a vista point.
- (5) *Other Features*. Optional items include benches, bicycle parking, shade structures, kiosks, interpretive displays, telephones, and coin operated binoculars (See Index 912.3).
Do not include picnic tables at vista points.
- (6) *Sanitary Facilities*. Restrooms are usually not provided.

914.4 Vista Point Parking

See Index 912.2 for additional parking area design requirements.

Parking capacity should be based on an analysis of current traffic data. However, at least five vehicle spaces should be provided. The maximum parking capacity should be 0.025 times the DHV or 50 spaces, whichever is less. This number may be exceeded at high use trailheads.

Approximately one-quarter to one-third of the spaces should be allocated to long vehicles (cars with trailers, recreational vehicles, and buses).

Geometrics should be such that all types of vehicles entering the vista point can safely negotiate and exit the facility.

Topic 915 – Park & Ride Facilities

915.1 Park & Ride Facilities General

Park & ride facilities must be considered for inclusion on all major transportation projects that include, but are not limited to, new freeways, interchange modifications, lane additions, transit facilities, and HOV lanes. See Chapter 8, Section 7 of the Project Development Procedures Manual for additional information.

Refer to Topic 912 – Landscape Site Design.

See Index 912.2 for additional parking area design requirements.

Park & ride facilities are to be designed as multi-modal facilities. Provisions for pedestrians, bicyclists, transit, single-occupancy vehicles, and multi-occupancy vehicles are to be provided as appropriate. The local transit provider should be consulted to determine if the facility should provide connections to transit.

The design of a park & ride facility should consider the operations and maintenance of the facility, both in terms of effort as well as safety.

915.2 Site Selection

Park & ride facilities are typically placed to reduce congestion, and to improve air quality, usually associated with other transportation opportunities such as HOV lanes and transit. The specific choice as to location and design should be supported by a detailed analysis of demand and the impact of a park & ride facility based upon these parameters:

- corridor congestion
- community values
- air quality
- transit operations
- overall safety
- multi-modal opportunities

Full involvement of the project development team should be engaged in the evaluation and recommendation of park & ride type, classification, site, and appurtenant facilities.

Refer to the Project Development Procedures Manual and the Park & Ride Program Resource Guide for additional information on site selection.

CHAPTER 1000 – BICYCLE TRANSPORTATION DESIGN

Topic 1001 – Introduction

Index 1001.1 – Bicycle Transportation

The needs of nonmotorized transportation are an essential part of all highway projects. Mobility for all travel modes is recognized as an integral element of the transportation system. Therefore, the guidance provided in this manual complies with Deputy Directive 64-R2: Complete Streets - Integrating the Transportation System. See AASHTO, “Guide For The Development Of Bicycle Facilities”.

Design guidance for Class I bikeways (bike paths), Class III bikeways (bike routes) and Trails are provided in this chapter. Design guidance that addresses the mobility needs of bicyclists on all roads as well as on Class II bikeways (bike lanes) is distributed throughout this manual where appropriate. Design guidance for Class IV bikeways (separated bikeways) is provided in DIB 89. The AASHTO Guide for the Development of Bicycle Facilities also provides additional bikeway guidance not included in this chapter. In addition, bikeway publications and manuals developed by organizations other than FHWA and AASHTO also provide guidance not covered in this manual.

See Topic 116 for guidance regarding bikes on freeways.

1001.2 Streets and Highways Code References

The Streets and Highways Code Section 890.4 defines a “bikeway” as a facility that is provided primarily for bicycle travel. Following are other related definitions, found in Chapter 8 Nonmotorized Transportation, from the Streets and Highway Code:

- (a) Section 887 – Definition of nonmotorized facility.
- (b) Section 887.6 – Agreements with local agencies to construct and maintain nonmotorized facilities.
- (c) Section 887.8 – Payment for construction and maintenance of nonmotorized facilities approximately paralleling State highways.
- (d) Section 888 – Severance of existing major non- motorized route by freeway construction.
- (e) Section 888.2 – Incorporation of nonmotorized facilities in the design of freeways.
- (f) Section 888.4 – Requires Caltrans to budget not less than \$360,000 annually for nonmotorized facilities used in conjunction with the State highway system.
- (g) Section 890.4 – Class I, II, III, and cycle tracks or separated bikeway definitions.

July 1, 2020

- (h) Section 890.6 - 890.8 – Caltrans and local agencies to develop design criteria and symbols for signs, markers, and traffic control devices for bikeways and roadways where bicycle travel is permitted.
- (i) Section 891 – Local agencies must comply with design criteria and uniform symbols.
- (j) Section 892 – Use of abandoned right-of-way as a nonmotorized facility.

1001.3 Vehicle Code References

- (a) Section 21200 – Bicyclist's rights and responsibilities for traveling on highways.
- (b) Section 21202 – Bicyclist's position on roadways when traveling slower than the normal traffic speed.
- (c) Section 21206 – Allows local agencies to regulate operation of bicycles on pedestrian or bicycle facilities.
- (d) Section 21207 – Allows local agencies to establish bike lanes on non-State highways.
- (e) Section 21207.5 – Prohibits motorized bicycles on bike paths or bike lanes.
- (f) Section 21208 – Specifies permitted movements by bicyclists from bike lanes.
- (g) Section 21209 – Specifies permitted movements by vehicles in bike lanes.
- (h) Section 21210 – Prohibits bicycle parking on sidewalks unless pedestrians have an adequate path.
- (i) Section 21211 – Prohibits impeding or obstruction of bicyclists on bike paths.
- (j) Section 21400 – Adopt rules and regulations for signs, markings, and traffic control devices for roadways user.
- (k) Section 21401 – Only those official traffic control devices that conform to the uniform standards and specifications promulgated by the Department of Transportation shall be placed upon a street or highway.
- (l) Section 21717 – Requires a motorist to drive in a bike lane prior to making a turn.
- (m) Section 21960 – Use of freeways by bicyclists.
- (n) Section 21966 – No pedestrian shall proceed along a bicycle path or lane where there is an adjacent adequate pedestrian facility.

1001.4 Bikeways

- (1) *Role of Bikeways.* Bikeways are one element of an effort to improve bicycling safety and convenience - either to help accommodate motor vehicle and bicycle traffic on the roadway system, or as a complement to the road system to meet the needs of the bicyclist.

Off-street bikeways in exclusive corridors can be effective in providing new recreational opportunities, and desirable transportation/commuter routes. Off-street bikeways can also provide access with bridges and tunnels which cross barriers to bicycle travel (e.g., freeway or river crossing). Likewise, on-street bikeways can serve to enhance safety and

convenience, especially if other commitments are made in conjunction with establishment of bikeways, such as: elimination of parking or increased roadway width, elimination of surface irregularities and roadway obstacles, frequent street sweeping, established intersection priority on the bike route street as compared with the majority of cross streets, and installation of bicycle-sensitive loop detectors at signalized intersections.

- (2) *Decision to Develop Bikeways.* Providing an interconnected network of bikeways will improve safety for all users and access for bicycles. The development of well conceived bikeways can have a positive effect on bicyclist and motorist behavior. In addition, providing an interconnected network of bikeways along with education and enforcement can improve safety and access for bicyclists. The decision to develop bikeways should be made in coordination with the local agencies.

Topic 1002 – Bikeway Facilities

1002.1 Selection of the Type of Facility

The type of facility to select in meeting the bicyclist's need is dependent on many factors, but the following applications are the most common for each type.

- (1) *Shared Roadway (No Bikeway Designation).* Most bicycle travel in the State now occurs on streets and highways without bikeway designations and this may continue to be true in the future as well. In some instances, entire street systems may be fully adequate for safe and efficient bicycle travel, where signing and pavement marking for bicycle use may be unnecessary. In other cases, prior to designation as a bikeway, routes may need improvements for bicycle travel.

Many rural highways are used by touring bicyclists for intercity and recreational travel. It might be inappropriate to designate the highways as bikeways because of the limited use and the lack of continuity with other bike routes. However, the development and maintenance of 4-foot paved roadway shoulders with a standard 4 inch edge line can significantly improve the safety and convenience for bicyclists and motorists along such routes.

- (2) *Class I Bikeway (Bike Path).* Generally, bike paths should be used to serve corridors not served by streets and highways or where wide right of way exists, permitting such facilities to be constructed away from the influence of parallel streets. Bike paths should offer opportunities not provided by the road system. They can either provide a recreational opportunity, or in some instances, can serve as direct high-speed commute routes if cross flow by motor vehicles and pedestrian conflicts can be minimized. The most common applications are along rivers, ocean fronts, canals, utility right of way, abandoned railroad right of way, within school campuses, or within and between parks. There may also be situations where such facilities can be provided as part of planned developments. Another common application of Class I facilities is to close gaps to bicycle travel caused by construction of freeways or because of the existence of natural barriers (rivers, mountains, etc.).
- (3) *Class II Bikeway (Bike Lane).* Bike lanes are established along streets in corridors where there is significant bicycle demand, and where there are distinct needs that can be served

July 1, 2020

by them. The purpose should be to improve conditions for bicyclists in the corridors. Bike lanes are intended to delineate the right of way assigned to bicyclists and motorists and to provide for more predictable movements by each. But a more important reason for constructing bike lanes is to better accommodate bicyclists through corridors where insufficient room exists for side-by-side sharing of existing streets by motorists and bicyclists. This can be accomplished by reducing the number of lanes, reducing lane width, or prohibiting or reconfiguring parking on given streets in order to delineate bike lanes. In addition, other things can be done on bike lane streets to improve the situation for bicyclists that might not be possible on all streets (e.g., improvements to the surface, augmented sweeping programs, special signal facilities, etc.). Generally, pavement markings alone will not measurably enhance bicycling.

If bicycle travel is to be provided by delineation, attention should be made to assure that high levels of service are provided with these lanes. It is important to meet bicyclist expectations and increase bicyclist perception of service quality, where capacity analysis demonstrates service quality measures are improved from the bicyclist's point of view.

Design guidance that addresses the mobility needs of bicyclists on Class II bikeways (bike lanes) is also distributed throughout this manual where appropriate.

(4) *Class III Bikeway (Bike Route)*. Bike routes are shared facilities which serve either to:

- (a) Provide continuity to other bicycle facilities (usually Class II bikeways); or
- (b) Designate preferred routes through high demand corridors.

As with bike lanes, designation of bike routes should indicate to bicyclists that there are particular advantages to using these routes as compared with alternative routes. This means that responsible agencies have taken actions to assure that these routes are suitable as shared routes and will be maintained in a manner consistent with the needs of bicyclists. Normally, bike routes are shared with motor vehicles. The use of sidewalks as Class III bikeways is strongly discouraged.

(5) *Class IV Bikeways (Separated Bikeways)*. See DIB 89 for guidance.

A Class IV bikeway (separated bikeway) is a bikeway for the exclusive use of bicycles and includes a separation required between the separated bikeway and the through vehicular traffic. The separation may include, but is not limited to, grade separation, flexible posts, inflexible posts, inflexible barriers, or on-street parking. See DIB 89 for further Class IV guidance.

It is emphasized that the designation of bikeways as Class I, II, III, and IV should not be construed as a hierarchy of bikeways; that one is better than the other. Each class of bikeway has its appropriate application.

In selecting the proper facility, an overriding concern is to assure that the proposed facility will not encourage or require bicyclists or motorists to operate in a manner that is inconsistent with the rules of the road.

An important consideration in selecting the type of facility is continuity. Alternating segments of Class I to Class II (or Class III) bikeways along a route are generally incompatible, as street crossings by bicyclists is required when the route changes character. Also, wrong-way

bicycle travel will occur on the street beyond the ends of bike paths because of the inconvenience of having to cross the street. However, alternating from Class IV to Class II may be appropriate due to the presence of many driveways or turning movements. The highway context or community setting may also influence the need to alternate bikeway classifications.

Topic 1003 – Bikeway Design Criteria

1003.1 Class I Bikeways (Bike Paths)

Class I bikeways (bike paths) are facilities with exclusive right of way, with cross flows by vehicles minimized. Motor vehicles are prohibited from bike paths per the CVC, which can be reinforced by signing. Class I bikeways, unless adjacent to an adequate pedestrian facility, (see Index 1001.3(n)) are for the exclusive use of bicycles and pedestrians, therefore any facility serving pedestrians must meet accessibility requirements, see DIB 82. However, experience has shown that if regular pedestrian use is anticipated, separate facilities for pedestrians maybe beneficial to minimize conflicts. Please note, sidewalks are not Class I bikeways because they are primarily intended to serve pedestrians, generally cannot meet the design standards for Class I bikeways, and do not minimize vehicle cross flows. See Index 1003.3 for discussion of the issues associated with sidewalk bikeways.

(1) *Widths and Cross Slopes.* See Figure 1003.1A for two-way Class I bikeway (bike path) width, cross slope, and side slope details. The term “shoulder” as used in the context of a bike path is an unobstructed all weather surface on each side of a bike path with similar functionality as shoulders on roadways with the exception that motor vehicle parking and use is not allowed. The shoulder area is not considered part of the bike path traveled way.

Experience has shown that paved paths less than 12 feet wide can break up along the edge as a result of loads from maintenance vehicles.

(a) **Traveled Way.** **The minimum paved width of travel way for a two-way bike path shall be 8 feet**, 10-foot preferred. **The minimum paved width for a one-way bike path shall be 5 feet.** It should be assumed that bike paths will be used for two-way travel. Development of a one-way bike path should be undertaken only in rare situations where there is a need for only one-direction of travel. Two-way use of bike paths designed for one-way travel increases the risk of head-on collisions, as it is difficult to enforce one-way operation. This is not meant to apply to two one-way bike paths that are parallel and adjacent to each other within a wide right of way.

Where heavy bicycle volumes are anticipated and/or significant pedestrian traffic is expected, the paved width of a two-way bike path should be greater than 10 feet, preferably 12 feet or more. Another important factor to consider in determining the appropriate width is that bicyclists will tend to ride side by side on bike paths, and bicyclists may need adequate passing clearance next to pedestrians and slower moving bicyclists.

See Index 1003.1(16) Drainage, for cross slope information.

July 1, 2020

(b) **Shoulder. A minimum 2-foot wide shoulder, composed of the same pavement material as the bike path or all weather surface material that is free of vegetation, shall be provided adjacent to the traveled way of the bike path when not on a structure;** see Figure 1003.1A. A shoulder width of 3 feet should be provided where feasible. A wider shoulder can reduce bicycle conflicts with pedestrians. Where the paved bike path width is wider than the minimum required, the unpaved shoulder area may be reduced proportionately. If all or part of the shoulder is paved with the same material as the bike path, it is to be delineated from the traveled way of the bike path with an edgeline.

See Index 1003.1(16), Drainage, for cross slope information.

(2) *Bike Path Separation from a Pedestrian Walkway.* The CVC requires a pedestrian to use a pedestrian facility when adjacent to a bike path. Thus, the bike path would be only for bicycles if there is an adjacent pedestrian facility. This may be either immediately adjacent or with a separation between the pedestrian facility and the bike path. The separation may be—but not limited to—fences, railings, solid walls, or landscaping. If a separation is used, it should not obstruct stopping sight distance along curves or corner sight distance at intersections with roadways or other paths.

(3) *Clearance to Obstructions.* **A minimum 2-foot horizontal clearance from the paved edge of a bike path to obstructions shall be provided.** See Figure 1003.1A. 3 feet should be provided. Adequate clearance from fixed objects is needed regardless of the paved width. If a path is paved contiguous with a continuous fixed object (e.g., fence, wall, and building), a 4-inch white edge line, 2 feet from the fixed object, is recommended to minimize the likelihood of a bicyclist hitting it. **The clear width of a bicycle path on structures between railings shall be not less than 10 feet.** It is desirable that the clear width of structures be equal to the minimum clear width of the path plus shoulders (i.e., 14 feet).

The vertical clearance to obstructions across the width of a bike path shall be a minimum of 8 feet and 7 feet over shoulder. Where practical, a vertical clearance of 10 feet is desirable.

(4) *Signing and Delineation.* For application and placement of signs, see the California MUTCD, Section 9B. For pavement marking guidance, see the California MUTCD, Section 9C.

(5) *Intersections with Highways.* Intersections are an important consideration in bike path design. Bicycle path intersection design should address both cross-traffic and turning movements. If alternate locations for a bike path are available, the one with the most beneficial intersection characteristics should be selected.

Where motor vehicle cross traffic and bicycle traffic is heavy, grade separations are desirable to eliminate intersection conflicts. Where grade separations are not feasible, assignment of right of way by traffic signals should be considered. Where traffic is not

Figure 1003.1A

Two-Way Class I Bikeway (Bike Path)

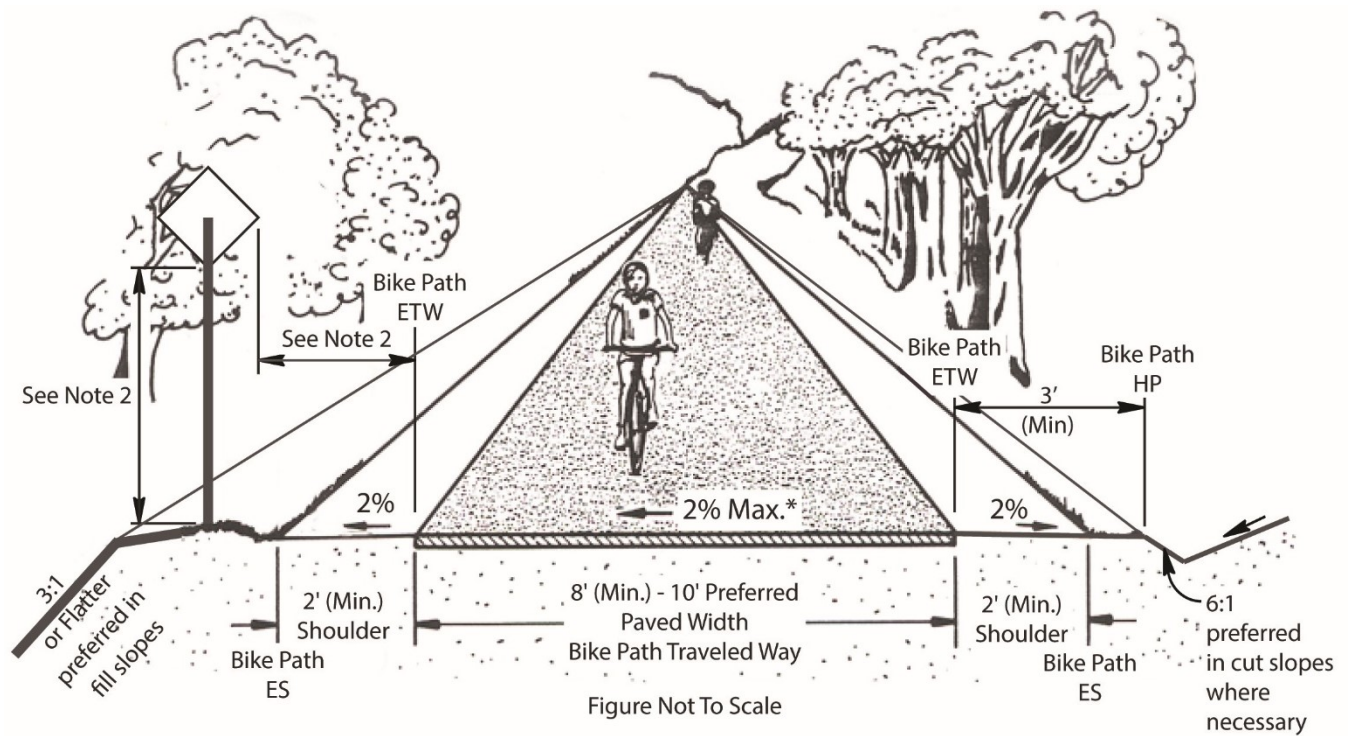

NOTES:

- (1) See Index 1003.1(15) for pavement structure guidance of bike path.
- (2) For sign clearances, see California MUTCD, Figure 9B-1. Also, for clearance over the shoulder see Index 1003.1(3).
- (3) The AASHTO Guide for the Development of Bicycle Facilities provides detailed guidance for creating a forgiving Class I bikeway environment.

*1% cross-slope minimum.

July 1, 2020

heavy, "STOP" or "YIELD" signs for either the path or the cross street (depending on volumes) may suffice.

Bicycle path intersections and their approaches should be on relatively flat grades. Stopping sight distances at intersections should be checked and adequate warning should be given to permit bicyclists to stop before reaching the intersection, especially on downgrades. When contemplating the placement of signs the designer is to discuss the proposed sign details with their District Traffic Safety Engineer or designee so that conflicts may be minimized. Bicycle versus motor vehicle collisions may occur more often at intersections, where bicyclists misuse pedestrian crosswalks; thus, this should be avoided.

When crossing an arterial street, the crossing should either occur at the pedestrian crossing, where vehicles can be expected to stop, or at a location completely out of the influence of any intersection to permit adequate opportunity for bicyclists to see turning vehicles. When crossing at midblock locations, right of way should be assigned by devices such as "YIELD" signs, "STOP" signs, or traffic signals which can be activated by bicyclists. Even when crossing within or adjacent to the pedestrian crossing, "STOP" or "YIELD" signs for bicyclists should be placed to minimize potential for conflict resulting from turning autos. Where bike path "STOP" or "YIELD" signs are visible to approaching motor vehicle traffic, they should be shielded to avoid confusion. In some cases, Bike Xing signs may be placed in advance of the crossing to alert motorists. Ramps should be installed in the curbs, to preserve the utility of the bike path. Ramps should be the same width as the bicycle paths. Curb cuts and ramps should provide a smooth transition between the bicycle paths and the roadway.

Assignment of rights of way is necessary where bicycle paths intersect roadways or other bicycle paths. See the California MUTCD, Section 9B.03 and Figure 9B-7 for guidance on signals and signs for rights of way assignment at bicycle path intersections.

- (6) *Paving at Crossings.* At unpaved roadway or driveway crossings, including bike paths or pedestrian walkways, the crossing roadway or driveway shall be paved a minimum of 15 feet to minimize or eliminate gravel intrusion on the path. The pavement structure at the crossing should be adequate to sustain the expected loading at that location
- (7) *Bike Paths Parallel and Adjacent to Streets and Highways.* A wide separation is recommended between bike paths and adjacent highways (see Figure 1003.1B). **The minimum separation between the edge of traveled way of a one-way or a two-way bicycle path and the edge of traveled way of a parallel road or street shall be 5 feet plus the standard shoulder width. Bike paths within the clear recovery zone of freeways shall include a physical barrier separation.** The separation is unpaved and does not include curbs or sidewalks. Separations less than 10 feet from the edge of the shoulder are to include landscaping or other features that provide a continuous barrier to prevent bicyclists from encroaching onto the highway. Suitable barriers may include fences or dense shrubs if design speeds are less than or equal to 45 miles per hour. Obstacles low to the ground or intermittent obstacles (e.g., curbs, dikes, raised traffic bars, posts connected by cable or wire, flexible channelizers, etc.) are not to be used because bicyclists could fall over these obstacles and into the roadway.

Figure 1003.1B

Typical Cross Section of Class I Bikeway (Bike Path) Parallel to Highway

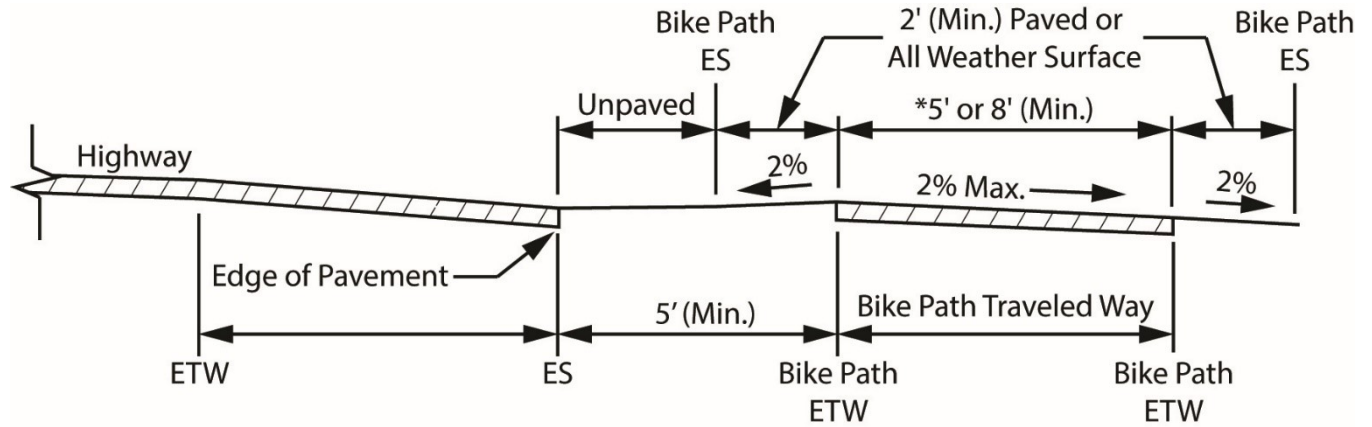

NOTE:

(1) See Index 1003.1(6) for guidance on separation between bike paths and highways.

*One-Way: 5' Minimum Width

Two-Way: 8' Minimum Width

July 1, 2020

Bike paths immediately adjacent to streets and highways are not recommended. While they can provide separation between vehicles and nonmotorized traffic, they typically introduce significant conflicts at intersections. In addition, they can create conflicts with passengers at public transit facilities, and with vehicle occupants crossing the path. They are not a substitute for designing the road to meet bicyclist's mobility needs. Use of bicycle paths adjacent to roads is not mandatory in California, and many bicyclists will perceive these paths as offering a lower level of mobility compared with traveling on the road, particularly for utility trips. Careful consideration regarding how to address the above points needs to be weighed against the perceived benefits of providing a bike path adjacent to a street or highway. Factors such as urban density, the number of conflict points, the presence or absence of a sidewalk, speed and volume should be considered.

(8) *Bike Paths in the Median of Highway or Roadway.* Bike paths should not be placed in the median of a State highway or local road, and shall not be in the median of a freeway or expressway. Bike paths in the median are generally not recommended because they may require movements contrary to normal rules of the road. Specific problems with such facilities may include:

- (a) Right-turns by bicyclists from the median of roadways are unexpected by motorists.
- (b) Devoting separate phases to bicyclist movements to and from a median path at signalized intersections increases intersection delay.
- (c) Left-turning motorists must cross one direction of motor vehicle traffic and two directions of bicycle traffic, which may increase conflicts.
- (d) Where intersections are infrequent, bicyclists may choose to enter or exit bike paths at midblock.
- (e) Where medians are landscaped, visibility between bicyclists on the path and motorists at intersections may be diminished. See Chapter 900 for planting guidance.

(9) *Bicycle Path Design Speed.* The design speed of bicycle paths is established using the same principles as those applied to highway design speeds. **The design speed given in Table 1003.1 shall be the minimum.**

Installation of "speed bumps", gates, obstacles, posts, fences or other similar features intended to cause bicyclists to slow down are not to be used.

(10) *Horizontal Alignment and Superelevation.* The minimum radius of curvature negotiable by a bicycle is a function of the superelevation of the bicycle path surface, the coefficient of friction between the bicycle tires and the bicycle path surface, and the speed of the bicycle.

For all bicycle path applications the maximum superelevation rate is 2 percent.

The minimum radius of curvature should be 90 feet for 20 miles per hour, 160 feet for 25 mile per hour and 260 feet for 30 miles per hour. No superelevation is needed for radius of curvature meeting or exceeding 100 feet for 20 miles per hour, 180 feet for 25 miles per hour, and 320 feet for 30 miles per hour. When curve radii smaller than those given because of right of way, topographical or other considerations, standard curve warning signs and supplemental pavement markings should be installed. The negative

Table 1003.1

Bike Path Design Speeds

Type of Facility	Design Speed (mph) ⁽¹⁾
Bike Paths with Mopeds Prohibited	20
Bike Paths with Mopeds Permitted	30
Bike Paths on Long Downgrades (steeper than 4%, and longer than 500')	30

NOTE:

⁽¹⁾On bike paths with mopeds prohibited, a lower design speed can be used for the crest vertical curve, equivalent to 1 mile per hour per percent grade for grades exceeding a vertical rise of 10 feet, when at a crest in path.

effects of nonstandard curves can also be partially offset by widening the pavement through the curves.

(11)*Stopping Sight Distance.* To provide bicyclists with an opportunity to see and react to the unexpected, a bicycle path should be designed with adequate stopping sight distances. **The minimum stopping sight distance based on design speed shall be 125 feet for 20 miles per hour, 175 feet for 25 miles per hour and 230 feet for 30 miles per hour.** The distance required to bring a bicycle to a full controlled stop is a function of the bicyclist's perception and brake reaction time, the initial speed of the bicycle, the coefficient of friction between the tires and the pavement, and the braking ability of the bicycle.

Stopping sight distance is measured from a bicyclist's eyes, which are assumed to be 4 ½ feet above the pavement surface to an object ½-foot high on the pavement surface.

(12)*Length of Crest Vertical Curves.* Figure 1003.1C indicates the minimum lengths of crest vertical curves for varying design speeds.

(13)*Lateral Clearance on Horizontal Curves.* Figure 1003.1D indicates the minimum clearances to line of sight obstructions, *m*, for horizontal curves. It is assumed that the bicyclist's eyes are 4 ½ feet above the pavement surface to an object ½-foot high on the pavement surface.

Bicyclists frequently ride abreast of each other on bicycle paths, and on narrow bicycle paths, bicyclists have a tendency to ride near the middle of the path. For these reasons, lateral clearances on horizontal curves should be calculated based on the sum of the stopping sight distances for bicyclists traveling in opposite directions around the curve. Where this is not possible or feasible, the following or combination thereof should be

July 1, 2020

Figure 1003.1C

Minimum Length of Bicycle Path Crest Vertical Curve (L) Based on Stopping Sight Distance (S)

$$L = 2S - \frac{1600}{A} \quad \text{when } S > L$$

Double line represents S = L

L = Minimum length of vertical curve – feet

A = Algebraic grade difference – %

$$L = \frac{AS^2}{1600} \quad \text{when } S < L$$

S = Stopping sight distance – feet

Refer to Index 1003.1(11) to determine “S”, for a given design speed “V”

Height of cyclist eye = 4½ feet

Height of object = ½ foot

A (%)	S = Stopping Sight Distance (ft)												
	70	90	110	125	130	150	170	175	190	210	230	250	270
3													7
4									20	60	100	140	
5							20	30	60	100	140	180	220
6		S > L				33	73	83	113	153	193	233	270
7				21	31	71	111	121	151	191	231	273	319
8			20	50	60	100	140	150	180	221	265	313	365
9		2	42	72	82	122	162	172	203	248	298	352	410
10		20	60	90	100	140	181	191	226	276	331	391	456
11		35	75	105	115	155	199	211	248	303	364	430	501
12	7	47	87	117	127	169	217	230	271	331	397	469	547
13	17	57	97	127	137	183	235	249	293	358	430	508	592
14	26	66	106	137	148	197	253	268	316	386	463	547	638
15	33	73	113	146	158	211	271	287	338	413	496	586	683
16	40	80	121	156	169	225	289	306	361	441	529	625	729
17	46	86	129	166	180	239	307	325	384	469	562	664	775

S < L

Figure 1003.1D

Minimum Lateral Clearance (m) on Bicycle Path Horizontal Curves

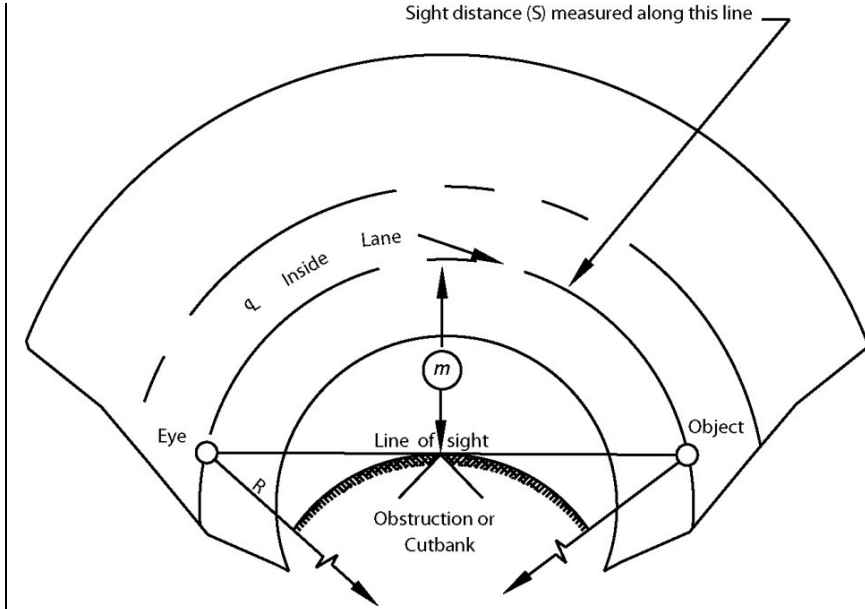

S = Sight distance in ft.

R = Radius of ϕ of lane in ft.

m = Distance from ϕ of lane in ft.

Refer to Index 1003.1(11) to determine "S" for a given design speed "V".

Angle is expressed in degrees

$$m = R \left[1 - \cos \left(\frac{28.65S}{R} \right) \right]$$

$$S = \frac{R}{28.655} \left[\cos^{-1} \left(\frac{R-m}{R} \right) \right]$$

Formula applies only when S is equal to or less than length of curve.

Line of sight is 28" above ϕ inside lane at point of obstruction.

Height of bicyclist's eye is 4 1/2 ft.

R (ft)	S = Stopping Sight Distance (ft)										
	60	80	100	120	140	160	180	200	220	240	260
25	15.9										
50	8.7	15.2	23.0	31.9	41.5						
75	5.9	10.4	16.1	22.8	30.4	38.8	47.8	57.4	67.2		
95	4.7	8.3	12.9	18.3	24.7	31.8	39.5	48.0	56.9	66.3	75.9
125		6.3	9.9	14.1	19.1	24.7	31.0	37.9	45.4	53.3	1.76
155		5.1	8.0	11.5	15.5	20.2	25.4	31.2	37.4	44.2	51.4
175		4.6	7.1	10.2	13.8	18.0	22.6	27.8	33.5	39.6	46.1
200		4.0	6.2	8.9	12.1	15.8	19.9	24.5	29.5	34.9	40.8
225			5.5	8.0	10.8	14.1	17.8	21.9	26.4	31.3	36.5
250			5.0	7.2	9.7	12.7	16.0	19.7	23.8	28.3	33.1
275			4.5	6.5	8.9	11.6	14.6	18.0	21.7	25.8	30.2
300			4.2	6.0	8.1	10.6	13.4	16.5	19.9	23.7	27.7
350				5.1	7.0	9.1	11.5	14.2	17.1	20.4	23.9
390				4.6	6.3	8.2	10.3	12.8	15.4	18.3	21.5
500					4.9	6.4	8.1	10.0	12.1	14.3	16.8
565					4.3	5.7	7.2	8.8	10.7	12.7	14.9
600					4.1	5.3	6.7	8.3	10.1	12.0	14.0
700						4.6	5.8	7.1	8.6	10.3	12.0
800						4.0	5.1	6.2	7.6	9.0	10.5
900							4.5	5.6	6.7	8.0	9.4
1000							4.0	5.0	6.0	7.2	8.4

July 1, 2020

provided: (a) the path through the curve should be widened to a minimum paved width of 14 feet; and (b) a yellow center line curve warning sign and advisory speed limit signs should be installed.

(14)*Grades.* Bike path grades must meet DIB 82. The maximum grade rate recommended for bike paths should be 5 percent. Sustained grades should be limited to 2 percent.

(15)*Pavement Structure.* The pavement material and structure of a bike path should be designed in the same manner as a highway, with a recommendation from the District Materials Branch. It is important to construct and maintain a smooth, well drained, all-weather riding surface with skid resistant qualities, free of vegetation growth. Principal loads will normally be from maintenance and emergency vehicles.

(16)*Drainage.* For proper drainage, the surface of a bike path should have a minimum cross slope of 1 percent to reduce ponding and a maximum of 2 percent per DIB 82. Sloping of the traveled way in one direction usually simplifies longitudinal drainage design and surface construction, and accordingly is the preferred practice. **The bike path shoulder shall slope away from the traveled way at 2 percent to 5 percent to reduce ponding and minimize debris from flowing onto the bike path.** Ordinarily, surface drainage from the path will be adequately dissipated as it flows down the gently sloping shoulder. However, when a bike path is constructed on the side of a hill, a drainage ditch of suitable dimensions may be necessary on the uphill side to intercept the hillside drainage. Where necessary, catch basins with drains should be provided to carry intercepted water under the path. Such ditches should be designed in such a way that no undue obstacle is presented to bicyclists.

Culverts or bridges are necessary where a bike path crosses a drainage channel.

(17)*Entry Control for Bicycle Paths.* Obstacle posts and gates are fixed objects and placement within the bicycle path traveled way can cause them to be an obstruction to bicyclists. Obstacles such as posts or gates may be considered only when other measures have failed to stop unauthorized motor vehicle entry. Also, these obstacles may be considered only where safety and other issues posed by actual unauthorized vehicle entry are more serious than the safety and access issues posed to bicyclists, pedestrians and other authorized path users by the obstacles.

The 3-step approach to prevent unauthorized vehicle entry is:

- (a) Post signs identifying the entry as a bicycle path with regulatory signs prohibiting motor vehicle entry where roads and bicycle paths cross and at other path entry points.
- (b) Design the path entry so it does not look like a vehicle access and makes intentional access by unauthorized users more difficult. Dividing a path into two one-way paths prior to the intersection, separated by low plantings or other features not conducive to motor vehicle use, can discourage motorists from entering and reduce driver error.
- (c) Assess whether signing and path entry design prevents or minimizes unauthorized entry to tolerable levels. If there are documented issues caused by unauthorized motor vehicle entry, and other methods have proven ineffective, assess whether the issues posed by unauthorized vehicle entry exceed the crash risks and access issues posed by obstacles.

If the decision is made to add bollards, plantings or similar obstacles, they should be:

- Yielding to minimize injury to bicyclists and pedestrians who may strike them.
- Removable or moveable (such as posts, bollards or gates) for emergency and maintenance access must leave a flush surface when removed.
- Reflectorized for nighttime visibility and painted, coated, or manufactured of material in a bright color to enhanced daytime visibility.
- Illuminated when necessary.
- Spaced to leave a minimum of 5 feet of clearance of paved area between obstacles (measured from face of obstacle to face of adjacent obstacle). Symmetrically about the center line of the path.
- Positioned so an even number of bicycle travel lanes are created, with a minimum of two paths of travel. An odd number of openings increase the risk of head-on collisions if traffic in both directions tries to use the same opening.
- Placed so additional, non-centerline/lane line posts are located a minimum of 2 feet from the edge of pavement
- Delineated as shown in California MUTCD Figure 9C-2.
- Provide special advance warning signs or painted pavement markings if sight distance is limited.
- Placed 10 to 30 feet back from an intersection, and 5 to 10 feet from a bridge, so bicyclists approach the obstacle straight-on and maintenance vehicles can pull off the road.
- Placed beyond the clear zone on the crossing highway, otherwise breakaway.

When physical obstacles are needed to control unauthorized vehicle access, a single non-removable, flexible, post on the path centerline with a separate gate for emergency/maintenance vehicle access next to the path, is preferred. The gate should swing away from the path.

Fold-down obstacle posts or fold-down bollards shall not be used within the paved area of bicycle paths. They are often left in the folded down position, which presents a crash hazard to bicyclists and pedestrians. When vehicles drive across fold-down obstacles, they can be broken from their hinges, leaving twisted and jagged obstructions that project a few inches from the path surface.

Obstacle posts or gates must not be used to force bicyclists to slow down, stop or dismount. Treatments used to reduce vehicle speeds may be used where it is desirable to reduce bicycle speeds.

For obstacle post visibility marking, and pavement markings, see the California MUTCD, Section 9C.101(CA).

(18)*Lighting.* Fixed-source lighting raises awareness of conflicts along paths and at intersections. In addition, lighting allows the bicyclist to see the bicycle path direction, surface conditions, and obstacles. Lighting for bicycle paths is important and should be considered where nighttime use is not prohibited, in sag curves (see Index 201.5), at

July 1, 2020

intersections, at locations where nighttime security could be a problem, and where obstacles deter unauthorized vehicle entry to bicycle paths. See Index 1003.1(17). Daytime lighting should also be considered through underpasses or tunnels.

Depending on the location, average maintained horizontal illumination levels of 5 lux to 22 lux should be considered. Where special security problems exist, higher illumination levels may be considered. Light standards (poles) should meet the recommended horizontal and vertical clearances. Luminaires and standards should be at a scale appropriate for a pedestrian or bicycle path. For additional guidance on lighting, consult with the District Traffic Electrical Unit.

1003.2 Class II Bikeways (Bike Lanes)

Design guidance that address the safety and mobility needs of bicyclists on Class II bikeways (bike lanes) is distributed throughout this manual where appropriate.

For Class II bikeway signing and lane markings, see the California MUTCD, Section 9C.04.

1003.3 Class III Bikeways (Bike Routes)

Class III bikeways (bike routes) are intended to provide continuity to the bikeway system. Bike routes are established along through routes not served by Class I or II bikeways, or to connect discontinuous segments of bikeway (normally bike lanes). Class III facilities are facilities shared with motor vehicles on the street, which may be indicated by placing bike route signs along roadways. Additional enhancement of Class III facilities can be provided by adding shared roadway markings along the route. For application and placement of signs and pavement markings, see the California MUTCD Sections 9B and 9C.

Minimum widths for Class III bikeways are represented, in the minimum standards for highway lanes and shoulder.

Since bicyclists are permitted on all highways (except prohibited freeways), the decision to designate the route as a bikeway should be based on the advisability of encouraging bicycle travel on the route and other factors listed below.

- (1) *On-street Bike Route Criteria.* To be of benefit to bicyclists, bike routes should offer a higher degree of service than alternative streets. Routes should be signed only if some of the following apply:
 - (a) They provide for through and direct travel in bicycle-demand corridors.
 - (b) Connect discontinuous segments of bike lanes.
 - (c) They provide traffic actuated signals for bicycles and appropriate assignment of right of way at intersections to give greater priority to bicyclists, as compared with alternative streets.
 - (d) Street parking has been removed or restricted in areas of critical width to provide improved safety.
 - (e) Surface imperfections or irregularities have been corrected (e.g., utility covers adjusted to grade, potholes filled, etc.).

(f) Maintenance of the route will be at a higher standard than that of other comparable streets (e.g., more frequent street sweeping).

- (2) *Sidewalk as Bikeway.* Sidewalks are not to be designated for bicycle travel. Wide sidewalks that do not meet design standards for bicycle paths or bicycle routes also may not meet the safety and mobility needs of bicyclists. Wide sidewalks can encourage higher speed bicycle use and can increase the potential for conflicts with turning traffic at intersections as well as with pedestrians and fixed objects.

In residential areas, sidewalk riding by young children too inexperienced to ride in the street is common. It is inappropriate to sign these facilities as bikeways because it may lead bicyclists to think it is designed to meet their safety and mobility needs. Bicyclists should not be encouraged (through signing) to ride their bicycles on facilities that are not designed to accommodate bicycle travel.

- (3) *Shared Transit and Bikeways.* Transit lanes and bicycles are generally not compatible, and present risks to bicyclists. Therefore sharing exclusive use transit lanes for buses with bicycles is discouraged.

Bus and bicycle lane sharing should be considered only under special circumstances to provide bikeway continuity, such as:

- (a) If bus operating speed is 25 miles per hour or below.
- (b) If the grade of the facility is 5 percent or less.

1003.4 Trails

Trails are generally, unpaved multipurpose facilities suitable for recreational use by hikers, pedestrians, equestrians, and off-road bicyclists. While many Class I facilities are named as trails (e.g. Iron Horse Regional Trail, San Gabriel River Trail), trails as defined here do not meet Class I bikeways standards and should not be signed as bicycle paths. Where equestrians are expected, a separate equestrian trail should be provided. See DIB 82 for trail requirements for ADA. See Index 208.7 for equestrian undercrossing guidance.

- Pavement requirements for bicycle travel are not suitable for horses. Horses require softer surfaces to avoid leg injuries.
- Bicyclists may not be aware of the need to go slow or of the separation need when approaching or passing a horse. Horses reacting to perceived danger from predators may behave unpredictably; thus, if a bicyclist appears suddenly within their visual field, especially from behind they may bolt. To help horses not be surprised by a bicyclist, good visibility should be provided at all points on equestrian paths.
- When a corridor includes equestrian paths and Class I bikeways, the widest possible lateral separation should be provided between the two. A physical obstacle, such as an open rail fence, adjacent to the equestrian trail may be beneficial to induce horses to shy away from the bikeway, as long as the obstacle does not block visibility between the equestrian trail and bicycle path.

See FHWA-EP-01-027, *Designing Sidewalks and Trails for Access* and DIB 82 for additional design guidance.

July 1, 2020

1003.5 Miscellaneous Criteria

The following are miscellaneous bicycle treatment criteria. Specific application to Class I, and III bikeways are noted. Criteria that are not noted as applying only to bikeways apply to any highway, roadways and shoulders, except freeways where bicycles are prohibited), without regard to whether or not bikeways are established.

Bicycle Paths on Bridges – See Topic 208.

- (1) *Pavement Surface Quality.* The surface to be used by bicyclists should be smooth, free of potholes, and with uniform pavement edges.
- (2) *Drainage Grates, Manhole Covers, and Driveways.* Drainage inlet grates, manhole covers, etc., should be located out of the travel path of bicyclists whenever possible. When such items are in an area that may be used for bicycle travel, they shall be designed and installed in a manner that meets bicycle surface requirements. See Standard Plans. They shall be maintained flush with the surface when resurfacing.

If grate inlets are to be located in roadway or shoulder areas (except freeways where bicycles are prohibited) the inlet design guidance of Index 837.2(2) applies.

Future driveway construction should avoid construction of a vertical lip from the driveway to the gutter, as the lip may create a problem for bicyclists when entering from the edge of the roadway at a flat angle. If a lip is deemed necessary, the height should be limited to ½ inch.

- (3) *At-grade Railroad Crossings and Cattle Guards.* Whenever it is necessary for a Class I bikeway, highway or roadway to cross railroad tracks, special care must be taken to ensure that the safety of users is protected. The crossing must be at least as wide as the traveled way of the facility. Wherever possible, the crossing should be straight and at right angles to the rails. For bikeways or highways that cross tracks and where a skew is unavoidable, the shoulder or bikeway should be widened, to permit bicyclists to cross at right angles (see Figure 1003.5). If this is not possible, special construction and materials should be considered to keep the flangeway depth and width to a minimum.

Pavement should be maintained so ridge buildup does not occur next to the rails. In some cases, timber plank crossings can be justified and can provide for a smoother crossing.

All railroad crossings are regulated by the California Public Utilities Commission (CPUC). All new bicycle path railroad crossings must be approved by the CPUC. Necessary railroad protection will be determined based on a joint field review involving the applicant, the railroad company, and the CPUC.

Cattle guards across any roadway are to be clearly marked with adequate advance warning. Cattle guards are only to be used where there is no other alternative to manage livestock.

The California MUTCD has specific guidance on Rail and Light Rail crossings. See Part 8 of the California MUTCD.

Figure 1003.5
Railroad Crossing Class I Bikeway

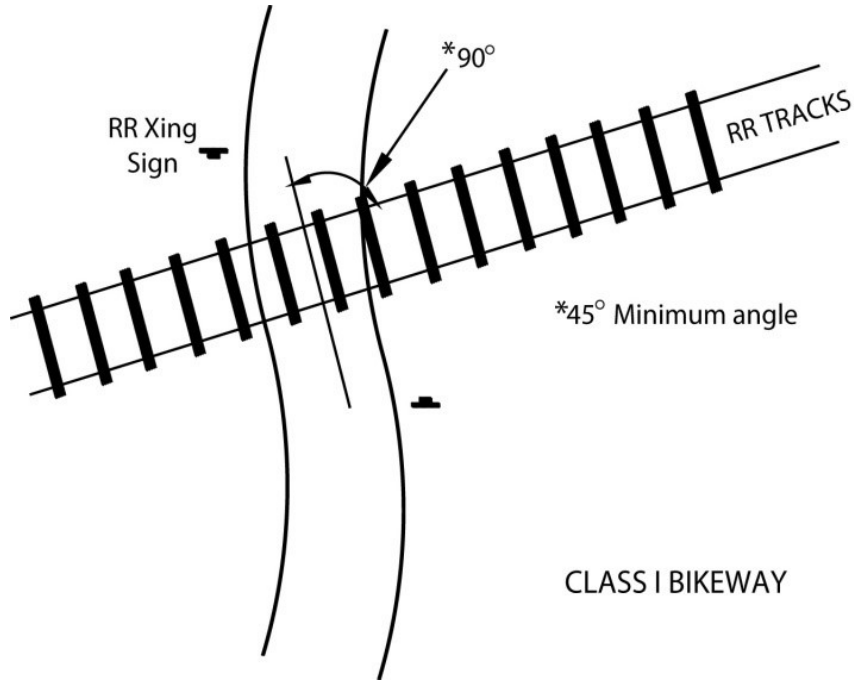

NOTE:

See Index 403.3 Angle of Intersection for Class II and Class III facilities.

CHAPTER 1100 – HIGHWAY TRAFFIC NOISE ABATEMENT

Topic 1101 – General Requirements

Index 1101.1 – Introduction

The abatement of highway traffic noise is a design consideration that is required by State and Federal Statutes and regulations and by Department policy. This chapter provides design standards relating to the location, height and length of noise barriers and includes discussion on alternative designs, maintenance and emergency access considerations and aesthetics of noise barriers. Procedures and policies on minimum attenuation, design goals, assessing noise impacts, noise abatement criteria levels, priorities, feasibility and reasonableness, and cost-effectiveness are contained in the Project Development Procedures Manual (produced by the Division of Design), the California Traffic Noise Analysis Protocol, and its companion publication, Technical Noise Supplement (both produced by the Division of Environmental Analysis).

1101.2 Objective

The objectives are: for new construction or reconstruction of highways, to limit the intrusion of highway noise into adjacent areas; on existing freeways to limit the noise intrusion to achievable levels within practical and financial limitations; and to limit the noise to the levels specified by statute for qualifying schools adjacent to freeways. To achieve these objectives the Department supports the following four approaches to alleviate traffic noise impacts:

- (1) *Reduction at the Source.* Reduction of traffic noise at the source is the most cost effective noise control strategy. Therefore, the Department encourages and supports design measures that reduce traffic noise impacts on adjacent roadside communities.

Designers are encouraged to consider mitigating traffic noise at the tire/pavement interface in order to minimize noise emanating from the highway. Quieter pavement strategies exist for flexible and rigid pavements on and off of structures. Refer to the Quiet Pavement Bulletin dated October 6, 2009 and the Pavement Program for more information. Low noise rumble strips are under development for reducing exterior roadside noise levels while maintaining or increasing interior vehicle noise and tactile feedback.

- (2) *Encouraging Compatible Adjacent Land Use.* The Department encourages local governments controlling development or land use near known highway locations to exercise their powers and responsibility to minimize the effect of highway vehicle noise through appropriate land use control. For example, cities and counties have the power to control development by the adoption of land use plans and zoning, subdivision, building and housing regulations.
- (3) *Noise Abatement.* The Department will attempt to locate, design, construct, and operate State highways to minimize the intrusion of traffic noise into adjacent areas. When this is not possible, noise impacts may be attenuated by the construction of noise barriers.

July 1, 2020

Construction of noise barriers must result in at least a 5 decibel reduction of noise at the impacted receptors.

(4) *Noise Abatement by Others.* An increasing number of requests are being made to the Department by owners or developers to attenuate noise reaching adjacent properties for which the State's mitigation priority is low or nonexistent. The general policy is that all feasible steps must be taken in the design of the adjacent development to attenuate noise so as not to require encroachment on the State's right of way. The State shall assume no review authority or responsibility of any kind for the structural integrity or the effectiveness of the sound attenuation of walls constructed by others outside of the State's right of way. Where it is determined to be necessary to permit others to construct a noise barrier within the State's right of way, the general policy is that the design will meet geometric, structural, acoustic, and safety standards as established in this and other manuals and that the effects of the barrier on operation, maintenance and aesthetics of the highway will be more beneficial than detrimental.

1101.3 Terminology

The terms “noise barrier” and “soundwall” are often used interchangeably. Technically, a “noise barrier” may be any feature which blocks, prevents or diminishes the transmission of noise. An earth berm could serve this purpose. A large building could serve as a noise barrier to shield receptors from the noise source. A dense growth of vegetation, if it were wide enough and dense enough, could be considered a noise barrier. Studies have shown, however, that adequate density would equate to a vegetative expanse of at least 100 feet. A “soundwall” is a particular type of noise barrier. It is a wall, which may be constructed of concrete panels, masonry blocks, wood boards or panels, or a variety of other materials.

1101.4 Procedures for Assessing Noise Impacts

Highway traffic noise impacts are identified in the project noise study report and are listed in the environmental document. The procedures for assessing noise impacts for new highway construction or reconstruction projects, retrofit projects (Community Noise Abatement Program - HB311) along existing freeways, and School Noise Abatement Projects (HB312), are included in Title 23, United States Code of Federal Regulations Part 772, the California Traffic Noise Analysis Protocol, the Project Development Procedures Manual, and Section 216 of the Streets and Highways Code.

1101.5 Prioritizing Construction of Retrofit Noise Barriers

Legal requirements and procedures for prioritizing the construction of noise attenuation barriers are provided in Section 215.5 of the Streets and Highway Code and in the California Traffic Noise Analysis Protocol.

Topic 1102 – Design Criteria

1102.1 General

This section covers the noise barrier location, various design aspects such as height and length of noise barriers, alternative designs, maintenance considerations, and aesthetic considerations. Various types of Department standards and pre-approved alternative noise barrier designs are referenced. Noise barrier design procedures, from the acoustical standpoint, are included in the California Traffic Noise Analysis Protocol. Noise level criteria and guidelines on noise reduction can be found in the California Traffic Noise Analysis Protocol and the Project Development Procedures Manual.

1102.2 Noise Barrier Location

- (1) *Lateral Clearances.* **Minimum lateral clearance to noise barriers shall be as provided in Topic 309.1, Horizontal Clearances, of this manual, but shall not be less than 10 feet.** Lateral clearances greater than the minimums should be used whenever feasible. Where terrain permits, the most desirable location for a noise barrier from a safety perspective is just inside the right of way or, alternatively, 30 feet or more from the traveled way.

When lateral clearance is 15 feet or less, the noise barrier shall be placed on a safety shape concrete barrier. Guardrail or safety shape barrier protection should be considered when the noise barrier is located between 15 feet and 30 feet from the edge of traveled way.

When the noise barrier is placed closer than 16 feet from the traveled way, Traffic Operations should be consulted early in the design. Signs (overhead and ground mounted) and other poles and standards for lighting, Transportation Management items, call boxes, etc. should be detailed for mounting on the wall, incorporated into the wall foundation and possibly recessed into the surface of the wall.

- (2) *Sight Distance Requirements.* The stopping sight distance is of prime importance for noise barriers located on the edge of shoulder along the inside of a curve. Horizontal clearances which reduce the stopping sight distance should be avoided. Noise barriers within gore areas should begin or end at least 200 feet from the theoretical curb nose location.
- (3) *Ultimate Location.* Noise barriers should be constructed at the ultimate location – at the appropriate height and upon the proper foundation – for the facility as discussed in the Project Development Procedures Manual and the California Traffic Noise Analysis Protocol.

1102.3 Noise Barrier Height and Position

- (1) *Minimum Height.* Noise barriers should have a minimum height of 6 feet (measured from the top of the barrier to the top of the foundation).
- (2) *Maximum Height.* Noise barriers should not exceed 14 feet in height (measured from the pavement surface at the face of the safety-shape barrier) when located 15 feet or less from the edge of the traveled way, and should not exceed 16 feet in height above the ground line when located more than 15 feet from the traveled way.
- (3) *Truck Exhaust Intercept.* Current FHWA noise barrier design procedures result in noise barrier heights which often do not intercept noise emitted from the exhaust stack of trucks. For design purposes, the noise barrier should intercept the line of sight from the exhaust stack of a truck to the receptor. The truck stack height is assumed to be 11.5 feet above the

July 1, 2020

pavement. The receptor is assumed to be 5 feet above the ground and located 5 feet from the living unit nearest the roadway. If this location is not representative of potential outdoor activities, then another appropriate location should be justified in the noise study report.

- (4) *Multi-story Development.* The noise barrier should not be designed to shield more than the first story of multi-story residences unless it provides a minimum reduction of 5 decibels for a substantial number of residences at a reasonable increase in cost. If the noise barrier is extended in height to provide attenuation beyond the first story, attenuation should effectively reduce noise by at least 5 decibels at the receptors precipitating the increase in height.
- (5) *Parallel Noise Barriers.* Frequently, noise barriers are constructed to shield noise receivers on both sides of a highway. These are referred to as parallel barriers. If the barrier surfaces are hard, relatively smooth, and nonporous, such as concrete or masonry surfaces, the barriers can reflect noise back and forth between the barriers, decreasing their effectiveness. As a result of research performed by the Department and others, reflective parallel barriers should have a width-to-height ratio (W:H) of at least 10:1 to avoid the risk of perceptible reduction in performance of both noise barriers. The width is the distance between the two barriers, and the height is the average height of both barriers with reference to the roadway elevation. For example, two parallel barriers, one 10 feet, the other 14 feet high, should be separated by at least 120 feet to avoid a noticeable degradation in performance. A perceptible, or noticeable decrease in performance is defined as a reduction of 3 decibels or more in noise attenuation.
- (6) *Potential Reflection.* Reflected noise may be an issue for elevated receptors on the opposite side of the roadway. Paving to the base of the noise barrier can create a 'hard' surface and in combination with a soundwall can form a concave shape which might focus sound energy on an opposite roadside community. When possible, keep the finish grade to the base of the noise barrier composed of less-reflective 'soft' material such as uncompacted dirt or ground vegetation. Parallel barriers (discussed above) may also raise reflected noise concerns. Traffic variation and metrological influences make noise measurements at large distances imprecise, while extensive noise studies in the past are inconclusive at finding any distinguishable or discernable change in acoustics due to reflection only. To address concerns and/or complaints regarding reflected noise, a number of absorptive noise barrier systems have been pre-approved for use both on and off of structures. The list of pre-approved absorptive noise barrier systems is available on the Division of Engineering Services Authorized Materials List at: <http://www.dot.ca.gov/aml/>.

1102.4 Noise Barrier Length

- (1) *General.* Careful attention should be given to the length of a noise barrier to assure that it provides adequate attenuation for the end dwelling. The California Traffic Noise Analysis Protocol provides guidance on determining how far beyond the end dwelling a noise barrier should be extended. When appropriate, consideration should be given to terminating the noise barrier with a section of the barrier perpendicular to the freeway. This could reduce the overall barrier length, but may require an easement or acquisition from the property owner to permit construction of the noise barrier off the right of way.
- (2) *Gap Closures.* In some cases, short gaps may exist between areas qualifying for a noise barrier. The closure of these gaps should be considered on a project by project basis and be justified in the project report.
- (3) *Local Street Connections.* At on- and off-ramp connections to local streets, the Department's responsibility for noise abatement should be limited to areas where the traffic noise level from the State highway is the predominant noise source.

- (4) *Barrier Overlaps.* When the noise barrier has overlapping sections, such as when concealing an access opening, the walls must be overlapped a minimum of 2.5 to 3 times the offset distance in order to maintain the integrity of the sound attenuation.

1102.5 Alternative Noise Barrier Designs

- (1) *General.* Every noise barrier that is constructed as a part of new highway construction or reconstruction, or along freeways as a part of the Community and School Noise Abatement Programs, requires at least two alternative designs included in the bid package. Bridge Reference Specifications 51-561(51SWAL), located on the Division of Engineering Services (DES) website provides the means to include alternative soundwall systems in the bid package. The contract plans should include masonry block as the state design and at least one of the approved soundwall systems listed in the Specification 51-56 (51SWAL). An aesthetic features sheet should be included in the plans for both the masonry block soundwall and for each of the alternatives selected.

The masonry block soundwall sheets (B15-1 to B15-15) can be found in the Standard Plans.

Other design alternatives may be considered provided they meet the structural and noise attenuation criteria. Questions regarding the approval status of various designs or products should be directed to the Division of Design, Office of Innovative Design and Delivery.

Project Files for each noise barrier project should include the justification and background for the design type or the options allowed on each project.

- (2) *Design Procedures.* As a minimum, the soundwall plans are to show each of the following:

- Horizontal alignment
- Wall profile made up of a top of Soundwall line and a Top of Footing/Concrete, Barrier/Retaining Wall line
- Applicable standard soundwall detail sheets
- Pile spacing
- Footing steps
- Locations of expansion joints
- Access gates
- Aesthetic features sheet

The following guidance should also be used:

- If the profile grade of the soundwall exceeds six (6) percent, the Top of the Soundwall line should be stepped.
- If the soundwall is on a footing and the Top of Soundwall line is stepped, the Top of Footing line should also be stepped.
- If the Top of Soundwall line is parallel to the profile grade, the Top of Footing line should be parallel to the profile grade of the soundwall.
- If the soundwall is on a concrete barrier, the Top of Concrete Barrier line must be constant height above the profile grade and the Bottom of Concrete Barrier line should be shown on the plans.

If the soundwall is on a Retaining Wall, the Top of Retaining Wall line or the Bottom of Footing line and Retaining Wall height should be shown on the plans.

July 1, 2020

- The original ground (OG) line and any known utilities should be shown on the Soundwall Plan sheets.

(3) *Pay Quantities.* Soundwalls are to be measured by the square foot between the elevation lines shown on the plans and the length of the wall. Soundwall footings are to be paid as minor concrete and concrete barriers are to be paid for as concrete barrier (modified). Piles are to be paid for separately to facilitate minor changes in the field.

Refer to the Standard Special Provisions for more information on measurement and pay quantities.

When calculating costs for determining “reasonableness,” all pay quantities associated with the proposed soundwalls should be included in the analysis. Refer to the California Traffic Noise Analysis Protocol for a discussion on this topic.

(4) *Working Drawings.* Working Drawings are no longer required for state designed masonry block soundwalls in view of the fact that all the information necessary to construct the wall should be shown in the contract plans. The Special Provisions for Alternative Soundwall systems should require the successful bidder to submit four (4) sets of drawings for initial review and between six (6) and twelve (12) additional sets, as requested by the Engineer, for final approval and use during construction. Refer to Bridge Reference Specification 51-561(51SWAL) for more information.

(5) *Preliminary Site Data.* In using the "Top of Soundwall/Bottom of Concrete Barrier" line concept, it is important that the preliminary site data be as complete as possible. To eliminate or minimize construction change orders the following guidance is provided:

- Provide accurate ground line profiles.
- Select only standard or pre-approved design alternative soundwall types.
- Provide adequate information based on foundation investigation.
- Locate overhead and underground utilities.
- Review drainage and show any modifications on the plans.
- Determine and specify architectural treatment.
- Determine the need for special design, and coordinate with the Office of Structures Design during the early stages of design.

1102.6 Noise Barrier Aesthetics

(1) *General.* A landscaped earth berm or a combination wall and berm tend to minimize the apparent noise barrier height and are an aesthetically acceptable alternative among noise barrier options; however, these alternatives are not always suitable for many sites due to limited space.

Some additional cost to enhance the aesthetic quality of the noise barrier is usually warranted. Early community involvement toward proposing aesthetic treatment improvements on noise barriers is recommended to accommodate contextual considerations. However, accountability for designs that significantly increase the cost of the noise barrier should be a topic for discussion early in the design process.

Soundwalls should not be designed with abrupt beginnings or ends. Generally, the ends of the soundwall should be tapered or stepped if the height of the soundwall exceeds 6 feet. See Standard Plans for further details. Consult the District Landscape Architect regarding the design of tapers or stepped ends, aesthetic treatment, highway planting and landscaping adjacent to noise barriers. Refer to DIB 88 for additional information.

- (2) *Aesthetic Treatment.* Standard aesthetic treatments have been developed by the DES Office of Structure Design for the various alternative materials.

When treatment that is not a standard aesthetic treatment is proposed for noise barriers, contact the District Landscape Architect for selection of the most appropriate treatment. The District Traffic Engineer or designee should be consulted in these instances to ensure that the treatment of choice satisfies all safety requirements.

- (3) *Planting Near Noise Barriers.* The use of plants in conjunction with noise barriers can help to combat graffiti and promote public acceptance of the noise barrier. When landscaping is to be placed adjacent to the soundwall, which will eventually screen a substantial portion of the wall, only minimal aesthetic treatment is justified. Coordinate with District Maintenance when planting near or on noise barriers.

See Index 904.7 and the Project Development Procedures Manual for additional information.

- (4) *Transparent Barriers.* Noise barriers may impact viewsheds where consideration of transparent barriers may be warranted. A list of pre-qualified transparent barrier systems is available on the Authorized Materials List at: <http://www.dot.ca.gov/aml/>.

1102.7 Maintenance Consideration in Noise Barrier Design

- (1) *General.* Noise barriers placed within the area between the shoulder and right of way line complicate the ongoing maintenance operations. When there is a substantial distance behind the noise barriers and in front of the right of way line, special consideration is required. If the adjoining land is occupied with streets, roads, parks, or other large parcels, an effort should be made during the right of way negotiations to have the abutting property owners maintain the area. In this case, the chain link fence at the right of way line would not be required. Maintenance by others may not be practical if a number of small individual properties abut the noise barrier.
- (2) *Access Requirements.* Access to the back side of the noise barrier must be provided if the area is to be maintained by the Department. In subdivided areas, access can be via local streets, when available. If access is not available via local streets, access gates or openings are essential at intervals along the noise barrier. Access may be provided via offsets in the barrier. Offset barriers must be overlapped a minimum of 2.5 to 3 times the offset distance in order to maintain the integrity of the sound attenuation of the main barrier. Location of the access openings must be coordinated with the District maintenance office.
- (3) *Noise Barrier Material.* The alternative materials selected for the noise barrier should be appropriate for the environment in which it is placed. For walls that are located at or near the edge of shoulder, the portion of the noise barrier located above the safety-shape concrete barrier should be capable of withstanding the force of an occasional vehicle which may ride up above the top of the safety barrier.

1102.8 Emergency Access Considerations in Noise Barrier Design

- (1) *General.* In addition to access gates being constructed in noise barriers to satisfy the Department's maintenance needs, they may also be constructed to provide a means to access the freeway in the event of a catastrophic event which makes the freeway impassable for emergency vehicles. These gates are not intended to be used as an alternate means of emergency access to adjacent neighborhoods. Access to those areas should be planned and provided from the local street system. Small openings may also be provided in the noise barrier which would allow a fire hose to be passed through it. Local

July 1, 2020

emergency response agencies should be contacted early in the design process to determine the need for emergency access gates and fire hose openings.

- (2) *Emergency Access Gate Requirements.* Access gates in noise barriers should be kept to a minimum and should be at least 1,000 feet apart. Locations of access should be coordinated with the District Maintenance office. Only one opening should be provided at locations where there is a need for access openings to serve both the emergency response agency and the Department's maintenance forces. Gates should be designed to comply with the soundwall details developed by the Office of Structures Design.
- (3) *Fire Hose Access Openings.* When there is no other means of providing fire protection to the freeway, small openings for fire hoses may be provided. Fire hose access should be located as close as possible to the fire hydrants on the local street system. Where possible, fire hose access should be combined with emergency or maintenance access openings. The Office of Structures Design should be requested to design fire hose access openings.

1102.9 Drainage Openings in Noise Barrier

Drainage through noise barriers is sometimes required for various site conditions. Depending on the size and spacing, small, unshielded openings at ground level can be provided in the barriers to allow drainage and not adversely impact the noise attenuation of the barrier. The following sizes of unshielded openings at ground level are allowed for this purpose:

- (a) Openings of 8" x 8" or smaller, if the openings are spaced at least 10 feet on center.
- (b) Openings of 8" x 16" or smaller, if the openings are spaced at least 20 feet on center, and the noise receiver is at least 10 feet from the nearest opening.

The location and size of the drainage openings need to be designed based on the hydraulics of the area. The design should take into consideration possible erosion problems that may occur at the drainage openings.

Where drainage requirements dictate openings that do not conform to the above limitations, shielding of the opening will be necessary to uphold the noise attenuation of the barrier. The shielding designed must consider the hydraulic characteristics of the site. When shielding is determined to be necessary, consultation with the District Hydraulics Unit and the District Traffic Safety Engineer or designee is recommended, as well as the Division of Environmental Analysis.

A

AASHTO STANDARDS	Policy on Use of	82.3
ABANDONMENT	Water Wells	110.2
ABBREVIATIONS	Official names	61.1
ABRASION		855.2
ACCELERATION LANE	At Rural Intersections	405.1
ACCESS CONTROL	Definition	62.6
		104
	Alignment, Existing	104.3
	Alignment, New	104.3
	Frontage Roads	104.3
	Frontage Roads Financed by Others	104.3
	General Policy	104.1
	Highways, Definition	62.3
	Interchanges	504.8
	Intersections	405.6
	Openings	104.2
	Openings, Financial Responsibility	205.5
	Openings on Expressways	205.1
	Openings in Relation to Median Openings	104.5
	Rights, Protection of	104.4
ACCESSIBILITY REQUIREMENTS	Curb Ramps, Guidelines for	105.4
	Driveways	205.3
	Provisions for Disabled Persons	105.3
	Refuge Areas	403.7
	Roadside Sites	912.1
ACCIDENT DATA	Intersections	402.2
ACCRETION	Definition	806.2
ACQUISITION	Definition	62.6
	Partial	62.6
	of Material and Disposal Sites	111.5
ADT/AADT	see AVERAGE DAILY TRAFFIC	
AESTHETIC FACTORS	Contour Grading and Slope Rounding	304.4
	In Design	109.3
	Landscape Architecture Design	901.2
	Materials and Color Selection	705
	Noise Barrier	1102.6

December 31, 2020

	Retaining Walls	210.5
AGGRADATION	Definition	806.2
AGGREGATE BASE	see BASE Engineering Criteria	663
AGGREGATE SUBBASE	Engineering Criteria	663
AGGRESSIVE	Definition	806.2
AGREEMENTS	Drainage, Cooperative	803.2
	Materials	111.4
AIR POLLUTION	Control of Burning	110.3
	Control of Dust	110.3
AIR RIGHTS		62.6
AIRWAY-HIGHWAY		207
	Clearances	207.2
	Submittal of Data	207.3
ALIGNMENT	Aesthetic Factors	109.3
	Bridges	203.9
	Channel	862.2
	Consistency (Horizontal)	203.3
	Controls (Horizontal)	203.1
	Coordination (Horizontal/Vertical)	204.6
	Culverts	823.2
	Horizontal	203
	Vertical (Grade)	204
ALLEY	Definition	62.3
ALLUVIUM	Definition	806.2
ALTERNATIVES FOR CULVERT PIPES		857
ALUMINUM PIPE		852.5
ANGLE OF INTERSECTION		403.3
APPRAISAL		62.6
APPROACH SLABS, STRUCTURE	New Construction Projects	208.11
	Rehabilitation Projects	209.4
APPROVALS	Nonstandard Design Features	82.2
	Proprietary Items	110.10
	Special Designs	606.2
AREAS OF CONFLICT	Intersections	403.2
ARTERIAL	Minor, Definition	81.4

	Principal, Definition	81.4
AQUEDUCT	Definition	806.2
AQUIFER	Definition	806.2
		841.2
ARCH CULVERTS		852.3
		852.4
		852.5
		852.6
ARMOR		873.3
ARTERIAL HIGHWAYS		62.3
ARTESIAN WATERS	Definition	806.2
ASPHALT CONCRETE	see FLEXIBLE PAVEMNT	
ASPHALT TREATED PERMEABLE BASE	Definition	62.7
	Catalog	623.1
	Design, Asphalt Pavement	633.1
	Pavement Drainage	662.3
AUXILIARY LANES		62.1
	Interchange	504.5
AVAILABLE HEAD, USE OF		821.1
		821.4
AVERAGE DAILY TRAFFIC		62.8
		103.1
AVULSION	Definition	806.2
AXIS OF ROTATION	Superelevation	202.4
AXLE LOADS, EQUIVALENT SINGLE	see EQUIVALENT SINGLE AXLE LOADS	

B

BACKFILL, CULVERTS		829.2
BACKWATER	Definition	806.2
		821.4
		864.4
BAFFLE		873.4
BANK	Definition	806.2
	Guide	873.4

December 31, 2020

	Protection, Definition	806.2
BANK PROTECTION		870
	Armor	873.3
	Design, Concepts	873.1
	Design, High Water and Hydraulics	873.2
	Geomorphology and Site Considerations	872.3
	Training	873.4
BARRIER	Concrete on Walls	210.6
	Median	305.3
	Noise	1100
	Railing	208.10
BASE	Definitions	62.7
	Aggregate	662.1
	Asphalt Treated	662.2
	Asphalt Treated Permeable	662.3
	Cement Treated	662.2
	Cement Treated Permeable	662.3
	Description	602.1
	Engineering Criteria	663
	Granular, Untreated	662.1
	Hot Mix Asphalt Concrete	662.2
	Lean Concrete	662.2
	Treated Permeable	662.3
BASEMENT SOIL	see SUBGRADE	
BASIN CHARACTERISTICS	Elevation	812.7
	Land Use	812.4
	Orientation	812.8
	Shape	812.2
	Size	812.1
	Slope	812.3
	Soil & Geology	812.5
	Storage	812.6
BEDLOAD	Definition	806.2
		851.2
BENCHES	Drains	834.4
	Slope	304.3
BERM		835
BIKEWAY	Class I, Design Criteria	1003
	Class II Width	301.2
	Class III	1003.3
	Class IV	1002.1

	Definitions	62.1 1001.4
	Design Considerations	404.2
	Facilities	1002
	Markings	1004
	Overcrossings	208.6
	Planning Criteria	1002
	Railings	208.10
	Refuge Areas	403.7
	Standards	1000
	Traffic Control Devices	1004
	Trails	1003.4
	Undercrossings	208.6
BITUMINOUS	Coatings On Pipes	852.4
BORDER INSPECTION STATIONS		107.3
BORROW	Definition	62.7
BRANCH CONNECTION		62.4
	Freeway-to-freeway	504.4
	Interchange, Entrances and Exits	504.2
BRIDGE REPLACEMENT & REHABILITATION PROGRAM		43.3
BRIDGES		208
	Alignment	203.9
	Approach Railing	208.10
	Clearances	309
	Deer Crossing	208.8
	Definition	62.2
	Embankment Slopes	208.5
	Equipment Crossings	208.8
	Falsework Clearance	204.8
	Flood Design	821.3
	Grade Line	204.7
	Overloads	110.1
	Slope Treatment, End	707
	Structure Depth	204.8
	Structure, Open End	208.5
	Types of Structures	62.2
	also see GRADE SEPARATION STRUCTURES	
BROKEN-BACK CURVE	see CURVES	
BULBOUTS	see CURB, EXTENTIONS	
BULKHEADS	Type	873.3 883.3

December 31, 2020

BULKING	Definition	806.2
	Factors	813.8 861.2 864.3
BUSBAYS	see CURB, EXTENTIONS	
BUSBULBS	see CURB, EXTENTIONS	
BUSINESS DISTRICT	Definitions	62.6
BYPASS HIGHWAY		62.3
C		
CALIFORNIA OPERATIONAL SAFETY AND HEALTH (CAL-OSHA)		
	Tunnel Safety Orders	110.12
CALIFORNIA R-VALUE	Definition	62.7
	Measurement of	614.3
	Record Keeping	605.1
CALIFORNIA ROAD SYSTEM MAP		81.4
CAMBER	Definition	806.2 829.2
CANTILEVER WALLS		210.1
CAPACITY	Drainage Structure	806.2
	Highway	102
	Intersection	402.1
	Operational Features Affecting Design	402.1
	Ramp Intersection	406
CAPILLARITY	Definition	806.2
CAPILLARY WATER	Definition	806.2 841.2
CAPITAL PREVENTATIVE MAINTENANCE		603.3
CATCH BASIN	Definition	806.2
	Inlets	837.2
CATCH POINT	Clearance to Right of Way Line	304.2
	Side Slope Standards	304.1
CATTLE PASSES		208.8
CEMENT TREATED PERMEABLE BASE	also see BASE Definition	62.7

CENTRAL ANGLE		203.4
CENTRIFUGAL FORCE	Formula	202.1
	Superelevation	202
CHAIN LINK	Fences	701.2
	Railings, Bridges	208.10
CHANNEL, ROADSIDE	Alignment & Grade	862.2
	Changes	867
	Characteristics	813
	Cross Section	863
	Design Consideration	861
	Flow Classifications	866.2
	Flow Equations	866.3
	Linings	865
	Stability	864
	Unlined	861.9
CHANNELIZATION		62.4
	Design Standards	405
	Left-turn	405.2
	Principles of	403
	Right-turn	405.3
CHANNELIZATION, PRINCIPLES OF		403
	Angle of Intersection	403.3
	Areas of Conflict	403.2
	Major Movements	403.1
	Points of Conflict	403.4
	Precautions	403.12
	Prohibited Turns	403.8
	Refuge Areas	403.7
	Signal Control	403.9
	Speed-change Areas	403.5
	Summary	403.11
	Traffic Control Devices	403.10
	Turning Traffic	403.6
CHECK DAM	Definition	806.2
CIENEGA	Definition	806.2
CLEANOUT	Definition	806.2
		842.4
CLEAR DISTANCE	Stopping Sight Distance on Horizontal Curves	201.6
CLEAR RECOVERY ZONE		309.1
CLEARANCES		309

December 31, 2020

	Airway-highway	207
	Falsework	204.6
	Lateral, for Elevated Structures	309.4
	Minimum	309.1
	Pedestrian Over Crossings	309.2
	Railroad	309.5
	Signs, Vertical	309.2
	Slope to Right of Way Line	304.2
	Structures, Horizontal	309.1
	Structures, Vertical	309.2
	Tunnel	309.3
CLIMATE	Pavement Map	615
CLIMBING LANES	Transitions	206.2
	Sustained Grades	204.5
CLOVERLEAF INTERCHANGE	Local Streets	502.2
	Freeway-to-freeway	502.3
COATINGS	Pipe	852.4
COEFFICIENT OF ROUGHNESS	Channels	866.3
	Conduit	851.2
COEFFICIENT OF RUNOFF	Definition	806.2
		819.2
COLLECTOR ROAD	Definition	62.3
		81.4
COLLISIONS		402.2
COLORS, SELECTION	Concrete	705.1
	Steel Structures	705.2
COMFORT FACILITIES	Safety Roadside Rest Area	913
COMFORTABLE SPEEDS	see MAXIMUM COMFORTABLE SPEED	
COMMERCIAL DRIVEWAYS		205
COMMUNITY NOISE ABATEMENT PROGRAM		1101.4
COMPOSITE PAVEMENT	Definition	62.7
	Engineering Properties	642.1
	Mechanistic-Empirical Method	606.3
	New Construction	643
	Pavement Preservation	644
	Performance Factors	642.2
	Reconstruction	643
	Rehabilitation	645

December 31, 2020

	Types	641
COMPOUND CURVES		203.5
	Superelevation	202.6
CONCENTRATED FLOW	Definition	806.2
CONCENTRATION	Drainage, Definition	806.2
CONCRETE	Base, Lean	62.7
		662.2
	Gravity Walls	210.2
	Painting	705.1
	Pavement, Rigid	620
	Portland Cement Pavement (PCCP)	
	see RIGID PAVEMENT	
	Retaining Walls	210.2
CONDEMNATION	Definition	62.6
	Inverse	62.6
CONDUIT	Cross Section	851.2
	Definition	806.2
	Irrigation	905.3
	Protective Coating	854.3
CONGESTION MITIGATION AND AIR QUALITY		
IMPROVEMENT PROGRAM (CMAQ)		43.2
CONNECTIONS	Access Openings on Expressways	205.1
	Branch	62.4
	Branch Interchange, Entrances and Exits	504.2
	Driveways on Frontage Roads	205.4
	Driveways on Rural Roads	205.4
	Driveways on Urban Roads	205.3
	Financial Responsibility	205.5
	Freeway-to-freeway	62.4
		504.4
	Freeway with Local Roads	106.2
	Local Facility	203.1
	Private Road	205.2
	Roadway	107.1
CONSERVATION OF MATERIALS AND ENERGY		110.11
CONSTRUCTIBILITY	Pavement	618.2
CONTINUOUSLY REINFORCED CONCRETE PAVEMENT		621.2
	also see RIGID PAVEMENT	

December 31, 2020

CONSTRUCTION	Freeway Connections with Local Roads	106.2
	Initial and Stage	106.1
	Temporary Features	82.1
	Temporary Pavements and Detours	612.6
CONTOUR GRADING		304.4
	Aesthetics	109.3
CONTRACTORS YARDS/PLANT SITES		112
CONTRAST TREATMENT		704
	Policy	704.1
CONTROL	Drainage, Definition	806.2
	Erosion	110.2
		906
	Traffic, Devices	62.8
		403.10
	Traffic, Special Problems	110.7
CONTROL OF ACCESS	see ACCESS CONTROL	
CONTROL OF POLLUTION	see POLLUTION CONTROL	
CONTROLLED ACCESS HIGHWAY		62.3
CONTROLLING CRITERIA		82.1
CONVENTIONAL HIGHWAYS		62.3
	Sidewalks	105.1
COORDINATION WITH OTHER AGENCIES		108
	Transit Loading Facilities	108.2
	Divided Nonfreeway Facilities	108.1
	with FHWA	108.3
COST REDUCTION INCENTIVE PROPOSALS	Walls	210.4
COUNTERFORT WALLS		210.2
CRASH CUSHIONS		702.1
CRIB WALLS		210.2
CRITICAL	Depth, Definition	806.2
	Flow, Definition	806.2
	Slope, Definition	806.2
	Velocity, Definition	806.2
CROSS DRAINAGE		820
CROSS SECTION	City Streets and County Roads	308.1
	Clear Recovery Zone,	309.1
	Effects on Drainage	833

December 31, 2020

	Frontage Roads	310.1
	Geometric	62.1
	Grade	204.2
	Multilane, All Paved	307.5
	Multilane, Divided	307.4
	Multilane, 2R & 3R Criteria	307.6
	Outer Separation	310.2
	State Highway	307
	Two-lane, New Construction	307.2
	Two-lane, 2R & 3R	307.3
	Warrants for	307.1
CROSS SECTION, OTHER THAN STATE HIGHWAY ROADS		308
	City and County Roads	308.1
CROSS SECTION, STATE HIGHWAY	see CROSS SECTION	
CROSS SLOPES	Effects on Drainage	833
	Gutter	303.2
	Median	305.2
	Pavement	301.2
	Shoulder	302.2
	Structures	208.2
CROSSINGS	Bicycle	208.6
	Deer	208.8
	Equestrian	208.7
	Equipment	208.8
	Pedestrian	208.6
	Railroad	104.3
CUL-DE-SAC STREET		62.3
CULVERTS	Alignment & Slope	823.4
	Alternative Pipes	857
	Anchorage	829.5
	Available Head	821.4
	Backwater	825.1
	Bedding & Backfill	829.2
	Box and Arch	852.3
	Bridges	821.3
	Buoyant Forces	826.3
	Camber	823.2
	Choice of Type	851.2
	Culvert Design System	825.3
	Curvature	823.2
	Definition	806.2
	Design Discharge	821.2
	Design Flood, Definition	806.2

December 31, 2020

Design Frequency, Definition	806.2
Design Storm, Definition	806.2
End Treatment	826.2
Entrance Design	826
Entrance Riser	826.3
Gradeline	823.2
Headwall	826.3
Headwater	821.4
Height of Cover	829.2
	856
Hydrologic Considerations	821.2
Improved Inlets	826.4
Inlet Control	825.2
Joints	829.4
Length	854.1
Minimum Cover	828.3
Multiple Pipes	856.5
Outlet Design	824.2
Piping	827
Roughness	829.3
Sag	851.2
Service Life	829.7
Settlement	855
Slope	829.2
Transitions	823.2
Type Selection	826.4
	824
CURB RAMPS	105.4
Guidelines for	105.4
Policy and Procedure	105.3
CURBS	303
Bridges	303.5
Design Considerations	404.2
Extensions	303.4
Frontage Roads and Streets	303.6
General Policy	303.1
Grade Separations	303.5
Gutter Pan, Cross Slope	303.2
Median	305.4
Position of	303.5
Ramps	504.3
Returns, for City Streets	405.8
Structures	303.5
Types and Uses	303.2

CURVES	Broken-back	203.7
	Compound	203.5
	Compound, Superelevation of	202.6
	Horizontal	203
	Length and Central Angle	203.4
	Location of Ramp on	504.2
	Maximum Comfortable Speeds	202.2
	Radius	203.2
	Ramp Widening	504.3
	Reversing	203.6
	Reversing, Superelevation Transition for	202.5
	Spiral	203.8
	Superelevation	202
	Three-Center	405.7
	Vertical	204.4
CUT WIDENING		304.3
D		
D-LOAD	Cracking D-Load	856.2
	Definition	806.2
	Reinforced Concrete Pipe	852.1
DAM		829.9
DEAD END STREET	Definition	62.3
DEBRIS		813.8
	Barrier, Definition	806.2
	Basin, Definition	806.2
	Bulking	813.8
	Control Structure	822.2
	Definition	806.2
	Rack, Definition	806.2
	Riser	822.2
DECELERATION LANE		403.4
	Left Turns	405.2
	Right Turns	405.3
DECISION SIGHT DISTANCE		201.7
DEER CROSSINGS		208.8
DEFENSE ROUTE	Rural and Single Interstate Routes	309.2
DEFINITIONS		62
	Drainage	806.2

December 31, 2020

	Pavement Structural Section	62.7
	Deflection Studies	635.1
DEGRADATION	Definition	806.2
DELAY	Definition	62.8
DENSITY		62.8
DESIGN	Bank Protection	873.1
	Capacities	102
	Designation	103
	Discharge	811.3
	Discharge, Estimating	819
	Flood, Establishing	818.2
	Frequency, Definition	806.2
	Geometric Standards	200
	Hourly Volume	103.1
	Hourly Volume, Definition	62.8
	Interchange	504
	Intersection	405
	Period	103.2
	Philosophy	81.1
	Shore Protection	883.1
	Speed (see DESIGN SPEED)	
	Standards, Applications	80
	Storm	821.2
	Storm, Definition	806.2
	Wave Heights	883.2
DESIGN DESIGNATION	Design Period	103.2
	Relation to Design	103.1
DESIGN HOURLY VOLUME		62.8
		103.1
DESIGN LIFE	Pavement	612
	Relation to Design Period	103.1
DESIGN SPEED		101
	Definition	62.8
	Entrances & Exits	504.2
	Freeway-to-freeway Minimum	504.4
	Freeway Entrances & Exits	504.2
	Local Facility	101.1
	Scenic Values	109
	Selection	101.1
	Standards	101.2
DESIGN VEHICLE	Definition	62.10

December 31, 2020

		404
	Transit	404.2
	California Truck	404.2
	Offtracking	404.1
	STAA Truck	404.2
	Swept Width	404.2
	Tracking With	404.2
	Turning Templates	404.3
	Wheelbase	404.2
DESIGN VOLUME	see DESIGN HOURLY VOLUME	
DESIGN, FACTORS AFFECTING		401
	Bicycles	401.6
	Driver	401.2
	Environment	401.4
	General	401.1
	Pavement	611
	Pedestrian	401.5
	Vehicle	401.3
DESIGN, OPERATIONAL FEATURES AFFECTING		402
	Accidents	402.2
	Capacity	402.1
	Undesirable Geometric Features	402.2
DESIGNATION, DESIGN	Design Period	103.2
	Relation to Design	103.1
DETOURS		110.7
	Local Roads Used as	106.2
DETRITUS	Definition	806.2
DHV	see DESIGN HOURLY VOLUME	
DIAMOND INTERCHANGE		502.2
DIKES	Frontage Roads and Streets	303.6
	General Policy	303.1
	Guide, Earthen	873.4
	PCC Grouted Riprap	873.4
	Position of	303.5
	Ramp	504.3
	Toe, Earthen	873.4
	Types and Uses	303.3
DISCHARGE	Definition	806.2
	Design	811.3
	Estimating	819
	Peak	811.3

December 31, 2020

DISPOSAL SITES/MATERIALS SITES		111
	Acquisition of	111.5
	Environmental Requirements	111.1
	Information Furnished to Prospective Bidders	111.3
	Investigation of Local Material Sources	111.2
	Mandatory, on Federal-aid Projects	111.6
	Material Arrangements	111.4
DISTANCE, CLEAR	Stopping Sight Distance on Horizontal Curves	201.6
DITCHES	Grade	834.3
	Side	303.2
		834.3
	Slope	834.3
DIVERGING		62.8
DIVERSION	Definition	806.2
DIVIDED HIGHWAY	Definition	62.3
	Grade Line	204.2
DIVIDED NONFREEWAY FACILITY		108.1
DIVISION OF DESIGN		10
DOWEL BAR		622.7
	Definition	62.7
DOWNDRAINS	Definition	806.2
	Flume	834.4
	Pipe	834.4
DRAIN	Edge System (see EDGE DRAIN)	
DRAINAGE	Area, Definition	806.2
	Area	819.2
	Basic Policy	803.1
	Channels	861
	Computer Programs	819.6
		825.3
	Cooperative Projects Policy	803.2
	Course, Definition	806.2
	Definition	806.2
	Design Responsibility	802.1
	Detention Basins	891.3
	Divide, Definition	806.2
	Easement, Definition	806.2
	Economics of Design	801.5
	Galleries	841.5
	Glossary of Terms	806.2

December 31, 2020

	Median	834.2
	Objectives of Design	801.4
	Pavement	650
	by Pumping	839
	Roadway	830
	Section, Duties of	802.1
	Subsurface	840
	System, Definition	806.2
DRAINS	Anchorage	834.4
	Benches	834.4
	Entrance Standards	834.4
	Geotextile	841.5
	Horizontal	841.5
	Outlet Treatment	834.4
	Overside, Spacing & Location	834.4
	Service Life	857.1
		857.2
	Slope	834.4
	Subsurface Types	841.5
DRIVEWAYS		205
	Access Openings on Expressways	205.1
	Commercial	205.3
	Financial Responsibility	205.5
	Frontage Roads	205.4
	Local Standards	205.3
	Pedestrian Access	205.3
	Private, Definition	62.3
	Residential	205.3
	Rural Areas	205.4
	Urban	205.3
DRY WEATHER FLOWS	Definition	806.2
DUFF	Site Preparation	904.2
E		
EARTH RETAINING SYSTEMS	Anchored Wall	210.2
	Cantilever Wall	210.2
	Concrete Gravity Wall	210.2
	Counterfort Wall	210.2
	Crib Wall; Concrete, Steel and Timber	210.2
	Drainage	210.8
	Electroliers and Signs	210.8

December 31, 2020

	Footings	210.8
	Gabion Basket Wall	210.2
	Gravity Wall	210.2
	L-Type Wall	210.2
	Masonry Wall	210.2
	Mechanically Stabilized Wall	210.2
	Non-Gravity Cantilevered Walls	210.2
	Proprietary	210.2
	Reinforced Embankments	210.2
	Rock Gravity Wall	210.2
	Rock/Soil Anchors	210.2
	Safety Railings	210.6
	Salvaged Material Retaining Wall	210.2
	Secant Soldier Pile Wall	210.2
	Sheet Pile Wall	210.2
	Slurry Diaphragm Wall	210.2
	Soil Mix Wall	210.2
	Soil Nail Wall	210.2
	Soil Reinforcement Systems	210.2
	Soldier Pile Wall with Lagging	210.2
	Tangent Soldier Pile Wall	210.2
	Tire Anchored Timber Wall	210.2
	Utilities	210.8
EARTHQUAKE CONSIDERATIONS		110.6
EASEMENT	Definition	62.6
	Definition	806.2
ECONOMIC ANALYSIS	see LIFE-CYCLE COST ANALYSIS	
EDDY LOSS	Definition	806.2
EDGE DRAIN		651.2
	System, Definition	62.7
ELECTROLIERS AND SIGNS	Walls	210.7
EMBANKMENT	Definition	62.7
	Side Slope Standards	304
	Slopes at Structures	208.5
	Structure Approach Embankment	208.11
EMINENT DOMAIN	Definition	62.6
ENCROACHMENT	Definition	62.6
END OF FREEWAY	Connections with Local Roads	106.2
ENDWALL	Definition	806.2
ENERGY	Dissipator, Definition	806.2

December 31, 2020

	Dissipator	827.2
	Grade Line, Definition	806.2
	Head, Definition	806.2
ENTRANCE	Design (Hydraulic)	826
	Freeway Interchange	504.2
	Head, Definition	806.2
	Loss, Definition	806.2
ENVIRONMENTAL REQUIREMENTS	Transit Loading Facilities	108.2
	Contractor's Yard and Plant Site	112
	FHWA	108.3
	Material Sites and Disposal Sites	111
	Median Width	305.1
	Project Development	81.1
	Special Considerations	110
EQUALIZER	Definition	806.2
	826.3	
EQUESTRIAN TRAILS	see TRAILS, MULTIPURPOSE	
EQUESTRIAN	Definition	62.10
	Undercrossing and Overcrossing	208.7
EQUIPMENT CROSSINGS		208.8
EQUIVALENT SINGLE AXLE LOADS	Definition	62.7
	Conversion ESAL to Traffic Index	613.3
	ESAL Constants	613.3
	Lane Distribution Factors	613.3
	Projections, Truck Traffic	613.3
EROSION	And Accretion, Definition	806.2
	Control, Channel & Shore	871.1
	Control, General	906.1
	Control, Planting	906.3
	Control, Sediment Control	906.2
	Control, Soil Surface Protection	906.2
	Control, Water Pollution	110.2
	Definition	806.2
	Permanent Erosion Control Establishment	906.5
EVAPORATION	Definition	806.2
		812.8
		814.4
		819.2
EXITS	Freeway Interchange	504.2
EXPRESSWAY		62.3

December 31, 2020

F

FAA	Abbreviation	61.1
	Notice Requirements	207.3
FACTORS AFFECTING INTERSECTION DESIGN		
	see DESIGN, FACTORS AFFECTING	
FALSEWORK		204.8
	Grade Line	204.8
	Vertical Clearance	204.8
	Width of Traffic Openings	204.8
	Worker Safety	204.8
FAN	Definition	806.2
FEDERAL-AID		40
	Funding Determination	44
	Programs (see also PROGRAMS)	43
	System	42
FEDERAL LANDS PROGRAM		43.4
FENCES		701
	Approval	701.1
	Barbed Wire, Type BW	701.2
	Chain Link	701.2
	Exceptions to Standard Types	701.2
	Freeways and Expressways	701.2
	Location of	701.2
	Locked Gates	701.2
	Median	701.2
	on Other Highways	701.3
	Policy and Purpose	701.1
	Retaining Walls	210.6
	Safety Roadside Rest Area Layout	913.3
	Standard Types	701.2
	Vinyl-clad	705.1
	Weathering Type Steel	705.1
	Wire Mesh, Type WM	701.2
FHWA	Approval of Locked Gates	701.2
	Approval of Mandatory Sites	111.6
	Coordination With	108.7
	Federal-aid	40
FILTER FABRIC		841.5

December 31, 2020

FLAP GATES	Definition	806.2
		821.6
		838.5
FLARED END SECTION		826.3
		834.4
FLEXIBLE PAVEMENT	Definition	62.7
	Aged Residue (AR)	632.1
	Analytical Depth	635.2
	Transit Pads	636.4
	California R-value	633.1
	Climate Region	632.1
	Cold in-Place Recycled Asphalt	635.1
	Concrete Overlay	635.1
	Data Collection	635.2
	80th percentile Deflection	635.2
	Deflection Studies	635.2
	Empirical Method	633.1
	Engineering Analysis Software	637
	Full Depth Hot Mix Asphalt	633.1
	Gravel Equivalent	633.1
	Gravel factor (G_r)	633.1
	Grouping	635.2
	Hot Mix Asphalt (HMA)	631
	Hot Mixed Asphalt Base	633.1
	Hot Recycled Asphalt	635.2
	International Roughness Index (IRI)	635.2
	Intersections	636.3
	Lean Concrete Base (LCB)	635.2
	Lime Treated Subbase	633.1
	Mainline	636.1
	Mill and Overlay	635.2
	Open Graded Friction Course (OGFC)	631.4
	Park & Ride Facilities	636.4
	Pavement Condition Report	635.2
	Pavement Preservation	634
	Percent Reduction in Deflection	635.2
	Percent Reduction in deflection required at the Milled depth	635.2
	Performance Factors	633.2
	Performance Graded (PG)	632.1
	Polymer modified binders	632.1
	RHMA-G	631.4
	RHMA-O	631.4
	Ramp Termini	636.1
	Reflective crack retardation	635.2
	Remove and Replace	635.2

December 31, 2020

	Ride Quality	635.2
	Roadside Facilities	636.4
	Safety Roadside Rest Areas	636.4
	Rubberized HMA	631.5
	SAMI-R	631.8
	Shoulders	636.2
	Smoothness	635.2
	Stress Absorbing Membrane Interlayers (SAMI)	631.8
	Structural Adequacy	635.2
	Test Sections	635.2
	Tolerable Deflection at the Surface (TDS)	635.2
	Tolerable Deflections	635.2
	Traffic Index (TI)	633.1
	Traveled Way	636.1
	Treated Permeable Base (TPB)	633.1
	Wearing Course	633.1
	Whitetopping	635.2
FLOOD	Base	818.1
	Control Projects	803.2
	Design	818.1
	Design Criteria, Recommended	821.3
		831.3
	Greatest of Record	821.3
	Magnitude	817
	Maximum Historical	818.1
	Measurement	817.2
	Plain, Definition	806.2
	Plane, Definition	806.2
	Stage, Definition	806.2
	Waters, Definition	806.2
FLOW	Channel	816.6
	Critical	864.3
	Definition	806.2
	Line	806.2
	Subcritical	864.3
	Supercritical	864.3
FREE	Outlet, Definition	806.2
	Water, Definition	806.2
FREEBOARD	Definition	806.2
		866
FREEWAY		62.3
	Classified Landscape	62.5
	Entrances and Exits at Interchanges	504.2

	900
FREEWAY CONNECTIONS WITH EXISTING ROADS	106.2
FREEWAY-TO-FREEWAY CONNECTIONS	62.4
	504.4
Branch Connections	504.4
Grade Line	204.2
Grades	504.4
Lane Drops	504.4
Metering	504.3
	504.4
Shoulder Width	504.4
FREEWAY-TO-FREEWAY INTERCHANGES	502.3
FRENCH DRAINS	Definition 806.2
	841.5
FRICITION FACTORS	202.1
FRONTAGE ROADS	Definition 62.3
	Cross Section Standards 310
	Access Control 104.3
	Cross Section 310.1
	Curbs 303.6
	Driveways 205.4
	Financed by Others 104.3
	Headlight Glare 310.3
	Horizontal Clearance 309.1
	Outer Separation 310.2
	Railroad Crossings 104.3
	Sidewalks 105.1
FUNDING	44
	Federal-Aid Eligibility 44.1
	Federal Participation Ratio 44.2
FUNNELING	403.1
G	
GALLERIES	Drainage 841.5
GEOMETRIC CROSS SECTIONS	300
	Definition 62.1
GEOMETRIC DESIGN	Definition 62.4
	Structure Standards 200

December 31, 2020

	Undesirable Geometric Features, Intersections	402.2
GEOTECHNICAL DESIGN REPORT		113
	Content	113.2
	Local Materials Sources	111.2
	Policy	113.1
	Side Slope Standards	304.1
	Submittal and Approval	113.3
GORE		62.4
	Contrasting Surface Treatment	504.2
	Paved Gore	504.2
GRADE	Cross Section, Position with Respect to	204.2
	to Drain, Definition	806.2
	Freeway Entrance Standards	504.2
	Freeway Exit Standards	504.2
	Freeway-to-freeway Connection Standards	504.4
	General Controls	204.1
	Horizontal Alignment, Coordination with	204.6
	Ramps	504.2
	Rolling Profile	204.1
	Safety Roadside Rests	912.1
	Separate Lines	204.7
	Separation	62.4
	Separation Structures	208
	Separation, Pedestrian	105.2
	Standards	204.3
	Stopping Sight Distance at Crests	201.4
	Stopping Sight Distance at Sags	201.5
	Structures	204.8
	Sustained Grades	204.5
	Vertical Curves	204.4
GRADE LINE	Bridge Decks	204.8
	Depressed, Under Structures	204.8
	General	204.1
	Separate	204.7
	Structures	204.8
GRADE SEPARATION STRUCTURES		208
	Cattle Passes, Equipment, and Deer Crossings	208.8
	Cross Slope	208.2
	Curbs	303.5
	Equestrian Undercrossing	208.7
	Median	208.3
	Open End Structures	208.5
	Pedestrian	105.2

	Pedestrian Overcrossings and Undercrossing	208.6
	Railings	208.10
	Railroad Underpasses and Overheads	208.9
	Sidewalks	208.4
	Widths	208.1
GRADIENT (SLOPE)	Definition	806.2
GRADING PLANE	Definition	62.7
GRATED LINE DRAIN		837.2
GRAVEL EQUIVALENT		635.2
GRAVITY WALL		210.2
GROIN		883.3
GROUND WATER	Definition	806.2
		841.2
GUARDRAIL	Bridge Approach Railings	208.10
	References	702
GUIDE BANK		873.4
GUTTER PAN	Cross Slope	303.2
	General Policy	303.1
	Uses, Curb Types	303.2
GUTTERS, SIDE		834.3
	Capacity	836.2
	Grade	836.2
	Intersection, at	836.2
	Types	836.1
	Valley	836.2

H

HAULING	Overloaded Material/Equipment , Design for	110.1
HEAD	Available	821.4
HEADLIGHT GLARE		310.3
HEADLIGHT SIGHT DISTANCE	Grade Sags	201.5
HEADWAY		62.8
HIGH SPEED RAIL	Definition	62.10
	Clearances	309.1
HIGHWAY		62.3

December 31, 2020

	Capacity	102
	Context	81.6
	Controlled Access	62.3
	Conventional	62.3
	Federal Lands Program	43.4
	Interstate, Definition	81.4
	Major	62.3
	National Highway System	42
	Parkway	62.3
	Pedestrian Facilities	105
	Radial	62.3
	Route Numbers	21.2
	Scenic	62.3
	State System	81.4
	Structures, Definitions	62.2
	Structures, Grade Line	204.8
	Through	62.3
	Types, Definitions	62.3
HIGHWAY DESIGN MANUAL STANDARDS		82.1
HORIZONTAL ALIGNMENT	Aesthetic Factors	109.3
	Alignment Consistency	203.3
	Bridges	203.9
	Broken Back Curves	203.7
	Compound Curves	203.5
	Curve Length and Central Angle	203.4
	General Controls	203.1
	Grade, Coordination with	204.6
	Radius	203.2
	Reversing Curves	203.6
	Standards for Curvature	203.2
	Spiral Transition	203.8
HORIZONTAL CLEARANCE	Bridges	309.1
	Between Elevated Structures	309.4
	Clear Distance	201.6
	Noise Barriers	1102.2
	Off-track Maintenance	309.5
	Railroad Walkway	309.5
	Railroads, Adjacent to	309.5
	Retaining Walls	309.1
	Structure	309.1
	Tunnels	309.3
HORIZONTAL DRAINS		841.5
HOT MIX ASPHALT CONCRETE BASE		

December 31, 2020

	also see BASE Engineering Criteria	663
HOT MIXED ASPHALT		631.1
	also see FLEXIBLE PAVEMENT	
HYDRAULIC	Gradient, Definition	806.2
	Jump, Definition	806.2
	Mean Depth, Definition	806.2
	Mean Depth	864.3
	Radius, Definition	806.2
HYDRAULIC DESIGN DISCHARGE	Empirical Methods	819.2
	Field Investigation	815.3
	Hydrograph Methods	816.5
	Rational Methods	819.2
	Regional Analysis	819.2
	Statistical Methods	819.3
	Summary of Methods	819.1
HYDROGRAPH	Definition	806.2
		816.5
	SCS Triangular	819.4
	Synthetic	819.4
	Unit	819.4
HYDROGRAPHY	Definition	806.2
HYDROLOGIC DATA	Basin Characteristics	812
	Federal Agencies	815.3
	Field Investigations	815.3
	Precipitation	815.2
		815.3
	Rainfall	815.5
	Sources	815.3
	Stream Flow	815.4
	Surface Runoff	815.2
	Transfer of Data	819.5
HYDROLOGICAL ANALYSIS	Gumbel Extreme Value Distribution	819.3
	Log Normal Distribution	819.3
	Log Pearson Type III Distribution	819.3
	Objectives	811.2
	Rational Methods	819.2
	Regional Analysis Methods	819.2
	SCS Triangular Hydrograph	819.4
	Synthetic Hydrograph	819.4
	Unit Hydrograph	819.4
HYDROLOGY	Definition	806.2

December 31, 2020

		811.1
HYDROPLANING	Definition	831.4
I		
INFILTRATION		602.1
		819.2
	Definition	806.2
INITIAL CONSTRUCTION	and Stage	106.1
INLETS	Combination	837.2
	Curb Opening	837.2
	Grate	837.2
	Hydraulic Design	837.4
	Location and Spacing	837.3
	Pipe Drop	837.2
	Time, Definition	806.2
	Transition	826.4
	Types	837.2
	Use of	837.1
INSPECTION STATIONS, BORDER		107.3
INTERCHANGES	Access Control	504.8
	Aesthetic Factors	109.3
	Approval of Design	503.2
	Auxiliary Lanes	504.5
	Cloverleaf	502.2
	Concepts	501.1
	Data Required for Design	503.1
	Definition	62.4
	Design, Procedure	503
	Design, Standards	504
	Diamond	502.2
	Elements	62.4
	Freeway Entrances and Exits, Design	504.2
	Freeway-to-freeway	502.3
	Freeway-to-freeway Connections, Definition	62.4
	Freeway-to-freeway Connections, Standards	504.4
	Freeway-to-freeway, Minimum Design Speed	504.4
	Freeway-to-freeway Omission of Movements	502.3
	Grade Separations	62.4
	Grades Exits/Entrances	504.2
	Lane Reduction	504.6
	Local Streets	502.2

Parallel Street Systems	502.2
Ramps	504.3
Reviews	503.2
Sight Distance for Planting	904.6
Single Point Interchange	502.2
Spacing	501.3
Traffic	500
Trumpet	502.2
Two-quadrant Cloverleaf	502.2
Types	502
Warrants	501.2
Weaving Sections	504.7
also see RAMPS	

INTERMODAL SURFACE TRANSPORTATION

EFFICIENCY ACT (ISTEA)	40
-------------------------------	----

INTERSECTION

Access Control	405.6
Accidents	402.2
Angle of Intersection	403.3
Areas of Conflict	403.2
Bicycle, Affecting Design of	401.6
Capacity	402.1
Capacity, Ramps	406
Channelization	403
Definition	62.4
Design, Factors Affecting	401
Design, Operational Features Affecting	402
Design, Standards	405
Design Vehicle	404
Driver, Affecting Design of	401.2
Environment, Affecting Design of	401.4
General, Factors Affecting Design	401.1
at Grade	400
Grade Separations	62.4
Left-turn Channelization	405.2
Major Movement, Preference to	403.1
Median Openings	405.5
Operational Features	402
Pedestrian, Affecting Design of	401.5
Points of Conflict	403.4
Precautions	403.12
Prohibited Turns	403.8
Public Road	405.7
Ramp	406
Refuge Area	403.7
Returns and Corner Radii, City Street	405.8

December 31, 2020

	Right-turn Channelization	405.3
	Right-turn Lanes at Off Ramp	405.3
	Roundabout, Definition	62.4
	Sight Distance	405.1
	Signal Control	403.9
	Speed-change Areas	403.5
	Traffic Control Devices	403.10
	Traffic Islands	405.4
	Turning Traffic	403.6
	Types	401.5
	Undesirable Geometric Features	402.2
	Vehicle, Affecting Design of	401.3
	Widening at Signalized Intersections	405.9
INTERSTATE	Definition	81.4
	Funding	42.2
	Numbering	21.2
INUNDATE	Definition	806.2
INVERSE CONDEMNATION	Definition	62.6
INVERT	Definition	806.2
	Paving, Definition	806.2
	Paving	852.1
		852.4
		853.6
	Protection	852.4
		852.5
INVERTED SIPHON	Definition	806.2
		829.7
IRRIGATION		905
	Conduit	905.3
	Design, General	905.1
	System Equipment	905.4
	Temporary	905.5
	Water Supply	905.2
ISLAND		62.4
	Traffic	405.4
ISOHYETAL	Line, Definition	806.2
	Map, Definition	806.2
ISOVEL	Definition	806.2
ISTEA		41.1
		42.2

J

JACK	Definition	806.2
JACKING OPERATIONS	Definition	806.2
JETTY	Definition	806.2
	Types	873.4
JOINT	Longitudinal	62.7
	Pavement	622.4
	Seals	62.7
JOINT BANK PROTECTION COMMITTEE		802.3
JOINT PLAIN CONCRETE PAVEMENT		621.2
	also see RIGID PAVEMENT	
JOINTS	Culverts	829.4
		854.1
JUNCTION STRUCTURES		838.5

K

KINEMATIC WAVE EQUATION		816.6
KIRPICH EQUATION		816.6
K-RAIL		204.8

L

L-TYPE WALL		210.2
LAG	Definition	806.2
LAMINAR FLOW	Definition	806.2
LANDSCAPE	Aesthetic Factors	109.3
	Architecture, Definitions	62.5
	Architecture - Roadsides	900
	Architecture – Roadside Sites	910
	Design Standards	901.2
LANE	Addition	206.2
	Addition on Ramps	504.3
	Auxiliary	62.1
		504.5

December 31, 2020

	Climbing	204.5
		206.2
	Deceleration	405.2
		405.3
	Definitions	62.1
	Drops	206.3
Drops on Freeway-to-freeway Connectors		504.4
	Drops on Ramps	504.3
	Express Toll Lanes	62.8
	High-Occupancy Vehicle	62.8
	High Occupancy Toll	62.8
	Left Turn	405.2
	Managed, Definition	62.8
	Median, Definition	62.1
	Multiple, Definition	62.1
	Numbering	62.1
	Passing	204.5
	Reductions	206.3
	Reduction at Interchanges	504.6
	Right Turn	405.3
	Separate Turning	403.6
	Speed Change	403.5
	Speed Change, Definition	62.1
	Traffic, Definition	62.1
	Two-way Left-turn Lanes	405.2
	Width	301.1
	Width on Curves	504.3
	Width of Opening for Falsework	204.8
	Width, Ramps	504.3
LATERAL	Definition	806.2
		838.4
		838.5
LEAN CONCRETE BASE	see BASE	
	Definition	62.7
	Engineering Criteria	662
	Design, Flexible (Asphalt) Pavement	635.2
	Capital Preventive Maintenance (CAPM)	624.2
LEFT-TURN CHANNELIZATION		405.2
LEFT-TURN REFUGE		403.7
LEGISLATION		41
	ISTEA	41.1
LEVEE	Definition	806.2

LEVEL OF SERVICE	Definition	62.8
		102
LIFE-CYCLE COST ANALYSIS (LCCA)		619
LIME	Treatment Definition	614.4
	Use of	633.1
LIME TREATED SUBBASE	see SUBBASE	
LOAD TRANSFER DEVICE	see DOWEL BAR	
LOADING FACILITIES	Transit	108.2
LOCAL STREETS/ROADS	Cross Section	308.1
	Definition	62.3
		81.4
	Design Speed	101.1
	Driveways	205.3
	Grade	204.1
	Horizontal Alignment	203.1
	Interchanges	502.2
	Returns and Corner Radii	405.8
	Superelevation	202.7
LOCKED GATES		701.2
LOG OF TEST BORINGS		210.8

M

MAINTAINABILITY	Pavement	618.1
MAINTENANCE	Definitions	62.7
MAINTENANCE VEHICLE PULLOUT	Definition	62.1
MAINTENANCE YARDS	On Freeways	107.2
MAJOR STREET/MAJOR HIGHWAY	Definition	62.3
MANDATORY MATERIAL SITES	Federal-aid Projects	111.6
MANNING	Equation	866.3
	Roughness Coefficient	851.2
		866.3
MARKERS		702.1
	Contrast Treatment	704.1
MATERIALS	Availability, Pavement	617.1
	Color Selection for Steel Structures	705.2
	Conservation of	110.11

December 31, 2020

	Hauling, Overloaded Design	110.1
	Information Furnished to Prospective Bidders	111.3
	Plants	112
	Recycling, Pavement	617.2
	Report (see MATERIALS REPORT)	
	Sites	111
	Sites, Acquisition	111.5
	Sites, Arrangements	111.4
	Sites, Environmental Requirements	111.1
	Sites, Investigation of Local Sources	111.2
	Sites, Mandatory	111.6
	Special Treatment	705.1
MATERIALS REPORT	Content	114.3
	Local Materials Sources	111.2
	Policy	114.1
	Preliminary	114.4
	Requesting	114.2
	Retention of Records	114.5
	Reviews	114.5
MAXIMUM COMFORTABLE SPEED	Chart	202.2
	Superelevation	202.2
MAY	Definition and Usage	82.1
MEAN VELOCITY		864.3
MECHANISTIC-EMPIRICAL		606.3
MEDIAN	Definition	62.1
	Aesthetic Factors	109.3
	Barriers	305.3
	Cross Slope	305.2
	Curbs	305.4
	Decking on Bridge	208.3
	Fencing	701.2
	Grade	834.2
	Lane	62.1
	Left-turn Lane	405.2
	Openings	405.5
	Paved	305.5
	Position	303.5
	Separate Roadways	305.6
	Standards	305
	Tree Planting	904.5
	Width	305.1
MERGING	Definition	62.8

December 31, 2020

METEOROLOGY	Evapo-transpiration	814.4
	Rainfall	814.2
	Snow	814.3
	Tides and Waves	814.5
	Tsunami	814.5
METERING		504.3
	Definition	62.8
	Freeway-to-Freeway Connections	504.4
	Lane Merges	206.3
	Ramp Lane Drops	504.3
MINIMUM TURNING RADIUS	Definition	62.4
MINOR ARTERIAL	Definition	81.4
MISCELLANEOUS STANDARDS		700
	Fences	701
	Guardrail	702
	Mailboxes	702
	Markers	702
MUD FLOW	Definition	806.2
MULTILANE CROSS SECTIONS	All Paved	307.5
	Divided	307.4
MULTIPLE LANES	Definition	62.1
MULTIPLE PIPES		824.2
N		
NATIONAL HIGHWAY SYSTEM		42.1
NAVIGABLE WATERS	Definition	806.2
NEGATIVE PROJECTING CONDUIT	Definition	806.2
NOISE ABATEMENT		1100
	By Others	1101.2
	Objective	1101.2
	Prioritizing	1101.5
	Terminology	1101.3
NOISE BARRIERS	Aesthetics	1102.6
	Alternate Designs	1102.5
	Clearances	1102.2
	Design Criteria	1102
	Design Procedures	1102.5

December 31, 2020

	Drainage Openings	1102.9
	Emergency Access	102.8
	Heights	1102.3
	Lengths	1102.4
	Location	1102.2
	Maintenance Considerations	1102.7
	Pay Quantities	1102.5
	Planting	904.6
		1102.6
	Preliminary Site Data	1102.5
	Sight Distance Requirements	1102.2
NONFREEWAY FACILITIES	Conversion to Divided	108.1
NONMOTORIZED TRAFFIC	Provisions for	104.3
NORMAL DEPTH	Definition	806.2
		864.2
O		
OFF-SET LEFT-TURN LANE	Definition	62.4
OFF-SITE DRAINAGE	Definition	806.2
OFFTRACKING	Definition	62.4
	Design Considerations	404.1
ON-SITE DRAINAGE	Definition	806.2
ON-STREET PARKING	Definition	62.1
		402.3
OPEN CHANNEL	Definition	62.8
OUTER SEPARATION	Definition	62.1
		310.2
OUTFALL	Definition	806.2
OUTWASH	Definition	806.2
OVERFLOW	Channel	861.5
OVERLAND FLOW		816.6
OVERLAYS	Asphalt On Structure Decks	607.6
	Definitions	62.7
OVERLOADS	Design for	110.1

P

PAINTING	Concrete	705.1
	Steel	705.2
PARALLEL STREET SYSTEMS	Interchanges	502.2
PARK AND RIDE LOTS		915
	Definition	62.5
	Pavement Structural Section Design	636.4
PARKING	Area Design	912.2
PARKWAY	Definition	62.3
PARTIAL ACQUISITION	Definition	62.6
PASSING LANE		204.5
PASSING SIGHT DISTANCE		201.2
PAVEMENT/PAVEMENT STRUCTURE	Capital Preventive Maintenance	603.3
	Composite see COMPOSITE PAVEMENT	
	Condition Survey	603.3
	Cross Slopes	301.2
	Definition	62.7
	Design Life, Definition	62.7
	Design Life	612
	Detours	603.6
	Drainage, Impact of	651.1
	Flexible see FLEXIBLE PAVEMENT	
	Joints	622.4
	Layers	602
	New	603.1
	Performance see PAVEMENT SERVICE LIFE	62.7
	Portland Cement Concrete	603
	Preservation	603.3
	Reconstruction	603.5
	Reductions	206.3
	Rehabilitation, Roadway	603.4
	Rehabilitation, Definition	62.7
	Rigid see RIGID PAVEMENT	
	Tapered Edge	302.3
	Serviceability, Definition	62.7
	Service Life, Definition	62.7
	Structure	62.7
	Surface Course	62.7
	Temporary	603.6
	Transitions	206
	Transitions for Freeways, Temporary	206.4

December 31, 2020

	Type Selection	611.2
	Types of Projects	603
	Widening	603.2
	Width	301.1
PEAK FLOW	Definition	806.2
		811.3
PEDESTRIAN FACILITIES		105
	Accessibility Requirements	105.3
	Bridges	208.4
	Conventional Highways	105.1
	Crosswalk, Definition	62.4
	Curb Ramps, Guidelines	105.4
	Design Considerations	404.2
	Freeway Facilities	105.1
	Frontage Roads	105.1
	Grade Separations	105.2
	Pedestrian, Definition	62.10
	Overcrossings	105.2
	Overcrossing/Undercrossing, Standards	208.6
	Railings	208.10
	Refuge, Definition	62.4
	Refuge Areas	403.7
	Replacement in Kind	105.1
	School Walkways	105.1
	Sidewalks	105.1
	Sidewalks, Definition	62.1
	Sidewalks, Structures	208.4
	Trails	1003.4
	Undercrossings	105.2
		208.6
PERCHED WATER	Definition	806.2
		841.4
PERCOLATING WATERS	Definition	806.2
PERMEABILITY	Definition	806.2
		841.2
PHYSICALLY DISABLED PERSONS		
	see ACCESSIBILITY REQUIREMENTS	
PIPE	Alternative Pipe Culvert Selection Procedure Using AltPipe	857.2
	Cast in Place Concrete	852.2
	Concrete Box and Arch, Strength Requirements	852.3
	Corrugated Aluminum Pipe and Arch, Strength Requirements	852.5
	Corrugated Steel Pipe and Arch, Strength Requirements	852.4

	Culverts	828.2
		828.3
	Minimum Cover	856.5
	Minimum Diameter	838.4
	Multiple	824.2
	Plastic, Strength Requirements	852.7
	Protective Coatings	852.4
	Reinforced Concrete, Strength Requirements	852.1
	Standards for Drain	838.4
	Structural Metal Pipe and Arch, Strength Requirements	852.6
PIPING	Definition	806.2
		829.3
PLACE TYPES	Definition	81.3
	Rural Area	81.3
	Suburban Area	81.3
	Urban Area	81.3
PLANT SITES/CONTRACTOR'S YARD		112
PLANTING	Aesthetic Factors	109.3
	Airports and Heliports	904.8
	Design	904
	Establishment	904.9
	General	904.1
	Locating Plants	904.4
	Locating Trees	904.5
	Selection	904.3
	Sight Distance	904.6
	Site Preparation	904.2
	Trees	904.5
	Vines	904.7
PLASTIC COATINGS		852.4
POINT OF CONCENTRATION	Definition	806.2
POINTS OF CONFLICT	Intersections	403.4
POLICE FACILITIES		107.2
POLLUTION CONTROL	Air	110.3
	Water	110.2
PONDING		821.4
PORTLAND CEMENT CONCRETE	Channel Linings	865.2
	Pavement see RIGID PAVEMENT	

December 31, 2020

POSITIVE PROJECTING CONDUIT	Definition	806.2
POTAMOLOGY	Definition	806.2
PRECAST PANEL CONCRETE PAVEMENT		621.3
	also see RIGID PAVEMENT	
PRECIPITATION	Area, Definition	806.2
	Definition	806.2
	Mean Annual	819.2
	Point, Definition	806.2
PRELIMINARY HYDRAULIC DATA		805.1
PRESENT WORTH	see ECONOMIC ANALYSIS	
PRIORITY NETWORK	42 000 km	309.2
PRINCIPAL ARTIRIAL	Definition	62.3
PRIVATE ROAD	Definition	62.3
PRIVATE ROAD CONNECTIONS		205.2
	Financial Responsibility	205.5
	Sight Distance	405.1
PROCEDURAL REQUIREMENTS		82.4
PROGRAMS, FEDERAL-AID		
	Bridge Replacement and Rehabilitation Program	43.3
	Congestion Mitigation and Air Quality Improvement Program (CMAQ)	43.2
	Federal Lands Program	43.4
	Special Programs	43.5
	Surface Transportation Program (STP)	43.1
PROHIBITED TURNS		403.8
PROJECTING BARREL		826.3
PROJECTING ENDS		826.3
PROPRIETARY ITEMS		110.10
	Earth Retaining Systems	210.2
PROTECTION OF ACCESS RIGHTS		104.4
PROTECTION OF WETLANDS	see WETLANDS	
PROTECTIVE COATINGS		852.4
PUBLIC ROAD INTERSECTION		405.7
	Sight Distance	405.1
PULL OUTS	see TURNOUTS	

PUMPING	Definition	62.7
PUMPING PLANT		839.1
R		
R-VALUE	see CALIFORNIA R-VALUE	
RADIAL HIGHWAY	Definition	62.3
RADIUS	Curb	405.8
	Horizontal Alignment	203.2
RAILINGS	Bicycle	208.10
	Bridge	208.10
	Bridge Approach	208.10
	Cable	210.6
	Chain Link	208.10
	Earth Retaining Systems	210.6
	Guardrail	208.10
		702.1
	Pedestrian	208.10
	Vehicular	208.10
RAIL	Clearances	309.2
	Structures Adjacent to	309.5
	Commuter, Definition	62.10
	Conventional, Definition	62.10
	Crossings	104.3
	Grade Line of Structures	204.8
	High Speed, Definition	62.10
	High Speed, Clearances	309.1
	Light, Definition	62.10
	Overheads	208.9
	Slope Treatment, Structures	707
	Underpasses	208.9
RAINFALL	Definition	806.2
	Sources of Data	815.3
RAIN GAGE		819.5
RAINWASH	Definition	806.2
RAMPS	Curbs on	504.3
	Curb Ramps	105.4
	Definition	62.4
	Dikes	504.3
	Distance Between Exits	504.3

December 31, 2020

	Distance Between On-Ramps	504.3
	Entrance and Exit	504.2
	Grade	504.2
	Grade Line	204.2
	Grade, Standards	204.3
	Hook	502.2
	Intersection Capacity	406
	Intersections on Crossroad, Location of	504.3
	Lane Drops	504.3
	Loop	504.3
	Metering (see METERING)	
	Pavement, Flexible	636.1
	Pavement, Rigid	626.1
	Pavement, Traffic Considerations	613.5
	Pavement Transitions	206
	Single Lane	504.3
	Structural Design	602.3
		603.5
		604.5
	Superelevation	504.3
	Tapers	206.3
	Termini, Flexible Pavement	636.1
	Termini, Rigid Pavement	626.1
	Transitions	504.3
	Two-lane Entrance	504.3
	Two-lane Exit	504.3
	Width	504.3
	Widening for Trucks	504.3
RATIONAL METHOD		819.2
RAVELING	Definition	62.7
REACH	Definition	806.2
RECORD KEEPING	Documentation, Type of Pavement	605.1
	Revisions	605.2
RECOVERY AREA		309.1
RECYCLING, ASPHALT CONCRETE	General	110.11
	Hot, Definition	62.7
REFUGE AREAS		403.7
REGIME	Definition	806.2
REHABILITATION, CULVERTS	General	853.1
	Caltrans Host Pipe Structural Philosophy	853.2
	Problem Identification and Coordination	853.3

	Alternative Pipe Liner Materials	853.4
	Cementitious Pipe Lining	853.5
	Invert Paving with Concrete	853.6
	Structural Repairs with Steel Tunnel Liner Plate	853.7
REHABILITATION, PAVEMENT	Capital Preventive Maintenance, part of	603.3
	Definitions	62.7
	Design Life	612.4
	Composite	645
	Flexible Pavement	635
	Rigid Pavement Strategies	625.2
REHABILITATION, ROADWAY		603.4
	Definitions	62.7
	Design Life	612.4
	Composite Pavement	645
	Flexible Pavement	635
	Rigid Pavement Strategies	625.2
REINFORCED EARTH SLOPES		210
RELICION	Definition	806.2
RELINQUISHMENT	Definition	62.6
REPLACEMENT IN-KIND	Sidewalks	105.1
REPLACEMENT PLANTING	Aesthetic Factors	109.3
RESEARCH/SPECIAL DESIGNS	Research, Experimentation	606.1
	Special Designs	606.2
	Mechanistic-Empirical Design	606.3
RESOURCES	Other, Pavement	604.3
RESTORATION PLANTING	Aesthetic Factors	109.3
RESURFACING	Definition	62.7
	see PRESERVATION, PAVEMENT	
	see REHABILITATION, PAVEMENT	
	see REHABILITATION, ROADWAY	
RETAINING WALLS		210
	Aesthetic Considerations	210.5
	Construction Methods and Types	210.2
	Guidelines for Plan Preparation	210.8
	Safety Railing, Fences, and Concrete Barriers	210.6
RETARD	Types	873.4

December 31, 2020

RETARDING BASIN	Definition	806.2
RETENTION BASIN	Definition	806.2
RETROGRESSION	Definition	806.2
RETURN WALLS		210.8
RETURNS, CITY STREET AND CORNER RADII		405.8
REVEGETATION	Aesthetic Factors	109.3
REVERSING CURVES		203.6
	Superelevation Transitions	202.5
REVETMENT	Definition	806.2
RIGHT OF ACCESS	Definition	62.6
RIGHT OF WAY	Definitions	62.6
	Through Public Domain	306.2
	Width	306.1
RIGHT-TURN CHANNELIZATION		405.3
RIGID PAVEMENT	Catalog	623.1
	Definition	62.7
	Design Procedure for	623
	Engineering Properties	622.1
	Joints	622.4
	New Construction	623
	Mechanistic-Empirical Procedures	606.3
	Engineering Procedures for Pavement Preservation	624
	Performance Factors	622.2
	Reconstruction	623
	Engineering Procedures for Pavement Rehabilitation	625
	Texturing	622.9
	Types	621
	also see CONCRETE	
RIPARIAN	Definition	806.2
RIPRAP	Definition	806.2
		827.2
		873.3
RISER	Culvert Entrance	822.2
	Definition	806.2
RISK ANALYSIS	Definition	806.2
		818.2
ROADBED	Definition	62.1

December 31, 2020

		62.7
ROADSIDE	Definition	62.1
	Landscape Architecture	900
ROADSIDE INSTALLATIONS		107
	Border Inspection Stations, Location of	107.3
	Define Roadside	62.1
	Maintenance Yards and Police Facilities	107.2
	Roadway Connections	107.1
ROADSIDE REST AREA, SAFETY	Definition	62.5
	Buildings and Structures	913.4
	General	913.1
	Layout	913.3
	Parking	913.6
	Pavement Design	613.5
	Pavement, Flexible	636.4
	Pavement, Rigid	626.4
	Public Information Display	913.8
	Signage	913.7
	Site Selection	913.2
	Utilities and Facilities	913.5
	Vending Facilities	913.9
	Water Supply	110.2
ROADSIDE MANAGEMENT	Vegetation Control	706.2
ROADSIDE SITES, LANDSCAPE ARCHITECTURE		910
ROADWAY	Connections	107.1
	Definition	62.1
	Drainage	830
	Structural Elements	601.2
ROCKFALL RESTRAINING NETS		703.2
ROUNDBABOUTS	Access Control	405.10
	Bicyclist Use	405.10
	Central Island	62.4
	Circulatory Roadway	62.4
	Definition	62.4
	Design Guidance	405.10
	Design Vehicle	405.10
	Entry Speeds	405.10
	Exit Design	405.10
	Inscribed Circle Diameter	62.4
	Landscape Buffer/Strip	405.10
		62.4

December 31, 2020

		405.10
	Lighting	405.10
	Number of Legs	405.10
	Path Alignment (Natural Path)	405.10
	Pedestrian Refuge	62.4
	Pedestrian Use	405.10
	Splitter Island	62.4
		405.10
	Stopping Sight Distance and Visibility	405.10
	Transit Use	405.10
	Truck Apron	62.4
	Vertical Clearance	405.10
ROUNDED INLET	Definition	806.2
ROUNDED LIP		826.3
RRR CRITERIA	Design Period	103.2
	Left-Turn Lanes	405.2
	Multi lane Cross Section	307.6
	Pavement Design Life	612.5
	Two-lane Cross Section	307.3
RUNNING	Speed	62.8
	Time	62.8
RUNOFF		816
	Drainage, Definition	806.2
	Factors Affecting	811.5
	Superelevation Transition	202.5
RURAL	Acceleration Lane at Intersection	405.1
	Access Control	504.8
	Area, Definition	81.3
	Design Speed	101.2
	Driveway Connection	205.4
	Interchange Spacing	501.3
	Median Standards	305.1
	Outer Separation	310.2
	Weaving Section	504.7
RURAL AND SINGLE INTERSTATE ROUTING		309.2
RUTTING	Definition	62.7
S		
SAFETY	Railings on Walls	210.5

	Reviews	110.8
	Roadside Rest Areas	913
	Tunnel Safety Orders	110.12
	Worker	110.7
		901.2
	Worker, Falsework Clearance	204.8
SAFETY ROADSIDE REST AREAS	see ROADSIDE REST AREA, SAFETY	
SAG CULVERT	Definition	806.2
		829.7
SCENIC	Highway	62.3
	Values	109
SCENIC VALUES IN PLANNING AND DESIGN		109
	Aesthetic Factors	109.3
	Basic Precepts	109.1
	Design Speed	109.2
SCHOOL PEDESTRIAN WALKWAYS		105.1
SCOUR	Definition	806.2
		827.2
SEA LEVEL RISE		883.2
SEAL	Fog	613.5
	Slurry	613.5
SEDIMENTATION	Definition	806.2
		823.2
		862.2
		865.2
SEPARATE ROADWAY		305.6
SERVICEABILITY	Definition	62.7
SETTLEMENT	Definition	62.7
	Structure Approach	208.11
SEVERANCE DAMAGES	Definition	62.6
SHADE REQUIREMENTS		912.2
SHALL	Definition and Usage	82.1
SHEET FLOW	Definition	806.2
SHOALING	Definition	806.2
SHORE PROTECTION		880

July 1, 2020

	Armor	883.3
	Design, Concepts	883.1
	Design, High Water and Design Wave Height	883.2
	Planning	882.1
	Site Considerations	882.3
SHOULD	Definition and Usage	82.1
SHOULDER	Cross Slope	302.2
	Definition	62.1
	Design Considerations	404.2
	Pavement, Flexible	636.2
	Pavement, Rigid	626.2
	Standards, Geometric	302
	Standards, Pavement	613.5
	Superelevation Transitions	202.5
	Transitions (Widen, Reduction)	206
	Width	302.1
	Width, Right Turn Channelization	405.3
	Width, Two-lane Roads, New Construction	307.2
SIDE GUTTERS/DITCHES		834.3
SIDE SLOPES		304
	Benches and Cut Widening	304.3
	Clearance to Right of Way Line	304.2
	Contour Grading and Slope Rounding	304.4
	Standards	304.1
	Stepped	304.5
	Structures	208.5
	Transition Slopes	304.1
	Widening	304.3
SIDEWALKS	see PEDESTRIAN FACILITIES	
SIGHT DISTANCE	Clear Distance (m)	201.6
	Corner	405.1
	Decision	201.7
	Decision at Intersections	405.1
	Exit Nose	504.2
	General	201.1
	Headlight, at Grade Sags	201.5
	Intersection	405.1
	Passing	201.2
	Planting	904.6
	Ramp Intersections	504.3
	Standards	201.1
	Stopping	201.3
	Stopping at Grade Crests	201.4

	Stopping at Grade Sags	201.5
	Stopping on Horizontal Curves	201.6
	Stopping at Intersections	405.1
SIGNAL CONTROL		403.9
SIGNALIZED INTERSECTION	Widening	405.9
SIGNS	Vertical Clearance	309.2
SILT	Definition	806.2
SILTATION		110.2
SIPHONS		829.7
SITE FINISHINGS	Definitions	62.5
SKEW	Angle	62.4
	Angle of Intersection	403.3
	Definition (Hydraulic)	806.2
SLIDE	Definition	806.2
SLIPOUT	Definition	806.2
SLOPE	Aesthetic Factors	109.3
	Cross	301.2
	Crown	301.2
	Definition (Hydraulic)	806.2
	Rounding	110.2
	Protection	873.3
	Shoulder Cross Slopes	302.2
	Side	304
	Side, Benches and Cut Widening	304.3
	Standards, Side Slopes	304.1
	Stepped	304.5
	Treatment Under Structures	707
SLOPE TREATMENT UNDER STRUCTURES		707
	Guidelines	707.2
	Policy	707.1
	Procedure	707.3
SLOTTED DRAINS		837.2
SLOUGH	Definition	806.2
SLUG FLOW	Definition	806.2
SNOW PACK		812.8
		814.3
SOFFIT	Definition	806.2

December 31, 2020

SOIL	Amending Soil	904.2
	Characteristics for Pavements	614.1
	Health	904.2
	Imported Topsoil	904.2
	Preserve Existing Topsoil	904.2
	Texture Rehabilitation	904.2
	Topsoil	904.2
	Unified Soil Classification System	614.2
SPACING	Drainage Pipes	824.2
	Vehicle	62.8
SPECIAL CONSIDERATIONS		110
	Air Pollution, Control of	110.3
	Control of Noxious Weeds	110.5
	Earthquake Consideration	110.6
	Overloaded Material Hauling, Design for	110.1
	Safety Reviews	110.8
	Traffic Control Plans	110.7
	Water Pollution, Control of	110.2
	Wetlands Protection	110.4
SPECIAL DESIGNS	see RESEARCH/SPECIAL DESIGNS	
SPECIAL STRUCTURES AND INSTALLATION		703
SPECIFIC ENERGY	Definition	806.2
		864.3
SPEED	Definition	62.8
	Comfortable (see MAXIMUM COMFORTABLE SPEED)	
	Design (see DESIGN SPEED)	
	High, Definition	62.8
	Low, Definition	62.8
	Operating	62.8
	Posted	62.8
	Running	62.8
	Speed Change Areas	402.5
SPEED-CHANGE LANES		62.1
	Intersections	403.5
	Left-turn Channelization	405.2
	Pavement Transitions	206
	Right-turn Channelization	405.3
	Speed Change Areas	402.5
SPILLWAY	Paved	834.4
SPIRAL TRANSITIONS		203.8

December 31, 2020

STABILIZATION TRENCHES		841.5
STAGE	Definition	806.2
STAGE CONSTRUCTION		106.1
	Freeway Connections with Local Roads	106.2
STANDARDS		80
	Approval for Nonstandard Design	82.2
	Boldface Standard	82.1
	FHWA and AASHTO	82.3
	Other Approval	82.1
	Permissive	82.1
	Underlined Standard	82.1
STATE HIGHWAY, CROSS SECTIONS		307
	also see CROSS SECTIONS	
STEEL STRUCTURES	Colors	705.2
STEPPED SLOPES		304.5
STOPPING SIGHT DISTANCE	see SIGHT DISTANCE	
STORAGE		838.4
	Basin, Definition	806.2
	Definition	806.2
	Depression	819.2
	Detention	812.6
	Interception	812.6
	Left-turns	405.2
	Retention, Definition	806.2
	Right-turns	405.3
STORM	Definition	806.2
	Design, Establishing	818.2
	Design, Recommended Criteria	821.2
	Drain, Definition	806.2
STP	see SURFACE TRANSPORTATION PROGRAM	
STREAM WATERS	Definition	806.2
STREETS	Definitions	62.3
STRUCTURAL PLATE	Arches	852.6
	Vehicular Underpasses	852.6
STRUCTURAL SECTION	see PAVEMENT STRUCTURE	
STRUCTURE APPROACH	Design Responsibilities	601.3
	Pavement Systems	672
	Structure Approach Slabs	209

December 31, 2020

	Slab-Rehabilitation Projects	673
STRUCTURE CLEARANCE		309
	Elevated Structures	309.4
	Horizontal	309.1
	Railroad	309.5
	Tunnel	309.3
	Vertical	309.2
STRUCTURES, SLOPE TREATMENT UNDER	see SLOPE TREATMENT	
STRUTTING	Definition	806.2
SUBBASE	Definition	62.7
	Description	602.1
	Engineering Criteria	663
	Lime Treated	662.2
	Treated	662.2
SUBCRITICAL FLOW	Definition	806.2
		864.3
SUBDRAIN	Definition	806.2
		841.5
SUBGRADE		614
	Definition	62.7
	Description	602.1
	Engineering Considerations	614.1
	Enhancement Fabrics	614.5
SUBSEAL		607.6
SUBSURFACE DRAINAGE		840
SUBURBAN		81.3
SUMP	Definition	806.2
		831.3
SUPERCritical FLOW	Definition	806.2
		864.3
SUPERELEVATION	Axis of Rotation	202.4
	Basic Criteria	202.1
	Bridge	203.9
	Channels	866.2
	City Streets and County Roads	202.7
	Comfortable Speeds	202.2
	Compound Curves	202.6
	Ramps	504.3
	Relationship to Speed on Curves	203.2

	Reversing Curves	203.6
	Runoff	202.5
	Standards	202.2
	Transition	202.5
SURFACE	Course, Definition	62.7
	Course, Description	602.1
	Runoff, Definition	806.2
	Water, Definition	806.2
	Water	831.1
SURFACE TRANSPORTATION PROGRAM		43.1
SWALE	Definition	806.2
SWEPT WIDTH	Definition	62.4
		404.1
	Design Considerations	404.2
T		
TAPERED INLET	Definition	806.2
		826.4
TEXTURING	Rigid Pavement	622.9
THREE-CENTER CURVE	Intersections	405.7
THROUGHWAY	Definition	62.3
TIME OF CONCENTRATION	Channel Flow	816.6
	Combined Flow	816.6
	Culvert Flow	816.6
	Kinematic Wave Equation	816.6
	Kirpich Equation	816.6
	Overland Equation	816.6
	Soil Conservation Service (SCS) Equation	816.6
	Upland Method	816.6
TOLL ROAD, BRIDGE OR TUNNELH		62.3
TOPSOIL	Site Preparation	904.2
TRACKING WIDTH	Definition	62.4
		404.1
	Design Considerations	404.2
TRAFFIC	Axle Load Spectra	613.4
	Considerations	401.3
	Considerations in Pavement Engineering	613
	Control Devices	62.8

December 31, 2020

	Control Devices	403.10
	Control Plans, Special Problems	110.7
	Definitions	62.8
	Engineering	82.7
	Index, TI	613.3
	Interchanges	500
	Islands	405.4
	Lane	62.1
	Markings	62.8
	Noise Abatement	1100
	Pedestrian Refuge	405.4
	Ramp Intersection Flow	406
	Sign	62.8
	Signals	62.8
	Specific Traffic Loading Considerations	613.5
	Volume Projections	613.2
	Volumes	102.1
TRAILS	Multipurpose	1003.5
TRANSIT	Bus Rapid Transit (BRT)	62.10
	Definition	62.10
	Design Vehicle	404.3
	Factors Affecting Design	401.6
	Loading Facilities	108.2
	Turning Templates	404.5
TRANSITIONS	General Standards, Pavement	206.1
	Lane Additions	206.2
	Lane Drops	206.3
	Pavement	206
	Spiral	203.8
	Superelevation	202.5
	Temporary Freeway	206.4
TRANSPARATION		812.8
		819.2
TRANSPORTATION MANAGEMENT AREA	Definition	81.3
	Interchange Spacing	501.3
TRASH RACK	Definition	806.2
		822.2
TRAVELED WAY	Definition	62.1
	Design Considerations	404.2
	Standards	301
TREATED BASE AND SUBBASE		662.2

TREATED PERMEABLE BASE AND SUBBASE		662.3
TREES	Conventional Highways	904.5
	Freeways and Expressways	904.5
	Selection	904.3
	Shade Requirements	912.2
TRUCK	Critical Lengths of Grade	204.5
	Design Vehicle	404.3
	Escape Ramps	702.1
	Turning Templates	404.5
	Turns	404.5
	Weighing Facilities	703.1
TRUMPET INTERCHANGE		502.2
TRUNK LINE	Definition	806.2
TUNNEL	Classification	110.12
	Clearances	309.3
	Liner Plate	852.6
	Projects	110.12
	Structural Repairs with Steel Tunnel Liner Plate	853.7
		838.4
TURBULENCE	Definition	806.2
TURBULENT FLOW	Definition	806.2
TURNING LANES	Left-turn Channelization	405.2
	Right-turn Channelization	405.3
	Separate	62.1
	Traffic	403.6
	Two-way Left-turn	405.2
TURNING RADIUS	Minimum	62.4
TURNING TEMPLATES		404.3
	Truck and Transit	407
TURNOUTS		204.5
TURNS, PROHIBITED	Intersections	403.8
TWO-LANE CROSS SECTIONS	New Construction	307.2
	RRR Projects	307.3
TWO-QUADRANT CLOVERLEAF INTERCHANGE		502.2
TWO-WAY LEFT-TURN LANES		405.2

December 31, 2020

UNDERCUT	Definition	806.2 865.2
UNDERDRAINS	Design Criteria	842.4
	Installations	842.2
	Open Joint	842.5
	Perforated Pipe	842.5
	Pipe	842.5
	Selection of Type	842.7
	Service Life	842.6
UNDERFLOW	Definition	806.2
UNDERPASS	Railroad, Grade Line	204.8
	Railroad	208.9
UNDIVIDED HIGHWAYS	Axis of Rotation	202.4
	Grade Line	204.2
UNTREATED GRANULAR BASE	see BASE	
URBAN/URBANIZED	Access Control	504.8
	Corner Radii	405.8
	Definition	81.3
	Design Speed	101.2
	Drive way	205.3
	Horizontal Clearance	309.1
	Interchange Spacing	501.3
	Median Standards	305.1
	Outer Separation	310.2
	Position of Curbs and Dikes	303.5
	Weaving Section	504.7
UTILITIES	at Walls	210.8
V		
VACATION	Definition	110.9
VALUE ANALYSIS		110.9
VEGETATION	Control	706.2
	Preserve Existing	904.2
VELOCITY HEAD	Definition	806.2 864.3
VERTICAL CLEARANCE	see CLEARANCES	

VERTICAL CURVES		204.4
	also see SIGHT DISTANCE	
VISTA POINTS		914
	Definition	62.5
	Amenities	914.3
	Aesthetic Factors	109.3
	General	914.1
	Parking	914.4
	Site Selection	914.2
VOLUME		62.8
	Design Hourly Volume	103.1
	Design Volume	62.8
W		
WALKWAYS	see PEDESTRIAN FACILITIES	
WALLS	Head	826.3
WALLS, RETAINING	see EARTH RETAINING SYSTEMS	
WATER	Conservation	901.2
	Course, Definition	806.2
	Holding Tank	913.5
	Irrigation Supply	905.2
	Pollution, Control of	110.2
	Quality Control Boards	110.2
	Shed	819.2
	Table, Definition	806.2
	Wastewater Disposal	913.5
	Way, Definition	806.2
	Wells, Abandonment	110.2
WATER LEVEL PROVINCE	Definition	820.5
	Annual Exceedance Probability	820.3
	Tide Gauge Stations	820.3
	Tailwater Elevation	820.4
	Co-tidal Lines	820.5
	Tidal Datums	820.8
WATER SUPPLY	Irrigation	905.2
	Safety Roadside Rest Areas	913.5
	Vista Points	914.3
WAVE	Height	873.2

December 31, 2020

	Run-up	873.2
WEAVING		62.8
	Sections	62.4
	Sections, Interchange	504.7
WEED CONTROL	Noxious, Control of	110.5
WEEPHOLES	Definition	806.2
WEIGHING FACILITIES	Truck	703.1
WEIR	Definition	806.2
WELLS		841.5
	Water, Abandonment	110.2
WETLANDS PROTECTION		110.4
WHEELBASE	Definition	62.4
WHEELCHAIR RAMPS	see CURB RAMPS	
WIDENING	Pavement	206.2
	Ramps, for Trucks	504.3
	Pavement Design Life	612.3
	Pavement, Project Type	603.2
	Signalized Intersections	405.9
	Slope Benches and Cut Widening	304.3
WIDTH	Driveway, Access Openings on Expressways	205.1
	Driveway, Urban	205.3
	Lane	301.1
	Lane, on Curves	504.3
	Left Turn Lanes	405.2
	Median	305.1
	Opening for Falsework	204.8
	Pavement	301.1
	Right of Way	306
	Shoulder	302.1
	Structures	208.1
	Swept, Definition	62.4
	Swept, Design Considerations	404.2
	Tracking, Definition	62.4
	Tracking, Design Considerations	404.2
Y		
YARDS	Maintenance	107.2
	Plant Sites, Contractors	112