

SPACE TRANSPORTATION STUDY
V23 LAUNCH PAD

VANDENBERG AIR FORCE BASE, CALIFORNIA

UNMANNED LAUNCH VEHICLE
IMPACTS
ON EXISTING MAJOR FACILITIES

Prepared By
SVERDRUP & PARCEL AND ASSOCIATES, Inc.
Engineers-Architects-Planners
St. Louis, Missouri

For
United States Air Force
Space Division
Los Angeles, California

DISTRIBUTION STATEMENT A
Approved for public release;
Distribution Unlimited

October 18, 1984

DTIC QUALITY INSPECTED 4

BMDOTIC

19980302 060

200152

Accession Number: 0152
Title: Unmanned Launch Vehicle Impacts on
Existing Major Facilities: V23
Launch Pad, Vandenberg AFB,
California
Contract Number: F04701-77-C-0199
Corporate Author or Publisher: Svedrup & Parcel and Associates,
Inc., St. Louis, MO
Report Prepared For: U.S. Air Force, Space Division, Los
Angeles, CA
Publication Date: Oct 18, 1984
Pages: 85
Descriptors, Keywords: Space Transportation Launch Pad V23
Scope Sidemount Vehicle Base Concept
Option

FOREWORD

This memorandum report is submitted in compliance with the requirements of the modification (DCAL #285) to Contract No. F04701-77-C-0109, dated July 13, 1984.

This report summarizes the modifications required to the existing major facilities of Space Launch Complex 6 (SLC-6) to accommodate the launching of an Unmanned Launch Vehicle (ULV). Determination of the modifications required will be limited to two basic concepts, namely the Side Mount Vehicle and the In-Line Vehicle.

SUMMARY

This study measures the impact on the existing major facilities of Space Launch Complex (SLC-6) to accommodate the launching of an Unmanned Launch Vehicle (ULV). Modifications to the existing facilities were determined for two basic vehicle concepts, namely the Side Mount Vehicle and the In-Line Vehicle. These vehicle concepts along with options to each are summarized below:

1. Basic Concept for Side-Mount Vehicle

Major modifications to the existing facilities consist of the following:

MST - Extension of crane runway for stacking of new vehicle.

SAB - Addition of new roof trusses, new side bays, four retractable arms, two new drive trucks, increased power supply and lighting, elevated track support and new foundations for servicing requirements for the new vehicle.

AT - Addition of retractable arm and its drive system for the Centaur umbilical service and vent lines.

1984 Construction Cost (incl. 50% increase for construction interruptions)	--	\$67 million
Construction Schedule (assuming no shutdowns for SSV activities)	--	20 months
Engineering Schedule	--	18 months

2. Option for Side-Mount Vehicle

Major modifications to the existing facilities consist of the following:

PCR - Addition of roll ramp actuators, screw jacks and hydraulic cylinders to stack and service the new vehicle, along with addition of new PCR tiedowns.

AT - Addition of retractable arm and its drive system for the Centaur umbilical service and vent lines.

1984 Construction Cost (incl. 50% increase for construction interruptions)	--	\$42 million
Construction Schedule (assuming no shutdowns for SSV activities)	--	16 months
Engineering Schedule	--	14 months

3. Basic Concept for In-Line Vehicle

Major modifications to the existing facilities consist of the following:

MST - Modification to existing roof and main framing to incorporate increased travel of the existing bridge crane during stacking of the new vehicle.

SAB - Addition of a new bridge crane to operate with the MST crane during stacking operations. Addition of new structure and SAB drive trucks to support the new crane.

LM - Modifications to the ISS, SSME East Wall Framework, and Sound Suppression Water System and the addition of a new flame deflector and rise-off umbilical masts.

AT - Extension of the lightning arrester tower.

1984 Construction Cost (incl. 50% increase for construction interruptions)	--	\$55 million
Construction Schedule (assuming no shutdowns for SSV activities)	--	18 months
Engineering Schedule	--	20 months

4. Option for In-Line Vehicle

Major modifications to the existing facilities consist of the following:

MST - 65' vertical extension of MST roof to accommodate stacking of new vehicle; addition of two new trucks.

SAB - Extension of weatherseal to mate with MST roof extension.

LM - Modifications to the ISS, SSME East Wall Framework, and Sound Suppression Water System and the addition of a new flame deflector and rise-off umbilical masts.

AT - Extension of the lightning arrester tower.

1984 Construction Cost (incl. 50% increase for construction interruptions)	--	\$53 million
Construction Schedule (assuming no shutdowns for SSV activities)	--	20 months
Engineering Schedule	--	20 months

The schedules shown above are based on uninterrupted construction. In evaluating the future launch activities at SLC-6, the construction costs and schedules shown above should be modified to reflect impacts associated with other SSV activities.

TABLE OF CONTENTS

	<u>Page</u>
Foreword	i
Summary	ii
I SCOPE	1
II SIDE-MOUNT VEHICLE	3
A. BASIC CONCEPT	3
1. MST Modifications	3
2. SAB Modifications	3
3. AT Modifications	6
B. OPTION 1	7
1. PCR Modifications	8
2. New PCR Tiedowns	9
3. AT Modifications	9
C. CONSTRUCTION COST ESTIMATE	9
D. CONSTRUCTION SCHEDULE	14
E. CONCLUSIONS	16
III IN-LINE VEHICLE	17
A. BASIC CONCEPT	17
1. MST Modifications	17
2. SAB Modifications	18
3. LM Modifications	18
4. AT Modifications	22
B. OPTION 1	23
1. MST Modifications	23
2. MST Tiedown Foundations	24
3. LM and AT Modifications	24
C. CONSTRUCTION COST ESTIMATE	24
D. CONSTRUCTION SCHEDULE	28
E. CONCLUSIONS	30

I SCOPE

A. GENERAL

The existing Space Shuttle Launch Complex 6 (SLC-6) facilities accommodates the launching of a manned Space Shuttle Vehicle (SSV). On-going studies by others developed two basic concepts for an Unmanned Launch Vehicle (ULV) to be launched at SLC-6 in conjunction with the manned space shuttle. This report determines the modifications necessary to the existing major facilities for launch operation of the ULV.

B. CONCEPT SCOPES

Modifications were determined for two basic concepts of the ULV and for options to each of these concepts. The basic concepts and options investigated are as follows:

1. Side Mount Vehicle

a. Basic Concept (Martin Marietta Corp.): Use the MST for erection of the Propulsion Avionics (P/A) module and Payload (P/L) module and the SAB for servicing of the P/A and P/L modules, for clean rooms provisions and Support Equipment (SE).

b. Option 1 (Aerospace Corp.): Use Payload Changeout Room (PCR) for erection and servicing of P/A and P/L modules, for airlock assembly and for any added SE.

2. In-Line Vehicle

a. Basic Concept (Boeing Corporation)

1) Use cranes in the MST and SAB for erection of the P/A module and P/L module. Provide platforms and clean rooms in the MST for servicing.

2) Modify Launch Mount (LM) to permit use of flame deflector under the two propulsion engines. Incorporate new location for umbilical service mast.

b. Option 1 (Aerospace Corp.): Raise the MST roof to locate lifting crane above the P/L module. Provide platforms and clean rooms in the MST for servicing the P/A and P/L modules.

C. CRITERIA

1. SRB ground interfaces remain the same as for the Space Shuttle Vehicle (SSV - manned shuttle) interfaces.

2. The launch complex shall retain its capability to launch the manned shuttle.

3. Generate a Rough Order of Magnitude (ROM) cost estimate for all facility modifications.

4. Support equipment will be evaluated and estimated by others.

5. Generate a construction schedule based on uninterrupted construction.

6. Modifications determined to be necessary to the existing facilities were based on the information given in the excerpts from MMC, Aerospace and Boeing concept reports. Copies of this information is given in Appendix A.

II SIDE MOUNT VEHICLE

Two concepts of the Side Mount Vehicle were investigated. The basic concept uses the MST and SAB for the erection and servicing of the P/A and P/L modules whereas Option I utilizes the PCR for the same functions.

A. BASIC CONCEPT (Sketches SK-D1 through D9 of Appendix B)

1. General

The basic concept was based on the extension of the MST overhang to lift the side-mount vehicle, and the modification of the SAB to provide side rooms and supporting trucks for clean rooms, access platforms and support equipment. The concept consists of clean rooms projecting to the north and south from the sides of the SAB. Layouts indicated that such a concept for mounting and retracting of the clean rooms is not feasible due to the relative locations of the MST, SAB, and P/L module. Therefore, an alternate concept was used, namely retractable platforms supported from the SAB, with clean rooms supported on these platforms.

2. Mobile Service Tower (MST) Modifications

a. Structural: The MST overhang and crane runway was extended 15 feet to the west so that the P/A and P/L modules could be lifted from the transporter. The added load of the extension will require strengthening of some existing members.

b. Electrical: Extension of the MST crane runway will require additional conduits, junction boxes and crane operator stations. The extension of the MST structural framing will require additional lighting and power receptacles for maintenance and conduits for communications, and other SE needs.

3. Shuttle Assembly Building (SAB) Modifications

a. Structural

1) Structure above SAB: The P/L module must be lifted from the transporter and raised vertically using the MST bridge crane. The upper SAB structure along Line 7.4 must be removed to accommodate the MST cranehook and lifting sling. Demolition of the upper structure will

include removal of the SAB parapet, relocation of roof ventilators, removal of structure on Line 7.4 above El. 295', removal of purlins and roof deck between Column Lines 6 and 7.4.

New work includes new support trusses above Column Lines 6 and 7 to carry loads previously carried by Bent 7.4, a new parapet wall to mate with the MST, new seals to mate with MST, and possible strengthening of the existing columns and bracing along Lines A, B, E and F.

2) Side Rooms for Platforms and SE: An extension to the sides of the SAB will be required for equipment and access. As depicted in the MMC study, these rooms will extend from the roof to the new elevated trucks located at about El. 145'. The number of new platforms is not indicated, with the exception of the P/L access arm required at about El. 192' and 258'. The arms contain clean rooms at these elevations which would be moveable and supported from the new SAB side walls.

Sketches and investigation indicate that the only feasible method of providing the P/L clean rooms is by the addition of retractable arms to the SAB. Rotating arms do not appear viable due to the clear-arms requirements for the MST and PCR. Although some SAB columns may have to be interrupted, the upper P/L module doors should be lowered to permit the retractable arms to clear the main bracing levels of the SAB. The suggested relocated centerline of the doors is at El. 249'. It is felt that additional trucks as well as additional tiedowns will be required below the new side room extensions. These tiedowns would be required at both stored and LM positions. One area of additional concern which could present future problems is the slidewire clearance to new SAB structure/retractable clean room arms.

3) Added Trucks and Outrigger Tracks: The basic concept indicated the use of elevated outrigger tracks to support an additional set (two) of trucks. The weight of the increased structural framing, P/L access platforms and clean rooms and other support equipment dictated the need for the added trucks. Rough-order-of-magnitude (ROM) calculations of the increased weight indicated that the addition of one truck on the north and south side of the SAB is adequate. The trucks will be located between SAB Column Lines 6 and 7 since most of the added load is concentrated in this area.

The rails for each truck will be supported on a two span, continuous double trussed space frame. From a review of Sketches SK-D5 and D6, it can be seen that the location of the existing electrical and air conditioning tunnels on the north side of the SAB indicate the need to locate the foundations, rail support structure, and truck further north. An extension to the added framing of the SAB is necessary to transmit the new loads to the trucks. The location of the rail support structure interferes with the Support Equipment Building (SEB), the Fuel Holding Area (FHA) earth-filled, cellular concrete barrier and the elevated Film Camera (FC). The rail support structure was elevated to clear the SEB.

One cell of the FHA concrete barrier should be demolished and the FC should be relocated. The required travel of the trucks is approximately 290 feet between tiedowns. Tiedown loads can be transmitted from SAB Column Lines 6 or 7 through the end portable of the rail support structure to the concrete foundations. The location of the truck, rail support structure and foundations will be symmetrical about the centerline of the Launch Pad to attain better distribution of loads.

4) Foundations: The rail support structure is supported on elevated concrete foundations supported by drilled-in pile caissons. Drilled-in pile caissons were chosen in lieu of H-piles to eliminate the possibility of soil settlement. The two-span continuous rail support structure minimizes the number of pile caissons. The additional weight to the SAB will overstress the present SAB tiedown foundations. Therefore, the proposed east and west foundations will serve as additional tiedown foundations for the SAB in the Servicing (near LM) and the Park position. To minimize the lateral loads on the drilled-in caissons, the foundations will be anchored laterally in both directions. A problem of great concern is the ability to transmit the added loads to the proposed tiedown foundations without overstressing the existing SAB foundations.

The western cell of the FHA cellular barricade interferes with the rail support structure and foundation and should be removed. Some underground electrical ducts may have to be removed for the southwest foundation.

b. Mechanical

The added truck must be hydraulically connected to the existing eastern set of SAB trucks, in the southeast and northeast quadrant, to assure proper load distribution to all trucks. Trucks will be drive trucks and all hydraulic units, such as the motor pump, accumulator and supply unit must be provided.

c. Electrical

Electrical modifications required are as follows:

- 1) Add power for the new clean rooms.
- 2) Make the SAB suitable for hazardous vapors. This is a worst case consideration since radii of hazardous piping and systems are not fully available.
- 3) Add lighting, HVAC power, and conduit with J boxes for SE to the new clean rooms.
- 4) Add power and controls for the four modified CCAA type drives to move the clean room arms into position.
- 5) Since two new drive trucks are added, modify the existing electrical system to operate all trucks.
- 6) Modify existing lighting and add new lighting suitable for hazardous area classification to the added areas of the SAB.
- 7) The present cable and power availability from the PCR substation will be too low for the existing and added requirements of the drive trucks and retractable arms. Therefore, add new SAB reel cable, circuit breakers and a larger transformer.

4. Access Tower (AT) Modifications

a. Structural: Modifications to the AT consists of adding a moving arm for the Centaur umbilical service and vent lines. The servicing arm will be a rolling beam type structure similar to the existing Crew Cabin Access Room (CCAA). The drive system for extending and retracting the arm will be similar to the system used for the CCAA.

The arm will be supported by the AT and located between Column Lines 1 and 2. The top of the beam was located at approximately El. 183' which is about 50 feet below the CCAA. Minor amount of modification will be required to the AT structural framing. For the purpose of assessing the structural capability of the AT and foundation for the

added weight, an assumption made was that the arm would be extended only for Centaur servicing which is of short duration (less than 16 hours). Thus, the arm would be in the retracted position for the critical loading conditions of either launch induced overpressures or seismic loadings. The critical columns of the AT are the southeast and northwest columns. With the arm in retracted position, the critical stresses will be reduced as the eccentric load of the moving arm will reduce the eccentricity of the deadload of the ETVA and overpressures. Therefore, the AT and AT foundation should be structurally adequate for the added load of the servicing arm.

b. Electrical: Modifications required to the electrical systems consist of providing power wiring additions for the moving operation of the Centaur servicing arm. Added lighting and service receptacles as well as SE conduit and J boxes for SE will be needed as well.

B. OPTION 1 (Sketches SK-D10 through SK-D15 of Appendix B)

1. General

This concept was based on the use of the PCR to lift and service the P/A and P/L modules. This concept appears feasible since the PCR was previously designed to carry higher loads than those associated with the ULV.

The developed vehicle concept (Aerospace) was based on the following assumptions:

a. P/A module can be transported in a vertical attitude, or the transporter may be modified to accomplish repositioning from horizontal to vertical.

b. Erection Scheme

1) 20' long trucks ride in each U-housing. They are powered vertically by roll ramp actuators at top of PCR.

2) Horizontal arms pivoted at the U-housing/trucks attach to the modules. Arms may be extended 2' by external screw jacks.

a) Arms pivot through an arc of 80°, horizontally.

b) Arms are pivoted 60° and stored against the PCR structure.

c) South arm has a scissors configuration which attaches to a reaction rail on the PCR. It provides lateral adjustment of ± 6 ".

d) North arm has a hydraulic cylinder for lateral setting, by-passed to south arm for final lateral adjustments.

e) New set of PCR tiedowns required.

c. Airlock assembly provided on arms for access to P/L module hatches.

2. PCR Modifications

a. Structural: Minor modifications to the U-housing and movable PCR platforms would be required, and these could be accomplished without major disruption between SSV launches. The use of roll ramp actuators, screw jacks and hydraulic cylinders appears feasible with the following clarifications:

1) The inclined struts which support the ends of the erection arms should be inverted, otherwise the U-housing would have to be increased in height to support the trucks which travel in the U-housing.

2) The hydraulic cylinder shown attached to the north arm must be reconfigured to clear the platforms on this side, however, the general scheme is workable (SK-10).

3) New structure to support the guide rail on the south side must be added to the PCR (SK-10).

4) Only one set of P/L hatches can be serviced at a time. Additional access between the PCR and the new clean rooms on the arms must be provided at the upper access hatches.

5) Due to SAB height clearances, the P/L module cannot be transported through the SAB at its final mating elevation. An additional set of PCR tiedowns will be required to provide a PCR stop position at which the P/L module may be stacked.

6) During the process of existing construction, the OMBUU platform was reconfigured and later modified. This platform must be modified to clear the new erection arms. This applies to the existing fixed structure as well as the SE portion of the platform.

7) The U-housing stiffeners and/or welds were reduced in size as a cost savings step during the shop drawing review phase of the Pkg. III activity. These items would have to be brought up to the status of the design drawings.

8) Some of the fixed platforms which service the orbiter must be modified to movable platforms as previously designed.

9) The airlock assembly could be installed by using the SAB overhead crane or a mobile crane. Only P/L module hatches at one elevation may be serviced at any one time.

b. Electrical: Additional power and controls are required for the modified OMBUU and movable platforms, for the airlocks on the erector arms and for the modified erection mechanism. Some additional lighting is also required in these areas. It is assumed that the added power required will exceed the present PCR cable capacity. Thus, a larger cable, reel modifications and a substation breaker replacement would be required.

c. Mechanical: Add hydraulic lines and air lines. Hydraulic supply will probably be adequate due to previous elimination of the erector mechanism.

3. New PCR Tiedowns

A new set of PCR tiedowns is required for the installation and mating of the P/A and P/L modules. Only one set of PCR tiedowns was installed near the LM and these cannot be used with the proposed erection scheme. The approximate locations of the tiedowns are shown on Sketch SK-D15. The easternmost tiedowns must avoid the trench extending from the fuel and oxidizer valve pits. The proposed tiedown locations should not cause any overstress in the existing foundations.

It was assumed that the tiedown castings will be similar to the existing castings. Installation of the tiedown castings will require some demolition of concrete and drilling of the anchor bolts. Reinforcing cut in process of demolition must be replaced.

4. AT Modifications: The AT modifications will be the same as for the Basic Concept.

C. CONSTRUCTION COST ESTIMATE

The construction cost estimate is given for the 1984 FY. The cost estimates were derived using previous cost estimates made for the present SLC-6 construction and updating them to 1984 using 6% escalation per year. Quantities for the modifications were derived by using

volumetric ratios of additional structure to the original structure, comparison of moving arm to the CCAA, and ROM design. Quantities based on ROM design include a 25% contingency. Costs are based on uninterrupted construction except for shutdowns due to missile launch at adjacent sites. The cost estimate includes markup items which are identified in the tables. Escalation to midpoint construction is not included. The total cost is increased by 50% to reflect the added cost due to construction interruptions caused by the requirement of maintaining the SSV launch schedule.

BASIC CONCEPT

MST MODS

Structural	2,250,000
Electrical	<u>60,000</u>

\$ 2,310,000

SAB MODS

Added Structural Framing	12,100,000
New Trackwork	200,000
Track Support Structural	2,200,000
Foundations	1,600,000
Miscellaneous (Relocation Existing Structures)	500,000
Demolition	350,000
Electrical	2,580,000
Mechanical (2 Drive Trucks + Hydraulics)	<u>1,850,000</u>

\$21,380,000

AT MODS

Structural Framing	100,000
Centaur Servicing Arm (Includes Struct, Mech, & Elec)	1,300,000
Electrical	<u>180,000</u>

1,580,000

Total \$25,270,000

Extra 25% for Supervision (Labor* x 20%)

695,000

Subtotal 25,965,000

Congested Site

15% 3,895,000

Subtotal 29,860,000

Labor Availability Factor

(80% of Labor*) x 25%

3,285,000

Subtotal \$33,145,000

		\$33,145,000
O&P (Subcontractor)	10%	<u>3,314,000</u>
	Subtotal	\$36,459,000
Overhead & General Conditions for Prime Contractor	10%	<u>3,646,000</u>
	Subtotal	\$40,105,000
Profit (Prime Contractor)	10%	<u>4,011,000</u>
	Subtotal	\$44,116,000
Bond 0.8%		<u>353,000</u>
	Total	\$44,469,000
Interruptions for SSV Launch Schedule	50%	<u>22,235,000</u>
		\$66,704,000

*Assume labor is 55% of Total Cost

OPTION 1

PCR MODS

Platforms & U-Housing	300,000	
Erection Arms	11,300,000	
Clean Rooms	1,000,000	
Electrical	1,270,000	
Mechanical	<u>300,000</u>	
		14,170,000

Tiedowns (Additions) 300,000

AT MODS

Structural Framing	100,000	
Centaur Servicing Arm		
(Includes Struct, Mech & Elec)	1,300,000	
Electrical	<u>180,000</u>	
		<u>1,580,000</u>

Total \$16,050,000

		\$16,050,000
Extra 25% for Supervision (Labor* x 20%)		<u>441,000</u>
	Subtotal	16,491,000
Congested Site	15%	<u>2,474,000</u>
	Subtotal	18,965,000
Labor Availability Factor (80% of Labor*) x 25%		<u>2,086,000</u>
	Subtotal	\$21,051,000
O&P (Subcontractor)	10%	<u>2,105,000</u>
	Subtotal	\$23,156,000
Overhead & General Conditions for Prime Contractor	10%	<u>2,316,000</u>
	Subtotal	\$25,472,000
Profit (Prime Contractor)	10%	<u>2,547,000</u>
		\$28,019,000
Bond 0.8%		<u>224,000</u>
	Total	\$28,243,000
Interruption for SSV Launch Schedule	50%	<u>14,122,000</u>
	Total	\$42,365,000

*Assume labor is 55% of Total Cost

D. CONSTRUCTION SCHEDULE

The construction schedule is based on uninterrupted construction, i.e. no shutdowns for SSV launches, servicing, or pre-launch preparations. It was further assumed that the contractor is provided with ample lay-down and storage areas for all construction materials.

Months after award of contract - Basic Concept

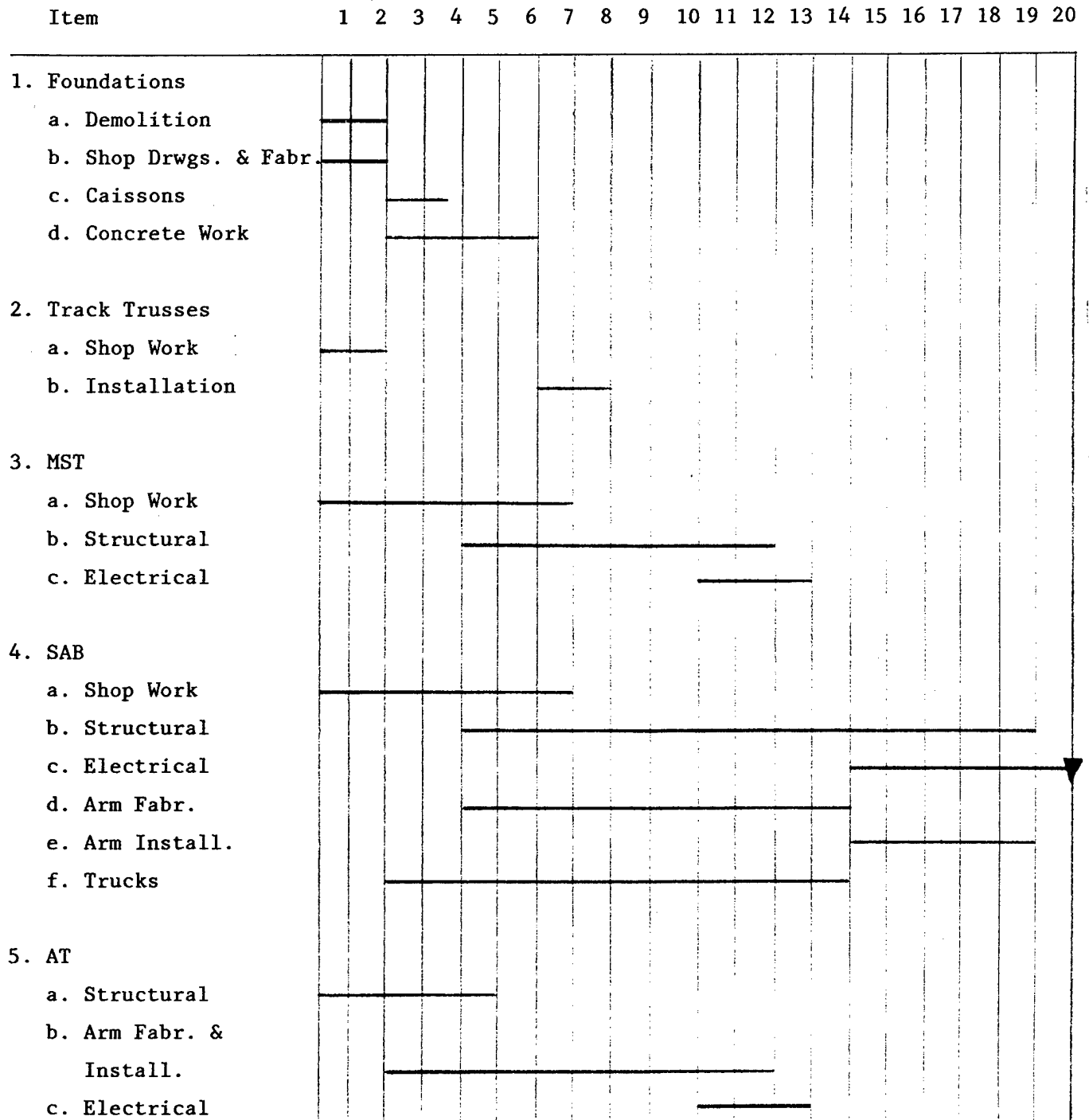

Months after award of contract - Option 1

Item

1 2 3 4 5 6 7 8 9 10 11 12 13 14 15 16 17 18 19 20

1. PCR

- a. Shop Dwgs & Fabr.
- b. Platform Mods
- c. Structural
- d. Electrical
- e. Mechanical
- f. Arm Fabr.
- g. Arm Install.

2. Tiedowns

3. AT

- a. Structural
- b. Arm Fabr. & Install.
- c. Electrical

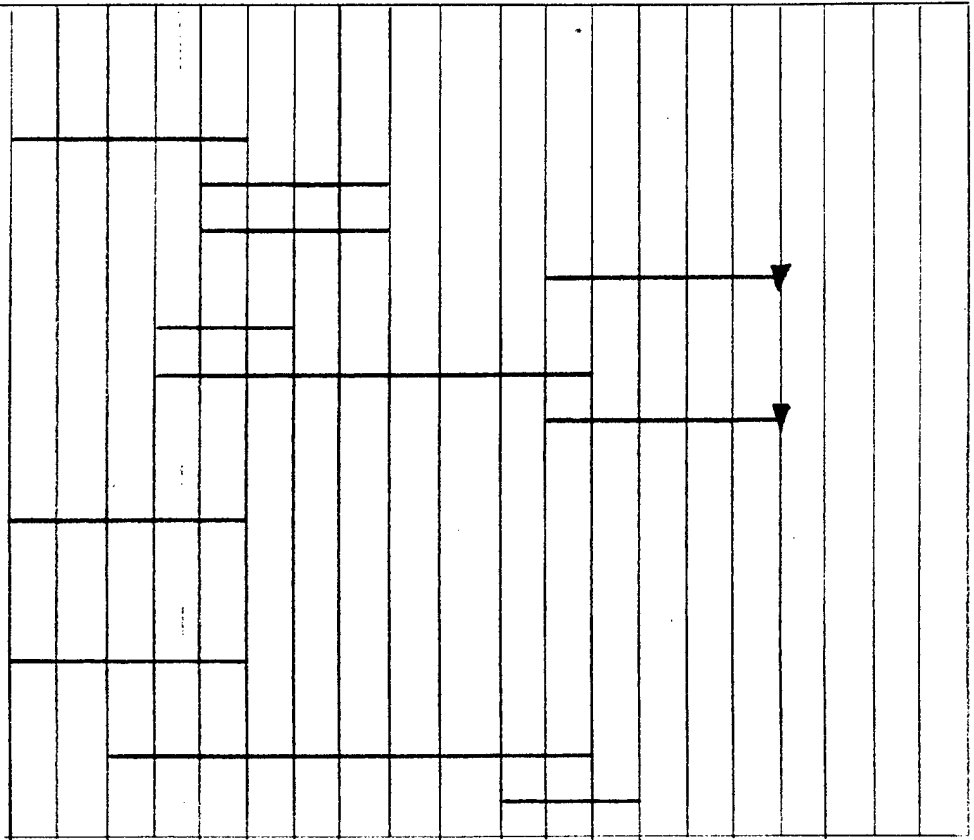

E. CONCLUSIONS

Both concepts are feasible. A concept recommendation cannot be intelligently made since the facility modifications are only a part of the total scenario of converting SLC-6 for ULV launches as well as SSV launches. In the concept selection, consideration should be given to cost, impact on construction and impact on launch schedule.

1. Basic Concept

Advantages

a. During a complete down time of the SSV launch activities, facility modifications can be made simultaneously to the SAB, MST, AT and foundations.

b. Considerable amount of steel work can be built using modular construction and the units can be preassembled off site.

c. Upon completion of all facility modifications, launch preparation can proceed smoothly.

Disadvantages

a. Considerable more facilities require modifications. Extensive foundation work is necessary along with demolition of existing structures.

b. Additional foundations, retractable arms and raised tracks further congests the area.

c. Construction time will be lengthy.

2. Option 1

Advantages

a. Additional structures are not necessary.

b. SAB maintains its clean appearance.

c. No work on MST.

d. Cost of modifications is less.

e. Construction time is less.

Disadvantages

a. Most of the modifications are concentrated in one facility. This may extend completion time depending on non-use of the PCR.

b. Some items must be removable and stored.

c. Pickup of the P/A and P/L modules must occur with the PCR in the PPR position. PCR has to move a greater distance while transporting the modules.

III IN-LINE VEHICLE

Two concepts of the In-Line Vehicle were investigated. The basic concept (Boeing) uses the MST and SAB for erection of the P/A and P/L modules whereas Option 1 (Aerospace) utilizes only the MST for the same function.

A. BASIC CONCEPT (Sketches SK-D16 through SK-D34 of Appendix B)

1. General

The basic concept consists of the use of the existing MST bridge crane in conjunction with a new 100 ton SAB crane to erect the P/L module of the In-Line Vehicle. A major objection of this erection method concerns the requirement for the 100 ton crane to travel from the new SAB rails to the MST rails. Small vertical deflections between rails due to dead load, wind and temperature effects could prevent the "near perfect" alignment required for smooth crane operation. Additionally, any electrical cables used to operate the SAB crane must travel with it and may require a special take-up reel. Proper synchronization between the two cranes to mate the vehicle would present more problems which are considered very difficult to achieve. However, the method is feasible.

2. MST Modifications

a. Structural: Structural modification to the MST consists of additional fixed structure to support the stored MST crane, significant roof modifications to provide a slot in the MST, the addition of two trolleys to maneuver the In-Line handling frame, significant column and vertical diagonal modifications, reconfiguration of the ET nose cone platform and requirements for a set of roll-up MST doors to allow passage of the SAB crane.

While it is possible to accommodate this system structurally, it is felt that the elimination of columns between 5B and 5F for crane access should be avoided. Such modification would result in higher loads to existing columns which were previously reinforced with cover plates. Additional welding to these columns could result in a greater potential for crack development due to fatigue considerations. Alter-

natively, any previously reinforced columns which are found to be overstressed should be replaced rather than again cover-plated.

b. Electrical: Cutouts and additional raised roof structure will require relocation of conduits and new lighting. Extension of crane cables will be required for the new storage position of the existing crane. Added lighting and power will also be required in this area.

3. SAB Modifications

a. Structural: Structural modification to the SAB consists of the addition of a new 100 ton crane and modifications to the existing structure to support it. The roof trusses of SAB Column Lines 7 and 7.4 will be cut to permit movement of the crane lifting frame during erection procedure. Thus, added stiffening trusses will be required above the SAB roof at Column Lines 6, 7 and 7.4. The added height and wind area may cause an overload of the SAB truck wheels and rails. The increased weight of the added structure and increase wind areas require the addition of one set (two) of trucks under the SAB. Present SAB framing must be strengthened for the addition of the trucks.

b. Electrical: Power and lighting must be provided to the new work levels and operator service levels for the new crane above the SAB roof. Electrical cables travelling with the crane will probably need a special take-up reel. In assuming the worst case, the SAB must be modified for hazardous classification service.

Since two new trucks will be added, modify the existing electrical system to operate all trucks. Assume a new SAB reel cable, circuit breakers and a larger transformer are required.

c. Mechanical: The added truck must be hydraulically connected to the existing eastern set of SAB trucks, in the southeast and northeast quadrant, to assure proper load distribution to all trucks. Trucks will be drive trucks and all hydraulic units, such as the motor pump, accumulator and supply unit will be provided.

4. Launch Mount (LM) Modifications

a. Ice Suppression System (ISS) Duct and Duct Housing: The ISS 36-inch diameter duct and duct housing must be removed to permit installation of the flame deflector for ULV launches. In the existing construction, three segments (Segments B, C and D) of the ISS duct

housing and one segment (Segment B) of the 36-inch diameter ducts are presently removable. The following modifications must be made:

- 1) Cut duct housing Segment A at Line A as shown on Sketch SK-D22 and modify the segment to make it removable.
- 2) Cut the two 36-inch diameter ducts (Segment C) at Line B and modify ducts for future removal operations.
- 3) Provide an enclosure for Segment A (Sketch SK-D18) of the 36-inch ducts or remove duct section to within end vertical enclosure of LM. Removal of duct Section A would require removal of the pipe support, the addition of a new flange connection at cut line and a temporary support of remaining duct.
- 4) Provide a removable enclosure over the duct housing adjacent to Segment A for ULV. See Sketch SK-D25.

Problem areas associated with removing the ISS Duct and Duct Housing:

- 1) Permanent bench marks (BM-1, 2 and 3 shown on Sketch SK-D20) are located on the top of 6" pipes on the centerline of the SSME and LM. Bench Mark BM-2 establishes the Working Point (WP) of SLC-6. Bench Marks BM-1 and BM-3 must be removed to permit installation of the flame deflector. Bench Mark BM-2 could possibly be left in-place but extreme care must be exercised during the flame deflector installation.
- 2) During duct and duct housing reinstallation for SSV launch, the removed bench marks would have to be reinstalled and the location of all bench marks must be rechecked. Bench Marks BM-1 and BM-3 are attached to duct housing segments A and C respectively. Accurate reinstallation of the two segments is necessary.
- 3) The removal and reinstallation of the 36-inch diameter duct and the duct housing will take a considerable length of launch turnaround time. Revised enclosures must be air tight against launch environment.
- 4) Section E-E shows a cross-section through Segment A of the Duct Housing. Note the location and connection of bench mark BM-1. Section D-D shows a cross-section through duct housing Segments B and C.

b. SSME East Wall Framework

Approximately 14 feet of the central portion of the east wall framework above Elevation 125'-3" must be removed for ULV launches. Modify removed portion and remaining structure for reinstallation capability for SSV launches. Provide removable vertical and horizontal closure plates over exposed open areas.

c. Flame Deflector

Provide a new removable flame deflector structure above Elev. 125'-3". The structure will provide housing and space for the sound suppression water. The structure shall be configured to prevent any overstress of existing LM.

d. Rise Off Umbilical Mast

Option 1: The existing hold-down beam must be modified to support the rise-off umbilical masts. The hold-down beam will require extensive modifications to support the umbilical masts. Base plates will be required between the bottom of the hold-down beam and the top of the concrete. Horizontal and vertical stiffeners must be added to the side and top plates of the hold-down beam. The hold-down beam houses the Sound Suppression Water (SSW) headers and nozzles, thus working space, inside the beam, is practically non-existent. Therefore, the hold-down beam must be removed and reinstalled in segments for the addition of the required support framing. Water nozzles and nozzle cover plates add to problems of the framing installation. Sketches SK-D30 and SK-D31 show an elevation of and section through the hold-down beam. It may be necessary to utilize structural framing of the existing umbilical room and the flame deflector for support of the umbilical mast. Routing of the fuel lines and electrical lines through the east-wall framework and the umbilical room to the proposed umbilical mast may be possible. It will result in revisions to the structure framing and SE.

Option 2: This option utilizes Tail Service Masts (TSM) similar to the existing TSM, located at the east end of the LM. This option does not appear to be practical based on the following problems:

1) Interference with MST Column Line 4 when the MST is in servicing position at the LM. MST Column Line 4 cannot be cut.

2) Interference with the vertical SSW duct and housing on the east end of the LM.

3) Difficulty to provide support for the TSM. Support would have to be provided by the flame deflector but columns would be required under the flame deflector bents. This will be difficult due to the lack of space as the flame deflector houses two 36-inch diameter ISS ducts and two SSW pipes.

4) Items 1 through 3 above assume SSME ignited in flight. If flame deflector is used they will be in the path of the deflected exhaust plume.

Any advantages would be outweighed by the above problems.

Option 3: This option utilizes a TSM, similar to the existing TSM, located at the end of a rotating/retractable arm extended from a structure outside of the LM envelope. A structure similar to the AT and a retractable arm similar to the CCAA could be used. The supporting structure of the arm must be located beyond the MST envelope. This would result in an extension of the arm of at least 80 feet. Foundations for the supporting structure will present significant problems. On the north side the tunnel housing the ISS ducts will present difficulties. On the south side the facility valve pit and underground utilities will interfere with the foundation. The option is feasible but it has numerous disadvantages.

e. Sound Suppression Water System

To permit the installation of the flame deflector, a portion of the eastwall framework must be removed. This portion of the Eastwall Framework houses some SSW nozzles and pipes. The nozzles and pipes must be removed and modified for fast reinstallation for changeout compatible to the two types of vehicle launches.

SSW water must also be provided for the proposed flame deflector. The assumption was made that SSW from the header behind the Eastwall Framework is not necessary for the launching of the ULV. Therefore this water can be used for the new flame deflector needs. Modification to the vertical feeder pipe in this area can be modified by adding a tee-section of pipe in this line and extending a new pipe from it to the flame deflector. See Sketches SK-D32 and SK-D33 for proposed details.

A valve must be added on each line to direct the water to the area needed. Some concrete demolition is required for the installation of the tee-section and the revised location of the orifice.

f. Electrical Modifications

Due to removal of ISS duct covers and duct sections beyond the bolted flange at LM, the electrical power, instrumentation wires and conduits upstream at "duct cut line B" will need to be broken. This change will require addition of J boxes and terminations for all power, control, and instrumentation circuits. It appears preferable to add aircraft type connectors and receptacles to expedite make/break timelines and also because of space constraints in the "break" zone.

The relocated TSM needs for this concept will require new conduit runs to serve the SE needs. Any additional power needs in the new TSM locations are unknown at this time, but these would require modification and added J boxes in the LM rooms serving the TSM zones.

5. Access Tower (AT) Modifications

Structural: The Boeing report states that the umbilical interfaces for the LH2 venting, and the electrical services to the payload will be located at the same location as the SSV External Tank Venting. Thus, the present ET vent arm can be used for the support and interface of the required umbilicals, vent lines and electrical lines. The weight of all additional lines required for the ULV at this location should not exceed 50,000 pounds. If the added weight exceeds 50,000 pounds additional columns may be required for the AT. These columns would be added under the cantilever support truss for the ET vent arm. A minimum number of 6 columns, braced in both directions, would be added. The Boeing Corp. was contacted and they informed S&P that the extent of the number of lines required is not known at this time. For this study it will be assumed that the added loads will not exceed the capacity of the AT.

A required modification to the AT is the extension of the lightning arrestor tower. A new 63-foot extension will be added above Elevation 343'-9 5/8". The existing 40' tower and steel pole will be reused above the 63-foot extension. See Sketch SK-D34 for the proposed modification.

B. OPTION 1 (Sketches SK-D18 through SK-D38 of Appendix B)

1. MST Modifications

a) Structural: This concept consists of raising the existing MST bridge crane to sufficient height to lift and stack the P/L module. The roof of the MST must be raised about 65' to Elevation 438. Much higher overpressure loads will result in the requirement for a heavier MST roof. Columns along the western faces of the MST must be reinforced to carry the additional loads, and columns along the eastern side of the MST will require reinforcing to a lesser extent. The reinforcing of columns on the west is feasible since these columns were not previously modified. However, any additional strengthening to columns on the east side could be a problem since these columns were previously cover-plated. Rather than reinforcing them in-place, replacement of such may be required. The modifications to the SAB consist primarily of removing Column Line 7.4 to accommodate the additional MST crane hook coverage, and rebuilding to form a new weatherseal with the MST.

The advantages of this concept versus the basic in-line concept are as follows:

- 1) New SAB crane is not required.
- 2) Modifications to previously modified columns are less severe.
- 3) Only one structure is significantly impacted.

The disadvantages of this concept versus the basic in-line concept are as follows:

- 1) SAB must be raised to form a weatherseal with the MST.
- 2) Two new MST trucks may be required since prior analysis indicates that one truck was at 97% of its capacity.

b) Mechanical: The added trucks must be hydraulically connected to the existing set of MST trucks to assure proper load distribution to all trucks. Trucks will be drive trucks and all hydraulic units, such as the motor pump, accumulator and supply unit will be provided.

c) Electrical: Added power to the crane as well as added lighting is required at the higher elevations. Electrical services are also needed to the new platforms and work zones.

2. MST Tiedown Foundations:

From a cursory review of the tiedown foundation design, the added weight of the MST structural framing will result in foundation stresses close to the allowable stresses. The added framing must be held to a minimum. The ten-foot thick foundation supporting the PCR and MST tiedown is the critical foundation. Decreased loads of the PCR, resulting from the elimination of the ET and shuttle erection, should assist in maintaining the foundation stresses at acceptable levels.

3. LM and AT Modifications:

These structures must be modified as described for the Basic Concept.

C. CONSTRUCTION COST ESTIMATE

The construction cost estimate is given for the year 1984. The cost estimates were derived using previous cost estimates made for the present SLC-6 construction and updating them to 1984 using 6% escalation per year. Quantities for the modifications were derived using volumetric ratios of additional structure to the original structure and ROM design. Unit costs are based on uninterrupted construction except for shutdowns due to missile launch at adjacent sites. Escalation to midpoint construction is not included. The cost is increased by 50% to reflect the added cost due to construction interruption caused by the requirement of maintaining the SSV launch schedule.

BASIC CONCEPT

MST MODS

Structural	5,830,000	
Electrical	<u>800,000</u>	
		\$ 6,630,000

SAB MODS

Structural	4,100,000	
Electrical	1,000,000	
Mechanical (Drive Trucks)	<u>1,850,000</u>	
		\$ 6,950,000

LM MODS

Structural	1,750,000	
Electrical	320,000	
Mechanical (SSWS)	<u>5,000,000</u>	
		\$ 7,070,000

AT MODS

Structural	55,000	
Electrical	<u>30,000</u>	
		<u>85,000</u>

Total \$20,735,000

Extra 25% for Supervision (Labor* x 20%) 570,000

Subtotal 21,305,000

Congested Site 15% 3,196,000

Subtotal 24,501,000

Labor Availability Factor

(80% of Labor*) x 25% 2,695,000

Subtotal \$27,196,000

		\$27,196,000
O&P (Subcontractor)	10%	<u>2,720,000</u>
	Subtotal	\$29,916,000
Overhead & General Conditions for Prime Contractor	10%	<u>2,992,000</u>
	Subtotal	\$32,908,000
Profit (Prime Contractor)	10%	<u>3,291,000</u>
	Subtotal	\$36,199,000
Bond 0.8%		<u>290,000</u>
	Total	\$36,489,000
Interruptions for SSV Launch Schedule	50%	<u>18,246,000</u>
		\$54,735,000

*Assume labor is 55% of Total Cost

OPTION 1

MST MODS

Structural	9,300,000	
Electrical	990,000	
Mechanical (Drive Trucks)	<u>1,850,000</u>	
		\$12,140,000

SAB MODS

Structural	500,000	
Electrical	<u>100,000</u>	
		\$ 600,000

LM MODS

Structural	1,750,000	
Electrical	320,000	
Mechanical (SSWS)	<u>5,000,000</u>	
		\$ 7,070,000

AT MODS

Structural	55,000	
Electrical	<u>30,000</u>	
		<u>85,000</u>
	Total	\$19,895,000

		\$19,895,000
Extra 25% for Supervision (Labor* x 20%)		<u>547,000</u>
	Subtotal	20,442,000
Congested Site	15%	<u>3,066,000</u>
	Subtotal	23,508,000
Labor Availability Factor (80% of Labor*) x 25%		<u>2,586,000</u>
	Subtotal	\$26,094,000
O&P (Subcontractor)	10%	<u>2,609,000</u>
	Subtotal	\$28,703,000
Overhead & General Conditions for Prime Contractor	10%	<u>2,870,000</u>
	Subtotal	\$31,573,000
Profit (Prime Contractor)	10%	<u>3,157,000</u>
		\$34,730,000
Bond 0.8%		<u>278,000</u>
	Total	\$35,008,000
Interruptions for SSV Launch Schedule	50%	<u>17,504,000</u>
		\$52,512,000

D. CONSTRUCTION SCHEDULE

The construction schedule is based on uninterrupted construction, i.e. no shutdowns for SSV launches, servicing, or pre-launch preparations. It was further assumed that the contractor is provided with ample lay-down and storage areas for all construction materials.

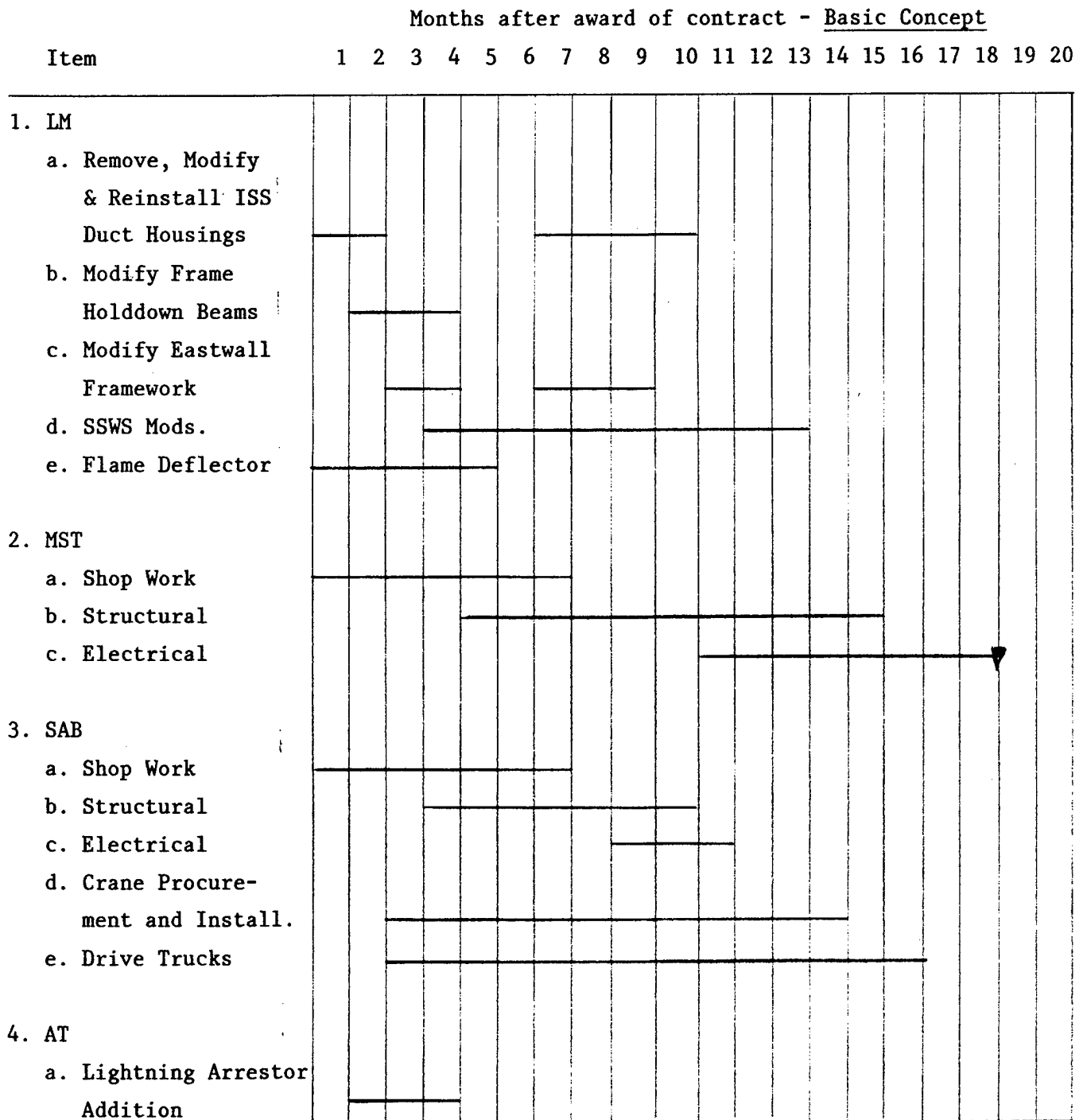

Months after award of contract - Option 1

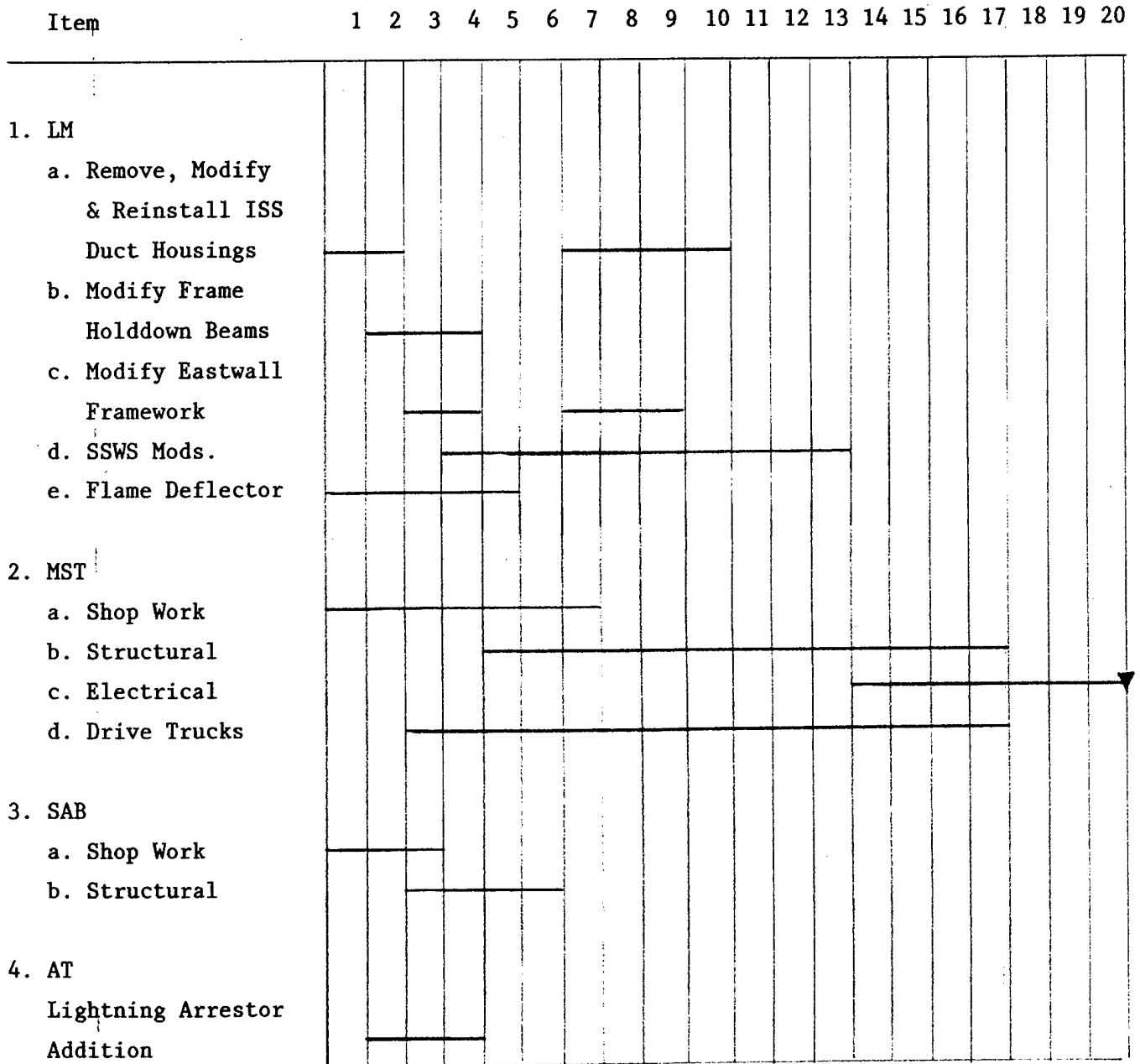

E. CONCLUSIONS

Both concepts are feasible. A concept recommendation cannot be intelligently made since the facility modifications are only a part of the total scenario of converting SLC-6 for ULV launches as well as SSV launches. In the concept selected, consideration should be given to cost, impact on construction and launch schedules, and practicality of the two concepts.

1. Basic Concept

Advantages

New MST trucks are not required.

Disadvantages

- a. More facilities are extensively modified.
- b. Existing SAB trucks are not adequate.
- c. Modification of MST columns is more severe.
- d. Synchronization of SAB and MST cranes.
- e. New SAB crane is required.

2. Option 1

Advantages

- a. Only minor modification is required to the SAB.
- b. Existing SAB trucks are adequate.
- c. Modification to existing MST columns is less severe on previously over-stressed columns.
- d. No problem with synchronization of cranes during stacking.
- e. Existing MST bridge crane is re-used.

Disadvantages

- a. Two new MST drive trucks are required.
- b. SAB must be raised to form a weatherseal with the MST.

A disadvantage of both concepts is the time required to reconfigure the LM from an SSV launch to a ULV launch and vice versa. Consideration should be given to the time required to remove and install the various LM items.

APPENDIX A

NO.	REVISION	DATE	BY	CHKD.
1	ISSUED FOR CONSTRUCTION	11/17/61	J. L. B.	J. L. B.
2	REVISION TO DRAWING	11/17/61	J. L. B.	J. L. B.
3	REVISION TO DRAWING	11/17/61	J. L. B.	J. L. B.
4	REVISION TO DRAWING	11/17/61	J. L. B.	J. L. B.
5	REVISION TO DRAWING	11/17/61	J. L. B.	J. L. B.
6	REVISION TO DRAWING	11/17/61	J. L. B.	J. L. B.
7	REVISION TO DRAWING	11/17/61	J. L. B.	J. L. B.
8	REVISION TO DRAWING	11/17/61	J. L. B.	J. L. B.
9	REVISION TO DRAWING	11/17/61	J. L. B.	J. L. B.
10	REVISION TO DRAWING	11/17/61	J. L. B.	J. L. B.

YELLOW PAINT DESIGN INDICATING POINTS
DARKENED THROUGH ON ACCESS PANELS

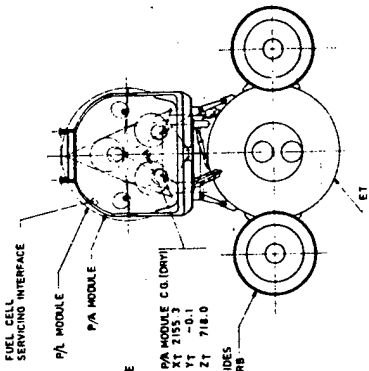
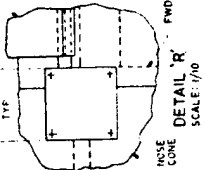
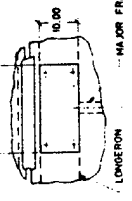
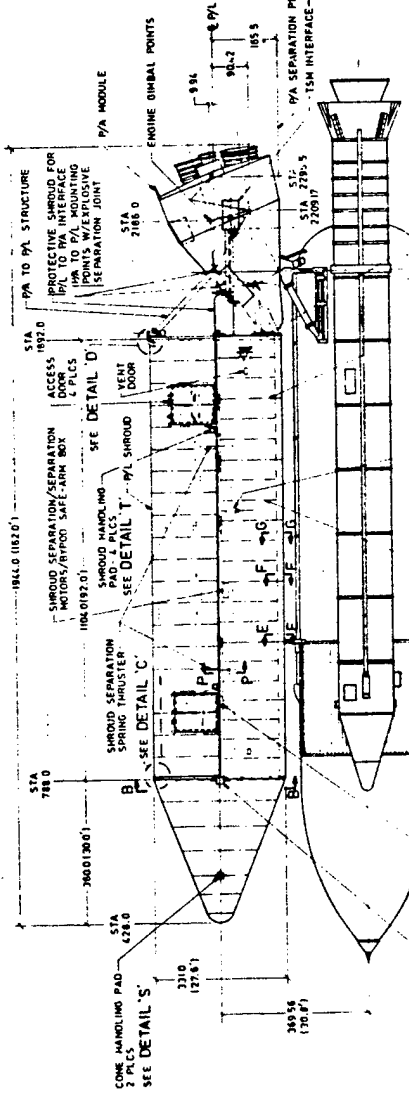
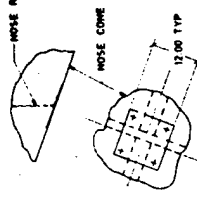
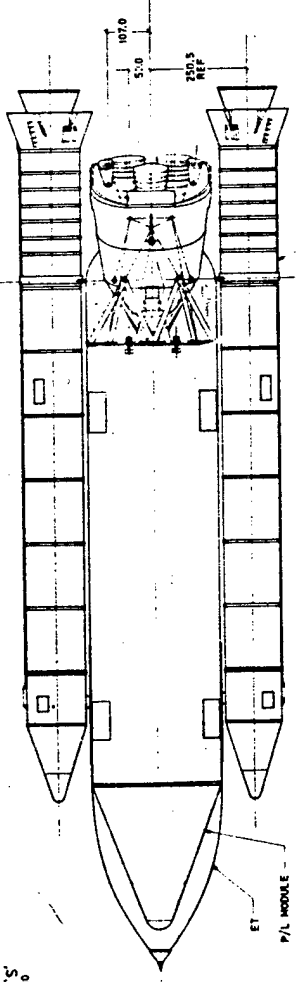
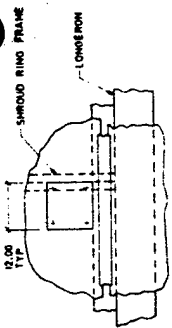

VIEW LOOKING FWD

NOTE:
1. SECTION VIEWS & DETAILS ARE FOUND ON SHIT 2
2. SIDE MOUNT UNMANNED LAUNCH VEHICLE VARIATIONS - DWD-826AP00138

MAJOR BASELINE COMPONENT CONFIGURATION
1. ET
2. SRB
3. P/A MODULE
4. P/L MODULE

STANDARD EXCEPT FWD BIPOD
STANDARD EXCEPT FWD BIPOD
STANDARD EXCEPT FWD BIPOD
STANDARD EXCEPT FWD BIPOD

STABILITY FRAME
15 PLCS

MAJOR FRAME
5 PLCS

MAJOR FRAME
5 PLCS

NO.	REVISION	DATE	BY	CHKD.
1	ISSUED FOR CONSTRUCTION	11/17/61	J. L. B.	J. L. B.
2	REVISION TO DRAWING	11/17/61	J. L. B.	J. L. B.
3	REVISION TO DRAWING	11/17/61	J. L. B.	J. L. B.
4	REVISION TO DRAWING	11/17/61	J. L. B.	J. L. B.
5	REVISION TO DRAWING	11/17/61	J. L. B.	J. L. B.
6	REVISION TO DRAWING	11/17/61	J. L. B.	J. L. B.
7	REVISION TO DRAWING	11/17/61	J. L. B.	J. L. B.
8	REVISION TO DRAWING	11/17/61	J. L. B.	J. L. B.
9	REVISION TO DRAWING	11/17/61	J. L. B.	J. L. B.
10	REVISION TO DRAWING	11/17/61	J. L. B.	J. L. B.

826AP00138
SIDE MOUNT UNMANNED LAUNCH VEHICLE
MODEL SM 1B
CONFIGURATION
\$ 53100 826AP00138

V23 ULV Processing (P/A & P/L Module Mating)

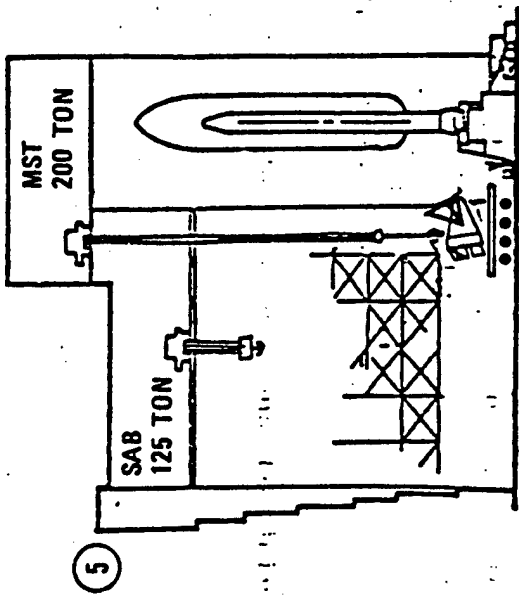

P/A MODULE STACK

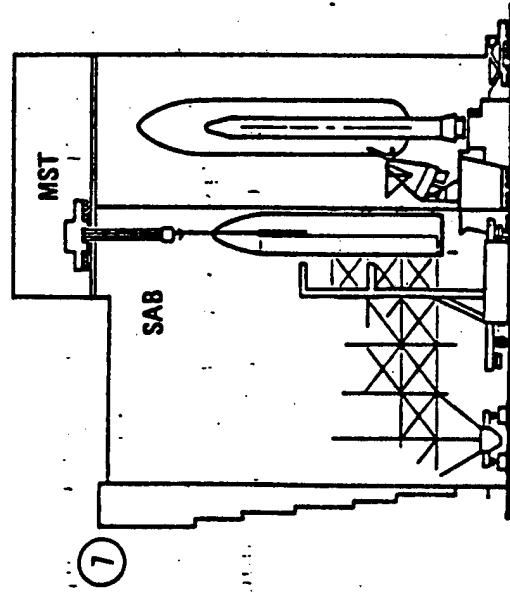
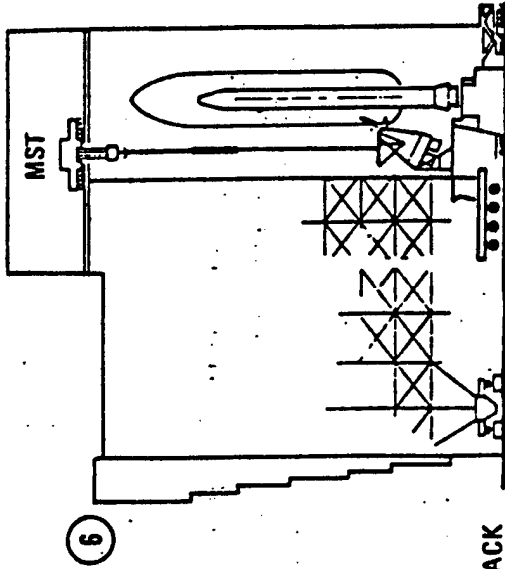

P/L MODULE STACK

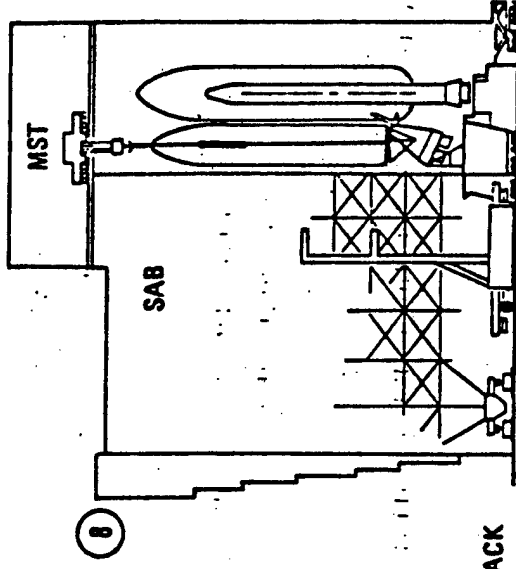

MMC Side-Mount

Modified SAB & MST

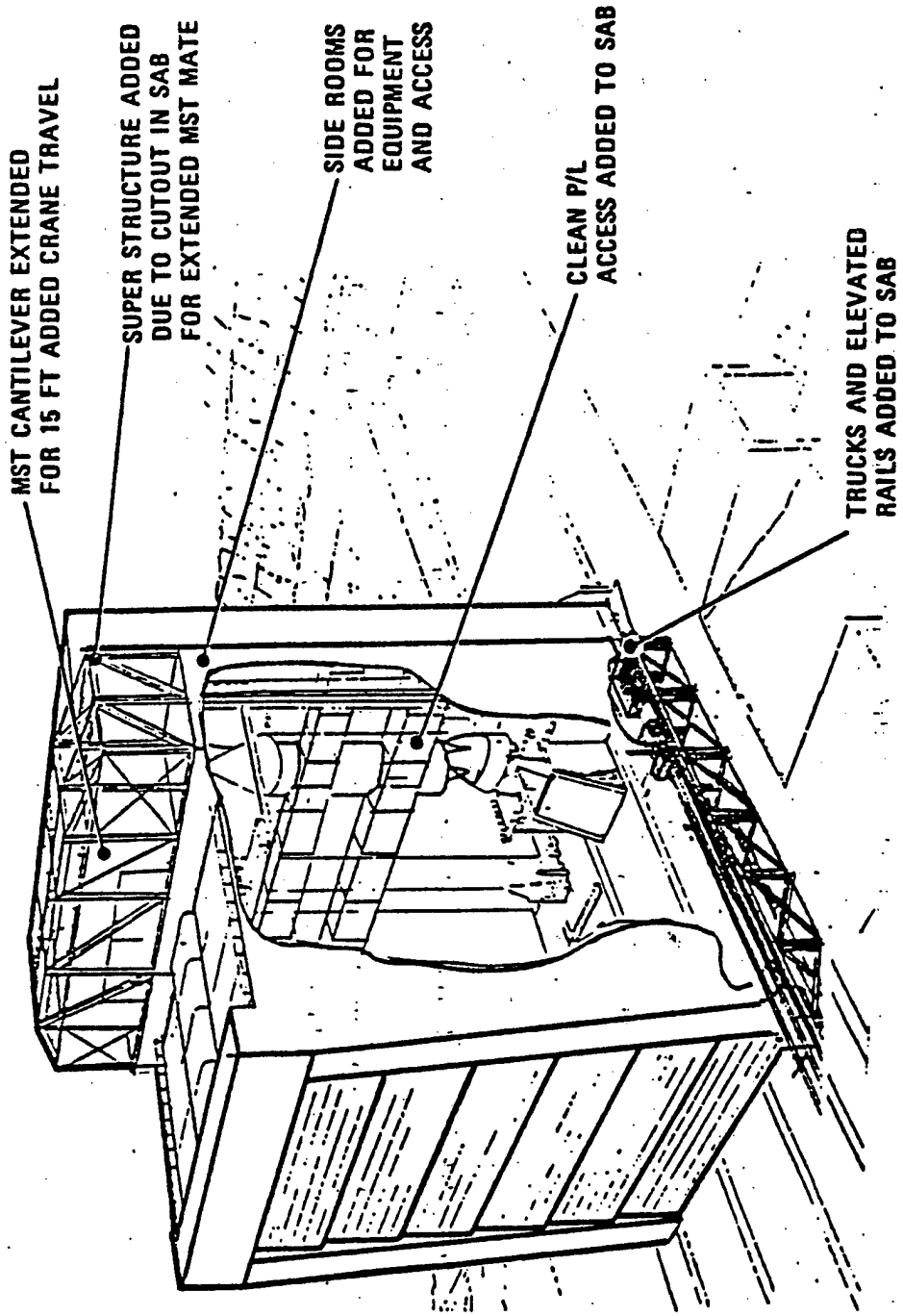

MMC Side-Mount

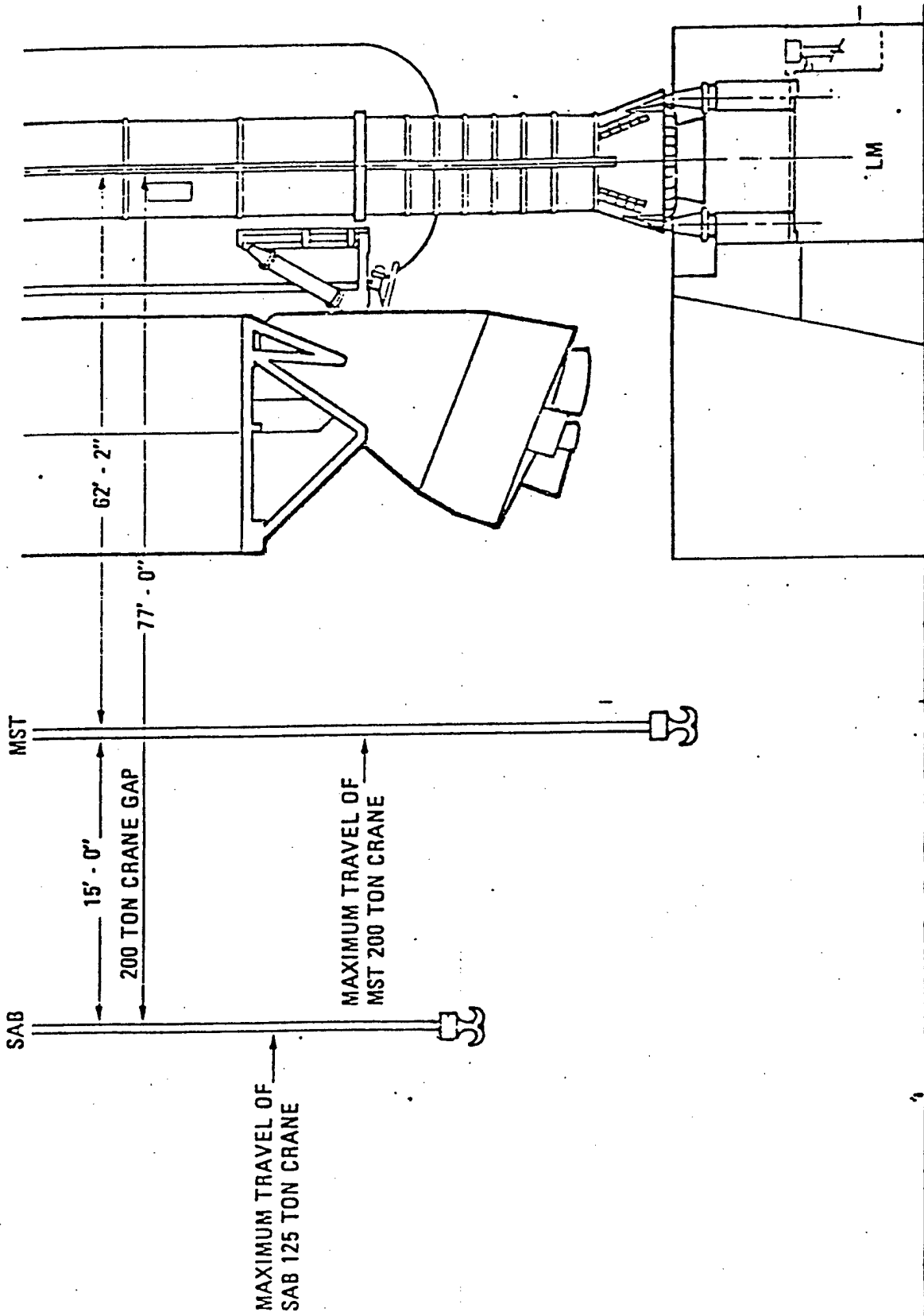

MMC Side-Mount

44-8

MATING MECHANISM ASSY. - SO. SIDE

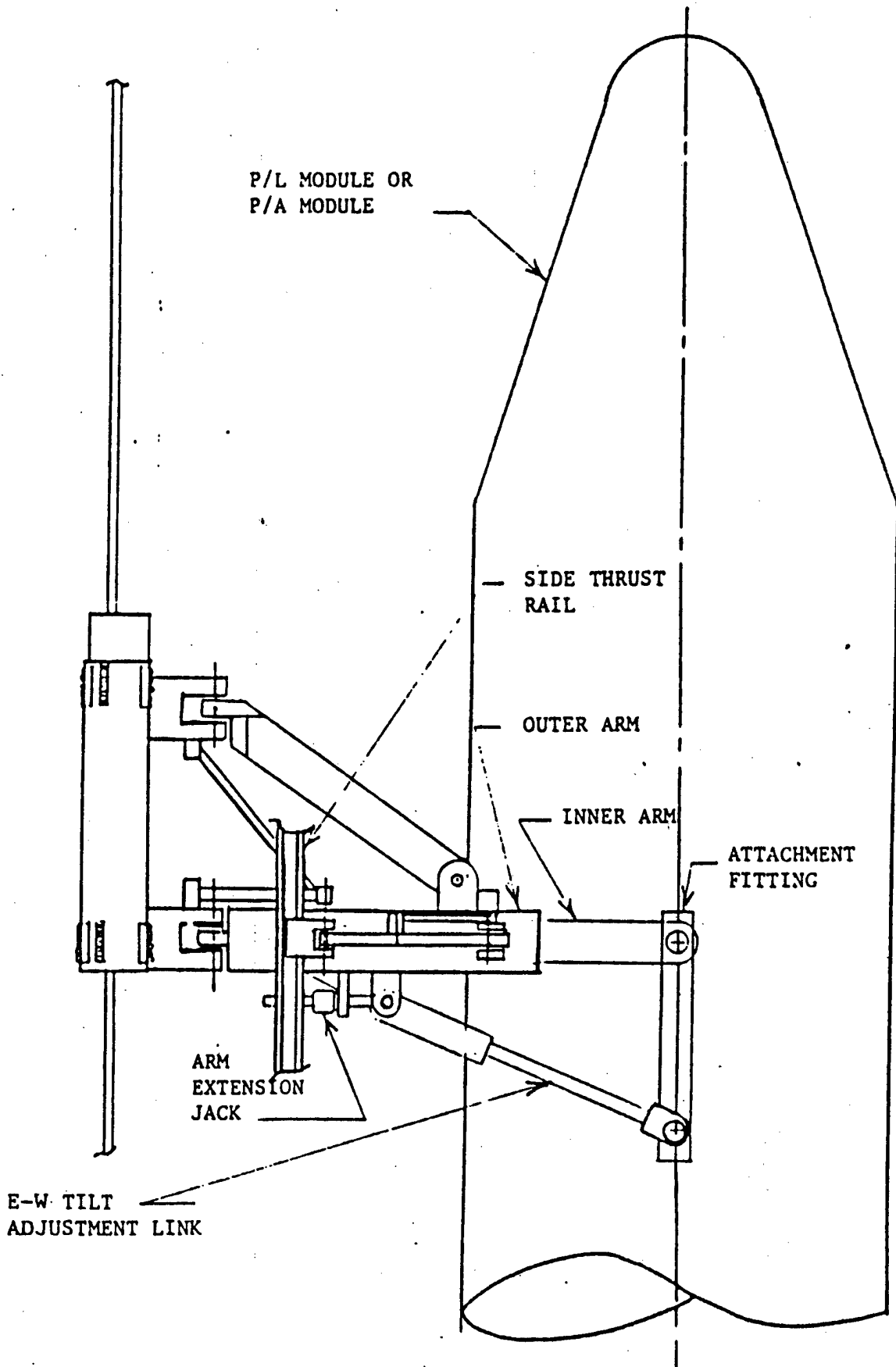

E-W TILT
ADJUSTMENT LINK

ARM
EXTENSION
JACK

P/L MODULE OR
P/A MODULE

SIDE THRUST
RAIL

OUTER ARM

INNER ARM

ATTACHMENT
FITTING

FIG. 1

Aerospace Side-Mount

SHT. 7 OF 16

MATING MECHANISM PLAN VIEW

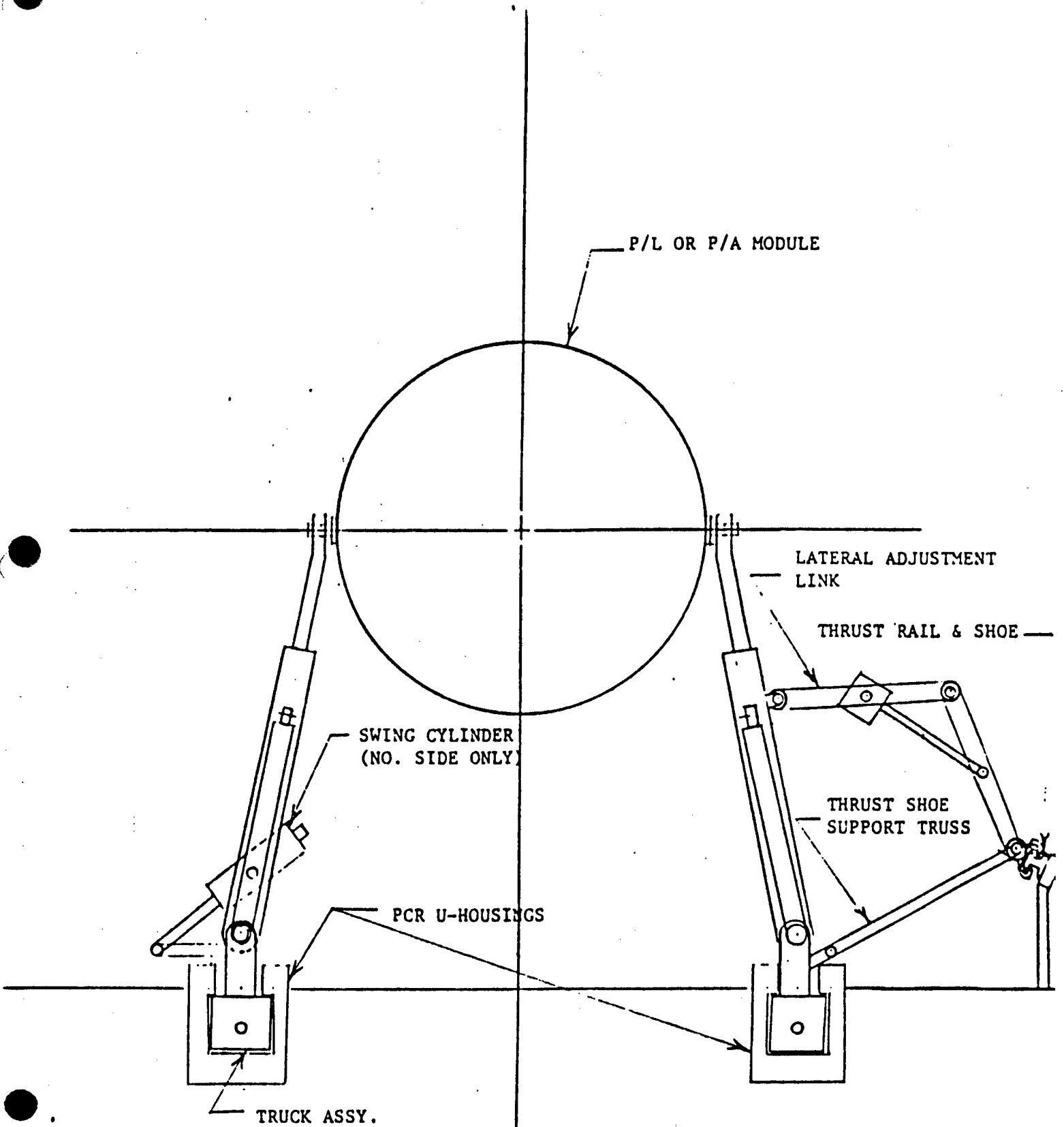

Aerospace Side-Mount

SHT. 8 OF 16

FIG. 2

VERTICAL TRUCK ASSY

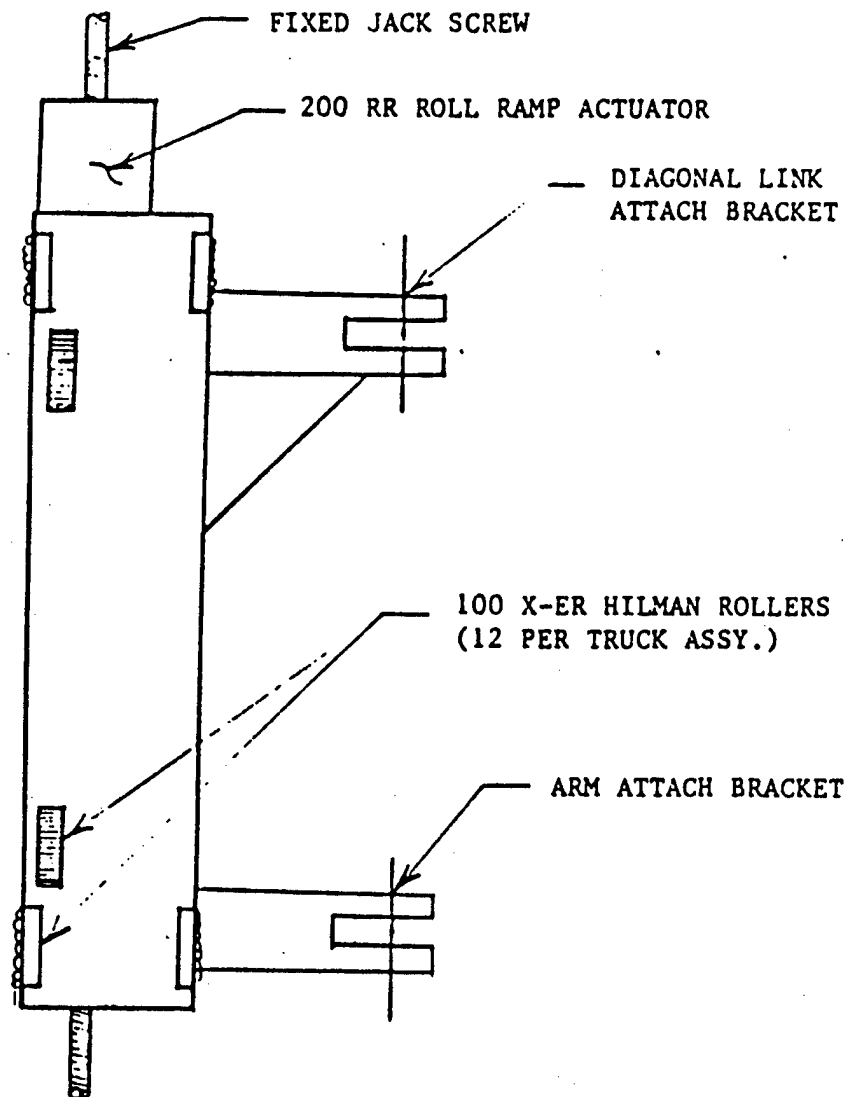
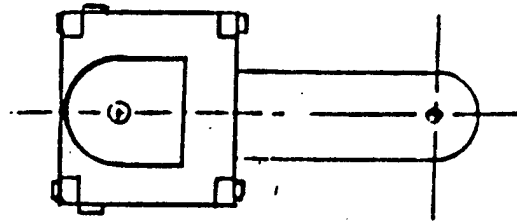

Aerospace Side-Mount
SHT. 9 OF 16

FIG. 3

MST Modification

Option II

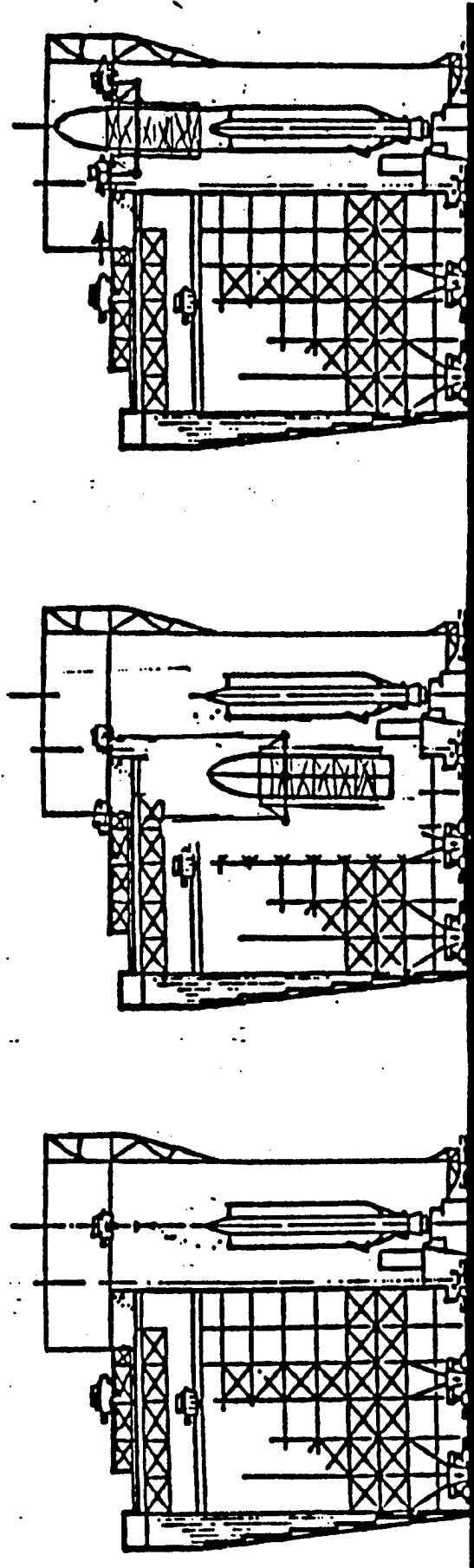

ULV Installed in MST

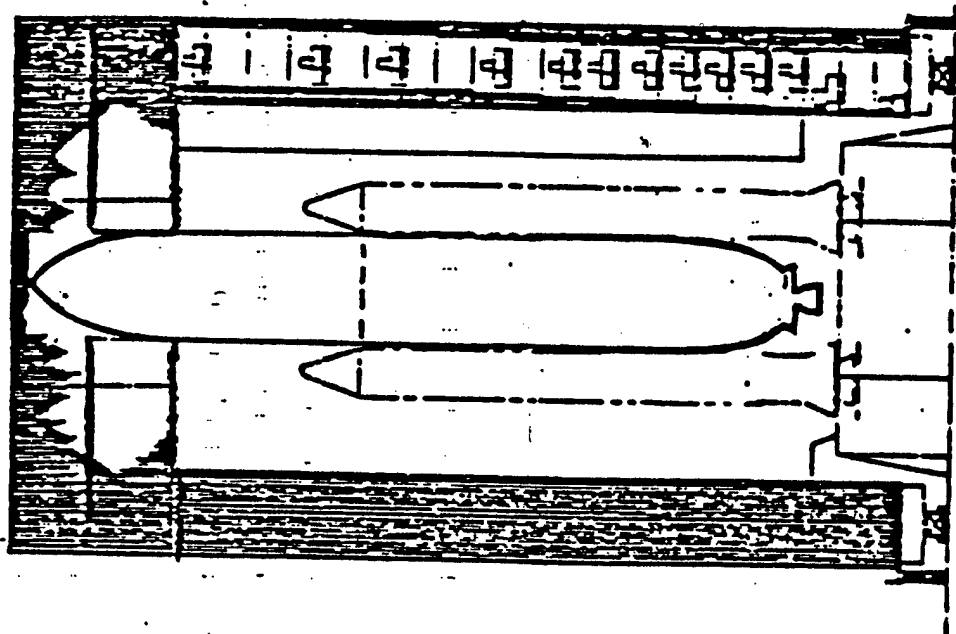

- ULV PENETRATES ROOF STRUCTURE BUT NOT OUTER ROOF
- MSF ROOF AT ELEV 375'
- ULV PENETRATES TO APPROXIMATELY ELEV 370'
- VARIOUS MODIFICATION OPTIONS BEING INVESTIGATED

LAUNCH MOUNT MODIFICATION OPTIONS

REQUIREMENT - SSME EXHAUST ACCOMMODATION

- OPTION I o Flame Deflector with water suppression
- o Modification to STS ice suppression system to allow removal and reinstallation
- OPTION II o Air start SSME's

REQUIREMENT - PROVIDE LO₂, LH₂ AND ELECTRICAL SERVICING TO P/A MODULE

- OPTION I o Provide alternate routing for piping and electrical systems through the area inside LM structure
- o Penetrate LM surface and engage umbilical interface on P/A module with new umbilical masts and plates
- OPTION II o Interface with existing STS rise off umbilical masts above LM surface
- o Provide surface mounted and protected LO₂ and LH₂ lines and electrical services to P/A module umbilical masts
- OPTION III o Provide umbilical arms from location outside LM envelope with rotating/retracting mode at T-O

Launch Mount Modification Option I

- PRIMARY IMPACT OF CENTRAL SSME IS ON VEHICLE HEATING AND ACOUSTICS
- ADD FLAME DEFLECTOR ON TOP OF CENTER OF LAUNCH MOUNT TO AVOID VEHICLE HEATING FROM SSME PLUME RECIRCULARIZATION
- ADD WATER SPRAY FOR SOUND SUPPRESSION $\approx 10-15$ dB REDUCTION BASED ON MODEL TESTING
- ADD RISE OFF T-O UMBILICAL MASTS

111 17...
(2005)

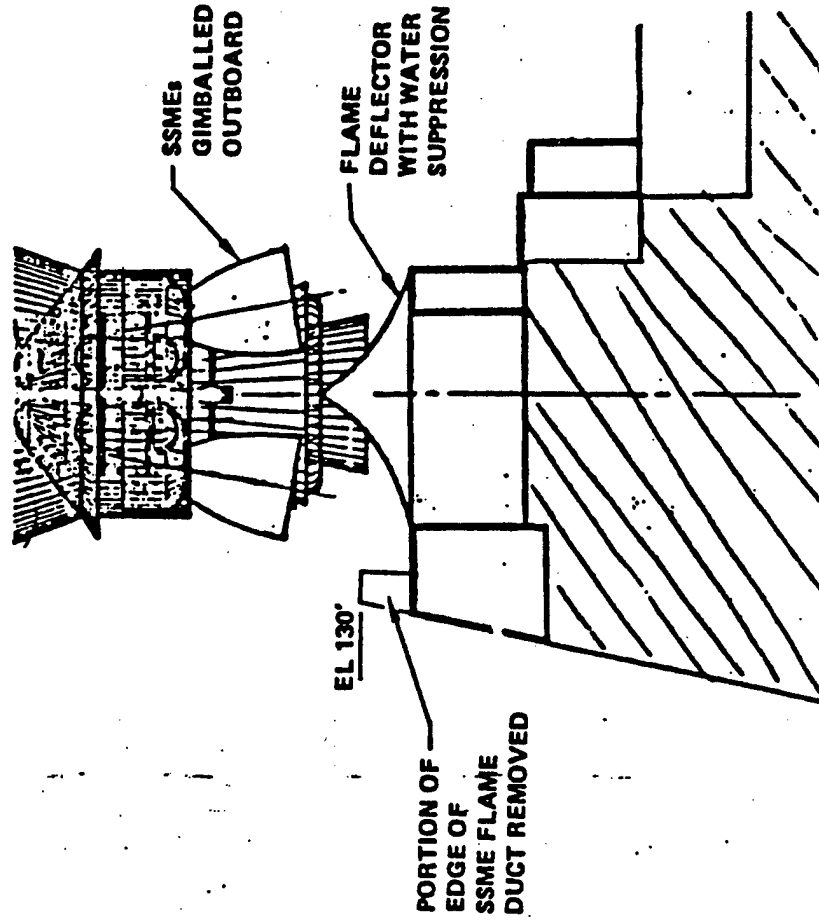
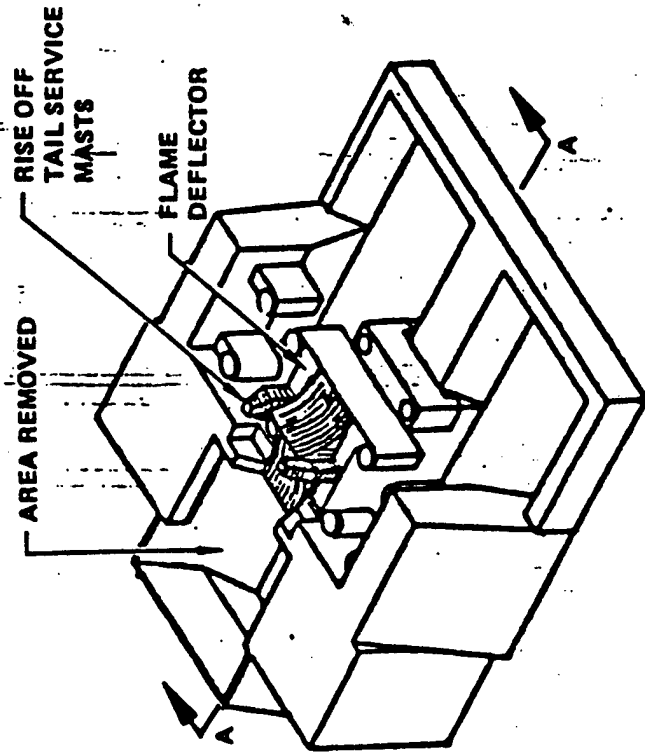

SECTION A-A THROUGH LAUNCH MOUNT

LV-115

LM Modification Option II

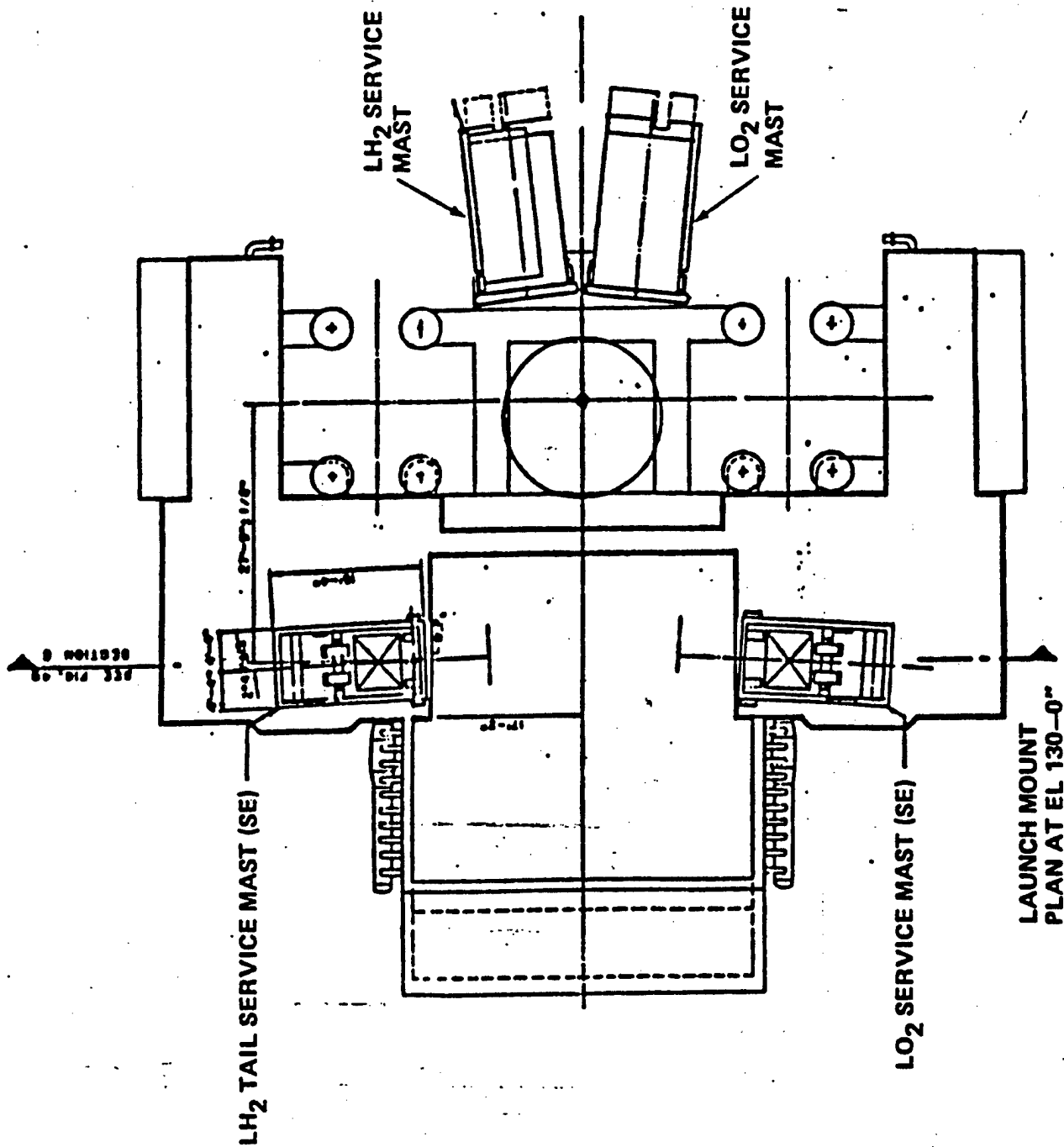

LM Modification Option III

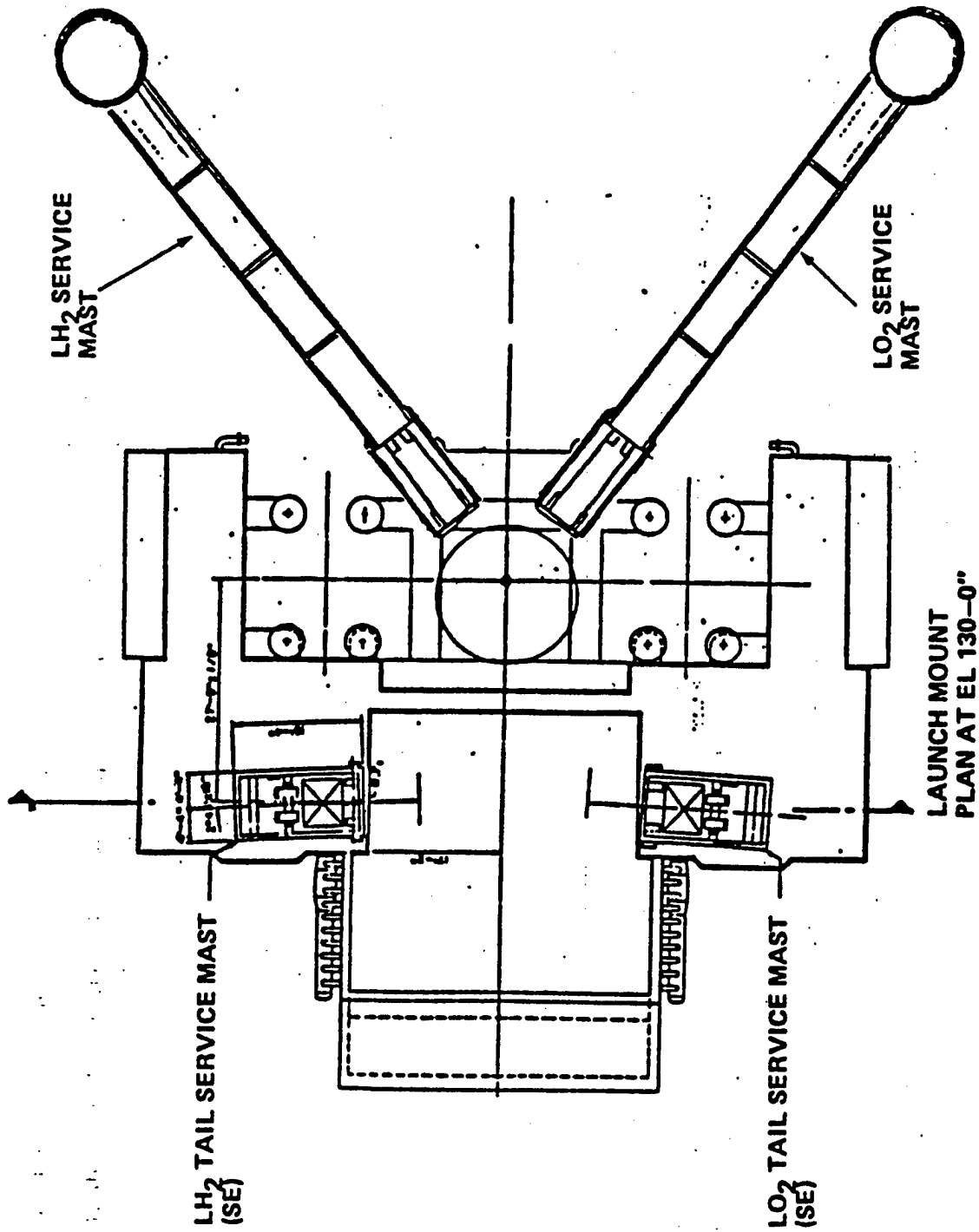

LV-112

Boeing In-Line

SHT. 15 OF 16

VAFB Facility Modifications

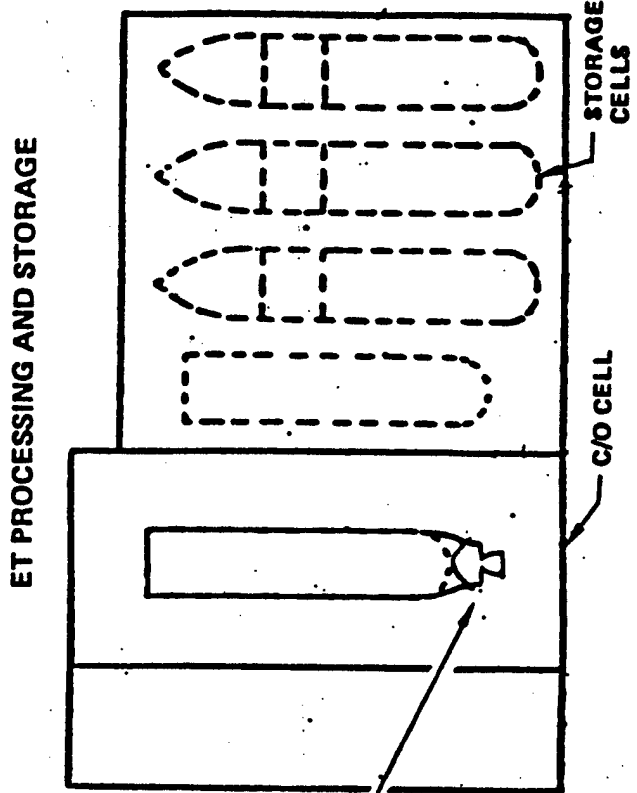
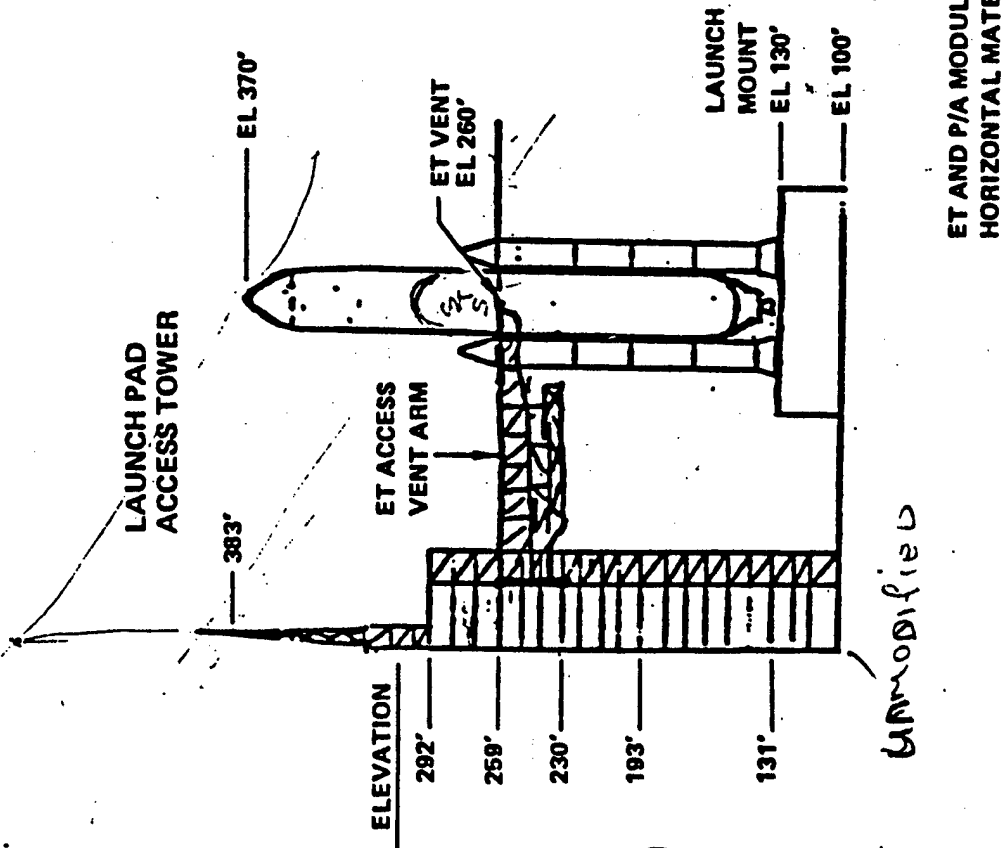

ET AND P/A MODULE HORIZONTAL MATE

APPENDIX B

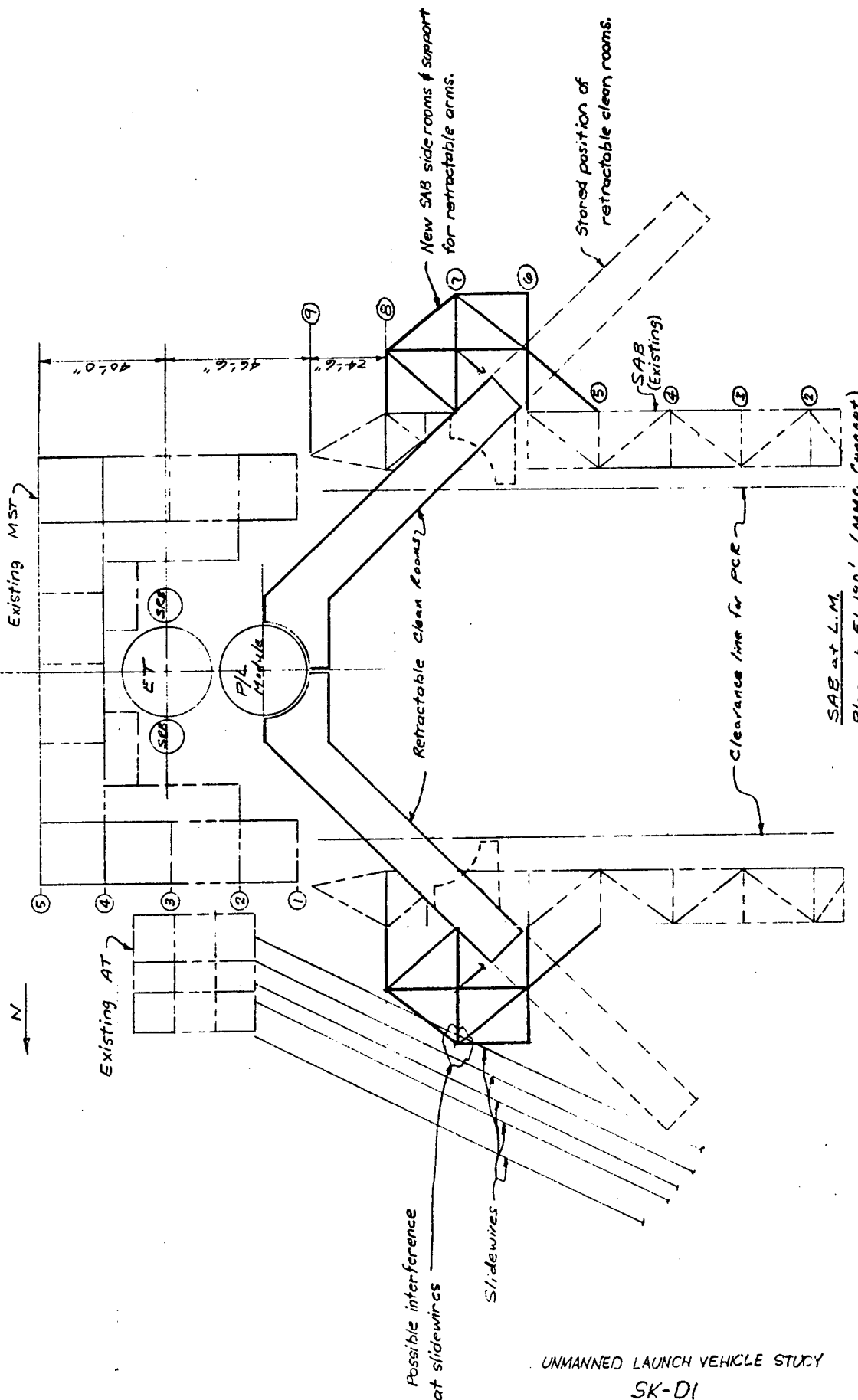

SAB at L.M.
 Plan at El. 190' (MMC Concept)
 1/23/61

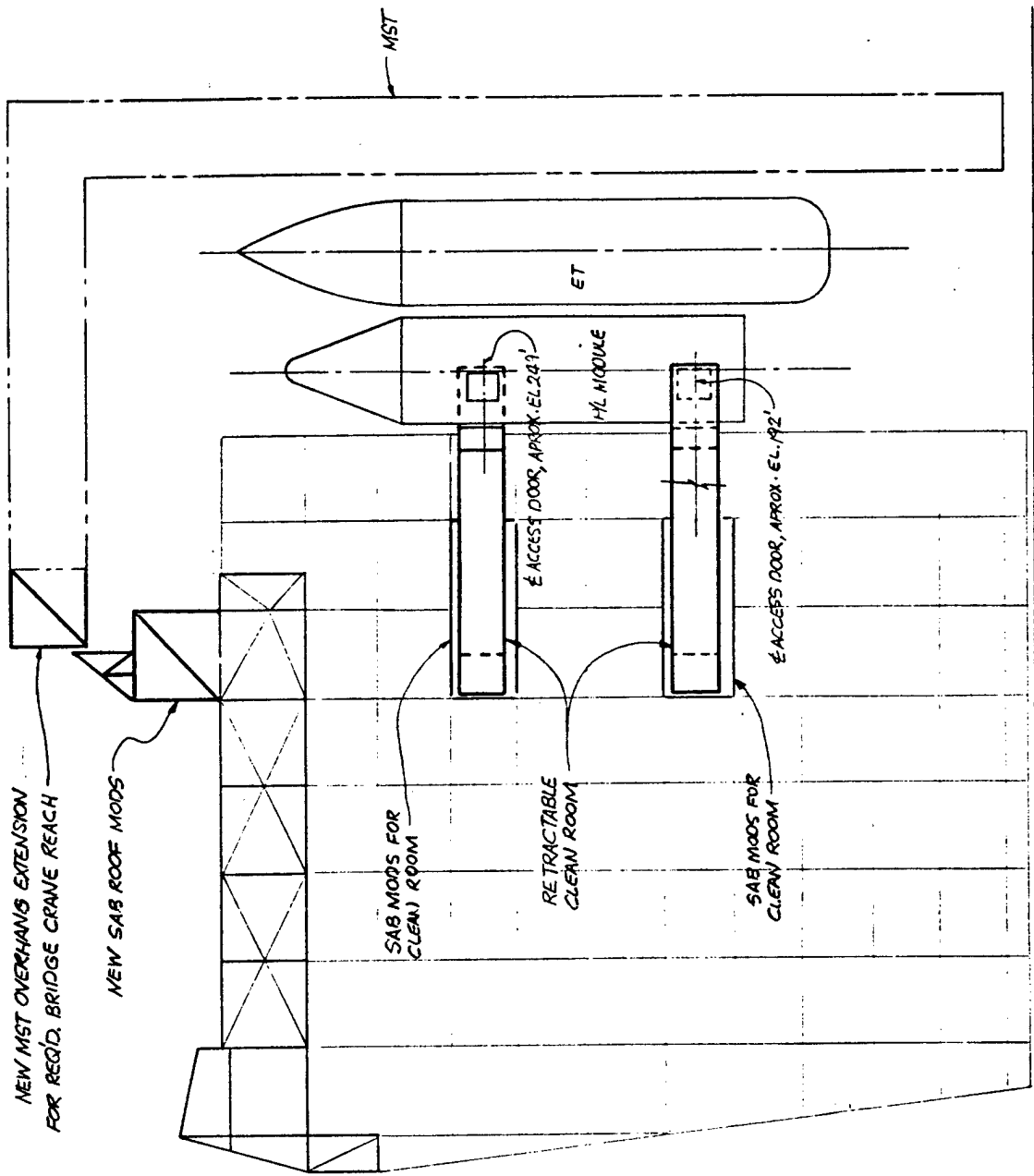

CROSS SECTION THRU SAB @ L.M. (M.M.C. CONCEPT)

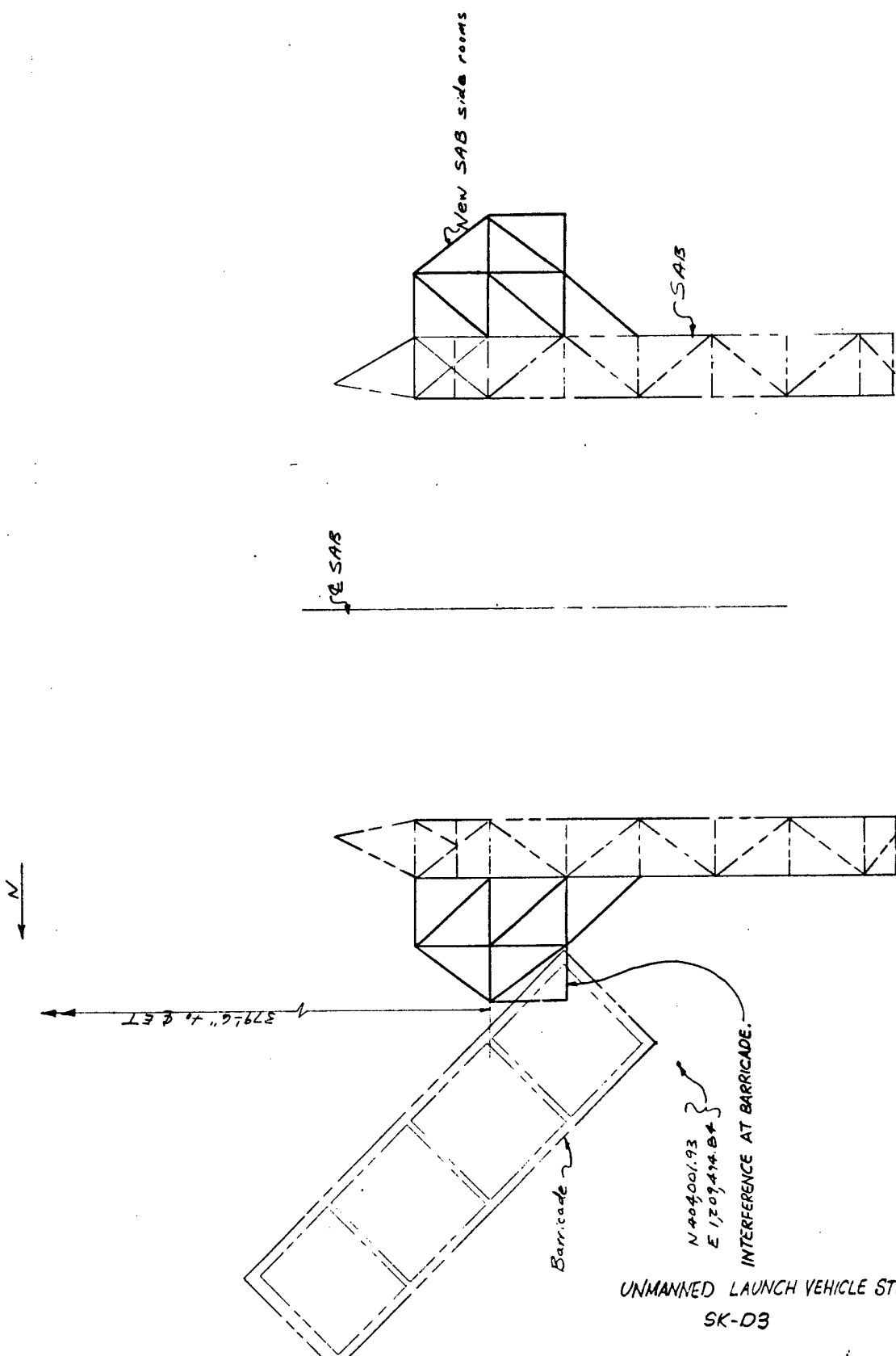

New SAB side rooms

SAB

SE SAB

N

379.6" + 2 ET

Barricade

N 40° 00' 1.93
E 170° 41' 4.84

INTERFERENCE AT BARRICADE.

Plan - SAB at Packed Position (El. 190') - MMC Concept
1" = 30'

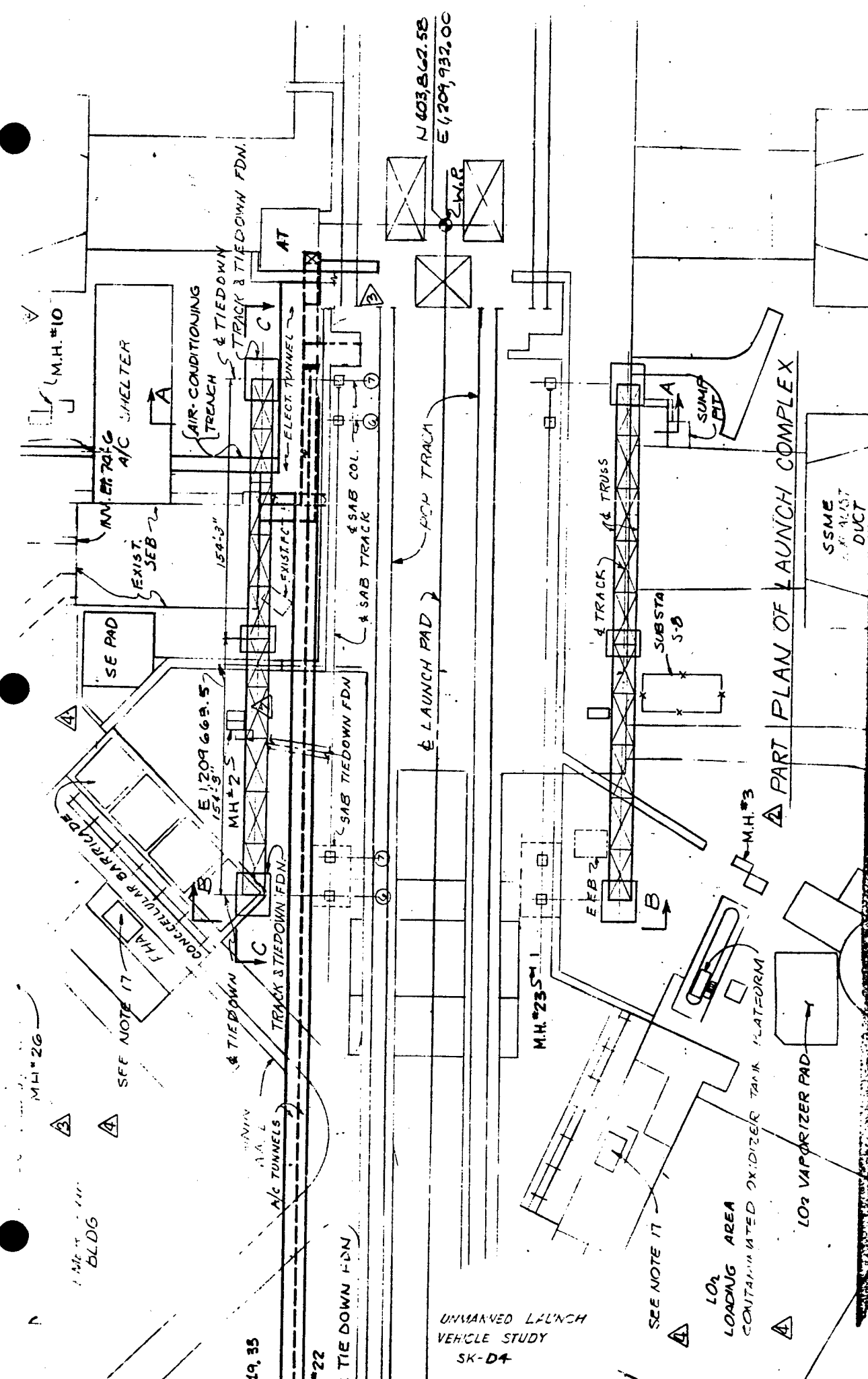

N 403,862.58
E 4209,932.00

M.H.#10

SHelter

AIR-CONDITIONING
TRENCH & TIEDOWN
TRACK & TIEDOWN FDN.

AT

ELECT. TUNNEL

SE TRACK

LAUNCH PAD

FOR TRACK

SE TRACK

SE TRACK

SE TRACK

SE TRACK

SE TRACK

SE TRACK

SE TRACK

SE TRACK

SE TRACK

SE TRACK

SE TRACK

SE TRACK

SE TRACK

SE TRACK

PART PLAN OF LAUNCH COMPLEX

SSME
EXIST
DUCT

SEE NOTE 17

LO₂ LOADING AREA
CONTAMINATED OXIDIZER TANK PLATFORM

LO₂ VAPORIZER PAD

UNMANNED LAUNCH
VEHICLE STUDY
SK-D4

SEE NOTE 17

M.H.#26

BLDG

CONCRETE BARRIAGE

SE PAD

EXIST. SEB

154'-3"

E 1209662.5

M.H.#2

SE TRACK

LAUNCH PAD

SE TRACK

SE TRACK

SE TRACK

SE TRACK

SE TRACK

SE TRACK

SE TRACK

SE TRACK

SE TRACK

SE TRACK

SE TRACK

SE TRACK

SE TRACK

SE TRACK

SE TRACK

149.35

22

R TIE DOWN FDN

A/C TUNNELS

SE TRACK

LAUNCH PAD

SE TRACK

SE TRACK

SE TRACK

SE TRACK

SE TRACK

SE TRACK

SE TRACK

SE TRACK

SE TRACK

SE TRACK

SE TRACK

SE TRACK

SE TRACK

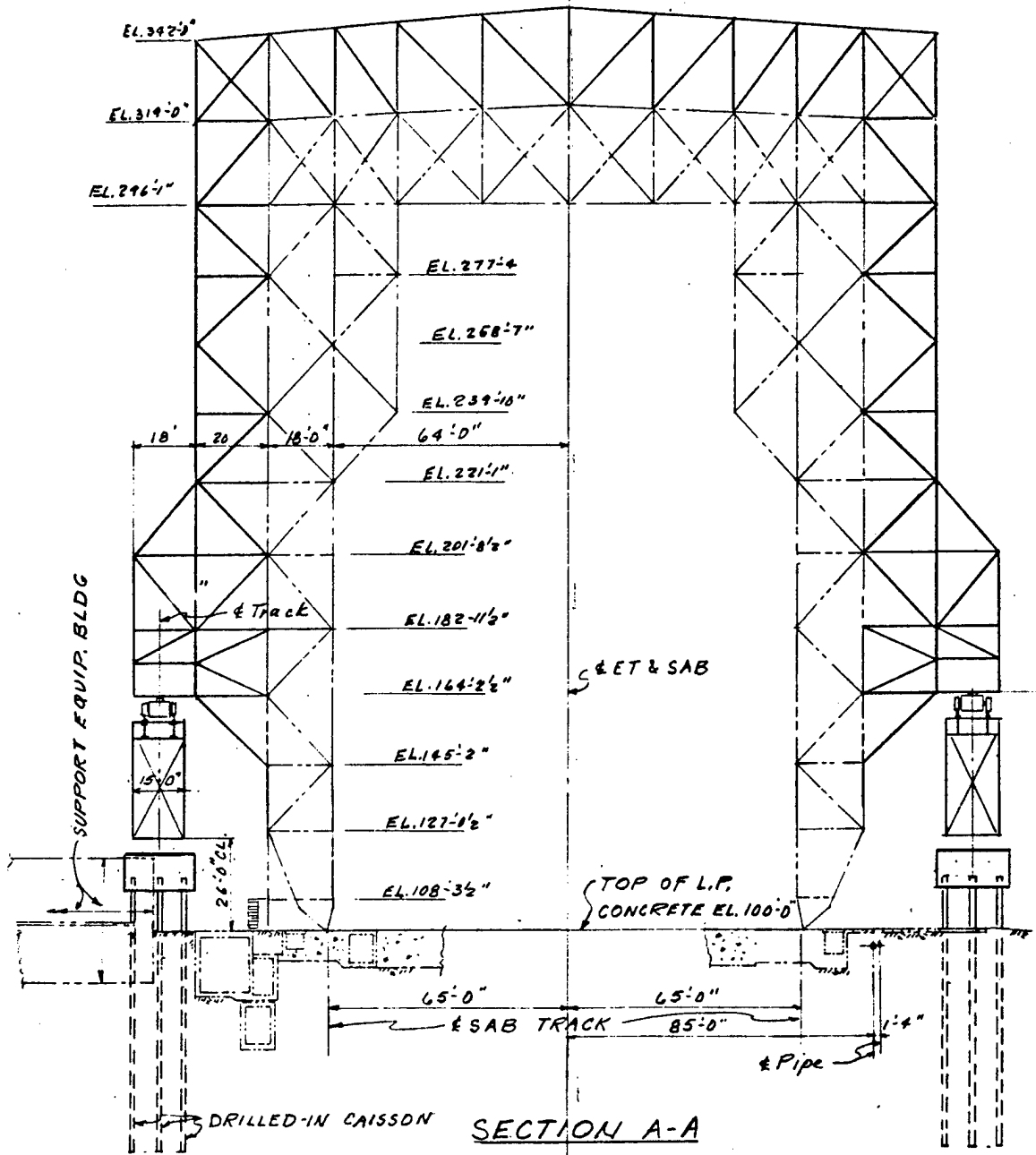

SECTION A-A

Scale 1" = 30'-0"

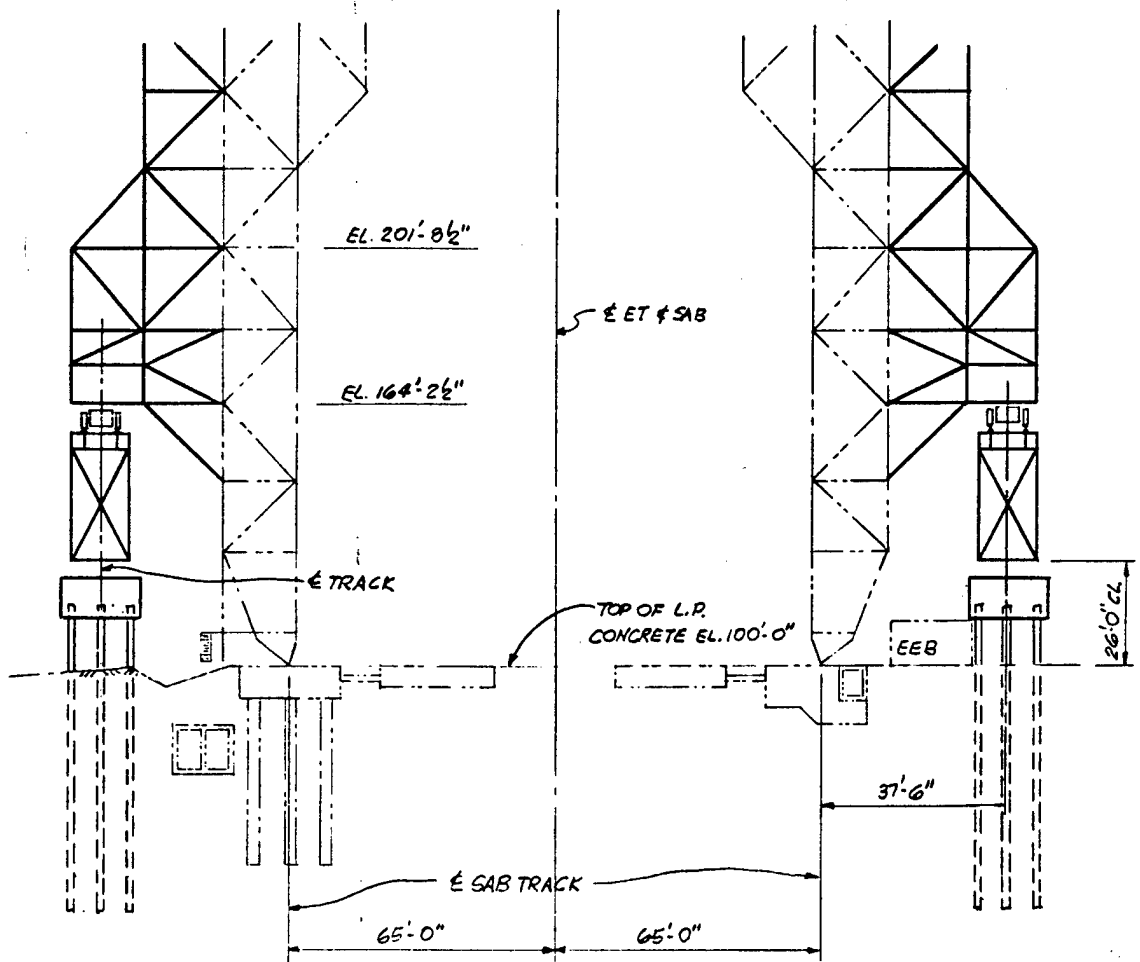

SECTION B-B

SVERDRUP & PARCEL

JOB

SHEET NO. OF

DATE

COMPUTATIONS FOR

BY CHKD

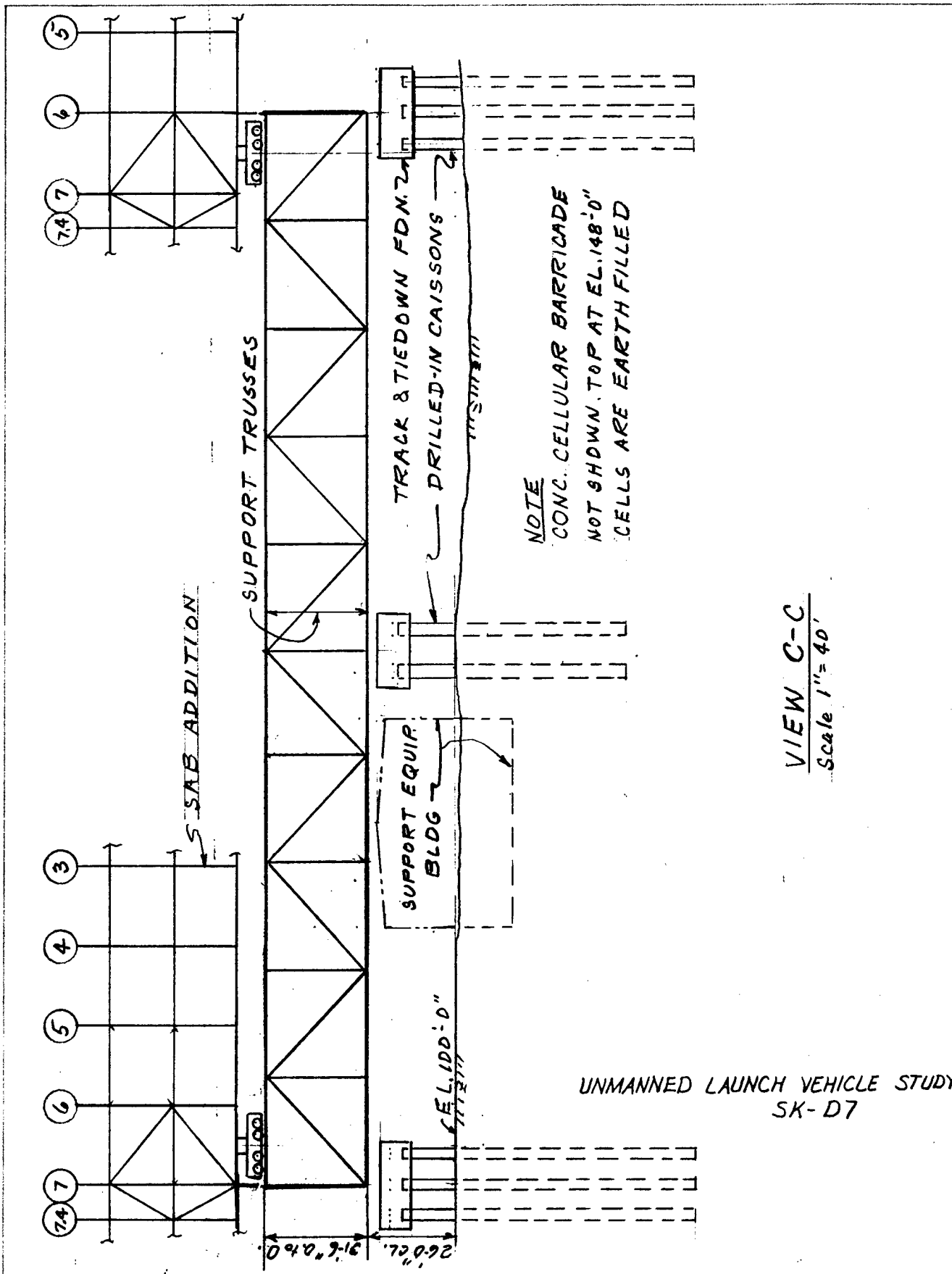

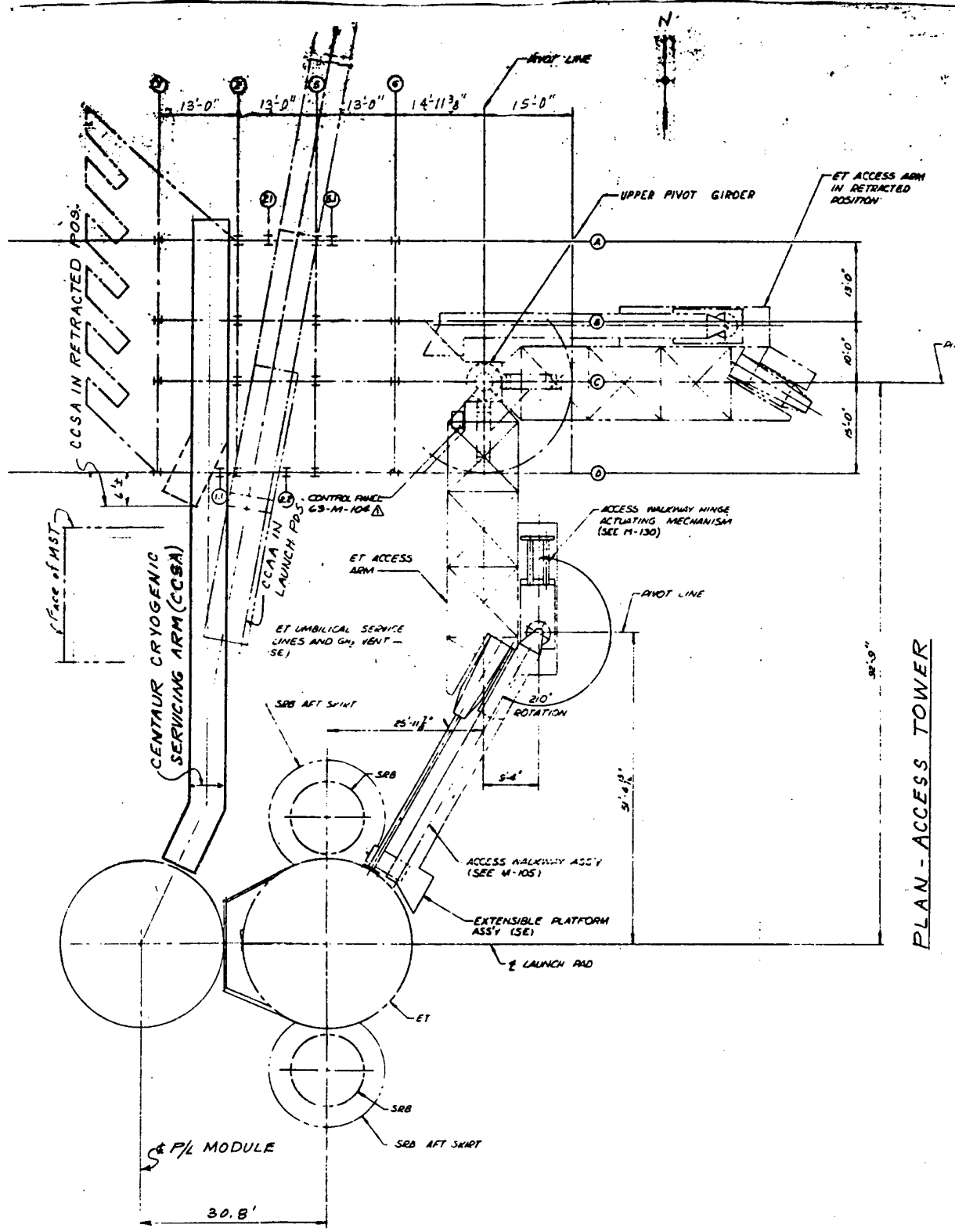

PLAN - ACCESS TOWER

PLAN

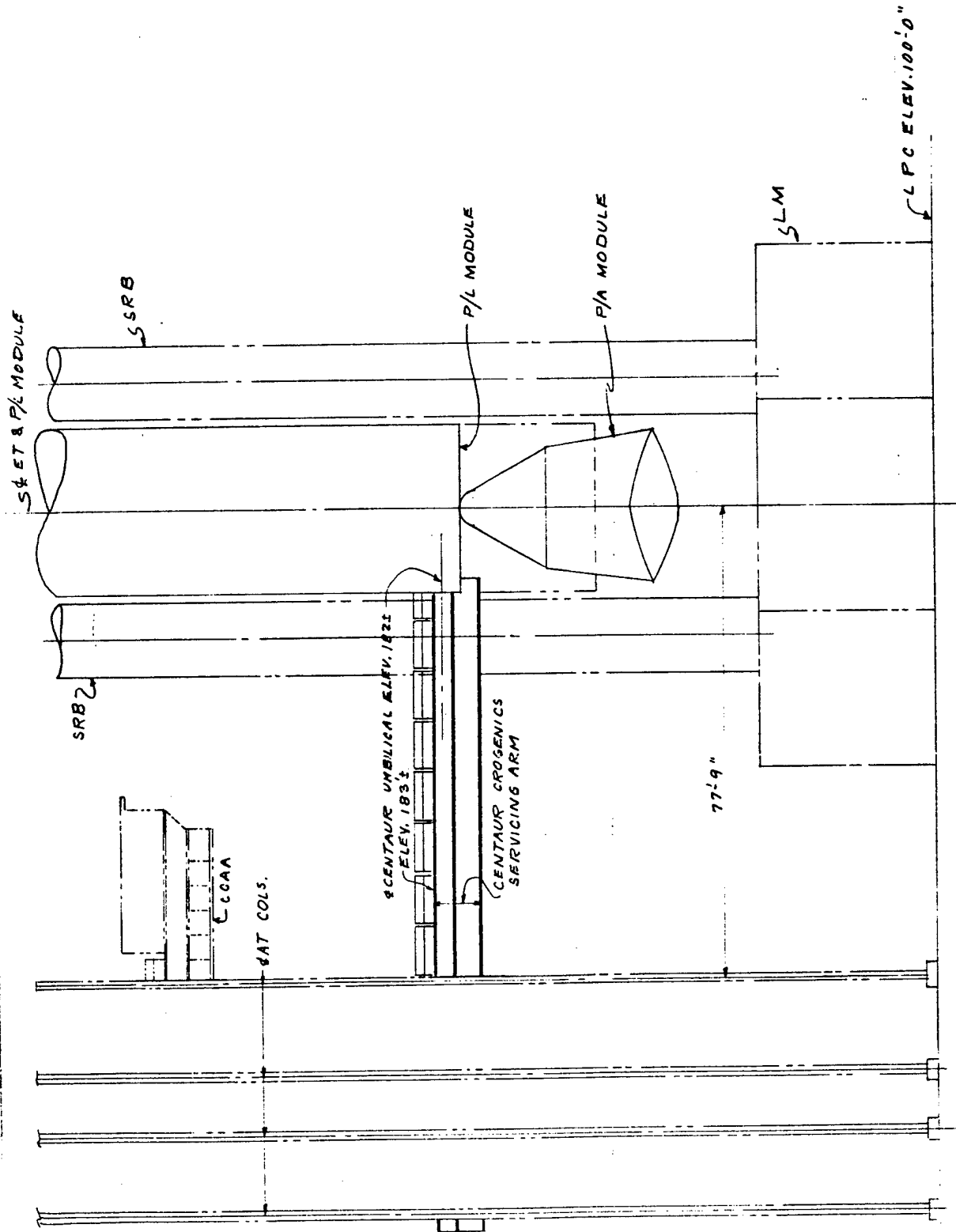

AT ELEVATION

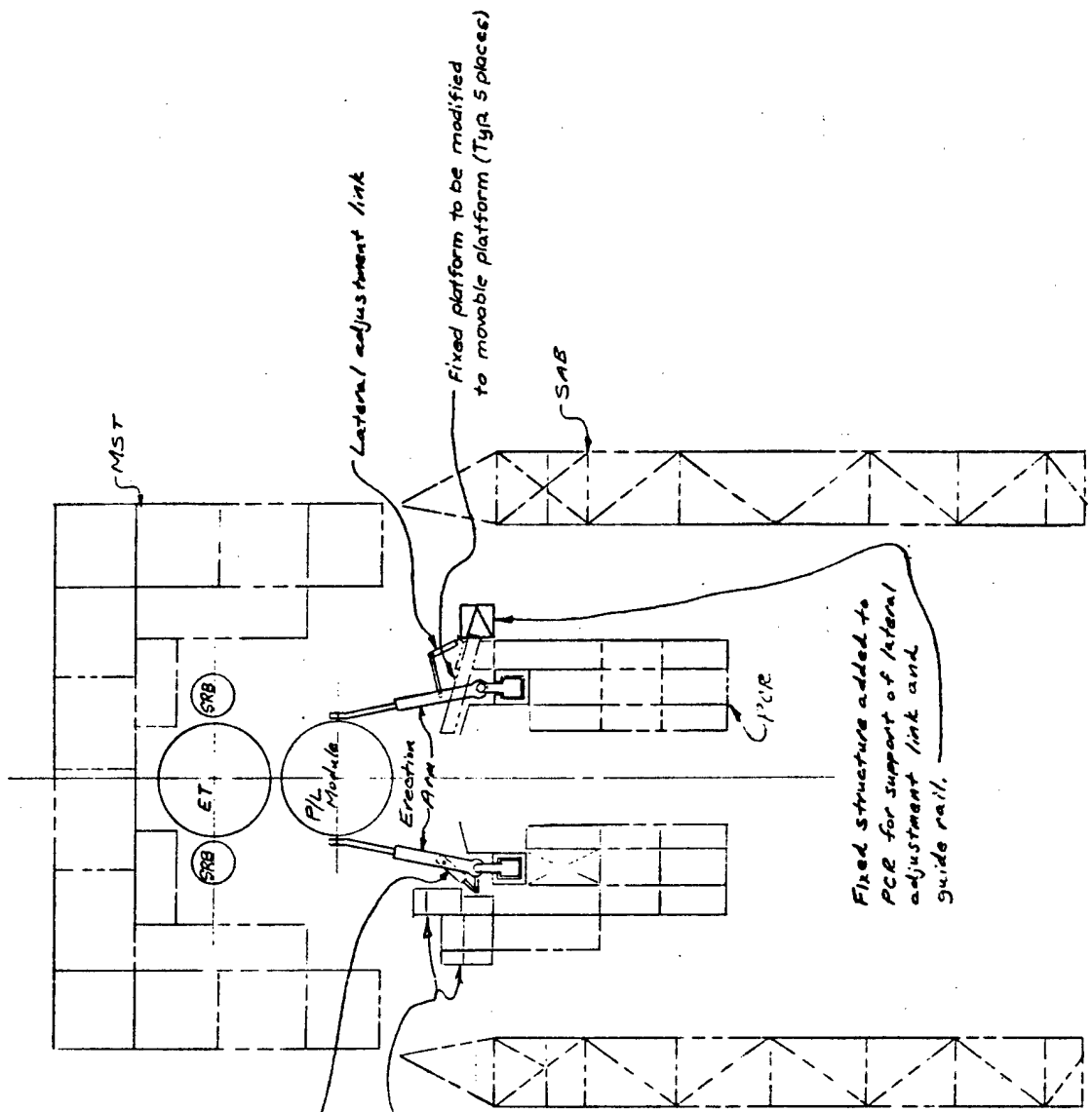

Plan - PCR/SAB/MST at P/L Stacking Position (Aerospace Concept)
 1/2 = 30'

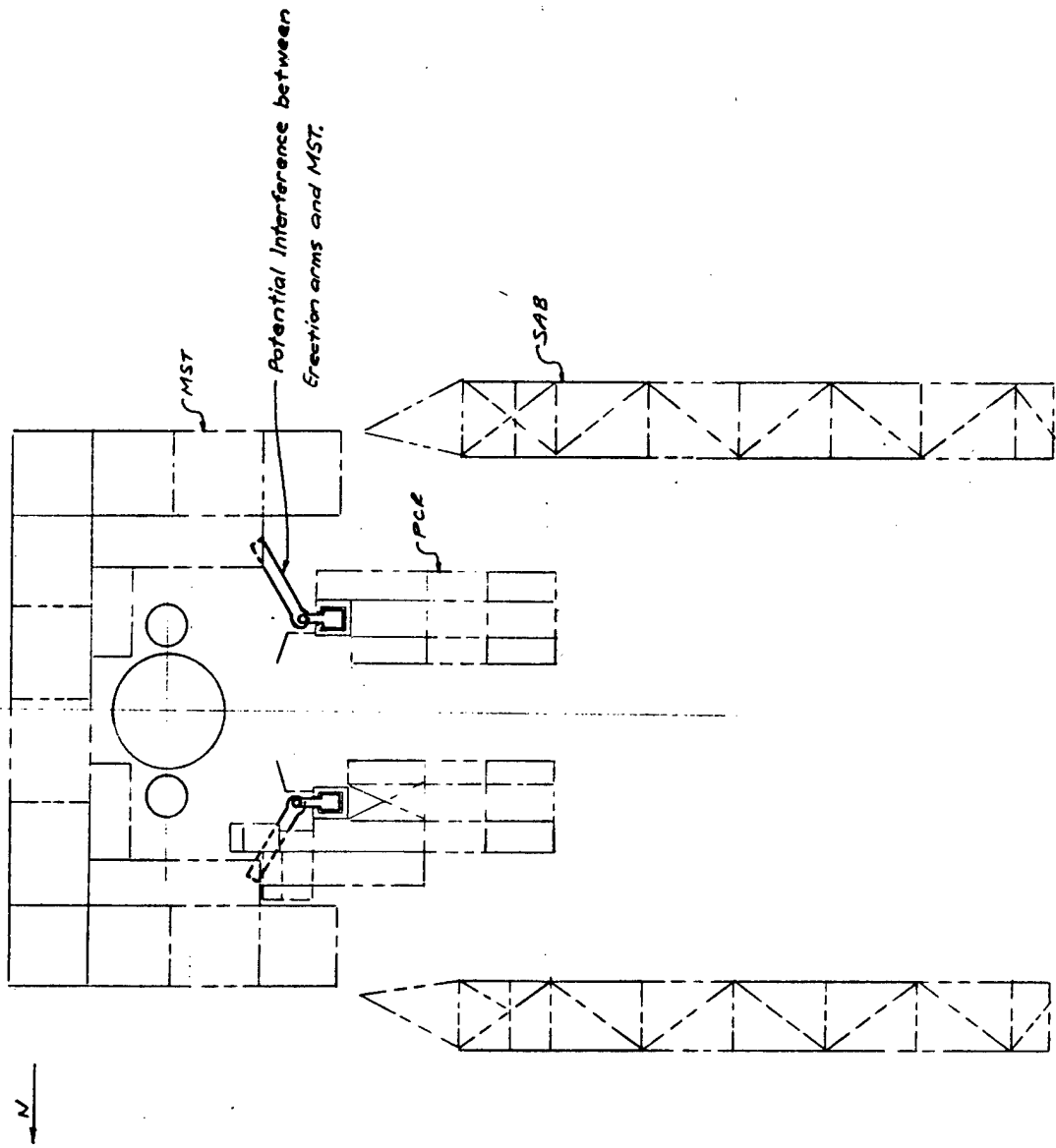

PLAN-PCR of SSV Payload Erection Position (Aerospace Concept)
1"=30'

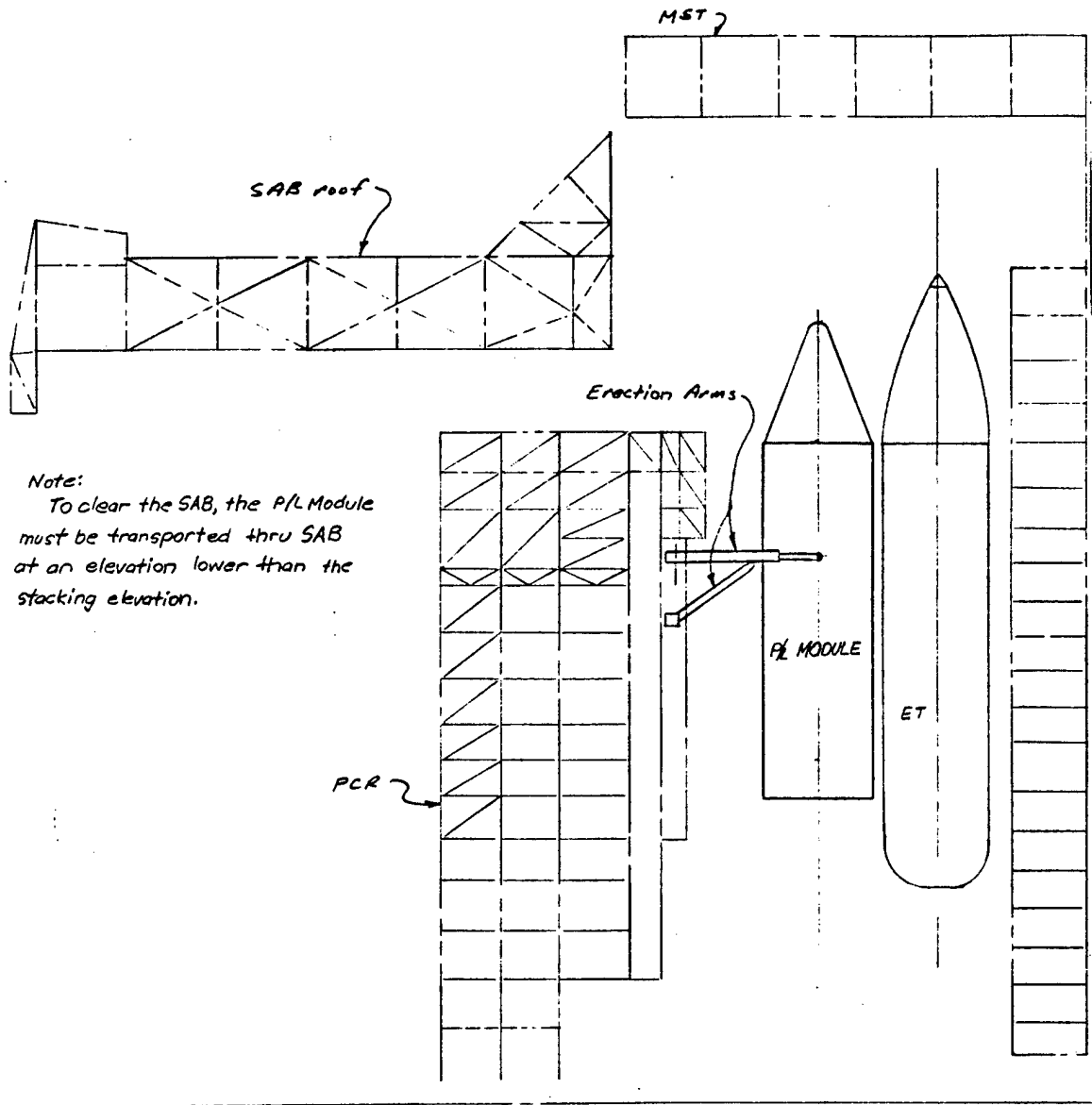

Note:
 To clear the SAB, the P/L Module
 must be transported thru SAB
 at an elevation lower than the
 stacking elevation.

Elevation- PCR at P/L Module Stacking Position (Aerospace Concept)
 1" = 30'

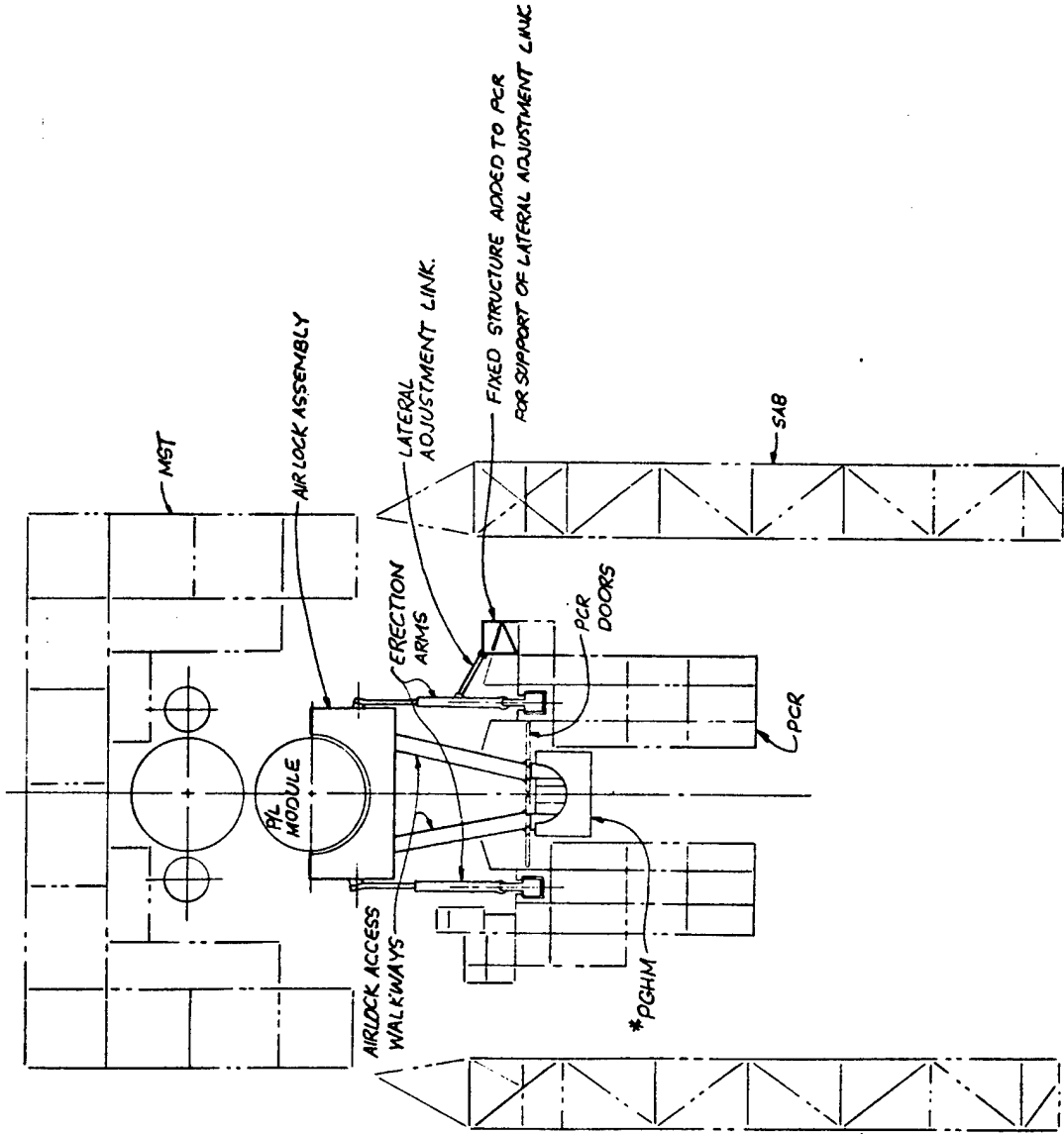

* ACCESS TO WALKWAYS
MAY BE FROM PGHM OR
LRU PLATFORMS.

Plan PCR Airlock Walkways (Aerospace Concept)

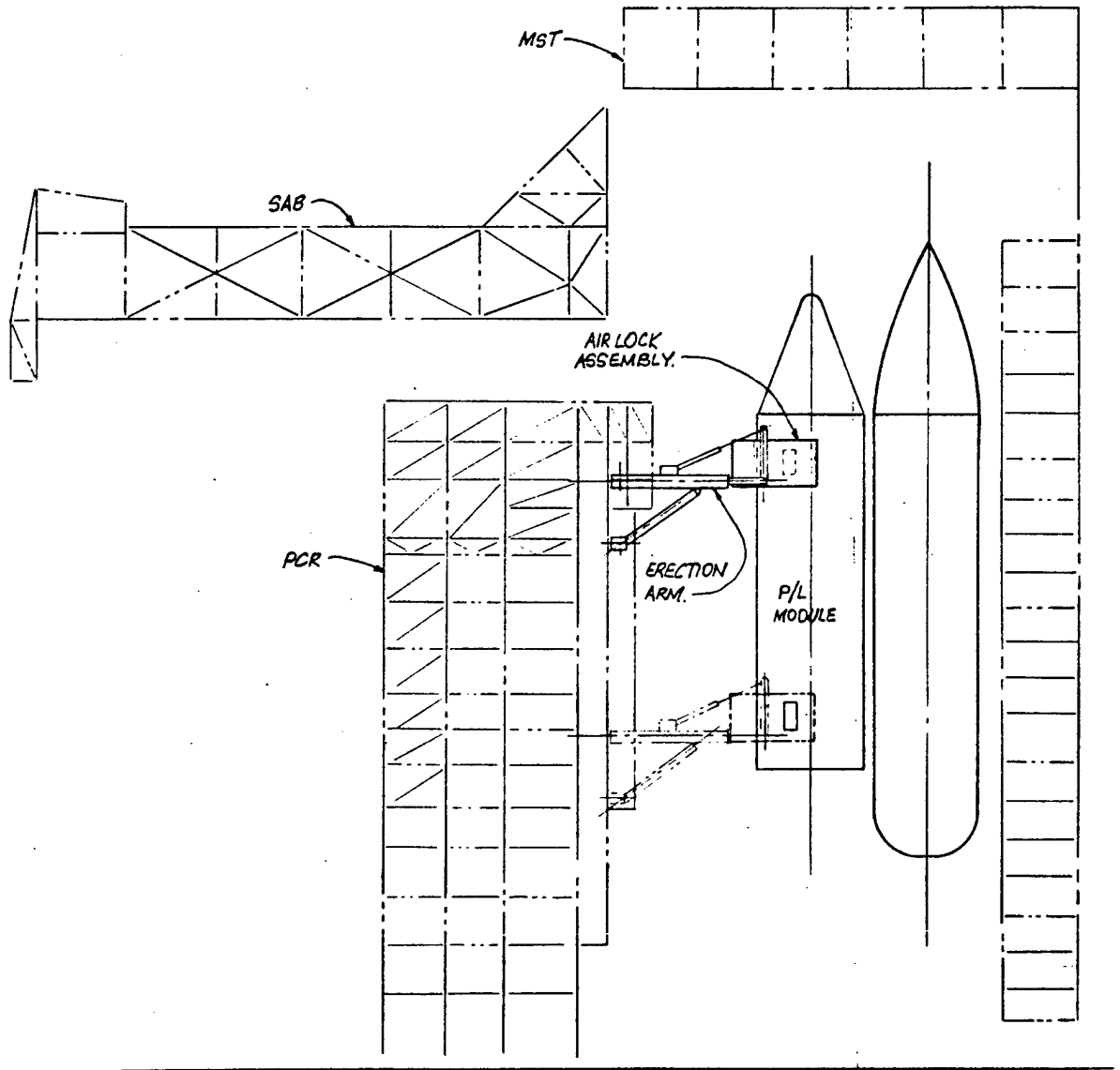

Elevation- PCR Airlock Walkways (Aerospace Concept)

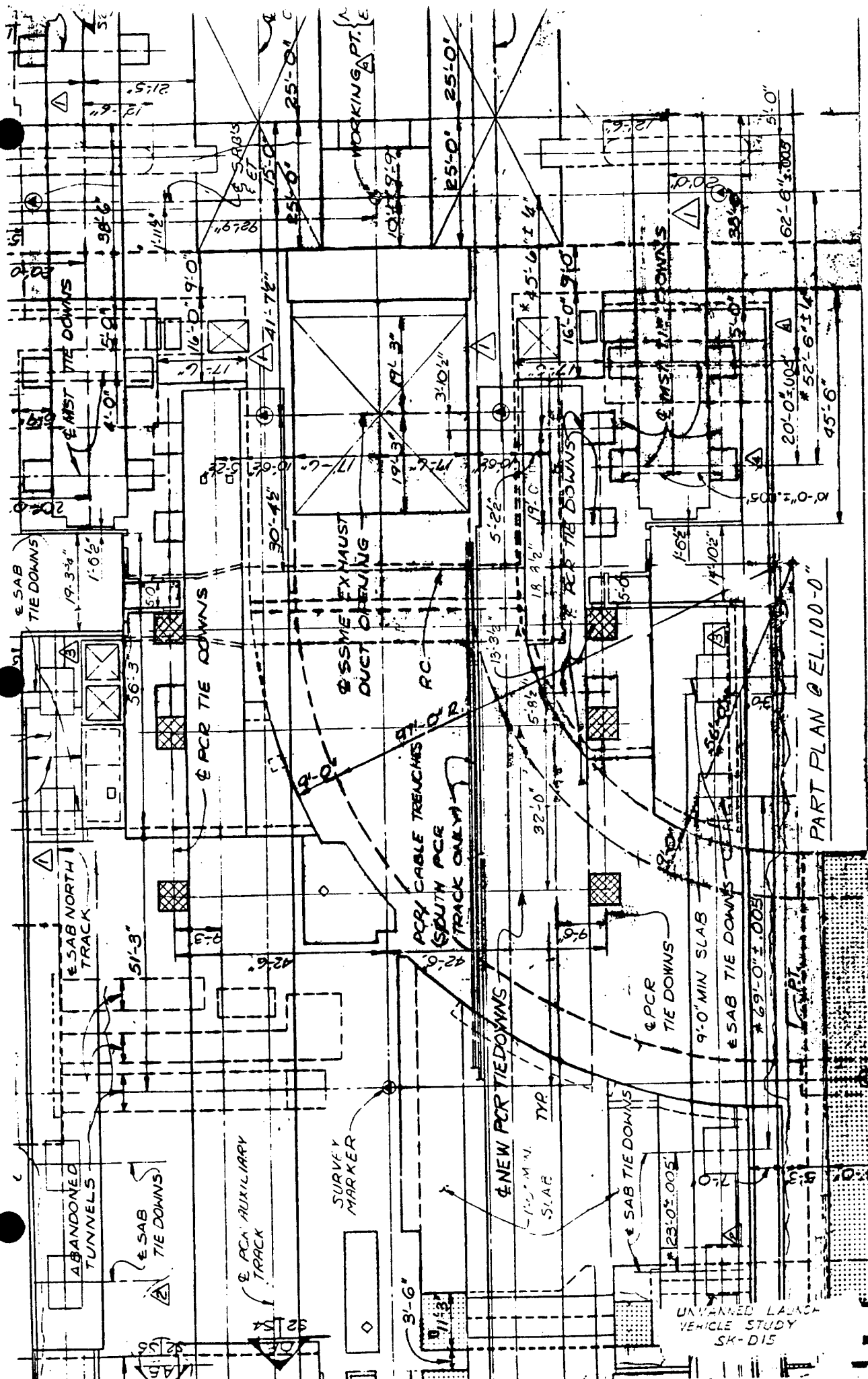

PART PLAN @ EL. 100'-0"

UNARMED LAUNCH
VEHICLE STUDY
SK-D15

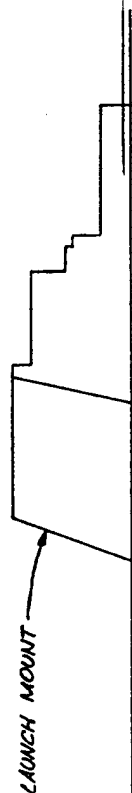
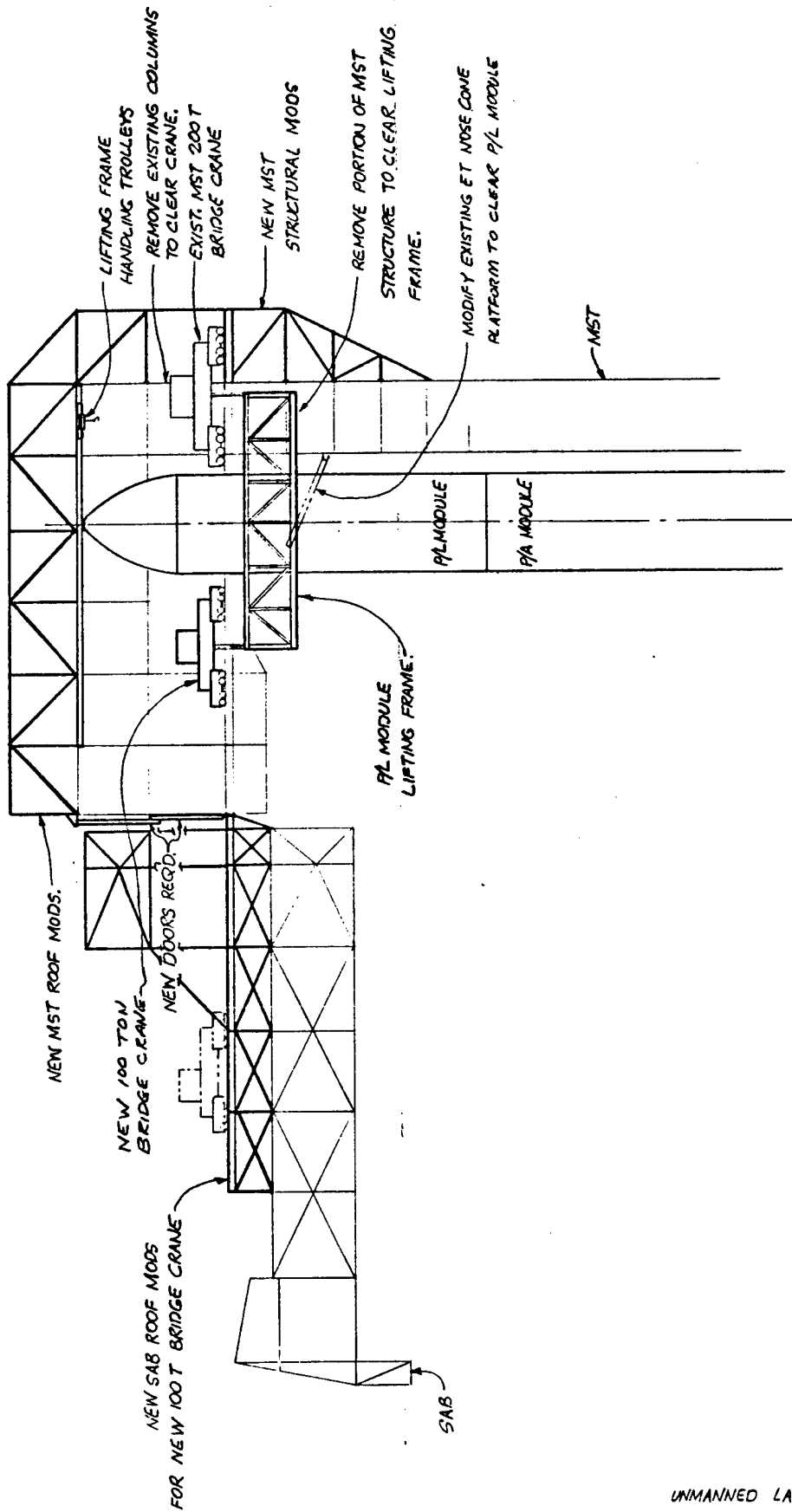

Elevation - Boeing In-Line Concept

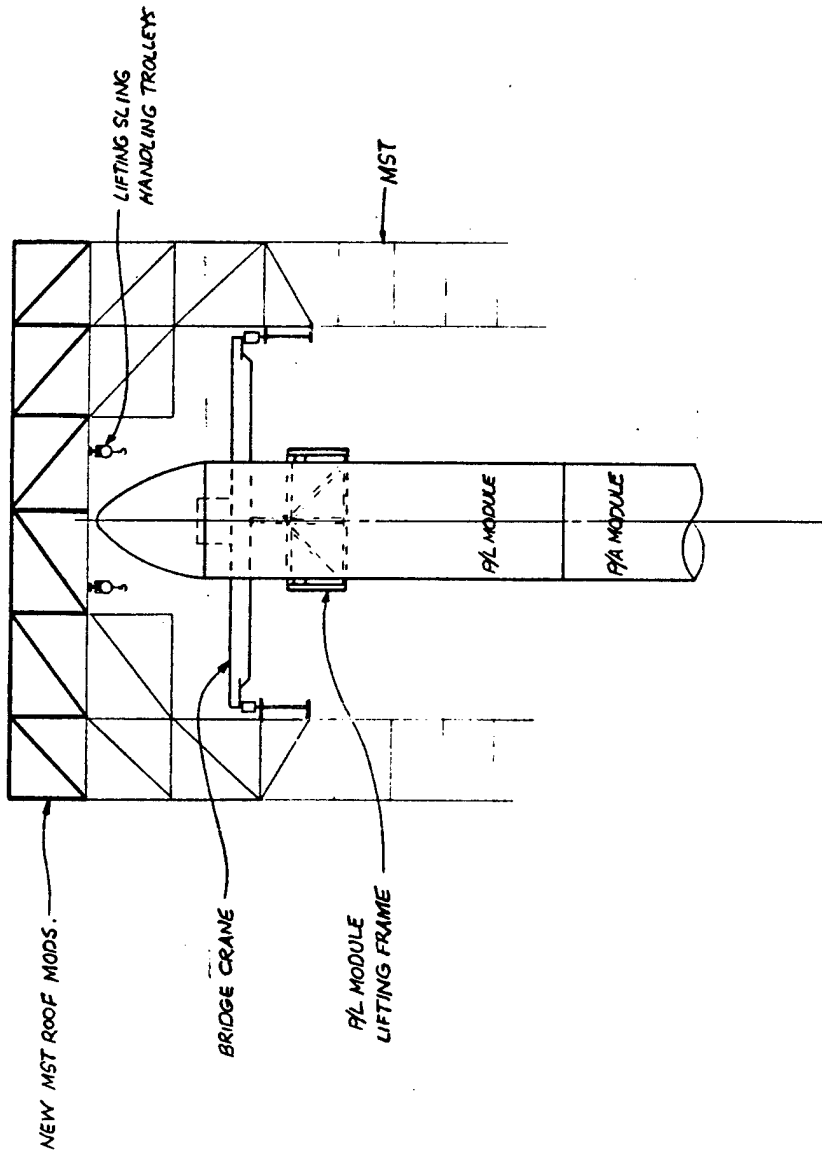

West Elevation of MST Soaring In-Line Concept

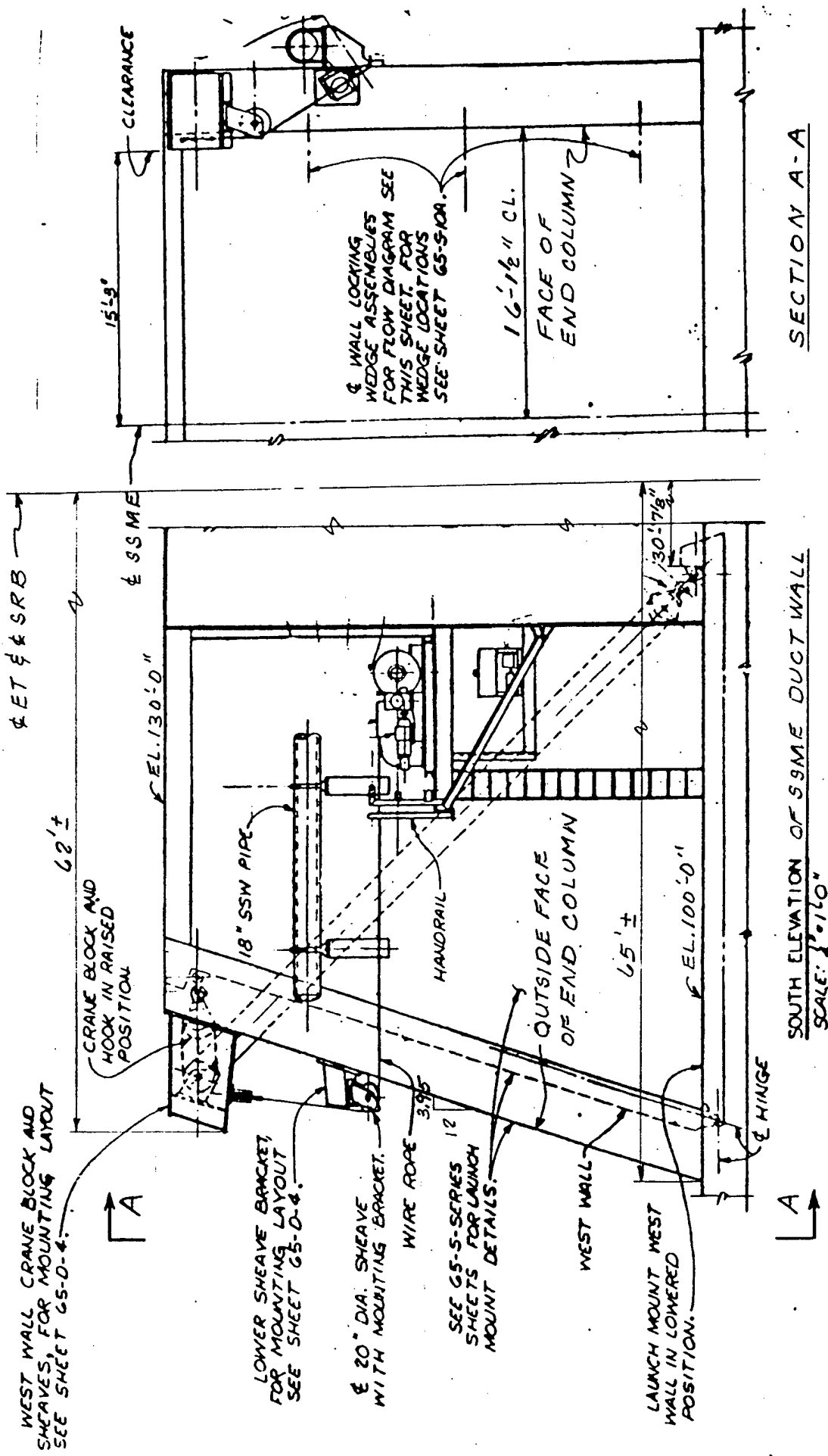

LET & SRB

WEST WALL CRANE BLOCK AND SHEAVES, FOR MOUNTING LAYOUT SEE SHEET 65-D-4.

A

62'±

CRANE BLOCK AND HOOK IN RAISED POSITION

F. EL. 130'-0"

SSME

CLEARANCE

15'-9"

LOWER SHEAVE BRACKET, FOR MOUNTING LAYOUT SEE SHEET 65-D-4.

20" DIA. SHEAVE WITH MOUNTING BRACKET.

WIRE ROPE 3/8"

SEE 65-S-SERIES 12 SHEETS FOR LAUNCH MOUNT DETAILS.

HANDRAIL

WEST WALL

65'±

LAUNCH MOUNT WEST WALL IN LOWERED POSITION.

A

HINGE

F. EL. 100'-0"

130'-7 1/2"

WALL LOCKING WEDGE ASSEMBLIES FOR FLOW DIAGRAM SEE THIS SHEET FOR WEDGE LOCATIONS SEE SHEET 65-S-10A.

16'-1 1/2" CL.

FACE OF END COLUMN

SOUTH ELEVATION OF SSME DUCT WALL
SCALE: 3/8" = 1'-0"

SECTION A-A

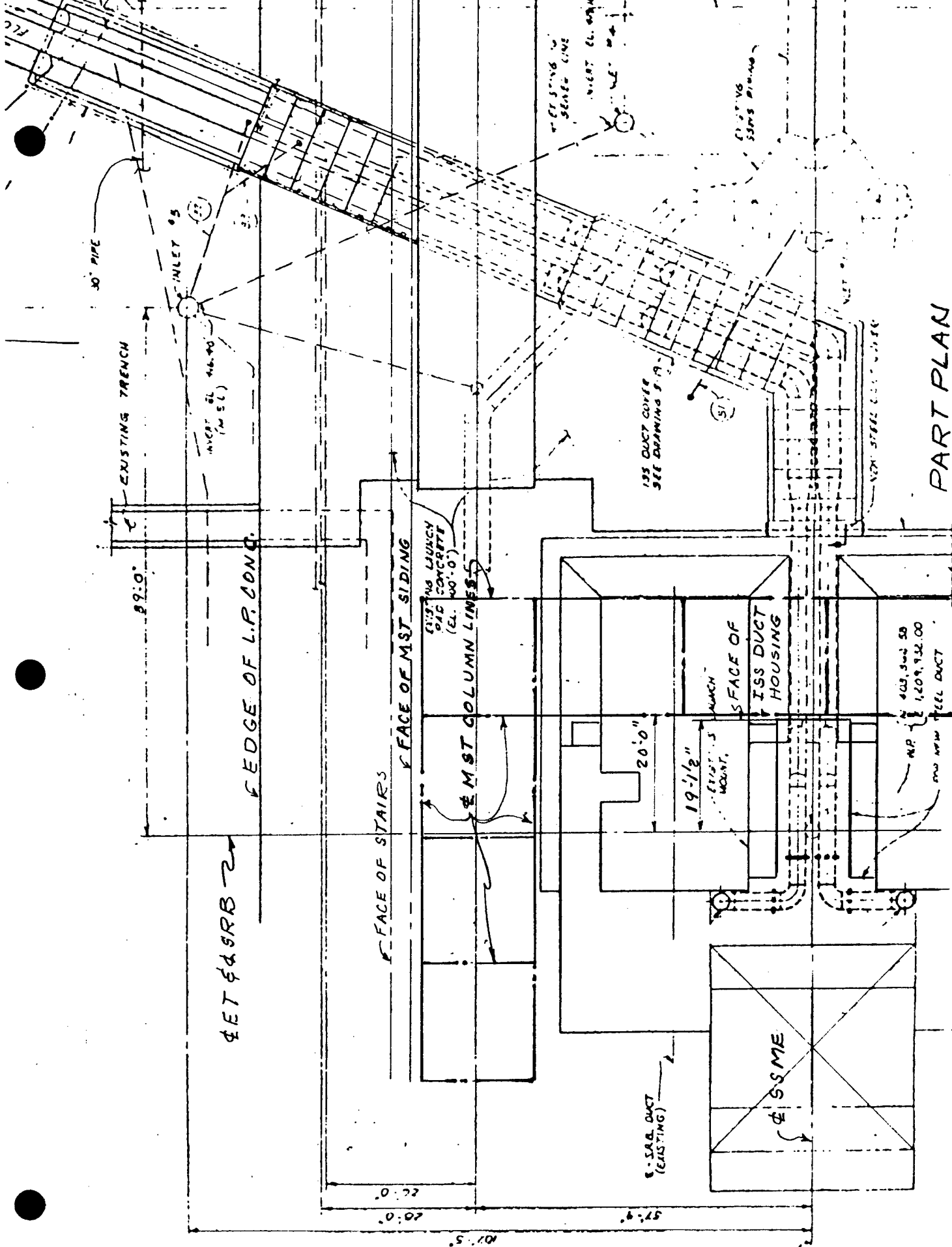

EXISTING TRENCH

30" PIPE

89'-0"

GET 45RB

EDGE OF L.P. CONG.

FACE OF STAIRS

FACE OF MST SIDING

MST COLUMN LINES

EXISTING LAUNCH PAD CONCRETE (EL. 40'-0")

8" DIA. DUCT (EXISTING)

20'-0"

19'-1/2"

EXISTING MOUNT.

FACE OF ISS DUCT HOUSING

4" DIA. ME

405,300.50
1,209,932.00
NEW 4" DIA. STEEL DUCT

PART PLAN

107'-5"

57'-9"

60'-0"

60'-0"

125 DUCT COVER SEE DRAWING 8-19

EXISTING W/ SEWER LINE

INVERT EL. 41.10

EXISTING 33" DIA. PIPE

NEW STEEL DUCTWORK

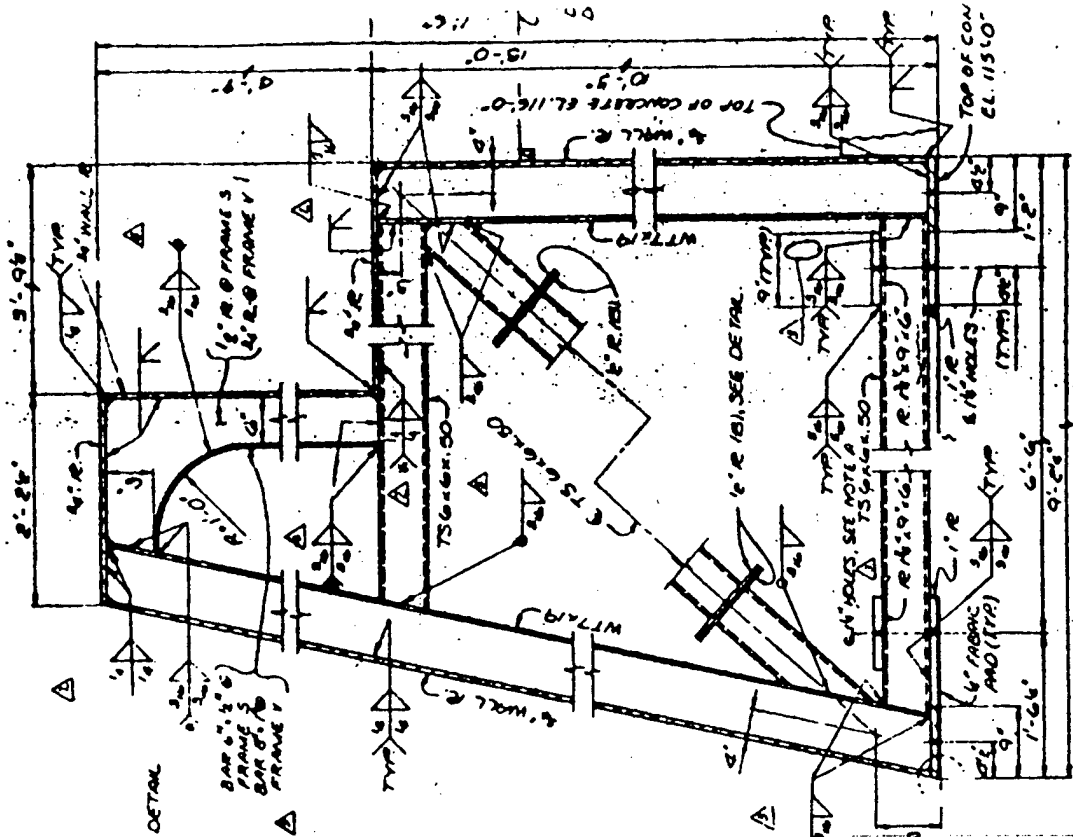

FRAME 5

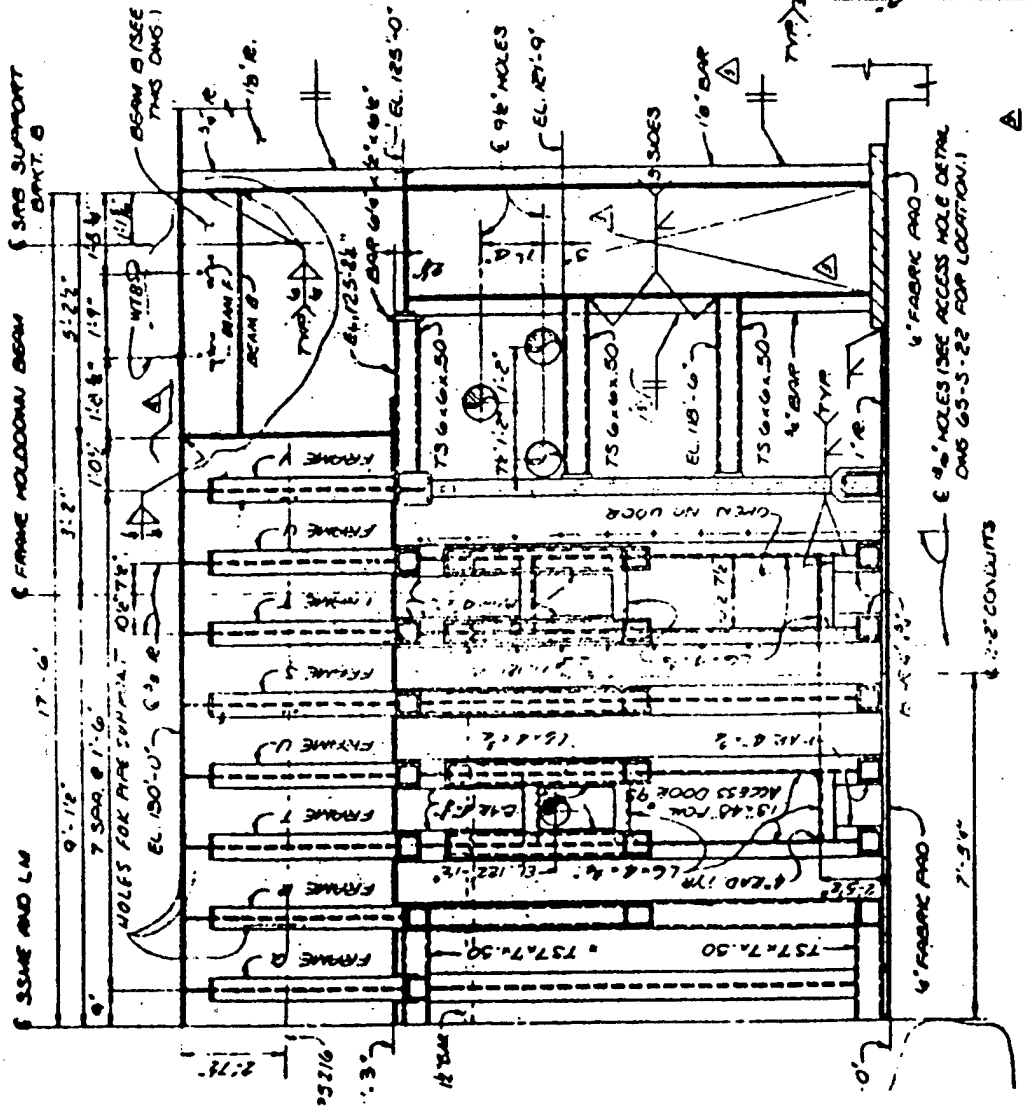

SECTION THRU EAST WALL FRAMEWORK
(LOOKING EAST)

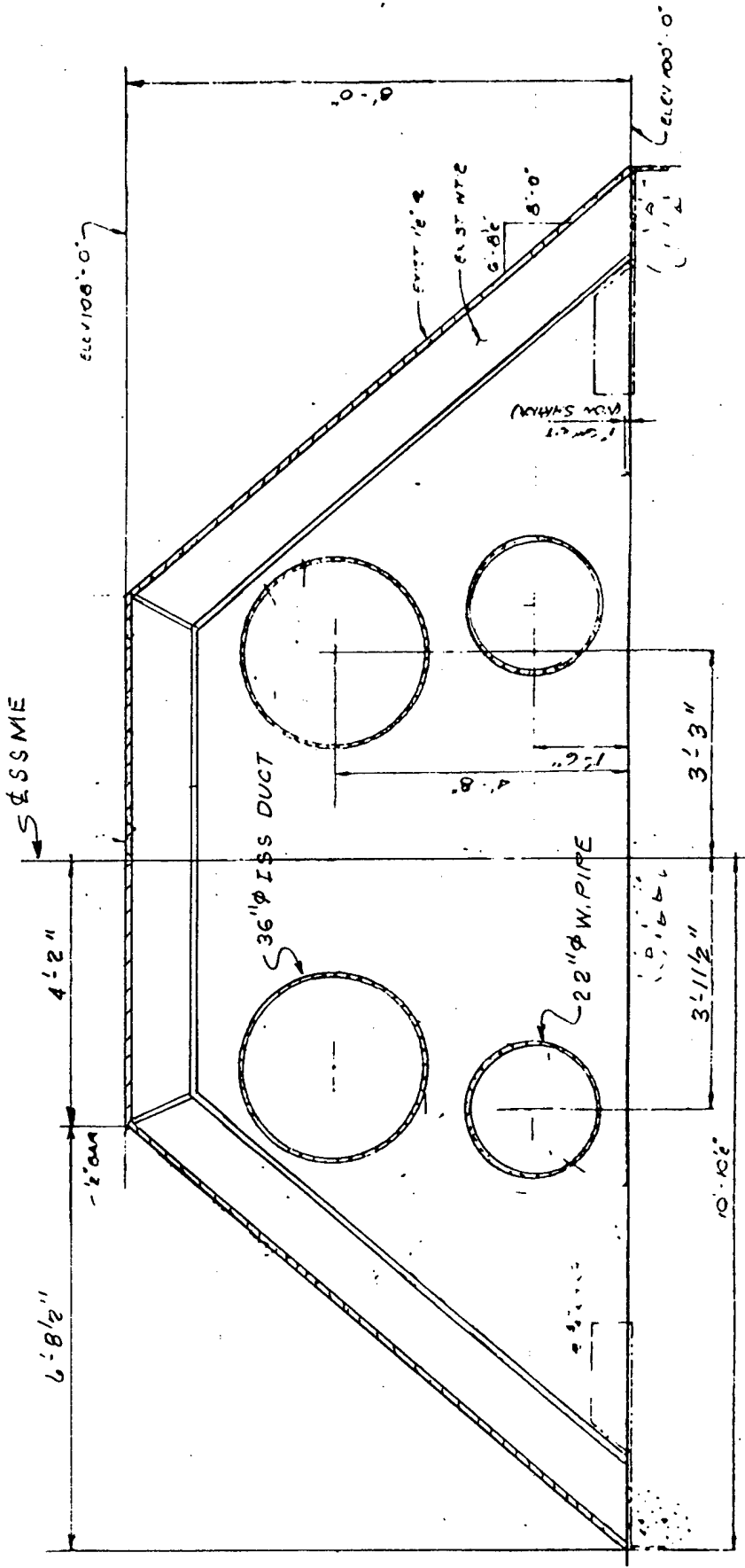

SECTION THRU EXIST. FLAME DEFLECTOR

Scale 3/8" = 1'-0"

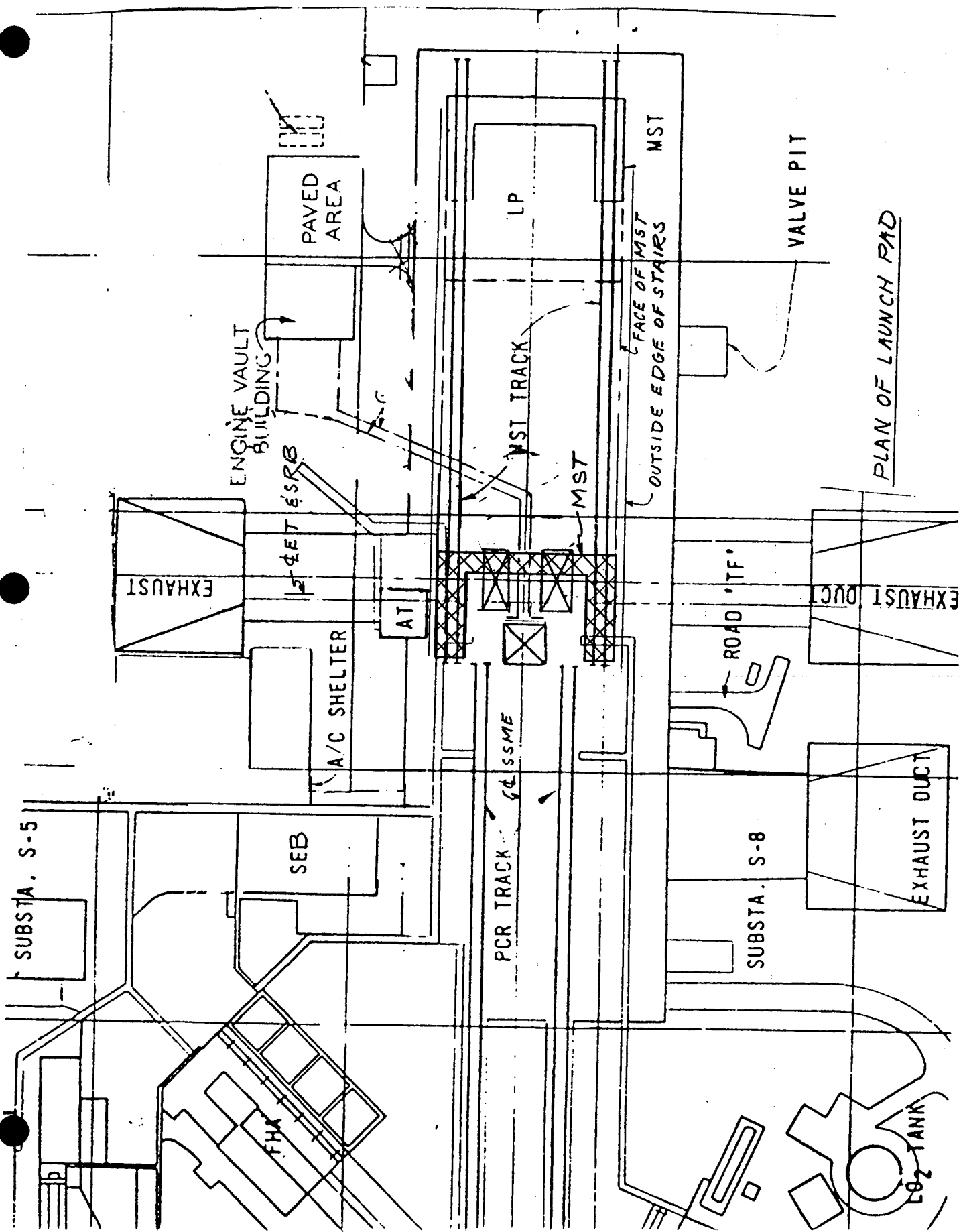

SUBSTA. S-5

ENGINE VAULT BUILDING

PAVED AREA

EXHAUST

SEB

A/C SHELTER

AT

PCR TRACK

SSME

LP

MST TRACK

MST

MST

FACE OF MST
OUTSIDE EDGE OF STAIRS

ROAD 'TF'

SUBSTA. S-8

VALVE PIT

EXHAUST DUCT

EXHAUST DUCT

PLAN OF LAUNCH PAD

O2 TANK

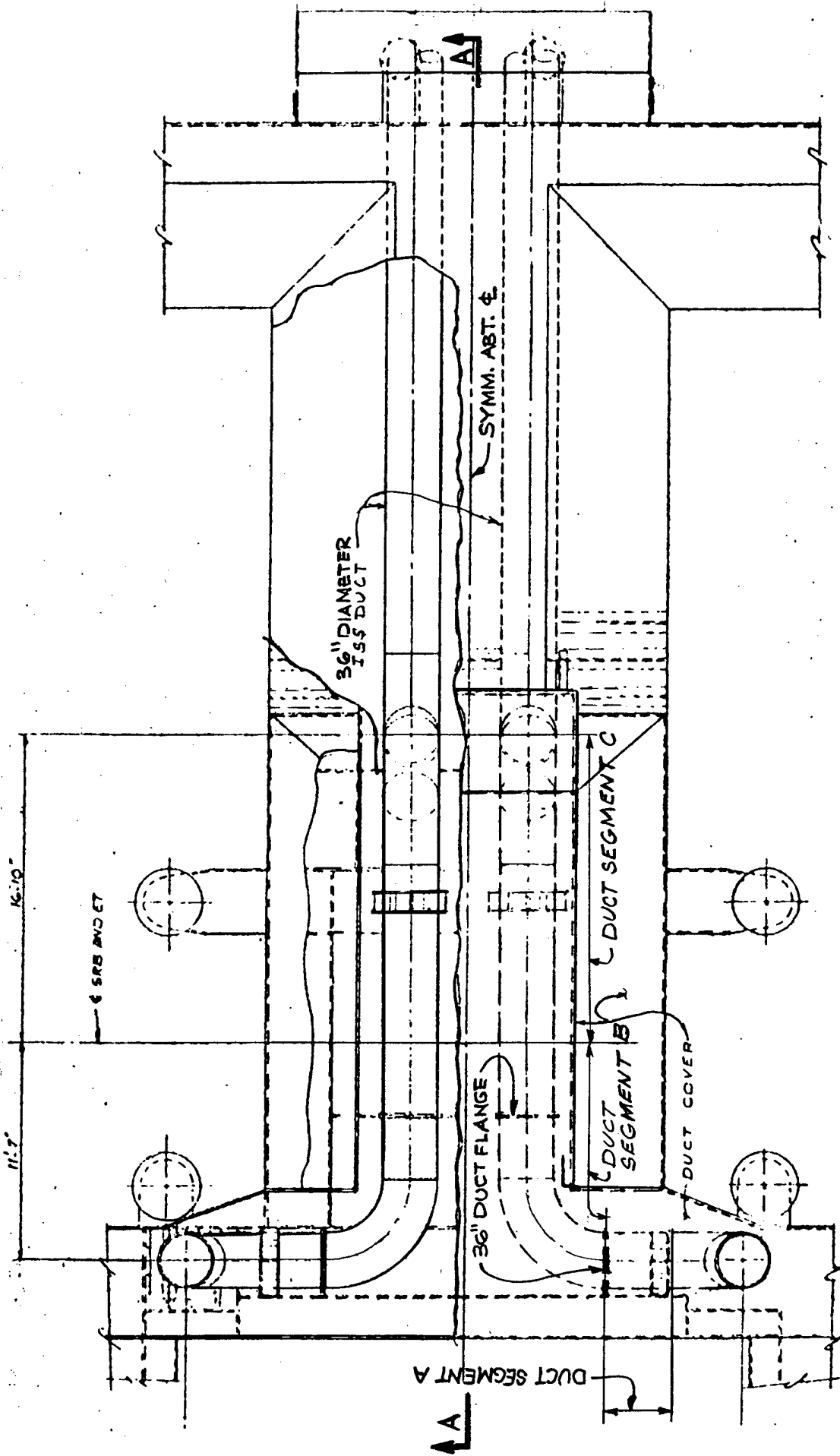

PARTIAL PLAN - ISS AT LAUNCH MOUNT
 SCALE: 1/4" = 1'-0"

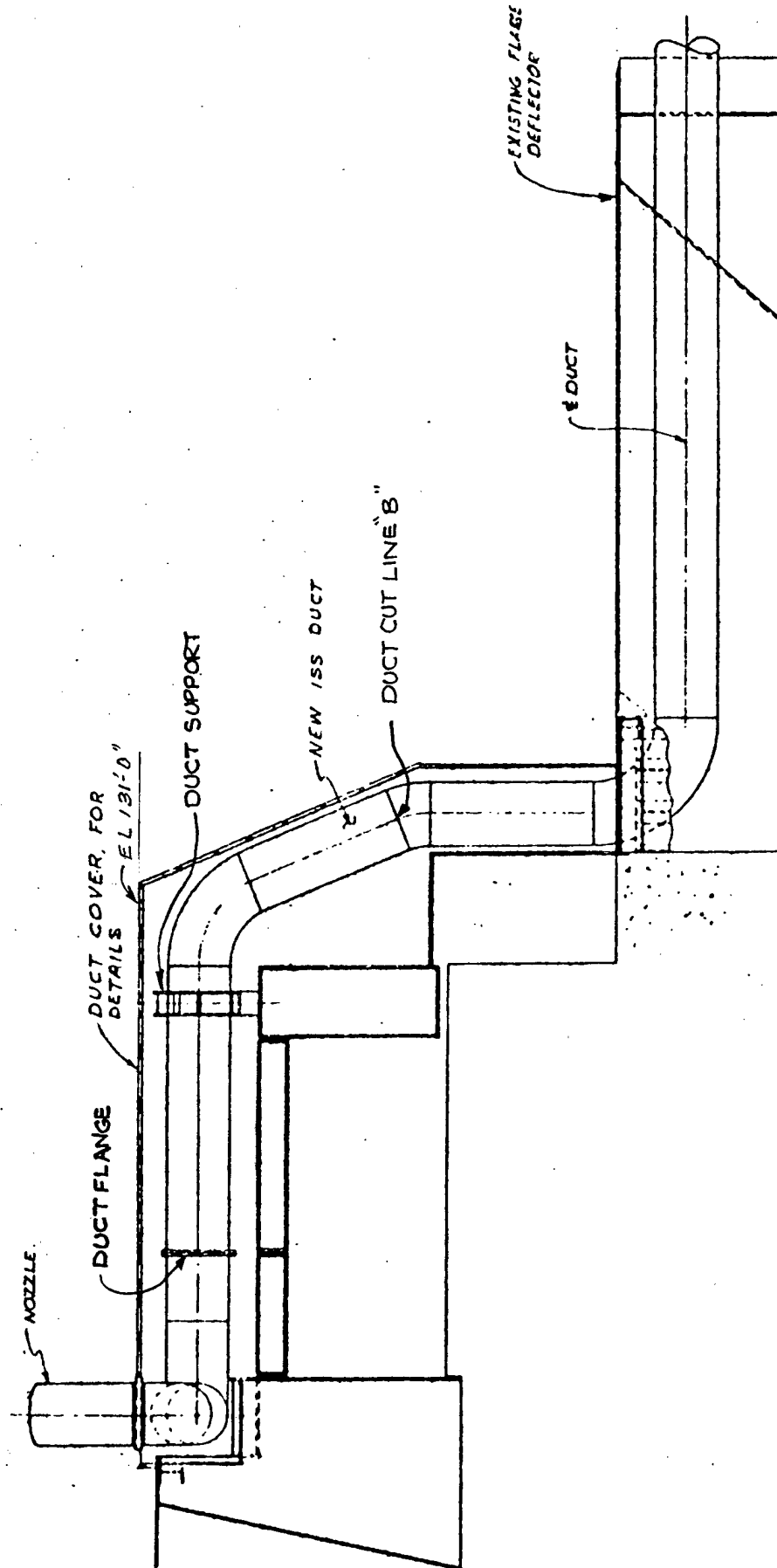

SECTION A-A
 10/11/60

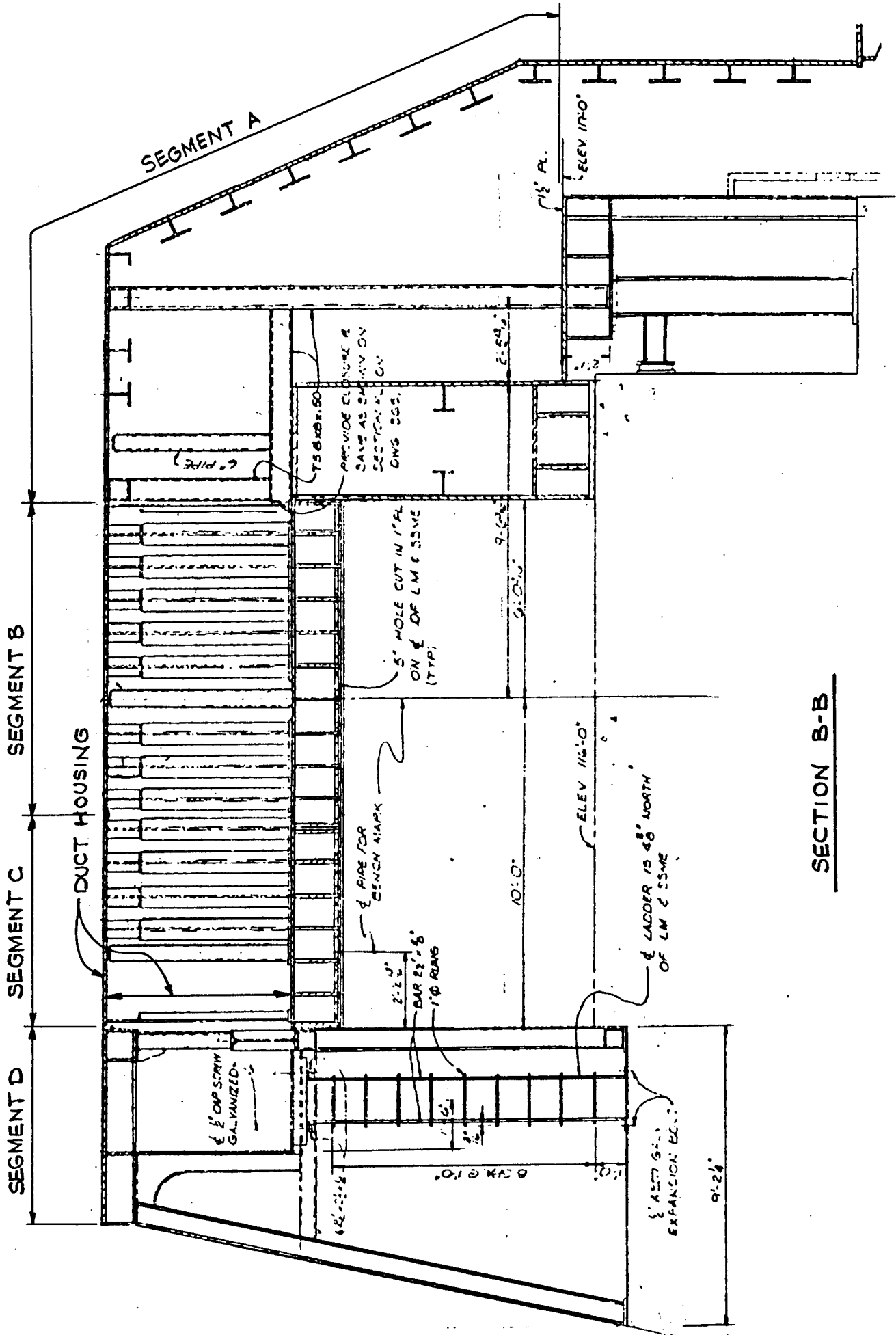

SEGMENT A

SEGMENT B

SEGMENT C

SEGMENT D

DUCT HOUSING

6" PIPE

756 x 81.50
 PROVIDE CLOSURE &
 SAME AS SHOWN ON
 SECTIONAL ON
 DWS 225.

5" HOLE CUT IN 1.75" R.
 ON 4" OF LM & SSWE
 (TYP)

PIPE FOR
 BENCH MARK

2.25"
 BAR 27.5"
 1" REBAR

1/2" DIA GALV.
 STEEL

LADDER IS 48" NORTH
 OF LM & SSWE

1/4" DIA
 EXPANSION BOLT

ELEV 117'-0"

ELEV 115'-0"

SECTION B-B

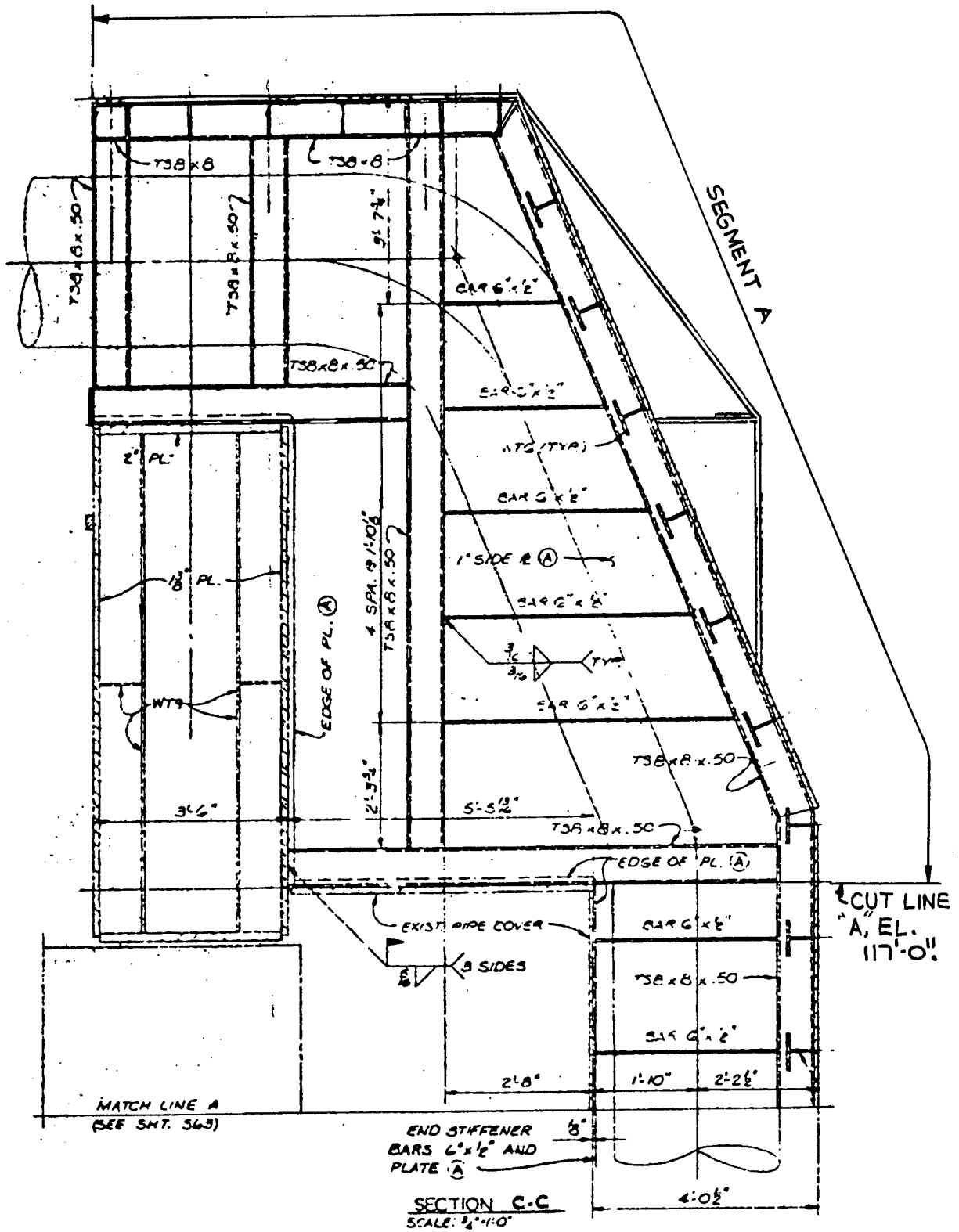

UNMANNED LAUNCH VEHICLE STUDY
SK-D22

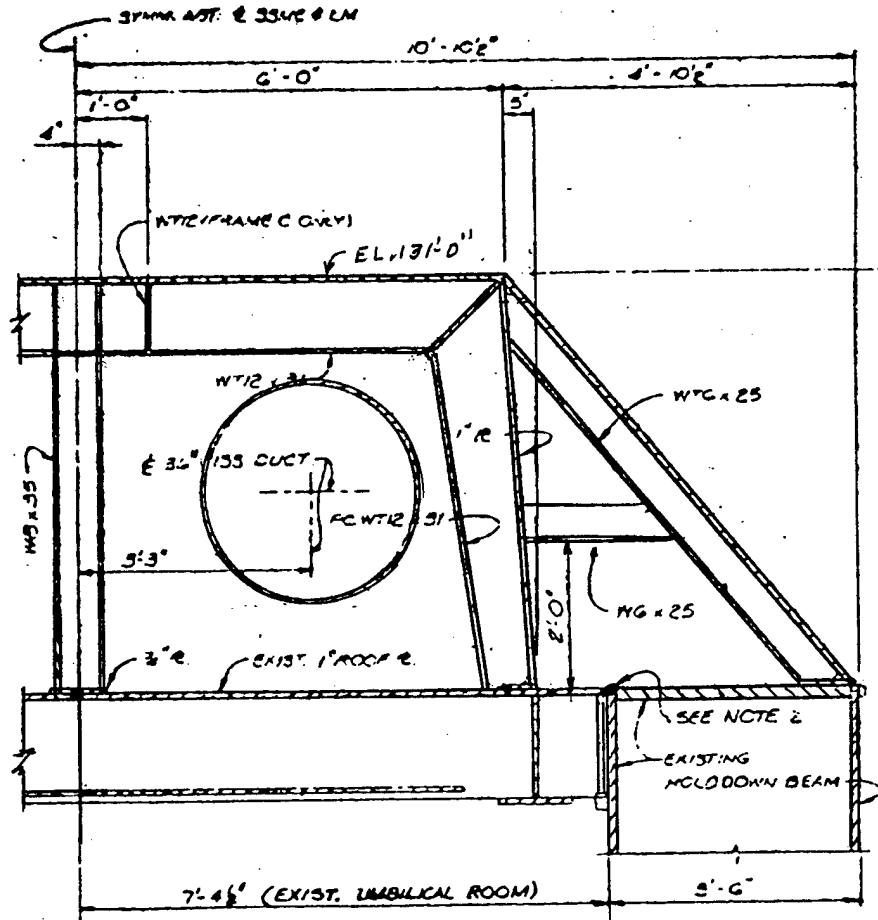

SECTION D-D

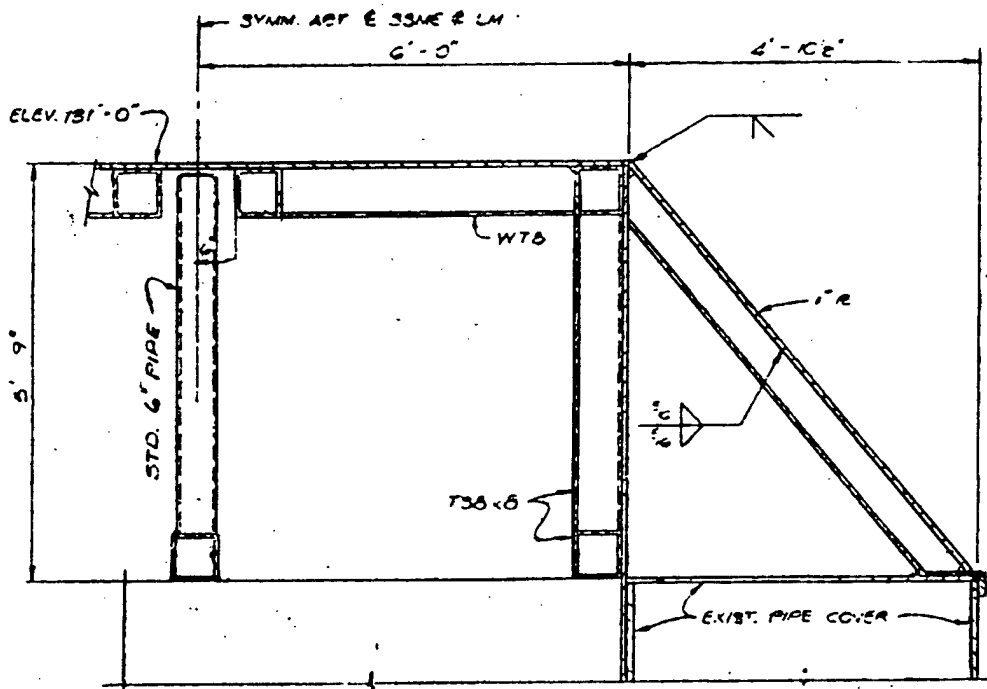

SECTION E-E
SCALE: 3/8" = 1'-0"

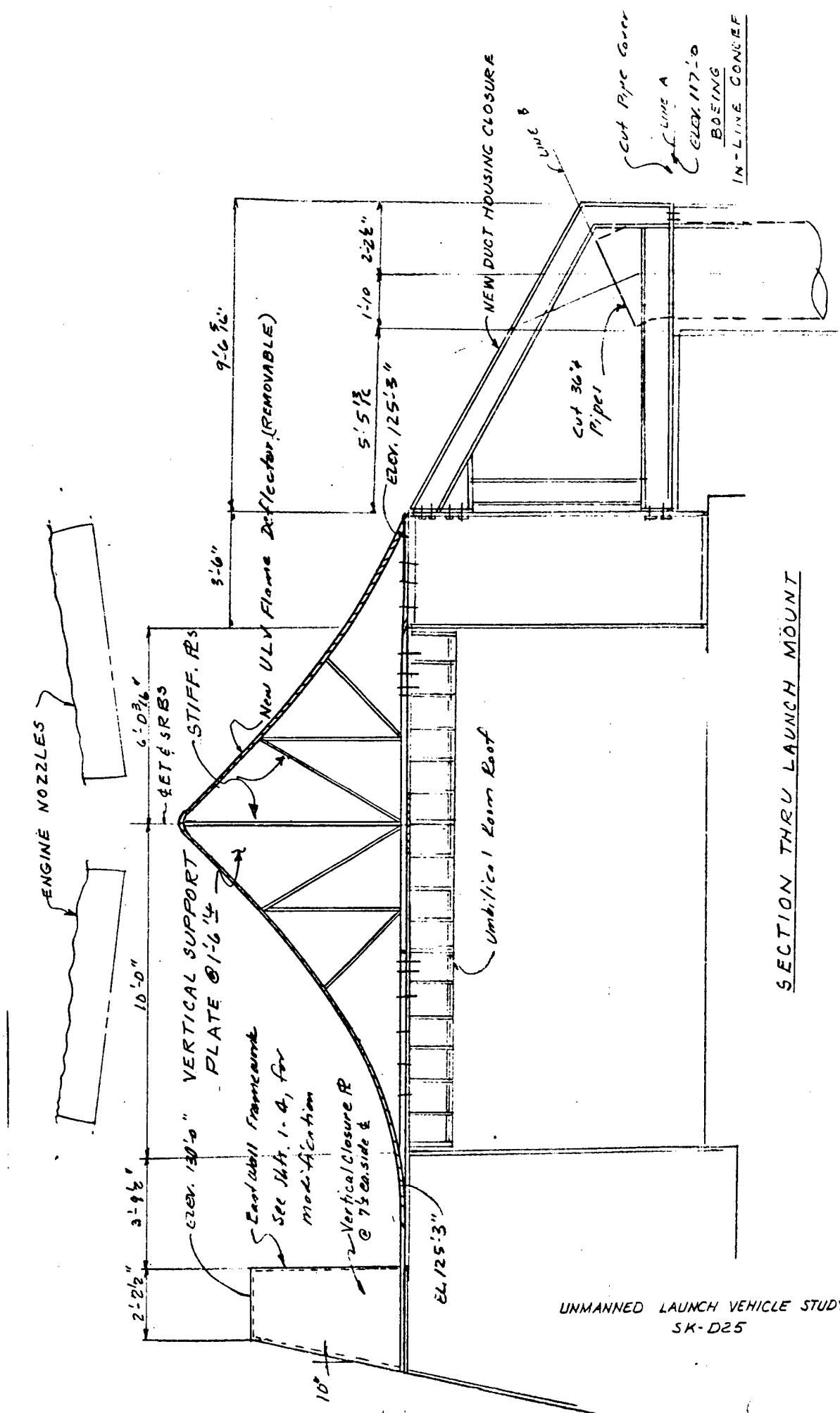

SECTION THRU LAUNCH MOUNT

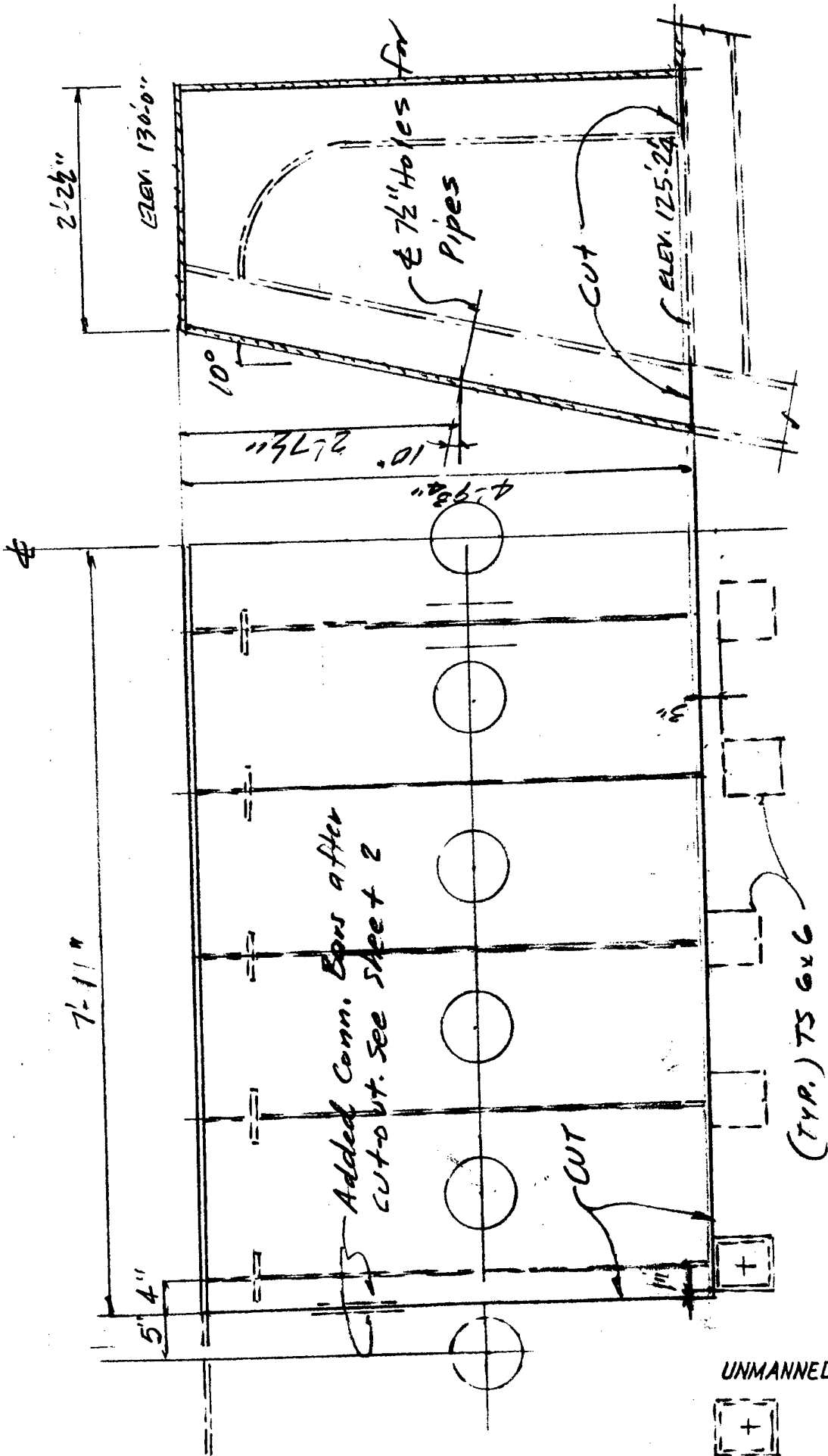

SECTION OF EAST WALL FRAMEWORK

CUT LINES

BOEING
IN-LINE CONCEPT

SYVERDRUP & PARCEL

JOB 5576 VAFB LM

SHEET NO. 2 OF _____

DATE 9-28-84

COMPUTATIONS FOR ULV Concept

BY Dillon CHKD _____

BOEING IN-LINE CONCEPT

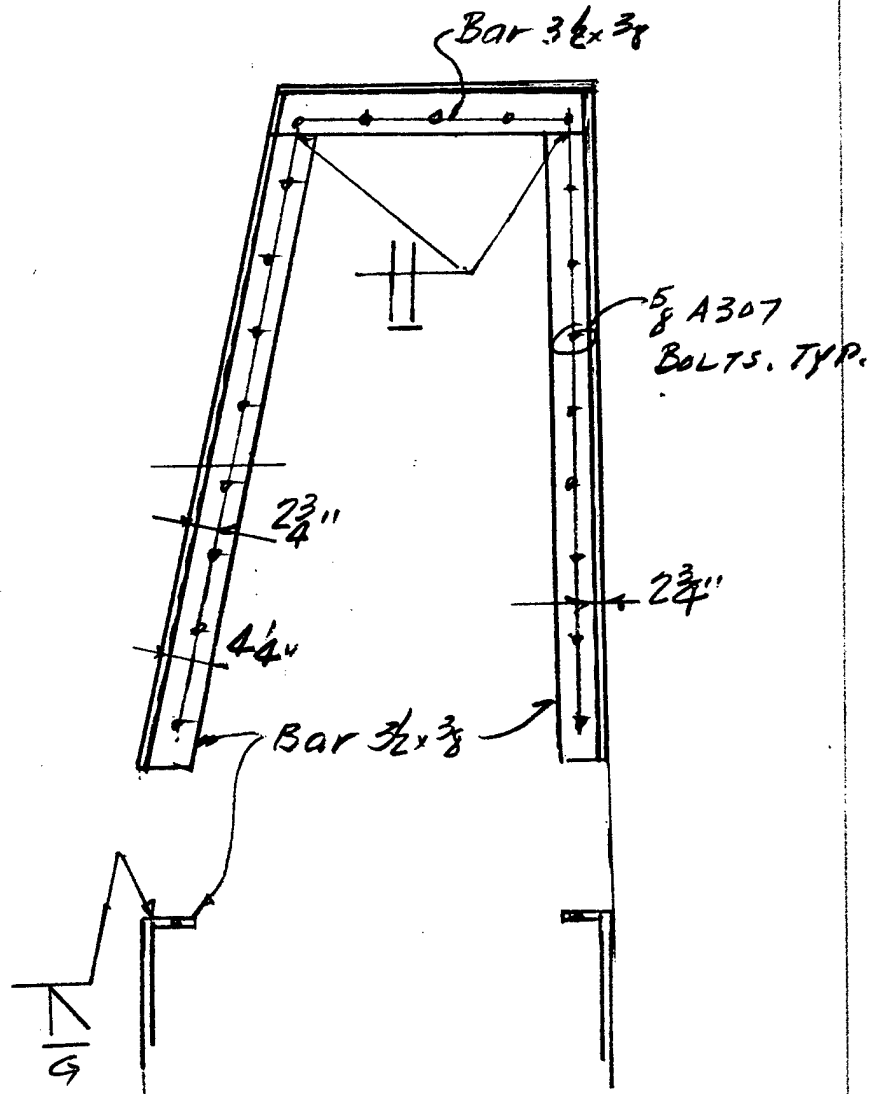

TYPICAL END CONNECTION BARS
ADDED TO CUT-OUT SECTION FROM
SHEET 1.

BOEING IN-LINE CONCEPT

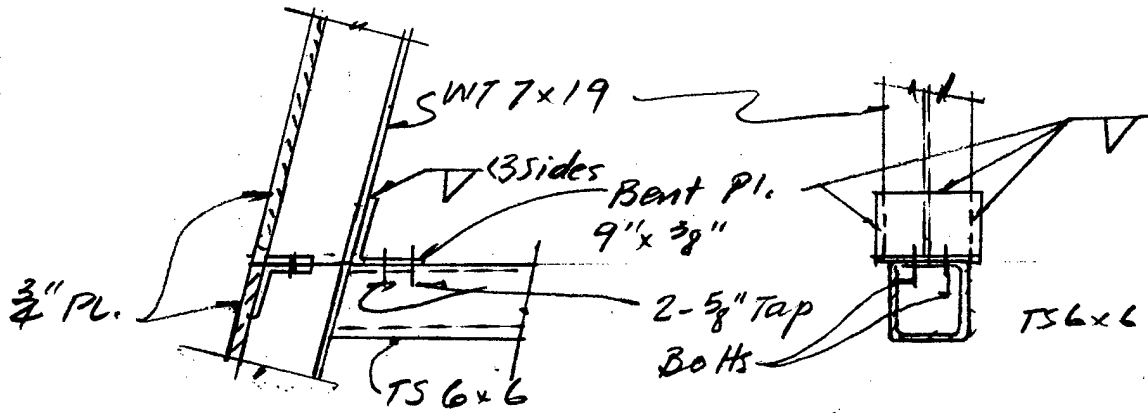

RECONNECTION OF WT 7x19

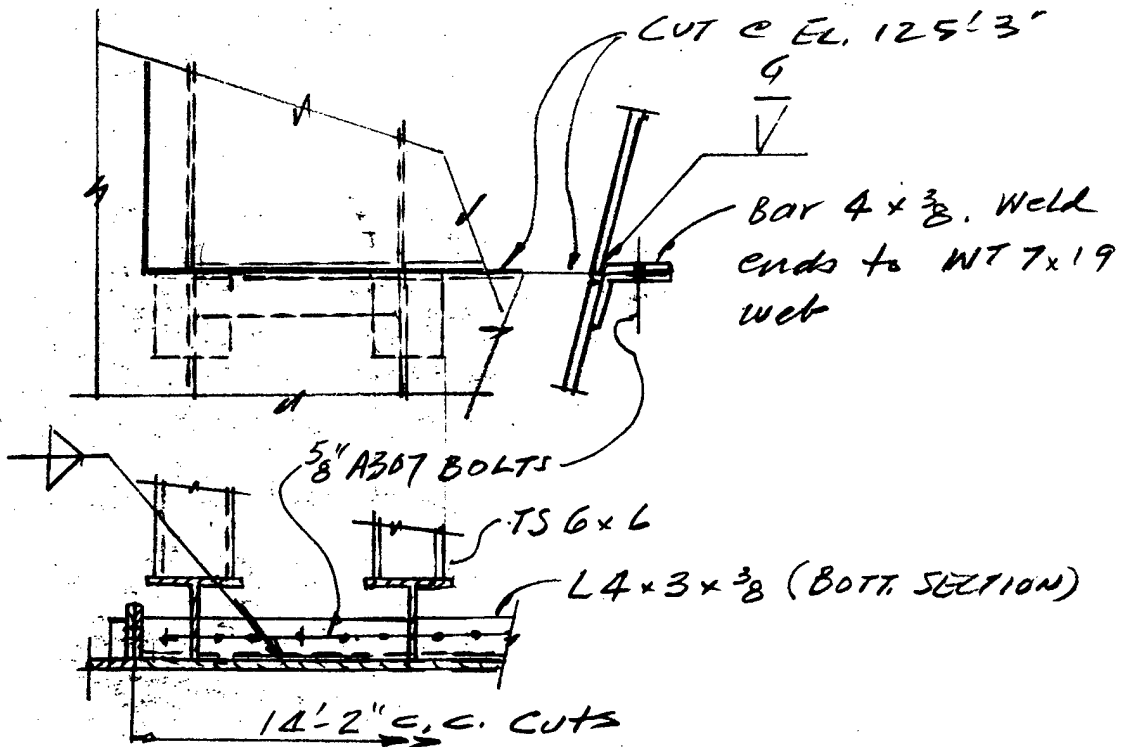

RECONNECTION OF BOTTOM CUT @ EL 125'3"

BOEING IN-LINE CONCEPT

CLOSURE PLATE OVER CUT-
OUT OF EAST WALL
FRAMEWORK

CTSK Hd. A307
5/8" Bolt (TYP.)

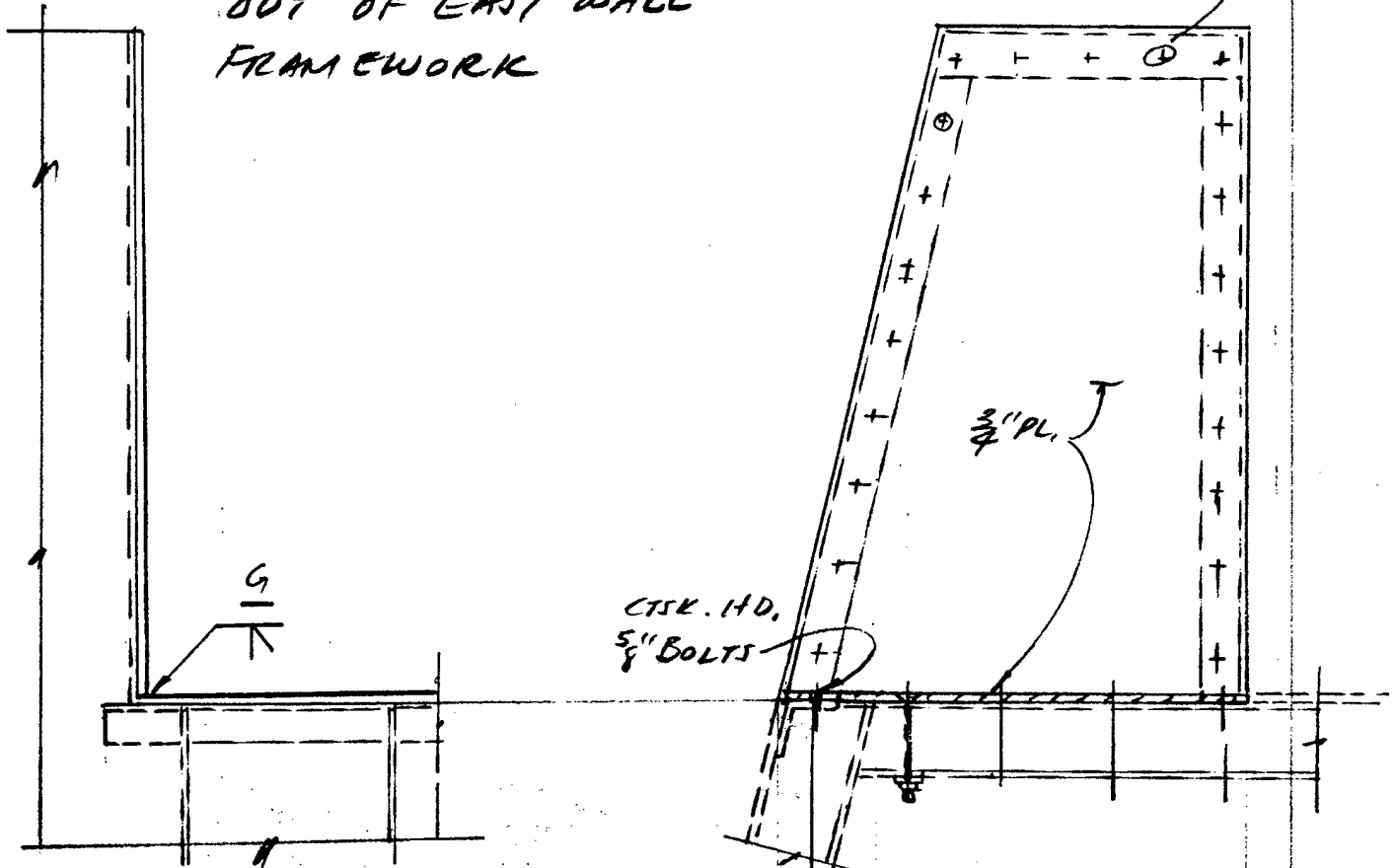

CTSK. HD.
5/8" BOLTS

CTSK. 5/8" BOLTS
THRU T56x6

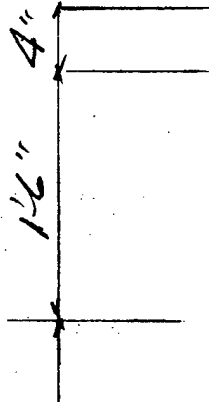

Bar 4 x 3/8

3"

3/4" PL.
EXIST.

UNMANNED LAUNCH VEHICLE STUDY
SK-D29

Neat 3/4" PL.

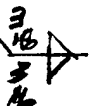

SVERDRUP & PARCEL

JOB 5576

SHEET NO. OF

DATE Oct. 1984

COMPUTATIONS FOR ULV-IN-LINE CONCEPT

BY RehagenCHKD

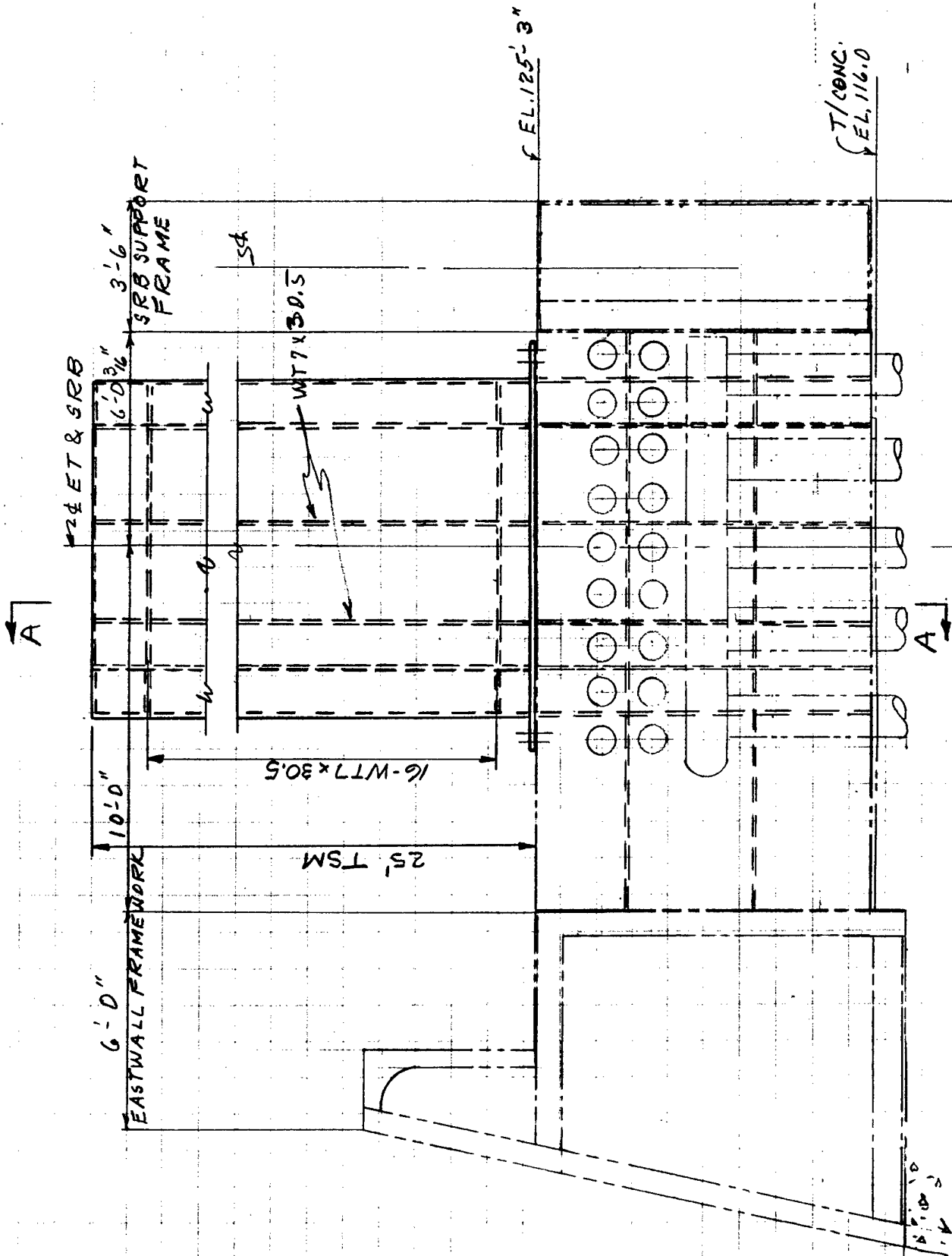

ELEVATION - FRAME HOLDDOWN BEAM

SVERDRUP & PARCEL

JOB

SHEET NO. OF

DATE Oct. 1984

COMPUTATIONS FOR ULV-IN-LINE CONCEPT

BY Rehagen CHKD

RISE OFF T-O UMBILICAL MAST

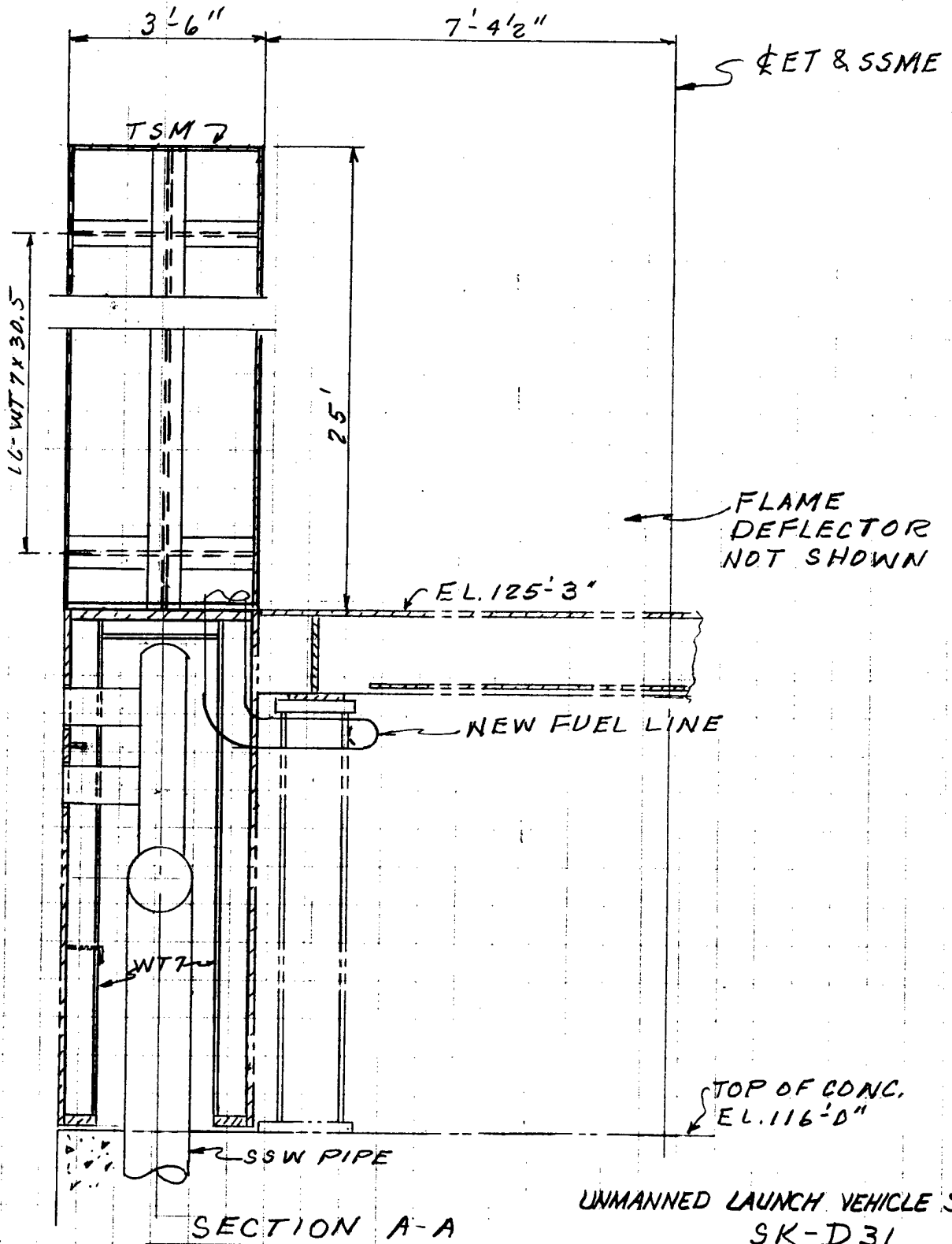

50

UNMANNED LAUNCH VEHICLE STUDY
SK-D31

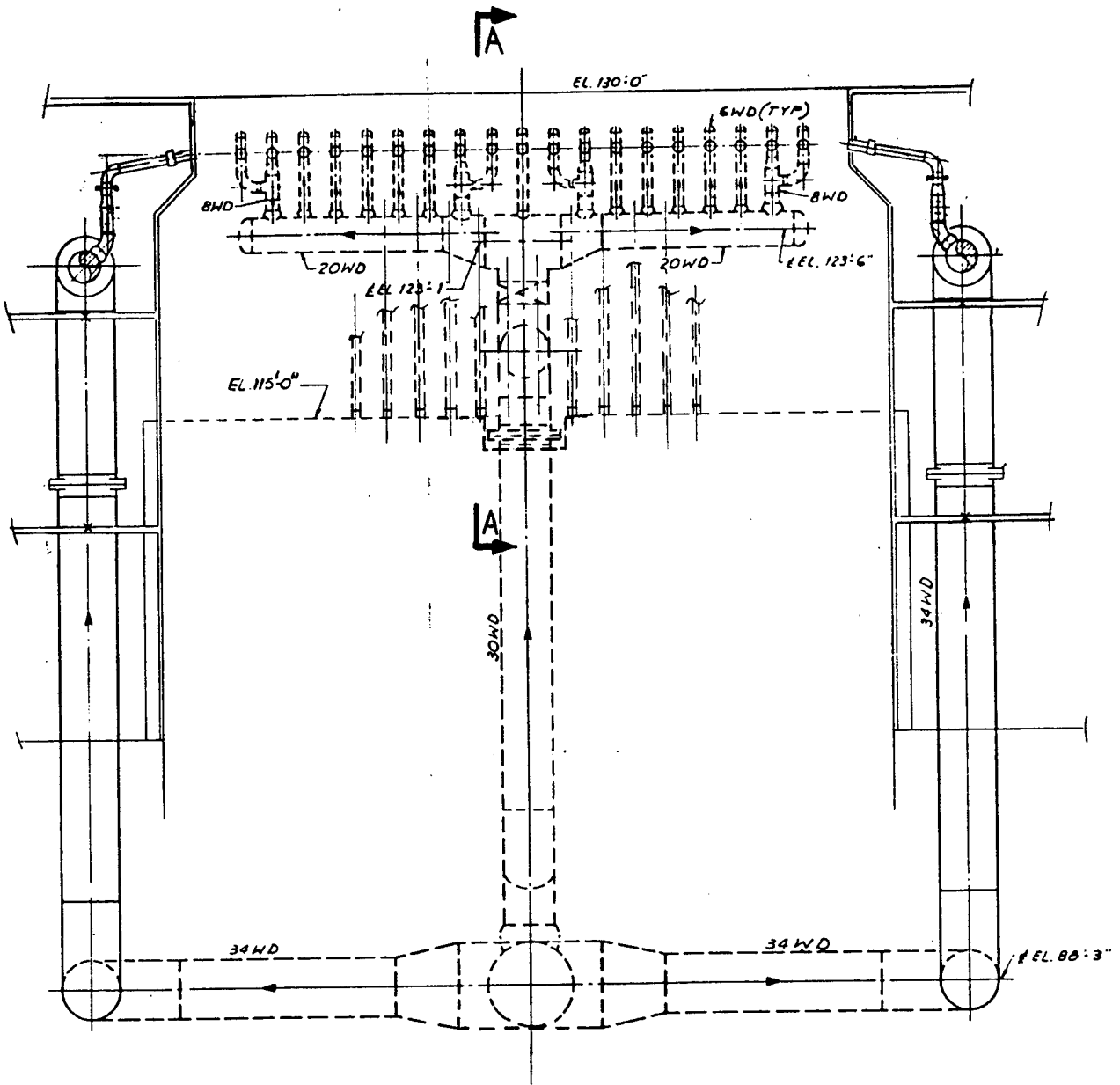

ELEVATION - SSW PIPE LAYOUT

UNMANNED LAUNCH VEHICLE STUDY
SK - D32

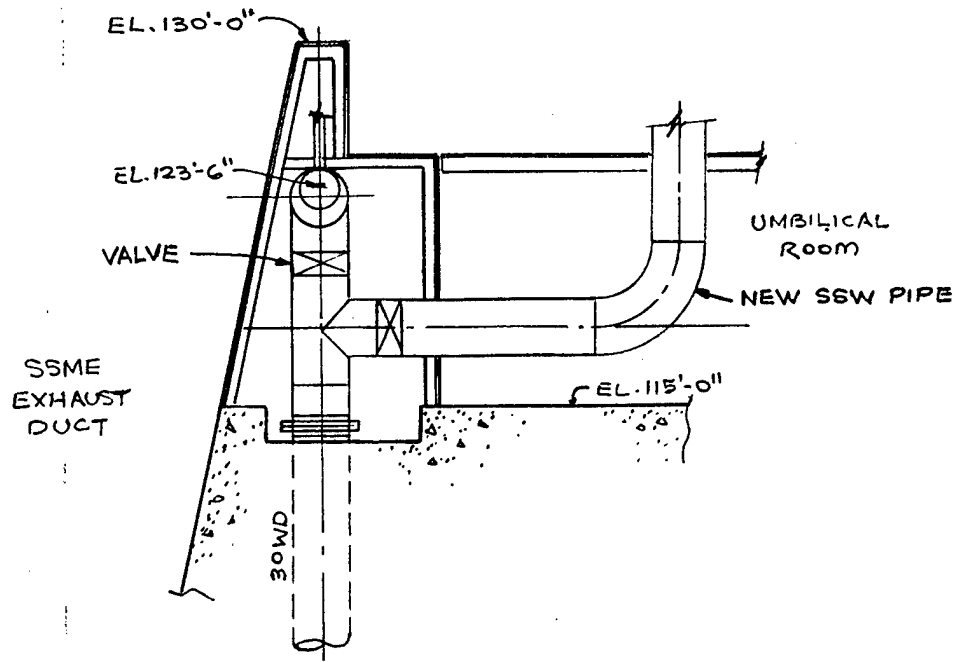

SECTION A-A

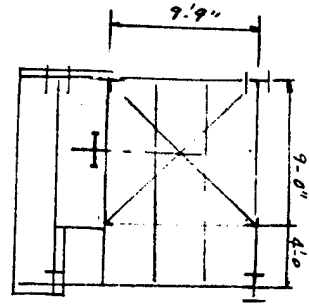
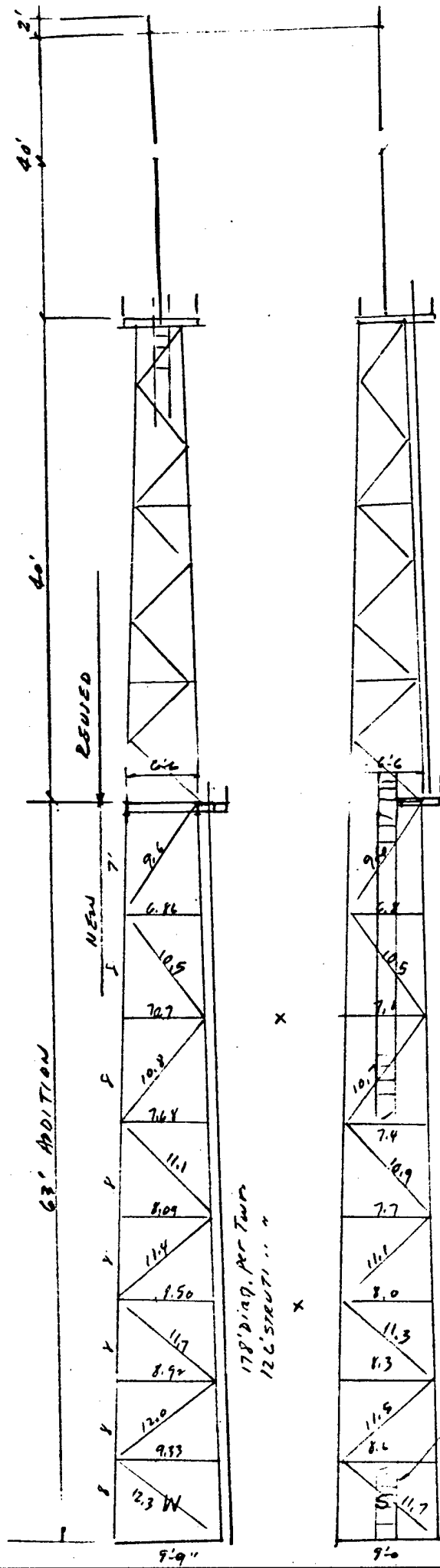

10.2' dia. X

UNMANNED LAUNCH VEHICLE STUDY
BOEING IN LINE CONCEPT

SK-D34

11.7' dia.

New ladder

LADDER ON SOUTH
E - OPP. HAND TO W
N - " " TO S

LIGHTNING PROTECTORS
OF RAC ET EXTENSION
IF 63' ADD'DD HEIGHT

Sheet 2

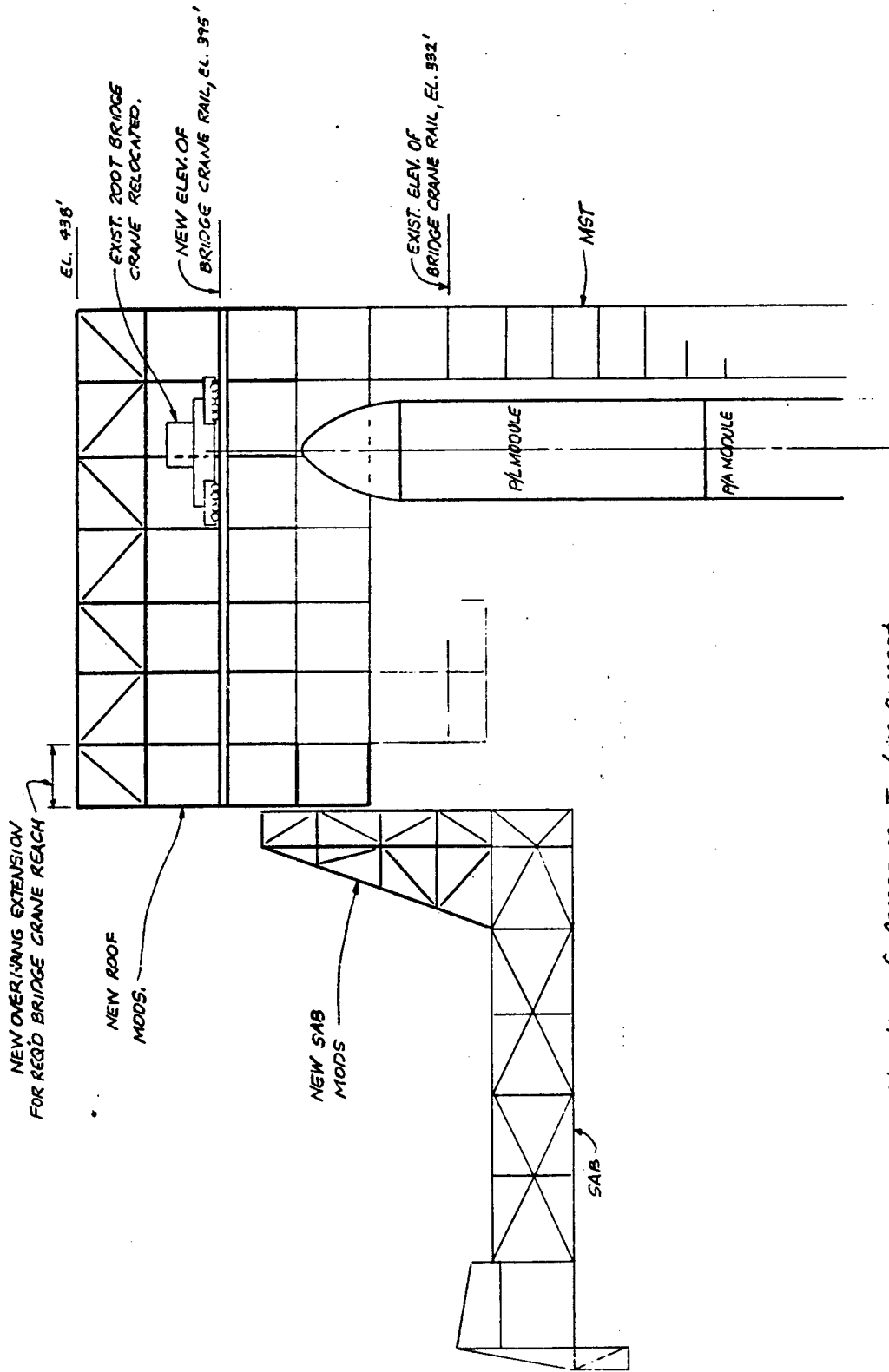

Elevation of Aerospace In-Line Concept

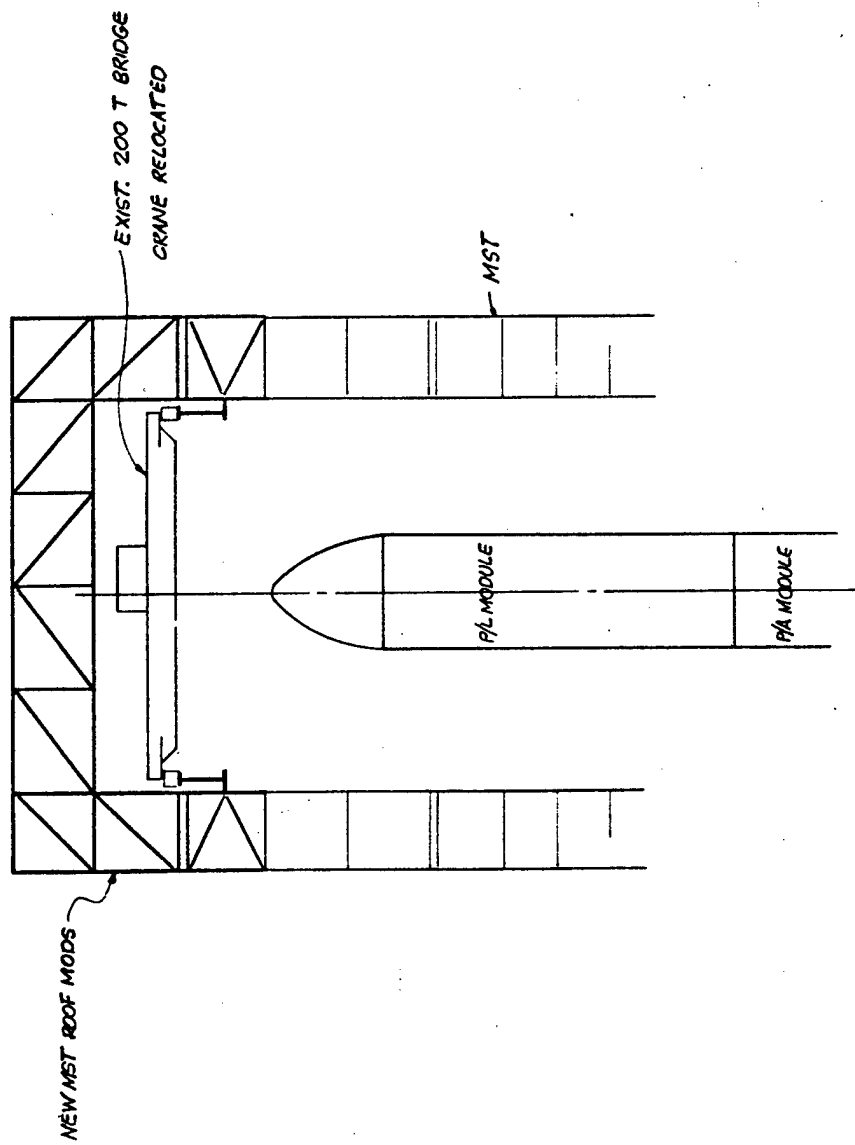

West Elevation of Aerospace In-Line Concept

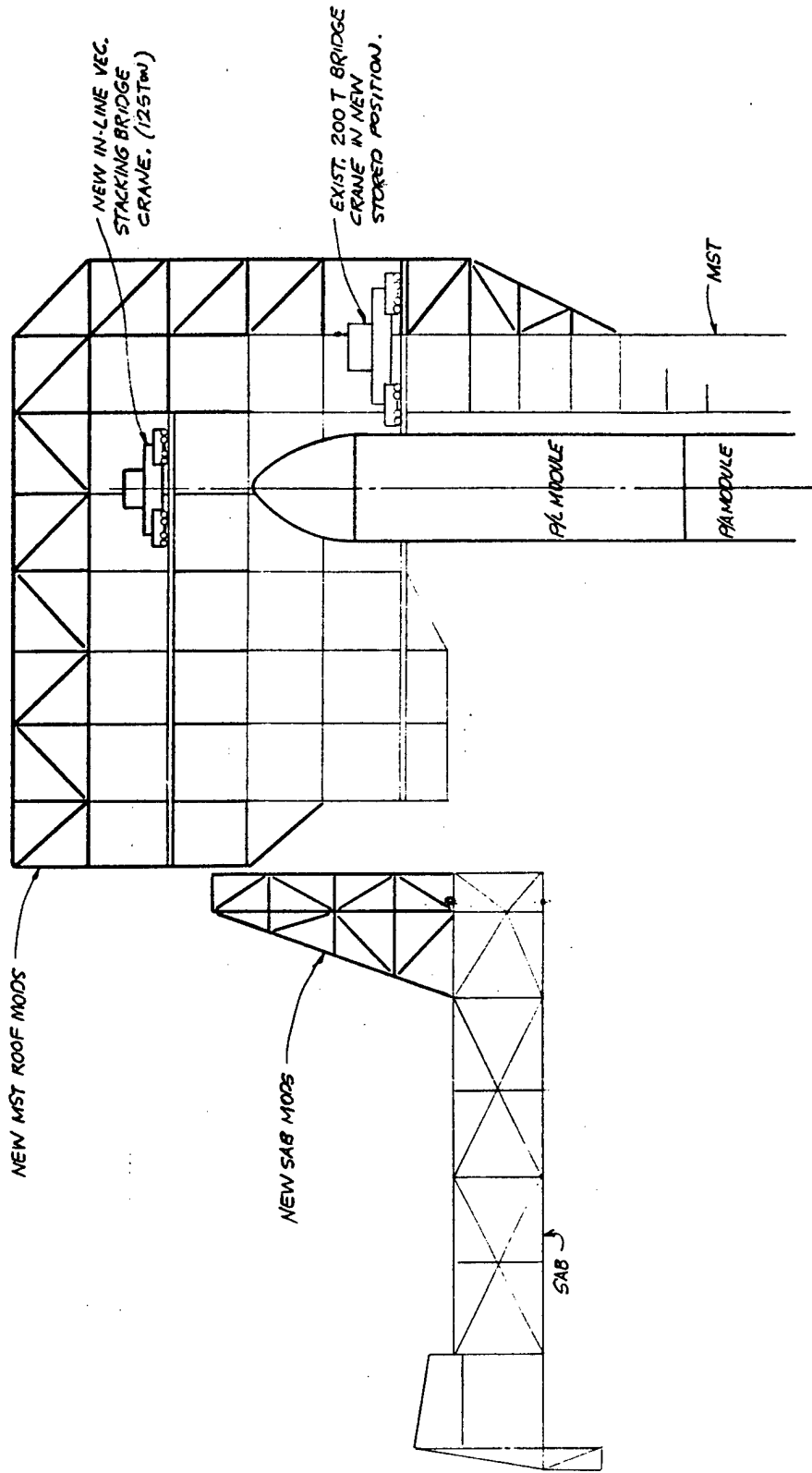

Elevation of Aerospace In-Line Concept (Alternate)

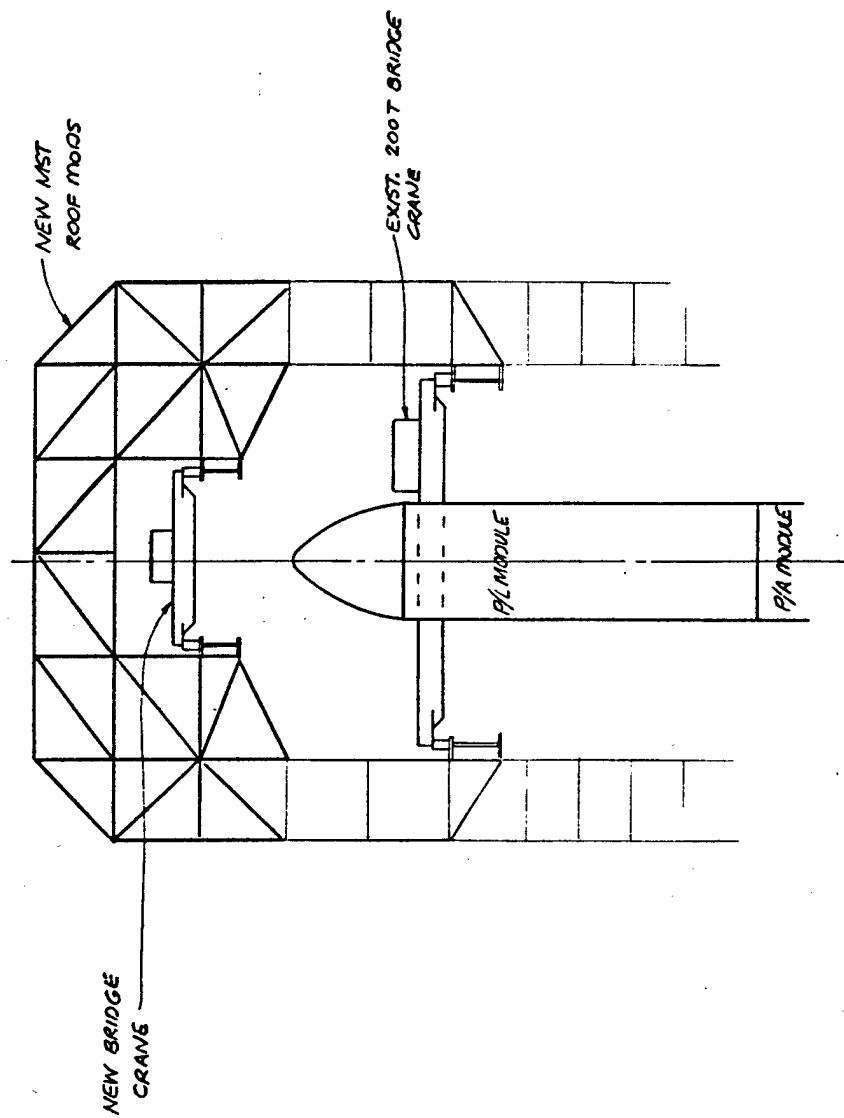

West Elevation of Aerospace In-Line Concept (Alternate)