



U.S. Department
of Transportation

**Federal Railroad
Administration**

FIRE SAFETY OF PASSENGER TRAINS

Phase I: Material Evaluation (Cone Calorimeter)

Office of Research
and Development
Washington, DC 20590

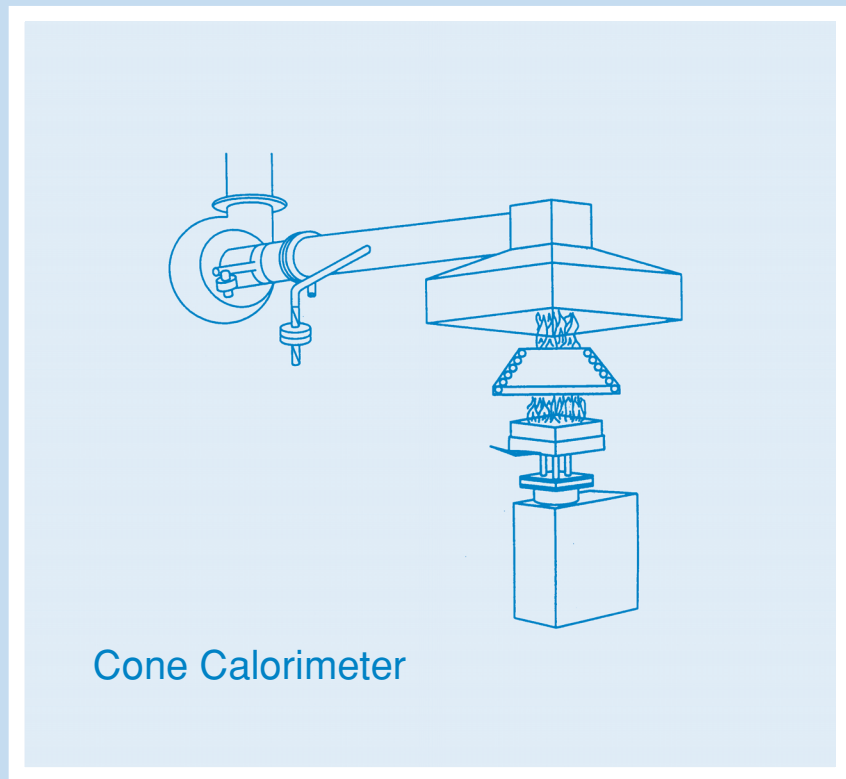

NOTICE

This document is disseminated under the sponsorship of the Department of Transportation in the interest of information exchange. The United States Government assumes no liability for its contents or use thereof.

NOTICE

The United States Government does not endorse products or manufacturers. Trade or manufacturers' names appear herein solely because they are considered essential to the objective of this report.

REPORT DOCUMENTATION PAGE

Form Approved
OMB No. 0704-0188

Public reporting burden for this collection of information is estimated to average 1 hour per response, including the time for reviewing instructions, searching existing data sources, gathering and maintaining the data needed, and completing and reviewing the collection of information. Send comments regarding this burden estimate or any other aspect of this collection of information, including suggestions for reducing this burden, to Washington Headquarters Services, Directorate for Information Operations and Reports, 1215 Jefferson Davis Highway, Suite 1204, Arlington, VA 22202-4302, and to the Office of Management and Budget, Paperwork Reduction Project (0704-0188), Washington, DC 20503.

1. AGENCY USE ONLY (Leave blank)		2. REPORT DATE January 1999 REPRINT June 2004		3. REPORT TYPE & DATES COVERED Interim Report March 1994-June 1998	
4. TITLE AND SUBTITLE Fire Safety of Passenger Trains Phase I: Material Evaluation (Cone Calorimeter)				5. FUNDING NUMBERS R8022/RR893	
6. AUTHOR(S) Richard D. Peacock and Emil Braun*					
7. PERFORMING ORGANIZATION NAME(S) AND ADDRESS(ES) *Building and Fire Research Laboratory National Institute of Standards and Technology (NIST) U.S. Department of Commerce Gaithersburg, MD 20899				8. PERFORMING ORGANIZATION REPORT NUMBER DOT-VNTSC-FRA-98-26	
9. SPONSORING/MONITORING AGENCY NAME(S) AND ADDRESS(ES) U.S. Department of Transportation Federal Railroad Administration Office of Research and Development Washington, DC 20590				10. SPONSORING/MONITORING AGENCY REPORT NUMBER DOT/FRA/ORD-99/01	
11. SUPPLEMENTARY NOTES *Under contract to:		U.S. Department of Transportation Research and Special Program Administration John A. Volpe National Transportation Systems Center Cambridge, MA 02142-1093			
12a. DISTRIBUTION/AVAILABILITY This document is also available to the U.S. public through the National Technical Information Service, Springfield VA 22161 This document is also available on the FRA web site at www.fra.dot.gov .				12b. DISTRIBUTION CODE	
13. ABSTRACT (Maximum 200 words) As part of the passenger equipment rulemaking required by Congress, the Federal Railroad Administration (FRA) has proposed that its existing fire safety guidelines be made mandatory. A major conclusion of a FRA-funded 1993 study by the National Institute of Standards and Technology (NIST) was that the use of fire hazard assessment techniques, based on modeling and supported by measurement methods based on heat release rate (HRR), could provide a more credible and cost-effective means to predict real-world fire behavior of passenger train materials than the current approach. A comprehensive three-phase fire safety research program is being conducted by NIST under the sponsorship of the FRA Office of Research and Development to demonstrate the practicality and effectiveness of HRR-based test methods and hazard analysis techniques when applied to passenger train fire safety. The results of the research program will assist the FRA in determining appropriate fire safety requirements for the final passenger equipment rule. This document presents the Phase I results of the program which focused on the evaluation of passenger rail car interior materials using Cone Calorimeter test data. A summary of U.S. transportation agency requirements for various types of vehicles is also provided. An update of U.S. and European passenger train fire performance requirements and related research is included. In Phase II, the Cone Calorimeter quantitative test data will be used as an input to a computer fire model as part of a fire hazard analysis. Phase III will involve real-scale testing of a full-scale rail car in order to verify the fire hazard analysis based on the computer model. This report is also published by NIST as report number NISTIR-6132. (Reprint: includes corrected tables on pages 2-18, 5-8 and 5-9, A-1, and D-3 and D-4)					
14. SUBJECT TERMS Fire safety, passenger trains, passenger rail, railroads, Federal Railroad Administration, passenger train safety, transportation fire safety, high-speed ground transportation, system safety, heat release rate, large-scale fire tests, small-scale fire tests, fire test methods, NIST, Cone Calorimeter, fire safety guidelines, fire modeling, fire hazard assessment.				15. NUMBER OF PAGES 196	
				16. PRICE CODE	
17. SECURITY CLASSIFICATION OF REPORT Unclassified	18. SECURITY CLASSIFICATION OF THIS PAGE Unclassified	19. SECURITY CLASSIFICATION OF ABSTRACT Unclassified	20. LIMITATION OF ABSTRACT None		

METRIC/ENGLISH CONVERSION FACTORS

ENGLISH TO METRIC

METRIC TO ENGLISH

LENGTH (APPROXIMATE)	LENGTH (APPROXIMATE)
1 inch (in) = 2.5 centimeters (cm)	1 millimeter (mm) = 0.04 inch (in)
1 foot (ft) = 30 centimeters (cm)	1 centimeter (cm) = 0.4 inch (in)
1 yard (yd) = 0.9 meter (m)	1 meter (m) = 3.3 feet (ft)
1 mile (mi) = 1.6 kilometers (km)	1 meter (m) = 1.1 yards (yd)
	1 kilometer (km) = 0.6 mile (mi)

AREA (APPROXIMATE)	AREA (APPROXIMATE)
1 square inch (sq in, in ²) = 6.5 square centimeters (cm ²)	1 square centimeter (cm ²) = 0.16 square inch (sq in, in ²)
1 square foot (sq ft, ft ²) = 0.09 square meter (m ²)	1 square meter (m ²) = 1.2 square yards (sq yd, yd ²)
1 square yard (sq yd, yd ²) = 0.8 square meter (m ²)	1 square kilometer (km ²) = 0.4 square mile (sq mi, mi ²)
1 square mile (sq mi, mi ²) = 2.6 square kilometers (km ²)	10,000 square meters (m ²) = 1 hectare (ha) = 2.5 acres
1 acre = 0.4 hectare (he) = 4,000 square meters (m ²)	

MASS - WEIGHT (APPROXIMATE)	MASS - WEIGHT (APPROXIMATE)
1 ounce (oz) = 28 grams (gm)	1 gram (gm) = 0.036 ounce (oz)
1 pound (lb) = 0.45 kilogram (kg)	1 kilogram (kg) = 2.2 pounds (lb)
1 short ton = 2,000 pounds (lb) = 0.9 tonne (t)	1 tonne (t) = 1,000 kilograms (kg) = 1.1 short tons

VOLUME (APPROXIMATE)	VOLUME (APPROXIMATE)
1 teaspoon (tsp) = 5 milliliters (ml)	1 milliliter (ml) = 0.03 fluid ounce (fl oz)
1 tablespoon (tbsp) = 15 milliliters (ml)	1 liter (l) = 2.1 pints (pt)
1 fluid ounce (fl oz) = 30 milliliters (ml)	1 liter (l) = 1.06 quarts (qt)
1 cup (c) = 0.24 liter (l)	1 liter (l) = 0.26 gallon (gal)
1 pint (pt) = 0.47 liter (l)	
1 quart (qt) = 0.96 liter (l)	
1 gallon (gal) = 3.8 liters (l)	
1 cubic foot (cu ft, ft ³) = 0.03 cubic meter (m ³)	1 cubic meter (m ³) = 36 cubic feet (cu ft, ft ³)
1 cubic yard (cu yd, yd ³) = 0.76 cubic meter (m ³)	1 cubic meter (m ³) = 1.3 cubic yards (cu yd, yd ³)

TEMPERATURE (EXACT)	TEMPERATURE (EXACT)
$[(x-32)(5/9)] \text{ } ^\circ\text{F} = y \text{ } ^\circ\text{C}$	$[(9/5)y + 32] \text{ } ^\circ\text{C} = x \text{ } ^\circ\text{F}$

QUICK INCH - CENTIMETER LENGTH CONVERSION

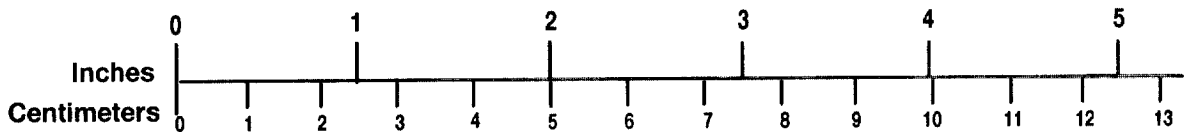

QUICK FAHRENHEIT - CELSIUS TEMPERATURE CONVERSION

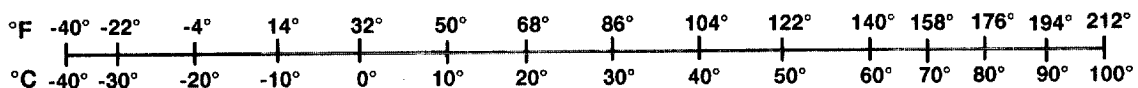

For more exact and/or other conversion factors, see NIST Miscellaneous Publication 286, Units of Weights and Measures. Price \$2.50 SD Catalog No. C13 10286

Updated 1/23/95

PREFACE

In 1984, the Federal Railroad Administration (FRA) issued fire safety guidelines that recommended the use of certain flammability and smoke emission test methods and performance criteria for intercity and commuter rail cars. Those guidelines were identical to Urban Mass Transportation Administration (UMTA), now Federal Transit Administration (FTA), recommended practices for rail transit vehicles, also issued in 1984. The FRA issued revised guidelines in 1989 that used terms and categories to more closely reflect passenger train design and furnishings; smoke emission performance criteria for floor coverings and elastomers were also included. As part of the passenger equipment rulemaking process required by Congress, the FRA has proposed that the guideline requirements be made mandatory for existing, rebuilt, and new rail cars.

In 1993, the National Institute of Standards and Technology (NIST) completed a comprehensive evaluation of the U.S. and European approaches to passenger train fire safety, sponsored by the FRA. The evaluation was directed by the John A. Volpe National Transportation Systems Center (Volpe Center), Research and Special Programs Administration, USDOT. A major conclusion of the NIST study was that the use of fire hazard and fire assessment techniques, based on mathematical modeling and supported by measurement methods using heat release rate (HRR), could provide a more credible and cost-effective means to predict actual passenger train material fire behavior.

The Volpe Center then developed a comprehensive three-phase passenger train fire safety research program to be conducted by NIST under the sponsorship of the FRA Office of Research and Development (R&D). This research program is directed at providing the scientific basis for using a systems approach to maintain and improve the level of passenger train fire safety. The focus is to demonstrate the practicality and effectiveness of HRR-based test methods and hazard analysis techniques when applied to passenger trains. The Cone Calorimeter test method (ASTM 1354) provides small-scale data measurement of heat release rate, smoke emission, specimen mass loss, and combustion gases. This quantitative data can be used to evaluate the performance of individual component materials and assemblies and as inputs for fire modeling. Such modeling allows consideration of other factors in addition to material flammability, as well as fire-safety tradeoffs in design and performance for the entire system. This approach is consistent with ongoing efforts to develop performance-based fire codes in the United States and Europe.

This document presents the results of the first phase of the program focused on the evaluation of passenger train interior materials using the Cone Calorimeter test method. The Cone Calorimeter test data were compared with data from FRA-cited small-scale test methods to determine relative material fire performance. In Phase II, the Cone Calorimeter quantitative test data will be used as an input to a computer model as part of a fire hazard analysis. Phase III will involve real-scale testing of a full-size rail car to verify the use of the fire hazard analysis based on the computer model.

The results of this research program will assist the FRA in developing appropriate fire safety performance requirements for inclusion in the passenger equipment final rule.

ACKNOWLEDGMENTS

Direction and technical review of the Phase I interim report were provided by Steven R. Ditmeyer, Director; Claire L. Orth, Chief, Equipment and Operating Practices Division; and Thomas N. Tsai, Senior Project Engineer; all of the Federal Railroad Administration, Office of Research & Development; and Robert M. Dorer, Chief, High-Speed Ground Transportation Division and Alfred E. Barrington, Chief, Safety and Environmental Technology Division, John A. Volpe National Transportation Systems Center (Volpe Center).

Stephanie H. Markos, Volpe Center, provided overall project technical direction, specific oversight of Phase I task progress, and technical review of all Phase I work products. She also provided major assistance in preparing Chapters 2 and 3 of this interim report.

Douglas Karan, Senior Interior Designer, Office of Engineering - Equipment Design, Amtrak and James P. Gourley, former Amtrak Senior Fire Protection Engineer, provided invaluable engineering assistance by furnishing copies of flammability and smoke emission test data, samples of typical Amtrak passenger rail car interior materials, and review and comments on the draft Phase I interim report.

Constantine P. Sarkos, Richard E. Lyon, and Timothy R. Marker, Fire Safety Section, Aircraft Safety R & D Branch, William J. Hughes Technical Center, Federal Aviation Administration; Roy Field, Office of Safety and Security, Office of Program Management, Federal Transit Administration; Charles Hott, Special Vehicle and Systems Division, Office of Crashworthiness, Safety Performance Standards, National Highway Traffic Safety Administration; and Lt. Andrew L. Grenier and Lt. Anthony T. DiSanto, Lifesaving and Fire Standards Division, Office of Design and Engineering, Marine Safety and Environment directorate, Office of the Commandant, United States Coast Guard USCG); and Louis Nash, Marine Fire and Safety Research Branch, Applied Engineering Division, USCG R&D Center; all provided valuable information and assistance concerning their agency's fire safety requirements and related research efforts.

A Peer Review Committee was established to guide the development of this research program. Members of this committee include: Douglas Karan, Amtrak; James P. Gourley, formerly of Amtrak; Vytenis Babrauskas, Fire Science and Technology, Inc.; Merritt M. Birky, U.S. National Transportation Safety Board; John Devlin, Schirmer Engineering Company; Arthur G. Bendelius, Parsons, Brinckerhoff Quade & Douglas, Inc.; Thomas W. Fritz, Armstrong World Headquarters; Arthur F. Grand, Omega Point Laboratories; Gerald Hoefstader, Bombardier Corporation; David A. Marchitello, formerly of Chestnut Ridge Foam, Inc.; William R. Segar, ADtranz ABB Daimler-Benz Transportation; James M. Surless, Long Island Railroad; and Joseph B. Zicherman, Integrated Fire Technology/Fire Cause Analysis, Inc.; all of whom provided important input during the progress of the Phase I tasks. Their scientific and practical knowledge, candid discussions relating to fire safety and rail transportation vehicle material selection, as well as their comments on the draft Phase I interim report, are also greatly appreciated.

Finally, the authors extend special thanks to Cassandra L. Oxley, Planner's Collaborative/EG&G Services, for her extensive editorial coordination in preparing this report for publication, and to Barbara Siccone, Planners Collaborative and Carmen Knox, Camber Corporation, who provided formatting expertise/typing support, and graphics assistance, respectively.

TABLE OF CONTENTS

<u>Section</u>	<u>Page</u>
1. Introduction	1-1
1.1 Recent Train Fires	1-3
1.2 Heat Release Rate (HRR) and Fire Hazard Analysis	1-5
1.3 Previous FRA Passenger Train Fire Safety Studies	1-6
1.3.1 1993 U.S. and European Passenger Train Fire Evaluation	1-6
1.3.2 1984 FRA/Amtrak Study	1-6
1.4 Overall Project Objective	1-7
1.5 Overall Project Technical Approach	1-8
1.6 Phase I Report	1-8
1.6.1 Phase I Scope	1-9
1.6.2 Phase I Report Organization	1-9
2. Transportation Vehicle Fire Safety Requirements	2-1
2.1 U.S. Passenger Train Fire Safety Requirements	2-1
2.2 Other U.S. Transportation Vehicle Fire Safety Requirements	2-5
2.2.1 Rail Transit Vehicles	2-5
2.2.2 Motor Vehicles	2-9
2.2.3 Aircraft	2-12
2.2.4 Passenger Vessels	2-14
2.3 U.S. Fire Safety Requirements Commentary	2-17
2.4 European Passenger Train Fire Safety Requirements	2-20
2.5 European Passenger Train HRR and Hazard Analysis Research	2-22
2.6 Summary	2-24
3. Passenger Train Materials	3-1
3.1 Typical Materials	3-1
3.1.1 Coach/First Class Cars	3-1
3.1.2 Cafe/Lounge and Dining Cars	3-3
3.1.3 Sleeping Cars	3-4
3.1.4 Miscellaneous Component Materials	3-4
3.2 Materials Selected for Testing	3-5
3.3 Summary	3-8
4. FRA-Cited Test Method Evaluation	4-1
4.1 ASTM E 162/D 3675	4-2
4.1.1 Application and Performance Criteria	4-2
4.1.2 Test Data	4-2
4.2 ASTM E 648	4-3
4.2.1 Application and Performance Criterion	4-4
4.2.2 Test Data	4-4

TABLE OF CONTENTS (cont.)

<u>Section</u>		<u>Page</u>
4.3	FAR 25.853 (a) and ASTM C 542	4-4
	4.3.1 Application and Performance Criteria	4-5
	4.3.2 Test Data	4-5
4.4	ASTM E 662	4-6
	4.4.1 Application and Performance Criteria	4-7
	4.4.2 Test Data	4-7
4.5	Previous Passenger Vehicle-Related Test Data	4-9
4.6	Summary	4-9
	4.6.1 Flammability	4-9
	4.6.2 Smoke Emission	4-10
5.	Cone Calorimeter Test Method Evaluation	5-1
5.1	Exposure Conditions	5-4
	5.1.1 Exposure Conditions in Current Generation Test Methods	5-4
	5.1.2 Exposure Conditions in Unwanted Fires	5-4
	5.1.3 Chosen Exposure Conditions for Cone Calorimeter Testing	5-5
5.2	Cone Calorimeter Test Results	5-6
	5.2.1 Individual Component Materials	5-7
	5.2.2 Component Assemblies	5-10
	5.2.3 Previous Passenger Vehicle-Related Cone Calorimeter Test Data ...	5-13
5.3	Summary	5-15
6.	Comparison of Small-Scale Test Data	6-1
6.1	Flammability	6-1
	6.1.1 ASTM E 162 and ASTM D 3675	6-1
	6.1.1.1 Comparison Parameter	6-2
	6.1.1.2 Comparison Between ASTM E 162/D 3675 and ASTM E 1354	6-3
	6.1.2 ASTM E 648	6-6
	6.1.2.1 Comparison Parameter	6-6
	6.1.2.2 Comparison Between ASTM E 648 and ASTM E 1354 ...	6-6
	6.1.3 FAR 25.853 (a) and ASTM C 542	6-7
	6.1.3.1 Comparison Parameter	6-7
	6.1.3.2 Comparison Between FAR 25.853 (a) and ASTM E 1354 ...	6-8
6.2	Smoke Emission – ASTM E 662	6-8
	6.2.1 Comparison Parameter	6-10
	6.2.2 Comparison Between ASTM E 662 and ASTM E 1354	6-11
6.3	Comparison with Previous U.S. Passenger Vehicle-Related Fire Test Data ..	6-14
6.4	Test Result Uncertainty	6-16
6.5	Summary	6-16

TABLE OF CONTENTS (cont.)

<u>Section</u>	<u>Page</u>
7. Summary	7-1
7.1 U.S. Transportation Vehicle Requirements and Research	7-2
7.1.1 U.S. Rail Transportation Vehicle Fire Safety Requirements	7-2
7.1.2 Other U.S. Transportation Vehicle Fire Safety Requirements	7-2
7.1.3 U.S. Transportation Vehicle Fire-Related Research	7-3
7.2 European Fire Safety Requirements and HRR Research	7-4
7.3 Amtrak Material Test Data Evaluation	7-4
7.3.1 FRA-Cited Test Method Data	7-5
7.3.2 Cone Calorimeter Test Data	7-5
7.3.3 Comparison of FRA-Cited Test Method Data and Cone Calorimeter Test Data	7-6
7.4 Application to Phase II Tasks and Overall Project	7-7
8. References	8-1
Appendix A. FRA Flammability and Smoke Emission Requirements for Intercity and Commuter Rail Car Materials	A-1
Appendix B. U.S. Rail Car Fire Safety Test Methods and Performance Criteria	B-1
Appendix C. Cone Calorimeter Overview	C-1
Appendix D. Cone Calorimeter Test Data	D-1

LIST OF FIGURES

<u>Figure</u>	<u>Page</u>
3-1. Amtrak Coach Car	3-1
3-2. Carpet and Resilient Rubber Floor Covering	3-2
3-3. Seats	3-2
3-4. Cafe/Lounge Car	3-3
3-5. Dining Car	3-3
3-6. Sleeping Car Compartment	3-4
3-7. Coach Seat Assembly	3-5
5-1. General View of the Cone Calorimeter (ASTM E 1354, ISO 5660)	5-2
5-2. Comparison of Cone Calorimeter HRR for Two Foam Samples	5-12
5-3. Comparison of Cone Calorimeter HRR for Two Upholstery Fabrics	5-12
5-4. Cone Calorimeter HRR-Cotton Muslin Interliner (Sample 1b)	5-13
5-5. Comparison of Cone Calorimeter HRR - Two Seat Assemblies with Sample 1c Fabric	5-14
5-6. Comparison of Cone Calorimeter HRR - Two Seat Assemblies with Sample 2c Fabric	5-14
6-1. Comparison of I_s as Measured According to ASTM E 162 / D 3675 and Peak HRR as Measured in the Cone Calorimeter	6-4
6-2. Comparison of Char Length as Measured According to FAR 25.853 (a) to the Ratio of Time to Ignition and Peak HRR as Measured in the Cone Calorimeter	6-9
6-3. Specific Optical Density as Determined From the Specific Extinction Area	6-12
6-4. Comparison of ASTM E 662 D_s (4.0) and Calculated Cone Calorimeter D_s (1.0) ...	6-13

LIST OF TABLES

<u>Table</u>	<u>Page</u>
2-1. U.S. Flammability and Smoke Emission Requirements for Passenger Rail Cars	2-3
2-2. FAR 25.853 Aircraft Interior Cabin Material Requirements	2-13
2-3. Major U.S. Transportation Vehicle Fire Performance Requirements	2-18
3-1. Selected Passenger Train Materials Evaluated in This Study	3-6
4-1. ASTM E 162/D 3675 Test Data for Passenger Rail Materials	4-3
4-2. ASTM E 648 Test Data for Passenger Rail Materials	4-4
4-3. FAR 25.853 (a) Test Data for Passenger Rail Materials	4-6
4-4. ASTM E 662 Test Data for Passenger Rail Materials	4-8

LIST OF TABLES (cont.)

<u>Table</u>		<u>Page</u>
5-1.	Fire Exposure Conditions for FRA-Cited Test Methods and in Typical Fires	5-6
5-2.	Summary Cone Calorimeter Individual Material HRR Data	5-8
5-3.	Summary Cone Calorimeter Individual Material Smoke Data	5-9
5-4.	Summary Cone Calorimeter HRR and Smoke Data for Selected Component Combinations	5-11
6-1.	Passenger Rail Car Material Small-Scale Test Data Comparison	6-15

1. INTRODUCTION

Fire safety is an area of particular interest for both conventional intercity and commuter passenger trains and new, often more lightweight high-speed trains. A systems approach to fire safety addresses rail car design and materials, detection and suppression systems, passenger evacuation, and their interaction. The Federal Railroad Administration (FRA) is sponsoring a three-phase research program directed at providing the scientific basis for using this systems approach to maintain and improve the level of passenger train fire safety. This report describes the results of Phase I which focused on the evaluation of rail car interior materials using data from existing FRA-cited test methods and an alternative test method using the Cone Calorimeter [1].

In 1984, the FRA issued passenger train fire safety guidelines that recommended the use of certain flammability and smoke emission test methods and performance criteria for intercity and commuter rail cars [2]. Those guidelines were identical to Urban Mass Transportation Administration (UMTA), now Federal Transit Administration (FTA) recommended practices for rail transit vehicles, also issued in 1984 [3]. The FRA issued revised guidelines in 1989 that used terms and categories to more closely reflect passenger train design and furnishings; smoke emission performance criteria for floor coverings and elastomers were also included [4]. Appendices A and B, respectively, contain a table listing the current FRA-cited test methods and performance criteria and more descriptive information. As part of the passenger rail equipment rulemaking process required by Congress, the FRA has proposed that passenger train materials be required to meet these test methods and performance criteria [5].

Currently, the U.S. and European approaches to passenger train fire safety rely primarily on individual small-scale test methods to evaluate material fire performance. However, a 1993 study by the National Institute of Standards and Technology (NIST), sponsored by the FRA, concluded that an alternative approach could provide a more credible and cost-effective means to predict the fire performance of passenger train materials [6]. This alternative approach employs fire hazard* assessment techniques, using fire modeling based on test methods using *heat release rate* (HRR) data. An extensive effort sponsored by the European Railway Research Institute (ERRI) is also underway to relate small-scale and real-scale fire performance using HRR and fire modeling.

* Fire hazard: the seriousness of the exposure conditions which threaten the physical well being of the occupant. The hazard may come from various sources, for example, smoke inhalation, direct flame burn, injuries due to trauma (e.g., ceiling collapse), high temperatures, or the inability to escape due to lack of visibility or the presence of irritant gases which may affect breathing and visibility.

Based primarily on small-scale test methods which demonstrate fire characteristics of individual materials, the FRA and other similar requirements form a prescriptive set of design specifications which historically have been used to evaluate transportation vehicle material fire performance. This approach provides a screening device to allow interested parties to identify particularly hazardous materials and select preferred combinations of individual components; material suppliers can independently evaluate the fire safety performance of their own materials. However, in most ground transportation applications, end-use assemblies have not been tested.

Considerable advances in fire safety engineering have been made since the original development of the current FRA-cited test methods and performance criteria. While much of the data obtained from those test methods provide a relative ranking of materials under the specified exposure conditions, quantitative data which can be used for fire modeling and hazard analysis is not available. In addition, the 1993 NIST study and several other studies have concluded that the impact of material interactions and changes in real-scale passenger vehicle interior geometry are also critical factors to be evaluated in predicting actual fire behavior. These factors cannot be evaluated through small-scale tests alone.

To assess the feasibility of applying HRR test methods and fire modeling and hazard analysis techniques to U.S. passenger trains, the John A. Volpe National Transportation Systems Center (Volpe Center) developed a comprehensive three-phase fire safety research program to be conducted by NIST.

This interim report presents the Phase I results of the NIST research which involved the conduct of *ASTM E 1354, Standard Test Method for Heat and Visible Smoke Release Rates for Materials and Products Using an Oxygen Consumption Calorimeter (Cone Calorimeter)* [1] tests to evaluate the fire performance of materials currently used in U.S. passenger trains.

The Phase II interim report will present the results of the input of Cone Calorimeter and other HRR and smoke data into a computer fire model to analyze the overall contribution of materials to the fire hazard used in a particular rail car application. The Phase III interim report will present the results of full-scale tests conducted to verify the results of Phases I and II. A final report will integrate the three interim reports and present recommendations to the FRA.

A Peer Review Committee consisting of representatives from passenger train system operators, rail car builders, material manufacturers, and test laboratories was established to provide technical advice on the project test plan, results, and practicality of recommendations.

1.1 RECENT TRAIN FIRES

U.S. passenger train accidents involving major fires occurred near Silver Spring, Maryland in 1996 and near Mobile, Alabama in 1993 [7][8]. The National Transportation Safety Board (NTSB) identified emergency evacuation, communications, and locomotive fuel tank integrity as major safety issues in both accidents. In the 1996 accident, three train crew and nine passenger deaths were caused by fire when a Maryland Area Rail Commuter (MARC) train and an Amtrak train collided; 26 passengers were injured. The NTSB commissioned a special study which tested MARC interior materials [9]. (The results of the MARC tests will be discussed in Chapter 6 of this report.) While noting that some MARC rail car interior materials did not meet “federal” (i.e., FRA/FTA) flammability and smoke performance criteria, the NTSB questioned the usefulness of the tests in predicting the fire safety of the car interior environment since the guidelines do not provide for the “integrated use” of materials. The 1993 accident occurred when an Amtrak train derailed on a misaligned bridge. Forty-two passengers and five train crew died (including two service crew members of smoke inhalation); 173 persons were injured.

A 1982 Amtrak train fire in Gibson, California caused two passenger deaths and two serious passenger injuries; numerous passengers and train crew were also treated for smoke inhalation. The NTSB investigation determined that the probable fire cause was a discarded cigarette in a sleeping compartment seat cushion. Several areas of concern were identified, including materials, fire detection, ventilation, passenger evacuation, and communications [10].

In 1996, a “shuttle” train fire occurred in the Channel Tunnel between England and France. The train carried 200 trucks; two train crew, truck drivers, and other passengers were riding in a separate coach. Although all persons were evacuated uninjured, several rail shuttle and truck cars were destroyed and the tunnel was severely damaged. Among the issues identified in the investigation report were fire detection, emergency evacuation, and communications [11].

A 1994 VIA Canada passenger train fire at Brighton, Ontario injured 46 persons, most while they were evacuating the train. The fire, caused by the ignition of leaking locomotive fuel, destroyed the train club car and extensively damaged a coach. Emergency evacuation and fuel tank integrity were identified as safety issues [12].

Several British Rail train fires have resulted in casualties. A 1995 passenger train fire resulted from a ruptured locomotive fuel tank near Maidenhead, England. One person was killed by another train after exiting the InterCity Express train to escape the fire; five others were injured

from smoke inhalation or other causes. Recommendations were made to improve material fire resistance, toilet plumbing, emergency equipment, communications, and fuel tank integrity [13][14].

A 1983 British Rail train fire severely damaged two coach cars along half their length. The stated cause of the fire was a discarded cigarette in a “foam-type gangway unit,” the fire then spread along the roof line. Recommendations were made for redesign of the car roofs and evacuation instruction improvements [15]. Finally, a 1978 fire in a British sleeping car led to 11 passenger deaths and injuries. Ignition of soiled bed linens stored next to an electric heater resulted in the complete loss of one sleeping car and heavy smoke damage to a second sleeping car. Material flammability, heater design, smoke detection, emergency egress, and crew training were identified as important issues in that fire [16].

The FRA has addressed passenger train safety through recent rulemaking processes. In addition to specific fire safety items, including materials, fire hazard analyses are required in the proposed passenger equipment rule [5]. FRA has also issued final and proposed rules pertaining to emergency preparedness and radio communications [17][18]. In addition, fuel tank integrity is addressed in the proposed passenger rail equipment rule. A special National Fire Protection Association (NFPA) task force is also examining passenger train fire safety; Chapter 2 describes that effort in more detail. In addition, the Volpe Center is conducting a passenger train evacuation study which uses a systems approach to evaluate emergency exits, lighting, and signs.

1.2 HEAT RELEASE RATE (HRR) AND FIRE HAZARD ANALYSIS

Better understanding of the underlying phenomena governing fire initiation and growth has led to the development of HRR test methods which can better predict the real-scale burning behavior of materials and assemblies [19].

HRR is considered to be a key indicator of fire performance and is defined as the amount of energy that a material produces while burning. For a given confined space (e.g., rail car interior), the air temperature is increased as the HRR increases. Even if passengers do not come into direct contact with the fire, they could be injured by high temperatures, heat fluxes, and/or smoke and gases emitted by materials involved in the fire. Accordingly, the fire hazard to passengers of these materials can be directly correlated to the HRR of an actual fire.

HRR and other data measurements generated from oxygen consumption calorimeters (e.g., Cone Calorimeter) can be used as an input to evaluate the contribution of a material's overall contribution to the fire hazard in a particular rail car application. Fire modeling and hazard analysis techniques allow evaluation of a range of design parameters, including material flammability, geometry, fire detection, fire suppression, and evacuation, as well as design tradeoffs which may arise from combinations of the parameters. However, further tests and assessment are considered necessary to evaluate the suitability of fire modeling and hazard analysis techniques for application to typical passenger train fire scenarios. Testing a range of materials according to HRR test methods will also allow evaluation of the ability of a predictive fire model to minimize, but not eliminate, the need for real-scale tests to assess overall passenger train fire performance. Limited real-scale tests may still be required to verify the accuracy of fire hazard analysis calculations, particularly when dramatically new designs or materials are incorporated into new passenger rail cars.

Quantitative fire modeling and hazard analysis techniques have the potential of providing significant cost savings. Alternative protection strategies can be studied within the hazard analysis framework to give the benefit-cost relation for each. In addition, measures are evaluated as a system with their many interactions, including the impact of both structure and contents. Providing these alternatives promotes design flexibility which reduces redundancies and cost without sacrificing safety. New technology can be evaluated before it is brought into practice, thereby reducing the time lag currently required for acceptance. Thus, quantitative hazard analysis can be a powerful complement to existing passenger train fire performance requirements and a useful tool in evaluating improvements to them.

Several independent sources support this new direction for passenger train fire safety. Studies by ERRI [20] [21]; Cappuccio [22], Barnett [23], and Parker [24] on transit system analysis; Schirmer Engineering Corporation on Amtrak stations, tunnels, and train cars [25]; and Burdett, Ames, and Fardell on the King's Cross subway station fire [26], all recommend the use of HRR-based test methods, incorporated with fire modeling and hazard analysis, to assess potential hazards under real fire conditions.

1.3 PREVIOUS FRA PASSENGER TRAIN FIRE SAFETY STUDIES

Previous passenger train fire safety studies sponsored by the FRA are summarized below. Part of the purpose of the current NIST research program is to extend the research from the earlier FRA-

sponsored studies and other related studies to account for the effects of material interaction and rail car geometry on overall passenger train fire safety.

1.3.1 1993 U.S. and European Passenger Train Fire Evaluation

The 1993 NIST study included a comprehensive evaluation of the U.S. and European approaches to passenger train fire safety [6]. French, German, British, and International Union of Railways (UIC) fire performance requirements were reviewed to determine their comparability. The current European approach to fire safety uses test methods similar in approach to the FRA. In addition to material test methods, the effects of vehicle design, detection and suppression systems, and emergency egress were reviewed. NIST concluded that hazard analysis using HRR data could provide a more credible and cost-effective means to evaluate passenger train material fire performance. Chapter 2 of this interim report summarizes and updates the U.S. and European approaches to passenger train fire safety information provided in the 1993 report.

1.3.2 1984 FRA/Amtrak Study

In addition to the 1993 report cited above, the FRA funded an Amtrak material fire safety study which was published in 1984 [27]. That earlier study included a series of tests to assess the burning behavior of materials used for Amtrak passenger rail car interior furnishings. Small-scale laboratory tests of individual materials using various interior components and full seat assembly tests were conducted, along with eight real-scale mock-up tests (four of these fully furnished).

The comparison of small-scale flammability and smoke emission test data with real-scale test data showed that the small-scale tests were able to adequately predict the effect of changes in materials within the same real-scale geometry. However, when the geometry of the real-scale test mockup was changed, the chosen small-scale tests failed to predict the effect of the changes. In particular, the addition of a full-length carpet covering to the underside of the overhead baggage rack made ignition easier; this led to more rapid fire growth and spread, as well as full involvement of the mock-up compartment.

HRR test results were also included in that study. Small-scale, seat assembly, and real-scale mock-up test data were compared. The relative fire performance of the materials (from lowest HRR to highest HRR) was consistent in mock-up tests (for a given geometry of the real-scale mock-up).

The FRA/Amtrak study identified several material and design features considered important for fire safety. Along with specific design recommendations for luggage rack and wall coverings, and armrests, the report suggested a possible rail car interior evaluation protocol as follows:

- A small number of real-scale tests to determine a set of acceptable materials for the geometry of the rail car, and
- A series of small-scale tests to evaluate alternative materials. Materials which are equal or better than the materials tested in the real-scale rail car could be substituted without further real-scale testing.

The 1984 Amtrak material test data represented the results of only a limited number of tests. The effects of changes in component materials, material interaction, and rail car geometry were identified as important issues requiring further study.

Since 1984, better understanding of the relationship between small-scale and real-scale tests has led to small-scale test methods which can successfully predict end-use burning behavior of materials. Thus, the primary use for real-scale tests now is to verify small-scale test data.

1.4 OVERALL PROJECT OBJECTIVE

The overall project objective is to fully demonstrate the practicality and effectiveness of HRR-based test methods and hazard analysis methodology when applied to passenger train fire safety. The results of this project are intended to provide: (1) the FRA with additional information to use in finalizing the fire safety provisions in the proposed passenger equipment rule, and (2) car builders and passenger train system operators with increased design flexibility to permit incorporation of innovative materials and designs in future passenger rail cars. The successful application of this alternative approach could provide a more cost-effective way to evaluate the real-world fire performance of passenger train materials.

1.5 OVERALL PROJECT TECHNICAL APPROACH

To evaluate the applicability of fire modeling and hazard analysis when applied to passenger train design, appropriate HRR data must be obtained, fire modeling and hazard analysis conducted, and the results of the methodology tested against real-scale fire simulations designed to verify the predicted outcome. This research consists of the following three phases:

- During Phase I, selected rail car interior materials were evaluated using the Cone Calorimeter test method. The use of this test method and resulting HRR data have been reviewed with respect to current FRA-cited tests, performance criteria, and flammability and smoke emission data to compare the relative performance of current materials. This report documents the results of the Phase I research tasks.
- During Phase II, the applicability of fire modeling and hazard analysis techniques to predict rail car fire hazards and mitigate those hazards will be evaluated. Real-scale tests of assemblies such as seats will be conducted to obtain component fire performance data. The evaluation will include changes in rail car design and materials, detection and suppression systems, and passenger evacuation, to assess the relative impact on fire safety for a range of design parameters.
- During Phase III, selected full-scale proof tests of passenger rail car equipment, in actual end-use configuration, will be performed to verify the predicted system performance against the small-scale and real-scale assembly tests and hazard analysis studies.

1.6 PHASE I REPORT

This report describes the results of Phase I of the NIST work effort. The Cone Calorimeter was investigated as an alternative test method which could provide multiple measures of fire performance for component materials and assemblies using a single test method. These measures include:

- ignitability,
- HRR, and
- release rate for smoke, products of combustion, and toxic gases.

The use of a single test method resulted in all materials being evaluated under comparable fire conditions. The measured properties were obtained under identical fire exposure conditions. In Phase II, the Cone Calorimeter quantitative test data will be used as an input to fire hazard analyses using a computer fire model.

1.6.1 Phase I Scope

This Phase I report describes the results of the following major tasks:

- A review of U.S. transportation vehicle requirements and related research.
- A review and update of European regulations and research efforts related to passenger train fire safety.
- Evaluation of currently available passenger train materials using the Cone Calorimeter test method. This task included selection of a range of interior materials, testing of the materials according to ASTM 1354, and analysis of the test data with respect to the existing FRA performance criteria.

1.6.2 Phase I Report Organization

Chapter 2 briefly reviews the current U.S. and European approaches to passenger train fire safety and summarizes other passenger transportation vehicle fire safety regulations and research.

Chapter 3 describes typical U.S. passenger train materials and the specific materials evaluated during Phase I.

Chapter 4 reviews the data for the materials described in Chapter 3 when tested according to the following existing FRA-cited test methods:

- American Society for Testing and Materials (ASTM)
 - E 162, *Surface Flammability of Materials Using a Radiant Energy Source* [28]
 - D 3675, *Surface Flammability of Cellular Materials Using a Radiant Energy Source* [29]
 - E 648, *Critical Radiant Flux of Floor Covering Systems Using a Radiant Energy Source* [30]
 - C 542, *Specification for Lock-Strip Gaskets* [31]
 - E 662, *Specific Optical Density of Smoke Generated by Solid Materials* [32], and
- Federal Aviation Administration (FAA)
 - *14 CFR, Part 25, Subsection 25.853 (a) Compartment Interiors* [33].

Chapter 5 discusses fire exposure conditions and contains the test data for each of the passenger train interior materials tested according to the Cone Calorimeter (ASTM E 1354) [1]). Chapter 6 presents a comparison of data from FRA-cited individual test methods and the Cone Calorimeter

test method. Chapter 7 summarizes the overall results of the Phase I work effort. The impact of results on the next phases of the research program is also discussed.

Appendices A and B contain additional information relating to current FRA-cited test methods and performance criteria. Appendix C provides an overview of the Cone Calorimeter test method. Appendix D contains detailed Cone Calorimeter test data for each of the 30 component materials evaluated in this report.

2. TRANSPORTATION VEHICLE FIRE SAFETY REQUIREMENTS

The majority of the FRA guideline (and proposed rule) requirements for U.S. passenger train fire safety consist of small-scale test methods and performance criteria for individual materials. The objectives are to prevent fire, retard its growth and spread, and provide adequate evacuation time for passengers and crew. The FRA requirements form a prescriptive set of design specifications for selecting materials. In addition to small-scale flammability and smoke emission test methods, the FRA requirements include a large-scale fire endurance test for car flooring assemblies [34]. Design, detection and suppression, and evacuation requirements are also specified to a limited degree. Chapter 4 and Appendix B further describe the FRA-cited test methods and performance criteria.

For the purpose of this report, the term “requirements” is used generically to include: regulations, standards, rules, specifications, guidelines, recommendations, and recommended practices. Regulations and rules are the only requirements that can be and usually are legally enforceable unless other requirements are included in contracts or jurisdictional codes.

This chapter provides an overview of U.S. passenger train material selection requirements and a review of other U.S. transportation vehicle fire safety requirements and related research. Additional information on European passenger rail equipment requirements and research efforts not available at the time of the 1993 NIST study is also included.

One objective of using materials which demonstrate low flammability and smoke emission is to provide time for passengers to evacuate a potentially hazardous situation. Accordingly, emergency egress requirements for selected U.S. transportation vehicles and selected European rail vehicles are also noted.

2.1 U.S. PASSENGER TRAIN FIRE SAFETY REQUIREMENTS

Interest in improving passenger train fire safety is not new. From 1906 to 1928, the Pennsylvania Railroad undertook an ambitious program to replace its wooden rail car fleet with all-steel cars due to a concern for safety and fire prevention [35]. Emphasis in recent years on passenger comfort and aesthetic appeal has led to the increased use of synthetic materials [36]. Use of plastics in rail car interiors started in the early 1950s [37] [38]. Over the years, concern has been

raised over the flammability and impact on fire hazard of these materials in end-use configuration, although they are generally tested individually only in small-scale [39].

Specific requirements for intercity passenger rail car material flammability first appeared in 1966 [35]. These rail car specifications dictated “flame tests” for seat foam materials before the material use would be approved for the original Metroliner passenger rail cars.

In 1984, the FRA issued fire safety guidelines for intercity passenger and commuter rail train materials [2] identical to the Urban Mass Transportation Administration (UMTA) (now Federal Transit Administration (FTA) test methods and performance criteria for rail transit vehicles also issued in 1984 [3]. The FRA issued revised guidelines in 1989 to use terms and categories to more closely reflect passenger train design and furnishings and provide smoke emission performance criteria for floor coverings and elastomers [4]. The individual test methods measure one or more of four different fire performance phenomena: ignition resistance, flame spread, smoke emission, and fire endurance. The requirements are based in large part on two small-scale test methods: *ASTM E 162, Surface Flammability of Materials Using a Radiant Energy Source* [28] (with a variant, *ASTM D 3675* for cellular materials [29]) and *ASTM E 662, Specific Optical Density of Smoke Generated by Solid Materials* [32]. Several other requirements are specified for individual material applications. All of the test methods are designed to study aspects of a material's fire behavior in a fixed configuration and exposure, with the exception of *ASTM E 119, Fire Tests of Building Construction and Materials* (a large-scale fire endurance test) [34]. Chapter 4 and Appendix B describe the test methods and performance criteria in more detail.

The proposed FRA passenger equipment safety rule [5] would require that interior materials meet the FRA guideline fire safety requirements. Various fire hazard analyses of existing and new rail cars are also required; consideration of the need to provide sufficient time to safely evacuate the train is noted. (While this discussion focuses on materials, the FRA currently requires that each passenger car be equipped with four window emergency exits to assist passengers in escaping from an emergency, such as a fire [40]. In addition, the proposed FRA passenger equipment and final emergency preparedness rules contain additional provisions for passenger evacuation.)

For comparison purposes, Table 2-1 lists FRA [4][5], FTA [3], Amtrak [41], and National Fire Protection Association (NFPA) *130 Standard for Fixed Guideway Transit Systems* [42] material requirements. The majority are nearly identical; different provisions are noted. The draft flammability and smoke emission specifications for rail transit vehicles, originally developed by the Volpe Center in the 1970s [43], provides the basis for all requirements (see Section 2.2.1).

Table 2-1. U.S. Flammability and Smoke Emission Requirements for Passenger Rail Cars

MATERIALS		FLAMMABILITY		SMOKE EMISSION	
Category ^a	Function ^a	Test Procedure	Performance Criteria	Test Procedure	Performance Criteria
Passenger seats, sleeping and dining car components	Cushions, mattresses	ASTM D 3675	$I_s \leq 25$	ASTM E 662	$D_s(1.5) \leq 100$; $D_s(4.0) \leq 175$ ^b
	Seat frames, mattress frames	ASTM E 162	$I_s \leq 35$	ASTM E 662	$D_s(1.5) \leq 100$; $D_s(4.0) \leq 200$
	Seat and toilet shroud, food trays	ASTM E 162	$I_s \leq 35$	ASTM E 662	$D_s(1.5) \leq 100$; $D_s(4.0) \leq 200$
	Seat upholstery, mattress ticking and covers, curtains	FAR 25.853 (vertical)	Flame time ≤ 10 s Burn length ≤ 6 in	ASTM E 662	$D_s(4.0) \leq 250$ coated $D_s(4.0) \leq 100$ uncoated
Panels	Wall, ceiling, partition, tables and shelves, windscreen, HVAC ducting	ASTM E 162	$I_s \leq 35$	ASTM E 662	$D_s(1.5) \leq 100$; $D_s(4.0) \leq 200$
		ASTM E 119	as appropriate ^c	ASTM E 662	
	Window, light diffuser	ASTM E 162	$I_s \leq 100$	ASTM E 662	
Flooring	Structural	ASTM E 119	nominal evacuation time, at least 15 min	n.a.	n.a.
	Covering	ASTM E 648	C.R.F. ≥ 5 kW/m ² ^d	ASTM E 662 ^f	$D_s(1.5) \leq 100$; $D_s(4.0) \leq 200$
		ASTM E 162 ^e	$I_s \leq 25$		
Insulation	Thermal, acoustic	ASTM E 162	$I_s \leq 25$ ^g	ASTM E 662	$D_s(4.0) \leq 100$
Elastomers	Window gaskets, door nosing, diaphragms, roof mat	ASTM C 542	Pass	ASTM E 662	$D_s(1.5) \leq 100$; $D_s(4.0) \leq 200$
Exterior Plastic Components	End cap roof housings	ASTM E 162	$I_s \leq 35$	ASTM E 662	$D_s(1.5) \leq 100$; $D_s(4.0) \leq 200$
Component Box Covers	Interior, exterior boxes	ASTM E 162	$I_s \leq 35$	ASTM E 662	$D_s(1.5) \leq 100$; $D_s(4.0) \leq 200$

SOURCE: FRA Guidelines (1989) [4], NPRM (1997) [5]
FTA Recommended Practices (1984) [3]
Amtrak Specification No. 352 [41]
NFPA 130 (1997) [42]

- a Categories and functions follow the FRA guidelines. FTA recommend practices are similar, but not identical
- b FTA and NFPA 130 requirement is $D_s(1.5) \leq 100$; $D_s(4.0) \leq 200$
- c "May use test criteria for floors or criteria appropriate to the physical locations and magnitude of the major ignition, energy, or fuel loading sources."
- d Amtrak requirement is C.R.F. ≥ 6 kW/m²
- e NFPA 130 only
- f FRA only
- g Amtrak requirement is $I_s \leq 35$

These small-scale test methods and performance criteria are used to evaluate individual component materials and not necessarily end-use assemblies. For example, Amtrak seat cushions consist of cover fabric, interliner, and foam. The requirements for each component material are different; each is tested individually and not as part of an assembly. The upholstery cover fabric and interliner are tested according to FAA FAR, Part 25, subsection 25.853 (a) (Appendix F, Part I) [33] for ignition resistance, while the foam is tested using ASTM D 3675 for flame spread and heat generation. All three components are tested using ASTM E 662 for smoke emission.

Small-scale tests of individual component materials have advantages over assembly and real-scale tests. This type of test is especially useful as a screening device to select materials. Such individual testing allows individual parties to select preferred combinations of components and allowing material suppliers to independently evaluate the adequacy of their own products. However, the inability of the small-scale test methods and performance criteria to account for interactions between materials and for different end-use geometries is a major concern.

The previously cited Amtrak Specification 352 has recognized the need to evaluate individual test data in the context of the intended use of the material. Additional factors include but are not limited to quantity of material, configuration, proximity to other combustible materials, compartment volume, ventilation, presence of ignition sources, fire protection systems, and occupancy. Accordingly, Amtrak requires that the test data be combined with other information to develop a fire hazard assessment to select materials on the basis of function, safety, and cost.

Assembly and real-scale tests provide the advantage of material assessment in an actual end-use configuration. This is critical to permit the evaluation of the effects of material interaction and geometry in an end-use condition. However, such larger-scale testing does have disadvantages. Real-scale tests of complete assemblies are often several orders of magnitude more expensive than small-scale tests. In addition, the advantage of providing an overall assessment of the fire behavior of a material also can represent a disadvantage. By quantifying the outcome of the fire without a knowledge of the factors leading to the resulting fire and without relating the observed fire behavior to basic material properties, little insight into the intrinsic performance of the materials may result [44].

The 1984 FRA/Amtrak study, described earlier in Section 1.2.2, included a series of tests to assess the large-scale burning behavior of materials used as furnishings for passenger rail coach car interiors [27]. That study identified material test requirements and design features important

for fire safety. The effects of changes in component materials, material interaction, and rail car geometry were identified as important issues requiring further study.

In response to the proposed operation of a German magnetic levitation (maglev) high-speed train technology in Florida, the FRA sponsored studies published in 1991 and 1993 which identified fire issues for further analysis [45][46]. The FRA then sponsored a new NIST effort to compare U.S. and European approaches to passenger train fire safety. The 1993 NIST report included a comprehensive review of French and German passenger train fire safety requirements [6].

2.2 OTHER U.S. TRANSPORTATION VEHICLE FIRE SAFETY REQUIREMENTS

The overlap in fire safety requirements is not limited to rail transportation vehicles. In 1981, the U.S. Department of Transportation (USDOT) published a report which recognized the potential for similar requirements in multiple modes of transportation [47]. Fire protection and control, material controls, engine components, structural components, procedures, and buildings were all identified as areas for potential cooperation and common requirements between different transportation modes.

The USDOT Research and Special Programs Administration also recently published a report which examined materials research programs across all USDOT administrations. The report contains a discussion of common directions and technologies in research and development related to motor vehicles, rail cars, aircraft, and ships and is intended to highlight areas for potential cooperation in order to accelerate the use of advanced materials in transportation applications. Material fire safety is one area highlighted [48].

The remainder of this section reviews other U.S. transportation vehicle fire safety requirements and related research.

2.2.1 Rail Transit Vehicles

In the early 1970s, UMTA (now FTA) initiated an effort to evaluate and improve transit vehicle fire safety. As part of that effort, selected flammability and smoke emission test methods and appropriate performance criteria were published as draft guideline specifications [43].

In 1975 and 1978, rail transit car fire hazard evaluation reports for the Washington Metropolitan Area Transit Administration (WMATA) and Bay Area Rapid Transit District (BART) systems [49] [50] were published.

The WMATA subway car fire evaluation consisted of individual small-scale tests of several interior materials and seven full-scale tests to determine the overall effects of an assembled system as compared to the fire characteristics of the individual components. The intent was to assist WMATA in assessing the potential fire hazard in new Metrorail subway cars. One criterion was that the ignition not spread from the area of origin. While the small-scale test results indicated that the car interior may not be readily ignited by very small ignition sources, the full-scale test results showed that the materials failed to perform in their end-use configuration as would have been predicted. The evaluation report noted that the nylon-covered polyurethane seat cushions and PVC acrylic wall linings were a potential source of hazard since fire spread did occur beyond the area of origin. Hazardous levels of smoke were generated in four minutes for the polyurethane cushions and nine minutes for the neoprene/vinyl cushions. The report recommended that WMATA compare the time for development of dangerous smoke levels and fire spread from the area of origin and the time required to stop and evacuate the car. Consideration of neoprene material for the polyurethane cushions was suggested.

The UMTA-sponsored BART rail car evaluation included the review of interior and exterior car design, communication system, materials (tests and performance), fire detection and suppression, fire statistics, and scenarios. The report noted that the nylon/vinyl-covered polyurethane seats represented a significant hazard based on earlier tests; to improve evacuation time, their replacement was suggested. In addition, an intumescent coating for wall and ceiling liners, as well as floor assembly fire hardening were also recommended. In 1979, the BART Transbay Tube fire resulted in one firefighter death and 58 injuries from smoke inhalation and cyanide poisoning. The NTSB accident report found that the floor and seat cushions contributed to the severity of the fire and recommended that UMTA promulgate regulations establishing minimum fire safety standards for the design of rail transit cars [51].

In 1979, the National Academy of Sciences (NAS) published general guidelines for the use of flammable materials in rail transit vehicles [52]. Those guidelines recommended the use of only those polymeric materials that, by testing and comparison, were judged to be the most fire resistant and that have the lowest smoke and toxic gas emission rates. The NAS guidelines further suggested these be used sparingly, consistent with comfort and serviceability.

Also in the 1970s, Professor E.E. Smith and co-workers at Ohio State University (OSU) proposed a computational model for predicting fire growth in rail transit vehicles [53][54]. HRR data were used to describe limits on the combustibility parameters of products that should be used. To determine limits, a maximum loading of combustibles in terms of fuel, and smoke-producing or gas-generating items was calculated using test data and model predictions of the course of a fire. The model was based on a simplified ignition concept, one not consistent with current-day understanding of ignition and flame spread [55]. The necessary HRR data were obtained from the OSU apparatus (*ASTM E 906 Standard Test Method for Heat and Visible Smoke Release Rates for Materials and Products*) [56] and compared to real-scale fires. Most notable was a conclusion that small-scale tests are more reliable than real-scale fire tests for screening individual rail transit vehicle materials. In contrast, the primary purpose of real-scale testing is to evaluate the effects of material interaction and geometry in an actual train fire.

In 1982, UMTA funded an assessment of BART efforts to improve the fire safety of its rail transit cars [57]. The BART “fire hardening” program consisted of removing ignition sources, substitution of more fire-resistant materials (many of which met the original draft guideline specifications), addition of a special fire-resistant coating on the undersurface of the car floor, and the placement of fire stops at strategic places in the walls and ceilings. The final report concluded that full-scale tests showed that an arson fire was no longer expected to spread from the area of origin with the use of replacement interior materials and that removal of the equipment ignition sources and floor fire hardening would allow more time for passenger evacuation.

In 1984, UMTA published recommended practices for rail transit vehicle materials selection [3] based on the draft guideline specifications which contained flammability and smoke emission tests and selected performance criteria; seat components such as upholstery, cushion, shroud, and frame were included. The seat cushion material performance criteria effectively eliminated the use of polyurethane cushions. The fire endurance criterion required the structural floor to resist flame penetration and maintain its integrity for twice the nominal time it would take under normal circumstances to bring the train to a complete stop from the maximum speed, plus the time it would take to evacuate passengers to a safe area. The minimum time value criterion required was 15 minutes. The recommended tests are voluntary and intended to provide a screening device to identify particularly hazardous materials. (Note: The test procedures and performance criteria contained in the current FRA fire safety guidelines (and proposed rule) and NFPA 130 were adapted from the 1984 UMTA requirements.)

In 1987, UMTA published a review of BART “C” rail transit car fire safety characteristics [58]. BART fire experience, specifications and other documentation, materials, and small- and full-scale fire test data were examined for the prototype “C” car. Small-scale test material data for the original, fire-hardened, and prototype BART cars were compared. The results of a full-scale test of a partially furnished car were reviewed. The final report concluded that BART had made a reasonable effort to identify and address ignition sources and that fire prevention and containment principles had been used. It was also concluded that BART had tried to minimize the fire threat through materials and equipment selection. The report did recommend that certain additional ignition sources be considered and that materials used in the actual “C” car production be reviewed to identify any necessary revisions to the BART hazard analyses.

In 1991, the National Materials Advisory Board published a report sponsored by UMTA which discussed a rationale for assessing the potential toxic hazards of transit materials [59]. That report indicated that engineering calculations that define a fire scenario, fire growth, and toxicity data for the materials being evaluated should all be considered.

In 1992, FTA published a study which presented an engineering management tool for fire safety analysis [23]. The tool was intended to evaluate the trade-offs of material “self-termination,” and manual and automatic suppression. The report concluded that the most important area for research is the development of a better understanding of fire growth. Recommendations included further study of small-scale tests such as the Cone Calorimeter, extension of room fire computer models for application to trains, and large- or full-scale tests of actual rail vehicles.

The majority of the flammability and smoke emission test methods and performance criteria for rail transit vehicle interior materials contained in NFPA 130 [42], are identical to the FRA guidelines, the Amtrak specification, and the UMTA/FTA recommended practices. In addition, NFPA 130 encourages the use of tests that evaluate materials in certain subassemblies and the use of full-scale tests. NFPA 130 also includes requirements for ventilation, electrical fire safety, and communications. Furthermore, NFPA 130 specifies station, trainway, vehicle storage and maintenance area, and emergency procedure requirements, as part of a systems approach to fire safety.

As an option, NFPA 130 contains a “hazard load analysis” in an appendix, which can be used to evaluate overall material flammability in a rail transit vehicle. Based on previously cited work by Smith, a heat release rate test is utilized to determine a 180-second average heat release and smoke emission (the ASTM E 906 apparatus is specified for use in an example calculation).

These values are multiplied by the exposed surface area for each material and totaled. Finally, the total values are divided by the volume of the vehicle to obtain “fire and smoke load” for the vehicle per unit volume. A suggested performance criteria of “3000 KJ/m³ (80 BTU/ft³) is included as the maximum allowable loading to assure that a self-propagating fire will not occur with an initiating fire consisting of the equivalent of 1 lb (0.45 kg) of newsprint or 8 oz (0.23 kg) of lighter fluid.” However, it is not clear how the author of the original work arrived at the suggested performance criterion; he acknowledged that such a “hazard load” calculation did not provide a complete description of a fire [60].

A NFPA 130 Passenger Rail Equipment Special Task Force has reviewed the standard and has prepared recommended text revisions to include intercity passenger and commuter rail cars within its scope. The NFPA 130 Task Force is monitoring the progress of this current NIST fire safety research. The Task Force plans to take advantage of the project results when deciding on recommended revisions for material tests and performance criteria.

An ASTM committee has been developing a “Rail Transportation Fire Hazard Assessment Guide.” When completed, this guide will provide information on the use of standard test methods and fire engineering techniques to assess the fire hazard of rail transportation vehicles. However, full-scale validation of the methods has not yet been performed and is not currently planned by ASTM.

2.2.2 Motor Vehicles

Nonmetallic interior materials, including seat assemblies, of all motor vehicles sold in the United States must meet *Federal Motor Vehicle Safety Standard (FMVSS) No. 302, Flammability of Interior Materials - Passenger Cars, Multi-Purpose Passenger Vehicles, Trucks, and Buses* [61]. In the FMVSS No. 302 test method, specimens are mounted with their exposed surfaces facing down, in a horizontal orientation in a rectangular burn chamber. A small diffusion burner flame is applied from below to one end of the exposed surface of the test specimen. The time of flame spread between two marked points on the specimen holder is used to calculate the flame spread rate. A maximum flame spread rate of 4 in (10 cm) per minute is specified for all motor vehicle interior components exposed to the passenger compartment. Since its inception in 1968, this standard has been applied to school buses as well as cars, trucks, and general purpose buses and passenger vehicles.

In 1975, the fire safety of a transit bus supplied by the Washington (DC) Metropolitan Area Transit Authority (WMATA) was studied [62]. The objectives were to determine: the minimum ignition source necessary to initiate a fire in the bus and the means by which a fire once started, is most likely to grow and spread. A series of small-scale tests conducted with the nylon-covered polyurethane seat cushions showed that accidental ignition by a cigarette or dropped match was unlikely. However, seats could be ignited with one or two matches, if applied at the proper location (e.g., by an arsonist). Full-scale tests showed that, if ignited, fire growth and spread in the bus was primarily from seat to seat or seat to wall liners, which then led to full bus fire involvement. Between one and two minutes after the polyurethane was ignited, dense smoke filled the bus, seriously reducing visibility. Among the study conclusions were: full-scale tests were necessary to determine the interaction of materials and their performance under actual fire conditions, and the level of passenger safety could be determined in part by comparing the time required by evacuation with the time between initial ignition and the ignition of the polyurethane foam. The report stated that the level of fire safety could be improved by removing or protecting the polyurethane seat cushion.

In 1988, National Highway Traffic Safety Administration (NHTSA) issued an Advanced Notice of Proposed Rulemaking (ANPRM) in which upgrading of FMVSS 302 as it applied to large buses, including school buses was considered [63]. NHTSA requested responses to a number of questions relating to: fireproofing a vehicle interior to withstand a fuel-fed fire, fire causes, type of bus which should be covered, improvement of products in terms of flammability resistance, impact of these improvements on the seat padding requirements in FMVSS 222, appropriateness of the existing horizontal test, use of a systems approach to replicate a real-world fire, toxicity, cost benefits, etc.

In 1990, NHTSA commissioned an investigation of the state-of-the-art in seating materials which could be used for school buses and to develop the data necessary for the agency's use in possible rulemaking actions to upgrade No. FMVSS 302 [64]. Since seats represent the largest potential source of combustible load, six different seat assemblies having a range of fire performance were examined in school bus interior tests. Small-scale tests (Cone Calorimeter, Lateral Ignition and Flame Spread Test [LIFT], and National Bureau of Standards [NBS] Toxicity Protocol) were performed on the materials. Assembly tests using a large-scale calorimeter were conducted on single seat assemblies. Real-scale tests were performed using a simulated bus structure measuring 7.9-ft (2.4-m) wide by 6.9-ft (2.1-m) high by 27-ft (8.2-m) long and three seat assemblies. Small-scale, assembly, and real-scale test data were analyzed to compare seat materials with respect to ignitability, flame spread, HRR, smoke generation, and toxicity. All of the seat

assemblies tested passed FMVSS 302. However, three of the six assemblies produced lethal or incapacitating conditions in a school bus enclosure. One of the assemblies produced HRR values an order of magnitude greater than the other assemblies. Results from Cone Calorimeter sample tests showed peak HRR values ranging from 270 kW/m² for a fire-retardant polyurethane foam with a cover fabric meeting the FTA (and FRA) guideline performance criteria to 500 kW/m² for a baseline school bus seat with vinyl-covered polyurethane foam. Large-scale test data ranked the seat assemblies in the same order as the small-scale tests.

Computer fire modeling was used in the school bus study to evaluate the development of hazardous conditions in a compartment. It was employed to assess:

- the effects of different ignition sources and the resulting hazard due to temperature, irradiance, and toxicity; and
- the relative importance of the hazard causes (i.e., temperature, irradiance, and toxicity).

The 1990 report concluded that small-scale tests alone were unable to provide a simple method for material selection that was consistent with all the real-scale test data. Like the 1984 FRA/Amtrak rail car study, small-scale and assembly tests of school bus seats could not account for the effects of varied geometries in actual bus interiors. A test protocol for seat assembly evaluation was proposed that combines enclosure fire testing (which provides measurement of HRR and gas concentrations) with a fire hazard analysis protocol to determine the time-to-untenable conditions in actual vehicle geometries. Under the proposed protocol, tested seat assemblies would be rejected if untenable (nonsurvivable) conditions developed in the test enclosure.

In 1991, NHTSA issued a request for comments which discussed the 1990 research study and the comments that it had received relating to the rulemaking proposed in 1988, and announced the intention to limit any potential regulatory changes to the fire resistance properties only of school buses [65]. NHTSA requested further comments relating to the 1990 study, availability of alternative small-scale tests, full-scale testing, UMTA recommended practices, costs, vandalism, etc. In 1992, NHTSA issued a revision to FMVSS 217 (requiring additional emergency exiting for school buses to allow swifter egress in accidents, including collision and fires [66]). The FMVSS 302 rulemaking has been on hold since 1993.

In 1993, FTA issued final fire safety recommended practices for selecting transit bus and van materials [67]. The majority of the recommended flammability and smoke emission test methods and performance criteria are similar to those which FTA had previously issued for rail transit vehicles. None of the rail or transit bus and van recommended practices are regulatory in nature.

2.2.3 Aircraft

The majority of Federal Aviation Administration (FAA) fire safety requirements for aircraft interior materials are contained in 14 CFR, Part 25, Subparts 25.853 and 25.855 (see Table 2-2) [68]. These requirements (referred to as FARs [Federal Airworthiness Regulations]) specify a variety of test methods for passenger compartment and cargo compartment interiors including small-scale burner tests, an oil burner test, a HRR test, and a smoke emission test.

FAR 25.853 (a) requires that, regardless of passenger capacity, all interior materials (including finishes or decorative surfaces must be tested according to Federal Test Method Standard 191 [69]). This small-scale test applies to seats, panels, liners, and ducting; performance criteria for flame time, burn length, and rate of flame spread vary accordingly.

In an actual aircraft post-crash fire, the ability of seats (typically made of a polyurethane core surrounded by a fire blocking layer) to conform to the oil burner test required by FAR 25.853 (c), was determined to be a significant factor in the high passenger survival rate [70].

In addition, for aircraft with a capacity of more than 20 passengers, FAR 25.853 (d) requires that interior ceiling and wall panels (other than light fixtures and windows), partitions, some gallery structures, and large cabinets meet a HRR test and a smoke emission test (Appendix F, Parts IV and V, respectively).

The required HRR test uses a version of the ASTM E 906 (OSU) test method (modified to improve its repeatability) and limits the maximum HRR to 65 kW/m^2 . In addition, the total heat release during the first two minutes of the test is limited to 65 kW-min/m^2 . These values were chosen based on comparisons with real-scale tests in order to eliminate materials which led to a shorter time to flashover in the real-scale tests [71].

The average density of material smoke emission (D_s) is required to not exceed 200 after 4 minutes using ASTM F 814 (a variation of ASTM 662, which uses a modified sample holder to allow testing of thermoplastic materials) [72].

Finally, FAR 25.855 requires that cargo compartment panels meet the oil burner test. However, the heat source is 91 kW/m² and the time period is 5 minutes.

The FAA has also published a report which contains explanatory information for fire safety tests and performance criteria for each aircraft component [73].

In addition to material fire performance requirements, the FAA requires passenger evacuation from an aircraft in 90 seconds [74]. The FAA also specifies additional requirements for the number, type, and location of emergency exits [75], and other emergency evacuation components.

Table 2-2. FAR 25.853 Aircraft Interior Cabin Material Requirements

COMPONENT	TEST CONDITIONS	CRITERIA
All Interior Materials 25.853 (a) Appendix F, Part I	FTMS 191 Vertical, horizontal, and 45° angles Bunsen or Tirrill burner 1 ½ in flame 1500° F Various exposure times	Ceiling panels, etc.: Average burn length < 6 in (15 cm) Average flame time after removal <15 s Floor covering, etc.: Average burn length < 8 in (20 cm) Average flame time after removal <15 s Plastic windows, signs, etc. Average burn length < 2.5 in (6.3 cm)
All Seat Cushions* (including blocking layer and upholstery) 25.853 (c) Appendix F, Part II	Kerosene oil burner 119kW/m ² 2 minutes 3 samples	For 2/3 of samples tested, the burn length must not reach the side opposite the burner or 17 in (42.5 cm) Average weight loss must not exceed 10% 2/3 of total # of samples must not exceed 10% weight loss
Interior Ceiling and Wall Materials, Partitions, Galley Structures** 25.853 (d) Appendix F, Part IV	Modified ASTM E 906 Radiant flux of 3.5 W/cm ² 5 min 3 samples	Average peak HRR limited to 65 kW/m ² Total average HRR after 1st 2 min limited to 65 kW-min/m ²
Interior Ceiling and Wall Materials, Partitions, Galley Structures** 25.853 (d) Appendix F, Part V	ASTM F 814 (modified ASTM E 662) 3 samples	D _s < 200 at 4 min

NOTES: * In addition to 25.853 (a)
** More than 20 passenger capacity

2.2.4 Passenger Vessels

The U.S. Coast Guard (USCG) fire performance requirements for U.S. flag passenger vessel materials vary according to the number of passengers, vessel gross tonnage, and length and are contained in 46 CFR, Subchapters H, K, and T [76][77][78]. Certain revisions to Subchapters K and T were issued on September 30, 1997 [79].

Due to variations between the types of passenger vessels, it is not possible in this interim report to provide a complete summary of all USCG fire-related regulations. The following text highlights several requirements similar to those for other U.S. transportation vehicles.

Subchapter Q, Part 164 also provides test method specifications and performance criteria for approved “noncombustible” and “fire-resistive” materials used onboard passenger vessels [80]. For example, Subpart 164.008 requires that bulkhead panels pass ASTM E-119 for 30 to 60 minutes for integrity depending on use and 15 minutes for thermal insulation. Subpart 164.009 provides definitions of common “noncombustible” materials and includes the test procedure which other materials must pass to be considered noncombustible. For very thin interior finishes, Subpart 164.012 describes flame spread and smoke limit requirements of 20 and 10 respectively according to *ASTM E-84 Standard Test Method for Surface Burning Characteristics of Building Materials* [81].

Subchapter H applies to any U.S. flag passenger ship of 100 or more gross tons. Subpart 72.05 relies primarily on structural fire endurance (e.g., passive) requirements and uses the traditional approach of dividing ships into main vertical zones to limit fire spread and protect escape routes. Accordingly, structural components (bulkheads and decks) must be constructed of steel or approved noncombustible materials and meet various fire endurance and time performance criteria, depending on the location and function of spaces protected. In addition, fire barriers and lining materials are required to be noncombustible; and furnishings are to be of USCG approved “fire-resistive materials.” Ceilings and linings must be of approved noncombustible materials. In certain accommodation spaces, thickness limits and use restrictions are stated for combustible veneers. Frames of freestanding furniture and other furnishings (e.g., chairs and sofas) are required to be entirely constructed of USCG approved noncombustible materials; draperies are required to be made of fire-resistive fabrics. Rugs are required to be wool or other material which has fire-resistive equivalency. In passageways and stairway enclosures, all chair and sofa upholstery and padding must be of approved fire-resistant materials.

The construction and arrangement requirements contained in Subchapter K, Subpart D, apply to any U.S. flag passenger ship which is less than 100 gross tons and either carries more than 150 passengers or with overnight accommodations for 50 or more passengers. Structural fire endurance requirements are similar to Subchapter H requirements, except as noted therein. In addition, mattresses and bedding components must comply with the flammability requirements in *16 CFR, Part 1632 Standard for the Flammability of Mattresses and Mattress Pads* [82] and contain no polyurethane foam. Ceilings, linings, or other interior trim, furniture and furnishings, and rugs and carpets must meet Subpart 72.05; the latter may meet either ASTM E-84 or ASTM E-648 [30]. In addition, draperies, curtains and other similar furnishings must meet *NFPA 701 Standard Methods of Fire Tests for Flame Resistant Textiles and Film* [83]. The maximum fire load limit of combustibles must not exceed 3 lb/ft² (15 kg/m²) for a low-risk area and 7.5 lb/ft² (37.5 kg/m²) for a high-risk area. Insulation must be noncombustible.

With some exceptions, Subchapter T, Subpart D, applies to any U.S. flag passenger ship less than 100 gross tons and which carries 150 or less passengers or with overnight accommodations for 49 or fewer passengers. It should be noted that vessels of this class include those with wooden, fiber-reinforced plastic (FRP), or aluminum, as well as those with steel hulls. A major provision in these requirements is that the structural provisions allow the use of FRP materials including composite laminate construction, if they meet certain ASTM E-84 criteria. General purpose resin may be used if it does not meet those ASTM E-84 provisions only if certain other conditions (e.g., limit ignition sources and provide fire detection and extinguishing system) are met; however, general purpose resin cannot be used if the vessel has accommodations for more than 12 persons.

Deviation from the USCG regulations is required to demonstrate an equivalent level of safety on a case-by-case basis [84].

The USCG structural fire protection Navigation and Vessel Inspection Circular (NVIC 9-97) provides guidance for typical acceptable methods of complying with the regulations [85]. The NVIC reflects current fire protection technologies and includes summary tables of tests and performance criteria, as well as more detailed information for construction and arrangement. Alternative approaches are described which could be used to fulfill the structural protection requirements cited in the regulations. For example, the use of fire blocking layers placed over foam padding is permitted if tested for effectiveness according to California Technical Bulletin 133 (TB 133) *Flammability Test Procedure for Seating Furniture for Use in Public Occupancies* [86].

The USCG requires that all vessels provide at least two means of escape from all passenger-accessible areas. Additional requirements relate to the vertical travel distance, stairway sizing, and several other provisions relating to emergency egress. For higher passenger density dinner excursion and gambling vessels, NVIC 8-93 provides a description of equivalent alternatives for meeting requirements for means of escape, main vertical zones, and safe refuge areas [87]. One provision allows the main vertical zone to be longer if the fire load is limited to 3 lb/ft² (15 kg/m²) and automatic sprinklers are provided.

The United States is a signatory to the International Maritime Organization (IMO) which publishes passenger ship requirements for fire safety and means of escape in the *International Convention for the Safety of Life at Sea (SOLAS)* [88]. Those fire safety requirements are similar to the USCG regulations but apply to vessels that carry more than 12 passengers and operate on international voyages. The IMO has recently adopted a new Fire Test Procedures Code [89]. The tests in that Code must be used by all signatory countries effective in 1998. The SOLAS provisions for means of escape are similar to the USCG regulations.

The USCG allows the use of the IMO *International Code of Safety for High-Speed Craft (HSC Code)* as an alternative for small passenger vessels less than 100 gross tons which carry more than 150 passengers [90]. The HSC Code defines a new “fire restricting” class of materials which can be qualified by two International Organization for Standardization (ISO) HRR test methods [91][92]. ISO 9705 is specified for bulkheads and wall and ceiling linings; certain performance criteria in terms of average and peak HRR, as well as average and maximum smoke emission rates, are provided. ISO 5660 uses the Cone Calorimeter for furniture items (not including upholstery and fabrics) and other components; however, the IMO does not specify performance criteria. To fill that gap, the USCG is conducting a research project to identify what the appropriate classification criteria should be for U.S. flag ships.

As a result of U.S. regulatory reform, the USCG initiated and chaired an NFPA technical committee to develop consensus standards as an alternative to the current regulations and NVICs [93]. Various *NFPA 301, Code for Safety to Life From Fire on Merchant Vessels* requirements are described for vessels carrying more than 12 passengers [94]. Materials requirements are similar to the USCG regulations and the NVIC 9-97 with some exceptions. The passenger capacity, type of service (day or overnight), and whether or not the space is protected with automatic sprinklers determine flame spread limits. NFPA 301 means-of-egress provisions appear to be adapted for the marine environment from *NFPA 101 Life Safety Code* [95] and depend on the number of passengers and whether or not overnight accommodations are provided.

NFPA 301 includes an appendix which is intended to allow the vessel designer and operator to comply with the Code while accommodating new or unique vessel uses or incorporating new or transfer technology. The appendix provides a standardized hazard analysis and risk assessment methodology to use in demonstrating equivalent safety. The methodology includes a description of several analysis techniques (e.g., preliminary hazard analysis, fault tree analysis, criticality analysis), data inputs (e.g., vessel physical description, design and operating assumptions and conditions), hazard correction measures, verification and documentation of equivalence.

Since the recently adopted *NFPA 301* will be subject to continuous revision (most likely in three year cycles), it will more easily be kept current with new technologies.

2.3 U.S. FIRE SAFETY REQUIREMENTS COMMENTARY

A considerable overlap exists for passenger transportation vehicle fire safety requirements; they are prescriptive and intended to prevent fire ignition or retard fire growth and spread. The FRA, Amtrak, FTA, and NFPA all specify identical small-scale test methods and similar performance criteria to evaluate the flammability and smoke emission properties of individual component interior materials used in rail vehicles (see Table 2-3). The FRA has proposed that the test methods and performance criteria cited in its existing guidelines be required for new or rebuilt passenger rail equipment. The proposed rule also requires that a fire hazard analysis be conducted for existing, rebuilt, and new cars.

The NFPA 130 standard contains identical tests and similar performance criteria for rail transit vehicle interior materials and describes a “hazard load analysis” method which can be used to evaluate overall material flammability. Although a heat release test is included, it is not clear how the author of the original work arrived at the suggested performance criterion. Moreover, the geometry of the vehicle and placement of combustibles in the vehicle can play a significant role in actual exposures of a given material. The NFPA 130 “hazard load analysis” method is an attempt to provide a simplified and semi-quantitative analysis to assess the overall contribution to fire hazard of the materials used in interior linings and fittings. The method recognizes HRR as the key variable in fire hazard and ties performance to real-scale test results. However, adding values for all exposed materials in a vehicle to obtain a hazard load assumes that every part of every material ignites and burns simultaneously. In reality, different propensities for ignition, flame spread, and heat release make this a highly conservative approach. Current fire hazard modeling techniques and correlations can provide a more realistic assessment of the contribution of materials to the overall fire hazard.

Table 2-3. Major U.S. Transportation Vehicle Fire Performance Requirements

MODE	COMPONENT	PROPERTY	TEST PROCEDURE	CRITERIA
Surface (cars, trucks, & buses) NHTSA	All nonmetallic interior materials	Flame Spread	49 CFR 571.302 FMVSS 302	Rate: ≤ 4 in/min
Surface Mass Transportation Vehicles (Passenger trains, rail & bus transit) FRA, FTA	Seat cushions & mattresses	Flame Resistance	14 CFR 25.853 (a) (Upholstery, etc.)	Flame Time: ≤ 15 s Burn length: ≤ 6 in
	Panel, partition, wall, ceiling	Flame Spread	ASTM E 3675 (Foam)	I_s : ≤ 25
	Elastomers	Smoke Emission	ASTM E 662	D_s (4.0): ≤ 250 (coated) D_s (4.0): ≤ 100 (uncoated)
	Floor covering	Flame Spread	ASTM E 162	I_s : ≤ 35
	Other seat materials, panels, walls, & partitions, ceiling (also elastomers floor covering - FRA)	Flame Spread	ASTM C 542	Pass
	Floor structure	Flame Spread	ASTM E 648	CFR > .5 watts/cm ² (5 kW/m ²)
		Smoke Emission	ASTM E 662	D_s (1.5): ≤ 100 D_s (4.0): ≤ 200
		Fire Endurance	ASTM E 119	Pass: 15 min nominal (twice evacuation time)
Air (Commercial aviation aircraft) FAA	Cabin & cargo compartment materials: seats, panel, liner, ducting	Flame Resistance 1. Vertical 2. Horizontal 3. Degree	14 CFR 25 25.853 (a)	Flame time: ≤ 15 s Flame time of drippings: ≤ 3 s Burn length: 6 in
	Seats	Flame Resistance	25.853 (c) Oil Burner (2 min)	Burn length: ≤ 17 in Weight loss: $\leq 10\%$
	Cabin & compartment liner	Fire Endurance	25.855 Oil Burner (5 min)	No flame penetration Peak temperature 4 in (102 mm) above specimen: = 400 ° F (204 ° C)
	All large area cabin interior materials (more than 20 passenger capacity)	Heat Release Rate	25.853 (d) ASTM E 906	Peak HRR in 5 min: ≤ 65 kW/m ² Total HRR in 2 min: ≤ 65 kW-min/m ²
		Smoke Emission	ASTM F 814	D_s (4.0): ≤ 200
Marine (Commercial passenger vessels) Subchapter K (See also Subchapters H & T) USCG See also IMO Resolution MSC. 61 (67), 1996	Divisions, bulkhead panels, decks, floor	Fire Endurance	46 CFR 116.415 Standard Fire Test	Class A: 1 h Class B: 30 min
	Ceilings, linings, trim, interior finishes, decorations	Noncombustibility	46 CFR 116.422 (a) 46 CFR 164.009	
	Certain interior finish, veneer, trim, decorations	Flame Spread Smoke Emission	46 CFR 116.422 (b) CFR 164.012 (ASTM E 84)	I_s : ≤ 20 D_s : ≤ 10 Additional volume limitations/use restrictions on combustible veneers Approved
	Furnishings - Sofas, other materials - Frames	Fire Resistance Noncombustibility	46 CFR 116.423 46 CFR 72.05.55 46 CFR 164.009	
	- Drapes, curtains	Fire Resistance	NFPA 701	Small-scale char length: (1) 3.5 - 5.5 in avg of 10 specimens (2) 4.5 - 6.5 in max for each (varies by weight) Large-scale char length: varies (folded or straight)
	- Carpet (wool or equivalent)	Flame Spread Smoke Emission	ASTM E 84 or E 648 ASTM E 662	I_s : ≤ 75 or CRF: > .8 kW/m ² (8 kW/m ²) D_s : ≤ 100 or D_s : ≤ 450

The NFPA 130 Passenger Rail Equipment Special Task Force is monitoring the progress of this current NIST fire safety research. The Task Force plans to take advantage of the project results when deciding on recommended revisions for material test methods and performance criteria.

NHTSA motor vehicle requirements use a small-scale test method for all interior nonmetallic materials to provide a screen against materials which ignite easily or initially burn rapidly. However, that test has not been shown to be effective in predicting fire hazards for larger vehicles such as transit buses and vans. Since NHTSA determined that additional extensive research would be required before revising FMVSS 302, the agency required additional exits to be installed on new school buses.

Current FAA aircraft flammability requirements for interior materials specify small burner tests, oil burner tests, a HRR test, and a smoke emission test. The FAA small burner test method is also specified by the FRA for seat upholstery, mattress covers, and curtains; however, the FAA requires that all interior finish materials be tested. The oil burner test method specified for seat cushions represents a severe initiating fire exposure in a postcrash scenario where passenger evacuation must be accomplished within 90 seconds. However, this fire severity is not typical of the majority of passenger train fires and available evacuation time for train passengers is longer in most cases. Accordingly, the fire hazard and environment are quite different for passengers using the two transportation modes. The FAA HRR test method uses an apparatus similar to the Cone Calorimeter; however, the apparatus is not adaptable for fabric testing. More importantly, the use of the FAA test and performance criteria would eliminate many of the materials currently used in passenger trains. The Cone Calorimeter provides a more accurate measurement of HRR (see Chapter 5); this is particularly important in the use of such data as inputs in computer fire models to perform fire hazard analysis.

The existing USCG passenger vessel fire safety requirements primarily rely on passive structural fire barriers and separation to prevent or limit fire spread and allow for emergency egress. Several material tests and performance criteria are similar to those cited by the FRA. The USCG permits designers to submit an engineering analysis to evaluate materials used in relation to the vessel environment. This case-by-case approach allows the use of alternatives which provide an equivalent level of safety and meet the intent of the fire protection regulations. The NVIC for structural fire protection also describes alternative approaches to meeting the current USCG regulations. For high-speed craft, the USCG permits the use of two ISO codes that use HRR test methods to evaluate materials; a research study is underway to identify appropriate HRR criteria for furniture used on U.S. flag vessels.

The NFPA 301 Code includes material requirements that vary depending on the type of service provided to passengers and whether areas are protected with automatic sprinklers. In addition, that code allows for the use of a hazard analysis approach to accommodate new or unique vessel uses or for incorporating new or transfer technology.

The FAA and USCG have both accepted the use of HRR as a means to evaluate material fire performance for aircraft and marine vessels. Although the passenger hazards and environment are different, the results of the NIST passenger train research study will assist the FRA in formulating comparable material performance criteria using HRR.

2.4 EUROPEAN PASSENGER TRAIN FIRE SAFETY REQUIREMENTS

German passenger train fire safety requirements are based on a systems approach to fire safety. *DIN 5510, Preventive Railway Fire Protection in Railway Vehicles*, published by the German Standards Institute (DIN), requires that the supporting structures, fittings, and linings of passenger trains be selected and arranged to prevent or delay danger to passengers, crew, and rescue personnel caused by the development, propagation, and spread of fire [96]. The highest level of protection is required for trains which cannot be evacuated anywhere along the track, e.g., in tunnels.

A series of tests to evaluate material performance must be used to prove compliance with the DIN requirements. These tests provide a means to prevent the fire or retard its growth and spread.

The German requirements appear to include test methods and criteria to address the flammability of most materials in a manner at least as strict as the U.S. requirements. Criteria for insulation materials are notably missing from the German requirements. Insulation material criteria are appropriately included in the U.S. requirements since such materials are in widespread use in the rail industry [97].

The French approach to preventing a fire or retarding its growth and spread is similar to its U.S. counterpart, in that materials are individually considered. French requirements rely heavily on material controls [98] [99]. However, the French approach uses a complex system based on several classification indices, each derived from several test results. The French requirements then classify the materials based on the perceived risk to occupants. In practice, it is not clear

how such a classification is achieved. In addition to materials, emergency egress requirements are specified [100].

The International Union of Railways (UIC) *Code 564-2, Regulations Relating to Fire Protection and Fire-fighting Measures in Passenger-carrying Railway Vehicles or Assimilated Vehicles Used on International Services*, covers passenger rail car design for international service in Europe [101]. There is considerable overlap between this code and the French requirements. As a general guideline for vehicle design, the UIC Code 564-2 states that: “the coach design and interior fittings must above all prevent the spread of fire.” To address this provision, a set of material test methods is included, similar in intent and implementation to the French requirements, which cover vehicle design (to reduce potential ignition), compartmentation (to prevent spread of fire from one vehicle to another), electrical systems, fire detection in engine compartments, fire extinguishers, fire alarms, and emergency egress (via door and window design).

Judging the equivalence of the French and UIC requirements to the U.S. requirements is much more difficult. Although test methods are similar to those used in the United States, the complex array of performance criteria in the French standards make an exact comparison of the pass-fail criteria impossible. Litant concluded that the French requirements do not provide an improvement over the U.S. rail guidelines [102]. The French specification does not include requirements for fire barrier endurance testing. Since the majority of passenger rail car fires originate beneath the car floor, such testing is appropriately included in the U.S. requirements.

The *British Standard Code of Practice for Fire Precautions in the Design and Construction of Railway Passenger Rolling Stock* (BS 6853) [103][104] defines two categories of vehicle use:

- Trains which require higher resistance to fire (underground, sleeping cars, unmanned operating trains), and
- All other vehicles.

BS 6853 includes fire performance provisions for material selection, compartmentation (particularly in sleeping cars), electrical equipment, and cooking equipment. Small-scale testing for material selection uses a variety of British Standard tests on individual component materials to evaluate material flammability and smoke emission. BS 6853 states that certain passenger trains require a higher resistance to fire and includes those trains operating in confined situations (underground or on elevated structures), those carrying sleeping cars, or unmanned operation

trains. A fire hazard assessment provision states that fire behavior should be judged by product characteristics, e.g., ignitability, rate of surface spread of flame, rate of heat release, smoke generation, combustion gases, and release of other harmful products. Design considerations which should also be taken into account when selecting products are the material quantity, its position, configuration, and orientation in the vehicle; interaction of materials, air flow, proximity to ignition sources, etc. Real-scale testing is recommended when “the proposed construction represents a significant departure from the normal practice.” Fire endurance requirements are similar to the U.S. Provisions for “aiding passenger and crew escape” including emergency exits and lighting are also included.

2.5 EUROPEAN PASSENGER TRAIN HRR AND HAZARD ANALYSIS RESEARCH

Several European countries have active programs to improve passenger train fire safety evaluation. A great deal of effort is being expended to relate small-scale and real-scale performance by the use of fire modeling. This work is being conducted by individual countries (France, Germany, Sweden, United Kingdom) and in coordinated activities under the sponsorship of the European Railway Research Institute (ERRI) and the Commission for European Standardization (CEN).

The British Rail (BR) small-scale test program is targeted at developing a database of HRR data for all rail materials in current use [105]. BR’s Cone Calorimeter work is supplemented by real-scale assembly tests in a Furniture Calorimeter as part of the ERRI research effort [106]. Assemblies tested in the Furniture Calorimeter include: seat assemblies, sidewall and ceiling panel assemblies, catering refuse bags and contents, plastic towel dispenser units, and vending machines. No other test method data are available for the materials.

The Furniture Calorimeter testing uses the methods specified in the British Standards Institute (BSI) documents for the fire evaluation of mock-up upholstered furniture. These methods use small wood cribs as the ignition source. The UK government trend toward privatization of its rail industry has led to an increase in the rehabilitation of older equipment instead of the complete replacement of rolling stock. This has limited the availability of newer materials and assemblies available for testing.

However, BR has also conducted several real-scale test burns of existing coaches and sleeping cars. While much of this work has been performed for internal use, some tests have been

performed under the auspices of the ERRI activities. All of these tests relate to rail car fires on open trackways.

Other real-scale fire tests of rail cars located in tunnels have been conducted as part of the Channel Tunnel safety work leading up to the operation of shuttle trains carrying passengers and motor vehicles between England and France [107].

In the process of testing representative materials using a Cone Calorimeter, the London Underground Limited (LUL) has selected an exposure of 50 kW/m² for 20 minutes as a suitable exposure for material evaluation consistent with testing exposures and fire experience in the United Kingdom [105].

In 1990, Göransson and Lundqvist studied seat flammability in buses and rail transit trains using material tests and real-scale tests [108]. All of the seats used high-resilient foam covered with a variety of fabrics. Wall panels consisted of fabric-covered wood or metal panels. In the small-scale tests, the Cone Calorimeter was selected to provide ignition and heat release rate information. In real-scale tests, the maximum heat release rate of a seat assembly, about 200 kW, was not sufficient to ignite the panels or the ceiling “quickly” (unfortunately, “quickly” was not defined). However, ignition of adjacent seats was noted in real-scale mock-up tests.

Numerous international conferences have been held and a very large research project was conducted in Norway under the auspices of EUREKA (European Research Coordination Agency) by nine Western European nations [109]. A 1995 EUREKA test report reviewed 24 fire incidents over 20 years (1971-1991) and contained the following major conclusions relevant to this NIST study:

- Rolling stock represented the significant fuel load.
- Large amounts of smoke and fire gases were produced which can quickly fill the entire tunnel reducing visibility to less than 3.3 ft (1 m).
- In major incidents, flashover occurred after 7-10 minutes and total fire duration was from 30 minutes to several hours.

The EUREKA research team conducted a series of tests in a tunnel utilizing aluminum and steel-bodied German (DB) Inter-City and Inter-City Express rail cars. An extensive series of full-scale fire tests were conducted and HRR values were developed. Since most of these vehicles were

documented as to their (major) constituent fuels, the HRR data can be compared to the results for U.S. rail vehicles.

ERRI considered the use of the Cone Calorimeter to be the only small-scale apparatus suitable for providing useful data for computer modeling [20]. In a test application, ERRI used the HAZARD I model to simulate a fire in the British 10 ft (3 m) test cube and concluded that the use of the model to simulate fires in a railway vehicle was feasible [21]. The conduct of the following additional research: 1) Cone Calorimeter tests to provide data for use with the HAZARD I model and 2) comparison of the results of model simulations with real-scale fire tests was recommended. ERRI has conducted Cone Calorimeter and Furniture Calorimeter tests to provide input data for fire and hazard modeling of passenger coaches [106][110].

2.6 SUMMARY

There is considerable overlap in the existing U.S. transportation approach to fire safety. The FRA, Amtrak, FTA, NFPA 130 FAA, NHTSA, and USCG requirements all rely primarily on small-scale tests and similar performance criteria for many vehicle interior materials. The use of these tests has allowed interested parties to select preferred combinations of components and permits material suppliers to independently evaluate the adequacy of their materials. In the passenger rail equipment rule, the FRA has proposed that its existing material guidelines be made mandatory for existing, refurbished, and new rail cars to provide a minimum level of fire performance. Fire hazard analysis would also be required for existing, refurbished, and new rail cars.

Small-scale tests provide a means to select individual passenger train materials in terms of preventing initial ignition, retarding fire growth, and providing evacuation time. However, several studies which investigated rail and bus transit vehicle and passenger rail car material test requirements, concluded that small-scale tests alone could not account for the different effects of actual vehicle configurations and geometries.

Amtrak requires evaluation of individual test data in the context of the intended use of the material to develop a fire hazard assessment to select materials on the basis of function, safety and cost.

The NFPA 130 standard describes a “hazard load analysis” method provides a simplified and semi-quantitative analysis to assess the overall contribution to fire hazard of the materials used in interior linings and fittings. While the method recognizes HRR as the key variable in fire hazard and ties performance to real-scale test results, current fire hazard modeling techniques and correlations can provide a more realistic assessment of the contribution of materials to the overall fire hazard.

NFPA and ASTM are also conducting research efforts which are intended to provide additional tools to evaluate passenger train materials.

NHTSA motor vehicle requirements use a small-scale test method for all interior nonmetallic materials to provide a screen against materials that ignite easily or initially burn rapidly. However, that test has not been shown to be effective in predicting fire hazards for larger vehicles such as transit buses and vans. Since NHTSA determined that additional extensive research would be required before revising FMVSS 302, the agency required additional exits to be installed on new school buses.

The FAA oil burner test method for seat cushions represents a severe initiating fire exposure in a post-crash scenario where passenger evacuation must be accomplished in 90 seconds. However, that severity is not typical of the majority of passenger train fires; the available evacuation time for train passengers is also longer in most cases. Accordingly, the fire hazard and evacuation environment are quite different for passengers using the two transportation modes. Therefore, the required fire performance criteria may vary and still provide a comparable level of safety to passengers.

The Cone Calorimeter provides a more accurate measurement of HRR than the FAA-specified test method. This accuracy is particularly important in the use of such data as inputs to computer models to perform fire hazard analysis.

The existing USCG passenger vessel fire safety requirements primarily rely on structural barrier fire endurance and separation. However, alternative design approaches may be used if they provide an equivalent level of safety. The NFPA 301 marine vessel code permits the use of a hazard analysis approach to accommodate new or unique vessel uses or which incorporate new or transfer technology. For high-speed craft, the USCG permits the use of two ISO codes which use HRR test methods to evaluate materials; a research study is underway to identify appropriate HRR criteria for furniture used on U.S. flag vessels.

Existing European approaches to passenger train fire safety are generally similar to the U.S. approach. However, concerns about material interaction have led several European country efforts and coordinated ERRI and CEN activities to develop assessment tools for fire hazard evaluation based on a combination of Cone Calorimeter, Furniture Calorimeter, real-scale testing, and computer modeling of passenger train interior assembly fires.

The FAA and USCG have both accepted the use of HRR as a means to evaluate material fire performance for aircraft and marine vessels. However, the different fire hazards and operating and evacuation environments make it difficult to specify uniform performance criteria for all types of vehicles.

Nearly all current efforts in transportation vehicle fire safety are focused on the use of HRR data and fire hazard analysis to measure material fire performance. This approach is consistent with ongoing efforts to develop performance-based fire codes in the United States and Europe.

The remainder of this report describes the results of Cone Calorimeter tests of commonly used passenger rail car materials and compares HRR data to FRA-cited test data. The HRR data will also be used as inputs to the NIST fire computer model and hazard analysis in Phase II.

3. PASSENGER TRAIN MATERIALS

Passenger rail cars are constructed primarily of stainless steel; some newer designs incorporate aluminum components. Due to the typically longer distances traveled, the furnishing of conventional passenger rail equipment is more complex than that provided in a rail transit (e.g., subway, light rail) vehicle. Interior trim and furnishing depends upon the type of passenger service (intercity versus commuter) and type of car. Intercity passenger trains may consist of coach, food service, and/or sleeping cars. In addition, cooking equipment, heat and air conditioning systems, AC and DC power equipment, and lavatories are included in various passenger rail car designs. Multi-level rail cars have stairways which allow passengers to move from one level to another. New Amtrak high-speed trainsets will consist of coach, first class, lounge, and dining cars all of which will use interior materials similar to those in existing cars.

The remainder of this chapter describes the specific characteristics of typical passenger train interior materials selected for inclusion in this Phase I effort. Although the focus is on Amtrak rail car materials, they are intended to represent a range of those typically used in U.S. passenger trains.

3.1 TYPICAL MATERIALS

The Amtrak fleet consists of several generations of passenger rail cars. Cars typically have interior walls, ceilings, and floors partially covered with carpeting. In some configurations, the carpeting on walls has been replaced with fiberglass-reinforced plastic (FRP) material. Most intercity passenger and many commuter rail cars are equipped with upholstered seat cushions. The majority of rail car floors are constructed of plywood/metal (plymetal) panels.

3.1.1 Coach/First Class Cars

Coach cars contain rows of upholstered seats, windows, and overhead luggage storage space. Figure 3-1 shows a typical Amtrak coach car. The walls and ceiling are lined with fabric or carpet glued to a perforated sheet metal base material, or FRP. The underside of the overhead luggage storage rack is covered either with the



Figure 3-1. Amtrak Coach Car

same carpet or flexible polyvinyl chloride (PVC) fabric installed over a thin foam or rigid acrylic. The window assembly is FRP window mask with polycarbonate glazing. Wool/nylon fabric drapes are used at windows of coach cars used for overnight service. Fiberglass insulation is used in the floors, sidewalls, end walls, and air ducts in the cars. The floor covering consists of carpet and resilient rubber matting (see Figure 3-2).



Figure 3-2. Carpet and Resilient Rubber Floor Covering

Coach seats consist of fabric-covered foam cushions installed on steel seat frames with seat shrouds, back shells, and food trays made of PVC/acrylic. A wool/nylon blend and PVC upholstery over a muslin interliner have typically been used. Seat support diaphragms of chloroprene elastomer or fire-retardant cotton fabric provide flexible support for the seat bottom. Certain coaches used for longer distances are equipped with padded arm and leg rests, and chloroprene-covered steel foot rests, as well as fabric window drapes. The seats in sleeping cars are designed to convert to beds (see Section 3.1.4). Figure 3-3a shows a typical Amtrak coach seat.

The seats in first class sections are similar to coach seats but plush fabric upholstery installed over thicker foam cushions provides a higher level of comfort. Figure 3-3b shows a first class seat.



a. Coach



b. First Class

Figure 3-3. Seats

3.1.2 Cafe/Lounge and Dining Cars

Single level cafe/lounge car interior furnishings are similar to the coach cars. The cafe/lounge cars have a minimal food service area and reduced seat density and may be equipped with phenolic/wood laminate tables and PVC fabric upholstered padded seats. Stainless-steel counters and cabinets are used by the service crew. Wall surface linings consist primarily of a melamine or phenolic/plymetal laminate with carpet also used. Windows consist of polycarbonate glazing. The car floor covering may consist of carpet and/or resilient rubber mat. Figure 3-4a shows the interior of an Amtrak cafe/lounge car.

The Superliner bi-level observation cars use similar seat construction but with molded FRP wall surfaces with polycarbonate window glazing and space dividers. PVC cup holders line the bottom of the windows. Figure 3-4b shows the upper level of a Superliner observation car.



a. Single Level Cafe/Lounge Car



b. Bi-level Observation Lounge Car

Figure 3-4. Cafe/Lounge Car

Figure 3-5 shows a typical Amtrak dining car. Dining cars are equipped with tables, PVC upholstered cushion seats, polycarbonate windows, fabric window drapes, and resilient rubber floor covering. Like the coach cars, the walls and ceiling surfaces are lined with carpet glued to a perforated sheet metal base material. In some configurations, this carpet is replaced with FRP. Tables and seat assemblies are constructed similar to the cafe/lounge cars.



Figure 3-5. Dining Car

3.1.3 Sleeping Cars

Viewliner and Superliner sleeping cars contain a series of individual rooms arranged along a corridor plus luggage storage space. The seats in each individual compartment convert to beds with fabric-covered foam mattresses; pillows, cotton sheets, and wool blankets are provided. The sleeping compartment (see one variant in Figure 3-6), also have wool wall carpet, nylon floor carpet, as well as FRP wall and ceiling surfaces. Mattresses are constructed of the same type of foam as the coach and first class seats. The compartments may also contain additional seats. Fabric door curtains and window drapes provide privacy. Partitions between sleeping compartments and hallways are constructed of plymetal panels, which are covered by either melamine, FRP, or carpet.



a. Day



b. Night

Figure 3-6. Sleeping Car Compartment

3.1.4 Miscellaneous Component Materials

Elastomer materials are used for gasketing around door edges, around windows, and between cars. Other materials are used in hidden spaces (nonpassenger-accessible space), such as cable and wiring, pipe wrap, ventilation and air ducting.

3.2 MATERIALS SELECTED FOR TESTING

Materials selected for inclusion in the Cone Calorimeter test program reflected a broad range of interior finishing materials as used in the Amtrak fleet. In addition, other materials were tested because of their possible utility as new or replacement materials for existing applications. All the materials are classified into five broad categories:

- Seats and mattress assemblies (foam, with upholstery or other covering);
- Wall and window surfaces (carpet, plastic laminate, composite, window masks);
- Curtains, drapes, and other fabrics (sleeping car door, window, bedding);
- Floor covering (carpet, resilient rubber mat); and
- Miscellaneous components (cafe/lounge/diner tables, pipe wrap, air ducts, elastomers).

These five categories are similar to the categories used by Amtrak for interior furnishing materials and to those used by the FRA categories which include curtains, drapes, and fabrics in the same category as seat assemblies and mattresses. For this study, those materials are listed separately; their HRR results will be different since they are thinner than the thicker assemblies. Several of the FRA categories have been combined into the miscellaneous category above.

Table 3-1 lists the selected materials which were tested. This table includes an arbitrary sample number designation that will be used for material identification throughout this report. For assembly samples such as seat cushions, mattresses, bed pads, pillows, and window assemblies, the individual component materials are identified in the material description.

A representative seat cushion assembly sample consists of foam core, interliner, and fabric upholstery components (see Figure 3-7). The individual materials are identified by a letter along with the sample number. For example, Sample 1 comprises four component materials: a foam core (Sample 1a), a cotton interliner (Sample 1b), wool/nylon fabric upholstery (Sample 1c), and PVC upholstery (Sample 1d).



Figure 3-7. Coach Seat Assembly

Table 3-1. Selected Passenger Train Materials Evaluated in This Study

CATEGORY	SAMPLE NO.*	MATERIAL DESCRIPTION (COMPONENTS)
SEAT AND BED ASSEMBLIES	1a, 1b, 1c, 1d	Seat cushion, (foam, interliner, fabric/PVC cover)
	2a, 2b, 2c	Seat cushion, (foam, interliner, fabric cover)
	3	Graphite-filled foam
	4	Seat support diaphragm, chloroprene elastomer
	5	Seat support diaphragm, FR cotton muslin
	6	Seat shroud, PVC/acrylic
	7	Armrest pad, coach seat (foam on metal support)
	8	Seat footrest cover pad, coach seat (chloroprene elastomer)
	9	Seat track cover, chloroprene elastomer
	10a, 10b, 10c	Mattress (foam, interliner, ticking)
	11a, 11b, 11c	Bed pad (foam, interliner, ticking)
WALL AND WINDOW SURFACES	12	Wall finishing, wool carpet
	13	Wall finishing, wool fabric
	14	Space divider, polycarbonate
	15	Wall material, FRP/PVC
	16	Wall panel, FRP
	17	Window glazing, polycarbonate
	18	Window mask, FRP
CURTAINS, DRAPES, AND FABRICS	19	Privacy door curtain and window drape, wool/nylon
	20	Window curtain, polyester
	21	Blanket, wool fabric
	22	Blanket, modacrylic fabric
	23a, 23b	Pillow, cotton fabric/polyester filler
FLOOR COVERINGS	24	Carpet, nylon
	25	Rubber mat, styrene butadiene
MISC	26	Cafe/lounge/diner table, phenolic/wood laminate
	27	Air duct, neoprene
	28	Pipe wrap insulation foam
	29	Window gasketing, chloroprene elastomer
	30	Door gasketing, chloroprene elastomer

* – letters indicate individual component materials in an assembly. Individual component materials are listed in order in parentheses following the material description

Note: All foam except Sample 3 is the identical type

Sample 2 is also a seat assembly which consists of three components: foam core, interliner, and plush wool/nylon cover fabric. The foam and interliner of Samples 1 and 2 are identical. Sample 3 is a foam product which was being considered for potential passenger train use.

Several other components of the seat assembly were also tested. These were:

- two seat support diaphragms (Samples 4 and 5);
- seat shroud (Sample 6);
- coach seat armrest pad molded to a steel frame (Sample 7);
- coach seat footrest cover (Sample 8); and
- seat track cover (Sample 9).

Passenger sleeping compartments can be configured as either seating areas or sleeping areas. Seat configuration is somewhat different from coach seat configuration, but comparable materials are used in the seat assemblies. The conversion to a sleeping configuration introduces additional materials not found in other types of cars, including mattress assembly, bed pad assembly, blanket, pillow, sheets, and pillow case. The mattress and bed pad were composed of three materials: a cover fabric (ticking), an interliner, and a foam core. The foam cushion material used in the mattress and bed pad were the same as used in Samples 1 and 2 seat assemblies, differing only in thickness. The pillow was composed of a fire-resistant (FR) cotton cover fabric and polyester filler material.

Two general types of Amtrak wall finishing materials were tested: textile (carpet and fabric) and composite (plastic laminate on wood and FRP/PVC) wall coverings.

The window assembly represents a large proportion of the interior wall surface. The window assembly is composed of a tinted and clear two-layer polycarbonate glazing, a metallic frame, an elastomer gasket, and a FRP window mask. The window assembly was disassembled and each layer of the glazing was tested separately. The window mask is included as part of the window assembly, but could also represent a major part of the wall finishing material.

A wool/nylon fabric used for sleeping compartment door curtains and window drapes and another polyester window drape fabric were tested.

Two types of floor covering materials were tested: a nylon closed-loop pile carpet and a raised disc-patterned resilient rubber mat.

Miscellaneous materials tested included: a cafe/lounge/diner table (phenolic sheet laminated onto 3/4-in (1.86-cm) thick plywood composite, air duct, pipe wrap insulation, and chloroprene elastomer window and door gaskets.

3.3 SUMMARY

Thirty materials, reflecting a broad cross section of Amtrak passenger train interior finishing materials, were selected for Cone Calorimeter testing. The seat assemblies, wall and ceiling finishing materials, and floor coverings represent the bulk of the interior fire load found in most passenger rail cars. Materials such as mattresses, bed pads, blankets, and pillows increase the fire load in sleeping cars.

4. FRA-CITED TEST METHOD EVALUATION

The FRA cites several fire performance test methods for flammability and smoke emission:

ASTM E 162, Standard Test Method for Surface Flammability of Materials Using a Radiant Energy Source [28], and an equivalent method for flexible materials, *ASTM D 3675, Standard Test Method for Surface Flammability of Cellular Materials Using a Radiant Heat Energy Source* [29],

- *ASTM E 648, Standard Test Method for Critical Radiant Flux of Floor Covering Systems Using a Radiant Heat Energy Source* [30],
- FAR 25.853 (a), *Vertical Bunsen Burner Test for Cabin and Cargo Compartment Materials* [33],
- *ASTM C 542, Specification for Lock-Strip Gaskets* [31],
- *ASTM E 662, Standard Test Method for Specific Optical Density of Smoke Generated by Solid Materials*, [32] and
- *ASTM E 119, Fire Tests of Building Construction and Materials* [34].

All the test methods except ASTM E 119 represent reaction-to-fire tests that define material fire performance under specified conditions. Appendix B includes a more detailed description of each test method. ASTM E 119 is a large-scale fire endurance test that measures fire and thermal penetration resistance of a material or assembly. Since this report is concerned with material contribution to fire initiation and growth as determined by small-scale measurements, that test method will not be discussed further.

For each of the FRA-cited small-scale test methods, this chapter summarizes the test procedure, performance criteria, and available test data for the materials evaluated. For some materials, only certification of compliance with the FRA requirements was available from material suppliers, without accompanying quantitative data. Since the primary use of these data in this report is for quantitative comparison with Cone Calorimeter data, information for these materials was noted as “not available.”

4.1 ASTM E 162 / D 3675

ASTM E 162, and its variant for cellular materials, ASTM D 3675, both measure flame spread and rate of energy release under a radiant flux which varies over the length of the sample (from about 40 kW/m² at the end where the sample is ignited, down to 3 kW/m² at the far end of the sample). Both methods rank materials based on a flame spread index, I_s , which is a combination of a “flame spread potential,” F_s , and a “heat generation potential,” Q , such that:

$$I_s = F_s \times Q \quad (1)$$

The value of I_s can be as low as 0 and has no upper limit. The higher the flame spread index, the greater the flammability. The calculation algorithm of I_s is identical for both test methods. More details about these ASTM test methods can be found in Appendix B.

4.1.1 Application and Performance Criteria

The FRA performance criteria for this test method range from $I_s \leq 25$ to $I_s \leq 100$, with different values applicable to specific components as follows:

- $I_s \leq 25$ for seat cushions and insulation;
- $I_s \leq 35$ for seat and mattress frames, wall and ceiling panels, and most other interior furnishing components; and
- $I_s \leq 100$ for windows and light diffusers.

4.1.2 Test Data

Data from manufacturer and/or supplier tests are tabulated in Table 4-1 for those materials that have ASTM E 162 or D 3675 performance criteria. Component materials which are tested by other test methods are not shown in the table.

Most of the materials meet the FRA performance criteria; however, there are exceptions:

- The graphite-filled foam (Sample 3) had an I_s of 442. This material was under consideration for passenger rail seat applications, but is not in current use. However, testing of this foam as an assembly with appropriate cover fabrics has not shown that it is more hazardous than other foams in current use [103].

Table 4-1. ASTM E 162/D 3675 Test Data for Passenger Rail Materials

CATEGORY	SAMPLE NO.	MATERIAL DESCRIPTION (COMPONENT)	I_s
SEAT AND BED ASSEMBLIES	1a	Seat cushion (foam)	8
	2a		
	3	Graphite-filled foam	442*
	4	Seat support diaphragm, chloroprene	7.8
	5	Seat support diaphragm, FR cotton muslin	26
	6	Seat shroud, PVC/acrylic	4
	7	Seat armrest pad (foam on metal support)**	33
	8	Footrest cover pad, coach seat (PVC-covered foam)	9
	9	Seat track cover, chloroprene	33
	10a	Mattress (foam)	8
	11a	Bed pad (foam)	8
WALL AND WINDOW SURFACES	12	Wall finishing, wool carpet	4.5
	14	Space divider, polycarbonate	56*
	15	Wall material, FRP/PVC	4
	16	Wall panel, FRP	3.1
	17	Window glazing, polycarbonate	56
	18	Window mask, FRP	4
MISC	26	Cafe/lounge/diner table, phenolic/wood laminate	29
	27	Air duct, neoprene	n.a.
	28	Pipe wrap insulation foam	7
	29	Window gasketing, chloroprene elastomer	33
	30	Door gasketing, chloroprene elastomer	33

n.a. – quantitative data not available

* – does not meet current FRA criteria

** – sample not available for testing, literature value taken from reference [27]

- Polycarbonate is used both as a window material and as an interior space divider. This material had an I_s of 56. As a window material, this value meets the FRA criteria, (with a performance criteria of $I_s \leq 100$). However, when used as an interior wall panel, the required performance criteria is lower, $I_s \leq 35$.

4.2 ASTM E 648

ASTM E 648 exposes a specimen placed horizontally to a radiant energy source that varies across a 3.3 ft (1 m) length from a maximum of 11 kW/m² down to 1 kW/m². After ignition by a

small line burner at the high energy end of the specimen, the distance at which the floor material ceases burning is determined. This point defines the critical radiant flux (CRF) necessary to support continued flame spread. More details about this ASTM test method can be found in Appendix B.

4.2.1 Application and Performance Criterion

The FRA cites the ASTM 648 test method to evaluate the fire performance of all floor coverings used in passenger rail cars, including carpet and resilient rubber mat in coach, sleeping, and dining cars. The FRA performance criterion is a CRF greater than or equal to 0.5 W/cm² (5 km/m²).

4.2.2 Test Data

Data obtained from Amtrak and other sources are tabulated in Table 4-2 for those materials that were tested according to ASTM E 648. Component materials not tested according to ASTM E 648 are not shown in the table.

Table 4-2. ASTM E 648 Test Data for Passenger Rail Materials

SAMPLE NO.	MATERIAL DESCRIPTION (COMPONENT)	CRF W/cm ² (kW/m ²)
24	Carpet, nylon	1.08 (10.8)
25	Rubber mat, styrene butadiene	0.63 (6.3)

4.3 FAR 25.853 (a) AND ASTM C 542

FAR 25.853 (a), Appendix F, specifies a small-scale Bunsen burner type test wherein a vertically suspended sample of a material is exposed to a small flame from a gas burner. A flame is applied to the lower edge of the specimen for either 12 or 60 s, depending on the end use of the product. After the burner is removed, a determination is made of the afterflame time, i.e., the length of time a flame persists on the specimen, total flaming time of any dripping material, and the burn length or char length on the specimen once burning has completely ended. The intent of the test is to define materials that do not support combustion once the ignition burner has been removed from the sample.

ASTM C 542 defines required properties of gasketing materials including “resistance to sunlight, weathering, flame, oxidation, deformation under load, and gripping pressure required to separate gasketing joints.” For flame propagation, a small vertical sample is exposed to the flame from a small gas burner for 15 min for dense materials. The length of material left after exposure to the flame is intended to provide a measure of the flammability of the material. Since the adoption of the 1989 FRA guidelines, ASTM has separated the flammability requirements to a separate standard, ASTM C 1166, with identical testing requirements [111]. More details about the FAR 25.853(a) and ASTM C 542 test methods can be found in Appendix B.

Amtrak also requires that fabric materials meet the requirements of NFPA 701 [82]. Two test methods are included in the standard, a small-scale burner test for fabrics (except for coated blackout linings) and a larger-scale test for fabric blackout linings and lined draperies. In the small-scale test used by Amtrak, a relatively small, vertically-oriented specimen is exposed to a small burner flame for 12 seconds. The acceptance criteria for this test depends on the weight of the materials being tested and the absence of flaming drips during the test. The intent and severity of the test is similar to the FAR 25.853 (a) test.

4.3.1 Application and Performance Criteria

In the current context, FAR 25.853 (a) is used to assess the acceptability of seat upholstery, mattress ticking, and curtains for use in passenger trains. The FRA performance criteria for the test method are an afterflame time less than or equal to 10 s and a burn length less than or equal to 6 inches. The mattress and pillow cover do meet NFPA 701 [82]. ASTM C 542 is used to assess elastomers and uses a purely qualitative acceptance criteria of “no flame propagation or progressive glow at the end of the 15 min test.”

4.3.2 Test Data

Since FAR 25.853 (a) and ASTM C 542 are similar in intent and application, only the quantitative data from the FAA 25.853 test will be discussed in this report. FAA test performance data for materials are tabulated in Table 4-3. Data for the ASTM C 542 small burner test was not considered because it is a simple pass-fail test and not appropriate for comparison to HRR test data. Component materials which are tested according to other test methods are not shown in the table.

Table 4-3. FAR 25.853 (a) Test Data for Passenger Rail Materials

CATEGORY	SAMPLE NO.	MATERIAL DESCRIPTION (COMPONENT)	BURN LENGTH (in)	FLAME TIME (s)
SEAT AND BED ASSEMBLIES	1b	Seat cushion, fabric/PVC cover { (Interliner) (Fabric) (Vinyl)	n.a.	n.a.
	1c		0.2	0
	1d		n.a.	n.a.
	2b	Seat cushion, plush cover { (Interliner) (Fabric)	n.a.	n.a.
	2c		0.2	0
	10b	Mattress { (Interliner) (Fabric)	n.a.	n.a.
	10c		n.a.	n.a.
	11b	Bed pad { (Interliner) (Fabric)	n.a.	n.a.
11c	n.a.		n.a.	
CURTAINS, DRAPES, AND FABRICS	19	Door privacy curtain/window drape, wool/nylon	1.2	0
	20	Drapery fabric, polyester	3.5	n.a.
	21	Blanket fabric, wool	n.a.	n.a.
	22	Blanket, modacrylic fabric	n.a.	n.a.
	23b	Pillow, cotton (Fabric)	n.a.	n.a.

n.a. – quantitative data not available

While it was expected that data would be available for all components of an assembly, such as a mattress (ticking, interliner, foam core), it is not clear if, in practice, testing and performance criteria are applied to every component. It may be that interliner materials, for example, are typically excluded from testing because they are not specifically named in the FRA categories.

4.4 ASTM E 662

ASTM E 662 is widely used in testing of transportation-related materials. The test exposes small, solid specimens to a radiant energy of 25 kW/m² in a flaming (piloted ignition) or nonflaming mode. The smoke produced by the burning specimen is collected in the test chamber. The attenuation of a light beam is a measure of the optical density or “quantity of smoke” that a material produces under the given conditions of the test. The measured parameter is D_s , a measure of the accumulated optical density of smoke in the test chamber at a particular instant of time. The smoke density is expressed as:

$$D_s = \frac{V}{AL} \log \left(\frac{I_o}{I} \right) \quad (2)$$

where V is the volume of the chamber, fixed at 0.51 m^3 , A is the area of exposed sample, L is the path length of light beam through the smoke, I_o is the intensity of light beam before start of test, and I is the intensity of light beam during the test [112].

Unless there is settling of smoke in the test chamber, D_s increases with time. More details about this ASTM test method can be found in Appendix B.

4.4.1 Application and Performance Criteria

The FRA requirements apply D_s criteria to all materials used in rail car interiors. There are two D_s values at each exposure condition, flaming and nonflaming. At a time of 1.5 minutes, the D_s must be less than or equal to 100. At a time of 4 minutes, the D_s must be less than or equal to 200. For seat upholstery, mattress ticking, and curtains, the D_s at 4 minutes must be less than or equal to 250 for coated fabrics and less than or equal to 100 for uncoated fabrics.

4.4.2 Test Data

The material test data are tabulated in Table 4-4 for D_s (1.5 min) and D_s (4 min) under flaming exposure conditions. While it was expected that data would be available for all components of an assembly, such as a mattress (ticking, interliner, foam core), it is not clear if, in practice, testing and performance criteria are applied to every component. It may be that interliner materials, for example, are typically excluded from testing because they are not specifically named in the FRA categories.

Most of the materials meet the current FRA smoke emission criteria. However, there are exceptions. A seat support diaphragm (Sample 4), armrest and footrest pads (Samples 7 and 8), seat track cover (Sample 9), and door and window gasketing (Samples 29 and 30) do not meet the smoke emission criteria. Amtrak is currently considering replacements for these materials which have better fire performance. The other seat support diaphragm (Sample 5) is well within the FRA criteria. Since many of these materials are used only in small quantities, they represent a small portion of the fire load in a typical vehicle interior. However, further analysis is necessary to evaluate their contribution to overall fire hazard.

Table 4-4. ASTM E 662 Test Data for Passenger Rail Materials

CATEGORY	SAMPLE NO.	MATERIAL DESCRIPTION (COMPONENT)	SMOKE DATA	
			D _s (1.5)	D _s (4)
SEAT AND BED ASSEMBLIES	1a	Seat cushion, fabric/PVC cover { (Foam) (Interliner) (Fabric) (Vinyl)	29	76
	1b		n.a.	n.a.
	1c		n.a.	57
	1d		n.a.	175
	2a	Seat cushion, fabric cover { (Foam) (Interliner) (Fabric)	29	76
	2b		n.a.	n.a.
	2c		48	146
	3	Graphite-filled foam	6	33
	4	Seat support diaphragm, chloroprene elastomer	205*	509*
	5	Seat support diaphragm, FR cotton	76	108
	6	Seat shroud, PVC/acrylic	22	152
	7	Armrest pad, coach seat** (foam on metal support)	43	347*
	8	Footrest cover pad, coach seat	43	347*
9	Seat track cover, chloroprene	202*	499*	
10a	10b	Mattress { (Foam) (Interliner) (Fabric)	29	76
			n.a.	n.a.
			n.a.	n.a.
11a	11b	Bed pad { (Foam) (Interliner) (Fabric)	29	76
			n.a.	n.a.
			n.a.	n.a.
WALL AND WINDOW SURFACES	12	Wall finishing, wool carpet	37	101
	13	Wall finishing fabric, wool	100	163
	14	Space divider, polycarbonate	1	12
	15	Wall material, FRP/ PVC	22	152
	16	Wall material, FRP	29	129
	17	Window glazing, polycarbonate	2	72
	18	Window mask, FRP	n.a.	n.a.
CURTAINS, DRAPES, AND FABRICS	19	Door privacy curtain/window drape fabric	35	57
	20	Drapery fabric, polyester	n.a.	n.a.
	21	Blanket fabric, wool	n.a.	n.a.
	22	Blanket, modacrylic	127	127
	23a	Pillow { (Foam) (Fabric)	n.a.	n.a.
23b	n.a.		n.a.	
FLOOR COVERINGS	24	Carpet, nylon	47	140
	25	Rubber mat, styrene butadiene	6	147
MISC	26	Cafe/lounge/diner table, phenolic/wood laminate	19	91
	27	Air duct, neoprene	n.a.	n.a.
	28	Pipe wrap insulation foam	44	53
	29	Window gasketing, chloroprene elastomer	202*	499*
	30	Door gasketing, chloroprene elastomer	202*	499*

n.a. – quantitative data not available

* – does not meet FRA guidelines

** – literature value taken from reference [26]

4.5 PREVIOUS PASSENGER VEHICLE-RELATED TEST DATA

The 1984 FRA/Amtrak study included small-scale laboratory tests on individual materials from Amtrak passenger cars [27]. The majority of the materials tested met the FRA performance criteria for ASTM E 162/D 3675, with I_s values ranging from 3 to 960. A non-fire retardant foam seat assembly and a wall covering carpet exceeded the FRA performance criteria. For smoke emission, fewer of the materials tested met the FRA performance criteria for ASTM E 662, with D_s data for 4 minutes ranging from 41 to 620.

The NHTSA school bus study also included flame spread test results from the LIFT apparatus. The LIFT data shows a wide variation in test results. While the primary use for LIFT data is to provide flame spread inputs for computer models, the data is not useful for ranking material performance.

More recently, tests were conducted to evaluate materials as part of the NTSB investigation of the 1996 MARC commuter train and Amtrak train collision and fire [8]. A wider range of test results was evident, with the I_s ranging from 8 (for a seat cushion assembly) to 1145 (for a seat back pad cover foam). For ASTM E 662, D_s ranged from 51 to 373 for 4 minutes. With the exception of the seat back pad cover foam, the MARC materials performed similarly to the Amtrak materials.

4.6 SUMMARY

Material flammability and smoke emission test data were obtained for thirty materials from manufacturers and/or suppliers. Additional data from related studies were also reviewed. For some materials, only certification of compliance with the FRA performance criteria was available from material suppliers, without accompanying quantitative data. Since the primary use of these data in this report is for quantitative comparison with Cone Calorimeter data, information for these materials was noted as “not available.” For a few materials, only 1984 data were available.

4.6.1 Flammability

Because of specific end-use applications, not all materials required evaluation by the same test methods. Twenty-one materials required ASTM E 162 or D 3675 testing. Test data were available for nineteen of these materials. Although not so specified in the FRA requirements, I_s values were available for window and door gasketing.

Of the materials currently in use, only the space divider does not meet the FRA flammability performance criterion. Polycarbonate is used both as window glazing and as an interior space divider. As a window glazing, the material meets FRA performance criterion I_s of 100; however, when used as an interior space divider it does not meet the lower performance criterion specified I_s of 35.

ASTM E 648 was used to evaluate two floor covering materials: nylon carpet and resilient rubber floor mat. The test data indicated that both met the FRA performance criteria.

The FAR 25.853 (a) test method was considered applicable to 9 samples or 10 unique component materials. The burn length test data available for 4 of the 10 materials indicated they met the FRA performance criteria. Flame time was available for only 3 of the 10 materials. Data for the ASTM C 542 small burner test were not considered because it is a simple pass-fail test and not appropriate for comparison to HRR test data.

Data from the 1984 FRA/Amtrak study, the 1990 NHTSA study, and the 1996 MARC study show performance similar to the current tests.

4.6.2 Smoke Emission

ASTM E 662 tests were used to evaluate 30 samples which represent 40 unique component materials. Test data was available for 25 components at the D_s (1.5) level and 27 components at the D_s (4.0) level of performance. At D_s (1.5), five materials did not meet FRA criteria. At D_s (4.0), seven materials did not meet FRA criteria. Most of these materials (seat support diaphragm, amrest pad, footrest pad, seat track cover, window and door gasketing) represent a small portion of the fire load in a typical vehicle interior. Amtrak is currently considering replacement materials with better fire performance.

It is unclear whether the contribution from all these materials would be significant. However, the issue cannot be adequately assessed through small-scale tests alone. Again, part of the purpose of the current research effort to apply fire hazard analysis to passenger trains is to allow quantitative evaluation of the contribution of an individual material or combination of materials to the overall fire hazard in a passenger rail car.

5. CONE CALORIMETER TEST METHOD EVALUATION

In the majority of fire cases, the most crucial question that can be asked by the person responsible for fire protection is: “How big is the fire?” Put in quantitative terms, this translates to: “What is the heat release rate (HRR) of this fire?” HRR is a measure of the amount of energy that a material produces while burning. For a given confined space (e.g., rail car interior), the air temperature increases as the HRR increases. If passengers do not come into direct contact with the fire, they would most likely be injured from the high temperatures, high heat fluxes, and large amounts of toxic gases emitted by materials involved in the fire. Accordingly, the life threat to passengers of these materials can be directly correlated to the HRR of a real fire.

Recently, NIST examined the pivotal nature of HRR measurements in detail [113]. Not only is HRR seen as the key indicator of real-scale fire performance of a material or construction, it is, in fact, the single most important variable in characterizing the “flammability” of products and their consequent fire hazard.

The delay in ignition time, as measured by various small-scale Bunsen burner-type tests, such as that specified in FAR 25.853 (a) has only a minor effect on the development of fire hazard. For all but the most flammable materials, ignition is followed by some period of slow growth and then a rapid rise to hazardous conditions. Thus, the initial ignition is typically important only for already poorly performing materials. Material requirements for smoke emission are intended to ensure appropriate visibility of exit signs and egress routes in the event of a fire. Like ignitability and toxicity, smoke emission is largely a function of the HRR of a material. Hirschler showed that materials with low HRR also possess low smoke emission [114]. Although examples of typical fire histories demonstrate that fire deaths are primarily caused by toxic gases, the toxicity of the vast majority of common construction materials is similar [115]. Thus, the relative toxicity of combustion gases plays a smaller role than the HRR of a fire.

Small-scale test measurement of HRR is not new. For instance, ASTM 906 (OSU Calorimeter) [56] was originally developed in the early 1970s and has been used in aircraft and rail transit applications. However, its results, when compared against other measurement methods, have been found to substantially underestimate the HRR [116]. A number of other instruments were also designed during the 1970s, but were limited because of either poor validity or practical operational difficulties.

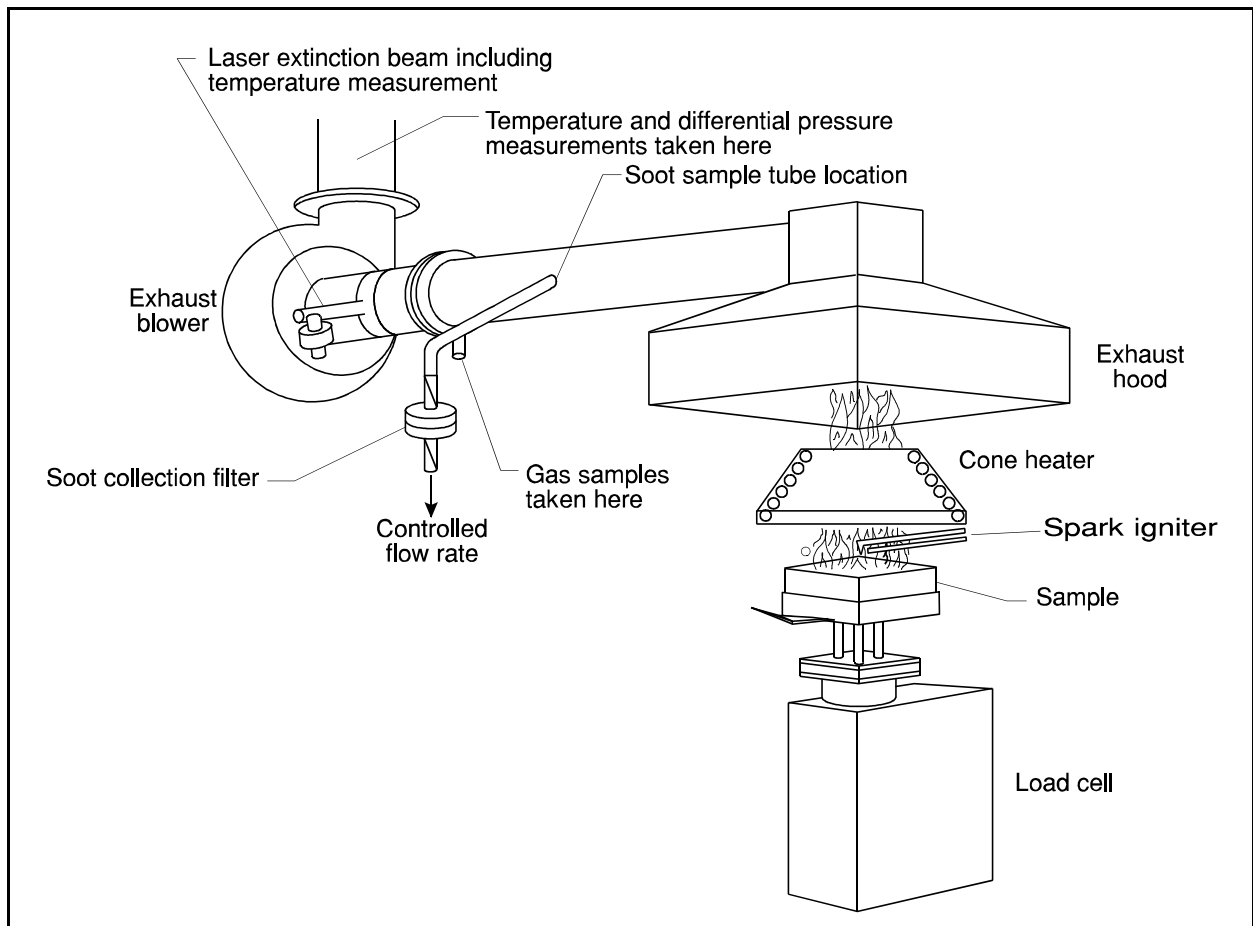

Figure 5-1. General View of the Cone Calorimeter (ASTM E 1354, ISO 5660)

To address these limitations, NIST developed a new and more practical instrument, known as the Cone Calorimeter (Figure 5-1). The Cone Calorimeter is a single test apparatus which provides a measurement of HRR, specimen mass loss, smoke production, and combustion gases. The ASTM E 1354 standard for the Cone Calorimeter defines the design and operational details of the apparatus [1]. Many traditional devices for assessing flammability were not based on realistic fire conditions, nor were measurements taken which have quantitative engineering significance. As a result, they could only be used to pass or fail a specimen, according to some selected regulatory requirements.

Because both its design and its data are firmly based on an engineering understanding of fire, the Cone Calorimeter has wider applicability than other test methods. It can be used to:

- Provide data needed for state-of-the art fire models;
- Provide data used to predict real-scale fire behavior by means of simple formulas or correlations;
- Rank order products according to their performance; or, simply to
- Pass or fail a product according to a criterion level.

The Cone Calorimeter is an extremely flexible device that can expose test specimens to:

- an external radiant flux ranging from zero to 100 kW/m²;
- an external piloted ignition condition (electric spark);
- a horizontal or a vertical orientation while maintaining the specimen surface parallel to the cone heater.

Test specimens are nominally 4 x 4 in (100 x 100 mm) and up to 2-in (50-mm) thick. For materials that expand during the burning process, a wire grid is placed over the specimen surface to prevent the material from expanding into the cone heater and increasing the burning rate and HRR. During testing, the specimen is placed on a load platform and its mass along with all other measurements are recorded for later analysis.

Smoke measurements are made on the effluent flow by means of a helium-neon laser beam projected across the exhaust duct. This results in an instantaneous measure of the optical smoke density. Gas species can be directly measured along with HRR, or gas may be sampled for later analysis.

Cone Calorimeter tests are specified by ASTM E 1354 to be done only in the horizontal orientation. This is because: (1) many products show serious testing difficulties (e.g., melting) when tested in the vertical orientation; (2) conversely, the vertical orientation does **not** provide “a better simulation” of the burning of vertical objects. This is because there is no direct connection between flame heat flux in a small-scale test and in a real-scale fire. The actual fluxes occurring in a real-scale fire are determined by many factors, including size of room, thickness of hot gas layer, flame spread occurring over other surfaces, etc. None of these are subject to the control of the small-scale apparatus but, rather, must be specifically modeled.

Validation of small-scale HRR data against large-scale fires has been successfully undertaken in several instances, such as for combustible walls and ceilings and upholstered furniture. Appendix C provides additional Cone Calorimeter test method information.

5.1 EXPOSURE CONDITIONS

Since the Cone Calorimeter can be used for a variety of test conditions, appropriate exposure conditions must be established for each application. The following sections provide details of: (1) the exposure levels in the existing FRA-cited test methods and (2) a discussion of exposure levels in actual fires. The exposure conditions for the Cone Calorimeter tests described later in this chapter are discussed in terms of these two sources.

5.1.1 Exposure Conditions in Current Generation Test Methods

The FRA-cited test methods expose materials to a diverse set of fire conditions. These conditions range from a modest flame impingement constituting a radiant energy level of less than 5 kW/m² for the FAR 25.853 test to approximately 40 kW/m² for ASTM E 162/D 3675. There are two exposure conditions for ASTM E 662: flaming and nonflaming. The nonflaming exposure utilizes a 25 kW/m² radiant source. The flaming exposure uses a multi-tubed diffusion burner to augment the radiant source. The maximum radiant energy level to the specimen is estimated at approximately 35 kW/m². The wide range of exposure conditions, from less than 5 kW/m² for the FAR 25.853 (a) test method to approximately 40 kW/m² for ASTM E 162/D 3675 makes it difficult to choose an appropriate exposure level for Cone Calorimeter testing. Thus, some discussion of exposure levels in real fires is necessary.

5.1.2 Exposure Conditions in Unwanted Fires

Exposure conditions in unwanted fires have been studied since the beginning of organized fire research [117]. However, standards defining fire growth characteristics are rare. In the United States, no set of standard fire growth definitions exists. In the United Kingdom, the characteristics of unwanted fires have been categorized by the British Standards Institution (BSI) in its Code of Practice for the Assessment of Toxic Hazards in Fire in Buildings and Transport [118]. The Code of Practice itemizes the following six types of fires:

- I. Self-sustained smoldering decomposition (i.e., a cigarette on upholstered furniture or bedding);

- II. Nonflaming oxidative decomposition;
- III. Nonflaming pyrolytic decomposition;
- IV. Developing fires, flaming (pre-flashover fires);
- V. Fully-developed fires, high ventilation (post-flashover fuel-controlled fires);
- VI. Fully-developed fires, low ventilation (post-flashover ventilation-controlled fires).

From the initiation of decomposition to suppression or completion of burning of a fuel, real-scale fires can undergo radical changes during the course of fire development. The first three types of fire: self-sustained smoldering, nonflaming oxidative, and nonflaming pyrolytic, represent non-flaming combustion. Heat flux levels in these fires would be low.

The last three types of fire: developing; fully-developed, high ventilation; and fully-developed, low ventilation; represent flaming combustion. For developing fires, heat flux levels can range from 20 to 50 kW/m². Fully developed compartment fires are considered to be post-flashover fires. Generally, all contents of a compartment are actively burning. Heat flux to surrounding items is typically above 50 kW/m² [96] to 75 kW/m² [119].

Actual exposure levels in passenger train fires are expected to be within the ranges discussed above. Peak heat flux at floor level, measured in the 1984 Amtrak vehicle interior tests, ranged from 0.5 kW/m² up to 62 kW/m² [27]. A typical exposure level for seat tests is 35 kW/m² [120]. Exposure levels for wall and ceiling panels can range from floor level exposure up to the levels expected in post-flashover fires noted above.

5.1.3 Chosen Exposure Conditions for Cone Calorimeter Testing

Exposure levels for a range of small-scale tests and actual fires are summarized in Table 5-1. In the existing FRA-cited test methods, these levels ranged from less than 5 kW/m² to 40 kW/m². Exposure levels in actual developing fires can range from 20 to 50 kW/m². Fully developed compartment fires are described as post-flashover fires with typical heat flux to surrounding items up to 75 kW/m². These flux levels are consistent with actual passenger train car interior tests.

The primary purpose of fire hazard analysis is to simulate the likely outcome of actual fire scenarios. For fire hazard analysis, successful simulation depends upon realistic exposure conditions for the data used as input to the fire models used in the analysis. As illustrated in

Table 5-1. Fire Exposure Conditions for FRA-Cited Test Methods and in Typical Fires

TEST METHOD/FIRE TYPE	HEAT SOURCE	MAXIMUM RADIANT ENERGY TO SAMPLE (kW/m ²)
ASTM E 162/D 3675	Radiant	40
ASTM E 662, flaming	Radiant/Flame	35
ASTM E 662, nonflaming	Radiant	25
ASTM E 648	Radiant	11
FAA 25.853 (a)	Small Flame	< 5
Developing fire		< 50
Post-flashover fire		≥ 50 - 75
Real-scale train fire experiments		0.5 to 62

Table 5-1, exposure conditions in actual fires range up to 50 to 75 kW/m² and are certainly higher than the exposure conditions used in the FRA-cited test methods. In order to capture a material's performance under all flaming conditions, including developing and post-flashover fires, a value higher than those used in the existing FRA test method requirements is necessary. Accordingly, a heat flux exposure level of 50 kW/m² was deemed most appropriate for the Cone Calorimeter testing program. All Cone Calorimeter tests in this study were conducted at a heat flux exposure of 50 kW/m². This level represents a severe fire exposure consistent with actual train fire tests. With the high performance level typical of currently used materials, levels higher than 50 kW/m² are unlikely. A spark igniter was used to ignite the pyrolysis gases. All specimens were wrapped in aluminum foil on all sides except for the exposed surface. A metal frame was used; where necessary, a wire grid was added to prevent expanding samples from entering into the cone heater.

5.2 CONE CALORIMETER TEST RESULTS

This section describes Cone Calorimeter test results of passenger train car materials. Several characteristic data measurements obtained from the Cone Calorimeter can be used for comparison to real-scale tests. These measurements include:

- ignition time: a measure of how easily a material can be ignited,
- time to peak HRR: a measure of the speed of fire growth,
- peak HRR: a measure of how large a fire will result from a burning material,
- specific extinction area: a measure of smoke production of the material, and
- effective heat of combustion: a measure of the amount of heat released from a burning material per unit mass of sample burned.

These data are presented for both individual component materials and for assemblies which represent actual end-use configurations. Appendix D contains a tabulation of all Cone Calorimeter test data including additional summary information for all materials tested.

Cone Calorimeter data are presented as averages of all replicates for an individual test specimen. ASTM 1354 establishes the within-laboratory variability (repeatability, r) and the variability between laboratories (reproducibility, R) which are given, in terms of peak heat release rate per unit area, \dot{q}''_{max} as:

$$r = 13.3 + 0.13 \dot{q}''_{max} \quad (3)$$

$$R = 60.4 + 0.141 \dot{q}''_{max} \quad (4)$$

where r and R are computed for the 95 percent probability level and are in the same units (kW/m^2) as is \dot{q}''_{max} . Uncertainty ranges for other variables derived in the test are generally similar and may also be found in ASTM E 1354.

5.2.1 Individual Component Materials

The individual material data obtained from the Cone Calorimeter tests are shown in Tables 5-2 and 5-3. Table 5-2 summarizes three characteristic measures of HRR: ignition time, time-to-peak HRR, and peak HRR. Table 5-3 summarizes comparative data for smoke production in the form of the average specific extinction area (SEA), σ_s (m^2/kg), for the first 180 s of each test, obtained from the Cone Calorimeter for each test material. This average value for smoke production is used since peak SEA values are particularly sensitive to instantaneous fluctuations in specimen mass loss so that the longer average value is more representative of overall material performance (some tests ended in less than 180 s and some extended much longer than 180 s).

Ignition times varied from 5 s for the seat and mattress assembly interliner (Samples 1a, 2a, 10a, and 11a) to 115 s for a polycarbonate window glazing (Sample 17). The majority of materials with the shortest ignition times were thin textile samples, such as the interliner, seat upholstery fabric (Samples 1c and 2c), cotton seat support diaphragm (Sample 5), curtain and drapery fabrics (Samples 19 and 20), and wool blanket (Sample 21). Thin materials, such as the interliner, cotton seat support diaphragm, mattress and bed pad cover (Samples 10c and 11c), wool blanket, and pipe insulation foam (Sample 28) had the shortest time-to-peak HRR. This ranged from 10 to 15 s. The longest times were recorded for the seat shroud (Sample 6),

Table 5-2. Summary Cone Calorimeter Individual Material HRR Data

CATEGORY	SAMPLE NO.	MATERIAL DESCRIPTION (COMPONENT)	TIME TO IGNITION (s)	TIME TO PEAK HRR (s)	PEAK HRR ₂ (kW/m ²)
SEAT AND BED ASSEMBLIES	1a 1b 1c 1d	Seat cushion { Foam Interliner Fabric PVC	15 5 10 5	25 15 20 10	75 25 425 360
	2a 2b 2c	Seat cushion { Foam Interliner Fabric	15 5 10	25 15 35	80 25 265
	3	Graphite-filled foam	10	10	90
	4	Seat support diaphragm, chloroprene	30	55	295
	5	Seat support diaphragm, FR cotton muslin	5	10	195
	6	Seat shroud, PVC/Acrylic	30	350	110
	7	Armrest pad, coach seat (foam on metal support)	15	170	660
	8	Seat footrest cover, chloroprene elastomer	25	100	190
	9	Seat track cover, chloroprene elastomer	20	40	265
	10 / 11a 10 / 11b 10 / 11c	Mattress and bed pad* { Foam Interliner Fabric	10 5 5	20 10 10	80 25 150
WALL AND WINDOW SURFACES	12	Wall finishing, wool carpet	30	95	655
	13	Wall finishing, wool fabric	20	35	745
	14	Space divider, polycarbonate	110	155	270
	15	Wall material, FRP / PVC	25	40	120
	16	Wall panel, FRP	55	55	610
	17	Window glazing, polycarbonate	95	245	350
	18	Window mask, FRP	45	70	400
CURTAINS, DRAPES, AND FABRICS	19	Door privacy curtain/window drapery fabric, wool/nylon	15	20	310
	20	Drapery fabric, polyester	20	30	175
	21	Blanket fabric, wool	10	15	170
	22	Blanket, modacrylic fabric	15	25	20
	23	Pillow, cotton cover, polyester filler	25	60	340
FLOOR COVERINGS	24	Carpet, nylon	10	70	245
	25	Rubber mat, styrene butadiene	35	90	305
MISC	26	Cafe/lounge/diner table, phenolic/wood laminate	45	55	245
	27	Air duct, neoprene	30	55	140
	28	Pipe wrap insulation foam	5	10	95
	29	Window gasketing, chloroprene elastomer	30	330	385
	30	Door gasketing, chloroprene elastomer	40	275	205

* Only difference in mattress and bed pad was end-use thickness. Cone Calorimeter samples were tested at the same thickness.

Table 5-3. Summary Cone Calorimeter Individual Material Smoke Data

CATEGORY	SAMPLE NO.	MATERIAL DESCRIPTION (COMPONENT)	SEA 180s AVERAGE σ_s (m ² /kg)
SEAT AND BED ASSEMBLIES	1a 1b 1c 1d	Seat cushion { Foam Interliner Fabric PVC	30 420 230 780
	2a 2b 2c	Seat cushion { Foam Interliner Fabric	30 420 390
	3	Graphite-filled foam	50
	4	Seat support diaphragm, chloroprene elastomer	1390
	5	Seat support diaphragm, FR cotton muslin	490
	6	Seat shroud, PVC/Acrylic	490
	7	Armrest pad, coach seat (foam on metal support)	780
	8	Seat footrest cover, chloroprene elastomer	960
	9	Seat track cover, chloroprene elastomer	1140
	10/11a 10/11b 10/11c	Mattress and bed pad { Foam* Interliner Fabric	80 70 80
WALL AND WINDOW SURFACES	12	Wall finishing, wool carpet	510
	13	Wall finishing, wool fabric	260
	14	Space divider, polycarbonate	1010
	15	Wall material, FRP/ PVC	700
	16	Wall panel, FRP	530
	17	Window glazing, polycarbonate	1000
	18	Window mask, FRP	680
CURTAINS, DRAPES, AND FABRICS	19	Door privacy curtain/window drapery fabric, wool/nylon	380
	20	Drapery fabric, polyester	800
	21	Blanket, wool	560
	22	Blanket, modacrylic fabric	n.a.
	23	Pillow, cotton cover/polyester filler	570
FLOOR COVERINGS	24	Carpet, nylon	350
	25	Rubber mat, styrene butadiene	1400
MISC	26	Cafe/lounge/diner table, phenolic/wood laminate	80
	27	Air duct, neoprene	810
	28	Pipe wrap insulation foam	690
	29	Window gasketing, chloroprene elastomer	1190
	30	Door gasketing, chloroprene elastomer	1210

* Only difference in mattress and bed pad was end-use thickness. Cone Calorimeter samples were tested at the same thickness.

elastomeric gasketing (Samples 29 and 30), the two polycarbonate materials (Samples 14 and 17), with times of 350, 305, and 275, and 150 s and 155 s, respectively.

Peak HRR varied over more than an order of magnitude from 25 kW/m² for a thin fabric interliner (Sample 10b) to 745 kW/m² for a wall fabric (Sample 13). In general, Table 5-2 shows lower peak HRR rates for the seat and mattress foams, ranging from 65 to 80 kW/m² and higher values for wall surface materials, ranging from 120 to 745 kW/m². Other fabric and thin sheet materials display intermediate values between these two extremes. This performance is consistent with the current FRA specified ASTM E 162 criteria which provide the strictest flame spread index requirements for seat cushion foam ($I_s \leq 25$), intermediate requirements for most other materials ($I_s \leq 35$), and least stringent requirements for window materials ($I_s \leq 100$).

Cone Calorimeter smoke data are presented in terms of an average specific extinction area (SEA) which is a measure of the smoke production of a material. Like the ASTM E 662 specific optical density measurement (D_s), the SEA (σ_s) is a measure of the attenuation of light by soot particles. The Cone Calorimeter smoke data show trends similar to the HRR data. The lowest values were noted for the seat and mattress foams (Samples 1a, 2, 3, 9, 10a and 11a). The highest values were noted for several thin materials: seat support diaphragm (Sample 4), seat track cover (Sample 9), FRP/ PVC wall material (Sample 15), rubber floor covering (Sample 25), and gasketing (Samples 29 and 30). The thicker polycarbonate space divider and window glazing (Samples 14 and 17) also had high smoke values.

Several materials showed elevated HRR and smoke values over an extended period of time. For example, the following materials showed HRR values greater than 100 kW/m² for more than 500 s: space divider (Sample 14), wall material (Sample 15), window glazing (Sample 17), and window and door gasketing (Samples 29 and 30). Smoke values generally paralleled the HRR results. Although the peak HRR of these materials fall into an intermediate range, the extended duration of the HRR curve makes these materials important for study in future fire hazard analysis efforts.

5.2.2 Component Assemblies

An important observation from this phase of the study is that the burning behavior of seat assemblies can be approximated by summing the HRR and smoke data for the component individual materials, accounting for the time delay until each material begins to burn. Table 5-4

Table 5-4. Summary Cone Calorimeter HRR and Smoke Data for Selected Component Combinations

COMPONENT ASSEMBLY TESTED					HRR DATA			SMOKE DATA
MATERIAL DESCRIPTION	Foam	Inter-liner	Fabric	Vinyl	Time to Ignition (s)	Time to Peak HRR (s)	Peak HRR (kW/m ²)	SEA 180s Average σ_s (m ² /kg)
SEAT CUSHION ASSEMBLIES	-	✓	✓	-	12	25	420	170
	-	✓	✓a	-	7	35	260	360
	-	✓	-	✓	7	10	360	510
	✓	-	✓	-	12	15	255	320
	✓	-	✓a	-	7	30	270	290
	✓	✓	✓	-	12	23	365	260
	✓	✓	✓a	-	7	35	260	400
	✓	✓	-	✓	6	15	370	510
	✓b	-	✓	-	12	25	400	370
	✓b	-	✓a	-	8	35	270	290
	✓b	✓	✓	-	12	25	400	90
	✓b	✓	✓a	-	8	35	275	220
	✓b	✓	-	✓	6	15	400	470
	MATTRESS ASSEMBLY	✓	✓	✓	X	7	10	170
BED PAD ASSEMBLY	✓	✓	✓	7		10	170	30
PILLOW	✓	✓	-	7		10	160	560

a – plush fabric
b – graphite foam

 – assemblies in current use. NOTE: the interliner is being discontinued due to design considerations.

presents data for combinations of materials as they might be used in typical end-use applications comparable to those presented in Tables 5-2 and 5-3. Table 5-4 summarizes the ignition time, time-to-peak HRR, peak HRR, and 180 s average specific extinction area for most combinations of components so that the performance of various assemblies may be estimated. Figures 5-2 to 5-6 show typical HRR curves obtained for components from the three seat cushion assemblies—by component and as configured in current end-use applications. Figure 5-2 shows the HRR curves for the foam from coach seat assembly (Samples 1 and 3 – note that Samples 1 and 2 used identical foams so only one is included in the figure). Sample 1 foam exhibits a peak HRR of nearly 80 kW/m² with a steady decay in the HRR curve after the peak HRR. The Sample 3 foam shows a peak HRR of about 65 kW/m² and a second broader peak of about 60 kW/m² after which the HRR curve decays. The time for the initial peak HRR is the same for both foam samples.

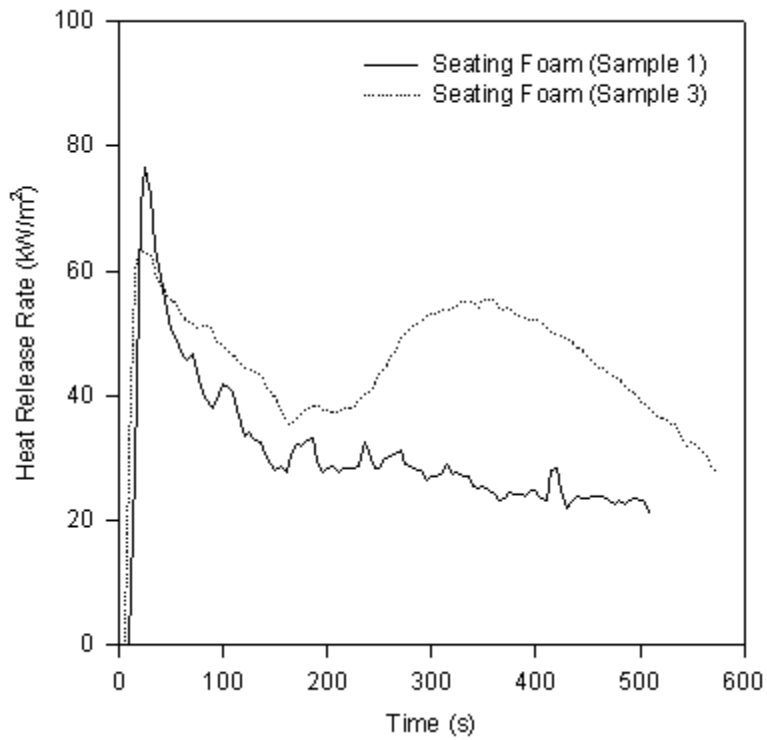

Figure 5-2. Comparison of Cone Calorimeter HRR for Two Foam Samples

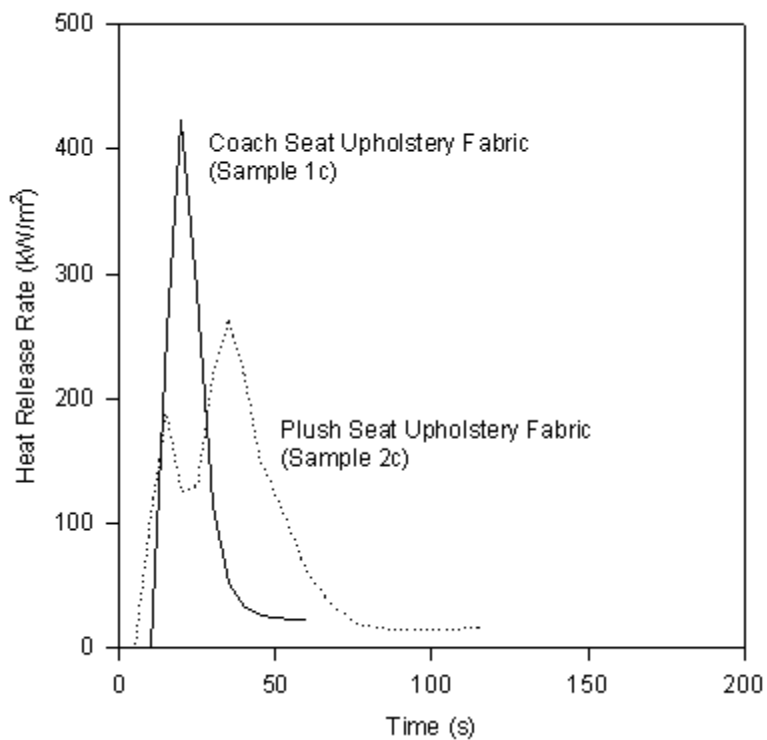

Figure 5-3. Comparison of Cone Calorimeter HRR for Two Upholstery Fabrics

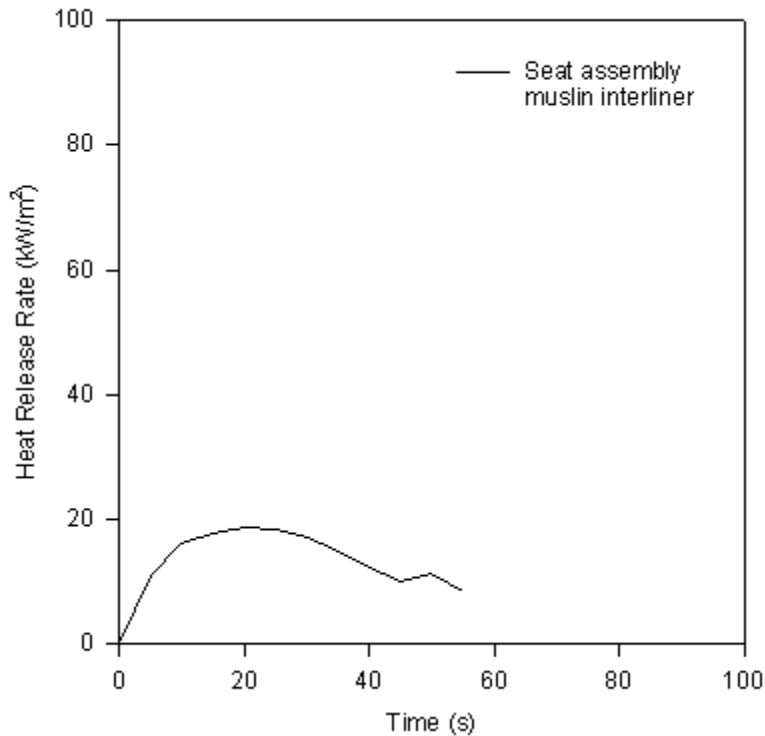

Figure 5-4. Cone Calorimeter HRR-Cotton Muslin Interliner (Sample 1b)

Figure 5-3 compares the HRR for the two upholstery cover fabrics in Samples 1 and 2. While the burning duration is much shorter for the cover fabric than the foam samples, the peak HRR for each cover fabric is several times greater than the peak HRR for the foam samples—420 kW/m² for Sample 1c and 265 kW/m² for Sample 2c. Figure 5-4 shows the HRR for the cotton muslin interliner used in all seat assemblies with a peak HRR of about 20 kW/m².

Figures 5-5 and 5-6 show the HRR curves for fully assembled seat cushion systems. It should be noted that the early high peak HRR of the cover fabric is apparent in all assemblies. Secondary peaks indicative of involvement of the foams can also be seen. The peak HRR for the various assemblies was generally between the highest and lowest peak HRR for individual component materials making up each assembly.

5.2.3 Previous Passenger Vehicle-related Cone Calorimeter Test Data

The 1984 FRA/Amtrak, 1990 NHTSA school bus, and 1996 MARC studies include results of Cone Calorimeter tests on individual materials from Amtrak and MARC passenger rail cars [27] [64][9].

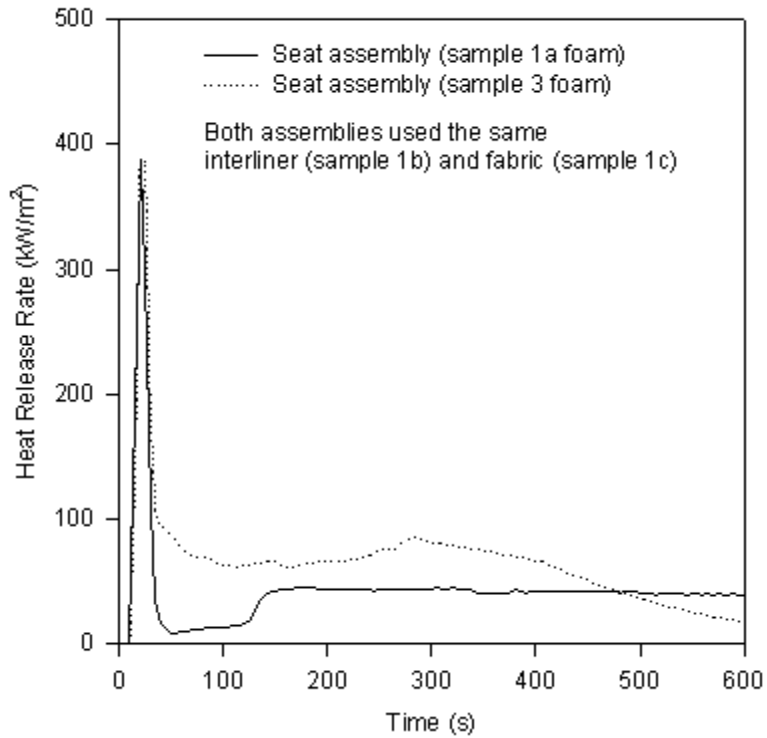

Figure 5-5. Comparison of Cone Calorimeter HRR - Two Seat Assemblies with Sample 1c Fabric

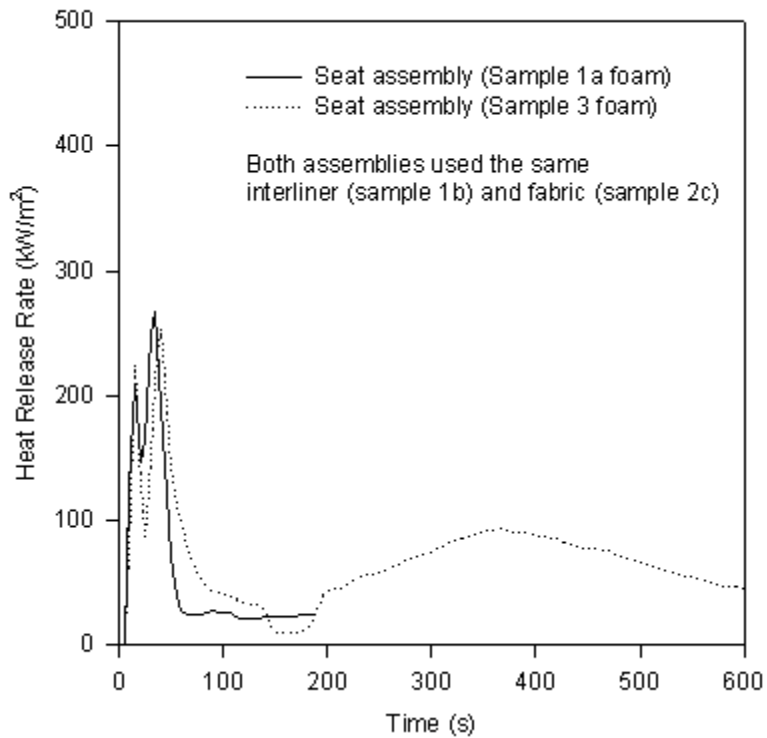

Figure 5-6. Comparison of Cone Calorimeter HRR - Two Seat Assemblies Sample 2c Fabric

In the 1984 FRA/Amtrak study, tests conducted at a relatively modest incident flux of 25 kW/m² showed a range of peak HRR from 27 to 600 kW/m².

With a wider range of material performance and incident fluxes, the data from the NHTSA study shows a higher lower boundary for the peak HRR. In the NHTSA school bus tests, peak HRR ranged from 180 to 670 kW/m² for incident flux levels from 35 to 75 kW/m².

In the MARC tests, peak HRR ranged from 134 to 271 kW/m² for incident flux levels from 25 to 55 kW/m². As expected, the peak HRR increased with increasing incident heat flux – increasing about 10 to 20 percent from 35 to 55 kW/m².

5.3 SUMMARY

An analysis of exposure levels in the existing FRA-cited test methods shows that the maximum radiant energy to the sample surface ranged from less than 5 kW/m² to 40 kW/m². Exposure levels in actual developing fires can range from 20 to 50 kW/m². Fully developed compartment fires are described as post-flashover fires with typical heat flux to surrounding items up to 75 kW/m². A heat flux exposure level of 50 kW/m² was deemed most appropriate for Cone Calorimeter tests. In order to capture a material's performance under all flaming conditions, including developing and post-flashover fires, values higher than used in the existing FRA test method requirements is necessary. Selected Cone Calorimeter test data were tabulated for all component materials of the thirty samples, individually and in end use combinations. Test materials were characterized by ignition time, peak HRR, and average specific extinction area. Additional data for each material are included in Appendix D.

Times to ignition varied from 5 s for the cotton interliner used in the seat assemblies to 115 s for the window glazing. In general, seat and bedding materials and curtain and fabric materials exhibited the shortest times to ignition, typical of thin materials. Wall and window surfaces, as well as window and door gaskets, had the longest times to ignition, typical of thicker materials.

Peak HRR varied over an order of magnitude from 65 kW/m² for the graphite foam to 745 kW/m² for the wall fabric. The majority of the 34 individual sample materials tested had peak HRR between 100 and 600 kW/m²:

- 6 materials had peak HRR below 100 kW/m² – including all the seat and mattress foams;

- 25 materials had peak HRR between 100 and 600 kW/m²; and,
- 3 materials had peak HRR over 600 kW/m² – usually thin materials.

Since the seat foam is one of the largest single combustible materials in a rail car, the low HRR results are particularly important.

SEA data showed a larger distribution for the 180 s average, σ_s (m²/kg), as compared to the peak HRR. Peak σ_s varied from 30 m²/kg for a seating foam to 1400 m²/kg for a seat support diaphragm and a rubber floor covering material.

Several materials showed elevated HRR and smoke values over an extended period of time. Although the peak HRR of these materials fall into an intermediate range, the extended duration of the HRR curve makes these materials important for study in future fire hazard analysis efforts.

For component assemblies of materials, the time to ignition was controlled by the exposed layer of material. The peak HRR for assemblies was generally between the highest and lowest peak HRR for individual component materials making up the assembly. Smoke data was greatly reduced compared to individual component materials with 180 s average (σ_s) varying from 30 m²/kg for a mattress assembly to 560 m²/kg for a pillow.

Cone Calorimeter data from the 1984 FRA/Amtrak study, 1990 NHTSA school bus study, and 1996 MARC rail car study shows material performance similar to the materials tested for this study. In addition, the NHTSA and MARC data includes tests conducted at a range of incident fluxes which showed an expected increase in peak HRR as incident heat flux increased.

6. COMPARISON OF SMALL-SCALE TEST DATA

HRR and fire hazard analysis are the primary focus of this current study of passenger train fire safety. HRR is the key indicator of real-scale fire performance of a material or construction, including ignition, flammability [71], and smoke emission generation [115] properties. Test methods based on HRR provide the data necessary to conduct fire hazard analyses and can also be used to predict real-scale fire behavior. Although passenger rail car materials have historically been tested according to test methods and performance criteria which are not directly related to HRR, there have been very few serious fires involving materials which meet the FRA requirements. Thus, it is expected that the Cone Calorimeter HRR-based test data can predict material performance in a manner comparable to that provided by the FRA-cited test methods and specified performance criteria.

In this section, the Cone Calorimeter test data are compared to test data obtained from Amtrak for FRA-cited test methods. Although the primary use of the HRR data is as input to a fire hazard analysis, this comparison is also intended to provide a better understanding of the relationships and limitations of Cone Calorimeter test data relative to FRA-cited test method data.

6.1 FLAMMABILITY

Several FRA-cited test methods include measures of material flammability in terms of flame spread (ASTM E 162, D 3675, and E 648) or ignition/burn resistance (FAA 25.853 (a) and ASTM C 542). ASTM E 162 and D 3675 measure downward flame spread on a near vertically mounted specimen (the specimen is tilted 30° from the vertical with the bottom of the specimen further away from the radiant panel than the top of the specimen). FAR 25.853 (a) and ASTM C 542 are small burner tests which measure a material's resistance to ignition and burning for a small sample of material. ASTM E 648 measures lateral flame spread on a horizontally mounted specimen. Since ASTM E 648 was designed to measure fire performance of flooring materials, it is the only test method that attempts to replicate end-use conditions.

6.1.1 ASTM E 162 and ASTM D 3675

The flame spread index, I_s , calculated from the ASTM E 162 or D 3675 test data, is composed of two factors—a flame spread factor, F_s , comparable to an average flame spread rate down the

sample surface, and a heat release factor, Q , which represents a measure of the peak HRR. The test is conducted under an incident heat flux that decreases down the length of the sample. F_s and Q are really coupled parameters—as the burning area increases, the heat released increases. The burning area will increase as the flame spreads along the sample surface. At any moment in time, the larger the burning area, the higher the measure of the heat released will be.

Conventional flame spread tests, such as ASTM E 162 and D 3675, evaluate material performance under specific laboratory conditions and the measured parameters rank material performance relative to other materials. Still, researchers have applied flame spread models to these devices. Gross and Loftus were pioneers in developing a flame spread model for E 162 [121]. This model was subsequently generalized for other applications by Rockett [122], who demonstrated that:

$$V_f \propto \dot{q}(t)_f^2 \quad (5)$$

where V_f is the flame spread rate and $\dot{q}(t)_f^2$ is the heat flux reradiated back to the sample surface.

Since only a fraction of the total heat released in any given time interval by the combustion process is reradiated back to the sample surface, this shows that flame spread rate is directly related to the total heat released from the flame. The remaining energy is lost to the surroundings. The heat generation potential, Q , is a measure of this heat release.

The work of Rockett further showed that sample pyrolysis, i.e., sample mass burning rate, is an important burning characteristic that influences the measurement of Q . Assuming that the sample is completely consumed, the mass burning rate, \dot{m} , can be related to the flame spread rate by:

$$\dot{m} = \rho_m A_s V_f \quad (6)$$

where ρ_m is the sample density and A_s is the cross-sectional area of the sample.

6.1.1.1 Comparison Parameter

In an idealized system, the HRR, \dot{q} , is related to the mass burning rate, \dot{m} , by:

$$\dot{q} = \dot{m} \Delta H \quad (7)$$

where ΔH is the heat of combustion assuming complete combustion. The \dot{q} represents the energy released by a burning material. A portion of this energy is reradiated back down to the sample surface. The rest is lost to the surroundings.

For the Cone Calorimeter, an estimate of \dot{q} is derived from measurements of the oxygen concentration and flow velocity in the exhaust duct and \dot{m} is measured directly. While ΔH is not known, an effective heat of combustion, ΔH_{eff} , can be determined from the ratio of \dot{q}'/\dot{m} .

According to Rockett, only a fraction of \dot{q} is reradiated to the sample surface, such that the fraction of heat flux reradiated to the sample surface from the flame, \dot{q}_f is:

$$\dot{q}_f = \chi \dot{q} \quad (8)$$

where χ is a function of flame shape, flame thickness, and flame emissivity [95]. As in the case of ASTM E 162, the Cone Calorimeter also imposes an external heat flux across the sample surface to augment the energy reradiated to the sample surface from the flame. Thus a correlation would be expected between Q measured in the ASTM E 162 test and \dot{q}''_{max} measured in the Cone Calorimeter test.

The overall ASTM E 162 measure, I_s , is a combination of the flame spread factor and the heat generation factor. The relative importance of the flame spread factor and the heat generation factor will dictate how well this overall measure will correlate with the Cone Calorimeter peak HRR. It should be noted from equation (6) that the flame spread factor is proportional to the mass burning rate, \dot{m} . Equation (7) shows that \dot{m} is also proportional to \dot{q} . Therefore, \dot{q}''_{max} should provide an appropriate parameter for comparison between the Cone Calorimeter and the ASTM E 162/D 3675 data.

6.1.1.2 Comparison Between ASTM E 162/D 3675 and ASTM E 1354

Figure 6-1 shows an excellent relationship between I_s and \dot{q}''_{max} . The I_s is predictive of a minimum value for the HRR. This implies that a low flame spread index is required but not necessarily sufficient to guarantee a low HRR. For example, from the solid line in Figure 6-1, an I_s value of 25 would indicate that the peak HRR measured in the Cone Calorimeter would be at least 125 kW/m². It does not indicate an upper limit on the HRR. A number of materials which had low I_s values had high HRR values. These are labeled in the figure indicating the material and the sample number. Conversely, the HRR provides an upper boundary for the I_s . The solid

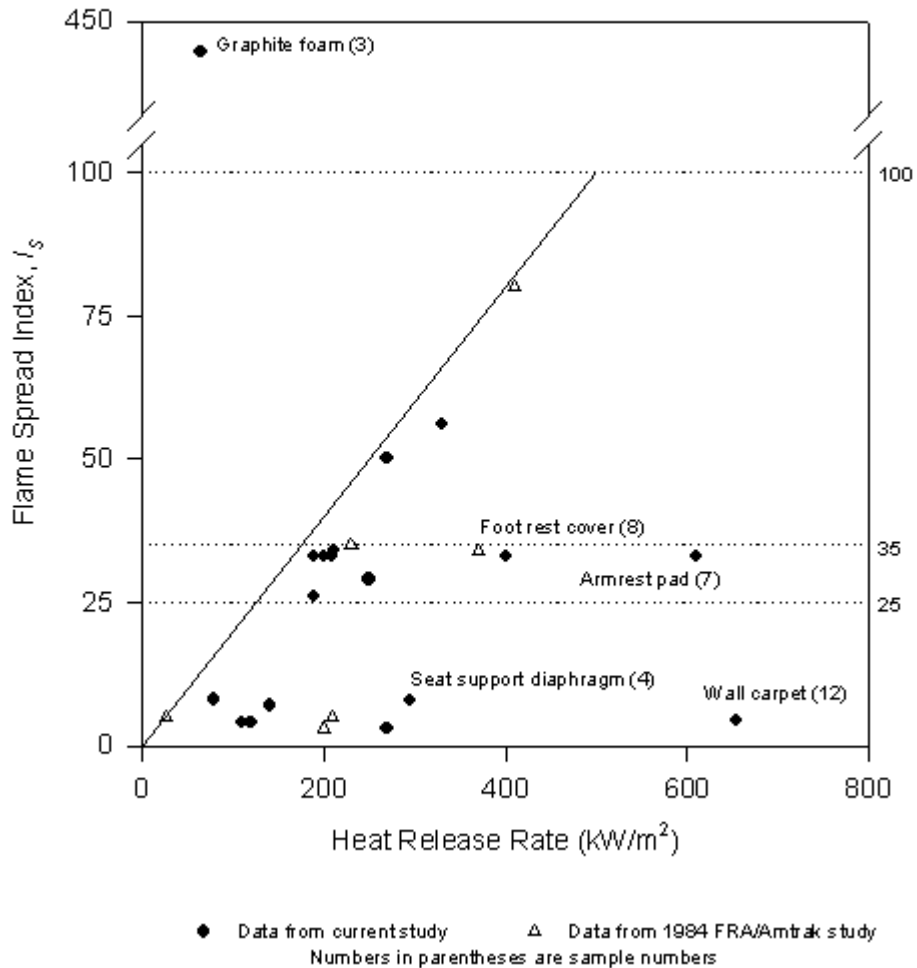

Figure 6-1. Comparison of I_s as Measured According to ASTM E 162 / D 3675 and Peak HRR as Measured in the Cone Calorimeter

line shown in Figure 6-1 is a simple linear estimate of the boundary. Again, with the exception of the graphite foam, materials with a low HRR have a low I_s value. The FRA performance criteria for ASTM E 162 / D 3675 use several performance levels for I_s , depending on the end-use application. These levels are superimposed on Figure 6-1 as horizontal dashed lines at I_s values of 25, 35, and 100. Most of the test data shown in Figure 6-1 represent materials which meet the FRA performance criteria and are comparable to the Cone Calorimeter data. These values are shown in Figure 6-1 without additional labeling. Materials which have unexpectedly low or high HRR values relative to the corresponding values are labeled in Figure 6-1 with both the material name and sample number.

For most of the exceptions, the HRR was higher than would be expected from the I_s value of the material. The following currently used materials have higher than expected values in Cone Calorimeter tests:

- The wall carpet (Sample 12) had an I_s of 4.5 according ASTM E 162 and an HRR value of 655 kW/m².
- The chloroprene seat support diaphragm (Sample 4) had an I_s of 7.8 for ASTM E 162 and an HRR value of 295 kW/m².
- The armrest pad (Sample 7), had an I_s of 33 according to ASTM E 162 and an HRR value of 610 kW/m².
- The footrest pad (Sample 8), had an I_s of 33 according to ASTM E 162 and an HRR value of 400 kW/m².

For these materials, the Cone Calorimeter data showed that even though these materials exhibit a low flame spread index in ASTM E 162, they produce considerable heat once ignited and may contribute to fire development.

Conversely, the polycarbonate space divider (Sample 14) and graphite foam (Sample 3) had Cone Calorimeter values within the comparable limits, but did not meet the FRA performance criteria. The polycarbonate space divider had an I_s of 50 according to ASTM E 162 and an HRR value of 270 kW/m². However, the same material used as a window glazing would meet the FRA performance criteria. Thus, this discrepancy should not be of great concern.

The graphite foam, a new material which was being considered for use in seat assemblies, is the only material which does not meet the FRA performance criteria yet meets the comparable Cone Calorimeter performance levels. The ASTM 3675 test indicated this material has an I_s value of 442. The Cone Calorimeter value of 65 kW/m² is comparable to the other foam materials tested. The different performance in the two test methods is likely due to the different wire grid sizes and sample sizes used in the two test methods. In ASTM D 3675, a wire grid with approximately 1-in (25-mm) holes is used. The grid size used in the Cone Calorimeter is smaller, approximately 1/4 in (6 mm). This smaller size prevents the intumescing of the material and thus the expansion of the material toward the radiant heat source. In ASTM D 3675, this expansion and additional exposure heat flux leads to rapid flame along the sample. The smaller size of the Cone Calorimeter sample limits the expansion further.

This material behavior should be studied further, including additional small-scale tests of the individual material and mock-up tests of seat assemblies which include the foam. If, upon a full evaluation of this material's performance, the higher values are shown to be a correct measure of the material performance, as opposed to simply an artifact of specific test conditions, it

represents a rare case of Cone Calorimeter material fire performance underestimation compared to ASTM E 162 / D 3675.

6.1.2 ASTM E 648

ASTM E 648 measures the response of a floor covering sample to a radiant energy source that varies across a 3.3-ft (1-m) length from a maximum of 11 kW/m² down to 1 kW/m². (After ignition by a small line burner at the high-energy end of the specimen, the distance at which the floor covering material ceases burning is determined. This point defines the minimum or critical radiant flux [CRF] necessary to support continued flame spread. Note: FRA uses W/cm²; this report uses kW/m²).

6.1.2.1 Comparison Parameter

ASTM E 648 utilizes a radiant panel similar in design to that used by ASTM E 162. The orientation of the sample in ASTM E 648 is horizontal, rather than slanted vertically as in ASTM E 162; the maximum exposure intensity is less, only 11 kW/m². However, like ASTM E 162, flame spread in ASTM E 648 can be modeled as an opposed flow analog. Therefore, much of the previous analysis is also appropriate to this test method. Since the test criterion is burn resistance and the CRF is the heat flux at the point where flame spread stops, (i.e., burning ceases), HRR should provide a suitable comparison parameter between ASTM E 648 and the Cone Calorimeter. For simplicity, the peak HRR will be used; additional Cone Calorimeter tests (at varying incident flux levels) could allow estimation of a CRF directly from Cone Calorimeter data. For material qualification tests or simple comparisons between test methods, peak HRR provides a sufficient parameter.

6.1.2.2 Comparison Between ASTM E 648 and ASTM E 1354

Two floor covering materials were included in the evaluation. ASTM E 648 data was available for both of the materials. The floor carpet (Sample 24) and the resilient rubber floor mat (Sample 25) exhibited respective CRF values of 10.8 kW/m² and of 6.3 kW/m² according to ASTM E 648 and respective peak HRR \dot{q}_{\max}'' values, of 250 kW/m² and of 300 kW/m² in the Cone Calorimeter.

These data are also consistent with floor and wall carpet test data from the 1984 Amtrak study. In that study, three carpet samples were tested according to ASTM E 162 and in the Cone Calorimeter (although at a lower heat flux exposure of 25 kW/m²) and one sample was tested

according to ASTM E 648. (Note: the Cone Calorimeter was not accepted as an ASTM test at that time.) The three carpet samples were all outside the FRA performance criteria and had \dot{q}_{\max}'' values greater than 300 kW/m².

With the extremely limited amount of data, no specific comparison is considered appropriate at this time.

6.1.3 FAR 25.853 (a) and ASTM C 542

FAR 25.853 (a) and ASTM C 542 test the ability of a material to cease burning once a small gas burner flame has been withdrawn. The test methods are used primarily to evaluate the fire performance of textile and elastomeric materials.

Vertical flame spread mechanisms have been developed for thermally thick and thermally thin materials. Many of these have been reviewed by Janssens [123]. These models have generally been applied to cases of one-sided burning. Although two-sided burning can be expected in the small-burner tests, the same parameters control flame spread and burn resistance.

6.1.3.1 Comparison Parameter

Vertical upward burning flame spread has been shown to be a function of heat flux received by a material and a material's ease of ignition, i.e., ignition time. The heat flux received by a material in a test is a combination of an externally imposed heat flux and the heat flux radiated to the material from the flame created by the burning material. Janssens shows that Hasemi and Delichatsios derived a comparable expression that relates the velocity of the base of the flame, V_p , to HRR and the ignition time of the material:

$$V_p \propto \frac{(\dot{q}')^n}{t_{ig}} \quad (9)$$

where \dot{q}' (kW·m⁻¹) is the HRR per unit width over the material surface ahead of the base of the flame, t_{ig} (s) is the ignition time of the material at the exposure heat flux, and n is an empirical constant.

In the case of vertical upward flame spread, as \dot{q}' decreases, the flame spread rate, V_p , decreases. The upward flame spread rate is also lower the longer it takes a material to reach its ignition temperature. Janssens has shown that a criterion for continued flame spread is:

$$t_b \geq \frac{t_{ig}}{K' \dot{q}'' - 1} \quad (10)$$

where t_b (s) is the burn time of a segment of material, K' is an empirical constant for the case of $n=1$ in equation (9) and \dot{q}'' ($\text{kW} \cdot \text{m}^{-2}$) is the HRR per unit area. In general, K' is not known and must be determined from experiments. Conversely, burning will stop if t_b is less than zero. As a first approximation, the burn time, t_b , is simply proportional to:

$$t_b \propto \frac{t_{ig}}{\dot{q}''} \quad (11)$$

and should represent a suitable measure for comparing FAR 25.853 (a) char length data to Cone Calorimeter data.

6.1.3.2 Comparison Between FAR 25.853 (a) and ASTM E 1354

Figure 6-2 shows a comparison of char length data from FAR 25.853 (a) and the ratio of ignition time, t_{ig} , to the peak HRR, \dot{q}''_{max} . In Figure 6-2, the values for the ratio of ignition time, t_{ig} , to the peak HRR, \dot{q}''_{max} , have been normalized by multiplying by 100. Thus, for thin textile materials, a value of the ratio of less than 6 in the Cone Calorimeter should compare to a char length of less than 5 in (50 mm) in FAR 25.853 (a). Although the comparison is based on a limited number of data values, the correlation coefficient is quite high at $r^2 = 0.98$.

6.2 SMOKE EMISSION – ASTM E 662

ASTM E 662 measures the smoke generation from small, solid specimens exposed in:

- a flaming mode to a radiant heat flux augmented by the presence of a specially designed pilot burner for an estimated total heat flux of 35 kW/m^2 , and
- a nonflaming mode to only a radiant heat flux of 25 kW/m^2 .

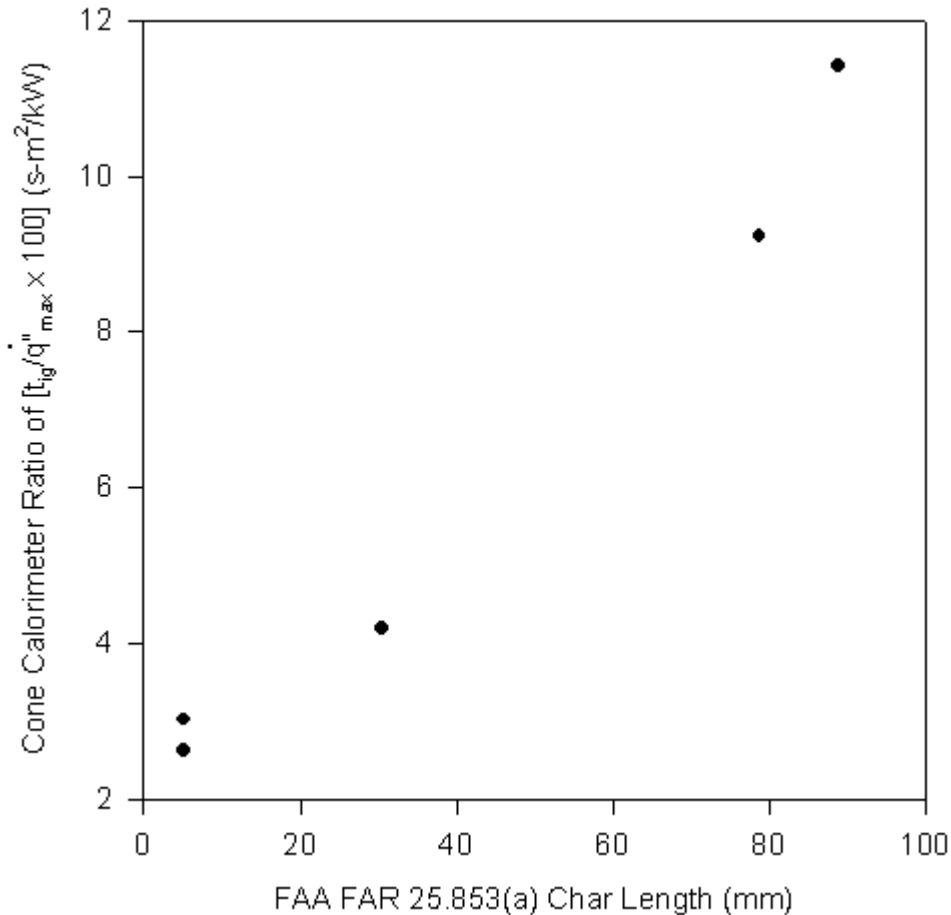

Figure 6-2. Comparison of Char Length as Measured According to FAR 25.853 (a) to the Ratio of Time to Ignition and Peak HRR as Measured in the Cone Calorimeter

The nonflaming mode is an example of nonflaming oxidative decomposition. As long as the exposure remains at a low level of heat flux ($\leq 25 \text{ kW/m}^2$), the sample will rarely transition into flaming combustion. While it may produce large quantities of smoke relative to the amount of sample burned, the total smoke production and the maximum smoke density in the nonflaming mode has generally been found to be less than during the flaming exposure mode [112]. The detection by train occupants or installation of smoke detection systems also reduces the risk of prolonged nonflaming combustion. Since the total smoke production for a material is a function of both the rate of smoke production and the burning rate of the material, the typically dramatically higher burning rate in a flaming fire leads to correspondingly higher total smoke production in flaming fires. Therefore, the Cone Calorimeter smoke data is more appropriately compared to the ASTM E 662 flaming mode data.

6.2.1 Comparison Parameter

An engineering comparison between ASTM E 662 and the Cone Calorimeter must reconcile the differences in the combustion system and the measurement procedures. ASTM E 662 measures a specific optical density, D_s , of smoke during the combustion process in a closed chamber. Also, the measurement is performed with a polychromatic light beam. Performance criteria are based on smoke density concentrations not exceeding prescribed values in 1.5 and 4 minutes from the start of the exposure. Cone Calorimeter smoke measurement is based on an instantaneous measurement of smoke concentration in a flowing system, i.e., an open system. Smoke is measured by a monochromatic light beam in the Cone Calorimeter apparatus. The standard reporting units for the smoke parameter in the Cone Calorimeter is the extinction coefficient, k , or the specific extinction area, σ_s (m^2/kg). While no direct comparison would be expected between D_s and σ_s , several researchers [124] [125] [126] have derived relationships between the accumulated smoke density concentration, D_s , and measurements made in real-scale fire tests of the extinction coefficient.

The specific optical density, D_s (repeated from equation (2)), is defined as:

$$D_s = \frac{V}{AL} \log \left(\frac{I_o}{I} \right) \quad (12)$$

where L is the path length of the light beam through the smoke, I_o is the intensity of the original light beam, and I is the intensity of the light beam attenuated by the smoke.

For ASTM E 662, the right-hand side of equation (12) includes a geometric factor V/A , where V is the volume of the chamber and A is the area of the exposed sample.

The expression for the extinction coefficient, k , is comparable:

$$k = \frac{1}{L} \ln \left(\frac{I_o}{I} \right) \quad (13)$$

For the Cone Calorimeter flow-through system, an equivalent geometric factor can be defined as the volumetric flow rate through the duct, v_p , divided by the exposed surface area of the burning sample, A . The integrated specific optical density can then be expressed as:

$$D_s = \frac{\int k_i v_i dt}{2.303A} \quad (14)$$

Equation (14) indicates that, if the instantaneous values for the extinction coefficient, weighted by v_i/A , are integrated from the start of the burning until the test specimen burns out, an accumulated value for D_s is computed as a function of time. Equation (14) can be applied to the Cone Calorimeter smoke data.

6.2.2 Comparison Between ASTM E 662 and ASTM E 1354

Figure 6-3 shows the results of applying equation (14) to the Cone Calorimeter smoke data. The computed D_s will differ from that measured in ASTM E 662 by the geometric constant and the difference in exposure heat flux incident on the sample surface. Because of these differences, comparing the integrated values from both test methods is more appropriate than comparing the time histories of smoke emission from both test methods.

Additional differences will appear for those materials that become liquid during the combustion process. For these materials, ASTM E 662 results may be lower than comparable Cone Calorimeter results. Since materials can flow out of the vertically-oriented sample holder in ASTM E 662, the total smoke production may be underestimated for some samples.

Assuming no changes in chemistry result from increasing the external heat flux from 35 kW/m² to 50 kW/m², D_s is only a measure of the smoke concentration. The smoke concentration is a function of the mass burning rate. As the external heat flux increases, the mass burning rate will increase, causing D_s to increase more rapidly. This would imply that the time to reach a specific D_s value would be shorter at 50 kW/m² than at 35 kW/m²; that is, the Cone Calorimeter should produce a given D_s faster than in ASTM E 662.

The FRA requirements cite two specimen exposure times for smoke emission data with multiple performance levels, depending on the end-use application: D_s (1.5 min) \leq 100 and D_s (4 min) \leq 100, 200, or 250, depending upon end-use application. Figure 6-4 shows the comparison of these two test methods using D_s (4 min) for ASTM E 662 on the horizontal axis and D_s (1.5 min) for the Cone Calorimeter on the vertical axis for the materials in this study.

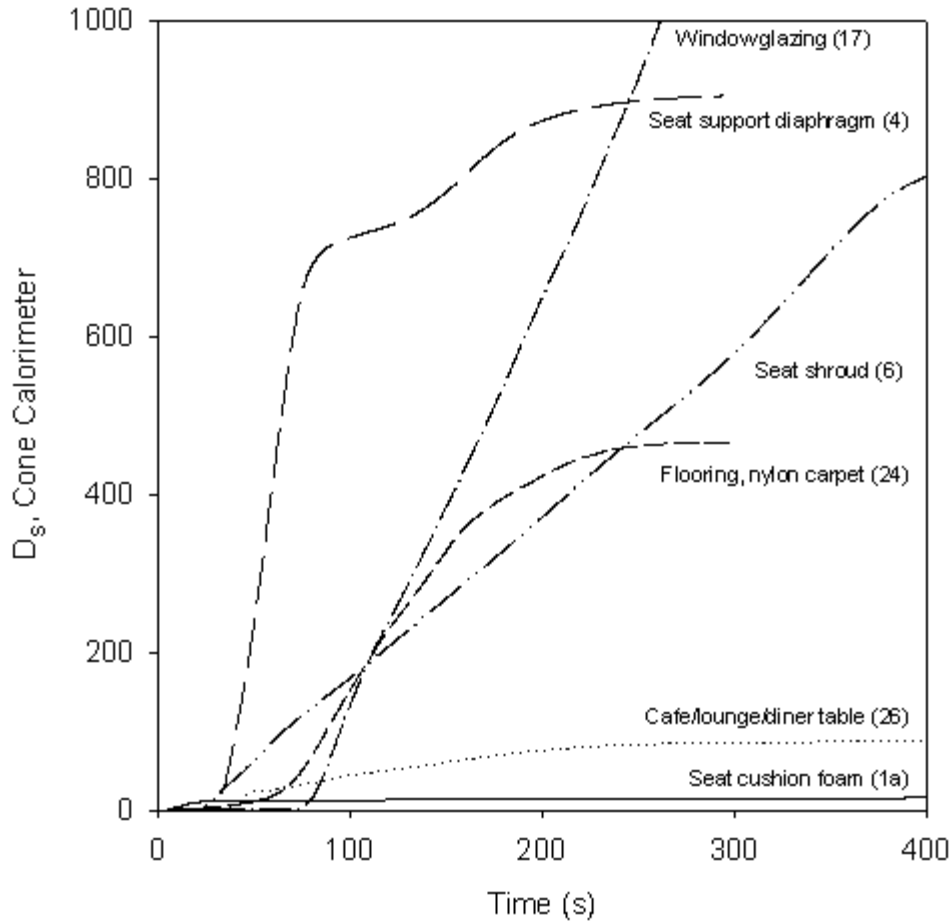

Figure 6-3. Specific Optical Density as Determined From the Specific Extinction Area

The Cone Calorimeter data show that a D_s (1 min) of ≤ 250 would result in comparable material performance to ASTM E 662. The longer time averaging of the 4-minute time scale (compared to the 1.5-minute values) kept uncertainty in the smoke measurement within sufficient limits to allow an adequate comparison. No similar comparison could be found for ASTM E 662 data at the shorter 1.5-minute exposure time. Since the main purpose of using the D_s values derived from Cone Calorimeter data is to demonstrate their comparability to ASTM E 662 data, the 4-minute values provide a sufficient comparison. In addition, for fire hazard analysis, Cone Calorimeter smoke production rates (in the form of kg of soot produced per kg of sample burned) are used. These rates are expressed as a function of time and thus are not unique to a particular exposure time.

In general, materials which have a high ASTM E 662 D_s value have a correspondingly high Cone Calorimeter D_s value. A simple straight line regression, shown as a diagonal line in Figure 6-4,

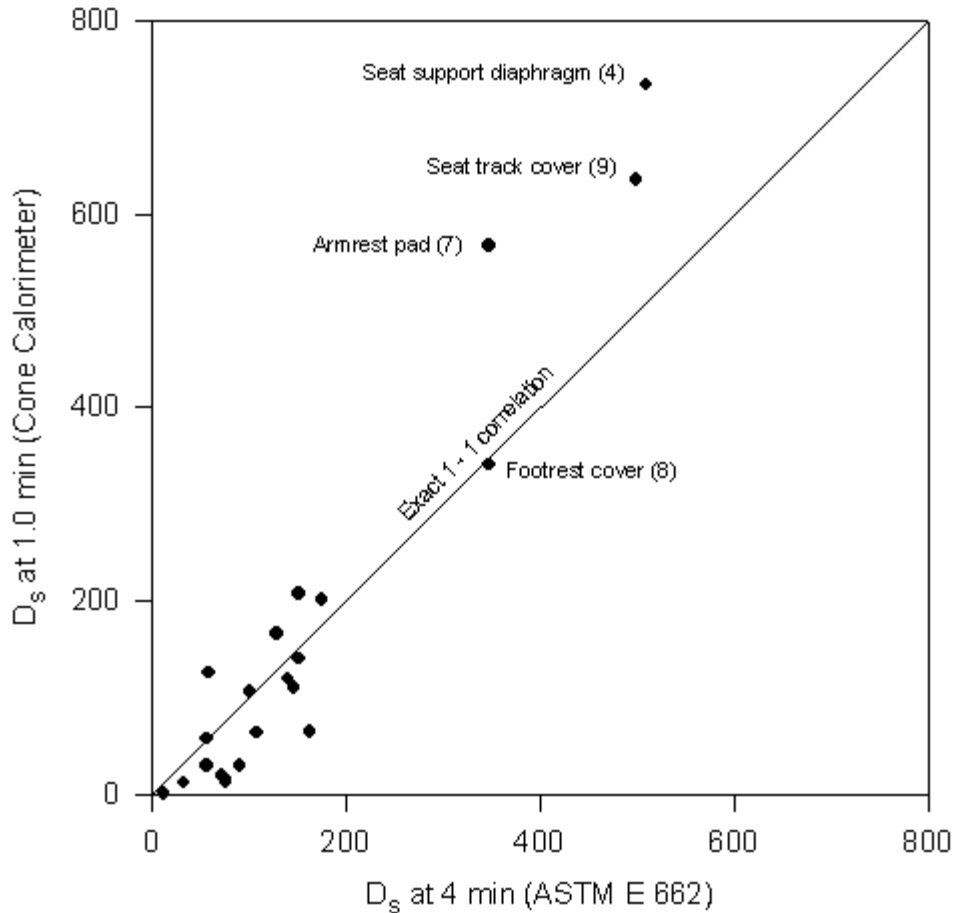

Figure 6-4. Comparison of ASTM E 662 D_s (4.0) and Calculated Cone Calorimeter D_s (1.0)

is a good representation of the comparison. The correlation coefficient for this straight line is $r^2 = 0.87$. Most of the test data are grouped in the lower left quarter of Figure 6-4, which indicates that the materials meet both the FRA performance criteria and have correspondingly lower Cone Calorimeter D_s values. This consistency with the HRR results was also noted by Hirschler for a wide range of plastics – “the better performing materials in terms of HRR and smoke emission are mostly identical materials” [127]. Materials which do not meet the FRA smoke emission performance criteria are labeled in Figure 6-4 with the material name and sample number.

This comparison is consistent with data from the MARC study which showed that materials with a high D_s in ASTM E 662 typically have a high smoke extinction area in the Cone Calorimeter.

6.3 COMPARISON WITH PREVIOUS U.S. PASSENGER VEHICLE-RELATED FIRE TEST DATA

Several previous NIST studies have presented the results of passenger vehicle material Cone Calorimeter and FRA-cited test methods. The 1984 FRA/Amtrak study includes small-scale laboratory tests on individual materials from Amtrak passenger cars. That study includes several of the same materials used in this current study. The 1990 NHTSA study included Cone Calorimeter test data for a range of seating assemblies used in school buses. More recently, the 1996 MARC commuter rail car study also includes both FRA test method data and a range of Cone Calorimeter data. Table 6-1 shows test data from these three studies along with comparable data from the current study derived from Tables 4-1, 4-2, 4-4, 5-2, and 5-4.

As in the current study, trends of comparable performance are seen in the previous related studies which compare HRR data from the Cone Calorimeter with I_s data from ASTM E 162/D 3675. For all four studies, the material test data from the current study are most comparable to the MARC commuter rail car data. As would be expected, the material flammability and smoke emission test data from the 1984 FRA/Amtrak tests are somewhat higher than from the more recent tests. Some of the older materials included in the 1984 study were less fire-resistant materials which show poorer fire performance than newer materials intended to comply with the FRA criteria, e.g., a non-fire-retardant polyurethane foam seat assembly and a wall covering which both exhibited high I_s values in the ASTM E 162/D 3675 tests and high HRR values in the Cone Calorimeter test. Conversely, one of the seat assemblies from the 1984 Amtrak tests included a “low-smoke” chloroprene foam which had a very low HRR in the Cone Calorimeter. Although tested at a relatively low incident flux of 25 kW/m², the seat assembly would also have a low HRR at higher fluxes. That seat assembly also had a low I_s value in the ASTM E 162/D 3675 test, but the HRR value in the Cone Calorimeter was much lower than other assemblies with comparable I_s values. The 1990 NHTSA study also included a seat assembly of non-fire-retardant polyurethane foam which had a high HRR. With these exceptions, the majority of the comparable materials had similar HRR values, with peak HRR ranging from about 200 to 400 kW/m². The 1990 NHTSA and MARC studies also include Cone Calorimeter data for materials tested at a range of incident heat flux levels from 25 to 55 kW/m². As expected, peak HRR typically increases with increasing incident heat flux, from 35 to 45 kW/m²; peak HRR values rise about 10 to 20 percent. The ignition time decreases with increasing incident heat flux.

Table 6-1. Passenger Rail Car Material Small-Scale Test Data Comparison

MATERIAL	DATA SOURCE	FLAME SPREAD		SMOKE EMISSION	PEAK HRR
		ASTM E 162 I_s	ASTM E 648 CRF (KW/m ²)	ASTM E 662 D_s (4.0)	ASTM E 1354 (kW/m ²)
SEAT CUSHION ASSEMBLY ^a	1*	x	x	x	260 - 420
	2	5 - 960	x	140 - 620	27 - 600
	3	x	x	x	180 - 670 ^b
	4	x	x	x	164 - 192 ^c
WALL AND CEILING MATERIAL ^d	1	3 - 4	x	129 - 152	120 - 270
	2	< 5 - 80	x	250 - 410	410
	4	24	x	79 - 109	134 - 222 ^c
WINDOW MASK ^d	1	35	x	x	210
	2	3 - 35	x	41 - 320	200 - 370
	4	62	x	234 - 373	206 - 265 ^c
FLOOR COVERING ^d	1	x	6 - 11	140	245 - 340
	2	x	6 - > 11	170 - 250	350 - 380

* Source of data: 1 – Current report, 2 – 1984 Amtrak Study [27], 3 – 1990 NHTSA study [64], 4 – 1996 MARC study [9]

a Includes range of data from all complete seat assemblies tested

b Includes data from all complete seat assemblies tested and a range of heat flux exposures, 25-75 kW/m²

c Includes data from a range of heat flux exposures, 35-55 kW/m²

d Includes range of data from all samples tested

Although representing a range of materials from different passenger vehicle applications tested over a 15-year period, the majority of the data from the earlier studies are consistent with data from this current study. Materials exhibiting low HRR values in the Cone Calorimeter typically have corresponding low I_s values in ASTM E 162/D 3675.

6.4 TEST RESULT UNCERTAINTY

To put the comparison of the FRA-cited test methods with the Cone Calorimeter in context, it is also important to consider the uncertainty in the test results. This uncertainty represents the variability which can be expected in test results for a material. For the test methods included in this study, the following statements were available:

- ASTM E 162 / D 3675 – include no statement of precision;
- ASTM E 648 – approximately 20% within laboratory variability, 35% between laboratory variability;
- FAR 25.853 (a) and ASTM C 542 – include no statement of precision;
- ASTM E 662 – ranges from 5.7 to 51% within laboratory variability, 16 to 120% between laboratory variability, depending upon the material tested;
- Cone Calorimeter
 - approximately 13% within laboratory variability, 14% between laboratory variability for peak HRR.
 - approximately 8% within laboratory variability, 22% between laboratory for smoke extinction area, σ_s .

These uncertainties imply, for example, that there is **no** real difference between a material with a D_s value of 200 and 200 plus or minus a minimum of 200 x 5.7 percent or 11.4. Indeed, the uncertainty could be as much as 200 plus or minus 200 x 120 percent or 240.

6.5 SUMMARY

The Cone Calorimeter test data were compared to the FRA-cited test method data for a range of representing those currently used in passenger trains. These comparisons were intended to

provide a better understanding of the relative fire performance of those materials as well as prospective materials.

For the majority of materials, the Cone Calorimeter results provide a good correlation with FRA-cited test results. For example, most materials which have a low HRR have a correspondingly low flame spread (I_s) value (ASTM E 162). However, several materials (wall carpet, seat support diaphragm, armrest pad, and foot rest covers) which had low I_s values had higher HRR values in the Cone Calorimeter test. For these materials, the Cone Calorimeter data showed that even though these materials exhibit a low flame spread index in ASTM E 162, they produce considerable heat once ignited and may contribute to fire development. One material (graphite foam) had a low HRR value and a high I_s . For this material, the different wire grid sizes used for the ASTM and Cone Calorimeter tests were seen as being responsible for the anomalous results. However, the fire behavior of this material should be studied further.

Cone Calorimeter data from the 1984 FRA/Amtrak study, 1990 NHTSA school bus study, and 1996 MARC commuter rail study show performance similar to the materials tested for this study. In addition, the NHTSA and MARC data showed an expected increase in peak HRR with increased incident heat flux.

The following rationale was used in comparing Cone Calorimeter test data with FRA-cited test method data:

- The I_s is predictive of a minimum value for the HRR. With the exception of the graphite foam, materials which have low HRR values have a correspondingly low I_s .
- The test method specified in FAR 25.853 (a) assesses a material's resistance to small ignition sources. For the Cone Calorimeter, a comparable value is based upon the ratio of the ignition time to the peak HRR. A simple linear regression resulted in a high correlation coefficient of $r^2 = 0.98$. The char length comparison is based on a limited amount of data.
- Only two floor covering materials were available for Cone Calorimeter tests, with ASTM E 648 data also available for both. Thus, there is too little data for a meaningful comparison between these test methods for passenger train applications.

- For equivalence to ASTM E 662, an optical density measure was derived as an integrated value based upon the smoke extinction coefficient from the Cone Calorimeter. Comparing Cone Calorimeter and ASTM E 662 data for this calculated smoke density showed an appropriate comparison for the 4-minute E 662 values in 17 of the 22 cases where data were available. A simple linear regression resulted in a good correlation coefficient of $r^2 = 0.87$.
- No appropriate comparison was apparent for the 1.5-minute values. Since the main purpose of using the Cone Calorimeter D_s data values is to demonstrate their comparability to ASTM E 662 data, the 4-minute values provide a sufficient comparison.

While the materials tested represent a range of those currently used in passenger trains, many other material combinations are possible in actual use. Accordingly, the comparisons are intended only to show that the Cone Calorimeter test method provides an approach to screen passenger rail car interior materials similar to that provided by the FRA-cited test methods. For the majority of materials, the relative ranking from “best” to “worst” was similar in both test methods.

While the uncertainty for the Cone Calorimeter test results are lower than other test methods, the uncertainty inherent in all individual test methods make their use “less meaningful.” New materials and designs are better judged through a systems approach which considers the impact of materials, car design, detection and suppression, and evacuation options on overall fire safety. The use of HRR data provides the single most important measure characterizing the fire behavior of materials and can be used both as a screening tool and in an overall hazard analysis applied to passenger trains.

7. SUMMARY

In 1984, the FRA issued passenger train fire safety guidelines that recommended the use of certain flammability and smoke emission test methods and performance criteria for intercity and commuter rail cars. The FRA issued revised guidelines in 1989 that used terms and categories to more closely reflect passenger train design and furnishings; smoke emission performance criteria for floor coverings and elastomers were also included. Since the guidelines were initially issued, there have been very few serious fires involving materials which meet the FRA requirements. Accordingly, as part of the passenger rail equipment rulemaking process required by Congress, the FRA has proposed that materials be required to meet the 1989 fire safety tests and performance criteria. In addition, the conduct of fire hazard analyses would also be required in that proposed rule.

Considerable advances in fire safety engineering have been made since the original development of the existing FRA requirements. Heat release rate (HRR) is now considered to be a key indicator of fire performance. For a given confined space (e.g., rail car interior), the air temperature is increased as the HRR increases. Even if passengers do not come into direct contact with the fire, they could be injured by high temperatures, heat fluxes, and/or smoke and gases emitted by materials involved in the fire. Accordingly, the fire hazard to passengers of these materials can be directly correlated to the HRR of a real-world fire.

Test methods using HRR, such as the Cone Calorimeter (ASTM E 1354), have been shown to better predict the real-scale burning behavior of materials and assemblies in a more cost-effective manner than previously used test methods. HRR measurements have gained worldwide credibility for the regulation of building fire safety and are now being examined for a range of transportation vehicles. HRR data can also be used as an input into fire modeling and hazard analysis which allows evaluation of a range of design parameters, including material flammability, geometry, fire detection and suppression systems and evacuation time, as well as design tradeoffs which may arise from combinations of the parameters.

To assess the feasibility of applying HRR test methods and fire modeling and hazard analysis techniques to evaluate U.S. passenger train fire performance, FRA has funded a comprehensive three-phase research program which is being conducted by NIST. FRA will consider the results of this research project in Phase II of the passenger rail equipment rulemaking. The remainder of this chapter summarizes results of the Phase I work effort.

7.1 U.S. TRANSPORTATION VEHICLE REQUIREMENTS AND RESEARCH

A considerable overlap exists for transportation vehicle fire safety requirements which are generally based on small-scale test methods. The performance criteria are prescriptive and intended to prevent fire ignition, retard fire growth and spread, and provide evacuation time.

Small-scale test methods have historically been used to evaluate transportation material fire performance. This approach provides a screening device to allow interested parties to identify particularly hazardous materials and select preferred combinations of components; material suppliers can independently evaluate the fire safety performance of their own materials.

7.1.1 U.S. Rail Transportation Vehicle Fire Safety Requirements

FRA, Amtrak, FTA, and National Fire Protection Association (NFPA) 130 all specify identical small-scale tests methods and similar performance criteria to evaluate the flammability and smoke emission characteristics of individual component materials. As part of the passenger equipment rulemaking process required by Congress, the FRA has proposed that passenger train materials be required to meet these test methods and performance criteria. In addition, the proposed rail equipment rule requires that various fire hazard analyses of existing, rebuilt, and new rail cars be conducted.

Amtrak recognizes the need to evaluate individual test data in the context of the intended use of the material. Accordingly, Amtrak requires that the test data is combined with other information (e.g., quantity and location of material, potential ignition sources, etc.) to develop a fire hazard assessment to select materials on the basis of function, safety and cost.

NFPA 130 includes a “hazard load analysis” method which is an attempt to provide a simplified and semi-quantitative analysis to assess the overall contribution to fire hazard of the materials used in rail transit interior linings and fittings. However, current fire hazard modeling techniques and correlations can provide a more realistic assessment of the contribution of materials to the overall fire hazard.

7.1.2 Other U.S. Transportation Vehicle Fire Safety Requirements

NHTSA motor vehicle requirements use a small-scale test method for all interior nonmetallic materials to provide a screen against those which ignite easily or initially burn rapidly.

Current FAA aircraft flammability requirements for interior materials specify a variety of test methods including small burner tests, oil burner tests, a HRR test, and a smoke generation test. The FAA-specified small burner test for ignition resistance is also included in the FRA guidelines for seat upholstery, mattress covers, and curtains. The oil burner test method specified for seat cushions represents a severe initiating fire exposure in a post-crash scenario where passenger evacuation must be accomplished within 90 seconds. However, this fire exposure severity is not typical of the majority of passenger train fires. Moreover, the rail operating environment provides an evacuation route with less likelihood for injury. The FAA-specified HRR test method uses an apparatus similar to the Cone Calorimeter. However, the Cone Calorimeter provides a more accurate measurement of HRR.

The existing USCG passenger vessel fire safety requirements primarily rely on passive structural barrier fire endurance and separation to prevent or limit fire spread and allow for emergency egress. Several material tests and performance criteria are similar to those cited in the FRA guidelines. The USCG permits designers to submit an engineering analysis to evaluate materials used in relation to the vessel environment. This case-by-case approach allows the use of alternatives which provide an equivalent level of safety and meet the intent of the fire protection regulations.

The FAA and USCG have both accepted the use of HRR data as a means to evaluate the performance of certain aircraft and marine vessel materials.

7.1.3 U.S. Transportation Vehicle Fire-Related Research

The 1993 FRA-sponsored NIST study, as well as several other previous studies conducted for FRA, NHTSA, and FTA, have concluded that the impact of material interactions and changes in real-scale passenger vehicle interior geometry are also critical factors to be evaluated in predicting actual fire behavior. These factors cannot be evaluated through small-scale tests alone.

The NFPA and the American Society for Testing and Materials are also conducting research efforts which are intended to provide additional tools to evaluate passenger train materials.

In addition to the current FRA-sponsored research program, other HRR and other related fire performance research efforts are being conducted by FAA and USCG. Although the fire hazards

and evacuation environments are different, the results of the NIST research will assist the FRA in formulating comparable material performance criteria using HRR.

7.2 EUROPEAN FIRE SAFETY REQUIREMENTS AND HRR RESEARCH

Existing European approaches to passenger train fire safety have been generally similar to the U.S. approach. However, concerns about material interaction have led several European country efforts and coordinated European Railway Research (ERRI) and Commission for European Standardization (CEN) activities to develop assessment tools for fire hazard evaluation. The current focus is on developing the database necessary to utilize successfully fire and hazard modeling in the design of next generation passenger train systems. This database uses:

- Cone Calorimeter to provide small-scale test data on materials and assemblies;
- Furniture calorimeter to provide real-scale assembly test data;
- Fire hazard modeling as a means for evaluating and predicting system performance; and
- Large-scale fire tests to verify predicted system performance and material interaction. This large-scale fire testing has resulted in the development of several design fires for train tunnels that can be utilized in the design and evaluation of fire protection systems.

7.3 AMTRAK MATERIAL TEST DATA EVALUATION

Materials selected reflected a broad range of interior materials as used in the Amtrak fleet. In addition, other materials were tested because of their possible utility as new or replacement materials for existing applications. All the materials are classified into five broad categories:

- Seats and mattress assemblies (foam cushions, with upholstery or other covering);
- Wall and window surfaces (composite plastics, carpet);
- Curtains, draperies, and fabrics (windows, sleeping car doors, bedding);
- Floor covering (carpet, resilient rubber); and
- Miscellaneous components (diner/cafe/lounge tables, pipe wrap, air ducts, elastomers).

These five categories are similar to the categories used by Amtrak for interior furnishing materials and to those used by the FRA; however, several of the latter have been combined into the miscellaneous category.

7.3.1 FRA-Cited Test Method Data

Data collected from several sources showed that the majority of the selected Amtrak rail car materials tested met current FRA performance criteria for flammability and smoke emission. However, there were exceptions:

- A graphite foam seat material had a dramatically higher test result than the FRA performance criteria. Although the rapid flame spread of this material was demonstrated in the ASTM D 3675 test, further study is necessary to evaluate this material in large scale to evaluate the performance in actual end-use conditions. European operators report that they do not see this poor performance when the foam is tested with a fabric covering.
- Polycarbonate is used both as a window material and as an interior space divider. As a window material, the material meets FRA performance criteria; however, the material does not meet the performance criteria for interior space divider application.
- Several materials did not meet the FRA smoke emission performance criteria. A seat support diaphragm, armrest and footrest pads, seat track cover, and window and door gasketing do not meet one or both of the recommended limits for smoke emission. Amtrak is investigating the use of other materials which will meet the smoke emission requirements.

7.3.2 Cone Calorimeter Test Data

The Cone Calorimeter is a single test which provides a measurement of heat release rate (HRR), specimen mass loss, smoke production, and combustion gases. In addition, Cone Calorimeter test data provide the necessary data for fire hazard modeling methodologies which can evaluate a material's individual contribution to overall fire hazard in the context of its end use. These data include:

- ignition time, a measure of how easily a material can be ignited;
- time-to-peak HRR, a measure of the speed of fire growth;

- peak HRR, a measure of the how large a fire will result from a burning material; and
- specific extinction area, a measure of smoke production of the material.

An exposure level of 50 kW/m² was chosen for the Cone Calorimeter material tests conducted in this study. This level is consistent with: 1) the exposure levels in the existing FRA-cited test methods, and 2) exposure levels in actual fires.

Peak HRR varied over an order of magnitude from 65 kW/m² for the graphite foam to 745 kW/m² for wall fabric. In general, lower peak HRR were found for the seat and mattress foams, and higher values for wall surface materials. Other fabric and thin sheet materials display intermediate values between these two extremes. This performance is consistent with the current FRA which specify flame spread index (I_g) for seat foam, intermediate criteria for most other materials, and least stringent for window glazing materials.

Cone Calorimeter smoke emission data shows some similar trends to the HRR data. The lowest values were noted for the foam and interliner from the seat and mattress assemblies. Highest values were noted for several thin materials (a seat support diaphragm, seat track cover, PVC wall material, and rubber floor covering). These thinner materials tend to exhibit high peak values, over a short period of time. Most of the wall materials were between these extremes. The performance of the foam and surface materials is also consistent with the relative thickness and density of the materials.

7.3.3 Comparison of FRA-Cited Test Method Data and Cone Calorimeter Test Data

To evaluate material performance, Cone Calorimeter test data were compared with test data resulting from individual small-scale test methods cited by the FRA. These comparisons are intended to provide a better understanding of the relative performance of currently used and prospective materials.

While the materials tested represent a range of those currently used in passenger trains, many other material combinations are possible in actual use. Accordingly, the comparisons are intended only to show that the Cone Calorimeter test method provides an approach to screen passenger rail car interior materials similar to that provided by the FRA-cited test methods. For the majority of materials, the relative ranking from “best” to “worst” was similar in both test methods. While the uncertainty for the Cone Calorimeter test results are lower than other test

methods, the uncertainty inherent in all individual test methods make their use “less meaningful.” However, new materials and designs are better judged through a systems approach which considers the impact of material and design choices on the overall fire safety of the system. The use of HRR data in a hazard analysis applied to passenger trains could provide such an overall system evaluation.

7.4 APPLICATION TO PHASE II TASKS AND OVERALL PROJECT

The HRR data developed in Phase I will be used in Phase II of this research program to:

- evaluate the ability of computer modeling techniques to predict fire hazard in a rail environment; and
- to mitigate those hazards through combinations of material selection and design features.

In Phase II of this project, the fire performance data obtained from the Cone Calorimeter tests will be used as an input to a computer model (Hazard I) for compartment fires, to prepare a baseline analysis of passenger rail car configurations. The mathematical basis of the hazard analysis using the HRR test data will allow for the assessment of changes in materials, as well as car structural design, detection and suppression systems, and emergency access and evacuation. The intent is to demonstrate the prediction of fire hazard in a rail environment consisting of three scenarios (interior fire, exterior fire, and interior fire on a train in a tunnel) and the ability to mitigate those hazards through any combination of material selection and design features.

Ultimately, fire hazard analysis utilizing necessary data from small-scale HRR measurements may provide a true assessment of the contribution of a material or assembly to the overall fire hazard for identified passenger train fire scenarios. Such analyses can include the effects of rail car and system design, detection and suppression systems, and evacuation time, as well as any tradeoffs between multiple effects. For example, the interaction between materials and the effects of different compartment geometries can be assessed to provide a better overall measure of the fire hazard of materials and component assemblies than is now possible.

Quantitative fire modeling and hazard analysis techniques have the potential of providing significant cost savings. Alternative protection strategies can be studied within the hazard analysis framework to give the benefit-cost relation for each. In addition, measures are evaluated as a system with their many interactions, including the impact of both structure and contents.

Providing these alternatives promotes design flexibility which reduces redundancies and cost without sacrificing safety. New technology can be evaluated before it is brought into practice, thereby reducing the time lag currently required for acceptance. Thus, quantitative hazard analysis can be a powerful complement to existing passenger train fire performance requirements and a useful tool in evaluating improvements to them.

8. REFERENCES

- [1] American Society for Testing and Materials (ASTM). *Standard Test Method for Heat and Visible Smoke Release Rates for Materials and Products Using an Oxygen Consumption Calorimeter*. ASTM E-1354. Annual Book of ASTM Standards. Volume 04.07, 1997.
- [2] Federal Railroad Administration (FRA). “Rail Passenger Equipment; Guidelines for Selecting Materials to Improve Their Fire Safety Characteristics.” *Federal Register*, Vol. 49, No. 162, August 20, 1984. Notices. 33076-33078. Reissued in *Federal Register*, Vol. 49, No. 217, November 7, 1984. 44082-44584. U.S. Department of Transportation (USDOT). National Archives and Records Administration, Washington, DC.
- [3] Urban Mass Transportation Administration (UMTA). “Recommended Fire Safety Practices for Rail Transit Materials Selection.” *Federal Register*, Vol. 49, No. 158, August 14, 1984. Notices. 32482-32486. USDOT. National Archives and Records Administration, Washington, DC.
- [4] FRA. “Rail Passenger Equipment: Reissuance of Guidelines for Selecting Materials to Improve Their Fire Safety Characteristics.” *Federal Register*, Vol. 54, No. 10, January 17, 1989. Notices. 1837-1840. USDOT. National Archives and Records Administration, Washington, DC.
- [5] FRA. 49 CFR, Transportation, Parts 216, 223, 229, 231, 232, and 238: “Passenger Equipment Safety Standards, Notice of Proposed Rulemaking (NPRM).” *Federal Register*, Vol. 62, No.184, September 23, 1997. Proposed Rules. 49728-49824. USDOT. National Archives and Records Administration, Washington, DC.
- [6] Peacock, R.D., et al. *Fire Safety of Passenger Trains: A Review of U.S. and Foreign Approaches*. National Institute of Standards and Technology (NIST). Prepared for FRA, USDOT. Washington, DC. Final Report. Report No. DOT/FRA/ORD-93/23, December 1993.
- [7] National Transportation Safety Board (NTSB). *Railroad Accident Report: Derailment and Collision of Maryland Rail Commuter MARC Train 286 with National Railroad Passenger Corporation Amtrak Train 29, near Silver Spring, Maryland, on February 16, 1996*. Adopted: July 3, 1997. Washington, DC. Report No. NTSB/RAR-97/02.
- [8] NTSB. *Railway Marine Accident Report: Derailment of Amtrak Train No. 2, on the CSXT Big Bayou Canot Bridge Near Mobile, Alabama, September 22, 1993*. Adopted: March 21, 1995. Washington, DC. Report No. NTSB/RAR-95/02.
- [9] Gandhi, S., R.T. Long, and J.G. Quintiere. *Fire Tests of Passenger Rail Car Interior Materials*. Prepared by the Department of Fire Protection Engineering, University of Maryland for the NTSB. Final Report. Contract No. NTSB12-96-SP-034, September 1996.

- [10] NTSB. *Railroad Accident Report - Fire Onboard Amtrak Passenger Train No. 11, the Coast Starlight, Gibson, California, June 23, 1982*. Adopted: April 19, 1983. Washington, DC. Report No. NTSB/RAR-83/03.
- [11] Channel Tunnel Safety Authority. *Inquiry into the Fire on Heavy Goods Vehicle Shuttle 7539 on 18 November 1996*. The Stationary Office. London, May 1997.
- [12] Transportation Safety Board of Canada. *VIA Rail Canada Inc. - Fire Onboard Amtrak Passenger Train No. 66 - Struck a Piece of Rail on the Track - Mile 242.07, - CN North American Kingston Subdivision - Brighton, Ontario - 22 November 1994*. Report Number R94TO357, June 26, 1996.
- [13] “Investigation by HM Railway Inspectorate Into a Fire on a High Speed Train Near Maidenhead on Friday 8 September 1995.” Press release. Maidenhead, UK, January 16, 1996.
- [14] Hellicar, J. “Lessons from the Maidenhead Train Fire.” *Escape from Trains*. Seminar, Heathrow, UK. June 9-10, 1997. Independent Technical Conferences, Ltd., 1997.
- [15] “New Protection for Rolling Stock is to Follow Train Fire.” *FIRE* 77 (950): 11 (August 1984).
- [16] Department of Transport. *Railway Accident: Report on the Fire that Occurred in a Sleeping-Car Train on 6th July 1978 at Taunton in the Western Region, British Railways*. Her Majesty’s Stationery Office. London, November 15, 1979.
- [17] FRA. 49 CFR, Part 239, “Passenger Train Emergency Preparedness; Notice of Proposed Rulemaking.” *Federal Register*, Vol. 62, No. 36, February 24, 1997. Proposed Rule. 8330-8359. USDOT. National Archives and Records Administration, Washington, DC.
- [18] FRA. 49 CFR, Part 220, “Railroad Communications; Notice of Proposed Rulemaking.” *Federal Register*, Vol. 62, No. 123, June 26, 1997. Proposed Rule. 34544-34559. USDOT. National Archives and Records Administration, Washington, DC.
- [19] Babrauskas, V. and S.J. Grayson, Eds. *Heat Release Rate in Fires*. New York: Elsevier Applied Science, 1992.
- [20] European Rail Research Institute (ERRI). *Coaches: Reasons for Undertaking Supplementary Studies on Improvement of the Protection of Coaches Against Fire*. ERRI B 106/RP 22. Utrecht, 1992.
- [21] ERRI. *Coaches: Feasibility Study of Computer Modeling of Fires in Railway Vehicles With a View to Improving Passenger Safety*. ERRI B 106/RP 25. Utrecht, 1992.
- [22] Cappuccio, J.A. “Development of Analytical Techniques for Risk Management Training.” Master’s thesis. Worcester Polytechnic Institute, 1992.

- [23] Barnett, J.R. *Development of Analytical Techniques for Risk Management Training*. Worcester Polytechnic Institute. Prepared for FTA, USDOT. University Research Final Report. Report No. DOT-MA-11-0050-92-1, October 1992.
- [24] Parker, Arthur. "Fire Testing of Mass Transit Assemblies," Fire and Materials Conference. Washington, DC. To Get Date? Interscience Communications, Ltd. London, 1994.
- [25] Schirmer Engineering Corporation. *Life Safety Study and Computer Modeling Analysis for New York City Railroad Tunnels and Pennsylvania Station*. Contract to the National Railroad Passenger Corporation, Sec No. 15-890-29-04-00, 1990.
- [26] Burdett, J.R.F., S.A. Ames, and P.J. Fardell. "Selection of Materials and Composites to Minimize Fire Hazard," in *King's Cross Underground Fire: Fire Dynamics and the Organization of Safety*. The Institution of Mechanical Engineers. London, 1989.
- [27] Peacock, R.D. and E. Braun. *Fire Tests of Amtrak Passenger Rail Vehicle Interiors*, National Bureau of Standards (NBS). Prepared for FRA, USDOT. Technical Note 1193, 1984.
- [28] ASTM. *Standard Test Method for Surface Flammability of Materials Using a Radiant Heat Energy Source*. ASTM E 162, Annual Book of ASTM Standards, Volume 04.07, 1994.
- [29] ASTM. *Standard Test Method for Surface Flammability of Cellular Materials Using a Radiant Heat Energy Source*. ASTM D 3675, Annual Book of ASTM Standards, Volume 09.02, 1990.
- [30] ASTM. *Standard Test Method for Critical Radiant Flux of Floor Covering Systems Using a Radiant Heat Energy Source*. ASTM E 648, Annual Book of ASTM Standards, Volume 04.07, 1997.
- [31] ASTM. *Specification for Lock-Strip Gaskets*. ASTM C-542, Annual Book of ASTM Standards, Volume 04.07, 1995.
- [32] ASTM. *Standard Test Method for Specific Optical Density of Smoke Generated by Solid Materials*. ASTM E 662, Annual Book of ASTM Standards, Volume 04.07, 1995.
- [33] Federal Aviation Administration (FAA). *14 CFR, Aeronautics and Space; Subchapter C; Part 25, Airworthiness Standard, Transport Category Airplanes; Section 25.853(a). Compartment Interiors*. USDOT. As of January 1, 1997. National Archives and Records Administration. Washington, DC.
- [34] ASTM. *Fire Tests of Building Construction and Materials*. ASTM E 119 95A, Annual Book of ASTM Standards, Volume 04.07, Part IV, 1997.
- [35] Pennsylvania Railroad. "The Passing of the Wooden Passenger Car from This Railroad," 1928.

- [36] Troy, J.J. "Fire Protection Provisions for Rapid Transit Systems." *Fire Journal* 70: 13-17 (1976).
- [37] Wilkins, J. J. and R.R. Cavanaugh. *Plastics and Rail Transportation, Polymeric Materials and Their Use in Transportation, April 27-29, 1977*. The Polytechnic Institute of New York, 1977.
- [38] Cavanaugh, R. R. "Selection of Materials for Ground Transportation Vehicles," *Proceedings of the Sixth International Conference on Fire Safety, January 12-16, 1981*. Menlo Park, CA, 1981.
- [39] *Passenger Fire Safety in Transportation Vehicles*. Arthur D. Little. Prepared for Transportation Systems Center (TSC), US DOT. Report No. C-78203, 1975.
- [40] FRA. *49 CFR, Part 223, Safety Glazing Standards - Locomotives, Passenger Cars and Caboose, Subpart B, General Requirements, Section 223.9 Requirements for New or Rebuilt Equipment*. National Archives and Records Administration, Washington, DC. As of October 1, 1996.
- [41] National Railroad Passenger Corporation. *Specification for Flammability, Smoke Emissions and Toxicity*. Amtrak Specification No. 352, April 29, 1991.
- [42] National Fire Protection Association. *NFPA 130, Standard for Fixed Guideway Transit Systems*, Quincy, MA, 1997.
- [43] Litant, I. *Guideline for Flammability and Smoke Emission Specifications*. TSC-76-LFS-6, Transportation Systems Center (TSC), USDOT, 1976.
- [44] Peacock, R.D. and V. Babrauskas. "Analysis of Large-Scale Fire Test Data." *Fire Safety Journal* 17: 387-414 (1991).
- [45] Dorer, R.M. and W.T. Hathaway. *Safety of High Speed Magnetic Levitation Transportation Systems: Preliminary Safety Review of the Transrapid Maglev System*. Volpe Center, USDOT. Prepared for FRA, USDOT. Interim Report. Report No. DOT/FAR/ORD-90/09, November 1990.
- [46] Dorer, R.M., S.H. Markos, et al. *Safety of High Speed Magnetic Levitation Transportation Systems: German High Speed Maglev Train Safety Requirements Potential for Application in the United States*. Volpe Center, USDOT. Prepared for FRA, USDOT. Interim Report. Report No. DOT/FAR/ORD-92/02, February 1992.
- [47] Hathaway, W.T. *Commonalities in Transportation Fire Safety: Regulations, Research and Development, and Data Bases*. TSC, USDOT. Prepared for Office of the Secretary. Final Report. Report No. DOT-TSC-OST-80-5, November 1980.
- [48] Brecher, A. *Materials Research and Technology Initiatives*. Volpe National Transportation Systems Center (Volpe Center), USDOT. Prepared for Research and Special Programs Administration, USDOT. Report No. DOT-T-96-01, November 1995.

- [49] Braun, E. *Fire Hazard Evaluation of the Interior of WMATA Metrorail Cars*. NBS. Prepared for Washington Metropolitan Area Transit Authority. NBSIR 75-971, December 1975.
- [50] Braun, E. *Fire Hazard Evaluation of BART Vehicles*. NBS. Prepared for UMTA, USDOT. NBSIR 78-1421, March 1978.
- [51] NTSB. *Railroad Accident Report: Bay Area Rapid Transit District Fire on Train No. 117 and Evacuation of Passengers While in the Transbay Tube, San Francisco, California, January 17, 1979*. Adopted: July 19, 1979. Report No. NTSB/RAR-79-05.
- [52] *Fire Safety Aspects of Polymeric Materials*. Volume 8, Land Transportation Vehicles, National Materials Advisory Board Pub. NMAB 318-8, National Academy of Sciences, 1979.
- [53] Smith, E.E. "Fire Safety Evaluation of Rapid Transit System." Phase I Report to the Transit Development Corporation, Washington, D.C., unpublished, 1976.
- [54] Smith, E.E. "Fire Safety Evaluation of Rapid Transit Systems." *Proceedings of the International Conference on Fire Safety, January 17 to 21, 1983*. San Francisco, CA, 1983.
- [55] Mikkola, E. and I.S. Wichman. "On the Thermal Ignition of Combustible Materials." *Fire and Materials* 14: 87-96 (1989).
- [56] ASTM. *Standard Test Method for Heat and Visible Smoke Release Rates for Materials and Products*. ASTM E 906, Annual Book of ASTM Standards, Vol. 04.07, 1997.
- [57] Hathaway, W.T. and I. Litant. *Assessment of BART Fire Hardening Program*. Prepared by TSC, USDOT for UMTA, USDOT. Final Report. Report No. UMTA-MA-06-0060-82-3, November 1982.
- [58] Hathaway, W.T., S.H. Markos, and J.B. Baker. *Review of BART "C" Car Fire Safety Characteristics*. TSC, USDOT. Prepared for UMTA, USDOT. Final Report. Report No. UMTA-MA-06-0718-87-1, September 1987.
- [59] National Materials Advisory Board. *Fires in Mass Transit Vehicles: Guidelines for the Evaluation of Toxic Hazards*. Prepared for UMTA, USDOT. National Research Council and Transportation Research Board, National Academy Press, 1991.
- [60] Smith, E.E. "Application of Release Rate Data for Hazard Load Calculations." *Fire Technology* 10 (3) (1974).
- [61] National Highway Traffic Safety Administration (NHTSA), *49 CFR, Transportation, Part 571, Federal Motor Vehicle Safety Standards, Subpart 571.302, Flammability of Interior Materials - Passenger Cars, Multi-Purpose Passenger Vehicles, Trucks, and Buses*. National Archives and Records Administration. Washington, DC. As of October 1, 1996.

- [62] Braun, E. *Report of Fire Test on an AM General Metro Bus*. NBS. Prepared for WMATA. NBSIR 75-718, June 1975.
- [63] NHTSA, *49 CFR, Transportation; Part CFR 571 (FMVSS 302) Flammability of Interior Materials; Advance Notice of Rulemaking*. USDOT. *Federal Register*, Vol. 55, No. 214, November 4, 1988, 44627-44632. Proposed Rules. National Archives and Records Administration. Washington, DC.
- [64] Braun, E., et al. *Assessment of the Fire Performance of School Bus Interior Components*. NIST. Prepared for NHTSA, USDOT. NISTR 4347, July 1990.
- [65] NHTSA, *Flammability of Interior Materials in Buses; Request for Comments*. *49 CFR, Transportation, Part 571 (FMVSS 302)*. USDOT. *Federal Register*, Vol. 56, No. 38, February 26, 1991, 7826-7832. Proposed Rule. National Archives and Records Administration. Washington, DC.
- [66] NHTSA, *49 CFR, Transportation, Part 571 (FMVSS 217); Federal Motor Vehicle Safety Standards; Bus Emergency Exits and Window Retention and Release Final Rule*. USDOT. *Federal Register*, Vol. 57, No. 38, November 2, 1992, Rules and Regulations 49413-49425, (clarification issued December 2, 1992, Vol. 85, No. 229, 57020-57026). National Archives and Records Administration. Washington, DC.
- [67] FTA. *Recommended Fire Safety Practices for Transit Bus and Van Materials Selection*. USDOT. *Federal Register*, Vol. 58, No. 201, October 20, 1993. Notice. 54250-54254. National Archives and Records Administration. Washington, DC.
- [68] FAA. *14 CFR, Part 25, Subpart 25.853, Compartment Interiors, Sections (a)-(d); Subpart 25.855, Cargo or Baggage Compartments; and Appendix F to Part 25*. As of January 1, 1997. National Archives and Records Administration. Washington, DC.
- [69] Federal Test Method Standard 191, Method 5903.2. *Flame-resistance of Cloth, Vertical*. July 9, 1971. National Archives and Records Administration. Washington, DC.
- [70] “Design Standards for Aircraft Seats Make a Difference in Fire Safety.” FAA Technology Today 5 (4) (Summer 1996).
- [71] Peterson, J.M. “FAA Regulations on Aircraft Cabin Wall Materials.” Chapter 17(a) in *Heat Release in Fires*, by V. Babrauskas and S.J. Grayson. New York: Elsevier Applied Science, 1992.
- [72] ASTM. *Standard Test Method for Specific Optical Density of Smoke Generated by Solid Materials for Aerospace Applications*. ASTM F 814. Annual Book of ASTM Standards, Volume 04.07, 1984.
- [73] FAA. *Aircraft Material Fire Test Handbook*. FAA Technical Center. USDOT. Atlantic City. Report No. DOT/FAA/CT-89/15, September 1990.

- [74] NHTSA, *49 CFR, Transportation; Part 571 (FMVSS 217) Federal Motor Vehicle Safety Standards; Bus Emergency Exits and Window Retention and Release*. USDOT. As of October 1996. National Archives and Records Administration. Washington, DC.
- [75] FAA. *14 CFR, Part 25, Subparts 25.803, Emergency Evacuation; 25.807, Emergency Exits; and other related subparts*. USDOT. As of January 1, 1997. National Archives and Records Administration. Washington, DC.
- [76] United States Coast Guard (USCG). *46 CFR, Shipping; Subchapter H, Passenger Vessels, Part 72, Construction and Arrangement*. USDOT. As of October 1, 1996. National Archives and Records Administration. Washington, DC.
- [77] USCG. *46 CFR, Subchapter K, Small Passenger Vessels Carrying More Than 150 Passengers or with Overnight Accommodations for More than 49 Passengers, Part 116, Construction and Arrangement*. USDOT. As of October 1, 1996. National Archives and Records Administration. Washington, DC.
- [78] USCG. *46 CFR, Subchapter T, Small Passenger Vessels (Under 100 Gross Tons), Part 177, Construction and Arrangement*. USDOT. As of October 1, 1996. National Archives and Records Administration. Washington, DC.
- [79] USCG. “46 CFR, Parts 170, 171, 173, and Chapter I, Subchapters K and T; Small Passenger Vessel Inspection and Certification, Final Rule.” USDOT. *Federal Register*, Vol. 62, No. 169, September 30, 1997. 51326-51359. National Archives and Records Administration. Washington, DC.
- [80] USCG. *46 CFR, Shipping; Subchapter Q, Equipment, Construction, and Materials: Specifications and Approval, Part 164, Materials*. USDOT. As of October 1, 1996. National Archives and Records Administration. Washington, DC.
- [81] ASTM. *Standard Test Method for Surface Burning Characteristics of Building Materials*, ASTM E 8497-A. Annual Book of ASTM Standards, Volume 04.07, 1997.
- [82] Consumer Products Safety Commission. *16 CFR, Commercial Practices, Subchapter D, Flammable Fabrics Act Regulations, Part 1632, Standard for the Flammability of Mattresses and Mattress Pads*. As of January 1, 1997. National Archives and Records Administration. Washington, DC.
- [83] NFPA. *Standard Methods of Fire Tests for Flame Resistant Textiles and Film*. NFPA 701. Quincy, MA, 1996.
- [84] USCG, *46 CFR, Shipping; Subpart 70.15, Equivalents; Subpart 116.340, Alternate Design Considerations; and Subpart 177.340, Alternate Design Considerations*. As of October 1, 1996. National Archives and Records Administration. Washington, DC.

- [85] USCG. Navigation and Vessel Inspection Circular No. 9-97, *Guide to Structural Fire Protection* (NVIC 9-97). Commandant, Marine Safety and Environmental Protection, Office of Design and Engineering Standards, Life Safety and Fire Safety Standards (G-MSE-4), October 1997.
- [86] State of California. *Technical Bulletin 133 Flammability Test Procedure for Seating Furniture for Use in Public Occupancies*. Department of Consumer Affairs, Bureau of Home Furnishing and Thermal Insulation, 1992.
- [87] USCG. Navigation and Vessel Inspection Circular No. 8-93, *Equivalent Alternatives to 46 CFR, Subchapter H, Requirements Related to Means of Escape, Safe Refuge Areas, and Main Vertical Zone Length* (NVIC-8-93). Commandant, Office of Marine Safety Security and Environmental Protection, Ship Design Branch, Safety and Oversight Section (G-MTH-4), November 1993.
- [88] International Maritime Administration. *SOLAS: Consolidated edition. Consolidated text of the International Convention for the Safety of Life at Sea, 1974, and its Protocol of 1978; Articles, Annex and Certificates. Incorporating all amendments up to and including the 1990 amendments (1991 amendments included as an appendix)*. London, 1992.
- [89] IMO. *International Code for Application of Fire Test Procedures*. Resolution MSC. 61 (67). Adopted: 5 December 1996.
- [90] IMO. *International Code of Safety for High-Speed Craft*. Resolution MSC.36 (63). Adopted: 20 May 1994. London, 1995.
- [91] International Organization for Standardization (ISO). *International Standard-Full-Scale Room Test*. ISO 9705. Geneva, 1996.
- [92] ISO. *International Standard-Fire Test Reaction to Fire-Rate of Heat Release from Building Products*. ISO 5660. Geneva, 1993.
- [93] Snyder, J. "Fire Safety, New U.S. Vessel Fire Code Set for Comment." *Marine Log* (January 1997).
- [94] NFPA. *Code for Safety of Life from Fire on Merchant Vessels* (Proposed NFPA 301). Report on Proposals, F97. Quincy, MA. Adopted May 21, 1998.
- [95] NFPA. *Life Safety Code*, NFPA 101. Quincy, MA, 1997.
- [96] Deutsches Institut Für Normung e.V. *DIN 5510, Preventive Fire Protection in Railway Vehicles; Levels of Protection, Fire Preventive Measures and Certification*, Parts 1-8. Germany, 1988.
- [97] Hathaway, W.T. and I. Litant. *Rationale for Recommended Fire Safety Practices for Rail Transit Materials Selection*. TSC, USDOT. Prepared for UMTA, USDOT. Final Report. Report No. DOT-TSC-UMTA-81-74, January 1983.

- [98] l'Association Française de Normalisation (AFNOR), ed. *NF F 16-10, Railway Rolling Stock, Fire Behaviour, Choice of Materials*. Edited by Tour Europe Cedex 7, 92080 Paris la Defense, France, October 1988.
- [99] l'Association Française de Normalisation (AFNOR), ed. *NF F 16-10, Railway Rolling Stock, Fire Behaviour, Choice of Materials, Application to Electrical Equipment*. Tour Europe Cedex 7, 92080 Paris la Defense, France, October 1989.
- [100] l'Association Française de Normalisation (AFNOR). *NF F 16-103, Railway Rolling Stock, Fire Protection and Fire Fighting*. Tour Europe Cedex 7, 92080 Paris la Defense, France, June 1989.
- [101] International Union of Railways. *UIC Code 564-2 O, Regulations Relating to Fire Protection and Fire-fighting Measures in Passenger-carrying Railway Vehicles or Assimilated Vehicles Used on International Services*, 1991.
- [102] Litant, I. "Comparison of U.S. and French Regulations for Rail Transit Fire Safety." Presented at the Thirteenth International Conference on Fire Safety. San Francisco, CA, 1988.
- [103] Young, R. "Behaviour of Rail Vehicle Components in Fires." *Proceedings of Fire Performance of Materials in Mass Transport*, May 26, 1988. Rapra Technology Ltd. Shawbury, UK, 1988.
- [104] British Standards Institution. *BS 6853, British Standard Code of Practice for Fire Precautions in the Design and Construction of Railway Passenger Rolling Stock*. London, 1987.
- [105] Young, Roy. "Development of Heat Release Techniques Within European Railways." *Proceedings of the Fire Safety by Design Conference*. University of Sunderland, UK. Vol. 3, 1995.
- [106] ERRI. Young, R., Scientifics/British Railway Board. Edited by A. Kaminski, ERRI Technical Advisor. *Improvement of the Fire Protection of Passenger Rolling Stock, Results of Additional Cone Calorimeter Tests on Seat Materials and Furniture Calorimeter Tests on Mock-Up Seats*. ERRI C204.1/DT319. Utrecht, 1995.
- [107] Malhotra, H. L. "Fire Protection in Channel Tunnel Car Carrying Shuttles." *Proceedings of Interflam '93, 6th International Fire Conference*. Interscience Communications, Ltd. London, 1993.
- [108] Göransson, U. and A. Lundqvist. *Fires in Buses and Trains, Fire Test Methods*. Swedish National Testing and Research Institute, Sweden. SP Report No. 1990: 45, 1990.
- [109] *Fires in Transport Tunnels, Report on Full-scale Tests, EUREKA Project 499:FIRETUN*. editor Studiengesellschaft Stahlanwendung e.V., D-40213 Dusseldorf, Germany, November 1995.

- [110] ERRI. *Improvement of the Protections Against Fire of Passenger Rolling Stock; Progress Report on the Tests Carried Out Using A Cone Calorimeter and the Calculations with HAZARD 1.1. Software Package*. ERRI C 204/RP 1. Utrecht, 1994.
- [111] ASTM. *Standard Test Method for Flame Propagation of Dense and Cellular Elastomeric Gaskets and Accessories*, ASTM C 1166, Annual Book of ASTM Standards, Vol. 04.07, 1995.
- [112] Gross, D., Loftus, J.J., Lee, T.G., and Gray, V.E., *Smoke and Gases Produced by Burning Aircraft Interior Materials*, NBS, Building Science Series 18, 1969.
- [113] Babrauskas, V. and R.D. Peacock. "Heat Release Rate: The Single Most Important Variable in Fire Hazard." *Fire Safety Journal* 18 (3): 255-272 (1992).
- [114] Hirschler, M.M. "How to Measure Smoke Obscuration in a Manner Relevant to Fire Hazard Assessment: Use of Heat Release Calorimetry Test Equipment," *Journal of Fire Science* 9: 183-222 (1993).
- [115] Gann, R.G., V. Babrauskas, R.D. Peacock, and J.R. Hall, Jr. "Fire Conditions for Smoke Toxicity Measurement." *Fire and Materials* 18 (3): 193-199 (1994).
- [116] Babrauskas, V. "Comparative Rates of Heat Release from Five Different Types of Test Apparatuses." *Journal of Fire Sciences* 4: 148-159 (1986).
- [117] Inberg, S.M. *Fire Tests of Office Occupancies at US Bureau of Standards*. NFPA Quarterly 19 (3): 234-7 (1926).
- [118] *Toxicity of Combustion Products, Part 2. Guide to the Relevance of Small-scale Tests for Measuring the Toxicity of Combustion Products of Materials and Composites*. PD 6503: Part 2, British Standards Institution, London, 1988.
- [119] Babrauskas, V. "The Cone Calorimeter," Chapter 4 in *Heat Release in Fires* by V. Babrauskas and S.J. Grayson. New York: Elsevier Applied Science, 1992.
- [120] Ames, S., V. Babrauskas, and W. Parker. "Upholstered Furniture: Prediction by Correlations," Chapter 15 in *Heat Release in Fires*, by V. Babrauskas and S.J. Grayson. New York: Elsevier Applied Science, 1992.
- [121] Gross, D. and Loftus, J. "Surface Flame Propagation in Cellulosic Materials Exposed to Thermal Radiation," *Journal of Research*, NBS, 67C (Eng and Instr) 3: 251-258 (1963).
- [122] Rockett, J.A. *Mathematical Modeling of Radiant Panel Test Methods in Fire Safety Research*, NBS. Special Publication 411, 1974.
- [123] Janssens, M. *Flame Spread Properties from Cone Calorimetry - General* in *Heat Release in Fires*, Edited by V. Babrauskas and S.J. Grayson. New York: Elsevier Applied Science, 1992.

- [124] Östman, B.A-I. "Smoke and Soot," in *Heat Release in Fires*, edited by V. Babrauskas and S.J. Grayson. New York: Elsevier Applied Science, 1992.
- [125] Babrauskas, V. and Mulholland, G. *Smoke and Soot Data Determinations in the Cone Calorimeter, Mathematical Modeling of Fires*, ASTM STP 983, American Society for Testing and Materials, 1987.
- [126] Quintiere, J.G. "Smoke Measurements: An Assessment of Correlations Between Laboratory and Full-Scale Experiments." *Fire and Materials* 6: 3 & 4: 145-160 (1982).
- [127] Hirschler, M. M. "How to Measure Smoke Obscuration in a Manner Relevant to Fire Hazard Assessment: Use of Heat Release Calorimetry Test Equipment," *Journal of Fire Science* 9: 183-222 (1991).

**APPENDIX A. FRA FLAMMABILITY AND SMOKE EMISSION
REQUIREMENTS FOR INTERCITY AND COMMUTER
RAIL CAR MATERIALS**

CATEGORY	FUNCTION OF MATERIAL	TEST PROCEDURE	PERFORMANCE CRITERIA
PASSENGER SEATS, SLEEPING AND DINING CAR COMPONENTS	Cushions, Mattresses ^{1,2,5,9*}	ASTM D-3675	$I_s \leq 25$
		ASTM E-662	$D_s (1.5) \leq 100; D_s (4.0) \leq 175$
	Seat and/or Mattress Frame ^{1,5,8}	ASTM E-162	$I_s \leq 35$
		ASTM E-662	$D_s (1.5) \leq 100; D_s (4.0) \leq 200$
	Seat and Toilet Shroud, Food Trays ^{1,5}	ASTM E-162	$I_s \leq 35$
		ASTM E-662	$D_s (1.5) \leq 100; D_s (4.0) \leq 200$
	Seat Upholstery, Mattress Ticking and Covers, Curtains ^{1,2,3,5}	FAR 25.853 (Vertical)	Flame Time ≤ 10 sec.; Burn length ≤ 6 inch
		ASTM E-662	$D_s (4.0) \leq 250$ coated; $D_s (4.0) \leq 100$ uncoated
PANELS	Wall ^{1,5,10}	ASTM E-162	$I_s \leq 35$
		ASTM E-662	$D_s (1.5) \leq 100; D_s (4.0) \leq 200$
	Ceiling ^{1,5,10}	ASTM E-162	$I_s \leq 35$
		ASTM E-662	$D_s (1.5) \leq 100; D_s (4.0) \leq 200$
	Partition, Tables and Shelves ^{1,5}	ASTM E-162	$I_s \leq 35$
		ASTM E-662	$D_s (1.5) \leq 100; D_s (4.0) \leq 200$
	Windscreen ^{1,5}	ASTM E-162	$I_s \leq 35$
		ASTM E-662	$D_s (1.5) \leq 100; D_s (4.0) \leq 200$
	HVAC Ducting ^{1,5}	ASTM E-162	$I_s \leq 35$
		ASTM E-662	$D_s (4) \leq 100$
	Window ^{4,5}	ASTM E-162	$I_s \leq 100$
		ASTM E-662	$D_s (1.5) \leq 100; D_s (4.0) \leq 200$
	Light Diffuser ⁵	ASTM E-162	$I_s \leq 100$
		ASTM E-662	$D_s (1.5) \leq 100; D_s (4.0) \leq 200$
FLOOR COVERINGS	Structural ⁶	ASTM E-119	Pass
	Covering ^{7,10}	ASTM E-648	CRF ≥ 0.5 w/cm ²
		ASTM E-662	$D_s (1.5) \leq 100; D_s (4.0) \leq 200$
INSULATION	Thermal ^{1,2,5}	ASTM E-162	$I_s \leq 25$
		ASTM E-662	$D_s (4) \leq 100$
	Acoustic ^{1,2,5}	ASTM E-162	$I_s \leq 25$
		ASTM E-662	$D_s (4) \leq 100$
ELASTOMERS	Window Gaskets, Door Nosing, Diaphragms, Roof Mat ¹	ASTM C-542	Pass
		ASTM E-662	$D_s (1.5) \leq 100; D_s (4.0) \leq 200$
EXTERIOR PLASTIC COMPONENTS	End Cap, Roof Housings ^{1,5}	ASTM E-162	$I_s \leq 35$
		ASTM E-662	$D_s (1.5) \leq 100; D_s (4.0) \leq 200$
COMPONENT BOX COVERS	Interior, Exterior Boxes ^{1,3,5}	ASTM E-162	$I_s \leq 35$
		ASTM E-662	$D_s (1.5) \leq 100; D_s (4.0) \leq 200$

* Refers to Notes

SOURCES: *Federal Register*, January 17, 1989; *Federal Register*, September 23, 1997.

Note: 9-23-97 Federal Register has 2 errors: HVAC as well as Thermal and Acoustical Insulation D_s limits should be (4.0), instead of (1.5).

Notes

1. Materials tested for surface flammability should not exhibit any flaming running or flaming dripping.
2. The surface flammability and smoke emission characteristics should be demonstrated to be permanent by washing, if appropriate, according to FED-STD-191A Textile Test Method 5830.
3. The surface flammability and smoke emission characteristics should be demonstrated to be permanent by dry cleaning, if appropriate, according to ASTM D 2724. Materials that cannot be washed or dry cleaned should be so labeled and should meet the applicable performance criteria after being cleaned as recommended by the manufacturer.
4. For double window glazing, only the interior glazing should meet the materials requirements specified herein, the exterior need not meet those requirements.
5. ASTM E 662 maximum test limits for smoke emission (specified optical density) should be measured in either the flaming or nonflaming mode, depending on which mode generates the most smoke.
6. Structural flooring assemblies should meet the performance criteria during a nominal test period determined by the transit property. The nominal test period should be twice the maximum expected period of time, under normal circumstances, for a vehicle to come to a complete safe stop from maximum speed, plus the time necessary to evacuate all passengers from a vehicle to a safe area. The nominal test period should not be less than 15 minutes. Only one specimen need be tested. A proportional reduction may be made in the dimensions of the specimen provided that it represents a true test of its ability to perform as a barrier against under-car fires. Penetrations (ducts, etc.) should be designed against acting as passageways for fire and smoke.
7. Floor covering should be tested in accordance with ASTM E 648 with its padding, if the padding is used in actual installation.
8. Arm rests, if formed plastic, are tested as cushions, if hard material, are tested as a seat back shroud.
9. Testing is performed without upholstery.
10. Carpeting on walls and ceilings is to be considered wall and ceiling panel materials, respectively.

APPENDIX B. U.S. RAIL CAR FIRE SAFETY TEST METHODS AND PERFORMANCE CRITERIA

B.1 ASTM E 162 AND ASTM D 3675

The ASTM E 162 test method, illustrated in Figure B-1, was developed by NIST (then National Bureau of Standards [NBS]) in 1955 [1] [2]. A nearly identical method, ASTM D 3675 is used for cellular materials such as seat cushioning. This method measures flame spread and rate of energy release under a varying radiant flux from about 40 to 3 kW/m². The flame spread factor, F_s , calculated from the flame spread velocity, and the heat evolution factor, Q , determined by measuring the temperature in an exhaust duct, are combined to yield a flammability index, I_s :

$$I_s = F_s \times Q$$

The higher the index, the greater the flammability. The test instrument is calibrated to an arbitrary scale with red oak assigned an I_s of 100.

The criteria for this test method range from $I_s \leq 25$ for cushions, mattresses, floor coverings and insulation to $I_s \leq 100$ for window and light diffuser panels. With exceptions, these values are comparable to those typically found in building construction. An I_s of 75 is considered acceptable for the walls and ceilings of corridors in commercial buildings [3] [4], but a value of less than 25 is commonly required in local building codes for corridor linings in institutional

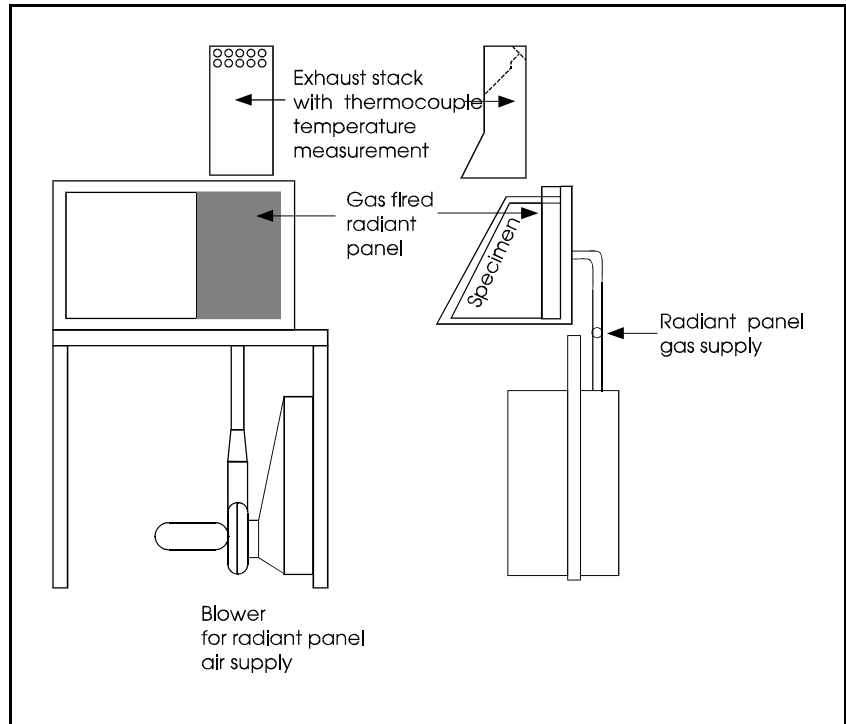

Figure B-1. ASTM E 162 Test Apparatus

buildings. The criteria for window and light diffuser panels of $I_s \leq 100$ is less restrictive than that for wall panels even though the exposure during a fire is identical. Small differences in the criteria such as the FRA criteria of $I_s \leq 25$ for insulation and $I_s \leq 35$ in the Amtrak specification would have little effect on fire safety. These differences are probably driven by desired product acceptability rather than by a desire for different levels of fire safety. However, there is no generally accepted level of performance based on this test method since it is not a prescriptive standard.

B.2 ASTM E 662

The ASTM E 662 test method (Smoke Density Chamber) [5], is used widely in testing of transportation-related materials. Shown in Figure B-2, it measures smoke generation from small, solid specimens exposed to a radiant flux level of 25 kW/m^2 in a flaming (piloted ignition) or nonflaming mode. The smoke produced by the burning specimen in the chamber is measured by a light source – photometer combination. The attenuation of the light beam by the smoke is a measure of the optical density or

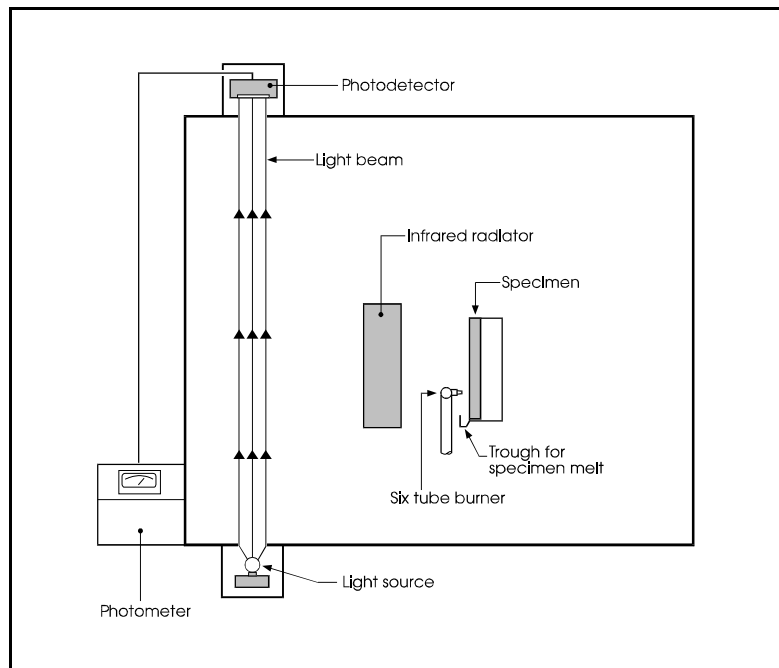

Figure B-2. ASTM E 662 Test Apparatus

“quantity of smoke” that a material will generate under the given conditions of the test. Two measures are typically reported. D_s is an instantaneous measure of the optical density at a particular instant in time. The maximum optical density, D_m , is used primarily in ranking the relative smoke production of a material and in identifying likely sources of severe smoke production. The criteria for this test method are typically D_s at 1.5 minutes ≤ 100 and D_s at 4 minutes ≤ 200 . Small differences in criteria such as the FRA requirement for D_s at 4 minutes ≤ 175 for cushions and mattresses would appear to have little effect on fire safety. Like the small differences in requirements for ASTM E 162, the differences are likely driven by perceived product acceptability rather than real differences in fire safety. Other criteria including the

omission of a requirement at 1.5 minutes for HVAC ducting are likely due to the inability of an otherwise acceptable product to meet the criteria.

B.3 ASTM E 648

The ASTM 648 test method, shown in Figure B-3, exposes a specimen placed horizontally to a radiant energy source that varies across a 3.3 ft (1 m) length from a maximum of 11 kW/m² down to 1 kW/m² [6]. After ignition by a small line burner at the high energy end, the distance at which the floor material stops burning is determined. This point defines the critical radiant flux (CRF) necessary to support continued flame spread. The higher the CRF, the better the fire performance of the floor covering is.

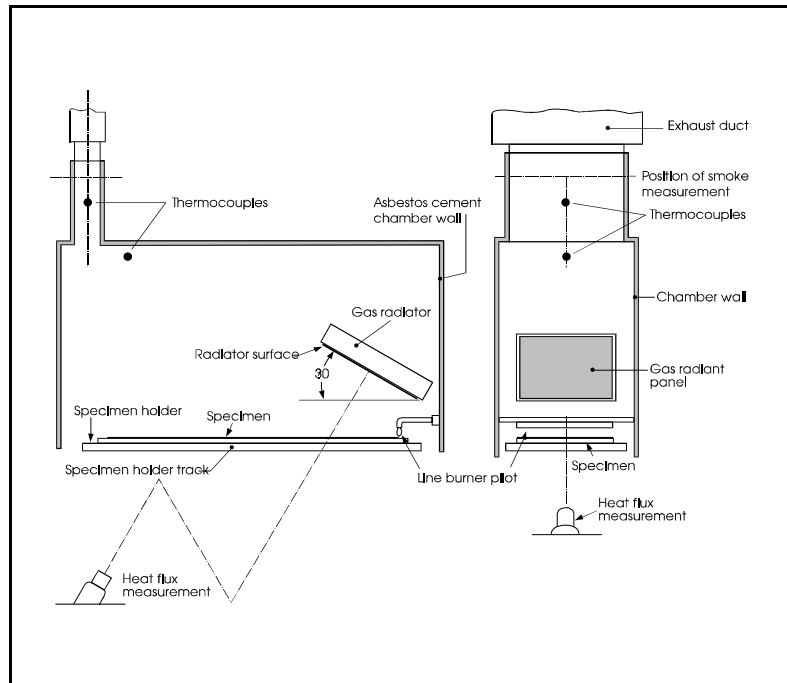

Figure B-3. ASTM E 648 Test Apparatus

Lawson recently reviewed the development, precision, and appropriate use of the this test method [7]. With exceptions, he notes that the precision of the test method is considered equivalent to other fire test methods and has generally reduced losses with fires involving carpet, where the floor covering materials are classified by this test method. Carpet taken from several large fatal fires in which the carpet was determined to be the means of fire spread was found to have very low CRFs when tested according to this method – less than 1 kW/m² [8]. The best performing floor covering would have a CRF greater than 11 kW/m². A performance criterion of 4.5 kW/m² for egressways in non-sprinklered public occupancies is currently in use [9] [10]. The FRA criteria of 5 kW/m² (.05 w/cm²) is somewhat more stringent. It is important to note that these test criteria essentially limit the carpeting such that it will not be the first item ignited. For fully involved fires, fluxes in excess of 20 kW/m² can be developed. In these extremes, carpet may become involved.

In many transportation vehicles, carpet is also routinely used for wall and ceiling covering. For such applications, the results of the horizontally-oriented test method would have little meaning. The additional requirement to test floor covering materials under ASTM E 162 is included to address vertically-oriented applications. Accordingly, the performance criterion for carpet is identical to other wall and ceiling coverings and is discussed in Section B.1.

B.4 FAA FAR 25.853 (a) and ASTM C 542

Small-scale tests, wherein a sample of a material is exposed to a small flame from an alcohol or gas burner have been frequently used and misused to test the flammability of materials since the 1930s [11]. During the 1950s and 1960s, there was an increased reliance on testing flammability of materials by means of Bunsen burner-type tests. This dependence has decreased in recent years following action by the Federal Trade Commission. The primary use of this type of test for passenger rail cars, is the Federal Aviation Administration (FAA) FAR 25.853 (a), Appendix F

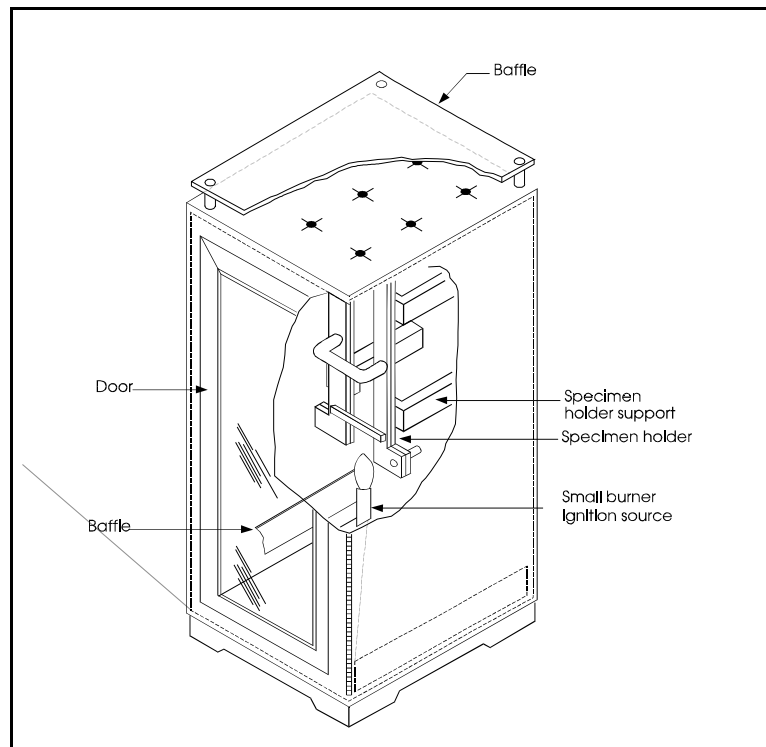

Figure B-4. FAR 25.853 (a) Test Apparatus

(Figure B-4). This standard, used in the current context to assess the acceptability of seat upholstery, mattress ticking and covers, and curtains, defines both a test procedure and performance criteria for small-scale fire performance of compartment interior materials used in transport category airplanes [12]. It is based on Federal Test Method Standard No. 191, Method 5903 [13]. The test procedure is a vertical test with a 1.5 in (3.9 cm) flame applied either for 12 seconds or for 60 seconds (determined by the end-use of the material) to the lower edge of a 2 in (5 cm) wide, 12 in (30.5 cm) long specimen. The test records the flame time, burn length, and flaming time of dripping material.

ASTM C 542 is a similar test which is used for elastomers (defined by FRA as window gaskets, door nosing, diaphragms, and roof mat). The test consists of a 46 cm (18 in) long specimen suspended over a Bunsen burner flame for 15 min. The length of material left after exposure to the flame is intended to provide a measure of the flammability of the materials.

References

- [1] Robertson, A.F., D. Gross, and J.J. Loftus. *A New Test Method for Evaluating Flammability of Interior Finishes*. National Bureau of Standards (NBS). Report 4364, 1955.
- [2] ASTM. *Standard Test Method for Surface Flammability of Materials Using a Radiant Heat Energy Source*. ASTM E 162. Annual Book of ASTM Standards, Volume 04.07, 1994.
- [3] Fang, J. B. *Fire Buildup in a Room and the Role of Interior Finish Materials*. NBS. Technical Note 879, 1975.
- [4] Fang, J. B. and D. Gross. "Contribution of Interior Finish Materials to Fire Growth in a Room," *Proceedings of Fire Safety Research Symposium*, August 22, 1973, NBS. Special Publication 411, 1973.
- [5] ASTM. *Standard Test Method for Specific Optical Density of Smoke Generated by Solid Materials*. ASTM E 662. Annual Book of ASTM Standards, Volume 04.07, 1995.
- [6] ASTM. *Specification for Lock-Strip Gaskets*. ASTM C 542. Annual Book of ASTM Standards, Volume 04.07, 1995.
- [7] Lawson, J. R. "Fire Tests and Flooring Materials." *Proceedings of the Second Fire and Materials International Conference*. September 23-24, 1993, Arlington, VA, 1993.
- [8] Hartzell, L.G. *Development of a Radiant Panel Test for Flooring Materials*. NBS. NBSIR 74-495, 1974.
- [9] Benjamin, I.A. and C.H. Adams. *Proposed Criteria for Use of the Critical Radiant Flux Test Method*. NBS. NBSIR 75-950, 1975.
- [10] Adams, C.H. and S. Davis. *Development of the Flooring Radiant Panel Test as a Standard Test Method*. NBS. NBSIR 79-1959, 1980.
- [11] British Standards Institution. *British Standards Specification 476*. London, 1936.
- [12] FAA. *14 CFR, Part 25, Subpart 25.853, Compartment Interiors, Sections (a)-(d); Subpart 25.855, Cargo or Baggage Compartments; and Appendix F to Part 25*. As of January 1, 1997. National Archives and Records Administration. Washington, DC.

[13] FAA. *49 CFR, Part 25, Subpart 25.853, Compartment Interiors, Sections (a)-(d); Subpart 25.855, Cargo or Baggage Compartments; and Appendix F to Part 25.* As of January 1, 1997. National Archives and Records Administration. Washington, DC.

APPENDIX C. CONE CALORIMETER OVERVIEW

Measurement of heat release rate (HRR) in small-scale is not new. For instance, the OSU Calorimeter [1], which was originally developed around 1970, has been discussed earlier. Its results, however, when compared against other measurement methods, have been found to substantially underestimate the HRR [2]. A number of other instruments were also designed during the 1970s, but were limited because of either poor validity or practical operational difficulties. However, with oxygen consumption calorimetry coming into use, it became obvious that an entirely new instrument should be built which is specifically designed to make use of this principle.

The development work led to a more practical instrument, known as the Cone Calorimeter. The apparatus (Figure C-1) makes use of an electric heater in the form of a truncated cone, hence its name. The apparatus is general-purpose and which may be used to test products for various applications. Thus, the heater had to be capable of being set to a wide variety of heating fluxes; the actual capability spans 0 to 100 kW/m². The design of the heater was influenced by an earlier ISO test on radiant ignition, ISO 5657 [3]. However, the requirements for the Cone Calorimeter went beyond the design parameters of the ISO 5657 cone, thus the actual heating cone in the Cone Calorimeter is a new design. The Cone Calorimeter represented such a significant step forward in fire testing instrumentation that it was awarded the prestigious R&D-100 award in 1988 [4]. The technical features are documented in several references [5][6][7][8]. Some of the most salient features include:

- horizontal or vertical specimen orientation,
- composite and laminated specimens can be tested,
- continuous mass loss load cell readings,
- feedback-loop controlled heater operation,
- HRR calibration using methane metered with mass flow controller,
- smoke measured with laser-beam photometer and gravimetrically, and
- provision for analyzing CO, CO₂, H₂O, HCl, and other combustion gases.

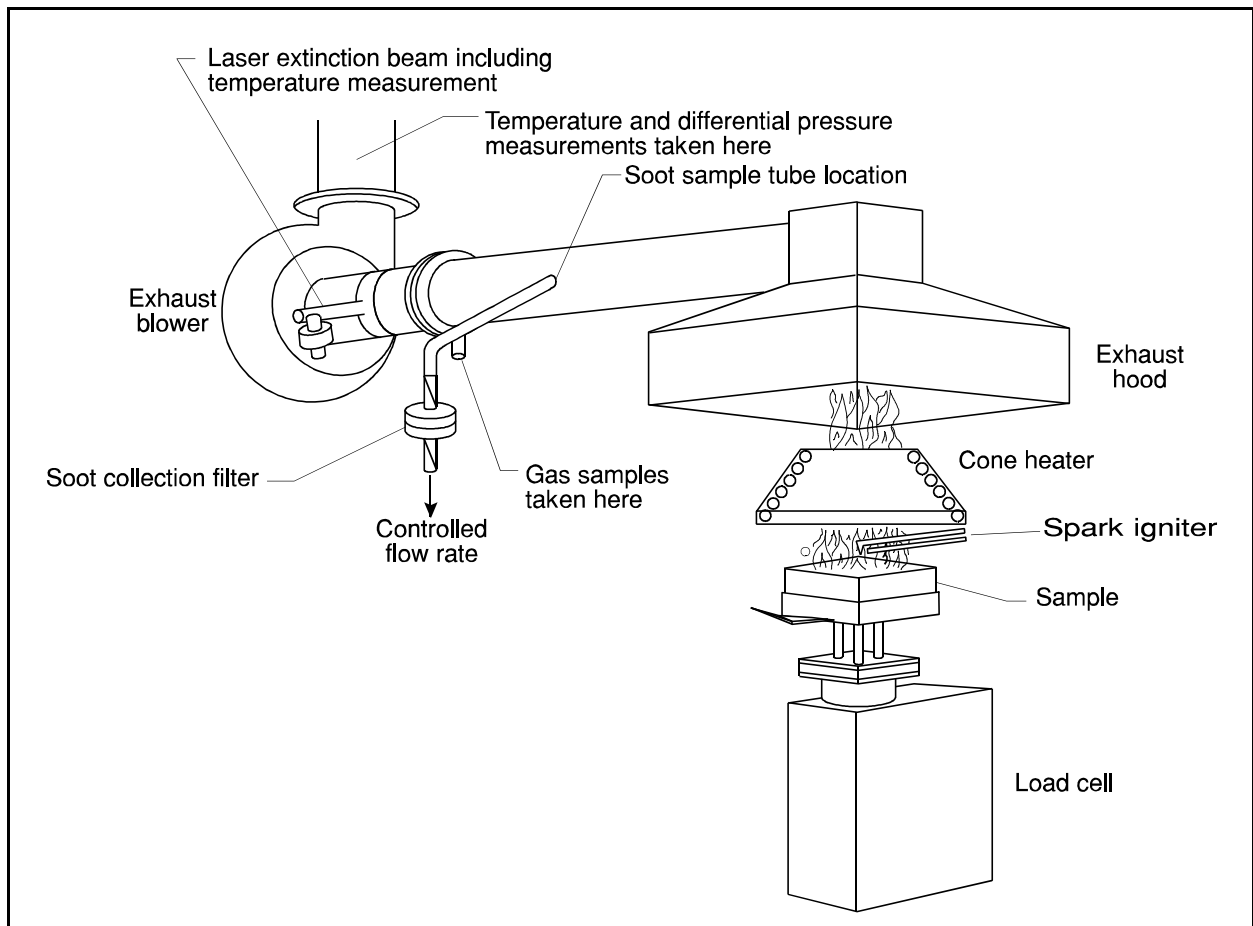

Figure C-1. General View of the Cone Calorimeter (ASTM E 1354, ISO 560)

The Cone Calorimeter is known as ASTM E 1354 [9] or as ISO 5660 [10]. The equipment is made by more than 10 manufacturers and is now used by over 100 laboratories worldwide.

Data from small-scale HRR measurements are reported in kW/m^2 . The extra m^2 , compared to the real-scale results, comes from the fact that in the real-scale, one is interested in the total heat being produced by the burning object. In small-scale, by contrast, the area of the specimen has no intrinsic significance, and results have to be reported on a per-unit-area basis. To go from small-scale data to real-scale predictions, then, requires that an “ m^2 factor” be supplied. This factor – in the simplest case of uniformly burning materials – is the area of flame involvement, at any given time of the fire. Today’s methods for estimating the real-scale HRRs do not, typically, treat this area-of-flame-involvement factor explicitly, but rather include it in the predictive correlations.

Validation of bench-scale HRR data against large-scale fires has been successfully undertaken in several instances; details are discussed below.

Many older devices for assessing flammability were not based on realistic fire conditions, nor were measurements taken which have quantitative engineering significance. As a result, they could only be used to pass or fail a specimen according to some regulatory requirement. Because its design and its data are firmly based on an engineering understanding of fire, the Cone Calorimeter has wider applicability. It can be used to:

- Provide data needed for state-of-the art fire models;
- Provide data used to predict real-scale fire behavior by means of simple formulas or correlations;
- Rank order products according to their performance; or, simply to
- Pass or fail a product according to a criterion level.

The earliest applications of Cone Calorimeter data have been in the polymers industry. Manufacturers typically have relied either on limiting oxygen index (LOI) [11] tests or on UL94 [12]. The former does give quantitative results and uses what would appear to be a suitable engineering variable. Moreover, a recent study has again clearly demonstrated that the results, while quantitative, are not capable of even correctly rank-ordering according to actual fire behavior [13]. However, the latter is a simple Bunsen burner type-test which gives only pass/fail results; it is clear that quantitative information useful for polymer development does not come from such a test.

For purposes of rank ordering and simplified quantification, it was originally proposed in 1984 that a variable should be considered which is \dot{q}_{\max}''/t_{ig} [14]. The ratio expressed here is the peak HRR divided by the time to ignition. Data obtained in the course of various room fire test programs had shown that this variable could account for—approximately—the heat release occurring from surfaces over which flame is spreading. This is possible since the flame spread process and the ignition process are governed by the same thermophysical properties of the material. More recently, Petrella has proposed to the plastics industry that a two-dimensional rating scale be considered, with the variable described above placed on one axis and the total heat released during test placed on the other axis [15]. Besides knowing how to analyze the data for such applications, the other important information needed is at what heat flux should the

specimen be tested. This question is not simple; a paper recently presented examines the necessary considerations [16].

Beyond rank ordering and simple product comparison, there have already been a number of noted successes where Cone Calorimeter HRR data were used for more detailed predictions:

- **Combustible wall and ceiling linings in rooms.** This is a very difficult problem, but very impressive success was achieved in the European “EUREFIC” research program [17]. It is especially noteworthy that data from only the Cone Calorimeter were required in making these real-scale predictions. Another approach to this same problem was developed at Lund University [18].
- **Upholstered furniture.** This problem was addressed at NIST in two separate research projects [19] [20]. Work is continuing in this area both at NIST and in a large European Community project in Europe.
- **Electric wire and cable.** In most countries, the large scale fire test for these products is a vertical cable tray test. In a research project conducted at BF Goodrich, it was demonstrated that the Cone Calorimeter can successfully predict the HRR results from several such large tests [21].
- **Noncombustibility and degrees of combustibility of building products.** Work has been done for the Canadian building code committee establishing the use of Cone Calorimeter data in those areas where the code had specified either noncombustibility tests or material-specific requirements [22][23].

These and other more specialized applications are discussed in detail in a recent textbook which comprehensively examines heat release in fires [24].

References

- [1] American Society for Testing and Materials (ASTM). *Standard Test Method for Heat and Visible Smoke Release Rates for Materials and Products*. ASTM E 906. Annual Book of ASTM Standards, Volume 04.07, 1997.
- [2] Babrauskas, V. “Comparative Rates of Heat Release from Five Different Types of Test Apparatuses.” *Journal of Fire Sciences* 4 (1986).
- [3] International Organization for Standardization (ISO). *Fire tests – Reaction to fire – Ignitability of building products*. ISO 5657. Geneva, 1986.
- [4] 1988 R&D•100 Award Winners. *Research & Development*, 30, October 1988.

- [5] Babrauskas, V. "Development of the Cone Calorimeter – A Bench-scale Heat Release Rate Apparatus Based on Oxygen Consumption." *Fire and Materials* 8 (1984).
- [6] Babrauskas, V., and W.J. Parker. "Ignitability Measurements with the Cone Calorimeter." *Fire and Materials* 11 (1987).
- [7] Babrauskas, V., and G. Mulholland. "Smoke and Soot Data Determinations in the Cone Calorimeter," in *Mathematical Modeling of Fires*, 83-104, (ASTM STP 983). ASTM, 1987.
- [8] Babrauskas, V. "The Cone Calorimeter – Fire Properties," in *New Technology to Reduce Fire Losses & Costs*, 78-87, S.J. Grayson and D.A. Smith, eds. London: Elsevier Applied Science Publishers, 1986.
- [9] ASTM. *Standard Test Method for Heat and Visible Smoke Release Rates for Materials and Products using an Oxygen Consumption Calorimeter*. ASTM E 1354, Annual Book of ASTM Standards, Vol. 04.97, 1997.
- [10] International Organization for Standardization. *International Standard – Fire Tests – Reaction to Fire – Rate of Heat Release from Building Products*. ISO 5660. Geneva, 1992.
- [11] ATSM. *Standard Method of Test for Flammability of Plastics using the Oxygen Index Method*. ASTM D 2863. 1995.
- [12] Underwriters Laboratories. "Tests for Flammability of Plastic Materials for Parts in Devices and Appliances (UL 94)," Northbrook, 1991.
- [13] Weil, E.D., et al. "Oxygen Index: Correlations to Other Fire Test." *Fire and Materials* 16:159-167 (1992).
- [14] Babrauskas, V. *Bench-scale Methods for Prediction of Full-scale Fire Behavior of Furnishings and Wall Linings*, Technical Report 84-10, Society of Fire Protection Engineers. Boston, 1984.
- [15] Petrella, R.V. Presentation to the Society of the Plastics Industry, Inc., Miami, FL, December, 1992.
- [16] Babrauskas, V. "Specimen Heat Fluxes for Bench-scale Heat Release Rate Testing" Paper presented at INTERFLAM '93, Oxford, April 1993.
- [17] Wickström, U., and U. Göransson. "Full-scale/Bench-scale Correlations of Wall and Ceiling Linings," *Fire and Materials* 16: 15-22 (1992).
- [18] Karlsson, B. "A Mathematical Model for Calculating Heat Release Rate in the Room Corner Test." Paper presented at ASTM International Symposium on Fire and Flammability of Furnishings and Contents, 1992.

- [19] Babrauskas, V., and J.F. Krasny. "Fire Behavior of Upholstered Furniture," NBS. Monograph 173, 1985.
- [20] Parker, W.J., et al. *Furniture Flammability: An Investigation of the California Technical Bulletin 133 Test. Part III: Full-scale Chair Burns*. NBS. NISTIR 4375, 1990.
- [21] Hirschler, M.M. "Electric Cable Fire Hazard Assessment with the Cone Calorimeter," in *Fire Hazard and Fire Risk Assessment*, 44-65, (ASTM STP 1150). ASTM, 1992.
- [22] Richardson, L.R., and M.E. Brooks. "Combustibility of Building Materials," in *Fire and Materials* 15: 131-136 (1991).
- [23] Richardson, L.R. "Determining Degrees of Combustibility of Building Materials — National Building Code of Canada," in *Proceedings of the First International Fire and Materials Conference*, 1-12, Interscience Communications, Ltd. London, 1992.
- [24] Babrauskas, V., and S.J. Grayson, eds. *Heat Release in Fires*. London: Elsevier Applied Science, 1992.

APPENDIX D. CONE CALORIMETER TEST DATA

This appendix contains samples of the summary data sheets for all of the materials tested in the Cone Calorimeter for this study.

The following tables and figures are included in this appendix:

Table D-1	Materials tested.
Tables D-2 and D-3	Summary of Cone Calorimeter heat release rate (HRR), smoke extinction area (SEA), and data for individual component materials tested.
Tables D-4 and D-5	Summary of Cone Calorimeter HRR and SEA data for assemblies of individual component materials tested.
Table D-6	Cone Calorimeter HRR and SEA data for individual component materials tested in this study. This table includes individual test results for all the Cone Calorimeter tests performed.
Figures D-1 thru D-37	Representative plots of HRR, heat of combustion, SEA, and mass loss rate for each of the 30 different individual component samples tested. These data were selected because of their usefulness in fire modeling.

Table D-1. List of Passenger Train Materials Used in this Study

CATEGORY	SAMPLE NO.*	MATERIAL DESCRIPTION (COMPONENTS)
SEAT AND BED ASSEMBLIES	1a, 1b, 1c, 1d	Seat cushion, (foam, interliner, fabric/PVC cover)
	2a, 2b, 2c	Seat cushion, (foam, interliner, fabric cover)
	3	Graphite filled foam
	4	Seat support diaphragm, chloroprene elastomer
	5	Seat support diaphragm, FR cotton muslin
	6	Seat shroud, PVC/acrylic
	7	Seat arm rest pad, (foam on metal support)
	8	Footrest cover, coach seat (PVC-covered foam)
	9	Seat track cover, chloroprene
	10a, 10b, 10c	Mattress (foam, interliner, ticking)
	11a, 11b, 11c	Bed pad (foam, interliner, ticking)
WALL AND WINDOW SURFACES	12	Wall finishing, wool carpet
	13	Wall finishing, wool fabric
	14	Space divider, polycarbonate
	15	Wall material, FRP / PVC
	16	Wall panel, FRP
	17	Window glazing, polycarbonate
	18	Window mask, FRP
CURTAINS, DRAPES, AND FABRICS	19	Door privacy curtain/window drapery fabric
	20	Drapery fabric, polyester
	21	Blanket, wool fabric
	22	Blanket, modacrylic fabric
	23a, 23b	Pillow, cotton fabric/polyester filler
FLOOR COVERINGS	24	Carpet, nylon
	25	Rubber mat, styrene butadiene
MISC	26	Cafe/lounge/diner table, phenolic/wood laminate
	27	Air duct, neoprene
	28	Pipe wrap insulation foam
	29	Window gasketing, chloroprene elastomer
	30	Door gasketing, chloroprene elastomer

* – letters indicate individual component materials in an assembly. Individual component materials are listed in order in parentheses following the material description.

Note: All foam except Sample 3 is the same type.

**Table D-2. Summary of Cone Calorimeter Heat Release Rate Data
For Individual Component Materials**

CATEGORY	SAMPLE NO.	IGNITION TIME (s)	TIME TO PEAK HRR (s)	PEAK HRR (kW/m ²)	HRR 180s AVG (kW/m ²)
SEAT AND BED ASSEMBLIES	1	15	25	75	40
		5	15	25	5
		10	20	425	30
		5	10	360	30
	2	15	25	80	40
		5	15	25	5
		10	35	265	50
	3	10	10	90	45
	4	30	55	295	115
	5	5	10	195	10
6	30	350	110	95	
7	15	170	660	430	
8	25	100	190	125	
9	20	40	265	205	
10/11a 10/11b 10/11c	10	20	80	20	
	5	10	25	<5	
	5	10	150	5	
WALL AND WINDOW SURFACES	12	30	95	655	395
	13	20	35	745	90
	14	110	155	270	210
	15	25	40	120	100
	16	55	55	610	140
	17	95	245	350	250
	18	45	70	400	110
CURTAINS, DRAPES, AND FABRICS	19	15	20	310	25
	20	20	30	175	30
	21	10	15	170	10
	22	15	25	20	<5
	23	25	60	340	110
FLOOR COVERINGS	24	10	70	245	95
	25	35	90	305	180
MISC	26	45	55	245	130
	27	30	55	140	70
	28	5	10	95	40
	29	30	330	385	175
	30	40	275	205	175

Table D-3. Summary Cone Calorimeter Smoke Data for Individual Component Materials

CATEGORY	SAMPLE NO.	SEA, σ_s (m ² /kg)	
		Peak	180s Avg
SEAT AND BED ASSEMBLIES	1	210 n.a. 420 1040	30 420 230 780
	2	210 n.a. 600	30 420 390
	3	430	50
	4	1780	1390
	5	1350	490
	6	1420	490
	7	1130	780
	8	1400	960
	9	1250	1140
	10/11a 10/11b 10/11c	280 n.a. 140	80 70 80
WALL AND WINDOW SURFACES	12	860	510
	13	460	260
	14	1960	1010.
	15	1330	700
	16	930	530
	17	1170	1000
	18	720	680
	19	480	380
CURTAINS, DRAPES, AND FABRICS	20	1090	800
	21	2440	560
	22	n.a.	N.a.
	23	660	570
FLOOR COVERINGS	24	770	350
	25	1600	1400
MISC	26	250	80
	27	1100	810
	28	1190	690
	29	1390	1190
	30	1470	1200

Table D-4. Summary Cone Calorimeter HRR for Selected Component Combinations

MATERIAL DESCRIPTION	FOAM	INTER-LINER	FABRIC	VINYL	TIME TO IGNITION (s)	TIME TO PEAK HRR (s)	PEAK HRR (kW/m ²)	HRR 60s AVG (kW/m ²)	HRR 180s AVG (kW/m ²)
SEAT CUSHION ASSEMBLIES		✓	✓		12	25	420	120	40
		✓	✓a		7	35	260	130	50
		✓		✓	7	10	360	120	40
	✓		✓		12	15	255	85	50
	✓		✓a		7	30	270	125	50
	✓	✓	✓		12	23	365	80	40
	✓	✓	✓a		7	35	260	85	50
	✓	✓		✓	6	15	370	160	55
	✓		✓		12	25	400	120	80
	✓		✓a		8	35	270	160	85
	✓b	✓	✓		12	25	400	150	90
	✓b	✓	✓a		8	35	275	150	75
	✓b	✓		✓	6	15	400	205	130
	MATTRESS ASSEMBLY	✓	✓	✓	X	7	10	170	78
BED PAD ASSEMBLY	✓	✓	✓	7		10	170	75	40
PILLOW	✓	✓		7		10	160	50	20

a – plush fabric
b – graphite foam

 – assemblies in current use. Note that the use of the interliner is being discontinued due to design considerations.

Table D-5. Summary Cone Calorimeter Smoke Data for Selected Component Combinations

MATERIAL DESCRIPTION	FOAM	INTER-LINER	FABRIC	VINYL	PEAK σ_s (m ² /kg)	60s AVG σ_s (m ² /kg)	180s AVG σ_s (m ² /kg)
SEAT CUSHION ASSEMBLIES		✓	✓		250	210	170
		✓	✓a		600	430	290
		✓		✓	910	510	510
	✓		✓		810	580	320
	✓		✓a		600	410	340
	✓	✓	✓		300	250	200
	✓	✓	✓a		600	420	360
	✓	✓		✓	770	510	510
	✓		✓		890	680	370
	✓		✓a		600	410	360
	✓b	✓	✓		270	180	90
	✓b	✓	✓a		550	350	240
	✓b	✓		✓	800	750	470
	MATTRESS ASSEMBLY	✓	✓	✓	X	140	80
BED PAD ASSEMBLY	✓	✓	✓	130		70	30
PILLOW	✓	✓		320		150	70

a – plush fabric
b – graphite foam

 – assemblies in current use. Note that the use of the interliner is being discontinued due to design considerations.

Table D-6. Cone Calorimeter Test Data for Assemblies and Individual Tests of Component Materials

Sample Number	Specimen Thickness	Initial Mass	Final Mass	Time to Ignition	Flameout Time	Peak values			180 s Average		Test Average					
						\dot{q}	Time to peak	σ_s	\dot{q}	σ_s	Total Heat Released	\dot{m}	σ_s	CO	CO ₂	H _c
	m	g	g	s	s	kW/m ²	s	m ² /kg	kW/m ²	m ² /kg	MJ/m ²	g/s·m ²	m ² /kg	kg/kg	kg/kg	MJ/kg

Sample 1a, 1b, 1c, 1d. Seat cushion (foam, interliner, fabric/PVC, cover)

1*	.051	63.8	48.8	13	461	242	15	750	47	318	15.7	3.69	189.1	.114	0.75	9.3
1*	.025	20.2	10.6	8	325	76	10	246	38	59	10.7	3.5	46	.098	0.89	9.8
1*	.0254	18.9	14.9	8	104	87	10	323	24	85	4.5	4.75	85.3	.052	0.90	10.0
1*	.051	61.1	52.3	11	242	262	15	825	48	323	10.6	4.12	254.5	.071	0.81	10.6
1*	.0504	72.1	66.1	7	61	387	10	908	40	513	8.1	12.23	512.9	.072	0.55	11.8
1*	.0504	92.7	84.5	6	74	373	15	770	55	514	10.5	14.64	514.1	.068	0.67	11.4
1*	.0508	82.9	79.8	12	38	361	25	0	26	0	4.7	0	0	.011	0.53	13.5
1*	.0504	76.3	33.2	11	1791	387	20	277	48	129	61.7	3.18	49.0	.114	1.13	12.7
1*	.0508	81.2	78.1	12	41	356	25	316	27	260	5.1	13.16	259.5	.013	0.57	14.6

* Tested sample was an assembly of component materials.

Key:

Time to ignition – time to sustained burning over most of the specimen surface
 \dot{q} – Heat release rate, the heat evolved from the specimen, per unit of time
 \dot{m} – Specimen mass loss rate, the mass lost by the specimen, per unit of time
 H_c – Effective heat of combustion, the measured heat release divided by the mass lost by the specimen

Flameout time – time to end of sustained burning period
 σ_s – specific extinction area, a measure of the smoke emission from the specimen
 CO, CO_2 – yield of CO and CO₂, mass of CO or CO₂ produced by the specimen divided by the mass lost by the specimen

Table D-6. Cone Calorimeter Test Data for Assemblies and Individual Tests of Component Materials

Sample Number	Specimen Thickness	Initial Mass	Final Mass	Time to Ignition	Flameout Time	Peak values		180 s Average		Test Average							
						\dot{q}	σ_s	\dot{q}	σ_s	\dot{q}	Total Heat Released	\dot{m}	σ_s	CO	CO ₂	H _c	
	m	g	g	s	s	kW/m ²	s	m ² /kg	kW/m ²	m ² /kg	kW/m ²	MJ/m ²	g/s.m ²	m ² /kg	kg/kg	kg/kg	MJ/kg

Sample 1a, 1b, 1c, 1d. Seat cushion (foam, interliner, fabric/PVC cover)

1*	.0504	58.2	54.0	12	81	423	25	250	39	172	114	7.4	8.63	172.1	.044	0.83	15.4
1*	.051	65.8	58.8	12	173	268	15	847	46	317	58	8.9	4.92	317.5	.078	0.83	11.3
1a	.0504	57.4	43.1	14	511	77	25	211	41	32	32	15.7	3.17	18.4	.113	0.87	9.7
1b	.001	54.0	53.6	5	55	19	20	2388	4	545	16	0.8	0.97	544.6	.429	1.38	16.4
1b	.001	48.5	48.1	5	55	30	5	39	5	297	18	0.9	0.90	296.9	.390	1.53	20.5
1c	.001	68.5	65.2	11	63	423	20	418	31	225	140	6.2	9.42	224.9	.032	0.78	16.7
1d	.001	69	64.3	7	36	363	10	1018	29	770	247	6.0	17.86	769.9	.059	0.44	11.4
1d	.001	69.5	65.1	7	44	354	15	1061	29	794	205	6.0	15.15	794.3	.066	0.49	12.1
1d	.003	71.6	67.0	7	39	369	10	1046	28	765	241	5.9	17.22	765	.054	0.45	11.2

* Tested sample was an assembly of component materials.

Key:

Time to ignition – time to sustained burning over most of the specimen surface
 \dot{q} – Heat release rate, the heat evolved from the specimen, per unit of time
 \dot{m} – Specimen mass loss rate, the mass lost by the specimen, per unit of time
 H_c – Effective heat of combustion, the measured heat release divided by the mass lost by the specimen

Flameout time – time to end of sustained burning period
 σ_s – specific extinction area, a measure of the smoke emission from the specimen
 CO , CO_2 – yield of CO and CO₂, mass of CO or CO₂ produced by the specimen divided by the mass lost by the specimen

Table D-6. Cone Calorimeter Test Data for Assemblies and Individual Tests of Component Materials

Sample Number	Specimen Thickness		Initial Mass	Final Mass	Time to Ignition	Flameout Time	Peak values			180 s Average		Test Average						
	m	g					g	q	Time to peak	σ_s	q	σ_s	Total Heat Released	m	σ_s	CO	CO ₂	H _c
	m	g	g	g	s	s	q	s	m ² /kg	kW/m ²	kW/m ²	m ² /kg	MJ/m ²	g/s·m ²	m ² /kg	kg/kg	kg/kg	MJ/kg

Sample 2a, 2b, 2c. Seat cushion (foam, interliner, fabric cover)

2*	.051	80.9	68.5	7	256	265	30	598	59	296	54	13.1	5.55	252.0	.073	0.83	9.3
2*	.051	82.8	76.4	7	86	272	30	594	43	386	109	8.2	11.73	386.3	.089	0.89	11.3
2*	.0508	93.6	83.4	7	193	266	35	594	60	286	62	11.1	6.50	286.4	.088	0.85	9.6
2*	.0508	96.6	90.9	7	67	259	35	598	42	406	141	7.7	13.97	405.8	.086	0.94	12.0
2*	.0508	97.6	91.7	7	71	261	35	590	44	381	136	8.1	13.43	380.9	.089	0.96	12.2
2c	.002	83.5	76.6	9	118	264	35	617	51	448	90	9.5	9.58	448	.108	1.00	12.2
2c	.002	82.1	75.8	7	74	273	30	595	45	403	142	8.5	13.99	402.7	.105	0.91	11.8
2c	.002	76.8	69.1	7	107	265	30	591	53	364	106	10.0	10.11	364.4	.093	0.92	11.4
2c	.0504	78.9	71.8	7	99	260	35	596	53	359	118	10.0	11.48	358.6	.094	0.98	12.5

* Tested sample was an assembly of component materials.

Key:

Time to ignition – time to sustained burning over most of the specimen surface
 q – Heat release rate, the heat evolved from the specimen, per unit of time
 \dot{m} – Specimen mass loss rate, the mass lost by the specimen, per unit of time
 H_c – Effective heat of combustion, the measured heat release divided by the mass lost by the specimen

Flameout time – time to end of sustained burning period

σ_s – specific extinction area, a measure of the smoke emission from the specimen
 CO, CO₂ – yield of CO and CO₂, mass of CO or CO₂ produced by the specimen divided by the mass lost by the specimen

Table D-6. Cone Calorimeter Test Data for Assemblies and Individual Tests of Component Materials

Sample Number	Specimen Thickness	Initial Mass	Final Mass	Time to Ignition	Flameout Time	Peak values		180 s Average		Test Average							
						q	Time to peak	σ _s	q	σ _s	q	Total Heat Released	m	σ _s	CO	CO ₂	H _c
	m	g	g	s	s	q	s	m ² /kg	kW/m ²	m ² /kg	kW/m ²	MJ/m ²	g/s·m ²	m ² /kg	kg/kg	kg/kg	MJ/kg
3*	.025	29.1	11.0	12	584	417	25	261	91	97	63	35.7	4.09	81.9	.058	1.58	17.4
3*	.025	43.1	13.4	8	873	254	40	524	69	219	56	48.2	4.75	189.9	.093	1.44	14.3
3*	.025	45.8	13.4	8	781	277	30	552	89	221	72	55.6	5.76	218.8	.082	1.51	15.2
3*	.025	29.4	8.7	12	727	387	25	277	91	83	58	41.4	4.02	87.6	.093	1.67	17.6
3*	.025	31.3	11.8	12	721	397	25	265	94	105	54	38.1	3.64	71.8	.091	1.58	17.3
3*	.025	42.0	14.0	6	781	402	15	793	127	470	66	50.7	5.06	246.4	.085	1.48	16.0
3*	.025	40.9	11.2	7	727	285	30	583	71	290	68	48.4	5.93	294.5	.091	1.41	14.4
3*	.013	20.1	14.2	4	286	125	5	211	50	33	43	12.0	2.4	26	.084	1.75	18.0
3*	.027	29.2	13.2	11	676	276	15	879	81	355	46	30.0	2.9	166	.128	1.49	16.6

Sample 3. Graphite-filled foam

* Tested sample was an assembly of component materials.

Key:

Time to ignition – time to sustained burning over most of the specimen surface
q – Heat release rate, the heat evolved from the specimen, per unit of time
m – Specimen mass loss rate, the mass lost by the specimen, per unit of time
H_c – Effective heat of combustion, the measured heat release divided by the mass lost by the specimen

Flameout time – time to end of sustained burning period
σ_s – specific extinction area, a measure of the smoke emission from the specimen
CO, CO₂ – yield of CO and CO₂, mass of CO or CO₂ produced by the specimen divided by the mass lost by the specimen

Table D-6. Cone Calorimeter Test Data for Assemblies and Individual Tests of Component Materials

Sample Number	Specimen Thickness	Initial Mass	Final Mass	Time to Ignition	Flameout Time	Peak values			180 s Average		Test Average						
						q	Time to peak	σ_s	q	σ_s	q	Total Heat Released	\dot{m}	σ_s	CO	CO ₂	H _c
	m	g	g	s	s	kW/m ²	s	m ² /kg	kW/m ²	m ² /kg	kW/m ²	MJ/m ²	g/s·m ²	m ² /kg	kg/kg	kg/kg	MJ/kg

Sample 3. Graphite-filled foam

3*	.027	30.7	13.3	12	676	252	20	884	73	364	52	34.5	3.2	150	.101	1.63	17.5
3*	.027	32.3	13.9	12	782	273	15	902	78	396	46	34.8	2.9	163	.108	1.50	16.7
3*	.028	47.5	17.5	8	952	271	30	625	92	309	51	47.5	3.93	135.6	.113	1.32	14.0
3*	.026	44.6	13.8	7	997	264	30	586	82	272	53	52.4	4.44	202.2	.099	1.46	15.1
3	.026	22.5	18.2	4	202	95	10	570	45	62	45	8.6	2.57	58.62	.093	1.60	17.6
3	.026	19.8	15.8	7	199	98	10	522	40	54	42	7.6	2.4	51	.079	1.52	16.7
3	.026	23.0	18.5	5	232	103	5	278	43	39	41	9.3	2.3	34	.088	1.63	18.2
3	.025	100.0	89.0	7	577	64	20	368	48	40	46	25.9	2.30	15.1	.056	2.08	20.7

* Tested sample was an assembly of component materials (including 1b, 1c, and 1d).

Key:

- Time to ignition – time to sustained burning over most of the specimen surface
- Flameout time – time to end of sustained burning period
- q – Heat release rate, the heat evolved from the specimen, per unit of time
- σ_s – specific extinction area, a measure of the smoke emission from the specimen
- \dot{m} – Specimen mass loss rate, the mass lost by the specimen, per unit of time
- CO, CO₂ – yield of CO and CO₂, mass of CO or CO₂ produced by the specimen
- H_c – Effective heat of combustion, the measured heat release divided by the mass lost by the specimen

Table D-6. Cone Calorimeter Test Data for Assemblies and Individual Tests of Component Materials

Sample Number	Specimen Thickness m	Initial Mass g	Final Mass g	Time to Ignition s	Flameout Time s	Peak values		180 s Average		Test Average								
						\dot{q} kW/m ²	Time to peak s	σ_s m ² /kg	\dot{q} kW/m ²	σ_s m ² /kg	\dot{q} kW/m ²	σ_s m ² /kg	Total Heat Released MJ/m ²	\dot{m} g/s·m ²	σ_s m ² /kg	CO kg/kg	CO ₂ kg/kg	H _c MJ/kg

Sample 4. Seat support diaphragm, chloroprene elastomer

4	.001	31.8	14.8	31	286	297	55	1795	114	1384	96	24.0	10.03	1231.	.122	0.93	12.5
4	.001	32.1	14.9	32	296	293	50	1763	113	1389	94	24.3	9.62	1207	.116	.92	12.5
4**	.001	31.0	16.5	27	132	458	55	1541	110	1265	203	20.0	21.02	1265.5	.106	0.86	12.3
4**	.002	33.2	16.1	51	134	654	60	2095	100	782	260	19.3	15.99	782.1	.081	.56	10.0

Sample 5. Seat support diaphragm, FR cotton muslin

5	.001	10.7	8.4	7	78	166	10	1515	9	504	31	2.0	4.91	504.5	.077	0.54	7.6
5	.001	10.9	8.7	7	60	237	15	1126	17	471	69	3.4	5.16	471.4	.097	0.58	13.5
5	.001	57.7	55.4	7	79	175	10	1397	9	505	32	2.1	4.59	505.0	.085	0.52	8.1

** Non standard test conditions.

Key:

Time to ignition – time to sustained burning over most of the specimen surface
 \dot{q} – Heat release rate, the heat evolved from the specimen, per unit of time
 \dot{m} – Specimen mass loss rate, the mass lost by the specimen, per unit of time
 H_c – Effective heat of combustion, the measured heat release divided by the mass lost by the specimen
Flameout time – time to end of sustained burning period
 σ_s – specific extinction area, a measure of the smoke emission from the specimen
 CO, CO_2 – yield of CO and CO₂, mass of CO or CO₂ produced by the specimen divided by the mass lost by the specimen

Table D-6. Cone Calorimeter Test Data for Assemblies and Individual Tests of Component Materials

Sample Number	Specimen Thickness	Initial Mass	Final Mass	Time to Ignition	Flameout Time	Peak values			180 s Average		Test Average					
						q	Time to peak	σ_s	q	σ_s	Total Heat Released	m	σ_s	CO	CO ₂	H _c

Sample 6. Seat shroud, PVC/Acrylic

6	.003	45.7	12.5	27	557	114	350	1419	98	506	83	43.7	9.90	581.9	.100	0.95	11.6
6	.002	43.5	11.7	29	602	106	345	1396	95	486	77	43.7	9.10	555.5	.098	0.98	12.1
6	.002	44.0	11.4	28	603	107	360	1457	92	481	76	43.3	9.29	551.7	.105	0.95	11.7

Sample 7. Armrest pad, coach seat (foam on metal support)

7	.007	115.3	62.8	16	1454	625	155	1190	414	818	81	116.5	8.41	647.3	.137	1.85	19.6
7	.007	116.9	63.7	17	1235	585	170	1121	437	733	100	121.9	9.27	603.3	.126	1.97	20.3
7	.007	116.3	61.6	17	777	766	180	1073	441	789	167	126	19.00	679.1	.128	1.95	20.4

Key:

- Time to ignition* – time to sustained burning over most of the specimen surface
- q* – Heat release rate, the heat evolved from the specimen, per unit of time
- m* – Specimen mass loss rate, the mass lost by the specimen, per unit of time
- H_c* – Effective heat of combustion, the measured heat release divided by the mass lost by the specimen
- Flameout time* – time to end of sustained burning period
- σ_s* – specific extinction area, a measure of the smoke emission from the specimen
- CO, CO₂* – yield of CO and CO₂, mass of CO or CO₂ produced by the specimen divided by the mass lost by the specimen

Table D-6. Cone Calorimeter Test Data for Assemblies and Individual Tests of Component Materials

Sample Number	Specimen Thickness m	Initial Mass g	Final Mass g	Time to Ignition s	Flameout Time s	Peak values			180 s Average			Test Average										
						q kW/m ²	Time to peak s	σ _s m ² /kg	q kW/m ²	σ _s m ² /kg	Total Heat Released MJ/m ²	ṁ g/s·m ²	CO kg/kg	CO ₂ kg/kg	H _c MJ/kg	q kW/m ²	σ _s m ² /kg	Total Heat Released MJ/m ²	ṁ g/s·m ²	CO kg/kg	CO ₂ kg/kg	H _c MJ/kg

Sample 8. Seat footrest cover, chloroprene elastomer

8	.004	51.5	29.9	28	407	151	85	1438	108	1104	80	30.0	7.28	798.3	.160	.91	12.3
8	.004	52.7	29.8	27	402	153	110	1386	111	1037	86	31.6	8.05	736.1	.159	0.90	12.2
8	.004	51.7	12.3	24	322	267	100	1378	157	748	146	42.8	15.63	532.4	.121	0.72	9.6

Sample 9. Seat track cover, chloroprene elastomer

9	.015	57.8	13.8	22	623	263	40	1270	202	1184	109	65.0	12.08	1026.0	.124	1.18	13.1
9	.015	57.9	15.8	16	517	263	45	1261	207	1155	124	61.1	13.64	1039.9	.130	1.14	12.8
9	.015	56.9	13.2	17	481	275	35	1206	211	1067	133	61.4	22.13	968.4	.122	1.11	12.4

Key:

Time to ignition – time to sustained burning over most of the specimen surface
q – Heat release rate, the heat evolved from the specimen, per unit of time
ṁ – Specimen mass loss rate, the mass lost by the specimen, per unit of time
H_c – Effective heat of combustion, the measured heat release divided by the mass lost by the specimen
Flameout time – time to end of sustained burning period
σ_s – specific extinction area, a measure of the smoke emission from the specimen
CO, CO₂ – yield of CO and CO₂, mass of CO or CO₂ produced by the specimen divided by the mass lost by the specimen

Table D-6. Cone Calorimeter Test Data for Assemblies and Individual Tests of Component Materials

Sample Number	Specimen Thickness	Initial Mass	Final Mass	Time to Ignition	Flameout Time	Peak values			180 s Average		Test Average						
						\dot{q}	Time to peak	σ_s	\dot{q}	σ_s	\dot{q}	Total Heat Released	\dot{m}	σ_s	CO	CO ₂	H _c
	m	g	g	s	s	kW/m ²	s	m ² /kg	kW/m ²	m ² /kg	kW/m ²	MJ/m ²	g/s-m ²	m ² /kg	kg/kg	kg/kg	MJ/kg

Sample 10a, 10b, 10c. Mattress (foam, interliner, ticking)

10*	.0508	58.4	47.6	8	242	175	10	113	57	23	53	12.2	4.96	23.0	.069	0.91	10.0
10*	.0504	12.4	9.8	7	120	162	10	318	22	73	39	4.3	2.18	73.2	.339	0.72	14.5
10*	.0508	56.2	49.0	7	153	157	10	129	41	35	56	7.8	5.45	35.5	.063	.83	9.5
10*	.0508	58.2	45.9	7	286	190	10	190	60	47	55	15.0	4.81	32.3	.073	0.95	10.8
10a	.0504	49.5	46.2	9	89	81	20	275	22	76	54	4.0	4.75	75.8	.054	0.97	10.7
10b	.001	49.1	49.0	5	35	14	10	0	1	38	5	.2	.51	38.3	.033	0.06	12.5
10b	.002	50.9	50.8	5	55	33	5	0	1	103	6	.3	.21	102.7	.152	0.51	43.8
10c	.001	53.0	51.5	8	46	159	10	169	8	85	54	1.8	3.20	84.8	.289	0.49	10.7
10c	.001	54.8	53.1	7	43	137	10	139	7	76	52	1.5	5.17	76.2	.215	0.38	8.0
10c	.001	56.6	55.0	7	37	154	10	119	7	65	64	1.5	4.87	64.9	.212	0.35	8.2

Key:

Time to ignition – time to sustained burning over most of the specimen surface
 \dot{q} – Heat release rate, the heat evolved from the specimen, per unit of time
 \dot{m} – Specimen mass loss rate, the mass lost by the specimen, per unit of time
 H_c – Effective heat of combustion, the measured heat release divided by the mass lost by the specimen
 Flameout time – time to end of sustained burning period
 σ_s – specific extinction area, a measure of the smoke emission from the specimen
 CO, CO₂ – yield of CO and CO₂, mass of CO or CO₂ produced by the specimen divided by the mass lost by the specimen

Table D-6. Cone Calorimeter Test Data for Assemblies and Individual Tests of Component Materials

Sample Number	Specimen Thickness m	Initial Mass g	Final Mass g	Time to Ignition s	Flameout Time s	Peak values			180 s Average			Test Average					
						q kW/m ²	Time to peak s	σ _s m ² /kg	q kW/m ²	σ _s m ² /kg	Total Heat Released MJ/m ²	ṁ g/s·m ²	σ _s m ² /kg	CO kg/kg	CO ₂ kg/kg	H _c MJ/kg	
																	q kW/m ²

Sample 11a, 11b. Bed pad (foam, ticking)

11*	.039	43.7	36.9	7	138	143	10	130	42	31	63	7.8	5.47	30.8	.051	0.87	10.2
11a	.051	48.0	44.0	8	112	82	15	202	25	53	47	4.7	4.32	53.3	.064	0.87	10.3
11a	.051	48.4	43.5	8	143	86	15	194	31	48	44	5.7	4.06	48.3	.062	0.89	10.3

Sample 12. Wall finishing, wool carpet

12	.01	30.4	7.3	27	303	663	90	847	397	506	285	76.9	16.00	502.5	.034	2.68	29.4
12	.01	30.2	7.3	32	296	674	85	852	400	504	298	77.4	15.90	510.2	.033	2.70	29.9
12	.01	29.8	7.1	31	374	628	110	873	385	529	226	75.7	15.12	514.9	.030	2.66	29.5

* Tested sample was an assembly of component materials.

Key:

Time to Ignition – time to sustained burning over most of the specimen surface
 q – Heat release rate, the heat evolved from the specimen, per unit of time
 ṁ – Specimen mass loss rate, the mass lost by the specimen, per unit of time
 H_c – Effective heat of combustion, the measured heat release divided by the mass lost by the specimen
 Flameout time – time to end of sustained burning period
 σ_s – specific extinction area, a measure of the smoke emission from the specimen
 CO, CO₂ – yield of CO and CO₂, mass of CO or CO₂ produced by the specimen divided by the mass lost by the specimen

Table D-6. Cone Calorimeter Test Data for Assemblies and Individual Tests of Component Materials

Sample Number	Specimen Thickness		Initial Mass		Final Mass		Time to Ignition		Flameout Time		Peak values			180 s Average		Test Average													
	m	g	g	g	s	s	s	s	s	s	kW/m ²	q	Time to peak	α _s	q	kW/m ²	α _s	m	Total Heat Released	q	kW/m ²	α _s	m ² /kg	CO	kg/kg	CO ₂	kg/kg	H _c	MJ/kg

Sample 13. Wall finishing, wool fabric

13	.002	20.3	11.6	21	483	745	35	464	91	263	41	18.8	2.68	209.2	.065	1.27	19.2
----	------	------	------	----	-----	-----	----	-----	----	-----	----	------	------	-------	------	------	------

Sample 14. Space divider, polycarbonate

14	.013	150.6	44.1	109	2402	286	155	2842	194	1025	110	251.1	7.12	794.7	.066	2.33	20.8
14	.013	145.7	45.1	106	2102	258	150	1073	222	994	122	242.6	8.20	778.3	.081	2.43	21.3

Sample 15. Wall material, FRP/PVC

15	.0015	22.4	5.6	22	283	122	25	1293	103	706	85	21.5	11.26	619.3	.099	0.87	11.3
15	.0015	21.7	4.8	24	341	119	50	1356	97	695	70	22.0	9.83	592.5	.115	0.93	11.5
15	.002	22.5	5.5	22	308	122	40	1328	101	706	78	21.9	10.94	626.9	.106	0.92	11.4

Key:

Time to Ignition – time to sustained burning over most of the specimen surface
 q̇ – Heat release rate, the heat evolved from the specimen, per unit of time
 ṁ – Specimen mass loss rate, the mass lost by the specimen, per unit of time
 H_c – Effective heat of combustion, the measured heat release divided by the mass lost by the specimen
 Flameout time – time to end of sustained burning period
 α_s – specific extinction area, a measure of the smoke emission from the specimen
 CO, CO₂ – yield of CO and CO₂, mass of CO or CO₂ produced by the specimen divided by the mass lost by the specimen

Table D-6. Cone Calorimeter Test Data for Assemblies and Individual Tests of Component Materials

Sample Number	Specimen Thickness m	Initial Mass g	Final Mass g	Time to Ignition s	Flameout Time s	Peak values		180 s Average		Test Average					
						q kW/m ²	Time to peak s	σ _s m ² /kg	q kW/m ²	σ _s m ² /kg	q kW/m ²	σ _s m ² /kg	Total Heat Released MJ/m ²	m g/s-m ²	CO kg/kg

Sample 16. Wall panel, FRP

16	.004	76.2	37.3	52	741	618	55	1052	140	568	89	61.2	8.00	599.3	.098	1.41	13.9
16	.004	74.1	30.7	53	722	563	55	864	142	441	91	60.6	9.57	519.7	.085	1.29	12.4
16	.004	78.6	36.8	57	863	655	60	860	137	575	84	66.8	7.43	615.6	.099	1.45	14.1

Sample 17. Window glazing, polycarbonate

17	.007	80.2	23.6	121	1081	358	135	1157	273	1009	139	133.0	10.55	914.8	.098	2.29	20.8
17	.011	78.7	28.9	83	1141	375	430	1256	195	1033	109	115.0	8.37	931.0	.077	2.33	20.4
17	.006	77.2	18.4	72	902	348	255	1117	292	944	173	142.7	16.47	797.0	.098	2.41	21.5
17	.006	80.5	24.5	109	1202	309	160	1165	234	1006	121	131.6	9.79	917.5	.086	2.32	20.8

Key.

Time to Ignition – time to sustained burning over most of the specimen surface
q – Heat release rate, the heat evolved from the specimen, per unit of time
m – Specimen mass loss rate, the mass lost by the specimen, per unit of time
H_c – Effective heat of combustion, the measured heat release divided by the mass lost by the specimen
Flameout time – time to end of sustained burning period
σ_s – specific extinction area, a measure of the smoke emission from the specimen
CO, CO₂ – yield of CO and CO₂, mass of CO or CO₂ produced by the specimen divided by the mass lost by the specimen

Table D-6. Cone Calorimeter Test Data for Assemblies and Individual Tests of Component Materials

Sample Number	Specimen Thickness m	Initial Mass g	Final Mass g	Time to Ignition s	Flameout Time s	Peak values			180 s Average			Test Average						
						\dot{q} kW/m ²	Time to peak s	σ_s m ² /kg	\dot{q} kW/m ²	σ_s m ² /kg	Total Heat Released MJ/m ²	\dot{m} g/s·m ²	σ_s m ² /kg	CO kg/kg	CO ₂ kg/kg	H _c MJ/kg		

Sample 18. Window mask, FRP

18	.002	43.4	24.3	46	308	364	65	729	101	699	81	20.7	14.43	580.6	.065	1.21	9.6
18	.002	46.1	26.4	43	267	369	70	733	117	659	104	22.9	16.92	612.6	.071	1.29	10.3
18	.002	46.4	25.5	46	317	461	70	693	114	670	90	23.7	13.85	563.9	.067	1.24	10.0

Sample 19. Door privacy curtain/window drapery fabric

19	.001	15.9	12.3	12	49	324	20	474	29	417	191	5.7	14.45	417.2	.035	0.87	14.1
19	.001	15.1	12.2	12	51	309	20	473	24	378	145	5.0	11.91	377.8	.039	0.80	15.1
19	.001	65.0	61.3	14	62	292	25	478	28	347	119	5.3	10.40	346.5	.044	0.72	14.3

Key:

- Time to Ignition* – time to sustained burning over most of the specimen surface
- Flameout time* – time to end of sustained burning period
- \dot{q} – Heat release rate, the heat evolved from the specimen, per unit of time
- σ_s – specific extinction area, a measure of the smoke emission from the specimen
- \dot{m} – Specimen mass loss rate, the mass lost by the specimen, per unit of time
- CO, CO₂ – yield of CO and CO₂, mass of CO or CO₂ produced by the specimen
- H_c – Effective heat of combustion, the measured heat release divided by the mass lost by the specimen

Table D-6. Cone Calorimeter Test Data for Assemblies and Individual Tests of Component Materials

Sample Number	Specimen Thickness m	Initial Mass g	Final Mass g	Time to Ignition s	Flameout Time s	Peak values			180 s Average			Test Average								
						\dot{q}	Time to peak s	σ_s	\dot{q}	σ_s	\dot{q}	σ_s	\dot{m}	Total Heat Released MJ/m ²	\dot{q}	σ_s	\dot{m}	CO kg/kg	CO ₂ kg/kg	H _c MJ/kg

Sample 20. Drapery fabric, polyester

20	.001	12.3	8.7	22	157	172	30	1125	26	707	38	5.0	4.28	707.4	.155	1.14	12.2
20	.001	58.6	54.8	19	138	227	30	1115	31	881	50	5.8	5.82	880.7	.180	1.14	13.6
20	.001	12.0	8.1	21	212	126	30	1032	28	819	29	5.3	2.95	682.4	.152	1.28	12.2

Sample 21. Blanket, wool fabric

21	.003	13.0	10.5	11	82	205	15	2232	10	645	36	2.3	2.71	645.4	.038	0.35	8.1
21	.003	11.5	9.2	11	82	144	15	3033	8	524	27	1.7	1.77	523.5	.043	.33	6.5
21	.003	11.4	9.3	11	82	155	15	2064	7	515	26	1.7	1.99	515.0	.060	.33	6.9

Sample 22. Blanket, modacrylic fabric

22	.003	4.3	1.4	17	62	18	25	n.a.	1.9	n.a.	9	0.4	1.35	n.a.	.091	0.73	10.7
----	------	-----	-----	----	----	----	----	------	-----	------	---	-----	------	------	------	------	------

Key:

Time to Ignition – time to sustained burning over most of the specimen surface
 \dot{q} – Heat release rate, the heat evolved from the specimen, per unit of time
 σ_s – Specimen mass loss rate, the mass lost by the specimen, per unit of time
 \dot{m} – Specimen mass loss rate, the mass lost by the specimen, per unit of time
 H_c – Effective heat of combustion, the measured heat release divided by the mass lost by the specimen

Flameout time – time to end of sustained burning period
 σ_s – specific extinction area, a measure of the smoke emission from the specimen
 \dot{m} – yield of CO and CO₂, mass of CO or CO₂ produced by the specimen
 H_c – Effective heat of combustion, the measured heat release divided by the mass lost by the specimen

Table D-6. Cone Calorimeter Test Data for Assemblies and Individual Tests of Component Materials

Sample Number	Specimen Thickness m	Initial Mass g	Final Mass g	Time to Ignition s	Flameout Time s	Peak values			180 s Average		Test Average							
						\dot{q}	Time to peak s	σ_s	\dot{q}	σ_s	\dot{q}	σ_s	Total Heat Released MJ/m ²	\dot{m}	σ_s	CO	CO ₂	H _c

Sample 23. Pillow

23	.051	9.3	0.0	13	226	324	40	668	114	558	100	21.0	13.4	548.7	.080	2.30	19.5
23	.051	8.8	0.0	31	181	367	55	620	106	525	133	19.3	16.92	525.3	.074	2.09	19.4
23	.051	8.9	0.2	28	127	331	80	681	103	614	196	18.6	13.89	614.0	.048	2.15	18.9

Sample 24. Floor covering, nylon carpet

24	.004	15.1	6.0	9	164	260	70	760	96	334	118	17.6	9.58	334.2	.040	1.60	17.0
24	.004	15.8	6.6	11	176	223	70	776	95	383	111	17.6	8.73	382.8	.041	1.59	16.9
24	.004	15.7	6.3	11	191	251	75	776	99	318	105	18.3	8.73	317.6	.049	1.60	17.2

Key:

Time to Ignition – time to sustained burning over most of the specimen surface
 \dot{q} – Heat release rate, the heat evolved from the specimen, per unit of time
 \dot{m} – Specimen mass loss rate, the mass lost by the specimen, per unit of time
 H_c – Effective heat of combustion, the measured heat release divided by the mass lost by the specimen
 Flameout time – time to end of sustained burning period
 σ_s – specific extinction area, a measure of the smoke emission from the specimen
 CO, CO₂ – yield of CO and CO₂, mass of CO or CO₂ produced by the specimen divided by the mass lost by the specimen

Table D-6. Cone Calorimeter Test Data for Assemblies and Individual Tests of Component Materials

Sample Number	Specimen Thickness m	Initial Mass g	Final Mass g	Time to Ignition s	Flameout Time s	Peak values		180 s Average		Test Average								
						\dot{q}	Time to peak s	σ_s	\dot{q}	σ_s	\dot{q}	σ_s	Total Heat Released MJ/m ²	\dot{m}	σ_s	CO kg/kg	CO ₂ kg/kg	H _c MJ/kg

Sample 25. Rubber mat, styrene butadiene

25	.004	53.5	28.3	36	937	338	85	1601	187	1341	90	80.2	4.13	1120.	.072	2.58	28.2
25	.002	53.7	28.5	37	1257	291	90	1589	175	1421	73	89	3.09	992.6	.116	2.84	31.1
25	.020	100.0	74.9	32	1247	281	95	1610	173	1425	69	83.1	3.09	943.1	.104	2.64	29.3

Sample 26. Cafe/Lounge/Diner table (phenolic/wood laminate)

26	.029	200.4	48.5	42	2103	233	1640	306	128	72	94	192.4	9.44	58.4	.006	1.47	11.2
26	.029	196.8	43.7	47	2162	241	55	208	129	78	90	188.8	9.1	43	.000	1.43	10.9
26	.029	198.8	47.7	43	2102	256	55	235	135	77	92	189.0	8.9	53	.0099	1.45	11.0

Key:

- Time to Ignition* -- time to sustained burning over most of the specimen surface
- \dot{q} -- Heat release rate, the heat evolved from the specimen, per unit of time
- \dot{m} -- Specimen mass loss rate, the mass lost by the specimen, per unit of time
- H_c -- Effective heat of combustion, the measured heat release divided by the mass lost by the specimen
- Flameout time* -- time to end of sustained burning period
- σ_s -- specific extinction area, a measure of the smoke emission from the specimen
- CO, CO₂ -- yield of CO and CO₂, mass of CO or CO₂ produced by the specimen divided by the mass lost by the specimen

Table D-6. Cone Calorimeter Test Data for Assemblies and Individual Tests of Component Materials

Sample Number	Specimen Thickness m	Initial Mass g	Final Mass g	Time to Ignition s	Flameout Time s	Peak values			180 s Average		Test Average						
						q kW/m ²	Time to peak s	O _s m ² /kg	q kW/m ²	O _s m ² /kg	q kW/m ²	Total Heat Released MJ/m ²	ṁ g/s·m ²	O _s m ² /kg	CO kg/kg	CO ₂ kg/kg	H _c MJ/kg

Sample 27. Air duct, neoprene

27	.001	24.2	20.4	29	269	150	55	1126	73	836	60	14.2	2.78	786.3	.044	2.09	32.8
27	.002	23.5	20.3	31	176	139	60	1155	66	856	86	11.9	3.37	856.0	.009	1.98	32.8
27	.001	25.2	21.7	31	236	136	50	1028	68	746	64	12.7	2.64	686.4	.039	1.99	31.9

Sample 28. Pipe wrap insulation foam

28	.013	7.8	3.2	7	158	91	10	1003	39	617	51	7.3	4.11	617.3	.115	1.08	14.1
28	.013	8.0	3.7	7	134	90	10	1219	37	712	58	6.8	4.33	712.2	.091	1.08	14.2
28	.013	7.9	3.8	7	134	98	10	1347	37	739	57	6.8	4.23	738.9	.107	1.11	14.7

Key:

Time to Ignition – time to sustained burning over most of the specimen surface
q – Heat release rate, the heat evolved from the specimen, per unit of time
m – Specimen mass loss rate, the mass lost by the specimen, per unit of time
H_c – Effective heat of combustion, the measured heat release divided by the mass lost by the specimen

Flameout time – time to end of sustained burning period
c_s – specific extinction area, a measure of the smoke emission from the specimen
CO, CO₂ – yield of CO and CO₂, mass of CO or CO₂ produced by the specimen divided by the mass lost by the specimen

Table D-6. Cone Calorimeter Test Data for Assemblies and Individual Tests of Component Materials

Sample Number	Specimen Thickness m	Initial Mass g	Final Mass g	Time to Ignition s	Flameout Time s	Peak values		180 s Average		Test Average					
						\dot{q} kW/m ²	Time to peak s	σ_s m ² /kg	\dot{q} kW/m ²	σ_s m ² /kg	\dot{q} kW/m ²	Total Heat Released MJ/m ²	\dot{m} g/s·m ²	σ_s m ² /kg	CO kg/kg

Sample 29. Window gasketing, chloroprene elastomer

29	.015	99.0	52.8	32	2222	223	290	1399	164	1235	90	197.0	2.6	707	.034	3.50	37.7
29	.015	99.0	52.3	34	2252	193	320	1418	165	1088	89	196.1	2.6	720	.059	3.43	37.1
29	.015	98.8	23.6	22	1382	734	375	1347	193	1234	201	272.8	8.5	674	.091	3.01	32.0

Sample 30. Door gasketing, chloroprene elastomer

30	.015	101.2	54.2	38	2222	207	275	1474	175	1212	121	263.5	2.7	731	.022	3.43	49.6
----	------	-------	------	----	------	-----	-----	------	-----	------	-----	-------	-----	-----	------	------	------

Key:

Time to ignition – time to sustained burning over most of the specimen surface
q̇ – Heat release rate, the heat evolved from the specimen, per unit of time
ṁ – Specimen mass loss rate, the mass lost by the specimen, per unit of time
H_c – Effective heat of combustion, the measured heat release divided by the mass lost by the specimen
Flameout time – time to end of sustained burning period
σ_s – specific extinction area, a measure of the smoke emission from the specimen
CO, CO₂ – yield of CO and CO₂, mass of CO or CO₂ produced by the specimen divided by the mass lost by the specimen

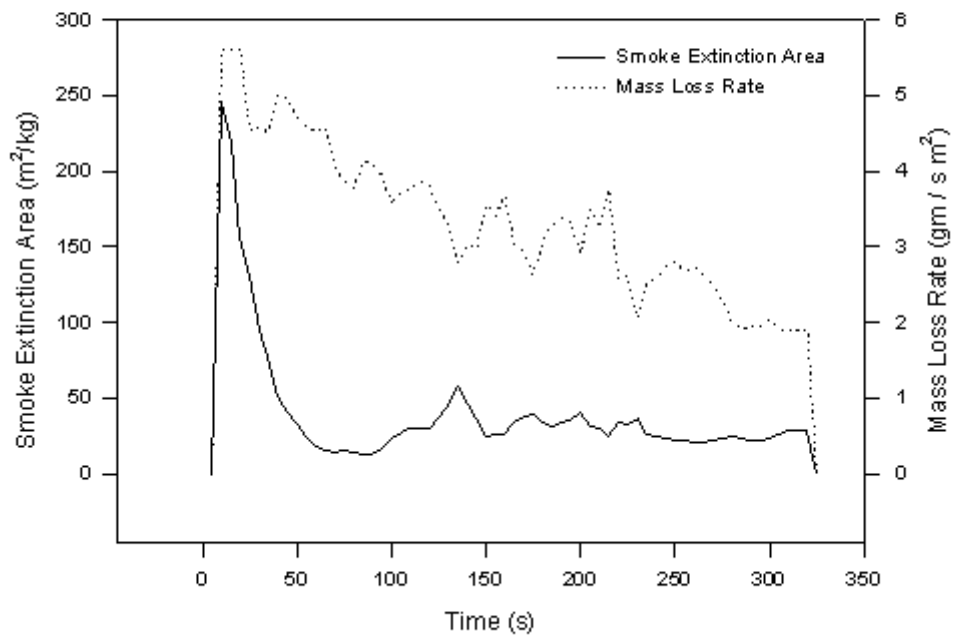
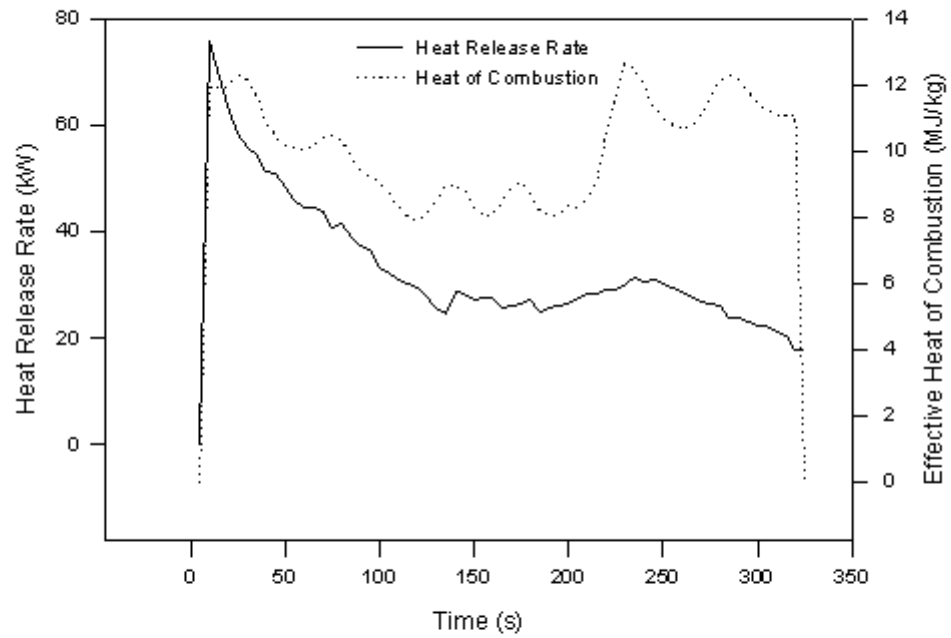

Figure D-1. Sample 1. Seat Cushion, Assembly

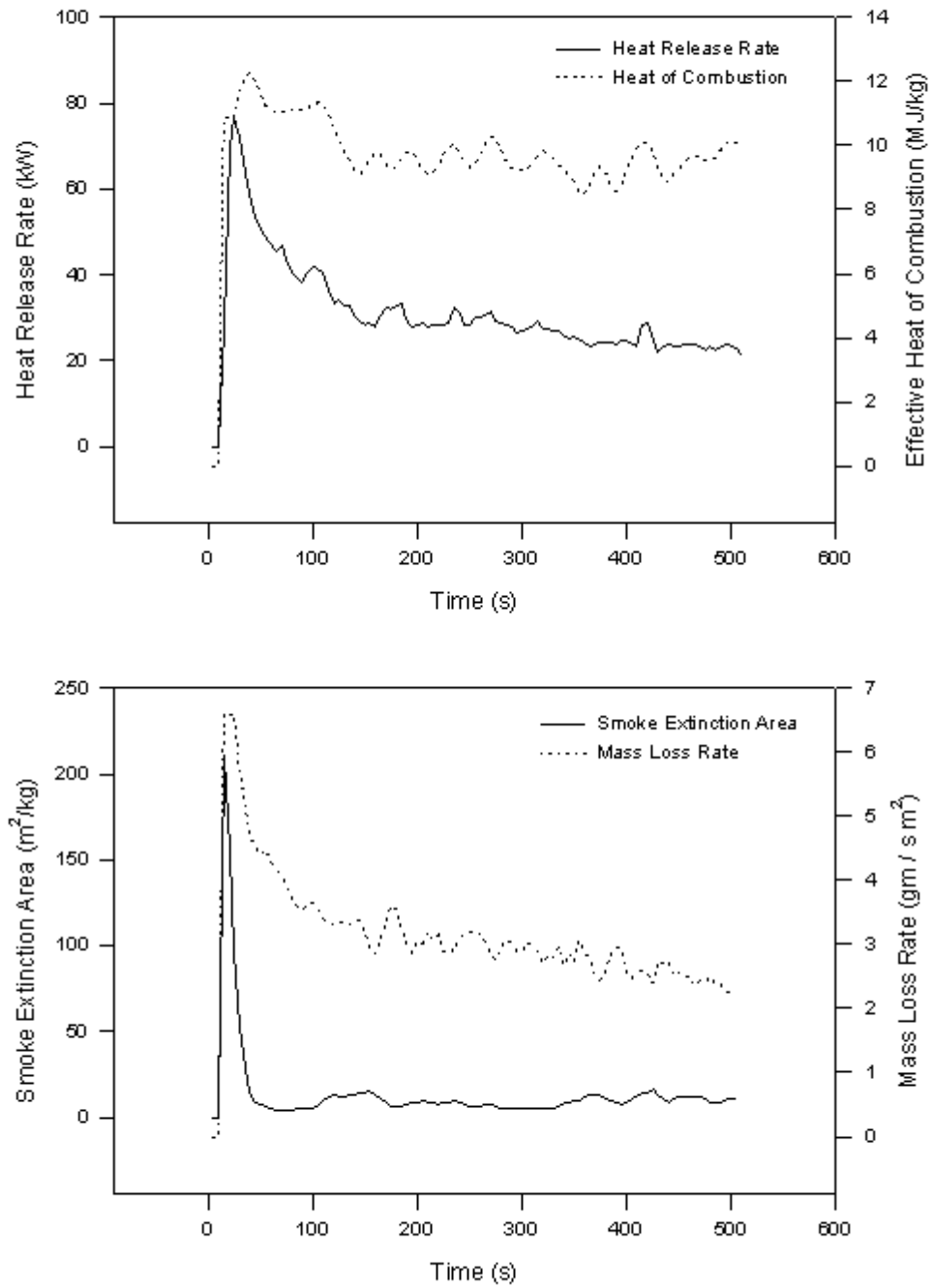

Figure D-2. Sample 1a. Seat Cushion, Foam Only

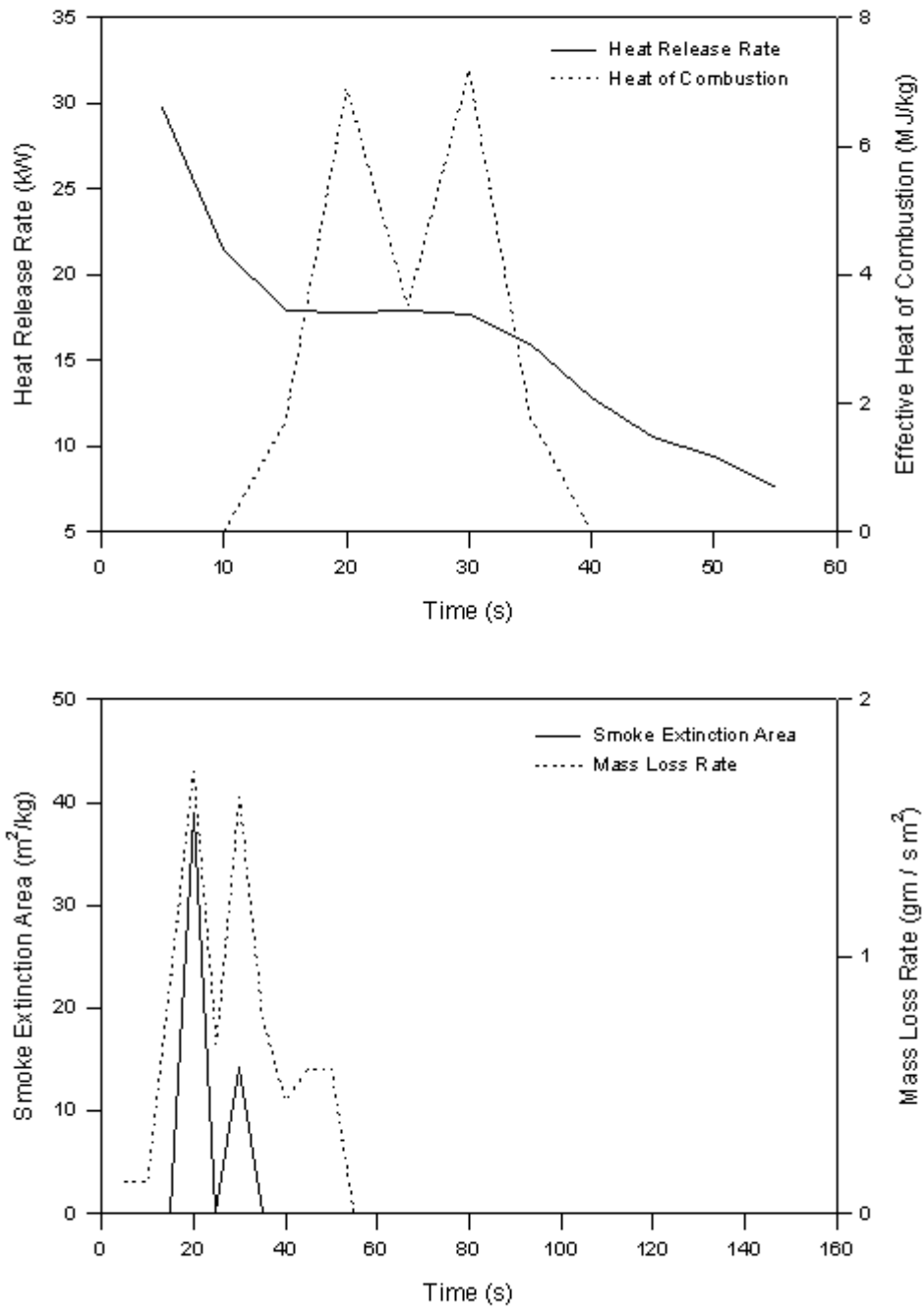

Figure D-3. Sample 1b. Seat Cushion, Interliner Only

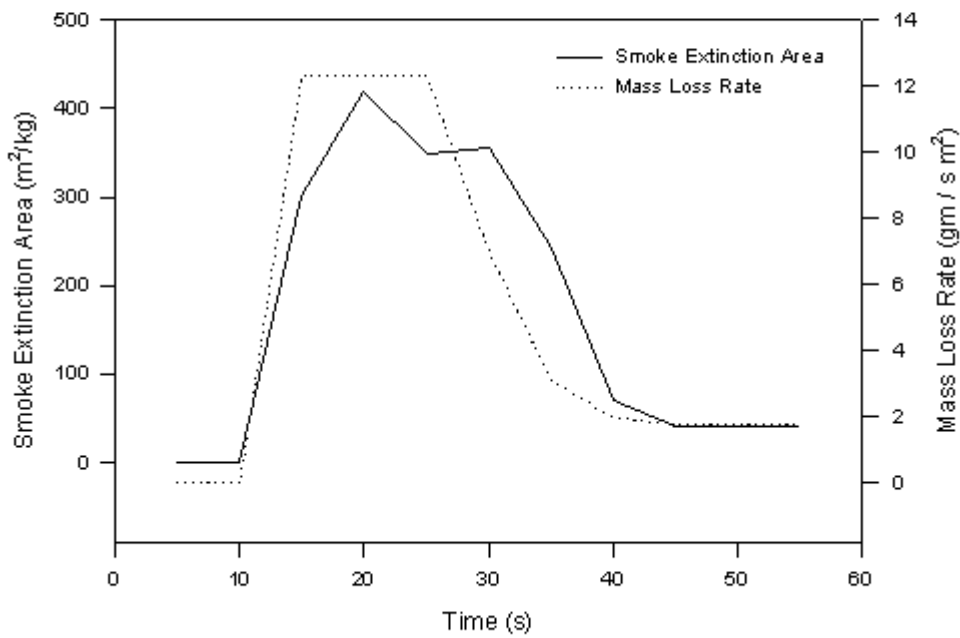
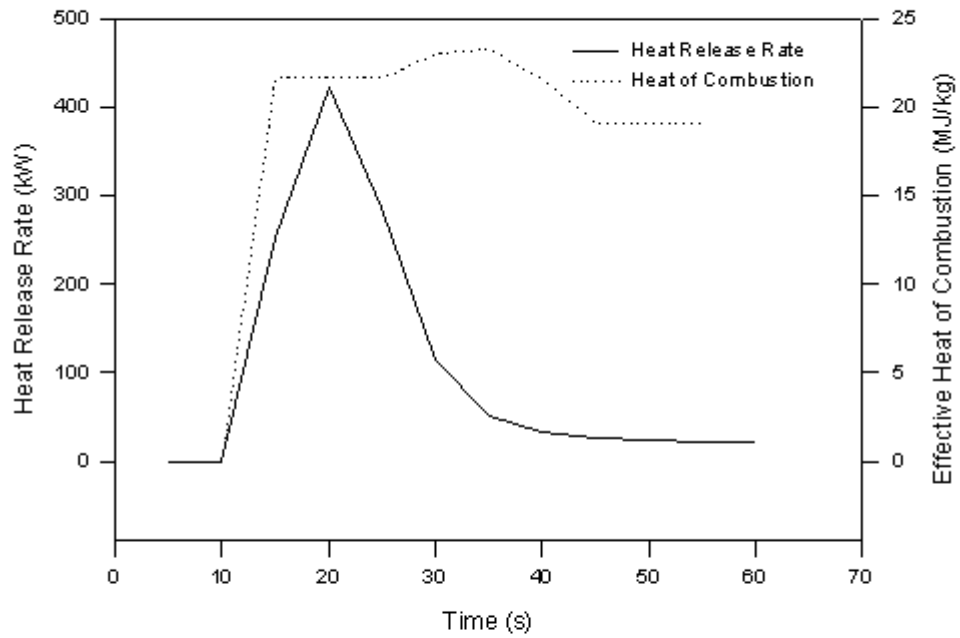

Figure D-4. Sample 1c. Seat Cushion, Fabric Only

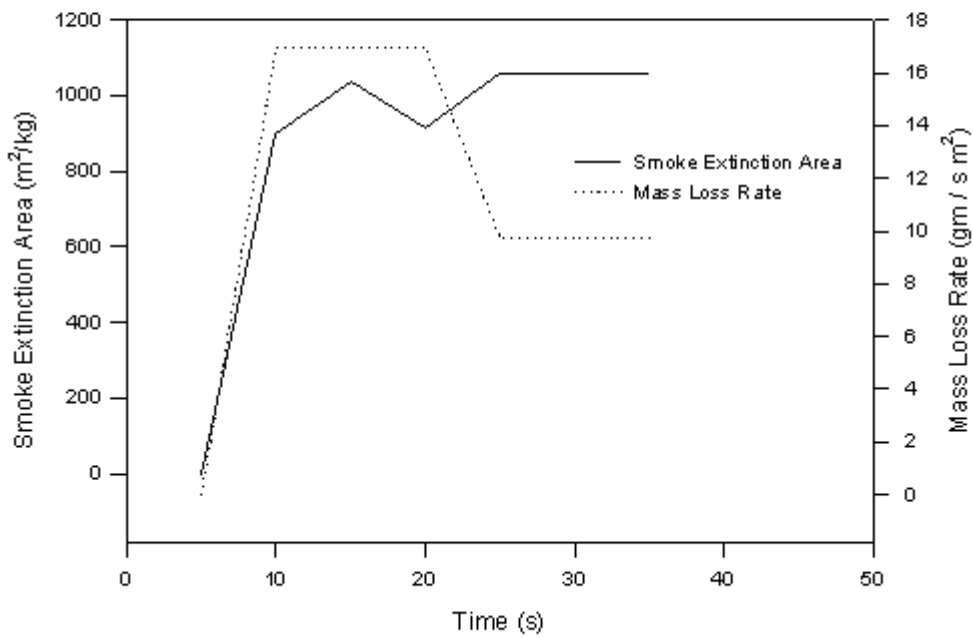
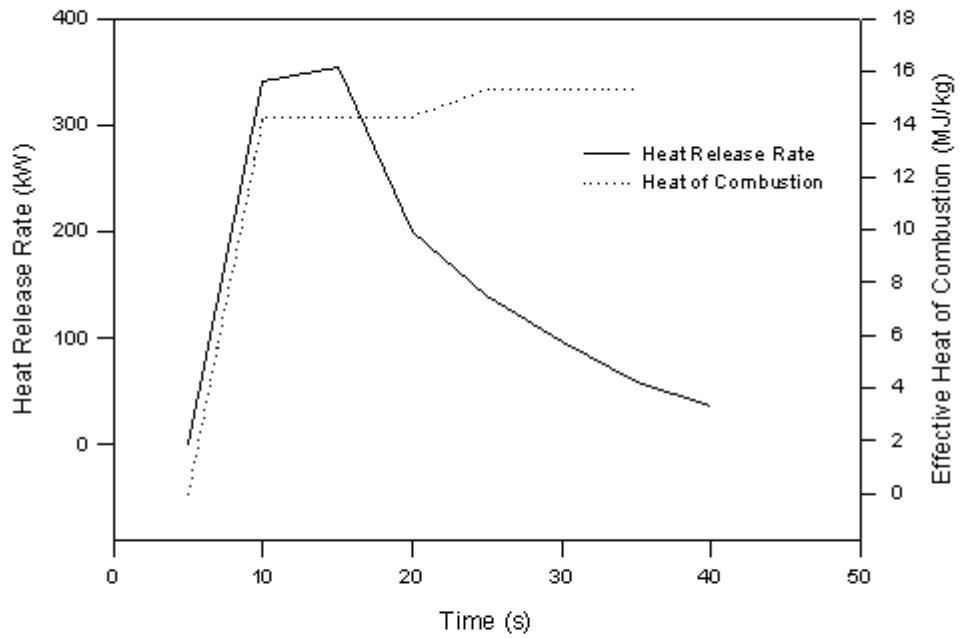

Figure D-5. Sample 1d. Seat Cushion, PVC Cover Only

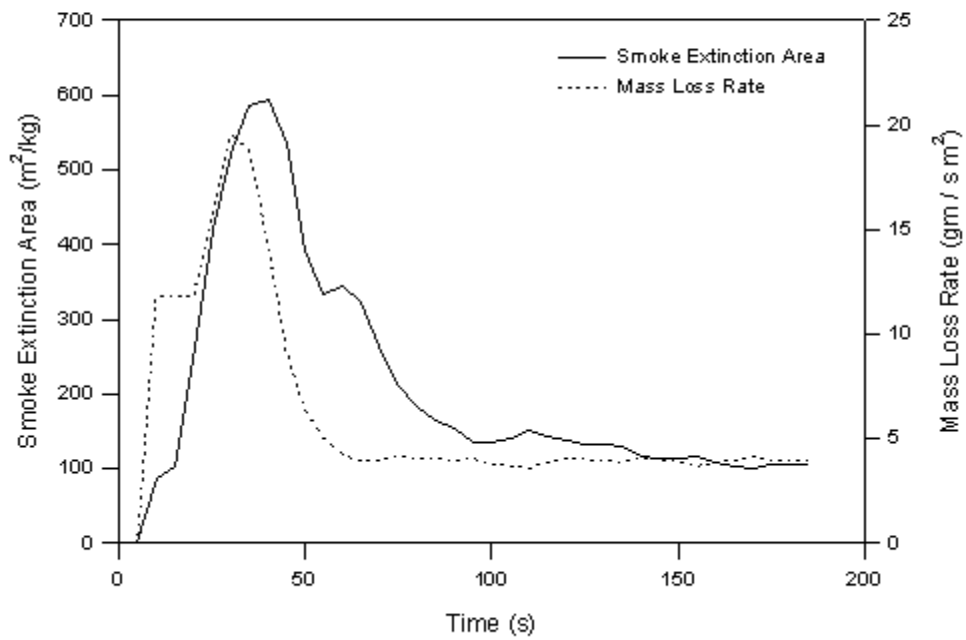
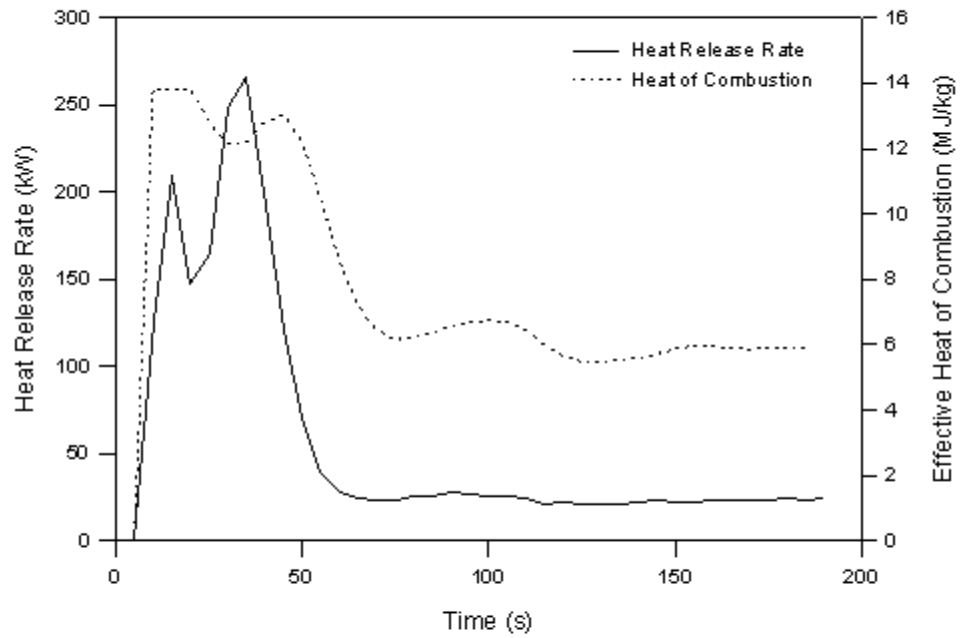

Figure D-6. Sample 2c. Seat Cushion, Fabric Cover Only

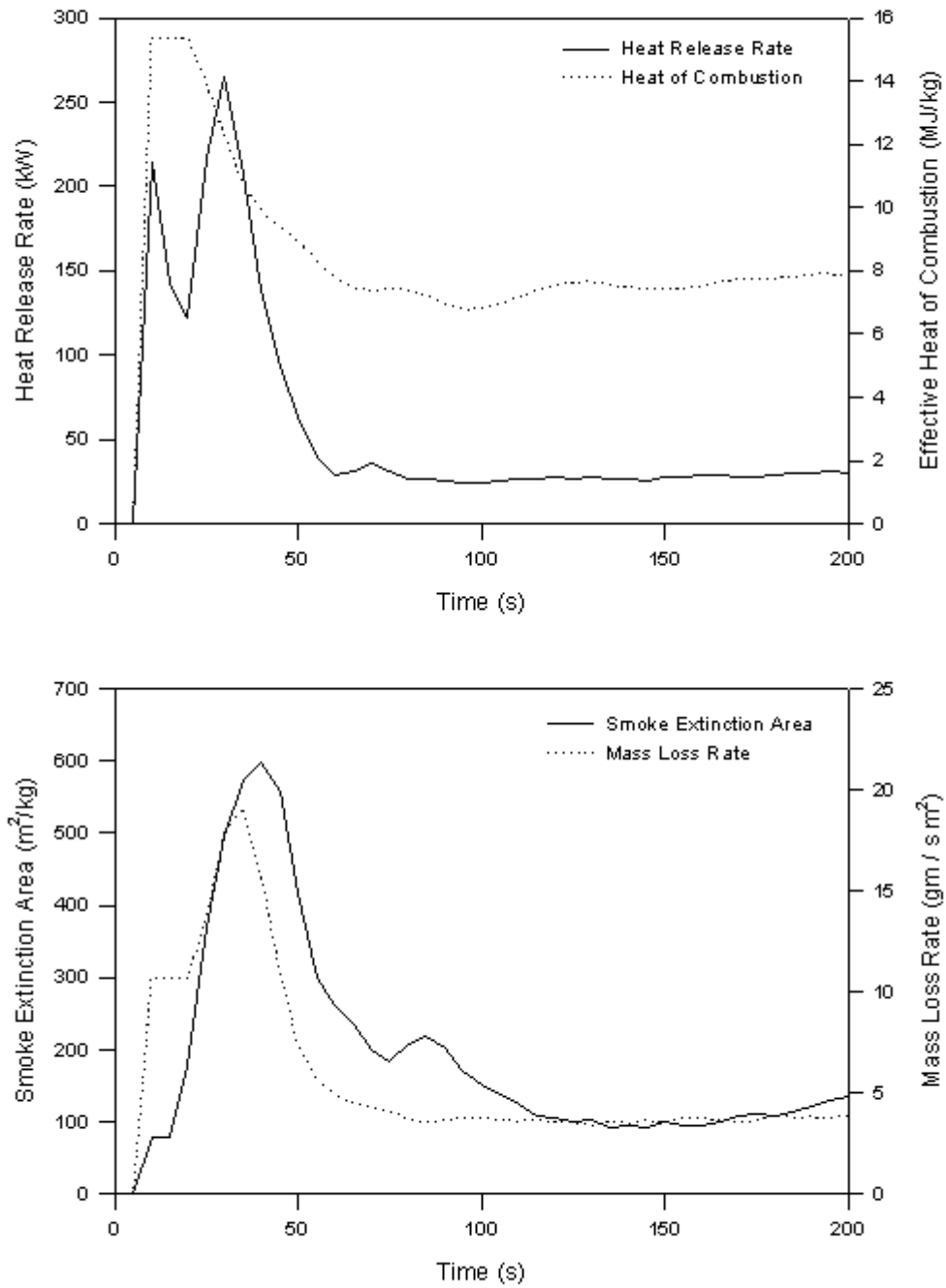

Figure D-7. Sample 2. Seat Cushion, Assembly

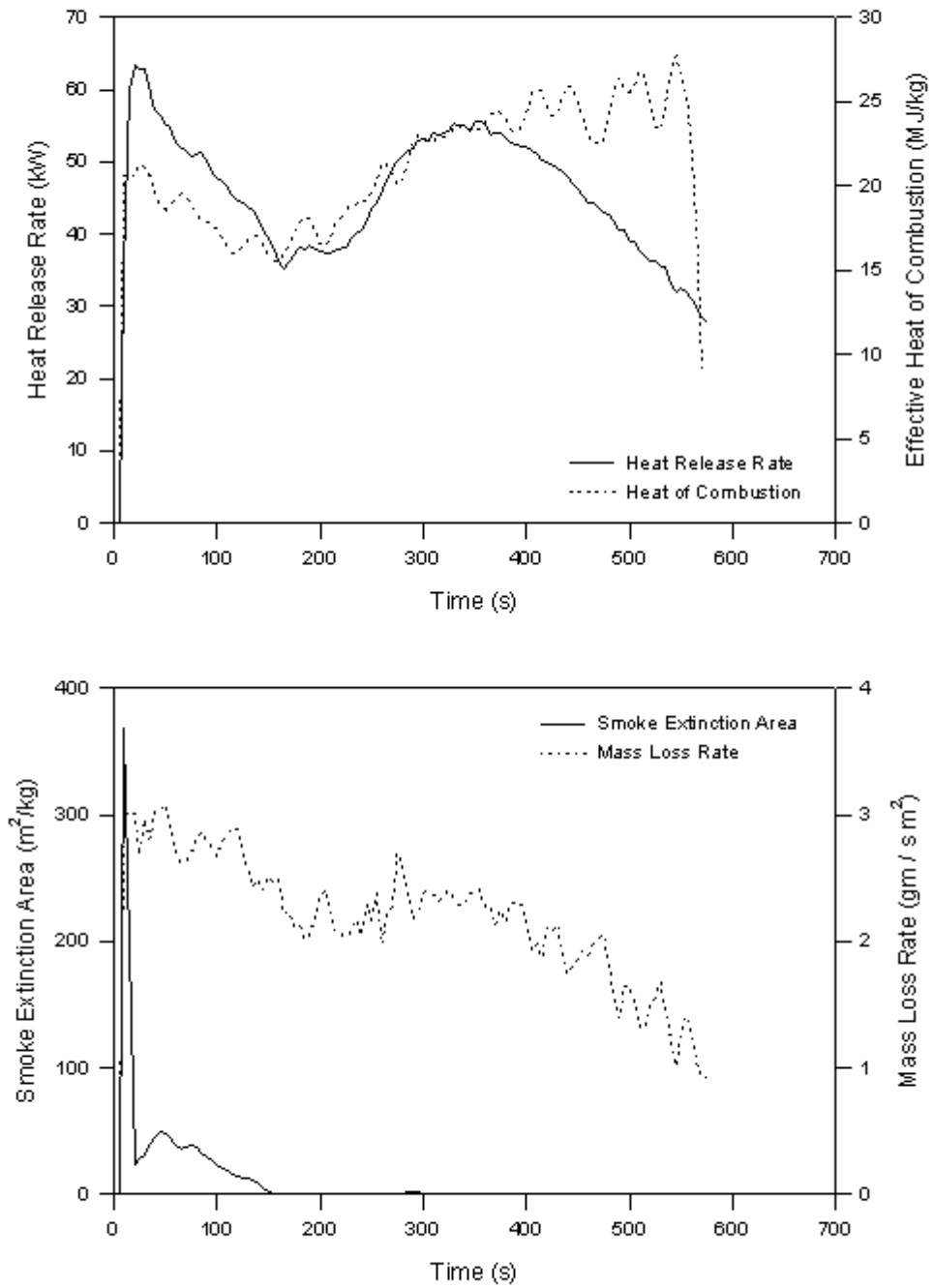

Figure D-8. Sample 3. Graphite-Filled Foam

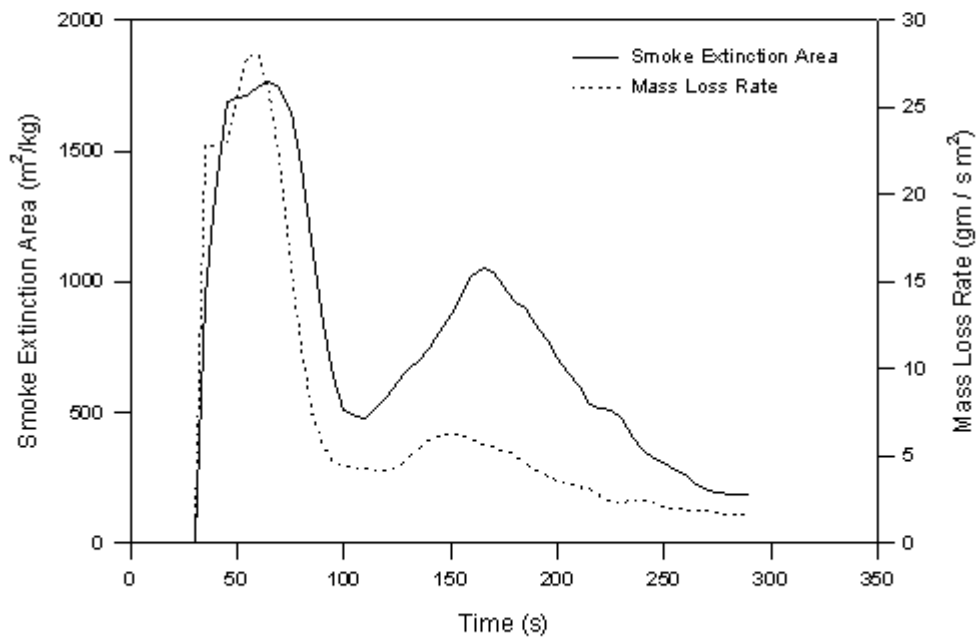
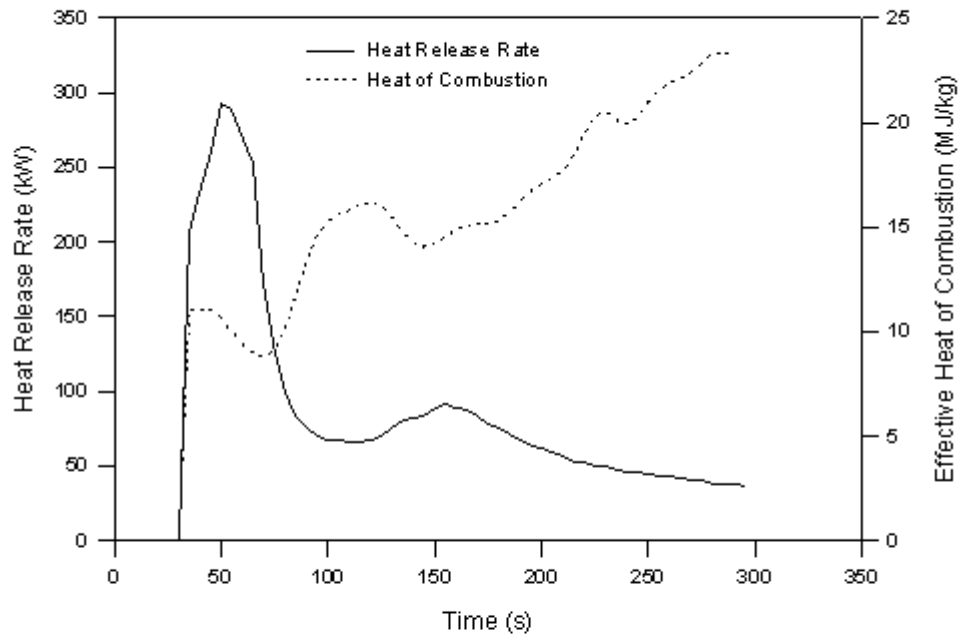

Figure D-9. Sample 4. Seat Support Diaphragm, Chloroprene

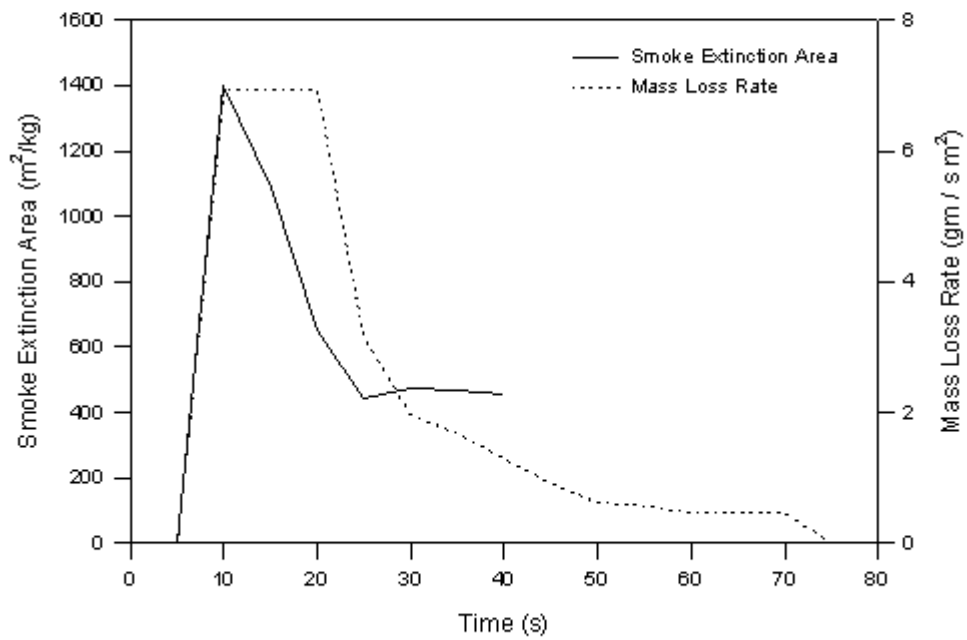
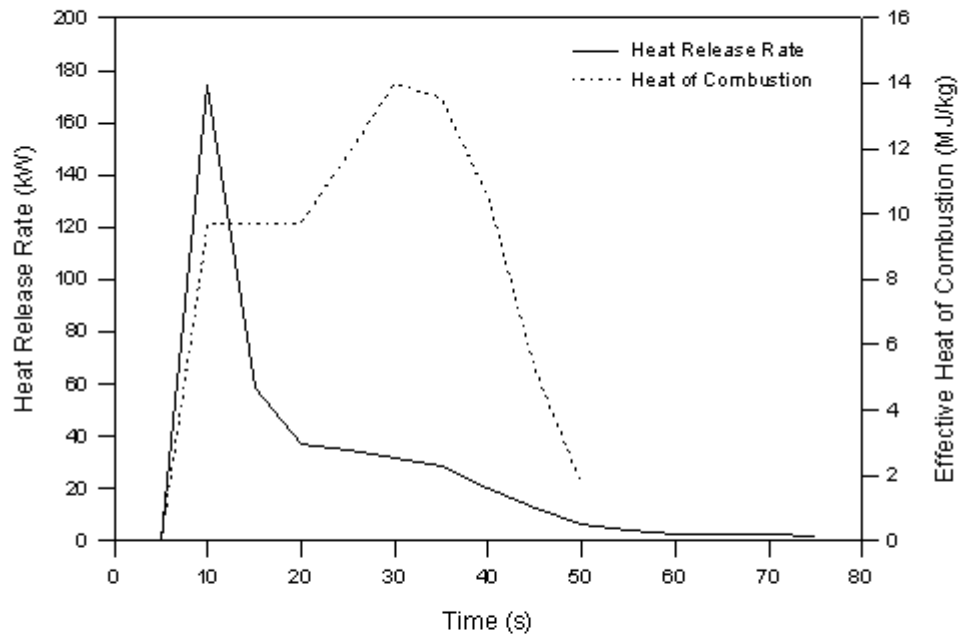

Figure D-10. Sample 5. Seat Support Diaphragm, FR Cotton Muslin

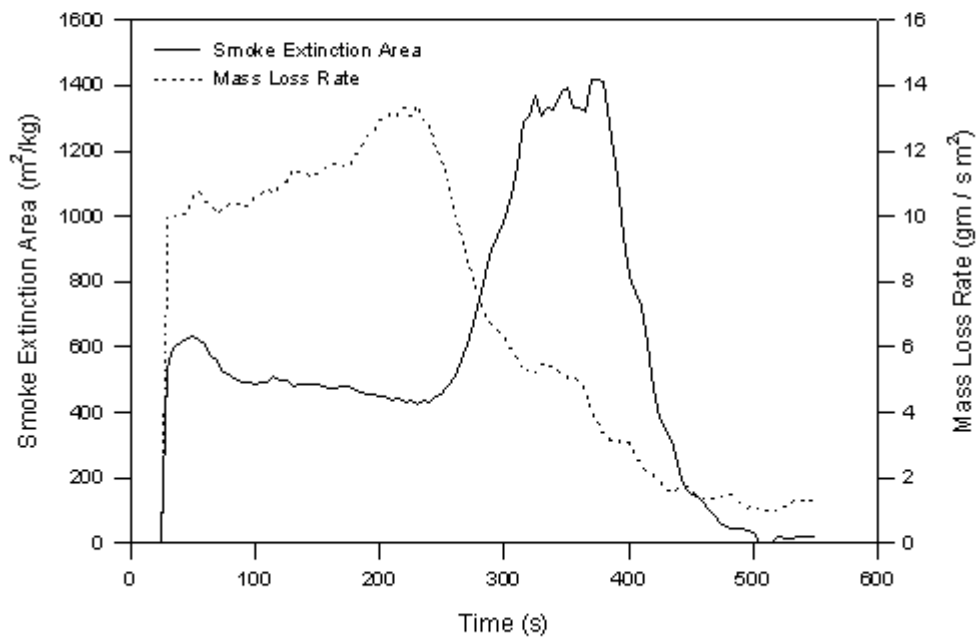
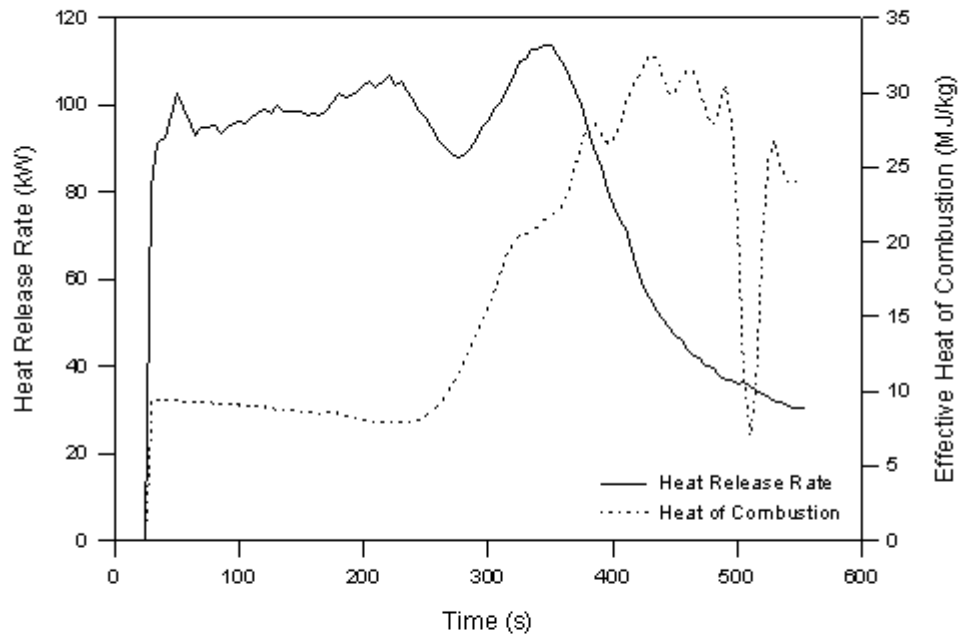

Figure D-11. Sample 6. Seat Shroud, PVC/Acrylic

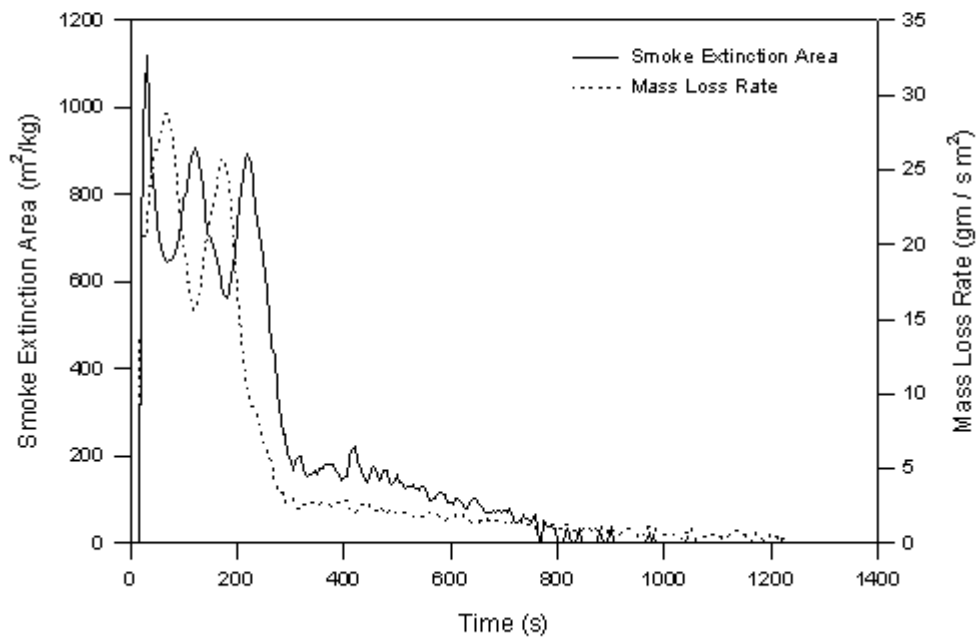
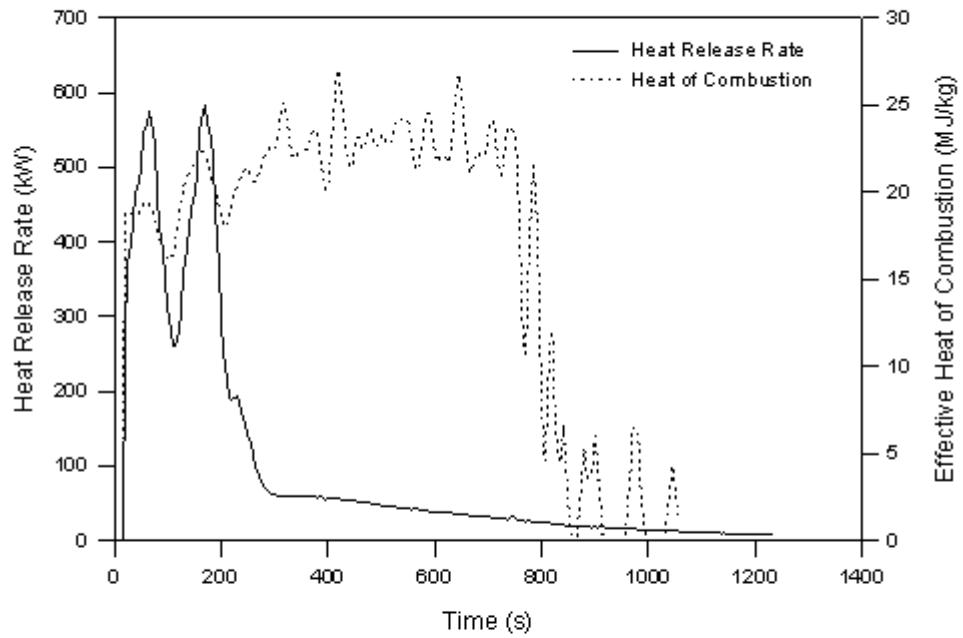

Figure D-12. Sample 7. Armrest Pad, Coach Seat (Foam on Metal Support)

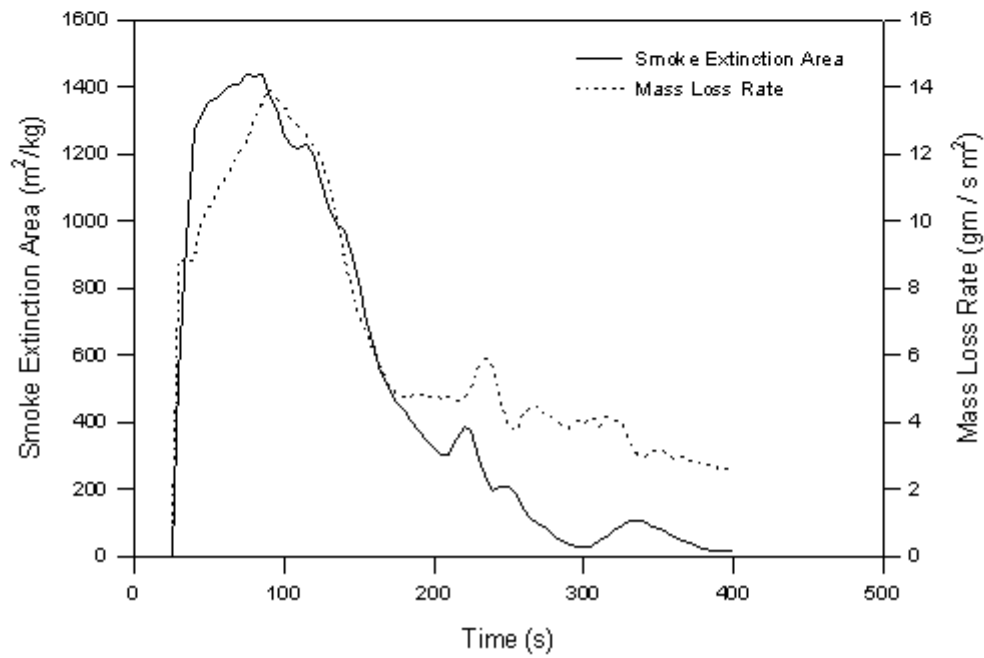
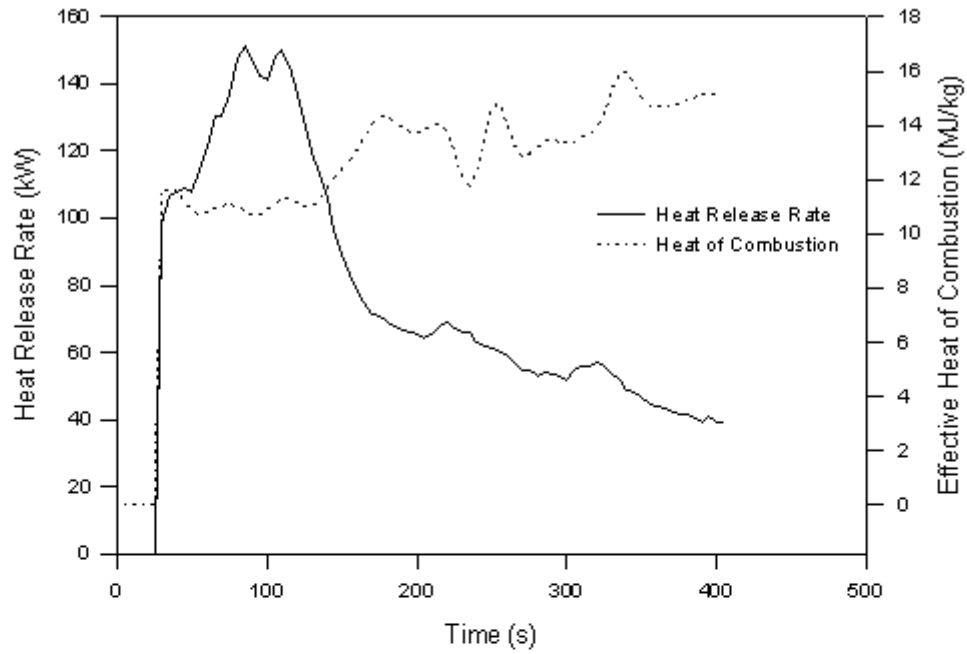

Figure D-13. Sample 8. Footrest Cover, Coach Seat

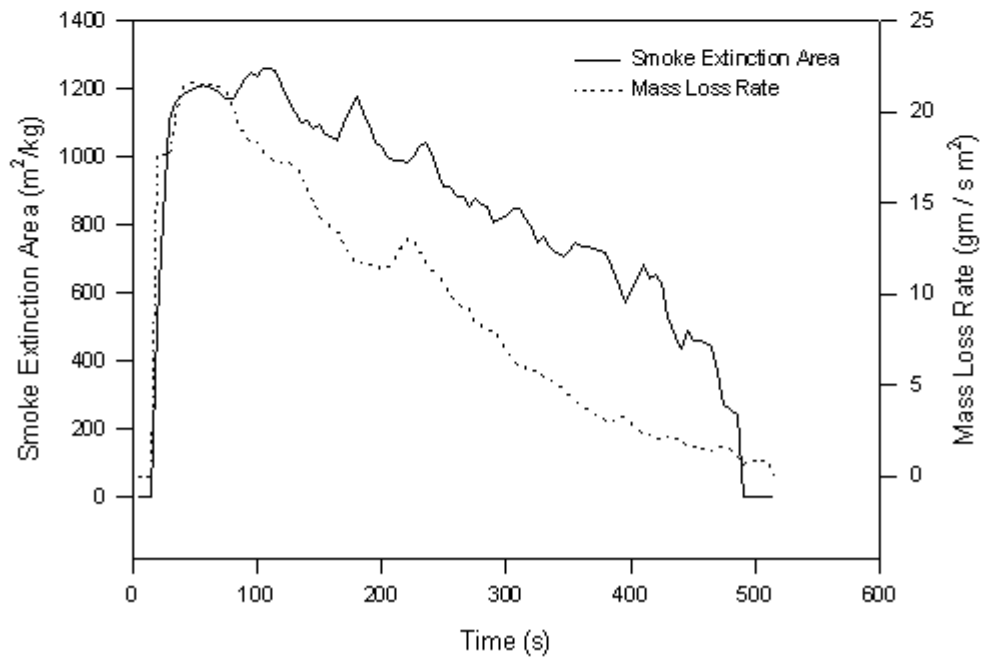
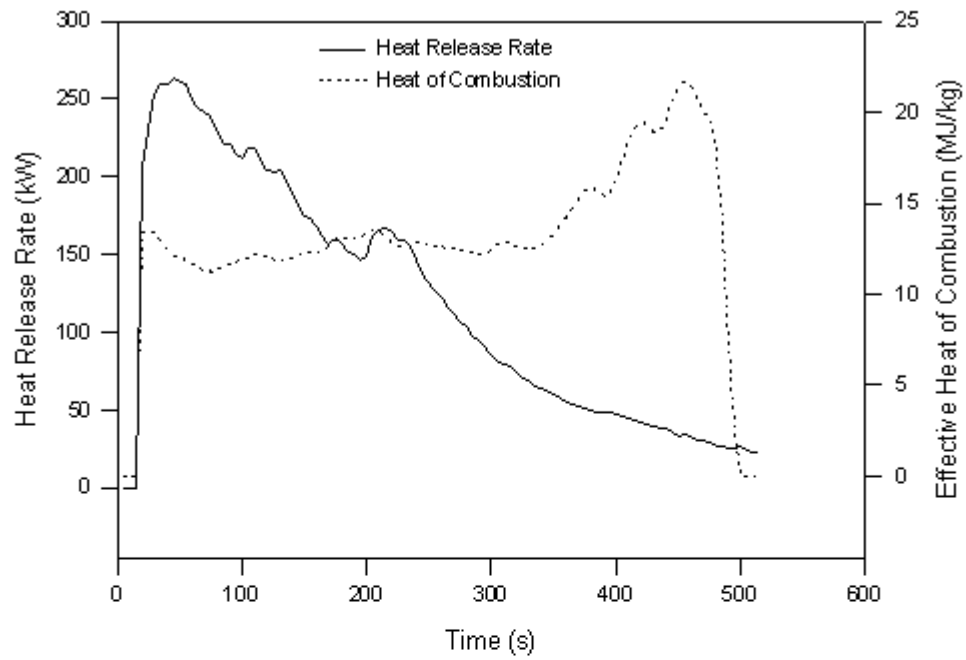

Figure D-14. Sample 9. Seat Track Cover, Chloroprene

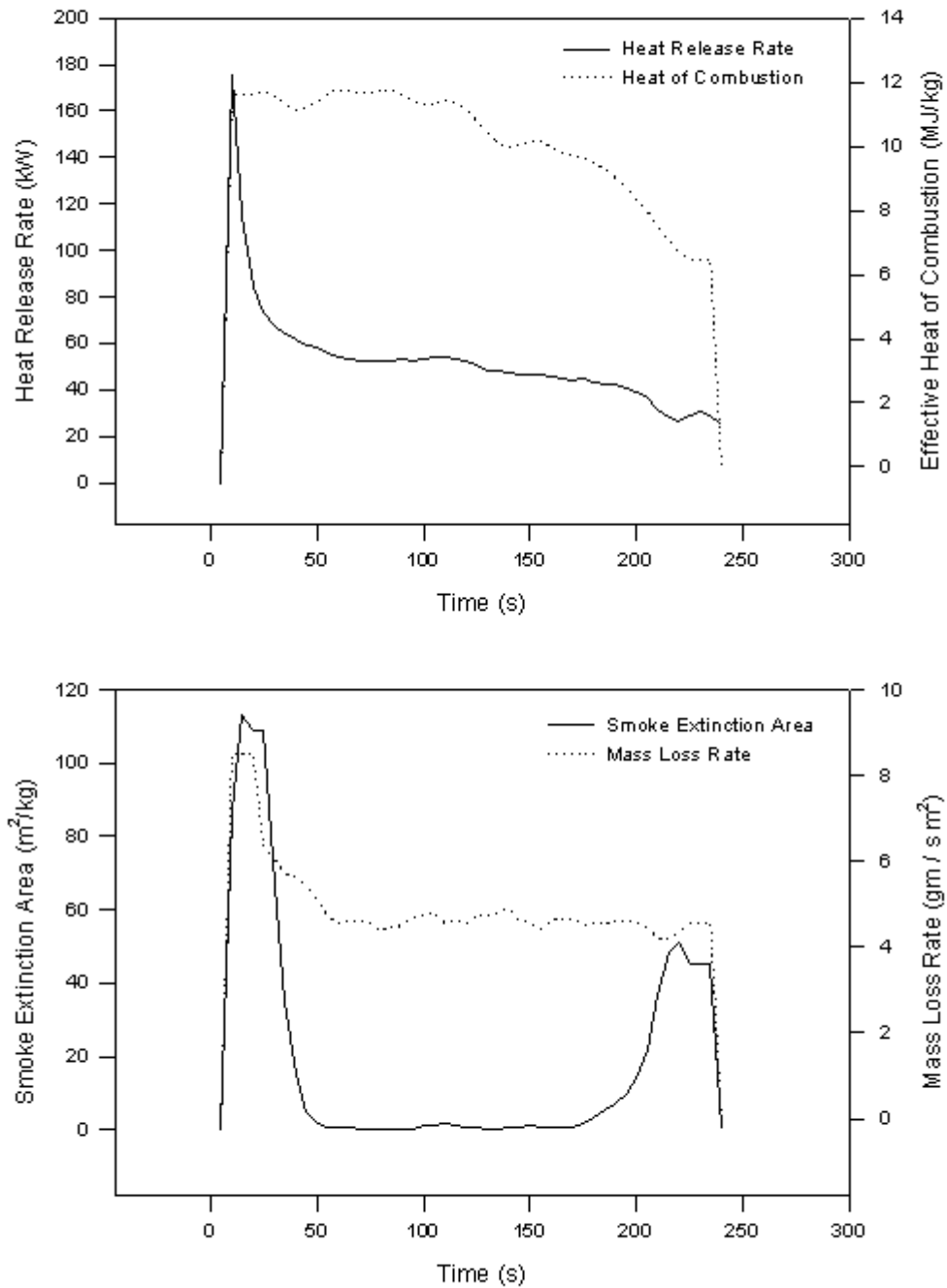

Figure D-15. Sample 10. Mattress, Assembly

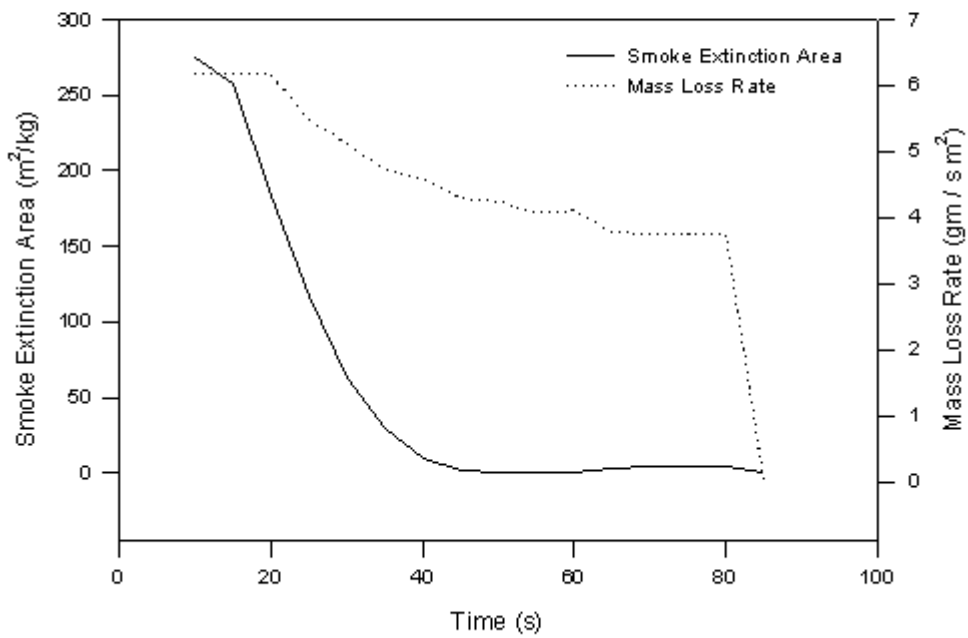
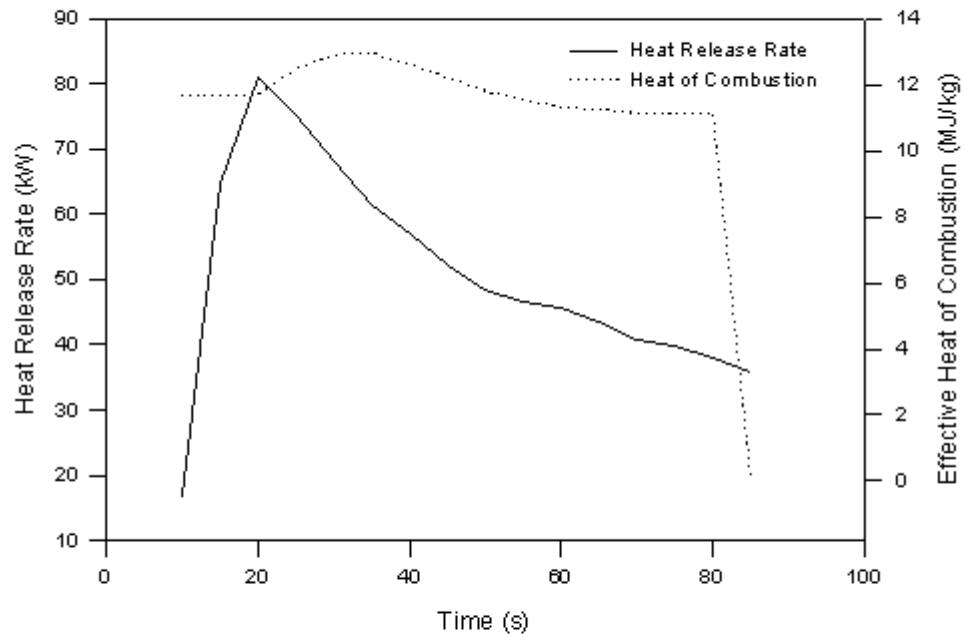

Figure D-16. Sample 10a. Mattress, Foam Only

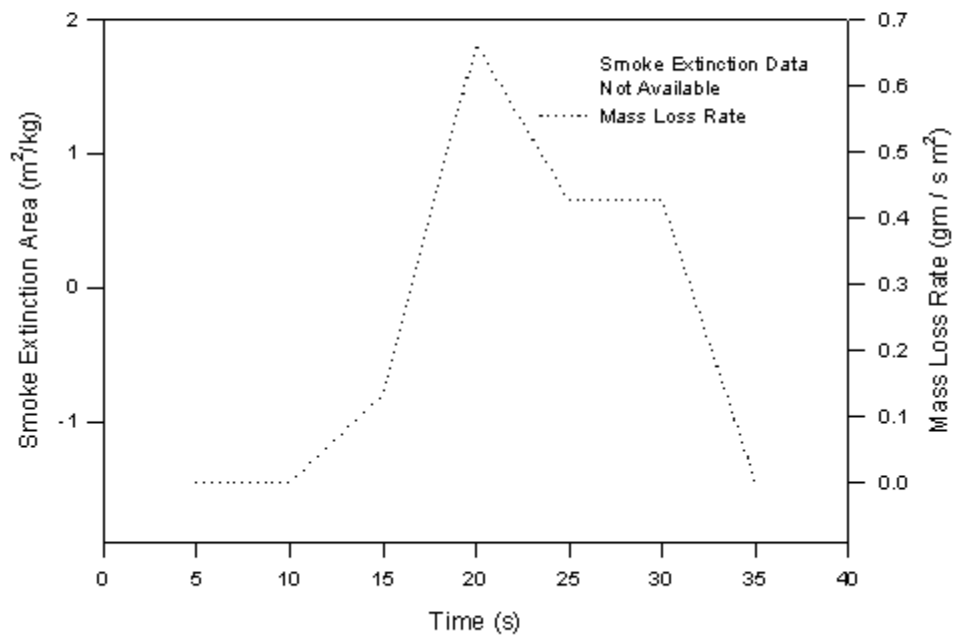
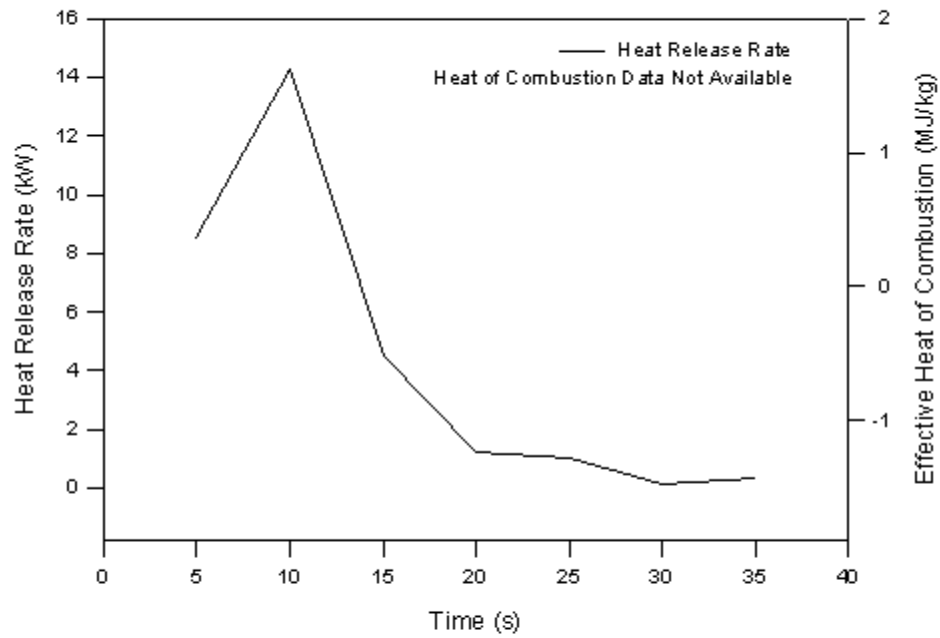

Figure D-17. Sample 10b. Mattress, Interliner Only

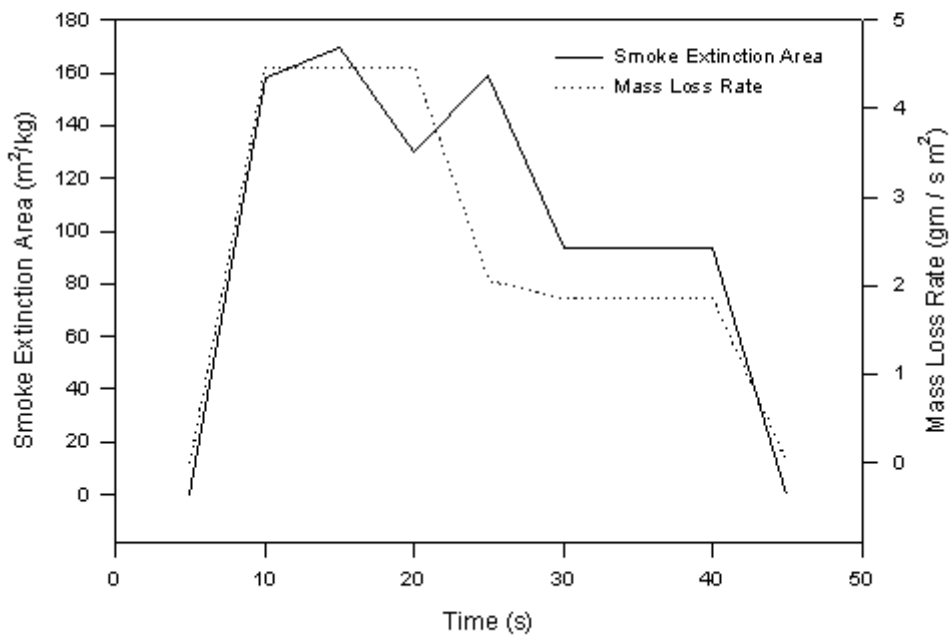
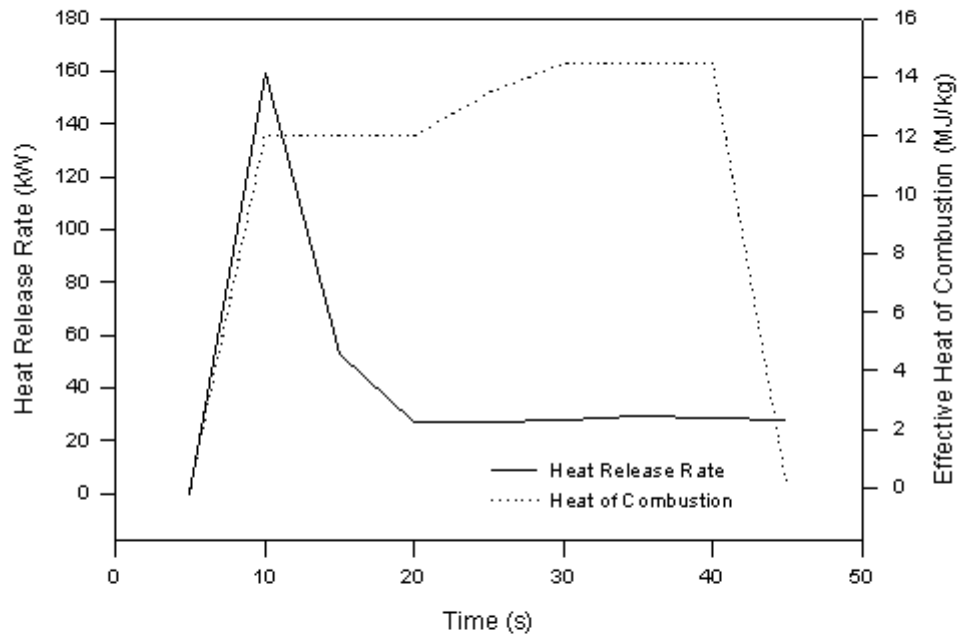

Figure D-18. Sample 10c. Mattress, Ticking Fabric Only

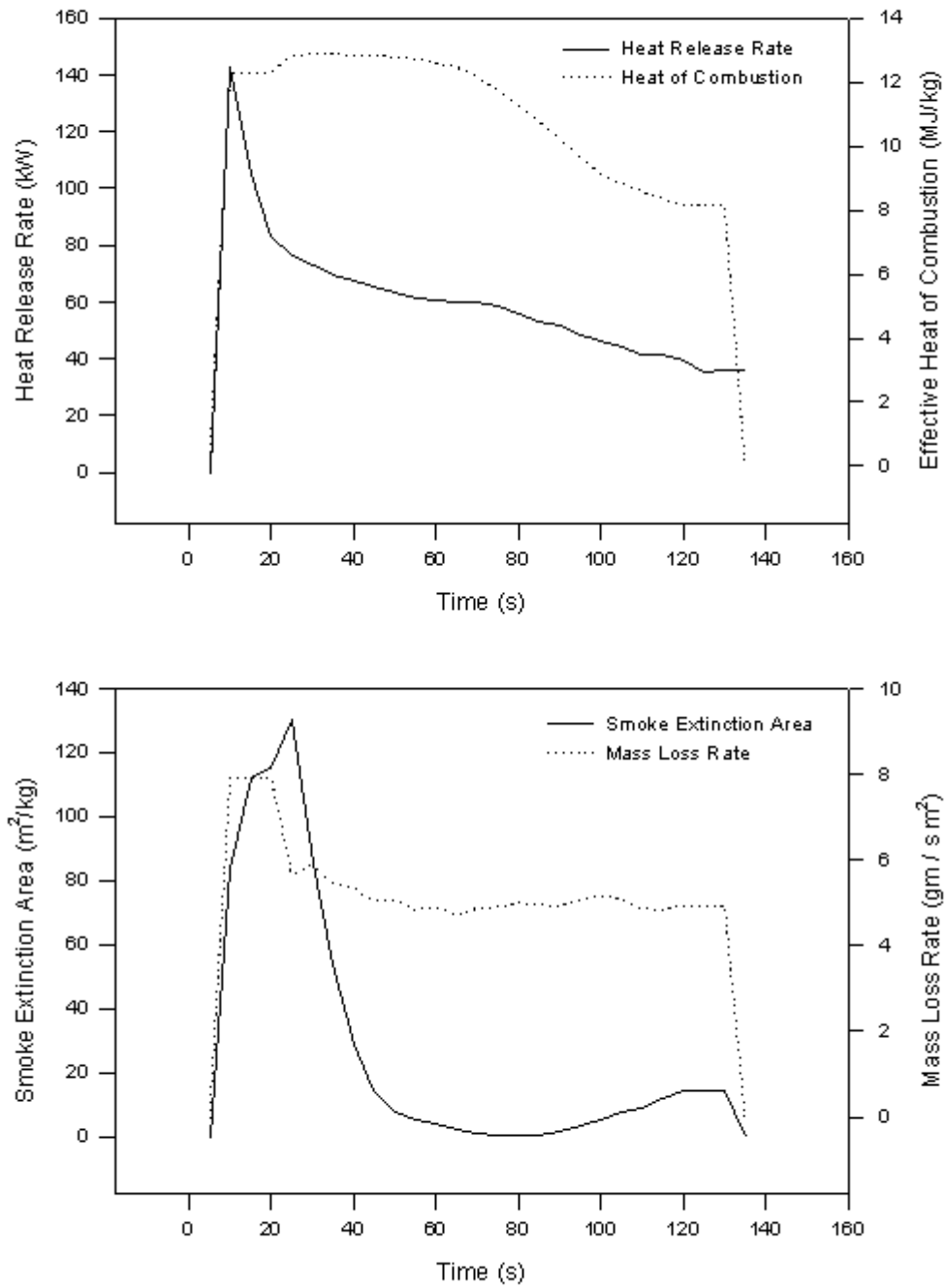

Figure D-19. Sample 11. Bed Pad, Assembly

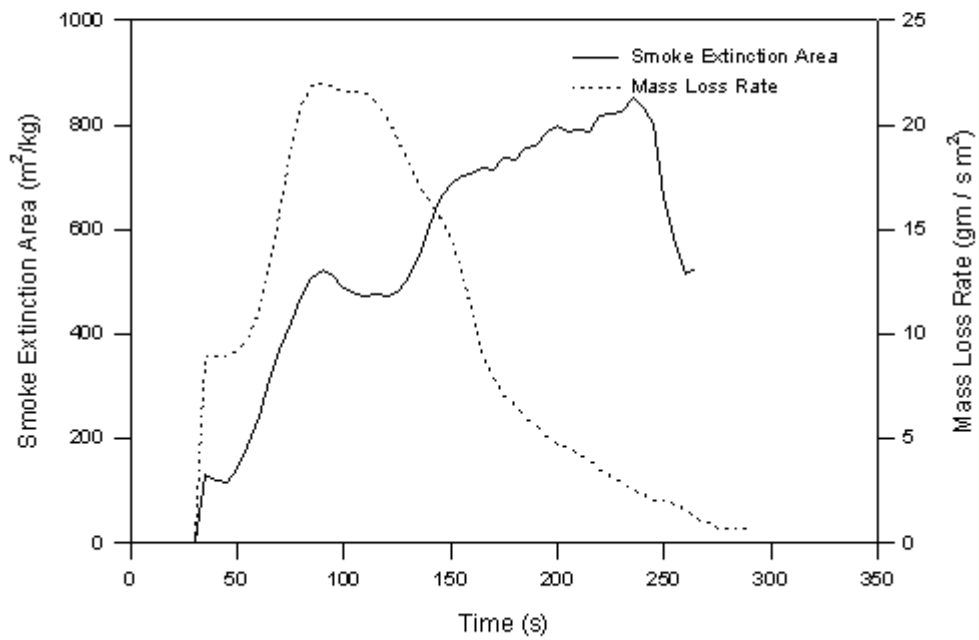
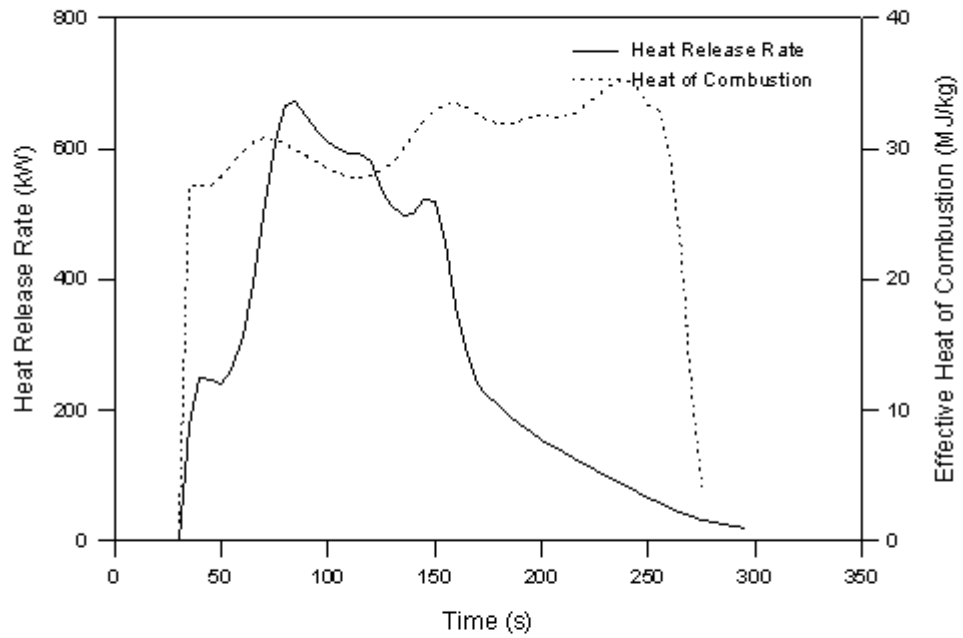

Figure D-20. Sample 12. Wall Finishing, Wool Carpet

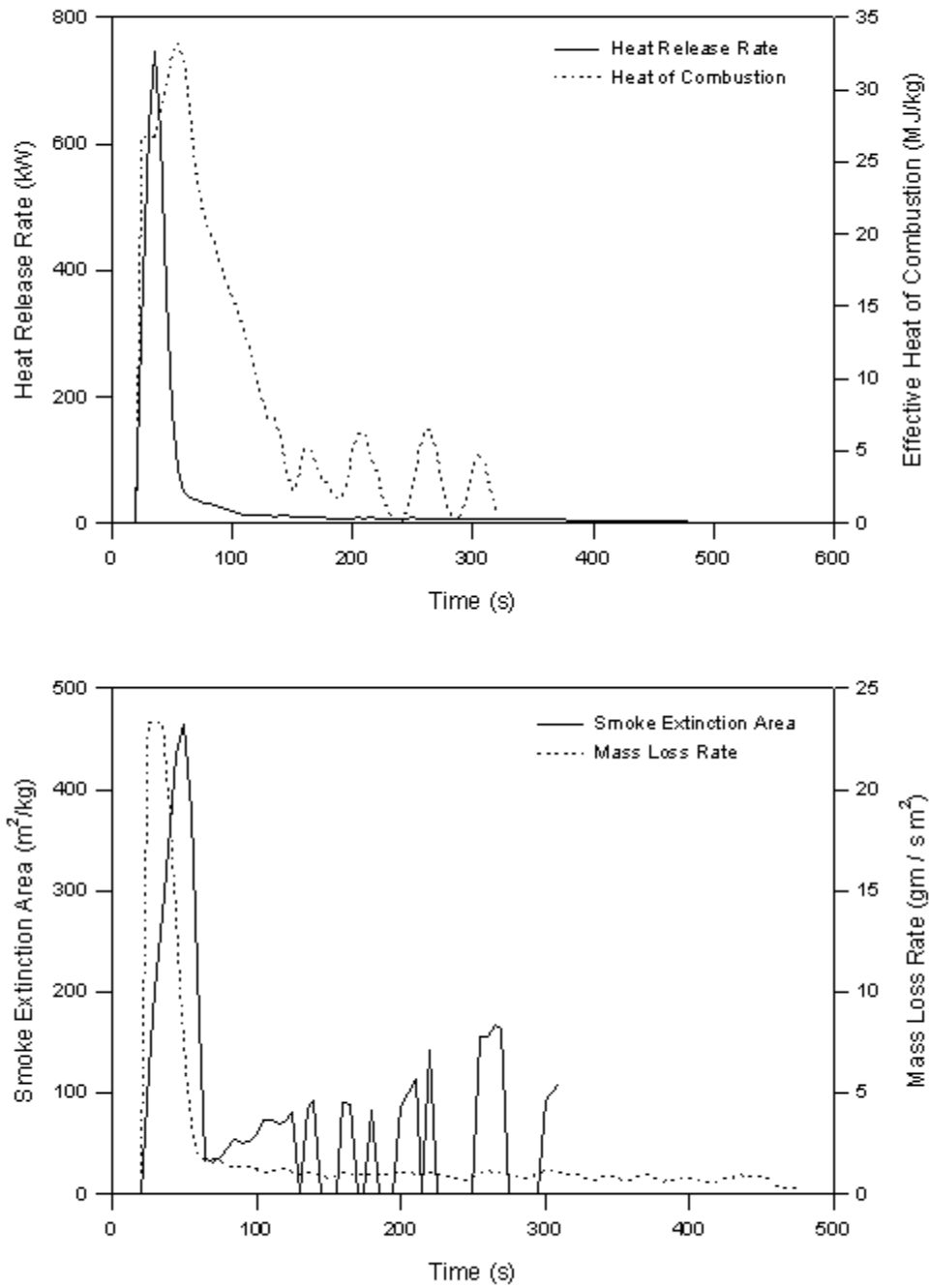

Figure D-21. Sample 13. Wall Finishing, Wool Fabric

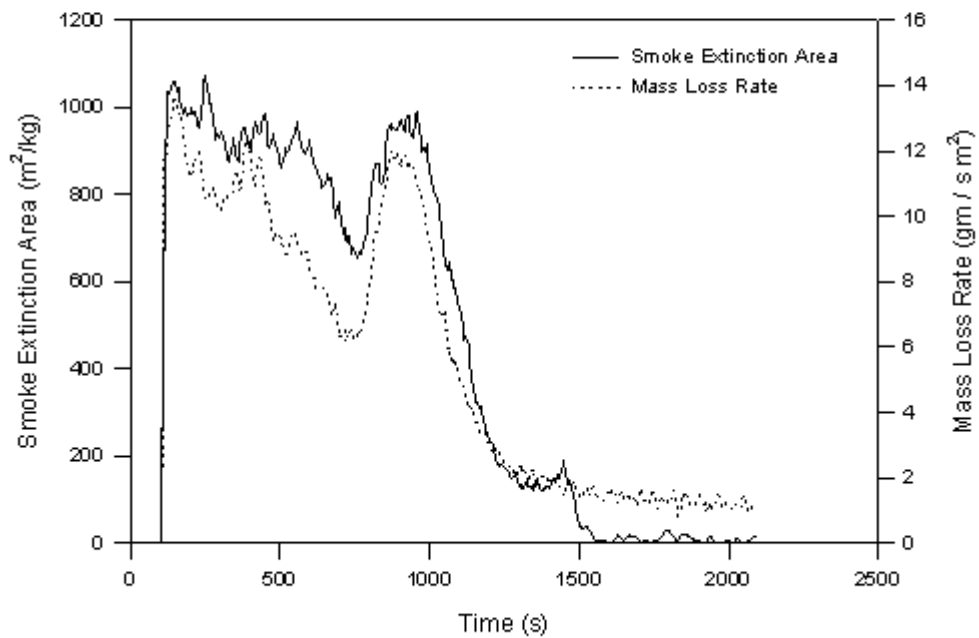
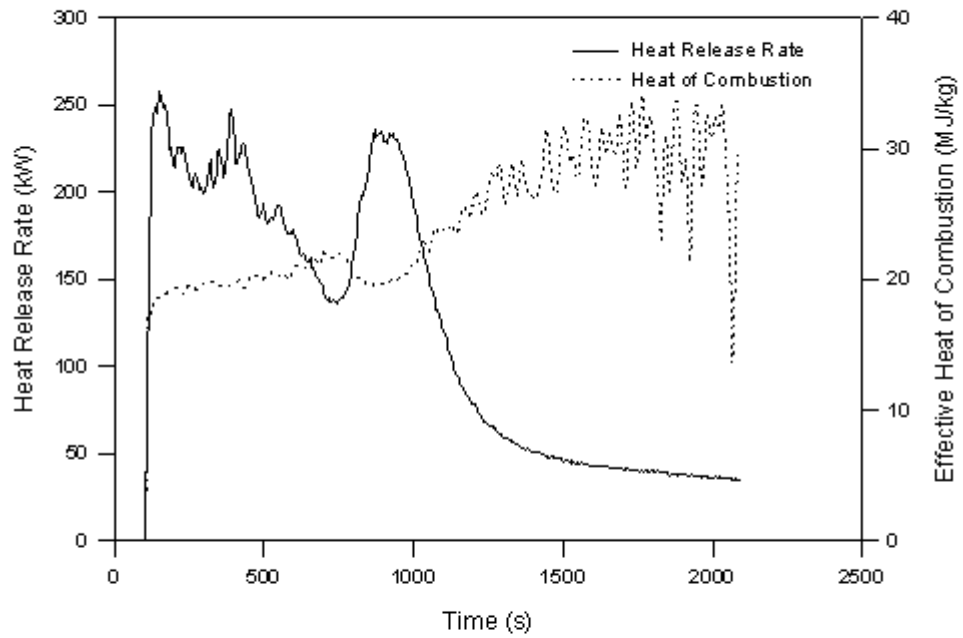

Figure D-22. Sample 14. Space Divider, Polycarbonate

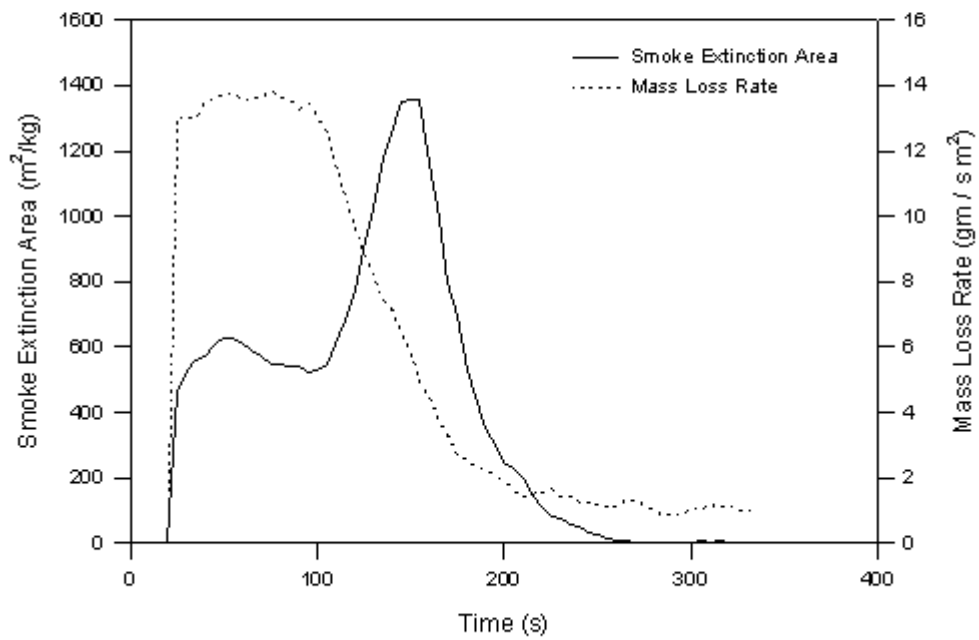
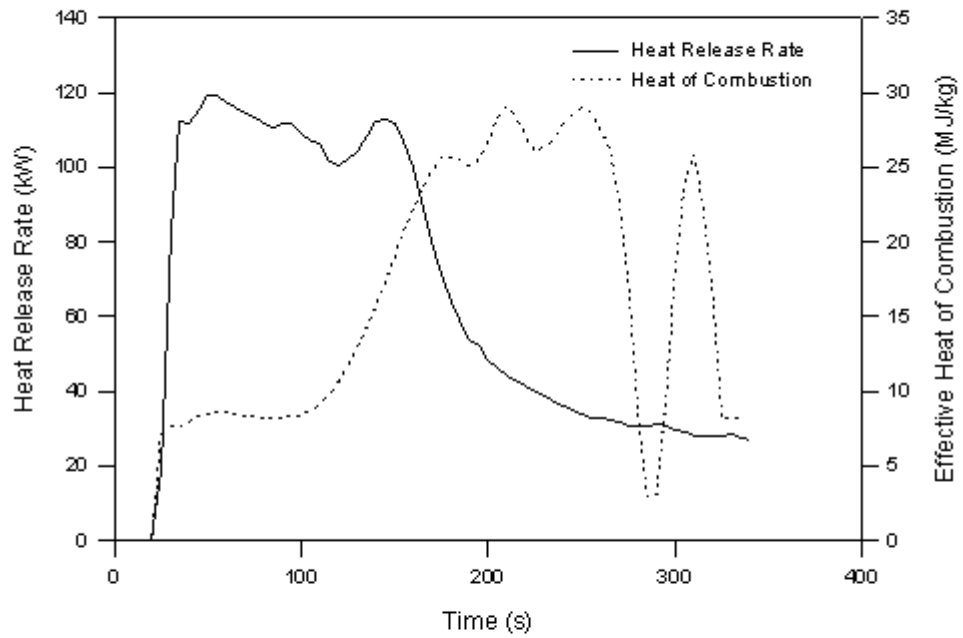

Figure D-23. Sample 15. Wall Material, FRP/PVC

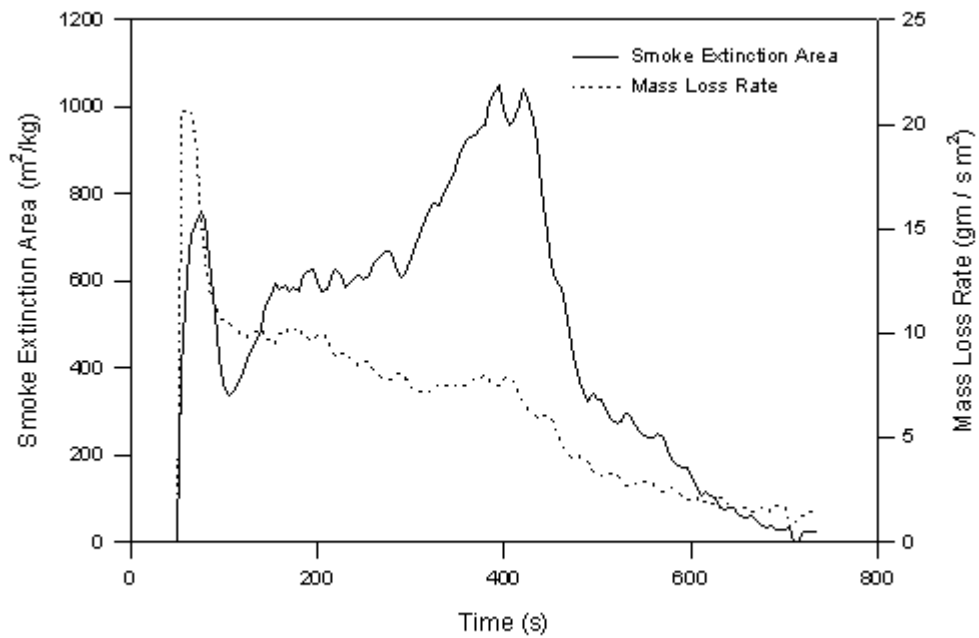
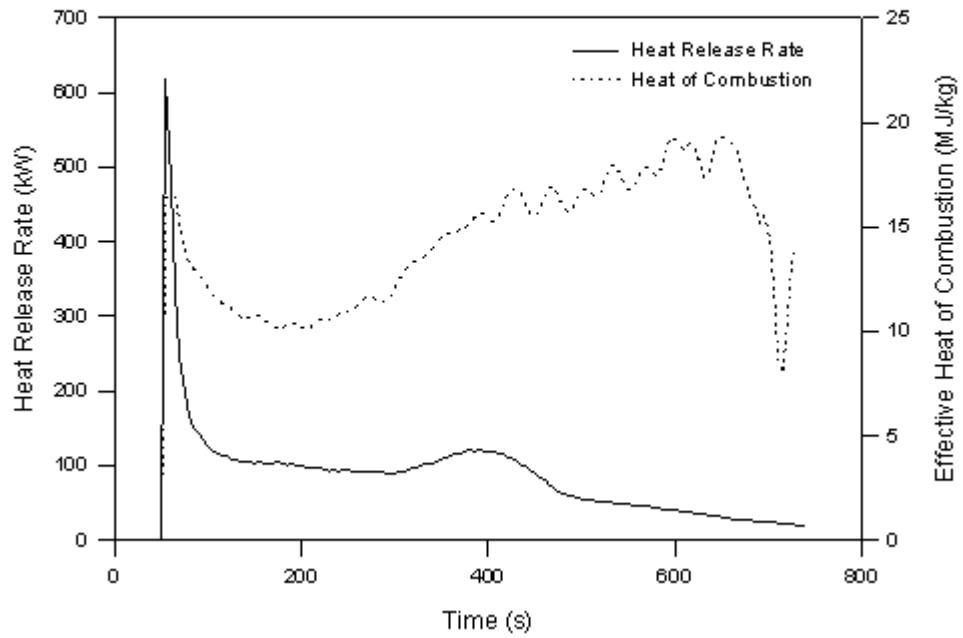

Figure D-24. Sample 16. Wall Panel, FRP

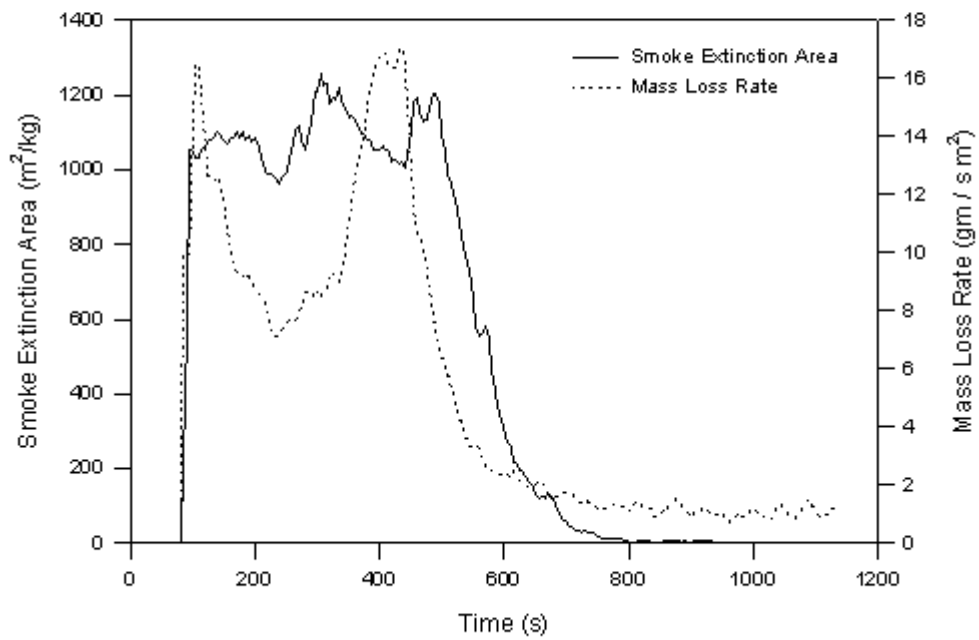
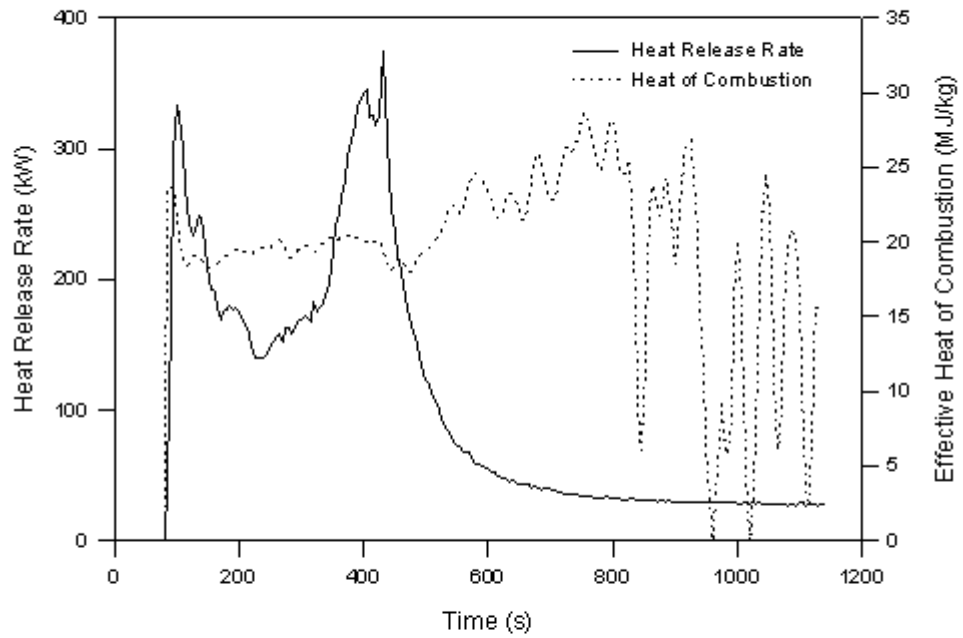

Figure D-25. Sample 17. Window Glazing, Polycarbonate

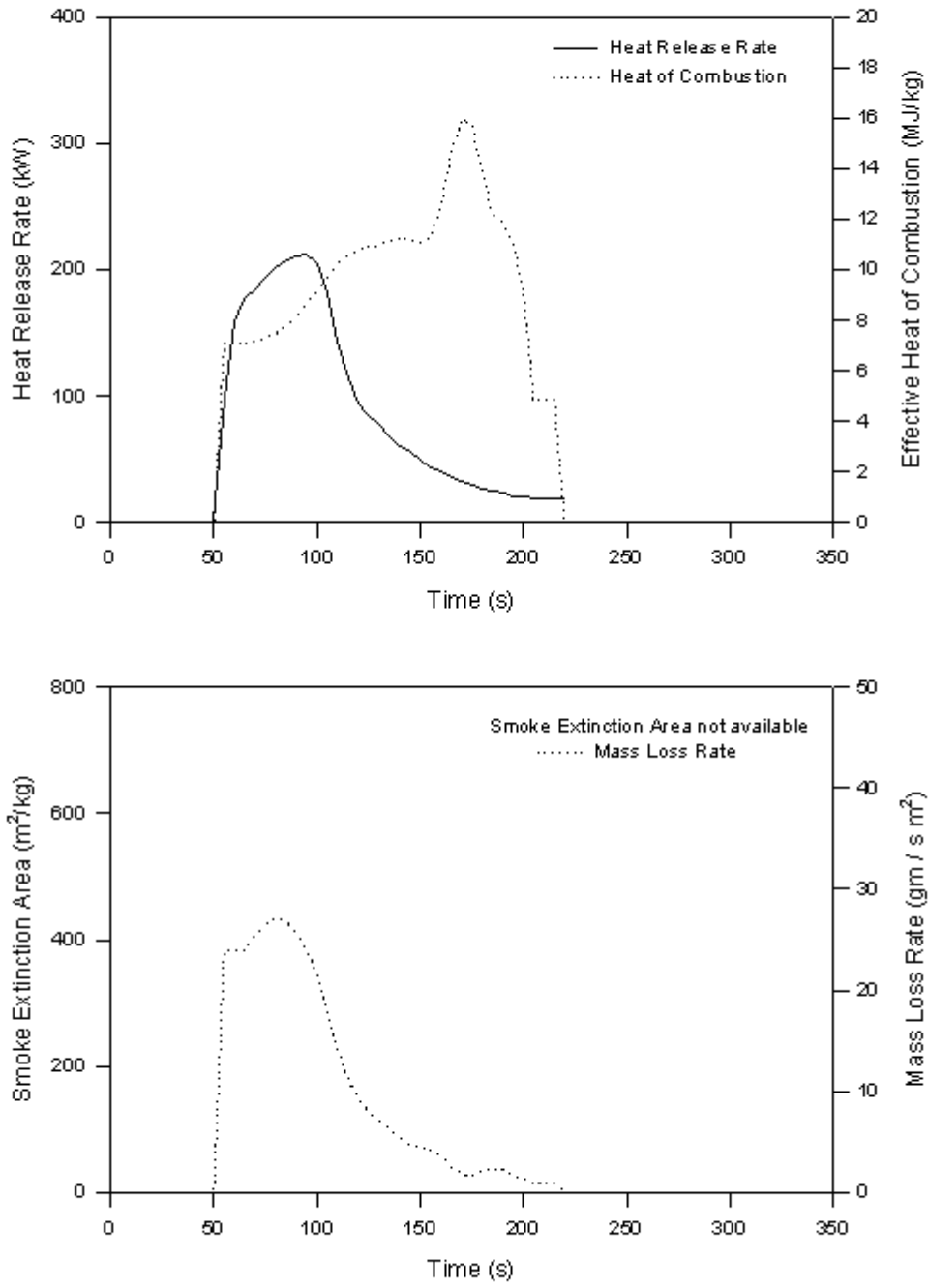

Figure D-26. Sample 18. Window Mask, FRP

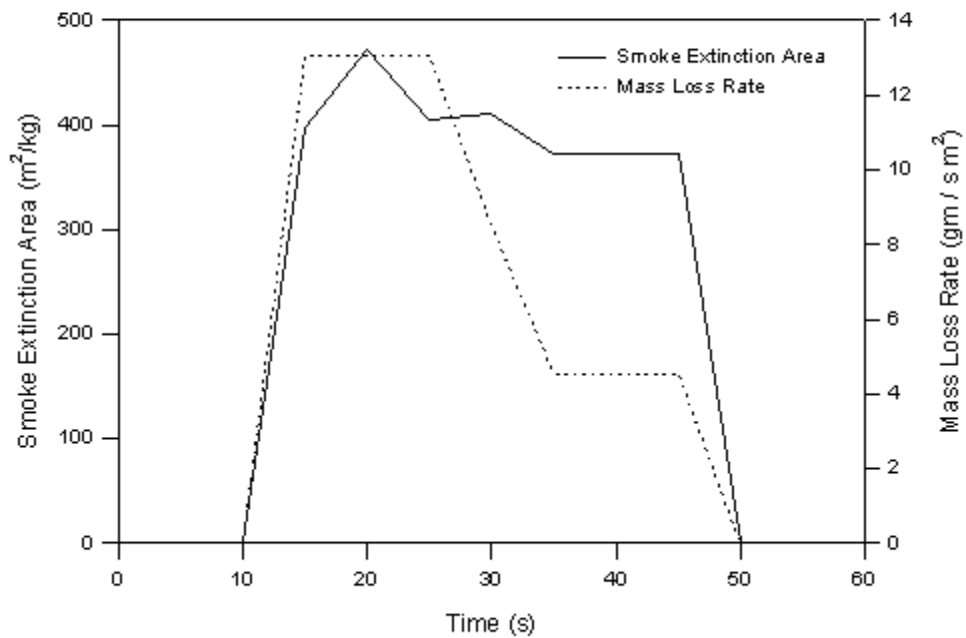
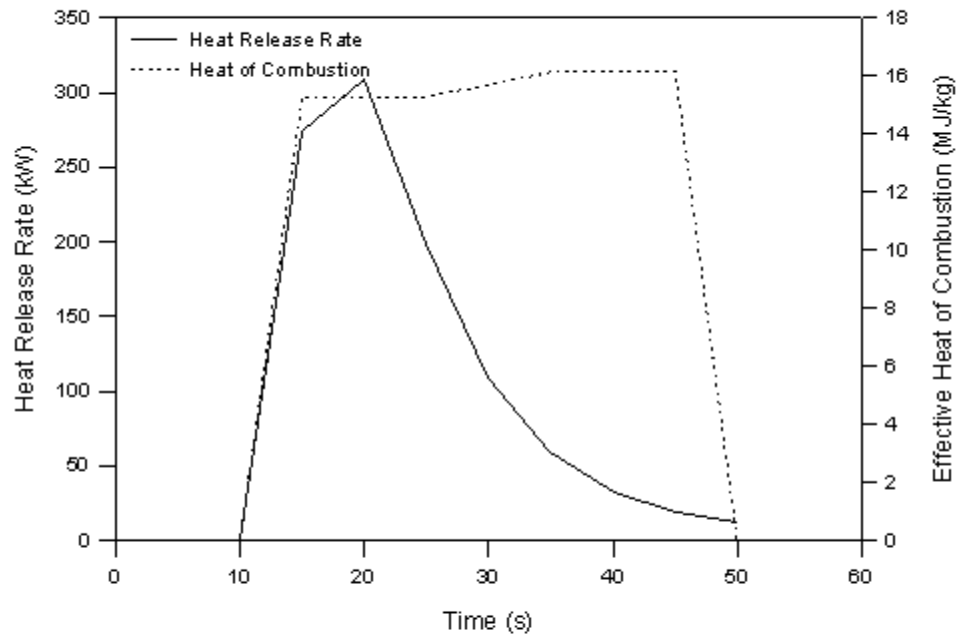

Figure D-27. Sample 19. Door Privacy Curtain/Window Drapery Fabric

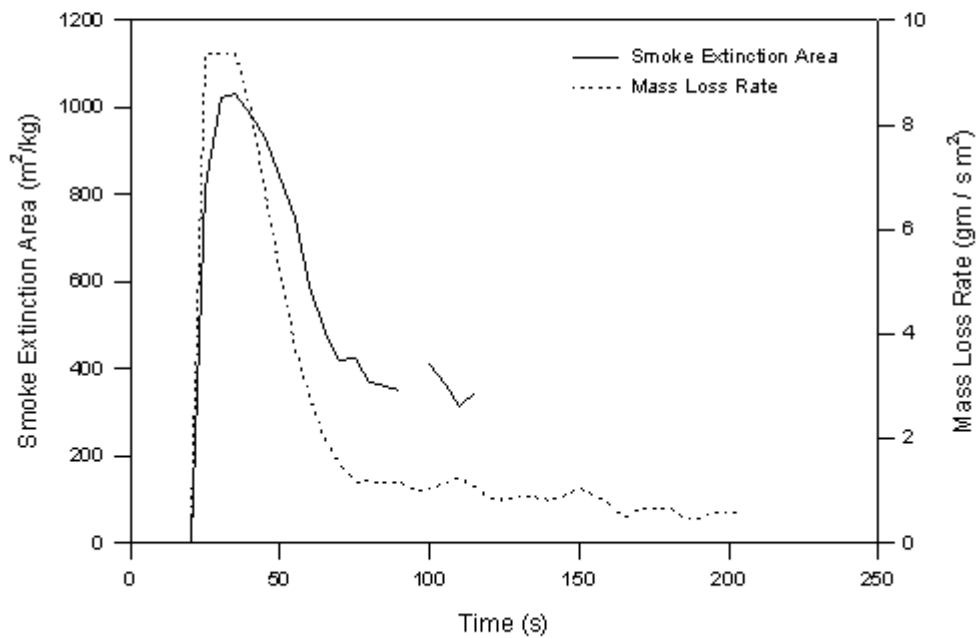
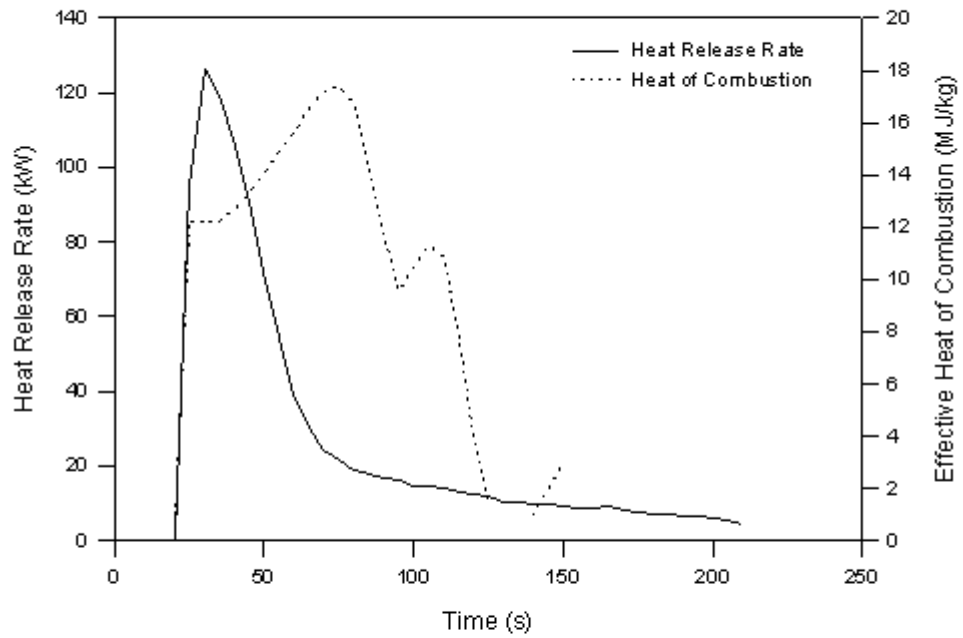

Figure D-28. Sample 20. Drapery Fabric, Polyester

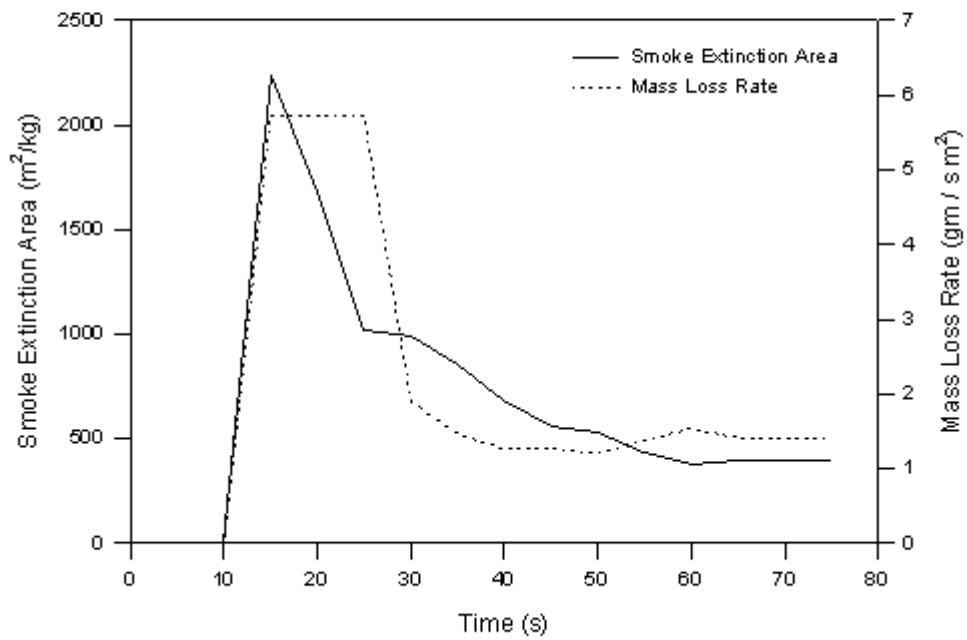
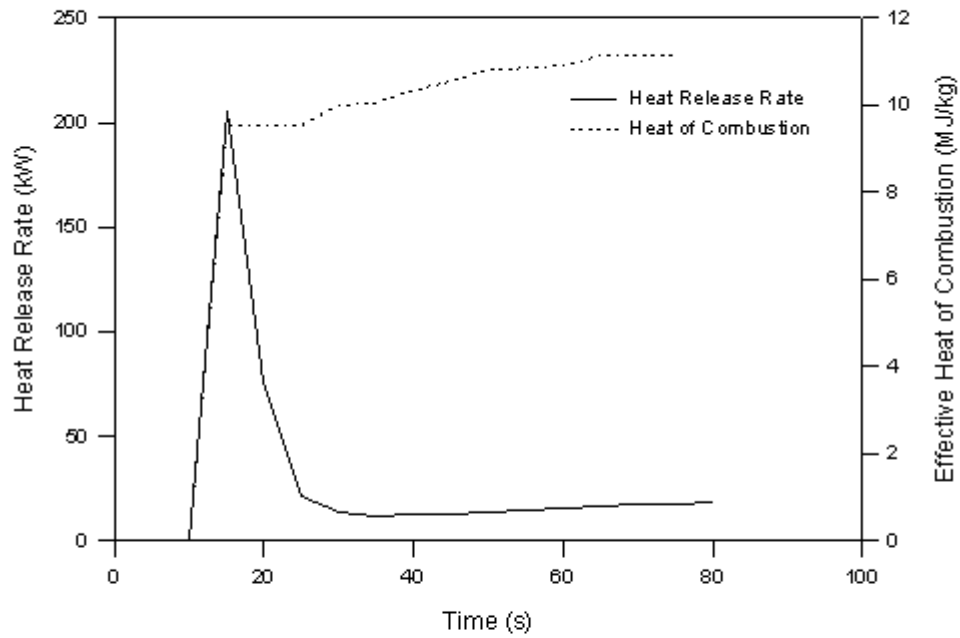

Figure D-29. Sample 21. Blanket, Wool Fabric

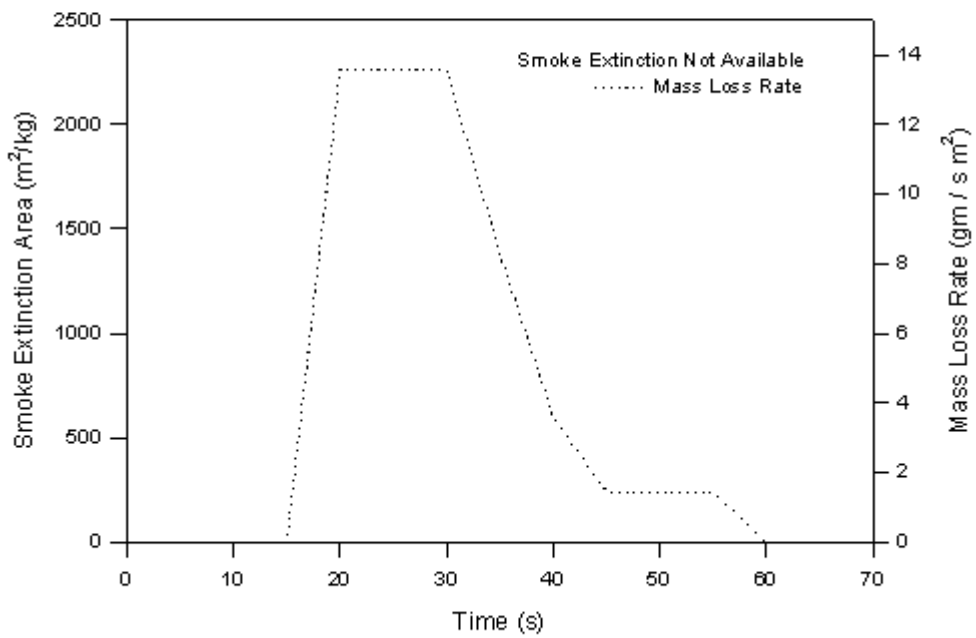
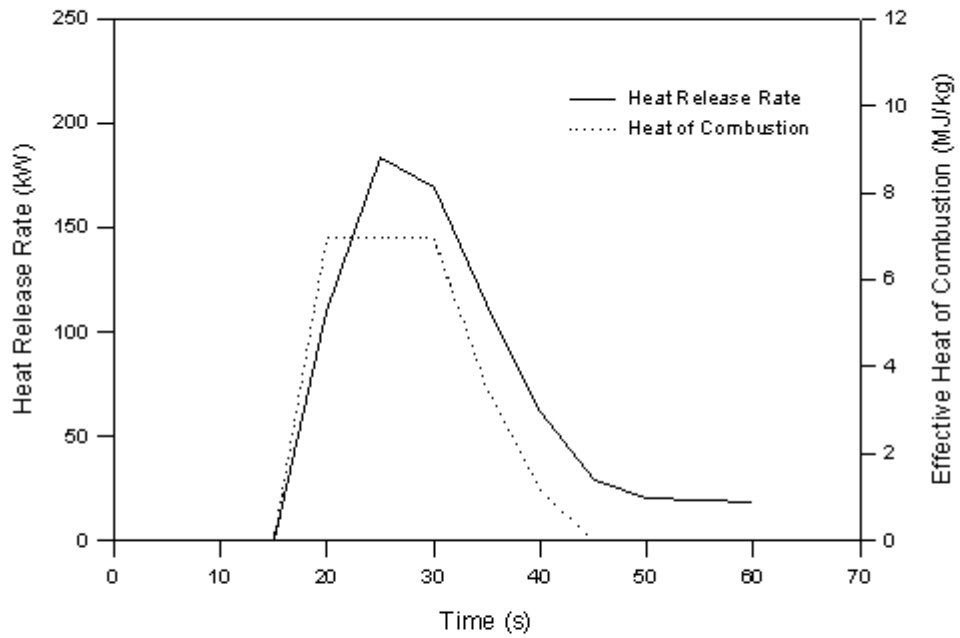

Figure D-30. Sample 22. Blanket, Modacrylic Fabric

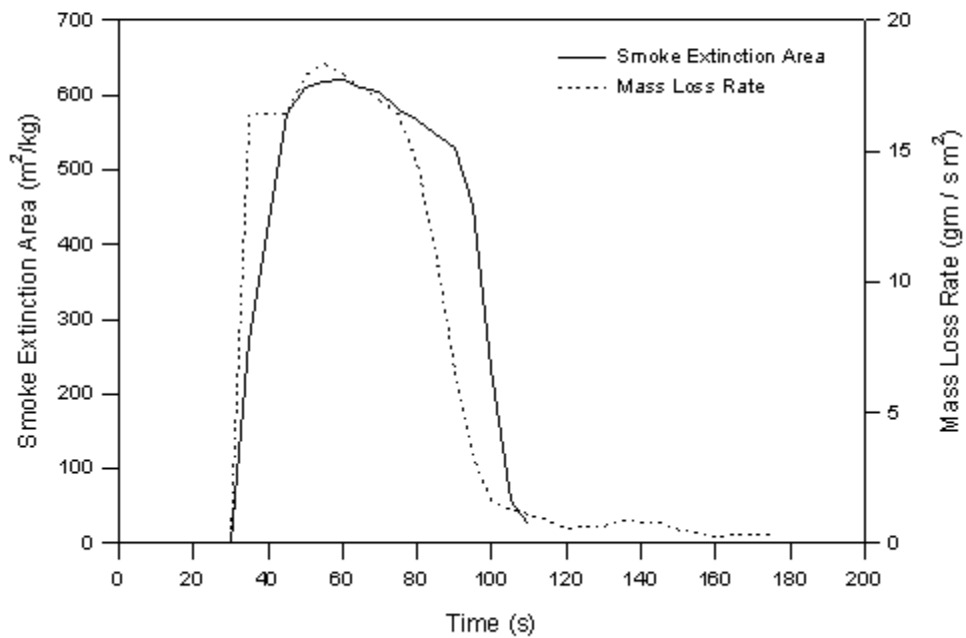
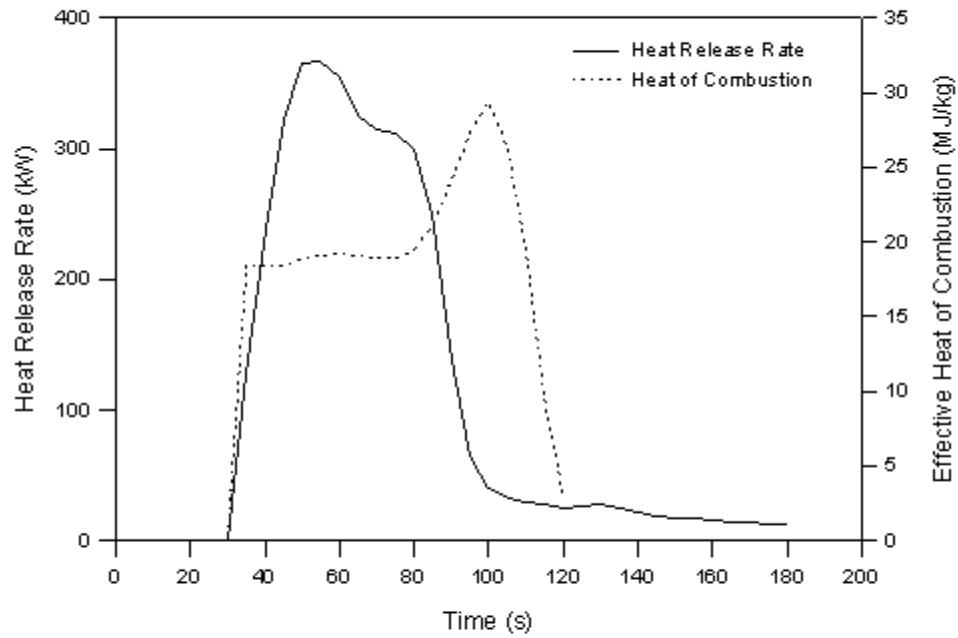

Figure D-31. Sample 23. Pillow

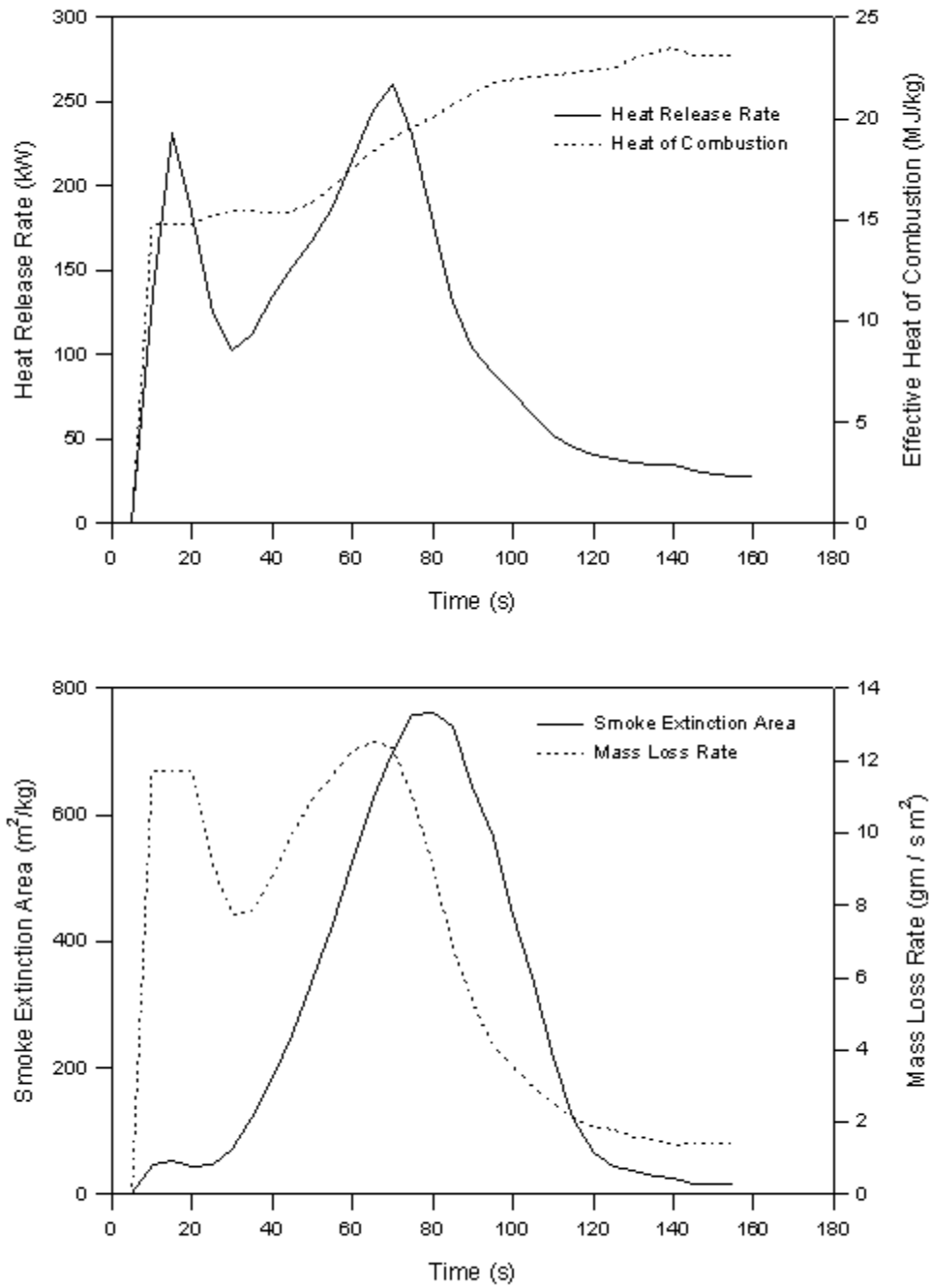

Figure D-32. Sample 24. Floor Covering, Nylon Carpet

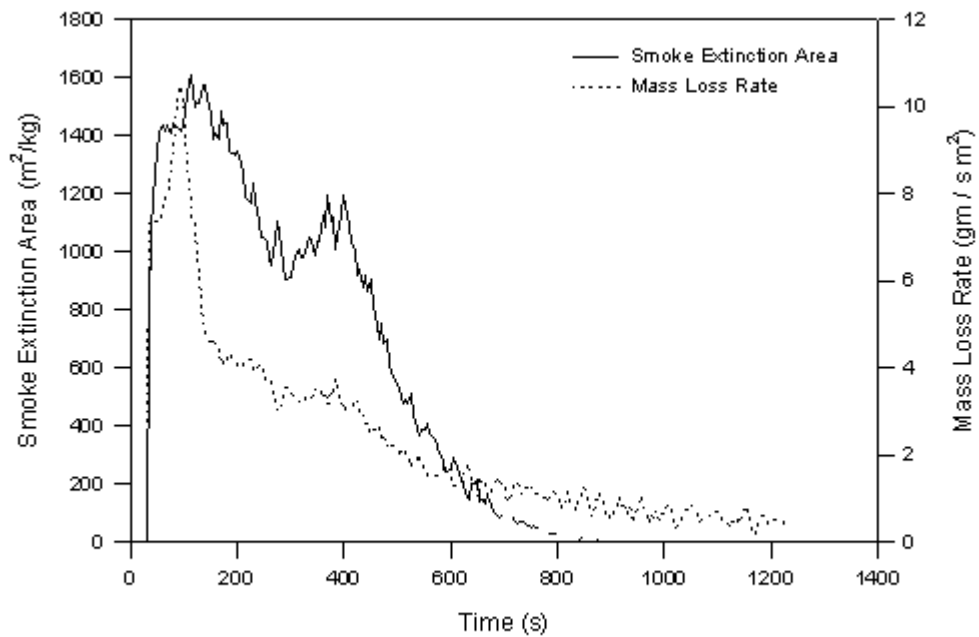
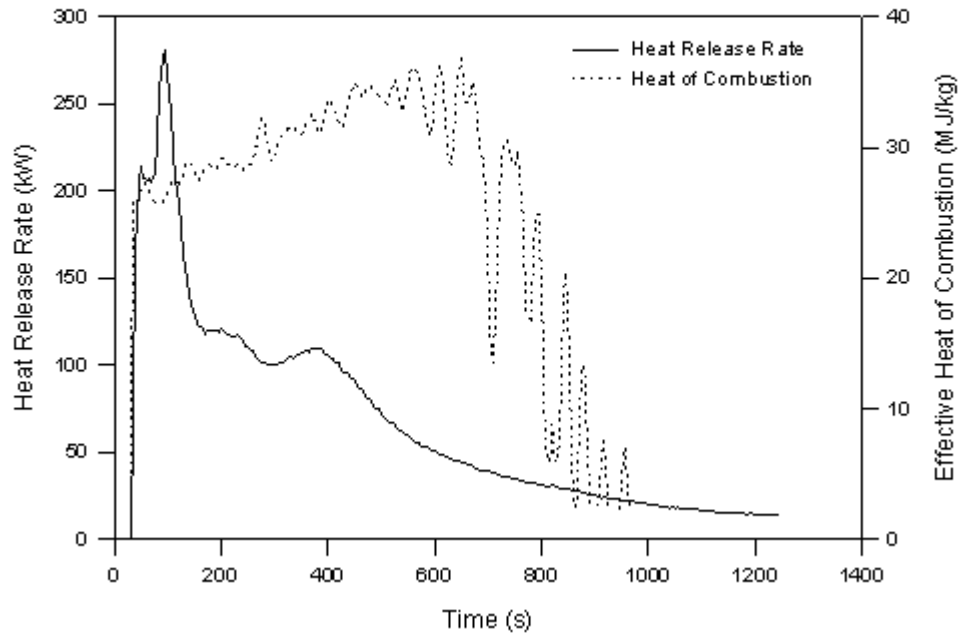

Figure D-33. Sample 25. Rubber Mat, Styrene Butadiene

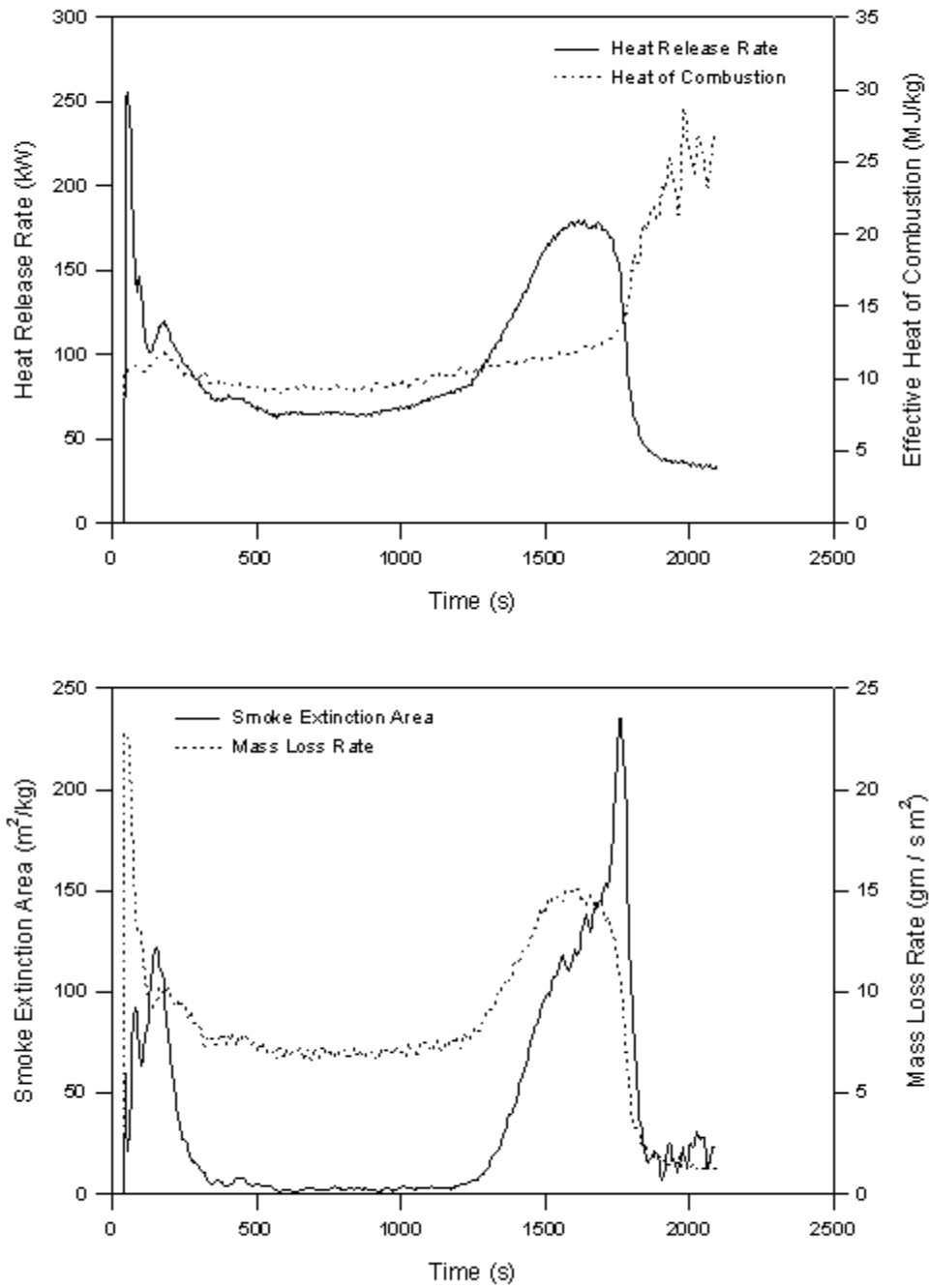

Figure D-34. Sample 26. Cafe/Lounge/Diner Table (Phenolic/Wood Laminate)

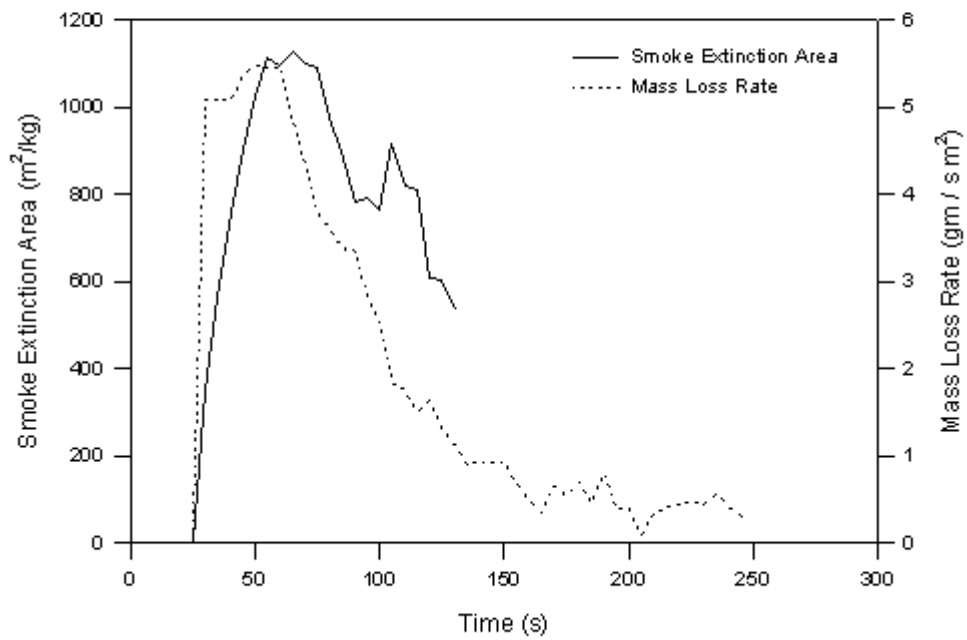
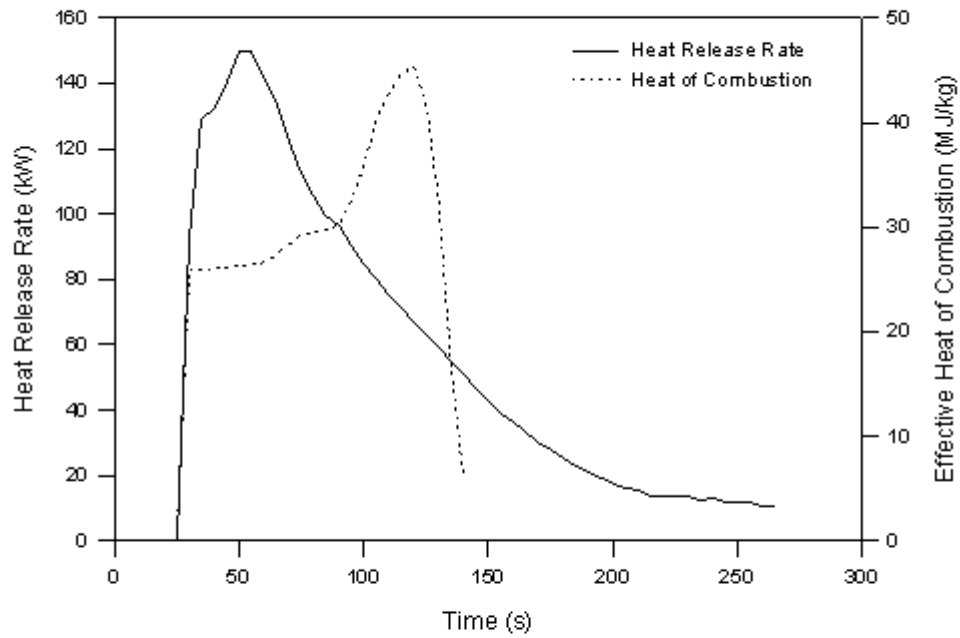

Figure D-35. Sample 27. Air Duct, Neoprene

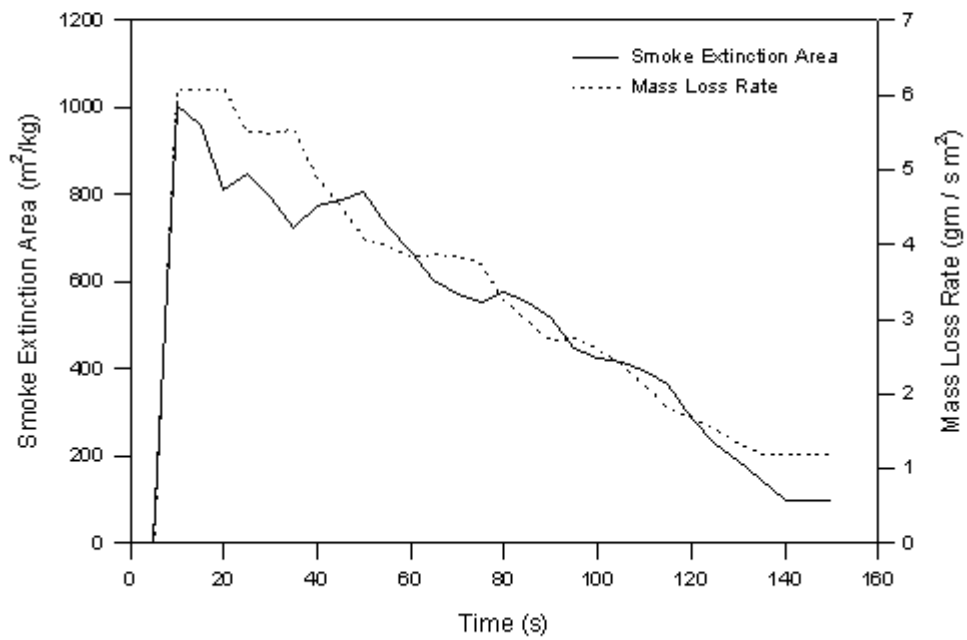
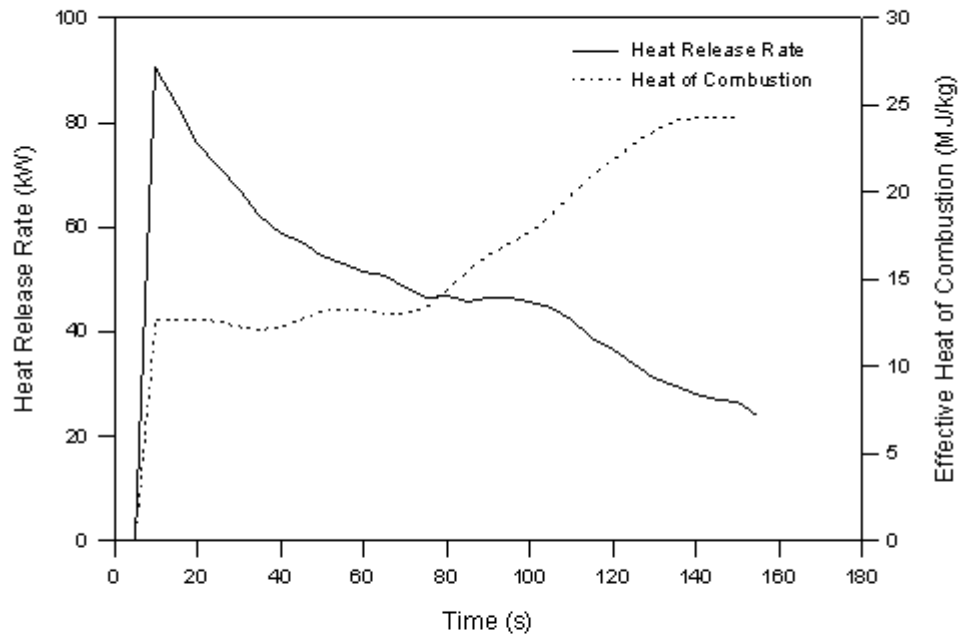

Figure D-36. Sample 28. Pipe Wrap Insulation Foam

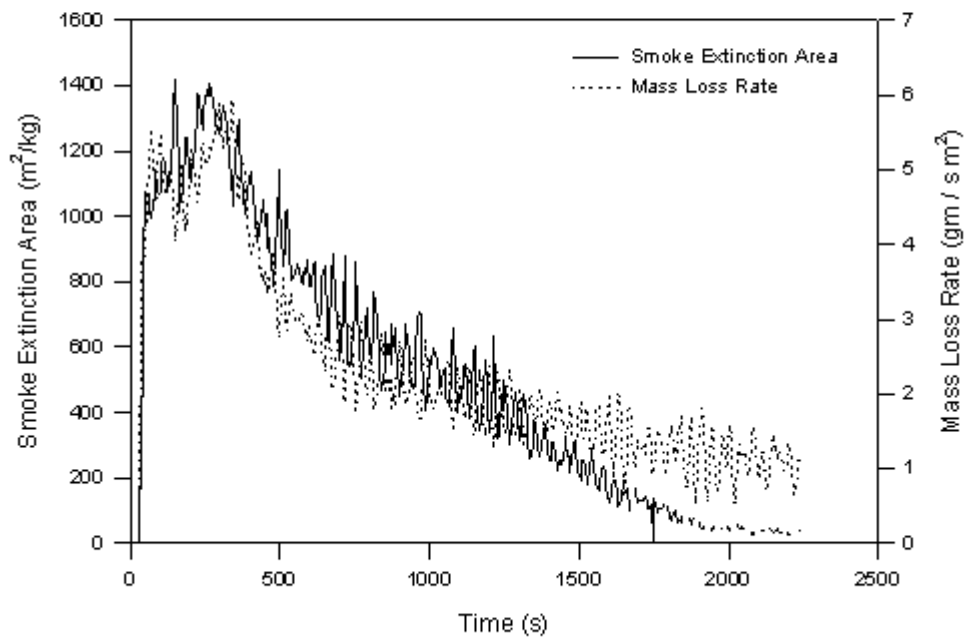
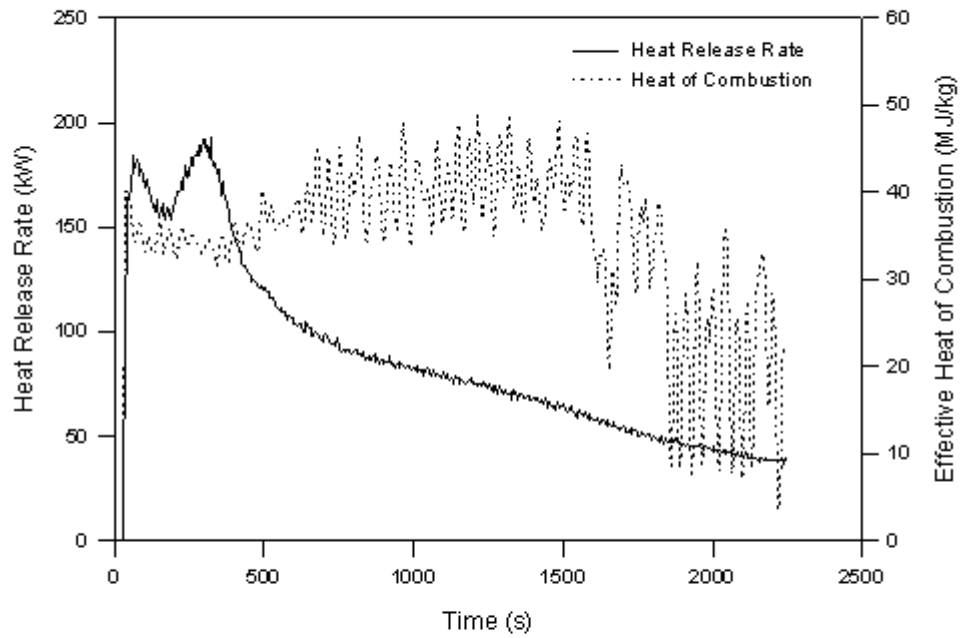

Figure D-37. Sample 29. Window Gasketing, Chloroprene Elastomer

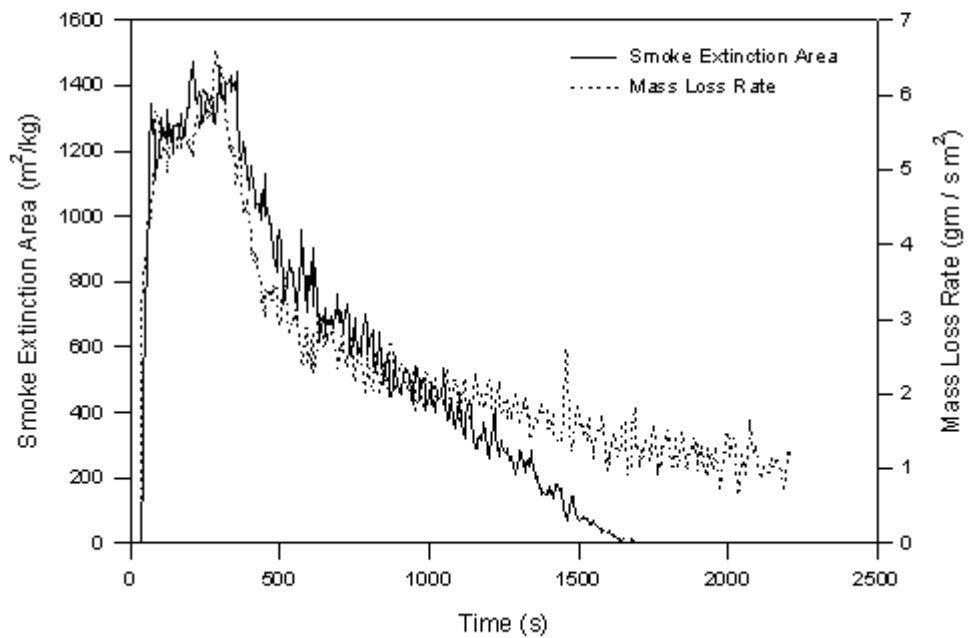
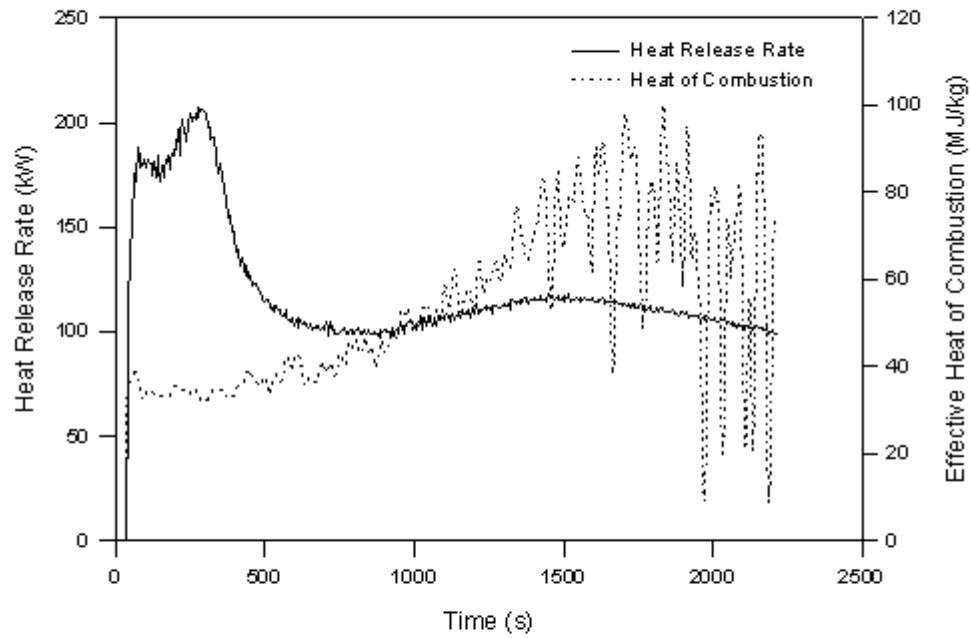

Figure D-38. Sample 30. Door Gasketing, Chloroprene Elastomer