

A RE-EVALUATION  
OF  
THE 1964 "L" STREET SLIDE

FINAL REPORT

By

Yoshiharu Moriwaki, Senior Project Engineer  
Ernesto E. Vicente, Assistant Project Engineer  
Shyn-Shiun Lai, Senior Staff Engineer

Woodward-Clyde Consultants  
Santa Ana, California

and

Thomas L. Moses, Jr., Regional Materials Engineer  
Central Region, Alaska DOT&PF, Anchorage, AK

April 1985

STATE OF ALASKA  
DEPARTMENT OF TRANSPORTATION AND PUBLIC FACILITIES  
DIVISION OF PLANNING  
RESEARCH SECTION  
2301 Peger Road  
Fairbanks, Alaska 99701-6394

The contents of this report reflect the views of the author who is responsible for the facts and the accuracy of the data presented herein. The contents do not necessarily reflect the official views or policies of the Alaska Department of Transportation and Public Facilities. This report does not constitute a standard, specification or regulation.

## TABLE OF CONTENTS

	<u>Page</u>
LETTER OF TRANSMITTAL	
TABLE OF CONTENTS	
1.0 INTRODUCTION .....	1
2.0 THE 1964 ALASKAN EARTHQUAKE .....	1
3.0 THE 1964 "L" STREET SLIDE .....	4
4.0 AREA GEOLOGY .....	10
5.0 SUBSURFACE CONDITIONS .....	12
6.0 REEVALUATION OF THE "L" STREET SLIDE .....	18
7.0 DISCUSSIONS AND CONCLUSIONS .....	28
8.0 RECOMMENDATIONS AND IMPLEMENTATIONS .....	31

## REFERENCES

Table 2-1 - Characteristics of the Prince William  
Sound Earthquake

- Figure 1 - Locations of Major Landslides Caused by  
the 1964 Alaskan Earthquake
- Figure 2 - Areal Photo of L-Street Slide Area
- Figure 3a - L-Street Slide Damage
- Figure 3b - L-Street Slide Damage
- Figure 4 - L-Street Slide Area
- Figure 5 - Three Cross-Sections from L Street Slide
- Figure 6 - Idealized Subsurface Conditions in  
L Street Slide Area
- Figure 7 - Evaluation Cross-Section
- Figure 8 - SPT Blowcounts in Major Sand Layers
- Figure 9 - Undrained Shear Strength from Various Tests
- Figure 10 - Backcalculation Cross Section
- Figure 11 - Liquefaction Potential of Major Sand Layers  
for Different Magnitude Earthquakes
- Figure 12 - Comparison of Estimated and Backcalculated  
Undrained Shear Strength
- Figure 13 - Backcalculated Normalized Undrained Shear  
Strength Variation with Number of Cycles
- Figure 14 - Evaluation Process for Seismic Site  
Stability

TABLE OF CONTENTS (Continued)

- APPENDIX A - Results of Geotechnical Field Investigation
- APPENDIX B - Results of Laboratory Tests
- APPENDIX C - Undrained Shear Strength of  
Bootlegger Cove Clay
- APPENDIX D - Procedure for Calculating Seismically-  
Induced Ground Displacements
- APPENDIX E - Selected Cross-Sections with CPT Results

## IMPLEMENTATION STATEMENT

This project was established when the State was planning the Knik Arm Crossing and one of the alternate routes was along "L" Street.

The report basically looks at a new theory (undrained failure through the clay which was recently studied for the 4th Avenue slide) for the cause and failure mechanism of the "L" Street slide. The predominant theory is that the landslides at both "L" Street and 4th Avenue were initiated due to liquification of a sand layer. The additional data gathered from the geotechnical investigations on this project adds to the existing geotechnical database related to the 1964 Anchorage earthquake and can be used by State or Federal agencies, consultants, etc. to aid in their decision-making processes for construction of buildings or roads.

No direct implementation of these results can be expected at this time.

Lorena A. Hegdal  
Research Engineer

## A RE-EVALUATION OF THE 1964 "L" STREET SLIDE

### 1.0 INTRODUCTION

The "L" Street slide caused by the 1964 Alaskan earthquake resulted in significant damage to structures particularly in the graben and pressure ridge zones. Subsequent to the slide, the area has been re-developed to the point where no noticeable remnants of the slide are now apparent. However, apart from some studies conducted shortly after the 1964 Alaskan earthquake, the 1964 "L" Street slide has not been fully investigated in recent years.

The objective of this study is to evaluate the likely mechanisms of the "L" Street slide caused by the 1964 Alaskan earthquake based on a limited program of field investigation, laboratory tests, and analyses. The general approach adopted in this study is similar to that used in a recent study by Woodward-Clyde Consultants (1982) which addressed the seismic stability of two sites near the 1964 Fourth Avenue slide.

### 2.0 THE 1964 ALASKAN EARTHQUAKE

In 1964, Alaska was shaken by one of the largest earthquakes ever to occur anywhere in historic times. The earthquake occurred at 5:36 pm local time on Friday, 27 March 1964 (3:36 am GMT, 28 March). The epicenter of the earthquake was estimated at coordinates 61.04°N, 147.73°W, approximately 130 km east of Anchorage. The magnitude of the earthquake was 8.5 (surface wave magnitude) and 9.2 (moment

magnitude); the seismic moment was estimated to be about  $8.2 \times 10^{29}$  dyne-cm. The key characteristics of the 1964 Alaskan earthquake are summarized in Table 2.1.

Strong motions from this earthquake were not recorded in the Anchorage area. However, based on patterns of damage (and lack of damage) to structures and their contents, peak ground acceleration levels in Anchorage were estimated to be about 0.15g to 0.2g (Housner and Jennings, 1973; Shannon and Wilson, 1964; Newmark, 1965). It is noted that this range of peak ground acceleration in Anchorage is not particularly large compared to those recorded during other earthquakes at other seismically active parts of the world.

The duration of perceptible ground motion in Anchorage was reported to range from 4 to 7 minutes, with strong shaking lasting approximately 2 to 3 minutes (Housner and Jennings, 1973; Steinbrugge, 1970). It is noted that this 2 to 3 minutes of strong ground shaking is very long compared to the recorded durations of strong ground shaking from other earthquakes.

Finally, it is noted that the 1964 Alaskan earthquake was caused by the breakage of the megathrust that dips at a shallow angle toward Anchorage from the southeast direction. The closest distance between Anchorage and the zone of aftershocks is about 65 km. It is noted that an earthquake source consisting of a megathrust is significantly different from many earthquake sources found in a place like California, where normal faults, strike-slip faults, and reverse faults (Bolt, 1978) cause earthquakes of moment magnitude generally lower than 9.2.

TABLE 2-1

CHARACTERISTICS OF THE PRINCE WILLIAM SOUND EARTHQUAKE

Date	March 27, 1964; 5:36 P.M. local time (March 28, 1964; 3:36 A.M. GMT)
Location	Epicenter: 61.04° N, 147.73° W Distance of epicenter from Anchorage was approximately 130 km (80 miles). Distance of aftershock zone from Anchorage was approximately 65 km (40 miles).
Size	Surface Wave Magnitude: $M_S^* = 8.5$ Moment Magnitude: $M_W^* = 9.2$ Seismic Moment: $M_O^* = 8.2 \times 10^{29}$ dyne.cm
Level of Shaking	In Anchorage: peak ground acceleration estimated to be approximately 0.15 to 0.20 g; Modified Mercalli intensity of VIII to IX.
Duration	In Anchorage: reported observations of the duration of felt motion were 4 to 7 minutes. The duration of strong shaking was approximately 2 to 3 minutes.

\*Note:

$M_S$  is measured from the amplitudes of 20-second period surface waves and is a suitable measure of the size of shallow earthquakes for magnitudes less than about 8.

$M_O$  is equal to the product of fault area, average fault slip, and shear modulus and is a physically vigorous measure of earthquake size.

$M_W$  is calculated from seismic moment  $M_O$ . It is equivalent to  $M_S$  below magnitude 8 but is a more suitable measure of the size of earthquake for magnitude greater than about 8.

### 3.0 THE 1964 "L" STREET SLIDE

Damage to buildings, in the relatively sparsely populated regions of Alaska affected by the 1964 Alaskan earthquake, was surprisingly small. On the other hand, the number and extent of landslides in several cities, including Anchorage, was enormous. Figure 1 shows the locations of the slides, including the "L" Street slide, triggered by this earthquake in the Anchorage area.

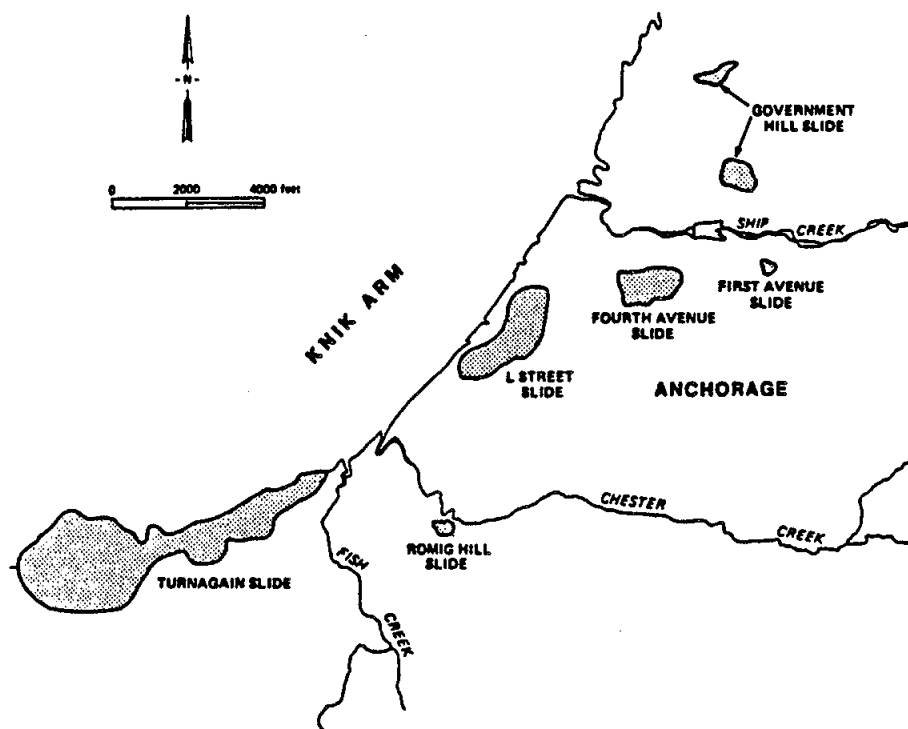

Figure 1 - Locations of Major Landslides Caused by the 1964 Alaskan Earthquake

An aerial photograph of the 1964 "L" Street slide is shown in Figure 2; additional photographs depicting damages caused by the slide are shown in figures 3(a) and 3(b). The 1964 "L"



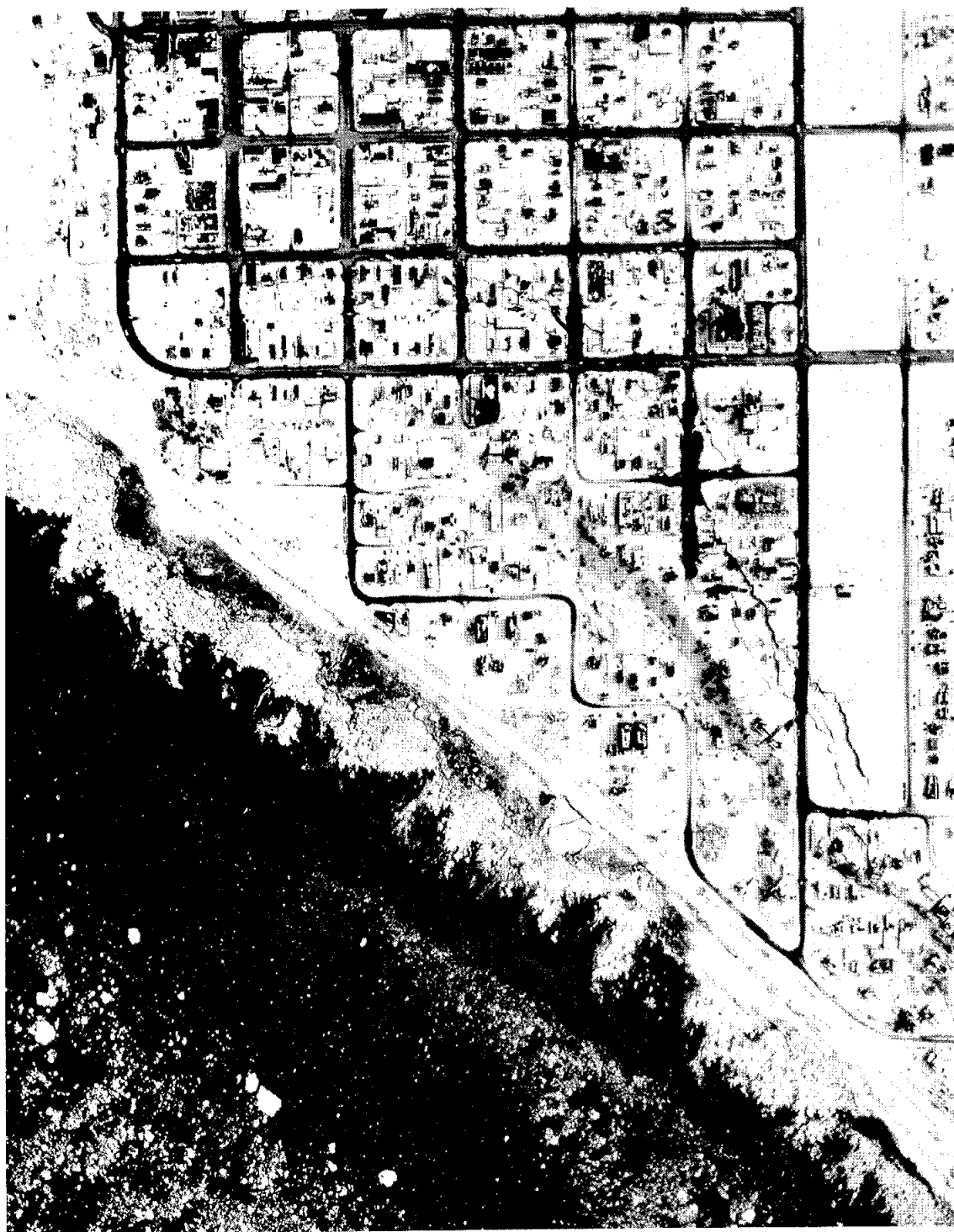

Figure 2 - Aerial Photo of "L" Street Slide Area

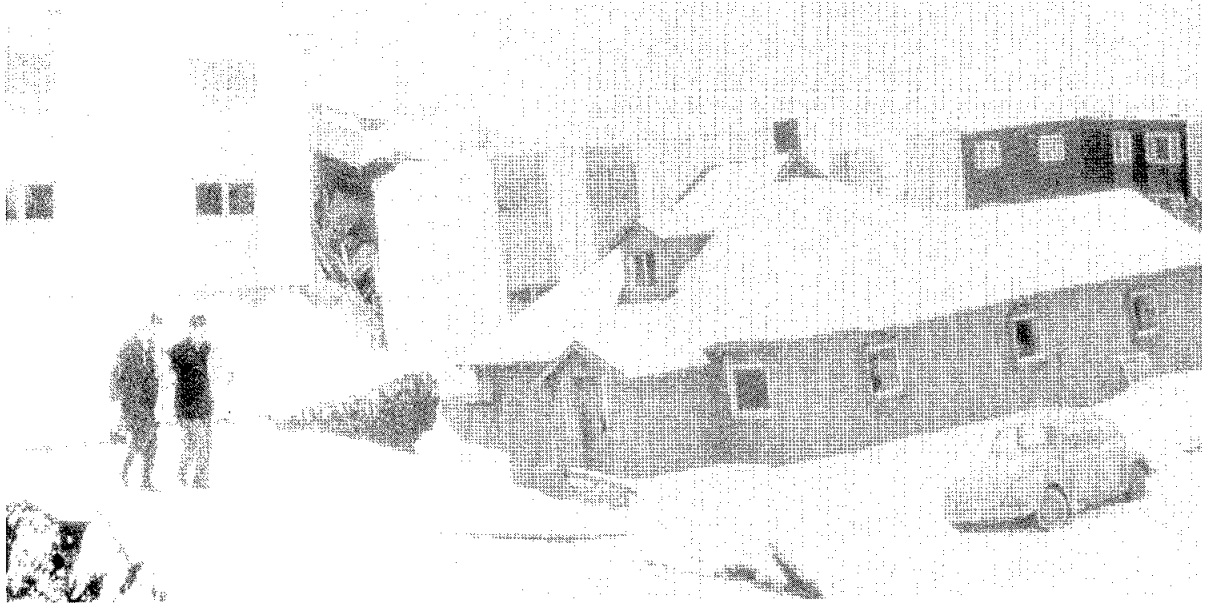

Figure 3(a) - L Street Slide Damage



Figure 3(b) - L Street Slide Damage

Street slide was a translatory slide (Hansen, 1965) involving a relatively horizontal, outward movement of a soil block toward the bluff with a graben forming behind the soil block. The areal extent of the "L" Street slide and three idealized cross-sections along the slide are shown in Figures 4 and 5, respectively. Figure 5 indicates the general nature of this translatory slide.

The 1964 "L" Street slide extended about 4,000 feet along the bluff, the width (from the bluff to the graben) of the soil block varied from about 150 feet to 400 feet, the width of the graben varied from less than 50 feet to about 250 feet, and the distance between the toe (as represented by the pressure ridges) of the slide to the back of the graben measured as much as about 1,200 feet. The available data on magnitude and direction of vertical and horizontal movements summarized in Figure 4 indicate a maximum horizontal displacement of the soil block of about 14 feet toward the northwest. Relatively few cracks were noted outside the graben (Shannon and Wilson, 1964).

Apparently, there was very little change in elevation within the slide block. Structures on the slide block, thus, suffered little, if any, damage from the slide movements (Shannon and Wilson, 1964). However, the graben areas vertically dropped by as much as about 10 feet. Many buildings and utilities in and along the edge of the graben, thus, were heavily damaged.

According to eyewitness accounts the slide occurred during the later part of the earthquake (Shannon and Wilson, 1964). While it is reasonable to assume that small local adjustments of the ground near the graben and pressure ridges occurred following the end of the earthquake, no

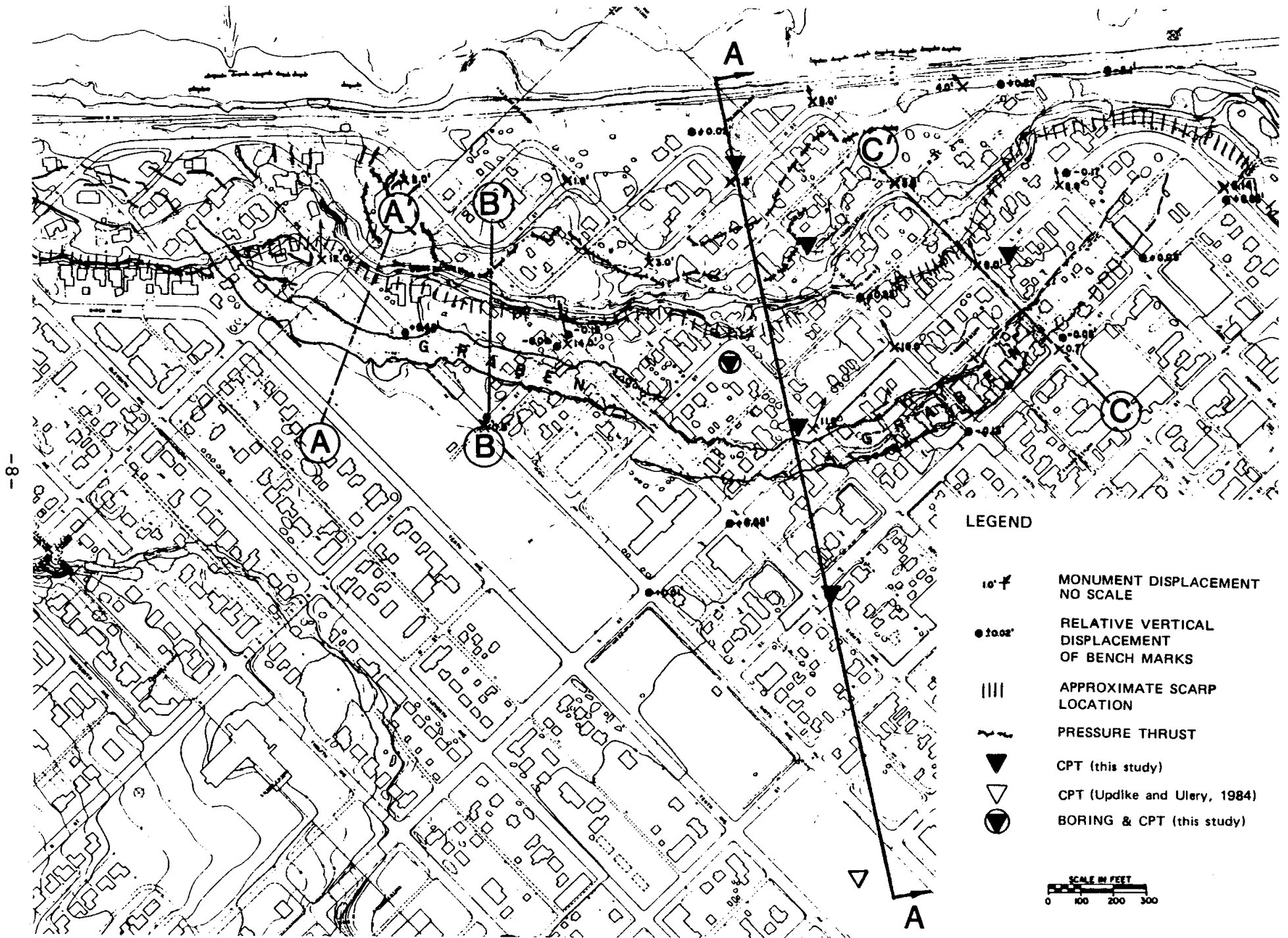

LEGEND

- 10' ± MONUMENT DISPLACEMENT  
NO SCALE
- 10.02' RELATIVE VERTICAL  
DISPLACEMENT  
OF BENCH MARKS
- ||||| APPROXIMATE SCARP  
LOCATION
- ~ ~ ~ PRESSURE THRUST
- ▼ CPT (this study)
- ▽ CPT (Updike and Ulery, 1984)
- ▼ BORING & CPT (this study)

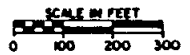
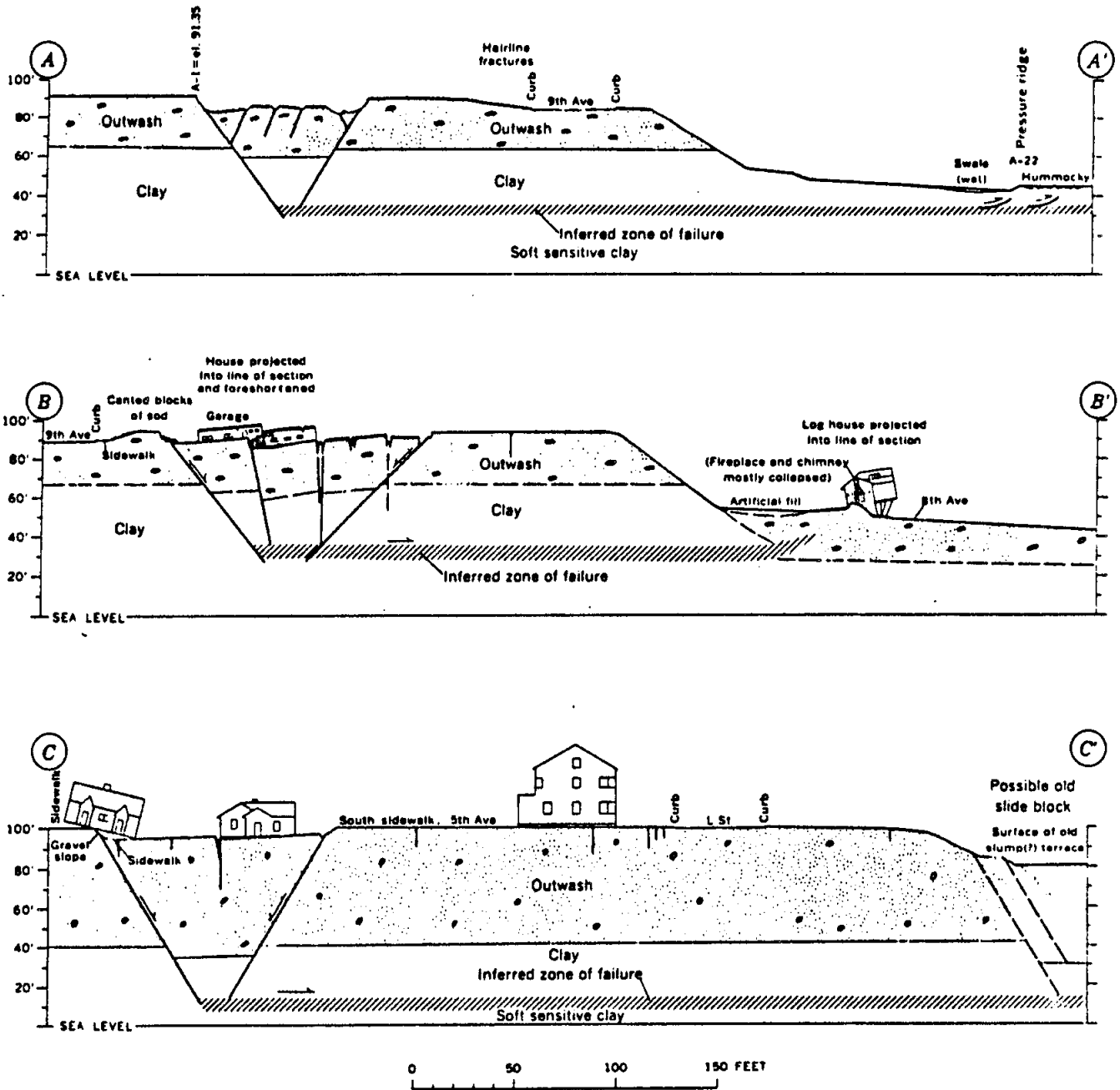

Figure 4 - L Street Slide Area



(Hansen, 1965)

Figure 5 - Three Cross-Sections from L Street Slide

discernable ground movement following the earthquake was detected in repeated measurements of control points after the earthquake (Shannon and Wilson, 1964).

Based on investigations (Shannon and Wilson, 1964) conducted shortly after the earthquake, the slide apparently was caused by "a drastic loss of strength and consequent failure of the dynamically sensitive saturated sands, silts and clayey silts of the Bootlegger Cove formation, and in most instances occurred near the top of the soft sensitive zone". According to the same investigations, this top of the soft sensitive zone ranged from about elevation 50 to somewhat below elevation 15. However, detailed discussions or documentation regarding the possible causes of the 1964 "L" Street slide does not appear to be readily available.

#### 4.0 AREA GEOLOGY

The "L" Street slide area sits on a ridge of sediments between Ship Creek to the north and Chester Creek to the south. The stratigraphy and recent geologic history of the Anchorage area are primarily the product of Quaternary glaciations and the intervening interglacial periods. The sediments directly underlying the 1964 "L" Street slide area are associated with the Naptowne glaciation and consist of the Naptowne outwash overlying the Bootlegger Cove Formation. The Bootlegger Cove Formation overlies a glacial till considered to be of Knik age (Reger and Updike, 1983).

The upper section of the Bootlegger Cove Formation was deposited in a proglacial lake in the Anchorage area. In the 1964 "L" Street slide area, the Bootlegger Cove Formation below elevation about 40 feet consists of normally

consolidated to slightly overconsolidated silty clay and clayey silt with lenses of silt and sand. This section of the Bootlegger Cove Formation includes the "soft sensitive clay" referred to by Shannon and Wilson (1964).

Local interbedding of sand and silt strata within the Bootlegger Cove Formation probably resulted from variations of the source sediments, streamflow velocities, distance from the sources and/or depositional environment within the lake. In the 1964 "L" Street slide area, this interbedding increases between elevations about 40 and 70 feet. The clays within this interbedded zone are stiff and have a higher degree of overconsolidation than the clay below this zone. Fluctuations of lake level during the Naptowne glaciation and subsequent draining of the lake in late Naptowne time probably exposed the lacustrine sediments to subaerial conditions. The subaerial exposure of the Bootlegger Cove Formation possibly caused desiccation, weathering, and oxidation of the sediments, resulting in the greater stiffness of the clay strata within the zone of interbedded soils relative to that of the sediments immediately beneath that zone.

Subsequent to the deposition of the Bootlegger Cove Formation, streams emanating from the retreating glaciers transported reworked silt, sand, gravel, and cobbles and deposited them on a broad plain. This deposit, known as the Naptowne outwash, overlies the Bootlegger Cove Formation and is the stratum exposed at the surface in the 1964 "L" Street slide area.

An idealized stratigraphy of the 1964 "L" Street slide area corresponding to the CPT 4 location is shown in Figure 6. From the bottom it consists of the glacial till, normally

consolidated to lightly over-consolidated Bootlegger Cove Formation, overconsolidated Bootlegger Cove Formation, and the Naptowne outwash. Note in Figure 6 the characteristic CPT shapes associated with each soil layer.

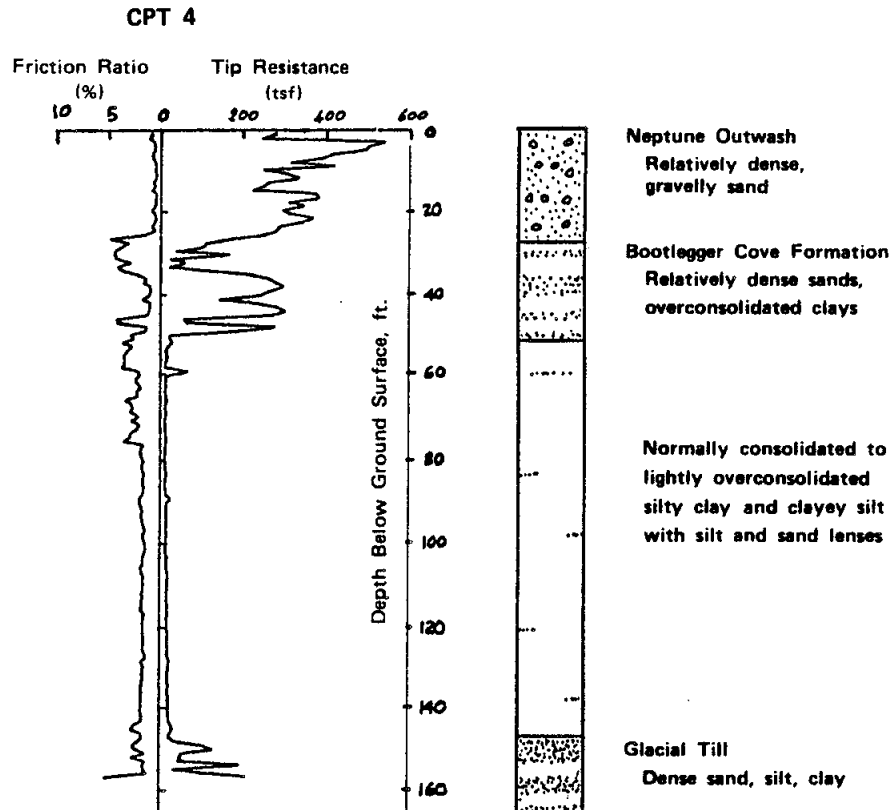

Figure 6 - Idealized Subsurface Conditions in L Street Slide Area

## 5.0 SUBSURFACE CONDITIONS

The subsurface conditions in the 1964 "L" Street slide area were investigated by advancing one boring with standard penetration tests (SPT), sampling, and in-situ vane tests; conducting 6 cone penetration test (CPT) soundings; and reviewing selected available subsurface information of the area. The locations of the boring and the CPT soundings are summarized in Figure 4 and the results of the field



investigation are summarized in Appendix A. As can be seen in Figure 4, the field investigation effort was concentrated along one section selected for the evaluation of the 1964 "L" Street slide. This section (A-A in Figure 4) will be referred to as the evaluation section or cross-section.

The evaluation cross-section indicated in Figure 4 is presented in Figure 7, together with the CPT results along the cross-section. The four main strata schematically shown in Figure 6 can be identified in Figure 7 at various CPT locations. It is interesting to note in Figure 7 the following apparent observations:

- 1) The top elevation of the glacial till appears to become deeper toward the west or toward the bluff and Knik Arms (see the evidence of glacial till near the bottom of CPT-1A, CPT-4, and PS-7);
- 2) The Naptowne outwash appears to disappear in the area just below the bluff (see CPT-6) where the pressure ridges were observed after the 1964 Alaskan earthquake, but sandy, gravelly top layer "reappears" farther away from the bluff (see CPT-1A); and
- 3) The elevations where the pressure ridges were observed after the 1964 Alaskan earthquake appear to correspond to those of the uppermost portion of the normally consolidated to lightly over-consolidated Bootlegger Cove Formation.

The SPT blowcounts obtained within the three major sand layers between elevations 55 feet and 40 feet (about 40 feet and 55 feet below the ground surface) at the boring location

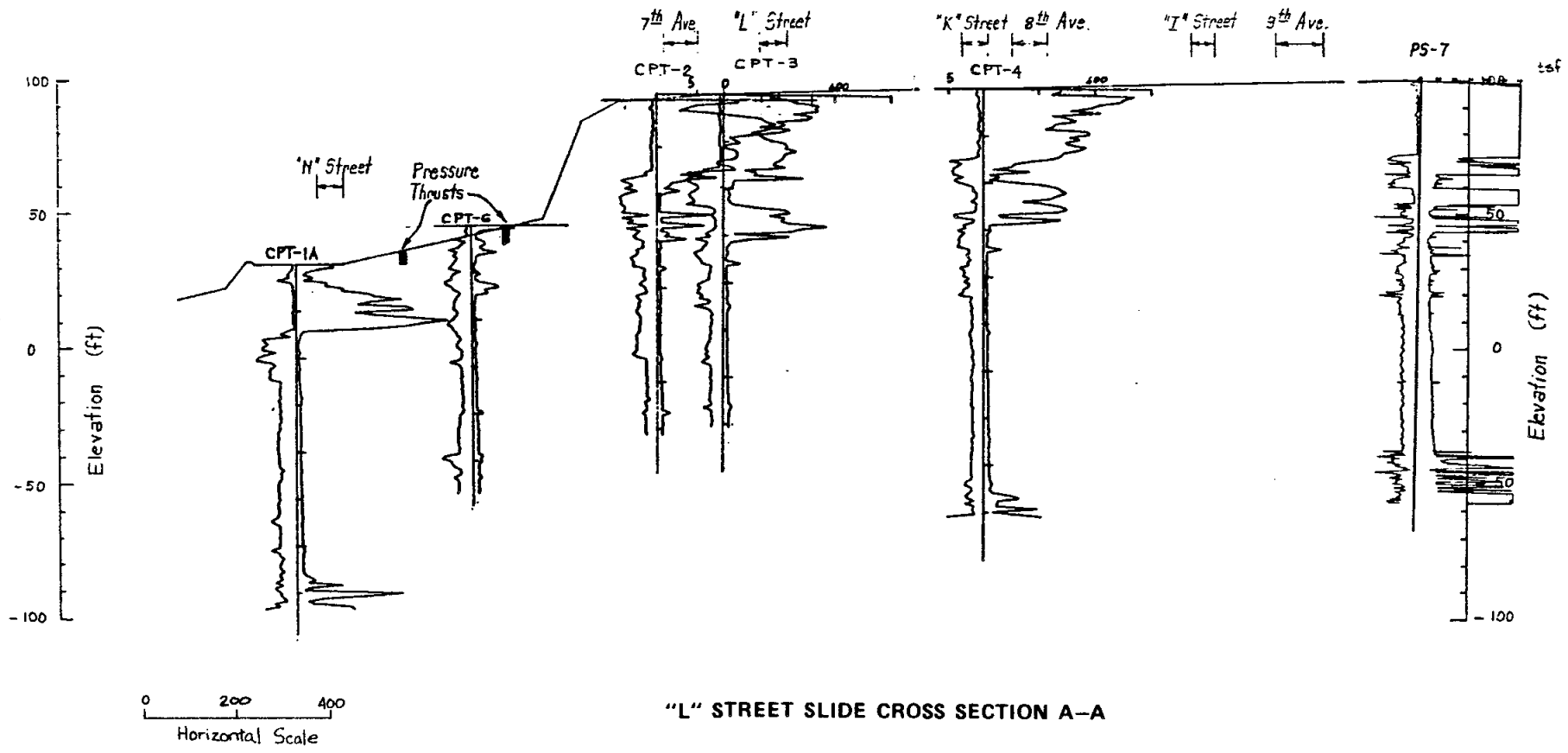

Figure 7 - Evaluation Cross-Section

which corresponds to CPT-2 location (Figures 4 and 7) are shown in Figure 8, together with the CPT-2 results. Note in Figure 8, both the original SPT blowcounts and those corrected for confining pressure effects (Seed and Idriss, 1982) are shown. It should be also noted in Figure 8 that the relatively low SPT blowcount at 43 feet below the ground

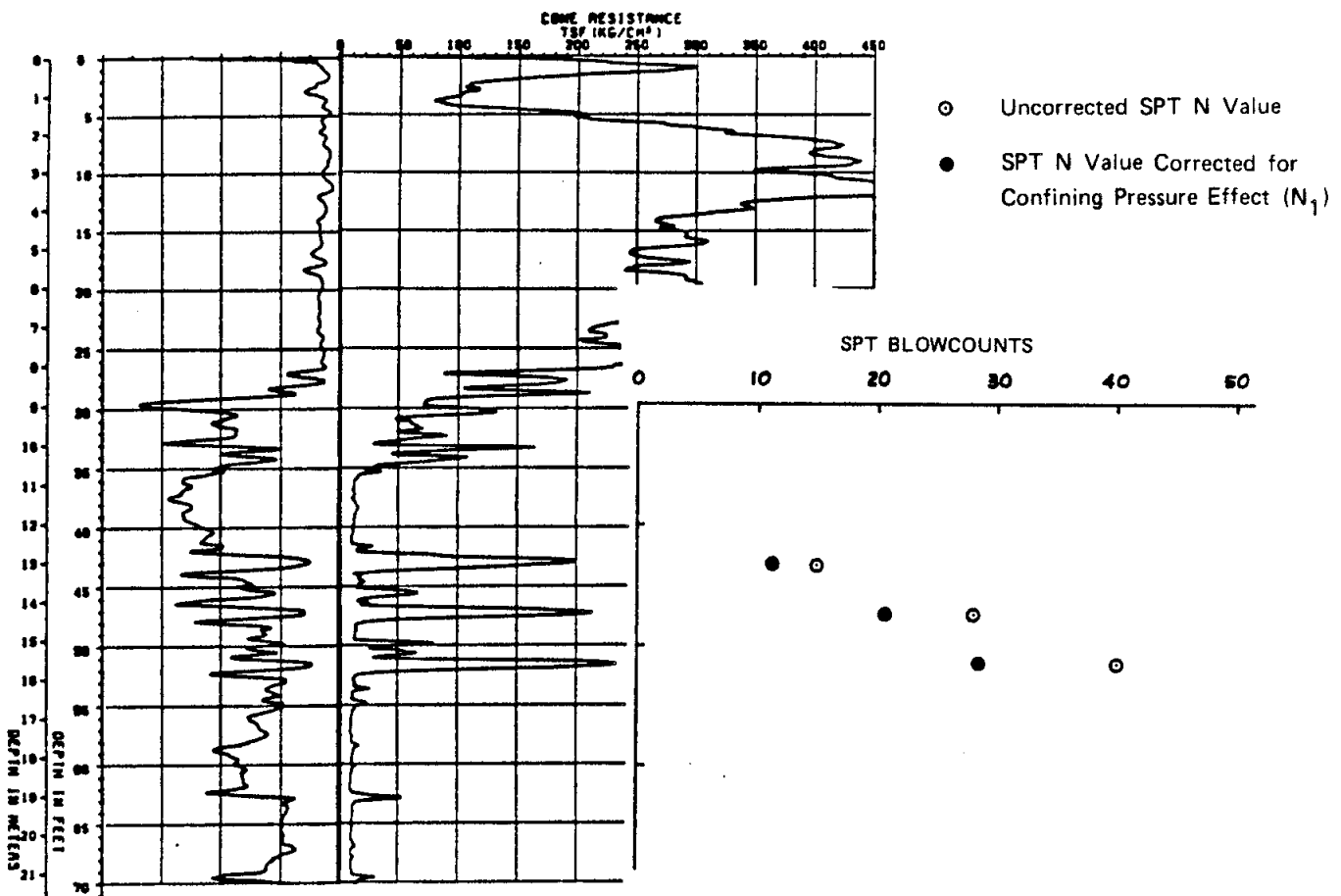

Figure 8 - SPT Blowcounts in Major Sand Layers

surface is considered primarily a result of thin clay seams observed in that sand layer. The SPT results together with the CPT results (tip resistance of up to 200 tsf or more as shown in Figure 8) indicate that at the CPT-2 location the three major sand layers appear to be dense.

A number of field and laboratory undrained shear strength determinations were made as part of the boring program at the CPT-2 location for clayey materials within the Bootlegger Cove Formation. In the field the undrained shear strength was estimated using torvane tests and field vane tests. In the laboratories the undrained shear strength was estimated using torvane tests, mini-vane tests, unconsolidated-undrained (UU) triaxial tests, one direct simple shear (DSS) test, and one direct shear test. The results of these tests (except the direct shear test) are summarized versus depth in Figure 9, along with the corresponding CPT-2 results. The two values, high and low, connected with a line for a mini-vane and field vane results in Figure 9 represent initial undrained shear strength (the higher value) and the remolded undrained shear strength (the lower value), where the remolding was accomplished by a multiple turning of the vane blades. Thus, the ratio of the higher value to the lower value can be viewed as a measure of the sensitivity of the materials. The dash line labeled TXCU in Figure 9 was estimated using the consolidated-undrained (CU) triaxial tests conducted on samples obtained from the 1964 Fourth Avenue slide area (Woodward-Clyde Consultants, 1982). It is noted that one direct shear test to estimate the strength loss due to large strain did not provide satisfactory results.

The following observations can be made in Figure 9:

- 1) The undrained shear strength appears to increase above about 55 to 60 feet from the ground surface (this corresponds to the overconsolidated Bootlegger Cove Formation; see Figure 6);

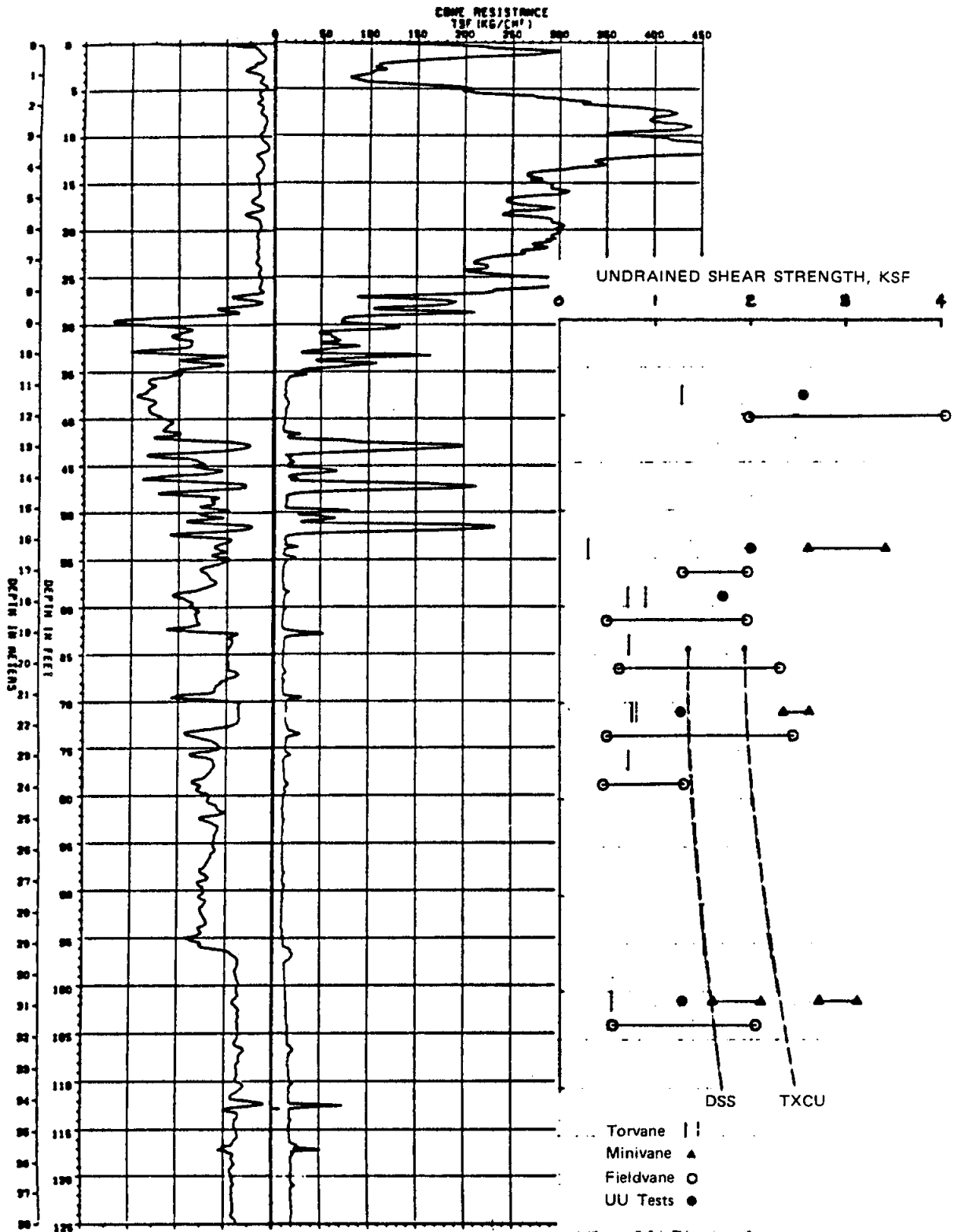

Figure 9 - Undrained Shear Strength from Various Tests

- 2) Below 55 to 60 feet from the ground surface, there is no apparent trend of either the undrained shear strength or the sensitivity with depth when only the results of torvane tests, mini-vane tests, field vane tests, and the UU tests are included;
- 3) The inferred undrained shear strength (see Appendix C) based on the DSS test and the TXCU tests shows a gradual increase with depth below 65 feet from the ground surface; and
- 4) The results of the torvane tests provide consistently low values and the results of the mini-vane tests provide consistently high but variable values.

#### 6.0 REEVALUATION OF THE "L" STREET SLIDE

The reevaluation of the 1964 "L" Street slide in this study followed an approach developed for a reevaluation of the 1964 Fourth Avenue slide by Woodward-Clyde Consultants (1982). It essentially consists of the following steps:

- 1) Backcalculate the range of undrained shear strength necessary to compute observed values of seismically induced displacement using the observed failure geometry, the available information on the 1964 Alaskan earthquake, and estimated subsurface conditions in the Anchorage area at that time; and
- 2) Compare the range of backcalculated undrained shear strength with the range of undrained shear strength estimated for the 1964 subsurface conditions.

The process of backcalculating undrained shear strength range corresponding to the displacement values observed for the 1964 "L" Street slide involved the following steps:

- 1) Using the observed failure geometry (see Figures 4 and 10), compute the active soil force ( $F_{da}$ ) using equation D-1 (Appendix D), the weight of the soil block ( $W$ ), and the length of the soil block ( $L$ );

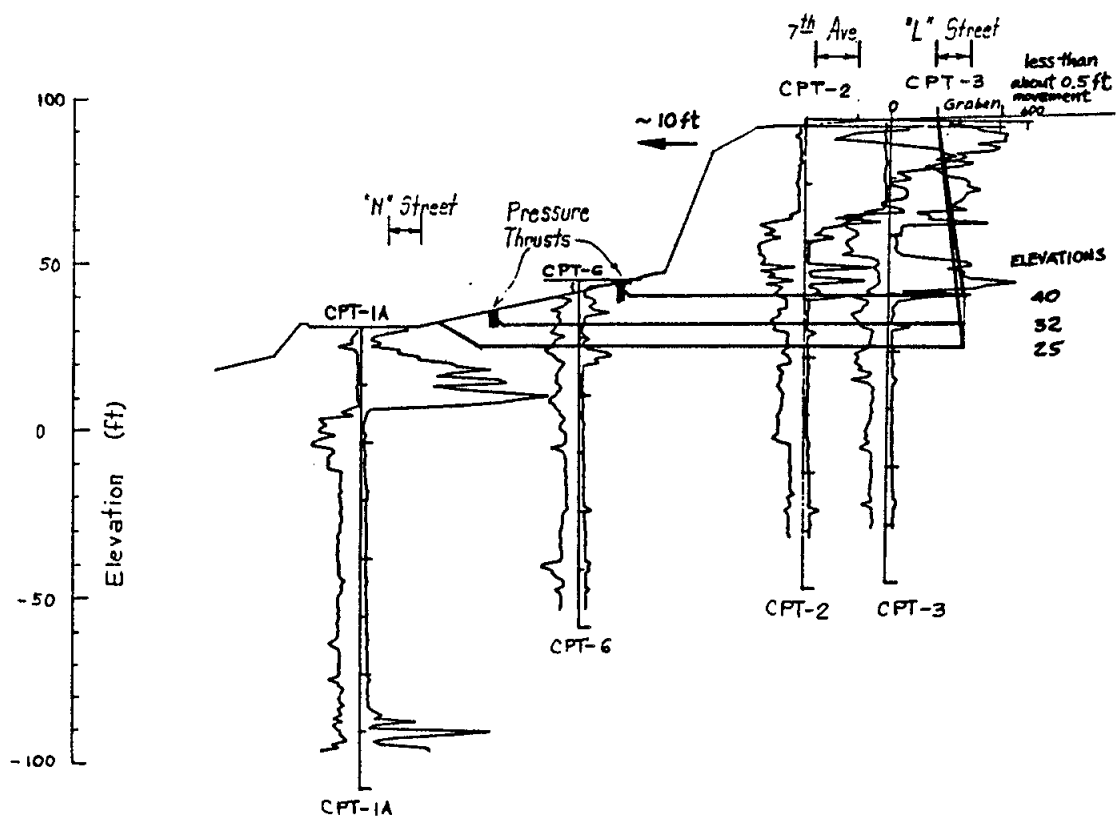

Figure 10 -Backcalculation Cross Section

- 2) Using Figure D-3 (Appendix D) and the value of measured soil block displacement, determine a range of  $K_y/K_{max}$  value required where  $K_y$  is the yield seismic coefficient and  $K_{max}$  is the maximum seismic coefficient as discussed in Appendix D (let  $K_y/K_{max} = C$ );
- 3) For a selected value of  $K_{max}$ , backcalculate a corresponding value of  $s_u$  (undrained shear strength) using the following equation:

$$s_u = \frac{K_{max} W + Fda}{C L} \quad (6-1)$$

(Because various values of  $C$ ,  $K_{max}$ ,  $W$ , and  $L$  are used in equation 6-1, a range of  $s_u$  value is computed.)

The main variables affecting the backcalculated shear strength range are the following: 1) the amount of earthquake induced displacement and how it varies with time during the shaking, 2) maximum seismic coefficient  $K_{max}$ , 3) weight of the soil block  $W$  as affected by the height of the soil block (or the depth of stipulated failure plane), and 4) the relationship between displacement and  $K_y/K_{max}$  shown in Figure D-3 (Appendix D).

The amount of earthquake induced displacement of the soil block in the evaluation cross-section shown in Figure 10 was about 10 feet. Based on the eyewitness account of the 1964 "L" Street slide (Shannon and Wilson, 1964), the amount of the displacement was assumed to be about 0.5 foot during the first half of the shaking and about 9.5 feet during the



second half of the shaking. The ground behind the graben did not move more than about 0.5 foot. The peak ground acceleration in the "L" Street slide area during the 1964 Alaskan earthquake was assumed to be between about 0.15g to 0.20g. Based on the subsurface conditions in the "L" Street slide area and the locations of the pressure ridges identified after the earthquake (Shannon and Wilson, 1964), the failure plane of the 1964 "L" Street slide was assumed for this cross-section to be horizontal and to lie within the elevation range from 25 feet to 40 feet. The details of the displacement computation are presented in Appendix D.

The undrained shear strength ranges backcalculated as outlined above do not depend on the sources of the undrained shear strength; they are just ranges required to compute the observed displacement values using the procedures described in Appendix D. However, in order to estimate the ranges of undrained shear strength in the "L" Street area corresponding to the conditions immediately before the 1964 Alaska earthquake, some additional specification of the types of soil that failed in the 1964 slide must be made. In the "L" Street slide area, the subsurface conditions are quite variable. Nevertheless, it is reasonable to evaluate whether the failure occurred primarily through the major sandy soil layers shown in Figure 6 or primarily through the normally consolidated to slightly overconsolidated clayey soils (the Bootlegger Cove clay) immediately below the sand layers.

The corrected SPT blowcount values for the three main sand layers shown in Figure 8 are shown in Figure 11 for liquefaction potential evaluation based on Seed and Idriss (1982). Note in Figure 11 that the lowest blowcount value considered to be affected by thin clay layers present in

that sand layer is not shown because the data likely was not representative of that sand layer. Based on the data shown in Figure 11, it is concluded that the liquefaction of the major sand layers was probably not the major cause of the 1964 "L" Street slide. (It is noted that the data presented in Figure 11 are very limited. However, data from other studies in the area tend to support this observation.)

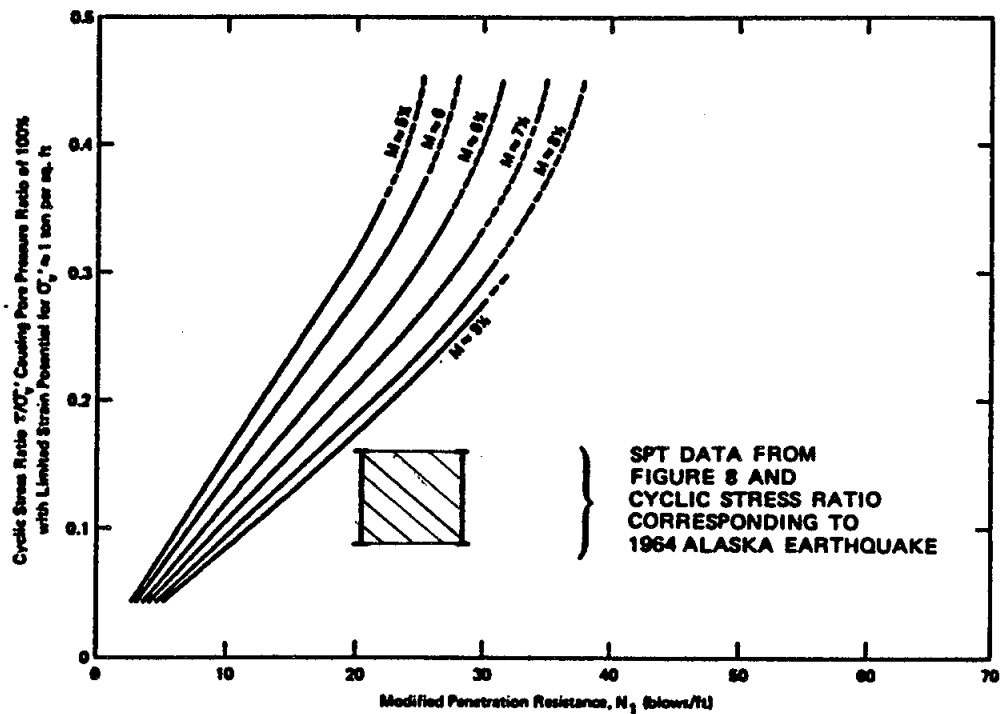

Figure 11 - Liquefaction Potential of Major Sand Layers for Different Magnitude Earthquakes

The undrained shear strength of the Bootlegger Cove clay below the sand layers immediately before the 1964 Alaskan earthquake was estimated using the SHANSEP (Stress History and Normalized Soil Engineering Properties) approach described by Ladd and Foott (1974). The details of this approach are summarized in Appendix C. In essence, the approach involves the following steps:

- 1) Based on results of the direct simple shear (DSS) tests (Appendix B of this report; Woodward-Clyde Consultants, 1982) on the appropriate Bootlegger Cove clay, obtain the following equation for undrained shear strength:

$$S_u = \sigma_v' (0.19) (\text{OCR})^{0.78} \quad (6-2)$$

where  $\sigma_v'$  = effective vertical stress at the time of shear strength determination.

OCR = overconsolidation ratio (=  $\sigma_{v' \text{max}} / \sigma_v'$ ) at the time of shear strength determination.

(see Appendix C for details)

- 2) Perform consolidation tests on appropriate samples to estimate the range of OCR at the time of sampling.
- 3) Estimate the 1964 OCR value based on the estimated subsurface conditions in 1964 including the water table location.

- 4) Estimate the undrained shear strength of the Bootlegger Cove clay immediately before the 1964 Alaska earthquake using Equation 6-2, estimated 1964 OCR, and estimated 1964 effective vertical stress.

The ranges of the backcalculated undrained shear strength and the estimated undrained shear strength based on the procedures just described are compared in Figure 12 for the soil block that moved about 10 feet and for the rest of the

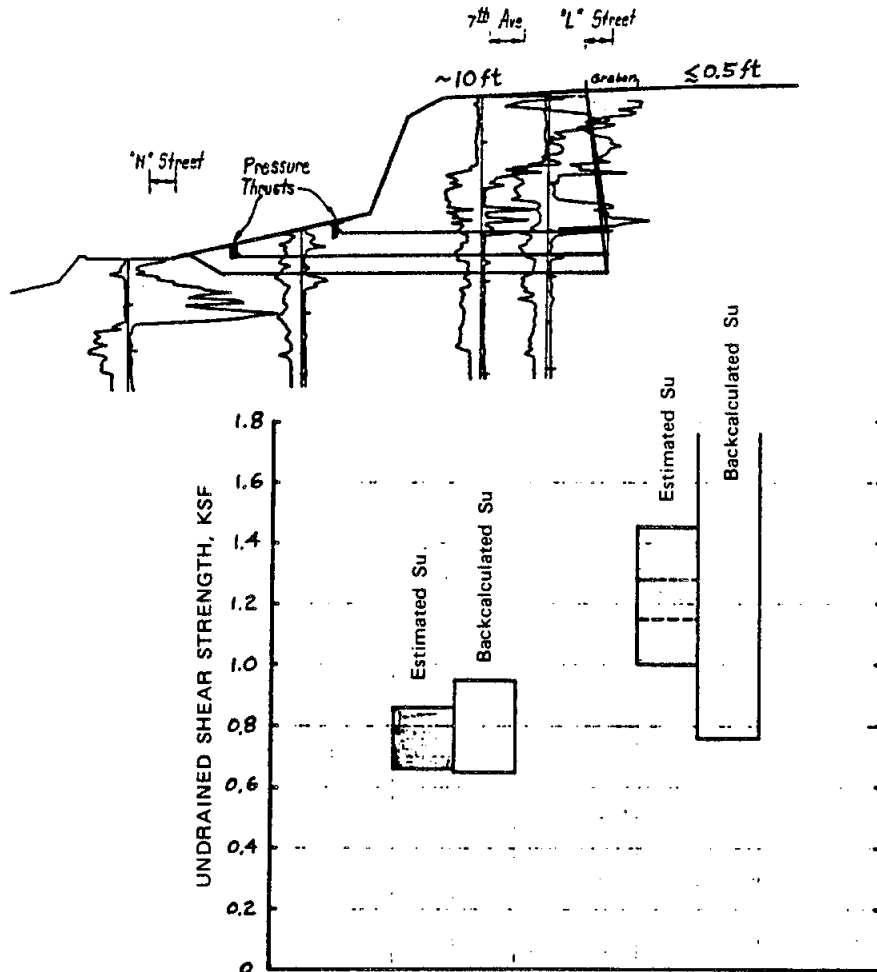

Figure 12 - Comparison of Estimated and Backcalculated Undrained Shear Strength

soil mass (that did not significantly move) behind the graben. As can be seen in Figure 12, the two sets of undrained shear strength ranges compare favorably.

Based on the areal distribution of the displacement in the "L" Street slide area, a surface displacement of 0.5 foot was assumed to occur without a significant reduction in undrained shear strength. Beyond this 0.5 foot displacement, the undrained shear strength was assumed to be reduced significantly to a large-strain residual value. In the analysis this strength reduction due to large straining was assumed to occur in the second half of the shaking. Thus, as part of the backcalculated procedure, the initial undrained shear strength and the residual undrained shear strength of the Bootlegger Cove clay are obtained.

The backcalculated undrained shear strength variation with time (or, equivalently, the number of cycles) during the shaking is shown in Figure 13. Note that the undrained shear strength is normalized with respect to the initial shear strength in Figure 13. The linear, 30 percent reduction of the undrained shear strength during the first half of the shaking corresponds to the assumed cyclically induced degradation in undrained shear strength (Appendix C in this report; Woodward-Clyde Consultants, 1982). The residual undrained shear strength ranging from 32 to 40 percent of the initial undrained shear strength shown in Figure 13 is slightly higher than the 30 percent value backcalculated for the 1964 Fourth Avenue slide area (Woodward-Clyde Consultants, 1982).

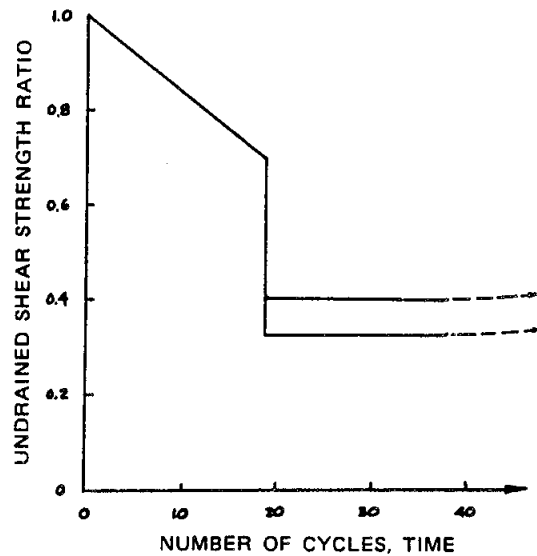

Figure 13 - Backcalculated Normalized Undrained Shear Strength Variation with Number of Cycles

Data from previous studies in the downtown Anchorage area (for example, Shannon and Wilson, 1964; Mitchell and others, 1973) indicated zones of highly sensitive clays in the Bootlegger Cove Formation. However, the residual undrained shear strength ranging from 30 to 40 percent of the initial undrained shear strength backcalculated in this study and a previous study (Woodward-Clyde Consultants, 1982) does not indicate highly sensitive clays. The following items may be part of the reasons for this apparent discrepancy:

- 1) The backcalculated residual undrained shear strength is an average value corresponding to the entire failure plane (longer than about 600 feet in this study) under the soil block in the evaluation cross-section;
- 2) At the location of CPT-2 in this study the field and laboratory tests indicated no highly sensitive clay at depths of testing;
- 3) None of the previous studies identified extended zones of highly sensitive clays (thus an average value of sensitivity over extended area may be much lower than those corresponding to localized areas of high sensitivity);
- 4) Sensitivity is an index property and not necessarily a direct indicator of the residual undrained shear strength; and
- 5) The backcalculated values of residual undrained shear strength are dependent on a number of factors including the assumption on when the large displacement started to occur. (In this study the large displacement was assumed to start in the second half of the shaking. However, for example, if the large displacement was assumed to start in the last quarter of the shaking, then the backcalculated residual undrained shear strength would have been about 20 percent of the initial value).

## 7.0 DISCUSSIONS AND CONCLUSIONS

The following conclusions can be stated from the reevaluation of the 1964 "L" Street slide based on a limited program of field investigation, laboratory tests, and analyses presented herein:

- 1) Because of the denseness and locations of the major sand layers (between 40 to 55 feet from the ground surface at CPT-2 location), it is not likely that the 1964 "L" Street slide was caused primarily by the liquefaction of these sand layers.
- 2) As can be seen in Figure 12, the undrained shear strength ranges backcalculated using the observed 1964 "L" Street displacement patterns and the displacement computation procedure summarized in Appendix D compare very favorably with the undrained shear strength ranges estimated for the 1964 conditions using the SHANSEP approach (Appendix C).
- 3) As can be seen in Figure 13, the backcalculated reduction in the undrained shear strength using the 1964 "L" Street slide conditions and the displacement computation procedure (Appendix D) indicates that about 60 to 70 percent strength reduction is required to compute the displacement patterns observed in the 1964 "L" Street slide. This assumes that the major part (computationally 9.5 feet during the second half of the shaking versus 0.5 foot during the first half) of the displacement occurred during the second half of the shaking -- an assumption consistent with the eyewitness accounts.



- 4) Based on the three preceding conclusions, it can be stated that the 1964 "L" Street slide likely was caused primarily by the failure through the upper part of the normally consolidated to lightly overconsolidated Bootlegger Cove Formation. It is also likely that the failure involved the loss of undrained shear strength due to earthquake (cyclic) loading and significant loss of undrained shear strength due to large straining of the clays, silts, and some sands in the Bootlegger Cove Formation.

It is emphasized that the displacement computation procedure described in Appendix D uses a gross average undrained shear strength below the sliding soil block. The range of the backcalculated initial undrained shear strength shown in Figure 12 and the range of the backcalculated residual undrained shear strength ratio shown in Figure 13 are, therefore, gross average values along the bottom of the sliding soil block shown in Figure 12. They say nothing about the details of the actual slide sequences involved in the 1964 "L" Street slide.

In particular, data from previous studies in the downtown Anchorage area (for example, Shannon and Wilson, 1964; Mitchell and others, 1973) indicated zones of highly sensitive clays in the Bootlegger Cove Formation. It has been also speculated that these zones of highly sensitive clays could have significantly contributed to the 1964 slides in the Anchorage area. The reevaluation of the 1964 "L" Street slide presented herein is not inconsistent with this view. It is quite possible that the 1964 "L" Street slide started in a local area (or areas) of highly sensitive clays and propagated to areas of less sensitive clays. This

possibility cannot be evaluated by the procedure described in Appendix D and probably cannot be meaningfully evaluated by any existing procedures, at least as applied to the 1964 "L" Street slide. However, the overall average initial and residual undrained shear strength over the entire "L" Street slide area may not have been significantly different from those shown in Figures 12 and 13.

It should be also emphasized that there are no data at present to suggest a direct relationship between the large strain reduction in undrained shear strength of clayey and silty soils and their sensitivity values. For example, a clay with sensitivity of 10 does not necessarily mean that the clay's undrained shear strength at large strains will be 10 percent of its initial strength.

At the boring location in this study the sensitivity value range from 1.5 to 4.9 based on the field vane tests and from 1.1 to 1.3 based on the mini-vane tests. Even if the direct relationship between the large strain reduction in undrained shear strength and the sensitivity is assumed, these values of sensitivity suggest 10 to 80 percent "individual point" reduction and 60 percent average reduction in undrained shear strength of these soils. This average value of 60 percent reduction is not incompatible with 60 to 70 percent average reduction in undrained shear strength backcalculated in this study.

Another factor that could have contributed to the 1964 "L" Street slide is "liquefaction" (or significant strength loss) of silt and sand lenses prevalent in general depth range corresponding to the location of likely failure plane (this also corresponds to the upper part of the normally consolidated to lightly overconsolidated Bootlegger Cove

DEPTH (FEET)	TIP RESISTANCE (TSF)	SLEEVE FRICTION (TSF)	FRICTION RATIO (%)	SOIL CLASSIFICATION	RUFACIES	SU=Sleeve* 1.1 (PSF)	SU=(C-T)/14.0 (PSF)
91.	11.75	.38*	3.20	CLAYEY SILTS AND SILTY CLAYS	F. II	827.	866.
92.	12.05	.29*	2.42	SANDY SILTS AND SILTS	F. III	642.	900.
93.	12.22	.34*	2.76	CLAYEY SILTS AND SILTY CLAYS	F. II	742.	915.
94.	17.59	.33*	1.90	SANDY SILTS AND SILTS	F. III	735.	1674.
95.	12.63	.25*	1.94	SANDY SILTS AND SILTS	F. III	539.	956.
96.	12.71	.35*	2.76	CLAYEY SILTS AND SILTY CLAYS	F. II	772.	959.
97.	12.14	.26*	2.13	SANDY SILTS AND SILTS	F. III	569.	868.
98.	11.50	.26*	2.30	SANDY SILTS AND SILTS	F. III	582.	768.
99.	11.50	.23*	1.97	SANDY SILTS AND SILTS	F. III	498.	759.
100.	12.39	.22*	1.74	SANDY SILTS AND SILTS	F. III	474.	877.
101.	13.61	.25*	1.85	SANDY SILTS AND SILTS	F. III	554.	1042.
102.	13.61	.27*	2.01	SANDY SILTS AND SILTS	F. III	602.	1034.
103.	16.15	.35*	2.17	SANDY SILTS AND SILTS	F. III	771.	1387.
104.	15.40	.28*	1.81	SANDY SILTS AND SILTS	F. III	613.	1271.
105.	14.67	.25*	1.71	SANDY SILTS AND SILTS	F. III	552.	1158.
106.	15.26	.26*	1.71	SANDY SILTS AND SILTS	F. III	574.	1234.
107.	15.26	.27*	1.79	SANDY SILTS AND SILTS	F. III	601.	1225.
108.	14.65	.26*	1.80	SANDY SILTS AND SILTS	F. III	580.	1129.
109.	14.74	.25*	1.68	SANDY SILTS AND SILTS	F. III	545.	1132.
110.	15.84	.27*	1.71	SANDY SILTS AND SILTS	F. III	596.	1281.
111.	15.65	.26*	1.64	SANDY SILTS AND SILTS	F. III	565.	1245.
112.	15.92	.26*	1.66	SANDY SILTS AND SILTS	F. III	581.	1274.
113.	16.66	.27*	1.62	SANDY SILTS AND SILTS	F. IV	594.	1371.
114.	15.82	.26*	1.67	SANDY SILTS AND SILTS	F. III	581.	1242.
115.	15.60	.25*	1.60	SANDY SILTS AND SILTS	F. III	549.	1202.
116.	15.89	.27*	1.70	SANDY SILTS AND SILTS	F. III	594.	1234.
117.	16.31	.49*	3.00	CLAYEY SILTS AND SILTY CLAYS	F. II	1076.	1285.
118.	16.46	.53*	3.25	CLAYEY SILTS AND SILTY CLAYS	F. II	1177.	1298.
119.	17.77	.41*	2.31	SANDY SILTS AND SILTS	F. IV	903.	1476.
120.	28.14	.41*	1.44	SILTY SANDS	F. IV		
121.	18.77	.35*	1.88	SANDY SILTS AND SILTS	F. III	776.	1601.
122.	18.56	.34*	1.84	SANDY SILTS AND SILTS	F. IV	751.	1562.
123.	18.16	.32*	1.74	SANDY SILTS AND SILTS	F. IV	695.	1496.
124.	18.82	.37*	1.95	SANDY SILTS AND SILTS	F. III	807.	1581.
125.	19.05	.33*	1.74	SANDY SILTS AND SILTS	F. IV	729.	1605.
126.	19.34	.36*	1.87	SANDY SILTS AND SILTS	F. IV	796.	1638.
127.	20.00	.41*	2.03	SANDY SILTS AND SILTS	F. III	893.	1723.
128.	19.93	.42*	2.09	SANDY SILTS AND SILTS	F. IV	916.	1704.
129.	20.74	.44*	2.10	SANDY SILTS AND SILTS	F. IV	958.	1811.
130.	20.59	.41*	1.98	SANDY SILTS AND SILTS	F. IV	897.	1781.
131.	22.89	.51*	2.22	SANDY SILTS AND SILTS	F. IV	1118.	2100.
132.	21.41	.43*	2.02	SANDY SILTS AND SILTS	F. IV	951.	1880.
133.	28.54	.61*	2.12	SANDY SILTS AND SILTS	F. IV	1331.	2890.
134.	21.61	.46*	2.14	SANDY SILTS AND SILTS	F. IV	1017.	1891.
135.	23.10	.49*	2.10	SANDY SILTS AND SILTS	F. IV	1067.	2095.
136.	21.89	.46*	2.11	SANDY SILTS AND SILTS	F. IV	1016.	1913.
137.	21.17	.41*	1.93	SANDY SILTS AND SILTS	F. IV	899.	1801.
138.	21.67	.47*	2.18	SANDY SILTS AND SILTS	F. IV	1039.	1864.
139.	21.37	.46*	2.14	SANDY SILTS AND SILTS	F. IV	1006.	1812.
140.	21.27	.44*	2.07	SANDY SILTS AND SILTS	F. IV	969.	1789.

DEPTH (FEET)	TIP RESISTANCE (TSF)	SLEEVE FRICTION (TSF)	FRICTION RATIO (%)	SOIL CLASSIFICATION	RF/FACIES	SU=Sleeve* 1.1 (PSF)	SU=(C-T)/14.0 (PSF)
41.	26.15	.99*	3.78	CLAYEY SILTS AND SILTY CLAYS	F.V	2175.	3370.
42.	30.24	1.21*	3.99	CLAYEY SILTS AND SILTY CLAYS	F.V	2654.	3945.
43.	23.86	.81*	3.41	CLAYEY SILTS AND SILTY CLAYS	F.V	1790.	3025.
44.	24.16	.87*	3.59	CLAYEY SILTS AND SILTY CLAYS	F.V	1908.	3059.
45.	32.46	1.91*	5.89	CLAYS	F.I	4206.	4235.
46.	42.11	2.57*	6.11	CLAYS	F.I	5660.	5605.
47.	57.44	3.18*	5.54	CLAYS	F.II	7001.	7786.
48.	71.53	3.85*	5.38	CLAYEY SILTS AND SILTY CLAYS	F.II	8466.	9790.
49.	81.16	3.98*	4.91	CLAYEY SILTS AND SILTY CLAYS	F.II	8767.	11157.
50.	149.84	3.70*	2.47	SILTY SANDS	F.IV		
51.	35.15	1.67*	4.74	CLAYEY SILTS AND SILTY CLAYS	F.II	3665.	4566.
52.	33.97	1.04*	3.05	SANDY SILTS AND SILTS	F.V	2279.	4389.
53.	171.16	2.57*	1.50	SANDS	F.VII		
54.	15.88	.37*	2.30	SANDY SILTS AND SILTS	F.IV	804.	1786.
55.	15.63	.36*	2.33	SANDY SILTS AND SILTS	F.IV	801.	1742.
56.	14.54	.49*	3.35	CLAYEY SILTS AND SILTY CLAYS	F.II	1072.	1577.
57.	12.26	.52*	4.21	CLAYEY SILTS AND SILTY CLAYS	F.II	1136.	1243.
58.	12.19	.51*	4.21	CLAYEY SILTS AND SILTY CLAYS	F.II	1129.	1224.
59.	12.90	.46*	3.54	CLAYEY SILTS AND SILTY CLAYS	F.II	1005.	1316.
60.	12.61	.27*	2.17	SANDY SILTS AND SILTS	F.III	602.	1266.
61.	12.44	.27*	2.14	SANDY SILTS AND SILTS	F.III	586.	1233.
62.	10.81	.23*	2.14	SANDY SILTS AND SILTS	F.III	509.	991.
63.	90.85	2.85*	3.14	SANDY SILTS AND SILTS	F.IV	6276.	12416.
64.	13.06	.35*	2.71	SANDY SILTS AND SILTS	F.II	779.	1294.
65.	12.12	.20*	1.65	SANDY SILTS AND SILTS	F.III	440.	1151.
66.	11.90	.20*	1.64	SANDY SILTS AND SILTS	F.III	429.	1111.
67.	11.18	.19*	1.71	SANDY SILTS AND SILTS	F.III	421.	999.
68.	12.23	.18*	1.49	SANDY SILTS AND SILTS	F.III	401.	1140.
69.	11.08	.19*	1.69	SANDY SILTS AND SILTS	F.III	412.	967.
70.	10.98	.19*	1.72	SANDY SILTS AND SILTS	F.III	415.	944.
71.	11.36	.20*	1.76	SANDY SILTS AND SILTS	F.III	440.	989.
72.	11.87	.19*	1.62	SANDY SILTS AND SILTS	F.III	423.	1053.
73.	11.56	.20*	1.71	SANDY SILTS AND SILTS	F.III	435.	1000.
74.	11.65	.19*	1.59	SANDY SILTS AND SILTS	F.III	408.	1004.
75.	12.54	.24*	1.94	SANDY SILTS AND SILTS	F.III	535.	1122.
76.	29.75	.87*	2.94	SANDY SILTS AND SILTS	F.IV	1924.	3571.
77.	11.63	.19*	1.63	SANDY SILTS AND SILTS	F.III	417.	974.
78.	11.53	.22*	1.94	SANDY SILTS AND SILTS	F.III	492.	951.
79.	11.74	.25*	2.12	SANDY SILTS AND SILTS	F.III	548.	972.
80.	12.42	.27*	2.19	SANDY SILTS AND SILTS	F.III	598.	1060.
81.	12.11	.27*	2.22	SANDY SILTS AND SILTS	F.III	591.	1007.
82.	12.80	.19*	1.52	SANDY SILTS AND SILTS	F.III	428.	1096.
83.	11.71	.15*	1.27	SANDY SILTS AND SILTS	F.III	327.	932.
84.	11.80	.18*	1.52	SANDY SILTS AND SILTS	F.III	395.	936.
85.	13.47	.22*	1.66	SANDY SILTS AND SILTS	F.III	492.	1165.
86.	24.95	.83*	3.33	SANDY SILTS AND SILTS	F.V	1828.	2796.
87.	11.99	.29*	2.45	SANDY SILTS AND SILTS	F.III	646.	936.
88.	11.17	.27*	2.40	SANDY SILTS AND SILTS	F.III	590.	810.
89.	11.77	.29*	2.49	SANDY SILTS AND SILTS	F.III	645.	887.
90.	11.07	.29*	2.63	CLAYEY SILTS AND SILTY CLAYS	F.II	641.	778.

\*\*\*\*\*  
 \*  
 \* WOODWARD-CLYDE \*  
 \*  
 \* CONSULTANTS \*  
 \*  
 \*\*\*\*\*

SOUNDING :ACPT5  
 IDENTIFICATION :ADOT-L STREET SLIDE / INST. NO: F15CKE075  
 LOCATION : XCORD: .0 YCORD: .0 ZCORD: 1.0  
 SOIL CHARACTERISTICS : GAMAT: 125.0 GAMAS: .0 WATER: .0  
 DATE :10- 5-84

DEPTH (FEET)	TIP RESISTANCE (TSF)	SLEEVE FRICTION (TSF)	FRICTION RATIO (%)	SOIL CLASSIFICATION	RUFACIES	S <sub>u</sub> =Sleeve* 1.1 (PSF)	S <sub>u</sub> =(C-T)/14.0 (PSF)
1.	274.52	3.16*	1.15	SANDS	F.VII		
2.	416.75	2.33*	.56	SANDS	F.VIII		
3.	424.82	2.34*	.55	SANDS	F.VIII		
4.	531.19	1.81*	.34	SANDS	F.VIII		
5.	548.20	2.96*	.54	SANDS	F.VIII		
6.	486.14	2.63*	.54	SANDS	F.VIII		
7.	564.22	2.60*	.46	SANDS	F.VIII		
8.	447.09	2.77*	.62	SANDS	F.VIII		
9.	490.45	2.21*	.45	SANDS	F.VIII		
10.	359.04	1.62*	.45	SANDS	F.VIII		
11.	333.83	1.67*	.50	SANDS	F.VIII		
12.	362.53	2.10*	.58	SANDS	F.VIII		
13.	275.26	2.04*	.74	SANDS	F.VIII		
14.	311.89	2.15*	.69	SANDS	F.VIII		
15.	430.27	2.88*	.67	SANDS	F.VIII		
16.	422.90	3.55*	.84	SANDS	F.VIII		
17.	421.67	4.01*	.95	SANDS	F.VII		
18.	338.92	2.61*	.77	SANDS	F.VIII		
19.	384.84	3.43*	.89	SANDS	F.VIII		
20.	374.61	2.85*	.76	SANDS	F.VIII		
21.	342.83	2.23*	.65	SANDS	F.VIII		
22.	95.30	2.91*	3.05	SANDY SILTS AND SILTS	F.IV	6395.	13418.
23.	55.42	2.02*	3.65	SANDY SILTS AND SILTS	F.V	4450.	7712.
24.	207.28	2.88*	1.39	SANDS	F.VII		
25.	245.01	2.11*	.86	SANDS	F.VII		
26.	218.05	2.35*	1.08	SANDS	F.VII		
27.	290.06	2.87*	.99	SANDS	F.VII		
28.	187.57	2.25*	1.20	SANDS	F.VII		
29.	188.89	1.72*	.91	SANDS	F.VII		
30.	200.62	1.91*	.95	SANDS	F.VII		
31.	206.62	2.60*	1.26	SANDS	F.VII		
32.	258.81	2.23*	.86	SANDS	F.VII		
33.	288.90	2.11*	.73	SANDS	F.VIII		
34.	77.80	2.91*	3.74	SANDY SILTS AND SILTS	F.V	6401.	10811.
35.	295.56	1.92*	.65	SANDS	F.VIII		
36.	84.52	2.14*	2.53	SILTY SANDS	F.IV		
37.	33.38	1.78*	5.33	CLAYS	F.II	3914.	4438.
38.	109.01	4.19*	3.84	SANDY SILTS AND SILTS	F.V	9209.	15234.
39.	40.76	1.70*	4.18	CLAYEY SILTS AND SILTY CLAYS	F.V	3748.	5475.
40.	32.79	1.78*	5.42	CLAYS	F.II	3910.	4327.

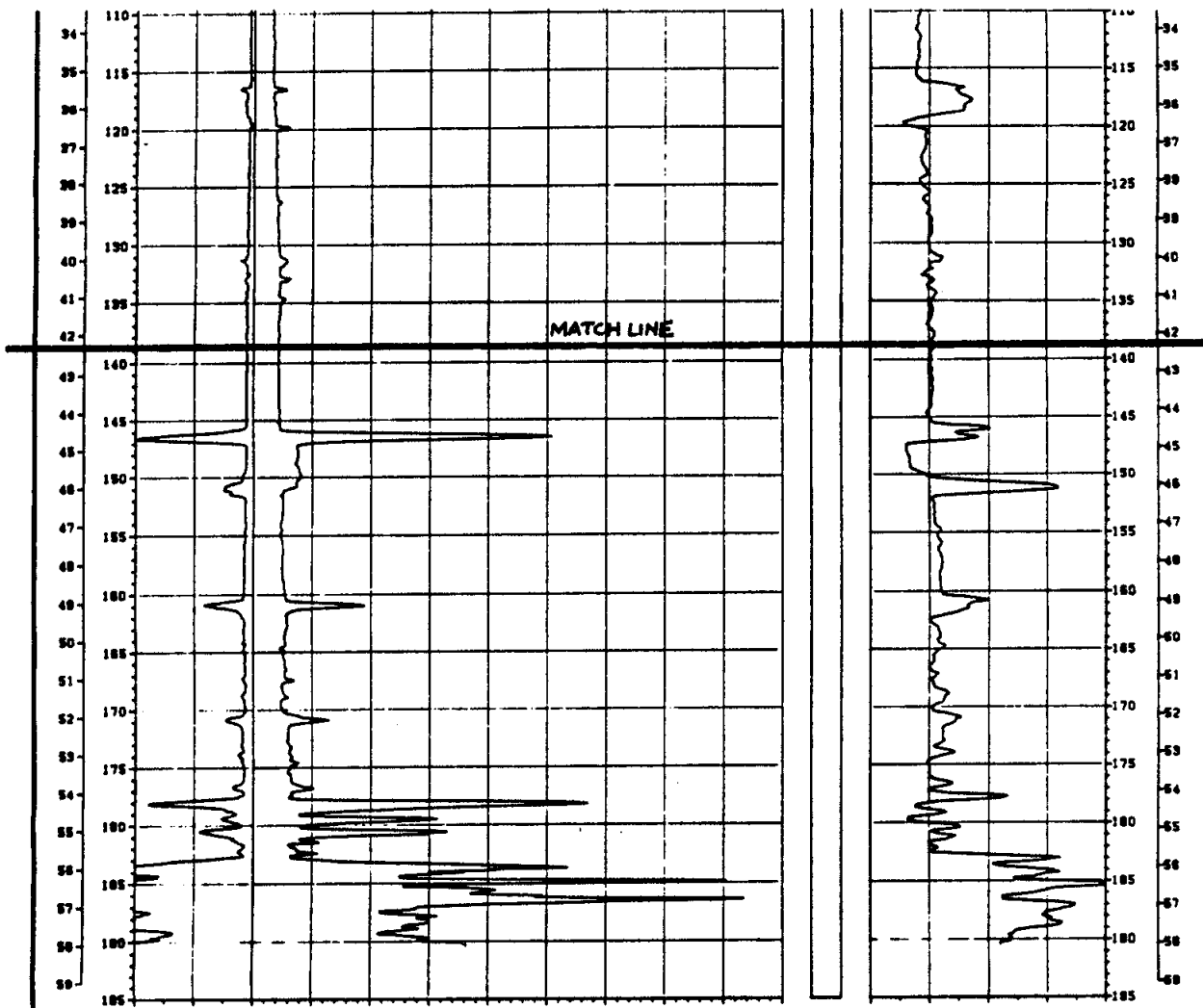

PROJECT: A00T - L STREET SLIDE  
 PROJECT NUMBER: 85-140-07  
 INSTRUMENT NUMBER: F15CKE075  
 DATE: 10/05/84

**CONE PENETROMETER TEST**  
 PROBE: CPT-5

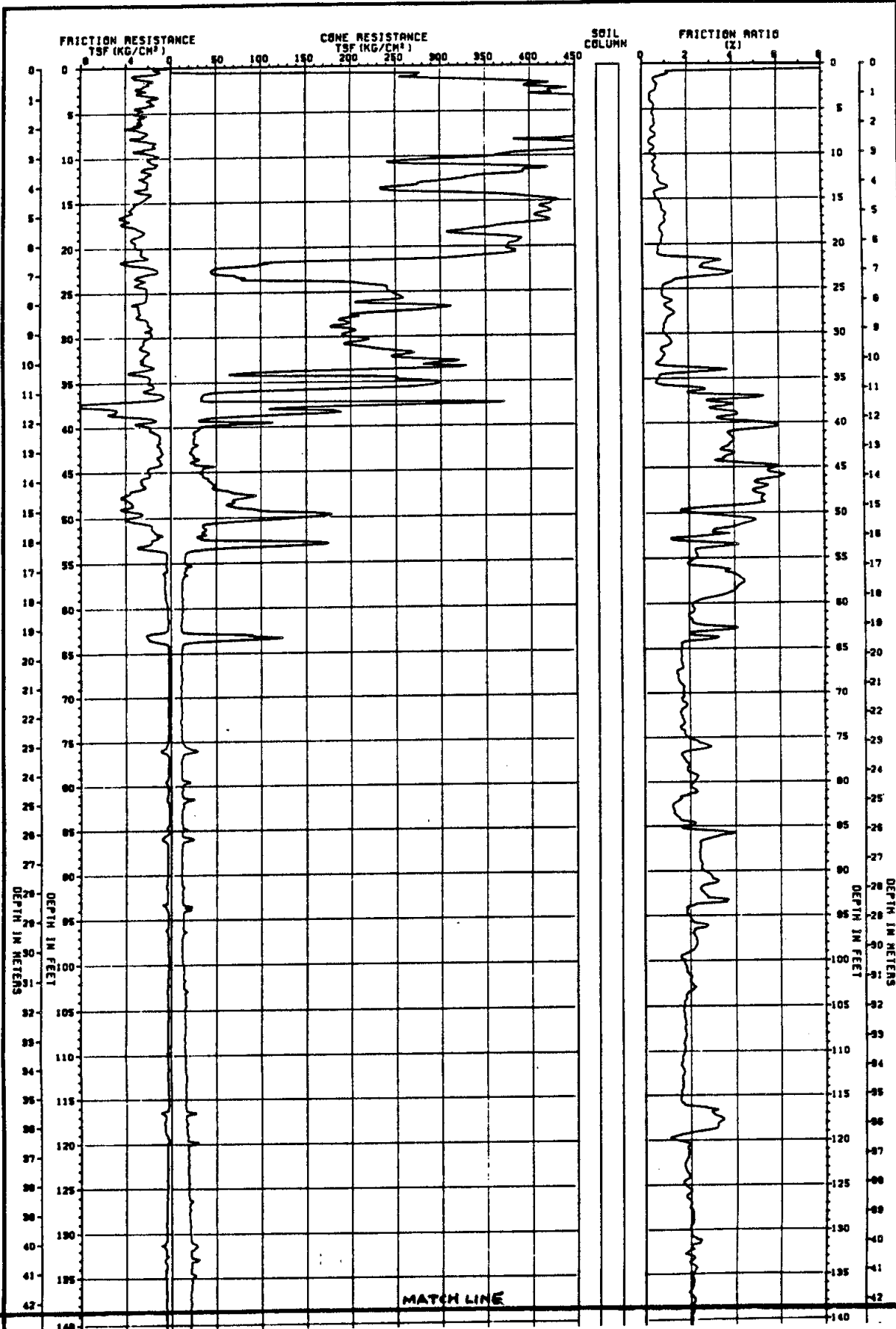

PROJECT: ADOT - L STREET SLIDE  
 PROJECT NUMBER: 85-140-07  
 INSTRUMENT NUMBER: FISCKE075  
 DATE: 10/05/84

A-24

CONE PENETROMETER TEST  
 PROBE: CPT-5

DEPTH (FEET)	TIP RESISTANCE (TSF)	SLEEVE FRICTION (TSF)	FRICTION RATIO (%)	SOIL CLASSIFICATION	RUFACIES SU=Sleeve* 1.1 SU=(C-T)/14.0		
						(PSF)	(PSF)
141.	21.07	.37*	1.75	SANDY SILTS AND SILTS	F. IV	811.	1751.
142.	21.52	.38*	1.77	SANDY SILTS AND SILTS	F. IV	838.	1806.
143.	21.37	.39*	1.81	SANDY SILTS AND SILTS	F. IV	851.	1776.
144.	21.30	.37*	1.76	SANDY SILTS AND SILTS	F. IV	825.	1757.
145.	22.72	.38*	1.66	SANDY SILTS AND SILTS	F. IV	830.	1951.
146.	22.55	.39*	1.72	SANDY SILTS AND SILTS	F. IV	853.	1918.
147.	29.70	.75*	2.51	SANDY SILTS AND SILTS	F. IV	1640.	2930.
148.	32.39	.85*	2.61	SANDY SILTS AND SILTS	F. IV	1860.	3306.
149.	23.92	.41*	1.71	SANDY SILTS AND SILTS	F. IV	900.	2087.
150.	24.04	.40*	1.66	SILTY SANDS	F. IV		
151.	37.36	.78*	2.08	SILTY SANDS	F. IV		
152.	101.73	2.64*	2.60	SILTY SANDS	F. IV		
153.	129.35	2.90*	2.24	SILTY SANDS	F. IV		
154.	53.36	.73*	1.36	SILTY SANDS	F. VI		
155.	50.15	1.31*	2.61	SANDY SILTS AND SILTS	F. IV	2880.	5780.
156.	47.08	.65*	1.38	SILTY SANDS	F. VI		
157.	194.22	3.13*	1.61	SANDS	F. VII		
158.	34.13	.52*	1.52	SILTY SANDS	F. VI		
159.	104.23	1.23*	1.18	SANDS	F. VII		
160.	207.45	10.77*	5.19	CLAYEY SILTS AND SILTY CLAYS	F. II	23687.	28207.



DEPTH (FEET)	TIP RESISTANCE (TSF)	SLEEVE FRICTION (TSF)	FRICTION RATIO (%)	SOIL CLASSIFICATION	RUFACIES	SU=Sleeve* 1.1 (PSF)	SU=(C-T)/14.0 (PSF)
91.	25.64	.50*	1.96	SANDY SILTS AND SILTS	F. IV	1106.	2850.
92.	14.06	.28*	1.99	SANDY SILTS AND SILTS	F. III	616.	1187.
93.	14.05	.25*	1.78	SANDY SILTS AND SILTS	F. III	550.	1177.
94.	15.43	.26*	1.70	SANDY SILTS AND SILTS	F. III	577.	1365.
95.	14.76	.27*	1.81	SANDY SILTS AND SILTS	F. III	588.	1260.
96.	15.54	.27*	1.74	SANDY SILTS AND SILTS	F. III	595.	1363.
97.	15.10	.25*	1.63	SANDY SILTS AND SILTS	F. III	541.	1291.
98.	14.51	.22*	1.50	SANDY SILTS AND SILTS	F. III	479.	1198.
99.	14.15	.20*	1.43	SANDY SILTS AND SILTS	F. III	445.	1137.
100.	15.83	.27*	1.69	SANDY SILTS AND SILTS	F. III	589.	1369.
101.	15.10	.23*	1.55	SANDY SILTS AND SILTS	F. III	515.	1255.
102.	14.92	.21*	1.43	SANDY SILTS AND SILTS	F. IV	469.	1221.
103.	13.41	.19*	1.38	SANDY SILTS AND SILTS	F. III	407.	996.
104.	13.83	.20*	1.43	SANDY SILTS AND SILTS	F. III	435.	1047.
105.	15.34	.25*	1.62	SANDY SILTS AND SILTS	F. III	547.	1254.
106.	15.80	.26*	1.62	SANDY SILTS AND SILTS	F. III	563.	1311.
107.	15.80	.26*	1.62	SANDY SILTS AND SILTS	F. III	563.	1302.
108.	16.53	.30*	1.82	SANDY SILTS AND SILTS	F. III	662.	1397.
109.	16.63	.29*	1.73	SANDY SILTS AND SILTS	F. III	633.	1402.
110.	19.21	.29*	1.49	SANDY SILTS AND SILTS	F. IV	630.	1762.
111.	17.28	.29*	1.66	SANDY SILTS AND SILTS	F. IV	631.	1478.
112.	17.58	.27*	1.56	SANDY SILTS AND SILTS	F. IV	603.	1511.
113.	17.58	.28*	1.60	SANDY SILTS AND SILTS	F. IV	619.	1502.
114.	17.85	.31*	1.71	SANDY SILTS AND SILTS	F. IV	672.	1532.
115.	17.09	.28*	1.66	SANDY SILTS AND SILTS	F. IV	624.	1415.
116.	17.15	.29*	1.68	SANDY SILTS AND SILTS	F. IV	634.	1414.
117.	18.30	.31*	1.69	SANDY SILTS AND SILTS	F. IV	680.	1570.
118.	17.92	.32*	1.79	SANDY SILTS AND SILTS	F. IV	706.	1506.
119.	18.03	.27*	1.47	SANDY SILTS AND SILTS	F. IV	583.	1513.
120.	17.37	.26*	1.52	SANDY SILTS AND SILTS	F. IV	581.	1410.
121.	17.73	.28*	1.58	SANDY SILTS AND SILTS	F. IV	616.	1453.
122.	17.24	.27*	1.56	SANDY SILTS AND SILTS	F. IV	592.	1374.
123.	17.42	.28*	1.59	SANDY SILTS AND SILTS	F. IV	609.	1390.
124.	18.86	.30*	1.57	SANDY SILTS AND SILTS	F. IV	651.	1587.
125.	18.57	.28*	1.49	SANDY SILTS AND SILTS	F. IV	609.	1537.
126.	18.43	.27*	1.49	SANDY SILTS AND SILTS	F. IV	604.	1508.
127.	18.72	.29*	1.54	SANDY SILTS AND SILTS	F. IV	634.	1540.
128.	20.06	.32*	1.59	SANDY SILTS AND SILTS	F. IV	702.	1723.
129.	18.72	.26*	1.39	SANDY SILTS AND SILTS	F. IV	572.	1522.
130.	20.62	.27*	1.30	SILTY SANDS	F. IV		
131.	22.76	.40*	1.76	SANDY SILTS AND SILTS	F. IV	881.	2082.
132.	20.81	.32*	1.52	SANDY SILTS AND SILTS	F. IV	696.	1794.
133.	20.68	.32*	1.56	SANDY SILTS AND SILTS	F. IV	710.	1767.
134.	18.85	.31*	1.62	SANDY SILTS AND SILTS	F. IV	672.	1496.
135.	19.60	.30*	1.55	SANDY SILTS AND SILTS	F. IV	668.	1595.
136.	20.31	.35*	1.71	SANDY SILTS AND SILTS	F. IV	764.	1687.
137.	20.62	.35*	1.68	SANDY SILTS AND SILTS	F. IV	762.	1723.
138.	20.48	.35*	1.72	SANDY SILTS AND SILTS	F. IV	775.	1694.
139.	20.18	.35*	1.71	SANDY SILTS AND SILTS	F. IV	759.	1642.
140.	20.78	.37*	1.76	SANDY SILTS AND SILTS	F. IV	805.	1719.

DEPTH (FEET)	TIP RESISTANCE (TSF)	SLEEVE FRICTION (TSF)	FRICTION RATIO (%)	SOIL CLASSIFICATION	RUFACIES	SU=Sleeve* 1.1 (PSF)	SU=(C-T)/14.0 (PSF)
41.	238.59	2.51*	1.05	SANDS	F.VII		
42.	141.68	2.49*	1.76	SANDS	F.IV		
43.	224.97	2.07*	.92	SANDS	F.VII		
44.	278.00	2.84*	1.02	SANDS	F.VII		
45.	300.83	3.16*	1.05	SANDS	F.VII		
46.	265.19	3.24*	1.22	SANDS	F.VII		
47.	55.43	2.33*	4.21	CLAYEY SILTS AND SILTY CLAYS	F.V	5134.	7499.
48.	65.76	2.70*	4.10	CLAYEY SILTS AND SILTY CLAYS	F.V	5932.	8966.
49.	277.14	3.44*	1.24	SANDS	F.VII		
50.	175.34	2.52*	1.44	SANDS	F.VII		
51.	21.17	.62*	2.92	SANDY SILTS AND SILTS	F.II	1360.	2569.
52.	21.29	.52*	2.46	SANDY SILTS AND SILTS	F.IV	1152.	2577.
53.	29.50	1.07*	3.63	CLAYEY SILTS AND SILTY CLAYS	F.V	2356.	3741.
54.	15.28	.41*	2.68	SANDY SILTS AND SILTS	F.II	901.	1701.
55.	13.59	.43*	3.20	CLAYEY SILTS AND SILTY CLAYS	F.II	957.	1450.
56.	17.06	.60*	3.51	CLAYEY SILTS AND SILTY CLAYS	F.II	1317.	1937.
57.	13.89	.47*	3.40	CLAYEY SILTS AND SILTY CLAYS	F.II	1039.	1475.
58.	12.11	.42*	3.43	CLAYEY SILTS AND SILTY CLAYS	F.II	914.	1212.
59.	11.72	.43*	3.69	CLAYEY SILTS AND SILTY CLAYS	F.II	951.	1148.
60.	64.88	1.34*	2.06	SILTY SANDS	F.VI		
61.	13.45	.26*	1.96	SANDY SILTS AND SILTS	F.III	580.	1377.
62.	13.57	.33*	2.44	SANDY SILTS AND SILTS	F.II	728.	1385.
63.	13.32	.28*	2.13	SANDY SILTS AND SILTS	F.III	624.	1340.
64.	12.77	.24*	1.86	SANDY SILTS AND SILTS	F.III	523.	1253.
65.	12.42	.28*	2.28	SANDY SILTS AND SILTS	F.III	623.	1194.
66.	12.95	.28*	2.15	SANDY SILTS AND SILTS	F.III	613.	1261.
67.	15.53	.52*	3.37	CLAYEY SILTS AND SILTY CLAYS	F.II	1151.	1620.
68.	13.13	.36*	2.76	CLAYEY SILTS AND SILTY CLAYS	F.II	797.	1269.
69.	11.74	.31*	2.67	CLAYEY SILTS AND SILTY CLAYS	F.II	690.	1061.
70.	14.59	.41*	2.84	SANDY SILTS AND SILTS	F.II	912.	1459.
71.	11.43	.23*	2.00	SANDY SILTS AND SILTS	F.III	503.	999.
72.	11.01	.31*	2.83	CLAYEY SILTS AND SILTY CLAYS	F.II	685.	930.
73.	11.88	.24*	2.00	SANDY SILTS AND SILTS	F.III	523.	1045.
74.	11.42	.25*	2.17	SANDY SILTS AND SILTS	F.III	545.	971.
75.	12.76	.36*	2.85	CLAYEY SILTS AND SILTY CLAYS	F.II	800.	1153.
76.	13.49	.39*	2.91	CLAYEY SILTS AND SILTY CLAYS	F.II	864.	1249.
77.	15.71	.55*	3.48	CLAYEY SILTS AND SILTY CLAYS	F.II	1203.	1557.
78.	11.77	.19*	1.58	SANDY SILTS AND SILTS	F.III	409.	985.
79.	11.94	.22*	1.83	SANDY SILTS AND SILTS	F.III	481.	1000.
80.	12.00	.22*	1.83	SANDY SILTS AND SILTS	F.III	483.	1000.
81.	11.70	.20*	1.74	SANDY SILTS AND SILTS	F.III	448.	948.
82.	11.21	.18*	1.57	SANDY SILTS AND SILTS	F.III	387.	869.
83.	11.99	.21*	1.75	SANDY SILTS AND SILTS	F.III	462.	972.
84.	12.29	.21*	1.71	SANDY SILTS AND SILTS	F.III	462.	1006.
85.	15.40	.23*	1.49	SANDY SILTS AND SILTS	F.IV	505.	1441.
86.	12.44	.20*	1.63	SANDY SILTS AND SILTS	F.III	446.	1009.
87.	12.27	.21*	1.69	SANDY SILTS AND SILTS	F.III	456.	976.
88.	12.45	.20*	1.60	SANDY SILTS AND SILTS	F.III	438.	993.
89.	13.00	.21*	1.61	SANDY SILTS AND SILTS	F.III	460.	1063.
90.	13.46	.23*	1.70	SANDY SILTS AND SILTS	F.III	503.	1119.

\*\*\*\*\*  
 \*  
 \* WOODWARD-CLYDE \*  
 \*  
 \* CONSULTANTS \*  
 \*  
 \*\*\*\*\*

SOUNDING :ACPT4  
 IDENTIFICATION :ADOT-L STREET SLIDE / INST. NO: F15CKE075  
 LOCATION : XCORD: .0 YCORD: .0 ZCORD: 1.0  
 SOIL CHARACTERISTICS : GAMAT: 125.0 GAMAS: .0 WATER: .0  
 DATE :10- 4-84

DEPTH (FEET)	TIP RESISTANCE (TSF)	SLEEVE FRICTION (TSF)	FRICTION RATIO (%)	SOIL CLASSIFICATION	RUFACIES	SU=Sleeve* 1.1 (PSF)	SU=(C-T)/14.0 (PSF)
1.	275.10	2.34*	.85	SANDS	F.VII		
2.	243.14	2.58*	1.06	SANDS	F.VII		
3.	539.69	3.08*	.57	SANDS	F.VIII		
4.	502.04	2.66*	.53	SANDS	F.VIII		
5.	492.13	2.66*	.54	SANDS	F.VIII		
6.	415.27	3.28*	.79	SANDS	F.VIII		
7.	390.42	2.65*	.68	SANDS	F.VIII		
8.	310.62	1.49*	.48	SANDS	F.VIII		
9.	418.83	1.68*	.40	SANDS	F.VIII		
10.	246.14	1.28*	.52	SANDS	F.VIII		
11.	303.44	1.15*	.38	SANDS	F.VIII		
12.	333.14	1.47*	.44	SANDS	F.VIII		
13.	260.11	1.90*	.73	SANDS	F.VIII		
14.	248.41	1.24*	.50	SANDS	F.VIII		
15.	220.98	1.75*	.79	SANDS	F.VII		
16.	371.58	1.37*	.37	SANDS	F.VIII		
17.	381.37	1.60*	.42	SANDS	F.VIII		
18.	307.37	1.44*	.47	SANDS	F.VIII		
19.	343.89	1.58*	.46	SANDS	F.VIII		
20.	292.67	2.46*	.84	SANDS	F.VII		
21.	308.02	1.66*	.54	SANDS	F.VIII		
22.	368.02	1.55*	.42	SANDS	F.VIII		
23.	338.85	1.86*	.55	SANDS	F.VIII		
24.	285.35	2.23*	.78	SANDS	F.VIII		
25.	279.63	1.51*	.54	SANDS	F.VIII		
26.	248.42	4.00*	1.61	SANDS	F.VII		
27.	166.46	7.96*	4.78	CLAYEY SILTS AND SILTY CLAYS	F.V	17505.	23539.
28.	109.26	3.39*	3.10	SANDY SILTS AND SILTS	F.IV	7452.	15359.
29.	103.57	3.85*	3.72	SANDY SILTS AND SILTS	F.V	8476.	14537.
30.	36.61	1.59*	4.33	CLAYEY SILTS AND SILTY CLAYS	F.II	3487.	4962.
31.	165.72	7.26*	4.38	SANDY SILTS AND SILTS	F.V	15969.	23398.
32.	23.28	.97*	4.16	CLAYEY SILTS AND SILTY CLAYS	F.II	2131.	3040.
33.	60.42	1.74*	2.88	SANDY SILTS AND SILTS	F.IV	3828.	8337.
34.	20.81	.86*	4.12	CLAYEY SILTS AND SILTY CLAYS	F.II	1886.	2669.
35.	107.15	3.87*	3.61	SANDY SILTS AND SILTS	F.V	8510.	14995.
36.	212.63	4.72*	2.22	SILTY SANDS	F.IV		
37.	261.26	3.42*	1.31	SANDS	F.VII		
38.	278.50	4.48*	1.61	SANDS	F.VII		
39.	295.65	2.72*	.92	SANDS	F.VII		
40.	263.91	2.45*	.93	SANDS	F.VII		

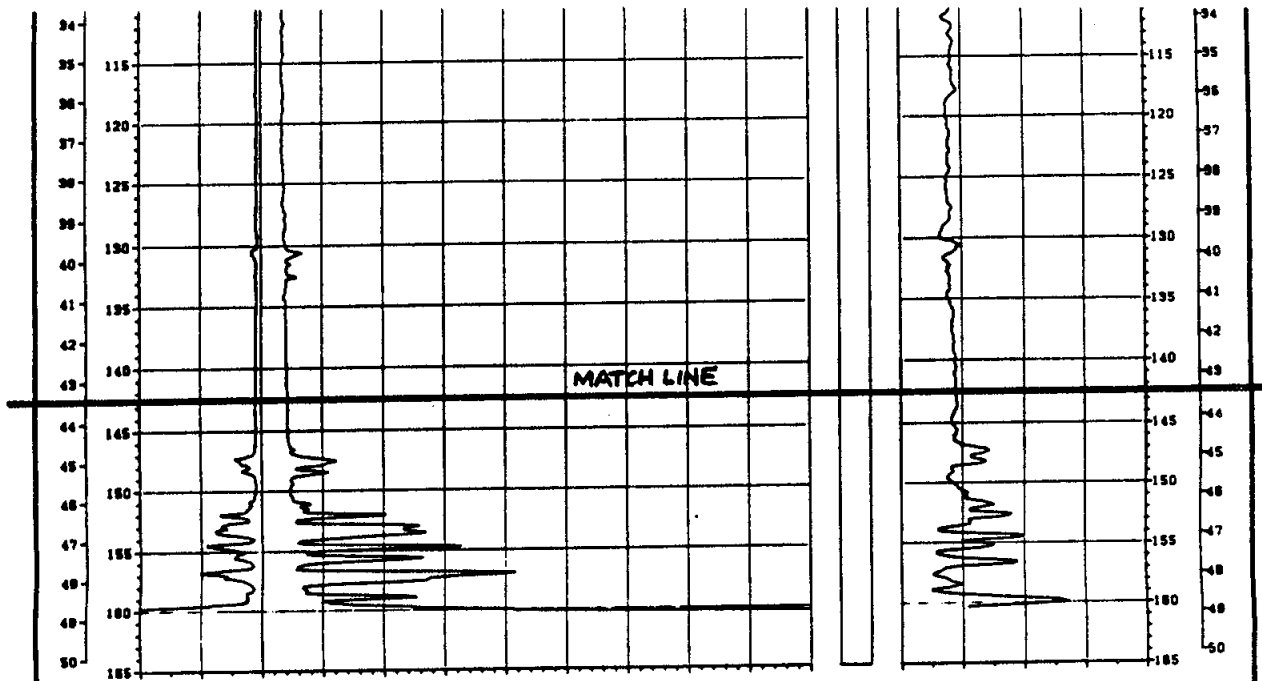

PROJECT: ADOT - L STREET SLIDE  
 PROJECT NUMBER: 85-140-07  
 INSTRUMENT NUMBER: F15CKE075  
 DATE: 10/04/84

**CONE PENETROMETER TEST**  
 PROBE: CPT-4

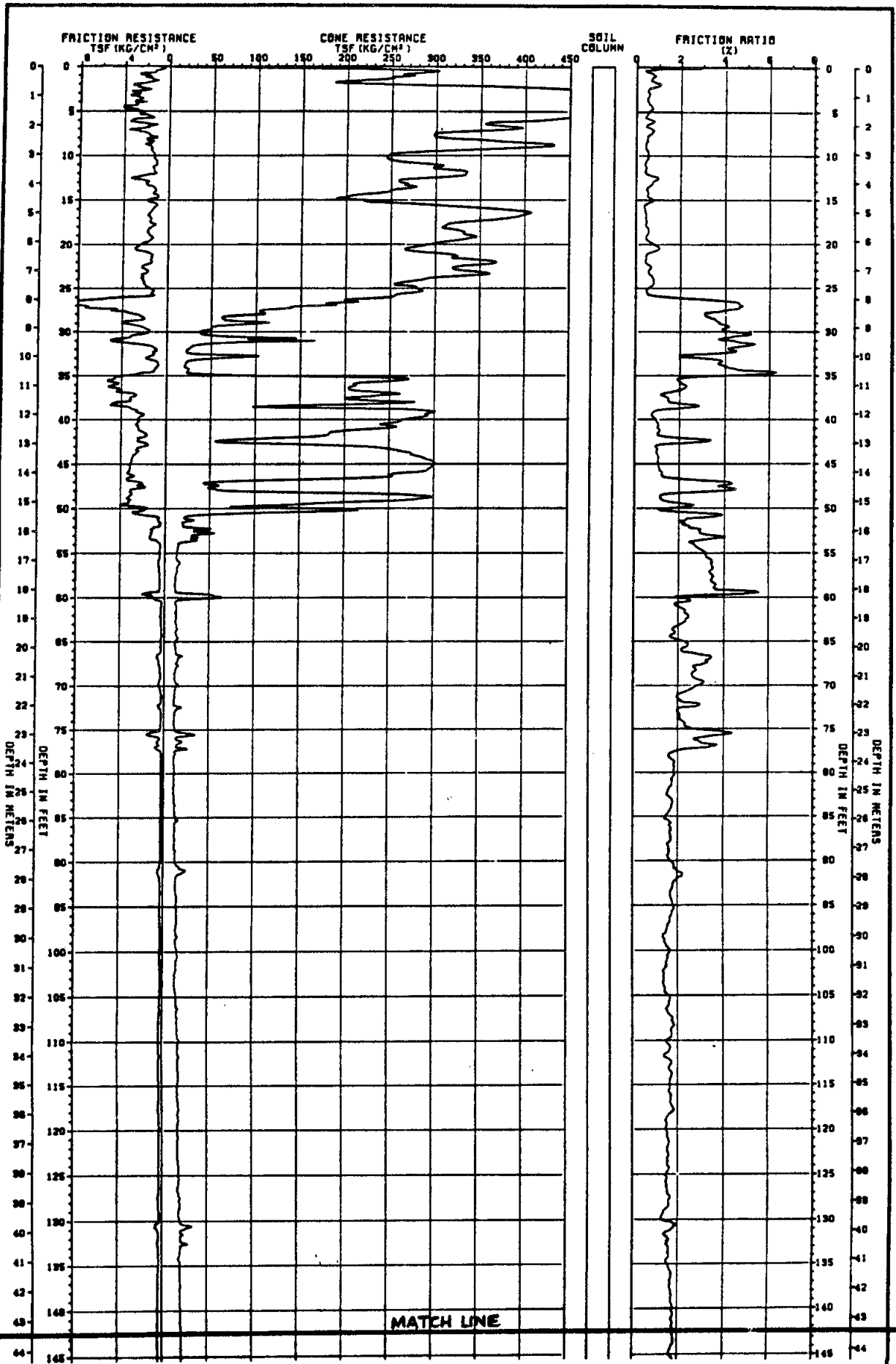

PROJECT: ADOT - L STREET SLIDE  
 PROJECT NUMBER: 85-140-07  
 INSTRUMENT NUMBER: F1SCKE075  
 DATE: 10/04/84

A-18

CONE PENETROMETER TEST  
 PROBE: CPT-4

DEPTH (FEET)	TIP RESISTANCE (TSF)	SLEEVE FRICTION (TSF)	FRICTION RATIO (%)	SOIL CLASSIFICATION	RUFACIES	SU=Sleeve* 1.1 (PSF)	SU=(C-T)/14.0 (PSF)
91.	17.02	.32*	1.88	SANDY SILTS AND SILTS	F. III	704.	1619.
92.	14.55	.30*	2.06	SANDY SILTS AND SILTS	F. III	659.	1257.
93.	14.02	.31*	2.24	SANDY SILTS AND SILTS	F. III	691.	1173.
94.	14.63	.35*	2.40	SANDY SILTS AND SILTS	F. IV	772.	1251.
95.	15.69	.41*	2.59	SANDY SILTS AND SILTS	F. II	894.	1393.
96.	14.93	.33*	2.24	SANDY SILTS AND SILTS	F. III	736.	1276.
97.	15.68	.41*	2.62	SANDY SILTS AND SILTS	F. II	904.	1374.
98.	16.14	.33*	2.03	SANDY SILTS AND SILTS	F. III	721.	1431.
99.	15.09	.40*	2.65	SANDY SILTS AND SILTS	F. II	880.	1272.
100.	16.14	.51*	3.15	CLAYEY SILTS AND SILTY CLAYS	F. II	1119.	1413.
101.	16.74	.31*	1.85	SANDY SILTS AND SILTS	F. III	681.	1490.
102.	16.44	.29*	1.76	SANDY SILTS AND SILTS	F. III	637.	1438.
103.	17.23	.30*	1.75	SANDY SILTS AND SILTS	F. III	663.	1542.
104.	17.21	.31*	1.78	SANDY SILTS AND SILTS	F. III	674.	1530.
105.	17.49	.32*	1.82	SANDY SILTS AND SILTS	F. III	700.	1561.
106.	18.25	.34*	1.86	SANDY SILTS AND SILTS	F. III	747.	1661.
107.	18.26	.31*	1.69	SANDY SILTS AND SILTS	F. IV	679.	1653.
108.	18.41	.32*	1.72	SANDY SILTS AND SILTS	F. IV	697.	1666.
109.	18.86	.33*	1.77	SANDY SILTS AND SILTS	F. IV	734.	1721.
110.	18.56	.33*	1.78	SANDY SILTS AND SILTS	F. IV	727.	1669.
111.	19.17	.36*	1.86	SANDY SILTS AND SILTS	F. IV	784.	1748.
112.	19.32	.37*	1.92	SANDY SILTS AND SILTS	F. III	816.	1760.
113.	20.25	.39*	1.91	SANDY SILTS AND SILTS	F. IV	851.	1884.
114.	21.42	.44*	2.04	SANDY SILTS AND SILTS	F. IV	961.	2042.
115.	19.91	.33*	1.67	SANDY SILTS AND SILTS	F. IV	731.	1818.
116.	30.01	.50*	1.68	SILTY SANDS	F. IV		
117.	27.82	.80*	2.87	SANDY SILTS AND SILTS	F. IV	1757.	2930.
118.	22.18	.37*	1.69	SANDY SILTS AND SILTS	F. IV	825.	2115.
119.	21.89	.37*	1.71	SANDY SILTS AND SILTS	F. IV	824.	2065.
120.	22.01	.37*	1.70	SANDY SILTS AND SILTS	F. IV	823.	2073.
121.	20.39	.32*	1.59	SANDY SILTS AND SILTS	F. IV	713.	1832.
122.	20.56	.32*	1.54	SANDY SILTS AND SILTS	F. IV	697.	1848.
123.	20.73	.34*	1.64	SANDY SILTS AND SILTS	F. IV	748.	1863.
124.	21.90	.38*	1.74	SANDY SILTS AND SILTS	F. IV	838.	2021.

DEPTH (FEET)	TIP RESISTANCE (TSF)	SLEEVE FRICTION (TSF)	FRICTION RATIO (%)	SOIL CLASSIFICATION	RUFACIES	SU=Sleeve* 1.1 (PSF)	SU=(C-T)/14.0 (PSF)
41.	38.05	2.09*	5.48	CLAYS	F. II	4587.	5070.
42.	119.38	2.40*	2.01	SILTY SANDS	F. IV		
43.	226.49	2.76*	1.22	SANDS	F. VII		
44.	242.44	3.03*	1.25	SANDS	F. VII		
45.	169.61	3.05*	1.80	SANDS	F. VII		
46.	223.69	3.00*	1.34	SANDS	F. VII		
47.	210.69	2.34*	1.11	SANDS	F. VII		
48.	238.80	2.94*	1.23	SANDS	F. VII		
49.	374.04	3.82*	1.02	SANDS	F. VII		
50.	284.07	3.49*	1.23	SANDS	F. VII		
51.	247.73	4.43*	1.79	SANDS	F. VII		
52.	39.66	1.02*	2.58	SANDY SILTS AND SILTS	F. IV	2251.	5201.
53.	240.43	4.47*	1.86	SANDS	F. VII		
54.	92.15	3.74*	4.06	SANDY SILTS AND SILTS	F. V	8231.	12682.
55.	26.68	.62*	2.34	SANDY SILTS AND SILTS	F. IV	1373.	3320.
56.	21.73	.53*	2.45	SANDY SILTS AND SILTS	F. IV	1171.	2604.
57.	13.64	.42*	3.09	CLAYEY SILTS AND SILTY CLAYS	F. II	927.	1440.
58.	12.31	.38*	3.10	CLAYEY SILTS AND SILTY CLAYS	F. II	840.	1241.
59.	18.74	.81*	4.30	CLAYEY SILTS AND SILTY CLAYS	F. II	1773.	2150.
60.	12.14	.49*	4.03	CLAYEY SILTS AND SILTY CLAYS	F. II	1076.	1199.
61.	10.65	.38*	3.56	CLAYEY SILTS AND SILTY CLAYS	F. II	834.	977.
62.	11.25	.36*	3.24	CLAYEY SILTS AND SILTY CLAYS	F. II	802.	1054.
63.	61.95	1.94*	3.13	SANDY SILTS AND SILTS	F. V	4266.	8288.
64.	12.32	.22*	1.77	SANDY SILTS AND SILTS	F. III	480.	1189.
65.	12.16	.23*	1.92	SANDY SILTS AND SILTS	F. III	514.	1157.
66.	13.06	.25*	1.90	SANDY SILTS AND SILTS	F. III	546.	1276.
67.	12.46	.26*	2.08	SANDY SILTS AND SILTS	F. III	570.	1182.
68.	10.66	.23*	2.14	SANDY SILTS AND SILTS	F. III	502.	916.
69.	11.73	.24*	2.07	SANDY SILTS AND SILTS	F. III	534.	1050.
70.	17.27	.49*	2.86	SANDY SILTS AND SILTS	F. II	1087.	1842.
71.	13.10	.51*	3.86	CLAYEY SILTS AND SILTY CLAYS	F. II	1112.	1238.
72.	13.67	.46*	3.38	CLAYEY SILTS AND SILTY CLAYS	F. II	1017.	1310.
73.	16.23	.60*	3.68	CLAYEY SILTS AND SILTY CLAYS	F. V	1314.	1657.
74.	18.48	.70*	3.81	CLAYEY SILTS AND SILTY CLAYS	F. II	1549.	1979.
75.	14.09	.42*	2.96	CLAYEY SILTS AND SILTY CLAYS	F. II	918.	1343.
76.	12.63	.44*	3.46	CLAYEY SILTS AND SILTY CLAYS	F. II	961.	1126.
77.	14.43	.28*	1.92	SANDY SILTS AND SILTS	F. III	610.	1374.
78.	15.49	.34*	2.22	SANDY SILTS AND SILTS	F. III	757.	1516.
79.	27.60	1.15*	4.17	CLAYEY SILTS AND SILTY CLAYS	F. II	2532.	3238.
80.	20.14	.45*	2.24	SANDY SILTS AND SILTS	F. IV	992.	2163.
81.	14.77	.28*	1.88	SANDY SILTS AND SILTS	F. III	611.	1387.
82.	14.45	.22*	1.51	SANDY SILTS AND SILTS	F. III	480.	1332.
83.	14.90	.28*	1.89	SANDY SILTS AND SILTS	F. III	620.	1387.
84.	14.47	.24*	1.65	SANDY SILTS AND SILTS	F. III	525.	1317.
85.	14.00	.23*	1.62	SANDY SILTS AND SILTS	F. III	499.	1241.
86.	13.56	.24*	1.80	SANDY SILTS AND SILTS	F. III	537.	1169.
87.	14.16	.27*	1.89	SANDY SILTS AND SILTS	F. III	589.	1246.
88.	15.33	.28*	1.82	SANDY SILTS AND SILTS	F. III	614.	1404.
89.	14.48	.25*	1.70	SANDY SILTS AND SILTS	F. III	542.	1274.
90.	14.78	.30*	2.00	SANDY SILTS AND SILTS	F. III	650.	1308.

\*\*\*\*\*  
 \* WOODWARD-CLYDE \*  
 \* CONSULTANTS \*  
 \*\*\*\*\*

SOUNDING :ACPT3  
 IDENTIFICATION :ADOT\_L STREET SLIDE / INST. NO: F15CKE075  
 LOCATION : XCORD: .0 YCORD: .0 ZCORD: 1.0  
 SOIL CHARACTERISTICS : GAMAT: 125.0 GAMAS: .0 WATER: .0  
 DATE :10- 4-84

DEPTH (FEET)	TIP RESISTANCE (TSF)	SLEEVE FRICTION (TSF)	FRICTION RATIO (%)	SOIL CLASSIFICATION	RUFACIES	SU=Sleeve* 1.1 (PSF)	SU=(C-T)/14.0 (PSF)
1.	175.53	1.02*	.58	SANDS	F.VII		
2.	242.76	1.02*	.42	SANDS	F.VIII		
3.	264.41	1.32*	.50	SANDS	F.VIII		
4.	344.29	2.38*	.69	SANDS	F.VIII		
5.	330.64	1.95*	.59	SANDS	F.VIII		
6.	339.67	1.43*	.42	SANDS	F.VIII		
7.	254.53	1.32*	.52	SANDS	F.VIII		
8.	321.32	2.31*	.72	SANDS	F.VIII		
9.	297.12	1.75*	.59	SANDS	F.VIII		
10.	192.47	1.02*	.53	SANDS	F.VIII		
11.	222.19	1.18*	.53	SANDS	F.VIII		
12.	187.08	.77*	.41	SANDS	F.VIII		
13.	151.08	.50*	.33	SANDS	F.VII		
14.	101.79	.47*	.46	SANDS	F.VII		
15.	133.14	.75*	.56	SANDS	F.VII		
16.	147.56	.86*	.58	SANDS	F.VII		
17.	171.64	1.12*	.65	SANDS	F.VII		
18.	221.29	1.24*	.56	SANDS	F.VIII		
19.	232.10	1.30*	.56	SANDS	F.VIII		
20.	225.54	.88*	.39	SANDS	F.VIII		
21.	264.22	1.03*	.39	SANDS	F.VIII		
22.	226.25	1.00*	.44	SANDS	F.VIII		
23.	216.68	.89*	.41	SANDS	F.VIII		
24.	213.96	.86*	.40	SANDS	F.VIII		
25.	190.93	.95*	.50	SANDS	F.VIII		
26.	181.86	1.15*	.63	SANDS	F.VII		
27.	225.06	1.35*	.60	SANDS	F.VIII		
28.	77.62	2.30*	2.96	SANDY SILTS AND SILTS	F.IV	5055.	10839.
29.	120.82	3.44*	2.85	SILTY SANDS	F.IV		
30.	110.99	7.03*	6.33	CLAYS	F.I	15456.	15588.
31.	288.37	2.97*	1.03	SANDS	F.VII		
32.	38.18	2.14*	5.60	CLAYS	F.II	4704.	5169.
33.	35.10	1.70*	4.84	CLAYEY SILTS AND SILTY CLAYS	F.II	3737.	4720.
34.	36.05	1.39*	3.86	CLAYEY SILTS AND SILTY CLAYS	F.V	3061.	4846.
35.	18.38	.67*	3.65	CLAYEY SILTS AND SILTY CLAYS	F.V	1476.	2313.
36.	17.94	.76*	4.25	CLAYEY SILTS AND SILTY CLAYS	F.II	1677.	2241.
37.	23.19	1.15*	4.94	CLAYS	F.II	2520.	2983.
38.	24.69	1.23*	4.99	CLAYS	F.II	2710.	3188.
39.	16.29	.74*	4.55	CLAYS	F.II	1631.	1979.
40.	23.35	.96*	4.11	CLAYEY SILTS AND SILTY CLAYS	F.II	2111.	2979.



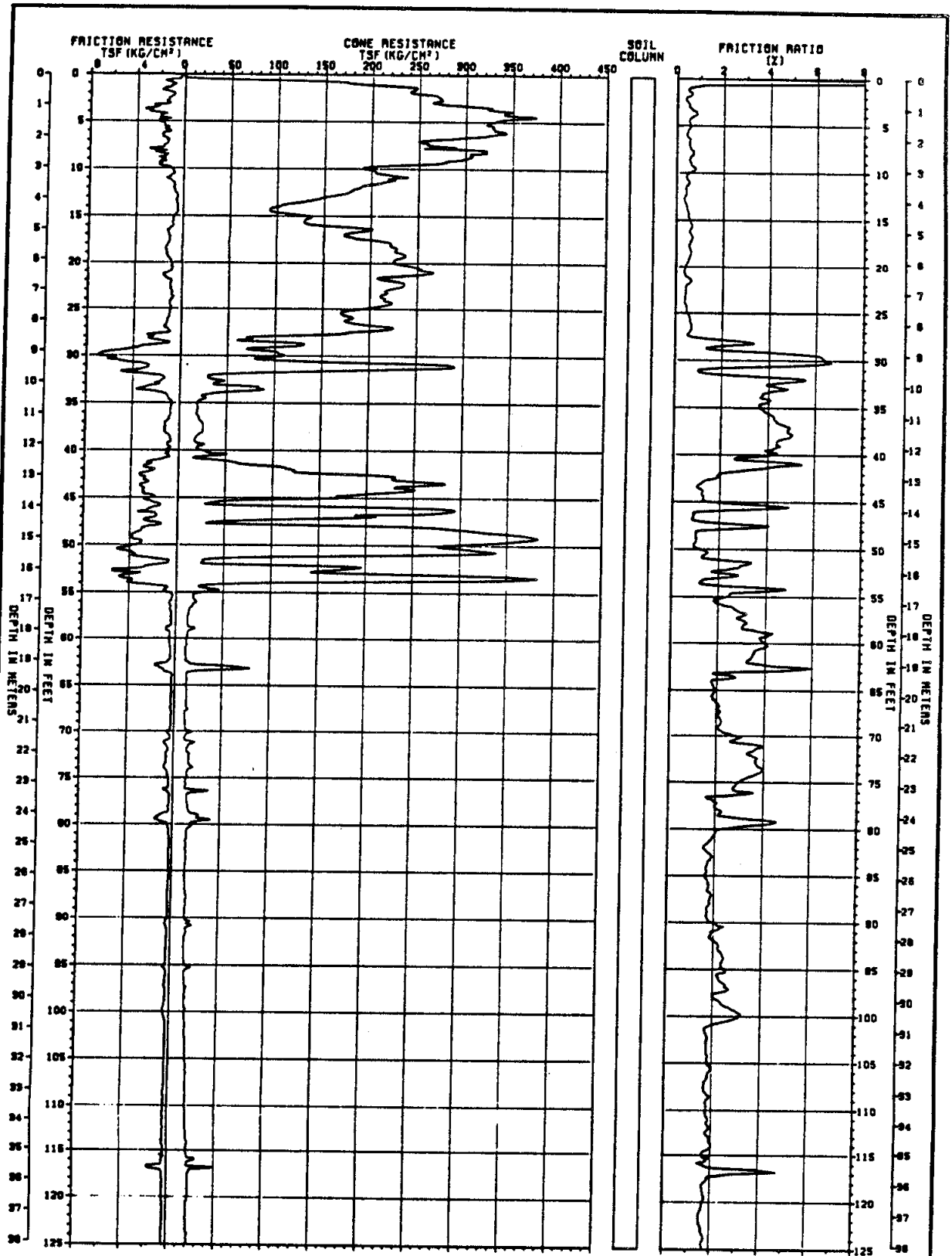

PROJECT: ADOT - L STREET SLIDE  
 PROJECT NUMBER: 85-140-07  
 INSTRUMENT NUMBER: F15CKE075  
 DATE: 10/04/84

A-14

CONE PENETROMETER TEST  
 PROBE: CPT-3

DEPTH (FEET)	TIP RESISTANCE (TSF)	SLEEVE FRICTION (TSF)	FRICTION RATIO (%)	SOIL CLASSIFICATION	RUFACIES	Su=Sleeve* 1.1 (PSF)	SU=(C-T)/14.0 (PSF)
91.	10.66	.30*	2.84	CLAYEY SILTS AND SILTY CLAYS	F. II	666.	710.
92.	10.12	.31*	3.06	CLAYEY SILTS AND SILTY CLAYS	F. II	681.	624.
93.	10.12	.29*	2.85	CLAYEY SILTS AND SILTY CLAYS	F. II	635.	615.
94.	10.13	.32*	3.12	CLAYEY SILTS AND SILTY CLAYS	F. II	695.	608.
95.	13.63	.50*	3.64	CLAYEY SILTS AND SILTY CLAYS	F. II	1091.	1099.
96.	16.02	.45*	2.80	SANDY SILTS AND SILTS	F. II	987.	1431.
97.	20.23	.31*	1.55	SANDY SILTS AND SILTS	F. IV	690.	2024.
98.	13.14	.20*	1.49	SANDY SILTS AND SILTS	F. III	431.	1002.
99.	13.44	.20*	1.51	SANDY SILTS AND SILTS	F. III	446.	1036.
100.	14.24	.21*	1.45	SANDY SILTS AND SILTS	F. III	454.	1141.
101.	14.64	.21*	1.44	SANDY SILTS AND SILTS	F. III	464.	1190.
102.	15.03	.24*	1.60	SANDY SILTS AND SILTS	F. III	529.	1236.
103.	15.25	.22*	1.46	SANDY SILTS AND SILTS	F. IV	490.	1259.
104.	15.73	.22*	1.43	SANDY SILTS AND SILTS	F. IV	495.	1319.
105.	16.64	.23*	1.39	SANDY SILTS AND SILTS	F. IV	509.	1440.
106.	16.85	.27*	1.60	SANDY SILTS AND SILTS	F. IV	593.	1461.
107.	19.26	.25*	1.28	SILTY SANDS	F. IV		
108.	17.46	.24*	1.39	SANDY SILTS AND SILTS	F. IV	534.	1530.
109.	18.26	.27*	1.47	SANDY SILTS AND SILTS	F. IV	591.	1635.
110.	19.86	.29*	1.46	SANDY SILTS AND SILTS	F. IV	638.	1855.
111.	18.18	.26*	1.43	SANDY SILTS AND SILTS	F. IV	572.	1606.
112.	18.09	.18*	1.00	SILTY SANDS	F. IV		
113.	18.57	.35*	1.88	SANDY SILTS AND SILTS	F. III	768.	1644.
114.	20.85	.32*	1.55	SANDY SILTS AND SILTS	F. IV	711.	1961.
115.	18.58	.27*	1.47	SANDY SILTS AND SILTS	F. IV	601.	1627.
116.	19.18	.29*	1.51	SANDY SILTS AND SILTS	F. IV	637.	1704.
117.	49.48	1.04*	2.10	SILTY SANDS	F. IV		
118.	20.56	.35*	1.69	SANDY SILTS AND SILTS	F. IV	764.	1884.
119.	20.57	.34*	1.66	SANDY SILTS AND SILTS	F. IV	751.	1876.
120.	20.39	.33*	1.63	SANDY SILTS AND SILTS	F. IV	731.	1841.
121.	24.79	.41*	1.64	SILTY SANDS	F. IV		
122.	19.79	.33*	1.67	SANDY SILTS AND SILTS	F. IV	727.	1738.
123.	20.46	.33*	1.62	SANDY SILTS AND SILTS	F. IV	729.	1825.
124.	20.49	.35*	1.69	SANDY SILTS AND SILTS	F. IV	762.	1820.
125.	19.70	.29*	1.47	SANDY SILTS AND SILTS	F. IV	637.	1698.

DEPTH (FEET)	TIP RESISTANCE (TSF)	SLEEVE FRICTION (TSF)	FRICTION RATIO (%)	SOIL CLASSIFICATION	RUFACIES	SU=Sleeve* 1.1 (PSF)	SU=(C-T)/14.0 (PSF)
41.	10.30	.48*	4.62	CLAYS	F. II	1047.	1105.
42.	15.52	.79*	5.06	CLAYS	F. II	1728.	1842.
43.	197.23	2.19*	1.11	SANDS	F. VII		
44.	20.21	1.01*	4.99	CLAYS	F. II	2219.	2494.
45.	16.07	.55*	3.41	CLAYEY SILTS AND SILTY CLAYS	F. II	1206.	1894.
46.	23.71	1.01*	4.27	CLAYEY SILTS AND SILTY CLAYS	F. II	2227.	2976.
47.	177.65	2.20*	1.24	SANDS	F. VII		
48.	22.45	.99*	4.42	CLAYEY SILTS AND SILTY CLAYS	F. II	2183.	2779.
49.	14.11	.35*	2.48	SANDY SILTS AND SILTS	F. II	770.	1578.
50.	47.70	1.43*	2.99	SANDY SILTS AND SILTS	F. V	3138.	6368.
51.	29.52	1.02*	3.45	SANDY SILTS AND SILTS	F. V	2241.	3762.
52.	111.12	3.19*	2.87	SILTY SANDS	F. IV		
53.	13.27	.24*	1.83	SANDY SILTS AND SILTS	F. III	534.	1423.
54.	11.71	.25*	2.14	SANDY SILTS AND SILTS	F. III	551.	1191.
55.	18.63	.35*	1.88	SANDY SILTS AND SILTS	F. III	771.	2170.
56.	11.03	.34*	3.10	CLAYEY SILTS AND SILTY CLAYS	F. II	752.	1076.
57.	10.43	.28*	2.67	CLAYEY SILTS AND SILTY CLAYS	F. II	613.	981.
58.	11.24	.34*	3.05	CLAYEY SILTS AND SILTY CLAYS	F. II	754.	1088.
59.	12.24	.47*	3.83	CLAYEY SILTS AND SILTY CLAYS	F. II	1031.	1222.
60.	11.65	.41*	3.48	CLAYEY SILTS AND SILTY CLAYS	F. II	892.	1129.
61.	10.83	.36*	3.31	CLAYEY SILTS AND SILTY CLAYS	F. II	789.	1002.
62.	9.55	.34*	3.53	CLAYEY SILTS AND SILTY CLAYS	F. II	742.	811.
63.	35.19	.61*	1.74	SILTY SANDS	F. IV		
64.	12.15	.22*	1.81	SANDY SILTS AND SILTS	F. III	484.	1164.
65.	12.04	.24*	1.96	SANDY SILTS AND SILTS	F. III	519.	1140.
66.	10.48	.20*	1.91	SANDY SILTS AND SILTS	F. III	440.	908.
67.	14.26	.22*	1.56	SANDY SILTS AND SILTS	F. III	489.	1439.
68.	11.68	.26*	2.22	SANDY SILTS AND SILTS	F. III	570.	1061.
69.	11.27	.29*	2.58	CLAYEY SILTS AND SILTY CLAYS	F. II	640.	994.
70.	15.47	.27*	1.74	SANDY SILTS AND SILTS	F. III	592.	1585.
71.	14.36	.21*	1.49	SANDY SILTS AND SILTS	F. III	471.	1417.
72.	13.48	.20*	1.47	SANDY SILTS AND SILTS	F. III	436.	1283.
73.	16.62	.51*	3.09	CLAYEY SILTS AND SILTY CLAYS	F. II	1130.	1723.
74.	14.08	.40*	2.86	CLAYEY SILTS AND SILTY CLAYS	F. II	886.	1351.
75.	13.08	.30*	2.28	SANDY SILTS AND SILTS	F. III	656.	1199.
76.	13.71	.39*	2.83	CLAYEY SILTS AND SILTY CLAYS	F. II	854.	1280.
77.	11.88	.30*	2.52	SANDY SILTS AND SILTS	F. II	659.	1010.
78.	12.49	.36*	2.85	CLAYEY SILTS AND SILTY CLAYS	F. II	783.	1088.
79.	15.85	.49*	3.06	CLAYEY SILTS AND SILTY CLAYS	F. II	1067.	1559.
80.	11.71	.32*	2.71	CLAYEY SILTS AND SILTY CLAYS	F. II	698.	959.
81.	11.23	.27*	2.41	SANDY SILTS AND SILTS	F. III	595.	881.
82.	11.24	.27*	2.36	SANDY SILTS AND SILTS	F. III	584.	874.
83.	11.18	.28*	2.48	SANDY SILTS AND SILTS	F. III	610.	856.
84.	10.80	.26*	2.44	SANDY SILTS AND SILTS	F. III	580.	793.
85.	11.00	.28*	2.56	CLAYEY SILTS AND SILTY CLAYS	F. III	620.	813.
86.	10.71	.27*	2.53	CLAYEY SILTS AND SILTY CLAYS	F. III	596.	762.
87.	11.01	.30*	2.76	CLAYEY SILTS AND SILTY CLAYS	F. II	669.	796.
88.	12.03	.37*	3.07	CLAYEY SILTS AND SILTY CLAYS	F. II	813.	933.
89.	10.71	.31*	2.93	CLAYEY SILTS AND SILTY CLAYS	F. II	690.	735.
90.	10.92	.32*	2.93	CLAYEY SILTS AND SILTY CLAYS	F. II	704.	756.

\*\*\*\*\*  
 \*  
 \* WOODWARD-CLYDE \*  
 \*  
 \* CONSULTANTS \*  
 \*  
 \*\*\*\*\*

SOUNDING :ACPT2  
 IDENTIFICATION :ADOT-L STREET SLIDE / INST.NO: F15CKE075  
 LOCATION : XCORD: .0 YCORD: .0 ZCORD: 1.0  
 SOIL CHARACTERISTICS : GAMAT: 125.0 GAMAS: .0 WATER: .0  
 DATE :10- 4-84

DEPTH (FEET)	TIP RESISTANCE (TSF)	SLEEVE FRICTION (TSF)	FRICTION RATIO (%)	SOIL CLASSIFICATION	RUFACIES	S <sub>u</sub> =Sleeve* 1.1 (PSF)	S <sub>u</sub> =(C-T)/14.0 (PSF)
1.	298.97	1.67*	.56	SANDS	F.VIII		
2.	148.00	.71*	.48	SANDS	F.VII		
3.	116.11	1.35*	1.16	SANDS	F.VII		
4.	85.03	.47*	.55	SANDS	F.VII		
5.	208.98	.96*	.46	SANDS	F.VIII		
6.	294.83	1.50*	.51	SANDS	F.VIII		
7.	387.02	1.78*	.46	SANDS	F.VIII		
8.	402.02	1.37*	.34	SANDS	F.VIII		
9.	439.22	1.84*	.42	SANDS	F.VIII		
10.	380.78	2.17*	.57	SANDS	F.VIII		
11.	489.63	1.22*	.25	SANDS	F.VIII		
12.	448.53	3.36*	.75	SANDS	F.VIII		
13.	345.57	1.49*	.43	SANDS	F.VIII		
14.	267.58	2.01*	.75	SANDS	F.VIII		
15.	286.94	1.92*	.67	SANDS	F.VIII		
16.	308.90	1.85*	.60	SANDS	F.VIII		
17.	244.84	2.30*	.94	SANDS	F.VII		
18.	253.54	2.16*	.85	SANDS	F.VII		
19.	291.62	1.84*	.63	SANDS	F.VIII		
20.	298.25	1.91*	.64	SANDS	F.VIII		
21.	296.95	2.02*	.68	SANDS	F.VIII		
22.	286.25	1.98*	.69	SANDS	F.VIII		
23.	225.48	1.53*	.68	SANDS	F.VIII		
24.	225.00	1.26*	.56	SANDS	F.VII		
25.	277.46	1.61*	.58	SANDS	F.VIII		
26.	290.82	1.86*	.64	SANDS	F.VIII		
27.	114.96	2.03*	1.77	SILTY SANDS	F.IV		
28.	167.29	2.39*	1.43	SANDS	F.VII		
29.	118.27	4.01*	3.39	SANDY SILTS AND SILTS	F.IV	8821.	16637.
30.	115.39	5.95*	5.16	CLAYEY SILTS AND SILTY CLAYS	F.II	13099.	16216.
31.	53.77	2.27*	4.22	CLAYEY SILTS AND SILTY CLAYS	F.V	4992.	7405.
32.	49.68	1.73*	3.49	SANDY SILTS AND SILTS	F.V	3814.	6811.
33.	29.36	1.35*	4.60	CLAYEY SILTS AND SILTY CLAYS	F.II	2971.	3900.
34.	84.47	2.41*	2.85	SANDY SILTS AND SILTS	F.IV	5296.	11764.
35.	27.56	1.18*	4.29	CLAYEY SILTS AND SILTY CLAYS	F.II	2601.	3625.
36.	13.47	.71*	5.30	CLAYS	F.I	1571.	1603.
37.	12.45	.67*	5.37	CLAYS	F.I	1471.	1448.
38.	14.89	.75*	5.05	CLAYS	F.II	1654.	1788.
39.	13.51	.71*	5.24	CLAYS	F.I	1557.	1582.
40.	11.92	.54*	4.56	CLAYS	F.II	1196.	1346.

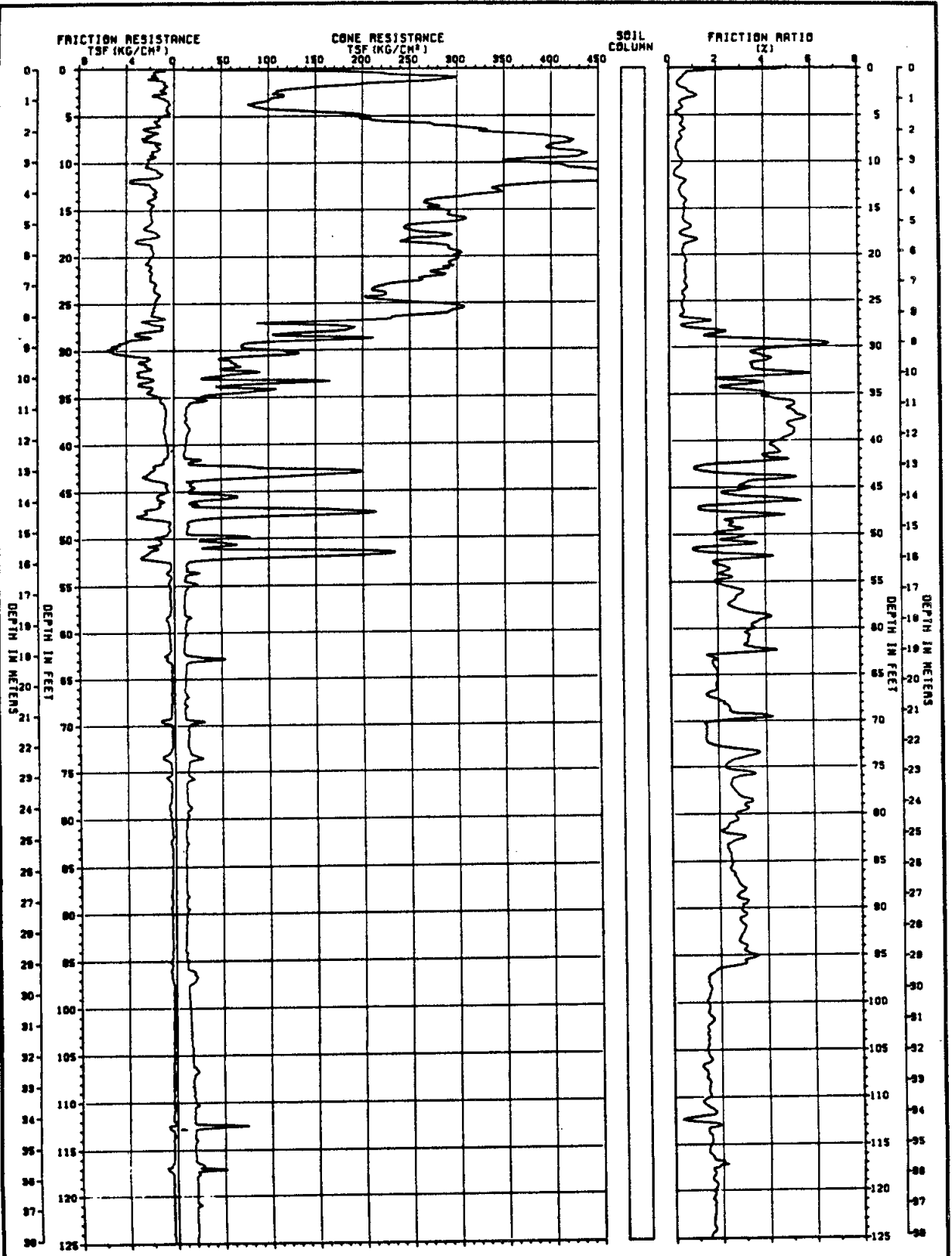

PROJECT: ADOOT - L STREET SLIDE  
 PROJECT NUMBER: 85-140-07  
 INSTRUMENT NUMBER: F15CKE07S  
 DATE: 10/04/84

**CONE PENETROMETER TEST**  
 PROBE: CPT-2

DEPTH (FEET)	TIP RESISTANCE (TSF)	SLEEVE FRICTION (TSF)	FRICTION RATIO (%)	SOIL CLASSIFICATION	RUFACIES	S <sub>u</sub> =Sleeve* 1.1 (PSF)	S <sub>u</sub> =(C-T)/14.0 (PSF)
91.	19.74	.52*	2.61	SANDY SILTS AND SILTS	F. IV	1133.	2007.
92.	20.27	.53*	2.60	SANDY SILTS AND SILTS	F. IV	1159.	2074.
93.	20.03	.53*	2.64	SANDY SILTS AND SILTS	F. IV	1163.	2031.
94.	23.45	.63*	2.68	SANDY SILTS AND SILTS	F. IV	1383.	2511.
95.	24.53	.72*	2.94	SANDY SILTS AND SILTS	F. IV	1587.	2656.
96.	21.07	.80*	3.81	CLAYEY SILTS AND SILTY CLAYS	F. V	1766.	2153.
97.	20.25	.66*	3.27	CLAYEY SILTS AND SILTY CLAYS	F. II	1457.	2027.
98.	20.55	.52*	2.51	SANDY SILTS AND SILTS	F. IV	1135.	2061.
99.	20.60	.51*	2.46	SANDY SILTS AND SILTS	F. IV	1115.	2059.
100.	21.08	.51*	2.42	SANDY SILTS AND SILTS	F. IV	1122.	2119.
101.	21.13	.51*	2.40	SANDY SILTS AND SILTS	F. IV	1116.	2117.
102.	21.73	.55*	2.51	SANDY SILTS AND SILTS	F. IV	1200.	2194.
103.	21.19	.52*	2.44	SANDY SILTS AND SILTS	F. IV	1137.	2108.
104.	22.32	.57*	2.54	SANDY SILTS AND SILTS	F. IV	1247.	2250.
105.	22.01	.54*	2.45	SANDY SILTS AND SILTS	F. IV	1186.	2207.
106.	22.39	.57*	2.55	SANDY SILTS AND SILTS	F. IV	1256.	2252.
107.	30.98	1.18*	3.81	CLAYEY SILTS AND SILTY CLAYS	F. V	2597.	3470.
108.	22.68	.59*	2.62	SANDY SILTS AND SILTS	F. IV	1307.	2276.
109.	24.01	.61*	2.54	SANDY SILTS AND SILTS	F. IV	1342.	2457.
110.	23.26	.45*	1.93	SANDY SILTS AND SILTS	F. IV	988.	2341.
111.	23.16	.51*	2.21	SANDY SILTS AND SILTS	F. IV	1126.	2317.
112.	24.72	.60*	2.43	SANDY SILTS AND SILTS	F. IV	1322.	2531.
113.	23.30	.59*	2.52	SANDY SILTS AND SILTS	F. IV	1292.	2320.
114.	24.07	.57*	2.36	SANDY SILTS AND SILTS	F. IV	1250.	2421.
115.	25.27	.47*	1.87	SANDY SILTS AND SILTS	F. IV	1040.	2583.
116.	29.40	.78*	2.65	SANDY SILTS AND SILTS	F. IV	1714.	3164.
117.	42.60	1.01*	2.37	SANDY SILTS AND SILTS	F. IV	2221.	5041.
118.	66.57	1.44*	2.17	SILTY SANDS	F. IV		
119.	42.89	1.36*	3.17	SANDY SILTS AND SILTS	F. V	2991.	5065.
120.	165.02	3.43*	2.08	SILTY SANDS	F. IV		
121.	41.97	1.37*	3.26	SANDY SILTS AND SILTS	F. V	3010.	4915.
122.	27.77	.81*	2.90	SANDY SILTS AND SILTS	F. IV	1772.	2878.
123.	381.33	8.81*	2.31	SANDS	F. IV		
124.	264.57	6.19*	2.34	SILTY SANDS	F. IV		
125.	99.62	1.88*	1.89	SILTY SANDS	F. IV		
126.	41.36	.64*	1.54	SILTY SANDS	F. VI		
127.	60.11	2.03*	3.37	SANDY SILTS AND SILTS	F. V	4457.	7453.
128.	196.26	4.95*	2.52	SILTY SANDS	F. IV		
129.	205.68	9.52*	4.63	SANDY SILTS AND SILTS	F. V	20951.	28231.

DEPTH (FEET)	TIP RESISTANCE (TSF)	SLEEVE FRICTION (TSF)	FRICTION RATIO (%)	SOIL CLASSIFICATION	RUFACIES	SU=Sleeve* 1.1 (PSF)	SU=(C-T)/14.0 (PSF)
41.	10.85	.41*	3.74	CLAYEY SILTS AND SILTY CLAYS	F. II	893.	1184.
42.	11.45	.46*	4.04	CLAYEY SILTS AND SILTY CLAYS	F. II	1018.	1261.
43.	11.80	.45*	3.84	CLAYEY SILTS AND SILTY CLAYS	F. II	997.	1302.
44.	13.30	.30*	2.23	SANDY SILTS AND SILTS	F. III	652.	1507.
45.	13.59	.33*	2.42	SANDY SILTS AND SILTS	F. II	724.	1540.
46.	13.89	.33*	2.34	SANDY SILTS AND SILTS	F. III	715.	1574.
47.	14.48	.35*	2.40	SANDY SILTS AND SILTS	F. IV	765.	1649.
48.	17.24	.43*	2.48	SANDY SILTS AND SILTS	F. IV	941.	2034.
49.	16.06	.40*	2.48	SANDY SILTS AND SILTS	F. IV	876.	1857.
50.	23.41	.53*	2.25	SANDY SILTS AND SILTS	F. IV	1159.	2898.
51.	18.18	.49*	2.70	SANDY SILTS AND SILTS	F. IV	1080.	2142.
52.	19.68	.48*	2.42	SANDY SILTS AND SILTS	F. IV	1048.	2347.
53.	15.60	.38*	2.41	SANDY SILTS AND SILTS	F. IV	827.	1755.
54.	16.01	.39*	2.41	SANDY SILTS AND SILTS	F. IV	849.	1805.
55.	13.85	.30*	2.17	SANDY SILTS AND SILTS	F. III	661.	1488.
56.	15.64	.38*	2.45	SANDY SILTS AND SILTS	F. IV	843.	1734.
57.	15.64	.37*	2.36	SANDY SILTS AND SILTS	F. IV	812.	1725.
58.	15.93	.36*	2.27	SANDY SILTS AND SILTS	F. IV	796.	1758.
59.	16.23	.36*	2.23	SANDY SILTS AND SILTS	F. III	796.	1792.
60.	17.18	.44*	2.54	SANDY SILTS AND SILTS	F. IV	960.	1919.
61.	17.90	.43*	2.40	SANDY SILTS AND SILTS	F. IV	945.	2013.
62.	17.35	.42*	2.40	SANDY SILTS AND SILTS	F. IV	916.	1925.
63.	17.47	.48*	2.75	SANDY SILTS AND SILTS	F. II	1057.	1933.
64.	18.60	.50*	2.71	SANDY SILTS AND SILTS	F. IV	1109.	2086.
65.	18.78	.48*	2.56	SANDY SILTS AND SILTS	F. IV	1058.	2103.
66.	17.83	.49*	2.74	SANDY SILTS AND SILTS	F. II	1075.	1958.
67.	17.69	.49*	2.77	SANDY SILTS AND SILTS	F. II	1078.	1929.
68.	17.03	.45*	2.65	SANDY SILTS AND SILTS	F. II	993.	1826.
69.	16.26	.46*	2.82	SANDY SILTS AND SILTS	F. II	1009.	1707.
70.	16.78	.45*	2.68	SANDY SILTS AND SILTS	F. II	989.	1772.
71.	17.31	.45*	2.62	SANDY SILTS AND SILTS	F. IV	998.	1839.
72.	16.23	.41*	2.54	SANDY SILTS AND SILTS	F. IV	907.	1676.
73.	16.16	.40*	2.50	SANDY SILTS AND SILTS	F. IV	889.	1657.
74.	16.76	.43*	2.58	SANDY SILTS AND SILTS	F. IV	951.	1734.
75.	17.35	.44*	2.52	SANDY SILTS AND SILTS	F. IV	962.	1809.
76.	17.65	.43*	2.44	SANDY SILTS AND SILTS	F. IV	947.	1843.
77.	21.91	.41*	1.85	SANDY SILTS AND SILTS	F. IV	892.	2442.
78.	17.34	.40*	2.30	SANDY SILTS AND SILTS	F. IV	877.	1781.
79.	17.03	.38*	2.26	SANDY SILTS AND SILTS	F. IV	847.	1728.
80.	17.03	.37*	2.19	SANDY SILTS AND SILTS	F. III	821.	1719.
81.	17.84	.43*	2.42	SANDY SILTS AND SILTS	F. IV	950.	1825.
82.	17.92	.48*	2.66	SANDY SILTS AND SILTS	F. IV	1049.	1828.
83.	18.22	.49*	2.70	SANDY SILTS AND SILTS	F. IV	1082.	1862.
84.	19.11	.52*	2.71	SANDY SILTS AND SILTS	F. IV	1139.	1980.
85.	19.41	.51*	2.61	SANDY SILTS AND SILTS	F. IV	1115.	2014.
86.	19.46	.47*	2.44	SANDY SILTS AND SILTS	F. IV	1045.	2012.
87.	20.69	.56*	2.73	SANDY SILTS AND SILTS	F. IV	1243.	2179.
88.	19.87	.48*	2.42	SANDY SILTS AND SILTS	F. IV	1058.	2053.
89.	20.07	.54*	2.67	SANDY SILTS AND SILTS	F. IV	1179.	2073.
90.	20.52	.57*	2.80	SANDY SILTS AND SILTS	F. IV	1264.	2128.

\*\*\*\*\*  
 \* \*  
 \* WOODWARD-CLYDE \*  
 \* \*  
 \* CONSULTANTS \*  
 \* \*  
 \*\*\*\*\*

SOUNDING :ACPT1A  
 IDENTIFICATION :ADOT-L STREET SLIDE / INST. NO: F15CCKE075  
 LOCATION : XCORD: .0 YCORD: .0 ZCORD: 1.0  
 SOIL CHARACTERISTICS : GAMAT: 125.0 GAMAS: .0 WATER: .0  
 DATE :10- 4-84

DEPTH (FEET)	TIP RESISTANCE (TSF)	SLEEVE FRICTION (TSF)	FRICTION RATIO (%)	SOIL CLASSIFICATION	RUFACIES	SU=Sleeve* 1.1 (PSF)	SU=(C-T)/14.0 (PSF)
1.	135.12	.76*	.56	SANDS	F.VII		
2.	78.23	.49*	.63	SANDS	F.VII		
3.	38.45	.43*	1.11	SILTY SANDS	F.VI		
4.	27.67	.36*	1.30	SILTY SANDS	F.IV		
5.	60.51	.65*	1.08	SILTY SANDS	F.VI		
6.	29.49	.81*	2.74	SANDY SILTS AND SILTS	F.IV	1778.	4159.
7.	111.76	.87*	.78	SANDS	F.VII		
8.	107.70	.58*	.54	SANDS	F.VII		
9.	171.38	.93*	.54	SANDS	F.VII		
10.	167.05	.87*	.52	SANDS	F.VII		
11.	264.25	1.19*	.45	SANDS	F.VIII		
12.	282.66	1.02*	.36	SANDS	F.VIII		
13.	379.71	1.29*	.34	SANDS	F.VIII		
14.	268.32	1.34*	.50	SANDS	F.VIII		
15.	222.29	.93*	.42	SANDS	F.VIII		
16.	405.09	2.03*	.50	SANDS	F.VIII		
17.	424.96	1.40*	.33	SANDS	F.VIII		
18.	212.53	1.38*	.65	SANDS	F.VII		
19.	285.09	1.37*	.48	SANDS	F.VIII		
20.	415.83	2.04*	.49	SANDS	F.VIII		
21.	549.32	3.02*	.55	SANDS	F.VIII		
22.	462.43	2.08*	.45	SANDS	F.VIII		
23.	407.47	1.34*	.33	SANDS	F.VIII		
24.	291.31	.50*	.17	SANDS	F.VIII		
25.	29.16	.41*	1.39	SILTY SANDS	F.IV		
26.	17.76	.42*	2.37	SANDY SILTS AND SILTS	F.IV	926.	2305.
27.	15.42	.15*	.97	SANDY SILTS AND SILTS	F.IV	329.	1962.
28.	12.68	.64*	5.02	CLAYS	F.II	1400.	1561.
29.	9.17	.42*	4.62	CLAYS	F.II	932.	1051.
30.	8.33	.34*	4.10	CLAYS	F.II	751.	922.
31.	7.48	.38*	5.03	CLAYS	F.I	828.	792.
32.	7.95	.39*	4.91	CLAYS	F.I	859.	850.
33.	17.37	.53*	3.03	SANDY SILTS AND SILTS	F.II	1158.	2187.
34.	8.78	.41*	4.68	CLAYS	F.II	904.	951.
35.	8.18	.46*	5.66	CLAYS	F.I	1019.	856.
36.	8.53	.50*	5.84	CLAYS	F.I	1096.	897.
37.	10.33	.37*	3.59	CLAYEY SILTS AND SILTY CLAYS	F.II	816.	1145.
38.	12.54	.39*	3.08	CLAYEY SILTS AND SILTY CLAYS	F.II	850.	1452.
39.	14.40	.53*	3.68	CLAYEY SILTS AND SILTY CLAYS	F.II	1166.	1709.
40.	11.70	.47*	4.01	CLAYEY SILTS AND SILTY CLAYS	F.II	1032.	1314.



\*\*\*\*\*  
 \*  
 \* WOODWARD-CLYDE \*  
 \*  
 \* CONSULTANTS \*  
 \*  
 \*\*\*\*\*

SOUNDING :ACPT1  
 IDENTIFICATION :ADDOT-L STREET SLIDE / INST. NO: F15CKE075  
 LOCATION : XCORD: .0 YCORD: .0 ZCORD: 1.0  
 SOIL CHARACTERISTICS : GAMAT: 125.0 GAMAS: .0 WATER: .0  
 DATE :10- 4-84

DEPTH (FEET)	TIP	SLEEVE	FRICTION	SOIL CLASSIFICATION	RUFACIES	SU=Sleeve* 1.1	SU=(C-T)/14.0
	RESISTANCE (TSF)	FRICTION (TSF)	RATIO (%)			(PSF)	(PSF)
1.	3.49	.29*	8.41	CLAYS	F.I	646.	490.
2.	123.14	.48*	.39	SANDS	F.VII		
3.	67.25	.47*	.70	SANDS	F.VII		
4.	44.97	.37*	.82	SILTY SANDS	F.VI		
5.	35.29	.16*	.46	SILTY SANDS	F.VI		
6.	37.91	.22*	.59	SILTY SANDS	F.VI		
7.	60.69	.50*	.83	SANDS	F.VII		
8.	117.38	.56*	.48	SANDS	F.VII		
9.	179.56	1.53*	.85	SANDS	F.VII		
10.	231.98	1.14*	.49	SANDS	F.VIII		
11.	316.80	1.90*	.60	SANDS	F.VIII		
12.	343.72	2.61*	.76	SANDS	F.VIII		
13.	274.33	1.29*	.47	SANDS	F.VIII		
14.	268.55	1.58*	.59	SANDS	F.VIII		
15.	476.07	1.52*	.32	SANDS	F.VIII		
16.	531.79	2.29*	.43	SANDS	F.VIII		
17.	498.11	1.79*	.36	SANDS	F.VIII		
18.	441.32	4.41*	1.00	SANDS	F.VII		

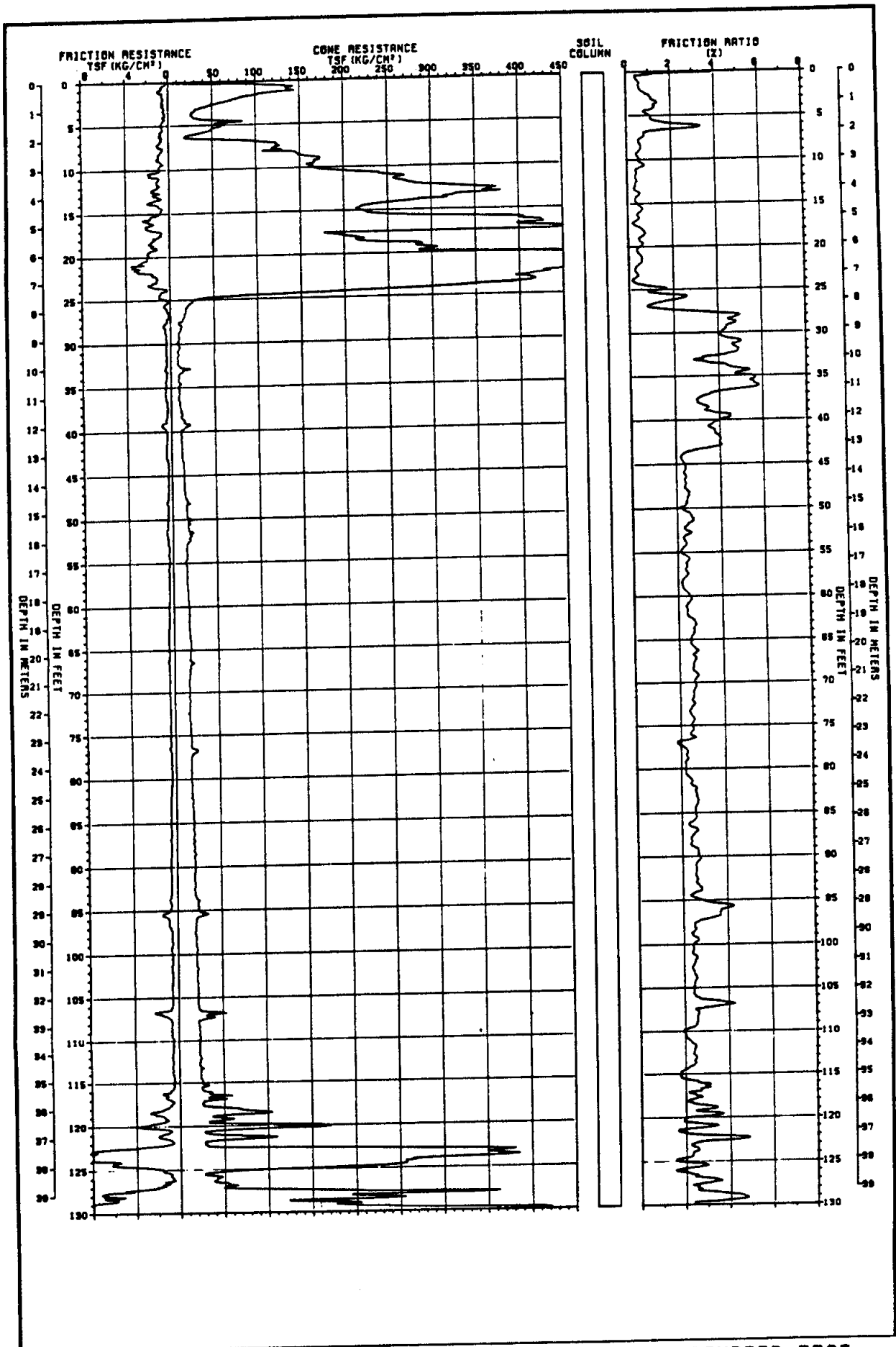

PROJECT: A00T - L STREET SLIDE  
 PROJECT NUMBER: 85-140-07  
 INSTRUMENT NUMBER: F15CKE075  
 DATE: 10/04/84

CONE PENETROMETER TEST  
 PROBE: CPT-1A

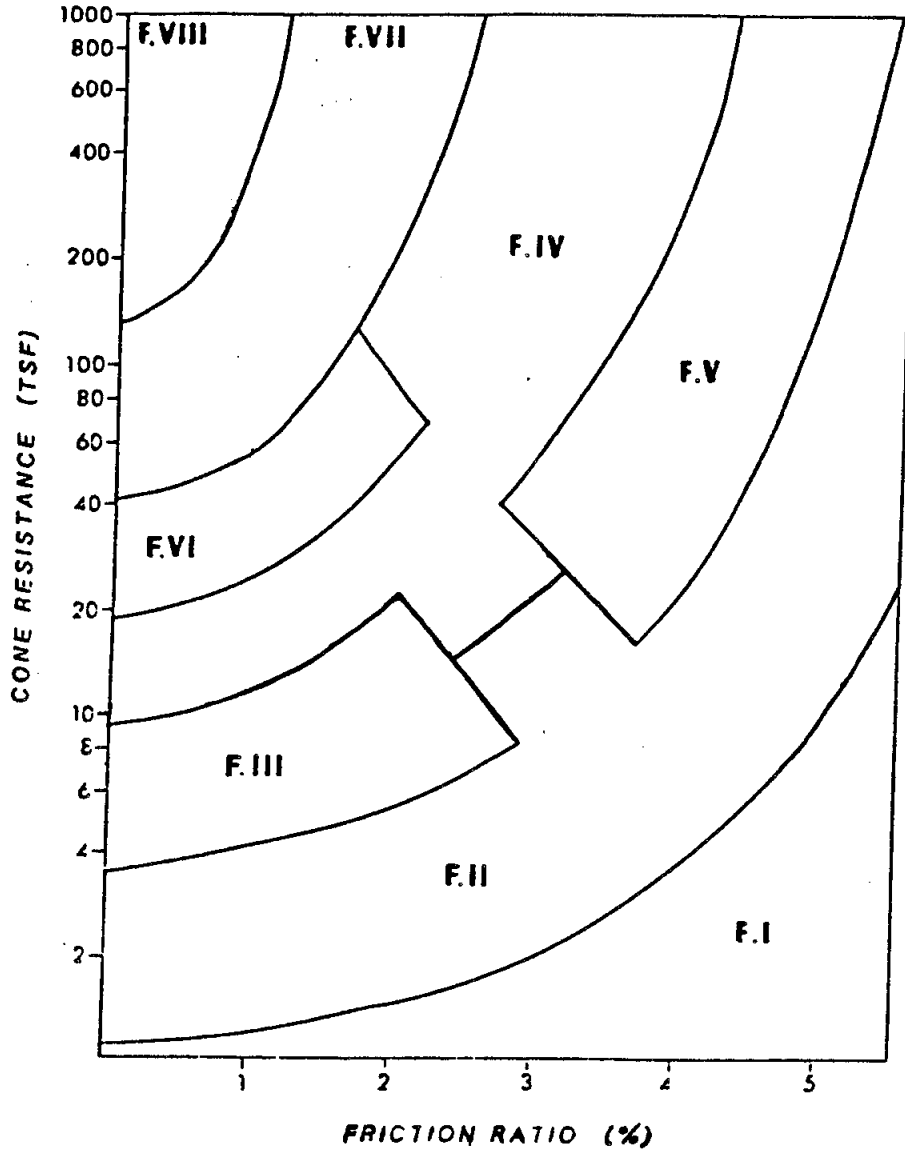

Fig. A-2 CPT-Facies Criteria for Bootlegger Cove Formation

1 bar = 100kPa = 1.02 kg/cm<sup>2</sup>

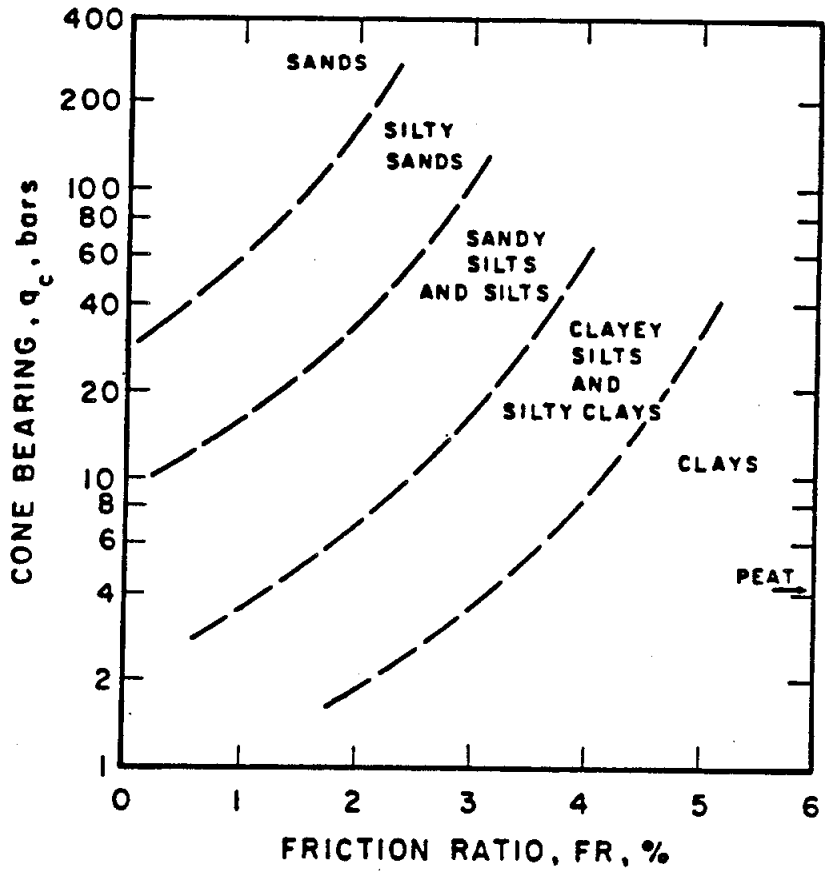

Fig. A-1 Simplified Classification Chart for Standard Electric Friction Cone

Karol-Warner vane shear. For the vane shear testing, a 2-1/2 inch by 6-1/2 inch tapered vane was pushed into the soil 18 inches below the bottom of the casing and rotated by a hand cranking mechanism at rate of 1/2 degree per second. The torsional force was measured by dial indicator. After the soil had reached the initial peak shear strength, the vane was manually rotated several revolutions to insure that the soil was disturbed. The residual soil strength was then measured one minute and ten minutes after the initial test.

Seven undisturbed samples were taken using a 3" shelly tube and an Acker piston sampler. Two shelly tube samples were sent to the Woodward-Clyde Consultants laboratory in Clifton, New Jersey for consolidation, direct shear, and direct simple shear testing. Five shelly tube samples were sent to the Alaska DOT&PF Central Laboratory for soil classification, UU triaxial, torvane, and mini-vane testing.

APPENDIX A  
RESULTS OF GEOTECHNICAL FIELD INVESTIGATION

The geotechnical field investigation included six Cone Penetrometer Testing (CPT) soundings and one sample boring. The CPT work was conducted by The Earth Technology Corporation and the sample boring was drilled by Alaska DOT&PF.

The CPT consists of pushing a 1.4 inch diameter instrumented cone into the soil at a continuous rate of 2 cm/sec. Strain gauges mounted in the cone tip and the shaft measured the tip resistance and friction resistance. The strain gauge readings are transmitted through an electric cable to recorders at the surface.

The soil classification criteria used with the CPT data are shown in Figure A-1 (Robertson and Campanella, 1984) and the classification criteria for the Bootlegger Cove Formation facies also used with the CPT data are shown in Figure A-2 (updike and Ulery, 1984). The CPT and related data are summarized in a series of figures and tables identified as A-3.

The sample boring was drilled with a truck mounted CME-75 rotary drill. The boring was advanced by hollow stem auger (3.25" I.D., 8.0" O.D.). The results of the boring are summarized in Figure A-4. Three Standard Penetration Tests (SPT) were made at depths of 42', 46', and 48'. The SPT test consists of driving a standard split-barrel sampler (1.4" I.D., 2.0" O.D.) with a CME 140 pound automatic trip hammer having a free fall of 30 inches. In addition, seven field vane shear tests were conducted on the soil with a

APPENDIX A

RESULTS OF GEOTECHNICAL FIELD INVESTIGATION

Udike, R. G., and Ulery, C. A. (1984), "A Geotechnical Cross-Section for Downtown Anchorage Utilizing the Electric Cone Penetration Test", Alaska Division of Geological and Geophysical Surveys Professional Report, in press.

Woodward-Clyde Consultants (1982), "Anchorage Office Complex, Geotechnical Investigation, Anchorage, Alaska", Report to Alaska Department of Transportation and Public Facilities, Central Region, Design and Construction, Anchorage, Alaska.



Robertson, P. K. and Campanella, R. G. (1984), "Guidelines for Use and Interpretation of the Electronic Cone Penetration Test", Soil Mechanics Series No. 69, Department of Civil Engineering, The University of British Columbia.

Seed, H. B., and Idriss, I. M. (1982), "Ground Motions and Soil Liquefaction During Earthquakes", Monograph No. 5, Monograph Series, Earthquake Engineering Research Institute, Berkeley, California, 134 p.

Seed, H. B., Lee, K. L., and Idriss, I. M. (1969), "Analysis of Sheffield Dam Failure", J. Soil Mechanics and Foundation Div., ASCE, v. 95, no. SM6, November, pp. 1453-1490.

Shannon and Wilson, (1964), "Report on Anchorage Area Soil Studies, Alaska", Report Prepared for the U.S. Army Engineer District, Anchorage, Alaska, Contract No. DA-95-507-CIVENG-64-18.

Steinbrugge, K. V. (1970), "Earthquake Engineering", Robert L. Wiegel, Editor, Prentice-Hall, pp. 167-226.

Urdike, R. G. (1984), "The Turnagain Heights Landslide--An Assessment Using the Electric Cone Penetration Test", Alaska Division of Geological and Geophysical Surveys Report of Investigation, in press.

Urdike, R. G., Cole, S. A., and Ulery, C. A. (1982), "Shear Moduli and Damping Ratios for the Bootlegger Cove Formation as Determined by Resonant-Column Testing", Alaska Division of Geological and Geophysical Surveys Geologic Report 73, p. 7-12.

- Ladd, C. C., and Foott, R. (1974), "New Design Procedure for Stability of Soft Clays", J. Geotechnical Eng. Div., ASCE, v. 100, No. GT7, July, pp. 763-786.
- Long, E. L. (1973), "Earth Slides and Related Phenomena", The Great Alaska Earthquake of 1964, National Academy of Science, pp. 644-773.
- Makdisi, F. I., and Seed, H. B. (1978), "Simplified Procedure for Estimating Dam and Embankment Earthquake-Induced Deformations", J. Geotechnical Eng. Div., ASCE, v. 104, No. GT7, July, pp. 849-867.
- Mitchell, J. K., Houston, W. N., and Yamane, G. (1973) "Sensitivity and Geotechnical Properties of Bootlegger Cove Clay", in National Academy of Sciences, The Great Alaska Earthquake of 1964, Engineering, p. 157-178.
- Newmark, N. M. (1965), "Effects of Earthquakes on Dams and Embankments", Geotechnique, v. 15, no. 2, June, pp. 139-159.
- O'Rourke, M. J., Bloom, M. C., and Dobry, R. (1982), "Apparent Propagation Velocity of Body Waves", Earthquake Engineering and Structural Dynamics, v. 10, no. 2, March, pp. 283-294.
- Reger, P. D., and Updike, R. G. (1983), "Upper Cook Inlet Area and the Matanuska Valley", in Pewe, T. OL., and Reger, B. D., A guidebook for the 4th International Permafrost Conference: Alaska Division of Geological and Geophysical Surveys Guidebook 1, p. 185-263.

## REFERENCES

- Bolt, B. A. (1978), "Earthquakes -- A Primer", W. H. Freeman and Company, 241 p.
- Hansen, W. R. (1965), "Effects of the Earthquake of March 27, 1964, at Anchorage, Alaska", The Alaska Earthquake, March 27, 1964, Effects on Communities, USGS, Professional Paper, 542-A.
- Harding Lawson Associates (1984) "Geotechnical Engineering Investigation, Anchorage Courthouse Addition, Anchorage, Alaska", Report to McCool-McDonald of Alaska, Inc.
- Housner, G. W., and Jennings, P. C. (1973), "Reconstituted Earthquake Ground Motion at Anchorage in The Great Alaska Earthquake of 1964", Engineering, NAS Pub. 1606, Washington: National Academy of Sciences.
- Idriss, I. M., and Seed, H. B. (1967), "Response of Earth Banks During Earthquakes", J. Soil Mechanics and Foundation Div., ASCE, v. 93, No. SM3, May, pp. 61-108.
- Ladd, C. C. (1981), "Discussion on Laboratory Shear Device", Laboratory Shear Strength of Soil, ASTM, STP 740, pp. 643-652.
- Ladd, C. C., Foott, R., Ishihara, K., Schlosser, F., and Poulos, H. G. (1977), "Stress-Deformation and Strength Characteristics", Proceedings, 9th International Conference on Soil Mechanics and Foundation Engineering, Tokyo, v. 2, pp. 421-494.

- 3) Detailed Microzonation for Planning Purposes - Although it is always difficult to produce a microzonation map of an area that would be useful and meaningful to many interested parties, a "block-by-block" type of microzonation in certain parts of Anchorage may have some merits. As the results of more recent geotechnical studies in the Anchorage area become available, the data base required to produce such a detailed microzonation map increases. Such a microzonation map should emphasize the relative risk of ground failure associated with various parts of Anchorage, should reflect the inevitable variations in the quality of the data base in various parts of Anchorage, and should allow for the possibility of conducting site specific studies as appropriate.

Anchorage area are summarized in Figure 14. Even for a minor structure, it is suggested that all the components shown in Figure 14 be addressed in some form. One additional item to be remembered in Figure 14 is that any seismic stability (displacement) evaluation procedure to be used for the Anchorage area should be calibrated using the observed site instability (or stability) during the 1964 Alaskan earthquake. A comprehensive guideline can outline the calibration process but should be flexible enough so that it is possible to exercise engineering judgement and to use different approaches as appropriate.

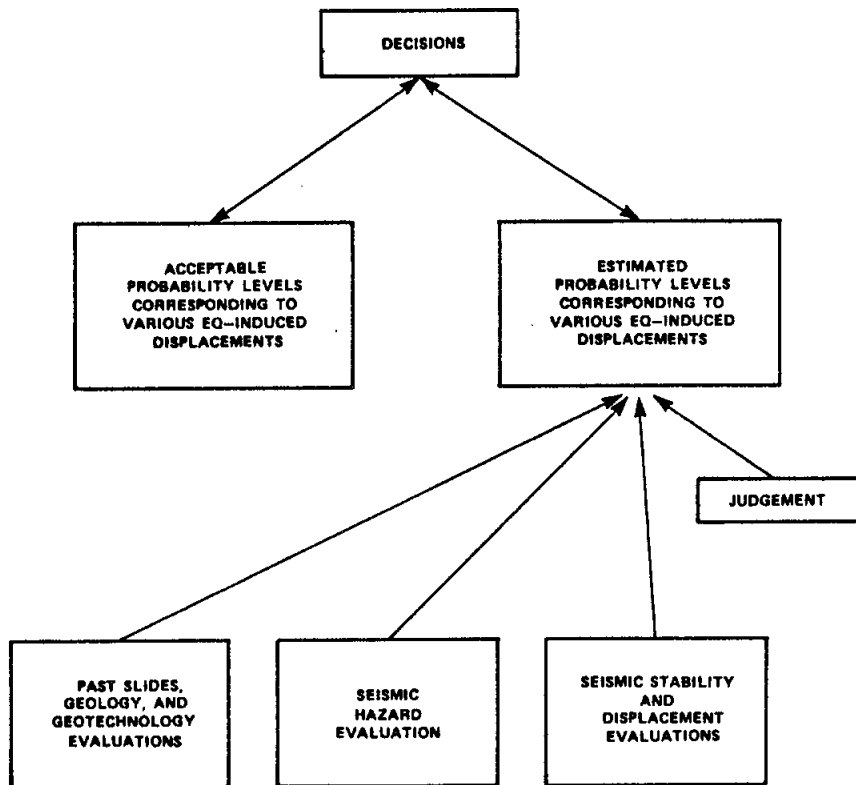

Figure 14 - Evaluation Process for Seismic Site Stability

Street slide summarized herein is based on limited amount of field and laboratory information. To conduct more comprehensive, and more definitive, reevaluation of the slide would require more CPT soundings (particularly in the northern part of the slide, along the bottom of the bluff line, and in and out of the graben area), more borings to obtain soil samples from various parts inside and outside slide area for additional testing, more analyses along more cross-sections representative of various parts of the slide, mapping of the distribution of sensitive clays and SPT blowcounts inside and outside of the slide area, an evaluation of the three-dimensional and possibly progressive nature of the slide (what determined the geometry of the 1964 "L" Street slide?), and an evaluation of the role played by silty and sandy lenses present in the normally consolidated to lightly over-consolidated part of the Bootlegger Cove Formation.

- 2) Guideline for Conducting Seismic Site Stability Evaluation in Anchorage Area - This study involving the 1964 "L" Street slide, a previous study by Woodward-Clyde Consultants (1982) involving the 1964 Fourth Avenue slide, and similar studies by others (for example, Shannon and Wilson, 1964; Hansen, 1965; Long, 1973; Mitchell and others, 1973; Updike, 1984; Updike and others, 1982) all indicate that conducting seismic site stability evaluation in the Anchorage area may require certain approaches which may be worthwhile compiling in a guideline format. The key components of the seismic site stability evaluation process for important structures and facilities in the

Formation). The stress concentrations at edges of silt and sand lenses could have induced high pore water pressures in these lenses (Seed and others, 1969).

Finally, based on the reevaluation of the 1964 "L" Street slide presented herein, the following two conclusions can be made regarding site stability evaluation in the Anchorage area due to earthquake loading conditions:

- 1) The shear strength determination procedure and the seismic displacement calculation procedure presented herein constitute together a practical evaluation tool which has been calibrated using the 1964 "L" Street slide (this study) and the 1964 Fourth Avenue slide (Woodward-Clyde Consultants, 1982).
- 2) Carefully conducted CPT soundings and field boring and sampling program combined with a careful laboratory testing program using appropriate testing methods are important in conducting seismic site stability evaluation in the Anchorage area.

#### 8.0 RECOMMENDATIONS AND IMPLEMENTATIONS

The reevaluation of the 1964 "L" Street slide was conducted based on a limited program of field investigation, laboratory tests, and analyses. Based on the results of this investigation summarized in this report, the following recommendations and implementations can be made:

- 1) More Comprehensive Reevaluation of the 1964 "L" Street Slide - The reevaluation of the 1964 "L"

DEPTH (FEET)	TIP RESISTANCE (TSF)	SLEEVE FRICTION (TSF)	FRICTION RATIO (%)	SOIL CLASSIFICATION	RUFACIES	SU=Sleeve* 1.1 (PSF)	SU=(C-T)/14.0 (PSF)
141.	21.59	.45*	2.09	SANDY SILTS AND SILTS	F. IV	993.	1825.
142.	21.35	.45*	2.09	SANDY SILTS AND SILTS	F. IV	982.	1782.
143.	21.64	.45*	2.09	SANDY SILTS AND SILTS	F. IV	995.	1815.
144.	22.00	.46*	2.07	SANDY SILTS AND SILTS	F. IV	1002.	1857.
145.	22.23	.44*	2.00	SANDY SILTS AND SILTS	F. IV	978.	1881.
146.	46.66	1.90*	4.07	CLAYEY SILTS AND SILTY CLAYS	F. V	4178.	5362.
147.	47.47	1.26*	2.65	SANDY SILTS AND SILTS	F. IV	2768.	5469.
148.	37.63	.46*	1.23	SILTY SANDS	F. VI		
149.	37.69	.50*	1.33	SILTY SANDS	F. VI		
150.	40.35	.75*	1.86	SILTY SANDS	F. IV		
151.	29.69	1.85*	6.22	CLAYS	F. I	4063.	2893.
152.	24.89	.53*	2.13	SANDY SILTS AND SILTS	F. IV	1166.	2199.
153.	24.49	.53*	2.17	SANDY SILTS AND SILTS	F. IV	1169.	2133.
154.	22.99	.50*	2.19	SANDY SILTS AND SILTS	F. IV	1108.	1909.
155.	23.07	.54*	2.32	SANDY SILTS AND SILTS	F. IV	1177.	1912.
156.	24.86	.60*	2.40	SANDY SILTS AND SILTS	F. IV	1313.	2159.
157.	24.56	.59*	2.40	SANDY SILTS AND SILTS	F. IV	1297.	2107.
158.	24.79	.60*	2.42	SANDY SILTS AND SILTS	F. IV	1320.	2131.
159.	25.84	.60*	2.34	SANDY SILTS AND SILTS	F. IV	1330.	2272.
160.	26.72	.63*	2.37	SANDY SILTS AND SILTS	F. IV	1393.	2389.
161.	94.97	3.22*	3.39	SANDY SILTS AND SILTS	F. V	7083.	12130.
162.	28.10	.71*	2.52	SANDY SILTS AND SILTS	F. IV	1558.	2568.
163.	27.73	.63*	2.27	SANDY SILTS AND SILTS	F. IV	1385.	2506.
164.	26.41	.63*	2.39	SANDY SILTS AND SILTS	F. IV	1389.	2309.
165.	26.67	.63*	2.37	SANDY SILTS AND SILTS	F. IV	1391.	2337.
166.	26.37	.57*	2.17	SANDY SILTS AND SILTS	F. IV	1259.	2285.
167.	26.30	.58*	2.21	SANDY SILTS AND SILTS	F. IV	1279.	2266.
168.	23.89	.51*	2.13	SANDY SILTS AND SILTS	F. IV	1119.	1913.
169.	25.75	.66*	2.56	SANDY SILTS AND SILTS	F. IV	1450.	2170.
170.	24.90	.52*	2.09	SANDY SILTS AND SILTS	F. IV	1145.	2039.
171.	57.14	1.68*	2.94	SANDY SILTS AND SILTS	F. IV	3696.	6636.
172.	29.48	.73*	2.46	SANDY SILTS AND SILTS	F. IV	1595.	2676.
173.	29.93	.74*	2.48	SANDY SILTS AND SILTS	F. IV	1633.	2731.
174.	32.17	.90*	2.81	SANDY SILTS AND SILTS	F. IV	1989.	3042.
175.	31.05	.62*	2.00	SANDY SILTS AND SILTS	F. IV	1366.	2873.
176.	31.85	.64*	2.02	SANDY SILTS AND SILTS	F. IV	1415.	2979.
177.	40.91	.86*	2.11	SILTY SANDS	F. IV		
178.	224.62	8.33*	3.71	SANDY SILTS AND SILTS	F. IV	18333.	30499.
179.	44.83	1.13*	2.53	SANDY SILTS AND SILTS	F. IV	2495.	4806.
180.	46.08	.89*	1.93	SILTY SANDS	F. IV		
181.	64.40	1.70*	2.64	SANDY SILTS AND SILTS	F. IV	3740.	7584.
182.	36.65	.81*	2.22	SANDY SILTS AND SILTS	F. IV	1790.	3611.
183.	61.87	4.00*	6.46	CLAYS	F. I	8793.	7205.
184.	149.62	9.34*	6.24	CLAYS	F. I	20540.	19731.
185.	319.11	22.11*	6.93	CLAYS	F. I	48652.	43935.
186.	202.70	11.27*	5.56	CLAYEY SILTS AND SILTY CLAYS	F. II	24794.	27296.
187.	141.98	9.91*	6.98	CLAYS	F. I	21802.	18613.
188.	139.09	8.28*	5.95	CLAYS	F. II	18207.	18191.
189.	129.55	7.06*	5.45	CLAYEY SILTS AND SILTY CLAYS	F. II	15533.	16820.
190.	150.96	7.19*	4.76	CLAYEY SILTS AND SILTY CLAYS	F. V	15809.	19869.



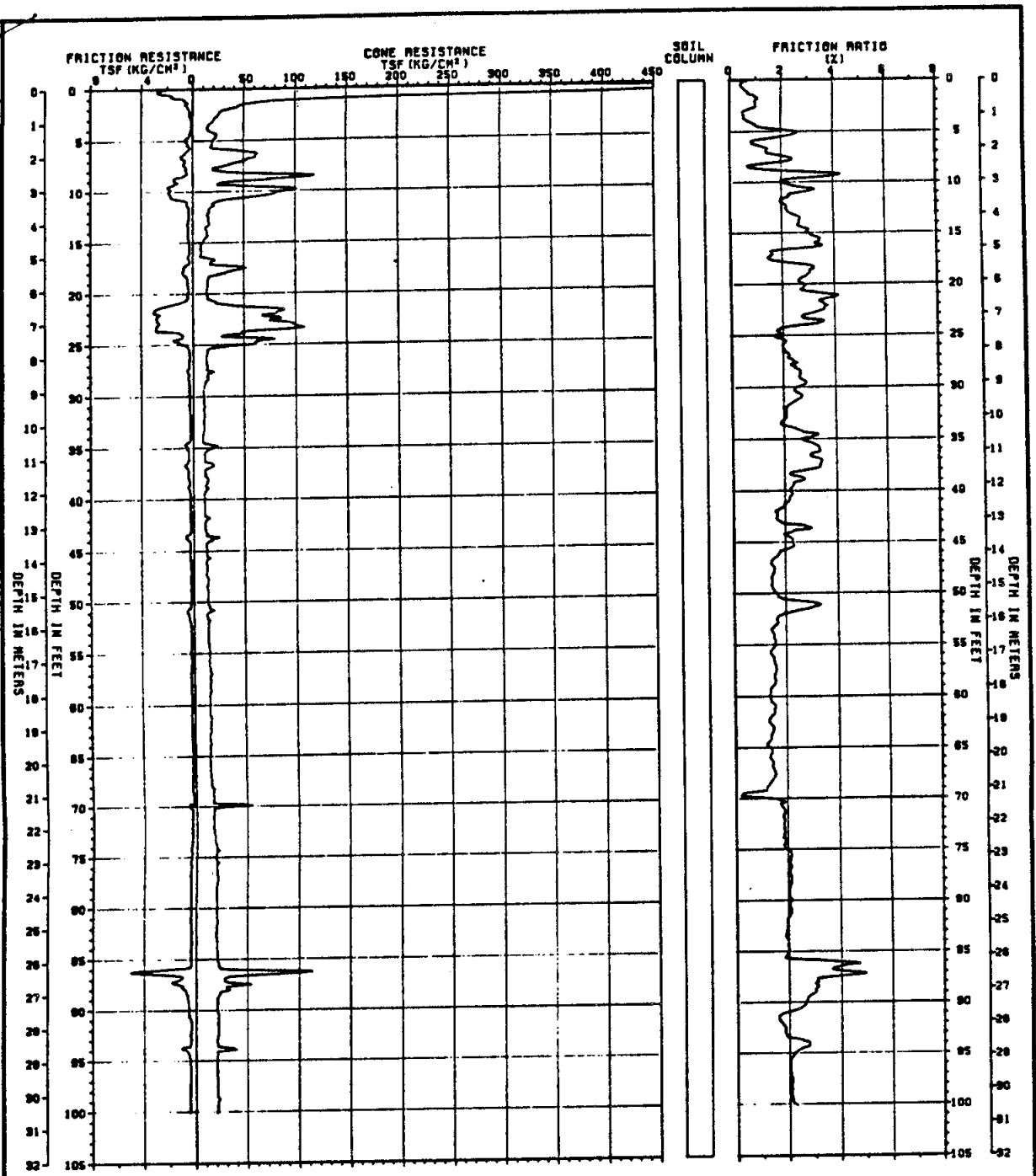

PROJECT: DOT - L ST. SLIDE  
 PROJECT NUMBER: 85-140-14  
 INSTRUMENT NUMBER: F15CKE075  
 DATE: 11/02/84

A-30

CONE PENETROMETER TEST  
 PROBE: DOT-C-6

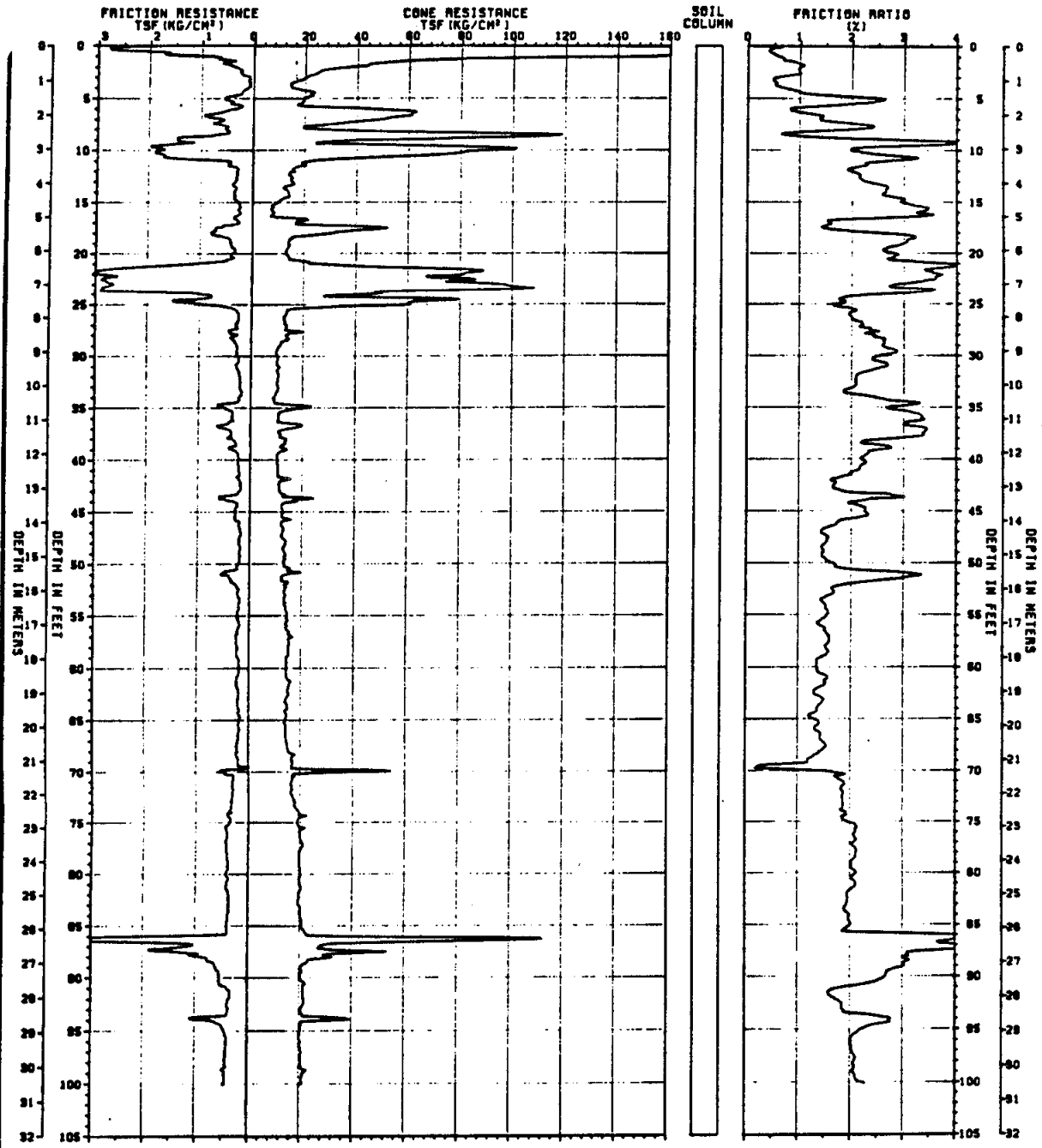

PROJECT: DOT - L ST. SLIDE  
 PROJECT NUMBER: 85-140-14  
 INSTRUMENT NUMBER: FISCKED75  
 DATE: 11/02/84

CONE PENETROMETER TEST  
 PROBE: DOT-C-6

\*\*\*\*\*  
 \* WOODWARD-CLYDE \*  
 \* CONSULTANTS \*  
 \* \*\*\*\*\*

SOUNDING :ACPT6  
 IDENTIFICATION :ADOT- L STREET SLIDE / INST. NO: F15CKE075  
 LOCATION : XCORD: .0 YCORD: .0 ZCORD: 1.0  
 SOIL CHARACTERISTICS : GAMAT: 125.0 GAMAS: .0 WATER: .0  
 DATE :11- 2-84

DEPTH (FEET)	TIP RESISTANCE (TSF)	SLEEVE FRICTION (TSF)	FRICTION RATIO (%)	SOIL CLASSIFICATION	RUFACIES	SU=Sleeve* 1.1 (PSF)	SU=(C-T)/14.0 (PSF)
1.	153.91	.97*	.63	SANDS	F.VII		
2.	33.93	.33*	.97	SILTY SANDS	F.VI		
3.	19.85	.11*	.53	SILTY SANDS	F.IV		
4.	15.63	.11*	.72	SILTY SANDS	F.IV		
5.	19.01	.50*	2.63	SANDY SILTS AND SILTS	F.IV	1100.	2671.
6.	45.82	.37*	.81	SILTY SANDS	F.VI		
7.	49.62	.69*	1.39	SILTY SANDS	F.VI		
8.	29.17	.53*	1.83	SILTY SANDS	F.IV		
9.	41.45	1.34*	3.24	SANDY SILTS AND SILTS	F.V	2955.	5841.
10.	88.65	1.80*	2.03	SILTY SANDS	F.IV		
11.	22.34	.58*	2.61	SANDY SILTS AND SILTS	F.IV	1283.	3093.
12.	16.21	.33*	2.02	SANDY SILTS AND SILTS	F.III	720.	2209.
13.	15.36	.35*	2.31	SANDY SILTS AND SILTS	F.IV	781.	2078.
14.	13.74	.36*	2.65	SANDY SILTS AND SILTS	F.II	801.	1838.
15.	9.30	.28*	2.98	CLAYEY SILTS AND SILTY CLAYS	F.II	610.	1195.
16.	8.18	.26*	3.23	CLAYEY SILTS AND SILTY CLAYS	F.II	581.	1026.
17.	16.68	.27*	1.60	SANDY SILTS AND SILTS	F.IV	587.	2231.
18.	30.65	.81*	2.64	SANDY SILTS AND SILTS	F.IV	1780.	4218.
19.	13.77	.41*	2.99	CLAYEY SILTS AND SILTY CLAYS	F.II	906.	1798.
20.	13.20	.37*	2.84	CLAYEY SILTS AND SILTY CLAYS	F.II	825.	1707.
21.	27.58	1.09*	3.95	CLAYEY SILTS AND SILTY CLAYS	F.V	2397.	3753.
22.	81.54	2.98*	3.65	SANDY SILTS AND SILTS	F.V	6548.	11452.
23.	97.53	2.79*	2.86	SILTY SANDS	F.IV		
24.	44.23	1.17*	2.64	SANDY SILTS AND SILTS	F.IV	2569.	6104.
25.	58.19	.95*	1.64	SILTY SANDS	F.VI		
26.	12.98	.25*	1.95	SANDY SILTS AND SILTS	F.III	557.	1622.
27.	13.44	.30*	2.22	SANDY SILTS AND SILTS	F.III	656.	1679.
28.	13.25	.33*	2.46	SANDY SILTS AND SILTS	F.II	717.	1643.
29.	10.56	.27*	2.59	CLAYEY SILTS AND SILTY CLAYS	F.III	602.	1250.
30.	10.06	.25*	2.51	CLAYEY SILTS AND SILTY CLAYS	F.III	556.	1169.
31.	10.95	.29*	2.66	CLAYEY SILTS AND SILTY CLAYS	F.II	641.	1288.
32.	10.36	.22*	2.08	SANDY SILTS AND SILTS	F.III	474.	1194.
33.	10.58	.22*	2.04	SANDY SILTS AND SILTS	F.III	475.	1217.
34.	8.52	.21*	2.46	CLAYEY SILTS AND SILTY CLAYS	F.III	461.	914.
35.	19.58	.52*	2.67	SANDY SILTS AND SILTS	F.IV	1150.	2485.
36.	10.66	.35*	3.32	CLAYEY SILTS AND SILTY CLAYS	F.II	779.	1201.
37.	13.75	.47*	3.44	CLAYEY SILTS AND SILTY CLAYS	F.II	1041.	1634.
38.	13.83	.39*	2.81	CLAYEY SILTS AND SILTY CLAYS	F.II	855.	1636.
39.	13.96	.37*	2.67	SANDY SILTS AND SILTS	F.II	820.	1646.
40.	10.36	.23*	2.19	SANDY SILTS AND SILTS	F.III	499.	1123.

DEPTH (FEET)	TIP RESISTANCE (TSF)	SLEEVE FRICTION (TSF)	FRICTION RATIO (%)	SOIL CLASSIFICATION	RUFACIES	SU=Sleeve* 1.1 (PSF)	SU=(C-T)/14.0 (PSF)
41.	10.50	.22*	2.14	SANDY SILTS AND SILTS	F. III	494.	1134.
42.	11.55	.18*	1.60	SANDY SILTS AND SILTS	F. III	407.	1275.
43.	11.27	.21*	1.82	SANDY SILTS AND SILTS	F. III	451.	1226.
44.	18.23	.40*	2.20	SANDY SILTS AND SILTS	F. IV	882.	2211.
45.	12.88	.29*	2.25	SANDY SILTS AND SILTS	F. III	638.	1438.
46.	12.02	.21*	1.78	SANDY SILTS AND SILTS	F. III	471.	1306.
47.	12.45	.18*	1.42	SANDY SILTS AND SILTS	F. III	389.	1359.
48.	13.61	.21*	1.52	SANDY SILTS AND SILTS	F. III	455.	1516.
49.	13.63	.20*	1.45	SANDY SILTS AND SILTS	F. III	435.	1510.
50.	13.27	.22*	1.67	SANDY SILTS AND SILTS	F. III	488.	1449.
51.	14.09	.46*	3.23	CLAYEY SILTS AND SILTY CLAYS	F. II	1001.	1558.
52.	13.22	.25*	1.92	SANDY SILTS AND SILTS	F. III	558.	1424.
53.	13.71	.22*	1.64	SANDY SILTS AND SILTS	F. III	495.	1485.
54.	13.64	.21*	1.52	SANDY SILTS AND SILTS	F. III	456.	1466.
55.	14.61	.22*	1.54	SANDY SILTS AND SILTS	F. III	495.	1596.
56.	14.28	.20*	1.42	SANDY SILTS AND SILTS	F. III	446.	1540.
57.	16.63	.27*	1.60	SANDY SILTS AND SILTS	F. IV	585.	1867.
58.	15.15	.23*	1.52	SANDY SILTS AND SILTS	F. III	507.	1646.
59.	14.23	.21*	1.45	SANDY SILTS AND SILTS	F. III	454.	1506.
60.	14.39	.19*	1.35	SANDY SILTS AND SILTS	F. IV	427.	1520.
61.	14.82	.23*	1.57	SANDY SILTS AND SILTS	F. III	512.	1573.
62.	14.87	.21*	1.38	SANDY SILTS AND SILTS	F. IV	451.	1571.
63.	14.12	.21*	1.47	SANDY SILTS AND SILTS	F. III	457.	1455.
64.	14.07	.19*	1.36	SANDY SILTS AND SILTS	F. III	421.	1439.
65.	13.98	.18*	1.32	SANDY SILTS AND SILTS	F. IV	406.	1417.
66.	14.03	.19*	1.33	SANDY SILTS AND SILTS	F. IV	411.	1415.
67.	14.48	.21*	1.44	SANDY SILTS AND SILTS	F. III	459.	1470.
68.	15.41	.22*	1.46	SANDY SILTS AND SILTS	F. IV	495.	1594.
69.	17.20	.20*	1.19	SANDY SILTS AND SILTS	F. IV	450.	1841.
70.	36.75	.57*	1.55	SILTY SANDS	F. VI		
71.	16.47	.31*	1.86	SANDY SILTS AND SILTS	F. III	674.	1719.
72.	16.19	.30*	1.87	SANDY SILTS AND SILTS	F. III	666.	1670.
73.	17.75	.33*	1.86	SANDY SILTS AND SILTS	F. III	726.	1884.
74.	19.59	.38*	1.93	SANDY SILTS AND SILTS	F. IV	832.	2138.
75.	18.74	.37*	1.95	SANDY SILTS AND SILTS	F. III	804.	2007.
76.	19.63	.41*	2.10	SANDY SILTS AND SILTS	F. IV	907.	2126.
77.	20.84	.43*	2.07	SANDY SILTS AND SILTS	F. IV	949.	2290.
78.	19.51	.41*	2.11	SANDY SILTS AND SILTS	F. IV	906.	2091.
79.	19.48	.39*	2.02	SANDY SILTS AND SILTS	F. III	866.	2077.
80.	20.10	.43*	2.12	SANDY SILTS AND SILTS	F. IV	937.	2157.
81.	19.88	.42*	2.11	SANDY SILTS AND SILTS	F. IV	923.	2117.
82.	19.28	.38*	1.95	SANDY SILTS AND SILTS	F. III	827.	2022.
83.	19.60	.38*	1.93	SANDY SILTS AND SILTS	F. IV	832.	2059.
84.	20.13	.40*	1.98	SANDY SILTS AND SILTS	F. III	877.	2126.
85.	20.44	.41*	2.00	SANDY SILTS AND SILTS	F. III	899.	2161.
86.	34.84	1.40*	4.02	CLAYEY SILTS AND SILTY CLAYS	F. V	3081.	4209.
87.	27.38	1.22*	4.45	CLAYEY SILTS AND SILTY CLAYS	F. II	2681.	3135.
88.	32.52	1.02*	3.13	SANDY SILTS AND SILTS	F. V	2239.	3860.
89.	20.28	.61*	3.03	SANDY SILTS AND SILTS	F. II	1352.	2103.
90.	20.40	.54*	2.67	SANDY SILTS AND SILTS	F. IV	1198.	2111.

DEPTH (FEET)	TIP RESISTANCE (TSF)	SLEEVE FRICTION (TSF)	FRICTION RATIO (%)	SOIL CLASSIFICATION	RUFACIES	SU=Sleeve* 1.1 (PSF)	SU=(C-T)/14.0 (PSF)
91.	21.40	.40*	1.85	SANDY SILTS AND SILTS	F. IV	871.	2245.
92.	21.61	.37*	1.70	SANDY SILTS AND SILTS	F. IV	808.	2266.
93.	20.16	.37*	1.84	SANDY SILTS AND SILTS	F. IV	816.	2050.
94.	30.87	.86*	2.78	SANDY SILTS AND SILTS	F. IV	1888.	3571.
95.	20.19	.45*	2.22	SANDY SILTS AND SILTS	F. IV	986.	2036.
96.	20.38	.41*	2.02	SANDY SILTS AND SILTS	F. III	906.	2054.
97.	20.70	.42*	2.04	SANDY SILTS AND SILTS	F. IV	929.	2091.
98.	20.63	.43*	2.08	SANDY SILTS AND SILTS	F. IV	944.	2072.
99.	21.26	.43*	2.04	SANDY SILTS AND SILTS	F. IV	954.	2153.
100.	20.54	.46*	2.24	SANDY SILTS AND SILTS	F. IV	1012.	2041.

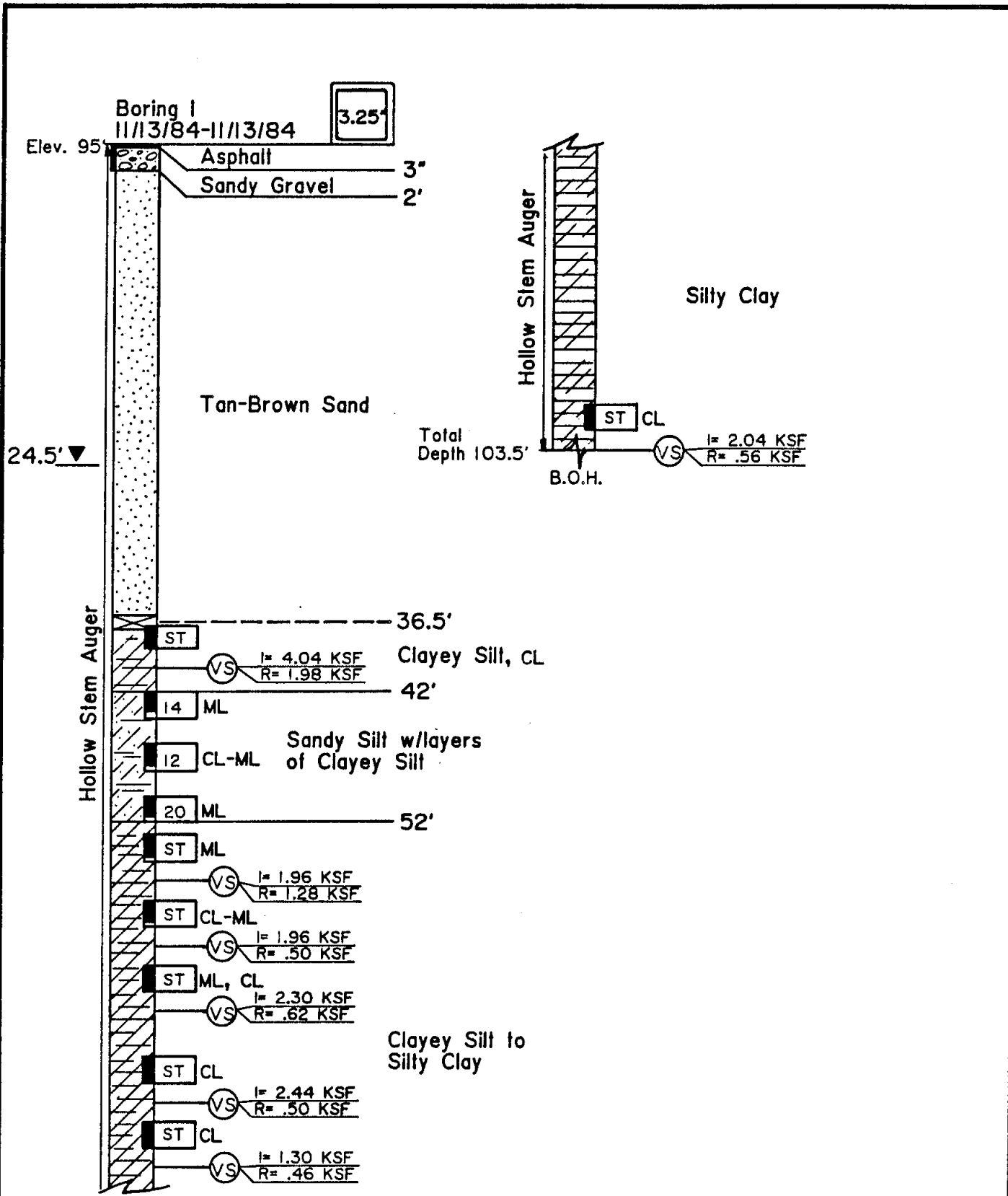

Fig. A-4

STATE OF ALASKA		
DEPARTMENT OF TRANSPORTATION AND PUBLIC FACILITIES		
<b>"L" STREET SLIDE</b>		
DESIGNED BY: T.M.	DRAWN BY: K.W.	SCALE: 1" = 10'

APPENDIX B

RESULTS OF LABORATORY TESTS

APPENDIX B  
RESULTS OF LABORATORY TESTS

Seven undisturbed samples were taken using a 3" shelby tube and an Acker piston sampler. Two shelby tube samples were sent to the Woodward-Clyde Consultants laboratory in Clifton, New Jersey for consolidation, direct shear, and direct simple shear testing. Five shelby tube samples were sent to the Alaska DOT&PF Central laboratory for soil classification, UU triaxial, torvane, and mini-vane testing.

The mini-vane test is a laboratory test consisting of pushing a 1/2 inch by 1/2 inch vane into a sample of "undisturbed" soil and applying a rotational force at a rate of 10 degrees per minute. After the soil had reach the initial peak shear strength, the vane was rotated rapidly to insure that the sample was disturbed. The residual soil strength was measured approximately five minutes after the initial test.

The results of these laboratory tests are summarized in the following pages.



RESULTS OF LABORATORY TESTS

CONDUCTED BY ALASKA DOT&PF

B.H. No. 1

Surface Elevation 95 ft.

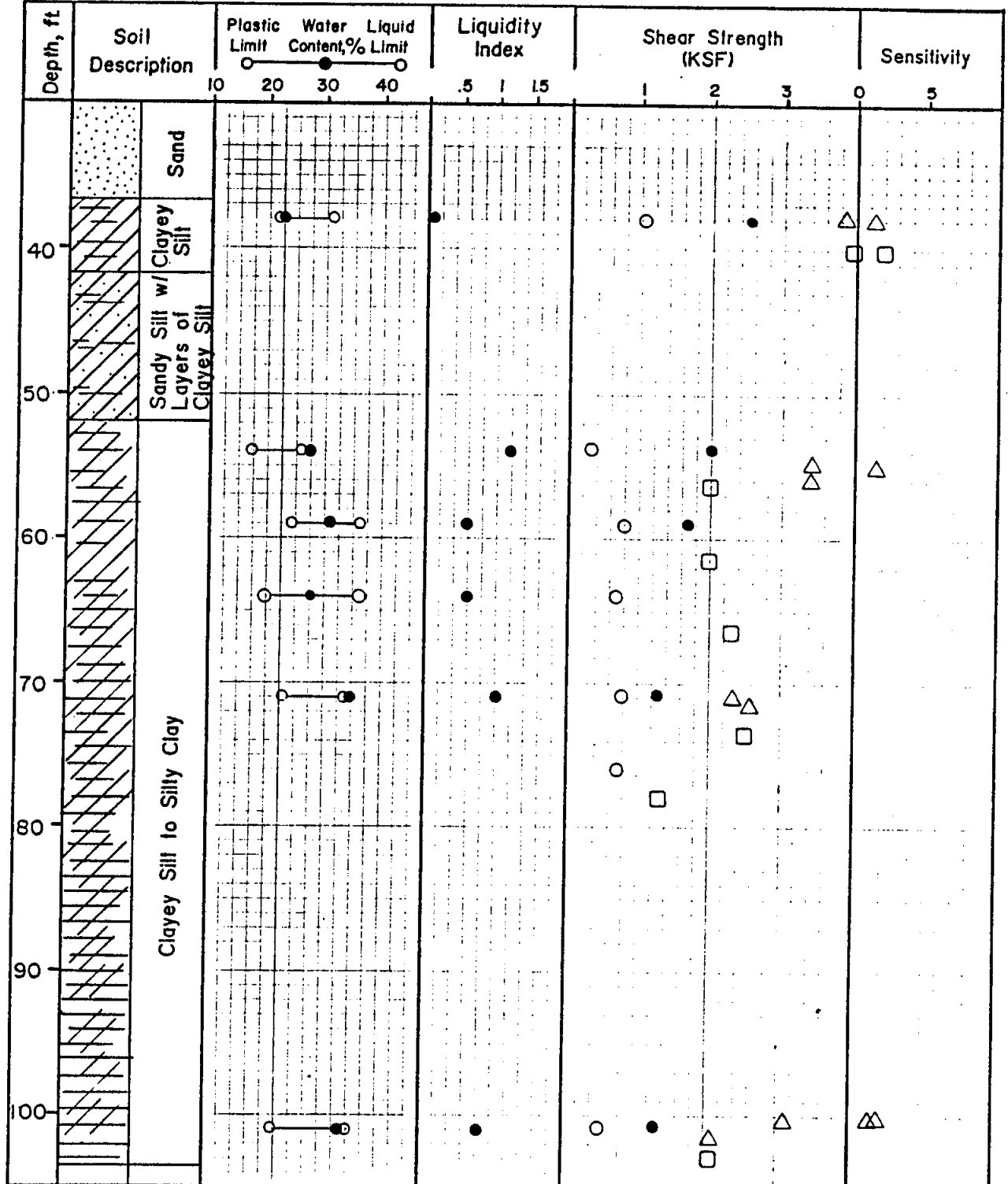

- Torvane
- △ Minivane
- Field Vane
- Unconsolidated Undrained

# ALASKA DOT/PF CENTRAL LAB

## Log of Shelby Tubes

Project Name L ST Slide

Project # F 21811

Boring# 1 Sample# 1037  
 Depth 37-39 Recovery 1'7"

Boring# 1 Sample# 10100  
 Depth 100-102 Recovery 1'10"

Boring# \_\_\_\_\_ Sample# \_\_\_\_\_  
 Depth \_\_\_\_\_ Recovery \_\_\_\_\_

B-4

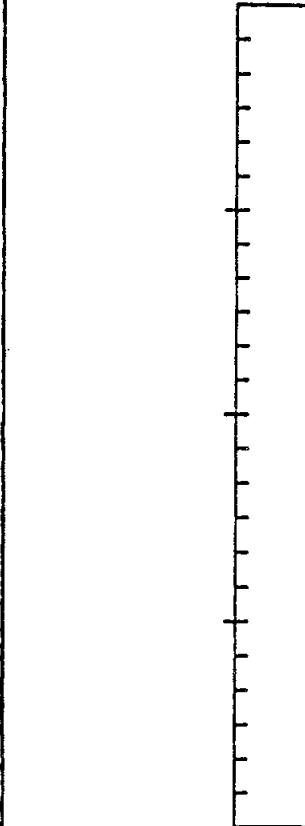
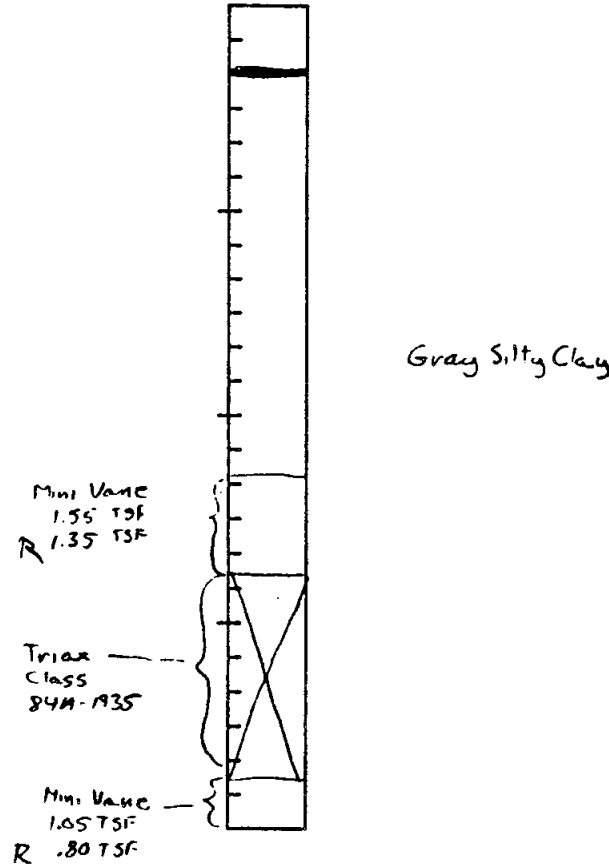
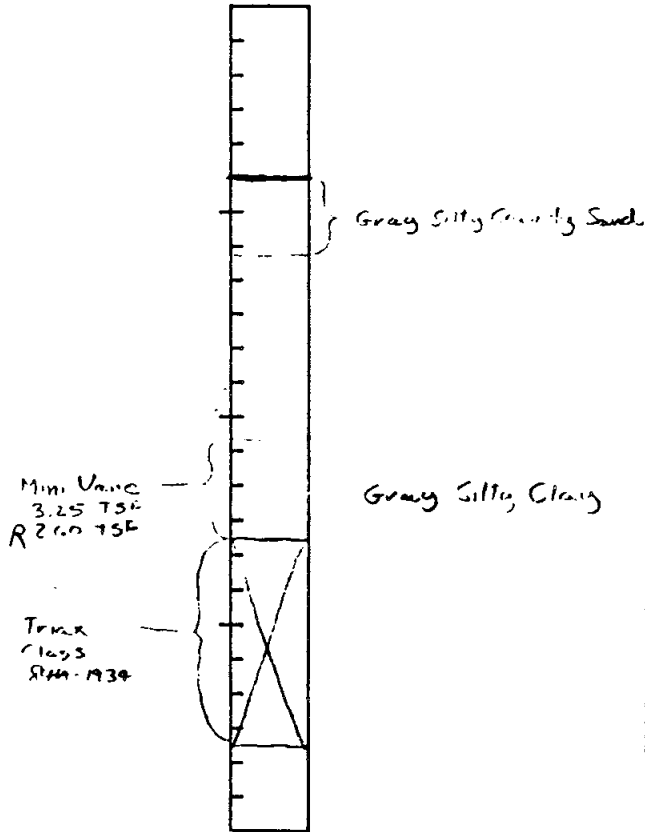

Consolidation



Unconfined  
 Compression  
 Test



Triaxial  
 Test

All foundation soils have classification and moisture contents.

# ALASKA DOT/PF CENTRAL LAB

## Log of Shelby Tubes

Project Name L St Slide

Project # F21811

Boring# 1 Sample# 1058  
 Depth 58-60 Recovery 1'11"

Boring# 1 Sample# 1070  
 Depth 70-72 Recovery 1'11"

Boring# 1 Sample# 1053  
 Depth 53-55 Recovery 1'10"

B-5

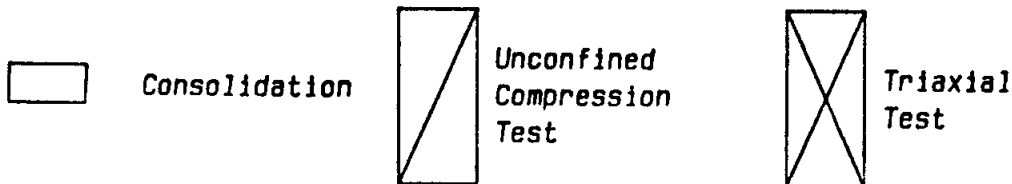
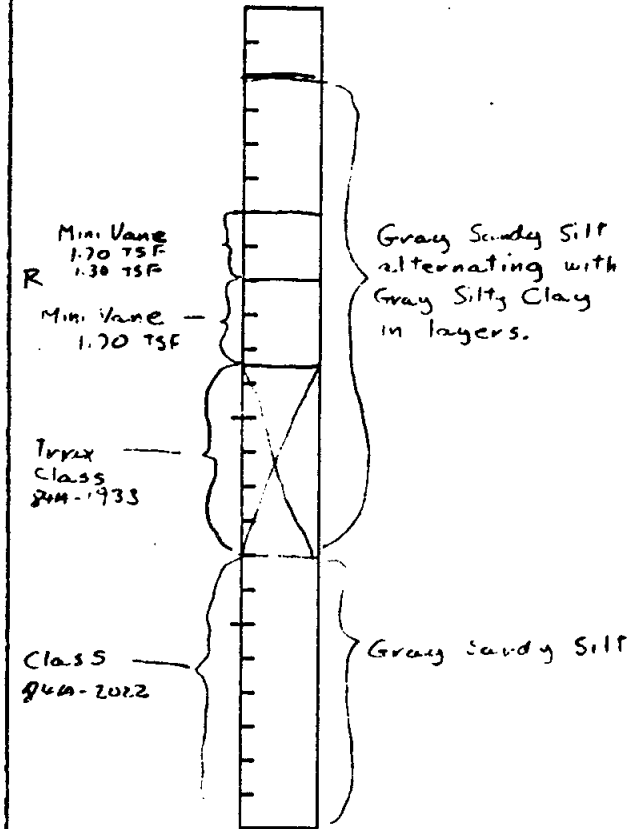
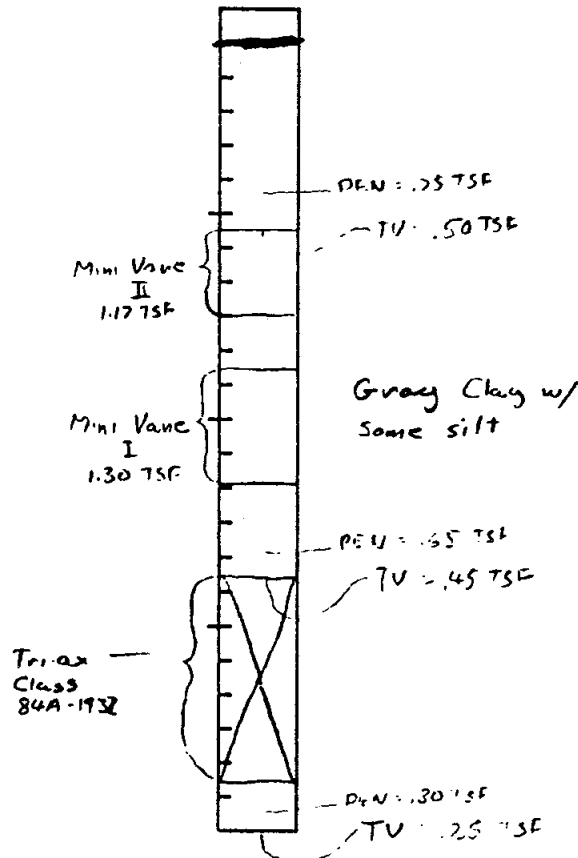
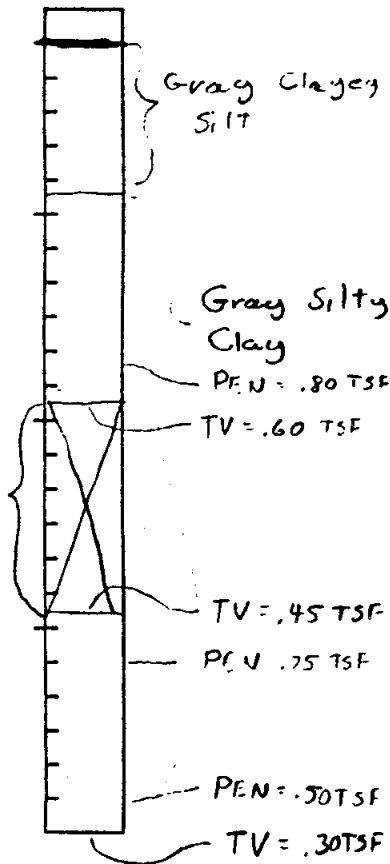

All foundation soils have classification and moisture contents.

STATE OF ALASKA  
DEPARTMENT OF TRANSPORTATION & PUBLIC FACILITIES  
MATERIALS SECTION

Project No.		Project Name "L" Street Slide										sheet of sheets								
Boring and Sample No.	Depth in Feet	Laboratory Number	Grading Analysis — % Passing								Atterberg Limits		Nat. Dry Density P.C.F.	Nat. Moist %	Specific Gravity	F.S.V. (Corps of Eng)	AASHO Group Classif.	Unified	AK DOT&PF	
			Gravel		Sand		Silt		Clay		Liquid Limit	Plastic Index								
			1"	1/2"	#4	#10	#40	#200	.02	.005										
1	37-39	84A-1934					100	99	77	30	31	9	105.3	22.1			A-4(9)	CL	ClySi	
1	42-44	84A-1991					100	73			20	3		24.8			A-4(0)	ML	SaSi	
1	46.5-47	84A-1993					100	91	50	18	22	5		21.8			A-4(2)	CL-ML	ClySi	
1	46-48	84A-1992					100	75			NV	NP		22.2			A-4(0)	ML	SaSi	
1	50-50.2	84A-1994					100	38	15		5	NV	NP		22.5			A-4(0)	SM	SaSi
1	50.2-52	84A-1995					100	84				NP		19.6			A-4(0)	ML	Si	
1	53-55	84A-2022					100	99	37	16	22	4		-			A-4(1)	CL-ML	Si	
1	53-55	84A-1933					100	97	62	28	26	9	96.5	27.4			A-4(7)	CL	ClySi	
1	58-60	84A-1931						100	91	48	36	12	93.5	30.6			A-6(13)	CL	SiCl	
1	70-72	84A-1932						100	95	50	34	11	87.3	34.5			A-6(12)	CL	SiCl	
1	100-102	84A-1935						100	99	51	35	13	90.1	33.0			A-6(14)	CL	SiCl	

B-6

Remarks: \_\_\_\_\_

\_\_\_\_\_

\_\_\_\_\_

**SHEAR STRENGTH (KSF)**

DEPTH	LL	PI	LI	M%	Torvane*		Field Vane Shear			Mini Vane			UU	
					Field	Lab	Initial	Residual**	Sens.	Initial	Residual	Sens.		
37'-39'	31	9	0	22.1	1.28						6.50	5.20	1.25	2.55
40.25'							4.04	1.98	2.0					
53'-55'	26	9	1.15	27.4	.30						3.4 3.4	2.6 --	1.3 --	2.0
56.5'							1.96	1.28	1.5					
58'-60'	36	12	.55	30.6	.72	.90								1.71
61 5'							1.96	.50	3.9					
63'-65'	36	16	.53	28.5	.73									
66.5'							2.30	.62	3.7					
70'-72'	34	11	1.05	34.5	.76	.80					2.34 2.60	-- --	-- --	1.27
73.5'							2.44	.50	4.9					
75'-77'					.72									
78.5'							1.30	.46	2.8					
100-102'	35	13	.85	33.0	.54						3.10 2.10	2.70 1.60	1.15 1.31	1.28
103.5'							2.04	.56	3.7					

\*Average  
\*\*1 minute reading

46 0700

10 X 10 TO THE INCH • / X 70 INCHES  
KEUFFEL & ESSER CO. MADE IN U.S.A.

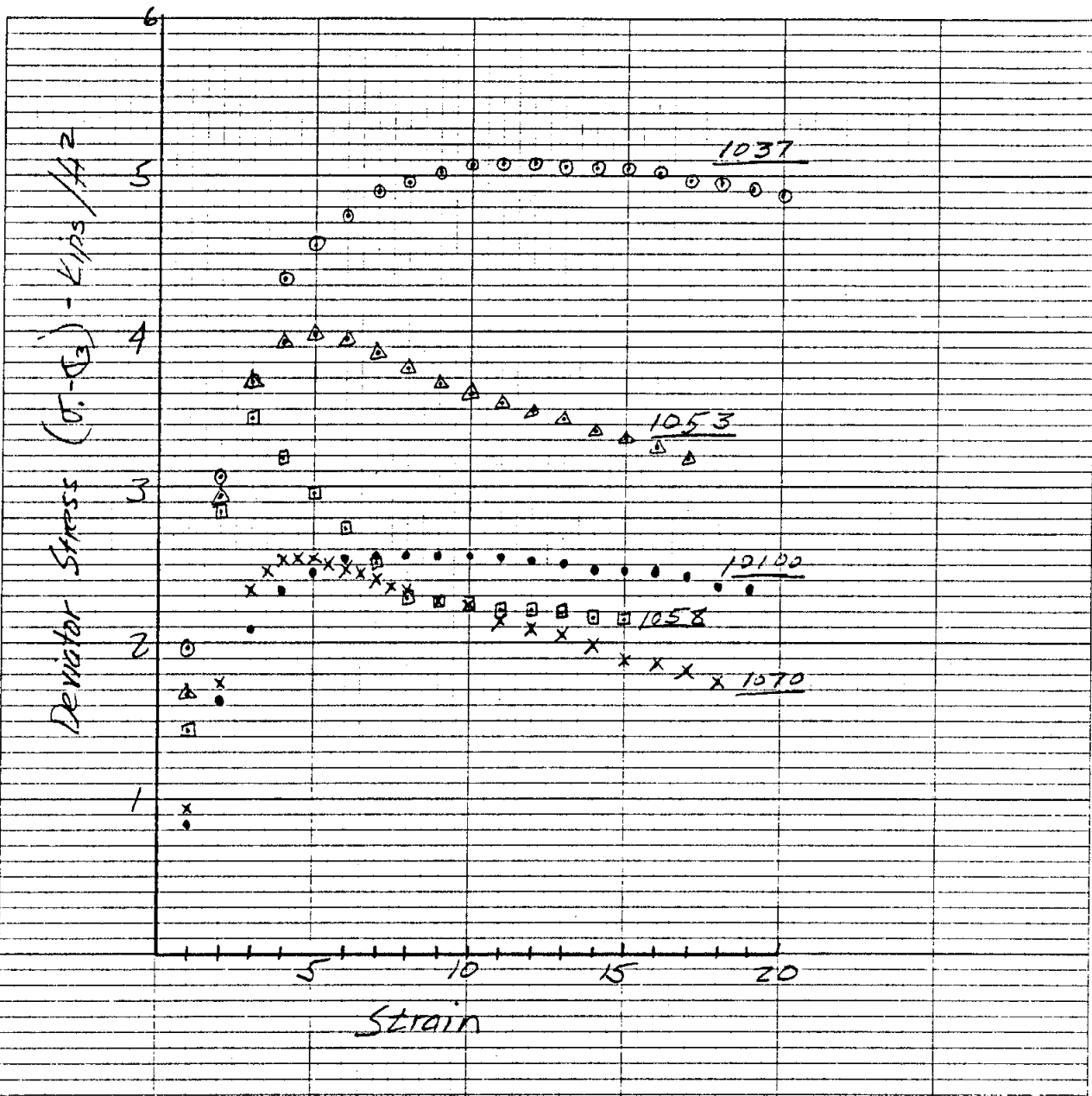

Sample No.	Depth	LL	PI	LI	M <sub>v</sub> %	$\gamma_d$	$\sigma_c$ (KSF)	$\epsilon_1$	$\epsilon_3$	$\sigma_1 - \sigma_3$ (KSF)
○ 1037	37-39	31	9	0	22.1	105.3	4.03	3.1	12	5.09
△ 1053	53-55	26	9	1.15	27.4	96.5	4.90	2.8	5	3.99
□ 1058	58-60	36	12	.55	30.6	93.5	5.04	2.9	3	3.42
X 1070	70-72	34	11	1.05	34.5	87.3	5.33	2.6	4.5	2.53
• 1100	100-102	35	13	.85	24.8	96.0	6.19	2.5	8	2.56

UU TEST RESULTS

"L" SLIDE

VANE SHEAR TEST  
DEPTH 61.5

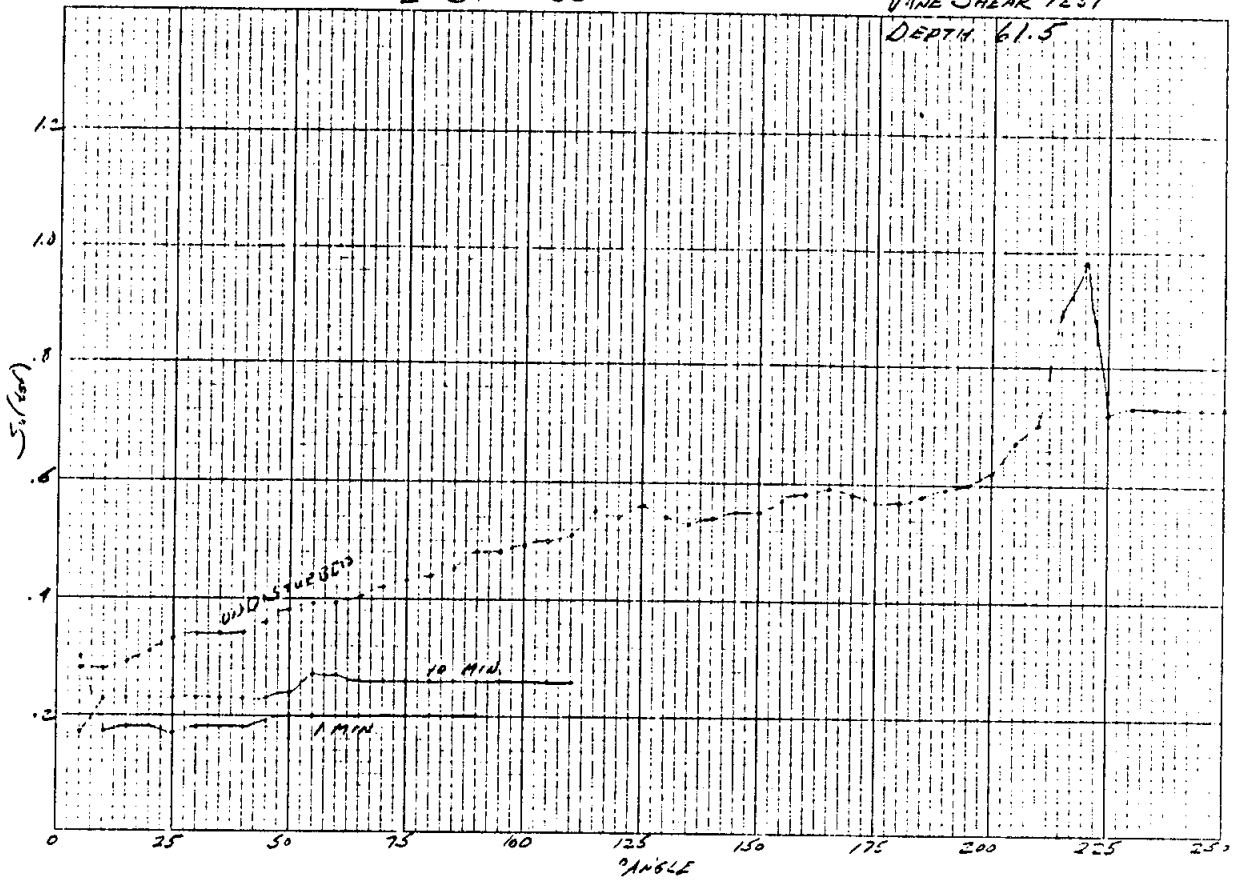

K&E 10 X 10 TO THE INCH - 1 1/2 INCHES  
KEUFFEL & ESSER CO. MADE IN U.S.A.

46 0700

"L" SLIDE

VANE SHEAR TEST  
DEPTH 66.5

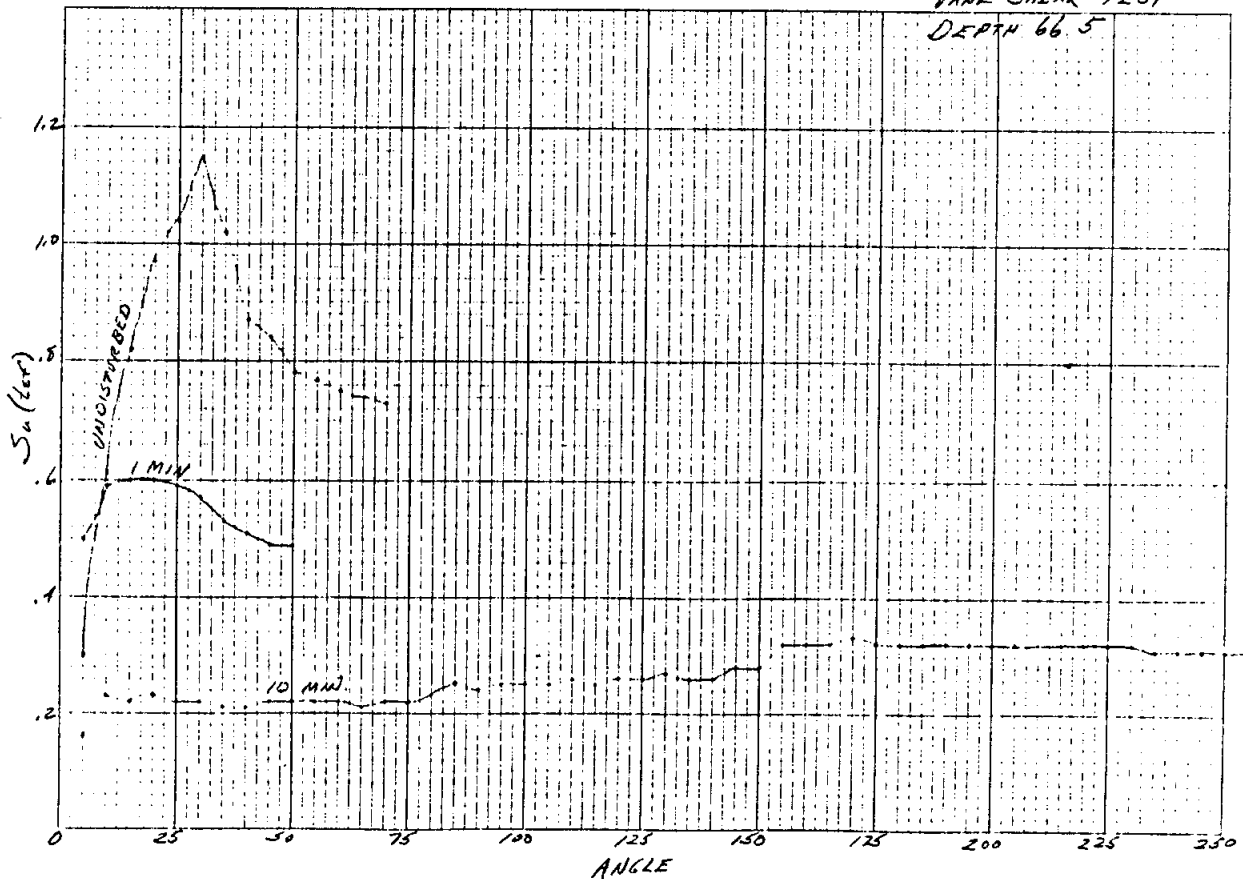



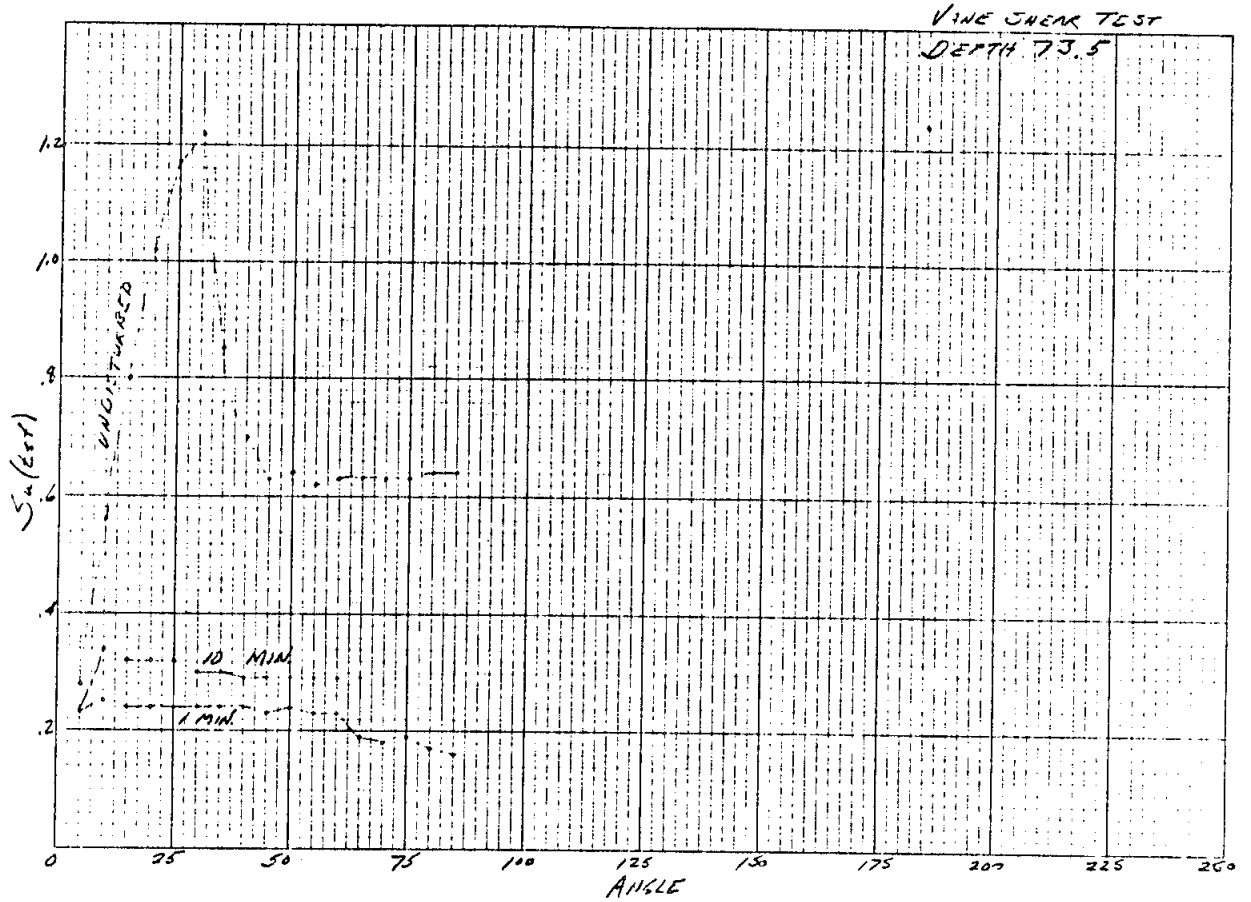

K-E 10 X 10 TO THE INCH - X 10 INCHES  
KEUFFEL & ESSER CO. MADE IN U.S.A.

46 0700

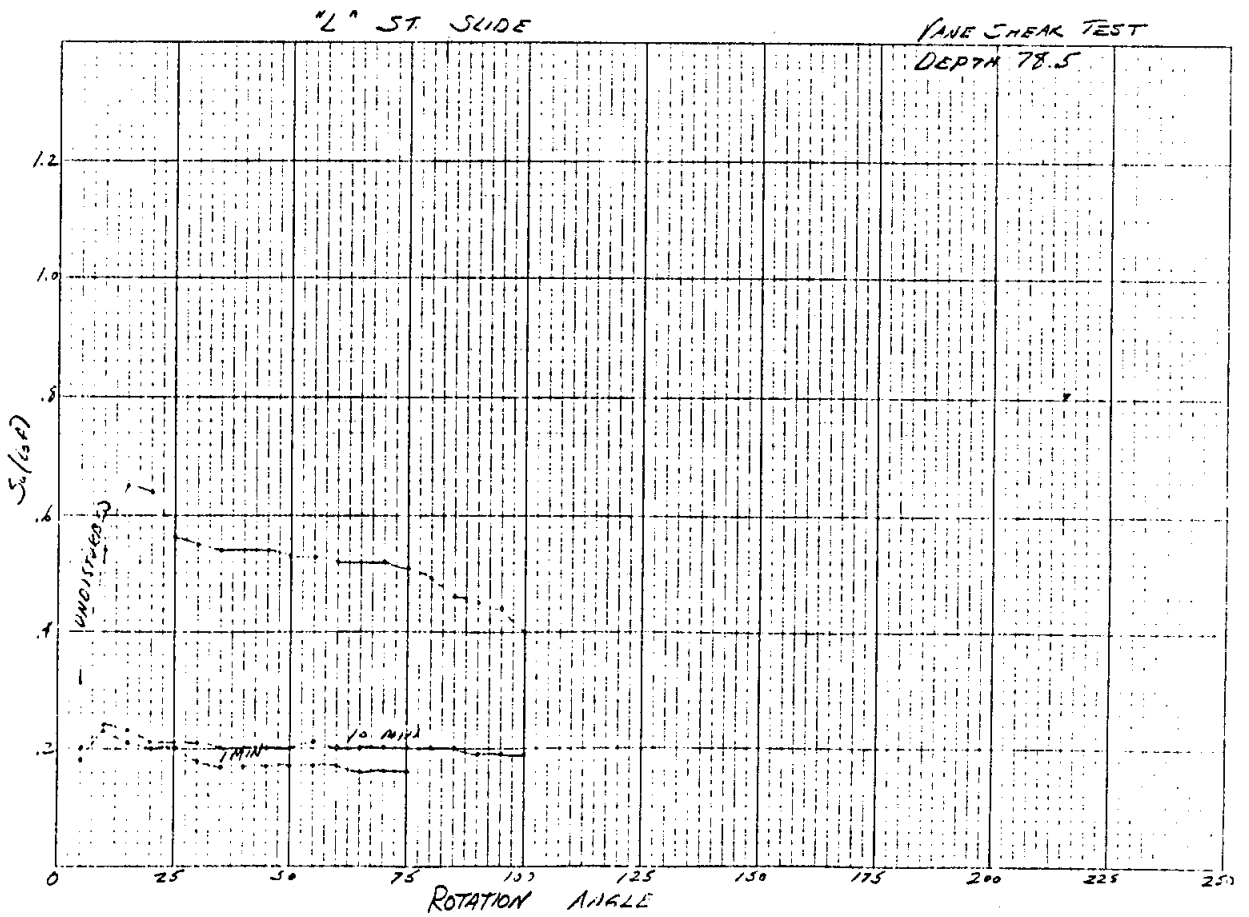

"L" SL. SLIDE

VANE SHEAR TEST

DEPTH 103.5

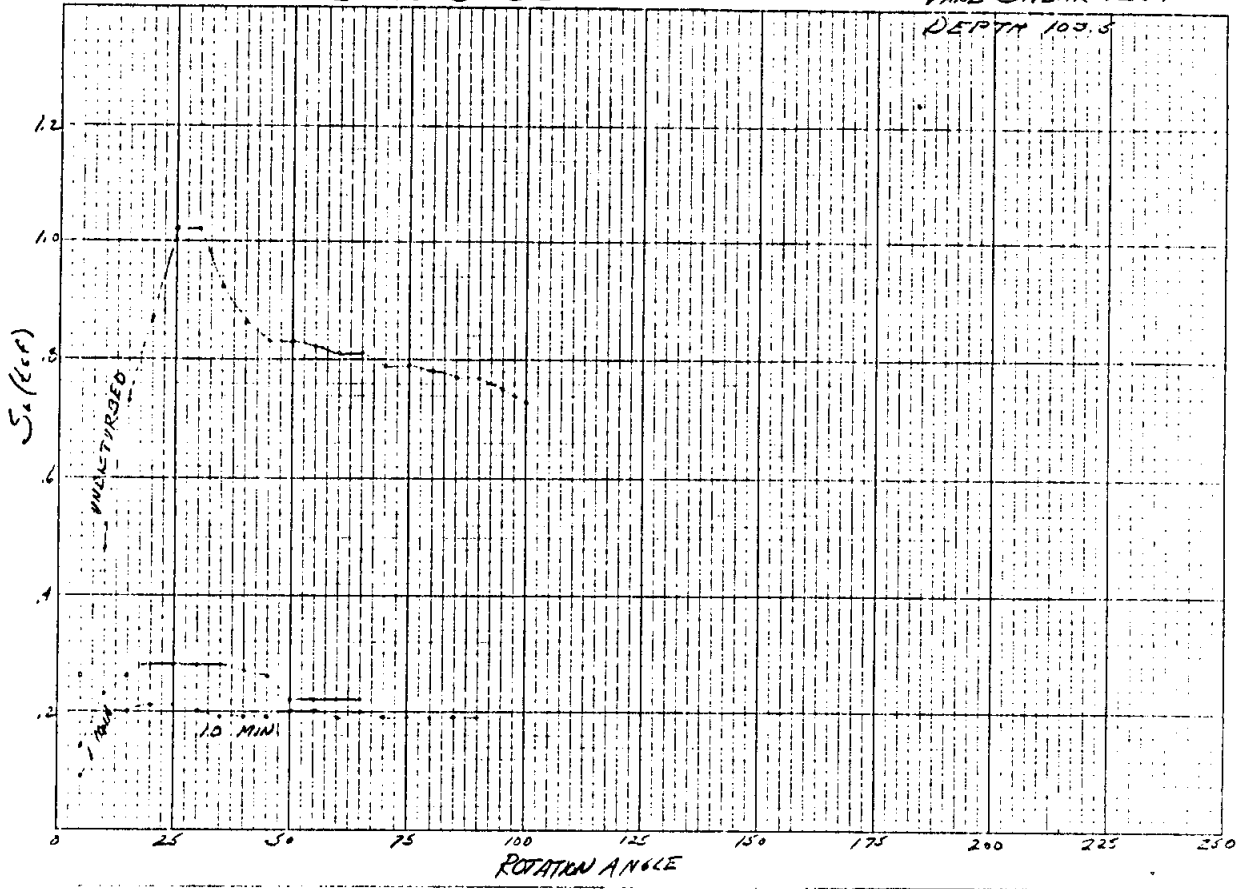

RESULTS OF LABORATORY TESTS

CONDUCTED BY WCC



# CONSOLIDATION TEST

Boring No:	TH - 1	Sample No:	FS-1063 E	Depth, ft:	84.3				
Material: CL, gray medium plastic silty CLAY									
	Water Content, %	Total Unit Weight, pcf	Void Ratio	Saturation, %	Height, inches	Diameter, inches	Specific Gravity	Liquid Limit, %	Plastic Limit, %
Initial	33.9	120.0	0.938	100.8	0.610	2.50	2.788	36	20
Final	31.8	121.1	.891	99.4	.595				

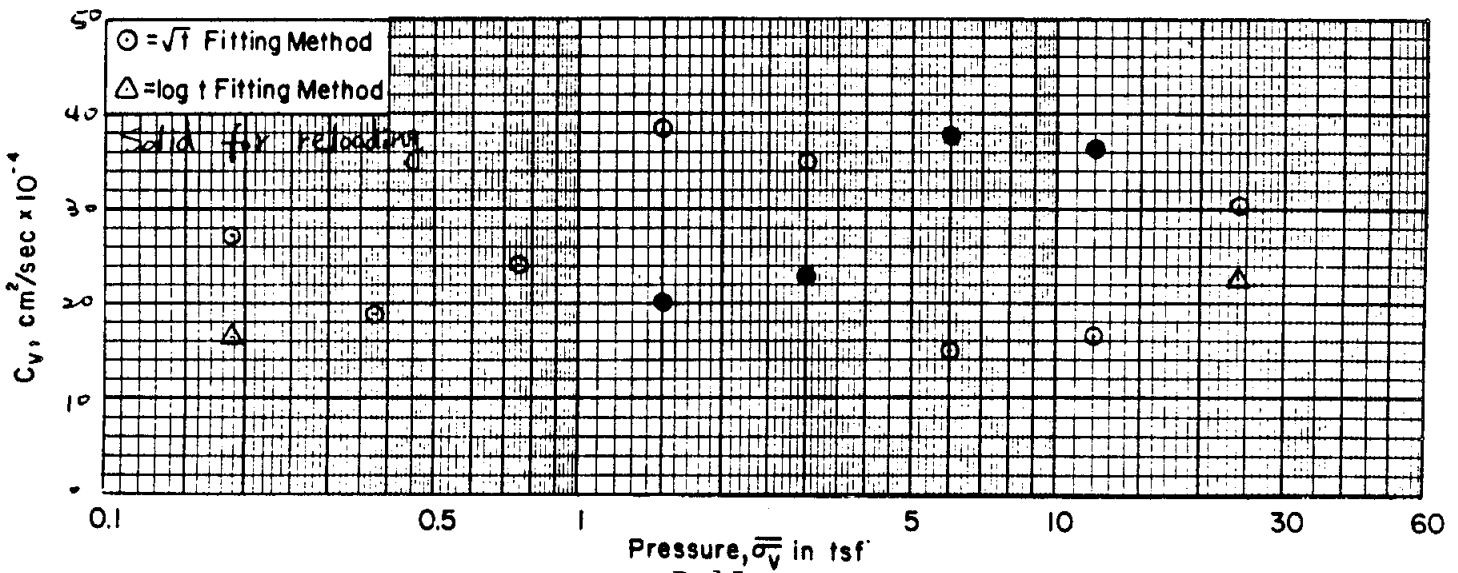
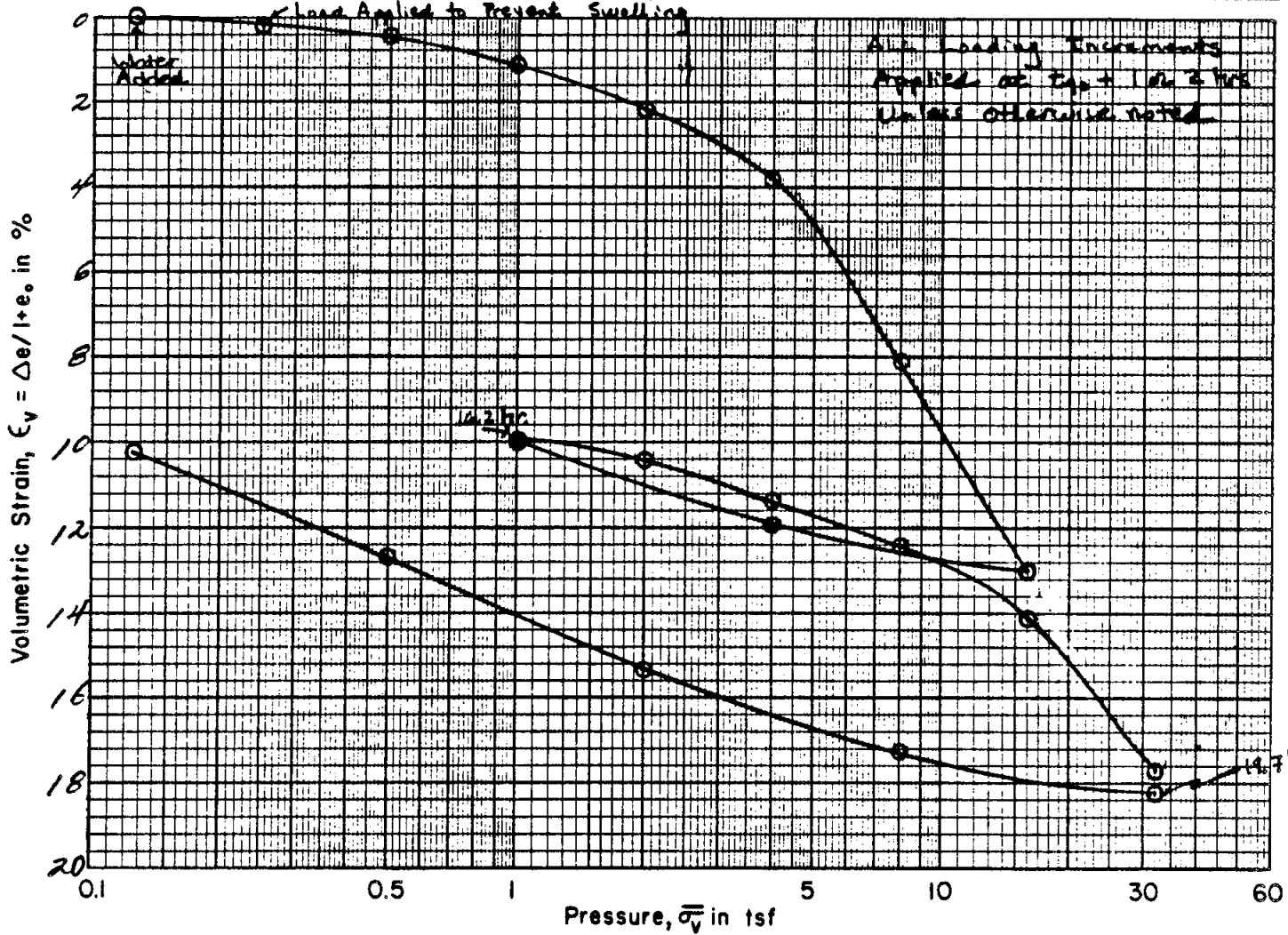

PROJ. NO. 04404200 DWG. BY H.Y.P. REV. BY LR-302

THIS DIRECT SIMPLE SHEAR TEST HAS BEEN CALCULATED USING CLIFTON  
LABORATORY PROGRAM NO. CL-C-055-1 ON FILE NO. D-190

PROJECT NO. 84C4232  
BORING NO. TH-1  
SAMPLE NO. FS-1063  
SPECIMEN NO. F.  
DEPTH(FT) 64.6  
TEST NO. NONE

INPUT DATA CHECKED BY *PT*  
DATE *12/5/84*  
RESULTS REVIEWED BY *PT*

NO TEST SPECIMEN CONSOLIDATED WITH AN AMBIENT SHEAR STRESS

PRE SHEAR STRESS CONDITIONS

SPECIMEN HEIGHT = 0.6151 INCH  
SPECIMEN AREA = 37.898 SQ. FT. \*10E-3

VERTICAL CONSOLIDATION STRESS = 16.0014 KSF  
OCR = 1.0000

PRE SHEAR VERTICAL CONSOLIDATION STRESS USED TO NORMALIZE TEST DATA

1	2	3	4	5	6	7	8	9	10	11	12
SHEAR STRAIN %	SHEAR STRESS KSF	VERT STRESS KSF	PORE PRESSURE CHANGE KSF	STRESS RATIO	SECANT SHEAR MODULUS KSF	TANGENT SHEAR MODULUS KSF	NORM SHEAR STRESS	NORM PORE PRESS CHANGE	NORM VERT STRESS	NORM SECANT MODULUS	NORM TANGENT MODULUS
0.0000	0.0000	16.0014	0.0000	0.0000	0.000	0.000	0.0000	0.0000	1.0000	0.000	0.000
0.0016	0.0187	15.9956	0.0058	0.0012	1152.359	860.212	0.0012	0.0004	0.9996	72.016	53.759
0.0033	0.0280	15.9929	0.0084	0.0017	860.212	722.253	0.0017	0.0005	0.9995	53.759	45.137
0.0049	0.0422	15.9929	0.0084	0.0026	865.622	1079.222	0.0026	0.0005	0.9995	54.097	67.452
0.0065	0.0631	15.9903	0.0111	0.0039	969.767	762.829	0.0039	0.0007	0.9993	60.605	47.673
0.0098	0.0710	15.9929	0.0084	0.0044	727.663	876.442	0.0044	0.0005	0.9995	45.475	54.773
0.0114	0.0988	15.9903	0.0111	0.0060	839.344	1322.778	0.0060	0.0007	0.9993	52.454	62.667
0.0130	0.1140	15.9903	0.0111	0.0071	876.442	706.023	0.0071	0.0007	0.9993	54.773	44.123
0.0163	0.1230	15.9877	0.0137	0.0077	756.337	413.875	0.0077	0.0009	0.9991	47.267	25.865
0.0179	0.1319	15.9877	0.0137	0.0082	737.744	685.725	0.0082	0.0009	0.9991	46.105	42.885
0.0211	0.1586	15.9877	0.0137	0.0099	750.344	1310.605	0.0099	0.0009	0.9991	46.892	81.906
0.0228	0.1879	15.9824	0.0190	0.0118	825.432	1042.804	0.0117	0.0012	0.9988	51.585	65.170
0.0240	0.1971	15.9824	0.0190	0.0122	757.757	1447.474	0.0122	0.0012	0.9988	47.254	104.221
0.0293	0.2963	15.9718	0.0296	0.0186	1012.597	2004.455	0.0185	0.0018	0.9982	63.292	125.268
0.0309	0.3119	15.9718	0.0296	0.0195	1009.702	734.426	0.0195	0.0018	0.9982	63.101	45.898
0.0341	0.3285	15.9718	0.0296	0.0206	962.231	499.085	0.0205	0.0018	0.9982	60.134	31.190
0.0374	0.3443	15.9718	0.0296	0.0216	920.899	427.401	0.0215	0.0018	0.9982	57.551	26.710
0.0423	0.3623	15.9639	0.0375	0.0227	857.090	470.682	0.0226	0.0023	0.9977	53.564	29.415
0.0520	0.4182	15.9540	0.0454	0.0242	902.912	499.761	0.0241	0.0028	0.9972	50.240	31.232
0.0715	0.5013	15.9428	0.0586	0.0314	700.859	420.773	0.0313	0.0037	0.9963	43.800	26.296
0.0797	0.5351	15.9349	0.0665	0.0336	671.740	403.867	0.0334	0.0042	0.9958	41.980	25.240
0.0992	0.6116	15.9164	0.0850	0.0384	616.756	299.033	0.0382	0.0053	0.9947	38.544	18.688
0.1349	0.6853	15.8900	0.1114	0.0431	507.836	287.247	0.0428	0.0070	0.9930	31.737	17.951
0.1463	0.7272	15.8742	0.1272	0.0458	497.011	471.841	0.0454	0.0079	0.9921	31.061	29.488

0.1463	0.7272	15.8742	0.1272	0.0458	497.011	471.841	0.0454	0.0079	0.9921	31.061	29.488
0.1577	0.7927	15.8478	0.1536	0.0500	502.641	380.097	0.0495	0.0096	0.9904	31.412	29.754
0.1935	0.8589	15.8161	0.1852	0.0543	443.949	223.445	0.0537	0.0116	0.9884	27.744	13.964
0.2065	0.8929	15.7977	0.2037	0.0565	432.470	250.199	0.0558	0.0127	0.9873	27.027	15.636
0.2341	0.9589	15.7634	0.2380	0.0602	409.592	222.134	0.0599	0.0149	0.9851	25.597	13.882
0.2634	1.0191	15.7264	0.2749	0.0648	386.925	212.799	0.0637	0.0172	0.9828	24.181	13.299
0.2780	1.0512	15.7080	0.2934	0.0669	378.140	270.958	0.0657	0.0183	0.9817	23.632	16.933
0.2975	1.1140	15.6631	0.3383	0.0711	374.452	243.070	0.0696	0.0211	0.9789	23.401	15.191
0.3658	1.2262	15.5734	0.4280	0.0797	335.212	148.779	0.0766	0.0267	0.9733	20.949	9.298
0.4113	1.2869	15.5206	0.4808	0.0829	312.868	146.680	0.0804	0.0300	0.9700	19.553	9.167
0.4812	1.3988	15.4177	0.5837	0.0907	290.667	134.613	0.0874	0.0365	0.9635	18.165	8.413
0.5706	1.4964	15.3016	0.6998	0.0978	262.230	107.829	0.0935	0.0437	0.9563	16.388	6.739
0.6113	1.5397	15.2409	0.7605	0.1010	251.873	104.580	0.0962	0.0475	0.9525	15.741	6.536
0.6958	1.6265	15.1169	0.8845	0.1076	233.748	97.380	0.1016	0.0553	0.9447	14.608	6.086
0.7852	1.7088	14.9982	1.0032	0.1139	217.615	89.799	0.1068	0.0627	0.9373	13.600	5.612
0.8308	1.7486	14.9348	1.0665	0.1171	210.487	84.469	0.1093	0.0667	0.9333	13.154	5.279
0.9332	1.8320	14.8082	1.1932	0.1237	196.320	76.276	0.1145	0.0746	0.9254	12.269	4.767
1.0307	1.9014	14.6789	1.3225	0.1295	184.474	67.337	0.1188	0.0826	0.9174	11.529	4.208
1.0876	1.9376	14.6076	1.3937	0.1326	178.146	59.121	0.1211	0.0871	0.9129	11.133	3.695
1.1884	1.9927	14.4757	1.5257	0.1377	167.677	56.005	0.1245	0.0953	0.9047	10.479	3.500
1.2957	2.0542	14.3517	1.6497	0.1431	158.537	54.716	0.1284	0.1031	0.8969	9.908	3.419
1.3494	2.0822	14.2831	1.7183	0.1458	154.306	49.369	0.1301	0.1074	0.8926	9.643	3.085
1.4632	2.1352	14.1564	1.8450	0.1509	145.929	47.648	0.1334	0.1153	0.8847	9.120	2.979
1.5802	2.1922	14.0298	1.9716	0.1563	138.727	43.918	0.1370	0.1232	0.8768	8.670	2.745
1.6355	2.2138	13.9664	2.0349	0.1585	135.361	40.287	0.1384	0.1272	0.8728	8.459	2.518
1.7591	2.2650	13.8345	2.1669	0.1637	128.763	37.293	0.1416	0.1354	0.8646	8.047	2.331
1.8729	2.3028	13.7105	2.2909	0.1680	122.954	34.432	0.1439	0.1432	0.8568	7.684	2.152
1.9379	2.3260	13.6472	2.3542	0.1704	120.026	33.865	0.1454	0.1471	0.8529	7.501	2.116
2.0582	2.3645	13.5284	2.4730	0.1748	114.882	27.672	0.1478	0.1545	0.8456	7.180	1.723
2.1769	2.3919	13.4097	2.5917	0.1784	109.879	24.841	0.1495	0.1620	0.8380	6.867	1.552
2.2484	2.4109	13.3543	2.6471	0.1805	107.229	23.644	0.1507	0.1654	0.8346	6.701	1.790
2.3703	2.4484	13.2434	2.7879	0.1849	103.294	32.610	0.1530	0.1724	0.8276	6.455	2.038
2.4224	2.4664	13.1880	2.8133	0.1870	101.316	30.384	0.1541	0.1758	0.8242	6.363	1.899
2.4907	2.4843	13.1300	2.8714	0.1892	99.745	26.664	0.1553	0.1794	0.8206	6.234	1.666
2.5541	2.5015	13.0772	2.9242	0.1913	97.940	23.719	0.1563	0.1827	0.8173	6.121	1.492
2.6874	2.5286	12.9611	3.0403	0.1951	94.093	21.638	0.1580	0.1900	0.8100	5.880	1.352
2.8142	2.5577	12.8556	3.1458	0.1990	90.885	20.747	0.1598	0.1966	0.8034	5.680	1.297
2.9475	2.5825	12.7500	3.2514	0.2028	87.616	19.422	0.1614	0.2032	0.7968	5.476	1.214
3.0792	2.6091	12.6471	3.3543	0.2063	84.734	16.502	0.1631	0.2096	0.7904	5.295	1.031
3.2239	2.6276	12.5442	3.4572	0.2095	81.504	15.723	0.1642	0.2161	0.7839	5.094	0.983
3.4824	2.6759	12.3542	3.6472	0.2166	76.841	18.410	0.1672	0.2279	0.7721	4.802	1.151
3.6205	2.7009	12.2619	3.7395	0.2203	74.600	13.939	0.1688	0.2337	0.7663	4.662	0.871
3.7587	2.7144	12.1669	3.8345	0.2231	72.215	12.274	0.1696	0.2396	0.7604	4.513	0.767
3.8888	2.7337	12.0772	3.9242	0.2263	70.296	13.030	0.1708	0.2452	0.7548	4.393	0.814
4.0319	2.7497	11.9927	4.0087	0.2293	68.200	13.039	0.1718	0.2505	0.7495	4.262	0.815
4.1636	2.7693	11.9083	4.0931	0.2326	66.512	12.854	0.1731	0.2558	0.7442	4.157	0.803
4.3115	2.7854	11.8238	4.1775	0.2356	64.603	11.479	0.1741	0.2611	0.7389	4.037	0.717
4.4513	2.8023	11.7447	4.2567	0.2386	62.954	9.038	0.1751	0.2660	0.7340	3.934	0.565
4.6009	2.8112	11.6576	4.3438	0.2411	61.102	6.113	0.1757	0.2715	0.7285	3.819	0.382
4.8805	2.8286	11.4966	4.5047	0.2460	57.958	7.070	0.1768	0.2815	0.7185	3.622	0.442
5.0106	2.8389	11.4280	4.5733	0.2484	56.659	8.558	0.1774	0.2858	0.7142	3.541	0.535
5.1683	2.8534	11.3568	4.6446	0.2513	55.211	9.871	0.1783	0.2903	0.7097	3.450	0.617
5.2934	2.8666	11.2882	4.7132	0.2540	54.155	8.658	0.1791	0.2945	0.7055	3.384	0.541
5.4414	2.8767	11.2170	4.7844	0.2565	52.866	6.094	0.1798	0.2990	0.7010	3.304	0.381
5.5926	2.8848	11.1457	4.8557	0.2588	51.583	3.989	0.1803	0.3035	0.6965	3.224	0.249
5.8495	2.8914	11.0428	4.9586	0.2618	49.431	4.337	0.1807	0.3099	0.6901	3.089	0.271
6.0267	2.9023	10.9425	5.0588	0.2652	48.157	6.530	0.1814	0.3162	0.6838	3.010	0.408
6.2656	2.9189	10.8528	5.1486	0.2690	46.586	4.893	0.1824	0.3218	0.6782	2.911	0.306
6.7225	2.9318	10.6628	5.3385	0.2750	43.612	4.139	0.1832	0.3336	0.6664	2.726	0.259
6.9501	2.9442	10.5784	5.4230	0.2783	42.362	2.901	0.1840	0.3399	0.6611	2.647	0.181

6.9501	2.9442	10.5784	5.4230	0.2783	42.362	2.901	0.1840	0.9389	0.6611	2.647	0.181
7.1744	2.9450	10.4887	5.5127	0.2808	41.049	1.204	0.1840	0.3445	0.6555	2.565	0.075
7.4183	2.9500	10.4069	5.5945	0.2835	39.767	1.629	0.1844	0.3496	0.6504	2.485	0.101
7.6410	2.9527	10.3224	5.6789	0.2860	38.642	0.111	0.1845	0.3549	0.6451	2.415	0.007
7.8605	2.9506	10.2433	5.7581	0.2880	37.536	0.227	0.1844	0.3598	0.6402	2.346	0.014
8.0686	2.9516	10.1720	5.8293	0.2902	36.531	2.699	0.1845	0.3643	0.6357	2.284	0.142
8.3060	2.9632	10.0955	5.9059	0.2935	35.676	3.080	0.1852	0.3691	0.6309	2.230	0.192
8.5141	2.9659	10.0243	5.9771	0.2959	34.835	1.067	0.1854	0.3735	0.6265	2.177	0.067
8.7579	2.9680	9.9504	6.0510	0.2983	33.989	0.641	0.1855	0.3782	0.6218	2.118	0.041
8.9872	2.9630	9.8818	6.1196	0.2998	32.969	1.018	0.1852	0.3824	0.6176	2.060	0.064
9.1871	2.9714	9.8158	6.1856	0.3027	32.343	2.058	0.1857	0.3866	0.6134	2.021	0.129
9.4359	2.9711	9.7525	6.2489	0.3047	31.488	0.278	0.1857	0.3905	0.6095	1.968	0.017
9.6700	2.9701	9.6839	6.3175	0.3067	30.714	1.024	0.1856	0.3948	0.6052	1.919	0.048
9.8846	2.9664	9.6232	6.3782	0.3083	30.010	0.742	0.1854	0.3986	0.6014	1.875	0.046
10.1073	2.9669	9.5625	6.4389	0.3103	29.354	0.765	0.1854	0.4024	0.5976	1.834	0.048
10.3317	2.9698	9.4992	6.5022	0.3126	28.745	1.111	0.1856	0.4064	0.5936	1.796	0.069
10.5267	2.9630	9.4438	6.5576	0.3137	28.147	2.191	0.1852	0.4098	0.5902	1.759	0.137
10.7706	2.9608	9.3831	6.6183	0.3156	27.490	1.497	0.1850	0.4136	0.5864	1.718	0.094
10.9689	2.9566	9.3250	6.6743	0.3171	26.954	2.113	0.1848	0.4172	0.5828	1.685	0.132
11.2079	2.9516	9.2696	6.7318	0.3184	26.335	0.561	0.1845	0.4207	0.5793	1.646	0.035
11.4128	2.9582	9.2168	6.7845	0.3210	25.920	0.930	0.1849	0.4240	0.5760	1.620	0.058
11.7233	2.9540	9.1482	6.8531	0.3229	25.198	2.276	0.1846	0.4283	0.5717	1.575	0.142
12.0208	2.9445	9.0796	6.9217	0.3243	24.495	1.376	0.1840	0.4326	0.5674	1.531	0.086
12.3199	2.9458	9.0110	6.9903	0.3269	23.911	0.432	0.1841	0.4369	0.5631	1.494	0.027
12.6841	2.9411	8.9477	7.0537	0.3287	23.187	1.986	0.1838	0.4408	0.5592	1.449	0.124
13.0304	2.9318	8.8791	7.1223	0.3302	22.500	2.875	0.1832	0.4451	0.5549	1.406	0.180
13.3214	2.9228	8.8131	7.1882	0.3316	21.941	2.714	0.1827	0.4492	0.5508	1.371	0.170
13.6027	2.9162	8.7498	7.2516	0.3333	21.439	3.224	0.1822	0.4532	0.5468	1.340	0.201
13.8986	2.9041	8.6918	7.3096	0.3341	20.895	2.809	0.1815	0.4568	0.5432	1.306	0.176
14.1944	2.8996	8.6311	7.3703	0.3360	20.428	0.937	0.1812	0.4606	0.5394	1.277	0.059
14.4887	2.8986	8.5704	7.4310	0.3382	20.006	1.949	0.1811	0.4644	0.5356	1.250	0.122
14.8317	2.8964	8.5123	7.4890	0.3391	19.461	3.563	0.1804	0.4680	0.5320	1.216	0.223
15.1406	2.8753	8.4543	7.5471	0.3401	18.991	2.540	0.1797	0.4717	0.5283	1.187	0.159
15.4235	2.8711	8.3936	7.6078	0.3421	18.615	1.635	0.1794	0.4754	0.5246	1.163	0.102
15.7649	2.8651	8.3355	7.6658	0.3437	18.174	2.875	0.1791	0.4791	0.5209	1.136	0.180
16.0771	2.8527	8.2775	7.7239	0.3446	17.744	3.544	0.1783	0.4827	0.5173	1.109	0.221
16.3990	2.8426	8.2221	7.7793	0.3457	17.334	3.207	0.1776	0.4862	0.5138	1.083	0.200
16.6948	2.8329	8.1667	7.8347	0.3469	16.969	4.471	0.1770	0.4896	0.5104	1.060	0.279
16.9989	2.8157	8.1112	7.8901	0.3471	16.564	4.423	0.1760	0.4931	0.5069	1.035	0.274
17.2541	2.8075	8.0558	7.9455	0.3485	16.272	1.982	0.1755	0.4966	0.5034	1.017	0.124
17.5321	2.8054	7.9978	8.0036	0.3508	16.002	3.485	0.1753	0.5002	0.4998	1.000	0.218
17.8508	2.7956	7.9371	8.0643	0.3510	15.605	5.516	0.1741	0.5040	0.4960	0.975	0.345
18.2393	2.7669	7.8817	8.1197	0.3511	15.170	3.786	0.1729	0.5074	0.4926	0.948	0.237
18.5271	2.7590	7.8210	8.1804	0.3528	14.892	4.317	0.1724	0.5112	0.4888	0.931	0.270
18.7872	2.7437	7.7577	8.2437	0.3537	14.604	5.309	0.1715	0.5152	0.4848	0.913	0.332
19.1774	2.7252	7.6970	8.3044	0.3541	14.211	5.164	0.1703	0.5190	0.4810	0.888	0.323
19.4651	2.7091	7.6336	8.3677	0.3549	13.918	4.670	0.1693	0.5229	0.4771	0.870	0.292
19.7821	2.6972	7.5703	8.4311	0.3563	13.625	5.460	0.1686	0.5269	0.4731	0.852	0.341
20.0764	2.6761	7.5070	8.4944	0.3565	13.330	6.408	0.1672	0.5309	0.4691	0.833	0.400
20.3804	2.6590	7.4410	8.5603	0.3573	13.047	5.568	0.1662	0.5350	0.4650	0.815	0.348
20.6926	2.6418	7.3698	8.6316	0.3585	12.767	3.636	0.1651	0.5394	0.4606	0.798	0.227



DIRECT ~~SHALE~~ SHEAR TEST

(Set up / Take Down)

Type Test D.S. Soil / Soil

WCC L-1000  
(2/82)

FILE NO
D- _____

Project No 8FC4232 Proj. Eng RS Test No \_\_\_\_\_

<input checked="" type="checkbox"/> Undisturbed	<input type="checkbox"/> Reconstituted	<input type="checkbox"/> Dynamic	<input type="checkbox"/> Constant Effort
Boring No <u>TH-1</u>	Composite No _____	<input type="checkbox"/> Kneading	_____ layers; _____ lb hammer
Sample No <u>S-1063</u>	Specimen No <u>4</u>	<input type="checkbox"/> Static	_____ Blows-Tamps/layer
Depth (ft) <u>64.8</u>	Remarks _____	<input type="checkbox"/> Tamping	<input type="checkbox"/> Under Compaction
Block No _____		<input type="checkbox"/> Other	_____ layers; _____ %WC

Water Content	1	2	3	Ave
Location				
Container No	<u>LA-139</u>			<u>686</u>
Wt. Cont. + Wet Soil (gm)	<u>127.90</u>			<u>127.90</u>
Wt. Cont. + Dry Soil (gm)	<u>103.65</u>			<u>103.65</u>
Wt. Container (gm)	<u>34.43</u>			<u>34.43</u>
Wt. Dry Soil (gm)				<u>42.34</u>
Water Content (%)	<u>35.03</u>			<u>27.56</u>

See Attached For Additional Water Contents

Specimen Weight

Wet + Stone, etc.	<u>716.21</u> gm
Stone, etc.	<u>561.53</u> gm
Initial Wet	<u>154.68</u> gm
Final Wet	<u>117.30</u> gm
Excess Oven Dry - Dish No <u>5J</u>	
Dry Soil + Dish	<u>916.32</u> gm
Dish	<u>823.35</u> gm
Excess Dry Soil	<u>22.97</u> gm

For Trimmed Specimen

	Height (in) or _____		Diameter (in) or _____	
	Initial (H <sub>0</sub> )	Final (H <sub>s</sub> )	Initial	Final
1	<u>1.0008</u>		<u>1-T</u>	
2	<u>1.0028</u>		<u>2-M</u>	
3	<u>1.0019</u>		<u>3-B</u>	
4	<u>1.0010</u>		<u>1-T</u>	
5	<u>1.0015</u>		<u>2-M</u>	
Ave	<u>1.0016</u>		<u>3-B</u>	

$\Delta H_c =$  \_\_\_\_\_ in  
 $\Delta H_t =$  \_\_\_\_\_ in  
 $\Sigma \Delta H =$  \_\_\_\_\_ in  
 $H_0 - H_s =$  \_\_\_\_\_ in

For Reconstituted  $H_0 =$  \_\_\_\_\_ in  
 or  
 Trimming Ring  $A_0 =$  4.909 in<sup>2</sup>  $V_i =$  80.573 cm<sup>3</sup>

Membrane

Regular: Thickness = \_\_\_\_\_ in  
Cir. = \_\_\_\_\_ / TT = \_\_\_\_\_ dia (in)

Wire Reinforced: Thickness = \_\_\_\_\_ in

Stress (tsf)	Dia by Pt. Tape (in)		Area (in <sup>2</sup> )
	Mens.	Corr.	

Preliminary  
 $V_{c0} =$  119.85 cc  $V_{d0} =$  105.57 cc

Final Visual Classification: \_\_\_\_\_

More detailed sketch on attached sheet

Trimming Remarks cf. moist grain plastic clay

Preliminary Cal. by RE Reviewed by RE Checked by \_\_\_\_\_

Trimmed/Comp. by [Signature] Setup by [Signature] Taken down by [Signature]  
 Date: 12/2/84 Date: 12/2/84 Date: 1/3/85

(See Back for Summary Calculations)

117.30

Cal. Constants:  $A$  (in<sup>2</sup>) = 0.7854  $D^2$  (in);  $A$  (ft<sup>2</sup>) = 0.7854  $D^2$  (ft);  $V$  (cm<sup>3</sup>) = 16.3871  $D^2$  (in);  $V$  (cm<sup>3</sup>) or 2.54<sup>3</sup> (in<sup>3</sup>)

# DIRECT SHEAR TEST CALCULATIONS

Type Test: Residual

Undisturbed;  Reconstituted - Specimen

Cyclic

Cyclic Rate: 1 Hz or \_\_\_\_\_

Static 0.00022"/min then 0.000286"/min @ 4th stage  
Strain Rate = \_\_\_\_\_ %/hr

$\bar{\sigma}_{vc}$  (after unloading) = \_\_\_\_\_ tsf

$\bar{\sigma}_{vc}$  = 16.000 tsf or ksf

$T_c$  = 0.0 tsf or \_\_\_\_\_

OCR<sub>cy</sub> = \_\_\_\_\_

$\bar{\sigma}_{vc(max)}$  = \_\_\_\_\_ tsf or \_\_\_\_\_

$\alpha = T_c / \bar{\sigma}_{vc}$

$\Delta V_{cy}$  = \_\_\_\_\_ cm<sup>3</sup>

OCR = \_\_\_\_\_

$T_c$  consol. path:   $K_0$  or   $95^\circ$

$\Delta H_{cy}$  = \_\_\_\_\_ inch

Consolidation time at  $\bar{\sigma}_{vc}$ :  Overnight;  1 days;  \_\_\_\_\_ hrs;  $\bar{\sigma}_{vc(max)}$  at \_\_\_\_\_

INITIAL  $H_0$  = 1.0016 in  $A_0$  (spec) = 4.909 in<sup>2</sup>  $A_0$  (men) = 4.909 in<sup>2</sup>  $V_0$  = 80.573 cm<sup>3</sup>

$(G_{vs} - \gamma_w) / G = (\gamma_w - \gamma_{sat}) / G$   
 $\omega$  (for S=100%) =  $(G_{vs} - \gamma_w) / G_{vs}$   
 $\Delta V$  (cm<sup>3</sup>) =  $16.3871 \cdot (\text{in}^3)$   
 $\gamma_w$  (head) =  $62.32 \text{ lb/ft}^3$  (soil) =  $64.20 \text{ lb/ft}^3$   
 $= 0.9982 \text{ g/cm}^3$

Cal. of WT of Dry Soil	By Initial Water Content	By Final Water Content	By Total Oven-dried Specimen
$W_1$ (%)	35.03	?	/
$W_2$ (%)			/
W <sub>ave</sub> (%)		27.56	/
WT. Wet Soil, $W_T$ (gm)	154.68	(146.12)	/
Partial WT. Dry Soil (gm)	$\Delta V$ (cm <sup>3</sup> ) during Test if Unload: (-) In; (+) Out		42.34
Excess Oven-Dried Soil (gm)	Corr. Wet WT, $W_L$ at $\bar{\sigma}_{vc} = W_T + \Delta V$		22.97
Total WT. Dry Soil, $W_d$ (gm)	114.55	91.96	65.31
$W_s$ used:	= <u>114.55</u> gm		

Variation of Height & Volume	During Initial Consol. " to " $\bar{\sigma}_{vc}$ or $\bar{\sigma}_{vc(max)}$	During Rebound " to " $\bar{\sigma}_{vc}$	After Test $\bar{\sigma}_{vc}$ to " $\bar{\sigma}_{vc}$
During Consolidation	8.0 tsf	tsf	0.0 tsf
Sign Convention: (+) $\Delta V$ out + $\Delta H$ down; (-) $\Delta V$ in / $\Delta H$ up			
$\Delta H$ (in)	0.1148		
Equip. Compressibility (in)	0.0033		
Corr. $\Delta H$ (in)	0.1115		
$\Delta V_m$ (cm <sup>3</sup> ) measured			
$\Delta V$ for $A_0$ soil	8.970		
$\Delta V$ for $A_m$ memb.			
$\Delta V$ used for $\Delta V_c$ measured.	$\Delta V_1$	$\Delta V_2$	$\Delta V_3$

Calculation of $\Delta V_c$ during consol. by different Procedures	$\Delta V_c$ by $\Delta W$ = $W_0 - W_c$	$\Delta V_c$ using $\Delta V$ measured = $\Delta V_1 + \Delta V_2$	$\Delta V_c$ for S=100% for $W_c = \frac{W_c - W_s}{W_s}$	By Measurements $V_c = H_c \cdot A_m$
	$W_0 - W_c = 8.56$ = $\Delta V_c$ (cm <sup>3</sup> )	$\Delta V_c = \dots + \dots$ = <u>8.970</u> cm <sup>3</sup>	$V_c = (\frac{1}{G_s} + W_c) W_s / \gamma_w$ $\Delta V_c = \dots$ cm <sup>3</sup>	$H_c = \dots$ in $A_m = \dots$ in <sup>2</sup> $V_c = \dots$ cm <sup>3</sup> $\Delta V_c = \dots$ cm <sup>3</sup>

Conclusions  
 $\Delta V_c$  used = 8.970 cm<sup>3</sup>  based on ave. values  $\Delta H_c = 0.1115$  in  
 $V_c = 71.603$  cm<sup>3</sup>  $\Delta V_c = \dots$  in  $H_c = 0.8901$  in  
 $A_c = V_c (\text{cm}^3) / 16.3871 / H_c (\text{in}) = \dots \text{ in}^2 / 0.144 = \dots \times 10^{-3} \text{ ft}^2$   
 $E_{ac} = 11.13\%$ ;  $E_{vc} = 11.13\%$ ;  $\gamma_c = \dots\%$  |  $\bar{\sigma}_{vc(max)}$   $E_{ac} = \dots\%$ ;  $E_{vc} = \dots\%$

Summary	Height (in)	Area in <sup>2</sup> or (ft <sup>2</sup> x 10 <sup>-3</sup> )	Volume (cm <sup>3</sup> )	Water Content (%)	Total Dry Unit Weight (lb/ft <sup>3</sup> )	Saturation (%)	Spec. Wgt. with Induced OCR
Initial	1.0016	34.0885	80.573	35.03	119.85	102.0	For S=100% $W_c + \Delta V_2 =$
After Consol.	0.8901	"	71.603	(27.37)	127.21	assume	$\Delta V_2$ (-) In; (+) Out
Equip. Compressibility	0-100 lbs	0.081 div/16 + 0.0 div				100.0 + 0.8 = 2.855	
	100-150	0.052 " + 2.9 "		1 Div =			
	150-200	0.040 " + 4.7 "		0.0001 in			
	200-1000	0.0324 " + 6.22 "					

$$S = \frac{W G_s \gamma_d}{G_s \gamma_w - \gamma_d} = \frac{W G_s \gamma_e}{G_s \gamma_w (1+w) - \gamma_e}$$

Calculated by RS Reviewed by RS Checked by \_\_\_\_\_  
 Date 1/7/85 Date 1/7/85 Date \_\_\_\_\_

WCC L-1000 (2/82)

PREPARED BY: YM	DATE:	<b>Woodward-Clyde Consultants</b> ORANGE COUNTY, CALIFORNIA	PROJECT NO.:	TASK:
CHECKED BY:	DATE:		PROJECT NAME:	
<b>SUMMARY OF DIRECT SHEAR TEST</b>			SHEET: _____	
			OF: _____	

BORING: TH-1, SAMPLE NO. FS-1063, DEPTH 64.8 ft

$\bar{T}_{vc} = 16 \text{ Ksf}$

CYCLE	HORIZ DISPLACEMENT (in)	MAX SHEAR STRESS (Ksf)	VOLUMETRIC STRAIN (%)	INFERRED FRICTION ANGLE (DEGREES)
1	0.2003	7.906	3.02	26.3
2	-0.1166	-7.884	6.83	26.2
3	0.2047	8.198	9.53	27.0
4	-0.1029	-6.466	11.91	22.0
5	0.2115	7.510	15.22	25.1
6	-0.1095	-5.682	18.71	19.6
7	0.2095	6.769	22.43	22.9

REFERENCE:

APPENDIX C

UNDRAINED SHEAR STRENGTH OF  
BOOTLEGGER COVE CLAY

APPENDIX C  
UNDRAINED SHEAR STRENGTH OF  
BOOTLEGGERS COVE CLAY

A primary tool for estimating the in-situ undrained shear strengths of the clay was the SHANSEP (Stress History and Normalized Soil Engineering Properties) approach described by Ladd and Foott (1974). SHANSEP was developed to provide a systematic method for estimating the undrained shear strength of clay soils, taking into account the factors that most strongly influence the undrained strength.

The SHANSEP method is based on the empirical observations that the results of laboratory tests on samples at the same overconsolidation ratio (OCR), but different consolidation stresses, exhibit similar stress-strain and strength characteristics when normalized with respect to consolidation stress ( $\sigma'_{vc}$ ). This observation, coupled with the fact that sample disturbance effects can be minimized by consolidating the laboratory sample to about twice its maximum past consolidation stress ( $\sigma'_{vm}$ ), provide the basis for the SHANSEP method.

SHANSEP, as developed by Ladd and Foott, involves the following basic steps: (1) obtain high quality undisturbed soil samples and evaluate the stress history (present effective stresses and OCR's) of the soil profile using consolidation tests, total unit weights, and the in-situ pore pressure conditions; (2) decide which shear strength tests best model the situation under consideration and the range of OCR values for which data are required; (3) consolidate the soil samples to be tested to about twice the

maximum past consolidation pressure and then reduce the stresses to give the desired OCR; and (4) perform the shear test.

Results from the direct simple shear (DSS) and triaxial (TX) tests from areas near the 1964 Fourth Avenue slide (Woodward-Clyde Consultants, 1982) in which the soil specimens were sheared monotonically to failure are shown in Figures C-1 and C-2. Figure C-1 shows the influence of overconsolidation on the normalized strength of the soil,  $S_u/\sigma'_{vc}$ . It is noted that for simulating horizontal shear stresses imposed by earthquake shaking and translational sliding, the DSS test provides better loading conditions than those of the TX test. The trend of increasing strength with increasing OCR for the Bootlegger Cove clay under TX and DSS conditions is described in the following expression:

$$S_u/\sigma'_{vc} = (S_u/\sigma'_{vc})_{NC} OCR^{0.78} \quad (C-1)$$

in which  $S_u/\sigma'_{vc}$  is the normalized undrained shear strength ratio at a given OCR and  $(S_u/\sigma'_{vc})_{NC}$  is that ratio for a normally consolidated (OCR=1) condition. The exponent of 0.78 on the OCR term is consistent with the data for many other soils (Ladd et al, 1977). As illustrated by Figure C-2, the test results indicated that there is a slight decrease of the undrained shear strength ratio with increasing plasticity index (PI) for the Bootlegger Cove clay. The DSS values for normally consolidated conditions varied from about 0.24 at a PI of 11 to about 0.18 at a PI of 25. One DSS test on a sample from the "L" Street slide area gave 0.185. Ladd (1981) has summarized similar data for other soft sedimentary clays that, in the range of PI values appropriate to the proposed site, have DSS undrained

strength ratios in the 0.20 to 0.22 range. These values are consistent with the DSS results obtained during this investigation. The Ladd (1981) data, however, show a trend of increasing strength ratio with increasing PI - opposite to the trend mentioned above. The reasons for these differences are not clear, and for the purposes of this study are thought to be not significant.

For comparative purposes, the results of the TX tests are also included in Figures C-1 and C-2. As is predicted by theory, and as shown from experience, shear strength ratios measured in TX tests are greater than those obtained from DSS tests. As discussed earlier in this Appendix for the conditions to be analyzed in this study, the DDS test provides a more appropriate measure of the undrained strength than does the TX test. From the range of DSS results obtained, a  $(S_u / \sigma'_{vc})_{NC}$  value of 0.19 was selected to estimate undrained strengths of the clay for the analyses. The expression:

$$S_u = 0.19 (\text{OCR})^{0.78} \sigma' v \quad (\text{C-2})$$

was thus felt to provide an appropriate estimation of the undrained shear strength of the Bootlegger Cove clay underlying the "L" Street slide area.

To obtain an estimate of the in situ undrained shear strength using equation C-2, the OCR of the soil must be known. This was evaluated from the results of one consolidation test performed on a soil sample at 64.5 feet from the ground surface at CPT-2 location. The results of this test are presented in Appendix B. The data from the test indicate OCR values ranging between about 1.2 and 1.6

as being appropriate for estimating the undrained shear strength of the clay in the zone about 65 feet from the ground surface at CPT-2 location. The clay in this zone is thought to be critical from seismic ground stability considerations. With the OCR and the vertical effective stress calculated from soil density and water table conditions, estimates of the undrained shear strengths were made using equation C-2 for the evaluation cross-section.

It should be noted that the undrained shear strength discussed to this point, represents peak strength appropriate for static undrained shear loading conditions. Changes to this existing strength condition can result due to cyclic shear strains induced by earthquake loading and/or due to large displacements from slide movements. The potential for changes due to these conditions was based on the cyclic DDS tests and large deformation direct shear tests conducted by Woodward-Clyde Consultants (1982). One large deformation direct shear test conducted as part of this study resulted in excessive loss of material to be of meaningful use.

To estimate the strength changes that could take place in the clay due to cyclic loading, DSS specimens tested by Woodward-Clyde Consultants (1982) were sheared cyclically at different levels of applied shear stress. During the tests, excess pore pressure accumulation was monitored with the number of applied stress cycles to develop an understanding of the clay response to a set of conditions equivalent to some given earthquake loading. Following the cyclic loading, the specimens were sheared to failure, while maintaining undrained conditions, to measure changes of the shear strength. The measured strength change and the



effective stress remaining at the end of cyclic loading for each specimen was used to develop the relationship illustrated in Figure C-3. Because it is the effective stress state of a soil at any given time during cyclic loading that determines the strength at that time, this relationship could be used with some assumed level of excess pore pressure accumulation to estimate the change to the undrained strength condition described earlier in the Appendix. For example, if the accumulated excess pore pressure reached 50 percent of the initial effective stress, the available strength at that time would be approximately 92 percent of the initial undrained shear strength.

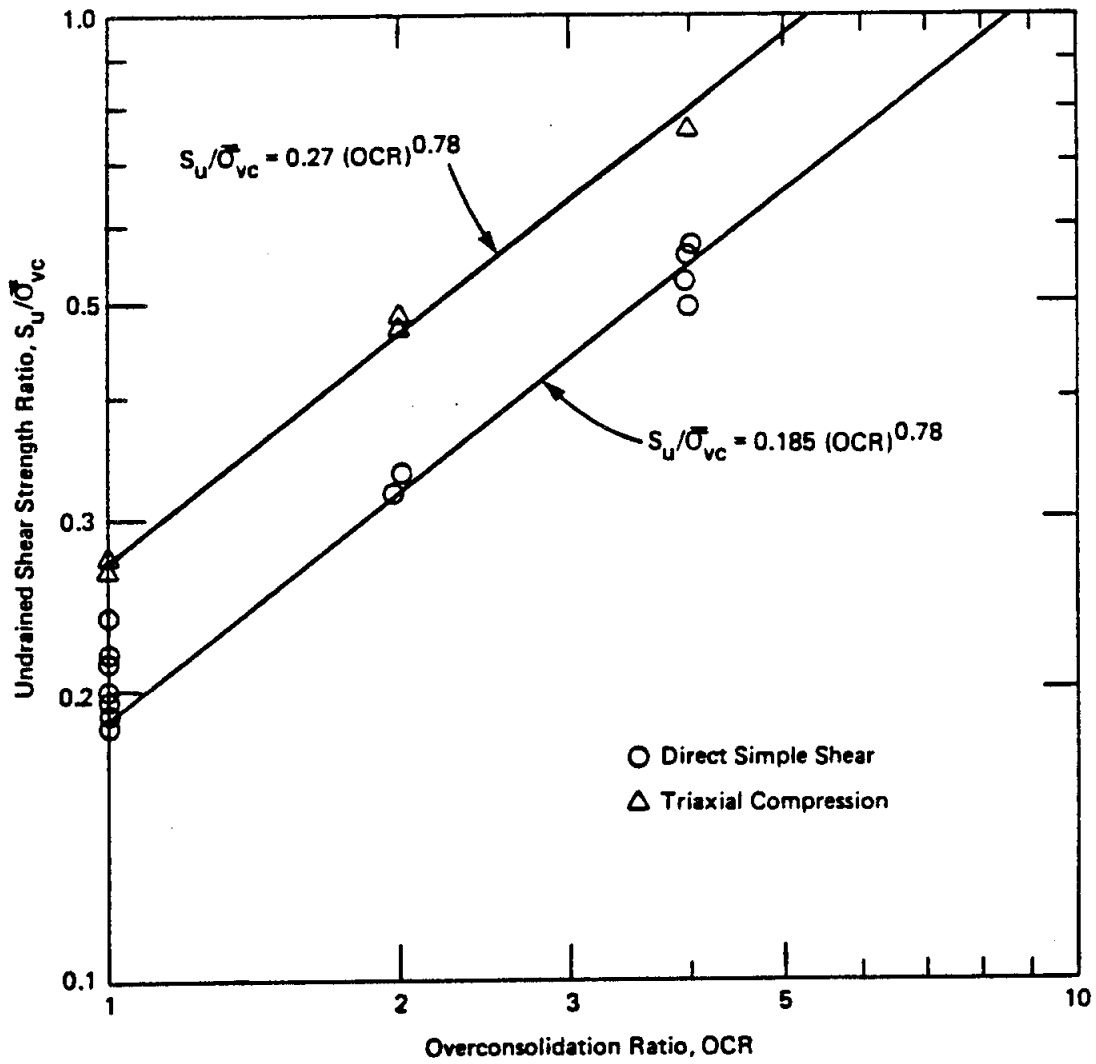

Project No.		<b>VARIATION OF NORMALIZED UNDRAINED SHEAR STRENGTH RATIO WITH OVERCONSOLIDATION</b>	<b>Figure C-1</b>
<b>Woodward-Clyde Consultants</b>			

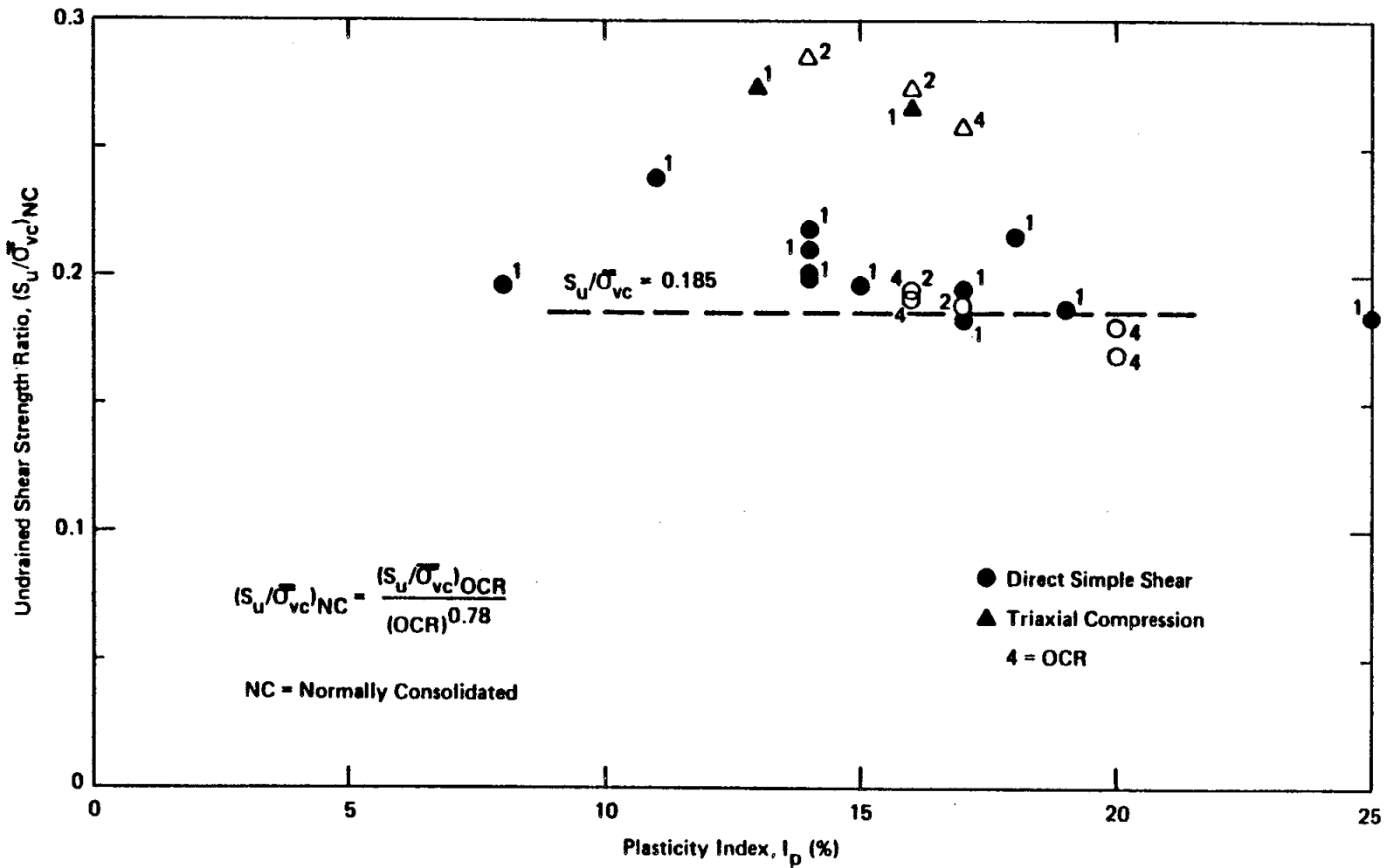

Note: Data representing normally-consolidated (OCR=1) clays are shown using solid symbols. Open symbols are used for data on over-consolidated clays.

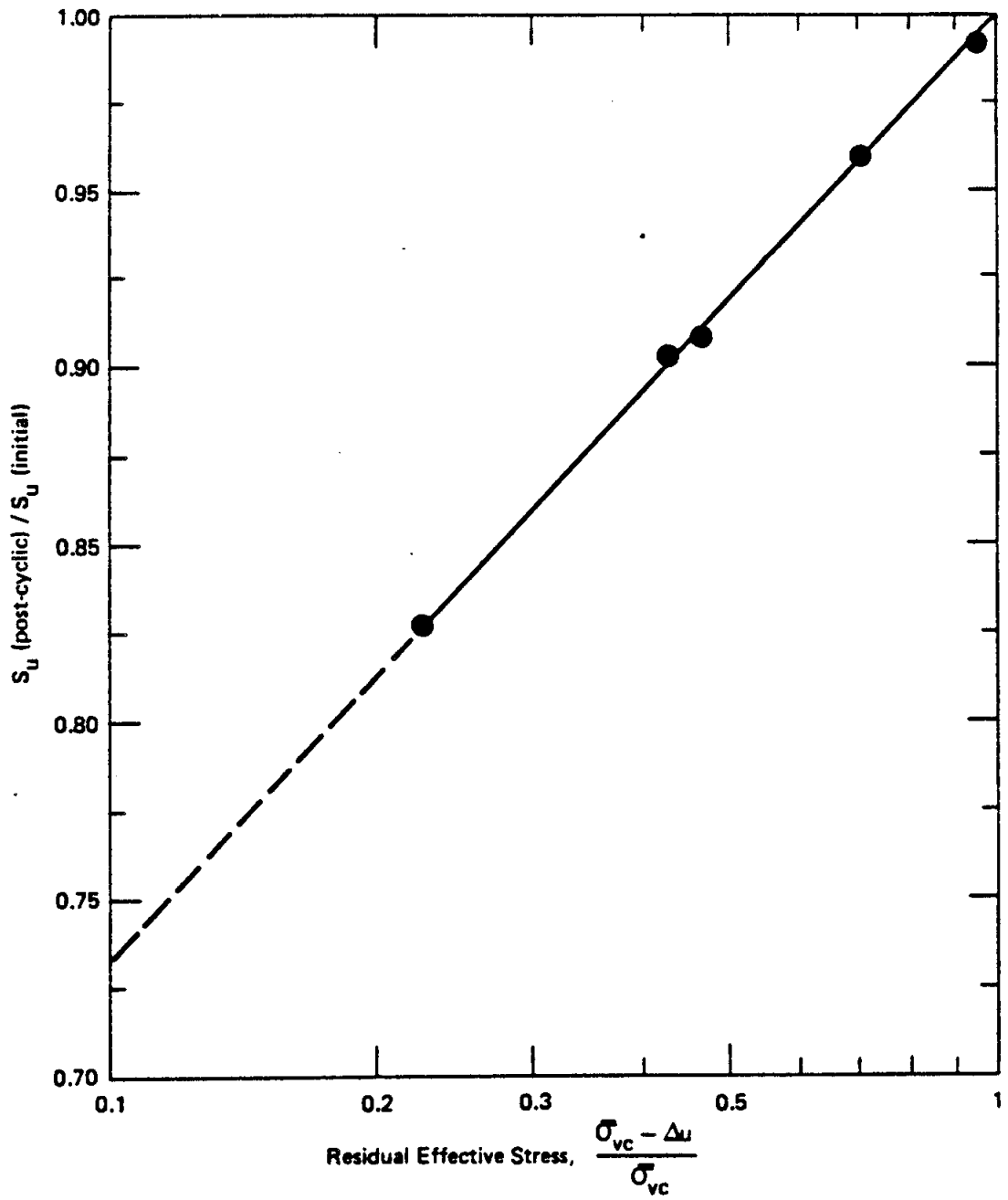

Project No.		<b>STRENGTH CHANGES DUE TO CYCLIC LOADING</b>	Figure C-3
<b>Woodward-Clyde Consultants</b>			

APPENDIX D

PROCEDURE FOR CALCULATING SEISMICALLY-INDUCED  
GROUND DISPLACEMENTS

APPENDIX D  
PROCEDURE FOR CALCULATING SEISMICALLY-INDUCED  
GROUND DISPLACEMENTS

A procedure used to calculate seismically-induced ground displacements of translatory slides such as the 1964 "L" Street slide is discussed in this Appendix. The method is based on Newmark's (1965) approach as refined by Makdisi and Seed (1977). The procedure is summarized in Figures D-1, D-2, and D-3 and example results are schematically summarized in Figure D-4.

In Figure D-1, the soil blocks shown are assumed to be rigid. The horizontal forces applied to the soil blocks by the grabens in Figure D-1 are labeled as "active" and "passive" resisting forces because they are forces exerted by the grabens under undrained conditions and not true active and passive forces. Note in Figure D-1a when the ground is shaking in the direction away from the bluff, the soil block is free to move in the direction of the bluff as long as the "active" soil force plus the inertia force on the soil block is greater than the resisting force at the bottom of the soil block. However, when the direction of shaking is toward the bluff, the soil block cannot move significantly in the direction away from the bluff because the "passive" soil force induced by the graben can be large.

The active soil force, due to the presence of a graben, in Figure D-1a was computed as follows:

$$F_{da} = 1/2 \gamma_t H^2 K_a \quad (D-1)$$

where  $\gamma_t$  = total unit weight of soil  
H = height of the soil block  
 $K_a$  = "active" soil pressure coefficient  
(0.3 was used in this study)

It is noted that this "active" soil force in fact represents the part of the horizontal component of the graven weight that acts in the direction of the sliding block.

As summarized in Figure D-1, the inertia force on the soil block can be calculated by multiplying the total weight of the soil block by the maximum seismic coefficient. The maximum seismic coefficient is the product of a freefield peak ground surface acceleration ( $a_{max}$ ) and a constant. The constant represents the effects of the height of the soil block, bluff topography, the length of the soil block, and others.

The effect of the height of the soil block can reduce the overall inertia force on the soil block by about 10 percent for the height range estimated in the 1964 "L" Street slide block because the ground acceleration at depth, in general, is lower than that at the ground surface (Seed and Idriss, 1982). The effect of the bluff topography can increase the ground acceleration by about 20 percent (Idriss and Seed, 1967). The effect of the length of the soil block is difficult to quantify because it depends on the predominant wave field (body waves or surface waves), apparent wave speed, wave lengths, and others. However, if the predominant waves are body waves, then using the concept of apparent wave velocity (O'Rourke and others, 1980), a reduction in  $a_{max}$  of 5 to 10% can be easily expected for a soil block length of about 1,000 feet to 2,000 feet. If, on

the other hand, the predominant waves are surface waves, then a reduction of  $a_{max}$  of up to 90% or more can be expected for the same range of soil block length. To incorporate the effect of these factors, a value of 1.1 was selected for the constant to modify the free field peak ground acceleration as discussed in the previous paragraph.

The resisting force due to soil shear strength acting at the bottom of the soil block in Figure D-1 can be computed by multiplying the length of the soil block by the average undrained shear strength of the soils involved. As discussed later, the average undrained shear strength of the soil depends on the level and length of shaking and the amount of displacement the soil block has undergone.

Using three of the forces just discussed, it is possible to calculate the yield seismic coefficient as follows:

$$K_y = \frac{F_{rs} - F_{da}}{W} \quad (D-2)$$

where  $F_{rs}$  = resisting force due to soil shear strength  
 $F_{da}$  = driving force due to active soil pressure  
 $W$  = weight of soil block

The yield seismic coefficient is that seismic coefficient which, when multiplied by the total weight of the block, gives large enough driving force due to earthquake inertia to make the total driving force equal to the total resisting force.



Once the yield seismic coefficient ( $K_y$ ) and the maximum seismic coefficient ( $K_{max}$ ) are known, the displacement of the soil block can be calculated. The basic process is schematically shown in Figure D-2. Every time the soil block is shaken beyond the yield point (between  $t_1$  and  $t_3$  in Figure D-2) as represented by the yield seismic coefficient, velocity in the direction of the movement is initiated that lasts for a certain period ( $t_1$  to  $t_3$  in Figure D-2). By integrating over this velocity (from  $t_1$  to  $t_3$  in Figure D-3), displacement is accumulated (from  $t_1$  to  $t_3$  in Figure D-2) in the direction of the bluff.

Based on the type of displacement calculation just described, Makdisi and Seed (1977) have graphically summarized the amount of expected displacement versus  $K_y/K_{max}$  for various magnitude earthquakes. Thus, using this graphical summary, it is possible to estimate seismically-induced displacements of a soil block if an earthquake magnitude and  $K_y/K_{max}$  are known.

However, the results by Makdisi and Seed cover only up to magnitude 8-1/4 earthquakes and concern only the displacements associated with earthdams. Because in this study the 1964 Alaska earthquake having a seismic moment magnitude of 9.2 had to be considered, the results of Makdisi and Seed were extrapolated to 9 plus earthquakes and expressed as displacement per number of cycles as shown in Figure D-3. Based on the relationship between the number of equivalent cycles (NC) and magnitude  $m$  presented by Seed and Idriss (1981), the following equation can be obtained by curve fitting and slight extrapolation:

$$NC = 0.24 e^{0.55m} \quad (D-3)$$

It is to be noted that the results of Makdisi and Seed (compiled for earthdams) based on our experience do provide reasonable numbers for offshore clay slopes of few degrees. Thus, using equation D-3 and Figure D-3, the displacement for any magnitude in 9 plus range for any number of cycles can be obtained if the  $K_y/K_{max}$  value is known.

Results of example calculations using the procedure just described are schematically summarized in Figure D-4. The procedure involves the following steps:

- (1) Calculate the weight of the soil block and the "active" force using the given geometry, equation D-1, and the unit weight of soils;
- (2) Calculate the resisting force by multiplying the appropriate undrained shear strength by the length of the soil block;
- (3) Calculate the maximum seismic coefficient ( $K_{max}$ ) based on  $a_{max}$  as discussed earlier;
- (4) Calculate the yield seismic coefficient ( $K_y$ ) using equation D-2; and
- (5) Calculate displacement for various number of cycles using Figure D-3 and a  $K_y/K_{max}$  value obtained from Steps 3 and 4.

In calculating the yield seismic coefficient, the value of undrained shear strength used varies depending on the level and length of shaking and the current displacement of the

soil block. This is summarized in Figure D-5. The strength-displacement relationship schematically shown in Figure D-5 is from a Woodward-Clyde Consultants (1982) study involving the 1964 Fourth Avenue slide.

The procedure discussed so far involves computing displacements given the geometry and shear strength; this is the conventional application of the procedure. However, the evaluation of the 1964 "L" Street slide involved computing the shear strength given the geometry and displacement values. In this case the procedure is similar to the previous one and the following steps are involved.

- 1) Calculate the weight of the soil block and the "active" force using the given geometry, equation D-1, and the unit weight of soils;
- 2) Calculate the maximum seismic coefficient ( $K_{max}$ ) based on  $a_{max}$  as discussed earlier;
- 3) For each cycle, using the assumed displacement versus number of cycle relationship, enter into Figure D-3 to obtain  $K_y/K_{max}$  values corresponding to the displacement for that cycle;
- 4) Using the value of  $K_y$  obtained from steps 2 and 3, compute the value of  $F_{rs}$  by the following equation:

$$F_{rs} = K_y W + Fda \quad (D-4)$$

- 5) Compute the required values of undrained shear strength by dividing  $F_{rs}$  by  $L$ .

The computation steps become slightly more complicated when the effect of cyclic degradation in undrained shear strength is included because, then, the displacement versus number of cycle relationship cannot be assumed. However, an iterative scheme using a computer makes it relatively straight forward to compute the required values of initial and residual undrained shear strengths.

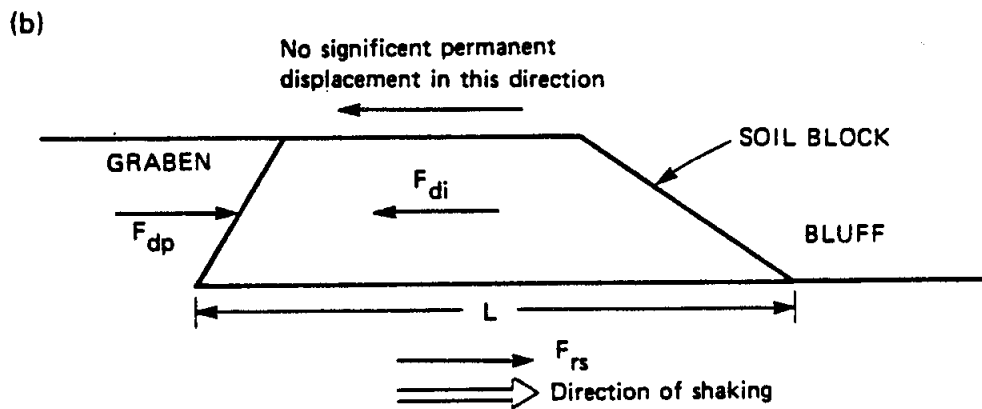
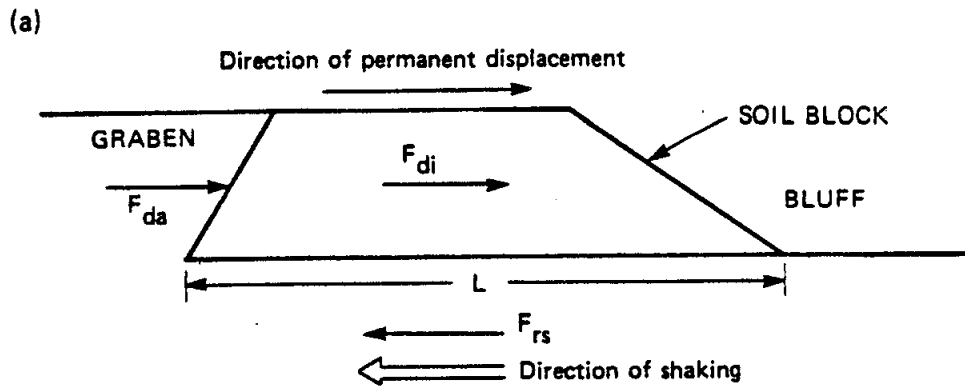

- $F_{da}$  = Driving force due to active soil pressure
- $F_{di}$  = Driving force due to earthquake inertia
- $F_{rs}$  = Resisting force due to soil shear strength
- $F_{dp}$  = Resisting force due to passive soil pressure

$$F_{di} = K_{max} W$$

where  $K_{max}$  = maximum seismic coefficient

$W$  = weight of soil block

$$F_{rs} = S_u L$$

where  $S_u$  = average undrained shear strength of soil

$L$  = length of soil block

Yield Seismic Coefficient

$$K_y = \frac{F_{rs} - F_{da}}{W}$$

Project No.		FORCES AND EQUATIONS IN DISPLACEMENT ANALYSIS	Figure D-1
Woodward-Clyde Consultants			

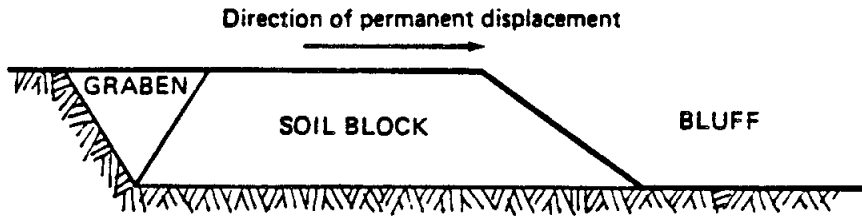

$$k_{yi+1} \leq k_{yi} \text{ due to cyclic degradation of soil strength}$$

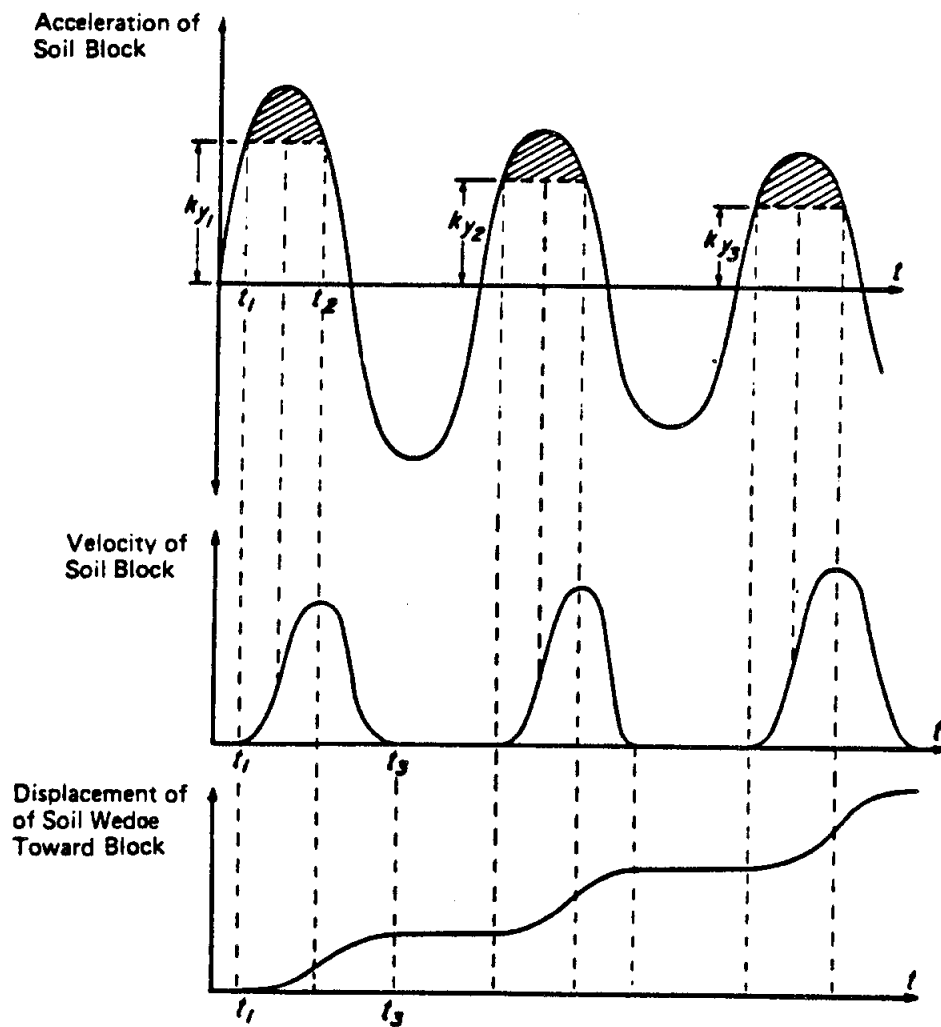

Project No.		<b>INTERGRATION OF ACCELEROGRAMS TO DETERMINE DISPLACEMENTS TOWARD BLUFF</b>	Figure D-2
<b>Woodward-Clyde Consultants</b>			

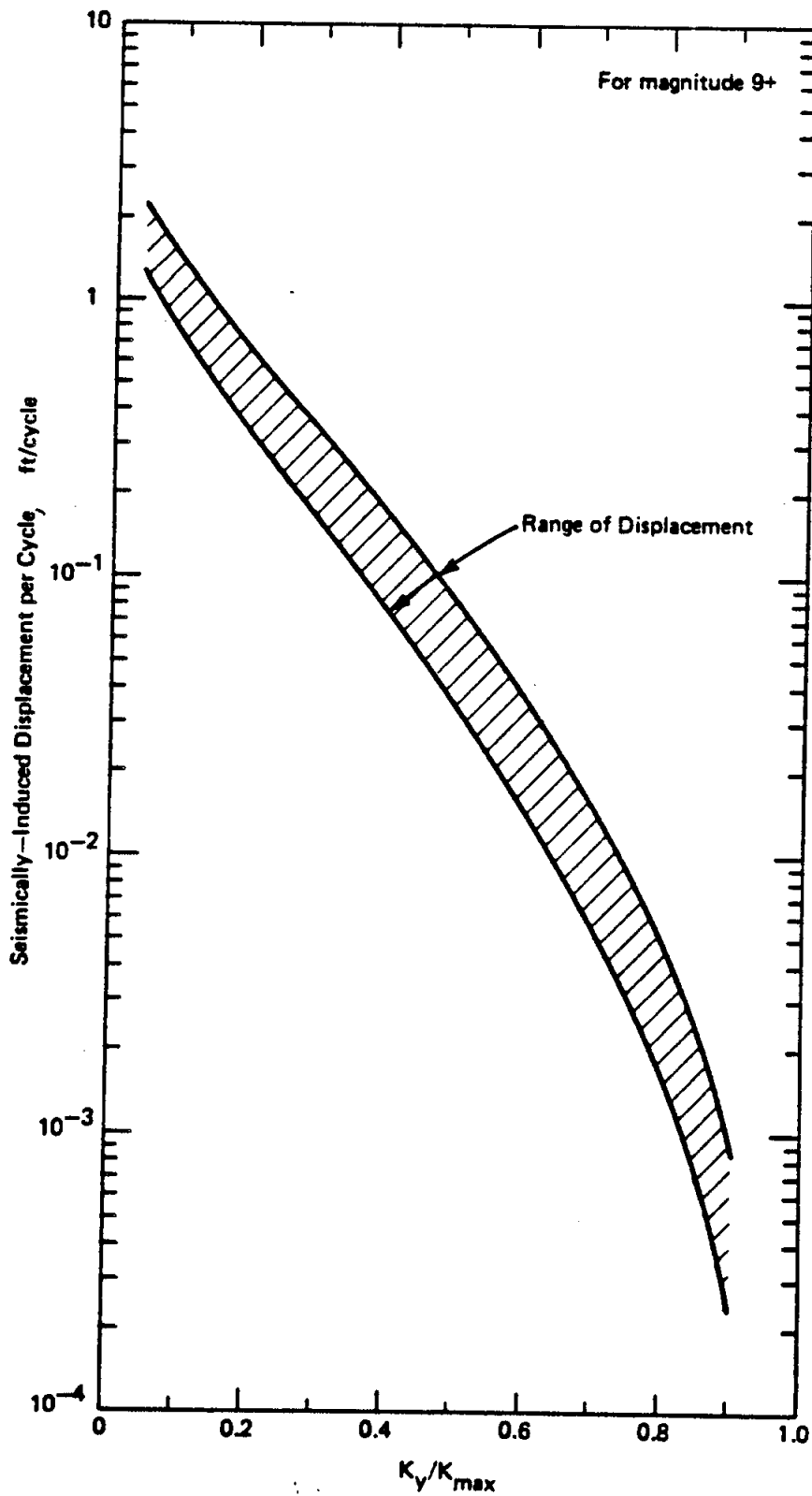

Project No.		SEISMICALLY-INDUCED DISPLACEMENT PER CYCLIC FOR MAGNITUDE 9+ EARTHQUAKES	Figure D-3
Woodward-Clyde Consultants			

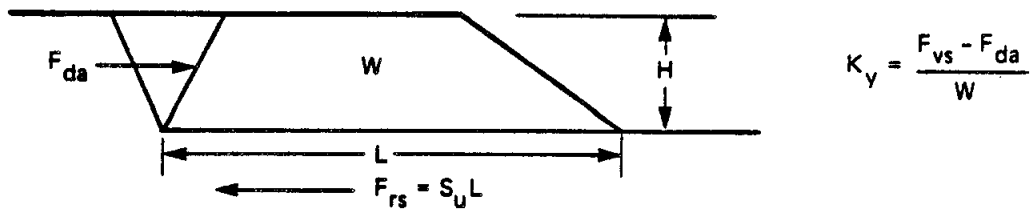

$S_u$  = Undrained Shear Strength

Initial  $S_u$  may be reduced by at most 25% due to cyclic loading as long as displacement is less than 0.5 ft; Initial  $S_u$  is reduced by 70% if displacement is more than 0.5 ft. (See Figure E-5)

$K_{max}$  = Maximum Seismic Coefficient

$K_{max}$  is proportional to  $a_{max i}$  (where  $a_{max i}$  is ith value of peak free-field surface acceleration)

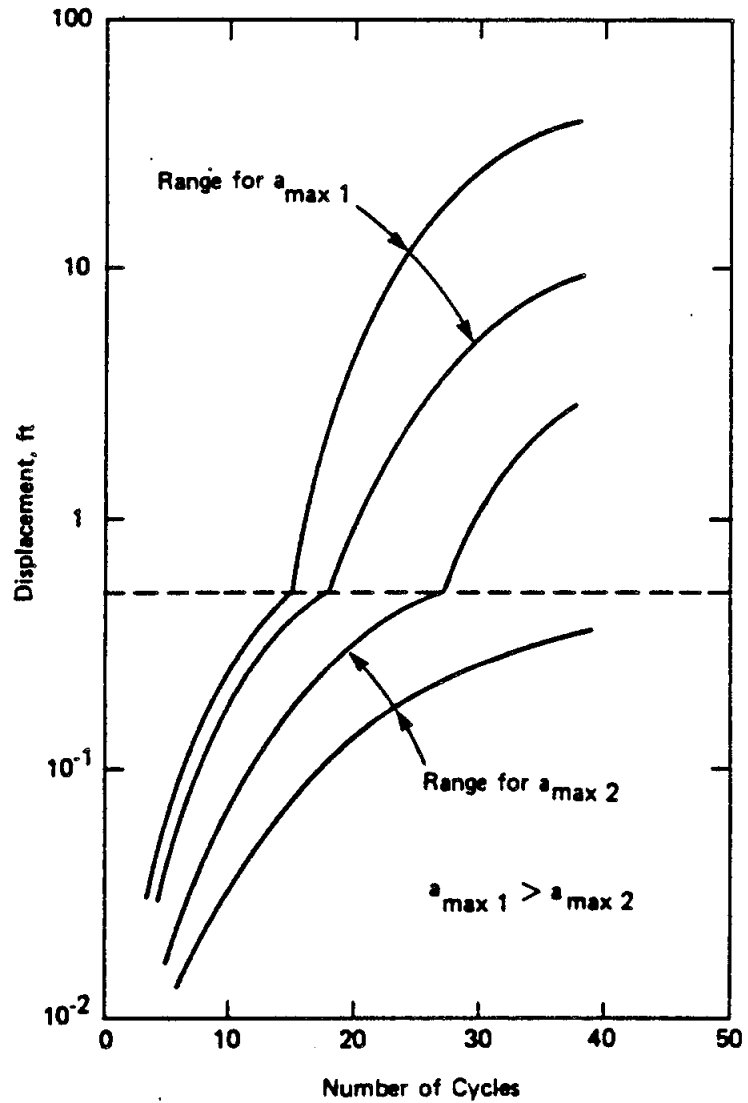

Project No.		SCHEMATIC SUMMARY OF DISPLACEMENT CALCULATIONS	Figure D-4
<b>Woodward-Clyde Consultants</b>			



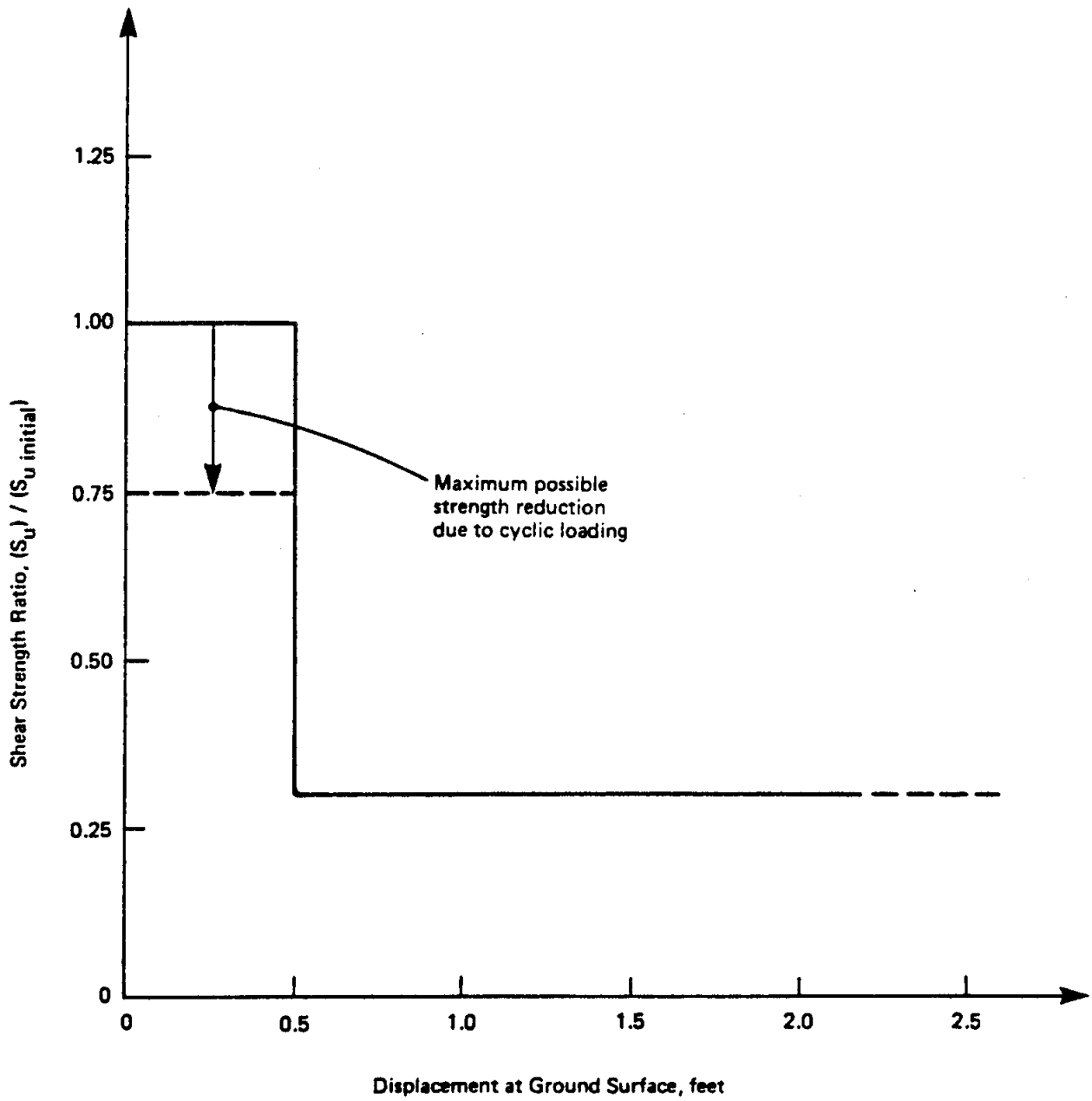

Project No.		IDEALIZED STRENGTH-DISPLACEMENT RELATIONSHIP FOR CLAYS	Figure D-5
Woodward-Clyde Consultants			

APPENDIX E

SELECTED CROSS-SECTIONS WITH  
CPT RESULTS

APPENDIX E  
SELECTED CROSS-SECTIONS WITH  
CPT RESULTS

The cross-sections identified as A-A, B-B, C-C, D-D, and E-E in Figure E-1 are shown in Figures E-2, E-4, E-5, E-6, and E-7, respectively, based only on the CPT results from this study and the studies by Updike and Ulery (1984) and Harding-Lawson Associates (1984). The cross-section A-A is also shown in Figure E-3 along with the appropriate boring logs from Shannon and Wilson (1964).

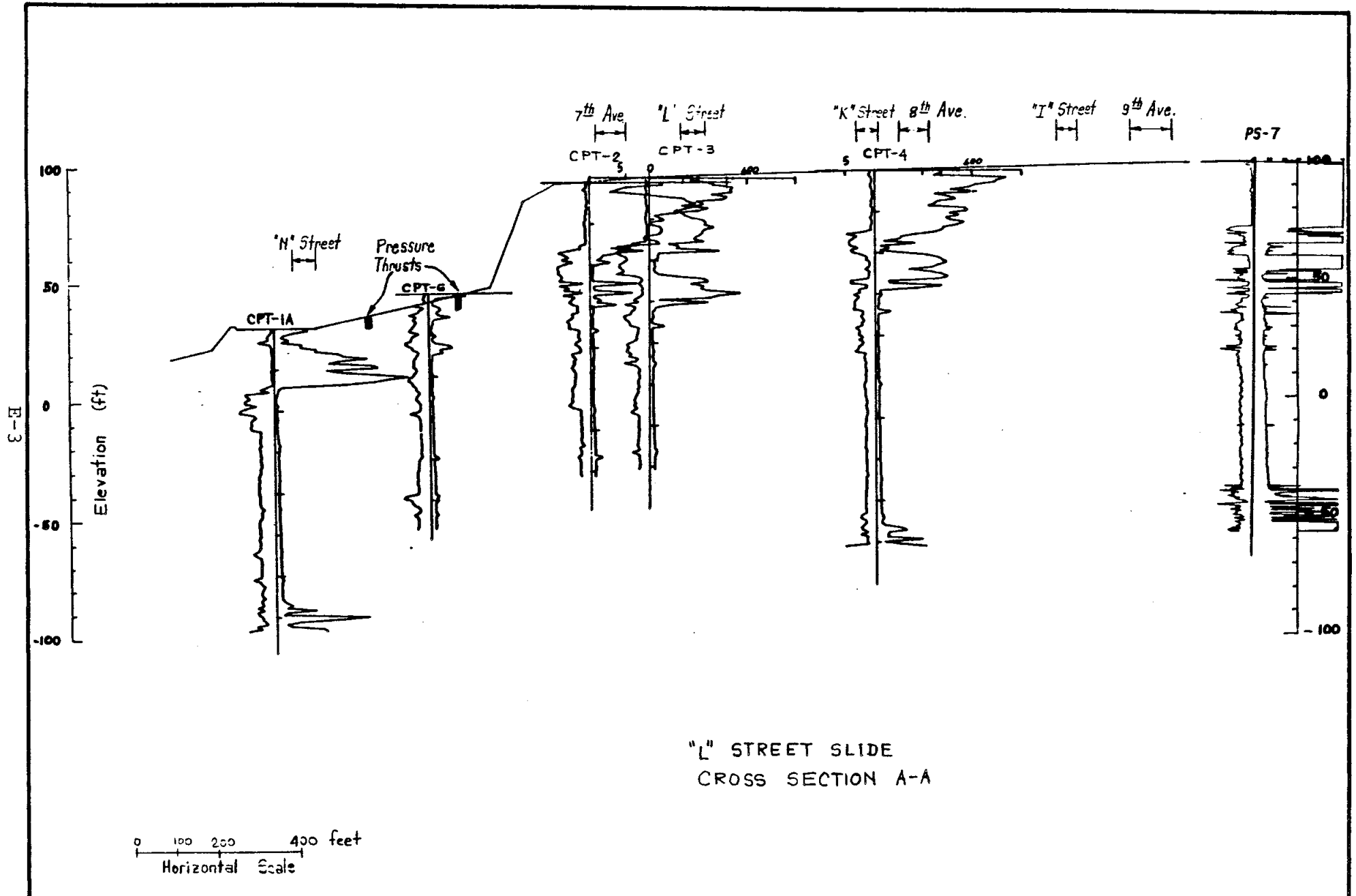

Project:  
Project No.

L STREET SLIDE CROSS SECTION A-A

Fig.  
E-2



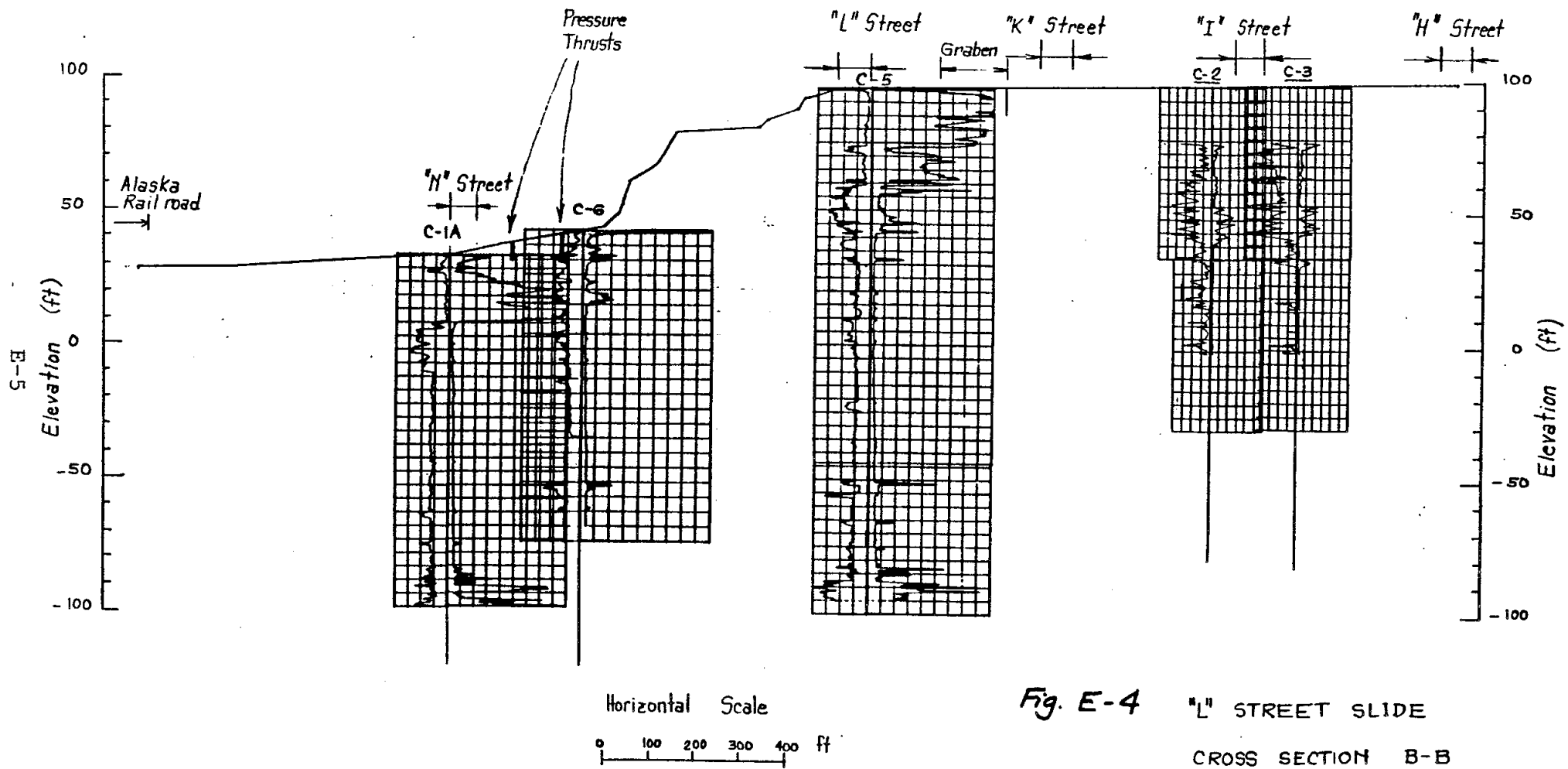
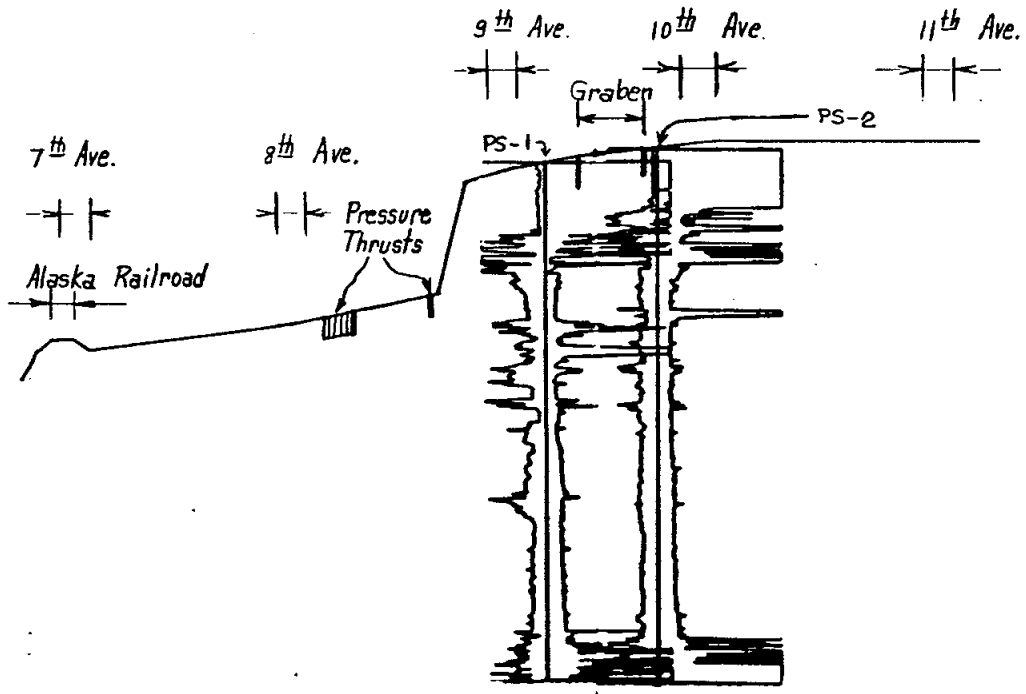

Fig. E-4 "L" STREET SLIDE  
CROSS SECTION B-B

9-E  
Elevation (ft)  
100  
50  
0  
-50  
-100



Elevation (ft)  
100  
50  
0  
-50  
-100

Horizontal Scale  
0 100 200 300 400 ft

Fig. E-5 "L" STREET SLIDE  
CROSS SECTION C-C

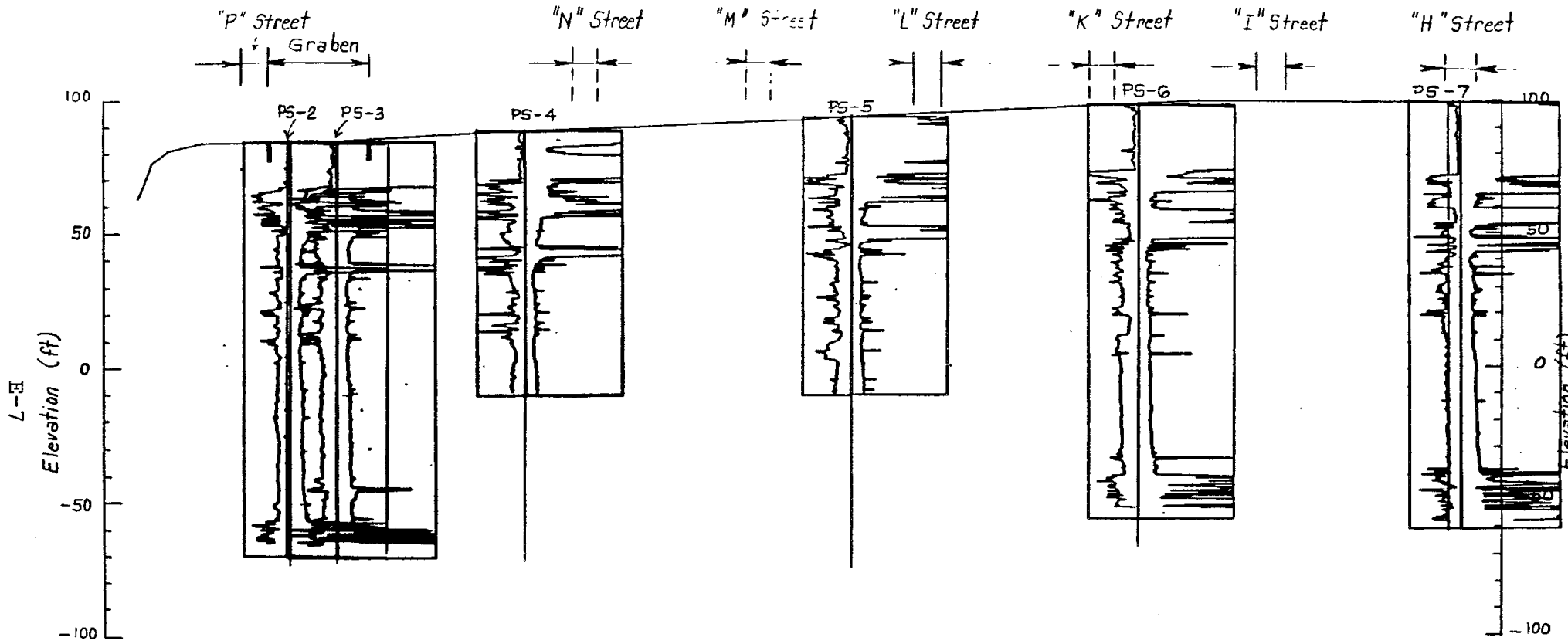
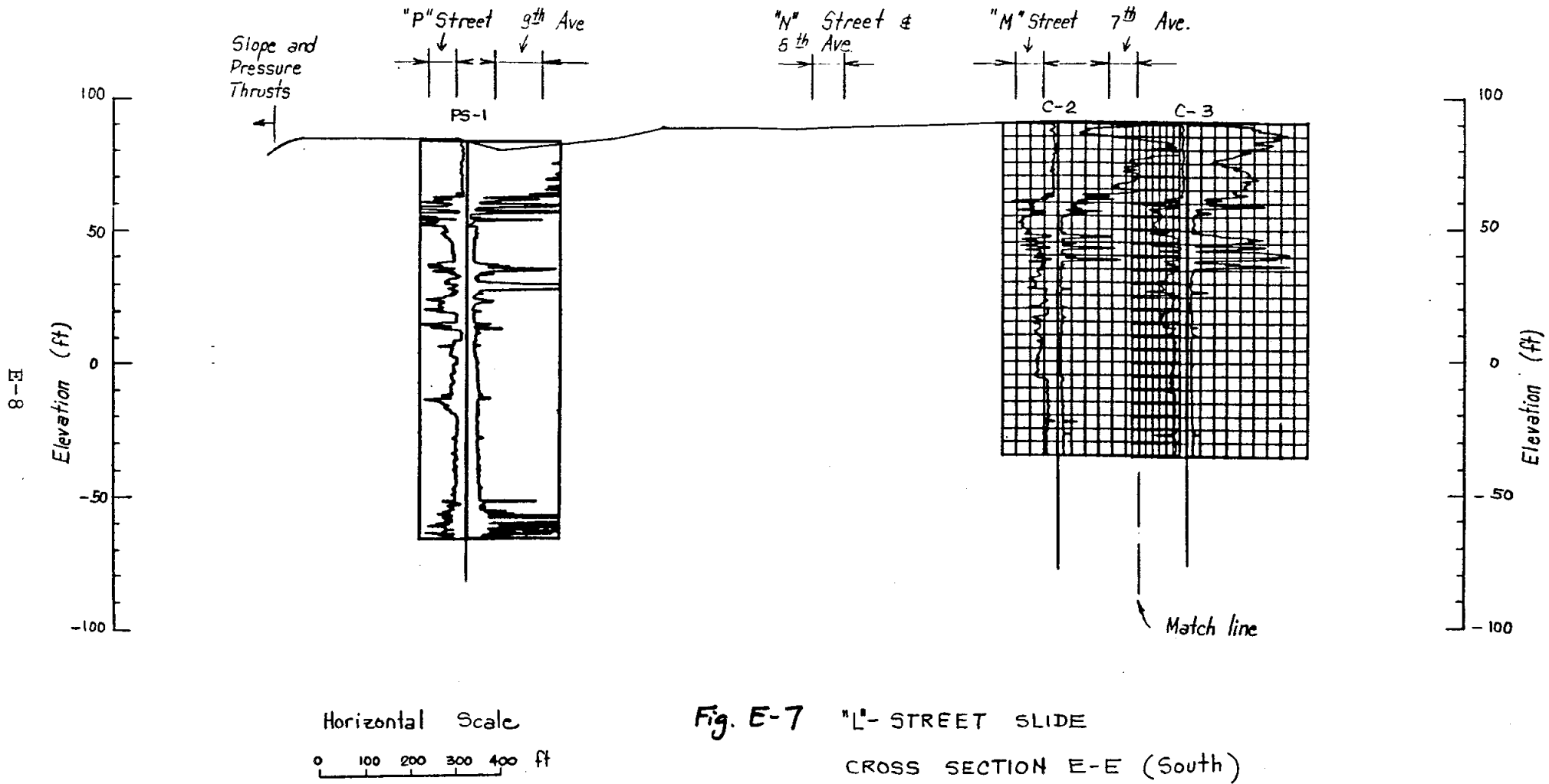

Fig. E-6 "L" STREET SLIDE  
CROSS SECTION D-D





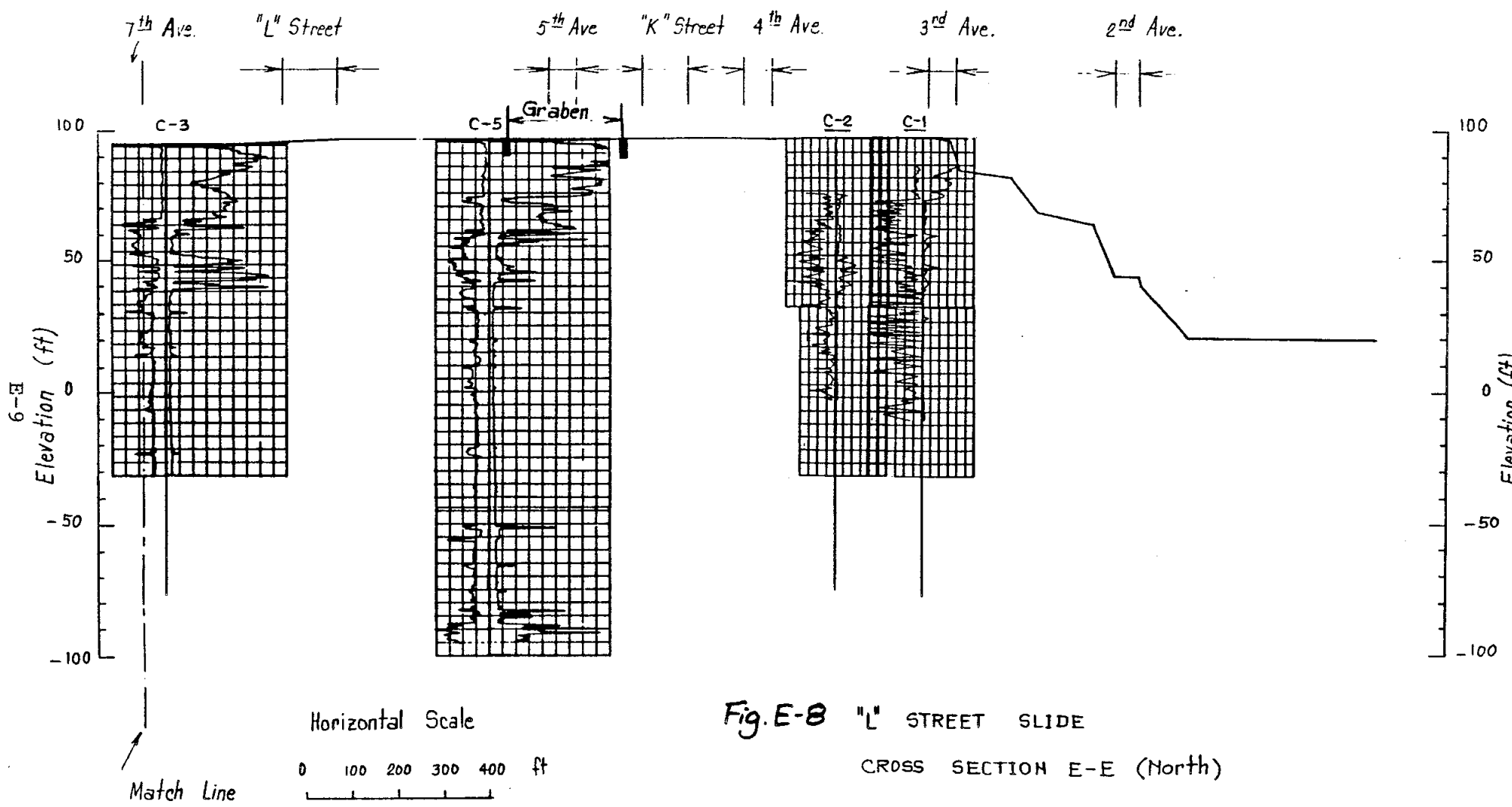

Fig. E-8 "L" STREET SLIDE  
 CROSS SECTION E-E (North)