

South Dakota Culvert Inlet Design Coefficients

FHWA-RD-01-076

JUNE 2001



U.S. Department of Transportation
Federal Highway Administration

Research, Development, and Technology
Turner-Fairbank Highway Research Center
6300 Georgetown Pike
McLean, VA 22101-2296

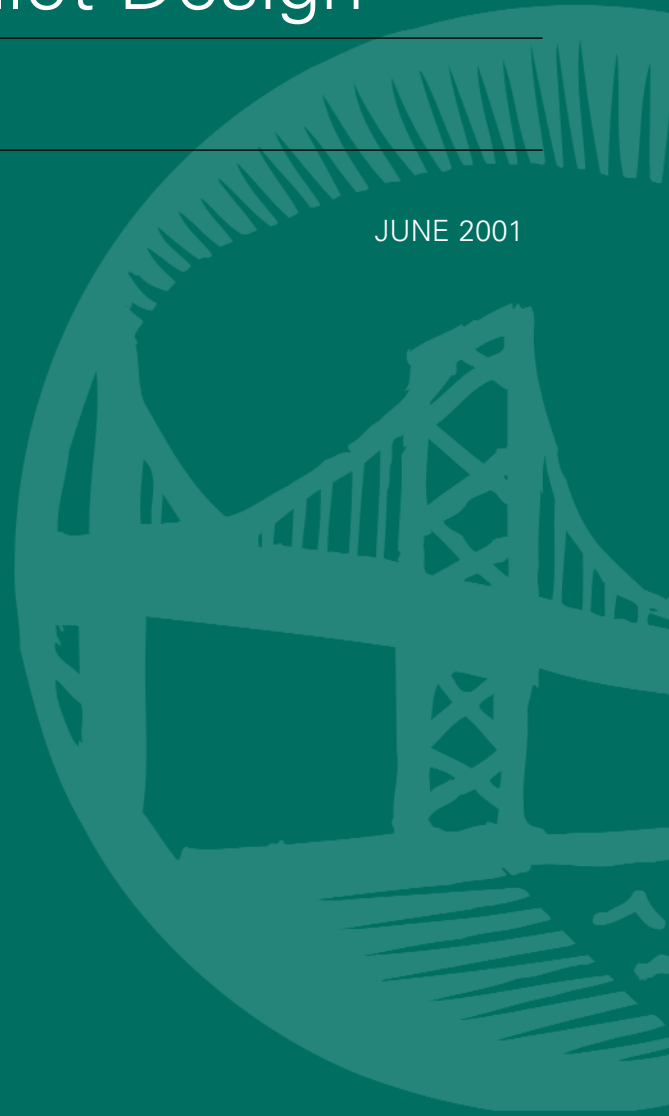



U.S. Department
of Transportation

**Federal
Highway
Administration**

Publication No. FHWA-RD-01-76

South Dakota

Culvert Inlet Design Coefficients

FOREWORD

This report documents a laboratory study that was done for the South Dakota DOT to develop hydraulic design coefficients for a commonly used precast box culvert end section. This report will be of interest to drainage engineers in several States where precast end sections are used. This report is being distributed as a web document only as a lab report from the TFHRC hydraulic laboratory.

T. Paul Teng, P.E.
Director, Office of Infrastructure
Research and Development

NOTICE

This document is disseminated under the sponsorship of the DOT in the interest of information exchange. The United States Government assumes no liability for its contents or use thereof. this report does not constitute a standard, specification, or regulation.

The United States Government does not endorse products or manufacturers. Trade and manufacturers' names appear in this report only because they are considered essential to the object of the document.

Technical Report Documentation Page

1. Report No. FHWA-RD-01-076	2. Government Accession No.	3. Recipient's Catalog No.	
4. Title and Subtitle SOUTH DAKOTA CULVERT INLET DESIGN COEFFICIENTS		5. Report Date	
		6. Performing Organization Code	
		8. Performing Organization Report No.	
7. Author(s) Frank Graziano, Stuart Stein, Ed Umbrell, and Brett Martin		10. Work Unit No. (TRAIS) 3D3b2152 11. Contract or Grant No. DTFH61-95-C-00066 13. Type of Report and Period Covered Final Report November 1995 - February 1996 14. Sponsoring Agency Code	
9. Performing Organization Name and Address GKY and Associates, Inc. 5411-E Backlick Road Springfield, VA 22151			
12. Sponsoring Agency Name and Address Office of Infrastructure Research and Development Federal Highway Administration 6300 Georgetown Pike McLean, VA 22101-2296			
15. Supplementary Notes Contracting Officer's Technical Representative (COTR): J. Sterling Jones, HRDI Contributors: Rich Phillips and Jon Becker, South Dakota Department of Transportation			
16. Abstract <p>Each year, the South Dakota Department of Transportation builds a number of box culverts through its highway construction program. In the past, cast-in-place box culverts were used exclusively; however, use of precast box culverts is becoming a viable option. The cast-in-place culverts feature 30-degree flared wingwalls and a beveled top edge. The precast culverts have a 0-degree flare and a constant 4-in (101.6-mm) bevel (regardless of barrel size) along the top of the wingwalls and the top edge of the culvert entrance.</p> <p>This report summarizes model testing performed on the above culvert shapes for the purpose of developing design coefficients for both inlet and outlet control. The most efficient configuration tested was the model of the cast-in-place box culvert.</p>			
17. Key Words Culverts, culvert design coefficients, inlet control, outlet control, hydraulic design.		18. Distribution Statement No restrictions. This document is available to the public through the National Technical Information Service (NTIS), Springfield, VA 22161	
19. Security Classif. (of this report) Unclassified	20. Security Classif. (of this page) Unclassified	21. No. of Pages 67	22. Price

SI* (MODERN METRIC) CONVERSION FACTORS

APPROXIMATE CONVERSIONS TO SI UNITS					APPROXIMATE CONVERSIONS FROM SI UNITS				
Symbol	When You Know	Multiply By	To Find	Symbol	Symbol	When You Know	Multiply By	To Find	Symbol
LENGTH					LENGTH				
in	inches	25.4	millimeters	mm	mm	millimeters	0.039	inches	in
ft	feet	0.305	meters	m	m	meters	3.28	feet	ft
yd	yards	0.914	meters	m	m	meters	1.09	yards	yd
mi	miles	1.61	kilometers	km	km	kilometers	0.621	miles	mi
AREA					AREA				
in ²	square inches	645.2	square millimeters	mm ²	mm ²	square millimeters	0.0016	square inches	in ²
ft ²	square feet	0.093	square meters	m ²	m ²	square meters	10.764	square feet	ft ²
yd ²	square yards	0.836	square meters	m ²	m ²	square meters	1.195	square yards	yd ²
ac	acres	0.405	hectares	ha	ha	hectares	2.47	acres	ac
mi ²	square miles	2.59	square kilometers	km ²	km ²	square kilometers	0.386	square miles	mi ²
VOLUME					VOLUME				
fl oz	fluid ounces	29.57	milliliters	mL	mL	milliliters	0.034	fluid ounces	fl oz
gal	gallons	3.785	liters	L	L	liters	0.264	gallons	gal
ft ³	cubic feet	0.028	cubic meters	m ³	m ³	cubic meters	35.71	cubic feet	ft ³
yd ³	cubic yards	0.765	cubic meters	m ³	m ³	cubic meters	1.307	cubic yards	yd ³
MASS					MASS				
oz	ounces	28.35	grams	g	g	grams	0.035	ounces	oz
lb	pounds	0.454	kilograms	kg	kg	kilograms	2.202	pounds	lb
T	short tons (2000 lb)	0.907	megagrams (or "metric ton")	Mg (or "t")	Mg (or "t")	megagrams (or "metric ton")	1.103	short tons (2000 lb)	T
TEMPERATURE (exact)					TEMPERATURE (exact)				
°F	Fahrenheit temperature	5(F-32)/9 or (F-32)/1.8	Celsius temperature	°C	°C	Celsius temperature	1.8C + 32	Fahrenheit temperature	°F
ILLUMINATION					ILLUMINATION				
fc	foot-candles	10.76	lux	lx	lx	lux	0.0929	foot-candles	fc
fl	foot-Lamberts	3.426	candela/m ²	cd/m ²	cd/m ²	candela/m ²	0.2919	foot-Lamberts	fl
FORCE and PRESSURE or STRESS					FORCE and PRESSURE or STRESS				
lbf	poundforce	4.45	newtons	N	N	newtons	0.225	poundforce	lbf
lbf/in ²	poundforce per square inch	6.89	kilopascals	kPa	kPa	kilopascals	0.145	poundforce per square inch	lbf/in ²

* SI is the symbol for the International System of Units. Appropriate rounding should be made to comply with Section 4 of ASTM E380.

Table of Contents

1. PROBLEM STATEMENT	1
2. EXPERIMENTAL SETUP	1
3. MODEL RUNS	7
4. DATA ANALYSIS	7
5. RESULTS	12
6. DISCUSSION	12
APPENDIX A. REGRESSION PLOTS	15
APPENDIX B. COMPARISON PLOTS	31
APPENDIX C. SPREADSHEETS OF DATA ANALYSIS FOR RUNS	41
REFERENCES	63

List of Figures

Figure 1.	Sketch of South Dakota cast-in-place culvert inlet, 30-degree wingwall flare (tested by culvert model 3).	2
Figure 2.	Schematic of the South Dakota precast culvert end section, 6-ft x 6-ft (1.8-m x 1.8-m) box (tested by culvert model 5).	3
Figure 3.	Schematic of the South Dakota precise culvert end section, 8-ft x 8-ft (2.4-m x 2.4-m) box.	4
Figure 4.	Schematic of the South Dakota precise culvert end section, 12-ft x 12-ft (3.7-m x 3.7-m) box (tested by culvert model 6).	5
Figure 5.	Sketch of experimental setup.	6
Figure 6.	Culvert model 1, HDS-5 chart 8, scale 3.	9
Figure 7.	Culvert model 2, 3:1 wingwall miter.	9
Figure 8.	Culvert model 3, cast-in-place, 30-degree wingwall flare.	10
Figure 9.	Culvert model 5, 6 ft x 6 ft precast, 0-degree wingwall flare.	10
Figure 10.	Culvert model 6, 12-ft x 12-ft (3.7-m x 3.7-m) precast, 0-degree wingwall flare.	11
Figure 11a.	Regression line vs. data, unsubmerged conditions, culvert model 1, run 39.	15
Figure 11b.	Regression line vs. data, submerged conditions, culvert model 1, run 39.	16
Figure 11c.	Regression line vs. data, unsubmerged conditions, culvert model 2, run 40.	17
Figure 11d.	Regression line vs. data, submerged conditions, culvert model 2, run 40.	18
Figure 11e.	Regression line vs. data, unsubmerged conditions, culvert model 3, run 33.	19
Figure 11f.	Regression line vs. data, submerged conditions, culvert model 3, run 33.	20
Figure 11g.	Regression line vs. data, unsubmerged conditions, culvert model 3, run 32.	21
Figure 11h.	Regression line vs. data, submerged conditions, culvert model 3, run 32.	22
Figure 11i.	Regression line vs. data, unsubmerged conditions, culvert model 4, run 34.	23
Figure 11j.	Regression line vs. data, submerged conditions, culvert model 4, run 34.	24
Figure 11k.	Regression line vs. data, unsubmerged conditions, culvert model 5, run 43.	25
Figure 11l.	Regression line vs. data, submerged conditions, culvert model 5, run 43.	26
Figure 11m.	Regression line vs. data, unsubmerged conditions, culvert model 5, run 12.	27
Figure 11n.	Regression line vs. data, submerged conditions, culvert model 5, run 12.	28
Figure 11o.	Regression line vs. data, unsubmerged conditions, culvert model 6, run 42.	29
Figure 11p.	Regression line vs. data, submerged conditions, culvert model 6, run 42.	30
Figure 12a.	Benchmark test, unsubmerged conditions.	31
Figure 12b.	Benchmark test, submerged conditions.	32
Figure 13a.	Effect of wingwall miter, unsubmerged conditions.	33
Figure 13b.	Effect of wingwall miter, submerged conditions.	34
Figure 14a.	Effect of constant bevel, unsubmerged conditions.	35
Figure 14b.	Effect of constant bevel, submerged conditions.	36
Figure 15a.	Effect of barrel slope, unsubmerged conditions.	37
Figure 15b.	Effect of barrel slope, submerged conditions.	38
Figure 16a.	Effect of configuration, unsubmerged conditions.	39
Figure 16b.	Effect of configuration, submerged conditions.	40

List of Tables

Table 1. Model run test matrix.....	8
Table 2. Summary of culvert inlet design coefficients	13

1. PROBLEM STATEMENT

Each year, the South Dakota Department of Transportation (DOT) builds a number of box culverts through its highway construction program. In the past, cast-in-place box culverts were used exclusively, but use of precast box culverts is becoming a viable option. The cast-in-place box culverts feature a beveled top edge and 30-degree flared wingwalls. A sketch of the cast-in-place culvert is shown in figure 1. The precast box culverts that are available from the South Dakota precast industry have wingwalls with a 0-degree flare (basically extensions of the culvert sides) and are mitered at a slope of 2:1. The precast inlets also come with a standard 4-in (101.6-mm) (regardless of barrel size) beveled edge along the bottom of the top edge of the inlet opening and along the top inside edges of the wingwalls. The precast sections follow the Minnesota DOT standards. Schematics of three precast inlet sizes, including 6-ft x 6-ft, 8-ft x 8-ft, and a 12-ft x 12-ft (1.8-m x 1.8-m, 2.4-m x 2.4-m, and 3.7-m x 3.7-m) box culvert, are shown in figures 2, 3, and 4.

Currently, design coefficients for the precast inlet configurations described above are not available due to a lack of model testing. To aid the South Dakota DOT in comparing the performance, and therefore cost-effectiveness, of the precast versus cast-in-place culvert inlets, culvert model experiments were undertaken at the Federal Highway Administration's Turner-Fairbank Highway Research Center located in McLean, Virginia.

2. EXPERIMENTAL SETUP

All tests were conducted in an apparatus designed and built specifically for testing model culverts. The basic components of the apparatus, as shown in figure 5, consisted of a headbox connected by a model culvert barrel to a tailbox. All of the components, the dimensions of which are shown in figure 5, were constructed of 3/4-in (19.1-mm) plywood.

Water entered the headbox in a direction perpendicular to the centerline of the culvert barrel. Toward the rear of the headbox, between the inflow pipe and the culvert inlet, a weir was installed to produce a uniform flow field across the cross-section of the headbox. After passing over the weir, the water flowed under a sheet of plywood tied loosely to the sides of the headbox. The plywood, which was free to float on the surface of the water, acted as a wave suppressor. Water then entered the culvert inlet.

After passing through the culvert barrel, water flowed into the tailbox where it was routed into a sump. The tailbox had an adjustable tailgate that allowed backwater to be created for the model runs investigating culverts operating under outlet control conditions.

Water depths in the culvert system were measured through ports in the plywood floor that were hydraulically connected via 1/8-in (3.2-mm) Tygon tubing to a pressure transducer. A valve manifold enabled each port to be isolated and the water depth to be measured via a commercially available data gathering/analysis software package. The transducer was calibrated daily prior to the conducting of the experiments.

Model inlets, which were constructed of either 1/2- or 3/4-in (12.7- or 19.1-mm) acrylic, were attached to an extension of the culvert barrel that protruded through the wall of the headbox. The sides of the model inlets were backfilled with gravel.

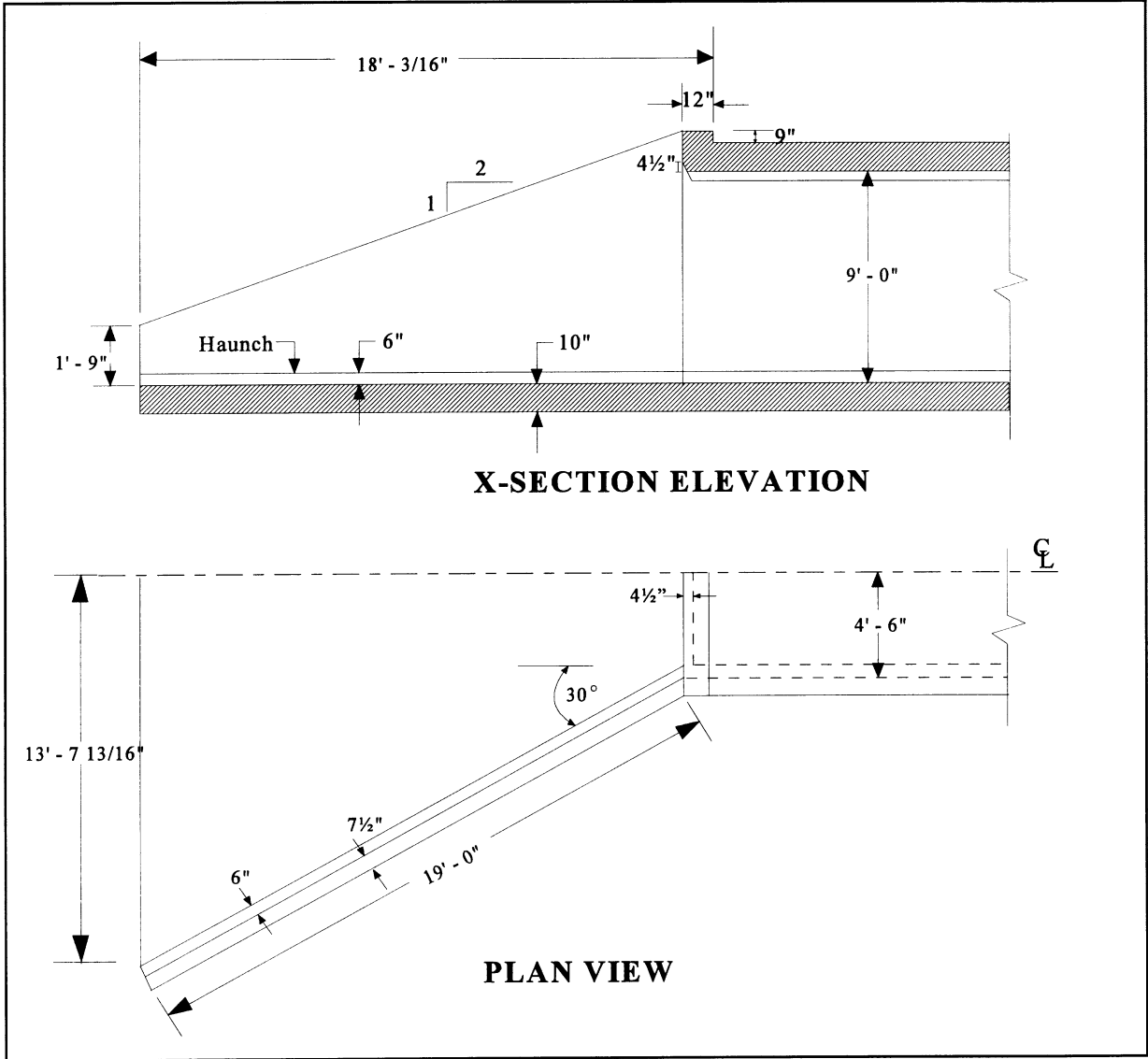

1 in = 25.4 mm, 1 ft = 0.305 m

Figure 1. Sketch of South Dakota cast-in-place culvert inlet, 30-degree wingwall flare (tested by culvert model 3).

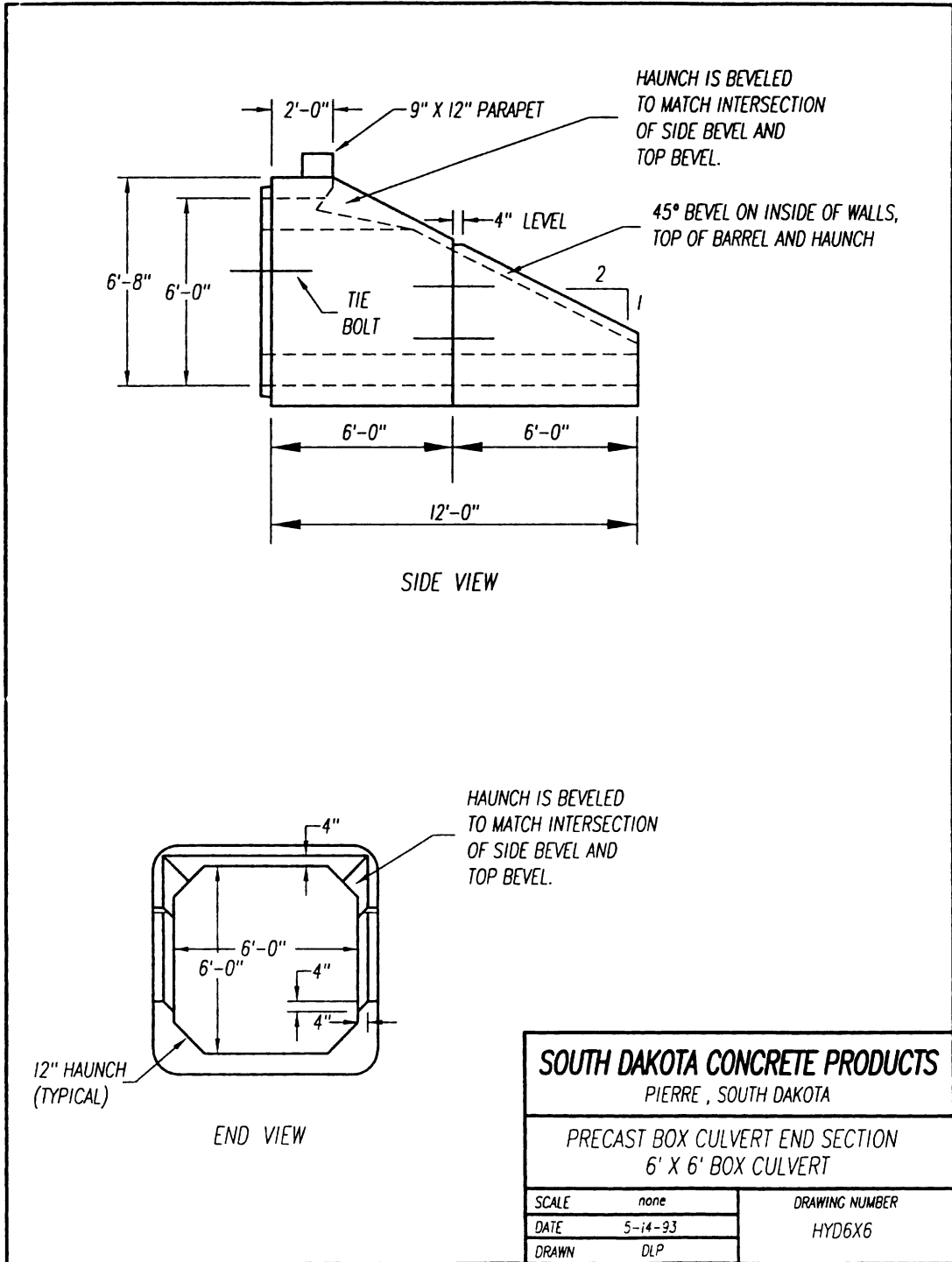

1 in = 25.4 mm, 1 ft = 0.305 m

Figure 2. Schematic of the South Dakota precast culvert end section, 6-ft x 6-ft (1.8-m x 1.8-m) box (tested by culvert model 5).

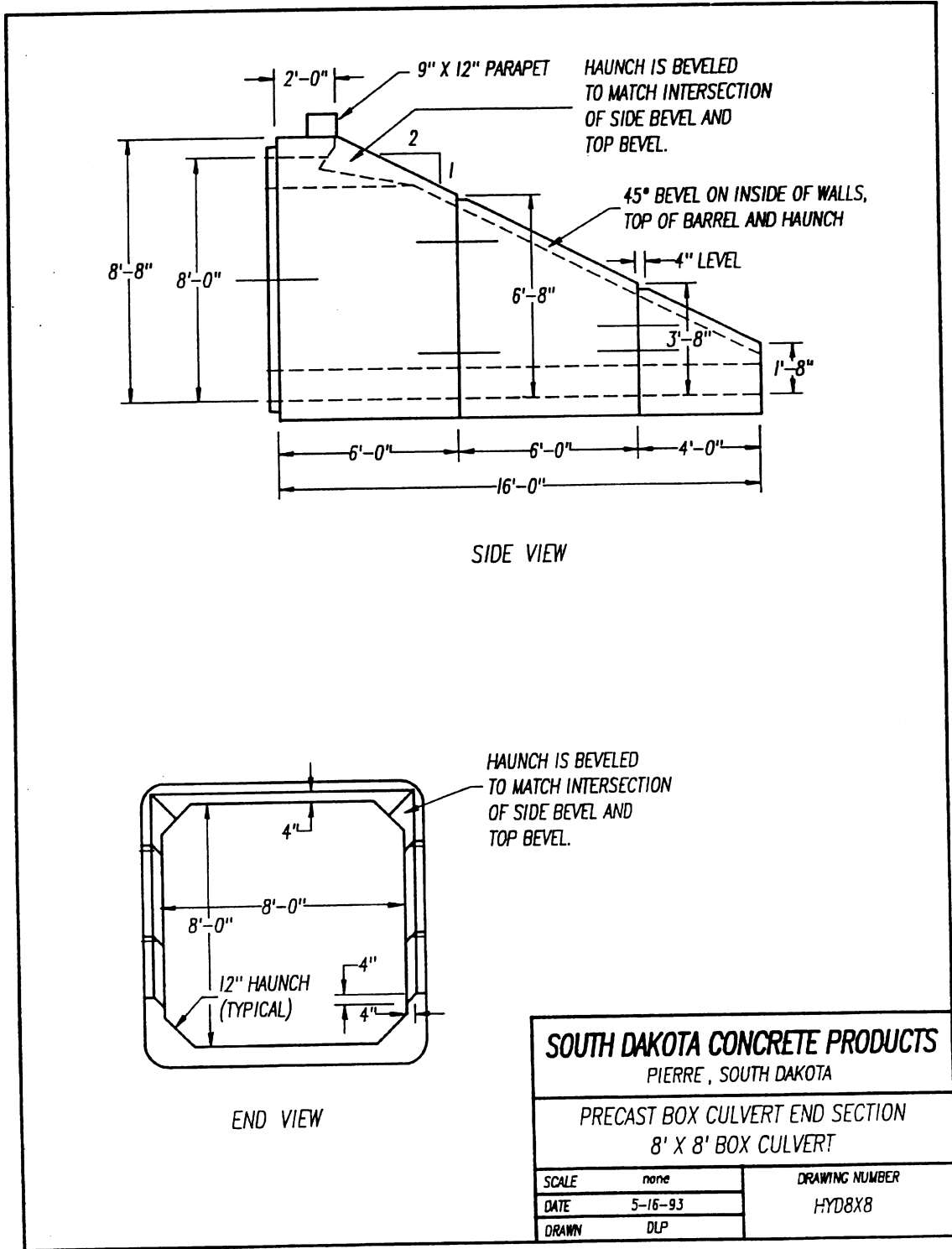

1 in = 25.4 mm, 1 ft = 0.305 m

Figure 3. Schematic of the South Dakota precise culvert end section, 8-ft x 8-ft (2.4-m x 2.4-m) box.

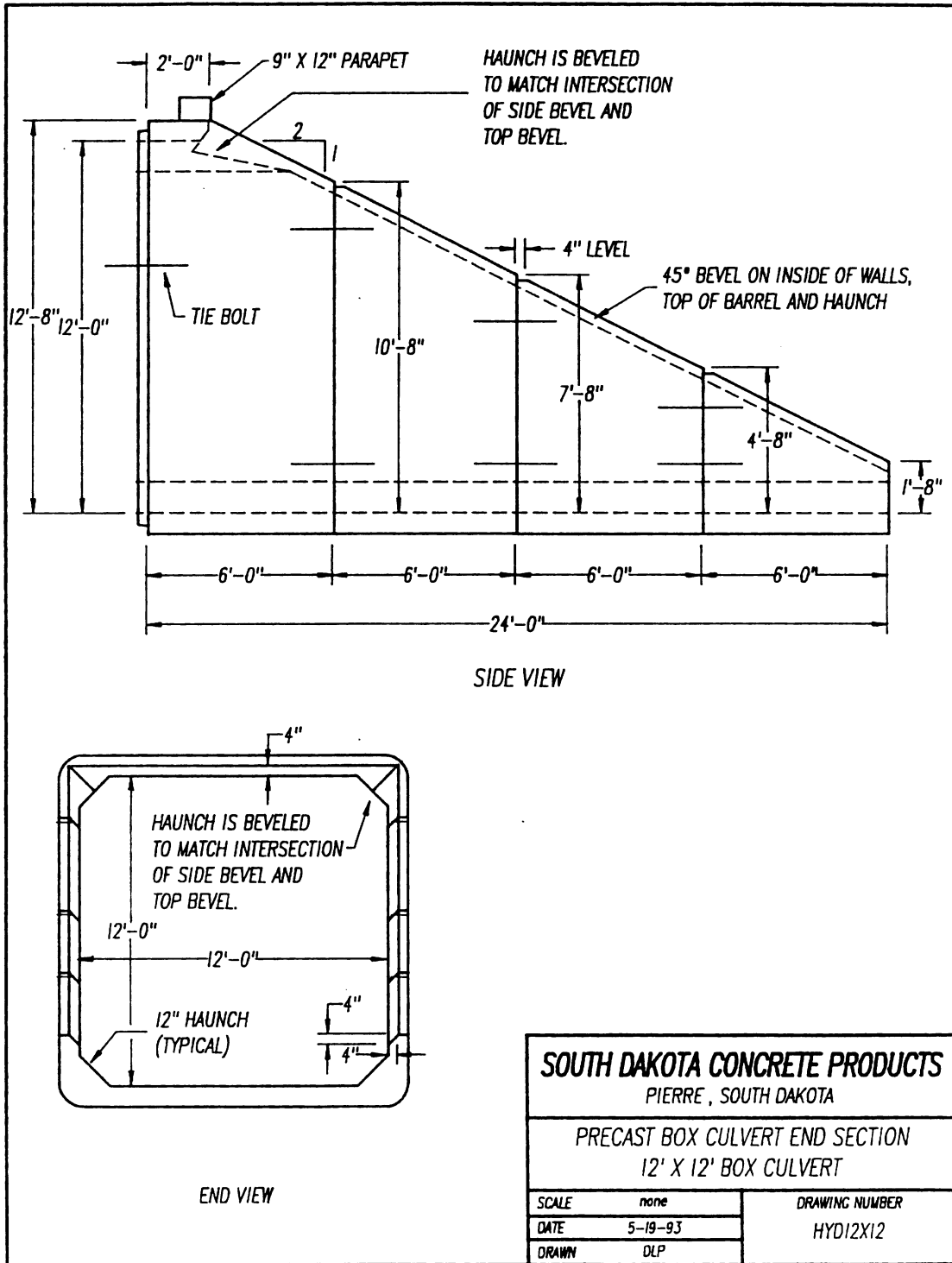

1 in = 25.4 mm, 1 ft = 0.305 m

Figure 4. Schematic of the South Dakota precise culvert end section, 12-ft x 12-ft (3.7-m x 3.7-m) box (tested by culvert model 6).

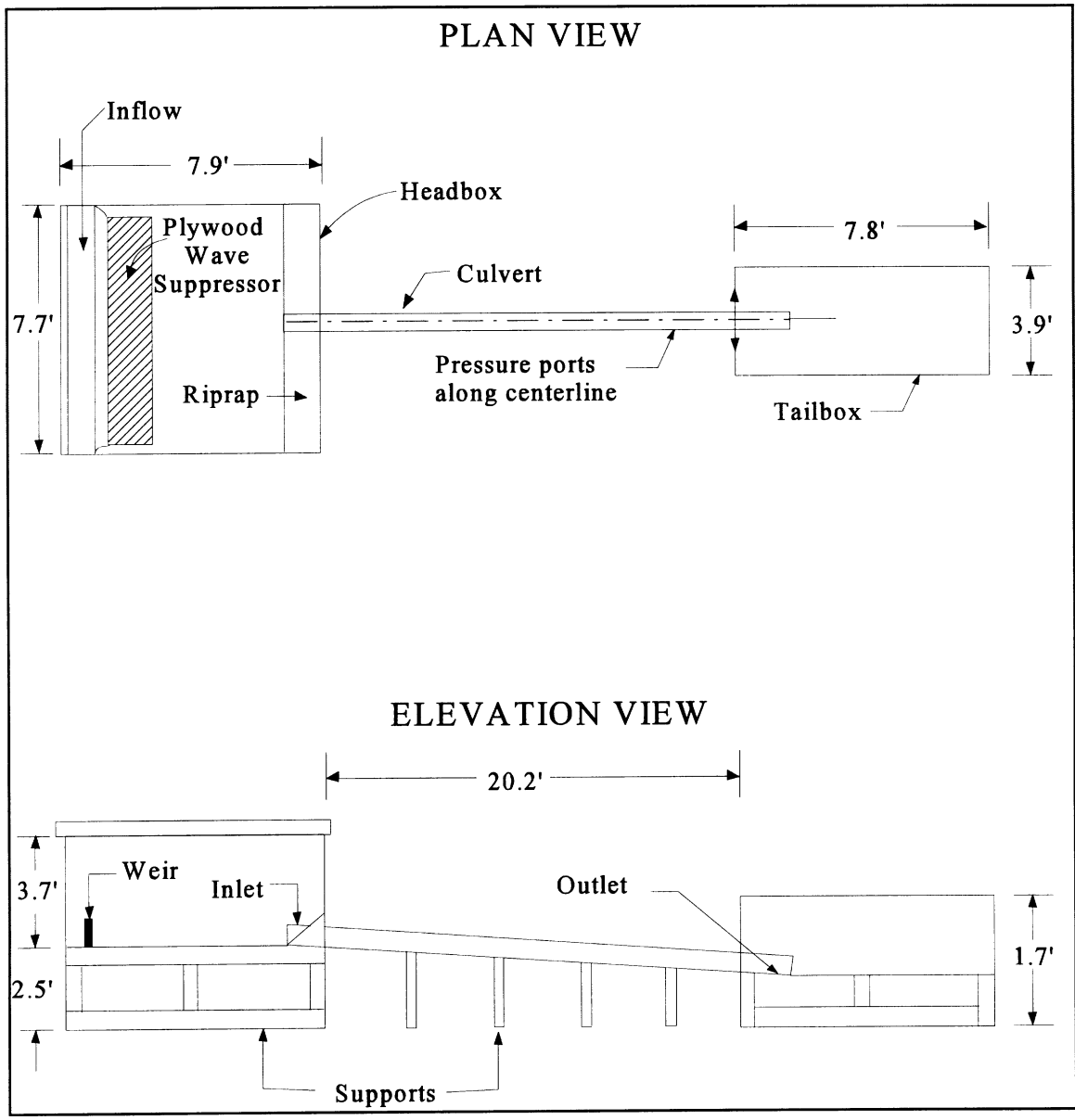

1 in = 25.4 mm, 1 ft = 0.305 m

Figure 5. Sketch of experimental setup.

3. MODEL RUNS

A test matrix was developed, in coordination with South Dakota DOT personnel, to investigate the effect of the following:

- Wingwall flare.
- Constant bevel height, regardless of culvert size.
- Wingwall miter slope.
- Parapets.
- Culvert barrel slope.

Table 1 details the culvert models tested in this study. Culvert model dimensions were developed from the dimensions shown in figures 1 through 4 with the appropriate scaling factor (as shown in table 1) applied. Photographs of each of the culvert models (including models 1, 2, 3, 5, and 6) are shown in figures 6 through 10, respectively. Note that culvert model 5 is shown installed in the headbox and that culvert model 4, which is not shown, is simply culvert model 5 without the parapet. Each culvert was tested under both inlet and outlet control conditions.

4. DATA ANALYSIS

Inlet Control

Design coefficients were developed by performing regressions of experimental data. For inlet control, unsubmerged conditions, design coefficients K and M were developed using Form 2 of the inlet control design equations (Normann, 1985) for each of the culvert models:

$$FORM\ 2 \quad \frac{HW}{D} = K \left[\frac{Q}{AD^{0.5}} \right]^M$$

Where:

- HW = headwater, ft.
- D = culvert barrel rise, ft.
- A = cross-sectional area of culvert barrel, ft².
- Q = flow, ft³/s.
- K, M = design coefficients.

Table 1. Model run test matrix.

	<i>Description</i>	<i>Model Culvert Parameters</i>							
		<i>Edge Type</i>	<i>Wingwall Flare</i>	<i>Wingwall Miter</i>	<i>Rise, D (ft)</i>	<i>Barrel Slope (ft/ft)</i>	<i>Wall Thickness (ft)</i>	<i>Bevel Height (ft)</i>	<i>Model Scale</i>
1	Rectangular; benchmark run; compares to HDS-5 Chart 8/3	Square	0E	2:1	0.5625	0.03	0.0625	NA*	1:10.67
2	Rectangular	Square	0E	3:1	0.5625	0.03	0.0625	NA	1:10.67
3	Rectangular with haunches and parapet; South Dakota cast-in-place model	Top edge beveled	30E	2:1	0.6042	0.03, 0.0175	0.0417	0.0250	1:15
4	Rectangular with haunches; South Dakota precast model of 6-ft x 6-ft box w/o parapet	Wingwall and top edge beveled	0E	2:1	0.5625	0.03	0.0625	0.0313	1:10.67
5	Rectangular with haunches and parapet; South Dakota precast model of 6-ft x 6-ft box	Wingwall and top edge beveled	0E	2:1	0.5625	0.03, 0.0175	0.0625	0.0313	1:10.67
6	Rectangular with haunches; South Dakota precast model of 12-ft x 12-ft box w/o parapet	Wingwall and top edge beveled	0E	2:1	0.75	0.03	0.0417	0.0208	1:16

* NA = Not applicable

1 ft = 0.305 m



Figure 6. Culvert model 1, HDS-5 chart 8, scale 3.

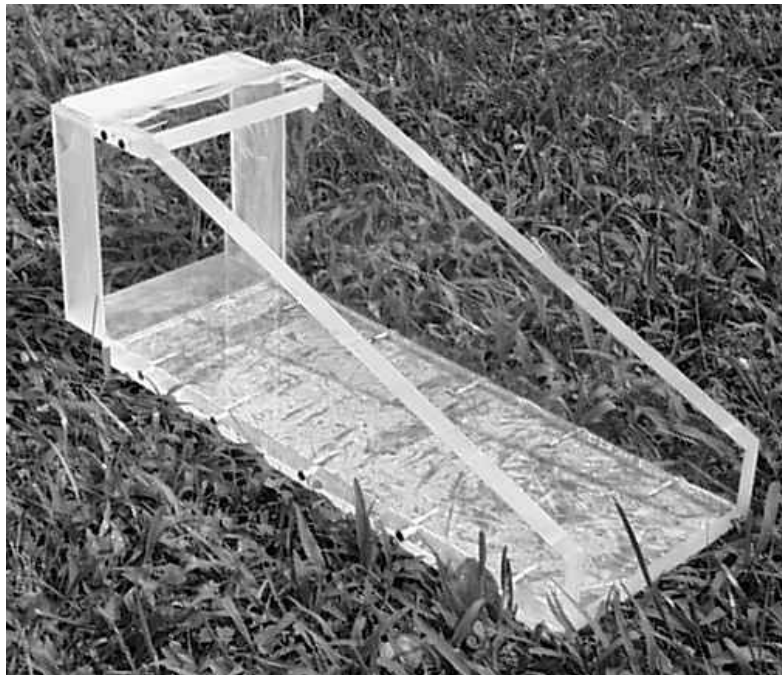

Figure 7. Culvert model 2, 3:1 wingwall miter.

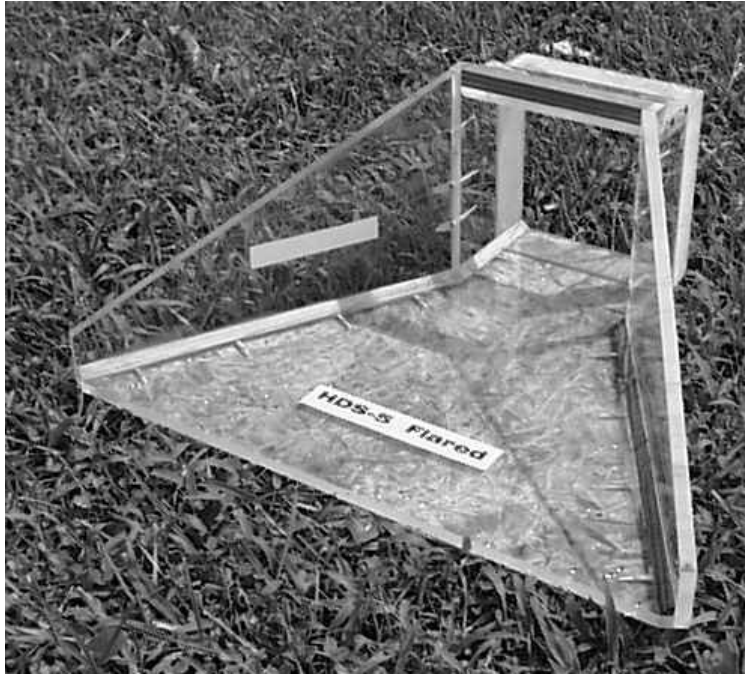

Figure 8. Culvert model 3, cast-in-place, 30-degree wingwall flare.



Figure 9. Culvert model 5, 6 ft x 6 ft precast, 0-degree wingwall flare.

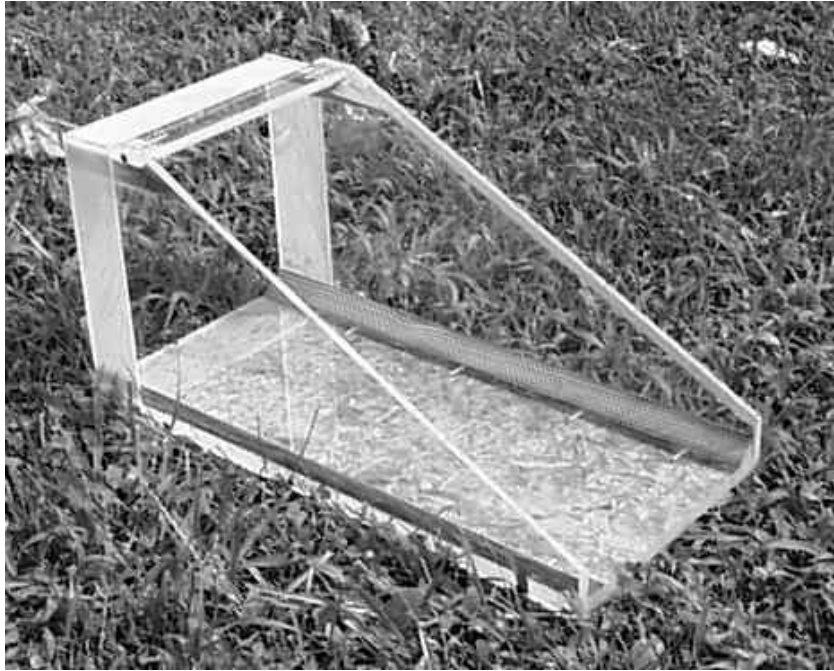

Figure 10. Culvert model 6, 12-ft x 12-ft (3.7-m x 3.7-m) precast, 0-degree wingwall flare.

For culvert model 1, design coefficients K and M were also developed using Form 1 of the culvert inlet design equations (Normann, 1985) to allow for a direct comparison to HDS-5:

$$FORM\ 1 \quad \frac{HW}{D} = \frac{H_c}{D} + K \left[\frac{Q}{AD^{0.5}} \right]^M + 0.7S$$

Where:

- H_c = specific head at critical depth, ft.
- S = slope, ft/ft.
- 0.7 = slope correction factor for mitered wingwalls.

For inlet control under submerged conditions, design coefficients c and Y were determined using Form 3 of the inlet control design equations (Normann, 1985) for each of the culvert models tested:

$$FORM\ 3 \quad \frac{HW}{D} = c \left[\frac{Q}{AD^{0.5}} \right]^2 + Y + 0.7S$$

Where:

- c, Y = design coefficients.

Outlet Control

The entrance loss coefficient under outlet control, K_e , was calculated for each culvert model using the following equation:

$$H_e = K_e \left[\frac{V^2}{2g} \right]$$

Where:

- H_e = entrance loss, ft.
- V = velocity, ft/s.
- g = gravity, ft/s².
- K_e = entrance loss coefficient.

5. RESULTS

A summary of the design coefficients developed for each of the model runs is presented in table 2. Where appropriate, design coefficients for a similar configuration in HDS-5 are included. Spreadsheets of the data analysis for each of the listed runs is presented in Appendix A.

Plots of the regression lines developed from the experimental data for each of the runs presented in table 2 are shown in figures 11a through 11p. Included on the plots are the individual data points, as well as the line representing the region over which the regression coefficients were developed. Plots of the design curves for culvert model 1 versus Hydraulic Design Series No. 5 (HDS-5), chart 8, scale 3 are presented in figures 12a and 12b. Figures 13a through 16b were developed to compare the effects of various experimental parameters, including:

- Wingwall miter.
- Constant bevel.
- Culvert barrel slope.
- Inlet configuration (wingwall flare, wingwall miter, and parapets).

6. DISCUSSION

Inlet Control

A comparison between the experimental results and HDS-5 for culvert model 1 is shown in figures 12a and 12b for unsubmerged and submerged conditions, respectively. Experimental results compare fairly well with HDS-5, given the uncertainty in the exact configuration of the HDS-5 model. Experimental results predict a lower (less than 10 percent) HW/D ratio than HDS-5 for both submerged and unsubmerged conditions.

Table 2. Summary of culvert inlet design coefficients.

<i>Culvert Model</i>	<i>Run No.</i>		<i>Inlet Control</i>										<i>Outlet Control</i>	
			<i>Unsubmerged</i>						<i>Submerged</i>				<i>Laboratory</i>	<i>HDS -5</i>
			<i>Form 1</i>			<i>Form 2</i>			<i>Laboratory</i>		<i>HDS - 5</i>			
			<i>Laboratory</i>		<i>HDS - 5</i>		<i>Laboratory</i>		<i>c</i>	<i>Y</i>	<i>c</i>	<i>Y</i>	<i>K_e</i>	<i>K_e</i>
			<i>K</i>	<i>M</i>	<i>K</i>	<i>M</i>	<i>K</i>	<i>M</i>						
1	39	11a,b; 12a,b; 13a,b; 16a,b	0.009	1.5432	0.061	0.75	0.4767	0.7252	0.0435	0.6152	0.0423	0.82		
	5												0.68	0.7
2	40	11c,d; 13a,b; 16a,b					0.4850	0.6699	0.0407	0.6311				
	20												0.59	
3	33	11e,f; 15a,b; 16a,b					0.3896	0.7940	0.0331	0.6337				
	32*	11g,h; 15a,b					0.4299	0.7332	0.0312	0.7288				
	21												0.25	0.2
4	34	11i,j; 14a,b; 16a,b					0.4792	0.6753	0.0432	0.5671				
	6												0.43	
5	43	11k,l; 15a,b; 16a,b					0.4026	0.7875	0.0384	0.5853				
	12*	11m,n; 15a,b					0.4889	0.6815	0.0343	0.7571				
	14												0.40	
6	42	11o,p; 14a,b					0.4368	0.7384	0.0506	0.5343				
	26												0.64	

* Barrel slope = 0.0175; all other runs, slope = 0.03

Figures 13a and b depict the effect of wingwall miter. For unsubmerged conditions (figure 13a), the miter slope appears to have no effect. Under submerged conditions (figure 13b), the 3:1 miter appears to be slightly more efficient at the higher HW/D ratios.

Figures 14a and b depict the effect of the constant bevel height (in terms of the bevel height to culvert rise ratio, B/D) regardless of culvert size. The plot of unsubmerged conditions (figure 14a) suggests that the B/D ratio has little effect. For submerged conditions (figure 14b), however, the higher B/D ratio results in a lower HW/D ratio (approximately 11 percent at the upper end of the experimental flow range). Therefore, for a constant bevel, the smaller culvert appears to be more efficient.

The effect of the culvert barrel slope is depicted in figures 15a and b. The data suggest that under unsubmerged conditions, the slope has a small effect (figure 15a), with the higher slope being more efficient. Figure 15b depicts submerged conditions and shows that the slope has less of an effect than under unsubmerged conditions, but that the higher slope is slightly more efficient.

The last set of figures, 16a and 16b, present the effects of various experimental parameters, including the parapet, wingwall miter, and wingwall flare. For unsubmerged conditions (figure 16a), the data suggest that the configuration does not have a great effect on headwater, with the exception of wingwall flare. The data suggest that the model of the cast-in-place, 30-degree flared wingwall inlet (model 3) is approximately 8 percent more efficient, over the experimental range, than the model of the 6-ft x 6-ft (1.8-m x 1.8-m) precast, 0-degree flared inlet (model 5).

For submerged conditions (figure 16b), results similar to the unsubmerged conditions were observed. The data suggest the following:

- Culverts with a parapet are slightly more efficient than those without a parapet.
- The 3:1 wingwall miter is slightly more efficient than the 2:1 wingwall miter.
- The most efficient configuration tested appears to be the cast-in-place, 30-degree flared wingwall inlet (model 3). Data from this experiment show a predicted HW/D ratio that is approximately 10 percent lower than the 6-ft x 6-ft (1.8-m x 1.8-m) precast, 0-degree flared inlet (model 5) under submerged flow conditions.

Outlet Control

Entrance loss coefficients, K_e , were computed for culvert models 1 and 3 under outlet control conditions. For culvert model 1, an experimental K_e of 0.68 was computed, compared to a value of 0.7 presented in table 12 of HDS-5. For culvert model 3, an experimental K_e of 0.25 compares favorably with the HDS-5 value of 0.2.

The K_e values computed for culvert models 5 and 6 were 0.40 and 0.65, respectively. As with the inlet control runs, the data suggest that the lower the B/D ratio, the less efficient the culvert. The K_e for the 12-ft x 12-ft (3.7-m x 3.7-m) culvert (model 6) approaches that of a square edge.

The computed K_e for culvert model 4 of 0.43 (compared to a K_e of 0.40 for model 5) suggests that the parapet may be slightly beneficial in passing flow under outlet control conditions.

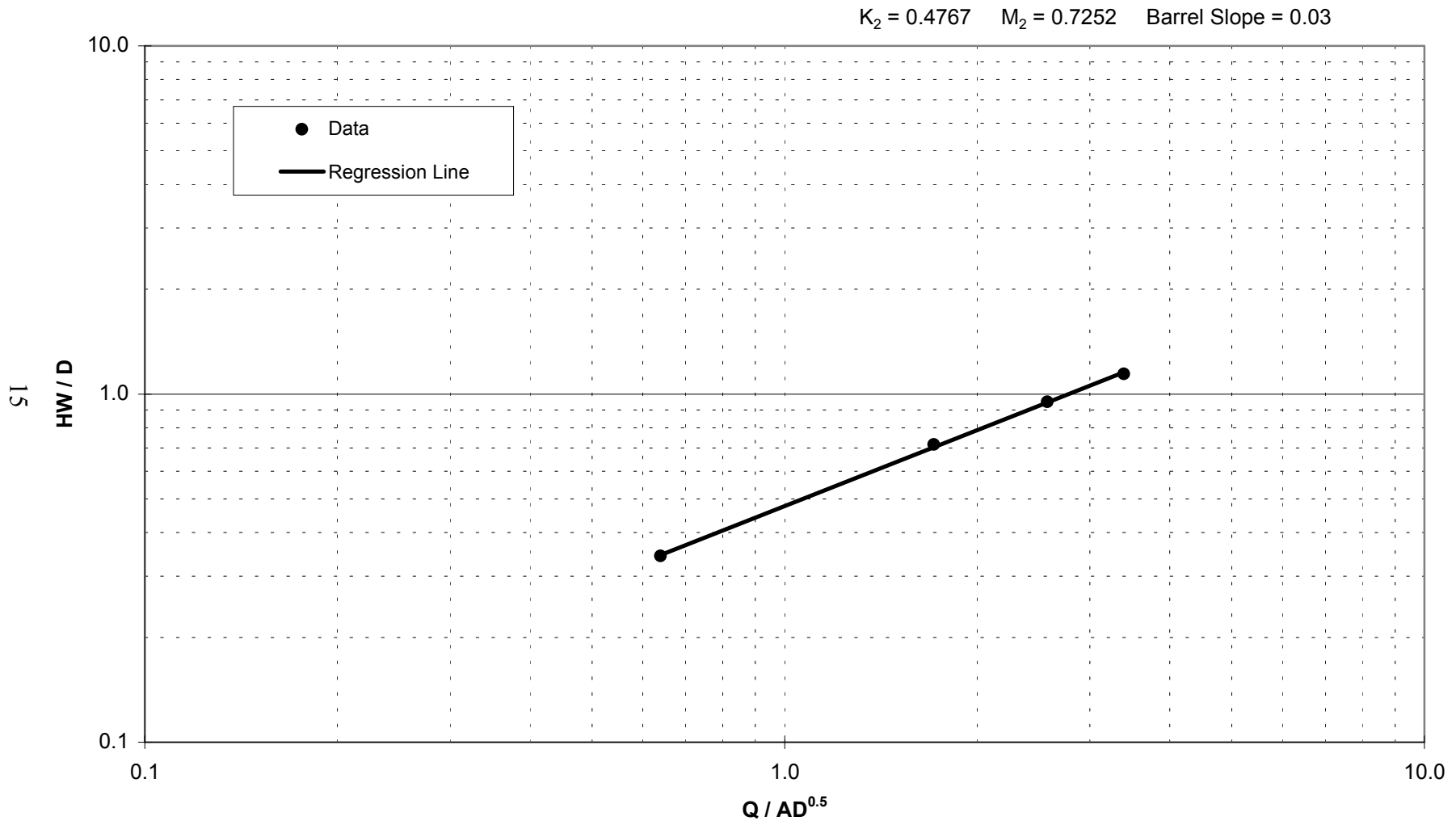

Figure 11a. Regression line vs. data, unsubmerged conditions, culvert model 1, run 39.

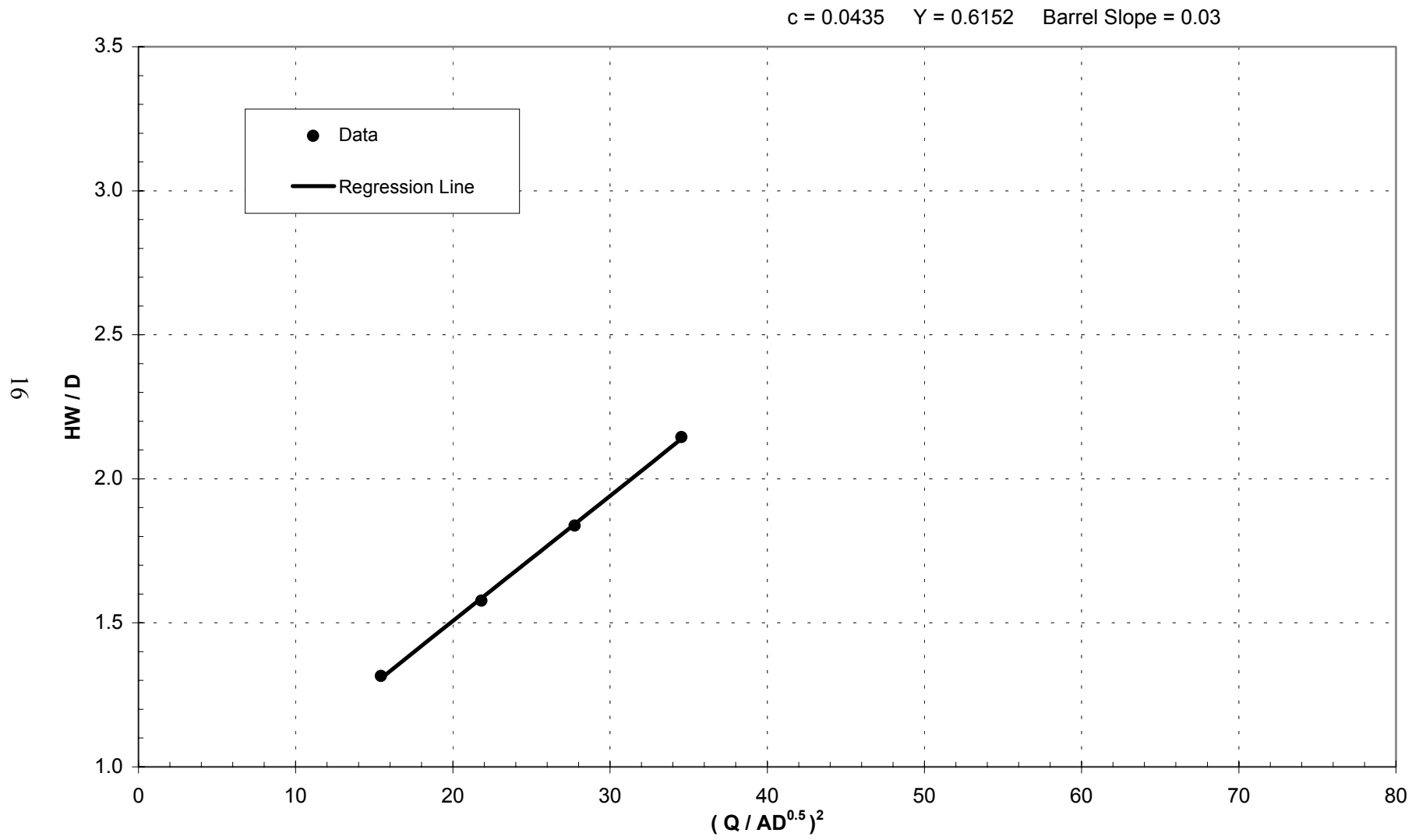

Figure 11b. Regression line vs. data, submerged conditions, culvert model 1, run 39.

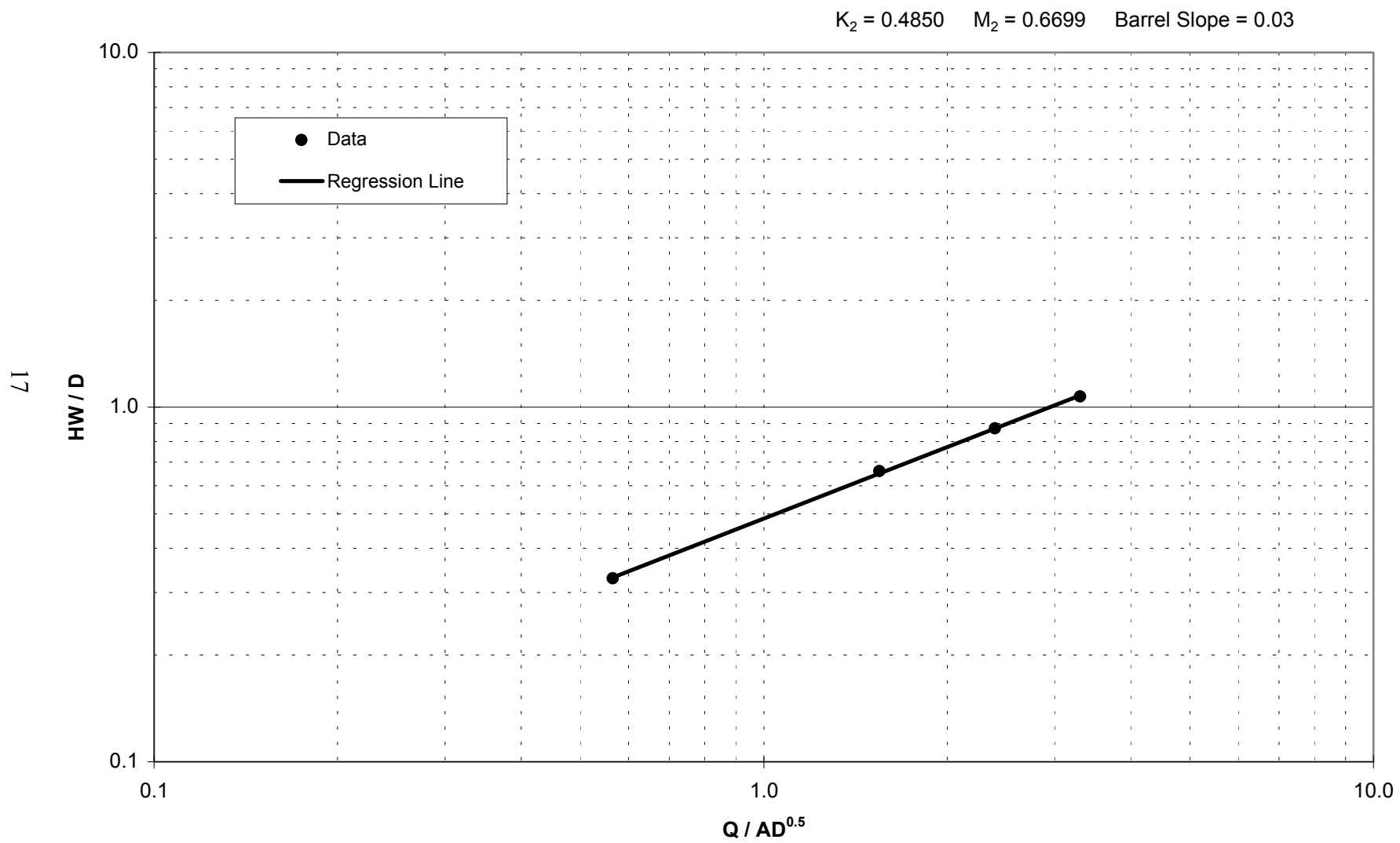

Figure 11c. Regression line vs. data, unsubmerged conditions, culvert model 2, run 40.

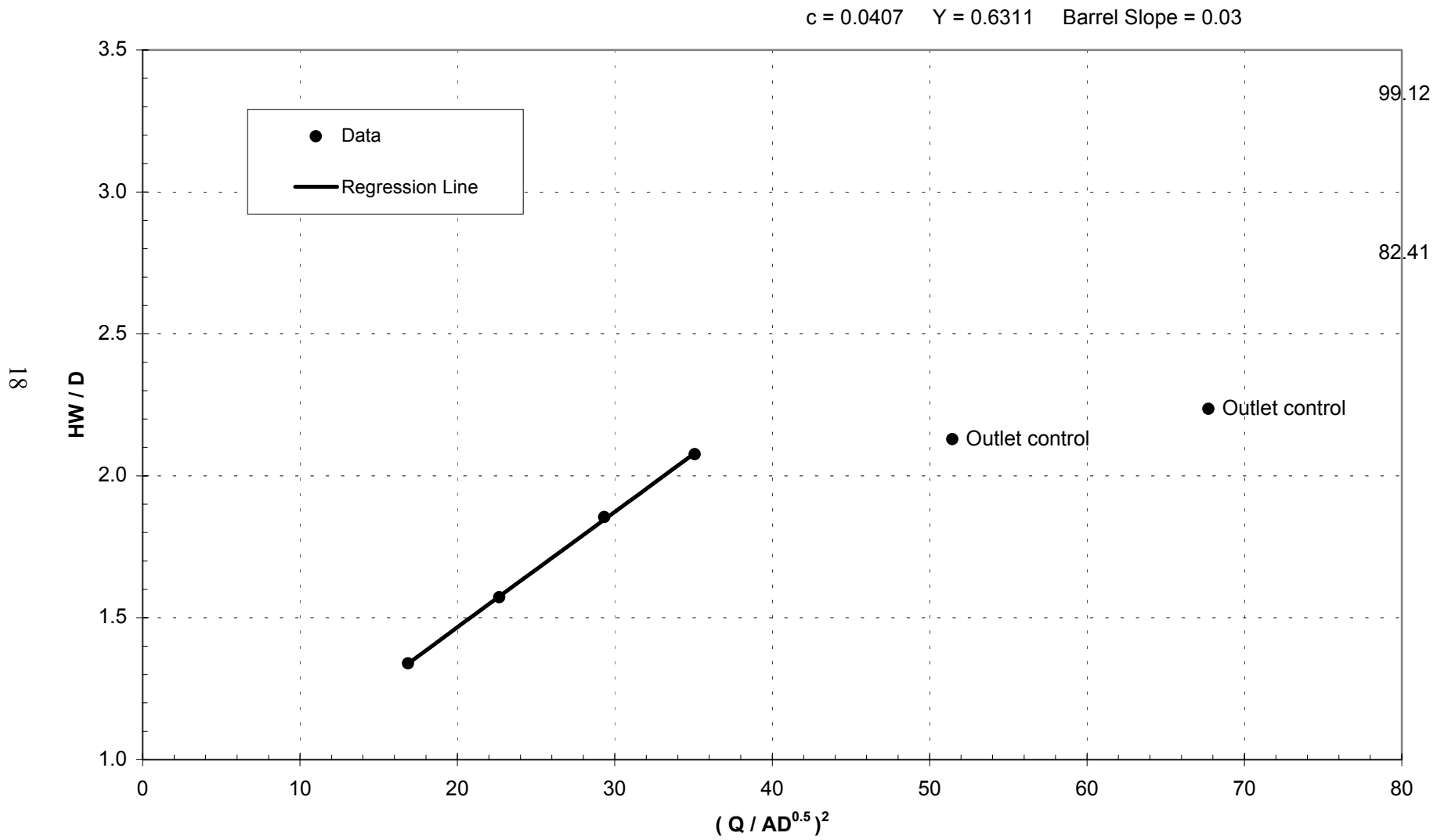

Figure 11d. Regression line vs. data, submerged conditions, culvert model 2, run 40.

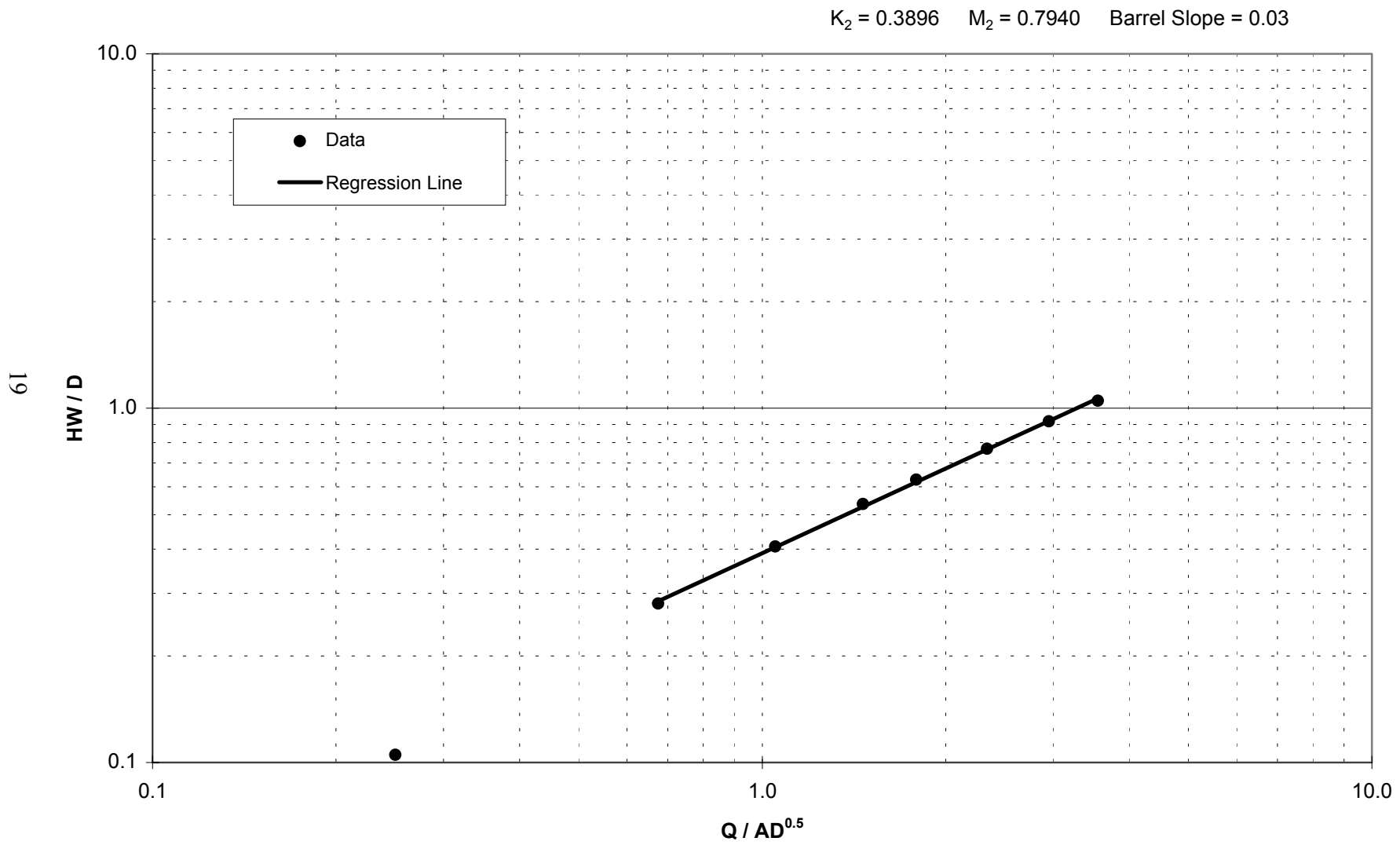

Figure 11e. Regression line vs. data, unsubmerged conditions, culvert model 3, run 33.

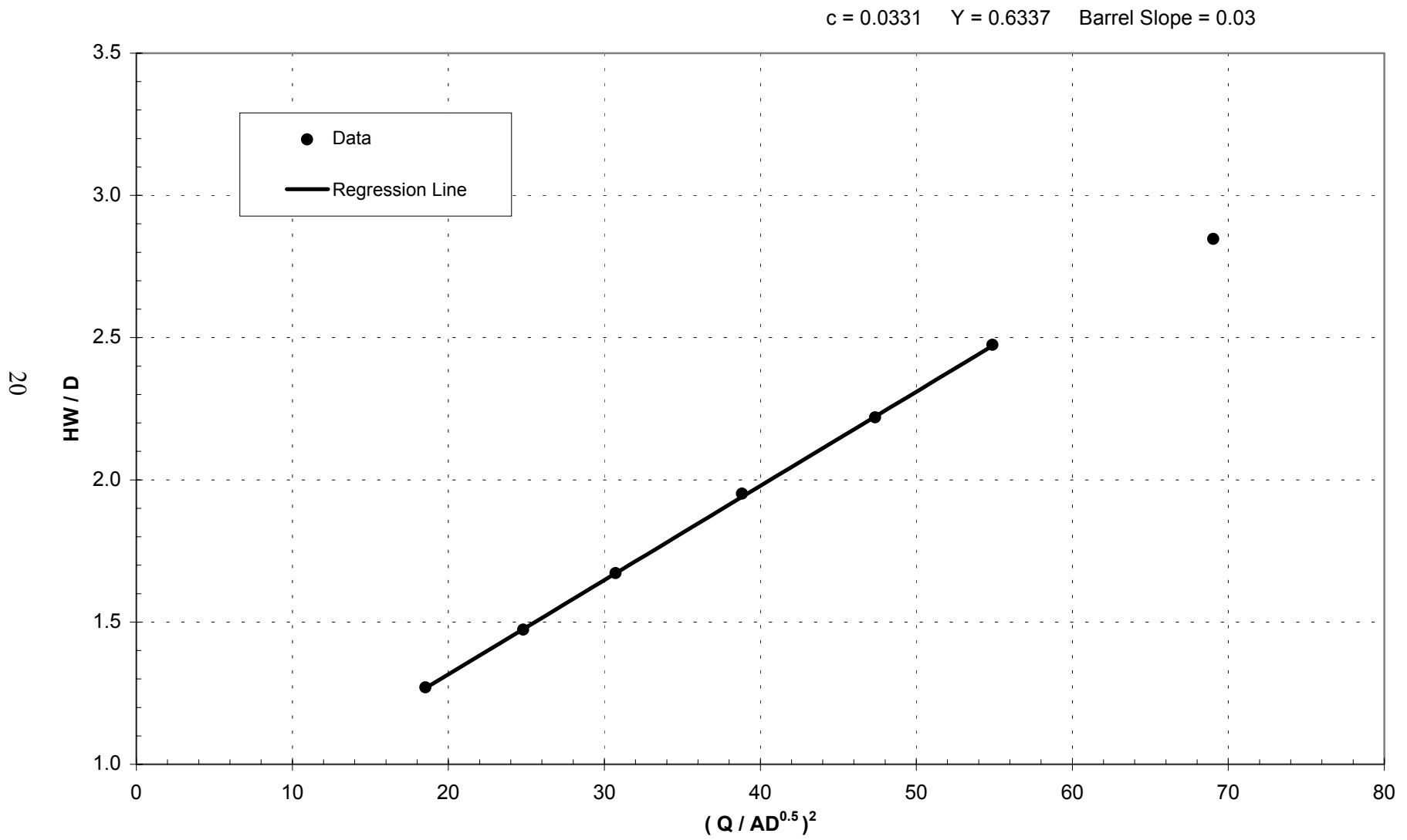

Figure 11f. Regression line vs. data, submerged conditions, culvert model 3, run 33.

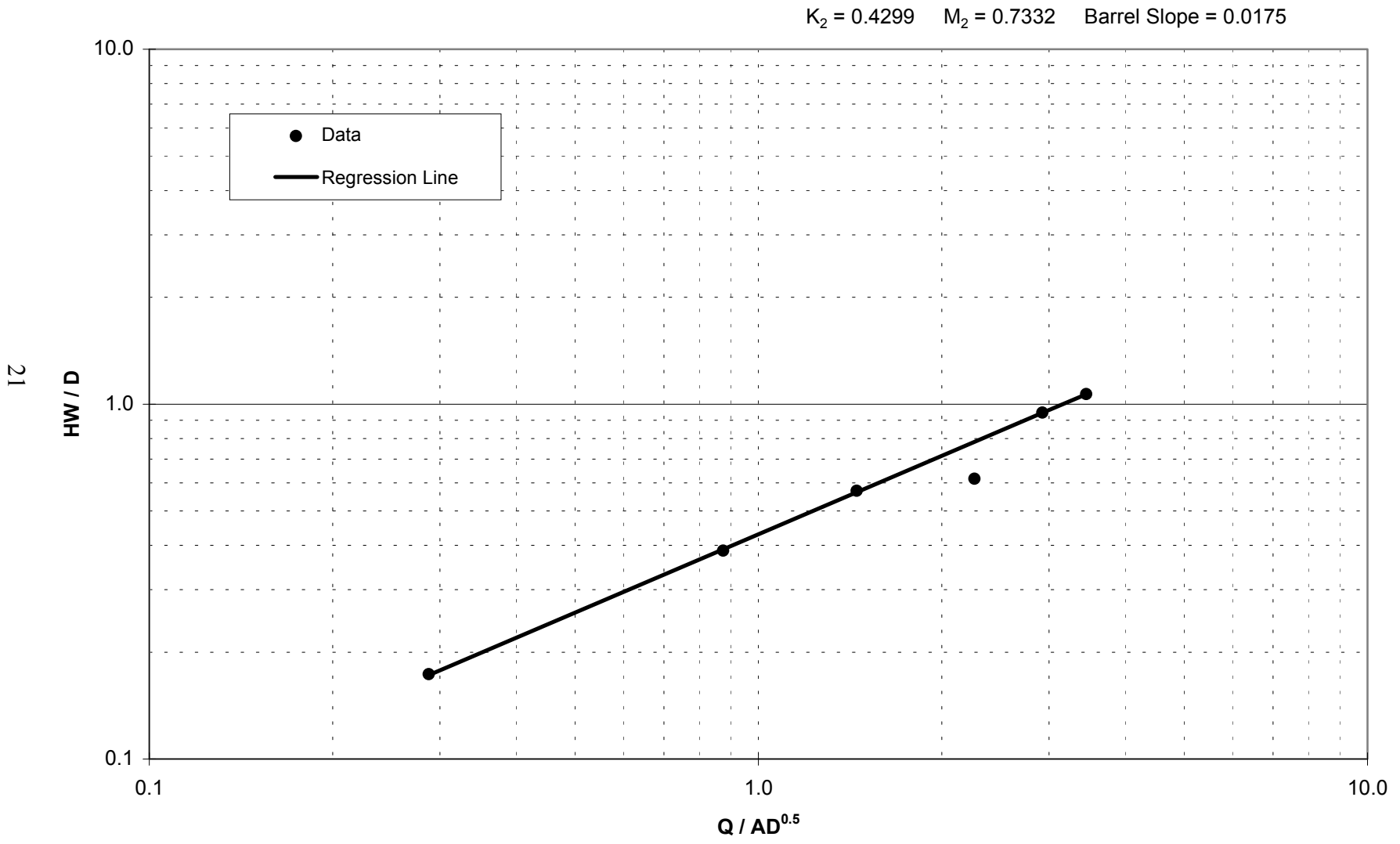

Figure 11g. Regression line vs. data, unsubmerged conditions, culvert model 3, run 32.

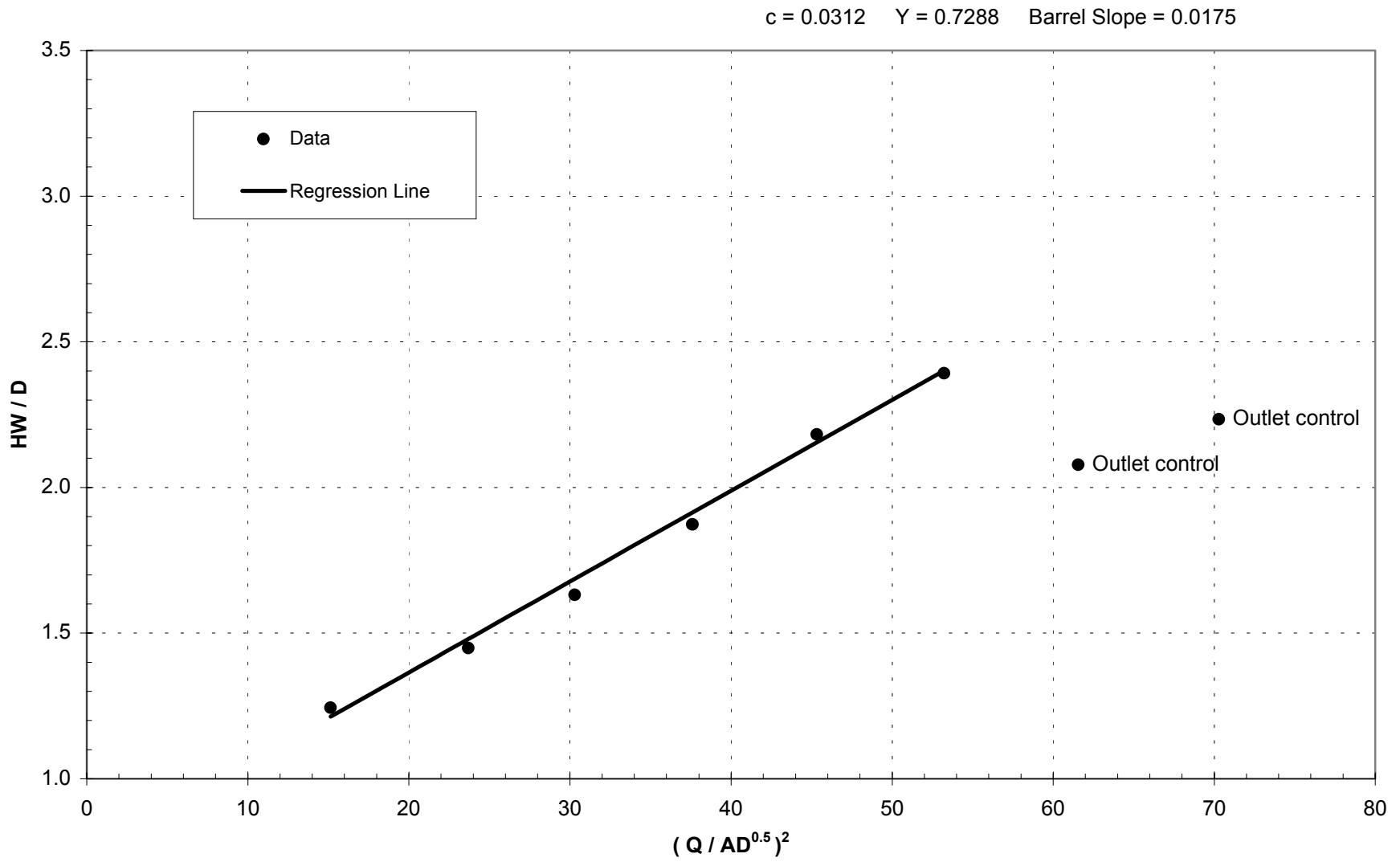

Figure 11h. Regression line vs. data, submerged conditions, culvert model 3, run 32.

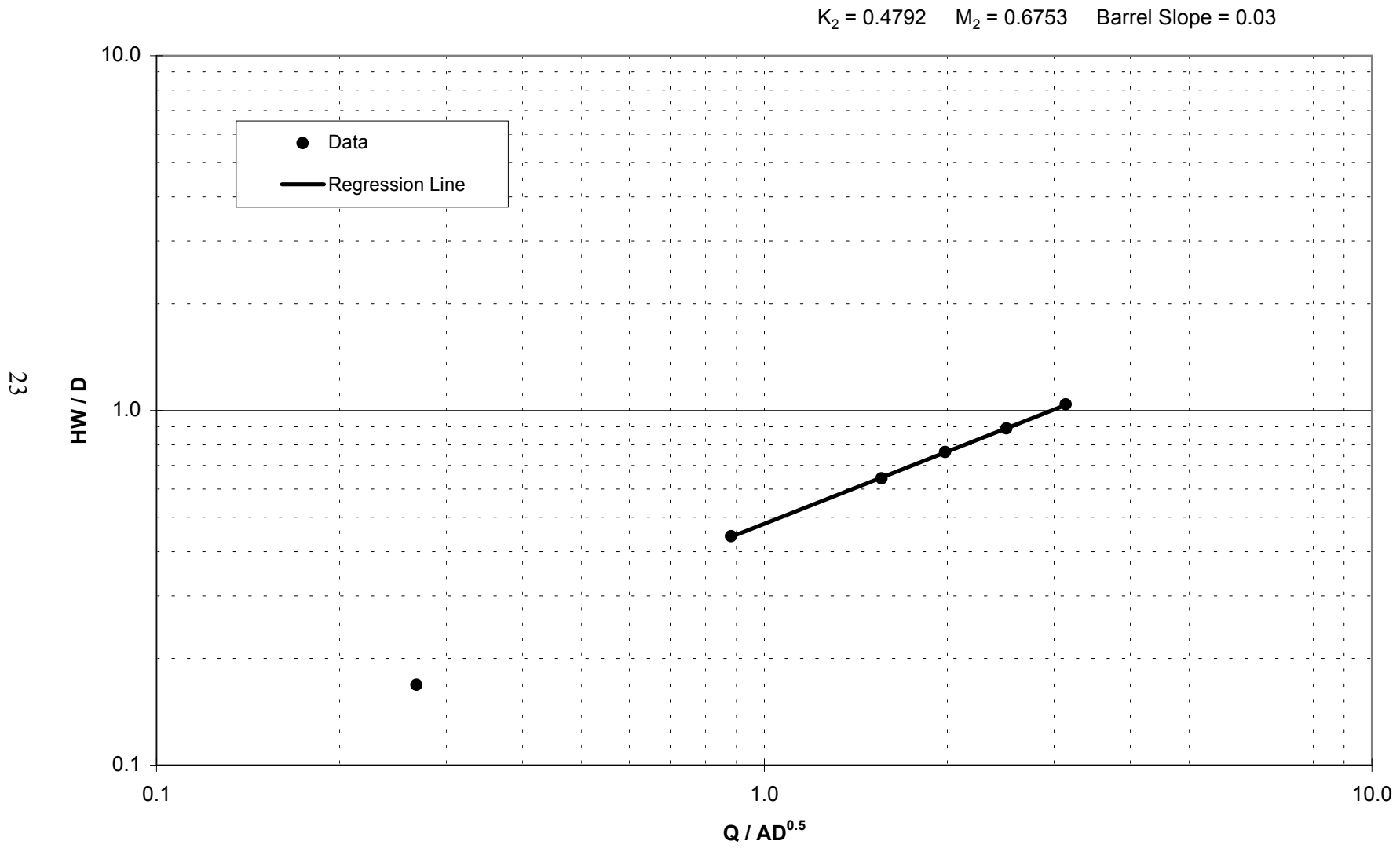

Figure 11i. Regression line vs. data, unsubmerged conditions, culvert model 4, run 34.

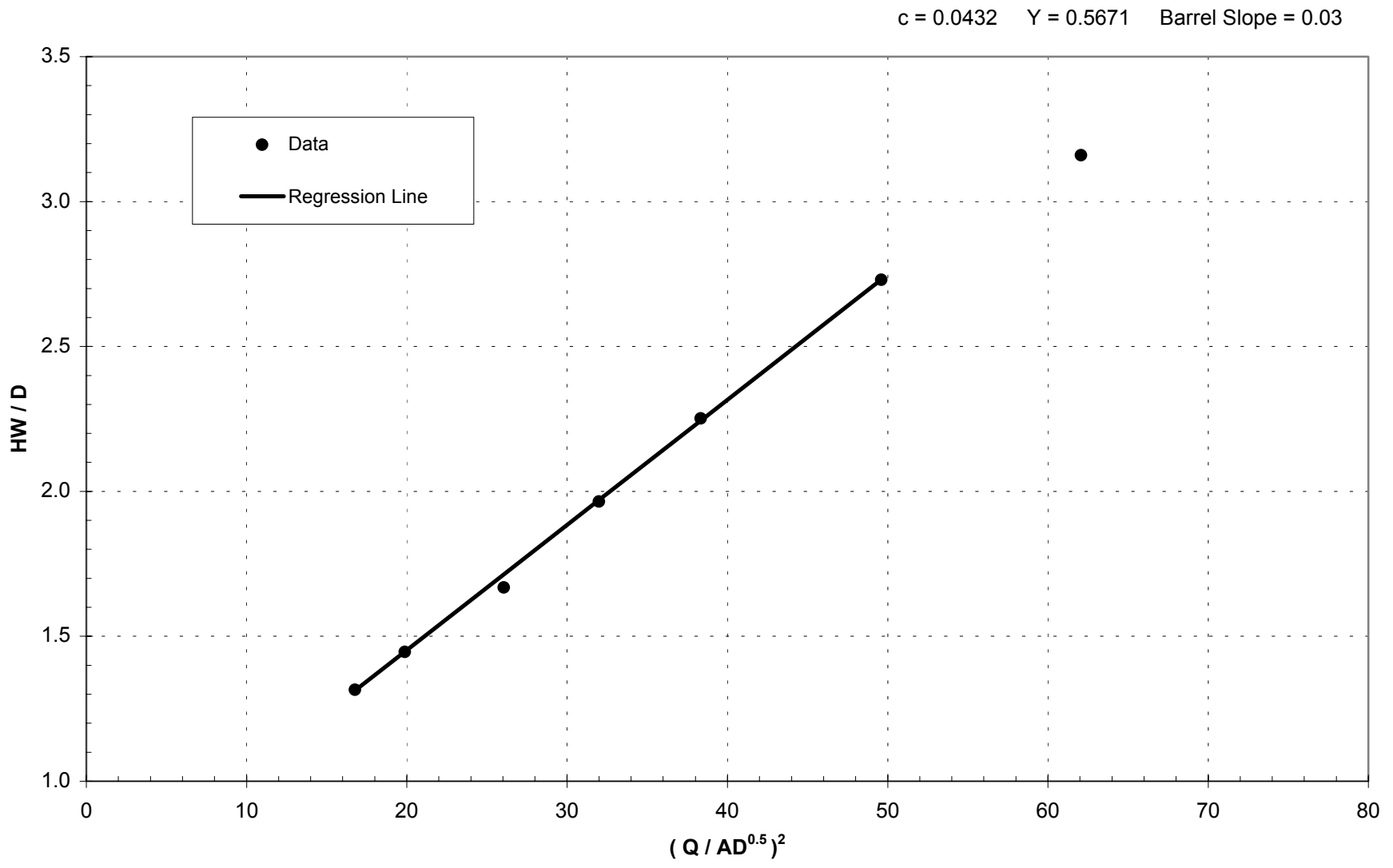

Figure 11j. Regression line vs. data, submerged conditions, culvert model 4, run 34.

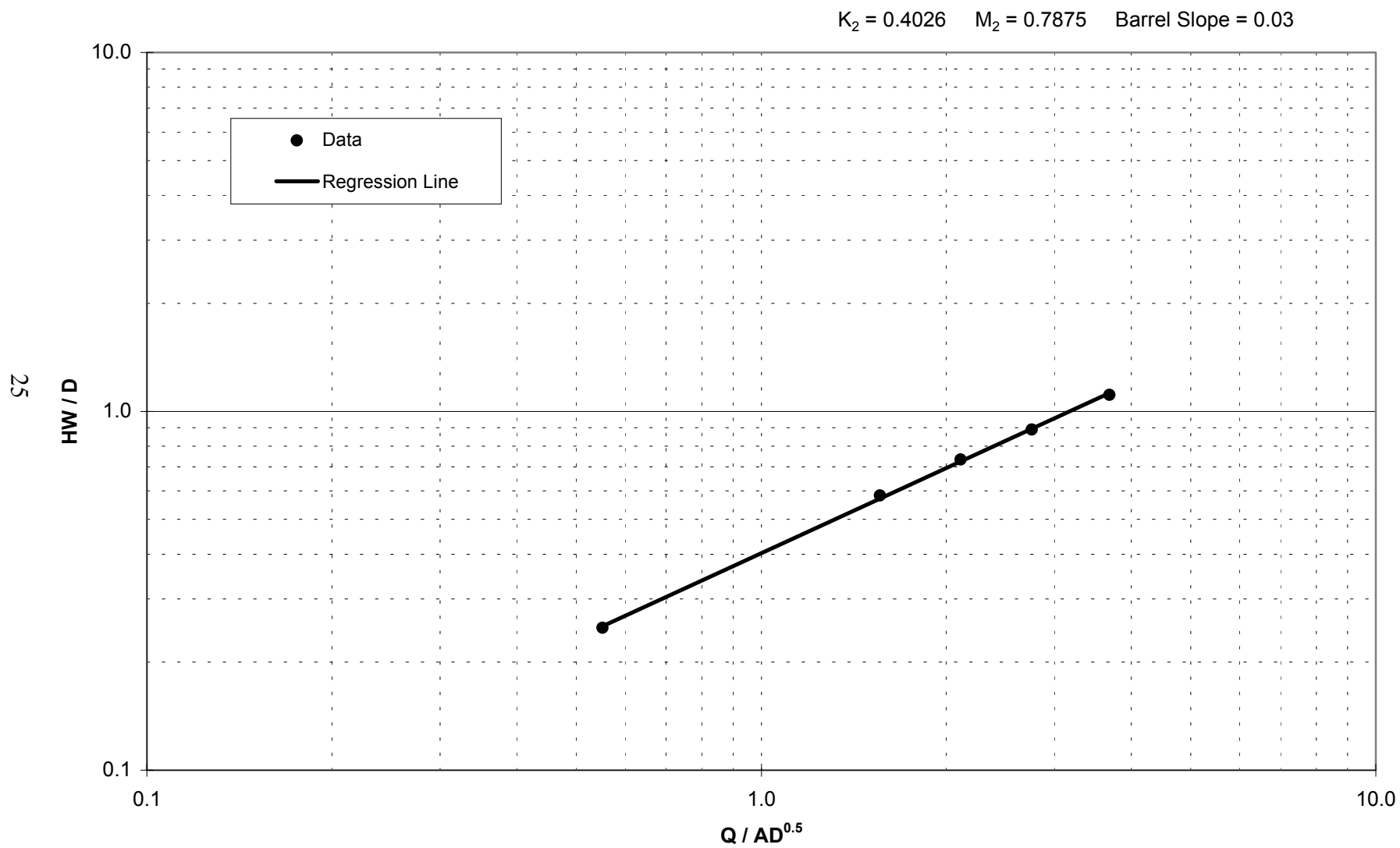

Figure 11k. Regression line vs. data, unsubmerged conditions, culvert model 5, run 43.

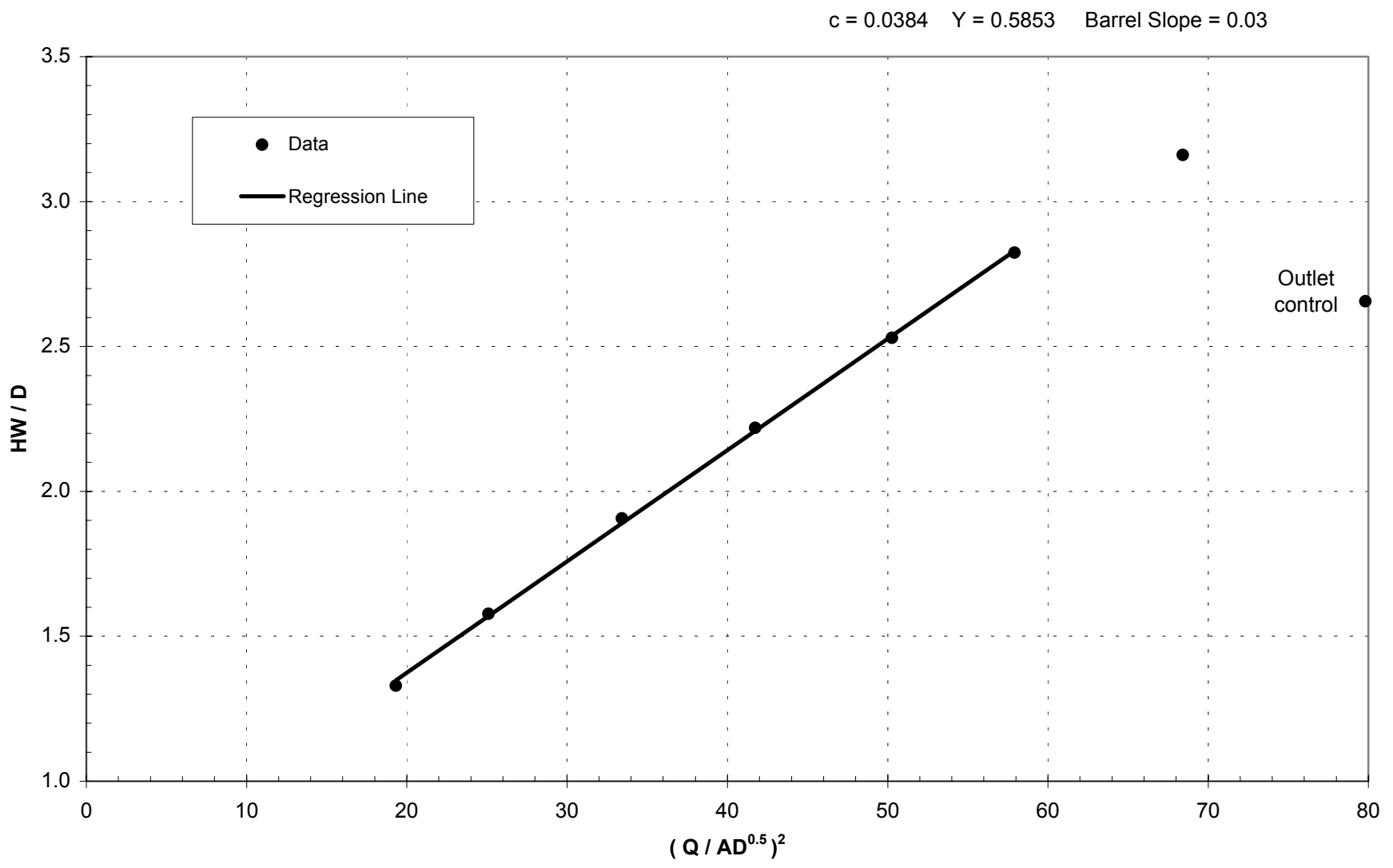

Figure 11. Regression line vs. data, submerged conditions, culvert model 5, run 43.

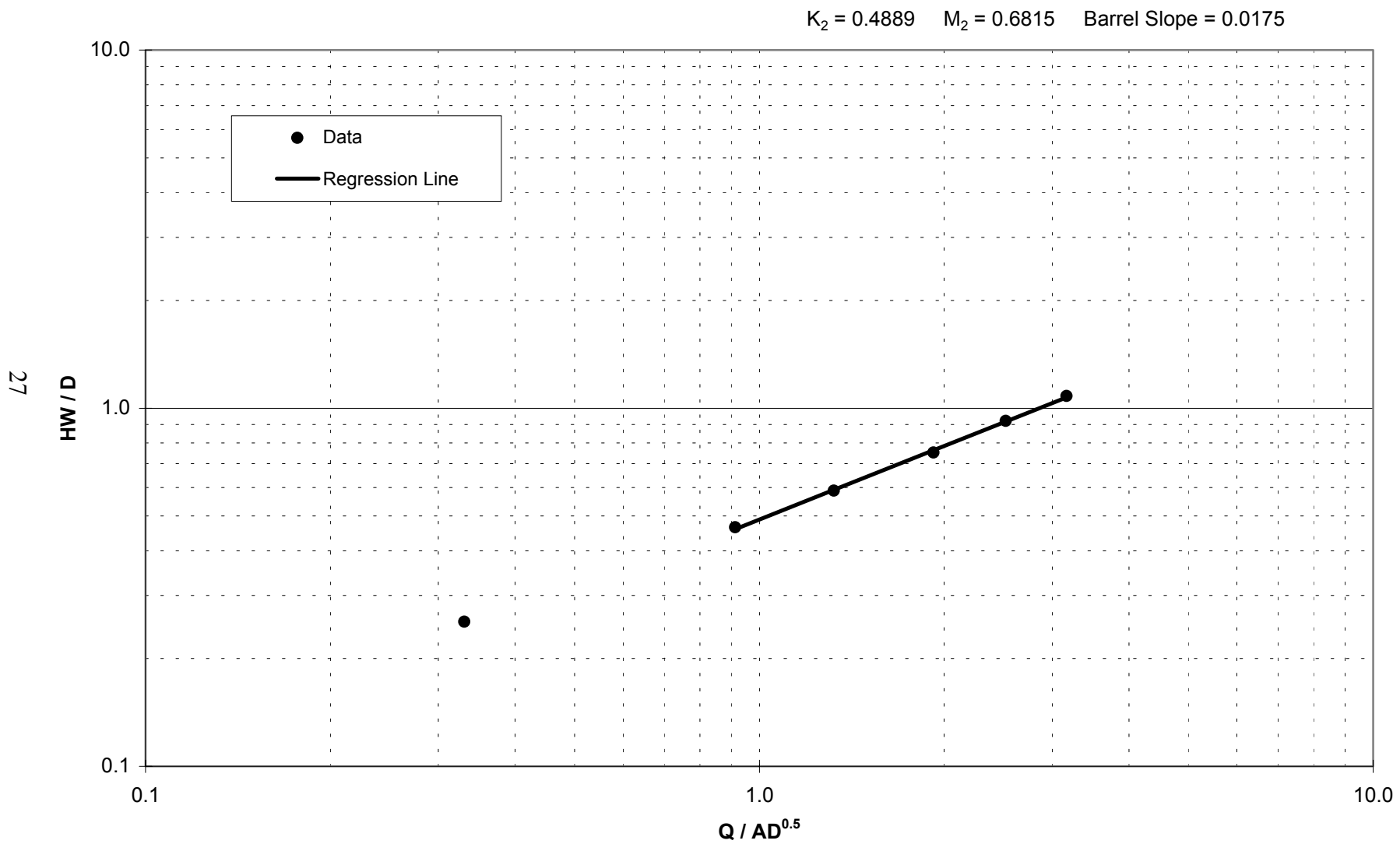

Figure 11m. Regression line vs. data, unsubmerged conditions, culvert model 5, run 12.

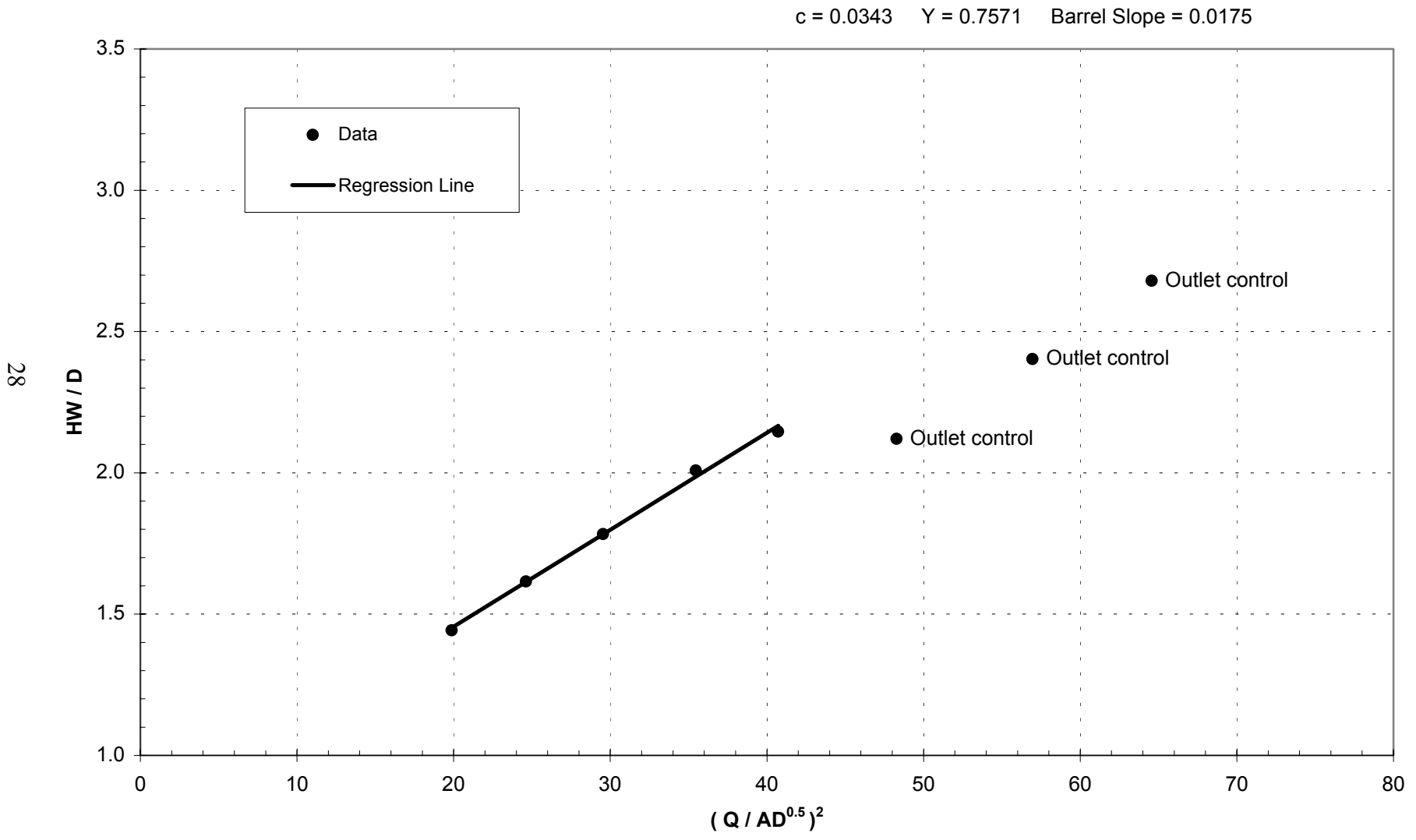

Figure 11n. Regression line vs. data, submerged conditions, culvert model 5, run 12.

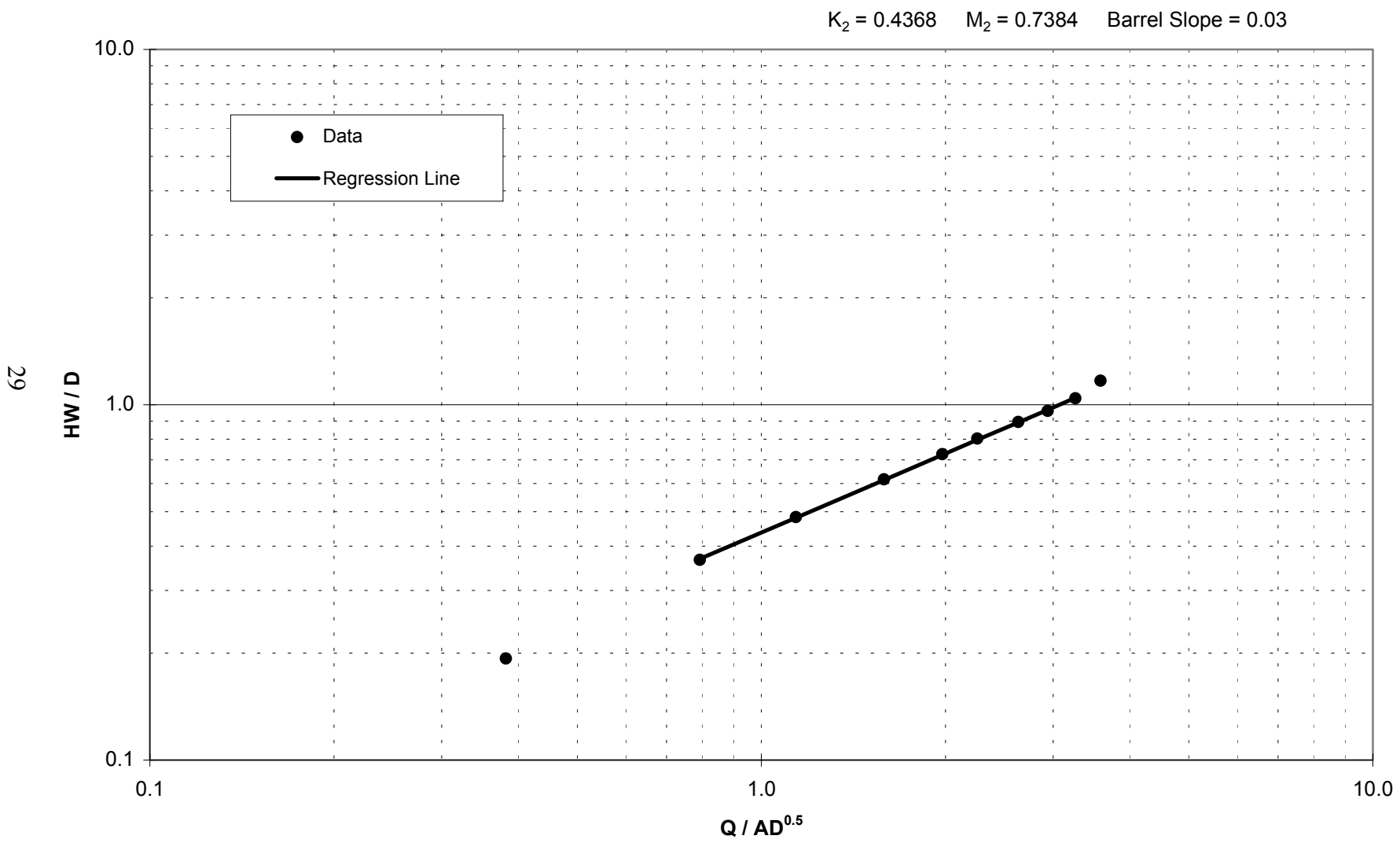

Figure 110. Regression line vs. data, unsubmerged conditions, culvert model 6, run 42.

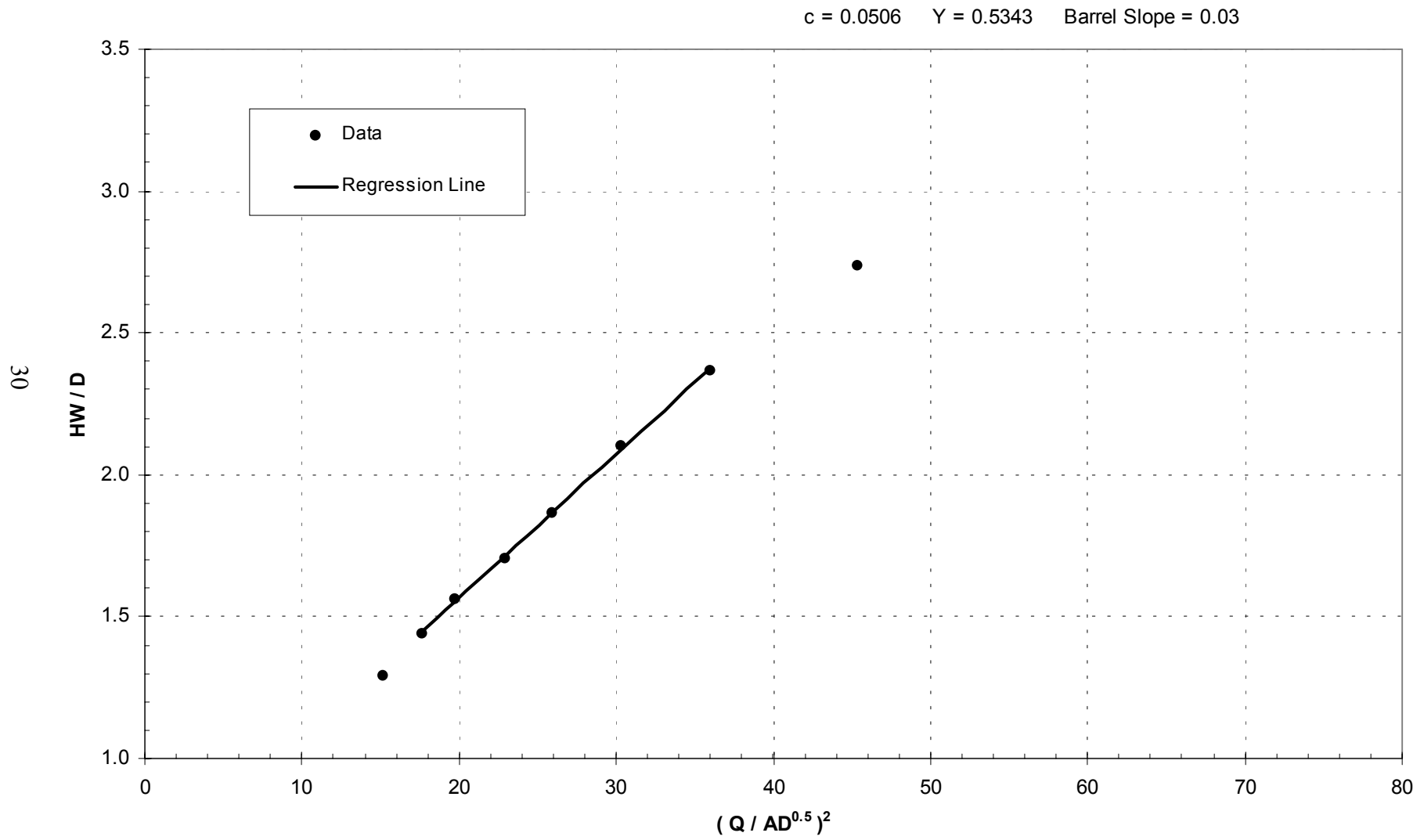

Figure 11p. Regression line vs. data, submerged conditions, culvert model 6, run 42.

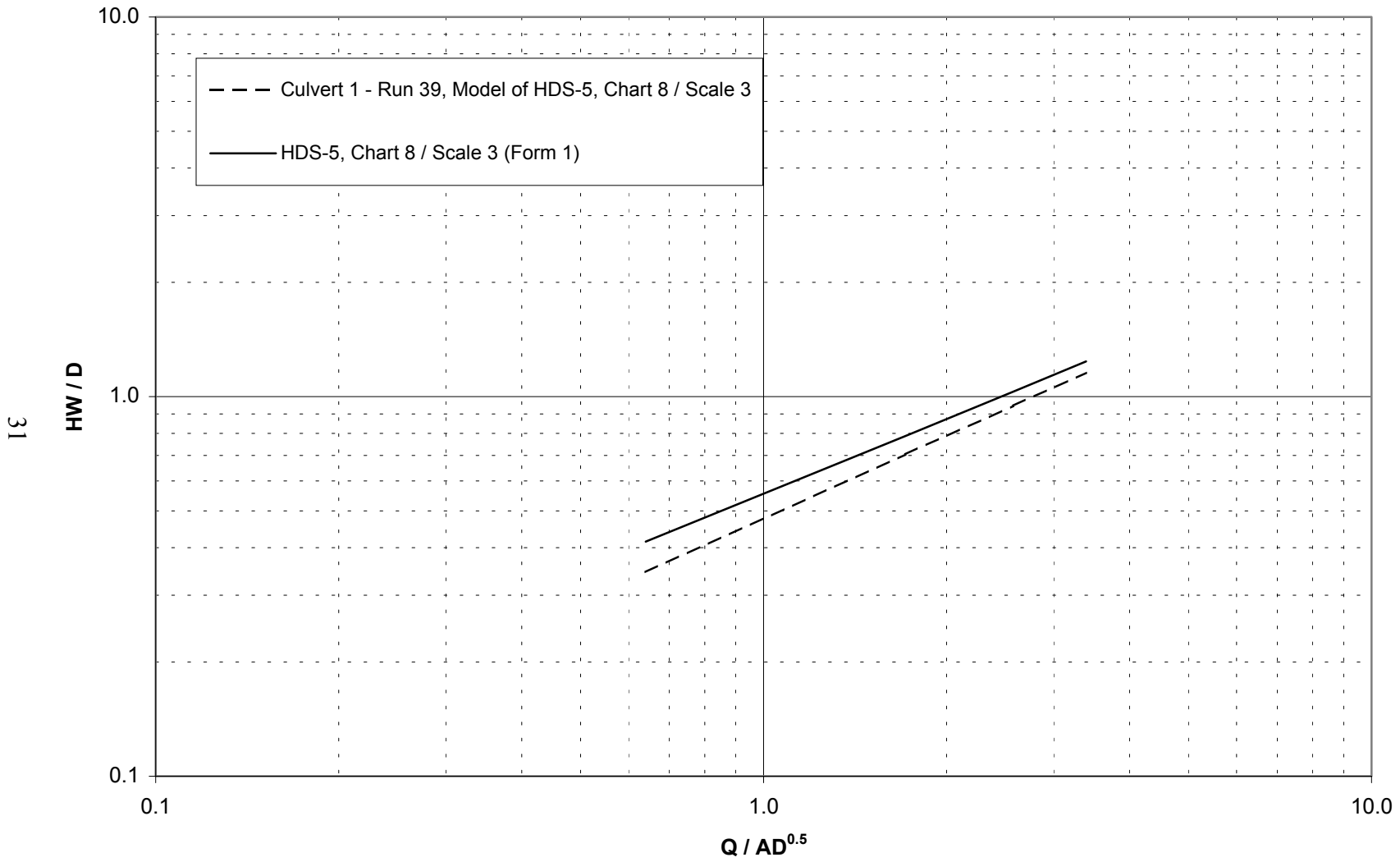

Figure 12a. Benchmark test, unsubmerged conditions.

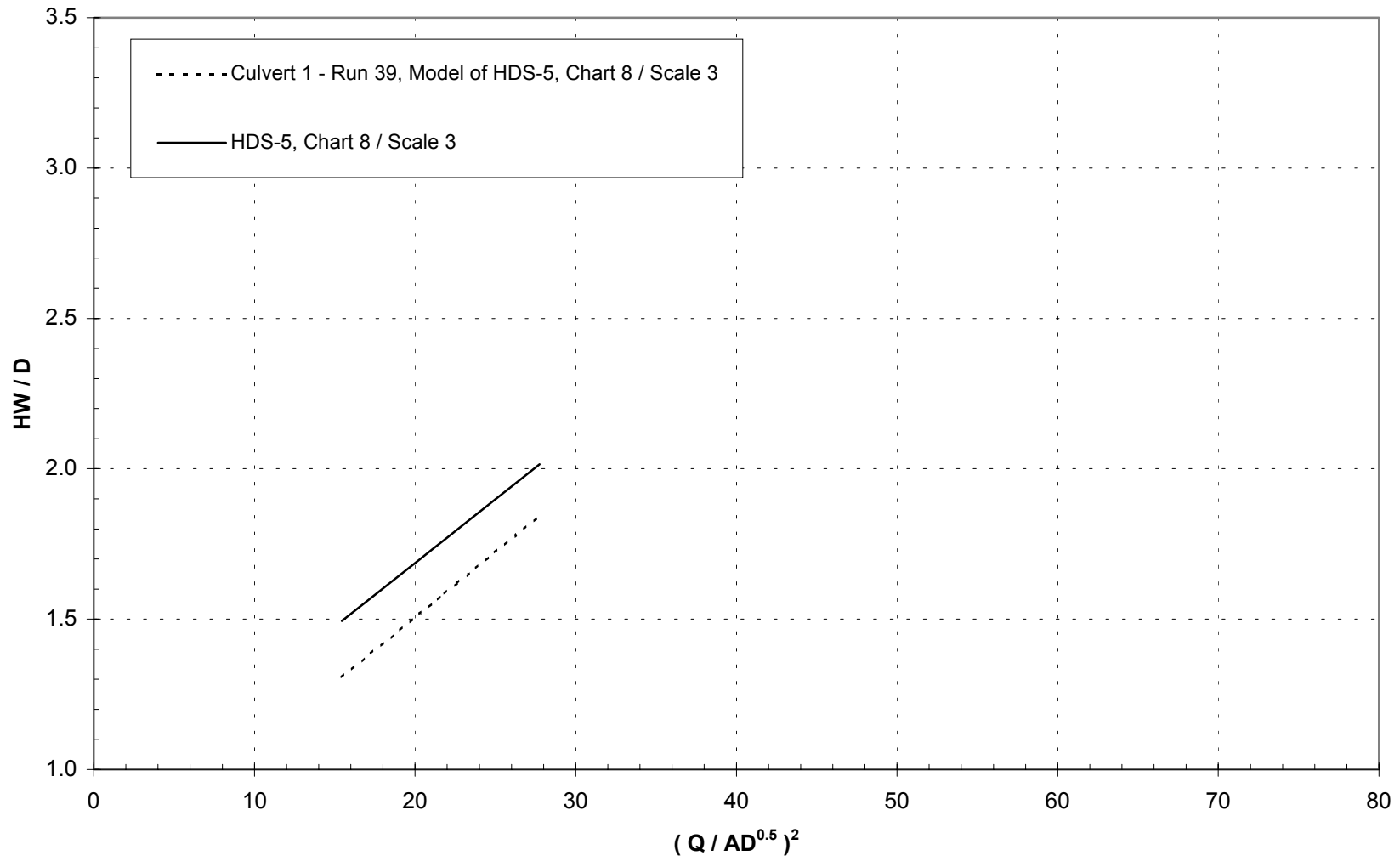

Figure 12b. Benchmark test, submerged conditions.

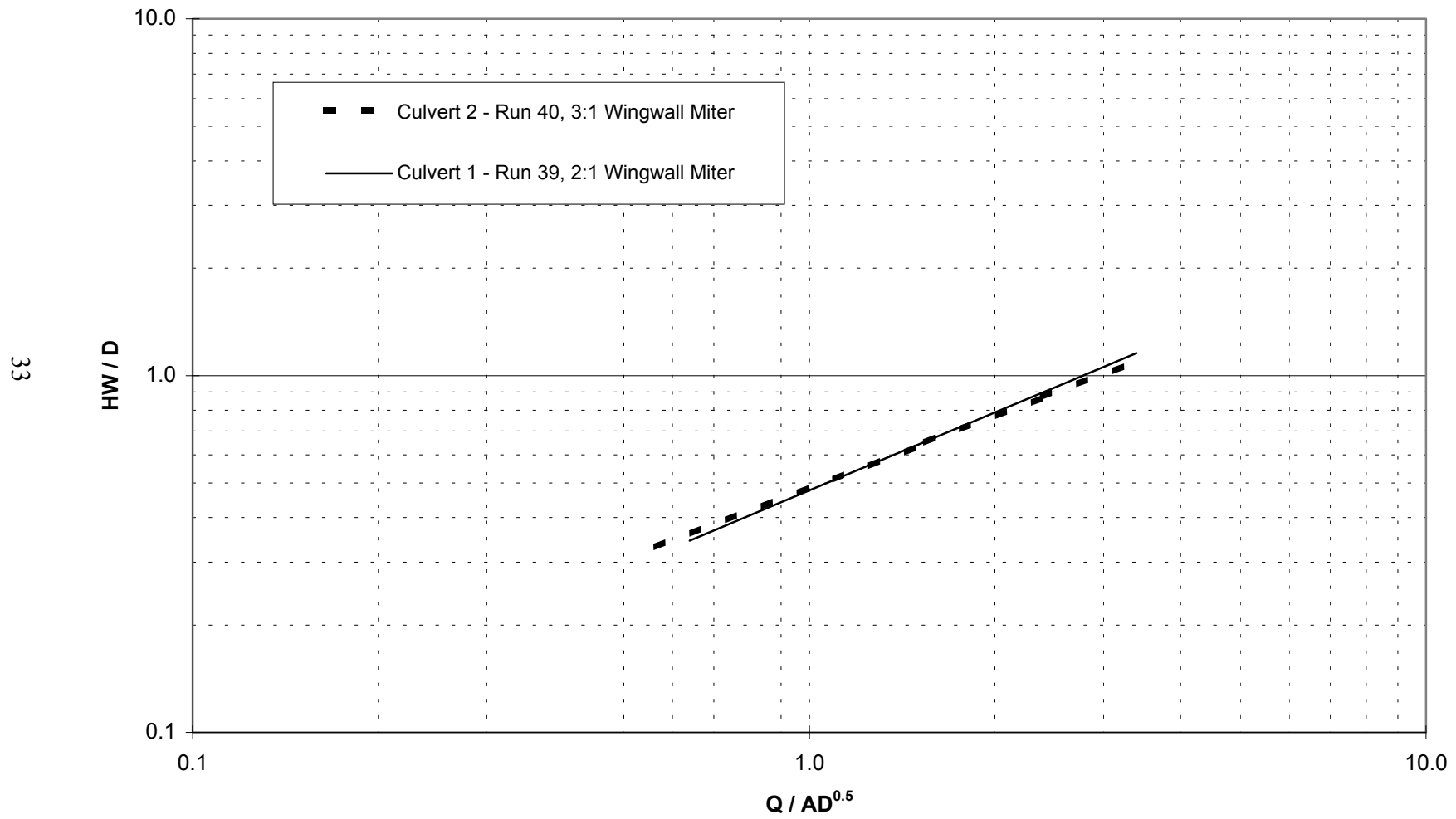

Figure 13a. Effect of wingwall miter, unsubmerged conditions.

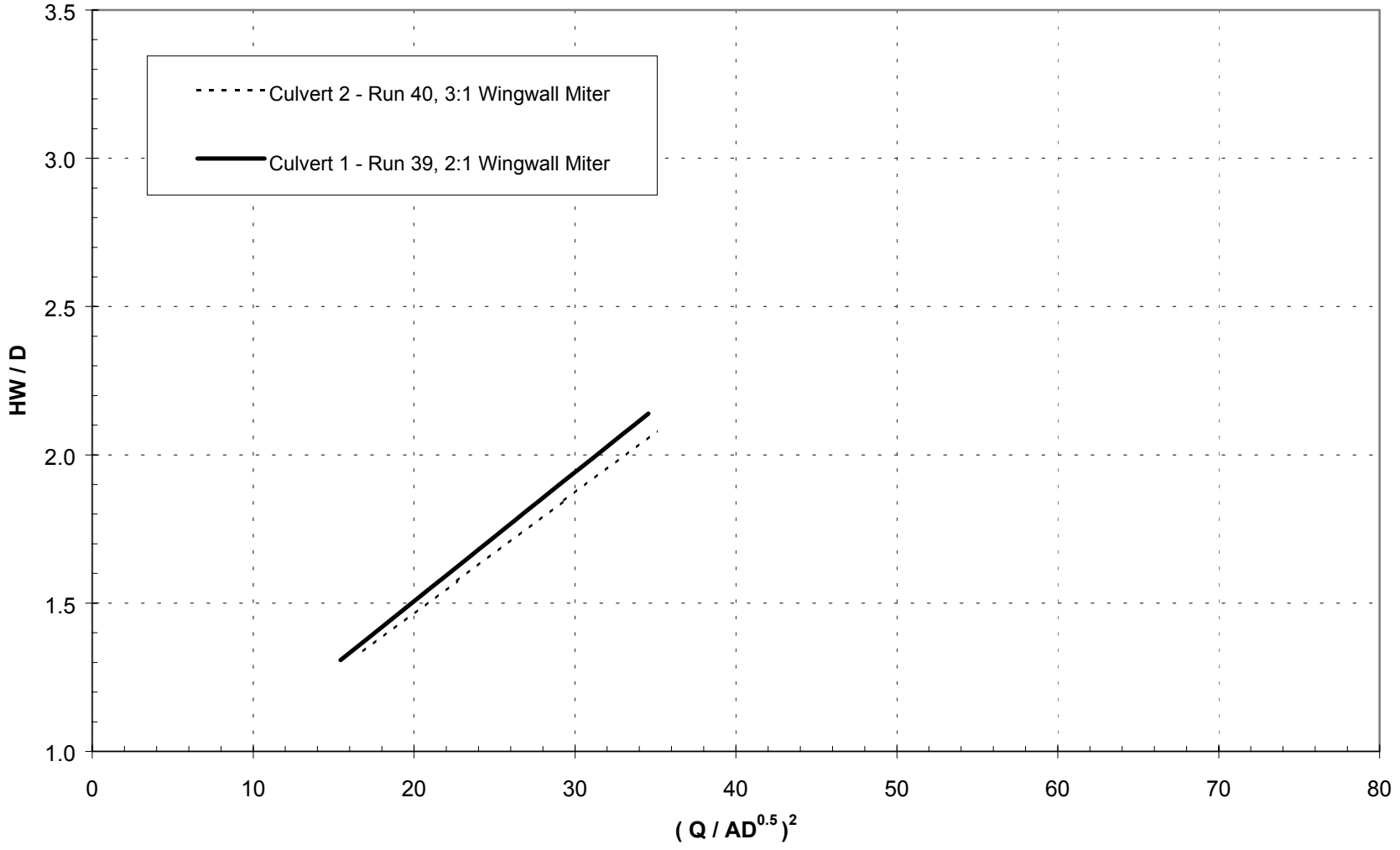
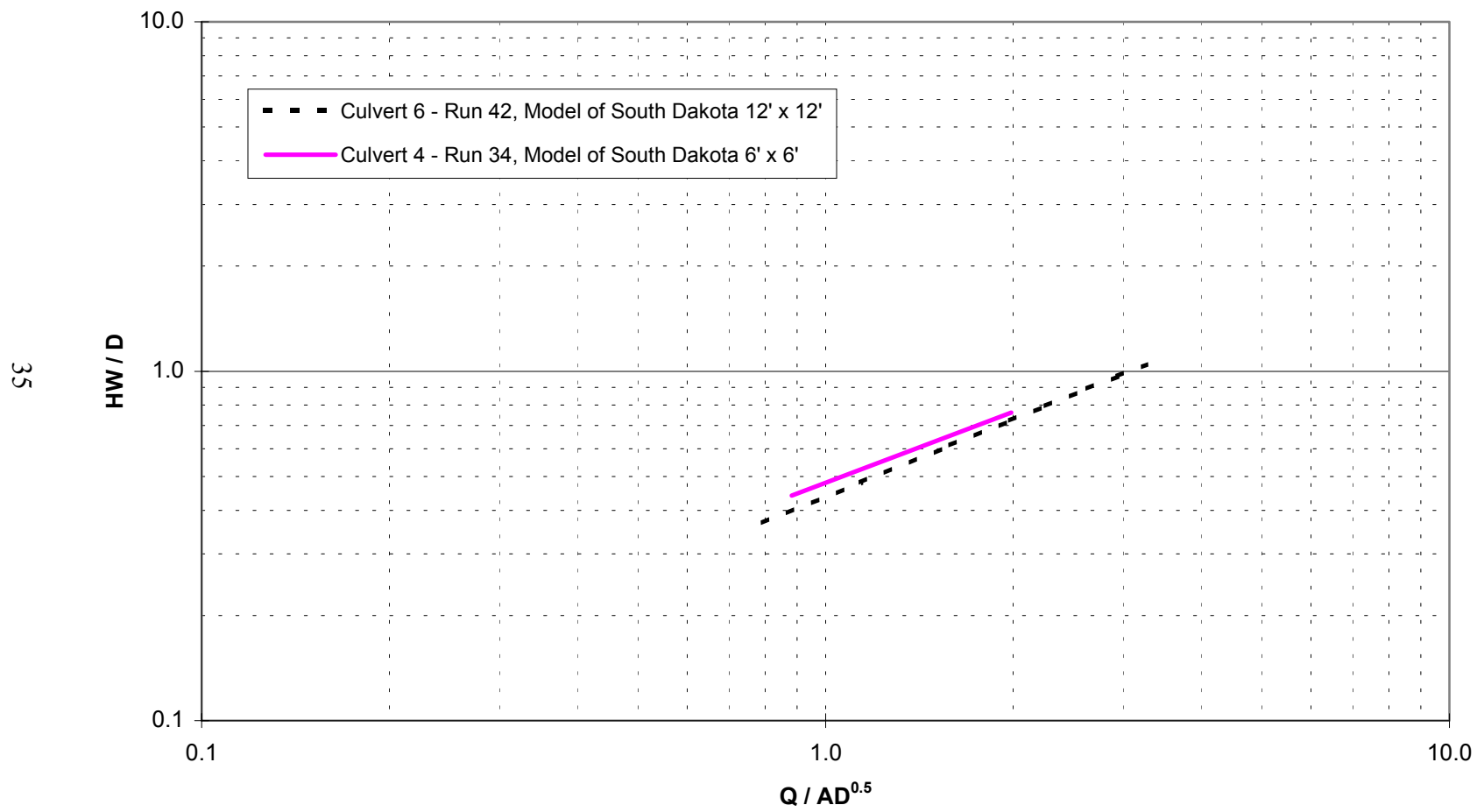
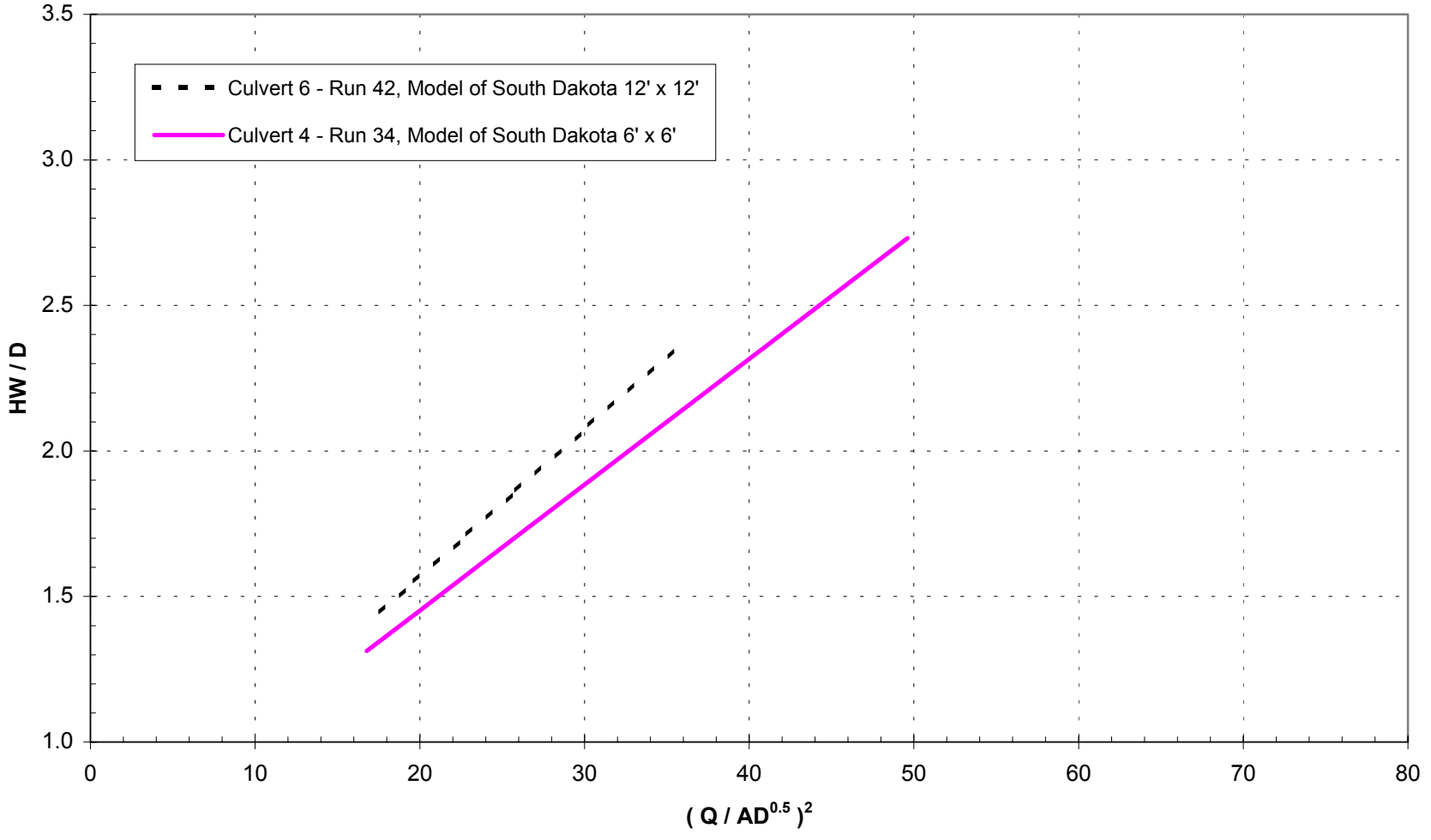

Figure 13b. Effect of wingwall miter, submerged conditions.



1 ft = 0.035 m

Figure 14a. Effect of constant bevel, unsubmerged conditions.



1 ft = 0.035 m

Figure 14b. Effect of constant bevel, submerged conditions.

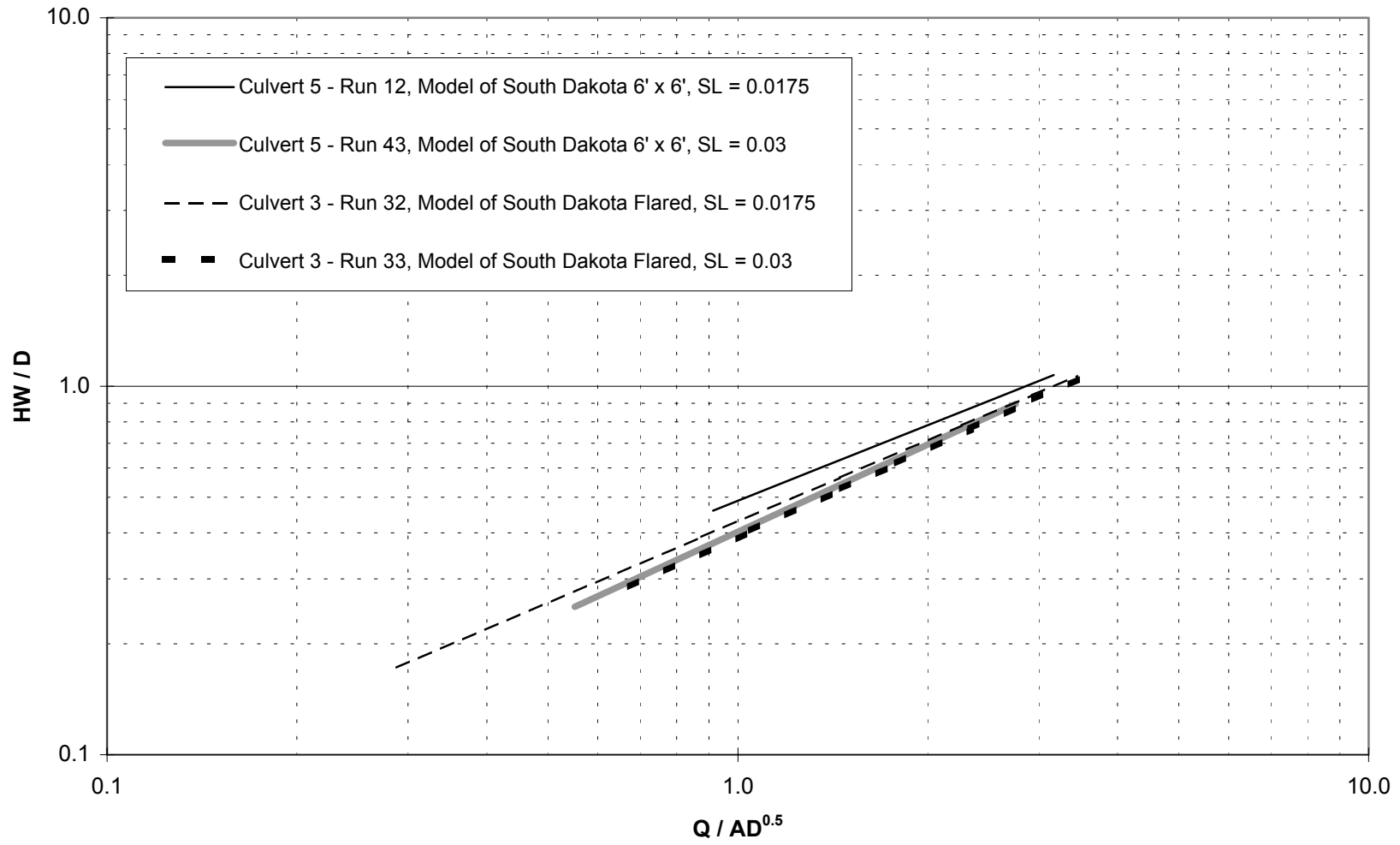

1 ft = 0.035 m

Figure 15a. Effect of barrel slope, unsubmerged conditions.

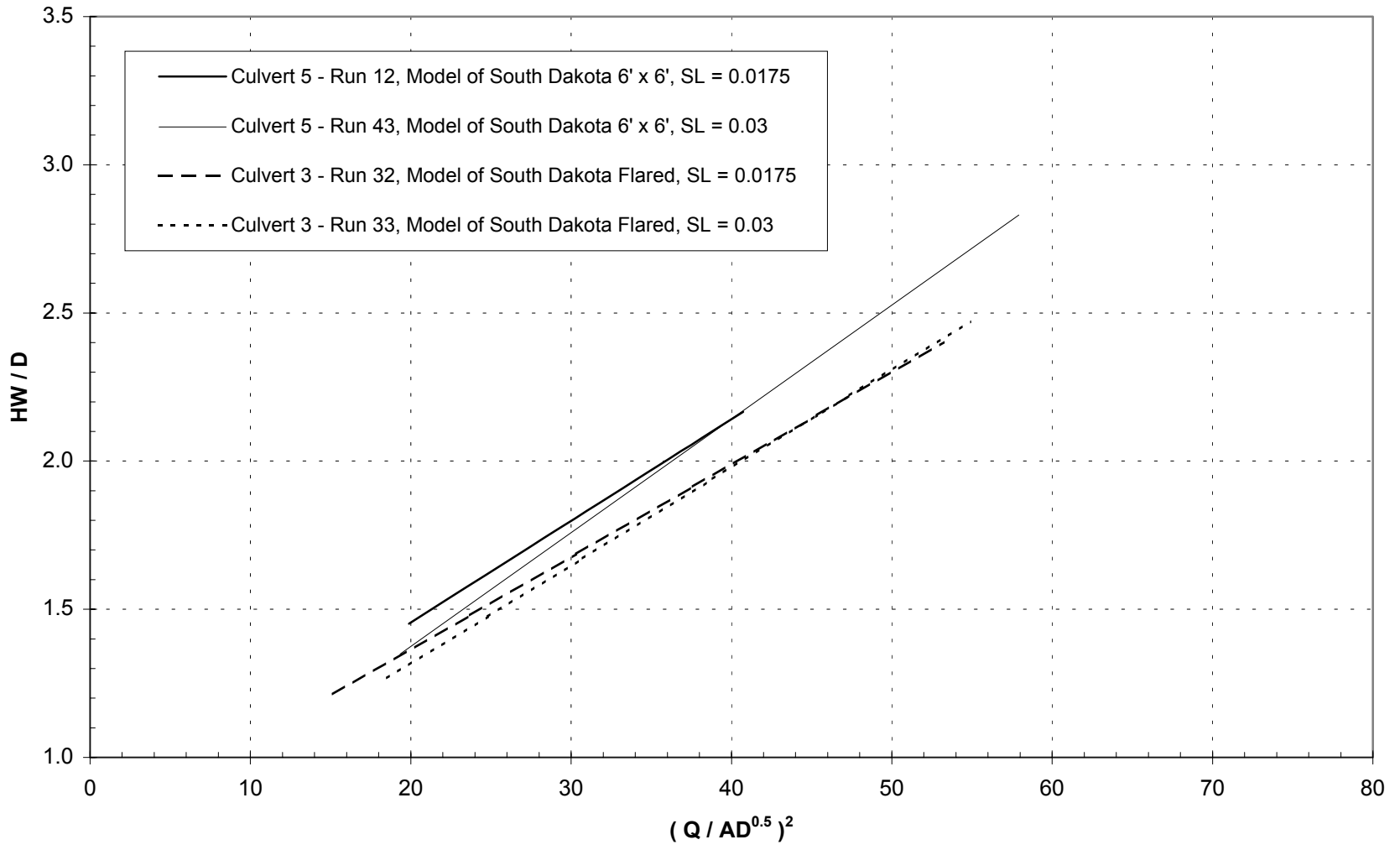

1 ft = 0.035 m

Figure 15b. Effect of barrel slope, submerged conditions.

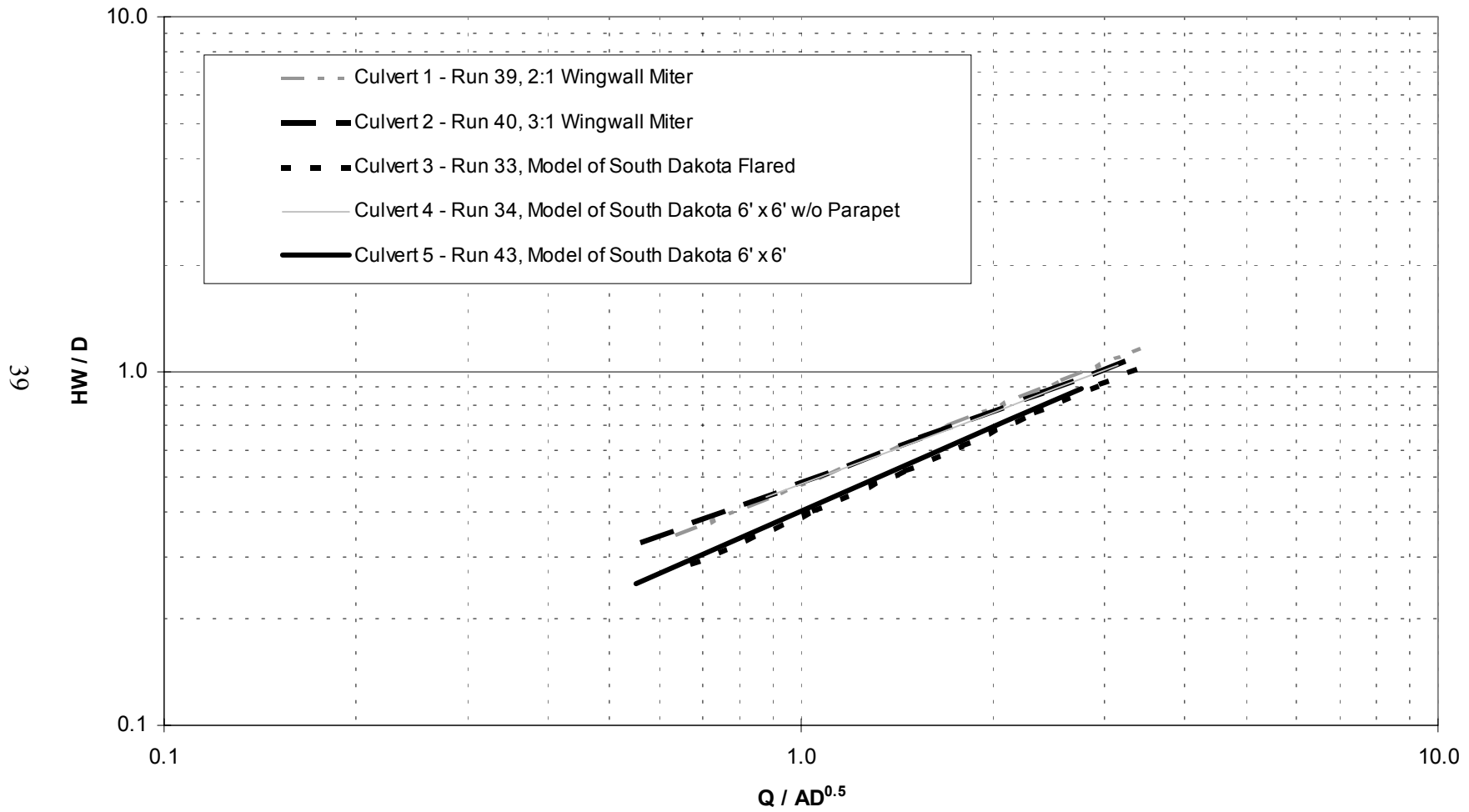

1 ft = 0.035 m

Figure 16a. Effect of configuration, unsubmerged conditions.

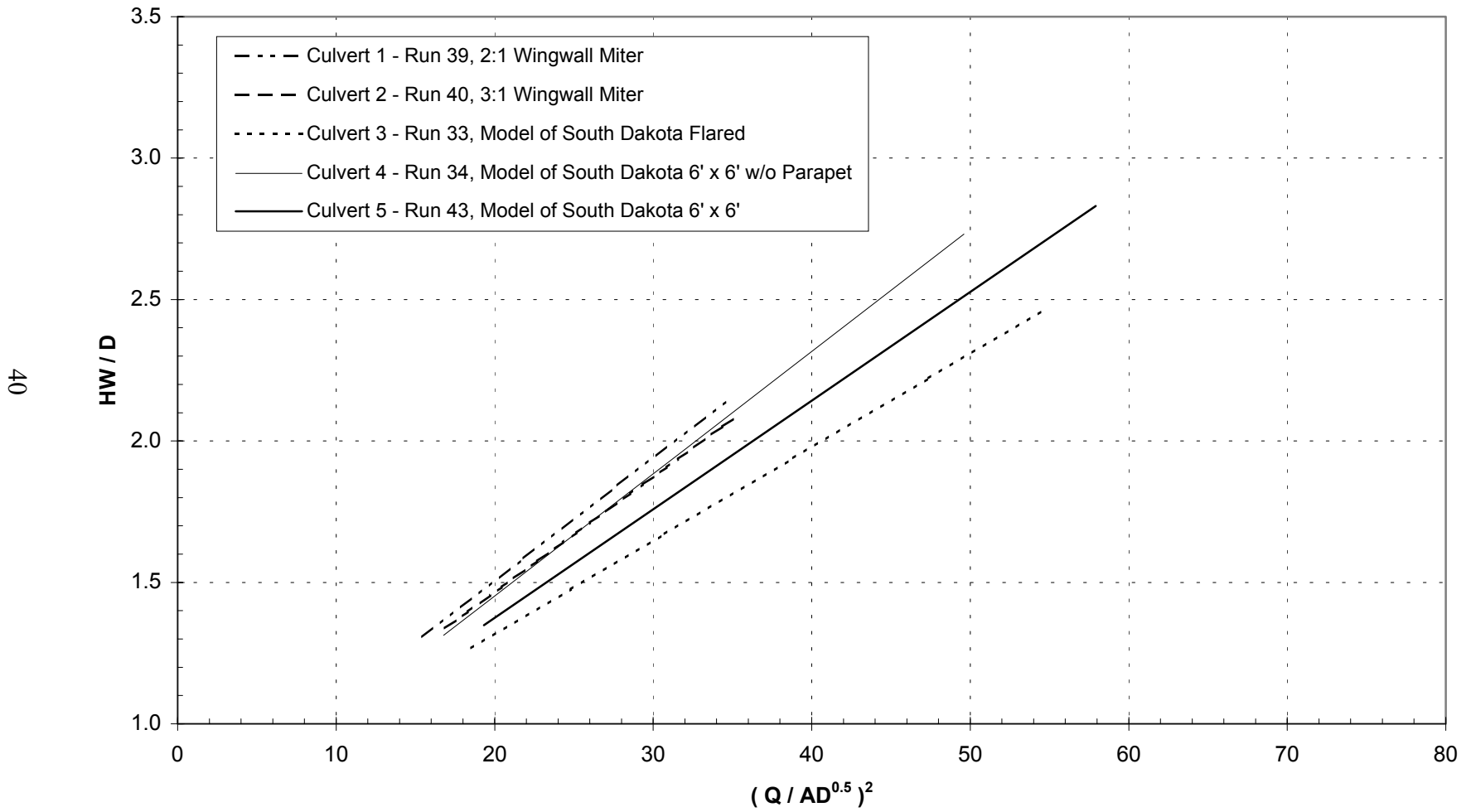

1 ft = 0.035 m

Figure 16b. Effect of configuration, submerged conditions.

APPENDIX C.
SPREADSHEETS OF DATA ANALYSIS FOR RUNS

Date: 11/9/1995
 Run#: 39
 Data Collected By: ELW
 Inlet Description: Square Edge - 2/1

Barrel Slope: 3.0 percent
 Barrel Type: Square Barrel
 Barrel Length: 20 feet
 Barrel Cross Sectional Area: 0.3164 ft²
 Culvert Height: 6.75 inches
 Culvert Width: 6.75 inches

Unsubmerged Inlet Control Design Constants

Form (1)
 K = 0.0090
 M = 1.5432

Form (2)
 K = 0.4767
 M = 0.7252

Submerged Inlet Control Design Constants

c = 0.0435
 Y = 0.6152

Definitions:

H_w = Headwater depth above inlet control section invert, ft
 D = Interior height of culvert barrel, ft
 H_c = Specific head at critical depth (d_c + V_c²/2g), ft
 Q = Discharge, ft³/s
 A = Full cross sectional area of culvert barrel, ft²
 S = Culvert barrel slope, ft/ft
 K, M, c, Y = Constants

Notes:

- 1). For mitered inlets use +0.7S instead of -0.5S as the slope correction factor.
- 2). For Unsubmerged Flow, H_w/D < 1.2.
- 3). For Submerged Flow, H_w/D > 1.5.
- 4). For Unsubmerged Flow, Q/(AD^{0.5}) < 3.5.
- 5). For Submerged Flow, Q/(AD^{0.5}) > 4.0.

43

Reading Number	H _w (mm)	H _w (ft)	D (ft)	Q (ft ³ /s)	Q (m ³ /s)	A (ft ²)	S (ft/ft)	H _c (ft)	Q/(AD ^{0.5})	H _w /D	H _c /D	Unsubmerged			Submerged			
												H _w /D - H _c /D - 0.7S	Form 1 Data Y X ln(H _w /D - H _c /D - 0.7S) ln(Q/(AD ^{0.5}))	Form 2 Data Y X ln(H _w /D) ln(Q/(AD ^{0.5}))	H _w /d + 0.5S	(Q/(AD ^{0.5})) ²		
0	0.0	0.0000	0.5625	0.0000	0.0000	0.31640	0.0300	0.0000	0.00000	0.00000	0.0000	-0.02100			0.015	0		
1	58.7	0.1926	0.5625	0.1519	0.0043	0.31640	0.0300	0.1969	0.63992	0.34237	0.3501	-0.02875	#NUM!	-0.44641	-1.07185	-0.44641	0.35737387	0.409499228
2	122.7	0.4026	0.5625	0.4061	0.0115	0.31640	0.0300	0.3795	1.71142	0.71566	0.6746	0.02007	-3.90832	0.53732	-0.33455	0.53732	0.730660542	2.928949322
3	162.7	0.5337	0.5625	0.6109	0.0173	0.31640	0.0300	0.4982	2.57457	0.94882	0.8857	0.04215	-3.16644	0.94568	-0.05254	0.94568	0.963818898	6.62839503
4	195.9	0.6426	0.5625	0.8052	0.0228	0.31640	0.0300	0.5989	3.39307	1.14246	1.0646	0.05684	-2.86753	1.22174	0.13319	1.22174	1.157461359	11.51293018
5	225.4	0.7396	0.5625	0.9323	0.0264	0.31640	0.0300		3.92882	1.31481							1.329814815	15.4356183
6	270.4	0.8870	0.5625	1.1089	0.0314	0.31640	0.0300		4.67291	1.57684							1.591844561	21.83612003
7	315.0	1.0334	0.5625	1.2501	0.0354	0.31640	0.0300		5.26819	1.83712							1.852124526	27.75381575
8	367.7	1.2064	0.5625	1.3949	0.0395	0.31640	0.0300		5.87835	2.14465							2.159648586	34.55495788

Date: 2/9/1996
 Run#: 40
 Data Collected By: ERU
 Inlet Description: Square Edge - 3/1

Barrel Slope: 3.0 percent
 Barrel Type: Square Barrel
 Barrel Length: 20 feet
 Barrel Cross Sectional Area: 0.3164 ft²
 Culvert Height: 6.75 inches
 Culvert Width: 6.75 inches

Unsubmerged Inlet Control Design Constants

Form (1)
 K = 0.0125
 M = -0.9928

Form (2)
 K = 0.4850
 M = 0.6699

Submerged Inlet Control Design Constants

c = 0.0407
 Y = 0.6311

Definitions:

H_w = Headwater depth above inlet control section invert, ft
 D = Interior height of culvert barrel, ft
 H_c = Specific head at critical depth (d_c + V_c²/2g), ft
 Q = Discharge, ft³/s
 A = Full cross sectional area of culvert barrel, ft²
 S = Culvert barrel slope, ft/ft
 K, M, c, Y = Constants

Notes:

- 1). For mitered inlets use +0.7S instead of -0.5S as the slope correction factor.
- 2). For Unsubmerged Flow, H_w/D < 1.2.
- 3). For Submerged Flow, H_w/D > 1.5.
- 4). For Unsubmerged Flow, Q/(AD^{0.5}) < 3.5.
- 5). For Submerged Flow, Q/(AD^{0.5}) > 4.0.

44

Reading Number	H _w (mm)	H _w (ft)	D (ft)	Q (ft ³ /s)	Q (m ³ /s)	A (ft ²)	S (ft/ft)	H _c (ft)	Q/(AD ^{0.5})	H _w /D	H _c /D	Unsubmerged		Submerged				
												Form 1 Data		Form 2 Data		H _w /d+0.5S	(Q/(AD ^{0.5})) ²	
												Y	X	Y	X			
												ln(H _w /D-H _c /D-0.7S)	ln(Q/(AD ^{0.5}))	ln(H _w /D)	ln(Q/(AD ^{0.5}))			
0	0.0	0.0000	0.5625	0.0000	0.0000	0.3164	0.0300	0.0000	0.00000	0.00000	0.0000					0.015	0	
1	56.4	0.1850	0.5625	0.1342	0.0038	0.3164	0.0300	0.1814	0.56551	0.32881	0.3224	-0.01461	#NUM!	-0.57002	-1.11227	-0.57002	0.343813065	0.319803616
2	113.2	0.3714	0.5625	0.3673	0.0104	0.3164	0.0300	0.3549	1.54772	0.66025	0.6309	0.00840	-4.77973	0.43678	-0.41514	0.43678	0.675250802	2.395426531
3	149.2	0.4894	0.5625	0.5686	0.0161	0.3164	0.0300	0.4749	2.39598	0.87008	0.8442	0.00486	-5.32721	0.87379	-0.13917	0.87379	0.88507874	5.740740672
4	183.6	0.6024	0.5625	0.7840	0.0222	0.3164	0.0300	0.5883	3.30378	1.07087	1.0459	0.00400	-5.52037	1.19507	0.06847	1.19507	1.085866142	10.91495943
5	229.5	0.7530	0.5625	0.9747	0.0276	0.3164	0.0300		4.10740	1.33873							1.353728492	16.8707481
6	269.5	0.8842	0.5625	1.1301	0.0320	0.3164	0.0300		4.76220	1.57189							1.586886847	22.67859437
7	318.0	1.0431	0.5625	1.2855	0.0364	0.3164	0.0300		5.41701	1.85448							1.869476524	29.343975
8	355.9	1.1677	0.5625	1.4055	0.0398	0.3164	0.0300		5.92299	2.07597							2.09096967	35.08183656
9	365.0	1.1975	0.5625	1.7022	0.0482	0.3164	0.0300		7.17307	2.12890							2.143900554	51.45294687
10	383.3	1.2574	0.5625	1.9529	0.0553	0.3164	0.0300		8.22969	2.23535							2.250345582	67.72771745
11	477.1	1.5653	0.5625	2.1542	0.0610	0.3164	0.0300		9.07795	2.78274							2.797735491	82.40922819
12	573.4	1.8811	0.5625	2.3626	0.0669	0.3164	0.0300		9.95598	3.34412							3.359123651	99.12162477

Date: 1/29/1996
 Run#: 33
 Data Collected By: ERU
 Inlet Description: South Dakota Flared
 Barrel Slope: 3.0 percent
 Barrel Type: Square Barrel with Haunches
 Barrel Length: 20 feet
 Barrel Cross Sectional Area: 0.36306 ft²
 Culvert Height: 7.25 inches
 Culvert Width: 7.25 inches

Unsubmerged Inlet Control Design Constants

Form (1)

K = 1.0000
 M = 0.0000

Form (2)

K = 0.3896
 M = 0.7940

Submerged Inlet Control Design Constants

c = 0.0331
 Y = 0.6337

Definitions:

H_w = Headwater depth above inlet control section invert, ft
 D = Interior height of culvert barrel, ft
 H_c = Specific head at critical depth (d_c + V_c²/2g), ft
 Q = Discharge, ft³/s
 A = Full cross sectional area of culvert barrel, ft²
 S = Culvert barrel slope, ft/ft
 K,M,c,Y = Constants

Notes:

- 1). For mitered inlets use +0.7S instead of -0.5S as the slope correction factor.
- 2). For Unsubmerged Flow, H_w/D < 1.2.
- 3). For Submerged Flow, H_w/D > 1.5.
- 4). For Unsubmerged Flow, Q/AD^{0.5} < 3.5.
- 5). For Submerged Flow, Q/AD^{0.5} > 4.0.

45

Reading Number	H _w (mm)	H _w (ft)	D (ft)	Q (ft ³ /s)	Q (m ³ /s)	A (ft ²)	S (ft/ft)	H _c (ft)	Q/(AD ^{0.5})	H _w /D	H _c /D	Unsubmerged		Submerged				
												H _w /D - H _c /D - 0.7S	Form 1 Data Y X ln(H _w /D - H _c /D - 0.7S) ln(Q/(AD ^{0.5}))	Form 2 Data Y X ln(H _w /D) ln(Q/(AD ^{0.5}))	H _w /d + 0.5S	(Q/(AD ^{0.5})) ²		
0	0.0	0.0000	0.6042	0.0000	0.0000	0.36306	0.0300	0.0000	0.00000	0.00000	0.00000				0.015	0		
1	19.3	0.0634	0.6042	0.0706	0.0020	0.36306	0.0300	0.1143	0.25028	0.10494	0.18919	-0.1052	#NUM!	-1.3852	-2.25435	-1.38517	0.119941618	0.062640909
2	51.7	0.1695	0.6042	0.1907	0.0054	0.36306	0.0300	0.2202	0.67576	0.28061	0.36447	-0.1049	#NUM!	-0.3919	-1.27078	-0.39192		
3	74.9	0.2456	0.6042	0.2966	0.0084	0.36306	0.0300	0.2950	1.05118	0.40646	0.48828	-0.1028	#NUM!	0.0499	-0.90026	0.04992	0.421462101	1.10498564
4	98.6	0.3236	0.6042	0.4132	0.0117	0.36306	0.0300	0.3676	1.46415	0.53557	0.60844	-0.0939	#NUM!	0.3813	-0.62443	0.38127		
5	115.6	0.3791	0.6042	0.5050	0.0143	0.36306	0.0300	0.4200	1.78951	0.62748	0.69517	-0.0887	#NUM!	0.5819	-0.46605	0.58194	0.642477565	3.202359886
6	141.4	0.4639	0.6042	0.6604	0.0187	0.36306	0.0300	0.5019	2.34013	0.76785	0.83073	-0.0839	#NUM!	0.8502	-0.26416	0.85021		
7	169.0	0.5543	0.6042	0.8334	0.0236	0.36306	0.0300	0.5859	2.95332	0.91746	0.96977	-0.0733	#NUM!	1.0829	-0.08615	1.08293		
8	193.2	0.6338	0.6042	1.0029	0.0284	0.36306	0.0300	0.6627	3.55400	1.04901	1.09688	-0.0689	#NUM!	1.2681	0.04785	1.26807	1.064008902	12.63091295
9	233.9	0.7673	0.6042	1.2148	0.0344	0.36306	0.0300		4.30484		1.27002							
10	271.3	0.8901	0.6042	1.4055	0.0398	0.36306	0.0300		4.98061		1.47326						1.488255417	24.80642649
11	307.8	1.0098	0.6042	1.5644	0.0443	0.36306	0.0300		5.54374		1.67133							
12	359.3	1.1786	0.6042	1.7587	0.0498	0.36306	0.0300		6.23201		1.95086							
13	408.6	1.3406	0.6042	1.9423	0.0550	0.36306	0.0300		6.88275		2.21884							
14	455.6	1.4948	0.6042	2.0906	0.0592	0.36306	0.0300		7.40834		2.47407							
15	524.2	1.7198	0.6042	2.3449	0.0664	0.36306	0.0300		8.30935		2.84659							

Date: 2/14/1996
 Run#: 43
 Data Collected By: ERU
 Inlet Description: South Dakota with Parapet

Barrel Slope: 3.00%
 Barrel Type: Square Barrel with Haunches
 Barrel Length: 20 feet
 Barrel Cross Sectional Area: 0.29883 ft²
 Culvert Height: 6.75 inches
 Culvert Width: 6.75 inches

Unsubmerged Inlet Control Design Constants

Form (1)

K = 1.0000
 M = 0.0000

Form (2)

K = 0.4026
 M = 0.7875

Submerged Inlet Control Design Constants

c = 0.0384
 Y = 0.5853

Definitions:

H_w = Headwater depth above inlet control section invert, ft
 D = Interior height of culvert barrel, ft
 H_c = Specific head at critical depth (d_c + V_c²/2g), ft
 Q = Discharge, ft³/s
 A = Full cross sectional area of culvert barrel, ft²
 S = Culvert barrel slope, ft/ft
 K,M,c,Y = Constants

Notes:

- 1). For mitered inlets use +0.7S instead of -0.5S as the slope correction factor.
- 2). For Unsubmerged Flow, H_w/D < 1.2.
- 3). For Submerged Flow, H_w/D > 1.5.
- 4). For Unsubmerged Flow, Q/AD^{1.5} < 3.5.
- 5). For Submerged Flow, Q/AD^{1.5} > 4.0.

Reading Number	H _w (mm)	H _w (ft)	D (ft)	Q (ft ³ /s)	Q (m ³ /s)	A (ft ²)	S (ft/ft)	H _c (ft)	Q/(AD ^{1.5})	H _w /D	H _w /D	Unsubmerged				Submerged		
												Form 1 Data		Form 2 Data		H _w /d+0.5S	(Q/(AD ^{1.5})) ²	
												Y	X	Y	X			
												ln(H _w /D-H _w /D-0.7S)	ln(Q/(AD ^{1.5}))	ln(H _w /D)	ln(Q/(AD ^{1.5}))			
0	0.0	0.0000	0.5625	0.0000	0.0000	0.29883	0.0300	0.0000	0.00000	0.00000	0.0000					0.015	0	
1	42.7	0.1402	0.5625	0.1236	0.0035	0.29883	0.0300	0.55149	0.24920	0.24920	0.24920	0.2282	-1.4775	-0.59513	-1.38951	-0.59513	0.264198017	0.3041423
2	99.9	0.3276	0.5625	0.3496	0.0099	0.29883	0.0300	1.55993	0.58239	0.58239	0.58239	0.5614	-0.5773	0.44464	-0.54062	0.44464	0.597385535	2.433386677
3	125.7	0.4124	0.5625	0.4732	0.0134	0.29883	0.0300	2.11142	0.73316	0.73316	0.73316	0.7122	-0.3395	0.74736	-0.31039	0.74736	0.748158355	4.458105415
4	152.5	0.5002	0.5625	0.6180	0.0175	0.29883	0.0300	2.75745	0.88918	0.88918	0.88918	0.8682	-0.1414	1.01431	-0.11746	1.01431	0.904180519	7.603557493
5	190.4	0.6246	0.5625	0.8264	0.0234	0.29883	0.0300	3.68711	1.11038	1.11038	1.11038				0.10470	1.30484		
6	227.9	0.7477	0.5625	0.9853	0.0279	0.29883	0.0300	4.39617	1.32925	1.32925	1.32925						1.591990376	25.10700891
7	270.4	0.8871	0.5625	1.1230	0.0318	0.29883	0.0300	5.01069	1.57699	1.57699	1.57699						1.921386702	33.44050792
8	326.9	1.0723	0.5625	1.2961	0.0367	0.29883	0.0300	5.78278	1.90639	1.90639	1.90639						2.233285214	41.7357719
9	380.3	1.2478	0.5625	1.4479	0.0410	0.29883	0.0300	6.46032	2.21829	2.21829	2.21829						2.543871391	50.27658424
10	433.6	1.4225	0.5625	1.5892	0.0450	0.29883	0.0300	7.09060	2.52887	2.52887	2.52887						2.837980461	57.92085956
11	484.0	1.5879	0.5625	1.7057	0.0483	0.29883	0.0300	7.61058	2.82298	2.82298	2.82298						3.175250802	68.43201743
12	541.8	1.7776	0.5625	1.8540	0.0525	0.29883	0.0300	8.27236	3.16025	3.16025	3.16025							
13	455.2	1.4935	0.5625	2.0023	0.0567	0.29883	0.0300	8.93415	2.65515	2.65515	2.65515							
14	569.9	1.8697	0.5625	2.2743	0.0644	0.29883	0.0300	10.14743	3.32386	3.32386	3.32386							
15	654.1	2.1458	0.5625	2.5250	0.0715	0.29883	0.0300	11.26617	3.81481	3.81481	3.81481							

Date: 10/31/1995
 Run#: 12
 Data Collected By: ELW
 Inlet Description: South Dakota with Parapet
 Barrel Slope: 1.75 percent
 Barrel Type: Square Barrel with Haunches
 Barrel Length: 20 feet
 Barrel Cross Sectional Area: 0.29883 ft²
 Culvert Height: 6.75 inches
 Culvert Width: 6.75 inches

Unsubmerged Inlet Control Design Constants

Form (1)
 K = 1.0000
 M = 0.0000

Form (2)
 K = 0.4889
 M = 0.6815

Submerged Inlet Control Design Constants

c = 0.0254
 Y = 1.0060

Definitions:

H_w = Headwater depth above inlet control section invert, ft
 D = Interior height of culvert barrel, ft
 H_c = Specific head at critical depth (d_c + V_c²/2g), ft
 Q = Discharge, ft³/s
 A = Full cross sectional area of culvert barrel, ft²
 S = Culvert barrel slope, ft/ft
 K,M,c,Y = Constants

Notes:

- 1). For mitered inlets use +0.7S instead of -0.5S as the slope correction factor.
- 2). For Unsubmerged Flow, H_w/D<1.2.
- 3). For Submerged Flow, H_w/D<1.5.
- 4). For Unsubmerged Flow, Q/AD^{0.5}<3.5.
- 5). For Submerged Flow, Q/AD^{0.5}>4.0.

Reading Number	H _w (mm)	H _w (ft)	D (ft)	Q (ft ³ /s)	Q (m ³ /s)	A (ft ²)	S (ft/ft)	H _c (ft)	Q/(AD ^{0.5})	H _w /D	H _c /D	Unsubmerged				Submerged		
												Form 1 Data		Form 2 Data		H _w /d+0.5S	(Q/(AD ^{0.5})) ²	
												Y	X	Y	X			
ln(H _w /D-H _c /D-0.7S)												ln(H _w /D)	ln(Q/(AD ^{0.5}))					
0	0.0	0.0000	0.5625	0.0000	0.0000	0.29883	0.0175	0.0000	0.00000	0.00000	0.0000					0.00875	0	
1	43.4	0.1425	0.5625	0.0742	0.0021	0.29883	0.0175	0.1383	0.33089	0.25328	0.2459	-0.00484	#NUM!	-1.10596	-1.37326	-1.10596	0.26203084	0.109491228
2	79.6	0.2612	0.5625	0.2048	0.0058	0.29883	0.0175	0.2562	0.91390	0.46442	0.4555	-0.00330	#NUM!	-0.09003	-0.76696	-0.09003	0.473171114	0.833211997
3	100.9	0.3309	0.5625	0.2966	0.0084	0.29883	0.0175	0.3237	1.32358	0.58822	0.5755	0.00050	-7.59796	0.28034	-0.53066	0.28034	0.596968139	1.751859646
4	128.8	0.4226	0.5625	0.4308	0.0122	0.29883	0.0175	0.4104	1.92234	0.75124	0.7296	0.00939	-4.66817	0.65354	-0.28603	0.65354	0.759989428	3.695391011
5	158.0	0.5183	0.5625	0.5650	0.0160	0.29883	0.0175	0.4887	2.52110	0.92141	0.8688	0.04036	-3.21002	0.92470	-0.08185	0.92470	0.930155658	6.355953365
6	185.4	0.6083	0.5625	0.7098	0.0201	0.29883	0.0175	0.5663	3.16713	1.08151	1.0068	0.06251	-2.77251	1.15283	0.07836	1.15283	1.090260645	10.03073718
7	211.3	0.6931	0.5625	0.8440	0.0239	0.29883	0.0175		3.76590	1.23214							1.240887649	14.18196923
8	247.3	0.8114	0.5625	0.9994	0.0283	0.29883	0.0175		4.45920	1.44240							1.451153033	19.88445114
9	276.9	0.9084	0.5625	1.1124	0.0315	0.29883	0.0175		4.96342	1.61490							1.623652304	24.63552628
10	305.7	1.0030	0.5625	1.2184	0.0345	0.29883	0.0175		5.43613	1.78303							1.791777122	29.55145896
11	344.2	1.1293	0.5625	1.3349	0.0378	0.29883	0.0175		5.95610	2.00773							2.016478201	35.47515784
12	367.9	1.2069	0.5625	1.4302	0.0405	0.29883	0.0175		6.38154	2.14567							2.154419291	40.72403323
13	363.4	1.1922	0.5625	1.5574	0.0441	0.29883	0.0175		6.94879	2.11942							2.128172572	48.2856315
14	411.9	1.3515	0.5625	1.6916	0.0479	0.29883	0.0175		7.54755	2.40260							2.411345509	56.96548031
15	459.3	1.5070	0.5625	1.8011	0.051	0.29883	0.0175		8.03601	2.67906							2.687810951	64.57747931
16	535.6	1.7571	0.5625	1.9988	0.0566	0.29883	0.0175		8.91840	3.12365							3.13240121	79.53780454
17	623.3	2.0450	0.5625	2.2072	0.0625	0.29883	0.0175		9.84805	3.63561							3.644358049	96.98415169
18	673.1	2.2083	0.5625	2.4579	0.0696	0.29883	0.0175		10.96679	3.92593							3.934675926	120.2705276

Date: 2/12/1995
 Run#: 42
 Data Collected By: ERU
 Inlet Description: South Dakota - 9.0"

Barrel Slope: 3.0 percent
 Barrel Type: Square Barrel with Haunches
 Barrel Length: 20 feet
 Barrel Cross Sectional Area: 0.55469 ft²
 Culvert Height: 9.0 inches
 Culvert Width: 9.0 inches

Unsubmerged Inlet Control Design Constants

Form (1)

K = 1.0000
 M = 0.0000

Form (2)

K = 0.4368
 M = 0.7384

Submerged Inlet Control Design Constants

c = 0.0506
 Y = 0.5343

Definitions:

H_w = Headwater depth above inlet control section invert, ft
 D = Interior height of culvert barrel, ft
 H_c = Specific head at critical depth (d_c + V_c²/2g), ft
 Q = Discharge, ft³/s
 A = Full cross sectional area of culvert barrel, ft²
 S = Culvert barrel slope, ft/ft
 K,M,c,Y = Constants

Notes:

- 1). For mitered inlets use +0.7S instead of -0.5S as the slope correction factor.
- 2). For Unsubmerged Flow, H_w/D < 1.2.
- 3). For Submerged Flow, H_w/D > 1.5.
- 4). For Unsubmerged Flow, Q/AD^{0.5} < 3.5.
- 5). For Submerged Flow, Q/AD^{0.5} > 4.0.

Reading Number	H _w (mm)	H _w (ft)	D (ft)	Q (ft ³ /s)	Q (m ³ /s)	A (ft ²)	S (ft/ft)	H _c (ft)	Q/(AD ^{0.5})	H _w /D	H _c /D	Unsubmerged				Submerged		
												Form 1 Data		Form 2 Data		H _w /d+0.5S	(Q/(AD ^{0.5})) ²	
												Y	X	Y	X			
NOT CORRECTED												ln(H _w /D-H _c /D-0.7S)	ln(Q/(AD ^{0.5}))	ln(H _w /D)	ln(Q/(AD ^{0.5}))			
0	0.0	0.0000	0.7500	0.0000	0.0000	0.55469	0.0300	0.0000	0.00000	0.00000	0.00000					0.015	0	
1	44.1	0.1446	0.7500	0.1836	0.0052	0.55469	0.0300	0.0859	0.38228	0.19280	0.11453	0.0573	-2.8600	-0.9616	-1.64608	-0.96161	0.207804024	0.146135727
2	83.6	0.2743	0.7500	0.3814	0.0108	0.55469	0.0300	0.1778	0.79396	0.36570	0.23707	0.1076	-2.2290	-0.2307	-1.00593	-0.23072	0.380704287	0.630372455
3	110.3	0.3620	0.7500	0.5474	0.0155	0.55469	0.0300	0.2513	1.13948	0.48261	0.33507	0.1265	-2.0672	0.1306	-0.72854	0.13057	0.497611549	1.298413772
4	141.0	0.4624	0.7500	0.7628	0.0216	0.55469	0.0300	0.3381	1.58792	0.61658	0.45080	0.1448	-1.9325	0.4624	-0.48357	0.46242	0.631579178	2.52148982
5	165.9	0.5444	0.7500	0.9500	0.0269	0.55469	0.0300	0.4037	1.97755	0.72583	0.53827	0.1666	-1.7924	0.6819	-0.32044	0.68186	0.740831146	3.910697978
6	183.6	0.6022	0.7500	1.0842	0.0307	0.55469	0.0300	0.4791	2.25690	0.80293	0.63880	0.1431	-1.9440	0.8140	-0.21949	0.81399	0.817930884	5.093619129
7	204.4	0.6706	0.7500	1.2643	0.0358	0.55469	0.0300	0.5406	2.63183	0.89414	0.72080	0.1523	-1.8817	0.9677	-0.11189	0.96768	0.909138233	6.926530807
8	219.3	0.7196	0.7500	1.4126	0.0400	0.55469	0.0300	0.6093	2.94059	0.95943	0.81240	0.1260	-2.0713	1.0786	-0.04142	1.07861		
9	238.3	0.7817	0.7500	1.5680	0.0444	0.55469	0.0300	0.6668	3.26406	1.04232	0.88907	0.1323	-2.0230	1.1830	0.04145	1.18297	1.057322835	10.65407273
10	267.0	0.8761	0.7500	1.7234	0.0488	0.55469	0.0300	0.7314	3.58752	1.16809	0.97520	0.1719	-1.7609	1.2775	0.15537	1.27746	1.183088364	12.87032047
11	294.9	0.9674	0.7500	1.8681	0.0529	0.55469	0.0300		3.88893	1.28981							1.304807524	15.12380472
12	329.7	1.0815	0.7500	2.0165	0.0571	0.55469	0.0300		4.19770	1.44204							1.457038495	17.62065034
13	357.0	1.1713	0.7500	2.1330	0.0604	0.55469	0.0300		4.44029	1.56168								
14	389.8	1.2787	0.7500	2.2990	0.0651	0.55469	0.0300		4.78581	1.70494								
15	426.8	1.4002	0.7500	2.4438	0.0692	0.55469	0.0300		5.08723	1.86691								
16	480.3	1.5758	0.7500	2.6451	0.0749	0.55469	0.0300		5.50626	2.10105								
17	541.8	1.7774	0.7500	2.8817	0.0816	0.55469	0.0300		5.99881	2.36986								
18	626.1	2.0542	0.7500	3.2348	0.0916	0.55469	0.0300		6.73396	2.73895								

Date: 10/17/1995
 Run#: 5
 Data Collected By: ELW
 Inlet Description: Square Edge w/o parapet - 2:1
 Barrel Slope: 0.50%
 Barrel Type: Square
 Barrel Length: 20ft = 6.096m
 Barrel Cross Sectional Area: 0.31641 ft²
 Culvert Height: 171.45 mm = 6.75"
 Culvert Width: 171.45 mm = 6.75"

Reading #	Headbox EGL	Projected EGL	He	Ke = 2g/V ² *He
1*	1.0378	1.0412	-0.0034	-1.3670
2	1.1366	1.1202	0.0165	0.5921
3	1.2528	1.2137	0.0391	0.6306
4	1.3378	1.2912	0.0466	0.4801
5	1.4610	1.3748	0.0862	0.6592
6	1.5634	1.4508	0.1126	0.6732
7	1.7506	1.5811	0.1695	0.7537
8	1.9177	1.6973	0.2204	0.7769
9	2.0868	1.8209	0.2659	0.7719
10	2.2904	1.9741	0.3163	0.7595
11	2.4802	2.1103	0.3698	0.7587
12	2.7632	2.3360	0.4273	0.7094

Reading #	Q (ft ³ /s)	V ² /2g (ft)	Port #	HGL (ft)	Measured EGL		Reading #	Q (ft ³ /s)	V ² /2g (ft)	Port #	HGL (ft)	Measured EGL	
					Horizontal Distance (ft)	HGL+V ² /2g (ft)						Horizontal Distance (ft)	HGL+V ² /2g (ft)
1	0.1271	0.00251	1	1.0407			2	0.4238	0.02785	1	1.1411		
				1.0413							1.1404		
				1.0253							1.1230		
				1.0440							1.1421		
				1.0381	2.00	1.0406					1.0896	2.00	1.1174
				1.0384	4.00	1.0409					1.0879	4.00	1.1158
				1.0384	6.00	1.0409					1.0863	6.00	1.1141
				1.0377	7.67	1.0402					1.0830	7.67	1.1109
				1.0374	10.00	1.0399					1.0774	10.00	1.1053
				1.0371	12.00	1.0396					1.0771	12.00	1.1050
				1.0367	14.00	1.0393					1.0732	14.00	1.1010
				1.0361	15.67	1.0386					1.0741	15.67	1.1020
				1.0367	18.00	1.0393					1.0709	18.00	1.0987
3	0.6321	0.0620	1	1.2546			4	0.7910	0.0971	1	1.3415		
				1.2595							1.3428		
				1.2421							1.3258		
				1.2549							1.3409		
				1.1490	2.00	1.2109					1.1890	2.00	1.2860
				1.1437	4.00	1.2057					1.1795	4.00	1.2765
				1.1365	6.00	1.1985					1.1706	6.00	1.2677
				1.1280	7.67	1.1899					1.1591	7.67	1.2562
				1.1230	10.00	1.1850					1.1467	10.00	1.2437
				1.1211	12.00	1.1830					1.1437	12.00	1.2408
				1.1122	14.00	1.1742					1.1312	14.00	1.2283
				1.1122	15.67	1.1742					1.1329	15.67	1.2299
				1.1093	18.00	1.1712					1.1237	18.00	1.2207
5	0.9182	0.1308	1	1.4633			6	1.0383	0.1672	1	1.5673		
				1.4656							1.5705		
				1.4495							1.5512		
				1.4656							1.5646		
				1.2365	2.00	1.3673					1.2733	2.00	1.4405
				1.2234	4.00	1.3542					1.2582	4.00	1.4254
				1.2162	6.00	1.3470					1.2421	6.00	1.4093
				1.1962	7.67	1.3270					1.2283	7.67	1.3955
				1.1778	10.00	1.3086					1.2064	10.00	1.3736
				1.1785	12.00	1.3092					1.1972	12.00	1.3644
				1.1617	14.00	1.2925					1.1765	14.00	1.3437
				1.1617	15.67	1.2925					1.1801	15.67	1.3473
				1.1493	18.00	1.2800					1.1631	18.00	1.3303
7	1.2042	0.2249	1	1.7556			8	1.3526	0.2837	1	1.9222		
				1.7546							1.9226		
				1.7379							1.9032		
				1.7543							1.9229		
				1.3412	2.00	1.5661					1.3917	2.00	1.6755
				1.3192	4.00	1.5441					1.3727	4.00	1.6564
				1.3031	6.00	1.5281					1.3524	6.00	1.6361
				1.2700	7.67	1.4949					1.2986	7.67	1.5823
				1.2467	10.00	1.4716					1.2753	10.00	1.5590
				1.2316	12.00	1.4565					1.2664	12.00	1.5501
				1.2070	14.00	1.4319					1.2290	14.00	1.5127
				1.2018	15.67	1.4267					1.2178	15.67	1.5016
				1.1870	18.00	1.4119					1.2051	18.00	1.4888
9	1.4903	0.3445	1	2.0915			10	1.6386	0.4164	1	2.2890		
				2.0919							2.2972		
				2.0705							2.2782		
				2.0932							2.2972		
				1.4544	2.00	1.7989					1.5279	2.00	1.9443
				1.4259	4.00	1.7703					1.4951	4.00	1.9115
				1.3963	6.00	1.7408					1.4524	6.00	1.8689
				1.3465	7.67	1.6909					1.3894	7.67	1.8059
				1.3091	10.00	1.6535					1.3510	10.00	1.7675
				1.2943	12.00	1.6388					1.3225	12.00	1.7390
				1.2579	14.00	1.6023					1.2756	14.00	1.6920
				1.2480	15.67	1.5925					1.2710	15.67	1.6874
				1.2254	18.00	1.5699					1.2323	18.00	1.6487

11	1.7728	0.4875	1	2.4823				12	1.9706	0.6023	1	2.7644			
			2	2.4846							2	2.7723			
			3	2.4869							3	2.7487			
			4	2.4869							4	2.7674			
			5	1.5971	2.00	2.0846					5	1.6929	2.00	2.2952	
			6	1.5387	4.00	2.0262					6	1.6375	4.00	2.2397	
			7	1.5013	6.00	1.9888					7	1.5915	6.00	2.1938	
			8	1.4344	7.67	1.9218					8	1.5049	7.67	2.1072	
			9	1.3862	10.00	1.8736					9	1.4334	10.00	2.0357	
			10	1.3579	12.00	1.8454					10	1.3967	12.00	1.9989	
			11	1.2959	14.00	1.7834					11	1.3238	14.00	1.9261	
			12	1.2943	15.67	1.7817					12	1.3304	15.67	1.9327	
			13	1.2510	18.00	1.7384					13	1.2779	18.00	1.8802	

Date: 10/19/1995
 Run#: 6
 Data Collected By: ELW
 Inlet Description: South Dakota w/o parapet- 2:1
 Barrel Slope: 0.50%
 Barrel Type: Square
 Barrel Length: 20ft = 6.096m
 Barrel Cross-Sectional Area: 0.29883 ft²
 Culvert Height: 171.45 mm = 6.75"
 Culvert Width: 171.45 mm = 6.75"

Reading #	Headbox EGL	Projected EGL	He
1*	1.0317	1.0440	-0.0123
2*	1.1197	1.1224	-0.0028
3*	1.2183	1.2221	-0.0039
4	1.3433	1.3104	0.0328
5	1.4444	1.3943	0.0501
6	1.5758	1.5087	0.0671
7	1.6807	1.5951	0.0856
8	1.8173	1.6867	0.1307
9	1.9240	1.7560	0.1680
10	2.0353	1.8462	0.1890
11	2.1275	1.9246	0.2029
12	2.3221	2.0689	0.2532
13	2.4883	2.2212	0.2670
14	2.6997	2.4023	0.2974

Reading #	Q (ft ³ /s)	V ² /2g (ft)	Port #	HGL (ft)	Horizontal Distance (ft)	Measured EGL		Reading #	Port #	HGL (ft)	Horizontal Distance (ft)	Measured EGL		
						HGL+V ² /2g (ft)						HGL+V ² /2g (ft)		
1	0.1766	0.00542	1	1.0443				2	0.3955	0.02720	1	1.1299		
			2	1.0446			2				1.1332			
			3	0.9918			3				1.0823			
			4	1.0459			4				1.1332			
			5	1.0377	2.00	1.0432	5				1.0925	2.00	1.1197	
			6	1.0371	4.00	1.0425	6				1.0909	4.00	1.1181	
			7	1.0374	6.00	1.0428	7				1.0906	6.00	1.1178	
			8	1.0381	7.67	1.0435	8				1.0863	7.67	1.1135	
			9	1.0364	10.00	1.0418	9				1.0820	10.00	1.1092	
			10	1.0351	12.00	1.0405	10				1.0810	12.00	1.1082	
			11	1.0344	14.00	1.0399	11				1.0787	14.00	1.1059	
			12	1.0344	15.67	1.0399	12				1.0774	15.67	1.1046	
			13	1.0348	18.00	1.0402	13				1.0758	18.00	1.1030	
3	0.6321	0.0695	1	1.2274				4	0.7663	0.1021	1	1.3547		
			2	1.2329			2				1.3553			
			3	1.1831			3				1.3071			
			4	1.2297			4				1.3560			
			5	1.1496	2.00	1.2191	5				1.2031	2.00	1.3052	
			6	1.1417	4.00	1.2112	6				1.1916	4.00	1.2937	
			7	1.1381	6.00	1.2076	7				1.1864	6.00	1.2885	
			8	1.1299	7.67	1.1994	8				1.1722	7.67	1.2744	
			9	1.1237	10.00	1.1932	9				1.1585	10.00	1.2606	
			10	1.1184	12.00	1.1879	10				1.1611	12.00	1.2632	
			11	1.1138	14.00	1.1833	11				1.1480	14.00	1.2501	
			12	1.1112	15.67	1.1807	12				1.1447	15.67	1.2468	
			13	1.1073	18.00	1.1768	13				1.1352	18.00	1.2373	
5	0.9182	0.1466	1	1.4573				6	1.0665	0.1978	1	1.5879		
			2	1.4580			2				1.5879			
			3	1.4081			3				1.5374			
			4	1.4541			4				1.5899			
			5	1.2398	2.00	1.3864	5				1.2972	2.00	1.4950	
			6	1.2326	4.00	1.3792	6				1.2851	4.00	1.4829	
			7	1.2162	6.00	1.3628	7				1.2654	6.00	1.4632	
			8	1.2011	7.67	1.3477	8				1.2448	7.67	1.4425	
			9	1.1841	10.00	1.3307	9				1.2205	10.00	1.4183	
			10	1.1834	12.00	1.3300	10				1.2106	12.00	1.4084	
			11	1.1657	14.00	1.3123	11				1.1877	14.00	1.3854	
			12	1.1709	15.67	1.3175	12				1.1883	15.67	1.3861	
			13	1.1555	18.00	1.3021	13				1.1759	18.00	1.3736	
7	1.1724	0.2390	1	1.6923				8	1.2819	0.2858	1	1.8284		
			2	1.6913			2				1.8304			
			3	1.6440			3				1.7805			
			4	1.6952			4				1.8301			
			5	1.3428	2.00	1.5819	5				1.3757	2.00	1.6614	
			6	1.3202	4.00	1.5592	6				1.3507	4.00	1.6365	
			7	1.3045	6.00	1.5435	7				1.3366	6.00	1.6224	
			8	1.2657	7.67	1.5048	8				1.2972	7.67	1.5830	
			9	1.2438	10.00	1.4828	9				1.2717	10.00	1.5574	
			10	1.2339	12.00	1.4730	10				1.2549	12.00	1.5407	
			11	1.2096	14.00	1.4487	11				1.2287	14.00	1.5144	
			12	1.2011	15.67	1.4401	12				1.2169	15.67	1.5026	
			13	1.1883	18.00	1.4274	13				1.1719	18.00	1.4577	

9	1.3631	0.3231	1	1.9370					10	1.4585	0.3699	1	2.0502				
			2	1.9367								2	2.0509				
			3	1.8862								3	1.9918				
			4	1.9364								4	2.0482				
			5	1.4117	2.00	1.7349						5	1.4495	2.00	1.8194		
			6	1.3898	4.00	1.7129						6	1.4278	4.00	1.7977		
			7	1.3688	6.00	1.6919						7	1.4032	6.00	1.7731		
			8	1.3219	7.67	1.6450						8	1.3507	7.67	1.7206		
			9	1.2913	10.00	1.6144						9	1.3146	10.00	1.6845		
			10	1.2753	12.00	1.5984						10	1.2907	12.00	1.6606		
			11	1.2457	14.00	1.5688						11	1.2543	14.00	1.6242		
			12	1.2428	15.67	1.5659						12	1.2569	15.67	1.6268		
			13	1.2169	18.00	1.5400						13	1.2297	18.00	1.5996		
11	1.5327	0.4085	1	2.1411					12	1.6774	0.4893	1	2.3350				
			2	2.1421								2	2.3369				
			3	2.0843								3	2.2785				
			4	2.1427								4	2.3379				
			5	1.4925	2.00	1.9009						5	1.5469	2.00	2.0362		
			6	1.4564	4.00	1.8648						6	1.5194	4.00	2.0086		
			7	1.4324	6.00	1.8409						7	1.4780	6.00	1.9673		
			8	1.3740	7.67	1.7825						8	1.4140	7.67	1.9033		
			9	1.3337	10.00	1.7421						9	1.3678	10.00	1.8571		
			10	1.3117	12.00	1.7201						10	1.3432	12.00	1.8325		
			11	1.2720	14.00	1.6804						11	1.3009	14.00	1.7901		
			12	1.2772	15.67	1.6857						12	1.2976	15.67	1.7869		
			13	1.2349	18.00	1.6434						13	1.2533	18.00	1.7426		
13	1.8046	0.5663	1	2.5030					14	1.9635	0.6704	1	2.7126				
			2	2.5059								2	2.7139				
			3	2.4432								3	2.6601				
			4	2.5010								4	2.7123				
			5	1.6214	2.00	2.1877						5	1.6972	2.00	2.3676		
			6	1.5741	4.00	2.1404						6	1.6381	4.00	2.3085		
			7	1.5348	6.00	2.1010						7	1.5833	6.00	2.2537		
			8	1.4557	7.67	2.0220						8	1.5052	7.67	2.1756		
			9	1.4026	10.00	1.9688						9	1.4528	10.00	2.1231		
			10	1.3747	12.00	1.9409						10	1.4101	12.00	2.0805		
			11	1.3166	14.00	1.8829						11	1.3481	14.00	2.0185		
			12	1.3114	15.67	1.8776						12	1.3373	15.67	2.0077		
			13	1.2674	18.00	1.8337						13	1.2858	18.00	1.9561		

Date:	11/02/1995	Reading #	Headbox EGL	Projected EGL	He	Ke = $2g/V^2+He$
Run#:	14					
Data Collected By:	ELW	1*	1.1301	1.1290	0.0011	0.1820
Inlet Description:	South Dakota w parapet- 2:1	2	1.1973	1.1913	0.0060	0.2658
		3	1.2648	1.2519	0.0129	0.3031
Barrel Slope:	0.50%	4	1.3717	1.3442	0.0275	0.3372
Barrel Type:	Square	5	1.4746	1.4332	0.0414	0.3398
Barrel Length:	20ft = 6.096m	6	1.5863	1.5281	0.0581	0.3494
Barrel Cross Sectional Area:	0.29883 ft ²	7	1.6800	1.6039	0.0761	0.3676
Culvert Height:	171.45 mm = 6.75"	8	1.7881	1.6905	0.0975	0.3914
Culvert Width:	171.45 mm = 6.75"	9	1.5304	1.2737	0.2567	0.8741
		10	2.0268	1.8846	0.1422	0.4099
		11	2.1293	1.9704	0.1589	0.4057
		12	2.3067	2.1243	0.1824	0.3840
		13	2.4881	2.2715	0.2166	0.3900
		14	2.7644	2.5215	0.2429	0.3521

Reading #	Q (ft ³ /s)	V ² /2g (ft)	Port #	HGL (ft)	Measured		Reading #	Q (ft ³ /s)	V ² /2g (ft)	Port #	HGL (ft)	Measured	
					Horizontal Distance (ft)	EGL HGL+V ² /2g (ft)						Horizontal Distance (ft)	EGL HGL+V ² /2g (ft)
1	0.1872	0.00609	1	1.1286			2	0.3602	0.02256	1	1.1982		
			2	1.1289						2	1.1972		
			3	1.1319						3	1.1982		
			4	1.1309						4	1.1959		
			5	1.1227	2.00	1.1288				5	1.1667	2.00	1.1892
			6	1.1227	4.00	1.1288				6	1.1637	4.00	1.1863
			7	1.1214	6.00	1.1275				7	1.1624	6.00	1.1850
			8	1.1204	7.67	1.1265				8	1.1611	7.67	1.1837
			9	1.1184	10.00	1.1245				9	1.1562	10.00	1.1787
			10	1.1207	12.00	1.1268				10	1.1555	12.00	1.1781
			11	1.1184	14.00	1.1245				11	1.1503	14.00	1.1728
			12	1.1198	15.67	1.1258				12	1.1529	15.67	1.1754
			13	1.1188	18.00	1.1249				13	1.1483	18.00	1.1709
3	0.4944	0.0425	1	1.2635			4	0.6851	0.0816	1	1.3675		
			2	1.2621						2	1.3743		
			3	1.2661						3	1.3753		
			4	1.2674						4	1.3698		
			5	1.2067	2.00	1.2492				5	1.2572	2.00	1.3388
			6	1.2005	4.00	1.2430				6	1.2480	4.00	1.3296
			7	1.1955	6.00	1.2380				7	1.2428	6.00	1.3244
			8	1.1909	7.67	1.2334				8	1.2306	7.67	1.3123
			9	1.1854	10.00	1.2279				9	1.2221	10.00	1.3037
			10	1.1837	12.00	1.2262				10	1.2198	12.00	1.3014
			11	1.1719	14.00	1.2144				11	1.1985	14.00	1.2801
			12	1.1755	15.67	1.2180				12	1.2064	15.67	1.2880
			13	1.1713	18.00	1.2138				13	1.2008	18.00	1.2824
5	0.8370	0.1218	1	1.4734			6	0.9782	0.1664	1	1.5840		
			2	1.4741						2	1.5869		
			3	1.4754						3	1.5879		
			4	1.4754						4	1.5863		
			5	1.3035	2.00	1.4253				5	1.3533	2.00	1.5197
			6	1.2910	4.00	1.4128				6	1.3337	4.00	1.5001
			7	1.2808	6.00	1.4026				7	1.3225	6.00	1.4889
			8	1.2684	7.67	1.3902				8	1.3002	7.67	1.4666
			9	1.2552	10.00	1.3771				9	1.2828	10.00	1.4492
			10	1.2503	12.00	1.3721				10	1.2792	12.00	1.4456
			11	1.2198	14.00	1.3416				11	1.2382	14.00	1.4046
			12	1.2339	15.67	1.3557				12	1.2536	15.67	1.4200
			13	1.2221	18.00	1.3439				13	1.2444	18.00	1.4108
7	1.0912	0.2071	1	1.6808			8	1.1972	0.2492	1	1.7838		
			2	1.6775						2	1.7884		
			3	1.6791						3	1.7900		
			4	1.6827						4	1.7900		
			5	1.3911	2.00	1.5981				5	1.4259	2.00	1.6751
			6	1.3691	4.00	1.5762				6	1.4052	4.00	1.6544
			7	1.3533	6.00	1.5604				7	1.3868	6.00	1.6360
			8	1.3264	7.67	1.5335				8	1.3579	7.67	1.6072
			9	1.3074	10.00	1.5145				9	1.3268	10.00	1.5760
			10	1.2999	12.00	1.5069				10	1.3153	12.00	1.5645
			11	1.2759	14.00	1.4830				11	1.2949	14.00	1.5442
			12	1.2730	15.67	1.4800				12	1.2917	15.67	1.5409
			13	1.2736	18.00	1.4807				13	1.2671	18.00	1.5163
9	1.2996	0.2937	1	1.9022			10	1.4126	0.3470	1	2.0269		
			2	1.4055						2	2.0266		
			3	1.4068						3	2.0259		
			4	1.4072						4	2.0279		
			5	0.9767	2.00	1.2704				5	1.5177	2.00	1.8647
			6	0.9596	4.00	1.2533				6	1.4862	4.00	1.8332
			7	0.9455	6.00	1.2392				7	1.4606	6.00	1.8076
			8	0.9144	7.67	1.2080				8	1.4167	7.67	1.7636
			9	0.9006	10.00	1.1943				9	1.3780	10.00	1.7249
			10	0.9006	12.00	1.1943				10	1.3678	12.00	1.7148
			11	0.8750	14.00	1.1687				11	1.3278	14.00	1.6747
			12	0.8809	15.67	1.1746				12	1.3212	15.67	1.6682
			13	0.8770	18.00	1.1706				13	1.2972	18.00	1.6442

Date: 11/15/1995
 Run#: 20
 Data Collected By: ELW
 Inlet Description: Square Edge - 3:1
 Barrel Slope: 0.50%
 Barrel Type: Square
 Barrel Length: 20ft = 6.096m
 Barrel Cross Sectional Area: 0.3164 ft²
 Culvert Height: 171.45 mm = 6.75"
 Culvert Width: 171.45 mm = 6.75"

Reading #	Headbox EGL	Projected EGL	He	Ke = 2g/V ² He
1	1.0193	1.0160	0.0033	0.3985
2	1.1007	1.0887	0.0121	0.4327
3	1.2002	1.1695	0.0307	0.5125
4	1.2771	1.2293	0.0479	0.5891
5	1.3899	1.3211	0.0688	0.5645
6	1.5084	1.4138	0.0946	0.5697
7	1.6106	1.4902	0.1203	0.5890
8	1.7146	1.5646	0.1501	0.6157
9	1.8088	1.6276	0.1812	0.6626
10	1.9324	1.7125	0.2200	0.6932
11	2.0637	1.8186	0.2451	0.6606
12	2.1932	1.9065	0.2867	0.6738
13	2.3600	2.0283	0.3317	0.6750
14	2.5296	2.1633	0.3663	0.6519

Reading #	Q (ft ³ /s)	V ² /2g (ft)	Port #	HGL (ft)	Horizontal Distance (ft)	Measured EGL		Reading #	Q (ft ³ /s)	V ² /2g (ft)	Port #	HGL (ft)	Horizontal Distance (ft)	Measured EGL	
						HGL+V ² /2g (ft)	HGL+V ² /2g (ft)							HGL+V ² /2g (ft)	HGL+V ² /2g (ft)
1	0.2295	0.00817	1	1.0177				2	0.4238	0.02786	1	1.0997			
			2	1.0184			2	1.0991							
			3	1.0197			3	1.1030							
			4	1.0213			4	1.1010							
			5	1.0085	2.00	1.0167	5	1.0587			2.00	1.0866			
			6	1.0052	4.00	1.0134	6	1.0558			4.00	1.0836			
			7	1.0056	6.00	1.0138	7	1.0538			6.00	1.0817			
			8	1.0052	7.67	1.0134	8	1.0479			7.67	1.0758			
			9	1.0026	10.00	1.0108	9	1.0463			10.00	1.0741			
			10	1.0020	12.00	1.0101	10	1.0449			12.00	1.0728			
			11	1.0030	14.00	1.0111	11	1.0387			14.00	1.0666			
			12	1.0016	15.67	1.0098	12	1.0384			15.67	1.0662			
			13	1.0016	18.00	1.0098	13	1.0384			18.00	1.0662			
3	0.6215	0.0599	1	1.1972				4	0.7240	0.0813	1	1.2749			
			2	1.2034			2	1.2766							
			3	1.2031			3	1.2792							
			4	1.1972			4	1.2779							
			5	1.1066	2.00	1.1665	5	1.1460			2.00	1.2273			
			6	1.1001	4.00	1.1600	6	1.1368			4.00	1.2181			
			7	1.0961	6.00	1.1560	7	1.1286			6.00	1.2099			
			8	1.0892	7.67	1.1492	8	1.1211			7.67	1.2024			
			9	1.0840	10.00	1.1439	9	1.1122			10.00	1.1935			
			10	1.0833	12.00	1.1433	10	1.1099			12.00	1.1912			
			11	1.0748	14.00	1.1347	11	1.1027			14.00	1.1840			
			12	1.0745	15.67	1.1344	12	1.1017			15.67	1.1830			
			13	1.0679	18.00	1.1278	13	1.0955			18.00	1.1768			
5	0.8864	0.1219	1	1.3901				6	1.0347	0.1661	1	1.5075			
			2	1.3891			2	1.5082							
			3	1.3911			3	1.5098							
			4	1.3894			4	1.5082							
			5	1.1923	2.00	1.3141	5	1.2356			2.00	1.4016			
			6	1.1831	4.00	1.3049	6	1.2254			4.00	1.3915			
			7	1.1726	6.00	1.2944	7	1.2149			6.00	1.3810			
			8	1.1611	7.67	1.2830	8	1.1903			7.67	1.3564			
			9	1.1450	10.00	1.2669	9	1.1791			10.00	1.3452			
			10	1.1450	12.00	1.2669	10	1.1699			12.00	1.3360			
			11	1.1293	14.00	1.2511	11	1.1496			14.00	1.3157			
			12	1.1283	15.67	1.2502	12	1.1522			15.67	1.3183			
			13	1.1198	18.00	1.2416	13	1.1352			18.00	1.3012			
7	1.1477	0.2043	1	1.6089				8	1.2537	0.2438	1	1.7126			
			2	1.6096			2	1.7123							
			3	1.6112			3	1.7142							
			4	1.6125			4	1.7195							
			5	1.2795	2.00	1.4839	5	1.3123			2.00	1.5561			
			6	1.2549	4.00	1.4592	6	1.2887			4.00	1.5325			
			7	1.2415	6.00	1.4458	7	1.2651			6.00	1.5089			
			8	1.2218	7.67	1.4261	8	1.2451			7.67	1.4889			
			9	1.1988	10.00	1.4031	9	1.2198			10.00	1.4636			
			10	1.1880	12.00	1.3923	10	1.2100			12.00	1.4538			
			11	1.1667	14.00	1.3710	11	1.1841			14.00	1.4278			
			12	1.1699	15.67	1.3743	12	1.1814			15.67	1.4252			
			13	1.1572	18.00	1.3615	13	1.1719			18.00	1.4157			
9	1.3278	0.2735	1	1.8068				10	1.4302	0.3173	1	1.9321			
			2	1.8061			2	1.9318							
			3	1.8114			3	1.9344							
			4	1.8110			4	1.9314							
			5	1.3379	2.00	1.6114	5	1.3770			2.00	1.6943			
			6	1.3182	4.00	1.5917	6	1.3501			4.00	1.6674			
			7	1.2989	6.00	1.5724	7	1.3258			6.00	1.6431			
			8	1.2631	7.67	1.5366	8	1.2936			7.67	1.6109			
			9	1.2395	10.00	1.5130	9	1.2618			10.00	1.5791			
			10	1.2241	12.00	1.4976	10	1.2461			12.00	1.5634			
			11	1.1985	14.00	1.4720	11	1.2116			14.00	1.5289			
			12	1.1965	15.67	1.4700	12	1.2073			15.67	1.5246			
			13	1.1775	18.00	1.4510	13	1.1867			18.00	1.5040			

11	1.5468	0.3711	1	2.0591			12	1.6563	0.4255	1	2.1886		
			2	2.0630						2	2.1969		
			3	2.0653						3	2.1952		
			4	2.0676						4	2.1923		
			5	1.4206	2.00	1.7917				5	1.4501	2.00	1.8756
			6	1.4029	4.00	1.7740				6	1.4298	4.00	1.8553
			7	1.3717	6.00	1.7428				7	1.3947	6.00	1.8202
			8	1.3327	7.67	1.7038				8	1.3560	7.67	1.7815
			9	1.2946	10.00	1.6657				9	1.3077	10.00	1.7332
			10	1.2785	12.00	1.6497				10	1.2887	12.00	1.7142
			11	1.2392	14.00	1.6103				11	1.2385	14.00	1.6640
			12	1.2329	15.67	1.6040				12	1.2418	15.67	1.6673
			13	1.2133	18.00	1.5844				13	1.2169	18.00	1.6424
13	1.7799	0.4914	1	2.3570			14	1.9035	0.5620	1	2.5230		
			2	2.3570						2	2.5312		
			3	2.3642						3	2.5348		
			4	2.3619						4	2.5295		
			5	1.5075	2.00	1.9989				5	1.5709	2.00	2.1329
			6	1.4757	4.00	1.9671				6	1.5279	4.00	2.0899
			7	1.4386	6.00	1.9300				7	1.4836	6.00	2.0456
			8	1.3816	7.67	1.8729				8	1.4167	7.67	1.9787
			9	1.3360	10.00	1.8273				9	1.3717	10.00	1.9337
			10	1.3228	12.00	1.8142				10	1.3494	12.00	1.9114
			11	1.2789	14.00	1.7702				11	1.2825	14.00	1.8445
			12	1.2569	15.67	1.7483				12	1.2779	15.67	1.8399
			13	1.2297	18.00	1.7210				13	1.2454	18.00	1.8074

Date: 11/21/1995
 Run#: 21
 Data Collected By: ELW
 Inlet Description: South Dakota Flare - 2:1
 Barrel Slope: 0.50%
 Barrel Type: Square
 Barrel Length: 20ft = 6.096m
 Barrel Cross Sectional Area: 0.36306 ft²
 Culvert Height: 171.45 mm = 6.75"
 Culvert Width: 171.45 mm = 6.75"

Reading #	Headbox EGL	Projected EGL	He	Ke = 2g/V ² *He
1*	0.9310	0.9313	-0.0003	-0.0789
2*	1.0244	1.0216	0.0027	0.0998
3	1.1274	1.1153	0.0121	0.1901
4	1.2178	1.1944	0.0234	0.2394
5	1.3140	1.2862	0.0278	0.1943
6	1.4019	1.3644	0.0375	0.2027
7	1.4914	1.4263	0.0651	0.2810
8	1.5969	1.5267	0.0701	0.2535
9	1.7151	1.6255	0.0896	0.2795
10	1.8126	1.7046	0.1080	0.2929
11	1.9274	1.8027	0.1247	0.2943
12	2.0878	1.9451	0.1427	0.2820
13	2.1926	2.0231	0.1695	0.3060
14	2.3591	2.1703	0.1888	0.2959

Reading #	Q (ft ³ /s)	V ² /2g (ft)	Port #	HGL (ft)	Horizontal Distance (ft)	Measured EGL HGL+V ² /2g (ft)	Reading #	Q (ft ³ /s)	V ² /2g (ft)	Port #	HGL (ft)	Horizontal Distance (ft)	Measured EGL HGL+V ² /2g (ft)
1	0.1730	0.00353	1	0.9301			2	0.4803	0.02717	1	1.0249		
			2	0.9308						2	1.0230		
			3	0.9321						3	1.0246		
			4	0.9311						4	1.0249		
			5	0.9281	2.00	0.9317				5	0.9931	2.00	1.0203
			6	0.9259	4.00	0.9294				6	0.9895	4.00	1.0167
			7	0.9262	6.00	0.9297				7	0.9872	6.00	1.0144
			8	0.9265	7.67	0.9300				8	0.9849	7.67	1.0121
			9	0.9255	10.00	0.9291				9	0.9826	10.00	1.0098
			10	0.9245	12.00	0.9281				10	0.9803	12.00	1.0075
			11	0.9245	14.00	0.9281				11	0.9777	14.00	1.0049
			12	0.9236	15.67	0.9271				12	0.9760	15.67	1.0032
			13	0.9242	18.00	0.9277				13	0.9741	18.00	1.0013
3	0.7345	0.0636	1	1.1217			4	0.9111	0.0978	1	1.2149		
			2	1.1302						2	1.2198		
			3	1.1312						3	1.2238		
			4	1.1263						4	1.2126		
			5	1.0489	2.00	1.1124				5	1.0915	2.00	1.1893
			6	1.0430	4.00	1.1065				6	1.0827	4.00	1.1805
			7	1.0397	6.00	1.1033				7	1.0774	6.00	1.1752
			8	1.0279	7.67	1.0914				8	1.0623	7.67	1.1601
			9	1.0285	10.00	1.0921				9	1.0587	10.00	1.1565
			10	1.0246	12.00	1.0882				10	1.0541	12.00	1.1519
			11	1.0187	14.00	1.0823				11	1.0469	14.00	1.1447
			12	1.0151	15.67	1.0787				12	1.0390	15.67	1.1368
			13	1.0115	18.00	1.0750				13	1.0335	18.00	1.1313
5	1.1018	0.1430	1	1.3123			6	1.2537	0.1852	1	1.3986		
			2	1.3150						2	1.4035		
			3	1.3150						3	1.4039		
			4	1.3136						4	1.4016		
			5	1.1335	2.00	1.2765				5	1.1683	2.00	1.3535
			6	1.1237	4.00	1.2667				6	1.1526	4.00	1.3377
			7	1.1184	6.00	1.2615				7	1.1503	6.00	1.3354
			8	1.0948	7.67	1.2378				8	1.1161	7.67	1.3013
			9	1.0899	10.00	1.2329				9	1.1142	10.00	1.2993
			10	1.0837	12.00	1.2267				10	1.1043	12.00	1.2895
			11	1.0755	14.00	1.2185				11	1.0971	14.00	1.2823
			12	1.0620	15.67	1.2050				12	1.0781	15.67	1.2632
			13	1.0515	18.00	1.1945				13	1.0630	18.00	1.2481
7	1.4020	0.2316	1	1.4931			8	1.5327	0.2767	1	1.5958		
			2	1.4911						2	1.5968		
			3	1.4911						3	1.5978		
			4	1.4902						4	1.5971		
			5	1.2001	2.00	1.4317				5	1.2379	2.00	1.5146
			6	1.1847	4.00	1.4163				6	1.2165	4.00	1.4933
			7	1.1768	6.00	1.4084				7	1.2064	6.00	1.4831
			8	1.1394	7.67	1.3710				8	1.1572	7.67	1.4339
			9	1.1362	10.00	1.3677				9	1.1640	10.00	1.4408
			10	1.1257	12.00	1.3572				10	1.1493	12.00	1.4260
			11	1.1165	14.00	1.3480				11	1.1444	14.00	1.4211
			12	1.0984	15.67	1.3300				12	1.1112	15.67	1.3879
			13	1.1572	18.00	1.3887				13	1.0906	18.00	1.3673
9	1.6492	0.3204	1	1.7165			10	1.7693	0.3688	1	1.8100		
			2	1.7129						2	1.8104		
			3	1.7136						3	1.8130		
			4	1.7172						4	1.8169		
			5	1.2861	2.00	1.6065				5	1.3225	2.00	1.6913
			6	1.2631	4.00	1.5835				6	1.2828	4.00	1.6516
			7	1.2510	6.00	1.5714				7	1.2815	6.00	1.6503
			8	1.1923	7.67	1.5127				8	1.2129	7.67	1.5817
			9	1.1926	10.00	1.5130				9	1.2037	10.00	1.5725
			10	1.1716	12.00	1.4920				10	1.1867	12.00	1.5554
			11	1.1588	14.00	1.4792				11	1.1759	14.00	1.5446
			12	1.1184	15.67	1.4388				12	1.1450	15.67	1.5138
			13	1.1096	18.00	1.4300				13	1.1194	18.00	1.4882

11	1.8964	0.4237	1	1.9265			12	2.0730	0.5062	1	2.0876		
			2	1.9291						2	2.0869		
			3	1.9259						3	2.0873		
			4	1.9281						4	2.0896		
			5	1.3606	2.00	1.7842				5	1.4196	2.00	1.9258
			6	1.3264	4.00	1.7501				6	1.3671	4.00	1.8734
			7	1.3120	6.00	1.7357				7	1.3642	6.00	1.8704
			8	1.2283	7.67	1.6520				8	1.2615	7.67	1.7677
			9	1.2336	10.00	1.6573				9	1.2569	10.00	1.7631
			10	1.2133	12.00	1.6369				10	1.2336	12.00	1.7398
			11	1.1998	14.00	1.6235				11	1.2185	14.00	1.7247
			12	1.1627	15.67	1.5864				12	1.1788	15.67	1.6850
			13	1.1237	18.00	1.5473				13	1.1322	18.00	1.6384
13	2.1683	0.5539	1	2.1916			14	0.1730	0.6380	1	2.3566		
			2	2.1906						2	2.3625		
			3	2.1942						3	2.3629		
			4	2.1939						4	2.3543		
			5	1.4442	2.00	1.9981				5	1.5072	2.00	2.1452
			6	1.4022	4.00	1.9561				6	1.4501	4.00	2.0882
			7	1.3950	6.00	1.9489				7	1.4390	6.00	2.0770
			8	1.2776	7.67	1.8314				8	1.2936	7.67	1.9317
			9	1.2835	10.00	1.8373				9	1.3127	10.00	1.9507
			10	1.2631	12.00	1.8170				10	1.2933	12.00	1.9313
			11	1.2418	14.00	1.7957				11	1.2612	14.00	1.8992
			12	1.1942	15.67	1.7481				12	1.1998	15.67	1.8378
			13	1.1549	18.00	1.7087				13	1.1526	18.00	1.7906

Date: 12/05/1995
 Run#: 26
 Data Collected By: ELW
 Inlet Description: South Dakota Flare - 12x12
 Barrel Slope: 0.50%
 Barrel Type: Square
 Barrel Length: 20ft = 6.096m
 Barrel Cross Sectional Area: 0.55469 ft²
 Culvert Height: 171.45 mm = 6.75"
 Culvert Width: 171.45 mm = 6.75"

Reading #	Headbox EGL	Projected EGL	He	Ke = 2g/V ² *He
1*	1.1508	1.1494	0.0014	1.7260
2*	1.2302	1.2284	0.0019	0.1751
3*	1.3021	1.3031	-0.0010	-0.0341
4	1.3980	1.3806	0.0173	0.3103
5	1.4899	1.4531	0.0368	0.4338
6	1.5790	1.5279	0.0511	0.4347
7	1.6696	1.5920	0.0776	0.5288
8	1.7795	1.6522	0.1274	0.7204
9	1.8834	1.7173	0.1661	0.7843
10	1.9803	1.7823	0.1980	0.8028
11	2.0955	1.8531	0.2424	0.8478
12	2.2734	1.9824	0.2910	0.8197
13	2.4779	2.1493	0.3287	0.7748
14	2.6520	2.2859	0.3660	0.7277

Reading #	Q (ft ³ /s)	V ² /2g (ft)	Port #	HGL (ft)	Horizontal Distance (ft)	Measured EGL HGL+V ² /2g (ft)	Reading #	Q (ft ³ /s)	V ² /2g (ft)	Port #	HGL (ft)	Horizontal Distance (ft)	Measured EGL HGL+V ² /2g (ft)
1	0.1271	0.00082	1	1.1503			2	0.4591	0.01064	1	1.2280		
			2	1.1499						2	1.2306		
			3	1.1519						3	1.2320		
			4	1.1512						4	1.2303		
			5	1.1486	2.00	1.1494				5	1.2162	2.00	1.2268
			6	1.1490	4.00	1.1498				6	1.2172	4.00	1.2278
			7	1.1493	6.00	1.1501				7	1.2159	6.00	1.2265
			8	1.1486	7.67	1.1494				8	1.2142	7.67	1.2249
			9	1.1486	10.00	1.1494				9	1.2133	10.00	1.2239
			10	1.1480	12.00	1.1488				10	1.2100	12.00	1.2206
			11	1.1496	14.00	1.1504				11	1.2123	14.00	1.2229
			12	1.1493	15.67	1.1501				12	1.2106	15.67	1.2213
			13	1.1493	18.00	1.1501				13	1.2110	18.00	1.2216
3	0.7593	0.0291	1	1.3100			4	1.0524	0.0559	1	1.3976		
			2	1.3117						2	1.3967		
			3	1.3143						3	1.3999		
			4	1.3143						4	1.3963		
			5	1.2723	2.00	1.3014				5	1.3176	2.00	1.3735
			6	1.2710	4.00	1.3001				6	1.3205	4.00	1.3764
			7	1.2671	6.00	1.2962				7	1.3173	6.00	1.3732
			8	1.2680	7.67	1.2971				8	1.3153	7.67	1.3712
			9	1.2644	10.00	1.2935				9	1.3136	10.00	1.3695
			10	1.2621	12.00	1.2912				10	1.3064	12.00	1.3623
			11	1.2608	14.00	1.2899				11	1.3045	14.00	1.3604
			12	1.2592	15.67	1.2883				12	1.3012	15.67	1.3571
			13	1.2582	18.00	1.2873				13	1.2979	18.00	1.3538
5	1.2960	0.0848	1	1.4869			6	1.5256	0.1175	1	1.5801		
			2	1.4908						2	1.5771		
			3	1.4948						3	1.5833		
			4	1.4872						4	1.5755		
			5	1.3586	2.00	1.4434				5	1.3973	2.00	1.5148
			6	1.3655	4.00	1.4503				6	1.4003	4.00	1.5177
			7	1.3530	6.00	1.4378				7	1.3894	6.00	1.5069
			8	1.3517	7.67	1.4365				8	1.3937	7.67	1.5112
			9	1.3510	10.00	1.4358				9	1.3871	10.00	1.5046
			10	1.3438	12.00	1.4286				10	1.3704	12.00	1.4879
			11	1.3383	14.00	1.4230				11	1.3665	14.00	1.4839
			12	1.3317	15.67	1.4165				12	1.3563	15.67	1.4738
			13	1.3287	18.00	1.4135				13	1.3547	18.00	1.4721
7	1.7057	0.1468	1	1.6752			8	1.8717	0.1768	1	1.7723		
			2	1.6693						2	1.7772		
			3	1.6598						3	1.7848		
			4	1.6742						4	1.7838		
			5	1.4301	2.00	1.5769				5	1.4547	2.00	1.6315
			6	1.4344	4.00	1.5812				6	1.4593	4.00	1.6361
			7	1.4186	6.00	1.5655				7	1.4475	6.00	1.6243
			8	1.4111	7.67	1.5579				8	1.4432	7.67	1.6200
			9	1.4203	10.00	1.5671				9	1.4360	10.00	1.6128
			10	1.4035	12.00	1.5504				10	1.4163	12.00	1.5931
			11	1.3963	14.00	1.5432				11	1.4111	14.00	1.5879
			12	1.3799	15.67	1.5268				12	1.3980	15.67	1.5748
			13	1.3691	18.00	1.5159				13	1.3822	18.00	1.5590
9	2.0483	0.2117	1	1.8766			10	2.2107	0.2466	1	1.9764		
			2	1.8842						2	1.9770		
			3	1.8878						3	1.9833		
			4	1.8848						4	1.9846		
			5	1.4816	2.00	1.6934				5	1.5118	2.00	1.7585
			6	1.4892	4.00	1.7009				6	1.5200	4.00	1.7667
			7	1.4718	6.00	1.6835				7	1.4944	6.00	1.7411
			8	1.4724	7.67	1.6842				8	1.4931	7.67	1.7398
			9	1.4610	10.00	1.6727				9	1.4852	10.00	1.7319
			10	1.4446	12.00	1.6563				10	1.4646	12.00	1.7112
			11	1.4350	14.00	1.6468				11	1.4613	14.00	1.7079
			12	1.4245	15.67	1.6363				12	1.4308	15.67	1.6774
			13	1.3983	18.00	1.6100				13	1.4229	18.00	1.6695

11	2.3802	0.2859	1	2.1030			12	2.6521	0.3550	1	2.2717		
			2	2.1030						2	2.2730		
			3	2.0928						3	2.2743		
			4	2.0830						4	2.2746		
			5	1.5364	2.00	1.8223				5	1.5846	2.00	1.9396
			6	1.5492	4.00	1.8351				6	1.6148	4.00	1.9698
			7	1.5233	6.00	1.8092				7	1.5699	6.00	1.9249
			8	1.5292	7.67	1.8151				8	1.5659	7.67	1.9209
			9	1.5066	10.00	1.7925				9	1.5666	10.00	1.9216
			10	1.4987	12.00	1.7846				10	1.5423	12.00	1.8973
			11	1.4865	14.00	1.7725				11	1.5233	14.00	1.8783
			12	1.4623	15.67	1.7482				12	1.4865	15.67	1.8415
			13	1.4354	18.00	1.7213				13	1.4672	18.00	1.8222
13	2.8993	0.4242	1	2.4800			14	3.1571	0.5030	1	2.6529		
			2	2.4744						2	2.6519		
			3	2.4757						3	2.6542		
			4	2.4816						4	2.6490		
			5	1.6791	2.00	2.1034				5	1.7139	2.00	2.2169
			6	1.6854	4.00	2.1096				6	1.7457	4.00	2.2488
			7	1.6424	6.00	2.0666				7	1.7067	6.00	2.2097
			8	1.6539	7.67	2.0781				8	1.6883	7.67	2.1914
			9	1.6132	10.00	2.0374				9	1.6716	10.00	2.1746
			10	1.5781	12.00	2.0023				10	1.6332	12.00	2.1362
			11	1.5696	14.00	1.9938				11	1.5958	14.00	2.0988
			12	1.5213	15.67	1.9456				12	1.5617	15.67	2.0647
			13	1.4948	18.00	1.9190				13	1.5161	18.00	2.0191

REFERENCES

Normann, Jerome M., et al., *Hydraulic Design of Highway Culverts*, FHWA Hydraulic Design Series No. 5, Publication No. FHWA-IP-85-15, Washington, DC, September 1985.