



U.S. Department
of Transportation
**Federal Aviation
Administration**

Aviation Environmental Design Tool (AEDT)

Technical Manual

Version 2c

September 2016



REPORT DOCUMENTATION PAGE

Form Approved
OMB No. 0704-0188

Public reporting burden for this collection of information is estimated to average 1 hour per response, including the time for reviewing instructions, searching data sources, gathering and maintaining the data needed, and completing and reviewing the collection of information. Send comments regarding this burden estimate or any other aspect of this collection of information, including suggestions for reducing this burden to Washington Headquarters Service, Directorate for Information Operations and Reports, 1215 Jefferson Davis Highway, Suite 1204, Arlington, VA 22202-4302, and to the Office of Management and Budget, Paperwork Reduction Project (0704-0188) Washington, DC 20503.

PLEASE DO NOT RETURN YOUR FORM TO THE ABOVE ADDRESS.

1. REPORT DATE (DD-MM-YYYY) 12-09-2016		2. REPORT TYPE Final		3. DATES COVERED (From - To) May 2015 to September 2016			
4. TITLE AND SUBTITLE Aviation Environmental Design Tool (AEDT) Technical Manual Version 2c				5a. CONTRACT NUMBER DTRT57-10-D-30023			
				5b. GRANT NUMBER			
				5c. PROGRAM ELEMENT NUMBER			
6. AUTHOR(S) <table><tr><td><u>U.S. DOT Volpe Center:</u> Ahearn, Meghan Boeker, Eric Gorshkov, Slava Hansen, Andrew Hwang, Sunje Koopmann, Jonathan Malwitz, Andrew Noel, George Reherman, Clay Senzig, David Solman, Gina Barberio Tosa, Yasunari Wilson, Andrew Zubrow, Alexis</td><td><u>FAA:</u> DiPardo, Joe Majeed, Mohammed <u>ATAC Corp:</u> Bernal, Jose Biederman, Andrew Dinges, Eric Rickel, Denise Yaworski, Michael <u>CSSI, Inc.</u> Hall, Clifford <u>Metron Aviation</u> Augustine, Stephen Foley, Ryan</td></tr></table>				<u>U.S. DOT Volpe Center:</u> Ahearn, Meghan Boeker, Eric Gorshkov, Slava Hansen, Andrew Hwang, Sunje Koopmann, Jonathan Malwitz, Andrew Noel, George Reherman, Clay Senzig, David Solman, Gina Barberio Tosa, Yasunari Wilson, Andrew Zubrow, Alexis	<u>FAA:</u> DiPardo, Joe Majeed, Mohammed <u>ATAC Corp:</u> Bernal, Jose Biederman, Andrew Dinges, Eric Rickel, Denise Yaworski, Michael <u>CSSI, Inc.</u> Hall, Clifford <u>Metron Aviation</u> Augustine, Stephen Foley, Ryan	5d. PROJECT NUMBER FA4SCL	
				<u>U.S. DOT Volpe Center:</u> Ahearn, Meghan Boeker, Eric Gorshkov, Slava Hansen, Andrew Hwang, Sunje Koopmann, Jonathan Malwitz, Andrew Noel, George Reherman, Clay Senzig, David Solman, Gina Barberio Tosa, Yasunari Wilson, Andrew Zubrow, Alexis	<u>FAA:</u> DiPardo, Joe Majeed, Mohammed <u>ATAC Corp:</u> Bernal, Jose Biederman, Andrew Dinges, Eric Rickel, Denise Yaworski, Michael <u>CSSI, Inc.</u> Hall, Clifford <u>Metron Aviation</u> Augustine, Stephen Foley, Ryan		
				5e. TASK NUMBER PA727			
5f. WORK UNIT NUMBER							
7. PERFORMING ORGANIZATION NAME(S) AND ADDRESS(ES) U.S. Department of Transportation Volpe National Transportation Systems Center 55 Broadway Cambridge, MA 02142				8. PERFORMING ORGANIZATION REPORT NUMBER DOT-VNTSC-FAA-16-17			
9. SPONSORING/MONITORING AGENCY NAME(S) AND ADDRESS(ES) U.S. Department of Transportation Federal Aviation Administration Office of Environment and Energy (AEE-100) 800 Independence Ave. SW Washington, DC 20591				10. SPONSOR/MONITOR'S ACRONYM(S) FAA			
				11. SPONSORING/MONITORING AGENCY REPORT NUMBER			
12. DISTRIBUTION AVAILABILITY STATEMENT This report is part of the AEDT 2c software release. It is publicly available.							
13. SUPPLEMENTARY NOTES FAA Program Managers: Joseph Dipardo, Mohammed Majeed							

14. ABSTRACT

The Federal Aviation Administration, Office of Environment and Energy (FAA-AEE) has developed the Aviation Environmental Design Tool (AEDT) version 2c software system with the support of the following development team: FAA, National Aeronautics and Space Administration (NASA), U.S. DOT Volpe National Transportation Systems Center (Volpe Center), ATAC Corporation, Metron Aviation, Wyle Laboratories, CSSI, Inc., Foliage, MIT, and Georgia Tech. AEDT 2c models aircraft performance in space and time to estimate fuel consumption, emissions, noise, and air quality consequences. AEDT is designed to process individual studies ranging in scope from a single flight at an airport to scenarios at the regional, national, and global levels. This Technical Manual describes the technical methodology in AEDT 2c .

15. SUBJECT TERMS

aircraft acoustics, aircraft emissions, aircraft performance, FAA, AEDT, air traffic, airspace, noise contours, impact evaluation, change analysis, environmental impact statement, environmental assessment, air quality, emissions dispersion

16. SECURITY CLASSIFICATION OF:

a. REPORT
Unclassified

b. ABSTRACT
Unclassified

c. THIS PAGE
Unclassified

17. LIMITATION OF ABSTRACT
UU

18. NUMBER OF PAGES
374

19a. NAME OF RESPONSIBLE PERSON
Alexis Zubrow

19b. TELEPHONE NUMBER (Include area code)
(617) 494-3857

PREFACE

This document is the Technical Manual for the Federal Aviation Administration (FAA) Office of Environment and Energy (AEE) Aviation Environmental Design Tool Version 2c (AEDT 2c) computer software, which is designed to compute noise, fuel consumption, emissions, and air quality consequences.

The USDOT Volpe National Transportation Systems Center (Volpe Center), the ATAC Corporation, Metron Aviation, CSSI, Inc., and the FAA AEE have jointly prepared this document. Additional documentation is available on the [AEDT Support website](#), including the AEDT 2c User Guide, AEDT 2c ASIF Reference Guide, and the AEDT 2c NEPA Guidance document.

DISCLAIMER

This document was produced by USDOT Volpe National Transportation Systems Center (Volpe Center), the ATAC Corporation, Metron Aviation, and CSSI, Inc., staff, who are responsible for the facts and accuracy of the material presented herein. The contents do not necessarily reflect the official views or policy of the U.S. Department of Transportation or the Federal Aviation Administration. This AEDT 2c Technical Manual does not constitute a standard, specification, or regulation.

AEDT uses data and methods from the EUROCONTROL Base of Aircraft Data (BADA). BADA is a tool owned by EUROCONTROL ©2016. All rights reserved.

Users of AEDT must follow the terms and conditions of their BADA license agreement with EUROCONTROL.

BADA is provided on a strict "AS IS" basis, without any warranty of any kind either express or implied including but not limited to the implied warranties of merchantability, fitness for a particular purpose, title and non-infringement.

Neither EUROCONTROL nor any third party (in particular aircraft manufacturers) warrant that BADA will be error-free or that such errors will be corrected. The BADA licensee is solely responsible for all costs and expenses associated with rectification, repair, or damage caused by such errors.

Neither EUROCONTROL nor any third party (in particular aircraft manufacturers) shall be liable to the BADA licensee or to any other party for any loss or damage whatsoever or howsoever arising directly or indirectly in connection with BADA or its use.

TABLE OF CONTENTS

PREFACE.....	I
DISCLAIMER.....	I
TABLE OF CONTENTS.....	II
LIST OF TABLES.....	XIII
LIST OF FIGURES.....	XVII
1. INTRODUCTION.....	1
1.1 OVERVIEW.....	1
1.2 SYSTEM ARCHITECTURE.....	1
1.3 ABOUT THIS TECHNICAL MANUAL.....	2
1.4 TERMINOLOGY.....	4
1.5 ABBREVIATIONS.....	17
2. DATA.....	20
2.1 AEDT DATABASES.....	20
2.1.1 <i>Overview</i>	20
2.1.2 <i>Study Database</i>	20
2.1.3 <i>Airport Database</i>	21
2.1.4 <i>Fleet Database</i>	22
2.1.5 <i>Equipment Operations (Study)</i>	22
2.2 INPUT DATA.....	23
2.2.1 <i>Summary of Input Data for Noise Computation</i>	23
2.2.1.1 Noise-Power-Distance (NPD) Data Sets.....	24
2.2.1.2 Spectral Data Sets.....	27
2.2.1.3 Helicopter Static Directivity Data Sets.....	28
2.2.1.4 Helicopter Operational Mode Adjustment.....	28
2.2.1.5 Helicopter Speed Coefficients.....	29
2.2.1.6 Receptor Information.....	29
2.2.1.7 Noise Metric Information.....	30
2.2.2 <i>Summary of Input Data for Emissions Inventory Computation</i>	33
2.2.2.1 Aircraft Operations.....	35
2.2.2.2 Auxiliary Power Unit (APU).....	36
2.2.2.3 Ground Support Equipment (GSE).....	36
2.2.2.4 Boilers and Space Heaters.....	37
2.2.2.5 Emergency Generator.....	38

2.2.2.6	Incinerator.....	40
2.2.2.7	Aircraft Engine Testing.....	40
2.2.2.8	Fuel Tank.....	40
2.2.2.9	Surface Coating/Painting.....	41
2.2.2.10	Deicing Area.....	41
2.2.2.11	Solvent Degreaser.....	41
2.2.2.12	Sand/Salt Pile.....	41
2.2.2.13	Training Fire.....	42
2.2.2.14	“Other” Stationary Sources.....	42
2.2.2.15	MOVES Emissions Inventory File.....	43
2.2.3	<i>External Data</i>	44
2.2.3.1	Weather Data for Aircraft Performance Modeling.....	44
2.2.3.1.1	Weather Data Interpolation.....	44
2.2.3.1.2	Weather Cache Processing.....	45
2.2.3.1.3	Weather Data Retrieval.....	46
2.2.3.2	Terrain Data.....	46
2.2.3.2.1	Terrain for Emissions Modeling.....	46
2.2.3.2.2	Terrain for Noise Modeling.....	46
2.2.3.3	Boundary.....	47
2.2.3.4	Demographics.....	47
2.2.3.5	Ambient Concentrations for Air Quality Analysis.....	47
2.2.3.6	Ambient Background Noise Data for Noise Analyses.....	48
2.2.3.7	Application of Ambient Background Noise Data for Time Audible Metrics.....	48
3.	AIRCRAFT PERFORMANCE.....	50
3.1	TRAJECTORIES.....	50
3.1.1	<i>Properties</i>	50
3.1.2	<i>Targets</i>	51
3.2	PERFORMANCE MODEL.....	51
3.3	WEATHER MODEL.....	52
3.3.1	<i>Common Elements</i>	53
3.3.1.1	Pressure Altitude.....	53
3.3.1.2	Temperature Deviation from ISA.....	53
3.3.2	<i>Airport Average Atmospheric Models</i>	54
3.3.2.1	AEDT Thermodynamic Profiles.....	54

3.3.2.2	Omnidirectional Wind	54
3.3.3	<i>High-Fidelity Weather Model</i>	55
3.4	FUEL CONSUMPTION MODELS.....	55
3.4.1	<i>Fixed-Wing BADA Fuel Consumption</i>	55
3.4.1.1	Fixed-Wing BADA Fuel Consumption - Turbofan engines.....	56
3.4.1.2	Fixed-Wing BADA Fuel Consumption - Turboprop engines	56
3.4.1.3	Fixed-Wing BADA Fuel Consumption - Piston engines.....	57
3.4.1.4	Fixed-Wing BADA Fuel Consumption-Cruise State.....	57
3.4.2	<i>Fixed-Wing Senzig-Fleming-Iovinelli Fuel Consumption - Turbofan engine</i>	58
3.4.2.1	SFI Fuel Consumption-Turbofan engine, departure.....	58
3.4.2.2	SFI Fuel Consumption-Turbofan engine, arrival.....	58
3.4.3	<i>BFFM2 Fixed-Wing Fuel Consumption</i>	58
3.4.4	<i>Helicopter Fuel Consumption</i>	59
3.5	GROUND TRACK	59
3.5.1	<i>Ground Track Definition and Computation</i>	59
3.5.2	<i>Points from Vectors</i>	64
3.5.3	<i>Radius of Curvature</i>	65
3.6	PROFILE-DRIVEN FLIGHT PERFORMANCE	65
3.6.1	<i>Local Weather</i>	66
3.6.2	<i>Airplane Profile Calculation</i>	66
3.6.2.1	Temporal and Trackwise Alignment.....	66
3.6.2.2	ANP Thrust Specification.....	68
3.6.2.2.1	Thrust Value.....	69
3.6.2.2.2	Thrust Rating.....	69
3.6.2.2.3	Minimum Engine-Out	70
3.6.2.3	True Airspeed	71
3.6.2.4	Displaced Thresholds and Threshold Crossing Heights.....	71
3.6.2.5	Profile Components	72
3.6.2.5.1	Fixed Point	72
3.6.2.5.2	Takeoff Ground Roll Step.....	72
3.6.2.5.3	Constant-CAS Climb Step	74
3.6.2.5.4	Accelerating Climb Step by Climb Rate.....	76
3.6.2.5.5	Accelerating Climb Step by Energy Share	78
3.6.2.5.6	Cruise-Climb Step.....	78

3.6.2.5.7	Descent Step	79
3.6.2.5.8	Deceleration-Sensitive Descend Step	80
3.6.2.5.9	Idle Descend Step	83
3.6.2.5.10	Level Step	83
3.6.2.5.11	Deceleration-Sensitive Level Step.....	83
3.6.2.5.12	Level-Idle Step	85
3.6.2.5.13	Fit-to-Track Step	85
3.6.2.5.14	Landing Ground Roll Step	86
3.6.2.5.15	Decelerate Step	87
3.6.3	<i>Helicopter Profile</i>	87
3.6.3.1	Helicopter Procedure Steps	88
3.6.4	<i>Flight Path Calculation</i>	90
3.6.4.1	3-D Flight Path Construction	90
3.6.4.2	Flight Path Length Adjustments.....	90
3.6.4.3	Optional Taxi Segment	91
3.6.5	<i>Bank Angle Treatment</i>	91
3.6.5.1	Bank Angle Smoothing and Filtering	92
3.6.5.2	Bank Angle Performance Effects.....	94
3.6.5.2.1	Common Elements	95
3.6.5.2.2	Approach	95
3.6.5.2.3	Departure	95
3.7	TRAJECTORY-DRIVEN FLIGHT PERFORMANCE	96
3.7.1	<i>Altitude Control Flights</i>	96
3.7.1.1	Overall Algorithm	98
3.7.1.2	SAE-AIR-1845/Doc 29 Control Target Matching	98
3.7.1.2.1	Analysis of Flight to or from an Altitude Control	99
3.7.1.2.2	Analysis of Flight to Candidate Altitude.....	102
3.7.1.2.3	Speed Schedule.....	104
3.7.1.2.4	Flap Schedule and Selection	104
3.7.1.2.5	Procedural CAS Progression.....	105
3.7.1.2.6	Procedural Altitude Progression.....	106
3.7.1.3	BADA Control Target Matching	107
3.7.1.3.1	BADA General Discussion	107
3.7.1.3.2	En-Route Recalculation for Departure Operations.....	113

3.7.1.3.3	Approach Operations.....	115
3.7.1.3.4	Overflight Operations	117
3.7.2	<i>Sensor Path Flights</i>	119
3.7.2.1	Preliminary Processing.....	119
3.7.2.2	Terminal Area.....	120
3.7.2.3	En-route Phase Overview.....	121
3.7.2.4	En-route Performance Segment Calculation.....	121
3.8	NOISE MODE	123
4.	NOISE	124
4.1	FLIGHT PATH SEGMENT PARAMETERS.....	124
4.1.1	<i>Closest Point of Approach and Slant Range</i>	127
4.1.2	<i>Speed, Altitude, Distance, and Power</i>	128
4.2	NOISE-POWER-DISTANCE (NPD) DATA COMPUTATIONS.....	130
4.2.1	<i>Noise Metric Approximations</i>	130
4.2.1.1	Maximum Noise Level Approximation	130
4.2.1.2	C-Weighted Metric Approximation.....	131
4.2.2	<i>Noise Level Interpolation/Extrapolation ($L_{P,D}$)</i>	131
4.2.2.1	Standard Noise Level Interpolation/Extrapolation	131
4.2.2.2	Additional Interpolation Information for Exposure-Based Noise Level Metrics	133
4.2.2.3	Additional Interpolation Information for Maximum Noise Level Metrics	133
4.2.2.4	Noise Level Interpolation/Extrapolation for Helicopters.....	134
4.3	GENERAL AEDT NOISE ADJUSTMENTS	134
4.3.1	<i>Atmospheric Absorption Adjustment (AA_{ADJ})</i>	134
4.3.2	<i>Acoustic Impedance Adjustment (AI_{ADJ})</i>	135
4.3.3	<i>Noise Fraction Adjustment for Exposure Metrics (NF_{ADJ})</i>	136
4.3.3.1	Noise Fraction Adjustment for Flight Path Segments.....	136
4.3.3.2	Noise Fraction Adjustment for Behind Start-of-Takeoff Roll	137
4.3.4	<i>Duration Adjustment for Exposure-Based Metrics (DUR_{ADJ})</i>	138
4.3.5	<i>Lateral Attenuation Adjustment (LA_{ADJ})</i>	138
4.3.5.1	Lateral Attenuation Adjustment for Civil Aircraft	139
4.3.5.2	Lateral Attenuation Adjustment for Military Aircraft	144
4.3.6	<i>Line-of-Sight Blockage Adjustment (LOS_{ADJ})</i>	147
4.4	FIXED-WING AIRCRAFT ADJUSTMENTS.....	149
4.4.1	<i>Thrust Reverser Adjustment (TR_{ADJ})</i>	149
4.4.2	<i>Ground-Based Directivity Adjustment (DIR_{ADJ})</i>	152

4.5	HELICOPTER ADJUSTMENTS.....	153
4.5.1	Source Noise Adjustment Due to Advancing Tip Mach Number (MN_{ADI} , Level Flyover only).....	153
4.5.2	Lateral Directivity Adjustment (LD_{ADI}).....	154
4.5.3	Static Directivity Adjustment (DIR_{HELI_ADI}).....	156
4.5.4	Static Operation Duration Adjustment (t_{HELI_static}).....	156
4.6	NOISE COMPUTATION.....	156
4.6.1	System Adjustments.....	159
4.6.2	Computation of Exposure-Based Noise Level Metrics.....	160
4.6.2.1	Fixed-Wing Aircraft Flight Operations.....	161
4.6.2.2	Fixed-Wing Aircraft Runup Operations.....	161
4.6.2.3	Helicopter Flight Operations.....	162
4.6.2.4	Helicopter Static Operations.....	163
4.6.3	Computation of Maximum Noise Level Metrics.....	163
4.6.3.1	Fixed-Wing Aircraft Flight Operations.....	164
4.6.3.2	Fixed-Wing Aircraft Runup Operations.....	164
4.6.3.3	Helicopter Flight Operations.....	165
4.6.3.4	Helicopter Static Operations.....	166
4.6.4	Computation of Time-Based Metrics.....	166
4.6.4.1	Flight Operations.....	167
4.6.4.2	Ground Operations.....	168
4.6.4.3	Time Audible Computations.....	168
4.6.5	Accumulation of Noise Metric Computations.....	170
4.6.5.1	Noise Metric Weighting and Averaging Factors.....	171
4.6.5.2	Accumulation of Exposure-based Noise Level Metrics.....	174
4.6.5.3	Accumulation of Maximum Noise Level Metrics.....	176
4.6.5.4	Accumulation of Time-based Noise Metrics.....	177
4.6.5.4.1	Additional Guidance for the Accumulation of Time Audible.....	178
4.6.5.5	Accumulation of Number Above Noise Level Metric.....	180
4.7	DYNAMIC GRID PROCESS.....	180
5.	EMISSIONS INVENTORY.....	182
5.1	AIRCRAFT EMISSIONS.....	182
5.1.1	Airborne Emissions.....	182
5.1.1.1	Boeing Fuel Flow Method 2.....	182
5.1.1.2	First Order Approximation 3.0 Method.....	184

5.1.1.3	Sulfur Approximation	188
5.1.1.4	CO ₂ and H ₂ O Approximations.....	188
5.1.1.5	Derivative Factors for Modeling VOC, NMHC, and TOG	189
5.1.1.6	Derivative Factors for Speciated Organic Gases	191
5.1.2	<i>Taxi Emissions</i>	191
5.1.3	<i>Startup Emissions</i>	193
5.1.4	<i>Auxiliary Power Units Emissions</i>	193
5.2	GROUND SUPPORT EQUIPMENT (GSE)	194
5.2.1	<i>GSE Population Processing Algorithm</i>	194
5.2.2	<i>Aircraft-Assigned GSE Processing Algorithm</i>	195
5.3	STATIONARY SOURCES	195
6.	EMISSIONS DISPERSION	198
6.1	AEDT AND AERMOD SOURCES	198
6.2	AEDT MAP PROJECTION	199
6.3	EMISSIONS FROM AIRBORNE AND GROUND ROLL FLIGHT SEGMENTS	199
6.3.1	<i>Three-dimensional Voxel Grid in AEDT</i>	199
6.3.2	<i>Two-dimensional Surface Voxel Grid</i>	200
6.3.3	<i>Voxel Grids Aligned with a Runway</i>	201
6.3.3.1	Three-dimensional Aligned Voxel Grid	201
6.3.3.2	Two-dimensional Aligned Surface Voxel Grid	202
6.3.4	<i>Allocating Emissions from Flight Segments</i>	203
6.4	EMISSIONS FROM TAXI SEGMENTS.....	205
6.5	EMISSIONS FROM GATES AND TERMINALS	206
6.6	EMISSIONS FROM STATIONARY SOURCES	208
6.7	EMISSIONS FROM ROADWAYS, PARKING FACILITIES, AND CONSTRUCTION SOURCES.....	210
6.8	APPLYING BACKGROUND CONCENTRATIONS.....	210
6.8.1	<i>AERMOD Background Concentrations Hourly File</i>	211
6.8.2	<i>Background Concentrations Non-Hourly File</i>	211
6.8.3	<i>Outputs of Background Concentrations</i>	212
6.9	WEATHER PROCESSING	213
6.9.1	<i>AERMET</i>	213
6.9.2	<i>AERMET Output Files</i>	214
6.10	TERRAIN PROCESSING	214
6.11	GENERATING HOURLY EMISSIONS FILES.....	214
6.12	GENERATING AERMOD INPUT FILES	215

6.12.1	<i>Weather Files</i>	215
6.12.1.1	Note to Users Outside of the United States.....	216
6.12.2	<i>AERMOD Input Files (.INP and .HRE)</i>	216
6.12.3	<i>AERMOD Hourly Input File for Background Concentrations</i>	216
6.13	RUNNING AERMOD	216
6.13.1	<i>Emissions Dispersion Output Options</i>	217
7.	GROUND OPERATIONS	218
7.1	AIRPORT CONFIGURATIONS.....	218
7.2	CONFIGURATION ACTIVATION BASED ON ACTIVATION PARAMETERS	218
7.3	TAXIWAY NETWORKS	221
7.3.1	<i>Taxi Network Elements and Terminology</i>	221
7.3.2	<i>Taxi Network Algorithm Overview</i>	223
7.3.2.1	Step 1 – Loading of Taxi Network Elements.....	223
7.3.2.2	Step 2 – Verification of Taxi Network Element Connectivity	223
7.3.2.2.1	Taxiway Connectivity	224
7.3.2.2.2	Taxipath Connectivity	226
7.3.2.3	Step 3 – Calculation of Taxiway-Taxiway Intersections	229
7.3.2.4	Step 4 – Calculation of Taxiway-Runway Intersections.....	231
7.3.2.5	Step 5 – Calculation of Taxiway-Gate Intersections.....	232
7.3.2.6	Step 6 – Insertion of Calculated Intersections into Taxiways	233
7.3.2.7	Step 7 – Transformation of Taxipaths.....	236
7.3.2.7.1	Determine Taxiway-Taxiway Intersections	236
7.3.2.7.2	Determine Taxiway-Gate Intersections	237
7.3.2.7.3	Determine Taxiway-Runway Intersections	238
7.3.2.7.4	Fill in Intermediate Taxiway Indices.....	239
7.3.2.8	Step 8 – Generation of Node Map	240
7.3.2.9	Step 9 – Generation of Network Map.....	243
7.3.2.9.1	Network Link Generation.....	243
7.3.2.9.2	Network Path Generation.....	244
7.4	AIR OPERATION SCHEDULING	246
7.4.1	<i>Pseudorandom Number Generation</i>	246
7.4.2	<i>Pseudo-schedule Generation</i>	247
7.4.3	<i>Schedule Generation</i>	248
7.5	DELAY MODEL	250

7.6	SEQUENCING MODEL.....	252
7.6.1	<i>Sequencing Algorithm and Outputs</i>	257
8.	ANNUALIZATION.....	259
8.1	OVERVIEW.....	259
8.2	PEAK MONTH AVERAGE DAY AND ANNUAL AVERAGE DAY ANNUALIZATIONS.....	261
9.	CHANGE ANALYSIS AND IMPACT EVALUATION.....	262
9.1	CHANGE ANALYSIS.....	262
9.1.1	<i>Change Analysis Report Statistics</i>	262
9.2	IMPACT EVALUATION.....	264
10.	ENVIRONMENTAL JUSTICE CAPABILITY.....	265
10.1	OVERVIEW.....	265
10.2	AMERICAN COMMUNITY SURVEY (ACS) DATA.....	265
10.3	DEMOGRAPHIC VARIABLES.....	266
11.	APPENDICES.....	268
11.1	NOISE ADJUSTMENT AND METRIC DERIVATIONS.....	268
11.1.1	<i>Derivation of the Acoustic Impedance Adjustment</i>	268
11.1.2	<i>Derivation of the Noise Exposure Fraction Adjustment</i>	271
11.1.3	<i>Derivation of the Time-Above Equation</i>	275
11.1.4	<i>Recalculation of NPD Data for Non-Reference Conditions</i>	277
11.1.5	<i>Calculating Audibility</i>	285
Part I of Calculations.....	286	
Part II of Calculations.....	288	
Part III of Calculations.....	289	
11.2	ACOUSTIC DATA DEVELOPMENT.....	290
11.2.1	<i>Acoustic Data Development Criteria</i>	290
11.2.2	<i>Overview of Spectral Class Development</i>	291
Step 1: Group Similar Aircraft/Engine Combinations.....	292	
Step 2: Visual Inspection of Potential Spectral Class Data.....	292	
Step 3: Verification of Proposed Spectral Class.....	293	
Step 4: Final Spectral Class.....	298	
11.2.3	<i>Performance and Acoustics</i>	299
11.2.3.1	AEDT Fleet Database Submittal Guidance for Fixed Wing Aircraft.....	299
11.2.3.1.1	Data Submittal Overview.....	299
11.2.3.1.2	Reference Conditions for Performance and Noise Data.....	299

11.2.3.1.3	Aircraft and Engine Data	300
11.2.3.1.4	Guidance for Default Weights and Procedures	301
11.2.3.1.5	Aerodynamic Coefficients	303
11.2.3.1.6	Engine Coefficients	303
11.2.3.1.7	Departure Procedures	305
11.2.3.1.8	Approach Procedures	309
11.2.3.1.9	Noise Data	312
11.2.3.2	AEDT Database Submittal Form for Propellor-Driven, Fixed-Wing Aircraft	315
11.2.3.2.1	Reference Conditions For Performance Data	316
11.2.3.2.2	Aircraft and Engine Data	316
11.2.3.2.3	Guidance for Default Weights and Procedures	317
11.2.3.2.4	Aerodynamic Coefficients	319
11.2.3.2.5	Engine Coefficients	319
11.2.3.2.6	Departure Procedures	320
11.2.3.2.7	Approach Procedures	322
11.2.3.2.8	Noise Data	324
11.2.3.3	AEDT Fleet Database Submittal Form for Helicopters	328
11.2.3.3.1	Reference Conditions for Performance Data	328
11.2.3.3.2	Aircraft and Engine Data	328
11.2.3.3.3	Speed Coefficients	329
11.2.3.3.4	Departure Procedures	330
11.2.3.3.5	Approach Procedures	331
11.2.3.3.6	NOISE DATA	333
11.2.3.3.7	Spectral Data	337
11.2.3.3.8	Directivity Data for Static Operations	339
11.3	AIRCRAFT NOISE AND PERFORMANCE DATA VERIFICATION AND VALIDATION	340
11.3.1	<i>NPD and Spectral Data Verification and Validation</i>	341
11.3.1.1	Internal Consistency	342
11.3.1.2	Comparison with NPDs of Similar Aircraft	342
11.3.1.3	Reprocessing NPDs and Comparison with Manufacture Submitted NPDs	342
11.3.2	<i>Spectral Class Assignments</i>	342
11.3.2.1	Normalization and Computation of Free-Field Effect	343
11.3.2.2	Comparison of Spectral Shape	344
11.3.2.3	Comparison of Atmospheric Absorption Effects	344

11.3.2.4	Comparison of Ground Effects Calculated using AC Spectra and SC Spectra	344
11.3.2.5	Comparison of Barrier Effects Calculated using AC Spectra and SC Spectra.....	344
11.3.2.6	Final Assignment of Spectral Class	344
11.3.3	<i>Performance Data Verification and Validation</i>	345
11.3.3.1	Internal Consistency.....	345
11.3.3.2	Consistency with Prior Submittals	345
11.3.3.3	Reasonableness.....	345
11.3.3.4	Suitability for Varying Atmospheric Conditions	345
11.3.4	<i>Model Comparison of Submitted Data with Certification Data</i>	346
11.4	EMISSIONS DISPERSION APPENDICES	347
11.4.1	<i>Constructing AERMOD Rectangle Sources from a Line Segment</i>	347
11.5	EMISSIONS FACTOR CALCULATION FOR STATIONARY SOURCES AND TRAINING FIRES	347
11.5.1	<i>Data Sources</i>	347
11.5.1.1	Other Category.....	347
11.5.1.2	Boilers and Space Heaters.....	348
11.5.1.3	Emergency Generators	350
11.5.1.4	Incinerators	351
11.5.1.5	Aircraft Engine Testing	352
11.5.1.6	Fuel Tanks	353
11.5.1.7	Surface Coating	361
11.5.1.8	Deicing.....	361
11.5.1.9	Solvent Degreasers	361
11.5.1.10	Particulate Piles.....	362
11.5.1.11	Training Fires.....	363
11.6	MAP PROJECTION METHOD.....	363
11.7	ENVIRONMENTAL JUSTICE DEMOGRAPHIC VARIABLES	365
12.	REFERENCES	371

LIST OF TABLES

Table 1-1 Definition of One-Third Octave-Bands.....	12
Table 2-1 Engine Power Setting Units.....	24
Table 2-2 Operational Mode for Each Fixed-Wing Aircraft NPD Data Set.....	25
Table 2-3 Operational Mode Procedure Steps for Each Helicopter NPD Data Set.....	25
Table 2-4 Substitution Operational Mode Procedure Steps Data for Helicopters, including the Appropriate Helicopter Operational Mode Adjustment	29
Table 2-5 Summary of AEDT Noise Metric Abbreviations and Definitions.....	30
Table 2-6 Input Data for APU.....	36
Table 2-7 Input Data for Aircraft-Assigned GSE.....	36
Table 2-8 Input Data for GSE Population	37
Table 2-9 Input Data for Boilers and Space Heater	38
Table 2-10 Input Data for Emergency Generator (EPA Methodology).....	39
Table 2-11 Input Data for Emergency Generators (USAF Methodology)	39
Table 2-12 Input Data for Incinerator	40
Table 2-13 Input Data for Aircraft Engine Testing	40
Table 2-14 Input Data for Fuel Tank	40
Table 2-15 Input Data for Surface Coating/Painting.....	41
Table 2-16 Input Data for Deicing Area	41
Table 2-17 Input Data for Solvent Degreaser	41
Table 2-18 Input Data for Sand/Salt Pile.....	42
Table 2-19 Input Data for Training Fire.....	42
Table 2-20 Input Data for “Other” Stationary Sources	42
Table 2-21 MOVES Emissions Inventory Results File Format	43
Table 2-22 Weather Data Formats Supported.....	44
Table 3-1 Properties and Units of Instantaneous States	50
Table 3-2 Properties and Units of Segments	51
Table 4-1 Position of the Receptor Relative to the Flight Path Segment	127
Table 4-2 AEDT Noise Metric-Specific Weighting and Averaging Factors	172
Table 5-1 Adjustment Factors for Installation Effects	183
Table 5-2 Mode Specific Values for Eq. 5-7 (FOA 3.0)	186
Table 5-3 Mode Specific Values of AFR.....	187
Table 5-4 Default Constant PM EI Values above the Mixing Height.....	188
Table 5-5 Constant CO ₂ and H ₂ O EI Values	188
Table 5-6 Pollutant Conversion Factors For Turbine Engines	190
Table 5-7 Pollutant Conversion Factors For Piston Engines	191
Table 5-8 Units for Stationary Sources & Training Fires	196
Table 6-1 AERMOD Source Modeling	199
Table 6-2 Accepted Weather Data Formats for Emissions Dispersion Modeling.....	215
Table 7-1 Assumed Extreme Values for Configuration Activation Parameters	219

Table 7-2 Reassigned Values of Projected Point pn.....	229
Table 7-3 Taxiway-Taxiway Intersections Calculated for the Taxi Network Shown in Figure 7-9 and Figure 7-10	235
Table 7-4 Taxiway-Runway Intersections Calculated for the Taxi Network Shown in Figure 7-9 and Figure 7-10	235
Table 7-5 Taxiway-Gate Intersections Calculated for the Taxi Network Shown in Figure 7-9 and Figure 7-10	236
Table 7-6 Insert Points for Each Taxiway in the Taxi Network Shown in Figure 7-9 and Figure 7-10	236
Table 7-7 Identical Points for Each Taxiway in the Taxi Network Shown in Figure 7-9 and Figure 7-10..	236
Table 7-8 Taxiway Indices for the new definition of the example taxipath; So far, only switches from one taxiway to the next are conveyed in the new taxipath definition	237
Table 7-9 Taxiway Indices for the new definition of the example taxipath; so far, the definition contains the switch from the gate to the first taxiway and switches from one taxiway to the next	238
Table 7-10 Taxiway Indices for the new definition of the example taxipath; So far, the definition contains the switch from the gate to the first taxiway, switches from one taxiway to the next, and the switch from the last taxiway to the runway	239
Table 7-11 Taxiway Indices for the new definition of the example taxipath; the definition now contains the taxiway indices for movement along the entire taxipath (from gate to each taxiway to the runway)	240
Table 7-12 Nodes generated after the first pass over all taxiway positions for the taxi network layout presented in Figure 7-10.....	241
Table 7-13 Additional nodes generated after the second pass over all taxiway positions in the taxi network layout presented in Figure 7-10	242
Table 7-14 Taxiway Indices of the example outbound taxipath (Gate G -> Runway End 1) along with the node IDs corresponding to each taxiway index	243
Table 7-15 Network Path Version of the Example Taxipath	244
Table 10-1 Average Atmospheric Attenuation Rates from SAE-AIR-1845 ⁵⁷	277
Table 10-2 Spectra for V2527 NPD from ANP Database and Calculated Source Spectra.....	281
Table 10-3 Reference Absorption Coefficients (from Table 10-1) and Coefficients for 10°C/80% Relative Humidity/101.325 kPa Calculated using SAE-ARP-866A ²¹ and SAE-ARP-5534 ²²	282
Table 10-4 A-weighted Levels for Reference and SAE-ARP-866A ²¹ Atmosphere and Difference Between Each Atmosphere, Δ_L	283
Table 10-5 A-weighted Levels for Reference and SAE-ARP-5534 ²² Atmosphere and Difference Between Each Atmosphere, Δ_L	283
Table 10-6 Original NPD Data	284
Table 10-7 Revised NPD Data Using SAE-ARP-866A ²¹	284
Table 10-8 Revised NPD Data Using SAE-ARP-5534 ²²	285
Table 10-9 One-Third Octave Band Characteristics	286
Table 10-10 EASN Threshold.....	288
Table 10-11 OEP Airport Atmospheric Condition Statistics.....	294
Table 10-12 Summary of A-weighted ΔA_{adj}	296

Table 10-13 Summary of A-Weighted ΔLOS_{adj}	298
Table 10-14 Reference Conditions for Performance Data	300
Table 10-15 General Aircraft and Engine Data Form	301
Table 10-16 Departure Takeoff Weights Form	302
Table 10-17 Guidance for Determining Departure Takeoff Weights.....	302
Table 10-18 Aerodynamic Coefficients Form.....	303
Table 10-19 Jet Engine Coefficients Form.....	304
Table 10-20 Propeller Engine Coefficients Form	305
Table 10-21 Default Takeoff Procedure Descriptions.....	306
Table 10-22 Takeoff Procedure Profile Form.....	308
Table 10-23 Takeoff Profile Points Form	308
Table 10-24 Approach Procedure Profile Form	311
Table 10-25 Approach Profile Points Form	311
Table 10-26 NPD Data Form	314
Table 10-27 Spectral Data Form	315
Table 10-28 Reference Conditions for Performance Data.....	316
Table 10-29 General Aircraft and Engine Data Form.....	317
Table 10-30 Departure Takeoff Weights Form	318
Table 10-31 Guidance for Determining Departure Takeoff Weights.....	318
Table 10-32 Aerodynamic Coefficients Form.....	319
Table 10-33 Propeller Engine Coefficients Form	320
Table 10-34 Takeoff Procedural Profile Form.....	321
Table 10-35 Takeoff Profile Points Form	322
Table 10-36 Approach Procedural Profile Form	323
Table 10-37 Approach Profile Points Form	324
Table 10-38 NPD Data Form	326
Table 10-39 Spectral Data Form	327
Table 10-40 Reference Conditions for Performance Data.....	328
Table 10-41 General Helicopter and Engine Data Form	329
Table 10-42 Helicopter Speed Coefficients.....	330
Table 10-43 Helicopter Departure Procedures Form	330
Table 10-44 Helicopter Approach Procedures Form	332
Table 10-45 Helicopter Taxi Procedures for a Helicopter with Wheels Form	332
Table 10-46 Helicopter Taxi Procedures for a Helicopter without Wheels Form.....	333
Table 10-47 Noise Type for Each Helicopter NPD Data Set	334
Table 10-48 Operation Mode for Each Helicopter NPD Data Set	334
Table 10-49 Helicopter NPDs for Dynamic Operations Form	335
Table 10-50 Helicopter NPDs for Static Operations Form	336
Table 10-51 Noise Data Substitutes for Missing Operational Modes.....	337
Table 10-52 NPD Adjustments for Helicopter Operations Form	337
Table 10-53 Helicopter Spectral Data for Spectral Class Determination Form	338

Table 10-54 Helicopter Directivity Adjustment Data Form 340
Table 10-55 Required Parameter Specifications for Boilers and Space Heaters 349
Table 10-56 Fuel Tank Vapor Molecular Weight and Liquid Density..... 354
Table 10-57 Fuel Tank Pressure Constants 355
Table 10-58 Fuel Tank Vacuum Breaker and Deck Drain Counts..... 358

LIST OF FIGURES

Figure 1-1 AEDT 2c System Structure	2
Figure 1-2 A-weighted and C-weighted Adjustment Curves.....	4
Figure 3-1 Cascade of Weather Data Sources.....	53
Figure 3-2 Track Computation – Pointwise Departure Track.....	61
Figure 3-3 Track Computation – Vector Departure Track.....	61
Figure 3-4 Track Computation – Pointwise Approach Track.....	62
Figure 3-5 Track Computation – Vector Approach Track.....	62
Figure 3-6 Track Computation – Pointwise Overflight Track	63
Figure 3-7 Track Computation – Pointwise Circuit/TGO Track	63
Figure 3-8 Track Computation – Vector Circuit/TGO Track	64
Figure 3-9 Altitude Controls.....	97
Figure 3-10 Effect of BADA Maximum Altitude on Interpretation of “AtOrBelow” Controls.....	98
Figure 3-11 Preserved Portion of Standard Path in Altitude-Controlled Flights.....	99
Figure 3-12 Candidate Altitudes for Flight To or From an “AtOrBelow” Altitude Control	102
Figure 3-13 Relationships Between Initial, Final, Latest, and Candidate for Departures and Overflights	102
Figure 3-14 Relationships Between Initial, Final, Latest, and Candidate for Approaches	103
Figure 4-1 Flight-Segment Geometry when a Receptor is Behind a Segment.....	125
Figure 4-2 Flight-Segment Geometry when a Receptor is Astride a Segment	126
Figure 4-3 Flight-Segment Geometry when a Receptor is Ahead of a Segment	126
Figure 4-4 Lateral Attenuation Geometry.....	140
Figure 4-5 Bank Angle ϵ , Elevation Angle β , Depression Angle ϕ , and Lateral Distance ℓ^{23}	140
Figure 4-6 Illustration of Engine-Installation Effects for Jet-Powered Airplanes ²³	142
Figure 4-7 Illustration of Ground-to-Ground Component of Lateral Attenuation	143
Figure 4-8 Illustration of Air-to-Ground Component of Lateral Attenuation	144
Figure 4-9 Illustration of Ground-to-Ground Component of Lateral Attenuation for Military Aircraft ...	145
Figure 4-10 Illustration of Air-to-Ground Component of Lateral Attenuation for Military Aircraft	146
Figure 4-11 Line-of-Sight (LOS) Blockage Concept.....	147
Figure 4-12 Modeling of Thrust Reverser Deployment During Landing Ground Roll	151
Figure 4-13 Ground-Based Directivity Adjustment.....	153
Figure 4-14 Elevation Angle for Helicopter Lateral Directivity Adjustment.....	155
Figure 4-15 Example Helicopter Sound Pressure Levels According to Elevation Angle	156
Figure 4-16 AEDT Acoustic Computation Process without Terrain for a Single Flight Segment	158
Figure 4-17 AEDT Acoustic Computation Process with Terrain for a Single Flight Segment	159
Figure 4-18 AEDT Accumulation of Acoustic Computation Process	171
Figure 4-19 Uncompressed Time Audible.....	179
Figure 5-1 TOG, NMHC, and VOC Calculations for Turbine Engines.....	189
Figure 5-2 TOG, NMHC, and VOC Calculations for Piston Engines	190
Figure 6-1 Flight Segment Splitting Algorithm.....	204
Figure 6-2 Creation of a New User-Defined APU	207

Figure 6-3 Creation of a New User-Defined Stationary Source	210
Figure 7-1 An Activation Parameter Value and its Criteria Range for Some Configuration and Hour	220
Figure 7-2 Intersection of Two Taxiway Segments (q and r)	224
Figure 7-3 Modified Rectangular Representation of Two Taxiway Segments (q and r)	226
Figure 7-4 Taxiway Segment Intersection with a Polygon Gate	228
Figure 7-5 Projection of a Point p onto a Line Segment Defined by Endpoints p1 and p2.....	229
Figure 7-6 Intersection of Two Taxiways	230
Figure 7-7 Taxiway-Runway Intersection.....	232
Figure 7-8 Taxiway-Gate Intersections	233
Figure 7-9 Simple Taxi Network	234
Figure 7-10 Simple Taxi Network with Intersection Points.....	235
Figure 7-11 Inbound Network Path Exit Property Definitions	245
Figure 7-12 Data Flow of the Delay-and-Sequencing (Queuing) Algorithm	250
Figure 7-13 Airside Queueing Model within WWLMINET	250
Figure 7-14 Airport Configuration Capacity Pareto Frontier	251
Figure 7-15 Example of a Runway End Serving Traffic from Several Queues.....	255
Figure 10-1 Acoustic Impedance Adjustment re. 406 newton-second/m ³	269
Figure 10-2 Acoustic Impedance Adjustment re. 400 newton-second/m ³	269
Figure 10-3 Observer/Flight Path Geometry	272
Figure 10-4 Meteorological Conditions Recorded During Noise Certification Tests ⁴⁸	279
Figure 10-5 EASN Threshold.....	287
Figure 10-6 Departure Class 104.....	292
Figure 10-7 Normalized Spectral Class 104 Data	293
Figure 10-8 Spectral Class 104 Ground Effect.....	294
Figure 10-9 Histogram of A-weighted $\Delta A A_{adj}$	295
Figure 10-10 Histogram of A-Weighted ΔLOS_{adj}	297
Figure 10-11 Departure Spectral Class 104.....	299
Figure 10-12 Example Maximum Takeoff Thrust vs. Temperature	305
Figure 10-13 Shape Comparison of Spectral Data	343

1. Introduction

1.1 Overview

The Aviation Environmental Design Tool (AEDT) is a software system that models aircraft performance in space and time to estimate noise, fuel consumption, emissions, and air quality consequences. AEDT is designed to process individual studies ranging in scope from a single flight at an airport to scenarios at the regional, national, and global levels. AEDT leverages geographic information system (GIS) and relational database technology to achieve this scalability and offer rich opportunities for exploring and presenting results. AEDT is actively used by the U.S. government for regulatory studies, research, and domestic aviation system planning, as well as domestic and international aviation environmental policy analysis.

In contrast to the individual noise and air quality analysis tools such as, Integrated Noise Model (INM) and Emissions and Dispersion Modeling System (EDMS), AEDT unifies noise, fuel consumption, and emissions calculation capabilities into a single application. AEDT includes a database of over 3,000 airframe-engine combinations and runway information for over 30,000 airports around the globe. These system databases allow users of AEDT to quickly build studies and estimate the interdependencies between noise, fuel consumption, and emissions consequences of aviation activity.

1.2 System Architecture

AEDT 2c is built on the Microsoft .NET Framework and SQL Server and is capable of running on Windows 7 and Windows Server operating systems. It is supported by extensive system databases covering airports, airspace, and fleet information that span the global nature of the aviation industry.

All information is rendered in a geospatial nature given the Esri-based core of the tool, which supports the compatibility with other geospatial applications. State-of-the-art software technology is used to enhance the capabilities of AEDT, such as the XML-based AEDT Standard Input File (ASIF) that allows for the input of large datasets of 4D trajectories, fleet information, and event assignments.

AEDT outputs include reports, graphs, and tables that summarize the flight performance, noise, contours, fuel burn, inventories (emissions and noise), and emissions dispersion results. Figure 1-1 displays a diagram of the AEDT 2c system structure.

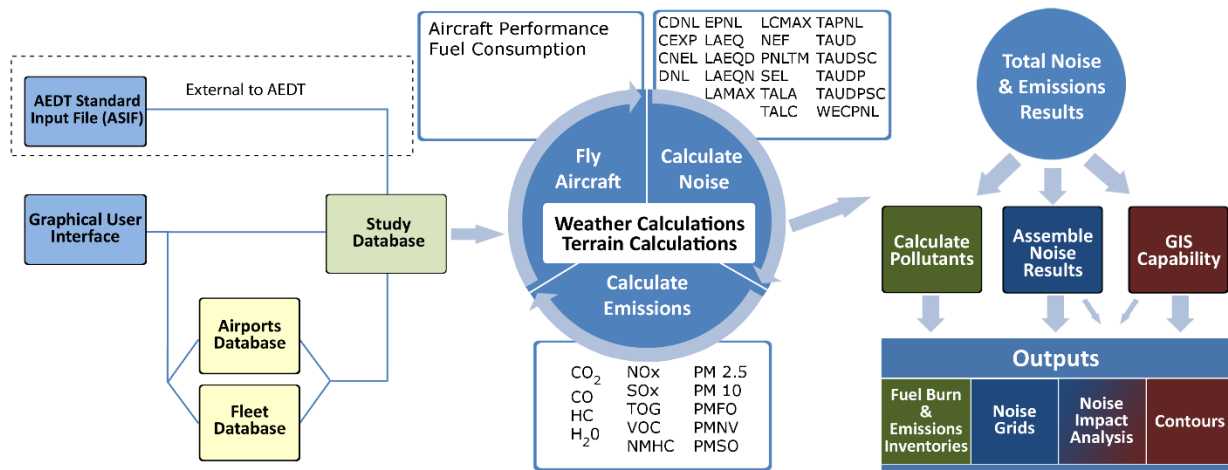

Figure 1-1 AEDT 2c System Structure

1.3 About this Technical Manual

This manual presents the technical details of the methodologies employed by AEDT 2c with respect to its primary functionality. The intended target audience is users who would like a deeper understanding of the technical details of how AEDT models noise, fuel burn, environmental inventories, and emissions dispersion. For information on how to use the AEDT 2c application, please refer to the AEDT 2c User Guide¹.

This Technical Manual is organized into the following Sections:

- Section 1 Introduction.
- Section 2 describes the AEDT databases and input data.
- Section 3 presents the models for aircraft performance.
- Section 4 presents the models related to noise computations and adjustments.
- Section 5 presents the models related to emissions inventory.
- Section 6 presents the models related to emissions dispersion.
- Section 7 presents the models related to ground operations.
- Section 8 provides an overview of annualization.
- Section 9 describes the methodology employed for change analysis and impact evaluation.
- Section 10 describes the environmental justice capability.
- Section 11 (the appendices) presents additional information on the following areas:
 - Noise metric derivations
 - Noise data development
 - Aircraft noise and performance data submittal, verification and validation
 - Algorithm for constructing AERMOD area source
 - Emissions factor calculation for stationary sources and training fires

- Map projection method
 - Environmental justice demographic variables
- Section 12 lists the referenced material in this manual.

1.4 Terminology

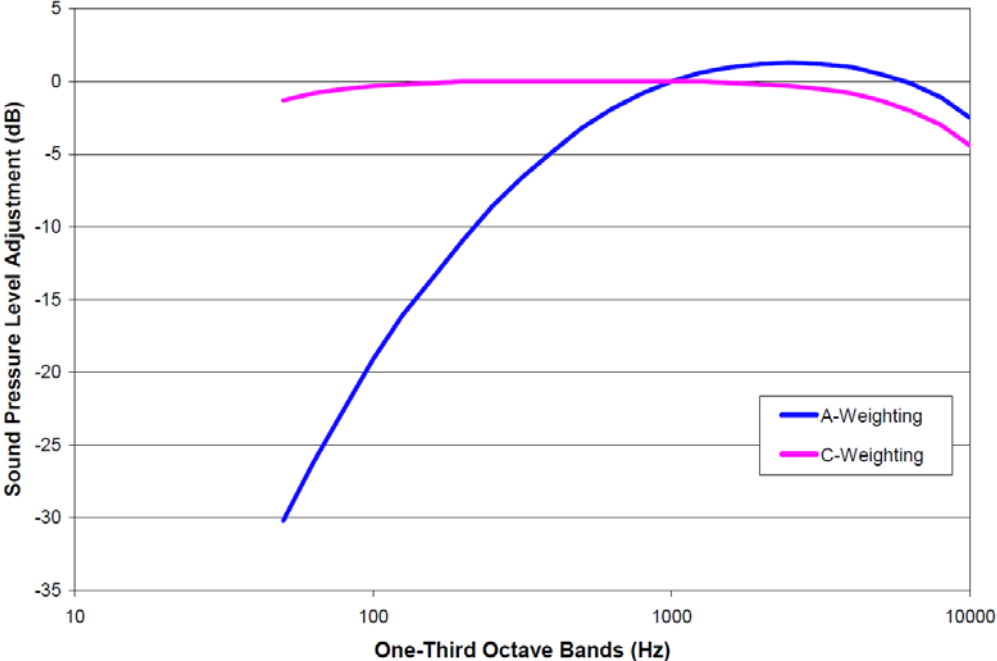
<p>A-weighted</p>	<p>A-weighted noise levels emphasize sound components in the frequency range where most speech information resides, yielding higher levels in the mid-frequency (2,000 to 6,000 Hz) range and lower levels in both low frequency and high frequency ranges. A-weighted noise level is used extensively for measuring and predicting community and transportation noise. The A-weighted and C-weighted adjustment curves are presented in Figure 1-2:</p>  <p>Figure 1-2 A-weighted and C-weighted Adjustment Curves</p>
<p>Above Field Elevation (AFE)</p>	<p>Altitude relative to the airport elevation. The FAA defines the airport elevation as the highest point of an airport’s usable runways. Therefore AFE equals the altitude (measured in height above mean sea level [MSL]) minus the airport elevation (measured in height above MSL).</p>
<p>Above Ground Level (AGL)</p>	<p>Altitude relative to the elevation of the ground.</p>
<p>Acoustic Impedance Adjustment</p>	<p>A sound level adjustment, computed as a function of receptor temperature, pressure, and elevation, which is applied to noise-power-distance (NPD) noise levels. Specific acoustic impedance is the product of the density of air and the speed of sound, and is related to the propagation of sound waves in an acoustic medium.</p>
<p>Acoustically Hard Surface</p>	<p>A highly reflective surface where the phase of the incident sound is essentially preserved upon reflection; example surfaces include water, asphalt, and concrete.</p>
<p>Acoustically Soft Surface</p>	<p>A highly absorptive surface where the phase of the incident sound is changed substantially upon reflection; example surfaces include ground covered with dense vegetation or freshly-fallen snow.</p>

Activation Parameter	In the context of airport configurations, an activation parameter is a parameter whose value for a given hour must satisfy a set of user-specified lower and/or upper bound criteria in order to activate the configuration. Ordinarily, a configuration is activated when all of the activation parameter values for a given hour (the current conditions) satisfy the respective criteria of the configuration and no other configuration has higher priority. The activation parameters are: wind speed, wind direction, hour of the day, ceiling, visibility and temperature.
Active Configuration	The active configuration is the airport configuration which is in effect for a given hour of some analysis year.
Advancing Tip Mach Number	The relative airspeed (in Mach) of the advancing blade tip of a helicopter's main rotor, accounting for airspeed, temperature and/or rotor RPM.
Advancing Tip Mach Number Adjustment	See Source Noise Adjustment Due to Advancing Tip Mach Number .
AERMOD	AERMOD is the USEPA short-range dispersion modeling tool that AEDT uses to model atmospheric dispersion.
Air-to-Ground Attenuation	See Refraction-Scattering Effects .
Aircraft Speed Adjustment	An adjustment made to exposure-based noise levels when aircraft speed differs from 160 knots, the reference speed for NPD data.
Ambient (noise)	The composite, all-inclusive sound associated with a given environment, excluding the analysis system's electrical noise and the sound source of interest. Several definitions of ambient noise have been adopted by different organizations depending on their application, such as natural ambient (natural sound condition in an area, excluding all human and mechanical sounds), existing ambient without aircraft (all-inclusive sound associated with a given environment, excluding the analysis system's electrical noise and the sound source of interest: aircraft), etc. Ambient data implementation in AEDT utilizes different ambient file formats specific to different noise metrics.
Annualization	The general term used for the collection of operations used to represent the aviation traffic to be modeled in a metric result. More specifically it is a weighted grouping of operations that are then normalized by the duration in days of the operations set. The term arose from the common application in noise modeling of taking a full year's set of aircraft operations and dividing by 365 (or 366 for a leap year) to achieve an average annual day.
Approach	A flight operation that begins in the terminal control area, descends, and lands on an airport runway, possibly exerts reverse thrust, and decelerates to taxi speed at some location on the runway.
Atmospheric Absorption	The change of acoustic energy into another form of energy (heat) when sound passes through the atmosphere. Several parameters such as temperature, pressure, and humidity are needed to specify the amount of atmospheric absorption, which is dependent upon the frequency of the sound as well. NPD data are corrected for atmospheric absorption in accordance with the Society of Automotive Engineers (SAE) Aerospace Recommended Practice (ARP) 866A ²² (SAE-ARP-866A), SAE Aerospace Information Report (AIR) 1845 ⁵⁹ (SAE-AIR-1845), and SAE ARP 5534 ²³ (SAE-ARP-5534).

Audibility	The measure of ability for an attentive listener to hear a particular acoustic event such as aircraft noise. Audibility is based on detectability from signal detection theory, and depends on both the actual aircraft sound level (“signal”) and the ambient sound level (or “noise”). The metric associated with audibility in AEDT is Time Audible.
Average Annual Day	The user-defined best representation of the typical annual conditions for the case airport. These conditions include the number and type of operations, runway usage, routing structure, temperature, atmospheric pressure, etc.
Bank Angle	The roll angle about the aircraft’s longitudinal axis. By convention a left turn has a positive bank angle and a right turn has a negative bank angle. Bank angle is presented in Figure 4-5.
Boeing Fuel Flow Method 2 (BFFM2)	Boeing Fuel Flow Method 2 is used to compute NO _x , HC, and CO in AEDT. See Section 5.1.1.1.
C-weighted	C-weighted noise levels, as compared with A-weighted noise levels, emphasize sound components between 100 Hz and 2 kHz. C-weighting is intended to simulate the sensitivity of the human ear to sound at levels above about 90 dB . C-weighted noise levels are commonly used for assessing scenarios dominated by low-frequency sound, e.g., locations behind start-of-takeoff roll. The A-weighted and C-weighted adjustment curves are presented in Figure 1-2.
Calibrated Airspeed (CAS)	The indicated airspeed of an aircraft (as read from a standard airspeed indicator), corrected for position and instrument error. Calibrated airspeed is equal to true airspeed in the standard atmosphere at sea level.
Change in Exposure (Delta Dose or DDOSE)	The difference between the cumulative, A-weighted, sound exposure level (L_{AE}) due to aircraft noise and the user-specified A-weighted ambient level at a given receiver location over a user-specified time period ⁱ .
Circuit Flight	A flight operation that combines a departure from and an approach to the same runway, with level-flight and/or varying-altitude segments in between
Closest Point of Approach (CPA)	Point on the flight path segment , not the extended flight path segment , which is the closest point of approach to the receptor .
Configuration	A configuration is a set of rules which specify the runway on which aircraft operate, and has associated arrival and departure capacities, and a set of activation parameter criteria. Configuration sets are ordered lists of configurations which are constant with respect to time because airport layouts are constant with respect to time.
Contour	An analysis of an area in the vicinity of an airport encompassed by a graphical plot consisting of a smooth curve, statistically regressed through points of equal level or time duration.
Corrected Net Thrust Per Engine	The net thrust per engine divided by the ratio of the ambient air pressure at aircraft altitude to the International Standard Atmosphere (ISA) air pressure at mean sea level.

ⁱ It is important to note that in AEDT, Change in Exposure uses a default time period of 12 hours. In addition, Change in Exposure levels below the specified threshold level will be reported as 0.0 dB, and levels are capped at 150 dB.

Decibel (dB)	A unit of measure for defining a noise level or a noise exposure level. The number of decibels is calculated as $10\log_{10}$ of the ratio of mean-square pressure or noise exposure . The reference root-mean-square pressure is 20 μPa , the threshold of human hearing.
Density Ratio	The ratio of density to the ISA sea-level value.
Departure	A flight operation that begins on a runway, proceeds down the runway, and climbs and accelerates to altitudes at specified distances.
Depression Angle	The angle between a line along the span of the aircraft's wing and a line parallel to the ground plane , which is a combination of the aircraft bank angle and elevation angle . Depression angle is presented in Figure 4-5.
Detectability	The ability to detect a signal in the presence of noise, based on signal detection theory. For the purposes of AEDT modeling, the terms "audibility" and "detectability" are used interchangeably.
Directivity Adjustment	A noise level adjustment resulting from the normalized noise pattern defined by a 360-degree area in the horizontal plane around a noise source. In AEDT, measurement-based directivity is accounted for in takeoff ground roll and runup operations for fixed wing aircraft with the Ground-Based Directivity Adjustment (DIR_{ADJ}). It is also accounted for in all static helicopter operating modes with the Static Directivity Adjustment ($\text{DIR}_{\text{HELI_ADJ}}$).
Distance Duration	An empirically-derived effect, expressed as a function of distance, which relates exposure-based noise levels to maximum-based noise levels. This effect is taken into account in the AEDT NPD data only for data corrected using the simplified data adjustment procedure in SAE-AIR-1845 ⁵⁹ .
Duration Adjustment	A noise level adjustment to exposure-based metrics to account for the effect of time-varying aircraft speed other than 160 knots (the NPD reference speed). Both acceleration and deceleration are accounted for with the Duration Adjustment (DUR_{ADJ}). It is not applied to maximum noise level metrics since they are mostly independent of speed. Helicopters also utilize duration adjustments; however they are based on helicopter-specific reference speeds . In addition, helicopters have a specific Static Operation Duration Adjustment ($t_{\text{HELI_static}}$) to account for duration effects due to static operations such as Hover, Ground Idle , and Flight Idle .
Elevation Angle	The angle between the line representing the propagation path between the aircraft source and receiver (at the aircraft's closest point of approach) and the line from the receiver to the projection of the flight path on the ground. Elevation angle is presented in Figure 4-5.
Emissions Index (EI)	A unique value for calculating emissions based on activity data in terms of a standard rate of emissions per unit of activity (e.g., grams of carbon dioxide emitted per kg of fossil fuel consumed).
Engine Breakpoint Temperature	The ambient air temperature (degrees F) above which the thrust output from a flat-rated engine begins to decrease.
Engine Installation Effect	A component of the lateral attenuation adjustment that takes into account the directivity of the sound from an aircraft as a function of engine/aircraft type (jet, prop, helicopter), engine mounting location (fuselage or wing), and depression angle .

Equivalent Airspeed	For an aircraft experiencing a given incompressible dynamic pressure, equivalent airspeed is the true airspeed at which the aircraft would experience the same incompressible dynamic pressure at ISA sea-level density.
Equivalent Auditory System Noise (EASN)	Equivalent Auditory System Noise (EASN) is the minimum threshold for audibility. It represents the lowest sound pressure levels detectable by humans with average hearing (on a one-third octave band basis), and is used in combination with an ambient file to compute audibility in AEDT.
ESRI	Software development and services company providing GIS software and geodatabase management applications.
Extended Flight Path Segment	A mathematical extension from either end of a geometrical flight path segment to infinity, used in AEDT for the computation of exposure based noise metrics.
First Order Approximation (FOA)	First Order Approximation (FOA) version 3.0 is used in AEDT to compute particulate matter below the mixing height. See Section 5.1.1.2.
Flight Idle	A static helicopter operation, where the helicopter is on the ground with the main rotor(s) operating at the same speed used for flight operations, but without generating lift.
Flight Operation	A moving (or dynamic) aircraft operation. There are five kinds of flight operations for fixed-wing aircraft in AEDT: approach , departure , overflight , circuit flight , and touch and go . There are three kinds of flight operations for helicopters in AEDT: approach , departure , and helitaxi .
Flight Path	A set of flight path segments describing geometrical and physical parameters used to model the movement of an aircraft in three-dimensional space. Each flight path point contains: (1) the geographical location (x- and y-value) relative to the origin of the airport, (2) the aircraft altitude above field elevation , (3) the aircraft ground speed (this is also the aircraft's true airspeed in situations of no wind), (4) the corrected net thrust per engine or equivalent parameter used to access the NPD curves, (5) duration (seconds) of the flight path segment following the point, and (6) aircraft bank angle for the flight path segment following the point (if applicable).
Flight Path Processing Module (FPPM)	The AEDT Flight Path Processing Module calculates trajectories to match altitude control definitions across all relevant phases of flight for civilian jet, turboprop, and piston propeller driven airplanes.
Flight Path Segment	A directed straight line in three-dimensional space, which includes the aircraft ground speed and corrected net thrust per engine at the beginning point of the line, and change in speed and thrust along the line to the end point.
Flight Profile	A set of points that models the geometrical and physical characteristics of an aircraft flight operation in the vertical plane. Each profile point contains: (1) the ground distance (x-value) relative to the origin of the operation, (2) the aircraft altitude above field elevation , (3) the aircraft true airspeed , and (4) the corrected net thrust per engine or equivalent parameter used to access the NPD curves. Profile points representing static operating modes within a helicopter profile also include the duration of time spent at the defined profile point.
Ground-Based Directivity Adjustment	See Directivity Adjustment .

Ground Effects (or Ground-to-Ground Attenuation)	A component of the lateral attenuation adjustment that takes into account the effects of sound propagating along the ground surface considered to be “acoustically soft” (such as grass) as a function of lateral distance .
Ground Idle	A static helicopter state of operation, where the helicopter is on the ground with the main rotor(s) turning at less than the speed required for flight.
Ground Plane	Without terrain elevation processing, the ground plane is the geometric, horizontal plane at the elevation of the airport. With terrain elevation processing, the elevation of the ground plane is determined using the user-selected elevation data for the area surrounding the airport.
Ground Speed	The speed of an aircraft, including all spatial components, from a frame of reference of an observer on the ground.
Ground-to-Ground Attenuation	See Ground Effects .
Ground Track	The trace of the flight path on the horizontal plane. Flight tracks are described as vector-type tracks consisting of one or more straight or curved segments, or point-type tracks consisting of an array of x,y points.
Hover in Ground Effect (HIGE)	A static helicopter state of operation, where the helicopter is hovering with the main rotor in aerodynamic ground effect (which are <i>not</i> the ground effect discussed above). Operations in aerodynamic ground effect require less power and are therefore typically quieter than HOGE operations.
Hover out of Ground Effect (HOGE)	A static helicopter state of operation, where the helicopter is hovering at a main rotor altitude above aerodynamic ground effect (which are <i>not</i> the ground effect discussed above). Operations out of aerodynamic ground effect require more power and are therefore typically louder than HIGE operations.
Integrated Adjustment Procedure	The preferred adjustment procedure used for developing NPD data from measured noise level data, which are used in AEDT. It is based on noise level data measured over the full spectral time history of an event. In the integrated procedure, off-reference aircraft speed, atmospheric absorption effects, and spherical divergence are considered. This adjustment procedure provides data consistent with Type 1 quality, as defined in SAE-AIR-1845 ⁵⁹ . See the definition of the Simplified Adjustment Procedure for comparison.
Internally Mixed Turbofan	Turbofan in which the bypass flow is also included during the measurement of the smoke number, indicating that the flow must take the bypass ratio into effect.
International Standard Atmosphere (ISA)	Internationally standardized functions of air temperature, pressure, and density versus aircraft altitude above mean sea level. The ISA is intended for use in calculations in the design of aircraft, in presenting test results of aircraft and their components under identical conditions, and to facilitate standardization in the development and calibration of instruments ² .
Lateral Attenuation Adjustment	An adjustment that results from the attenuation of noise at grid points laterally displaced from the ground projection of an aircraft flight path . It is a combination of attenuation due to ground effects , attenuation due to refraction-scattering effects and engine installation effects , as defined in SAE-AIR-5662 ²⁴ .

Lateral Directivity Adjustment	An adjustment that results from the linear interpolation between two of the three sets of helicopter NPDs (left, center and right), to account for helicopter in-flight directivity effects at a receiver location where the elevation angle is between -45 and 45 degrees.
Lateral Distance	The perpendicular distance from an aircraft's ground track to a receiver.
Line-of-Sight Blockage Adjustment	An adjustment that results from the attenuation due to line-of-sight (LOS) blockage from terrain features, and is based on the difference in propagation path length between the direct path and propagation path over the top of terrain features, known as path length difference.
Mach	A dimensionless number representing the speed of an object moving through air divided by the local speed of sound.
Maximum Noise Level	The maximum of a series of modeled sound pressure levels from a single flight.
Mean Sea Level (MSL)	The level of the surface of the sea with respect to the land, taken to be the mean level between high and low tide, and used as a standard base for measuring heights and depths. The MSL designation is used to indicate that an altitude is specified with respect to mean sea-level.
Mean-Square Sound Pressure	<p>A running time-average of frequency-weighted, squared instantaneous acoustic pressure. For example:</p> $p(t)_{AS}^2 = \int_{-\infty}^t P_A^2(\tau) \cdot e^{\frac{\tau}{t_0}} \frac{d\tau}{t_0}$ <p>where</p> <ul style="list-style-type: none"> $p(t)_{AS}^2$ A-weighted mean-square pressure using slow exponential time; P_A^2 A-weighted mean-square pressure; τ Time; and t_0 Initial time = 1 second.
Mean-Square Sound Pressure Ratio	The mean-square sound-pressure ratio is the ratio of the mean-square sound pressure divided by the square of the reference pressure 20 μPa . It is equivalent to $10^{\text{SPL}/10}$, where SPL is the sound pressure level .
Metric Family	A set of noise -level and time-based metrics differentiated by frequency weighting, either A-weighted , C-weighted , or tone-corrected perceived .
Metric Type	A metric belongs to one of three types: exposure-based, maximum-level-based, or time-based.
Mixing Height	The height at the top layer of atmosphere where relatively vigorous mixing of pollutants and other gases will take place for the airport in a given month. The mixing height varies both diurnally and seasonally. In AEDT, users can change the default mixing height value of 3,000 ft (AFE) for emissions inventories. The mixing height for emissions dispersion is fixed at 3,000 ft.
Net Thrust	The gross thrust of a jet engine minus the drag due to the momentum of the incoming air.
Noise	Any unwanted sound. "Noise" and "sound" are used interchangeably in this document.
Noise Exposure	See Sound Exposure .

Noise Fraction	The ratio of noise exposure at a grid point due to a flight path segment, and the noise exposure at the same grid point due to a straight, infinite flight path extended in both directions from the segment. The noise fraction methodology is based upon a fourth-power 90- degree dipole model of sound radiation.
Noise Fraction Adjustment	An adjustment that is a function of the ratio of the noise exposure at a grid point due to a flight path segment , and the noise exposure at the same grid point due to a straight, infinite flight path , extended in both directions from the segment. The application of the noise fraction adjustment to the NPD data facilitates the modeling of a three- dimensional flight path , using straight flight path segments.
Noise-Level Threshold	A noise level specified by the user that is the boundary value above which time-above calculations are performed.
Noise-Power-Distance (NPD) Data	A set of noise levels, expressed as a function of: (1) engine power, usually the corrected net thrust per engine ; and (2) distance. The NPD data in AEDT are corrected for aircraft speed, atmospheric absorption , distance duration , and spherical spreading. For helicopters, noise levels are presented as a function of: (1) operation mode; and (2) distance.
Noise Significance Tests	Tests performed by AEDT to determine if a flight operation is acoustically significant. Two types of tests are used: the relative noise-level/time test and the segment proximity test . The reason for performing these tests is to decrease runtime during a contour analysis. They are only performed when irregularly spaced grids are used.

<p>One-Third Octave-Bands</p>	<p>A method of characterizing the audio spectrum according to a series of frequency bands with constant-percentage-bandwidths, as described in ANSI S1.6-1984 (R2006) “Preferred Frequencies, Frequency Levels and Band Numbers for Acoustical Measurements”³ and ANSI S1.11-2004 “Specification for Octave-Band and Fractional-Octave- Band Analog and Digital Filters.”⁴ The standard one-third octave-bands used in AEDT are presented in Table 1-1.</p>																																																		
	<p>Table 1-1 Definition of One-Third Octave-Bands</p>																																																		
	<table border="1" style="margin-left: auto; margin-right: auto;"> <thead> <tr> <th data-bbox="669 529 954 583">One-Third Octave-Band Number</th> <th data-bbox="961 529 1180 583">Nominal Center Frequency (Hz)</th> </tr> </thead> <tbody> <tr><td>17</td><td>50</td></tr> <tr><td>18</td><td>63</td></tr> <tr><td>19</td><td>80</td></tr> <tr><td>20</td><td>100</td></tr> <tr><td>21</td><td>125</td></tr> <tr><td>22</td><td>160</td></tr> <tr><td>23</td><td>200</td></tr> <tr><td>24</td><td>250</td></tr> <tr><td>25</td><td>315</td></tr> <tr><td>26</td><td>400</td></tr> <tr><td>27</td><td>500</td></tr> <tr><td>28</td><td>630</td></tr> <tr><td>29</td><td>800</td></tr> <tr><td>30</td><td>1,000</td></tr> <tr><td>31</td><td>1,250</td></tr> <tr><td>32</td><td>1,600</td></tr> <tr><td>33</td><td>2,000</td></tr> <tr><td>34</td><td>2,500</td></tr> <tr><td>35</td><td>3,150</td></tr> <tr><td>36</td><td>4,000</td></tr> <tr><td>37</td><td>5,000</td></tr> <tr><td>38</td><td>6,300</td></tr> <tr><td>39</td><td>8,000</td></tr> <tr><td>40</td><td>10,000</td></tr> </tbody> </table>	One-Third Octave-Band Number	Nominal Center Frequency (Hz)	17	50	18	63	19	80	20	100	21	125	22	160	23	200	24	250	25	315	26	400	27	500	28	630	29	800	30	1,000	31	1,250	32	1,600	33	2,000	34	2,500	35	3,150	36	4,000	37	5,000	38	6,300	39	8,000	40	10,000
	One-Third Octave-Band Number	Nominal Center Frequency (Hz)																																																	
	17	50																																																	
	18	63																																																	
	19	80																																																	
	20	100																																																	
	21	125																																																	
	22	160																																																	
	23	200																																																	
	24	250																																																	
	25	315																																																	
	26	400																																																	
27	500																																																		
28	630																																																		
29	800																																																		
30	1,000																																																		
31	1,250																																																		
32	1,600																																																		
33	2,000																																																		
34	2,500																																																		
35	3,150																																																		
36	4,000																																																		
37	5,000																																																		
38	6,300																																																		
39	8,000																																																		
40	10,000																																																		
<p>Overflight</p>	<p>A flight operation that begins in the air, and remains in the air, in the study boundary, with optional user-specified changes in altitude and speed during the flight.</p>																																																		
<p>Procedure Steps</p>	<p>A prescription for flying part of a profile. Procedures include climbing at constant calibrated airspeed to a given altitude, accelerating to a given airspeed while climbing at a given vertical rate, etc.</p>																																																		
<p>Pressure Ratio</p>	<p>The ratio of pressure to the ISA sea-level value</p>																																																		
<p>Profile Points</p>	<p>The set of points that make up a flight profile. Profile points can be input directly into the AEDT or can be calculated by AEDT from a set of procedure steps.</p>																																																		
<p>°R</p>	<p>Degrees Rankine, which uses the Fahrenheit scale adjusted so that 0 degrees Rankine is equal to absolute zero.</p>																																																		
<p>Receptor</p>	<p>A receiver or grid point at which noise, time, or concentration values are computed.</p>																																																		

Reference Day Conditions	The atmospheric conditions corresponding to 77 degrees Fahrenheit (25 degrees Celsius), 70% relative humidity, and 29.92 in-Hg (760 mm-Hg). These are the atmospheric conditions to which aircraft noise certification data are corrected in accordance with 14 CFR Part 36 Section B36.7. These conditions are commonly referred to as ISA plus 10 degrees Celsius (ISA+10) .
Reference Speed	The noise -exposure reference speed in AEDT is 160 knots. Thus, L_{AE} and L_{EPN} values in the NPD database are referenced to 160 kts . The L_{ASmx} , L_{CSmx} , and L_{PNTSmx} values are assumed to be independent of aircraft speed.
Refraction	Change in the direction of sound propagation as a result of spatial changes in the speed of sound in a medium.
Refraction-Scattering Effects (or Air-to-Ground Attenuation)	A component of the lateral attenuation adjustment that takes into account the effects of refraction and scattering as sound propagates through the air to the receiver as a function of elevation angle .
Regular Grid	A set of receptor points spaced at fixed intervals, over a specified area in the vicinity of the case airport.
Relative Noise-Level/Time Test	A noise significance test in which all flight segments of all operations are sorted high-to-low according to the noise (time) contribution of each flight path segment at a regular grid point. Flight path segments considered significant are those whose cumulative noise (time) first equals or exceeds 97% of the total mean-square sound-pressure ratio (total time) at the grid point.
Runup	An activity in which an aircraft is testing engine operations on the ground. It is modeled in AEDT as an aircraft in a stationary position on the ground, with aircraft thrust held constant at a user-defined level for a time period.
Scattering	Irregular reflection or diffraction of sound in many directions.
Segment Proximity Test	A noise significance test in which a flight path segment, which is first determined to be insignificant by the flight path segment noise test, is further tested based on its distance to a regular grid point. If it is determined that the flight path segment is within a certain distance of the grid point, the flight path segment regains its significance status. This distance is based on the diagonal distance between base grid points (one times the diagonal distance for most metrics) as an acceptance criterion.
Simplified Adjustment Procedure	An adjustment procedure used for developing NPD data from measured noise level data, which are used in AEDT. In contrast to the integrated adjustment procedure , the simplified adjustment procedure is based on noise -level data measured at the time of the maximum noise level only. In the simplified adjustment procedure, off-reference aircraft speed, atmospheric absorption , distance duration effects, and spherical divergence are considered. This adjustment procedure provides data consistent with Type 2 quality as defined in SAE-AIR-1845 ⁵⁹ .
Slant Range Distance (SLR)	The line-of-sight distance between a receiver and a flight path segment .

Sound Pressure Level (SPL)	<p>Ten times the base-10 logarithm of the mean-square sound pressure, in a stated frequency band, to the square of the reference sound pressure of 20 μPa, which is the threshold of human hearing.</p> $SPL = 10 \log_{10} \left[\frac{p^2}{p_0^2} \right]$ <p>where</p> <p>p^2 Mean-square pressure (Pa²); and p_0 20 μPa.</p>
Sound Exposure (Noise Exposure)	<p>The integral over a given time interval ($t_2 - t_1$) of the instantaneous, frequency-weighted, squared sound pressure:</p> $E_{12} = \int_{t_1}^{t_2} p^2(t) dt$ <p>where</p> <p>E_{12} Sound exposure (Pa²s) over the time interval ($t_2 - t_1$).</p>
Sound Exposure Level	<p>Ten times the base-10 logarithm of the sound exposure divided by a reference sound exposure.</p> $L_E = 10 \log_{10} \left[\frac{E}{E_0} \right]$ <p>where</p> <p>E Sound exposure (Pa²s); E_0 (20 μPa)² (1 s) for A-weighted and C-weighted sound exposure; and E_0 (20 μPa)² (10 s) for tone-corrected perceived sound exposure.</p>
Sound Exposure Ratio	<p>Commonly called “energy”. The ratio of sound exposure over a reference sound exposure, or ten raised to power of one tenth the sound exposure level:</p> $\frac{E}{E_0} = 10^{\frac{L_E}{10}}$ <p>where</p> <p>E Sound exposure (Pa²s); E_0 Reference sound exposure (Pa²s); and L_E Sound exposure level (dB).</p>
Source Noise Adjustment Due to Advancing Tip Mach Number	<p>A noise adjustment based upon the change in Mach number of the advancing rotor blade of a helicopter. This adjustment is only applied during level flight segments, and accounts for airspeed, temperature and/or rotor RPM which deviate from helicopter-specific reference values.</p>
Spectrum	<p>A set of sound pressure levels in component frequency bands, usually one-third octave bands.</p>
Spectral Class	<p>A set of aircraft spectra which are grouped together based on similar spectral characteristics for similar operational modes.</p>

Spherical Divergence	Spherical divergence, which is taken into account in the AEDT NPD data, is defined as the transmission loss of mean-square sound pressure , which varies inversely with the square of the distance from a point source. In contrast, cylindrical divergence is the transmission loss of mean-square sound pressure , which varies inversely with distance from a line source.
Stage Length	A range of trip lengths/distances for departure profiles.
Standard Day Conditions	The atmospheric conditions corresponding to 59 degrees Fahrenheit (15 degrees Celsius), 70% relative humidity, and 29.92 in-Hg (760 mm-Hg). The values for temperature and atmospheric pressure are sea-level conditions for the ISA .
Static Directivity Adjustment	See Directivity Adjustment .
Static Operation	A stationary aircraft operation. Runup operations are the only kind of static operations available for fixed-wing aircraft in AEDT. There are four kinds of static operational modes for helicopters in AEDT: flight idle , ground idle , hover in ground effect , and hover out of ground effect . Static helicopter operations are utilized in conjunction with a static directivity adjustment .
Static Operation Duration Adjustment	See Duration Adjustment .
Static Thrust	Maximum thrust (lbs) produced by a stationary engine at sea-level, ISA conditions.
Statistical Compression	A method used to adjust TAUD to account for the effects of simultaneously occurring aircraft events on audibility. Also known as the overlapping events method.
Temperature Deviation	The difference between the temperature at a given location and time and the corresponding temperature in another atmosphere at the same location and time
Temperature Ratio	The ratio of temperature to the ISA sea-level value.
Thrust Reverser Adjustment	An empirically-derived noise adjustment to account for noise from thrust reverser deployment during the landing ground roll.
Thrust-Specific Fuel Consumption (TSFC)	The flow rate of fuel (mass/time) consumed by an engine per unit of thrust (force) produced by that engine. TSFC is a measure of the efficiency of the engine, with smaller values indicating higher efficiency.
Time-Above	The duration that a time-varying sound level is above a given sound level threshold.
Time Audible	The duration that a time-varying sound level may be detected in the presence of ambient noise as audible by a human observer with normal hearing, who is actively listening for aircraft noise.

Time-Averaging Constant	<p>A constant decibel value that is ten times the base-10 logarithm of the time interval associated with the metric divided by a reference time interval, which is usually one second. The time-averaging constant is equal to:</p> $\text{Time – Averaging Constant} = 10\log_{10}[N_T]$ <p>where</p> $N_T = \frac{T_i}{T_{ref}};$ <p>T_i Time interval associated with a particular metric (s); and T_{ref} Reference time interval (s).</p> <p>Using L_{dn} as an example, T_i is 86,400 seconds in 24 hours, T_{ref} is 1 second, and the time-averaging constant is 49.37 dB. The time-averaging constant is subtracted from the sound exposure level to compute an equivalent or average sound level.</p>
Tone-Corrected Perceived Noise Level	<p>Tone-corrected perceived noise levels are used to estimate human-perceived noise from broadband sound sources, such as aircraft, which contain pure tones or other major irregularities in their frequency spectra. It is calculated by applying an adjustment to the noise level that is related to the degree of irregularity that may occur among contiguous one-third octave band sound pressure levels of aircraft noise, as described in 14 CFR Part 36²¹.</p>
Touch and Go (TGO)	<p>A flight operation that begins with a level flight in the terminal control area, descends and lands on an airport runway, and then takes off immediately after landing and returns to level flight.</p>
True Airspeed (TAS)	<p>The speed of an aircraft (kts) relative to its surrounding air mass.</p>
Weighting Factor	<p>A numeric value that multiplies the sound exposure ratio associated with a time period for a given metric. For the exposure-based metrics, the weighting factor acts as a penalty for operations that occur during a specific time period. Usually larger penalties are applied during the night-time period when people are most sensitive to noise. For the maximum-level and time-based metrics, the weighting factors are either zero or unity. As such, they act as a binary switch allowing the user to select specific time periods for computation.</p>

1.5 Abbreviations

A term in bold indicates that it is defined in the Terminology or Abbreviations table.

AEDT	Aviation Environmental Design Tool
AEE	Office of Environment and Energy
AFE	Above Field Elevation
AGL	Above Ground Level
AFR	Air-to-Fuel Ratio
ANP	Aircraft Noise and Performance Model. See Section 2.1.4.
APEX	Aircraft Particle Emissions eXperiment. See Section 5.1.1.2.
BADA	Base of Aircraft Data. See Section 3.2.
BFFM2	Boeing Fuel Flow Method 2
BTU	British Thermal Unit
°C	Degrees Celsius (temperature)
CAEP	ICAO Committee on Aviation Environmental Protection
CAS	Calibrated Air Speed
CPA	Closest Point of Approach
CO	Carbon Monoxide
CO₂	Carbon Dioxide
CI	Concentration Index
dB	Decibel
EASN	Equivalent Auditory System Noise
EDMS	Emissions and Dispersion Modeling System
EDB	International Civil Aviation Organization (ICAO) Engine Emissions Databank
EI	Emissions index
Eurocontrol	European Organization for the Safety of Air Navigation
°F	Degrees Fahrenheit (temperature)
FAA	United States Federal Aviation Administration
FAR	Federal Aviation Regulation
ft	Feet
FOA	First Order Approximation
FSC	Fuel Sulfur Content
GIS	Geographic Information System
GUI	Graphical User Interface
HAP	Hazardous Air Pollutant
HC	Hydrocarbons
HIGE	Hover In Ground Effect
HOGE	Hover Out of Ground Effect
IATA	International Air Transport Association

ICAO	International Civil Aviation Organization
In-Hg	Inches of Mercury (barometric pressure)
INM	Integrated Noise Model
ISA	International Standard Atmosphere
km	Kilometers
kt, kts	Knots (international nautical miles per hour)
L_{AE}	A-weighted sound exposure level (SEL)
L_{ASmx}	Maximum A-weighted sound level with slow-scale exponential time weighting (LAMAX)
L_{CE}	C-weighted sound exposure level (CEXP)
L_{CSmx}	C-weighted maximum sound level with slow-scale exponential weighting characteristics (LCMAX)
L_{EPN}	Effective tone-corrected perceived noise level (EPNL)
L_{PNTSMX}	Maximum tone-corrected perceived noise level with slow-scale exponential time weighting (PNLTM)
lb	Weight
lbf	Pounds force
LTO	Landing and Takeoff
m	Meters
MOVES	Motor Vehicle Emission Simulator
MSL	Mean Sea Level
N	Newtons
NAAQS	National Ambient Air Quality Standards
NASA	National Aeronautics and Space Administration
NEPA	National Environmental Policy Act
nmi	International Nautical Miles (1,852 m)
NO_x	Oxides of Nitrogen
NPD	Noise-Power-Distance
NMHC	Non-Methane Hydrocarbons
PM	Particulate Matter
PIT	Population Import Tool
°R	Degrees Rankine
ROC	Rate of Climb
Pa	Pascal (unit of pressure, one Newton per square meter)
PCPA	Perpendicular Closest Point of Approach
s, sec	Second (time duration)
SLR	Slant Range Distance
SN	Smoke Number
SO_x	Sulfur Oxides

SPL	Sound Pressure Level
TAS	True Air Speed
THC	Total Hydrocarbons
TOG	Total Organic Gases
TSFC	Thrust-Specific Fuel Consumption
VOC	Volatile Organic Compounds

2. Data

2.1 AEDT Databases

2.1.1 Overview

The central data architecture of AEDT relies on a relational database management system (Microsoft SQL Serverⁱⁱ). There are two tiers in the architecture, a foundation comprised of two system provided databases (Airport and Fleet), and a superstructure (Study) for end user content management.

The two AEDT system databases, Airport and Fleet, define the relational data storage, referred to as a schema. They contain the geographic and source information for airport and equipment elements necessary to populate required parameters in the underlying environmental models – e.g., aerodynamic, emissions, and structural coefficients for both aircraft and non-aircraft equipment, external reference codes from standard aviation sources, runway and helipad data, historical meteorological values, etc.

The superstructure, generally referred to as Study, replicates a combined schema of the system databases and adds structure in the form of additional relational schema to establish a repository for operational inputs, results storage, user-defined elements, and graphical representations for a given analysis. A template Study database schema exists as the point of origin for creating a new study. Whenever a new study is created, typically using the graphical user interface, data desired by the user is retrieved from the system database(s) and placed into the new instance of a study database.

The concept of relational database management extends beyond just data storage to include a programmable engine for data storage and retrieval, enterprise storage platforms for scalability, and external access to input and output data.

The AEDT database schema is an open standard with respective database description documents for the three defined databases:

- Study: Baseline format for creating and importing a new study;
- Airport: Global set of airport-specific data using standard FAA, International Civil Aviation Organization (ICAO), and International Air Transport Association (IATA) codes; and
- Fleet: Data for all available equipment, both aircraft and non-aircraft, used in the performance, emissions, and noise environmental models

2.1.2 Study Database

The AEDT Study database contains all information, or references to external source data (weather, terrain, ambient, and map layers), including input and configuration, intermediate data, and output results for the AEDT application. A schematic representation of the database is available with the AEDT installation (C:\Program Files\FAA\AEDT\Documents\Study_ERD.pdf). The diagram highlights the

ⁱⁱ For AEDT 2c, the officially supported version of Microsoft SQL Server is 2008 R2. Other versions of MS SQL Server may work with the software but have not been thoroughly tested.

structures three main data areas (airport, fleet, and operations). Further, the diagram places the constellation of user settings, metric results constructs, and user-defined content such as equipment and airport configurations, and grouping and annualization of operations.

Any given study may contain one or more airports, each with one or many layouts, and each layout may have one or more operating configurations, e.g. north-flow or west-flow. AEDT's calculation of metric results is flexible enough to incorporate operations located at any of the airports included in the study. The relational links between operations and the airport(s) where those operations take place are maintained in the study.

Further, in developing any given study, one or more years (future or past) can be included and applied on a per metric result (output) basis. Individual airport layouts can be time constrained, if desired, to a time period and operations which may span larger time periods will be filtered by the system when creating the metric results. A common design for a study is the construct of a present airport layout and a future airport layout with respective operations for each layout. The metric results for each layout can then be compared to identify improvements in the environmental consequences of the new design.

The information defined in the Study database is available in the Study Database Description Document (Study DDD)⁵. The Study DDD specifies all parameter types and units, table structure (grouping of parameters), and the relational links between tables, i.e. the database schema.

2.1.3 Airport Database

The AEDT Airport database consists of 31 tables containing a global set of airports and airport data such as runways, historical atmospheric conditions, and time zones.

An AEDT study contains airport data from the Airport database. As noted in Section 2.1.1, the airport tables are populated with data pertinent to the airports referenced in the study. The initial population of the airport tables in a study database are a subset of the records contained in the Airport database:

1. ICAO and IATA airport codes including their time history of changes.
2. Historical averages of meteorological data from weather sensors (US only)
3. Airport surface structures, e.g. runways, taxiways, gates, buildings, etc.
4. Airspace geographical content on procedures, e.g. ground-tracks, altitude controls, etc.

Once the study database is established, additional detail about a given airport can be created or modified via the graphical interface or the ASIF import function. Further, if additional airports are desired after an initial set of airports are chosen they can be added to the study using the graphical interface functions.

The information defined in the Airport database is available in the Airport Database Description Document (Airport DDD)⁶. The Airport DDD specifies all parameter types and units, table structure (grouping of parameters), and the relational links between tables, i.e. the database schema.

2.1.4 Fleet Database

The AEDT Fleet database contains 152 tables that store aircraft and non-aircraft equipment related information for use by the AEDT system. The AEDT Fleet database tables are relationally linked and each falls into three tiers of aircraft data – physical, modeling, and type.

The Fleet database contains approximately 4,600 aircraft (airframe/engine combinations) and approximately 400 non-aircraft emissions sources (ground support equipment, stationary power and fuel equipment, and auxiliary power units).

The modeling tier contains aircraft modeling parameters specific to the three aircraft representations used to evaluate the environmental impacts of interest in AEDT. These three models are:

1. ICAO Engine Emissions Databank⁷ (EDB)
2. ICAO Aircraft Noise and Performance Database⁸ (ANP)
3. Eurocontrol Base of Aircraft Data⁹ (BADA)

The aircraft in the physical tier are assigned links to aircraft representations from each of the three models in the modeling tier. This mapping effectively condenses the fleet of physical aircraft into a modeling set of approximately 4,600 equipment records.

The type tier is the most abstract layer of the Fleet database. This representation is based on the ICAO Aircraft Type document, ICAO 8643¹⁰, and the IATA Aircraft Type Table¹¹. These Types address aircraft at the airframe level and are typically used by, for example, air traffic management systems to reference aircraft in schedule and operational records.

The non-aircraft emissions sources are available for use in modeling emissions and emissions dispersion metrics. The non-aircraft equipment are stored in hierarchical tables that separate the sources into categories according to the physical mechanisms of their respective emissions, e.g. combustion, evaporation, wind/run-off, etc. The set of system provided non-aircraft equipment is available for assignment to operations in two ways, either as stand-alone operations or associated with (and therefore proportional to) aircraft operations.

The information defined in the Fleet database is available in the Fleet Database Description Document (Fleet DDD)¹². The Fleet DDD specifies all parameter types and units, table structure (grouping of parameters), and the relational links between tables, i.e. the database schema.

2.1.5 Equipment Operations (Study)

The central construct in an AEDT Study is equipment operations. Operations can be specified in, broadly, two modes. Either as an explicitly scheduled operation where the minimum required information for the operation is the equipment to be used, the time at which the operation is to take place, and the location of the operation. Or, as an operational (time) profile where again the equipment and location of the operation must be specified by the user but the time component is an activity profile over an entire model year. The activity profile is the combination of three, hour-of-day/day-of-week/month-of-year, distributions that are applied by the system to form an annual explicit schedule.

The minimum information on the two forms of operations (activity profile and explicit schedule) can be further augmented with, where available or created by the user, additional geographic, temporal, and

logical information. For example, track geometry and controls can be applied to the aircraft operations. Gate and taxipath information can be applied to non-aircraft and aircraft operations. If even more detail is available, the desired trajectory or sensor path can be assigned to an aircraft operation.

These two operations forms are encapsulated in the AIR_OPERATION and STN_OP tables found in the Study database. The relational links between the equipment, location/geometry of the operation, and the time or activity profile are maintained within the Study database explicitly and do not relate back to the system Airport and Fleet databases.

Aircraft Operations

The root data for scheduled operation are records in the AIR_OPERATION table of the Study database. Each record links, at minimum, to an aircraft equipment record (FLT_EQUIPMENT), an airport layout record (AIRPORT_LAYOUT), and an operation type and count, e.g. departure, arrival, overflight, etc. For any operation record, additional information about the operation can be linked to and/or set in the record. The comprehensive list of optional and additional fields for the operation record are as follows:

- [USER_ID]
- [AIR_OPERATION_DETAIL_ID]
- [OPERATION_TIME] or [ACTIVITY_PROFILE]
- [PROFILE] or [STAGE_LENGTH] or [AIRPORT_PAIR]
- [DEPARTURE_RUNWAY_END] or [ARRIVAL_RUNWAY_END] or [TRACK] or [SENSOR_PATH]
- [ARRIVAL_GATE_ID] or [DEPARTURE_GATE_ID]
- [TAXI_OUT_TIME] or [TAXI_IN_TIME]
- [CRUISE_ALTITUDE]

Each of these fields can be addressed through the graphical user interface or the ASIF file. As noted above the field-level definitions for each item in this list is available in the Study DDD.

Non-Aircraft Operations (Activity Profile Only)

The root data for non-aircraft operations are stored in the STN_OP table of the Study database. Each record links, at minimum, to a non-aircraft equipment record (STN_SOURCE table), an airport layout record (AIRPORT_LAYOUT table), an activity profile record (ACTIVITY_PROFILE table) and an annual (or peak) operation count. For any non-aircraft operation record, additional information about the operation can be linked to and/or set in the record. The non-aircraft operation record can optionally specify a geographic location at which stationary emissions sources are located with the three additional fields: [ELEVATION], [LATITUDE], and [LONGITUDE].

The location fields can be addressed through the graphical user interface or the ASIF file in the same way that Aircraft Operations details are exposed. As noted above, these three field definitions are available in the Study DDD.

2.2 Input Data

2.2.1 Summary of Input Data for Noise Computation

The AEDT Fleet database contains noise vs. power vs. distance acoustic data (or noise vs. operational mode vs. distance data for helicopters), augmented by a database of spectral characteristics (known as spectral classes) and additional aircraft-specific data to support several noise adjustments available in AEDT.

2.2.1.1 Noise-Power-Distance (NPD) Data Sets

The noise vs. power vs. distance acoustic data (or noise vs. operational mode vs. distance data for helicopters) in AEDT, also referred to as NPD data, represent the aircraft source noise level for a given operational mode and power setting at a range of slant distances from the aircraft to account for acoustic propagation through a standard atmosphere. There are two types of NPDs in AEDT: fixed wing aircraft NPDs (for all commercial and military fixed wing aircraft), and helicopter NPDs. The NPD data for fixed-wing aircraft consist of a set of decibel (dB) levels for various combinations of aircraft operational modes, engine power settings, slant distances from aircraft to receptor, and base noise metrics that are associated with a specific aircraft engine. The NPD data for helicopters consist of a set of decibel levels for various combinations of aircraft operational modes, slant distances from aircraft to receptor, and base noise metrics that are associated with a specific helicopter engine. These data are usually obtained from the AEDT Fleet database, but they can also be user-defined. These commercial fixed-wing aircraft NPD data are also consistent with the Eurocontrol ANP databaseⁱⁱⁱ⁸.

An underlying assumption is that NPD data represent an aircraft proceeding along a straight flight path of infinite length and parallel to the ground through a standard atmosphere. Differences from this assumption, such as curved flight tracks and climbing/descending flight profiles, are accounted for by adjustments to the NPDs.

NPDs represent the source noise for a specific aircraft. A decibel level on an NPD includes the noise generated by the airframe and all engines^{iv}. For helicopters, NPDs also includes rotor noise.

For fixed wing aircraft, each NPD is associated with an engine power setting, also known as thrust setting. NPDs at different power settings represent the different types of noise generated by those power settings. Engine power setting is expressed on a per engine basis in a variety of units, as listed in Table 2-1. For helicopters, NPDs are not associated with an engine power setting and are associated with a helicopter operational mode instead.

Table 2-1 Engine Power Setting Units

Engine Power (Thrust) Setting	Description	Units
Pounds	Corrected net thrust per engine	Pounds force
TurbineInletTemperatureDegC	Turbine inlet temperature	Degrees Celsius
EnginePressureRatio	Engine pressure ratio	Dimensionless
EquivalentShaftPower	Equivalent shaft power	Horsepower
ManifoldPressureInHg	Manifold pressure	Inches of mercury
PoundsPerHourFuelFlow	Fuel mass flow rate	Pounds per hour
Percent	Percent of ISA sea-level static thrust	Percent (dimensionless)
PercentCorrectedRotorSpeed	Percent of maximum corrected rotor design speed	Percent (dimensionless)
FanSpeed	Fan speed	Rotations per minute

ⁱⁱⁱ The ANP NPD database does not include military or helicopter data.

^{iv} It is important to note that although engine power setting for a NPD is expressed on a per engine basis, the corresponding noise level on the NPD represents all engines on the aircraft.

Engine Power (Thrust) Setting	Description	Units
PercentFanSpeed	Percent of fan design speed	Percent (dimensionless)
PercentLowPressureCompressorSpeed	Percent of low pressure compressor design speed	Percent (dimensionless)
PowerLeverAngle	Power lever angle	Degrees (in decimals)
PercentPropellerOrCompressorRPM	Percent of propeller or compressor design speed	Percent (dimensionless)
PropellerOrCompressorRPM	Propeller or compressor speed	Rotations per minute

Different operational modes generate different types of noise. Typically, departure operations may be dominated by engine noise, whereas approach operations may be dominated by airframe noise. To account for these differences, NPDs are also delineated by operational mode. For fixed-wing aircraft, NPD data consist of two or more noise curves for each operational mode. Operational modes are sub-categories of phases of modeled flight. See Table 2-2 for a complete list of fixed-wing aircraft operational modes.

Helicopter NPD data consist of noise curves for each operational mode procedural step. While helicopters use the same general operational mode types as fixed-wing aircraft (approach, departure and level flight), AEDT further delineates helicopter operational mode to include a variety of different types of procedural steps. The NPD data for a helicopter, either from the AEDT Fleet database or user-defined, are organized according to dynamic operation modes (departure, approach, overflight, accelerate, decelerate, etc.) and static operational modes (ground idle, flight idle, hover in and out of ground effect). See Table 2-2 and Table 2-3 for a complete list of fixed-wing aircraft and helicopter operational mode procedure steps.

Table 2-2 Operational Mode for Each Fixed-Wing Aircraft NPD Data Set

Operational Mode	Description
A	Approach
D	Departure
L	Level flight

Table 2-3 Operational Mode Procedure Steps for Each Helicopter NPD Data Set

Operational Mode	Description	State
A	Approach at constant speed	Dynamic
D	Departure at constant speed	Dynamic
L	Level flyover at constant speed	Dynamic
G	Ground idle	Static
H	Flight idle	Static
I	Hover in ground effect	Static
J	Hover out of ground effect	Static
V	Vertical ascent in ground effect	Static
W	Vertical ascent out of ground effect	Static
Y	Vertical descent in ground effect	Static

Operational Mode	Description	State
Z	Vertical descent out of ground effect	Static
B	Approach with horizontal deceleration	Dynamic
C	Approach with descending deceleration	Dynamic
E	Depart with horizontal acceleration	Dynamic
F	Depart with climbing acceleration	Dynamic
T	Taxi at constant speed	Dynamic

Each NPD includes aircraft noise levels at the following ten distances: 200; 400; 630; 1,000; 2,000; 4,000; 6,300; 10,000; 16,000; and 25,000 ft. The propagation of aircraft noise under standard conditions is represented by NPDs in AEDT. The noise levels in the NPD data (for all aircraft types) have been adjusted for time-varying aircraft speed (exposure-based noise levels only), atmospheric absorption, distance-duration effects (if the simplified adjustment process is used for exposure-based noise levels)^v, and spherical divergence to each of the ten distances in accordance with the methodology presented in Reference 59 and summarized in Reference 14.

Each set of NPDs in the database includes separate NPDs for four different base noise metrics:

- L_{AE} A-weighted sound exposure level (SEL);
- L_{ASmx} Maximum A-weighted sound level with slow-scale exponential time weighting (LAMAX);
- L_{EPN} Effective tone-corrected perceived noise level (EPNL); and
- L_{PNTSmx} Maximum tone-corrected perceived noise level with slow-scale exponential time weighting (PNLTM).

All metrics in AEDT, including C-weighted and time-based metrics, are computed using these four base noise level metrics.

For fixed-wing aircraft, noise levels that lie between thrust values or between distance values are obtained by linear interpolation on thrust and logarithmic interpolation on distance. Extrapolation is used to obtain levels outside of the bounding thrust or distances values, see Section 4.2.2. For helicopters, no interpolation is performed between multiple operational modes

While the underlying databases for fixed-wing aircraft, helicopters, and military aircraft are based on the same data format (NPDs in conjunction with spectral data), there are several key differences in the AEDT Fleet database between helicopter and fixed-wing NPDs that warrant a more detailed description. The helicopter NPDs main differences are that:

- They are delineated according to operational mode instead of thrust/power setting;
- No interpolation is performed between multiple operational modes;

^v A specific adjustment is used to account for distance-duration effects computed with the simplified adjustment process. For military aircraft, NPD data were developed using the simplified data adjustment procedure, and distance duration effects were computed using an empirically-derived $6.0 \log_{10}[d/d_{ref}]$ relationship. In contrast, NPD data for civilian aircraft that were corrected using the simplified procedure were adjusted using an empirically-derived $7.5 \log_{10}[d/d_{ref}]$ relationship. It was decided that the 6-log relationship would be maintained for the military aircraft in AEDT 2c, since it represents a best-fit empirical relationship for those aircraft.

- For the dynamic operational modes they come in sets of three curves to represent helicopter noise lateral directivity; and
- For static operational modes each single NPD curve is paired with a helicopter-specific directivity adjustment to represent helicopter noise directivity.

For dynamic operational modes, there are three sets of noise levels for various combinations of helicopter operational modes (instead of thrust levels) at the ten standard distances. This set of three NPD curves is used to account for the asymmetrical directivity associated with helicopter noise; the three curves correspond to noise levels at locations directly below the helicopter (center) and at approximately 45 degrees to either side (left/right) of the centerline. For static operational modes, there is a single set of noise levels for various combinations of helicopter operational modes and slant distances from the helicopter to receptor. This single set of NPD curves is used in conjunction with a helicopter-specific directivity adjustment to account for static operational mode directivity (see Section 2.2.1.3).

2.2.1.2 Spectral Data Sets

The spectral data in AEDT consist of a set of sound pressure level vs. one-third octave-band frequency (50 Hz to 10 kHz) values measured at the time of $L_{AS_{MX}}$ or $L_{PNTS_{MX}}$ and corrected to a reference distance of 1,000 ft (305 m) using the SAE-AIR-1845⁵⁹ atmospheric absorption coefficients. These spectral data are used in AEDT to compute the following:

- Atmospheric absorption adjustment based on local temperature and relative humidity;
- Line-of-sight blockage adjustment due to terrain; and
- C-weighted noise metrics.

AEDT does not support a separate spectrum for each aircraft and operational mode. Instead, the spectral data in AEDT are in the form of spectral classes, which represent the spectral shape at time of maximum sound level for a group of aircraft deemed to have similar spectral characteristics for each different operation mode (approach, departure, level flight/afterburner). Sensitivity and validation tests were conducted on aircraft to identify appropriate spectral class groupings¹³.

The spectral class data was originally developed for the FAA's INM¹³. During the initial development process, aircraft were grouped together by engine type and/or number of engines (i.e., low-bypass ratio jet, high-bypass ratio jet, four engine jet, turboprop, piston, etc.); the groups were then broken down further by spectral shape. Some groups were partitioned further to eliminate the presence of widely used aircraft in the same group. For instance, aircraft that often fly similar missions (e.g., medium-range, narrowbody commercial jet aircraft) may be placed in separate groups, even though their spectral shapes are similar, because of differences in engine type and engine placement/configuration on the aircraft. Aircraft added since the initial development were assigned to a spectral class using a series of tests to determine the class which provided the best fit. The best fit was based on spectral shape and similarities in atmospheric absorption calculations over the ten NPD slant distances for five different temperature and humidity conditions^{vi} and line-of-sight blockage calculations over the ten NPD slant distances for seven path length differences^{vii}, rather than on aircraft type (although in the majority of

^{vi} The 5 temperature and humidity conditions used in the atmospheric absorption calculations are the SAE standard atmosphere and the 4 extremes for the Annex 16⁵⁴ allowable test window.

^{vii} The 7 path length differences used in the line-of-sight blockage calculations are -1.2, 0, 1.2, 2.4, 3.6, 6.1, and 31 meters.

cases, the best fit spectral class proved to contain aircraft of similar types). The spectral class assignment process is documented in Section 11.2.2.

Similar spectral data for military aircraft from the Noisefile Database in the United States Air Force NOISEMAP computer program²⁵ are included in AEDT. NOISEMAP is used for computing noise exposure at facilities dominated by military operations. The military data also exist in the form of one-third octave-band spectra measured at the time of LASmx. These data were corrected to a distance of 1,000 feet (305 meters) using the SAE-AIR-1845⁵⁹ atmospheric absorption coefficients to maintain similarity with the referenced report¹⁴.

Once the spectra were grouped together, a representative spectrum was determined for the group. The spectrum was calculated from a departure-weighted arithmetic average of the individual aircraft spectra in the group for commercial aircraft. For military aircraft, aircraft inventory data were collected and each spectral class was represented by the single military aircraft which had the highest number in physical fleet inventory. Some single- and twin-engine turboprops and turbojets (i.e., business jets) have commercial, military, and private usages. For these aircraft, the representative spectrum was calculated using an equally weighted arithmetic average of all of the individual aircraft spectra.

2.2.1.3 Helicopter Static Directivity Data Sets

The AEDT Fleet database includes directivity data for modeling noise from helicopter static operations (ground idle, flight idle, hover-in-ground-effect (HIGE), and hover-out-of-ground-effect (HOGE)). The static directivity data account for changes to the sound level as a function of the helicopter azimuth angle, which is measured clockwise from the nose of the helicopter. These data are based on empirical measurements, and account for relative differences in sound level at 15-degree increments around the helicopter at a nominal radial distance of approximately 200 ft. Many helicopters in the AEDT Fleet database have both acoustically hard and soft ground directivity data.

2.2.1.4 Helicopter Operational Mode Adjustment

Although the AEDT database has the capability to include NPDs representing 16 different operational mode procedure steps, many helicopters in the database do not have a complete set of NPDs representing all of these procedure steps. In cases where NPDs do not exist in the AEDT database to model a procedure step for a particular helicopter, existing NPDs may be modified with a helicopter operational mode adjustment specific for that helicopter. For each helicopter in the AEDT database, there are six helicopter operational mode adjustments: vertical ascent (Vert Asc), vertical descent (Vert Dec), depart with horizontal acceleration (Accel Hor), approach with horizontal deceleration (Decel Hor), depart with climbing acceleration (Accel Clm), and approach with descending deceleration (Decel Dsc). These adjustments are in decibels, and they are applied as straight additions to the existing NPD levels. These offsets are applied to A-weighted, C-weighted and P-weighted NPDs at all distances. The operational mode procedure step data substitutions, including the appropriate helicopter operational mode adjustment, are presented in Table 2-4. While all standard AEDT helicopters have these six parameters set to zero, user-defined helicopters may use these adjustments.

Table 2-4 Substitution Operational Mode Procedure Steps Data for Helicopters, including the Appropriate Helicopter Operational Mode Adjustment

Missing Operational Mode Procedure Step Data	Available Operational Mode Procedure Step Data + Helicopter Operational Mode Adjustment
Ground idle (G)	Flight idle (H)
Flight idle (H)	Ground idle (G)
Hover in ground effect (I)	Hover out of ground effect (J)
Hover out of ground effect (J)	Hover in ground effect (I)
Vertical ascent in ground effect (V)	Hover in ground effect (I) + Vert Asc Adjustment
Vertical ascent out of ground effect (W)	Hover out of ground effect (J) + Vert Asc Adjustment
Vertical descent in ground effect (Y)	Hover in ground effect (I) + Vert Des Adjustment
Vertical descent out of ground effect (Z)	Hover out of ground effect (J) + Vert Des Adjustment
Approach with horizontal deceleration (B)	Approach (A) + Decel Hor Adjustment
Approach with descending deceleration (C)	Approach (A) + Decel Des Adjustment
Depart with horizontal acceleration (E)	Departure (D) + Accel Hor Adjustment
Depart with climbing acceleration (F)	Departure (D) + Accel Clm Adjustment
Taxi at constant speed (T)	Flight idle (H), if it has wheels Hover in ground effect (I), if it does not have wheels

2.2.1.5 Helicopter Speed Coefficients

AEDT does not account for noise changes due to helicopter speed in the same manner as it does for fixed-wing aircraft. Since AEDT only has a single set of level flight NPDs for each helicopter that is referenced to a single speed, the helicopter speed coefficients are used to adjust level flyover noise as a function of helicopter forward speed, which causes a difference in rotor tip Mach number for the advancing vs. receding blades. This speed adjustment, known as source noise adjustment due to advancing tip Mach number, is only applied to level flight operations. Separate speed coefficients are provided for the left, center and right NPDs, resulting in different source noise adjustments due to advancing tip Mach number for each NPD. The source noise adjustment due to advancing tip Mach number is described in more detail in Section 4.5.1.

2.2.1.6 Receptor Information

Information about receptor locations is required for noise computations. AEDT receptor locations are expressed as either regularly spaced grids (rasters in GIS language), point or population centroids (vectors in GIS language), or dynamic grids (a collection of raster blocks built up by the system). The receptor locations for a regular grid are defined by the location of the lower-left corner of the grid (latitude, longitude), the distance between grid points in the two directions (feet), the number of grid points in the two directions, and the angle that the grid is rotated relative to the x,y axes (degrees counter-clockwise). Regular grids intended for rendering contours cannot be rotated.

A special case of a regular grid is the grid consisting of a single receptor, where the starting point for the grid is given by the lower-left corner, the distance between grid points is zero, and the size of the grid is one-by-one. These types of regular grids may be used to assess points of interest that are considered sensitive.

In order to improve contour fidelity and resolution, INM implemented the recursive grid concept, where the user defined the extent of a contour grid and tolerance parameters, which were then used by the

software to refine the grid point distribution of the contour grid in areas showing variation in noise levels. Instead of using recursive grids, AEDT uses dynamic grids. The dynamic grid concept in AEDT is also used to improve contour fidelity and resolution, but instead of using grid recursion (or subdivision), the user defines a small starting grid and the grid point distribution is expanded until all of the contours in a user-specified contour range are covered by the grid. There are two primary benefits to the dynamic grid:

1. The user does not need to know the geographic extent of the region of interest. Instead, the user only needs to know the minimum noise level of interest and AEDT will discover the geographic extents needed for the receptor set to close that lowest contour level (and by implication all higher noise level contours)
2. The resolution of the dynamic grid is variable over the receptor set. AEDT evaluates the geographic variation of the noise level and where the noise level is changing spatially, the system adds additional refinement to the dynamic grid by cutting the resolution of the grid in that region by a factor of two, effectively quadrupling the number of receptors analogous to the INM recursive grid. The benefit is more effective application of computational power on regions that matter most.

The improvement over implementations in, say, INM is that the receptor set can grow dynamically as necessary to close the contour of interest. One limitation of the dynamic grid receptor set is that the dynamic grid is currently only supported with the DNL metric.

See Section 4.7 for additional information on specifying the initial parameters for a dynamic grid and the AEDT process that then evaluates and stores the resulting receptor set.

2.2.1.7 Noise Metric Information

The noise-level and time-based metrics computed by AEDT are associated with three fundamental Groups: A-weighted, C-weighted, and tone-corrected perceived noise metrics.

A-weighted noise metrics give less weighting to the low and high frequency portions of the spectrum, providing a good approximation of the response of the human ear, and correlates well with an average person's judgment of the relative loudness of a noise event. C-weighted noise metrics are intended to provide a means of simulating human perception of the loudness of sounds above 90 decibels, and is more prominent at low frequencies than A-weighting. Tone-corrected perceived noise metrics are used to estimate perceived noise from broadband sound sources, such as aircraft, which can have significant tonal qualities.

AEDT includes 17 different noise metrics, as well as the capability to create user-defined noise metrics (see Table 2-5).

Table 2-5 Summary of AEDT Noise Metric Abbreviations and Definitions

Metric Type	AEDT Name	Standard Name	Definition/Full Name
A-Weighted Noise Metrics			
Exposure	SEL	L_{AE}	A-Weighted Sound Exposure Level
	DNL	L_{dn}	Day Night Average Sound Level
	CNEL	L_{den}	Community Noise Equivalent Level
	LAEQ	L_{AeqT}	Equivalent Sound Level

Metric Type	AEDT Name	Standard Name	Definition/Full Name
	LAEQD	L_d	Day-average noise level
	LAEQN	L_n	Night-average noise level
Maximum Level	LAMAX	L_{ASmx}	A-Weighted Maximum Sound Level
Time-Above	TALA	T_{ALA}	Time-Above A-Weighted Level
Time-Audible	TAUD	T_{Aau}	Time-Audible
	TAUDSC	T_{AudSC}	Time-Audible with Overlapping Events Method (Statistical Compression)
	TAUDP	T_{AudP}	Time-Audible Percent
	TAUDPSC	T_{AudPSC}	Time-Audible Percent with Overlapping Events Method (Statistical Compression)
C-Weighted Noise Metrics			
Exposure	CEXP	L_{CE}	C-Weighted Sound Exposure Level
	CDNL	L_{Cdn}	C-Weighted Day Night Average Sound Level
Maximum Level	LCMAX	L_{CSmx}	C-Weighted Maximum Sound Level
Time-Above	TALC	T_{ALC}	Time-Above C-Weighted Level
Tone-Corrected Perceived Noise Metrics			
Exposure	EPNL	L_{EPN}	Effective Perceived Noise Level
	NEF	L_{NEL}	Noise Exposure Forecast
	WECPNL	L_{WECPN}	Weighted Equivalent Continuous Perceived Noise Level
Maximum Level	PNLTM	L_{PNTSmx}	Tone-Corrected Maximum Perceived Noise Level
Time-Above	TAPNL	T_{APNL}	Time-Above Perceived Noise Level
Number Above Noise Level Metric			
Number Above Noise Level	NANL	NANL	Number Above Noise Level

All of the metrics in Table 2-5 are computed using the following four base noise level metrics:

L_{AE}	A-weighted sound exposure level (SEL);
L_{ASmx}	A-weighted maximum sound level (LAMAX);
L_{EPN}	Effective perceived noise level (EPNL); and
L_{PNTSmx}	Tone-corrected maximum perceived noise level (PNLTM).

Each NPD in the AEDT Fleet database has noise level data that correspond to one of these four base metrics. In addition, A-weighted NPDs (L_{AE} and L_{ASmx}) and the corresponding spectral class data are used to approximate the following C-weighted noise metrics to complement the AEDT Fleet database:

L_{CE}	C-weighted sound exposure level (CEXP); and
L_{CSmx}	C-weighted maximum sound level with slow-scale exponential weighting characteristics (LCMAX).

The C-weighting approximation method is described in Section 4.2.1.2.

The base metrics are then used to compute three types of metrics in AEDT:

1. Exposure-based metrics, including change in exposure;
2. Maximum noise level metrics; and
3. Time-based metrics.

The exposure-based metrics represent the total sound exposure for a given time period, often 24 hours, at a receptor location based upon average annual day conditions at an airport. AEDT base sound exposure metrics are:

L_{AE}	A-weighted sound exposure level (SEL);
L_{CE}	C-weighted sound exposure level (CEXP); and
L_{EPN}	Effective tone-corrected perceived noise level (EPNL).

These base sound exposure metrics are used by AEDT to generate average noise metrics by applying associated time-averaging constants and/or day, evening, and night-time weighting factors. AEDT standard average-level metrics based on SEL are:

L_{dn}	Day-night average noise level (DNL);
L_{den}	Community noise equivalent level (CNEL);
L_{Aeq24h}	24-hour average noise level (LAEQ);
L_d	15-hour (0700-2200) day-average noise level (LAEQD); and
L_n	9-hour (2200-0700) night-average noise level (LAEQN).

AEDT standard average-level metrics based on CEXP are:

L_{NEF}	Noise exposure forecast (NEF); and
L_{WECPN}	Weighted equivalent continuous perceived noise level (WECPNL).

The maximum noise level metrics represent the maximum noise level at a receptor location, taking into account a particular set of aircraft operations. AEDT standard maximum noise level metrics are:

L_{ASmx}	Maximum A-weighted sound level with slow-scale exponential weighting characteristics (LAMAX);
L_{CSmx}	Maximum C-weighted sound level with slow-scale exponential weighting characteristics (LCMAX); and
L_{PNTSmx}	Maximum tone-corrected perceived noise level with slow-scale, exponential weighting characteristics (PNLTM).

The time-based metrics represent the time (minutes) that the noise level is above a specified threshold, taking into account aircraft operations for a particular time period (24 hours). In AEDT, time-based metrics are derived from either exposure or maximum noise level metrics, or both. The derivation of the time-above metrics is presented in Section 11.1.3. AEDT standard time-based metrics are:

T_{ALA}	Time that the A-weighted noise level is above a user-defined sound level during the time period (TALA);
T_{ALC}	Time that the C-weighted noise level is above a user-defined sound level during the time period (TALC); and
T_{APNL}	Time that the tone-corrected perceived noise level is above a user-defined noise level during the time period (TAPNL).

A subset of the time-based metrics is time audible. Time audible (or audibility) is computed based on a comparison of aircraft noise against ambient noise to determine the time duration (or percentage of

time duration) that the noise may be audible to a human observer. For these calculations, the observer is assumed to have normal hearing and to be actively listening for aircraft noise. Time audible also takes into account aircraft operations for a particular time period (e.g., 24 hours). The process is based on detectability theory and is supplemented with research that has assessed human auditory detectability in different environments. In order to represent these different environments, the time audible metrics require highly detailed inputs, including FAA AEE-approved ambient noise files. More details on ambient noise file requirements can be obtained by contacting FAA AEE (see Sections 2.2.3.6 and 2.2.3.7 for more information).

Section 11.1.5 provides additional specifics on the theory and background of the time audible computation. A detailed discussion of audibility calculations is also presented in the “Assessment of Tools for Modeling Aircraft Noise in the National Parks”²⁷. AEDT standard time audible metrics are:

T_{Aud}	Time that aircraft are audible given study specific ambient noise (TAUD), and
T_{AudSC}	Time that aircraft are audible given study specific ambient noise with simultaneously occurring aircraft events (overlapping events) are accounted for with the statistical compression method (TAUDSC). See Section 4.6.5.4.1 for description on the statistical compression method.

Time audible metrics may also be expressed as a percentage of time that aircraft are audible given study specific ambient noise during the analysis time period.

In addition to the AEDT standard noise metrics, user-defined metrics are available. User-defined metrics must be derived from the base noise metrics in AEDT. The methods for calculating these types of metrics in AEDT are presented in Section 4.6. Number Above Noise Level can be computed from the base noise metrics: SEL, LAMAX, LCMAX and CEXP. The method for calculating Number Above Noise Level is presented in Section 4.6.

2.2.2 Summary of Input Data for Emissions Inventory Computation

This Section summarizes the input data necessary to compute an emissions inventory. AEDT provides default values for critical emissions parameters (e.g. emissions index, fuel sulfur content, etc.), but they can be overridden by the user. Default data values are either average values, typical values, or conservative values – values chosen to avoid the underreporting of emissions. Overriding default data is justified if the user possesses data that is more accurate than supplied default data.

An emissions inventory is an exhaustive list of the masses of various pollutants emitted within a given geographic region and time period (typically, one year). Emission inventories may attempt to capture all emissions across all source types and sectors or may be focused on specific sectors. For this document, the emissions inventories refer to aircraft and airport related emissions. Emissions inventories are typically itemized by individual emissions sources and source activities and include the following pollutants:

- Carbon Monoxide (CO),
- Hydrocarbons (HC),
- Non-Methane Hydrocarbons (NMHC),
- Volatile Organic Compounds (VOC),
- Total Organic Gases (TOG),

-
- Oxides of Nitrogen (NO_x),
 - Sulfur Oxides (SO_x),
 - Coarse Particulate Matter with aerodynamic diameter of $\leq 10 \mu\text{m}$ (PM₁₀),
 - Fine Particulate Matter with aerodynamic diameter of $\leq 2.5 \mu\text{m}$ (PM_{2.5}),
 - Non-Volatile Particulate Matter (PMNV),
 - Volatile Sulfate Particulate Matter (PMSO),
 - Volatile Organic Particulate Matter (PMFO),
 - Carbon Dioxide (CO₂),
 - Water (H₂O), and
 - Speciated Organic Gases (OG), such as
 - Methane (CH₄),
 - Formaldehyde,
 - Toluene,
 - Xylenes, and
 - Other potentially hazardous air pollutants of concern.

Fuel consumption is closely associated with emissions inventories; and therefore, is reported along with pollutants.

To begin an emissions inventory, the user must first know the spatial and temporal scope of the emissions to be included. For example, the spatial scope could be the airport fenceline for ground-based sources and the terminal control area for airborne aircraft. This is not to be confused with the geographic scope of receptor locations which typically extends well beyond the emissions source locations and into public, residential and other commercial areas in the vicinity. Moreover, the user must specify a vertical limit called the atmospheric “mixing height” which bounds the spatial scope of emissions sources vertically.

The temporal scope refers to a specific period of time covered by the inventory. This could be a historical year (e.g., 2000), a future year, or another interval of time (e.g. a single month). Just as spatial scope refers to a specific region of space, temporal scope refers to a specific period of time on a calendar, as opposed to some generic day, week, or month.

Given a spatial and temporal scope, the user must know which pollutant emitting activities are to be modeled for the emissions sources. AEDT emissions inventories are limited to the following types of emissions sources:

- Aircraft Operations
- Auxiliary Power Units (APU)
- Ground Support Equipment (GSE)
- Stationary Sources, such as
 - Boilers and Space Heater;
 - Emergency Generator;
 - Incinerator;
 - Aircraft Engine Testing;
 - Fuel Tank;
 - Surface Coating/Painting;

- Deicing;
- Solvent Degreaser;
- Sand/Salt Pile;
- Training Fire; and
- “Other” stationary sources.
- Motor Vehicle Emission Simulator (MOVES) Emissions Inventory File (see Section 2.2.2.15) that contains
 - Roadway;
 - Parking; or
 - Construction.

Each following subsection describes the necessary input data for each of the emissions source types.

2.2.2.1 *Aircraft Operations*

As for emissions from aircraft operations, consider only pollutants emitted from an aircraft’s main engine and exclude emissions from APUs which are typically found installed onboard aircraft. APUs are modeled as separate type of emissions sources.

The following input data are required:

- Airport layout (for departures and arrivals, required for delay and sequencing modeling)
 - Runway locations
 - Gate locations
 - Taxiway locations
 - Taxipath definitions
- Aircraft operation schedule
 - Date and time
 - Operation type (e.g., departure, arrival, touch and go, etc.)
 - Airframe model
 - Engine model
 - Flight profile
 - Runway
 - Flight track
 - Gate (for departures and arrivals)
- Meteorological conditions
 - Mean sea level pressure
 - Temperature
 - Relative humidity
 - Wind (speed and direction)

The meteorological parameter values should be applicable to the geography where the operation occurs and should reflect the prevailing local ambient conditions when the operation occurs.

2.2.2.2 Auxiliary Power Unit (APU)

APUs are typically installed on sufficiently large commercial aircraft. An APU operation therefore only occurs in conjunction with the operation of the aircraft on which the APU is installed.

Default emissions factor data are provided for system APUs. For user-defined APUs, the user can modify the emission factors. Table 2-6 summarizes the input data for APUs.

Table 2-6 Input Data for APU

Parameter Name	Units
Duration (operating time)	Minutes
CO emission factor	Kilograms per hour
THC emission factor	Kilograms per hour
NO _x emission factor	Kilograms per hour
SO _x emission factor	Kilograms per hour
PM ₁₀ emission factor	Kilograms per hour

In APU emissions, PM_{2.5} and PM₁₀ are considered to be equivalent.

2.2.2.3 Ground Support Equipment (GSE)

Ground Support Equipment (GSE) subcategories are determined by GSE type (e.g. air conditioner, baggage tractor, etc.) and by fuel type.

GSE emissions can be modeled in two different ways:

- “Aircraft-assigned GSE” which occurs in conjunction with the aircraft operation to which a GSE is assigned; or
- Non-aircraft operation (“GSE population”) in which total annual GSE operation time is accounted for, independent of aircraft operations.

Table 2-7 summarizes the input data for aircraft-assigned GSE. Default emission factor data are provided for system GSE. For user-defined GSE, the user can modify emission factors. Note that deterioration is not applied to user-defined GSE, and therefore manufacture year and age are not required.

Table 2-7 Input Data for Aircraft-Assigned GSE

Parameter Name	Units
Duration (operating time)	Minutes
Horsepower (power rating)	Horsepower
Load factor	Percent
Manufacture Year	None
CO emission factor	Grams per horsepower-hour
THC emission factor	Grams per horsepower-hour
NO _x emission factor	Grams per horsepower-hour
SO _x emission factor	Grams per horsepower-hour
PM ₁₀ emission factor	Grams per horsepower-hour

Table 2-8 summarizes the input data for GSE population. For a GSE population, the user provides the annual operating time (in hours) and the number of GSE units (population size). Default values are provided for horsepower and load factor. For user-defined GSE, the user can modify the emission factors. Note that deterioration is not applied to user-created GSE, and therefore manufacture year and age are not required.

Table 2-8 Input Data for GSE Population

Parameter Name	Units
Operation count (operating time)	Hours per year
Operational profiles	None
Number of units (population size)	Pieces of GSE
Horsepower (power rating)	Horsepower
Load factor	Percent
Manufacture Year	None
CO emission factor	Grams per horsepower-hour
THC emission factor	Grams per horsepower-hour
NO _x emission factor	Grams per horsepower-hour
SO _x emission factor	Grams per horsepower-hour
PM ₁₀ emission factor	Grams per horsepower-hour

2.2.2.4 Boilers and Space Heaters

Boilers and space heaters are stationary sources with a large variety of subcategories that are determined by the combination of fuel type, technology, and/or application scale.

Fuel types include:

- Coal (such as Anthracite, Bituminous, Sub-bituminous, and Culm);
- Fuel oil (such as Distillate, Number 2, Number 4, Number 5, and Number 6);
- Natural gas; and
- Liquefied petroleum gas (Butane and Propane).

Technology refers to boiler and space heater terms such as:

- Pre- or Post-New Source Performance Standards (NSPS);
- Dry bottom or wet bottom;
- Wall-fired, cell burner fired, or tangentially-fired;
- Cyclone furnace;
- Spreader stoker; and
- Reinjection.

Application scales of operation include:

- Over 100 million BTU per hour
- Ten to 100 million BTU per hour
- 0.3 to 10 million BTU per hour
- Residential

The user must determine which combination of these types most appropriately represent the boiler or space heater being modeled. Operation unit is different depending on the type of boiler or space heater. The following table summarizes the input data for boilers and space heaters.

Table 2-9 Input Data for Boilers and Space Heater

Parameter Name	Units
Operation count (number of units consumed)	Units per year
Operational profiles	None
CO emission index	Kilograms per unit
THC, TNMOC, TOC, or VOC emission index	Kilograms per unit
NOx emission index	Kilograms per unit
SOx emission index	Kilograms per unit, Kilograms per unit-percent fuel sulfur content, or Kilograms per unit-grains per 100 cubic feet of gas vapor
PM ₁₀ emission index or indices	Kilograms per unit, Kilograms per unit-percent fuel sulfur content, or Kilograms per unit-percent fuel ash content. For some subcategories, two emission indices are required (one with units kilograms per unit, and one with units kilograms per unit-percent fuel sulfur content), and the results from each are summed.
Fuel sulfur content	Percent, or Grains per 100 cubic feet of gas vapor
Fuel ash content	Percent
Fuel calcium to sulfur ratio	None
CO pollution control factor	Percent
HC, TNMOC, TOC, or VOC pollution control factor	Percent
NOx pollution control factor	Percent
SOx pollution control factor	Percent
PM ₁₀ pollution control factor	Percent
PM _{2.5} to PM ₁₀ ratio	None

2.2.2.5 Emergency Generator

Emergency generators are modeled via two distinct methodologies: The Environmental Protection Agency (EPA) methodology and the United States Air Force (USAF) methodology. Each methodology has different input data requirements.

Emergency generator subcategory is determined by the combination of methodology and fuel type. The fuel types for emergency generators include:

- Gasoline;
- Diesel;
- Distillate fuel oil;

- Kerosene/naphtha (jet fuel);
- Natural gas;
- Liquefied petroleum gas; and
- Residual and crude fuel oil.

Table 2-10 and Table 2-11 describe the input data for the EPA and USAF methodologies, respectively.

Table 2-10 Input Data for Emergency Generator (EPA Methodology)

Parameter Name	Units
Operation count (time operated)	Hours per year
Operational profiles	None
Power rating	Horsepower
CO emission factor	Grams per horsepower-hour
TOC emission factor	Grams per horsepower-hour
NOx emission factor	Grams per horsepower-hour
SOx emission factor	Grams per horsepower-hour
PM ₁₀ emission factor	Grams per horsepower-hour
CO pollution control factor	Percent
TOC pollution control factor	Percent
NOx pollution control factor	Percent
SOx pollution control factor	Percent
PM ₁₀ pollution control factor	Percent
PM _{2.5} to PM ₁₀ ratio	None

Table 2-11 Input Data for Emergency Generators (USAF Methodology)

Parameter Name	Units
Operation count (volume of fuel used)	Kiloliters per year
Operational profiles	None
CO pollution control factor	Percent
TOC pollution control factor	Percent
NOx pollution control factor	Percent
SOx pollution control factor	Percent
PM ₁₀ pollution control factor	Percent
CO emission index	Kilograms per kiloliter
TOC emission index	Kilograms per kiloliter
NOx emission index	Kilograms per kiloliter
SOx emission index	Kilograms per kiloliter-percent fuel sulfur content
PM ₁₀ emission index	Kilograms per kiloliter
Fuel sulfur content	Percent
PM _{2.5} to PM ₁₀ ratio	None

2.2.2.6 Incinerator

For incinerators, the user must determine which type (i.e., multiple or single chamber) best represents the incinerator being modeled. Table 2-12 summarizes the input data required for incinerators.

Table 2-12 Input Data for Incinerator

Parameter Name	Units
Operation count (mass consumed)	Metric tons per year
Operational profiles	None
CO emission index	Kilograms per metric ton
VOC emission index	Kilograms per metric ton
NOx emission index	Kilograms per metric ton
SOx emission index	Kilograms per metric ton
PM ₁₀ emission index	Kilograms per metric ton
CO pollution control factor	Percent
VOC pollution control factor	Percent
NOx pollution control factor	Percent
SOx pollution control factor	Percent
PM ₁₀ pollution control factor	Percent
PM _{2.5} to PM ₁₀ ratio	None

2.2.2.7 Aircraft Engine Testing

Table 2-13 summarizes the input data required for aircraft engine testing emissions sources.

Table 2-13 Input Data for Aircraft Engine Testing

Parameter Name	Units
Operation count (number of test cycles)	Test cycles per year
Operational profiles	None
Aircraft engine model	None
Time at 7% power	Minutes per test cycle
Time at 30% power	Minutes per test cycle
Time at 85% power	Minutes per test cycle
Time at 100% power	Minutes per test cycle

2.2.2.8 Fuel Tank

Table 2-14 summarizes the input data required for fuel tank emissions sources. Fuel tank subcategories are determined by fuel type and tank type.

Table 2-14 Input Data for Fuel Tank

Parameter Name	Units
Operation count (fuel throughput)	Kiloliters per year
Operational profiles	None
Tank height (length, if horizontal)	Meters
Tank diameter	Meters
Average liquid height	Meters

Parameter Name	Units
Maximum liquid height	Meters
Reid vapor pressure	Pounds per square inch
Mean wind speed	Meters per second

2.2.2.9 Surface Coating/Painting

Table 2-15 summarizes the input data required for surface coating/painting emissions sources. The surface coating/painting subcategory is determined by the volatile solution.

Table 2-15 Input Data for Surface Coating/Painting

Parameter Name	Units
Operation count (volume used)	Kiloliters per year
Operational profiles	None
VOC emission index	Kilograms per kiloliter
Pollution control factor	Percent

2.2.2.10 Deicing Area

Table 2-16 summarizes the input data required for deicing area emissions sources. Deicing area subcategories are determined by the deicer chemical used (i.e., ethylene glycol or propylene glycol) and the application (i.e., runway/taxiway surface deicing or aircraft deicing).

Table 2-16 Input Data for Deicing Area

Parameter Name	Units
Operation count (volume used)	Kiloliters per year
Operational profiles	None
VOC emission index	Kilograms per kiloliter
Deicing chemical density	Grams per liter
Concentration by mass	Percent

2.2.2.11 Solvent Degreaser

Table 2-17 summarizes the input data required for solvent degreaser emissions sources. The solvent degreaser subcategory is determined by the chemical used.

Table 2-17 Input Data for Solvent Degreaser

Parameter Name	Units
Operation count (volume used)	Kiloliters per year
Operational profiles	None
Solution density	Grams per liter
Percent of solvent disposed	Percent

2.2.2.12 Sand/Salt Pile

Table 2-18 summarizes the input data required for sand/salt piles.

Table 2-18 Input Data for Sand/Salt Pile

Parameter Name	Units
Operation count (mass throughput)	Metric tons per year
Operational profiles	None
Eroded surface area	Square meters
Mass disturbed per disturbance	Metric tons
Moisture content	Percent
Mean wind speed (at 10 meter height)	Meters per second
Fastest mile of wind (at 10 meter height)	Meters per second
Friction velocity	Meters per second
Surface roughness	Centimeters
Surface wind speed fraction	None

2.2.2.13 Training Fire

Table 2-19 summarizes the input data required for training fires. The training fire subcategory is determined by fuel type.

Table 2-19 Input Data for Training Fire

Parameter Name	Units
Operation count (volume of fuel used)	Gallons per year
Operational profiles	None
CO emission index	Kilograms per gallon
VOC emission index	Kilograms per gallon
NOx emission index	Kilograms per gallon
SOx emission index	Kilograms per gallon
PM ₁₀ emission index	Kilograms per gallon

2.2.2.14 "Other" Stationary Sources

Table 2-20 summarizes the input data required for "Other" stationary sources.

Table 2-20 Input Data for "Other" Stationary Sources

Parameter Name	Units
Operation count (number of units)	Units per year
Operational profiles	None
Operation unit	Metric Tons, Kiloliters, Thousands of Cubic Meters, Hours, Test Cycles, Gallons, or Minutes of operation
CO emission index	Kilograms per unit
THC emission index	Kilograms per unit
NOx emission index	Kilograms per unit
SOx emission index	Kilograms per unit
PM ₁₀ emission index	Kilograms per unit
PM _{2.5} to PM ₁₀ ratio	None
CO pollution control factor	Percent

THC pollution control factor	Percent
NOx pollution control factor	Percent
SOx pollution control factor	Percent
PM ₁₀ pollution control factor	Percent

2.2.2.15 MOVES Emissions Inventory File

Emissions inventory results from roadway, parking facility, and/or construction operations can be calculated externally with the EPA MOVES software and integrated into the AEDT emissions report.

The MOVES emissions inventory results must be in a .csv file following the format described in Table 2-21. For more information on creating the MOVES emissions inventory file, refer to the “Using MOVES with AEDT 2c” on the AEDT Support website (https://aedt.faa.gov/2c_information.aspx).

Table 2-21 MOVES Emissions Inventory Results File Format

YearID	Source	Pollutant ID	Emission Quant
Year – YYYY (example 2015)	Roadways Parking Facilities Construction	Matches the MOVES pollutant ID. CO 2 VOC 87 NMHC 79 TOG 86 NOx 3 SOx 31 PM ₁₀ 100 PM _{2.5} 110	Total annual emissions in the units of grams.

2.2.3 External Data

2.2.3.1 Weather Data for Aircraft Performance Modeling

This Section describes the weather data available for use in aircraft performance modeling in AEDT. AEDT can use high fidelity weather, airport annual average weather, or ISA weather for performance modeling used for noise and emissions modeling. Section 6.9 describes the use of weather for Emissions Dispersion Modeling.

The weather data formats and sources supported for Aircraft Performance Modeling in AEDT are described in the Table 2-22. There are additional formats and sources supported for Emissions Dispersion Modeling which are described in the next section.

Table 2-22 Weather Data Formats Supported

File Format	Use	Description Source
Rapid Update Cycle (RUC20/RUC13)	Aircraft Performance Modeling	Earth System Research Laboratory (ESRL) Rapid Update Cycle (RUC) ruc.noaa.gov
NCEP/NCAR (NCAR)	Aircraft Performance Modeling	National Centers for Environmental Prediction (NCEP) www.ncep.noaa.gov
GEOS	Aircraft Performance Modeling	Goddard Earth Observing System Model (GEOS-5) www.geos5.org
NCDC ASOS, ISHD, IGRA, FSL	Emissions Dispersion (and associated Aircraft Performance/Emissions Modeling)	NCDC weather station data collections of surface weather and upper atmosphere soundings. https://www.ncdc.noaa.gov/data-access/weather-balloon/integrated-global-radiosonde-archive http://esrl.noaa.gov/raobs/
Average Weather	Aircraft Performance and Acoustics Modeling	NCDC 30 year-normals of wind speed, temperature, pressure, and relative humidity based on ASOS weather observations.
International Standard Atmosphere (ISA)	When no other source is available.	Suitable for lapsing a vertical weather profile from mean sea level (MSL) with fixed temperature, pressure, and relative humidity for the globe.

2.2.3.1.1 Weather Data Interpolation

This Section describes the details of the interpolator currently implemented in the AEDT Weather Module.

The AEDT Weather Module accepts requests to evaluate four weather variables (temperature, barometric pressure, humidity, and wind vector) at 4D locations (lat, lon, altitude, time) specified as input to the module. As noted in the User Guide, a variety of weather data sources can be supplied to the AEDT system. The Weather Module processes available sources in a prioritized cascade from highest fidelity to lower fidelity to find the first (highest) weather source that covers the desired location. In addition, a control is available to the user that limits the starting (highest) fidelity source regardless of the full set of sources supplied in the study. This control/limit mechanism is useful for

testing and initial processing to evaluate computational performance and environmental results with various controlled sources.

Within a few special exceptions the Weather Module linearly interpolates the provided weather data sources at the input location. An instance of the Weather Module is created by the system when a metric result job is run. This weather module instance is initialized with the available weather sources (Table 2-22) specified (and provided) by the analyst in the study configuration. The weather data is prioritized in order of highest fidelity first. Further, the first three data sources must be pre-processed by the weather data loader which prepares the data for efficient AEDT execution.

The weather module instance is then available to the system to accept weather data retrieval requests on demand and evaluates those request at the given location (position and time). The following logical sequence is used to evaluate the weather variables at the desired location when the Weather Data Retrieval process (Section 2.2.3.1.3) selects one of the first three weather sources in Table 2-22, e.g. gridded weather data. Again the basic process is to linearly interpolate the weather data from the grid locations to the desired location.

1. Bounding time indices are calculated for the weather data source that bound (just before and just after) the desired time.
2. The bounding x/y (or lat/lon) indices are calculated for the weather data source that bound the desired x/y coordinates.
3. Weather variables for the full “column” of x/y/time indices are retrieved from the [cached] weather source. That is, the weather variables from all layers in the vertical dimension at each of the eight x/y/time bounding points are retrieved. The full set of vertical layers is necessary to resolve the possible ambiguity on bounding altitudes between geographic altitude and, for some weather source formats, pressure altitude. In this latter case the geopotential height for each layer is also retrieved.
4. For weather data sources that reside in pressure altitude coordinates, the geopotential height of each layer is used to calculate a bounding geographic altitude (uniform in x/y) for the layer. The two layers that the desired geographic height are then applied to select weather variables at the sixteen data points (two bounding coordinates for each of latitude, longitude, geographic altitude, and time) to be used in the linear interpolation.
5. All weather variables at the sixteen data point locations are then used to linearly interpolate the weather data variables at the desired lat/lon/alt/time location.

2.2.3.1.2 Weather Cache Processing

The first three weather data types in Table 2-22 are gridded sources stored in externally defined formats. For computational efficiency, data from these weather sources that lies within the study boundary (see Section 2.2.3.3 for details on the study boundary) are loaded into the weather cache before AEDT metric results are run to generate results.

There are two main areas of weather cache processing: the preloading of the weather cache (Weather Cache Loader) and the retrieval of weather from the cache (Weather Cache Populator).

In the Weather Cache Loader the following steps are performed:

1. A bounding polygon (typically the study boundary) is defined in the Weather Module

2. The data grid points from the weather source for all available time that fall within the bounding polygon are loaded into memory. Locations submitted in requests to the Weather Module can then be quickly evaluated.

The Weather Cache Populator performs the following steps:

1. The list of existing dates in the weather source are used to initialize the list of dates currently in the cache
2. The type of each weather source is recorded and stored in the prioritized cache list
3. For each weather data type, the following steps are performed:
 - a. A weather cache list for that type is initialized.
 - b. The list of applicable files are gathered from the directories.
 - c. For each file, a weather reader is instantiated based on the weather data type.
 - d. For each time slice the start time is calculated to be used as a time index in the cache.
 - e. The set of requested dates for the cache is updated to include any new dates.
 - f. All weather data located within the bounding polygon for the cached dates.

2.2.3.1.3 Weather Data Retrieval

The retrieval of weather data follows a logical cascade through the available weather sources (default, system, and user) in order of fidelity, highest to lowest. Note that the user can over-ride available weather by setting a weather fidelity limit flag, e.g. if a high fidelity weather source such as NCAR has been provided but the user wishes to limit the weather fidelity The following steps are performed to retrieve weather data in this method.

1. If the location is null or the weather fidelity limit is set to ISA-only, ISA weather is returned.
2. An attempt is made to retrieve weather from the list of supplied data sources.
 - a. First is a high fidelity weather call to the Weather Module is made which performs the following steps:
 - i. The weather cache manager is used to retrieve the weather cache.
 - ii. The list of available weather data types in the cache are looped through from highest to lowest fidelity.
 - iii. If a source is found, weather data variables are linearly interpolated from the cached values to the desired location/time.
 - iv. The interpolated weather variables (temperature, pressure, relative humidity, wind vector) are returned.
 - b. If the high fidelity request did not succeed (lack of data or coverage) the annual average weather associated with the Weather Data instance is returned along with a check for user defined mixing height.

2.2.3.2 Terrain Data

2.2.3.2.1 Terrain for Emissions Modeling

When running an emissions metric result, AEDT will use regulatory terrain (assumed perfectly flat) by default. The AEDT Emissions Dispersion Module (EDM) does not currently handle terrain.

2.2.3.2.2 Terrain for Noise Modeling

Varying terrain can greatly affect noise propagation. The terrain feature in AEDT allows for terrain elevation data of the modeling area to be included internally for noise computations. When terrain data are not included, AEDT assumes flat ground at a user-specified receptor elevation. Terrain elevation data

are accepted in the following formats: National Elevation Dataset (NED) GridFloat, and Digital Elevation Model (DEM) for noise considerations.

Terrain data are only supported if they are in one of the following projections: NAD83 or WGS84. If the terrain data are not in one of the supported projections, AEDT will produce an error message. Multiple resolutions of data are available among the different formats, and multiple files may be required to cover a desired geographical area. 3CD terrain elevations are a regular grid given in meters, three arc-seconds apart. A single 3CD file covers one degree in latitude by one degree in longitude (1201 x 1201 points).

NED GridFloat data are available in many resolutions, but 1/3 arc-second resolution is recommended because these data are available across the entire United States, whereas other resolutions are not. The area covered by a single file can vary. The spacing between points is dependent on location. For example, the three arc-second spacing in the Boston area is approximately 224 feet in the x (east-west) direction by 304 feet in the y (north-south) direction, while the three arc-second spacing in the San Francisco area is approximately 241 feet by 303 feet. NED GridFloat data are available from the United States Geological Survey (USGS) website at <http://seamless.usgs.gov/ned13.php>.

USGS stopped offering DEM data as of November 14, 2006, however AEDT supports the DEM format as a convenience. Information about DEM data is available from the USGS website at <http://eros.usgs.gov/#/Guides/dem>.

AEDT processes terrain data with the GlobalMapper software^{viii} using a nearest neighbor interpolation to evaluate elevations at any given point covered by a given dataset.

2.2.3.3 *Boundary*

AEDT accepts a user-defined study boundary as a geospatial boundary containing the area to be modeled. A study boundary is defined as a polygon, with each vertex consisting of a latitude and longitude pair. Latitude-longitude pairs can be specified in either Degree-Minute-Second (DMS) or Universal Transverse Mercator (UTM) coordinates.

A study boundary is not required to run AEDT, but one must exist to import high-fidelity weather. The boundary must also be rectangular in order to use high fidelity weather. The study boundary acts as the geographical bounding constraint on data imported into the study.

2.2.3.4 *Demographics*

U.S. Census data are required to generate the population exposure report. For information on downloading 2010 U.S. Census data, see “Using US Census Bureau Data in AEDT” on the AEDT Support website, Downloads page.

2.2.3.5 *Ambient Concentrations for Air Quality Analysis*

Ambient concentrations for the various pollutants are the measurement of the pollution in the atmosphere. This is typically the concentration of the pollutant after it has been emitted from a source and mixing has occurred in the atmosphere. For airport studies, the three key source categories are emissions from airport activities, emissions from other anthropogenic sources (either nearby or from

^{viii} For more details on GlobalMapper, see <http://www.bluemarblegeo.com/products/global-mapper.php>.

long-range transport), and natural sources. During airport evaluations, ambient, or local concentrations, are determined by either local monitoring or modeling and are directly comparable to the National Ambient Air Quality Standards (NAAQS). When monitoring data are used, specific for the airport, all three source categories are included and the measured values represent a total ambient concentration. AEDT models airport activities and as such the other two source categories must be added to determine the total ambient concentration. The concentration added from the non-airport source categories is usually referred to as the background concentration.

The primary source of background concentration data is from State and Local Ambient Monitoring Stations (SLAMS), but it can also be available from local and state control agencies. The EPA AirData website at <http://www.epa.gov/airdata/>, also provides background concentration data from outdoor monitors across the U.S. in multiple formats.

If specific airport measurement data are available, it is most often documented and available from the local airport authority. To completely characterize an airport, especially large airports, measurements must be extensively quality controlled (both spatially and temporally). The EPA provides guidance information at <http://www.epa.gov/ttn/amtic/>. Monitoring to determine local ambient concentration is often cost prohibitive and not routinely done in the U.S.; therefore modeling is primarily used to determine ambient concentration.

The National Ambient Air Quality Standards (NAAQS) should be reviewed before selecting the format and appropriate data for any pollutant.

2.2.3.6 *Ambient Background Noise Data for Noise Analyses*

Time-based noise metrics in AEDT require either an ambient threshold or ambient noise files depending on the noise metrics selected. All of these files include geospatial ambient noise data corresponding to a specific study area (and may also reflect specific study or operational conditions). There are two ambient noise file specifications. Both are grids of noise index values, the analogy in digital imagery being a bit map. The difference between the two specifications is the range of the “bit map” or noise index map. One is two digit indices which yields lower noise fidelity, i.e. fewer noise levels. The other is a three digit index yielding higher noise fidelity.

Time Above metrics (TALA, TAPNL, and TALC) can utilize either a 2 or 3 digit ambient grid file. Time Audible metrics require a 3 digit ambient grid file and an ambient spectral map file, which correlates unique spectra to each ambient sound level specified in the ambient grid file. The first file is the 3 digit ambient grid file, a text grid file that assigns a number, often representing the A-weighted ambient sound level, to study area grid points. The second file is the ambient spectral map file, which correlates unique spectra to the ambient sound levels specified in the ambient grid file.

2.2.3.7 *Application of Ambient Background Noise Data for Time Audible Metrics*

Users needing access to Time Audible (TAUD) metrics are required to submit their ambient data to FAA in accordance with the procedures detailed in the AEDT User Guide. FAA will perform a consistency check on the data and provide a study-specific key to unlock the TAUD functionality in AEDT for each approved ambient data set/study combination submitted. Users are advised to first contact the FAA Office of Environment and Energy for guidance on the applicability of a TAUD analysis to specific aviation proposals. Given:

- a. the anticipated process for collecting ambient data,
- b. the sensitivity of TAUD to ambient data, and
- c. the need for consistency between input files,

the FAA will provide a key file that enables the TAUD functionality in AEDT on a per-study basis for use in Federal projects.

3. Aircraft Performance

AEDT calculates aircraft performance information (such as flight path, thrust levels and fuel burn) for terminal-area and runway-to-runway operations. These calculations employ performance models to approximate the state of an aircraft through each full air operation. The calculated performance serves as the primary input to noise and emissions calculations.

3.1 Trajectories

AEDT calculates a complete four-dimensional representation (x, y, z, time) of each segment of the flight path as well as thrust, fuel burn, and emissions mode values. Since the variation of an aircraft's position is included, this progression of aircraft states is called a trajectory.

3.1.1 Properties

A trajectory is approximated by a set of segments. Each segment is associated with one initial and one final instantaneous aircraft state, along with a description of aircraft performance between those states. Given two adjacent segments, the final state of the first segment is equivalent to the initial state of the second segment. Each segment also includes some "nominal" properties, which constitute appropriate descriptions of the overall performance of the segment as a whole (or its surrounding environment).

Table 3-1 Properties and Units of Instantaneous States

Property	Units
Cumulative horizontal distance	m
Time	yr, mo, day, hr, min, s
Altitude with respect to the associated field elevation	m
Altitude with respect to mean sea level	m
Groundspeed	m/s
Corrected net thrust per engine	N
Mass	kg
Noise thrust	N, %, other (see Section 3.6.2.1)
Projected unit vector	(dimensionless) (see Section 3.7.1.2)
Bank angle (for fixed-wing; positive in a left turn)	degrees
Heading (true from north)	degrees
Latitude	degrees
Longitude	degrees

Table 3-2 Properties and Units of Segments

Property	Units
Horizontal length of segment	m
Change in noise thrust per engine	N, %, other (see Section 3.6.2.1)
Change in speed	m/s
Fuel flow rate per engine	kg/s
Amount of fuel burned (all engines)	kg
Duration	s
Total length of segment	m
Noise operation mode or helicopter mode	(dimensionless, see Section 2.2.1.1)
Trajectory mode	(dimensionless, see Section 5.1)
Nominal Mach number	(dimensionless, see Section 3.7.1.3.1.7)
Nominal dew point temperature	K
Nominal pressure	N/m/m
Nominal relative humidity	%
Nominal temperature	K
Nominal wind direction	degrees
Nominal wind speed	m/s
Nominal Mixing height	m
Nominal Pressure ratio	(dimensionless, see Section 1.4)
Nominal Temperature ratio	(dimensionless, see Section 1.4)

3.1.2 Targets

Performance in AEDT can be driven by a target flight profile or a target trajectory. Both methods require ground track specification, but the target states provided by profiles are not associated with any specific distances along the track, whereas target trajectories associate desired altitudes and speeds with the surface coordinates along the track.

Profile-driven flight performance is described in Section 3.6. Trajectory-driven flight performance is described in Section 3.7.

3.2 Performance Model

The performance model in AEDT is primarily based on recommendations from two aircraft flight performance specifications. The first is presented in European Civil Aviation Conference (ECAC) Doc 29¹⁵ (Doc 29), and since it is largely based on Society of Automotive Engineers (SAE) Aerospace Information Report (AIR) No. 1845⁵⁹ (SAE-AIR-1845), it is referred to herein as SAE-AIR-1845/Doc 29. This specification is intended for use only within the terminal area. Note that AEDT also uses the Senzig-Fleming-Iovinelli (SFI) fuel burn model^{16,17} in the terminal-area when the proper coefficients are available. The second specification used for performance calculations is presented in EUROCONTROL's User Manual for BADA¹⁸. BADA^{ix} flight dynamics equations and modeling coefficients are defined for all phases of flight, but within AEDT, they are primarily used for modeling the en-route phase. Note that BADA includes a fuel burn model, which is used for terminal area modeling when coefficients for the SFI fuel burn model are not available, and for en-route modeling regardless of coefficient availability.

^{ix} For the purposes of this document, all references to BADA should be considered as to BADA 3.

Both performance specifications maintain a core set of features including standard flight procedures. Each supplies an atmospheric model, equations that model the physics of flight, calculations of aerodynamic quantities for standard flap configurations, and thrust as a function of state for standard power settings. Furthermore, each specification has an associated database that includes modeling coefficients by aircraft for these calculations. The BADA specification is associated with the BADA database, while the SAE-AIR-1845/Doc 29 specification is associated with the Aircraft Noise and Performance (ANP) database.

Data from the BADA and ANP databases are stored in the AEDT Fleet database and contain modeling data for a limited set of equipment combinations (airframe, engine model, and engine modifications). For some equipment combinations that lack modeling data, alternative modeling combinations are provided that will approximate the combination. When modeling an aircraft in AEDT, it is possible for the BADA and ANP equipment combinations to be different. Each combination approximates the AEDT aircraft to the extent of the available data.

For operations in which aircraft altitude spans both terminal-area and en-route ranges, the model used for flight mechanics switches between SAE-AIR-1845/Doc 29 and BADA. In AEDT, this leads to portions of flights where BADA flight mechanics are used with aircraft that are not on the BADA speed schedule (because of the need to speed up from, or slow down to, the ANP schedule). These portions of flights are often described as “ANP-BADA transitions”. These are discussed in further detail in Section 3.7.1.3.2 and Section 3.7.1.3.3.2.

3.3 Weather Model

The variation of atmospheric conditions and wind over a given domain in space and time constitutes a weather field. Although the SAE-AIR-1845/Doc 29 performance model specifies the ISA for its weather model, AEDT uses a model that allows for customization of weather conditions based on high fidelity or airport-specific average weather data. AEDT assigns an order of precedence to the types of weather data it supports, so that when a weather value is required at a given location and time, the data are taken from the highest-ranked sources that encompass the coordinate. Where these domains overlap, the weather field is a cascade of sources of weather data that the user makes available in formats as described in Section 2.2.3.1. For more information regarding meteorological data processing associated with air quality dispersion modeling, please refer to section 6.9.

The hierarchy of weather data sources is traversed for every required location and time. When a location and time is specified, AEDT first checks whether or not there are RUC13/RAP13 data^x available at the requested location and time. If there are, then the weather at that location and time is taken from that dataset. If not, then it goes through the same process for RUC20/RAP20 data. The cycle continues for GEOS data, then NCAR data, and finally for the Airport database. If no data are available for the given location and time from any of these sources, ISA weather is used. This cascade of weather data sources is illustrated in Figure 3-1.

^x RAP data is the next-generation version of the RUC and officially replaced RUC in May 2012.

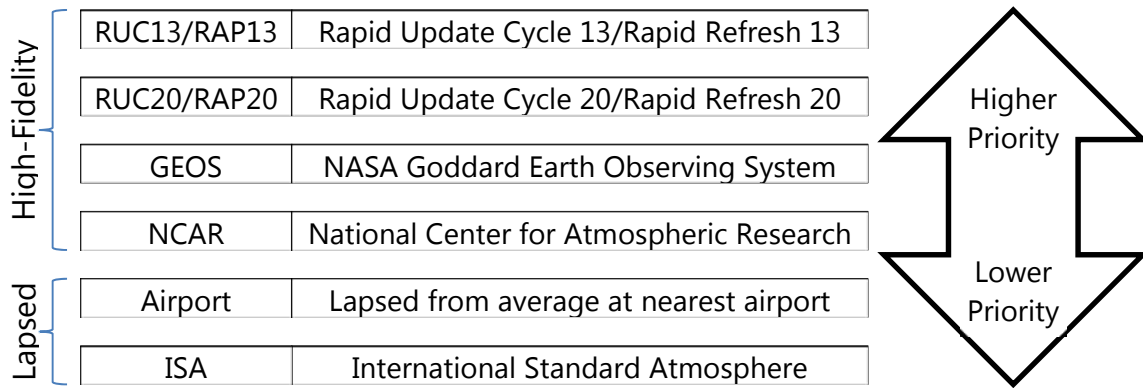

Figure 3-1 Cascade of Weather Data Sources

3.3.1 Common Elements

3.3.1.1 Pressure Altitude

Pressure altitude is defined as the MSL altitude in an ISA at which a given pressure or pressure ratio occurs. AEDT calculates pressure altitude, h_p , for a given pressure ratio, δ , by the equation:

$$h_p = \left(\frac{T_{SLISA}}{\alpha_{ISA}} \right) \cdot \left(1 - \delta^{\frac{1}{5.256}} \right) \quad \text{Eq. 3-1}$$

where

h_p	Pressure altitude (ft);
T_{SLISA}	ISA sea-level temperature 518.67 °R;
α_{ISA}	ISA temperature lapse rate 0.003566 °R/ft; and
δ	Pressure ratio at aircraft altitude (dimensionless).

3.3.1.2 Temperature Deviation from ISA

Temperature deviation from ISA is defined as the difference between the actual temperature at a given location and time and the temperature in the ISA.

$$\Delta T(x, y, z, t) = T(x, y, z, t) - T_{ISA}(z) \quad \text{Eq. 3-2}$$

where

$\Delta T(x, y, z, t)$	Temperature deviation from ISA as a function of location and time (K);
$T(x, y, z, t)$	Temperature as a function of location and time (K); and
$T_{ISA}(z)$	ISA temperatures as a function of altitude (K).

Temperature deviation from ISA is used in calculations discussed in Section 3.7.1.3.1.

3.3.2 Airport Average Atmospheric Models

3.3.2.1 AEDT Thermodynamic Profiles

Reference values for thermodynamic properties (temperature and pressure) internally calculated by AEDT are given at specified altitudes, and atmospheric profiles are constructed to fit those data in a physically realistic manner, similar to the manner in which the ISA was derived. These quantities are a function of altitude. In AEDT, the reference temperatures and pressures are 30-year annual average values associated with an airport relevant to the flight. There is no variation with respect to surface coordinate or time.

Temperature, T ($^{\circ}\text{R}$), at a given altitude, h (with respect to mean sea-level), is calculated by the equation:

$$T = T_{airport} - \alpha_{ISA} \cdot (h - h_{airport}) \quad \text{Eq. 3-3}$$

where

$h_{airport}$	Airport elevation above MSL (ft);
h	Altitude above MSL (ft);
$T_{airport}$	Airport temperature ($^{\circ}\text{R}$); and
α_{ISA}	ISA temperature lapse rate 0.003566 $^{\circ}\text{R}/\text{ft}$.

Pressure, P (inches Hg), is calculated by the equation:

$$P = P_{SLISA} \left[\left(\frac{P_{SL}}{P_{SLISA}} \right)^{\frac{1}{5.256}} - \frac{\alpha}{T_{SLISA}} h \right]^{5.256} \quad \text{Eq. 3-4}$$

where

P_{SL}	Sea-level pressure associated with the airport (inches Hg);
P_{SLISA}	ISA sea-level pressure 29.92 inches Hg; and
T_{SLISA}	ISA sea-level temperature 518.67 $^{\circ}\text{R}$.

3.3.2.2 Omnidirectional Wind

In the airport-average atmospheric model of AEDT, wind has a constant speed and varies such that it is always directed against the course of an aircraft (always a headwind). This value of headwind applies throughout the flight, without regard to altitude, latitude, longitude, time, or direction of travel. AEDT

uses an average headwind value associated with the nearest airport, and scales it by a multiplier associated with the runway corresponding to the operation. This scaling allows different headwinds to be associated with different runways.

3.3.3 High-Fidelity Weather Model

AEDT supports a high-fidelity model of weather that allows variation of all atmospheric properties (temperature, pressure, wind magnitude and direction, density, dew point, and relative humidity) along all three spatial dimensions, as well as in time. This is done by reading and interpolating weather data defined on 4-D grids. These grids are supplied by the user as files from sources described in Section 2.2.3.1. The data are defined on grids that are regularly spaced in time and along geographic coordinate systems, but irregularly spaced along the vertical direction.

In AEDT, all atmospheric data given for any specific time are interpolated linearly in space to define 3-D weather for that time. The atmosphere is assumed to remain static until the next time available in the data set. Whenever headwind is required, the wind vector field is interpolated to the desired location, and then the component of the interpolated vector that is opposite to the aircraft's direction of travel (i.e., headwind) is used.

3.4 Fuel Consumption Models

For fixed-wing aircraft, AEDT calculates the fuel consumed over each flight path segment by one of two methods. The first method, available in either the terminal or the en-route areas, calculates the fuel consumption for each flight segment in accordance with Section 3.9 of the BADA User Manual¹⁸ (see Section 3.4.1). The second method, available only in the terminal area, calculates the fuel consumption for each segment in accordance with the Senzig-Fleming-Iovinelli (SFI) method (see Section 3.4.2). Above the terminal area, AEDT uses the BADA method. A third method is used for fixed-wing aircraft which do not have thrust data in their performance calculations; for these aircraft AEDT uses Boeing Fuel Flow Method 2 (BFFM2 – Section 5.1.1.1) to determine fuel flow. The majority of aircraft using AEDT's implementation of the BFFM2 method are military airframes, however civil aircraft which do not use thrust as a parameter in their profile definitions also utilize this method to calculate fuel flow.

For helicopters, AEDT calculates the fuel consumed over each flight path segment using a time-in-mode fuel consumption method (see Section 3.4.4). AEDT uses the same method in the terminal and en-route areas.

Note that all of these methods specify the fuel flow rate. For the SFI and BFFM2 methods, AEDT calculates the amount of fuel consumed in a segment by multiplying the fuel flow rate per engine by the segment duration and the aircraft's number of engines. For the BADA method, AEDT calculates the amount of fuel consumed in a segment by multiplying the fuel flow rate for all engines by the segment duration.

3.4.1 Fixed-Wing BADA Fuel Consumption

The BADA fuel consumption model provides expressions for the nominal fuel flow rate. These expressions depend on the engine type (turbofan, turboprop, or piston), the aircraft's phase of flight (e.g. en-route climb, en-route descent, or cruise), and the engine's operating condition (e.g. nominal or idle thrust).

3.4.1.1 Fixed-Wing BADA Fuel Consumption - Turbofan engines

The nominal total rate of fuel flow f_{nom} (kg/min) for an aircraft, which is applicable for all situations where the aircraft is neither in the cruise phase of flight nor operating at an idle thrust setting, is given by:

$$f_{nom} = \left(1 + \frac{V_T}{C_{f_2}}\right) C_{f_1} F \quad \text{Eq. 3-5}$$

where

V_T	Aircraft true airspeed (speed in the air mass frame of reference) (kt);
C_{f_1}	Aircraft-specific 1st thrust specific fuel consumption coefficient (kg/min/kN);
C_{f_2}	Aircraft-specific 2nd thrust specific fuel consumption coefficient (kt); and
F	Aircraft total net thrust from its engines (kN).

The BADA total fuel flow rate f_{min} (kg/min) for a turbofan aircraft in an idle state is given by:

$$f_{min} = \left(1 - \frac{h}{C_{f_4}}\right) C_{f_3} \quad \text{Eq. 3-6}$$

where

h	Altitude above MSL (ft);
C_{f_3}	Aircraft-specific 1st descent fuel flow coefficient (kg/min); and
C_{f_4}	Aircraft-specific 2nd descent fuel flow coefficient (ft).

3.4.1.2 Fixed-Wing BADA Fuel Consumption - Turboprop engines

The nominal total rate of fuel flow f_{nom} (kg/min) for a turboprop aircraft, which is applicable for all situations where the aircraft is neither in the cruise phase of flight nor operating at an idle thrust setting, is given by:

$$f_{nom} = \left(1 - \frac{V_T}{C_{f_2}}\right) \frac{C_{f_1}}{1,000} V_T F \quad \text{Eq. 3-7}$$

where

V_T	Aircraft true airspeed (speed in the air mass frame of reference) (kt);
C_{f_1}	Aircraft-specific 1st thrust specific fuel consumption coefficient (kg/min/kN/kt);
C_{f_2}	Aircraft-specific 2nd thrust specific fuel consumption coefficient (kt); and
F	Aircraft total net thrust from its engines (kN).

The BADA total fuel flow rate f_{min} (kg/min) for a turboprop aircraft in an idle state is given by:

$$f_{min} = \left(1 - \frac{h}{C_{f_4}}\right) C_{f_3} \quad \text{Eq. 3-8}$$

where

h	Altitude above MSL (ft);
C_{f_3}	Aircraft-specific 1st descent fuel flow coefficient (kg/min); and
C_{f_4}	Aircraft-specific 2nd descent fuel flow coefficient (ft).

3.4.1.3 Fixed-Wing BADA Fuel Consumption - Piston engines

The nominal total rate of fuel flow f_{nom} (kg/min) for a piston-engine aircraft, which is applicable for all situations where the aircraft is neither in the cruise phase of flight nor operating at an idle thrust setting, is given by:

$$f_{nom} = C_{f_1} \quad \text{Eq. 3-9}$$

where

C_{f_1}	Aircraft-specific fuel flow coefficient (kg/min).
-----------	---

The BADA total fuel flow rate f_{min} (kg/min) for an aircraft in an idle state is given by:

$$f_{min} = C_{f_3} \quad \text{Eq. 3-10}$$

where

C_{f_3}	Aircraft-specific descent fuel flow coefficient (kg/min).
-----------	---

3.4.1.4 Fixed-Wing BADA Fuel Consumption-Cruise State

The BADA total fuel flow rate f_{CR} (kg/min) for a fixed-wing aircraft in a cruise state is calculated by scaling the nominal flow rate:

$$f_{CR} = C_{f_{CR}} f_{nom} \quad \text{Eq. 3-11}$$

where

$C_{f_{CR}}$	Aircraft-specific cruise fuel flow correction coefficient (dimensionless); and
f_{nom}	Nominal total rate of fuel flow (kg/min).

The cruise state is defined slightly differently in each of the trajectory modes (Section 3.1). In the Official Airline Guide (OAG) trajectory mode, AEDT defines the cruise state as all segments between Top of the Climb (TOC, where the aircraft first ends the initial en-route climb from the departure airport) and the Top of Descent (TOD, where the aircraft first begins the en-route descent to the arrival airport). In the radar and sensor path modes, AEDT defines the cruise state as any segment which has a climb or descent rate less than the threshold rate of 20 feet per minute. In the ANP extension mode, AEDT applies the cruise correction to those level segments which extend the trajectory to the boundary of the study area.

3.4.2 Fixed-Wing Senzig-Fleming-Iovinelli Fuel Consumption - Turbofan engine

In the SFI method¹⁷, the terminal area thrust specific fuel consumption method for the operational type (departures or arrivals) is used. The SFI methods are only used for turbofan engines in the terminal area.

3.4.2.1 SFI Fuel Consumption-Turbofan engine, departure

For the SFI method, fuel flow rate per engine during departure $f_{n_{dep}}$ (kg/min/eng) is calculated as:

$$f_{n_{dep}} = (K_1 + K_2M + K_3h_{MSL} + K_4F_n / \delta)\sqrt{\theta}F_n \quad \text{Eq. 3-12}$$

where

K_1	Aircraft-specific terminal-area departure TSFC constant coefficient (kg/min/kN),
K_2	Aircraft-specific terminal-area departure TSFC Mach coefficient (kg/min/kN),
K_3	Aircraft-specific terminal-area departure TSFC altitude coefficient (kg/min/kN/foot),
K_4	Aircraft-specific terminal-area departure TSFC thrust coefficient (kg/min/kN/lb);
h_{MSL}	Aircraft altitude (ft, MSL);
M	Aircraft Mach number (dimensionless);
θ	Ratio of temperature at aircraft altitude to sea level ISA temperature (dimensionless);
F_n / δ	Aircraft corrected net thrust per engine (lbf); and
F_n	Aircraft net thrust per engine (kN).

3.4.2.2 SFI Fuel Consumption-Turbofan engine, arrival

For the SFI method, fuel flow rate per engine during arrival $f_{n_{arr}}$ (kg/min/eng) is calculated as:

$$f_{n_{arr}} = \left(\alpha + \beta_1M + \beta_2e^{-\left(\frac{\beta_3F_n/\delta}{F_{n_0}}\right)} \right) \sqrt{\theta}F_n \quad \text{Eq. 3-13}$$

where

α	Aircraft-specific terminal-area arrival TSFC constant coefficient (kg/min/kN);
β_1	Aircraft-specific terminal-area arrival TSFC Mach coefficient (kg/min/kN);
β_2	Aircraft-specific terminal-area arrival TSFC thrust coefficient (kg/min/kN);
β_3	Aircraft-specific terminal-area arrival TSFC thrust ratio coefficient (dimensionless);
M	Aircraft Mach number (dimensionless);
θ	Ratio of temperature at aircraft altitude to sea level ISA temperature (dimensionless);
F_n / δ	Aircraft corrected net thrust per engine (lbf);
F_n	Aircraft net thrust per engine (kN); and
F_{n_0}	ISA sea-level static thrust (lbf).

3.4.3 BFFM2 Fixed-Wing Fuel Consumption

AEDT uses Boeing Fuel Flow Method 2 (BFFM2) when other sources for fuel consumption data are not available, e.g. the required SFI or BADA data don't exist for the particular aircraft, or thrust is not a parameter in the aircraft's performance profile. The BFFM2 method is:

$$W_f = \frac{B_m R W_f \delta}{\theta^{3.8} e^{0.2 M^2}} \quad \text{Eq. 3-14}$$

where

W_f	Fuel flow at non-reference conditions (kg/s);
B_m	Modal-specific adjustment factors (dimensionless);
$R W_f$	Fuel flow at reference conditions (kg/s);
M	Mach number (dimensionless);
θ	Temperature ratio (ambient to sea level standard - dimensionless); and
δ	Pressure ratio (ambient to sea level standard- dimensionless).

The fuel flow at reference conditions used in the BFFM2 are the fuel flow data found in the ICAO emissions database³⁴. Note that these are per engine fuel flows, not per aircraft. The modal-specific adjustment factors are listed in Table 5-1 below; these factors account for the effect of the operation of the aircraft's Environmental Control System (ECS) on the engine's compressor bleed air flow. These ECS adjustments are required since the fuel flow measurements for certification in the ICAO emission database are conducted without the compressor bleed air flow which drives the ECS.

As with the SFI methods, the total BFFM2 fuel consumption for a particular segment is the product of the fuel flow per engine during that segment, the segment's duration, and the number of engines on the aircraft.

3.4.4 Helicopter Fuel Consumption

AEDT uses a helicopter's engine-specific fuel flow rate that corresponds to the "climbout" ICAO operation mode (85% of maximum power). Because the helicopter terminal area profile calculations are modal rather than force-based, and unlike predictions for fixed-wing aircraft, the dynamic helicopter weight that results from decrementing the weight by the amount of fuel consumed over each flight path segment does not impact the calculated flight path or other performance parameters.

3.5 Ground Track

Ground tracks determine the lateral component of the path followed by an aircraft. They are ultimately represented by an ordered series of 2-D surface locations.

Surface locations can be expressed as either geographic coordinates or projected coordinates. Geographic coordinates are latitude and longitude values. Projected coordinates are Euclidean x and y values, representing displacement to the east and north, respectively, from a single centering geographic coordinate (the origin of the projected coordinate system). Except where otherwise stated, AEDT performance calculations take place in the projected coordinate space (in place of any geographic coordinates encountered, projected counterparts are created and used). Note that projected geometric distortions grow as horizontal distance from the projection origin increases, so ground track content far from the associated airport, as might be defined for a regional study, is modeled with reduced accuracy.

3.5.1 Ground Track Definition and Computation

A ground track in AEDT is defined in one of two ways:

1. "Pointwise" tracks; defined as an ordered set of geographic surface coordinates; or
2. "Vector" tracks; defined as an ordered set of vectoring commands (for example, fly straight 5.5 nmi, turn left 90 degrees at a radius of 2.0 nmi).

In either case, a ground track definition also includes:

- Type of air operation supported by the track
- The projection origin:
 - The associated airport reference point serves as the projection origin for most operation types (airport definitions in AEDT include the nominal location of the airport).
 - Overflight tracks are an exception, since they are not associated with an airport; in this case, the first track point serves as the projection origin (note that overflight tracks must be pointwise; vector overflight tracks are not supported by AEDT).
- If the supported operation type is not overflight, the associated runway's:
 - Geometry (location of the physical runway ends), and
 - Displaced threshold distance from runway end
- "Delta distance" by which to adjust certain track points that would typically coincide with the displaced threshold

AEDT combines all of the information from the track definition to compute a sequence of projected lateral coordinates along which performance results are constrained.

Certain points in computed AEDT tracks play special roles in supporting the trackwise alignment of flight profiles. These points, called "track anchors," are constructed by the system. A track's anchor can establish the point along the track where a profile begins, the point along the track where a profile in descent reaches the approach threshold crossing height, or both. These profile features are usually aligned to the runway's end or runways displaced thresholds location, and track anchors are nominally located at those thresholds, but with adjustments made according to the track's delta distance. More detailed information about how anchors are located for each track type follow below. More detailed information about how profiles are aligned to tracks according to anchors can be found in 3.6.2.1.

The following discussion outlines how AEDT computes tracks based on track definitions. Illustrations to support this discussion have the following common features:

- Circles represent track points, either directly from the track definition or generated by AEDT.
- Solid circles/arrows represent points/vectors from the track definitions.
- Dashed circles/arrows represent points/segments created by the system.
- D_i labels the i^{th} point/vector in the track definition.
- n is the number of points/vectors in the track definition.
- Δ is the track's "delta distance" specified by the user to adjust the runway's standard displaced threshold distance.

The relationship between defined and computed pointwise departure track points is illustrated in Figure 3-2. The first two points in the definition are meant to overlap the two runway ends (though, as shown, they need not necessarily do so), followed by any number of additional track points. The first point in the track definition is ignored by the track computation. Instead, the first point of the computed track is the anchor point constructed by AEDT on the runway, a distance Δ from the departure threshold location. This is followed by computed copies of the remaining defined track points (except for the first one). The last computed track point is computed by AEDT to be 100 nmi beyond the final defined point, along the heading between the final two defined points.

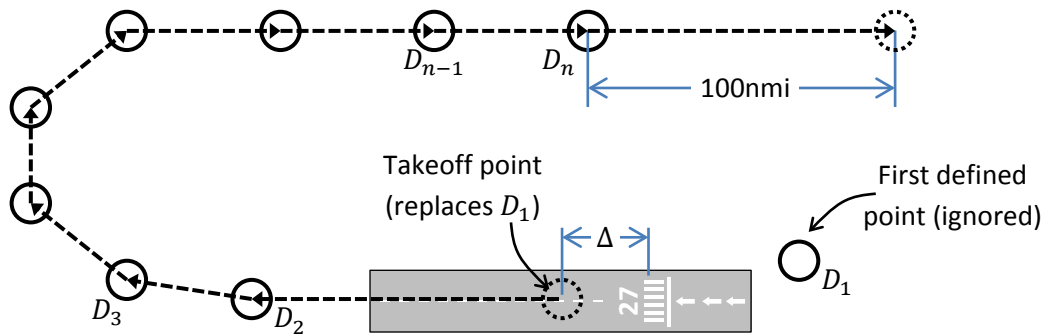

Figure 3-2 Track Computation – Pointwise Departure Track

The relationship between defined vector commands and computed vector departure track points is illustrated in Figure 3-3. The commands are meant to direct the track to proceed straight along the runway, followed by user-defined vectoring instructions. The first point of the computed track overlaps the departure threshold, with an offset of Δ . Additional points are then computed reflecting the sequence of vectoring commands. The last computed track point is computed by AEDT to be 100 nmi beyond the final point generated from vector commands, along the heading between the final two points generated from vector commands.

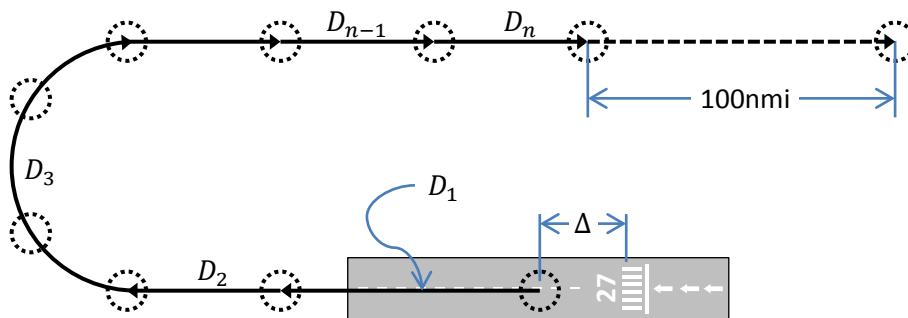

Figure 3-3 Track Computation – Vector Departure Track

The relationship between defined and computed pointwise approach track points is illustrated in Figure 3-4. The definition begins with any number of track points, with the final point intended to overlap the first runway end (though, as shown, it need not necessarily do so). The first computed track point is computed by AEDT to precede the first defined point by 100 nmi, along the heading between the first two defined points. This is followed by computed copies of all defined track points, except for the last one. The last point in the track definition is ignored by the track computation. Instead, the next point in the computed track is the anchor point constructed by AEDT on the runway, a distance Δ from the approach threshold location. The last track point computed by AEDT is beyond the approach threshold by the length of the runway, along the heading of the runway.

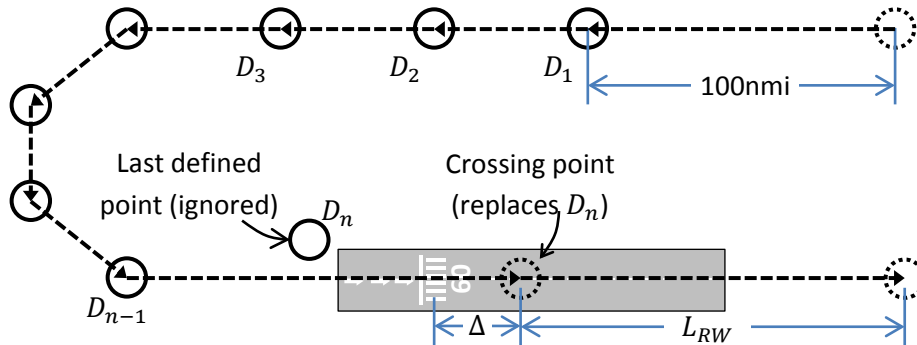

Figure 3-4 Track Computation – Pointwise Approach Track

The relationship between defined vector commands and computed vector approach track points is illustrated in Figure 3-5. The commands are meant to direct the track along user-defined vectoring instructions, followed by a straight approach that ends at the approach threshold. The first computed track point is computed by AEDT to precede the beginning of the first vectoring command by 100 nmi, along the heading between the first two points computed for that command. Additional points are then computed reflecting the sequence of vectoring commands, with the track point corresponding to the end of the final command overlapping the approach threshold. The last track point is computed by AEDT to be beyond the approach threshold by the length of the runway, along the heading of the runway.

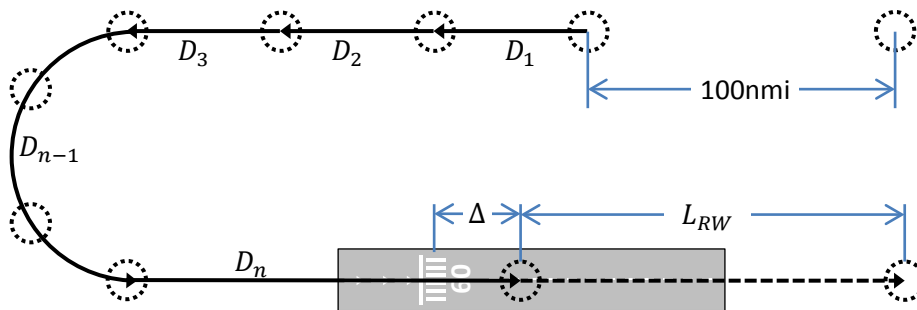

Figure 3-5 Track Computation – Vector Approach Track

The relationship between defined and computed pointwise overflight tracks is illustrated in Figure 3-6. The computed track begins with points at all locations from the track definition. The last point of the computed track is 100 nmi beyond the final defined point, along the direction of the final two defined points.

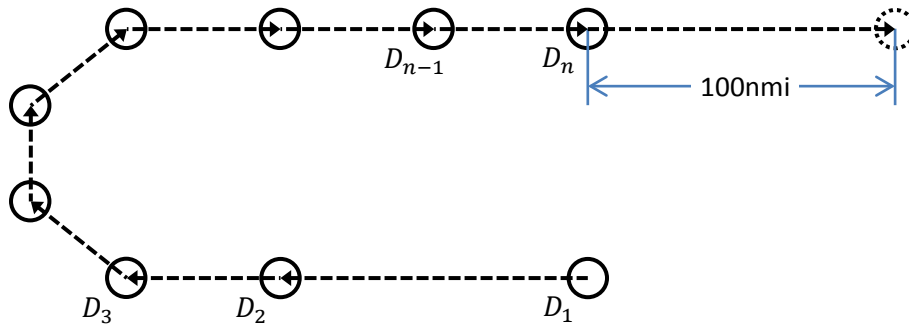

Figure 3-6 Track Computation – Pointwise Overflight Track

The relationship between defined and computed pointwise circuit/touch-and-go tracks is illustrated in Figure 3-7. The first two points in the definition are meant to overlap the two runway ends (though, as shown, they need not necessarily do so), followed by any number of additional points over which the aircraft is meant to pass, with the final defined point overlapping the first. The first point in the track definition is ignored by the track computation. Instead, the first point of the computed track is the anchor point constructed by AEDT on the runway, at a distance Δ further along than the approach threshold. This anchor is where the profile will reach the approach threshold crossing height, and where a circuit profile will begin takeoff ground roll. This is followed by points at all locations from the track definition, except for the first and last. The last point in the track definition is ignored by the track computation. Instead, the last point of the computed track overlaps the anchor point.

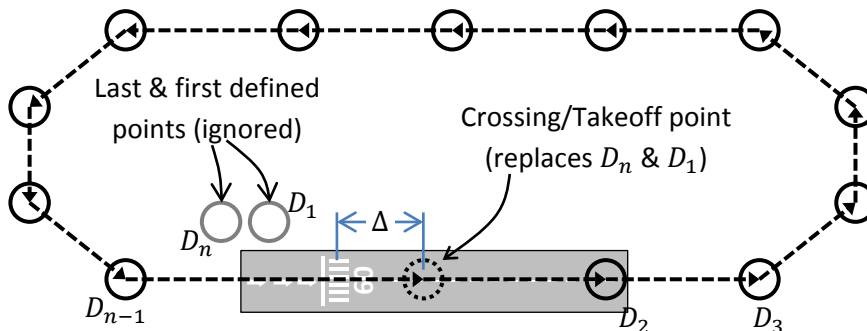

Figure 3-7 Track Computation – Pointwise Circuit/TGO Track

The relationship between defined and computed vector circuit/touch-and-go tracks is illustrated in Figure 3-8. The commands are meant to proceed straight along the runway, followed by arbitrary vectoring behavior that ends at the beginning of the first command. The first point of the computed track overlaps the approach threshold. This is followed by additional points reflecting the behavior indicated by the defined sequence of vectoring commands, ending at the approach threshold.

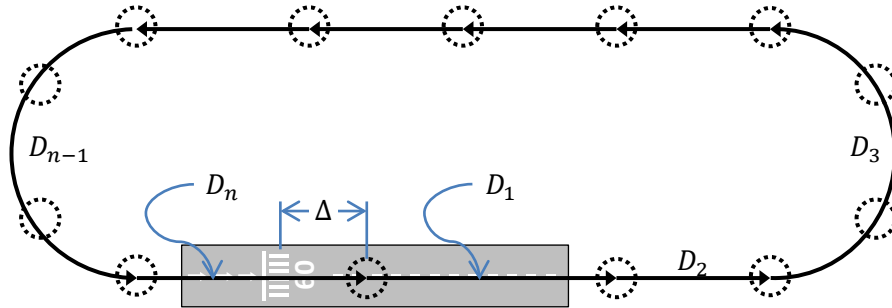

Figure 3-8 Track Computation – Vector Circuit/TGO Track

3.5.2 Points from Vectors

AEDT transforms the vectoring commands into a set of projected coordinates. To transform vectors into points, AEDT approximates turning segments by multiple straight segments, ensures that tracks line up with runways as appropriate, adds leader lines to approach tracks, and adds follower lines to departure tracks.

When processing an approach vector track, there is no information available *a priori* about the track's initial location or direction, so AEDT starts the track at the origin and heads north. After all of the x,y points are calculated, the entire set of track points is rotated and translated such that the segment corresponding to the final (straight) vector command is parallel to the runway and ends at the displaced approach threshold point along the runway.

When processing a departure vector track, AEDT makes the first track point coincide with the displaced takeoff threshold point on the runway.

AEDT approximates circular-arc portions of ground tracks with one or more pairs of straight line segments¹⁹. First, the number of sub-arcs, n_{sub} , to be used to span the total turning angle ξ (radians) of the arc is computed:

$$n_{sub} = \text{int} \left(1 + \frac{\xi}{40} \cdot \frac{180}{\pi} \right) \quad \text{Eq. 3-15}$$

where the function $\text{int}(x)$ returns the integer part of x .

Next, the angular extent, $\Delta\xi$ (radians), of each sub-arc is computed:

$$\Delta\xi = \frac{\xi}{n_{sub}} \quad \text{Eq. 3-16}$$

Each sub-arc is approximated by two straight line segments, bound by three surface coordinates. The first surface coordinate is at the start of the sub-arc, and the third point is at the end of the sub-arc. The second point is half-way along the angular extent of the sub-arc, with its distance from the center of the sub-arc, r_2 (m), given by:

$$r_2 = r \cdot \left[\cos\left(\frac{\Delta\xi}{2}\right) + \sqrt{\left(\frac{\Delta\xi}{2}\right)^2 - \sin^2\left(\frac{\Delta\xi}{2}\right)} \right] \quad \text{Eq. 3-17}$$

where

r Radius of the arc (m).

This method ensures that a line segment replaces not more than 20° of turn angle. Also, the sum of the lengths of the line segments equals the distance along the arc so that the flying time along the line segments is the same as the time that would be flown along the circular arc.

3.5.3 Radius of Curvature

The turning radius of an aircraft's ground track is an important consideration in accounting for aircraft banking. For vector tracks, there is no need to calculate the turning radius, since the radius is explicitly defined for each turning portion, and implicitly infinite for each straight portion. For pointwise tracks, the turning radius must be approximated from surface coordinate data. This objective is met through a three-step process:

1. Track point coordinates are interpolated at a regular spacing.
2. Turning radius is calculated from the interpolated points.
3. Turning radius values are interpolated back to the original points.

In the first step, each track is interpolated at 0.5 nautical mile intervals with cubic splines. A cubic spline is analogous to stretching a flexible piece of plastic so that it contacts all the track points. The interpolated track is smooth and continuous in the first derivative, and continuous in the second derivative, which eliminates sharp corners in the flight track that would be impossible for an aircraft to follow. Curvature derivatives are undefined at the track endpoints, so the second derivatives are set to zero, which is called the "natural" endpoint condition.

The next step is to calculate turning radius at each point by considering three consecutive track points at a time. The turning radius is equal to the radius of a circle passing through the three points. The circle radius r (m) is calculated as follows:

$$r = \frac{a \cdot b \cdot c}{4 \cdot K} \quad \text{Eq. 3-18}$$

where

a, b, c Distances between three consecutive points in the track (m); and
 K Area of a triangle formed by the points (m²).

The calculated radius is assigned to the middle point, and the process is repeated for each set of three consecutive track points. The first and last points have an undefined radius, so the radius at these points is set to infinity (as though the track were straight).

3.6 Profile-Driven Flight Performance

A flight profile describes the movement of an aircraft in terms of aircraft state characteristics (e.g. altitude, speed, flap setting, and thrust) as a function of horizontal distance over the ground (and in

some cases for helicopters, time). A flight profile does not contain information about the lateral path an aircraft follows over the ground. When performance is driven by a flight profile, AEDT calculates the profile as described in Section 3.6.2, with the weather model localized in the manner presented in Section 3.6.1.

3.6.1 Local Weather

For each step calculated in a procedure, weather conditions are taken to have no lateral or temporal variation. That is, atmospheric profiles at the most recently calculated surface coordinate and time are assumed to remain constant throughout the step. The term *atmospheric profiles* refers to the variation of local weather with altitude.

3.6.2 Airplane Profile Calculation

Airplane profiles describe how the state of an airplane changes as the flight progresses. When a flight profile is comprised of procedure steps, AEDT processes the steps one at a time to calculate profile points, ultimately expressing the steps in the same format as in Section 3.6.2.5. Otherwise, the profile is already expressed in this form directly as fixed points.

Sections 3.6.2.1 through 3.6.2.4 discuss aspects of the AEDT profile treatment that are independent of component type. Section 3.6.2.5 then details how each specific type of profile component is processed to determine segment end-point values of altitude, speed, noise thrust, and corrected net thrust.

3.6.2.1 Temporal and Trackwise Alignment

Since the duration and horizontal length of some procedure steps may change with local weather variation, the length of a flight profile depends on the time and location (distance along the computed track) where the profile begins. Since airplane profiles are calculated in forward order with respect to horizontal distance, and flight time is calculated along the flight path from the speed and track data, the profiles' initial time and trackwise distance are necessarily determined iteratively, as is the length of the "fit-to-track" segments in circuit and touch-and-go profiles. The first guess of initial trackwise distance is always zero (the beginning of the calculated ground track), while the first guess of initial time is set to whichever reference time is appropriate to the operation type (departure off-time for departures and circuits, arrival on-time otherwise). After the profile is calculated from these settings, improved guesses are formulated based on the amount by which the respective temporal and spatial targets were missed.

The process of aligning a departure procedure in time and along the track is illustrated in Figure 3-8. Initial distance along the track is known to be zero, so no trackwise iteration is required. Initial time is iteratively adjusted until takeoff ground roll in the calculated profile ends at "departure off-time".

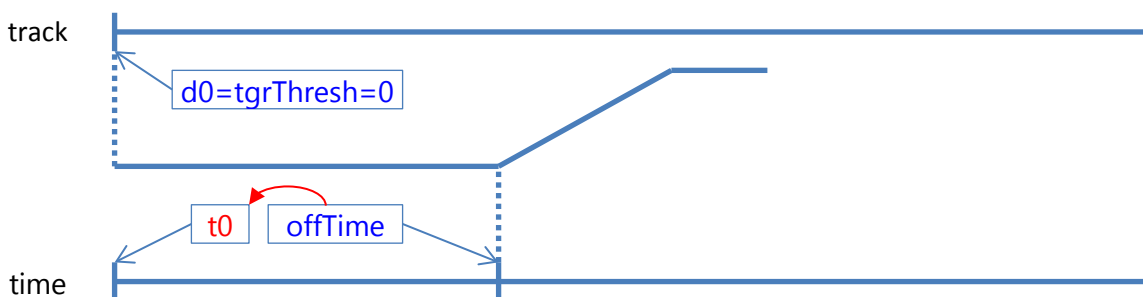

Figure 3-8 Track Alignment – Departure Procedure

The process of aligning an approach procedure in time and along the track is illustrated in Figure 3-9. Initial distance along the track is iteratively adjusted until the calculated profile reaches the threshold crossing height at the known track coordinate of the approach threshold. Initial time is iteratively adjusted until the landing ground roll in the calculated profile begins at “arrival on-time”.

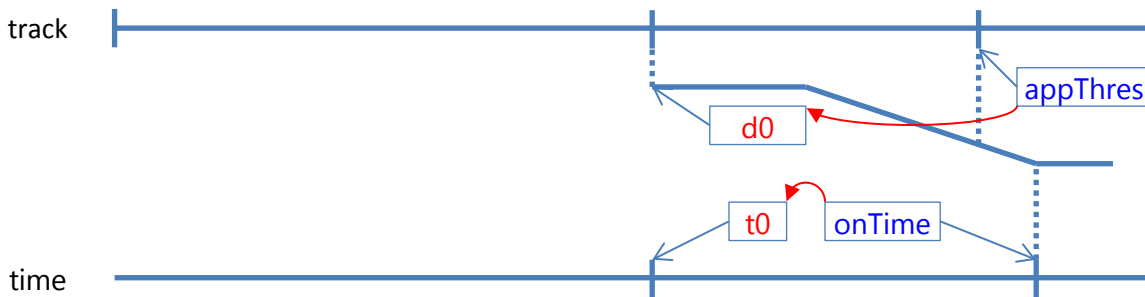

Figure 3-9 Track Alignment – Approach Procedure

The process of aligning an overflight procedure in time and along the track is illustrated in Figure 3-10. Initial distance along the track is known to be zero, so no trackwise iteration is required. Likewise, initial time is known to be “arrival on-time”, so no temporal iteration is required.

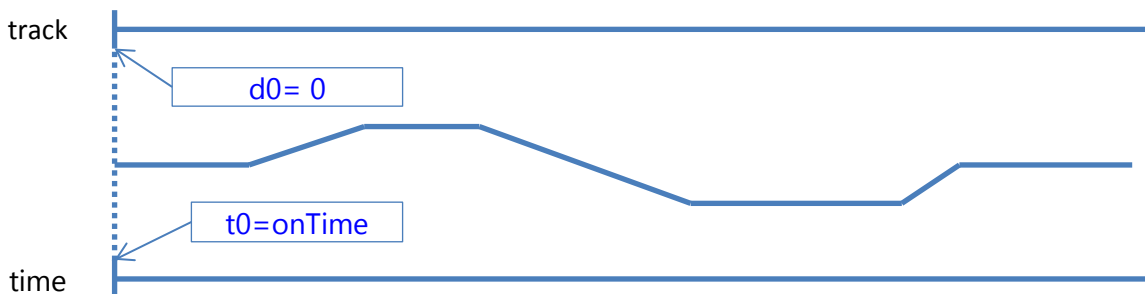

Figure 3-10 Track Alignment – Overflight Procedure

The process of aligning a touch-and-go procedure in time and along the track is illustrated in Figure 3-11. Initial distance along the track is iteratively adjusted until the calculated profile reaches the threshold crossing height at the known track coordinate of the approach threshold, which is zero or any multiple of the track length (since the track loops on itself). Initial time is iteratively adjusted until the landing ground roll in the calculated profile begins at “arrival on-time”. After the initial time and trackwise distance have been resolved, the length of the “fit-to-track” step is iteratively adjusted until the end of that step in the computed profile is beyond the initial track coordinate by the track’s length.

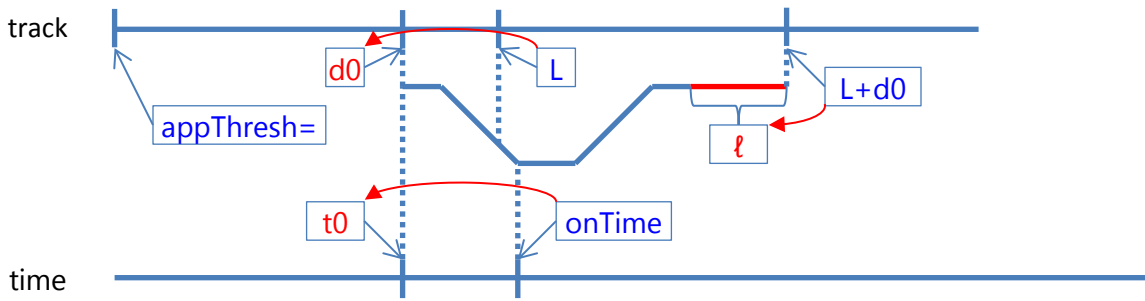

Figure 3-11 Track Alignment – TGO Procedure

The process of aligning a circuit procedure in time and along the track is illustrated in Figure 3-12. Initial distance along the track is known to be zero, so no trackwise iteration is required. Initial time is iteratively adjusted until takeoff ground roll in the calculated profile ends at “departure off-time”. After the initial time has been resolved, the length of the “fit-to-track” step is iteratively adjusted until the calculated profile reaches the threshold crossing height at the known track coordinate of the approach threshold, which is at the full track’s length from the beginning.

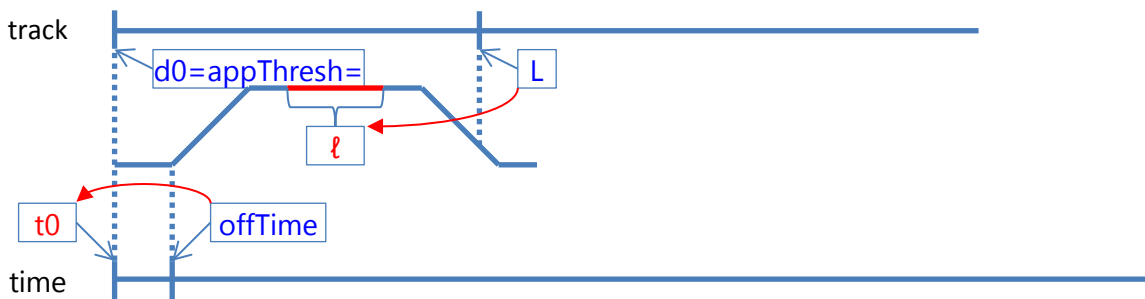

Figure 3-12 Track Alignment – Circuit Procedure

3.6.2.2 ANP Thrust Specification

Thrust figures prominently in the force balances used to model aircraft performance from procedural ANP profiles. It is also the primary basis for the determination of noise levels. In some contexts, such as the ANP performance specification or normalized plots in engine performance literature, it is expressed as the corrected net thrust per engine, which is the net thrust scaled by the local atmospheric pressure ratio. For certain profile components, the thrust may be specified as an input. This may take the form of a specific value or a thrust rating. There are also circumstances in which thrust is unknown and therefore calculated through an equation that models flight mechanics, such as the minimum (engine-out) force balance. Specific value, thrust rating, and minimum engine-out thrust (based on force balance) are described below.

Noise thrust indicates the value of an airplane’s power setting (the ‘Power’ in the Noise-Power-Distance data sets). Each aircraft is associated with empirical datasets that model the aircraft’s noise as a function of its noise thrust. Noise thrust is defined as the net corrected thrust when appropriate performance data are available. When appropriate performance data are not available (i.e., net corrected thrust is not directly calculated), the noise thrust can be defined as a percentage of the aircraft static thrust (where aircraft static thrust is in units of Newtons). If performance data or static thrust data are not

available^{xi}, noise thrust values can be taken from engine parameters and provided directly as inputs to the performance calculations; no physics-based performance modeling is done. The units of these inputs, described as “other”, are assumed to match the units used for the noise datasets.

3.6.2.2.1 Thrust Value

When thrust is provided as a specific value, the value indicates the magnitude of corrected net thrust per engine. For procedure steps, the given thrust is taken to apply throughout the entire step for the purpose of performance modeling. The specific value option is available for takeoff ground roll, constant-CAS climb, or accelerating climb steps, as well as for fixed profile points. It is also available as a percentage for braking ground roll.

3.6.2.2.2 Thrust Rating

When thrust is provided as a rating, the corrected net thrust per engine is calculated from a set of parameters from the ANP database. Ratings indicate a standard power level for the aircraft, such as maximum takeoff, reduced climb, idle, etc. Each rating that is defined for an aircraft has its own set of thrust parameter values. The parameter sets and thrust calculations used for aircraft modeled as jets are substantially different from those used for aircraft modeled as propeller-driven. The thrust rating option is available for takeoff ground roll, constant-CAS climb, and accelerating climb steps.

3.6.2.2.2.1 Jet Rated Thrust

AEDT calculates jet aircraft corrected net thrust per engine by using a modified version of SAE-AIR-1845⁵⁹ equation (A1):

$$\frac{F_n}{\delta} = E + F \cdot v + G_A \cdot h + G_B \cdot h^2 + H \cdot T_C \quad \text{Eq. 3-19}$$

where

$\frac{F_n}{\delta}$	Corrected net thrust per engine (lbf);
v	Equivalent/calibrated airspeed (kt);
h	Pressure altitude (ft) MSL;
T_C	Temperature (°C) at the aircraft; and
E, F, G_A, G_B, H	Regression coefficients that depend on power state (max-takeoff or max-climb power) and temperature state (below or above engine breakpoint temperature) (lbf, lbf/kt, lbf/ft, lbf/ft ² , lbf/°C, respectively).

AEDT models a jet engine by using sets of coefficients that are tailored for specific profile steps, such as takeoff, climb or idle steps. Many aircraft have two sets of coefficients for max-takeoff power and two sets for max-climb power. For a given power state, AEDT models the effect of jet engine breakpoint temperature by using coefficients $(E, F, G_A, G_B, H)_{low}$ for ambient temperatures below the breakpoint temperature and coefficients $(E, F, G_A, G_B, H)_{high}$ above breakpoint. AEDT calculates both $(F_n/\delta)_{low}$ and $(F_n/\delta)_{high}$ and then uses the smaller of the two values as the corrected net thrust for a given power state.

If the high-temperature coefficients do not exist in the database, AEDT calculates high-temperature corrected net thrust by the equation:

xi Performance or static thrust data may be unavailable for some military and general aviation aircraft.

$$\left(\frac{F_n}{\delta}\right)_{high} = F_{low} \cdot v + (E_{low} + H_{low} \cdot T_{BC}) \frac{1 - 0.003 \cdot T_F}{1 - 0.003 \cdot T_{BF}} \quad \text{Eq. 3-20}$$

where

$\left(\frac{F_n}{\delta}\right)_{high}$	High-temperature corrected net thrust (lbf);
$E_{low}, F_{low}, H_{low}$	Regression coefficients for the low-temperature equation (lbf, lbf/kt, lbf/°C, respectively);
v	Calibrated airspeed (kt);
T_F	Temperature (°F) at the aircraft;
T_{BC}	Breakpoint temperature, $T_{BC} = 30^\circ\text{C}$; and
T_{BF}	Breakpoint temperature, $T_{BF} = 86^\circ\text{F}$.

3.6.2.2.2 Propeller Rated Thrust

AEDT calculates propeller-driven aircraft corrected net thrust per engine by using SAE-AIR-1845⁵⁹ equation (A4):

$$\frac{F_n}{\delta} = \frac{\left(\frac{325.87 \cdot \eta \cdot P}{v_T}\right)}{\delta} \quad \text{Eq. 3-21}$$

where

325.87	Unit conversion: horsepower/kt to lbf;
η	Propeller efficiency, which depends on the power state (dimensionless);
P	Net power per engine (horsepower, MSL standard day), which depends on the power state (max-takeoff or max-climb);
v_T	True airspeed (kt); and
δ	Pressure ratio at aircraft altitude (dimensionless).

3.6.2.2.3 Minimum Engine-Out

The only force-balance based thrust level that can be specified as an input to AEDT performance calculations is the minimum engine-out thrust. This thrust is calculated by:

$$\frac{F_n}{\delta} = \frac{\left(\frac{W}{\delta_2}\right) \cdot \left\{ \left[\frac{\sin\left(\tan^{-1}\frac{G}{100}\right)}{K} \right] + R_f \right\}}{N - 1} \quad \text{Eq. 3-22}$$

where

W	Departure profile weight (lbf);
δ_2	Pressure ratio at altitude A_2 (dimensionless);
G	Engine-out percentage climb gradient from FAR Part 25 ²¹ (dimensionless): $G = 0$ for aircraft with Automatic Thrust Restoration Systems; $G = 1.2$ for 2-engine aircraft; $G = 1.5$ for 3-engine aircraft; or $G = 1.7$ for 4-engine aircraft.
K	Speed-dependent constant (dimensionless): $K = 1.01$ when climb speed ≤ 200 kts; or

$K = 0.95$ otherwise.

This constant accounts for the effects on climb gradient of climbing into an 8-knot headwind and the acceleration inherent in climbing at constant calibrated airspeed (true speed increases as air density diminishes with height);

R_f Drag-over-lift coefficient that depends on the flaps setting (dimensionless); and
 N Number of engines ($N > 1$) (dimensionless).

This option is available for constant-CAS climb or accelerating climb. Note that this method will underpredict the actual thrust required, since the R_f value used is for a standard, all-engines operating flight condition – an engine out condition will have significantly more drag than an all-engines operating condition.

3.6.2.3 True Airspeed

Procedural profiles specify speed in the form of calibrated airspeed. True airspeed is also relevant to the flight mechanics modeled by AEDT. Calibrated airspeed is assumed to equal equivalent airspeed in the ECAC Doc 29¹⁵ performance specification. True airspeed for the explicitly-defined portion of a profile-driven operation is therefore calculated by using SAE-AIR-1845⁵⁹ equation (A5):

$$v_T = v / \sqrt{\sigma} \quad \text{Eq. 3-23}$$

where

v_T True airspeed (kt);
 v Calibrated airspeed (kt); and
 σ Air density ratio at aircraft altitude (dimensionless).

3.6.2.4 Displaced Thresholds and Threshold Crossing Heights

A departure flight path starts at a given distance from the departure end of the runway:

$$D = D_{dep} + \Delta_{trk} \quad \text{Eq. 3-24}$$

where

D Start-roll distance (ft) from the end of the runway;
 D_{dep} Displaced departure threshold (ft) for the runway (user input); and
 Δ_{trk} Delta distance (ft) for the departure ground track (user input).

An approach flight touches down on the runway at a given distance from the approach end of the runway:

$$D = D_{app} + \Delta_{trk} + \frac{h_{tc} \cdot |d_{-1}|}{z_{-1}} \quad \text{Eq. 3-25}$$

where

D_{app} Displaced approach threshold (ft) for the runway (user input);
 h_{tc} Threshold crossing height (ft) for the runway (user input);
 d_{-1} Coordinate value (ft) of the profile point immediately before the touch-down point (it is a negative number); and

z_{-1} Altitude AFE (ft) of the profile point immediately before the touch-down point (the touch-down point has coordinates: $d_0 = 0, z_0 = 0$).

3.6.2.5 Profile Components

The following sections describe how AEDT processes specific profile component types. In general, one procedure step produces one profile point, but there are several exceptions. For example, a takeoff step produces two points (start-roll and takeoff rotation). Also, when there is a change in thrust setting (for example, going from max-takeoff to max-climb), an extra profile point is created so that thrust changes continuously over a small distance (1,000 ft), rather than discontinuously at a point.

Sometimes, data from one procedure step are combined with data from an adjacent step before a profile point can be computed. For example, two consecutive descent steps will specify their initial altitude, speed, and angle of descent. AEDT uses the second descent step's initial altitude as the final altitude for the first step. These algorithmic details are not described. Instead, the production of profile points is presented in terms of "initial" and "final" points that define a profile segment.

For detailed information about the format and content of inputs required for the creation of user-defined profiles, see the AEDT Standard Input File Reference Guide²⁰.

3.6.2.5.1 Fixed Point

A fixed profile point specifies much of the aircraft's state at a particular horizontal coordinate and time. Altitude, distance, speed, and noise thrust require no calculation, as they are given directly. AEDT does not adjust noise thrusts for non-standard temperature and pressure (that is, the input values of noise thrust are directly used in the noise tables, regardless of its units). If the noise thrust is specified as a percent, the corrected net thrust is calculated by applying the given percentage to the airplane's static thrust value. No corrected net thrust calculation is required when the noise thrust is specified in pounds (in which case the setting directly specifies the corrected net thrust) or any other units not mentioned here (in which case no relationship between noise thrust and actual engine thrust is specified).

3.6.2.5.2 Takeoff Ground Roll Step

A takeoff ground roll step models airplane acceleration on the ground before becoming airborne. For this type of step, the initial and final values of aircraft altitude are given (the elevation of the starting runway end), the initial and final values of speed and thrust are calculated, and the horizontal distance is calculated.

For jets, the corrected net thrust per engine $(F_n/\delta)_1$ at the start-roll point is calculated by using the departure thrust equation with $v_1 = 0$ kts. For props, the corrected net thrust per engine $(F_n/\delta)_1$ at the start-roll point is set equal to the corrected net thrust per engine $(F_n/\delta)_2$ at the end of the step.

For jets and props, the corrected net thrust per engine $(F_n/\delta)_2$ at the end of the step is calculated by using rated thrust as described in 3.6.2.2.2. The calibrated airspeed at the end of the step, which is used in the thrust equation, is modeled as the initial climb calibrated airspeed, and is calculated by using SAE-AIR-1845⁵⁹ equation (A7):

$$v_2 = C_f \cdot \sqrt{W} \quad \text{Eq. 3-26}$$

where

v_2	Initial climb calibrated airspeed (kt);
C_f	Takeoff speed coefficient that depends on flaps setting (kt/ $\sqrt{\text{lbf}}$); and
W	Departure profile weight (lbf); weight is assumed to remain constant for the entire departure profile.

For jets or props, $(F_n/\delta)_1$ can be a user-input value. If so, then $(F_n/\delta)_2$ is also set to equal the input value.

Takeoff ground-roll distance is calculated by using SAE-AIR-1845⁵⁹ equation (A6):

$$S_g = \frac{B_f \cdot \theta \cdot \left(\frac{W}{\delta}\right)^2}{N \cdot \left(\frac{F_n}{\delta}\right)_2} \quad \text{Eq. 3-27}$$

where

S_g	Ground-roll distance (ft);
B_f	Ground-roll coefficient, which depends on the flaps setting (ft/lbf);
θ	Temperature ratio at the airport elevation (dimensionless);
δ	Pressure ratio at the airport (dimensionless); and
$\left(\frac{F_n}{\delta}\right)_2$	Corrected net thrust per engine (lbf) at the end of takeoff step.

The takeoff ground-roll distance is corrected for headwind, by using SAE-AIR-1845⁵⁹ equation (A16):

$$S_{gw} = \frac{S_g \cdot (v_2 - w)^2}{(v_2 - 8)^2} \quad \text{Eq. 3-28}$$

where

S_{gw}	Ground-roll distance (ft) corrected for headwind;
v_2	Initial climb calibrated speed (kt); and
w	Headwind (kt).

The takeoff ground-roll distance is also corrected for runway gradient by using the equations:

$$S_{gc} = \frac{S_{gw} \cdot a}{a - 32.17 \cdot G} \quad \text{Eq. 3-29}$$

$$a = \frac{(v_2/\sqrt{\sigma})^2}{2 \cdot S_{gw}} \quad \text{Eq. 3-30}$$

$$G = \frac{E_2 - E_1}{L} \quad \text{Eq. 3-31}$$

where

S_{gc}	Ground-roll distance (ft) corrected for headwind and runway gradient;
S_{gw}	Ground-roll distance (ft) corrected for headwind;
a	Average acceleration (ft/s ²) along the runway;

G	Runway gradient; G is positive when taking-off uphill (dimensionless);
E_1, E_2	Runway end elevations (ft) MSL; and
L	Runway length (ft).

In AEDT, the corrected ground-roll distance S_{gc} is divided into sub-segments with variable lengths, with each segment covering an aircraft speed change of 20 kts. The number of sub-segments N_{segs} for the ground roll is calculated as:

$$N_{segs} = \text{int}\left(1 + \frac{v_{G_2}}{20}\right) \quad \text{Eq. 3-32}$$

where

N_{segs}	Number of sub-segments (dimensionless); and
$\text{int}(x)$	Function that returns the integer part of x .
v_{G_2}	Final groundspeed of the ground roll segment.

Acceleration is assumed to be constant, and each segment is calculated to cover an equal time period. The time, t , on each segment is calculated as:

$$t = \frac{2 \cdot S_{gc}}{v_{G_2} \cdot N_{segs}} \quad \text{Eq. 3-33}$$

where

t	Time (s) spent on each sub-segment.
-----	-------------------------------------

The distance, speed, and thrust values at the N_{segs} segment end points are calculated by linear interpolation on time.

3.6.2.5.3 Constant-CAS Climb Step

A constant-CAS climb segment models the climb of an aircraft at constant calibrated airspeed to a target altitude. For this type of step, the initial and final altitudes are given (A_1 is from the previous segment and A_2 is user input), the initial and final speeds are calculated using the final calibrated airspeed on the previous segment, the initial thrust $(F_n/\delta)_1$ is given from the previous segment, the final thrust is calculated, and the horizontal distance is calculated.

A climb segment is flown at constant calibrated airspeed, v , climbing from altitude A_1 to altitude A_2 . Even though a climb segment uses constant calibrated airspeed, the true airspeeds v_{T1} and v_{T2} at the segment end points are different because the air densities σ_1 and σ_2 are different. The speeds are calculated according to Eq. 3-23 from their corresponding density ratios.

The nominal corrected net thrust per engine, F_n/δ , and the final corrected net thrust per engine, $(F_n/\delta)_2$, are calculated differently depending on the thrust specification supplied for the procedure step:

1. When a thrust rating is specified, the nominal corrected net thrust per engine is calculated by using the rated thrust equations presented in 3.6.2.2.2 at the mid-point altitude $A_m = \frac{1}{2}(A_1 + A_2)$. Likewise, a nominal value of the pressure ratio, δ , is sampled at the mid-point altitude A_m . The

final corrected net thrust per engine is calculated from the same equations, at calibrated airspeed v and the final altitude A_2 .

- When thrust is specified directly by value without a cutback segment, the nominal value of corrected net thrust per engine is set to the specified value, $F_n/\delta = \text{user-input thrust}$. The nominal value of the pressure ratio, δ , is calculated at the mid-point altitude.

The calculated initial corrected net thrust per engine $(F_n/\delta)_1$ is retained, and the final corrected net thrust per engine is also set to the specified thrust.

- When a thrust is specified directly by value with a cutback segment, the nominal value of corrected net thrust per engine is set to the specified value, $F_n/\delta = \text{user-cutback thrust}$. The nominal value of the pressure ratio, δ , is calculated at the mid-point altitude.

The climb segment is calculated and then separated into two sub-segments, both having the same climb angle. The first sub-segment is assigned a 1,000 ft ground distance and the corrected net thrust per engine at the end of 1,000 ft is set equal to the user-cutback thrust value. If the original horizontal distance is less than 2,000 ft, one half of the segment is used to cutback thrust. The final thrust on the second sub-segment is also set equal to the user-cutback thrust. Thus, the second sub-segment is flown at constant thrust.

Another 1,000 ft sub-segment restores the thrust from the user-cutback value to the calculated value $(F_n/\delta)_2$ at altitude A_2 . This sub-segment is created in the next climb or acceleration segment.

- When engine-out minimum thrust is specified, the nominal value of corrected net thrust per engine F_n/δ is calculated by using the minimum engine-out procedure described in 3.6.2.2.3. The nominal value of the pressure ratio δ is set to the final value calculated at altitude A_2 .

Two 1,000 ft sub-segments are introduced in a manner similar to the user-cutback case.

The average climb angle is calculated by using SAE-AIR-1845⁵⁹ equation (A8):

$$\gamma = \sin^{-1} \left(K \cdot \left[\frac{N \cdot \left(\frac{F_n}{\delta} \right)}{\left(\frac{W}{\delta} \right)} - R_f \right] \right) \quad \text{Eq. 3-34}$$

where

γ	Average climb angle (radians)
K	Speed-dependent constant (dimensionless); K=1.01 when climb speed \leq 200 kt; or K=0.95 otherwise;
N	Number of engines (dimensionless);
$\left(\frac{F_n}{\delta} \right)$	Nominal value of corrected net thrust per engine (lbf);
δ	Nominal value of the pressure ratio (dimensionless);
W	Departure profile weight (lbf); and

R_f Drag-over-lift coefficient that depends on the flaps setting (dimensionless).

The above method of setting the constant K is slightly different than specified in SAE-AIR-1845⁵⁹, where the initial climb segment uses K=1.01, and climb segments after acceleration and flaps-retraction use K=0.95. The AEDT method is designed to handle flight profiles where the order of climb and acceleration segments is mixed.

The climb angle is corrected for headwind by using SAE-AIR-1845⁵⁹ equation (A17):

$$\gamma_w = \frac{\gamma \cdot (v - 8)}{(v - w)} \quad \text{Eq. 3-35}$$

where

γ_w Average climb angle corrected for headwind;
 γ Average climb angle (uncorrected);
 v Calibrated airspeed (kt) on the climb segment; and
 w Headwind (kt).

Finally, the horizontal distance for the climb segment is calculated by using SAE-AIR-1845⁵⁹ equation (A9):

$$S_c = \frac{A_2 - A_1}{\tan \gamma_w} \quad \text{Eq. 3-36}$$

where

S_c Horizontal distance (ft) for the climb segment;
 A_1 Initial altitude (ft) MSL; and
 A_2 Final altitude (ft) MSL.

3.6.2.5.4 Accelerating Climb Step by Climb Rate

An accelerating climb step models acceleration to a target calibrated airspeed at a specified rate of climb. For this type of step, the initial altitude A_1 , initial true airspeed v_{T1} , and initial thrust $(Fn/\delta)_1$ are given from the previous segment. The final calibrated airspeed v_2 and the average climb rate v_{T2} are user inputs. The final altitude, final true airspeed, final thrust, and horizontal flying distance are calculated.

Altitude, speed, thrust, and distance are calculated by using an iterative method. The final altitude $A_2 = A_1 + 250$ ft is used for the first iteration, and then A_2 is recalculated until the absolute difference between the current and next iteration A_2 values is less than one ft.

The horizontal distance is calculated by using SAE-AIR-1845⁵⁹ equation (A10):

$$S_a = \frac{0.95 \cdot k \cdot (v_{T2}^2 - v_{T1}^2)}{G_m - G} \quad \text{Eq. 3-37}$$

where

S_a Current iteration horizontal distance (ft);

g	Gravitational acceleration of Earth (ft/s ²)
k	Constant to convert kt ² to ft ² /s ² : $k = 2.8487$
v_{T_1}	Input initial true airspeed (kt);
v_{T_2}	Final true airspeed (kt) at current iteration σ_2 :

$$v_{T_2} = v_2 / \sqrt{\sigma_2}$$

where

v_2	Input final calibrated airspeed (kt);
σ_2	Air density ratio at current iteration final altitude A_2 (dimensionless);
G_m	Maximum acceleration available, as a fraction of g , for current iteration:

$$G_m = \frac{N \cdot \left(\frac{F_n}{\delta}\right)}{\left(\frac{W}{\delta}\right)} - R_f$$

where

(F_n/δ) Average corrected net thrust per engine (lb) at the current iteration:

$$\left(\frac{F_n}{\delta}\right) = \frac{1}{2} \left[\left(\frac{F_n}{\delta}\right)_1 + \left(\frac{F_n}{\delta}\right)_2 \right]$$

where

$(F_n/\delta)_1$	Input initial corrected net thrust per engine (lbf);
$(F_n/\delta)_2$	Final corrected net thrust per engine (lbf) at current iteration altitude A_2 ;
δ	Pressure ratio at current iteration mid-point altitude, $(A_1 + A_2)/2$ (dimensionless);
G	Climb gradient for the current iteration value of v_{T_2} (dimensionless):

$$G = \frac{v_{T_z}}{101.2686 \cdot \frac{1}{2} (v_{T_1} + v_{T_2})}$$

where

v_{T_z}	Input climb rate (ft/min).
-----------	----------------------------

The next-iteration final altitude A'_2 (ft) is calculated by using SAE-AIR-1845⁵⁹ equation (A11):

$$A'_2 = A_1 + \frac{S_a \cdot G}{0.95} \quad \text{Eq. 3-38}$$

When $A'_2 - A_2 < 1$ ft, the current iteration values of final altitude A_2 , final true airspeed v_{T_2} , final corrected net thrust per engine $(F_n/\delta)_2$, and horizontal distance S_a are used for the acceleration segment.

If during the iteration process $(G_m - G) < 0.02$, the acceleration is considered to be too small to achieve the desired v_2 in a reasonable distance. AEDT then limits the climb gradient to $G = G_m - 0.02$. In effect, the desired climb rate is reduced so that the airplane can maintain a minimum acceleration. If $G < 0.01$, AEDT issues an error message and stops computing the profile. If $G < 0.01$, there is not enough thrust to both accelerate and climb, as required by the segment parameters.

The acceleration segment distance is corrected for headwind by using SAE-AIR-1845⁵⁹ equation (A18):

$$S_{aw} = \frac{S_a \cdot (v_T - w)}{(v_T - 8)} \quad \text{Eq. 3-39}$$

where

S_{aw}	Horizontal distance (ft) corrected for headwind;
S_a	Horizontal distance (ft) for the acceleration segment, uncorrected; and
v_T	Sverage true airspeed (kts) on the segment:

$$v_T = (v_{T_1} + v_{T_2})/2$$

3.6.2.5.5 Accelerating Climb Step by Energy Share

An accelerating climb step by energy share models acceleration to a target calibrated airspeed with the rate of climb specified indirectly as a percentage of available acceleration. For this type of step, the initial altitude A_1 , initial true airspeed v_{T1} , and initial thrust $(F_n/\delta)_1$ are given from the previous segment. The final calibrated airspeed v_2 and the energy-share percentage value A_p are user inputs. The final altitude, final true airspeed, final thrust, and horizontal flying distance are calculated.

Acceleration percent (accel-percent) segments are calculated in a similar manner as acceleration segments (see Section 3.6.2.5.4 above). The key difference is that accel-percent segments utilize an input energy-share percentage value while acceleration segments use an input average climb rate. The energy-share percentage value defines the division of aircraft thrust between uses for climbing vs. accelerating. The climb gradient, G , in Eq. 3-37 is replaced with a climb gradient calculated using the input acceleration percent value (A_p). At an acceleration percent value of 100%, all thrust is dedicated to increasing airspeed and the climb rate will be zero. As A_p is decreased to 0%, more thrust is dedicated to climbing and less to acceleration. Acceleration for climbing is calculated as follows:

$$G = G_m \cdot (1 - A_p / 100) \quad \text{Eq. 3-40}$$

where

G	Acceleration available for climbing as a fraction of g also called the climb gradient (dimensionless);
G_m	Maximum available acceleration as a fraction of g , see Equation 2-35 (dimensionless); and
A_p	Percentage of thrust applied to acceleration.

Thus, Equation 3-40 is used instead to calculate G in Eq. 3-37, and the process is otherwise identical to the acceleration segment. Note that the limits on $G_m - G$ discussed in Section 3.6.2.5.4 will come into play when the value of A_p is very small.

3.6.2.5.6 Cruise-Climb Step

A cruise-climb step models a climb at a specific angle to a target altitude and calibrated airspeed. For this type of step, the initial altitude, true airspeed, and thrust are given from the previous segment. The final altitude A_2 , final calibrated airspeed v_2 , and climb angle γ are user inputs (the initial and final

calibrated airspeeds must be the same). The final true airspeed, final thrust, and horizontal distance are calculated. Cruise-climb thrust is less than "maximum-takeoff" or "maximum-climb" departure thrust.

The final corrected net thrust per engine is calculated by using SAE-AIR-1845⁵⁹ equation (A15) with an additive term for climb thrust:

$$\left(\frac{F_n}{\delta}\right)_2 = \frac{\left(\frac{W}{\delta_2}\right) \cdot \left(R_f + \frac{\sin \gamma}{0.95}\right)}{N} \quad \text{Eq. 3-41}$$

where

$\left(\frac{F_n}{\delta}\right)_2$	Corrected net thrust per engine (lbf) at altitude A_2 ;
W	Profile weight (lbf);
δ_2	Pressure ratio at altitude A_2 (dimensionless);
R_f	Drag-over-lift coefficient that depends on flaps and gear setting (dimensionless);
γ	Average climb angle (a positive value); and
N	Number of engines (dimensionless).

The horizontal distance is calculated by:

$$S_{cc} = \frac{A_2 - A_1}{\tan \gamma} \quad \text{Eq. 3-42}$$

where

S_{cc}	Horizontal distance (ft) for the cruise-climb segment;
A_1	Initial altitude (ft) MSL; and
A_2	Final altitude (ft) MSL ($A_1 < A_2$).

3.6.2.5.7 Descent Step

A descent step models descent at a specific angle to a target altitude and calibrated airspeed, neglecting deceleration effects. For this type of step, the initial altitude, true airspeed, and thrust are given from the previous segment. The final altitude A_2 , final calibrated airspeed v_2 , and descent angle γ are user inputs, with the final altitude and final calibrated airspeed being input on the following segment. The final true airspeed, final thrust, and horizontal distance are calculated.

The final true airspeed v_{T_2} (kt) is:

$$v_{T_2} = v_2 / \sqrt{\sigma_2} \quad \text{Eq. 3-43}$$

where

v_2	Input final calibrated airspeed (kt); and
σ_2	Density ratio at altitude A_2 (dimensionless).

The final corrected net thrust per engine is calculated by using SAE-AIR-1845⁵⁹ equation (A15):

$$\left(\frac{F_n}{\delta}\right)_2 = \frac{\left(\frac{W}{\delta_2}\right) \cdot \left(R_f - \frac{\sin \gamma}{1.03}\right)}{N} \quad \text{Eq. 3-44}$$

where

$$\left(\frac{F_n}{\delta}\right)_2 \quad \text{Corrected net thrust per engine (lbf) at altitude } A_2; \text{ and}$$

$$\gamma \quad \text{Average descent angle (a positive value).}$$

The final corrected net thrust per engine is corrected for headwind by using SAE-AIR-1845⁵⁹ equation (A19):

$$\left(\frac{F_n}{\delta}\right)_{2w} = \left(\frac{F_n}{\delta}\right)_2 + \frac{1.03 \cdot \left(\frac{W}{\delta_2}\right) \cdot \sin \gamma \cdot (w - 8)}{N \cdot v_2} \quad \text{Eq. 3-45}$$

where

$$\left(\frac{F_n}{\delta}\right)_{2w} \quad \text{Corrected net thrust per engine (lbf) for headwind } w;$$

$$w \quad \text{Headwind (kt); and}$$

$$v_2 \quad \text{Calibrated airspeed (kt) at altitude } A_2.$$

The horizontal distance is calculated by:

$$S_d = \frac{A_1 - A_2}{\tan \gamma} \quad \text{Eq. 3-46}$$

where

$$S_d \quad \text{Horizontal distance (ft) for the descent segment;}$$

3.6.2.5.8 Deceleration-Sensitive Descend Step

A deceleration-sensitive descend step models descent at a specific angle to a target altitude and calibrated airspeed, adjusting one of the targets to preserve the deceleration that would have been observed in an ISA. For this type of step, the initial altitude, true airspeed, and thrust are given from the previous segment. The final altitude A_2 , final calibrated airspeed v_2 , and descent angle γ are user inputs, with the final altitude and final calibrated airspeed being input on the following segment. The final true airspeed, final thrust, and horizontal distance are calculated. Although the inputs for this type of step are the same as for a standard descent step, this type of step (as well as the “Descend-Idle” step described in Section 3.6.2.5.9) is calculated in a way that preserves the acceleration value implied by its inputs.

In AEDT, the initial altitude and speed appear to be user-defined; however, a descend-decel segment is not actually calculated until the next segment is processed. This procedure is necessary so that an approach profile can start with a descend-decel segment.

The process for calculating Descend-Decel segments in AEDT is similar but not identical to the process described in Section B-10 of ECAC Doc 29¹⁵. AEDT assumes that the procedural profile using the descend-decel segment was defined for ISA reference conditions at a sea-level airport. The deceleration

that results over the segment given sea-level ISA conditions is assumed to remain constant even under non-sea level, non-ISA conditions, and other segment parameters are therefore modified for consistency under these conditions. Deceleration over the descend-decel segment for ISA conditions is calculated as:

$$a_{ISA} = \frac{\left(\sqrt{v_{T2ISA}^2 - w^2 \cdot \sin^2 \gamma} - w \cdot \cos \gamma \right)^2 - \left(\sqrt{v_{T1ISA}^2 - w^2 \cdot \sin^2 \gamma} - w \cdot \cos \gamma \right)^2}{2 \cdot S_d} \quad \text{Eq. 3-47}$$

where

a_{ISA} Acceleration for ISA conditions (ft/s²);
 v_{T1ISA} Initial true airspeed (ft/s) for ISA conditions σ_{1ISA} :

$$v_{T1ISA} = \left(\frac{101.2686}{60} \right) v_1 / \sqrt{\sigma_{1ISA}}$$

where

v_1 Input initial calibrated airspeed (kt);
 σ_{1ISA} Air density ratio at initial altitude A_1 (for ISA conditions);
 v_{T2ISA} Final true airspeed (ft/s) for ISA conditions σ_{2ISA} :

$$v_{T2ISA} = \left(\frac{101.2686}{60} \right) v_2 / \sqrt{\sigma_{2ISA}}$$

where

v_2 Input final calibrated airspeed (kt);
 σ_{2ISA} Air density ratio at final altitude A_2 (for ISA conditions);
 w Headwind (ft/s);
 γ Average descent angle (a positive value);
 S_d Horizontal distance (ft) for the descent segment:

$$S_d = \frac{A_2 - A_1}{\sin \gamma}$$

where

A_1 Initial altitude (ft) MSL; and
 A_2 Final altitude (ft) MSL ($A_1 > A_2$).

For non-ISA conditions, the segment's ISA deceleration and the input descent angle are held constant and either the final true airspeed or the segment length (and therefore final altitude) are adjusted.

When the segment following the descend-decel segment is a level, level-decel, level-idle, or land segment the input final altitude is maintained and the final true airspeed is adjusted to account for non-ISA conditions. The new final true airspeed (ft/s) is calculated as:

$$v'_{T_2} = \sqrt{\left(\sqrt{\left(\sqrt{v_{T_1}^2 - w^2 \sin^2 \gamma} - w \cdot \cos \gamma \right)^2 + 2s_d a_{ISA} + w \cdot \cos \gamma} \right)^2 + w^2 \cdot \sin^2 \gamma} \quad \text{Eq. 3-48}$$

where

v'_{T_2} Calculated final true airspeed for actual airport atmospheric conditions (ft/s); and
 v_{T_1} Input initial true airspeed for actual airport atmospheric conditions (ft/s).

When the segment following the descend-decel segment is a descend, descend-decel, or descend-idle segment the input final true airspeed is maintained and the segment length and final altitude are adjusted for non-ISA conditions. The new segment length is calculated as:

$$S'_l = \frac{\left(\sqrt{v_{T_2}^2 - w^2 \cdot \sin^2 \gamma} - w \cdot \cos \gamma \right)^2 - \left(\sqrt{v_{T_1}^2 - w^2 \cdot \sin^2 \gamma} - w \cdot \cos \gamma \right)^2}{2 \cdot a_{ISA}} \quad \text{Eq. 3-49}$$

where

S'_l Segment length adjusted for non-ISA conditions (ft);
 v_{T_1} Input initial true airspeed for actual airport atmospheric conditions (ft/s); and
 v_{T_2} Input final true airspeed for actual airport atmospheric conditions (ft/s).

The segment's new final altitude A'_2 is calculated as:

$$A'_2 = A_1 - s'_l \cdot \sin \gamma \quad \text{Eq. 3-50}$$

where

A'_2 Calculated final altitude (ft) MSL; and
 A_1 Input initial altitude (ft) MSL.

Descend-decel segment thrust values account for deceleration effects on thrust, unlike descent segments described in Section 3.6.2.5.7. Thrust is calculated with a force balance derived from SAE-AIR-1845⁵⁹ equation (A15) with an additional acceleration term:

$$\frac{F_n}{\delta} = \frac{W}{N \cdot \delta} \left(R \cdot \cos \gamma - \sin \gamma + \frac{a}{g} \right) \quad \text{Eq. 3-51}$$

where

$\frac{F_n}{\delta}$ Corrected net thrust per engine (lbf);
 W Aircraft weight (lbf);
 δ Pressure ratio at segment's altitude (dimensionless);
 N Number of engines (dimensionless);
 R Drag over lift coefficient that depends on flaps and gear setting (dimensionless);
 a Aircraft acceleration along the velocity vector (ft/s²);
 g Gravitational acceleration of Earth (ft/s²); and
 γ Descent angle (positive by convention).

3.6.2.5.9 Idle Descend Step

An idle descend step models descent at a specific angle and idle thrust setting to a target altitude and calibrated airspeed, adjusting one of the targets to preserve the deceleration that would have been observed in an ISA. For this type of step, the initial altitude, true airspeed, and thrust are given from the previous segment. The final altitude A_2 , final calibrated airspeed v_2 , and descent angle γ are user inputs, with the final altitude and final calibrated airspeed being input on the following segment. The final true airspeed, final thrust, and horizontal distance are calculated.

In AEDT, the initial altitude and speed appear to be user inputs; however, a descend-idle segment is not actually calculated until the next segment is processed. This procedure is necessary so that an approach profile can start with a descend-idle segment.

Descend-idle segments are calculated in the same manner as descend-decel segments described in Section 3.6.2.5.8 with the exception of thrust. Idle thrust is a rated thrust specification (see Section 3.6.2.2.2). The initial and final idle thrust values are calculated using the initial and final altitude and speed values as appropriate.

3.6.2.5.10 Level Step

A level step models level flight over a specific distance to a target calibrated airspeed, neglecting deceleration effects. For this type of step, the initial altitude, true airspeed, and thrust are given from the previous segment. The final altitude A_2 , final calibrated airspeed v_2 , and distance flown S_v are user inputs (the final altitude and speed must be the same as the initial values). The final thrust is calculated.

If the initial thrust is not the same as the final thrust (for example, the previous segment was a climb segment), then AEDT creates a 1,000 ft transition segment so that the major portion of the level segment is flown at constant thrust.

The corrected net thrust per engine is calculated by using SAE-AIR-1845⁵⁹ equation (A15) with zero descent angle:

$$\left(\frac{F_n}{\delta}\right)_2 = \frac{\left(\frac{W}{\delta}\right) \cdot R_f}{N} \quad \text{Eq. 3-52}$$

where

- $\left(\frac{F_n}{\delta}\right)_2$ Final corrected net thrust per engine (lbf) at altitude $A_1 = A_2$;
- W Profile weight (lbf);
- δ Pressure ratio at altitude $A_1 = A_2$ (dimensionless); and
- R_f Drag-over-lift coefficient that depends on flaps and gear setting (dimensionless).

3.6.2.5.11 Deceleration-Sensitive Level Step

A deceleration-sensitive level step models level flight over a specific distance to a target calibrated airspeed, adjusting the target speed to preserve the deceleration that would have been observed in an ISA. For this type of step, the step length, initial true airspeed, and step altitude are user inputs. The initial true airspeed and segment altitude must match the final values from the previous segment. The final true airspeed is defined by the following segment, and the constant segment thrust is calculated.

The level-deceleration segment is calculated and then separated into two sub-segments. The first sub-segment is assigned a 1,000 ft ground distance. The corrected net thrust at the beginning of this segment is equal to the final value from the previous segment, and the corrected net thrust at the end of 1,000 ft is set equal to the level-decel thrust. If the original horizontal distance is less than 2,000 ft, one half of the segment distance is used to transition the thrust. The final thrust on the second sub-segment is also set to the level-decel thrust. Thus, the second segment is flown at constant thrust.

Another 1,000 ft sub-segment restores the thrust from the level-decel value to the appropriate initial thrust for the following segment. This sub-segment is created in the following segment.

AEDT assumes that the procedural profile using the level-decel segment is defined for ISA reference conditions at a sea-level airport. The deceleration that results over the segment given sea-level ISA conditions is assumed to remain constant even under non-sea level, non-ISA conditions, and other segment parameters are therefore modified for consistency under these conditions. Deceleration over the level-decel segment for ISA conditions is calculated as:

$$a_{ISA} = \frac{\left(\left(\frac{v_2}{\sqrt{\sigma_{ISA}}} - w \right) \cdot \frac{101.2686}{60} \right)^2 - \left(\left(\frac{v_1}{\sqrt{\sigma_{ISA}}} - w \right) \cdot \frac{101.2686}{60} \right)^2}{2 \cdot S_d} \quad \text{Eq. 3-53}$$

where

a_{ISA}	Acceleration for ISA conditions (ft/s ²);
v_1	Input initial calibrated airspeed (kt);
v_2	Input final calibrated airspeed (kt);
σ_{ISA}	Air density ratio at segment altitude (for ISA conditions);
w	Headwind (kt); and
S_d	Input horizontal distance (ft) for the segment.

For non-ISA conditions, the segment's ISA deceleration is held constant and the segment length is adjusted. The new segment length (horizontal distance) is calculated as:

$$s'_d = \frac{\left(\left(\frac{v_2}{\sqrt{\sigma}} - w \right) \cdot \frac{1,012.686 \times 10^{-1}}{60} \right)^2 - \left(\left(\frac{v_1}{\sqrt{\sigma}} - w \right) \cdot \frac{1,012.686 \times 10^{-1}}{60} \right)^2}{2 \cdot a_{ISA}} \quad \text{Eq. 3-54}$$

where

s'_d	Segment length (ft); and
σ	Air density ratio at segment altitude (for actual airport conditions).

The level-decel segment thrust is calculated with SAE-AIR-1845⁵⁹ equation (A15) with an additional acceleration term and zero climb angle:

$$\frac{F_n}{\delta} = \frac{W}{N \cdot \delta} \left(R + \frac{a}{g} \right) \quad \text{Eq. 3-55}$$

where

$\frac{F_n}{\delta}$	Corrected net thrust per engine (lbf);
W	Aircraft weight (lbf);
δ	Pressure ratio at segment's altitude (dimensionless);
N	Number of engines (dimensionless);
R	Drag over lift coefficient that depends on flaps and gear setting (dimensionless);
a	Aircraft acceleration along the velocity vector (ft/s ²); and
g	Gravitational acceleration of Earth (ft/s ²).

3.6.2.5.12 Level-Idle Step

An idle level step models level flight at idle thrust over a specific distance to a target calibrated airspeed, adjusting the target speed to preserve the deceleration that would have been observed in an ISA. For this type of step, the step length, initial true airspeed, and step altitude are user inputs. The initial true airspeed and segment altitude must match the final values from the previous segment. The final altitude is set equal to the initial value, the final true airspeed is set equal to the initial true airspeed of the following segment, and the segment's idle thrust values are calculated.

The level-idle segment is calculated then separated into two sub-segments. The first sub-segment is assigned a 1,000 ft ground distance. The corrected net thrust at the beginning of this segment is equal to the final value from the previous segment, and the corrected net thrust at the end of 1,000 ft is set equal to the calculated initial idle thrust value. If the original horizontal distance is less than 2,000 ft, one half of the segment distance is used to transition the thrust. The final thrust on the second sub-segment is set to the calculated final idle thrust value.

Another 1,000 ft sub-segment restores the thrust from the final idle thrust value to the appropriate initial thrust for the following segment. This sub-segment is created in the following segment.

As for level-decel segments, AEDT assumes that the procedural profile using the level-idle segment was defined for ISA reference conditions at a sea-level airport. The deceleration that results over the segment given sea-level ISA conditions is assumed to remain constant even under non-sea level, non-ISA conditions, and other segment parameters are therefore modified for consistency under these conditions. The segment length for level-idle segments flown under non-ISA conditions is calculated using Eq. 3-53 and Eq. 3-54 from Section 3.6.2.5.11.

Idle thrust is a rated thrust specification (see Section 3.6.2.2.2). The initial and final idle thrust values are calculated using the constant segment altitude and the initial and final speed values as appropriate.

3.6.2.5.13 Fit-to-Track Step

A fit-to-track step models level flight over a specific distance. The distance is indeterminate from the perspective of the procedure definition, but is known at the time of profile calculation. This type of step only appears in procedure definitions for circuit profiles, but AEDT internally also adds a step of this type to the end of touch-and-go procedures. There are no user inputs for this type of step. For this type of step, the initial altitude, true airspeed, and thrust are given from the previous segment. The final altitude, true airspeed, and thrust are each the same as the corresponding initial values.

3.6.2.5.14 Landing Ground Roll Step

A landing ground roll step models ground roll from touch down over a specific distance to a target calibrated airspeed and thrust setting. For this type of step, the initial and final altitudes are given (the elevation of the touch-down end of the runway), the initial (landing) speed is calculated, the final roll-out true speed is calculated from a user-input calibrated speed v_2 , the initial (landing) thrust is calculated, the final thrust is calculated from a user-input percentage value P , and the ground-roll distance S_b is user input.

The landing calibrated airspeed is calculated by using SAE-AIR-1845⁵⁹ equation (A13):

$$v_1 = D_f \cdot \sqrt{W} \quad \text{Eq. 3-56}$$

where

- v_1 Calibrated airspeed (kt) just before landing;
- D_f Landing coefficient that depends on the flaps and gear setting (kt/ $\sqrt{\text{lb}}$); and
- W Approach profile weight (lb); weight is assumed to remain constant for the entire approach profile.

The initial and final true speeds are calculated by:

$$v_{T_1} = v_1 / \sqrt{\sigma} \quad \text{Eq. 3-57}$$

$$v_{T_2} = v_2 / \sqrt{\sigma} \quad \text{Eq. 3-58}$$

where

- σ Density ratio at airport altitude (dimensionless).

The initial thrust $(F_n/\delta)_1$ is calculated using the descent thrust equation with the landing descent angle, landing calibrated airspeed v_1 , and airport elevation (see Section 3.6.2.5.7).

The user-input percentage of thrust may also be used to calculate the final thrust for the landing segment representing the level of reverse thrust, if supplied by the user. The final thrust $(F_n/\delta)_2$ is calculated by:

$$\left(\frac{F_n}{\delta}\right)_2 = F_s \cdot \left(\frac{P}{100}\right) \quad \text{Eq. 3-59}$$

where

- $\left(\frac{F_n}{\delta}\right)_2$ Corrected net thrust per engine (lbf) at end of landing roll-out;
- F_s Static corrected net thrust per engine (an input parameter) (lbf); and
- P Percentage of thrust (an input parameter).

If the aircraft NPD curves are in percentages, the value of thrust that is actually assigned to the flight path segment is the percentage value P ; it is used to directly access the noise tables.

3.6.2.5.15 Decelerate Step

A decelerate segment models ground roll over a specific distance to a target calibrated airspeed and thrust. For this type of step, the initial and final altitudes are given (the elevation of the touch-down end of the runway), the initial speed is given from the previous step, and the final speed is calculated from user-input calibrated speed and density ratio. The initial thrust is given from the previous step, the final thrust is calculated from user-input percentage of thrust (see Section 3.6.2.5.13), and the ground-roll distance is user input.

3.6.3 Helicopter Profile

AEDT supports only one kind of flight profile input data for helicopters: an ordered set of procedure steps. Compared to fixed-wing aircraft, helicopter procedure steps are more similar to fixed-wing profile points than fixed-wing procedure steps. Like fixed-wing profile points, helicopter procedure steps explicitly define the flight profile, do not involve any flight performance calculations within AEDT, and are not modified by AEDT to account for non-standard atmospheric conditions. Unlike fixed-wing profile points, helicopter procedure steps are modal; they are defined as a set of procedure steps that each represents a helicopter flight operational mode.

The NPD data for helicopters used by AEDT reference operational modes and not thrust values. Available operational modes for helicopters include the following:

Dynamic operational modes:

- Constant-velocity descent
- Constant-velocity climb
- Constant-velocity level
- Vertical ascent with ground effect
- Vertical ascent without ground effect
- Vertical descent with ground effect
- Vertical descent without ground effect
- Level deceleration
- Descending deceleration
- Level acceleration
- Ascending acceleration
- Taxi

Static operational modes:

- Idle with ground support
- Idle without ground support
- Hover with ground effect
- Hover without ground effect

Each helicopter operational mode can have its own NPD curve that defines the source noise for that mode. There is only one NPD curve per mode, therefore there is no interpolation or extrapolation across helicopter NPD curves in AEDT. Note that AEDT does not require the existence of all modes. Thrust is not included in helicopter flight profiles.

An ordered set of helicopter procedure steps specifies a two-dimensional trajectory. For each point, the following data are given:

- Horizontal length (ft);
- Altitude of the helicopter above the helipad (ft);
- Helicopter groundspeed at the point (kts);
- Helicopter operational mode; and
- Time spent at a location for static operational modes (s).

The origin is where the computed horizontal coordinate is equal to zero, and it depends on the kind of flight operation:

- An approach origin is at the touchdown point and horizontal values are negative during descent.
- A departure origin is at the starting point on a helipad and horizontal values are positive.
- A taxi origin is at the starting point on a helipad and horizontal values are positive all the way to the end-point on the same or different helipad.
- An overflight origin is at the first point and horizontal values are positive.

For all types of operations, horizontal distance values increase as a helicopter flies along its profile. Profile speed is the ground speed at the profile point; it is the magnitude of the helicopter velocity vector. It is the same as true airspeed in cases where there is no wind. In the sections below, references to profile speed are talking about ground speed.

3.6.3.1 Helicopter Procedure Steps

Helicopter procedure steps explicitly define a helicopter's flight profile. There are no thrust, altitude, or speed calculations for helicopter flight profiles as there are for fixed-wing aircraft. The four types of helicopter flight operations (approach, departure, taxi and overflight) are created by using 14 types of procedure steps:

- **Start Altitude:** This step is used to start a profile at a given altitude and speed. The starting altitude and speed are inputs.
- **Constant-Velocity Level:** This step is used to maintain altitude and speed for a given distance. The track distance covered by the step is the only input. Altitude and speed are defined by the previous step.
- **Constant-Velocity Descent:** This step is used to descend at constant speed to a given altitude over a given distance. The track distance covered by the step and the final altitude are inputs. The initial altitude and speed are defined by the previous step.
- **Descending Deceleration:** This step is used to descend and decelerate to a final altitude and speed over a given distance. The track distance covered by the step, the final altitude, and the final speed are inputs. The initial altitude and speed are defined by the previous step.
- **Level Deceleration:** This step is used to decelerate to a final speed at constant altitude over a given distance. The track distance covered by the step and the final speed are inputs. The altitude and initial speed are defined by the previous step.
- **Vertical Descent:** This step is used to maintain horizontal position while descending to a final altitude over a given duration. The duration of the step and the final altitude are inputs. The horizontal position of the step is calculated from the previous step and the horizontal speed is zero.

- **Hover:** This step is used to maintain altitude and horizontal position for a given duration. The duration of the step is the only input. The altitude is defined by the previous step, the horizontal position of the step is calculated from the previous step, and the horizontal speed is zero.
- **Idle With Ground Support:** This step is used to maintain ground idle for a given duration. The duration of the step is the only input. The altitude is zero, the horizontal position of the step is calculated from the previous step, and the horizontal speed is zero.
- **Idle Without Ground Support:** This step is used to maintain flight idle for a given duration. The duration of the step is the only input. The altitude is zero, the horizontal position of the step is calculated from the previous step, and the horizontal speed is zero. Note that the noise modeling data used for flight idle segments is different from the noise data used for ground idle segments (modeled by “Idle with Ground Support” steps).
- **Vertical Climb:** This step is used to maintain horizontal position while ascending to a final altitude over a given duration. The duration of the step and the final altitude are inputs. The horizontal position of the step is calculated from the previous step and the horizontal speed is zero.
- **Level Acceleration:** This step is used to accelerate to a final speed over a given distance. The track distance covered by the step and the final speed are inputs. The altitude and initial speed are defined by the previous step.
- **Ascending Acceleration:** This step is used to climb and accelerate to a final altitude and speed over a given distance. The track distance covered by the step, the final altitude, and the final speed are inputs. The initial altitude and speed are defined by the previous step.
- **Constant-Velocity Climb:** This step is used to climb at constant speed to a given altitude over a given distance. The track distance covered by the step and the final altitude are inputs. The initial altitude and speed are defined by the previous step.
- **Taxi:** This step is used to taxi at a given constant speed. The speed is the only input. The track distance is calculated based on the assigned taxi ground track, and the altitude is defined by the previous step. AEDT allows helicopters defined as having wheels to taxi at zero altitude. Helicopters defined as not having wheels must taxi at an altitude greater than zero.

Some helicopter procedure steps correlate with different helicopter flight operational modes (and therefore different NPD and directivity data) depending on their altitude. When constructing flight paths with the Hover, Dep Vertical, and App Vertical procedure steps, AEDT calculates the ground effect altitude as follows:

$$A_{GE} = 1.5 \cdot D_{MR} \quad \text{Eq. 3-60}$$

where

A_{GE} Ground effect altitude (ft AFE); and
 D_{MR} Main rotor diameter (ft, an input parameter).

If the procedure step stays below the ground effect altitude, the resulting trajectory segment is assigned the corresponding flight operational mode with ground effect. If the step stays at or above the ground effect altitude, the resulting trajectory segment is assigned the corresponding flight operational mode without ground effect. If a given Vertical Climb or Vertical Descent procedure step crosses the ground effect altitude, AEDT automatically divides the step into two at the ground effect altitude and assigns flight operational modes to the two steps as appropriate.

AEDT does not correct for non-standard temperature and pressure when generating helicopter flight profiles. This means that the input values of altitude, speed, and duration are used exactly as specified regardless of the atmosphere defined.

3.6.4 Flight Path Calculation

3.6.4.1 3-D Flight Path Construction

A three-dimensional flight path is constructed by merging a two-dimensional profile (a set of distance vs. altitude points) with a two-dimensional ground track (an ordered set of latitude, longitude points). Where there is a track point, a z-value is computed by interpolating between two points on the profile. Where there is a profile point, the (x, y) values are computed on the ground-track segment under the profile point. The result of this construction is an ordered set of (x, y, z) points and associated speed and thrust data that describe the flight path.

When a track point lies between two profile points, a linear interpolation method is used to calculate the altitude, speed, and thrust at that point:

$$z = z_1 + f \cdot (z_2 - z_1) \quad \text{Eq. 3-61}$$

$$v_t = v_{T_1} + f \cdot (v_{T_2} - v_{T_1}) \quad \text{Eq. 3-62}$$

$$\left(\frac{F_n}{\delta}\right) = \left(\frac{F_n}{\delta}\right)_1 + f \cdot \left[\left(\frac{F_n}{\delta}\right)_2 - \left(\frac{F_n}{\delta}\right)_1\right] \quad \text{Eq. 3-63}$$

$$\Delta v = v_{T_2} - v_{T_1} \quad \text{Eq. 3-64}$$

$$\Delta F = \left(\frac{F_n}{\delta}\right)_2 - \left(\frac{F_n}{\delta}\right)_1 \quad \text{Eq. 3-65}$$

where

z	Altitude at the interpolated point (ft AFE);
f	Fraction of the distance from profile point 1 to the interpolated point divided by the distance from profile point 1 to point 2 (dimensionless);
z_1, z_2	Initial and final profile altitudes (ft AFE);
v_t	Speed at the interpolated point (kt);
v_{T_1}, v_{T_2}	Initial and final profile point speeds (kt);
(F_n / δ)	Corrected net thrust per engine (lbf) at the interpolated point;
$(F_n / \delta)_1$	Initial profile point corrected net thrust per engine (lbf); and
$(F_n / \delta)_2$	Final profile point corrected net thrust per engine (lbf).

3.6.4.2 Flight Path Length Adjustments

After AEDT constructs the ordered set of flight path points, they are processed to remove points that are too close together. If two (x,y,z) points are closer than 10 ft, and if the speed and thrust data are the same, one of the points is removed from the set of points.

The last step in constructing a flight path is to insert points into segments that are too long. A path segment is subdivided if its length multiplied by the change in speed is greater than 100,000 ft-kts. The number of sub-segments is calculated by:

$$N = \text{int} \left(1 + \sqrt{\frac{(v_{T_2} - v_{T_1}) \cdot L}{100,000}} \right) \quad \text{Eq. 3-66}$$

where

- N Number of equal-distance sub-vectors (dimensionless);
- $\text{int}(x)$ Function that returns the integer part of a number x ; and
- L Length of the vector (ft).

If the flight path segment is subdivided, the speed and thrust values at the end points of the equal-distance sub-segments are linearly interpolated by using the initial and final end-point values.

3.6.4.3 Optional Taxi Segment

To facilitate the computation of emissions metrics due to gate to runway taxi operations, AEDT uses taxi time values to calculate a taxi segment for arrival, departure and circuit airplane operations. Taxi time values are user specified and can be defined by airport average and/or flight operation. If both airport average and flight operation times are defined and the appropriate emissions settings are enabled, two segments will be computed.

The taxi segment has the following properties:

- Depending on the operation type, the following are identical to the first or last segment of the calculated flight path:
 - Geographic location (latitude and longitude)
 - Elevation
 - Time Stamp
 - Weather parameters
- The segment duration is defined as the user specified taxi time.
- The fuel flow rate is calculated using the engine specific unadjusted idle fuel flow rate.
- Fuel burn is calculated by multiplying the fuel flow rate by the segment duration and the number of engines.

The number of engines can be configured in the AEDT graphical user interface (GUI) to use all engines to calculate taxi fuel burn and emissions, rather than computing single engine taxi.

3.6.5 Bank Angle Treatment

The AEDT bank angle calculation methods are based on the guidance provided in the ECAC Doc 29¹⁵ (B-8):

$$\varepsilon = \tan^{-1} \left(2.85 \frac{v_g^2}{rg} \right) \quad \text{Eq. 3-67}$$

where

ε	Bank angle (radians, positive in a left turn and negative in a right turn);
v_g	Ground speed (kts);
r	Turn radius (ft); and
g	Gravitational acceleration of Earth (ft/s ²).

There are two important assumptions inherent in this equation:

1. The aircraft is in a coordinated turn where the velocity vector is always aligned with the aircraft roll axis.
2. Speed and acceleration in the vertical plane is insignificant. The flight procedures typically used in close proximity to airports do not result in large speed and acceleration values in the vertical plane.

3.6.5.1 *Bank Angle Smoothing and Filtering*

AEDT attempts to remove fluctuations in the bank angle through a sequence of smoothing, filtering, and limiting steps. The process is as follows:

1. Interpolate to stations every 0.5 nmi along the track.
2. Apply exponential smoothing.
3. Filter out fluctuations about zero.
4. Interpolate back onto original stations.
5. Apply upper limit.

The process is illustrated in Figure 3-3.

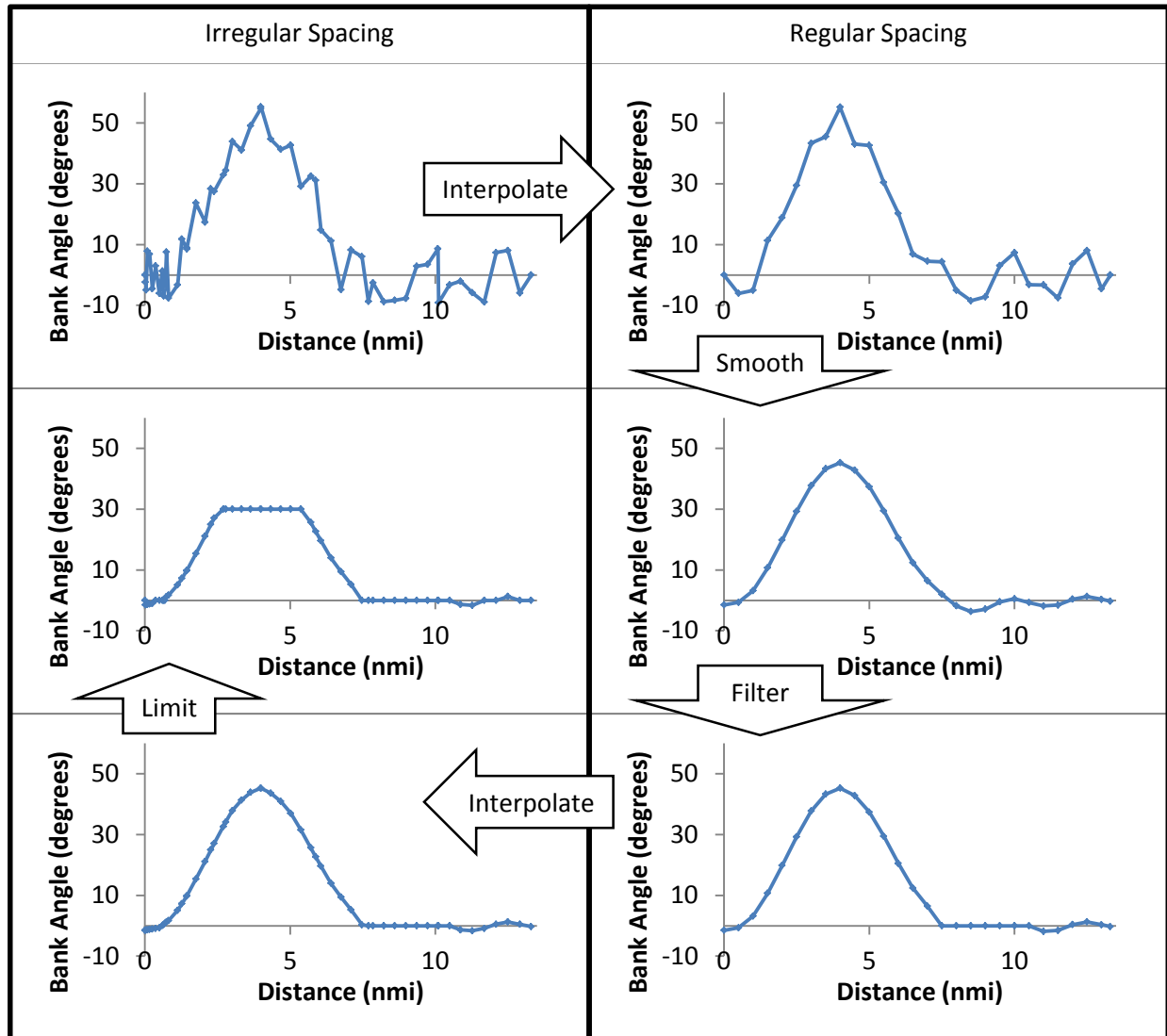

Figure 3-13 Example of Bank Angle Smoothing, Filtering, and Limiting

Interpolation at every 0.5 nmi leads to a collection of n bank angle samples, ϵ_i . The first sample ϵ_0 is at a distance of zero and has the same value as the original first bank angle. The last sample ϵ_{n-1} is at the same distance as the original last bank angle, and has the same value (unlike the rest of the samples, the spacing between the last sample and its predecessor is not 0.5 nmi).

Exponential smoothing is similar to a moving average except that points are weighted exponentially. The smoothed value is calculated recursively as follows:

$$\epsilon_{si} = (1 - b) \cdot \epsilon_i + b \cdot \epsilon_{si-1} \tag{Eq. 3-68}$$

where

- ϵ_{si} Smoothed bank value at index i ;
- b Smoothing parameter (dimensionless);
- ϵ_i Unsmoothed bank value at index i ; and
- ϵ_{si-1} Smoothed value at index $i - 1$.

The smoothing parameter b can have a range of values between 0 and 1. At $b = 0$ there is no smoothing, and at $b = 1$ all of the smoothed values are equal to the initial value. Between b values of 0 and 1, there are varying degrees of smoothing. The parameter is selected automatically in AEDT by using a variant of the signal to noise ratio on the calculated bank. The fluctuation magnitude N is defined as:

$$N = \frac{\text{median}(|\text{diff}(\varepsilon)|)}{\text{stdev}(\varepsilon)} \quad \text{Eq. 3-69}$$

where

stdev Standard deviation and
diff Point-by-point difference:

$$\text{diff}(\varepsilon_i) = \varepsilon_{i+1} - \varepsilon_i$$

Once fluctuation magnitude is calculated, the smoothing parameter is set to the smaller of two values:

$$b = \min(0.25 \cdot N, 0.5) \quad \text{Eq. 3-70}$$

This step limits the smoothing value to be between 0 and 0.5 regardless of maximum fluctuation magnitude.

The smoothing process is repeated ten times, forward and backward. The backward step removes biases introduced in the forward step. Repeated smoothing with a lower b value tends to reject high-frequency fluctuations more effectively than smoothing once with a higher b value.

After smoothing, the bank angles are filtered to ensure that data are compatible with typical flight operations. If the bank changes sign twice within a 30-second window, it is set to zero over the entire window. This step removes high-frequency oscillations caused by fluctuating data while preserving the actual aircraft banking.

After the bank angles are interpolated back from the smoothed and filtered equally spaced samples to the original path points, the final step is to limit bank angle values. If a bank angle has a magnitude less than 1 degree, it is set to zero degrees. If a bank angle exceeds a limit (+/- 30 degrees), it is set to the limit value. Large bank angles may indicate a flight path with unrealistic combinations of turn radii and airspeed. If the flight path uses a points-type track, fluctuations in the track data may result in unrealistically fluctuating turning radii and extreme bank angle fluctuations. If the smoothing and filtering process fails to eliminate such fluctuations, users may improve their results by replacing the points-type track with a vector track. Turning radii in vector tracks are specified by the user, therefore all fluctuation can be removed.

3.6.5.2 Bank Angle Performance Effects

Aircraft banking affects flight performance because a portion of the aircraft's lift is directed horizontally instead of vertically. Aircraft performance is calculated under the assumption that the aircraft is not banking, so the calculated aircraft flight path must be adjusted to be consistent with banking.

3.6.5.2.1 Common Elements

Regardless of operation type, the adjustment for aircraft banking begins by calculating, for each segment, the drag to lift ratio and acceleration. Acceleration follows from initial and final segment speed along with segment length, according to uniform acceleration. Drag to lift ratio (dimensionless) comes from the force balance:

$$R_f = \frac{\left(\frac{F_n N \delta}{\delta W} - \frac{a}{g} - \sin \gamma_A\right)}{\cos \gamma_A} \quad \text{Eq. 3-71}$$

where

$\frac{F_n}{\delta}$	Corrected net thrust per engine (lbf);
N	Number of engines (dimensionless);
δ	Pressure ratio (dimensionless);
W	Aircraft weight (lbf);
a	Acceleration along the flight path (ft/s ²);
g	Gravitational acceleration of Earth (ft/s ²); and
γ_A	Climb angle in the still-air frame of reference.

3.6.5.2.2 Approach

To account for the effects of bank angle on approach flight paths, AEDT increases thrust so that forces (thrust, drag, lift, and weight) are still in balance with banking effects in place. The initial thrust for each flight path segment $F_n/d1$ is recalculated using the following force balance equation:

$$F = \left(\frac{a}{g} + \frac{R_f}{\cos(\varepsilon)} \cos \gamma_A + \sin \gamma_A\right) W \quad \text{Eq. 3-72}$$

where

R_f	Drag to lift ratio (dimensionless); and
ε	Bank angle.

3.6.5.2.3 Departure

To account for the effects of bank angle on departure flight paths, AEDT reduces the climb angle and speed in order to balance the forces. Thrust and acceleration are not altered. Note that the reduced speed results in a reduced bank angle because bank is a function of speed, so it is recalculated. The climb angle with banking effects is calculated by solving:

$$R_f \cdot \frac{\cos \gamma_2}{\cos \varepsilon_1} + \sin \gamma_2 = R_f \cdot \cos \gamma_1 + \sin \gamma_1 \quad \text{Eq. 3-73}$$

where

ε_1	Aircraft bank angle at start of segment after smoothing and filtering;
γ_1	Climb angle without banking effects; and
γ_2	Climb angle with banking effects.

The new segment length L_{new} (ft) is calculated as follows:

$$L_{new} = L \frac{\cos \gamma_1}{\cos \gamma_2} \quad \text{Eq. 3-74}$$

where

L Length (ft) without banking effects.

Acceleration is held constant, so the new segment length must coincide with a change in endpoint speed to maintain consistency:

$$v_2^2 - v_1^2 = 2aL_{new} \quad \text{Eq. 3-75}$$

where

a Aircraft acceleration along the velocity vector (ft/s²);
 v_1 Aircraft true airspeed at start of vector (ft/s); and
 v_2 Aircraft true airspeed at end of vector (ft/s).

The vector speed along the horizontal plane v_g (ft/s) is then:

$$v_g = \frac{v_1 + v_2}{2} \cos \gamma_2 \quad \text{Eq. 3-76}$$

The segment speed can be used with Eq. 3-18 to calculate a new bank angle at the end of the segment, ϵ_2 .

3.7 Trajectory-Driven Flight Performance

Trajectory based flight performance is a subsection of aircraft performance in AEDT that allows for deviation from standard AEDT profiles and allows for much more freedom in choosing how an aircraft should fly. It is particularly useful for modeling situations where standard profiles do not accurately represent actual routes taken by aircraft. By defining points along the trajectory that the aircraft must pass through, operations can be modeled to fly more meaningful routes.

There are two types of trajectory-based inputs that can drive flight performance in AEDT: altitude controls and sensor paths. Flights driven by altitude controls are discussed in Section 3.7.1. Flights driven by sensor paths are discussed in Section 3.7.2.

3.7.1 Altitude Control Flights

Altitude controls are one type of trajectory-based input that can drive AEDT flight performance. They allow specification of precise 3-dimensional locations to be reached along the flight path. An altitude control defines rules for what an aircraft's altitude should and should not be as it passes over a particular track point. Specifically, it establishes a target altitude that an aircraft should try to reach as it passes over the track point, as well as restricted altitude ranges that the aircraft is not allowed to occupy as it passes over the track point. Note that track points are not required to have altitude controls associated with them, and only one altitude control can be assigned to a given track point. Also, although the ASIF input schema supports associating a speed with a track node in the same way that control altitudes are associated, these speeds do not affect performance calculations.

As mentioned, an altitude control is composed of a target and restrictions. In AEDT, the restriction aspect of an altitude control is derived from the target aspect (that is, the bounds of restricted altitude ranges are a function of the target altitude). AEDT supports three types of altitude restrictions:

1. “At” controls restrict the aircraft from being more than 300 ft from the target altitude when passing over the track point.
2. “AtOrAbove” controls restrict the aircraft from being more than 300 ft below the target altitude when passing over the track point.
3. “AtOrBelow” controls restrict the aircraft from being more than 300 ft above the target altitude when passing over the track point.

The three different restriction types are illustrated in Figure 3-9. This figure also illustrates that the 300ft buffers described above function as “tolerances” within which aircraft can miss target altitudes without entering restricted altitude ranges. Note that this tolerance of 300ft is fixed in AEDT, and cannot be changed by the user.

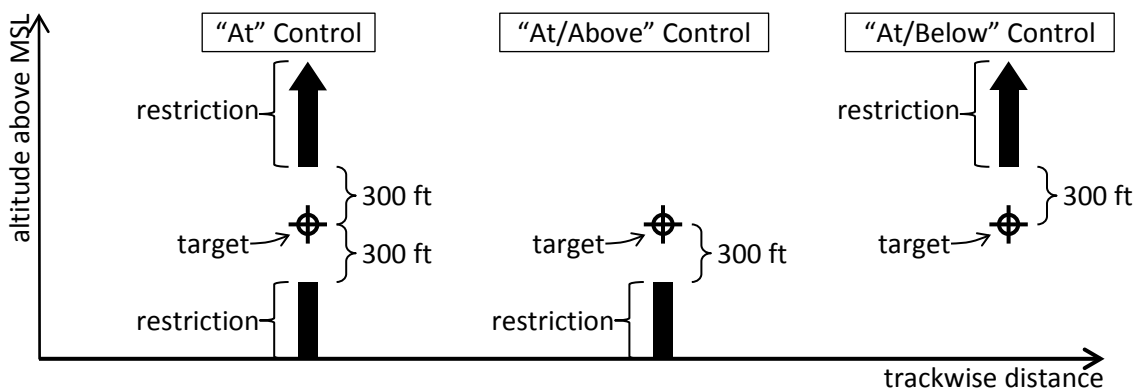

Figure 3-9 Altitude Controls

Additional notes about altitude controls include:

1. Controls specifying altitudes below 500 ft AFE are ignored by AEDT. That is, assigning a control targeting an altitude below 500 ft AFE is equivalent to assigning no control at all; no targets or restrictions are applied to aircraft altitude at the associated geographic location.
2. Controls on the first point in a departure track (corresponding to the beginning of takeoff ground roll) are ignored by AEDT.
3. Controls on the last two points in an approach track (corresponding to the approach threshold and the other runway end) are ignored by AEDT.
4. An aircraft must have procedural standard profiles in order to be used with a track that includes altitude controls. An error is generated during performance processing if this rule is violated.
5. Overflight tracks containing altitude controls must have a minimum of two altitude controls above 500 ft AFE. An error is generated during performance processing if this rule is violated.
6. Approach tracks cannot have sequentially ascending altitude control targets.
7. Departure tracks cannot have sequentially descending altitude control targets.
8. Altitude controls of type AtOrBelow are interpreted during performance processing as though their target altitude is the lesser of their given target altitude and the aircraft’s maximum BADA operating altitude. This interpretation is illustrated in Figure 3-10. Note that this is done

whether the specified target is in the terminal area or en-route. Also note that there are no analogous treatments for the other control types.

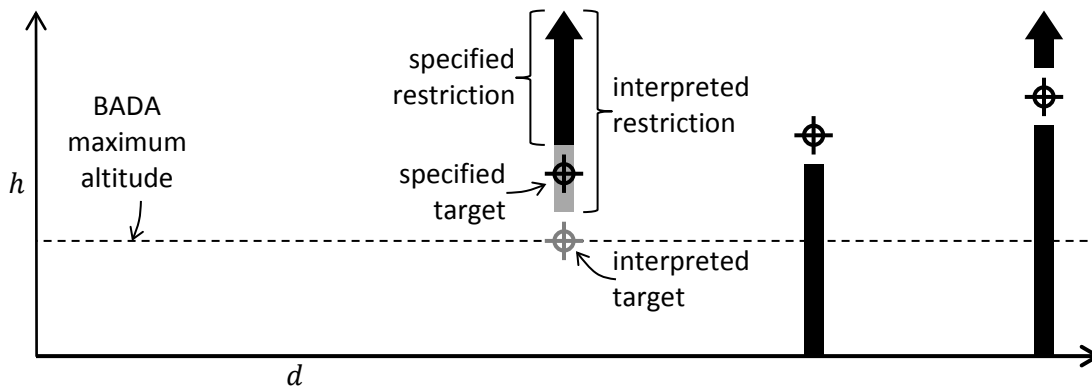

Figure 3-10 Effect of BADA Maximum Altitude on Interpretation of “AtOrBelow” Controls

AEDT calculates trajectories to match altitude control targets as closely as possible, within the limits of the given aircraft’s performance characteristics, and in the context of the defined atmospheric conditions. When a control’s altitude restrictions are violated due to aircraft performance limitations, AEDT issues an error message, and the flight’s trajectory is discarded and excluded from environmental impact calculations; in order to include the flight’s impact, the user must modify altitude controls as necessary to allow the restrictions to be met, assign a different airplane that can meet the restrictions, modify the airplane’s performance characteristic to enable it to meet the restrictions, or employ a combination of these strategies. Note that an airplane must feature BADA performance data, as well as ANP performance data including procedural profiles (some airplanes have only fixed-point ANP profiles) in order to be used in conjunction with altitude controls.

AEDT computes control-driven flight performance according to two performance specifications: SAE-AIR-1845⁵⁹ and BADA. SAE-AIR-1845⁵⁹ is nominally used to model performance below 10,000 ft AFE, while BADA is used above that altitude (there are exceptions to this rule in the case of overflight operations). The different methodologies used for each performance specification are detailed in Section 3.7.1.2 (SAE-AIR-1845⁵⁹) and 3.7.1.3 (BADA).

3.7.1.1 Overall Algorithm

When altitude controls are present, first the flight path is calculated from the procedure as though there are no controls, as described in Section 3.6. This “standard” flight path is then modified to match the control targets as closely as possible, with flight dynamics first modeled according to SAE-AIR-1845/Doc 29 up to 10,000 ft, and then according to BADA thereafter.

3.7.1.2 SAE-AIR-1845/Doc 29 Control Target Matching

Points in the standard flight path are retained or discarded based on the properties of the altitude control that is closest to the runway. Points are retained if they are closer to the runway than that control by at least 1000 ft, and if their altitude is lower than the control’s target altitude. Points which do not meet both of these criteria are discarded. Figure 3-11 illustrates which standard flight path points are preserved.

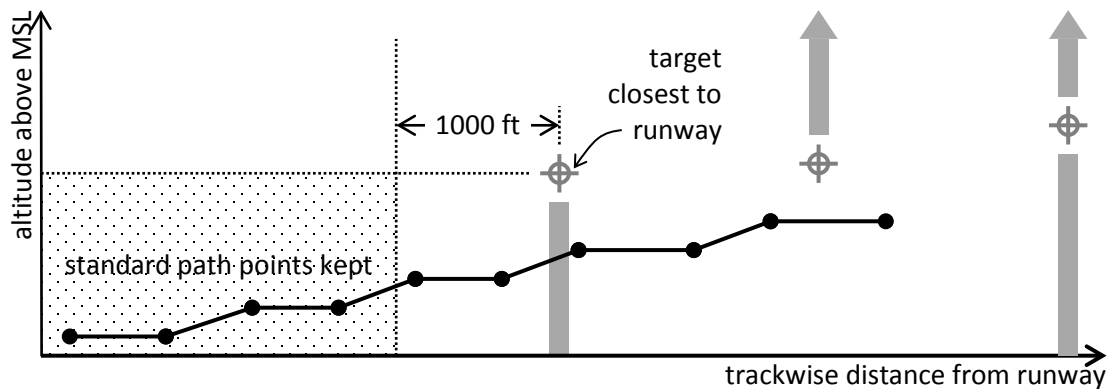

Figure 3-11 Preserved Portion of Standard Path in Altitude-Controlled Flights

If the entire preserved portion of the standard flight path is below 10,000 ft, performance beyond the preserved content is calculated nominally according to the SAE-AIR-1845/Doc 29 specification up to 10,000 ft. For each control, working trackwise away from the runway, the flight is computed to the associated target distance and as close as possible to the target altitude, as described in Section 3.7.1.2.1. If the achieved altitude does not violate the restriction posed by the altitude control, analysis of the flight proceeds to the next control. If the airplane altitude reaches or exceeds 10,000ft at any control, the result is truncated at 10,000 ft as necessary, and SAE-AIR-1845/Doc 29 control target matching ends.

3.7.1.2.1 Analysis of Flight to or from an Altitude Control

At the beginning of analysis for any control, the following quantities are known:

- h_T is the target altitude
- d_T is the target track coordinate
- h_L is the latest altitude
- d_L is the latest track coordinate
- R_L is the latest drag-to-lift ratio
- v_{C_L} is the latest CAS
- t_L is the latest time

The drag-to-lift ratio to use for the step, R , is chosen according to the flap schedule, based on R_L and v_{C_L} , the radius of curvature, and the aircraft course, Φ , to be used for the step sampled at d_L . The latest aircraft latitude, φ_L , and the latest aircraft longitude, λ_L , are also sampled at d_L . The latest weather conditions are sampled at $\{t_L, \varphi_L, \lambda_L, h_L\}$. The latest true airspeed, v_{A_L} , is calculated from latest weather and v_{C_L} . The target step height is given by:

$$\Delta h_T = h_T - h_L \quad \text{Eq. 3-77}$$

The target step trackwise length is:

$$\Delta d = |d_T - d_L| \quad \text{Eq. 3-78}$$

AEDT determines the closest achievable altitude at the target distance by calculating the thrust required for flight to a number of candidate altitudes and calibrated airspeeds, and comparing the required thrust to the thrust available. This is done in one of two ways, depending on the operation type, the latest state, the speed schedule, and the target altitude. If the operation is not an approach, target altitude is at or above the latest altitude, and the latest CAS is at or below the CAS scheduled at the latest altitude, then recursive bisection is used. Otherwise, progressive decimation is used.

3.7.1.2.1.1 Best-Effort Calculation through Recursive Bisection

This approach to determining the best effort to reach a control target can be broken into four phases. Note that in the descriptions of the phases that follow, when an altitude and CAS pair are “checked”, it means that they are tested together as a candidate final state as described in 3.7.1.2.2 to determine whether or not there is enough thrust available to reach them at the target distance. The four phases are as follows:

1. The target final altitude and the CAS scheduled are checked to determine whether or not they are supported by the available thrust. If so, they are selected as the final state, and the algorithm terminates. Otherwise, the latest altitude and CAS are checked to verify that they are supported; if not, the flight fails.
2. The interval between the latest altitude and the target altitude is searched, through recursive bisection, for the lowest final altitude at which the CAS scheduled there is unsupported by the available thrust (“lowest schedule-unsupported final altitude”). This is provisionally selected as the final altitude, subject to degradation as described in the next phase. Note that this process also identifies the highest final altitude at which the scheduled CAS is supported by the available thrust (“highest schedule-supported final altitude”), if it exists on the interval.
3. The latest CAS and the lowest schedule-unsupported final altitude are checked for support. If unsupported, then the final state is degraded to the highest schedule-supported final altitude, and the CAS scheduled there, terminating the algorithm.
4. At the lowest schedule-unsupported final altitude, the interval between the latest CAS and the CAS scheduled at that altitude is searched, through recursive bisection, for the highest final CAS that is supported. This altitude and CAS are then selected as the final state, and the algorithm terminates.

This process is illustrated in terms of the CAS schedule in Figure 3-12.

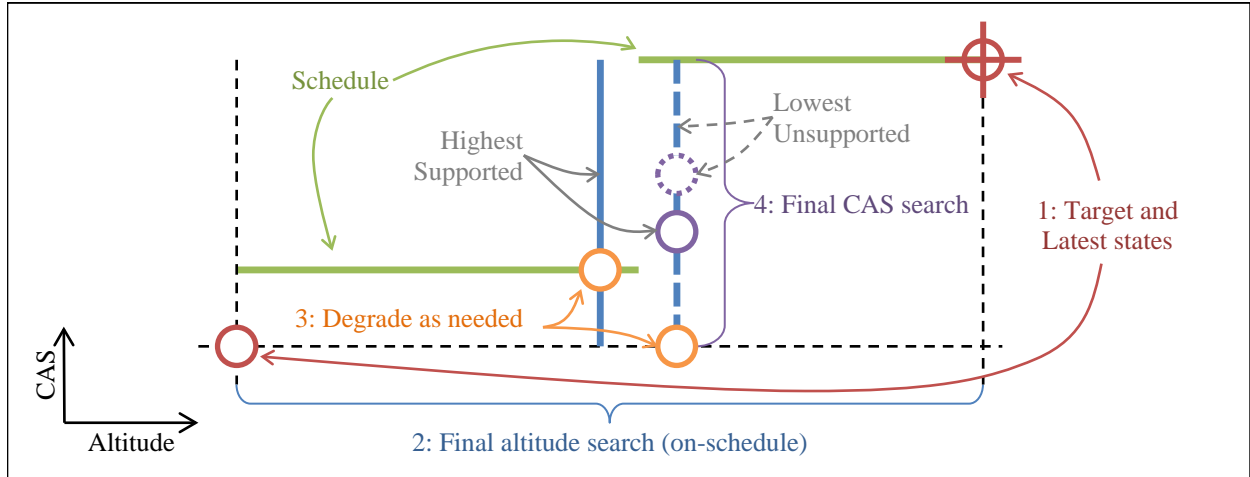

Figure 3-12 Phases of Best-Effort Calculation through Recursive Bisection

3.7.1.2.1.2 Best-Effort Calculation through Progressive Decimation

In this approach to determining the best effort reach the target altitude, the number of candidate altitudes, N , is given by:

$$N = \begin{cases} 1 & \text{if below is not allowed} \\ 11 & \text{otherwise} \end{cases} \quad \text{Eq. 3-79}$$

The j^{th} candidate altitude to be tested (j ranges from 0 to $N-1$) is:

$$h_{c_j} = h_T - \frac{j}{10} \Delta h_T \quad \text{Eq. 3-80}$$

For each candidate altitude, flight to that altitude and the target distance is calculated as described in Section 3.7.1.2.2.0. If the required thrust does not exceed the available thrust, then flight to the candidate is supported. If flight to any of the candidate altitudes is supported by available thrust, then the supported candidate that is closest to the target altitude is selected as the altitude for the aircraft at the track point. This process is illustrated for the case of an “AtOrBelow” control in Figure 3-13.

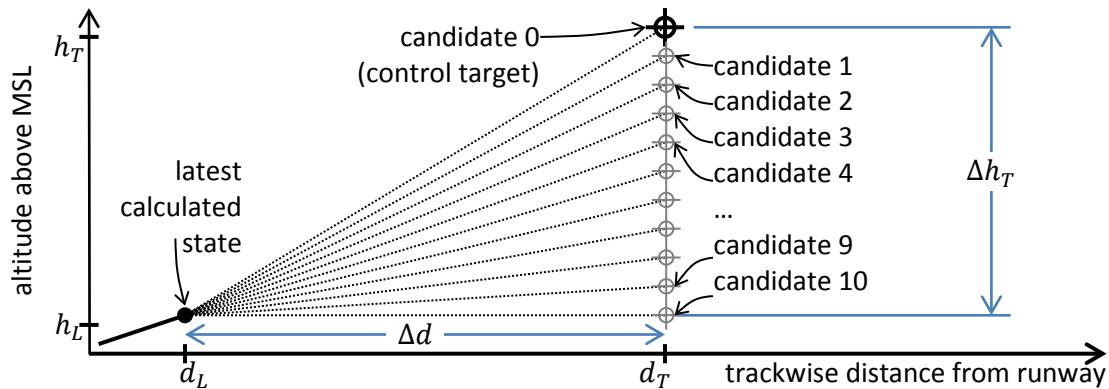

Figure 3-13 Candidate Altitudes for Flight To or From an “AtOrBelow” Altitude Control

3.7.1.2.2 Analysis of Flight to Candidate Altitude

At the beginning of analysis for any candidate altitude, latest altitude h_L and the candidate altitude h_C are known. The initial altitude, h_i is:

$$h_i = \begin{cases} h_C & \text{for approaches} \\ h_L & \text{otherwise} \end{cases} \quad \text{Eq. 3-81}$$

The final altitude h_f is:

$$h_f = \begin{cases} h_L & \text{for approaches} \\ h_C & \text{otherwise} \end{cases} \quad \text{Eq. 3-82}$$

The relationships that initial and final states have with latest and candidate states differs in this way because approach segments are processed in reverse temporal order as described earlier. These are illustrated in Figure 3-14 for departures and overflights, and in Figure 3-15 for approaches.

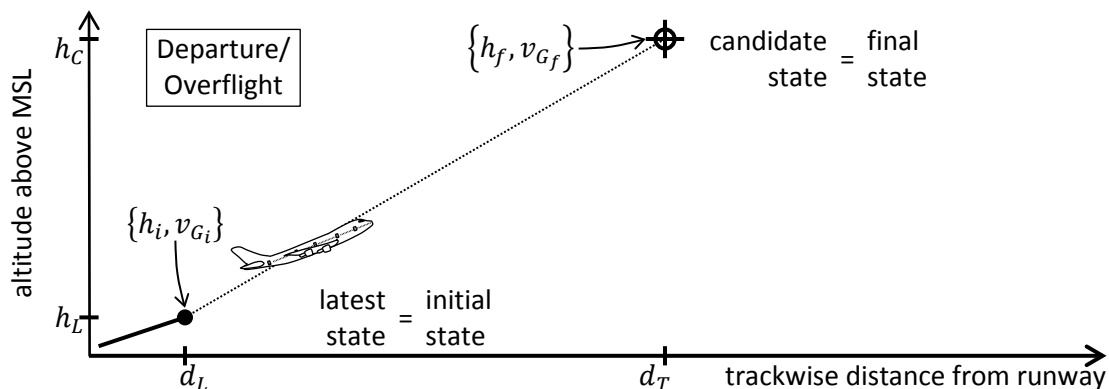

Figure 3-14 Relationships Between Initial, Final, Latest, and Candidate for Departures and Overflights

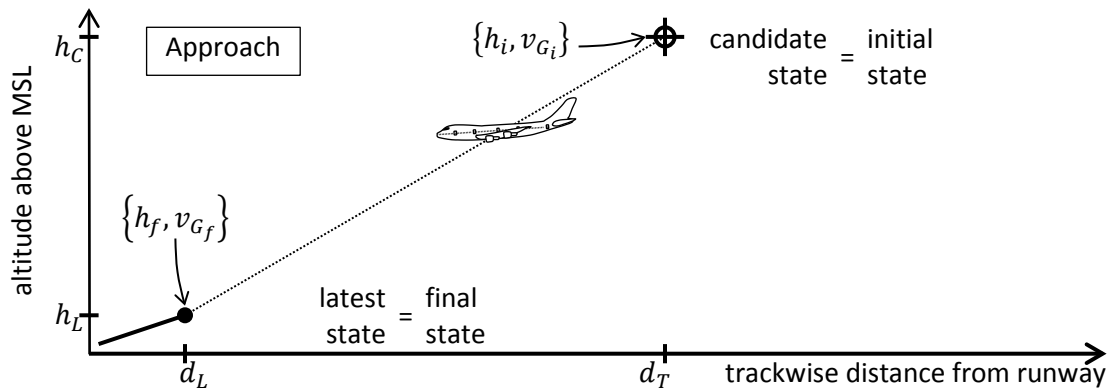

Figure 3-15 Relationships Between Initial, Final, Latest, and Candidate for Approaches

The candidate change in altitude is:

$$\Delta h = h_f - h_i \tag{Eq. 3-83}$$

Climb angle in the still-ground frame of reference is:

$$\gamma_G = \tan^{-1}(\Delta h / \Delta d) \tag{Eq. 3-84}$$

The latest groundspeed, v_{G_L} , is calculated from v_{A_L} , γ_G , Φ , and latest weather. The candidate CAS, v_{C_C} , is determined from CAS schedule based on h_C . The candidate weather conditions are sampled at $\{t_L, \phi_L, \lambda_L, h_C\}$. The candidate true airspeed, v_{A_C} , is calculated from candidate weather and v_{C_C} . The candidate groundspeed, v_{G_C} , is calculated from v_{A_C} , γ_G , Φ , and candidate weather. The initial groundspeed v_{G_i} is:

$$v_{G_i} = \begin{cases} v_{G_C} & \text{for approaches} \\ v_{G_L} & \text{otherwise} \end{cases} \tag{Eq. 3-85}$$

The final groundspeed v_{G_f} is:

$$v_{G_f} = \begin{cases} v_{G_L} & \text{for approaches} \\ v_{G_C} & \text{otherwise} \end{cases} \tag{Eq. 3-86}$$

The average groundspeed is:

$$\overline{v_G} = \frac{1}{2}(v_{G_i} + v_{G_f}) \tag{Eq. 3-87}$$

The pathwise step length is:

$$\Delta s = \sqrt{\Delta d^2 + \Delta h^2} \quad \text{Eq. 3-88}$$

The step duration is:

$$\Delta t = \Delta s / \bar{v}_G \quad \text{Eq. 3-89}$$

The step acceleration is:

$$a = \frac{v_{Gf}^2 - v_{Gi}^2}{2\Delta s} \quad \text{Eq. 3-90}$$

The bank angle, ε , is calculated from r and v_{GL} . The aircraft weight, W is taken from the procedural profile. The total thrust is determined by a force balance based on ECAC Doc29¹⁵ eq B20, with the aerodynamic term adjusted for bank angle:

$$F = W \left[R \frac{\cos \gamma_g}{\cos \varepsilon} + \sin \gamma_g + \frac{a}{g} \right] \quad \text{Eq. 3-91}$$

3.7.1.2.3 Speed Schedule

A speed schedule is an indication of how an airplane's calibrated airspeed should vary as a function of altitude. Airplane procedures provide information about the calibrated airspeeds at which the associated airplane might safely and realistically fly while in certain altitude ranges. For operations with altitude controls, AEDT analyzes the procedure to establish a speed schedule. The calibrated airspeeds used in performance calculations between controls are chosen in accordance with this schedule.

The construction of a flap schedule begins with the determination of the initial and final CAS and altitude for each step in the procedure, as outlined in Section 3.7.1.2.5 and Section 3.7.1.2.6. After the CAS and altitude progression for each procedure step has been established, the flap schedule construction process continues by defining a "bin" for each step. The bin is assigned the step's initial and final altitude and CAS, and its index within the procedure (the first step has index 1, the second has index 2, etc.). The resulting collection of bins constitutes the CAS schedule; for a given altitude, the scheduled CAS is interpolated from the values in the bin with the highest index among bins that contain that altitude.

3.7.1.2.4 Flap Schedule and Selection

A flap schedule is an indication of how an airplane's drag-to-lift ratio should vary as a function of calibrated airspeed. Airplane procedures provide information about the drag-to-lift ratios the associated airplane might realistically use while in certain CAS ranges. For operations with altitude controls, AEDT analyzes the procedure to establish a flap schedule. The drag-to-lift ratios used in performance calculations between controls are usually chosen in accordance with this schedule. Note, however, that

drag-to-lift ratio is never increased over the course of a departure operation, and is never reduced over the course of an approach operation.

The construction of a flap schedule begins with the determination of the initial and final CAS for each step in the procedure, as outlined in Section 3.7.1.2.5. After the CAS progression for each procedure step has been established, the flap schedule construction process continues by defining a “bin” for each step for which the drag-to-lift ratio is specified. The bin is assigned the step’s drag-to-lift ratio, its CAS range, and its index within the procedure (the first step has index 1, the second has index 2, etc.). Next, AEDT identifies all ranges of CAS that are not covered by bins. For each of these ranges, an additional bin is defined with that CAS range and the index and drag-to-lift ratio of the adjacent bin with the highest index. The resulting collection of bins constitutes the flap schedule; for a given CAS, the scheduled drag-to-lift ratio is the value from the bin with the highest index among bins that contain that CAS.

3.7.1.2.5 Procedural CAS Progression

Construction of CAS schedules and flap schedules requires determination of the progression of CAS over the course of the procedure. The amount of CAS information specified by a procedure step depends on the step type; steps may provide information about their initial CAS, final CAS, both, or neither. The nature of any CAS information provided also depends on the step type; CAS may be provided as a specific value (ex. 250 knots), as a conceptual value that can be computed (ex. “initial climb CAS” or “touch-down CAS”), or as a procedural notion (ex. “maintain current CAS”). CAS values are determined at the beginning and end of the procedure, as well as at the interface between each pair of adjacent procedure steps. Note that adjacent procedure steps can specify conflicting CAS information for the point at which they meet, in which case one or the other is chosen based on the order and types of the two steps.

To facilitate this determination, each type of step is assigned initial and final ranks that indicate how strongly any information from the step about that CAS value should be weighted. Ranks, from highest to lowest, are:

- Imposed
- Preferred
- Provided
- Allowed
- Unavailable

The initial and final CAS ranks associated with each step type are as follows:

Initial CAS Rank	Step Type	Final CAS Rank
Imposed	Takeoff ground roll	Imposed
Unavailable	Accelerate	Imposed
Allowed	Cruise climb	Imposed
Unavailable	Climb	Imposed
Preferred	Level	Provided

Initial CAS Rank	Step Type	Final CAS Rank
Preferred	Descend	Provided
Imposed	Landing ground roll	Unavailable
Imposed	Brake	Preferred

At each interface between two adjacent procedure steps, the CAS information from the higher-ranked step takes precedence over the lower-ranked step. For example, for a level step that is followed by a descend step, the level step's final CAS information is "Provided", whereas the descend step's initial CAS information is "Preferred"; the higher rank takes precedence, so the level step ends (and the descend step begins) at the descend step's initial CAS.

3.7.1.2.6 Procedural Altitude Progression

Construction of CAS schedules requires determination of the progression of altitude over the course of the procedure. The amount of altitude information specified by a procedure step depends on the step type; steps may provide information about their initial altitude, final altitude, both, or neither. The nature of any altitude information provided also depends on the step type; altitude may be provided as a specific value (ex. 1,000 ft), as a conceptual value that can be computed (ex. "on the ground"), or as a procedural notion (ex. "maintain current altitude"). Altitude values are determined at the beginning and end of the procedure, as well as at the interface between each pair of adjacent procedure steps. Note that adjacent procedure steps could specify conflicting altitude information for the point at which they meet, in which case one or the other is chosen based on the order and types of the two steps.

To facilitate this determination, each type of step is assigned initial and final ranks that indicate how strongly any information from the step about that altitude value should be weighted. Ranks, from highest to lowest, are

- Imposed
- Preferred
- Provided
- Allowed
- Unavailable

The initial and final altitude ranks associated with each step type are as follows:

Initial Altitude Rank	Step Type	Final Altitude Rank
Imposed	Takeoff ground roll	Imposed
Unavailable	Accelerate	Imposed
Allowed	Cruise climb	Imposed
Unavailable	Climb	Imposed
Preferred	Level	Imposed
Preferred	Descend	Unavailable
Imposed	Landing ground roll	Imposed

Initial Altitude Rank	Step Type	Final Altitude Rank
Imposed	Brake	Imposed

At each interface between two adjacent procedure steps, the altitude information from the higher-ranked step takes precedence over the lower-ranked step. For example, for a level step that is followed by a descend step, the level step's final altitude information is Imposed, whereas the descend step's initial altitude information is Preferred; the higher rank takes precedence, so the level step ends (and the descend step begins) at the level step's final altitude.

3.7.1.3 BADA Control Target Matching

BADA is used to simulate trajectories, or parts of trajectories, beyond the point where they first reach 10,000 ft AFE. Trajectory points calculated according to BADA are appended to any part of the trajectory computed by SAE-AIR-1845⁵⁹ (this includes the preserved portion of the standard procedure, as well as control-driven content up to 10,000 ft if there is any).

Fundamentally, AEDT uses BADA to model performance from one non-null altitude control to the next, regardless of the number of track segments in between those controls. As a result, AEDT with BADA does not "plan ahead" for upcoming changes in altitude and has no mechanism to change previously calculated points, unlike the SAE-AIR-1845⁵⁹ portion of AEDT which can adjust target points.

3.7.1.3.1 BADA General Discussion

This Section begins with an overview of the BADA performance model. This is followed by introductions to the fundamental elements of the BADA performance model.

3.7.1.3.1.1 Overview

BADA does not specify the overall structure of a flight (it could consist of any number of climb, cruise, and descent phases, arranged in any order). Instead, BADA provides performance calculation rules and modeling coefficients for each phase. For each phase type, a speed schedule is specified as a sequence of calibrated airspeeds with corresponding altitudes. Scheduled speeds increase with altitude. The maximum Mach number is also provided for each phase type. For the BADA weather model, each phase has a Mach transition altitude above which the maximum scheduled CAS is always limited by the maximum Mach number. BADA performance for a phase consists of any number (zero or greater) of constant-CAS steps below the Mach transition altitude, constant-Mach steps above Mach transition, and acceleration/deceleration steps.

Acceleration and deceleration steps below Mach transition serve to change CAS, whereas steps above Mach transition serve to change the Mach number. Since AEDT uses the BADA model primarily for en-route phases of flight, only the CAS scheduled for the en-route phase is used. Transitions between scheduled CAS values are therefore not encountered. Acceleration/deceleration steps are only performed to transition between two BADA phases, or between a BADA phase and the ECAC Doc 29¹⁵ model.

3.7.1.3.1.2 Mach Transition Altitude

Mach transition altitude for a phase is calculated for a given CAS and Mach number by the equation:

$$h_M = \left[1 - \frac{\left(\left[1 + \left(\frac{\gamma-1}{2} \right) \left(\frac{V}{V_{SSLISA}} \right)^2 \right]^{\frac{\gamma}{\gamma-1}} - 1 \right)^{\frac{\alpha_{ISA} R}{g}}}{\left[1 + \frac{\gamma-1}{2} M^2 \right]^{\frac{\gamma}{\gamma-1}} - 1} \right] \frac{T_{SL}}{\alpha_{ISA}} \quad \text{Eq. 3-92}$$

where

γ	Isentropic expansion coefficient for air 1.4 (dimensionless);
R	Real gas constant for air $287.04 \text{ m}^2/\text{K}/\text{s}^2$;
V	Calibrated airspeed (kt);
V_{SSLISA}	Atmospheric speed of sound at sea level in an ISA (kt);
M	Aircraft Mach number (dimensionless);
α_{ISA}	ISA temperature lapse rate 0.0065 (K/m) ;
g	Gravitational acceleration of Earth (m/s^2); and
T_{SL}	Atmospheric temperature at sea level (K).

The tropopause altitude h_t (m) is calculated from:

$$h_t = h_{tISA} + \frac{\Delta T_{ISA SL}}{\alpha_{ISA}} \quad \text{Eq. 3-93}$$

where

h_{tISA}	ISA tropopause altitude (m); and
$\Delta T_{ISA SL}$	Sea-level temperature deviation from ISA (K).

Note that AEDT calculates the sea-level temperature T_{SL} (K) by sampling the temperature at the associated airport and lapsing to sea-level:

$$T_{SL} = T_{airport} + \alpha_{ISA} h_{airport} \quad \text{Eq. 3-94}$$

where

$h_{airport}$	Airport elevation (m); and
$T_{airport}$	Atmospheric temperature at the airport elevation (K).

The temperature deviation from ISA follows directly as discussed in Section 3.3.1.2.

Also note that the calculation of Mach transition altitude is based on a lapsed weather model, similar to those discussed in Section 3.3.2.1. Because of this simplification, the actual weather at Mach transition can differ from the assumed weather if high-fidelity weather module is in use. As a result of this, there can be a discontinuity of several knots in the speed profile at the Mach transition.

3.7.1.3.1.3 BADA Energy Share

BADA makes use of an energy share factor when climbing or descending. The energy share factor is used to dictate how much of the available thrust is used towards climbing or descending and how much is used for forward thrust. The energy share is determined by the altitude regime currently being modeled. Using constant CAS, below the Mach transition altitude and below the tropopause the energy share, $f\{M\}$, is calculated via:

$$f\{M\} = \left\{ 1 + \frac{\gamma \cdot R \cdot k_T}{2 \cdot g} \cdot M^2 + \left(1 + \frac{\gamma - 1}{2} \cdot M^2 \right)^{\frac{-1}{\gamma - 1}} \left\{ \left(1 + \frac{\gamma - 1}{2} \cdot M^2 \right)^{\frac{\gamma}{\gamma - 1}} - 1 \right\} \right\}^{-1} \quad \text{Eq. 3-95}$$

where

k_T ISA temperature gradient with altitude, $-0.065 \times 10^{-1} \text{K/m}$

When above the tropopause, but below the Mach transition altitude, and using constant CAS, a different equation is used, as follows.

$$f\{M\} = \left\{ 1 + \left(1 + \frac{\gamma - 1}{2} \cdot M^2 \right)^{\frac{-1}{\gamma - 1}} \left[\left(1 + \frac{\gamma - 1}{2} \cdot M^2 \right)^{\frac{\gamma}{\gamma - 1}} - 1 \right] \right\}^{-1} \quad \text{Eq. 3-96}$$

When below the tropopause at constant Mach, the equation below is used.

$$f\{M\} = \left[1 + \frac{\gamma \cdot R \cdot k_T}{2 \cdot g} M^2 \right]^{-1} \quad \text{Eq. 3-97}$$

Constant Mach above the tropopause uses the following equation:

$$f\{M\} = 1.0 \quad \text{Eq. 3-98}$$

Finally, in cases where neither constant CAS nor constant Mach is used, the energy share factors are given by the following:

Acceleration in climb $f\{M\} = 0.3$

Deceleration in descent $f\{M\} = 0.3$

Deceleration in climb $f\{M\} = 1.7$

Acceleration in descent $f\{M\} = 1.7$

3.7.1.3.1.4 Drag

Drag D (N) is calculated from:

$$D = \left[C_{D0,CR} + C_{D2,CR} \left(\frac{mg}{\frac{1}{2}\rho V_T^2 S \cos \varepsilon} \right)^2 \right] \frac{1}{2} \rho V_T^2 S \quad \text{Eq. 3-99}$$

where

$C_{D0,CR}$	Parasitic drag coefficient in cruise configuration (dimensionless);
$C_{D2,CR}$	Induced drag coefficient in cruise configuration (dimensionless);
ε	Bank angle (radians);
S	Reference wing surface area (m ²);
m	Aircraft mass (kg);
ρ	Atmospheric density (kg/m ³); and
V_T	Aircraft true airspeed (m/s).

3.7.1.3.1.5 Thrust

With enough information, thrust can be calculated through an energy balance:

$$F = m \left(\frac{g}{V_T} \frac{dh}{dt} + a \right) + D \quad \text{Eq. 3-100}$$

or

$$F = \left[\frac{m \cdot g}{f\{M\} \cdot V_T} \right] \cdot \frac{dh}{dt} + D \quad \text{Eq. 3-101}$$

where

F	Aircraft total net thrust (N);
D	Aircraft drag (N);
a	Aircraft acceleration (m/s ²);
$\frac{dh}{dt}$	Aircraft climb rate (m/s); and
$f\{M\}$	Energy share.

Maximum total net thrust during climb in an ISA is given by:

$$F_{m_{cISA}} = \begin{cases} C_{Tc1} \times \left(1 - \frac{h}{C_{Tc2}} + C_{Tc3} \times h^2 \right) \text{ (jet)} \\ C_{Tc1} \times \left(1 - \frac{h}{C_{Tc2}} \right) / V_T + C_{Tc3} \text{ (turboprop)} \\ C_{Tc1} \times \left(1 - \frac{h}{C_{Tc2}} \right) + \frac{C_{Tc3}}{V_T} \text{ (piston)} \end{cases} \quad \text{Eq. 3-102}$$

where

h	Aircraft altitude above mean sea level (ft);
$C_{Tc,1}$	1st max climb thrust coefficient (N for jet or piston, kN for turboprop);
$C_{Tc,2}$	2nd max climb thrust coefficient (ft); and
$C_{Tc,3}$	3rd max climb thrust coefficient (ft ² for jet, N for turboprop, kN for piston).

The maximum total net thrust during climb F_{m_c} (N) for all weather contexts is given by:

$$F_{m_c} = \left(1 - C_{Tc5} \Delta T_{ISA_{eff}}\right) F_{m_{cISA}} \quad \text{Eq. 3-103}$$

with

$$\Delta T_{ISA_{eff}} = \Delta T_{ISA} - C_{Tc,4} \quad \text{Eq. 3-104}$$

and the limitations that

$$0.0 \leq C_{Tc5} \cdot \Delta T_{ISA_{eff}} \leq 0.4 \quad \text{Eq. 3-105}$$

and

$$C_{Tc5} \geq 0.0 \quad \text{Eq. 3-106}$$

where

- ΔT_{ISA} Atmospheric temperature deviation from ISA (K);
- $C_{Tc,4}$ 1st thrust temperature coefficient (K); and
- $C_{Tc,5}$ 2nd thrust temperature coefficient (K⁻¹).

The standard reduced total climb thrust F_{r_c} (N) is:

$$F_{r_c} = D + (F_{m_c} - D) \left(1 - C_{red} \cdot \frac{m_{max} - m}{m_{max} - m_{min}}\right) \quad \text{Eq. 3-107}$$

where

- m_{max} aircraft's maximum mass (kg);
- m_{min} aircraft's minimum mass (kg);
- C_{red} reduction coefficient (dimensionless) determined by the BADA aircraft engine type:

$$C_{red} = \begin{cases} 0.15(\text{jet}) \\ 0.25(\text{turboprop}) \\ 0.0(\text{piston}) \end{cases}$$

The maximum total net thrust during cruise F_{m_v} (N) is:

$$F_{m_v} = C_{Tcr} F_{m_c} \quad \text{Eq. 3-108}$$

where

- F_{m_c} Aircraft maximum total net thrust in climb (N) and
- C_{Tcr} Maximum cruise thrust coefficient 0.95 (dimensionless).

The standard total net thrust during descent F_{m_D} (N) is:

$$F_{m_D} = \begin{cases} C_{TD_{hi}} F_{m_c} (h > h_{des}) \\ C_{TD_{lo}} F_{m_c} (h \leq h_{des}) \end{cases} \quad \text{Eq. 3-109}$$

where

- $C_{TD_{lo}}$ Low altitude descent thrust coefficient (dimensionless);

$C_{TD_{hi}}$ High altitude descent thrust coefficient (dimensionless); and
 h_{des} Transition altitude for calculation of descent thrust (ft).

3.7.1.3.1.6 Speed and Altitude Limits

The maximum altitude achievable by the aircraft h_m (ft) is given by:

$$h_m = \min[h_{MO}, h_{max_0} + (\Delta T_{ISA} - C_{TC,A})G_t + (m_{max} - m)G_w] \quad \text{Eq. 3-110}$$

where

h_{max_0} Maximum altitude at MTOW under ISA conditions for maximum mass (allowing residual 300fpm ROC) (ft);
 h_{MO} Maximum operational height above sea level (ft);
 G_w Mass gradient on maximum altitude (ft/kg);
 G_t Temperature gradient on maximum altitude (ft/K);
 m_{max} Maximum mass (kg);
 $C_{TC,A}$ 1st thrust temperature coefficient (K);
 m Aircraft mass (kg); and
 ΔT_{ISA} Atmospheric temperature deviation from ISA (K).

The minimum calibrated airspeed in cruise $V_{min_{CR}}$ (kt) is calculated from:

$$V_{min_{CR}} = C_{Vmin} \cdot V_{stall_{CR}} \quad \text{Eq. 3-111}$$

where

C_{Vmin} Minimum speed coefficient in non-take-off configuration (dimensionless); and
 $V_{stall_{CR}}$ Aircraft's stall speed in cruise configuration (kt).

3.7.1.3.1.7 True Airspeed, Calibrated Airspeed and Mach Number

In the context of BADA, true airspeed V_T (m/s) is related to a given calibrated airspeed according to:

$$V_T = \sqrt{\frac{2}{\mu} \cdot \frac{P}{\rho} \left\{ \left(1 + \frac{P_{0ISA}}{P} \cdot \left[\left(1 + \frac{\mu}{2} \cdot \frac{\rho_{0ISA}}{P_{0ISA}} \cdot V^2 \right)^{1/\mu} - 1 \right] \right)^\mu - 1 \right\}} \quad \text{Eq. 3-112}$$

where

ρ Atmospheric density (kg/m³);
 P Atmospheric pressure (N/m²);
 P_{0ISA} ISA sea-level pressure (N/m²);
 ρ_{0ISA} ISA sea-level density (kg/m³);
 V Aircraft calibrated airspeed (m/s); and
 μ Ratio of gas constant to specific heat at constant pressure (dimensionless):

$$\mu = \frac{\gamma - 1}{\gamma}$$

where

γ Isentropic expansion coefficient for air, 1.4 (dimensionless).

Calibrated airspeed V (m/s) is therefore determined from true airspeed by:

$$V = \sqrt{\frac{2}{\mu} \cdot \frac{P_{0ISA}}{\rho_{0ISA}} \left\{ \left(1 + \frac{P}{P_{0ISA}} \cdot \left[\left(1 + \frac{\mu}{2} \cdot \frac{\rho}{P} \cdot V_T^2 \right)^{1/\mu} - 1 \right] \right)^\mu - 1 \right\}} \quad \text{Eq. 3-113}$$

Mach number is related to true airspeed by:

$$V_T = M \cdot \sqrt{\gamma \cdot R \cdot T} \quad \text{Eq. 3-114}$$

where

V_T Aircraft true airspeed (m/s);
 R Real gas constant for air $287.04 \text{ m}^2/\text{K} / \text{s}^2$;
 T Atmospheric temperature (K); and
 M Aircraft Mach number (dimensionless).

3.7.1.3.2 En-Route Recalculation for Departure Operations

The calculation of the en-route portion of departures begins with determining what calibrated airspeed (CAS) and maximum Mach number should characterize the climbout phase. The climbout CAS is taken to be the larger of the aircraft's BADA en-route climbout CAS and the CAS at the SAE-AIR-1845-BADA transition point discussed in Section 3.7.1.4.1. Likewise, the maximum Mach number is taken to be the larger of the aircraft's BADA en-route climbout maximum Mach number and the Mach number at the SAE-AIR-1845-BADA transition point.

Departure operations cannot have descending altitude control to altitude control steps, so AEDT checks that all departure steps will be either climb or level steps. Recalculation of the en-route flight profile begins from the SAE-AIR-1845-BADA transition point and continues to each successive altitude control further along the track with an altitude greater than 10,000 ft. Each control constitutes a target altitude and distance, to be reached from the latest calculated state (distance, altitude, speed, thrust, etc.). For the performance calculations for each target, the headwind is fixed to its value at the latest calculated location and time, and the atmospheric thermodynamic profiles are fixed to the profiles at the latest calculated geographic coordinate and time. Under these conditions, a profile is calculated according to the BADA specification to the target distance, with adjustments made to energy share and thrust to come as close as possible to the target altitude. If the aircraft state at the target distance does not meet the constraint imposed by the altitude control, the flight fails, and AEDT issues a message accordingly.

The profile calculated to each target is comprised of one or more steps. The latest calculated state is compared to the en-route climb parameters to determine an appropriate step type and limiting values for clipping (by interpolation). If the latest CAS is less than the climbout CAS and the latest Mach number is less than the climbout maximum Mach number, a full BADA increasing-CAS climb step is calculated and clipped where it reaches the target distance and/or the maximum Mach number. If the latest CAS is not less than climbout CAS but the latest Mach number is less than the climbout maximum Mach number, a BADA constant-CAS step is calculated to the target distance and clipped where it reaches the maximum Mach number. This step evaluation and clipping provide a new latest calculated state, and the process is repeated until the latest state is at the target distance. Note that the SAE-AIR-1845-BADA

transition point, and all BADA increasing-CAS climb steps that follow it, constitute the “transition” between the two models, as this sequence begins with a speed based on the ANP profile and ends on the BADA speed schedule.

3.7.1.3.2.1 Full BADA Increasing-CAS Climb Step

In the case of increasing CAS during climb, the energy share is held at a constant value and a final CAS is targeted. With the final CAS constrained, the final true airspeed (TAS) is a function of the step height. The step height and final TAS are not directly calculable, but can be iteratively determined together by finding the root of the function:

$$F(h_f) = \frac{v_{T_f}^2(h_f) - v_{T_i}^2}{2g(h_f - h_i)} - \frac{1 - f\{M\}}{f\{M\}} \quad \text{Eq. 3-115}$$

where

F	Function whose root is the altitude where the target CAS is reached (dimensionless);
h_f	Final altitude (m);
h_i	Initial altitude (m);
$f\{M\}$	BADA standard climb energy share for increasing-CAS climb 0.3 (dimensionless);
g	Earth’s gravitational acceleration (m/s ²);
v_{T_i}	Initial true airspeed (m/s); and
v_{T_f}	Final true airspeed (m/s).

This does not resolve the step length, however. The length of the step is related to the thrust through the climb angle equation Eq. 3-101. By solving this for the step length of the BADA maximum thrust setting at the final altitude, AEDT determines the shortest step length (steepest climb angle and largest acceleration) supported there.

If the climb angle of the standard BADA increasing-CAS climb step exceeds the angle of a direct climb to the target, the angle could be reduced either by reducing thrust or by reducing energy share. Since it is not realistic to reduce thrust while attempting to accelerate, AEDT calculates a reduced-angle increasing-CAS climb at full thrust, implicitly reducing the climb energy share below the standard value. With climb angle constrained, the geometry of the step is determined by iteratively finding the root of the function:

$$F(L) = \frac{T_m(L) - D(L)}{mg} - \sin \gamma - \frac{1}{g} \frac{\Delta v_T^2(L)}{2L} \quad \text{Eq. 3-116}$$

where

F	Function whose root is the step length where the target CAS is reached (dimensionless);
L	Step length (m);
T_m	BADA maximum climb thrust (N);
D	BADA drag (N);
m	Aircraft mass (kg);
g	Earth’s gravitational acceleration (m/s ²);
γ	Target climb angle (radians); and
Δv_T	Final true airspeed (m/s).

3.7.1.3.2.2 Constant CAS or Constant Mach Climb

For constant-CAS and constant-Mach BADA climbs, a target altitude and target climb angle are provided, and one aspect of speed is held fixed. AEDT begins by determining whether or not the target climb angle is supported at the target altitude by evaluating equation Eq. 3-101 for the climb angle using the target altitude and maximum climb thrust setting, using the appropriate energy share equation as discussed in Section 3.7.1.3.1.3. If the climb angle supported by maximum thrust at the target altitude meets or exceeds the target climb angle, the target is reached, and equation Eq. 3-101 is evaluated for thrust using the target climb angle and altitude. If the target climb angle is not supported by the maximum thrust at the target altitude, the maximum achievable altitude is determined by iteratively finding the root of the function:

$$F(h_f) = \frac{(T_m(h_f) - D(h_f))}{mg} f\{M\}(h_f) - \frac{(h_f - h_i)}{\sqrt{\Delta d^2 + (h_f - h_i)^2}} \quad \text{Eq. 3-117}$$

where

F	Function whose root is the maximum achievable step height (dimensionless);
h_f	Final altitude (m);
h_i	Initial altitude (m);
T_m	BADA maximum climb thrust (N);
D	BADA drag (N);
m	Aircraft mass (kg);
g	Earth's gravitational acceleration (m/s ²);
$f\{M\}$	BADA climb energy share for the given speed conditions; and
Δd	Distance to target (m).

3.7.1.3.3 Approach Operations

Approach operations cannot have ascending altitude control to altitude control steps, so AEDT ensures that all steps will be either descend or level steps. Thus, AEDT looks for the first altitude control with an altitude greater than 10,000 ft. Once it is determined which track segment to start modeling on, AEDT loops through the rest of the track segments, modeling from track segment to track segment as the altitude controls dictate.

Once the index of the next track segment in the track segment list is identified, the track segment is considered the current segment. The next altitude control following the current segment is then located in the list of track segments. The current segment and the next segment bridge a descent step. For the first BADA step, a decelerating descent step is substituted for a pure descent step, as the aircraft must transition from scheduled BADA CAS to interpolated SAE-AIR-1845⁵⁹ speeds. If one decelerating descent step is unable to slow down enough, the decelerating descent step is used again, until the speeds can be smoothly transitioned. After a step has been modeled, the next track segment becomes the current segment and a new next track segment is identified. This loop is repeated until all track segments with altitude controls have been modeled.

Approaches are modeled in reverse, from a step to step perspective. That is, the order of descending steps begins with the descent to 10,000 ft AFE and ends with the descent from the cruise altitude.

3.7.1.3.3.1 Descend Steps

When calculating a descend step, first a determination must be made regarding in which altitude region the step is taking place. If the descent will cross the Mach transition altitude, the step will be split into two pieces, one going from the starting step altitude dropping to the Mach transition altitude using the BADA Mach velocity, and one ranging from the transition altitude down to the final step altitude using the BADA CAS. The primary difference between those two steps is the velocity used. If the Mach transition altitude is not crossed during the step, then the step is not split.

For descent steps, the following is the methodology for how the step is calculated. First, based on if the step is starting above the Mach transition altitude or not, it is determined if BADA CAS or BADA constant Mach should be the speed used for the descent step.

Next, the aircraft headwind is calculated. This is done by finding the heading of the current track segment and taking the projection of the headwind, which is altitude dependent. The heading of the current track segment is found by converting the latitude and longitude of the endpoints of the track segment into a planar X-Y coordinate system via a geographic projection system. The X-Y coordinate system has its origin at the start point of the track segment, so finding the unit vector of the track segment is done by normalizing the X and Y components of the segment end point. That unit vector is then multiplied by the magnitude and vector of the headwind, resulting in the projection of the headwind vector onto the track segment vector.

AEDT calculates the dh/dt climb rate term of the force balance equation by dividing the change in altitude of the segment by the product of the segment length divided by the total segment speed (BADA speed – headwind).

Finally, AEDT calculates the energy share factor for the altitude region in which the step takes place. Once all of the terms on the right-hand side of Eq. 3-101 are known, the thrust for the step is calculated.

3.7.1.3.3.2 Decelerating Descent Steps

Decelerating descent steps are used to bridge the speed differences between the SAE-AIR-1845⁵⁹ and BADA models. These steps both descend to the next altitude control as well as decrease the aircraft's speed. This is done by substituting different end speed values than those dictated by the BADA CAS schedule. Other than that, they act like normal descent steps. Note that this step constitutes the "transition" between the two performance specifications models, as it begins on the BADA speed schedule and ends with a speed based on the ANP profile.

Once the descent step has been modeled, a fixed trajectory point is populated with the final altitude, the thrust for the step, the speed traveled during the step, the horizontal track distance of the step, operation mode type, and point number.

The thrust is then converted from raw force units to corrected net thrust per engine.

3.7.1.3.4 Overflight Operations

Overflight operations in BADA are less restricted than approaches and departures in terms of the steps they can process. Specifically, overflights are able to model ascending or descending altitude controls in any order required by using climb and descend steps respectively.

Due to the flexible nature of the trajectories overflights can be assigned to, AEDT uses BADA for any modeled altitudes at or above 10,000 ft and SAE-AIR-1845 / Doc-29 for any altitudes below 10,000ft. Overflights that have two controls that span the 10,000 ft altitude will use each model for their respective portions of the track between those two controls.

Overflight modeling consists of a similar iterative process that approaches and departures perform. The next track segment with an altitude control is identified as the current segment, and the next altitude control following that segment is identified as the target. If the target altitude control altitude is higher than the current altitude by more than 100 ft, a climb step is called, as described below. If the next target is lower than the current altitude by more than 100 ft, a descend step is called as described in Section 3.7.1.3.3.1. If neither of those step types are called, a cruise step is modeled.

3.7.1.3.4.1 Climb Steps

When calculating a climb step, first a determination must be made regarding in which altitude region the step is taking place. If the step will cross the Mach transition altitude, the step will be split into two pieces, one going from the starting step altitude leading up to the Mach transition altitude, and one ranging from the transition altitude to the final step altitude. The primary difference between those two steps is the velocity used. If the Mach transition altitude is not crossed during the step, then the step is not split.

For climb steps, the following is the methodology for how the step is calculated. First, based on if the step is starting above the Mach transition altitude or not, it is determined if BADA CAS or BADA constant Mach should be the speed used for the climb step.

Next, the aircraft headwind is calculated. This is done by finding the heading of the current track segment and taking the projection of the headwind, which is altitude dependent.

The heading of the current track segment is found by converting the latitude and longitude of the endpoints of the track segment into a planar X-Y coordinate system via a geographic projection system. The X-Y coordinate system has its origin at the start point of the track segment, so finding the unit vector of the track segment is done by normalizing the X and Y components of the segment end point. That unit vector is then multiplied by the magnitude and vector of the headwind returned by the Weather Module, resulting in the projection of the headwind vector onto the track segment vector.

The dh/dt climb rate term of the force balance equation is calculated by dividing the change in altitude of the segment by the product of the segment length divided by the total segment speed (BADA speed – headwind).

Finally, the energy share factor is calculated for the altitude region in which the step takes place. Once all of the terms on the right-hand side of Eq. 3-101 are known, the thrust for the climb step is calculated.

3.7.1.3.4.2 Climb Step Post-Processing

Once the climb step has been modeled, a fixed trajectory point is populated with the final altitude, the thrust for the step, the speed traveled during the step, the horizontal track distance of the step, operation mode type, and point number. The thrust is then converted from raw force units to corrected net thrust per engine via the following:

$$\frac{F_n}{\delta} = \frac{F/N}{\delta} \quad \text{Eq. 3-118}$$

where

δ	Atmospheric pressure ratio;
F	Total thrust; and
N	Number of engines.

If the thrust type is Percent, then the noise thrust is calculated as a percentage of static thrust, as discussed in Section 3.6.2.2.

Once the thrust has been converted, the trajectory point is then added to the end of the existing list of trajectory points.

3.7.1.3.4.3 BADA Thrust Limits

Once the thrust for the step has been determined, it is compared to the maximum achievable thrust the aircraft can produce at the altitude at which it is currently flying.

If the thrust needed to perform the climb step is greater than the maximum thrust the aircraft has available, the step is recalculated, with the aircraft flying at max thrust in an attempt to see how high it can climb over the course of track segment. The altitude achieved in this recalculation is then compared to the requirements of the altitude control.

To find the maximum achievable altitude, a convergence loop is established in which the end altitude is varied and the thrust calculated as with a normal climb step. The convergence is achieved when the calculated thrust is less than 1/1,000,000 Newtons less than maximum thrust. The altitude used on the iteration when that convergence criterion is achieved is the maximum achievable altitude.

If the maximum achievable altitude loop is unable to find a point of convergence, a secondary backup loop is initiated, where in each iteration, the final altitude is lowered from the previous target in 100 ft increments, starting at the original altitude control altitude. This loop replicates the climb step, with the exception of the exit criteria, which remains the same as the convergence loop.

If neither the convergence loop nor the secondary backup loop are able to find a satisfactory maximum achievable altitude, an exception is generated.

Once an achievable maximum altitude is determined, that altitude is compared to the criteria set forth by the altitude control. Additionally, AEDT allows for a 300 ft tolerance on either side of an altitude control altitude when checking if an altitude control has been satisfied. Specifically:

- If an achieved altitude is within 300 ft above or below an At type altitude control altitude, it is acceptable and within allowed tolerances.

- If an achieved altitude is below or within 300 ft above an AtOrBelow type altitude control altitude, it is acceptable and within allowed tolerances.
- If an achieved altitude is above or within 300 ft. below an AtOrAbove type altitude control altitude, it is acceptable and within allowed tolerances.

If the maximum achieved altitude is found to be within allowed tolerances, it is returned as the final altitude for the climb step.

3.7.1.3.4.4 Cruise Steps

Cruise steps follow the same force balance as the rest of the BADA steps, given in equation Eq. 3-101. However, the starting and ending altitudes of the step are equal, so thrust is equal to drag as given in Eq. 3-99. Cruise steps also have a slightly different limitation on thrust than climb steps. Specifically, maximum cruise thrust is set by BADA at 95% of maximum climb thrust.

For cruise segments longer than 10 nmi for which there is no change in altitude, a thrust transition segment is added after the first 1,000 ft of the segment. The purpose of these segments is to allow for any thrust or speed transitioning that may occur between a previous climb or descend step and the current level step.

3.7.2 Sensor Path Flights

AEDT supports trajectory specification for full flight runway-to-runway operations in the form of sensor path data. Each data sample specifies a location and groundspeed. The calculated performance result will tend to conform to these inputs, subject to the constraints of the performance model. The performance calculations for runway-to-runway operations proceed as follows:

- The input flight path is smoothed and filtered.
- The terminal-area departure portion of the operation is calculated.
- The en-route portion of the operation is calculated.
- The terminal-area approach portion of the operation is calculated.

Note that a sensor path may never reach 10,000 ft AFE, in which case the distance-weighted average altitude of the sensor path with respect to sea-level provides the dividing line at each end.

3.7.2.1 Preliminary Processing

First, before any preprocessing is performed on the original sensor path data, the horizontal length is calculated by integrating great circle path lengths between points. This is used to choose an appropriate standard profile by stage length for the terminal-area portion of the operation (see Table 11-16 or Table 11-30 for details on the correspondence between horizontal distance and stage length).

AEDT smooths and applies filters to the altitude and speed profiles implied by provided sensor path data. The user has the option whether or not the filtering will be applied. All samples preceding the first sample above 500 ft AFE at the departure airport, and all samples following the last sample above 500 ft AFE at the arrival airport, are discarded. Sensor path samples are discarded where the magnitude of acceleration to or from an adjacent sample exceeds the global longitudinal acceleration limit imposed by BADA. Samples for which the change in climb angle exceeds the BADA normal acceleration limit are also discarded. Exponential smoothing is applied to the remaining altitude and speed profiles in the forward and reverse directions. This results in the “trusted” path.

AEDT separates the trusted path into its phases. There can be up to five phases: terminal area-departure, enroute climb-out, enroute cruise, enroute descent, and terminal-area arrival. Three key altitudes are calculated to aid in this separation:

- Cruise Altitude is a distance-weighted average of the target altitudes.
- Departure Top Altitude is the altitude at which Doc29-based calculations are intended to end and give way to BADA-based modeling. It is the lesser of:
 - 10,000 feet above the departure airport, and
 - Cruise Altitude
- Arrival Top Altitude is the altitude at which Doc29-based calculations recommence. It is the lesser of the following two quantities:
 - 10,000 feet above the arrival airport
 - Cruise Altitude

Using these altitudes, the trusted path is separated as follows:

- The terminal-area departure phase consists of all points preceding the point where the altitude reaches the departure top altitude.
- The en-route climb phase consists of all points from where the departure top altitude is first reached to where the cruise altitude is first reached.
- The en-route cruise phase consists of all points from where cruise altitude is first reached, to where cruise altitude is last reached.
- The en-route descent phase consists of all points from where cruise altitude is last reached, to where the arrival top altitude is last reached.
- The terminal-area arrival phase consists of all points from where the arrival top altitude is last reached, and all subsequent points.

A final filtering step, which we refer to as “super-segmentation”, is applied to each phase. This process begins by identifying points for which acceleration is equal to the average acceleration for the phase, or for which climb angle is equal to 130% or 70% of the average climb angle in the phase. Points which meet any of these criteria are termed super-segmentation control points. Points which aren’t super-segmentation control points have their altitude and speed values modified according to interpolation of the altitudes and speeds at supersegmentation control points.

From this point, the smoothed, filtered, separated, and super-segmented points constitute target states for subsequent performance analysis.

3.7.2.2 Terminal Area

AEDT internally defines terminal-area operations for the departure and approach phases. Each of these operations contains a pointwise ground track based on the pre-processed sensor path data. For each target from the departure and en-route phases, the track for the departure operation has one track point with the same surface coordinate. In cases where the target is a super-segmentation control point, the corresponding track point has an altitude control of type “At or below”, targeting the altitude of the

control point. The track for the approach operation is constructed similarly, except that only targets from the approach phase are used. Altitude controls are then forced to be monotonically increasing (for departures) or decreasing (for approaches).

AEDT processes performance for the two terminal-area operations as described in section 3.7.1. The departure operation is processed first. The portion of that operation's performance up to where the departure top altitude is first reached (interpolating as needed) is kept as the departure performance. Then, AEDT processes performance for the en-route phases (described in the next section), and the approach operation. The final point in the result of each phase informs the initial point of the next phase, and all results are combined into a complete runway-to-runway result. Note that since the terminal area portion of sensor path analysis is performed using altitude controls, terminal area speeds are determined by the standard procedural profile, and sensor path speeds in the terminal area do not inform the performance results.

3.7.2.3 *En-route Phase Overview*

After the final state of the aircraft has been determined for the departure phase, performance calculations are performed for en-route phases. AEDT calculates performance for each en-route phase of targets in turn, using the final state of any given phase as the initial state of the subsequent phase. Note that when the computed departure phase extends beyond a given phase of en-route targets, performance analysis for that phase of targets is skipped.

Performance for an en-route phase of targets begins from the final state of the preceding computed phase. From there, a performance segment is computed for flight to the first target that follows. This is repeated for all subsequent targets in the phase.

3.7.2.4 *En-route Performance Segment Calculation*

En-route performance segments are computed for each target. AEDT calculates the segment such that it comes as close as possible to the target state, subject to the performance limitations of the aircraft, and prioritizing the target altitude over the target ground speed. For each segment of an en-route phase, the initial point is taken from the final point of the previous segment. This includes the initial altitude, h_i . All calculations to determine the final point are based on the initial time and initial aircraft weight. The final geographic coordinate is known from the sensor path specification, and as a result, the segment's horizontal length is known.

The final point of a segment is first limited by BADA envelope considerations. First, the envelope-limited final altitude, $h_f^{(1)}$, is determined by limiting the final altitude, $h_f^{(0)}$, specified in the sensor path by the maximum final altitude, h_{fmax} , with the aircraft mass taken from the initial point, and the temperature deviation sampled at the initial time and final geographic coordinate, at sea level. AEDT then determines the envelope-limited final groundspeed, $V_{Gf}^{(1)}$, by limiting the final groundspeed, $V_{Gf}^{(0)}$, specified in the sensor path by the minimum final calibrated airspeed, V_{min} , and by the BADA aircraft's maximum operating CAS, V_{MO} . Note that all comparisons between groundspeed, true airspeed, and calibrated airspeed are performed in the context of the envelope-limited final altitude, $h_f^{(1)}$.

Next, the BADA longitudinal acceleration limit is applied to the final groundspeed of the segment. The acceleration-limited final groundspeed, $V_{Gf}^{(2)}$, is initialized to the envelope-limited final groundspeed, $V_{Gf}^{(1)}$, and then limited by iteratively decrementing (or incrementing, as appropriate) by one foot per second until it satisfies:

$$\left| V_{Gf}^{(2)} - V_{Gi} \right| \leq \frac{a_{l,\max(civ)} \sqrt{L_h^2 + (h_f^{(1)} - h_i)^2}}{\frac{1}{2} (V_{Gf}^{(2)} + V_{Gi})} \quad \text{Eq. 3-119}$$

where

h_i	Initial altitude (m);
$h_f^{(1)}$	Envelope-limited final altitude (m);
$V_{Gf}^{(2)}$	Acceleration-limited final groundspeed (m/s);
V_{Gi}	Initial groundspeed (m/s);
L_h^2	Segment horizontal length (m); and
$a_{l,\max(civ)}$	Maximum longitudinal acceleration for civil flights.

The maximum allowed change in climb angle, $\Delta\gamma_{\max}$, from the previous segment's climb angle is calculated by:

$$\Delta\gamma_{\max} = \frac{a_{n,\max(civ)} \sqrt{L_h^2 + (h_f^{(1)} - h_i)^2}}{\left[\frac{1}{2} (V_{Gf}^{(2)} + V_{Gi}) \right]^2} \quad \text{Eq. 3-120}$$

where

$a_{n,\max(civ)}$	Maximum normal acceleration for civil flights.
-------------------	--

The acceleration-limited final altitude, $h_f^{(2)}$, is adjusted such that the climb angle, γ , does not differ from the previous segment's climb angle by more than this amount.

After limiting is complete, segment duration Δt (s) is calculated from:

$$\Delta t = \frac{\sqrt{L_h^2 + (h_f^{(2)} - h_i)^2}}{\frac{1}{2} (V_{Gf}^{(2)} + V_{Gi})} \quad \text{Eq. 3-121}$$

where

$h_f^{(2)}$	Acceleration-limited final altitude (m).
-------------	--

Acceleration a (m/s²) is calculated from:

$$a = \frac{V_{Gf}^{(2)} - V_{Gi}}{\Delta t} \quad \text{Eq. 3-122}$$

and the climb rate from:

$$\frac{dh}{dt} = \frac{h_f^{(2)} - h_i}{\Delta t} \quad \text{Eq. 3-123}$$

Drag is calculated as outlined in Section 3.7.1.3.1.4, and total net thrust is calculated according to Eq. 3-100, with the appropriate speed and density choices (initial values for initial thrust, final values for final thrust).

If the final thrust exceeds the maximum climb thrust (as evaluated at the final location) by more than 20%, then thrust limiting is applied. Here, the final speed is iteratively decremented, one knot at a time. With each iteration, the final thrust is recalculated in the same manner as originally calculated. Iteration continues as necessary until the final thrust is within limits, or until the final speed falls below either the initial segment speed or the stall CAS. If the final thrust still exceeds the limit, the final altitude is recursively bisected between the initial altitude and the final altitude until the interval is less than one foot. If the bisection method does not find an altitude that satisfies the thrust limits, the final altitude is set to the initial altitude; then checked if thrust limits are satisfied. If the final thrust still exceeds the limit, the air operation is rejected, and an error message is logged.

At this point, there is enough information available to calculate the segment fuel flow and fuel burn, along with the change in weight. Note that the initial thrust calculated for the segment overrides the final thrust calculated according to the previous segment.

3.8 Noise Mode

Performance calculations in AEDT include the determination of which NPD curve to use in noise calculations (discussed in Section 4). This determination is made for each individual trajectory segment. For helicopters, there is an NPD curve associated with each type of procedure step. Thus, each trajectory segment is assigned the NPD curve that corresponds to the type of procedure step undergone during that segment. For airplanes, all trajectory segments outside of the terminal area are assigned departure mode. Airplane segments in the terminal area that originate from explicit fixed-point profiles are assigned the NPD curve that is assigned to the nearest fixed-point at or preceding the trajectory segment. Airplane segments in the terminal area that originated from any other treatment are assigned departure mode if they are climbing, accelerating at constant altitude, or applying reverse thrust during ground roll; approach mode is assigned otherwise.

4. Noise

AEDT computes noise from a series of individual aircraft operations (known as single-event noise), and then accumulates these single-event noise levels across all of the events in an AEDT study into cumulative noise levels for the study. This is done according to the steps below:

1. Accept aircraft-specific data (equipment, noise, position, and operational data) and study-specific data (weather, terrain, boundary, or ambient data) as input (see Sections 2.2 and 0);
2. Determine the unadjusted noise values at the receptors (see Sections 4.2.1 and 4.2.2);
3. Apply adjustments to account for environmental, meteorological, operational and position effects (see Sections 4.3, 4.4 and 4.5);
4. Compute the single-event base metrics at the receptors (see Sections 4.6.1, 4.6.2, 4.6.3 and 4.6.4);
5. Repeat steps one through four for each unique, single event in the AEDT study;
6. Accumulate the noise output and compute the appropriate noise metrics (see Section 4.6.5); and
7. Annualize noise results (see Section 8).

Figure 4-16 and Figure 4-17 graphically summarize the acoustic computation process employed in AEDT.

Figure 4-18 graphically summarizes the accumulation of noise metric computation process.

The noise, aircraft flight profile and flight path computation methodologies implemented in AEDT Version 2c are compliant with European Civil Aviation Conference (ECAC) Doc 29 (3rd Edition) "Report on Standard Method of Computing Noise Contours around Civil Airports"¹⁵ and the International Civil Aviation Organization (ICAO) Doc 9911 (1st Edition), "Recommended Method for Computing Noise Contours Around Airports"⁵⁶. Both ECAC Doc 29¹⁵ and ICAO Doc 9911⁵⁶ are currently in the process of being updated, however it is expected that AEDT Version 2c will be compliant with both updated versions (Doc 29 4th Edition and Doc 9911 2nd Edition).

4.1 Flight Path Segment Parameters

As a prerequisite to noise level computations, AEDT computes several geometric and physical parameters associated with an aircraft flight path. This section describes the computation of these parameters.

Computation of the following flight-segment geometric parameters is presented in Section 4.1.1:

- The closest point of approach on the flight path segment, or the extended flight path segment, to the receptor; and
- The slant range from the receptor location to the closest point of approach.

Computation of the following flight-segment geometric and physical parameters is presented in Section 4.1.2:

- The speed along the flight path segment;
- The altitude associated with the flight path segment;
- The over-ground, sideline distance from the receptor location to the ground-projection of the closest point of approach; and
- The engine power associated with the flight path segment.

Figure 4-1 through Figure 4-3 present, respectively, the receptor/flight-segment geometry for the three general AEDT cases:

- The receptor is behind the flight path segment (Figure 4-1)
- The receptor is astride the flight path segment (Figure 4-2)
- The receptor is ahead of the flight path segment (Figure 4-3)

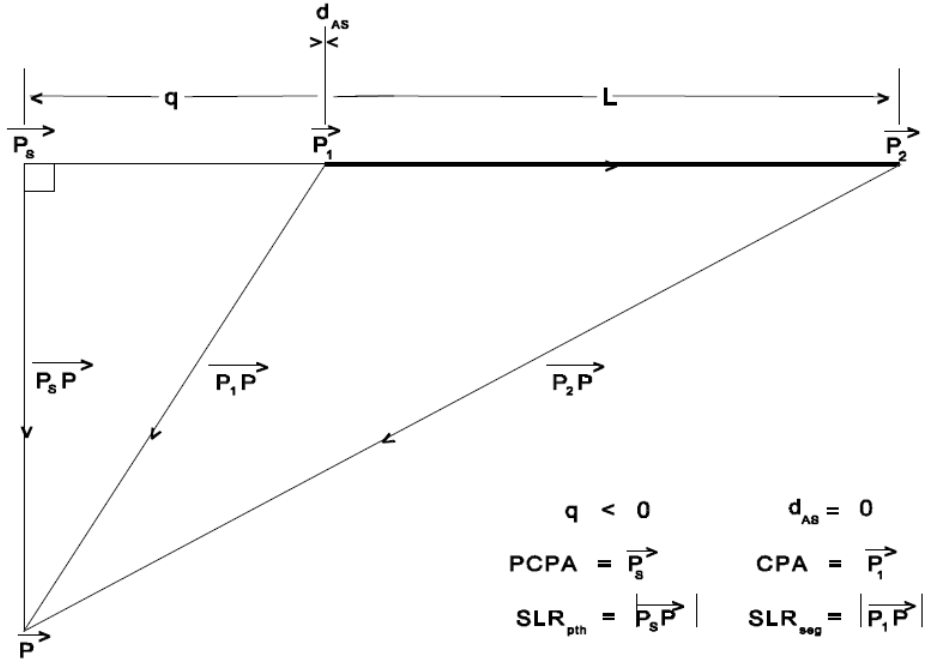

Figure 4-1 Flight-Segment Geometry when a Receptor is Behind a Segment

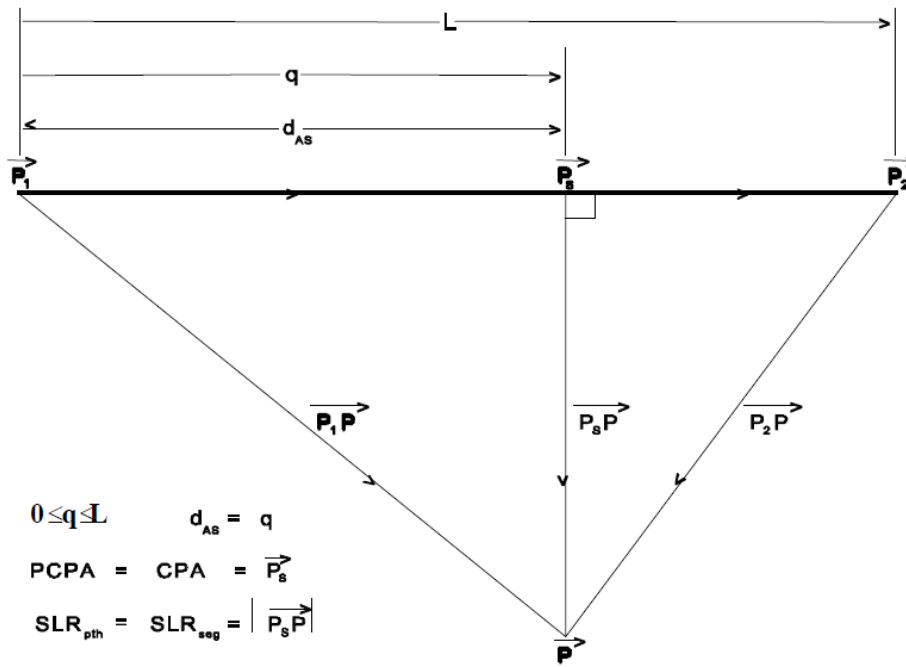

Figure 4-2 Flight-Segment Geometry when a Receptor is Astride a Segment

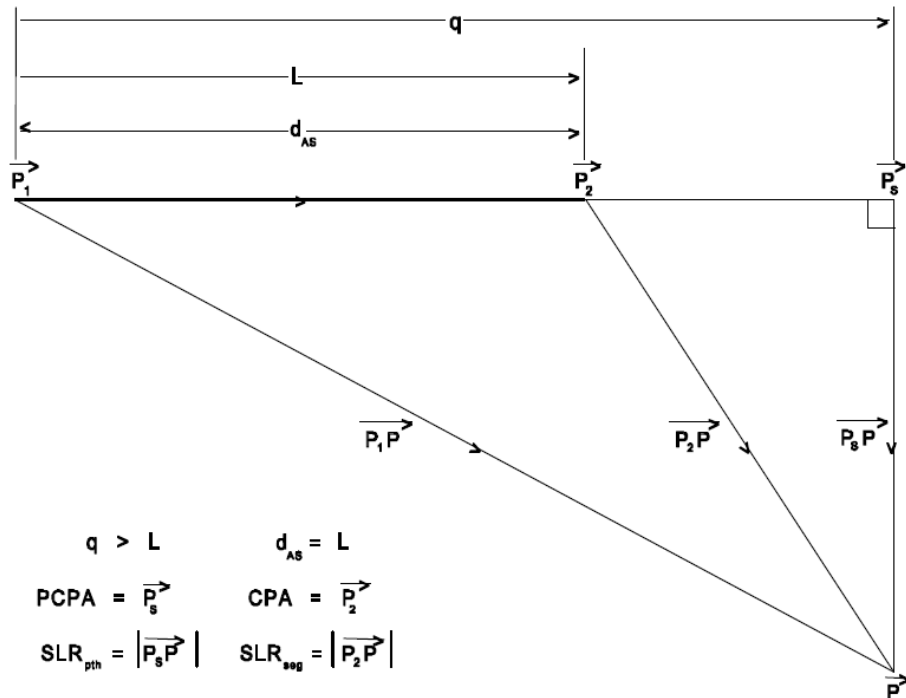

Figure 4-3 Flight-Segment Geometry when a Receptor is Ahead of a Segment

The variables shown in Figure 4-1 through Figure 4-3 are defined as follows:

P Receptor point

P_1	Start-point of the flight path segment
P_2	End-point of the flight path segment
P_s	PCPA, the point on the flight path segment, or the extended flight path segment, which is the perpendicular closest point of approach to the receptor, as defined in detail in Section 4.1.1, below. The specific definition depends on the position of the receptor relative to the flight path segment.
P_1P_2	Vector from the start of the flight path segment to the end of the flight path segment. It has a minimum length of 10 ft.
P_1P	Vector from the start of the flight path segment to the receptor. It has a minimum length of 1 ft.
P_2P	Vector from the end of the flight path segment to the receptor. It has a minimum length of 1 ft.
P_sP	Perpendicular vector from the receptor to PCPA on the flight path segment, or the extended flight path segment, as defined in detail in Section 4.1.1. It has a minimum length of 1 ft.
SLR_{pth}	$ P_sP $, the length of the perpendicular vector from the receptor to PCPA on the flight path segment, or the extended flight path segment as defined in detail in Section 4.1.1. It has a minimum length of 1 ft.
L	Length of the flight path segment. It has a minimum length of 1 ft.
CPA	Point on the flight path segment, not the extended flight path segment, which is the closest point of approach to the receptor, as defined in detail in Section 4.1.1. The specific definition depends on the position of the receptor relative to the flight path segment.
SLR_{seg}	Length of the vector from the receptor to CPA on the flight path segment, not the extended flight path segment, as defined in detail in Section 4.1.1. It has a minimum length of 1 ft.
q	Relative distance along the flight path segment, or the extended flight path segment, from P_1 to P_s (ft). The value of q is used to determine the position of the receptor relative to the flight path segment, as shown in Table 4-1.
d_{AS}	Distance along the flight path segment from the start of the segment at P_1 to CPA. Depending on the value of q , i.e., the relative geometry between the receptor and the flight path segment, d_{AS} takes on the values shown in Table 4-1.

Table 4-1 Position of the Receptor Relative to the Flight Path Segment

Value of q	Value of d_{AS}	Position of Receptor Relative to Flight Path Segment
$q < 0$	0	Receptor is behind segment (Figure 4-1)
$0 \leq q \leq L$	q	Receptor is astride segment (Figure 4-2)
$q > L$	L	Receptor is ahead of segment (Figure 4-3)

4.1.1 Closest Point of Approach and Slant Range

The closest point of approach and slant range parameters are fundamental to AEDT computations. The slant range is used for noise level interpolation of the NPD data (see Section 4.2.2). In addition, the computation of the closest point of approach and slant range parameters is a prerequisite to the noise

fraction algorithm used for exposure-based metrics (see Section 4.3.3) and for lateral attenuation (see Section 4.3.5).

The slant range from the receptor location to the closest point of approach on the flight path (SLR_{pth}) is defined as the distance from the perpendicular closest point of approach (PCPA), on the flight path segment or the extended flight path segment, to the receptor. SLR_{pth} is used for exposure-based metrics because NPDs represent aircraft data on infinitely long flight paths, and the time-based nature of the exposure-based metrics makes the difference between finite flight path segments (as modeled in AEDT) and infinite flight paths significant. To obtain the noise exposure level due to an aircraft proceeding along a finite flight path segment in AEDT, the exposure-based noise level data must be adjusted by the noise fraction adjustment, which accounts for the geometry difference between SLR_{pth} and SLR_{seg} . The specific definition of PCPA depends upon the position of the receptor location relative to the flight path segment. If the receptor is behind or ahead of the flight path segment, then the PCPA is the intersection point of the perpendicular from the receptor to the extended segment. If the receptor is astride the flight path segment, then the PCPA is the intersection point of the perpendicular from the receptor to the segment.

The exceptions to the above definition for slant range occur:

- When the receptor is behind a takeoff ground-roll segment (see Section 4.4.2);
- During runup operations; and
- When performing computations involving $L_{AS_{mx}}$, $L_{PNTS_{mx}}$, or time-based metrics.

In these cases, the slant range, designated SLR_{seg} , is defined as the distance from the receptor location to the closest point of approach on the flight path segment (CPA), not the extended flight path segment. The specific definition of the CPA depends on the position of the receptor location relative to the flight path segment. If the receptor is behind the flight path segment, the CPA is the start point of the segment. If the receptor is astride the flight path segment, the CPA is equivalent to the PCPA. If the receptor is ahead of the flight path segment, the CPA is the end point of the flight path segment.

4.1.2 Speed, Altitude, Distance, and Power

Computations of the following four parameters, associated with each flight path segment, are described in this Section.

- The speed at the CPA;
- The altitude at the CPA;
- The horizontal sideline distance from the receptor location to the vertical projection of the CPA; and
- The engine power setting (also known as thrust setting) at the CPA.

These computation methodologies are identical for fixed-wing aircraft and helicopters, except for the computation of engine power setting. Engine power setting is fixed for helicopters in AEDT. Therefore, the following engine power setting computation methodology is only applicable to fixed-wing aircraft.

The aircraft speed, AS_{seg} , at CPA is computed via linear interpolation as follows:

$$AS_{seg} = AS_{p1} + \left[\frac{\Delta AS}{2} \right] \quad \text{Eq. 4-1}$$

where

AS_{P1} Speed at the start of the flight path segment (kts); and
 ΔAS Change in speed along the flight path segment (kts).

AS_{seg} is used to compute the duration adjustment for exposure-based noise level metrics as presented in Section 3.4.4.

The altitude, d_{seg} , in ft at the CPA is computed via linear interpolation as follows:

$$d_{seg} = [P_1]_z + d_{AS} \left[\frac{(P_1 P_2)_z}{L} \right] + h_{terr} - h_{airport} \quad \text{Eq. 4-2}$$

where

$[P_1]_z$ Altitude at the start of the flight path segment, given by the z-component of the vector from the origin of coordinates to the start of the flight path segment (ft above field elevation);
 $(P_1 P_2)_z$ Change in altitude along the flight path segment (ft);
 h_{terr} Terrain elevation (ft MSL); when the terrain option is not invoked, $h_{terr} = h_{aprt}$; and
 $h_{airport}$ Airport elevation (ft MSL).

The sideline distance from the fixed path segment to the receptor, l_{seg} , defined as the distance in the horizontal plane from the receptor location on the ground to the vertical projection of the CPA, is computed as follows:

$$l_{seg} = (SLR_{seg}^2 - d_{seg}^2)^{1/2} \quad \text{Eq. 4-3}$$

where

SLR_{seg} Length of the vector (ft) from the receptor to CPA on the flight path segment, not the extended flight path segment; and
 d_{seg} As computed above (Eq. 4-2).

The sideline distance, l_{seg} , is used to compute the ground-to-ground component of the lateral attenuation adjustment as presented in Section 4.3.5.

For fixed-wing aircraft, the engine power setting, P_{seg} , at the CPA is computed via linear interpolation:

$$P_{seg} = P_{P1} + \left[\frac{d_{AS}}{L} \right] \cdot \Delta P \quad \text{Eq. 4-4}$$

where

P_{P1} Engine power at the start of the flight path segment (see Section 2.2.1.1 for units^{xii}); and
 ΔP Change in power along the flight path segment.

^{xii} Engine power setting, also known as thrust-setting, is expressed on a per engine basis in a variety of units, including pounds, percent, engine-pressure-ratio (EPR), as well as other units.

P_{seg} is used in performing noise level interpolation as presented in Section 4.2.2^{xiii}.

4.2 Noise-Power-Distance (NPD) Data Computations

Noise propagation is represented in AEDT with a database of NPD data, which are specific according to aircraft type, aircraft operation type, and noise metric (and, in the case of helicopters, directivity). As described in Section 2.2.1.1, the NPD data for a fixed-wing aircraft in AEDT consist of a set of decibel levels for various combinations of aircraft operational modes (approach, departure, overflight), engine power states and slant distances from receptor to aircraft. Each NPD has noise levels at the following ten AEDT distances: 200; 400; 630; 1,000; 2,000; 4,000; 6,300; 10,000; 16,000; and 25,000 ft. In addition, each set of NPDs include NPDs with the following base noise metrics: SEL, LAMAX, EPNL and PNLTM. When noise data are needed at thrust settings, distances and noise metrics not represented in the NPD data set, they are approximated for the existing NPD database. Section 4.2.1 discusses computations used to approximate base noise metrics, when they are not available in the AEDT database. Section 4.2.2 discusses methods for determining noise levels from the NPD data sets using interpolation and extrapolation.

4.2.1 Noise Metric Approximations

In order to compute all of the noise metrics in AEDT from the NPDs in the Fleet database, several noise metric approximations must be made. Section 4.2.1.1 presents methods for computing maximum noise level approximations if the Fleet database does not include maximum noise level NPDs for a particular airframe-engine-engine modification combination. Section 4.2.1.2 presents methods for computing C-weighted noise level approximations from A-weighted NPDs in the Fleet database.

4.2.1.1 Maximum Noise Level Approximation

For several aircraft in the AEDT Fleet database, measured L_{ASmx} and L_{PNTSmx} NPD data do not exist, and they are approximated using empirical equations expressed as a function of distance and sound exposure. These equations were developed from a statistical analysis of NPD data for aircraft in which all four base noise level metrics exist in the AEDT database. The equations are as follows:

For civil aircraft:

$$L_{ASmx} = L_{AE} - 7.19 - 7.73 \cdot \log_{10} \left[\frac{SLR_{pth}}{1,000} \right] \quad \text{Eq. 4-5}$$

$$L_{PNTSmx} = L_{EPN} + 1.22 - 9.34 \cdot \log_{10} \left[\frac{SLR_{pth}}{1,000} \right] \quad \text{Eq. 4-6}$$

where

- L_{AE} A-weighted sound exposure level (dB);
- L_{EPN} Effective perceived noise level (dB); and
- SLR_{PTH} The length (ft) of the perpendicular vector from the receptor to PCPA on the flight path segment, or the extended flight path segment.

For military aircraft:

^{xiii} The engine power setting for helicopters is an arbitrarily assigned number in AEDT, because the helicopter NPDs are dependent on operational mode, instead of thrust setting. The helicopter engine power setting is determined by $P_{seg} = P_{p1}$.

$$L_{ASmx} = L_{AE} - 7.84 - 6.06 \cdot \log_{10} \left[\frac{SLR_{pth}}{1,000} \right] \quad \text{Eq. 4-7}$$

$$L_{PNTSmx} = L_{EPN} + 2.51 - 5.84 \cdot \log_{10} \left[\frac{SLR_{pth}}{1,000} \right] \quad \text{Eq. 4-8}$$

4.2.1.2 C-Weighted Metric Approximation

C-weighted metrics are calculated using a simplified adjustment procedure, consistent with 14 CFR Part 36²¹, as follows:

1. The aircraft spectral class is used to create two weighted spectral classes: A-weighted and C-weighted;
2. Both weighted spectral classes are corrected back to the source (from the 1,000 ft reference) using SAE-AIR-1845⁵⁹. These are the two weighted source spectra;
3. Each weighted source spectrum is corrected to the ten standard AEDT NPD distances using the standard AEDT atmosphere (SAE-AIR-1845⁵⁹). This yields ten A-weighted spectra and ten C-weighted spectra;
4. The 24 one-third octave band values of each spectrum are logarithmically summed at each AEDT distance, yielding a distance-specific, weighted sound pressure level ($L_{A,d}$ and $L_{C,d}$). These levels are then arithmetically subtracted for each AEDT distance ($L_{A,d} - L_{C,d}$). This delta represents the difference between an A-weighted metric and a C-weighted metric at each distance; and
5. Each distance-specific delta is applied to the appropriate A-weighted NPD values ($NPD_{A,d} + (L_{A,d} - L_{C,d})$) at the corresponding AEDT distance, resulting in a C-weighted NPD.

4.2.2 Noise Level Interpolation/Extrapolation ($L_{p,D}$)

Each aircraft in the modeling layer of the AEDT Fleet database is assigned to an NPD data set that represents the noise levels for a discrete number of operation modes, thrust values, distance values and metrics. To obtain noise levels that lie between thrust values or between distance values, linear interpolation on thrust and logarithmic interpolation on distance are used. Extrapolation is used to obtain levels outside of the bounding thrust or distances values.

The NPD data are used to either interpolate or extrapolate an associated noise level value. The interpolation/extrapolation is a piecewise linear process between the engine power setting and the base-10 logarithm of the distance.

Since helicopter NPDs are organized by operational mode instead of thrust level in AEDT, an expanded process is utilized for helicopter noise interpolation/extrapolation (Section 4.2.2.4).

4.2.2.1 Standard Noise Level Interpolation/Extrapolation

Interpolation or extrapolation of NPD data for departure operations is performed using the NPD curves designated as departure curves. Similarly, interpolation or extrapolation of NPD data for approach, afterburner or overflight operations is performed using the NPD curves designated as approach, afterburner or overflight curves, respectively.

For each aircraft flight operation, NPD data are available for the four fundamental noise-level metrics, L_{AE} , L_{EPN} , L_{ASmx} , and L_{PNTSmx} . The appropriate metric is selected for interpolation or extrapolation based upon the user-defined noise metric or family of metrics to be computed at the receptor. The specific

distance and power value used in the interpolation/extrapolation process is dependent on the type of base metric selected. This section discusses the distance and power values for exposure-based noise-level metrics and maximum noise-level metrics, respectively.

Following is a generalized description of the noise interpolation for an engine power P and distance d ^{xiv}. For this interpolation, the engine power is bounded by NPD curves with engine power P_1 and P_2 . Within these NPD curves, the distance d is bounded by the NPD distances of d_1 and d_2 . For extrapolation, P_1 and P_2 and d_1 and d_2 are chosen to be the core database values closest to the desired power P or distance d .

The noise level at engine power, P_1 , and distance, d , is given by:

$$L_{P_1,d} = L_{P_1,d_1} + \frac{(L_{P_1,d_2} - L_{P_1,d_1}) \cdot (\log_{10}[d] - \log_{10}[d_1])}{(\log_{10}[d_2] - \log_{10}[d_1])} \quad \text{Eq. 4-9}$$

where

- P_1, P_2 Engine power values for which noise data are available in the NPD database (dependent on aircraft);
- d_1, d_2 Distance values for which noise data are available in the NPD database (ft);
- L_{P_1,d_1} Noise level at power P_1 and distance d_1 (dB);
- L_{P_2,d_1} Noise level at power P_2 and distance d_1 (dB);
- L_{P_1,d_2} Noise level at power P_1 and distance d_2 (dB); and
- L_{P_2,d_2} Noise level at power P_2 and distance d_2 (dB).

The noise level at engine power, P_2 , and distance, d , is given by:

$$L_{P_2,d} = L_{P_2,d_1} + \frac{(L_{P_2,d_2} - L_{P_2,d_1}) \cdot (\log_{10}[d] - \log_{10}[d_1])}{(\log_{10}[d_2] - \log_{10}[d_1])} \quad \text{Eq. 4-10}$$

Finally, the interpolated/extrapolated noise level at engine power, P , and distance, d , is given by:

$$L_{P,d} = L_{P_1,d} + \frac{(L_{P_2,d} - L_{P_1,d}) \cdot (P - P_1)}{(P_2 - P_1)} \quad \text{Eq. 4-11}$$

The above methodology is utilized when:

1. The engine power and/or distance associated with the receptor/segment pair lies between existing values in the NPD data (i.e., interpolation);
2. The power and/or distance associated with the receptor/segment pair is larger than existing values in the NPD data (i.e., extrapolation); or
3. The power associated with the receptor/segment pair is smaller than existing values in the NPD data (i.e., extrapolation). When noise levels are extrapolated to power settings below those represented by the NPD curves, the extrapolation is limited to 5 dB below the lowest noise curve. The limit is included to prevent extrapolation to unrealistic noise levels.

^{xiv} Several of the military aircraft contain NPD data for afterburner operations (equivalent of "FIXED" interpolation in NOISEMAP). If a particular flight path segment is identified as an afterburner segment, interpolation or extrapolation is only performed with regard to distance, not power.

The general noise interpolation/extrapolation process described in this section is applicable for the four fundamental noise-level metrics, L_{AE} , L_{EPN} , L_{ASmx} , and L_{PNTSmx} . The specific engine power and distance value used in the interpolation/extrapolation process is different for exposure-based noise-level metrics as compared with maximum noise-level metrics. In addition, another special noise extrapolation process is invoked when the distance associated with the receptor/segment pair is smaller than the smallest distance in the NPD data (i.e., 200 ft). These special cases are discussed separately for exposure-based noise-level metrics and maximum noise-level metrics (see Sections 4.2.2.2 and 4.2.2.3).

4.2.2.2 Additional Interpolation Information for Exposure-Based Noise Level Metrics

For exposure-based metrics, if the end points of a fixed path segment are defined by P_1 at the start of the segment, and P_2 at the end of the segment, then the exposure-based noise level, either L_{AE} or L_{EPN} interpolated or extrapolated for a receptor/segment pair, is given by:

$$L_{P,d} = \begin{cases} L_{P_{seg,d}=SLR_{pth}} & \text{Observer behind or ahead of segment} \\ L_{P_{seg,d}=SLR_{seg}} & \text{Observer astride segment} \end{cases} \quad \text{Eq. 4-12}$$

where

$L_{P_{seg,d}=SLR_{pth}}$ Interpolated noise level (dB) based upon engine power associated with the flight path segment, P_{seg} , as defined in Section 4.1.2, and the distance to the PCPA on the extended flight path segment; and

$L_{P_{seg,d}=SLR_{seg}}$ Interpolated noise level (dB) based upon engine power associated with the flight path segment, P_{seg} , and the distance to the CPA on the flight path segment where CPA = PCPA.

For the special case in which SLR_{pth} or SLR_{seg} is smaller than the smallest distance value in the NPD data, i.e., 200 ft, cylindrical divergence (i.e., line-source) is assumed, and a $10 \log_{10}[d_1/d_2]$ relationship is used for the L_{AE} -based and L_{EPN} -based noise-level metrics. For example, if L_{AE} at 200 ft and for a given power setting in the NPD data is 95.6 dB, the extrapolated L_{AE} at 100 ft and at the same power setting is $95.6 + 10 \log_{10}[200/100] = 98.6$ dB. In addition, AEDT uses a minimum slant distance of 1 ft.

4.2.2.3 Additional Interpolation Information for Maximum Noise Level Metrics

For maximum noise-level metrics, if the end points of a fixed path segment are defined by P_1 at the start of the segment, and P_2 at the end of the segment, then the maximum noise level, either L_{ASmx} or L_{PNTSmx} , as appropriate, interpolated/extrapolated for a receptor/segment pair, is given by:

$$L_{P,d} = \begin{cases} \text{Max}[L_{P,d,START}, L_{P,d,END}] & \text{Observer behind or ahead of segment} \\ \text{Max}[L_{P,d,START}, L_{P,d,PCPA}, L_{P,d,END}] & \text{Observer astride segment} \end{cases} \quad \text{Eq. 4-13}$$

where

$\text{Max}[]$ Function that returns the maximum of two or three noise level values;
 $L_{P,d,START}$ Interpolated noise level (dB) based upon the distance and engine power values associated with the start of the flight path segment;

$L_{P,d,END}$	Interpolated noise level (dB) based upon the distance and engine power values associated with the end of the flight path segment; and
$L_{P,d,PCPA}$	Interpolated noise level (dB) based upon the distance and engine power values associated with PCPA=CPA on the flight path segment.

As with exposure-based metrics, a special case applies for maximum noise level metrics when the distance is smaller than the smallest distance value in the NPD data, i.e., 200 ft. For the L_{ASmx} -based and L_{PNTSmx} -based noise metrics, spherical divergence (i.e., a point-source) is assumed and a $20 \log_{10}[d_1/d_2]$ relationship is used. For example, if L_{ASmx} at 200 ft and for given power setting in the NPD database is 95.6 dB, then the extrapolated L_{ASmx} at 100 ft at the same power setting is $95.6 + 20 \log_{10}[200/100] = 101.6$ dB. Similar to NPDs for exposure-based metrics, AEDT uses a minimum slant distance of 1 ft with maximum noise level NPDs.

4.2.2.4 Noise Level Interpolation/Extrapolation for Helicopters

Interpolation or extrapolation of helicopter NPD data is slightly more involved than the standard aircraft NPD interpolation and extrapolation. Besides the three standard dynamic operational modes (approach, departure and overflight), there are also helicopter noise data for four static modes (ground idle, flight idle, hover-in-ground-effect (HIGE), and hover-out-of-ground-effect (HOG)).

Although interpolation and extrapolation on the Helicopter NPDs for the four static modes are performed in the same manner as standard aircraft interpolation and extrapolation presented in Section 4.2.2, interpolation and extrapolation for the three dynamic modes are handled differently because the data set for each operational mode consists of three NPD curves, adding another dimension to the interpolation and extrapolation. The NPD curves for the dynamic modes also take into account in-flight directivity and are labeled Left, Center and Right. For these dynamic modes, interpolations and extrapolations between distance values are handled according to Section 4.2.2, and interpolations and extrapolations between the Left, Center and Right NPDs are accounted for with the Lateral Directivity Adjustment (see Section 4.5.2). Similar to afterburner NPDs for military aircraft, interpolation or extrapolation is only performed on helicopter NPDs with regard to distance, not power, since helicopter NPDs are organized according to operational mode, not thrust setting.

4.3 General AEDT Noise Adjustments

The sound level adjustments presented in Sections 4.3.1 through 4.3.6 are applicable to all aircraft in AEDT. These adjustments include atmospheric absorption (AA_{ADJ}), acoustic impedance (AI_{ADJ}), noise fraction (NF_{ADJ}), duration (DUR_{ADJ}), lateral attenuation (LA_{ADJ}) and line-of-sight blockage (LOS_{ADJ}).

4.3.1 Atmospheric Absorption Adjustment (AA_{ADJ})

The spectral data in AEDT has been corrected to reference day conditions, using the SAE-AIR-1845⁵⁹ standard atmosphere at a distance of 305 m. SAE-AIR-1845⁵⁹ specifies a hypothetical atmosphere using average atmospheric absorption rates. These average atmospheric absorption rates are also used in the calculation of the AEDT standard NPD data and are therefore already included in the NPDs in the AEDT Fleet database.

Sound propagation is affected by changes in atmospheric conditions. Sound levels tend to be lower in low humidity environments as compared to high humidity environments due to the increased atmospheric absorption associated with the lower humidity. The spectral database in AEDT allows a user to take into account atmospheric absorption due to the effects of local meteorological conditions on an

airport-specific basis. AEDT provides two different atmospheric adjustments based on international guidance: either SAE-ARP-866a (which takes into account temperature and relative humidity effects)²², or SAE-ARP-5534²³ (which takes into account temperature, relative humidity and atmospheric pressure effects).

The following steps, which are consistent with the simplified procedure of 14 CFR Part 36²¹, are used to correct the data to the user-defined atmospheric conditions:

1. The user determines whether to apply the SAE-ARP-866a or SAE-ARP-5534 atmospheric absorption adjustment to account for the user-defined atmospheric conditions.
2. The aircraft spectrum is A-weighted (or C-weighted, as appropriate) and corrected back to the source, (from the 1,000 ft reference), effectively removing the SAE-AIR-1845⁵⁹ atmosphere. This is the weighted source spectrum.
3. The weighted source spectrum is then corrected to the ten standard AEDT distances assuming two conditions: the AEDT standard atmosphere based on SAE-AIR-1845⁵⁹ and a user-supplied atmosphere generated with either SAE-ARP-866A²² or SAE-ARP-5534²³. These are spectrum_{1845, d} and spectrum_{MOD, d}, respectively.
4. The 24 one-third octave band values of each spectrum are logarithmically summed at each AEDT NPD distance, yielding a distance-specific, atmosphere-specific sound pressure level ($L_{1845, d}$ and $L_{MOD, d}$). These levels are then arithmetically subtracted for each AEDT distance ($L_{1845, d} - L_{MOD, d}$). This distance-specific delta represents the difference between the metric propagated through the SAE-AIR-1845⁵⁹ atmosphere and the metric propagated through the user-supplied atmosphere generated with either SAE-ARP-866A²² or SAE-ARP-5534²³ at each distance.
5. The distance-specific delta is the atmospheric absorption adjustment (AA_{ADJ}), which takes into account the user-defined temperature and humidity. It is applied to the appropriate NPD values ($NPD_d + (L_{1845, d} - L_{MOD, d})$) at the corresponding AEDT distance.

An example of the atmospheric absorption correction is presented in Section 11.1.4.

The atmospheric absorption correction for the C-weighted family of noise metrics is calculated similar to the process outlined above using C-weighting in place of A-weighting. The atmospheric absorption adjustment for tone-corrected perceived noise metrics is based on A-weighted spectral data. This process is considered to be a reasonable approximation for these metrics.

4.3.2 Acoustic Impedance Adjustment (AI_{ADJ})

Before the interpolated/extrapolated noise level data, $L_{p,d}$, are utilized for computations, an acoustic impedance adjustment, designated by the symbol AI_{ADJ} , is applied. Acoustic impedance is related to the propagation of sound waves in an acoustic medium, and is defined as the product of the density of air and the speed of sound. It is a function of temperature, atmospheric pressure, and indirectly altitude.

The noise-levels in the AEDT NPD database are corrected to reference-day conditions: temperature 77°F, pressure 29.92 inches of mercury, and altitude MSL. The noise levels can be adjusted to airport temperature and pressure by:

$$AI_{ADJ} = 10 \log_{10} \left[\frac{\rho \cdot c}{409.81} \right] \quad \text{Eq. 4-14}$$

$$\rho \cdot c = 416.86 \cdot \left(\frac{\delta}{\theta^{1/2}} \right) \quad \text{Eq. 4-15}$$

where

- AI_{ADJ} Acoustic impedance adjustment to be added to noise level data in the AEDT NPD database (dB);
- $\rho \cdot c$ Specific acoustic impedance at receptor altitude and pressure (N-s/m³);
- θ Ratio of absolute temperature at the receptor to standard-day absolute temperature at sea level; and
- δ Ratio of atmospheric pressure at the receptor to standard-day pressure at sea level.

When terrain elevation is invoked, AI_{ADJ} is computed and applied to the NPD data on a receptor-by-receptor basis, according to the receptor altitude, temperature, and pressure. Otherwise, the airport elevation and the receptor altitude are equivalent, and a single value of AI_{ADJ} is computed and applied, regardless of the observation point.

When terrain elevation is not invoked and when airport temperature, pressure, and altitude are equal to 77°F, 29.92 in-Hg, and 0 ft MSL, respectively, then AI_{ADJ} is essentially 0.0 dB (-4.0×10^{-6} dB).

4.3.3 Noise Fraction Adjustment for Exposure Metrics (NF_{ADJ})

The exposure-based noise level data interpolated/extrapolated from the AEDT NPD data, $L_{p,d}$, represents the noise exposure level associated with a flight path of infinite length. However, the aircraft flight path is described by a set of finite-length segments, each contributing varying amounts of exposure to the overall noise metric computed at a receptor.

The noise fraction algorithm, used exclusively for computation of the exposure-based metrics (L_{AE} , L_{CE} , L_{EPN}), and indirectly for computation of the time-above metrics (TA_{LA} , TA_{LC} , TA_{PNT}), computes the fraction of noise exposure associated with a finite-length flight path segment. This fraction of noise exposure is computed relative to the noise associated with a flight path of infinite length. It is based upon a fourth-power, 90-degree dipole model of sound radiation.

Computation of the noise fraction is necessary because the L_{AE} , L_{CE} , and L_{EPN} -based noise levels in the NPD database are computed assuming that an aircraft proceeds along a straight flight path, parallel to the ground, and of infinite length. To obtain the noise exposure level or time-above at a receptor location due to an aircraft proceeding along a finite fixed path segment, the exposure-based noise-level data, interpolated/extrapolated from the AEDT NPD data, must be adjusted by a fractional component, which is associated with the geometry of the receptor/flight-segment pair.

4.3.3.1 Noise Fraction Adjustment for Flight Path Segments

For an arbitrary segment, the fourth-power time-history model computes noise exposure fraction, F_{12} , as follows:

$$F_{12} = \left(\frac{1}{\pi} \right) \cdot \left[\frac{\alpha_2}{(1 + \alpha_2^2)} + \tan^{-1}(\alpha_2) - \frac{\alpha_1}{(1 + \alpha_1^2)} - \tan^{-1}(\alpha_1) \right] \quad \text{Eq. 4-16}$$

where

$$\alpha_1 = \frac{-q_1}{S_L} \quad \text{Eq. 4-17}$$

$$\alpha_2 = \frac{(-q_1 + L)}{S_L} \quad \text{Eq. 4-18}$$

$$S_L = S_0 \cdot 10^{\frac{[L_{E,P,d} - L_{Smz,p,d}]}{10}} \quad \text{Eq. 4-19}$$

where

q_1	Relative distance (ft) from the segment start point to point P _s ;
L	Length of segment (ft);
S_0	171.92 ft for L_{AE} and L_{CE} , or 1719.2 ft for L_{EPN} ;
$L_{E,P,d}$	Unadjusted interpolated NPD noise exposure level (dB) at 160 kts (L_{AE} , L_{CE} , L_{EPN}); and
$L_{Smx,p,d}$	Unadjusted interpolated NPD maximum noise level (dB) (L_{ASmx} , L_{CSmx} , L_{PNTSmx}).

Both $L_{E,P,d}$ and $L_{Smx,p,d}$ are interpolated from NPD data at a given engine power setting and at a distance SLR_{pth} , which is the distance from the receptor to the PCPA on the extended segment.

The noise fraction is then converted to a dB adjustment:

$$NF_{ADJ} = 10 \log_{10}[F_{12}] \quad \text{Eq. 4-20}$$

The noise fraction term in AEDT has a lower limit set to -150 dB. This corresponds to a minimum value of 10^{-15} for the energy fraction F , below which there would be a risk to produce an undetermined Logarithm (e.g., $F \leq 0$).

4.3.3.2 Noise Fraction Adjustment for Behind Start-of-Takeoff Roll

For a receptor behind the start-of-takeoff ground roll, a special case of the noise fraction equation applies. This special case noise fraction, denoted by the symbol F_{12}' , ensures consistency of computed exposure levels that are on a line at azimuth angle of 90 degrees measured from the nose of the aircraft at start of takeoff roll.

$$F_{12}' = \left(\frac{1}{\pi}\right) \cdot \left[\frac{\alpha_2}{(1 + \alpha_2^2)} + \tan^{-1}(\alpha_2) \right] \quad \text{Eq. 4-21}$$

$$\alpha_2 = \left(\frac{L}{S_L}\right) \quad \text{Eq. 4-22}$$

where L and S_L are defined in Section 4.3.3.1. This adjustment is supplemented by the ground based directivity adjustment DIR_{ADJ} (see Section 4.4.2).

The noise fraction for the special case of receptors behind the start-of-takeoff roll is then converted to a dB adjustment:

$$NF_{ADJ} = 10 \log_{10}[F_{12}'] \quad \text{Eq. 4-23}$$

A similar equation is used for receptors in front of the end point of the last approach segment.

$$F_{12}' = \left(\frac{1}{\pi}\right) \cdot \left| -\frac{\alpha_1}{(1 + \alpha_1^2)} - \tan^{-1}(\alpha_1) \right| \quad \text{Eq. 4-24}$$

$$\alpha_1 = \left(\frac{-L}{S_L}\right) \quad \text{Eq. 4-25}$$

4.3.4 Duration Adjustment for Exposure-Based Metrics (DUR_{ADJ})

For exposure-based metrics, consistent with SAE-AIR-1845⁵⁹, NPDs are derived for a reference speed of 160 kts for fixed-wing aircraft. For fixed-wing aircraft speeds other than 160 kts, the duration adjustment is applied to account for the effect of time-varying aircraft speed, acceleration, and deceleration. It is not applied to maximum noise level metrics since they are mostly independent of speed. In addition, since runup operations are static operations without associated speeds, the duration adjustment is not applied.

For fixed-wing aircraft, the L_{AE} and L_{EPN} values in the NPD database are referenced to an aircraft speed of 160 kts. For other aircraft speeds, the aircraft speed adjustment in dB, DUR_{ADJ} , is given by:

$$DUR_{ADJ} = 10 \log_{10} \left[\frac{AS_{ref}}{AS_{seg}} \right] \quad \text{Eq. 4-26}$$

where

- AS_{ref} Reference aircraft speed (160 kts for fixed-wing aircraft); and
- AS_{seg} Aircraft speed at the closest point for approach (CPA) for the segment).

Helicopters in the AEDT database are referenced to NPD-specific reference speeds based on measurement-specific information when the data were collected. These helicopter-specific reference speeds are applied as AS_{ref} in Eq. 4-26, when calculating the aircraft speed adjustment, DUR_{ADJ} , for helicopters.

4.3.5 Lateral Attenuation Adjustment (LA_{ADJ})

The difference in level between the sound directly under the aircraft's flight path and at a location to the side of the aircraft at the time of closest approach is termed lateral attenuation. The lateral attenuation adjustment takes into account the following effects on aircraft sound due to over-ground propagation^{xv}:

- Ground reflection effects
- Refraction effects
- Airplane shielding and engine installation effects

^{xv} The lateral attenuation adjustment in AEDT was derived from field measurements made over grass-covered, acoustically soft terrain. Consequently, when source-to-receiver propagation occurs primarily over an acoustically hard surface (e.g., water), and the hard surface dominates the study environment, it is possible that AEDT could under predict the actual noise level.

For the lateral attenuation adjustment in AEDT, the ground beneath the receptor is defined by a flat plane, regardless of whether the terrain feature is invoked or not. The absorption of reflected noise as it propagates over this flat plane (or any surface) is known as ground effect. The ground effect component of the lateral attenuation adjustment assumes propagation over soft ground, which is considered acoustically absorptive. This effect is defined by equation Eq. 4-34. In AEDT, the ground effect component of the lateral attenuation adjustment for helicopter and propeller aircraft (e.g., tour aircraft) can be turned off in order to model propagation over hard ground types. Since hard ground effects are most prominent close to the ground, jets are always modeled over soft ground in AEDT.

The specific algorithms used for computing lateral attenuation in AEDT are dependent on aircraft type, civil or military. Section 4.3.5.1 describes the lateral attenuation algorithms for civil aircraft, and Section 4.3.5.2 describes the lateral attenuation algorithms for military aircraft.

It is important to note that if terrain effects are included in an AEDT study, either the lateral attenuation adjustment or the line-of-sight blockage adjustment are implemented in the noise adjustment computation, but not both. Instead, the lateral attenuation adjustment is compared to the line-of-sight blockage adjustment on a segment-receiver calculation-by-calculation basis, and the larger of the two values is applied to the calculations. A detailed description of this computation is included in Section 4.3.6.

4.3.5.1 Lateral Attenuation Adjustment for Civil Aircraft

The lateral attenuation adjustment for civil aircraft is based on SAE-AIR-5662²⁴. SAE-AIR-5662²⁴ provides methods for combining multiple lateral attenuation effects, including those related to source configuration (recognizing different source effects among jet aircraft with fuselage-mounted engines and wing-mounted engines, as well as propeller-driven aircraft), and those related to propagation.

Computation of the lateral attenuation adjustment for aircraft in AEDT depends upon the following parameters:

1. The sideline distance from the flight path segment to the receptor, l_{seg}^{xvi} ;
2. The elevation angle, β , formed by SLR_{seg} and the horizontal plane of the receptor location, given by the following equation:

$$\beta = \sin^{-1} \left(\frac{d_{seg}}{SLR_{seg}} \right) \quad \text{Eq. 4-27}$$

where

d_{seg} See Eq. 4-2 and

$$SLR_{seg} = (d_{seg}^2 + l_{seg}^2)^{1/2} \quad \text{Eq. 4-28}$$

3. The aircraft bank angle, ε ; and

^{xvi} It is important to note that the lateral attenuation adjustment uses the sideline distance to the closest point of approach (CPA) on the segment as l_{seg} in the noise computation, and not the distance to the perpendicular closest point of approach (PCPA). In addition, AEDT can accept a lateral distance of l_{seg} equal zero, even though AEDT uses a minimum slant distance of 1 ft in most other portions of the noise computation process. When l_{seg} equals zero, the aircraft is directly above the receptor location.

4. The depression angle, φ , which is defined by β and ε in the following equation:

$$\varphi = \varepsilon + \beta \tag{Eq. 4-29}$$

These parameters are presented in Figure 4-4 and Figure 4-5.

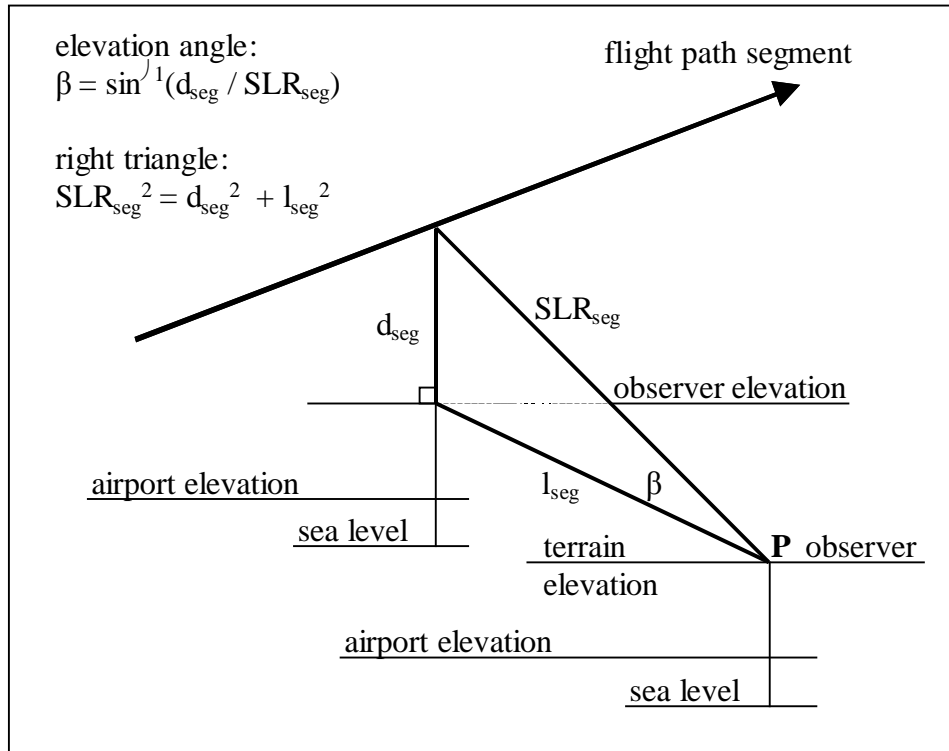

Figure 4-4 Lateral Attenuation Geometry

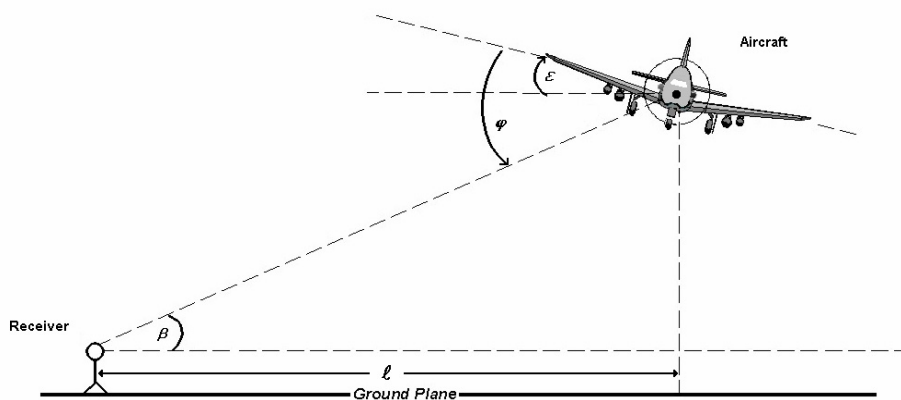

Figure 4-5 Bank Angle ε , Elevation Angle β , Depression Angle φ , and Lateral Distance l ²⁴

The four parameters are applied to the following equations for calculating lateral attenuation for civil aircraft that take into account engine-installation effects, $E_{\text{ENGINE}}(\varphi)$, attenuation due to ground effects, $G(l_{\text{seg}})$, and attenuation due to refraction-scattering effects, $\Lambda(\beta)$. These effects are calculated differently

for each aircraft engine-installation (wing-mounted, fuselage-mounted or propeller-driven engines) and for each of the following different sets of aircraft position criteria relative to the receiver:

1. Aircraft is on the ground or the elevation angle associated with the aircraft/receiver pair is less than 0 degrees;
2. Aircraft is airborne, the elevation angle is greater than 0 degrees, and the lateral (or sideline) distance is greater than 3,000 ft (914 m); or
3. Aircraft airborne, the elevation angle is greater than 0 degrees, and the lateral distance is less than or equal to 3,000 ft (914 m).

The engine-installation effect component of the lateral attenuation adjustment, $E_{ENGINE}(\varphi)$, accounts for any lateral directional effects due to noise shielding attributed to the location of the engines on the aircraft wing or fuselage. The engine-installation effect component is computed with the following equations, which are dependent on engine mounting location (fuselage or wing) and depression angle.

The engine installation effect (in dB) for an airplane with fuselage-mounted jet engines is:

$$E_{FUS}(\varphi) = 10 \log_{10}([0.1225 \cdot \cos^2(\varphi) + \sin^2(\varphi)]^{0.329}) \quad -180^\circ \leq \varphi \leq 180^\circ \quad \text{Eq. 4-30}$$

where

φ Depression angle (degrees).

The engine installation effect (dB) for an airplane with wing-mounted jets engines is:

$$E_{WING}(\varphi) = \begin{cases} 10 \log_{10} \left(\frac{[(0.0039 \cdot \cos^2(\varphi) + \sin^2(\varphi)]^{0.062}}{[0.8786 \cdot \sin^2(2\varphi) + \cos^2(2\varphi)] - 1.49} \right) & 0^\circ \leq \varphi \leq 180^\circ \\ -1.49 & 0^\circ > \varphi > -180^\circ \end{cases} \quad \text{Eq. 4-31}$$

The engine installation effect (dB) for an airplane with propeller-driven engines is:

$$E_{PROP}(\varphi) = 0.00 \quad \text{Eq. 4-32}$$

Since helicopter directional effects are represented by the left-center-right NPD curves and the directivity adjustments (see Section 4.4.2) their engine installation effects are already taken into account and therefore are represented by:

$$E_{HELI}(\varphi) = E_{PROP}(\varphi) = 0.00 \quad \text{Eq. 4-33}$$

The engine installation effects for jet-powered airplanes are illustrated in Figure 4-6.

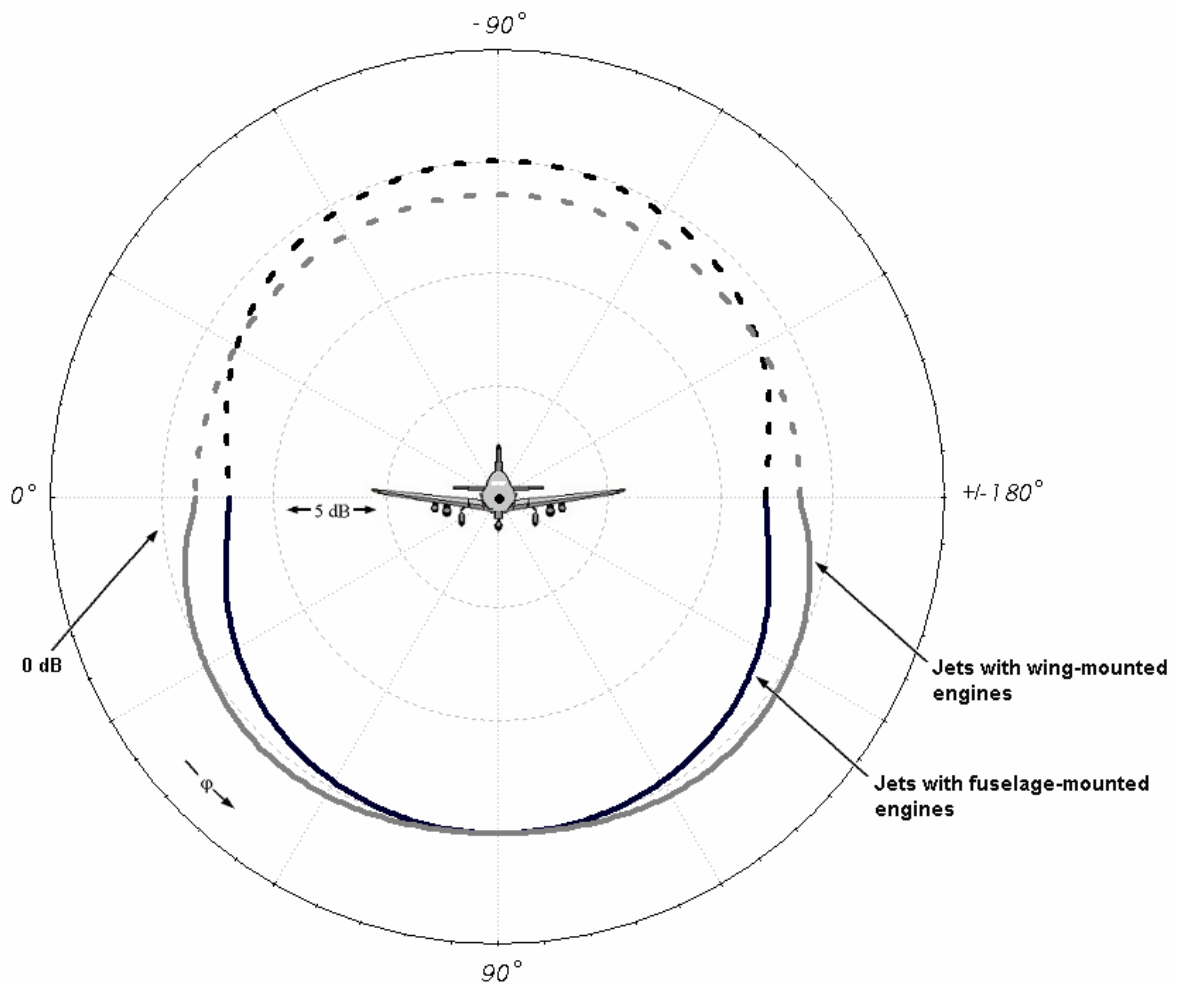

Figure 4-6 Illustration of Engine-Installation Effects for Jet-Powered Airplanes²⁴

The ground effect, or ground-to-ground, component of the lateral attenuation adjustment, $G(l_{seg})$, accounts for sound attenuation due to propagation over ground surfaces that may be considered to be “acoustically soft”, such as lawn or field grass. The ground-to-ground component is computed as follows:

$$G(l_{seg}) = \begin{cases} 11.83 \cdot [1 - e^{-0.00274 \cdot l_{seg}}] & 0 \leq l_{seg} \leq 914 \text{ m (3,000 ft)} \\ 10.86 & l_{seg} > 914 \text{ m (3,000 ft)} \end{cases} \quad \text{Eq. 4-34}$$

where

l_{seg} Sideline distance (m) in the horizontal plane from the receptor to the projection of the CPA.

The ground-to-ground component of the lateral attenuation adjustment is illustrated in Figure 4-7.

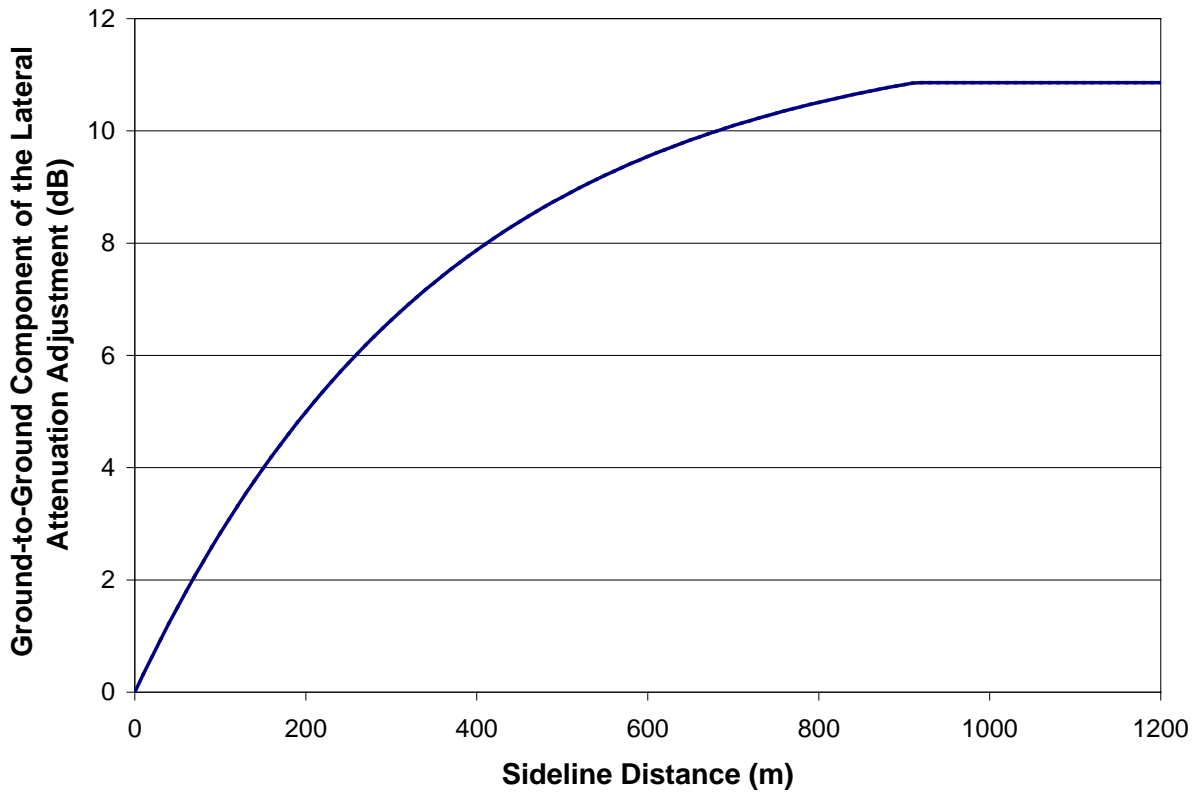

Figure 4-7 Illustration of Ground-to-Ground Component of Lateral Attenuation

The refraction-scattering, or air-to-ground, component of the lateral attenuation adjustment, $\Lambda(\beta)$, accounts for additional attenuation due to refraction and scattering of sound, as the result of wind and meteorological conditions. The air-to-ground component is computed as follows:

$$\Lambda(\beta) = \begin{cases} 10.86 & \beta \leq 0^\circ \\ 1.137 - (.229 \times 10^{-1})\beta + 9.72 \cdot e^{-0.142\beta} & 0^\circ < \beta \leq 50^\circ \\ 0.0 & 50^\circ < \beta \leq 90^\circ \end{cases} \quad \text{Eq. 4-35}$$

where

β Elevation angle (degrees); if $\beta \leq 0^\circ$ or the aircraft is on the ground, β is set to 0° .

The air-to-ground component of the lateral attenuation adjustment is illustrated in Figure 4-8.

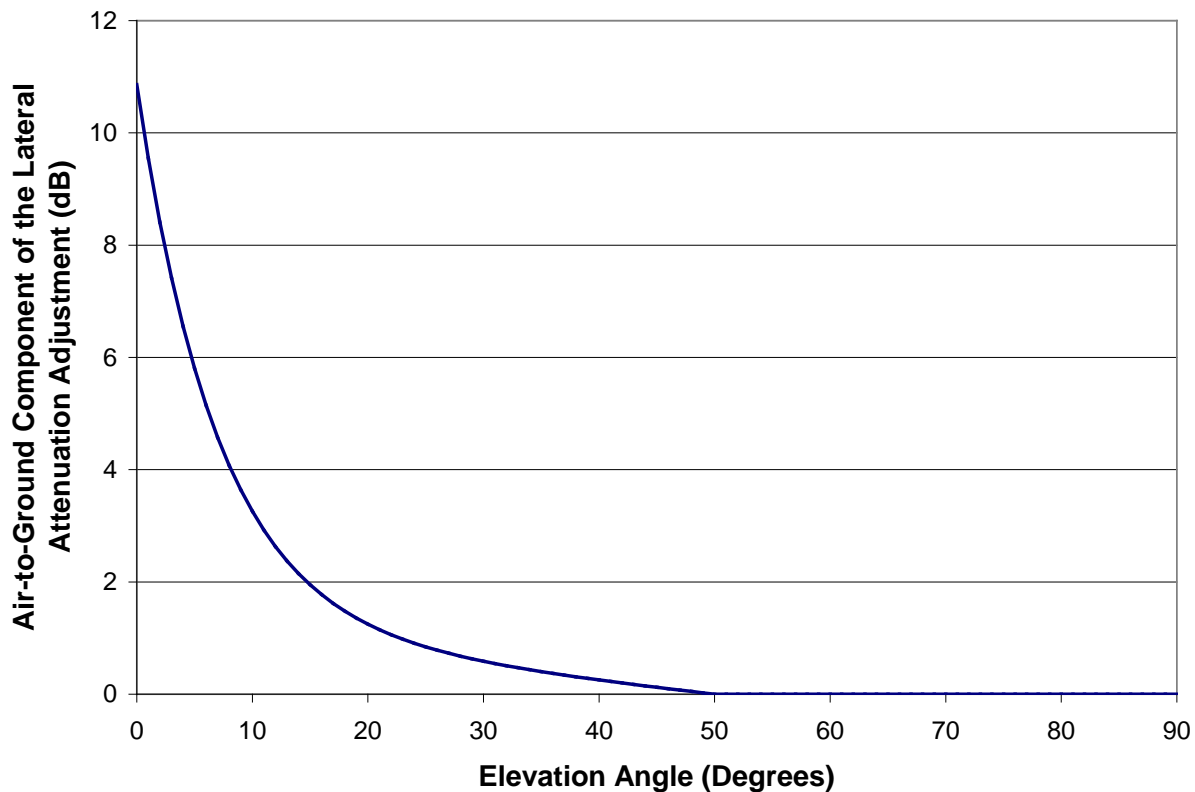

Figure 4-8 Illustration of Air-to-Ground Component of Lateral Attenuation

The overall lateral attenuation adjustment, LA_{ADJ} (in dB)^{xvii}, which takes into account the engine-installation effect component, $E_{ENGINE}(\varphi)$, the ground-to-ground component, $G(l_{seg})$, and the air-to-ground component, $\Lambda(\beta)$, is then computed as follows:

$$LA_{ADJ(AEDT)} = - \left[E_{ENGINE}(\varphi) - \frac{G(l_{seg}) \cdot \Lambda(\beta)}{10.86} \right] \quad \text{Eq. 4-36}$$

It is important to note that the depression angle in Figure 4-8 is general enough to include the bank angle, therefore the bank angle effect on lateral attenuation is already considered. If bank angle is not zero, the lateral attenuation will be non-symmetric from one side of the aircraft to another.

4.3.5.2 Lateral Attenuation Adjustment for Military Aircraft

The AEDT Fleet database includes all of the aircraft from the United States Air Force NOISEMAP suite of programs²⁵ as of March 2001. For military aircraft, computation of the lateral attenuation adjustment depends upon the elevation angle, β . If the elevation angle is less than 2 degrees, the adjustment has a ground-to-ground component only. If the elevation angle is greater than or equal to 2 degrees, it has

^{xvii} For AEDT aircraft, the sign of $LA_{ADJ(AEDT)}$ is made negative (see Eq. 4-36) in order to fit AEDT calculation conventions.

both a ground-to-ground and an air-to-ground component. In the latter case, the two components are computed separately and then combined.

The ground-to-ground component of the lateral attenuation adjustment (in decibels) is computed for military aircraft as follows^{xviii}:

$$G(l_{seg}) = \begin{cases} 15.09 \cdot [1 - e^{(-.274 \times 10^{-2}) \cdot l_{seg}}] & 0 \leq l_{seg} \leq 401 \text{ m (1316 ft)} \\ 10.06 & l_{seg} > 401 \text{ m (1316 ft)} \end{cases} \quad \text{Eq. 4-37}$$

where

l_{seg} Sideline distance (m) in the horizontal plane from the receptor to the projection of CPA.

The ground-to-ground component of the lateral attenuation adjustment for military aircraft is illustrated in Figure 4-9.

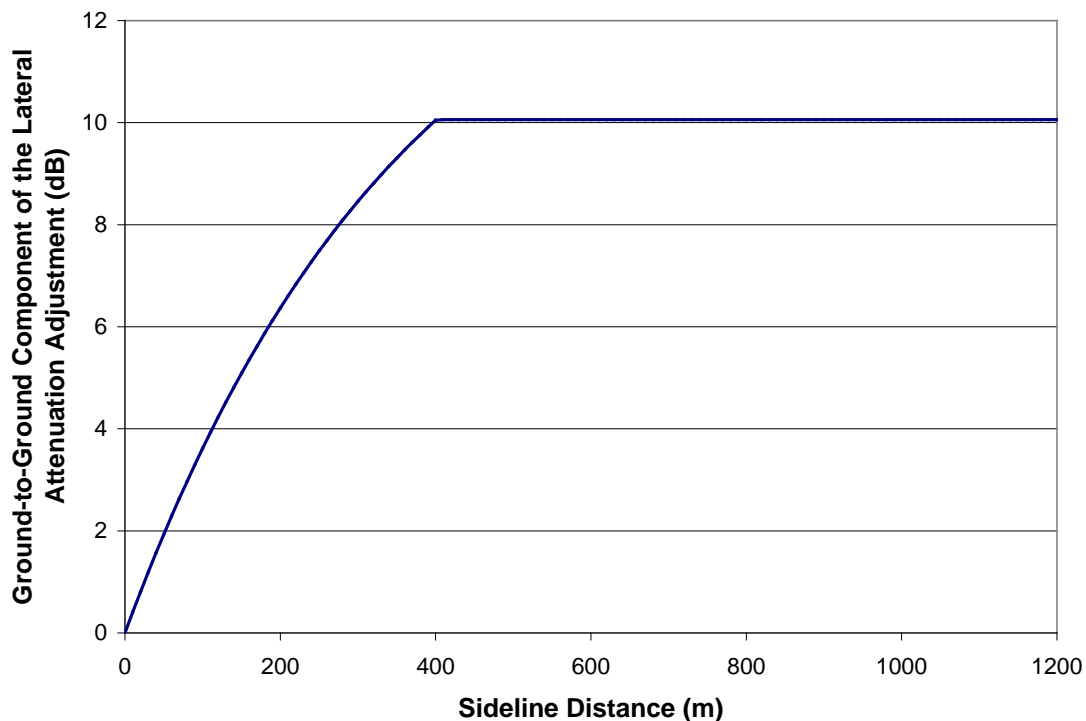

Figure 4-9 Illustration of Ground-to-Ground Component of Lateral Attenuation for Military Aircraft

^{xviii} The ground-to-ground component of the lateral attenuation adjustment actually computed by the NOISEMAP program depends on the one-third octave-band frequency characteristics of the noise source. Due to this fact, small differences are expected when comparing AEDT 2c and NOISEMAP results directly, especially in the immediate vicinity of the airport runways.

The air-to-ground component of the lateral attenuation adjustment (in decibels) is computed for military aircraft as follows:

$$\Lambda(\beta) = \begin{cases} \left(\frac{21.056}{\beta}\right) - 0.468 & 2^\circ \leq \beta \leq 45^\circ \\ 0 & 45^\circ \leq \beta \leq 90^\circ \end{cases} \quad \text{Eq. 4-38}$$

where

β Elevation angle (degrees); if $\beta > 0^\circ$, β is set to 0° .

The air-to-ground component of the lateral attenuation adjustment for military aircraft is illustrated in Figure 4-10.

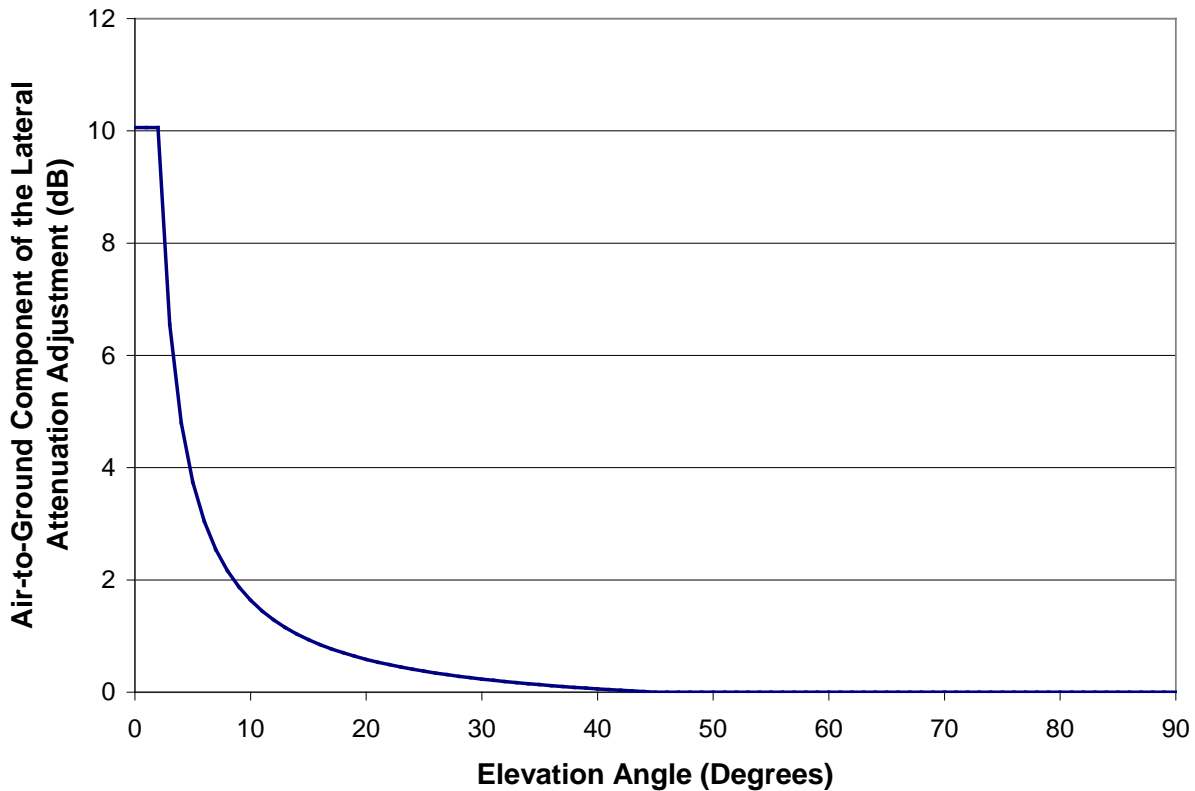

Figure 4-10 Illustration of Air-to-Ground Component of Lateral Attenuation for Military Aircraft

The overall lateral attenuation adjustment, LA_{ADJ} (in dB), which takes into account both the ground-to-ground component, $G(l_{seg})$, and the air-to-ground component, $\Lambda(\beta)$, for $2^\circ \leq \beta$, is then computed for military aircraft as follows:

$$LA_{ADJ(Military)} = \frac{G(l_{seg}) \cdot \Lambda(\beta)}{10.06} \quad \text{Eq. 4-39}$$

4.3.6 Line-of-Sight Blockage Adjustment (LOS_{ADJ})

This adjustment accounts for the attenuation due to line-of-sight (LOS) blockage from terrain features. The LOS blockage calculation is based on the difference in propagation path length between the direct path and propagation over the top of terrain features. The path length difference is used to compute the Fresnel Number (N_0), which is a dimensionless value used in predicting the attenuation provided by a noise barrier positioned between a source and a receiver. Figure 4-11 illustrates LOS blockage from a terrain feature.

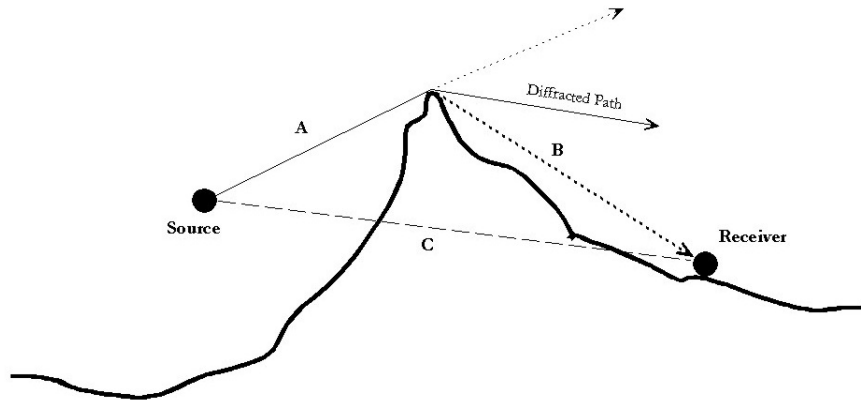

Figure 4-11 Line-of-Sight (LOS) Blockage Concept

The path length difference must be computed first using the following equation:

$$\delta_0 = (A + B) - C \tag{Eq. 4-40}$$

where

- A Distance between the source and the top of the barrier;
- B Distance between the top of the barrier and the receiver; and
- C Distance between the source and the receiver.

The LOS_{ADJ} is based on the theoretical, frequency-dependent barrier effect (assuming a barrier of infinite length), which is calculated with the following equation:

$$BE_i = \begin{cases} 5 + 20\log_{10} \left(\frac{\sqrt{2\pi|N_{0,i}|}}{\tan \left(\sqrt{2\pi|N_{0,i}|} \right)} \right) & N_{0,i} < 0 \\ 5 + 20\log_{10} \left(\frac{\sqrt{2\pi|N_{0,i}|}}{\tanh \left(\sqrt{2\pi|N_{0,i}|} \right)} \right) & N_{0,i} \geq 0 \end{cases} \tag{Eq. 4-41}$$

where

BE_i Barrier effect for the i-th one-third octave band; and
 $N_{0,i}$ Fresnel Number determined along the path defined by a particular source-barrier-receiver geometry for the i-th one-third octave band; computed as follows:

$$N_{0,i} = \pm 2 \left(\frac{\delta_0}{\lambda_i} \right) = \pm 2 \left(\frac{f_i \delta_0}{c} \right) \quad \text{Eq. 4-42}$$

where

\pm Positive in the case where the line of sight between the source and receiver is lower than the diffraction point and negative when the line of sight is higher than the diffraction point;
 δ_0 Path length difference determined along the path defined by a particular source-barrier-receiver geometry, and $=(A+B)-C$ (see Figure 4-11);
 λ_i Wavelength of the sound radiated by the source (i-th one-third octave band);
 f_i Frequency of the sound radiated by the source (i-th one-third octave band); and
 c Speed of sound.

In AEDT N_0 is limited to -0.1916 at the lower bound, and values of N_0 greater than 10 are set to 23.1²⁶.

Since LOS_{ADJ} is frequency dependent, the following adjustments are made to spectral classes in order to appropriately calculate LOS_{ADJ} :

1. The aircraft spectral class, SC , is corrected back to the source (from the 1,000 ft reference), effectively removing the SAE-AIR-1845⁵⁹ reference atmosphere, using the following equation:

$$SC_{Source,i} = SC_i - \left((ac_{ref,i}) \cdot \left[-\frac{1,000ft}{d_{ref}} \right] \right) \quad \text{Eq. 4-43}$$

where

$ac_{ref,i}$ Atmospheric absorption coefficient for the i-th third octave band for the reference atmosphere as presented in SAE-AIR-1845⁵⁹;
 SC_i i-th octave band of the spectral class;
 $SC_{Source,i}$ i-th octave band of the spectral class corrected back to the source; and
 d_{ref} 1,000 ft in AEDT.

2. The source spectrum is then corrected to the receptor distance in the study atmosphere generated with either SAE-ARP-866A²² or SAE-ARP-5534²³, using the following equation:

$$SC_{LOS,i} = SC_{Source,i} - \left((ac_{study,i}) \cdot \frac{SLR_{seg}}{d_{ref}} \right) \quad \text{Eq. 4-44}$$

where

$ac_{study,i}$ Atmospheric absorption coefficient for the i-th third octave band for the study-specific atmosphere as presented in SAE-ARP-866A²² or SAE-ARP-5534²³;
 $SC_{LOS,i}$ i-th octave band of the spectral class corrected back to the receptor;
 SLR_{seg} The slant range from the receptor to the point of closest approach on the segment (ft); and

d_{ref} 1,000 ft in AEDT.

- For each one-third octave band, the barrier effect is subtracted (in dB), BE_i , see Eq. 4-41, from SC_{LOS} , see Eq. 4-44. The result is referred to as $SC_{HPP,i}$.

$$SC_{HPP,i} = SC_{LOS,i} - BE_i \quad \text{Eq. 4-45}$$

- The energy is summed over $SC_{HPP,i}$ and converted to dB by the following equation:

$$HPP_{total} = 10 \log_{10} \left(\sum_{i=11}^{40} 10^{\frac{SC_{HPP,i}}{10}} \right) \quad \text{Eq. 4-46}$$

- The energy is summed over SC_{LOS} and converted to dB by the following equation:

$$LOS_{total} = 10 \log_{10} \left(\sum_{i=11}^{40} 10^{\frac{SC_{LOS,i}}{10}} \right) \quad \text{Eq. 4-47}$$

- Finally, LOS_{ADJ} can be computed using the following equation:

$$LOS_{ADJ} = HPP_{total} - LOS_{total} \quad \text{Eq. 4-48}$$

If line-of-sight blockage is selected for the noise calculations, LOS_{ADJ} is compared to LA_{ADJ} on a point-by-point basis and the larger of the two values is applied to the calculations. For each segment-based noise calculation, either LOS_{ADJ} or AI_{ADJ} are implemented, but not both. This allows for a seamless transition between LOS_{ADJ} and LA_{ADJ} , although it does not handle their interaction. As stated in the Federal Interagency Committee on Aviation Noise (FICAN) report "Assessment of Tools for Modeling Aircraft Noise in the National Parks"²⁷, this approach has been validated for distances up to 1,000 feet, beyond which a practical limit between 18 and 25 dB of attenuation can be expected due to refraction and scattering effects²⁸. Therefore, an 18 dB attenuation cap is implemented for LOS_{ADJ} in AEDT, as a practical upper limit on barrier attenuation.

4.4 Fixed-Wing Aircraft Adjustments

The sound level adjustments presented in this section are applicable only to fixed-wing aircraft, and not helicopters. These adjustments include thrust reverser (TR_{ADJ}) and ground-based directivity (DIR_{ADJ}).

4.4.1 Thrust Reverser Adjustment (TR_{ADJ})

For the special case of computing noise during thrust reverser deployment as part of the landing ground roll, an empirically-derived thrust reverser adjustment is employed. The thrust reverser noise assumptions represent reverse thrust levels in typical aircraft operations, while maintaining agreement between measured and modeled noise generated during landing ground roll. This methodology is based on ECAC Doc 29¹⁵ and "Thrust Reverser Analysis for Implementation in the Aviation Environmental Design Tool (AEDT)"²⁹, which is based on the ECAC Doc 29¹⁵ approach in conjunction with supplemental analysis of empirical thrust reverser deployment data for a variety of aircraft. These analyses were coordinated directly with the lead author of ECAC Doc 29¹⁵ and are being considered for possible future enhancement of that document.

In the legacy noise tool (INM versions prior to version 7.0), thrust reverser was applied to all STANDARD approach profiles as 60% of the max rated thrust for jets and 40% for props over a distance of 90% of the total roll-out distance after touchdown. In addition, thrust reverser thrust levels referenced Departure NPDs, instead of Approach NPDs. These thrust values during landing ground roll were used to ensure good agreement between measured and modeled noise levels, but are not necessarily representative of actual thrust levels during thrust reverser deployment. Since the aircraft performance model is common to noise and emissions computations in AEDT, the high thrust assumption is inappropriate when computing fuel burn and emissions. To appropriately model fuel burn and emissions, AEDT models peak thrust reverser engine power levels at 10% of max rated thrust for widebody aircraft, and 40% of max rated thrust for narrowbody aircraft, decreasing linearly to 10% of max rated thrust over a distance of 90% of the total roll-out distance after touchdown, all of which reference Approach NPDs^{xix}. In order to account for a higher noise level due to thrust reverser deployment than those due to a typical approach operation at a given thrust level, a thrust reverser adjustment is applied as an NPD dB adjustment that varies according to distance traveled from touchdown on the landing ground roll.

The thrust reverser adjustment for a given segment is calculated with the following equation:

$$TR_{ADJ} = \begin{cases} L_{unadj_{seg}} - L_{narrow_{seg}} & \text{narrowbody aircraft} \\ L_{unadj_{seg}} - L_{wide_{seg}} & \text{widebody aircraft} \\ 0 & \text{propeller and military aircraft} \end{cases} \quad \text{Eq. 4-49}$$

where

- $L_{unadj_{seg}}$ Noise level at $P_{unadj_{seg}}$ based on Departure NPDs when $P_{unadj_{seg}} \geq P_{final}$;
noise level at $P_{unadj_{seg}}$ based on Approach NPDs when $P_{unadj_{seg}} < P_{final}$;
- P_{final} The last power setting before thrust reverser is applied;
- $L_{narrow_{seg}}$ Noise level at $P_{narrow_{seg}}$ based on Approach NPDs; and
- $L_{wide_{seg}}$ Noise level at $P_{wide_{seg}}$ based on Approach NPDs.

The engine power level during reverse thrust for a given segment is derived according to the following equations:

$$P_{unadj_{seg}} = \left[\frac{d_{rev_{seg}}}{d_{rev}} \cdot (P_{60\%} - P_{10\%}) \right] + P_{10\%} \quad \text{Eq. 4-50}$$

$$P_{narrow_{seg}} = \left[\frac{d_{rev_{seg}}}{d_{rev}} \cdot (P_{40\%} - P_{10\%}) \right] + P_{10\%} \quad \text{Eq. 4-51}$$

$$P_{wide_{seg}} = \left[\frac{d_{rev_{seg}}}{d_{rev}} \cdot (P_{10\%} - P_{10\%}) \right] + P_{10\%} = P_{10\%} \quad \text{Eq. 4-52}$$

where

- $P_{60\%}$ 60% Max Thrust, which is the legacy reverse thrust implementation;

^{xix} There is no thrust reverser adjustment for propeller-driven aircraft in AEDT 2c.

- P_{40%} 40% Max Thrust, which is the current reverse thrust implementation for narrowbody aircraft;
- P_{10%} 10% Max Thrust, which is the current reverse thrust implementation for widebody aircraft;
- d_{rev} The distance along the runway from the point of thrust reverser deployment to the end of the landing ground roll, where:

$$d_{rev} = -0.9 \cdot s_{stop}$$
- s_{stop} The location on the runway where the landing ground roll ends; and
- d_{rev_seg} The distance along the runway from the aircraft position to the end of the landing ground roll, where:

$$d_{rev_seg} = -(300 + s_{stop} - d)$$

where

d Aircraft distance down the runway.

Engine power, aircraft speed, and reverse thrust levels for a standard landing ground roll are presented in Figure 4-12, where P_{rev} is 10% max thrust for widebody aircraft, and P_{rev} is 40% max thrust for narrowbody aircraft. In both cases, the ending engine power setting is 10%.

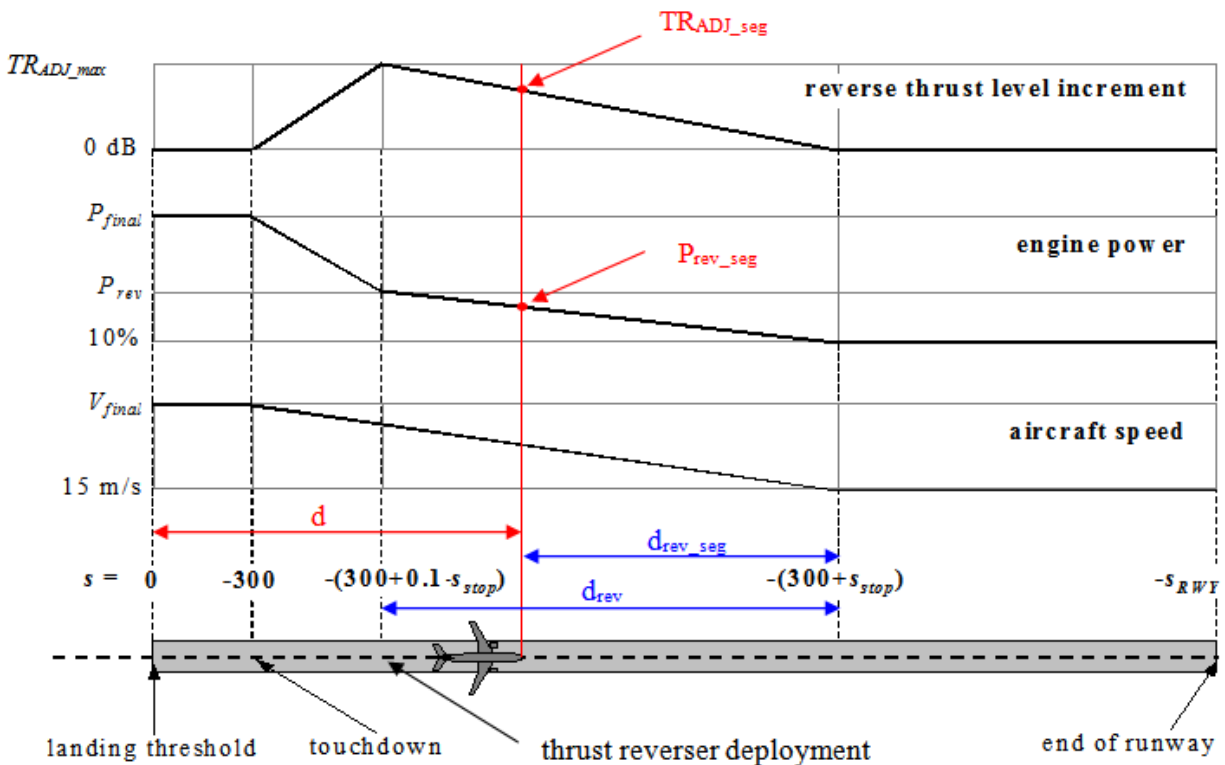

Figure 4-12 Modeling of Thrust Reverser Deployment During Landing Ground Roll

The thrust reverser adjustment in AEDT represents the most up-to-date method to model thrust reverser engine power levels used in the derivation of noise levels in an integrated model. Additional data collection and research efforts are ongoing and may result in future refinements.

4.4.2 Ground-Based Directivity Adjustment (DIR_{ADJ})

For the special case of computing noise behind the start-of-takeoff ground roll, as well as for computing metrics associated with runup operations, a field-measurement-based directivity adjustment is employed. This directivity adjustment is expressed as a function of azimuth angle, θ , defined as the angle formed by the direction of the nose of the aircraft and the line connecting the aircraft to the receptor.

To account for the effect of slight variations in the heading of the aircraft just prior to takeoff ground roll, among other effects, a directivity smoothing adjustment, computed as a function of slant range from the receptor location to the aircraft, is also applied.

The azimuth angle, θ (degrees), used in computing the directivity adjustment, is given by:

$$\theta = \cos^{-1}\left(\frac{q}{r_1}\right) \quad \text{Eq. 4-53}$$

where

- q Relative distance between points P_1 and P_s (ft) (by definition, the value of q is negative); and
- r_1 SLR_{seg} , the slant range from the receptor to the start of the takeoff roll (ft).

Since the value of q is negative, and the value of SLR_{seg} is positive, the value of θ is greater than 90 degrees when the receptor is behind start of takeoff.

The directivity adjustment, DIR_{ADJ} , is computed as a function of azimuth angle:

For θ between 90 and 148.4 degrees,

$$DIR_{ADJ} = 51.44 - (1.553 \cdot \theta) - ((15.147 \times 10^{-3}) \cdot \theta^2) + ((47.173 \times 10^{-6}) \cdot \theta^3) \quad \text{Eq. 4-54}$$

For θ between 148.4 and 180 degrees,

$$DIR_{ADJ} = 339.18 - ((25.802 \times 10^{-1}) \cdot \theta) - ((45.545 \times 10^{-4}) \cdot \theta^2) + ((44.193 \times 10^{-6}) \cdot \theta^3) \quad \text{Eq. 4-55}$$

Eq. 4-54 and Eq. 4-55 are plotted in Figure 4-13. The directivity adjustment is symmetric along the longitudinal axis of the aircraft in AEDT. This adjustment supplements the noise fraction adjustment for modeling noise from the start-of-takeoff ground roll, NF_{ADJ} (see Section 4.3.3).

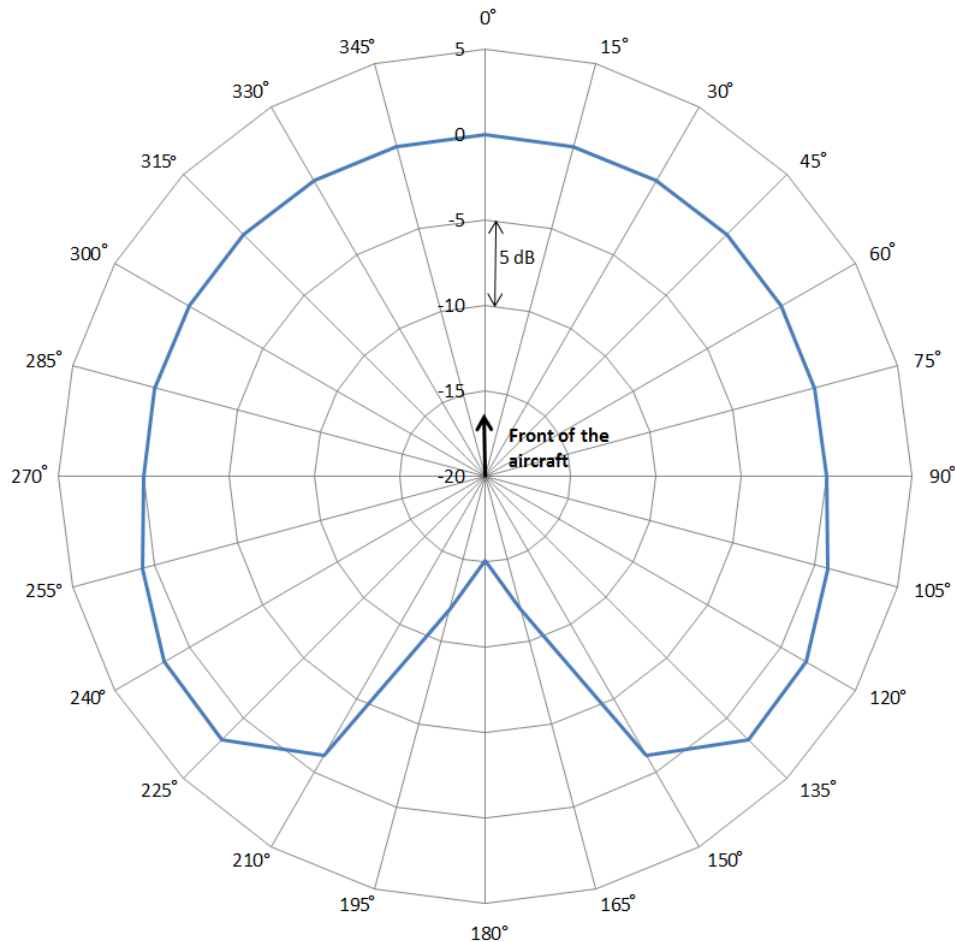

Figure 4-13 Ground-Based Directivity Adjustment

The directivity adjustment, DIR_{ADJ} , is modified by a smoothing equation that is computed as a function of slant range from the receptor location to start of takeoff, SLR_{seg} . The smoothing function is activated when SLR_{seg} is greater than 2,500 ft. The function, which reduces the directivity by a factor of 50% per doubling of distance, is given by:

$$DIR_{ADJ} = DIR_{ADJ} \cdot \left(\frac{2,500}{SLR_{seg}} \right) \quad SLR_{seg} > 2,500 \text{ feet} \quad \text{Eq. 4-56}$$

4.5 Helicopter Adjustments

The sound level adjustments presented in this Section are applicable only to helicopters. These adjustments include source noise due to advancing tip Mach Number (MN_{ADJ}), Lateral Directivity (LD_{ADJ}), static directivity (DIR_{HELI_ADJ}), and static operation duration (DUR_{HELI_ADJ}).

4.5.1 Source Noise Adjustment Due to Advancing Tip Mach Number (MN_{ADJ} , Level Flyover only)

This adjustment is necessary when the airspeed, temperature or rotor RPM deviates from the reference values. The adjustment is calculated using stored constants from a polynomial regression using the following equation:

$$MN_{ADJ} = B_0 + B_1 \cdot (M_{ADV_T} - M_{ADV_R}) + B_2 \cdot (M_{ADV_T} - M_{ADV_R})^2 \quad \text{Eq. 4-57}$$

where

B_0, B_1, B_2 Helicopter specific coefficients;
 V_T Operational airspeed (kts);
 V_R Reference airspeed for the noise curve (kts); and
 M_{ADV} Advancing tip Mach number, as defined by:

$$M_{ADV} = \frac{(1.688 \cdot V) + \left(\frac{\pi \cdot D \cdot RPM}{60}\right)}{c} \quad \text{Eq. 4-58}$$

where

V Airspeed (kts);
 D Blade diameter (ft);
 RPM Blade rotations per minute; and
 c Speed of sound in air (ft/s), as defined by:

$$c = 49.018 \cdot (459.63 + T)^{1/2} \quad \text{Eq. 4-59}$$

where

T Temperature (F).

An example of the derivation of advancing tip Mach number adjustment from measured data can be found in the 1993 report "Noise Measurement Flight Test of Five Light Helicopters"³⁰.

4.5.2 Lateral Directivity Adjustment (LD_{ADJ})

Helicopters are significantly more directive noise sources than fixed-wing aircraft. Helicopter in-flight directivity is implemented by using three sets of NPDs: left, center, and right (see Section 4.2.2.4). The left and right data are representative of the acoustic characteristics at a horizontal (to the side) elevation angle of 45 degrees; the center data are representative of the characteristics directly below the helicopter, or at 90 degrees. In cases where the elevation angle is between -45 and 45 degrees, a linear interpolation is performed on the observed elevation angle between the center NPD value and the left or right 45 degrees NPD value for all distances, which is reflected in the Lateral Directivity Adjustment (LD_{ADJ}). The Lateral Directivity Adjustment is calculated according to the following equation:

$$LD_{ADJ} = (L_{Left\ or\ Right} - L_{Center}) \cdot \left(\frac{|\beta| - 90}{45 - 90}\right) \quad \text{Eq. 4-60}$$

where

$L_{Left}, L_{Center}, L_{Right}$ Left, center, or right NPD data and
 β Observed elevation angle between 90 and 45 degrees on either side of the helicopter (see Figure 4-14).

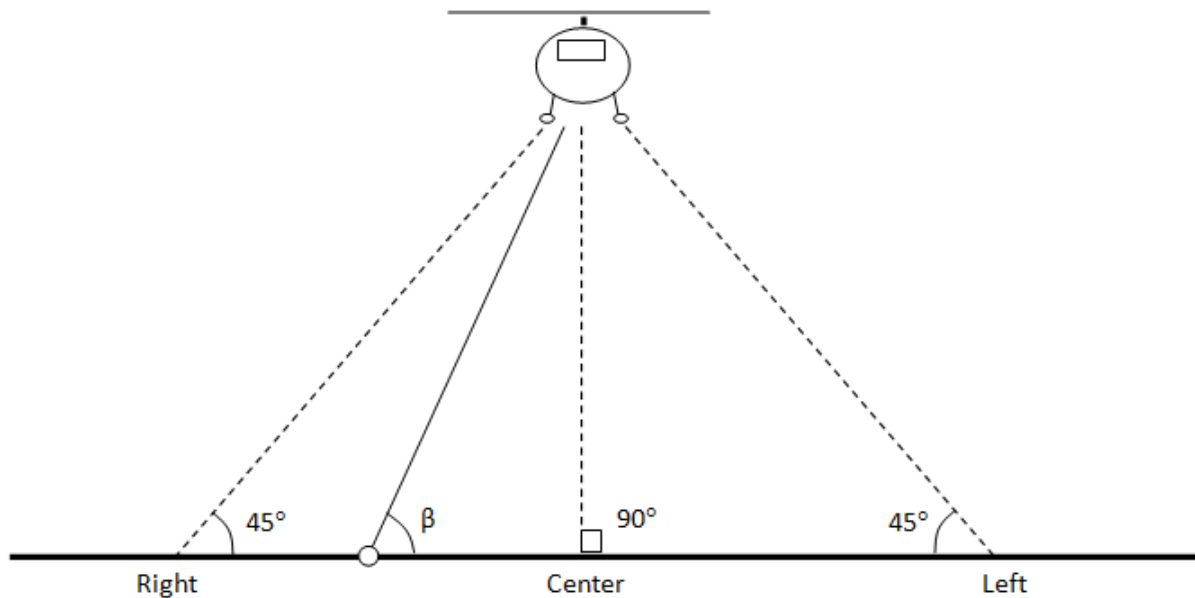

Figure 4-14 Elevation Angle for Helicopter Lateral Directivity Adjustment

For observed elevation angle less than 45 degrees on either side of the helicopter, no lateral directivity adjustment is applied, and the corresponding left or right NPD is used to determine the helicopter noise level. An example of the helicopter lateral directivity adjustment implementation is presented in Figure 4-14 for a dynamic operational mode; see Section 3.6.3 for a list of helicopter operational modes. An example of helicopter sound pressure levels according to elevation angle for a dynamic operational mode is shown in Figure 4-15.

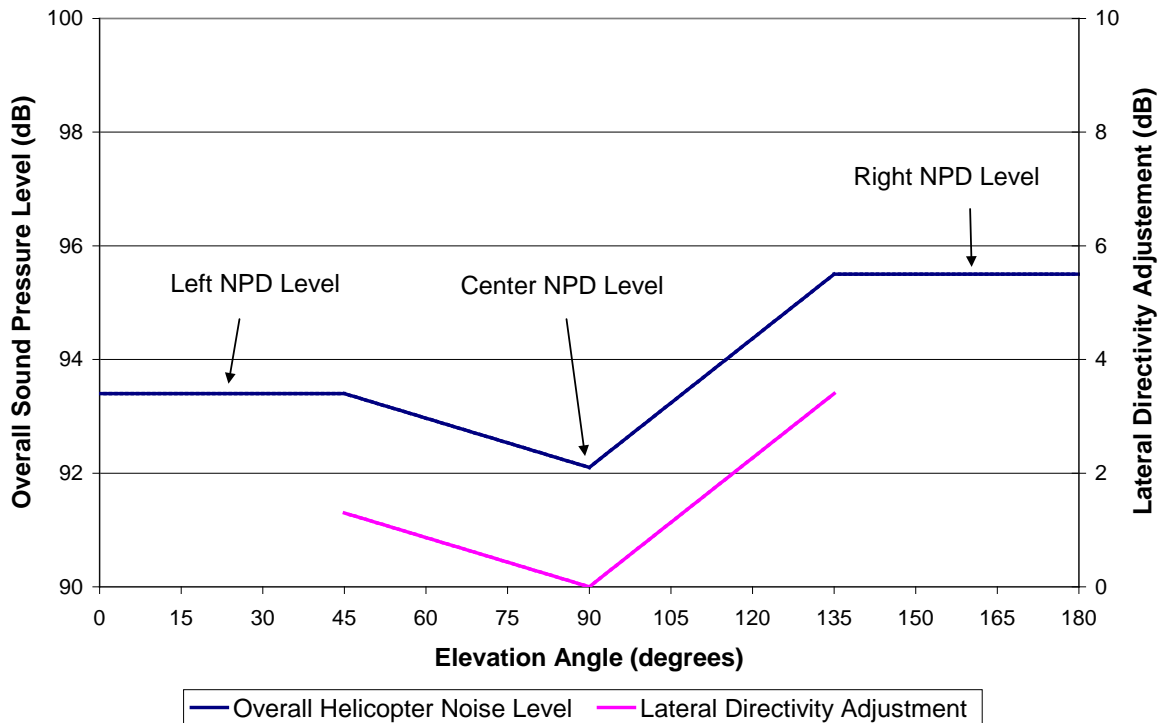

Figure 4-15 Example Helicopter Sound Pressure Levels According to Elevation Angle
(Including Helicopter Lateral Directivity Adjustment)

4.5.3 Static Directivity Adjustment (DIR_{HELI_ADJ})

The static directivity adjustment accounts for changes to the sound level as a function of the helicopter azimuth angle, which is measured clockwise from the nose. These adjustments are based on empirical data, and account for relative differences in sound level at different angles around the helicopter. DIR_{HELI_ADJ} is only applied during static helicopter operations (Flight Idle, Ground Idle, HIGE and HOGI). These data are helicopter-specific and included in the AEDT FLEET database, as described in Sections 2.2.1.3 and 2.2.1.3. Depending on data availability, different adjustments may be available for each of the four types of static helicopter operations^{xx}.

4.5.4 Static Operation Duration Adjustment (t_{HELI_static})

Helicopters can perform static operations along a flight track, and, as such, the duration of time spent on a segment during a static operation cannot be determined as a function of aircraft speed and segment length. Instead, the duration of a static event becomes a multiplier to the overall acoustical energy and is applied as the static operation duration adjustment once all the other general and helicopter adjustments have been applied (see Section 4.6.2.3).

4.6 Noise Computation

The single-event noise data described in Section 4.2 and the noise level adjustments described in Sections 4.3, 4.4, and 4.5 are used to compute the single-event noise values at the receptors. This

^{xx} In AEDT FLEET, helicopters with no static directivity data have their static directivity adjustments set entirely to 0.0 dB.

includes the application of system (or study-wide) adjustments to interpolated NPD data (see Section 4.6.1), the computation of the single-event noise for the nine base metrics in the following categories: exposure-based noise level metrics L_{AE} , L_{CE} and L_{EPN} (see Section 4.6.2), the maximum noise level metrics L_{ASmx} , L_{CSmx} and L_{PNTSmx} (see Section 4.6.3), and the time-based metrics TA_{LA} , TA_{LC} , and TA_{PNL} (see Section 4.6.4). The noise computations are run iteratively when additional base metrics are desired. Once all of the single events for an analysis have been computed for the applicable base metrics, then the single event results are accumulated across all of the events in the analysis, and the appropriate noise metrics are computed (see Section 4.6.5).

Figure 4-16 graphically summarizes the acoustic computation process employed in AEDT for computing noise from a single flight path segment (or runup or static operation) at a single receptor, when terrain processing is not selected. Figure 4-17 summarizes the same computation process, when terrain processing is selected.

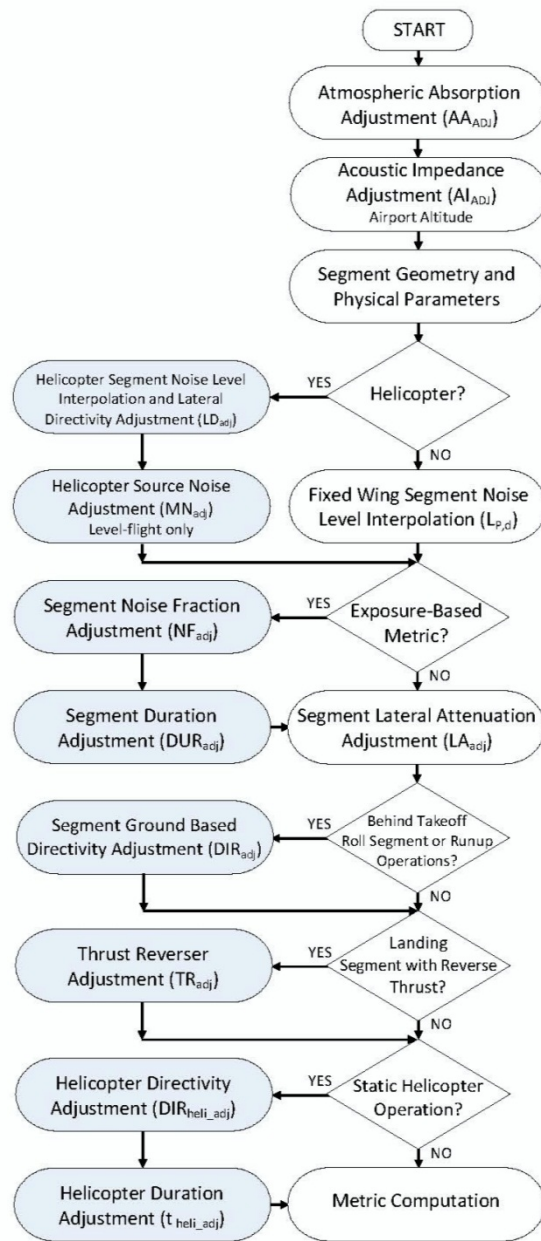

Figure 4-16 AEDT Acoustic Computation Process without Terrain for a Single Flight Segment

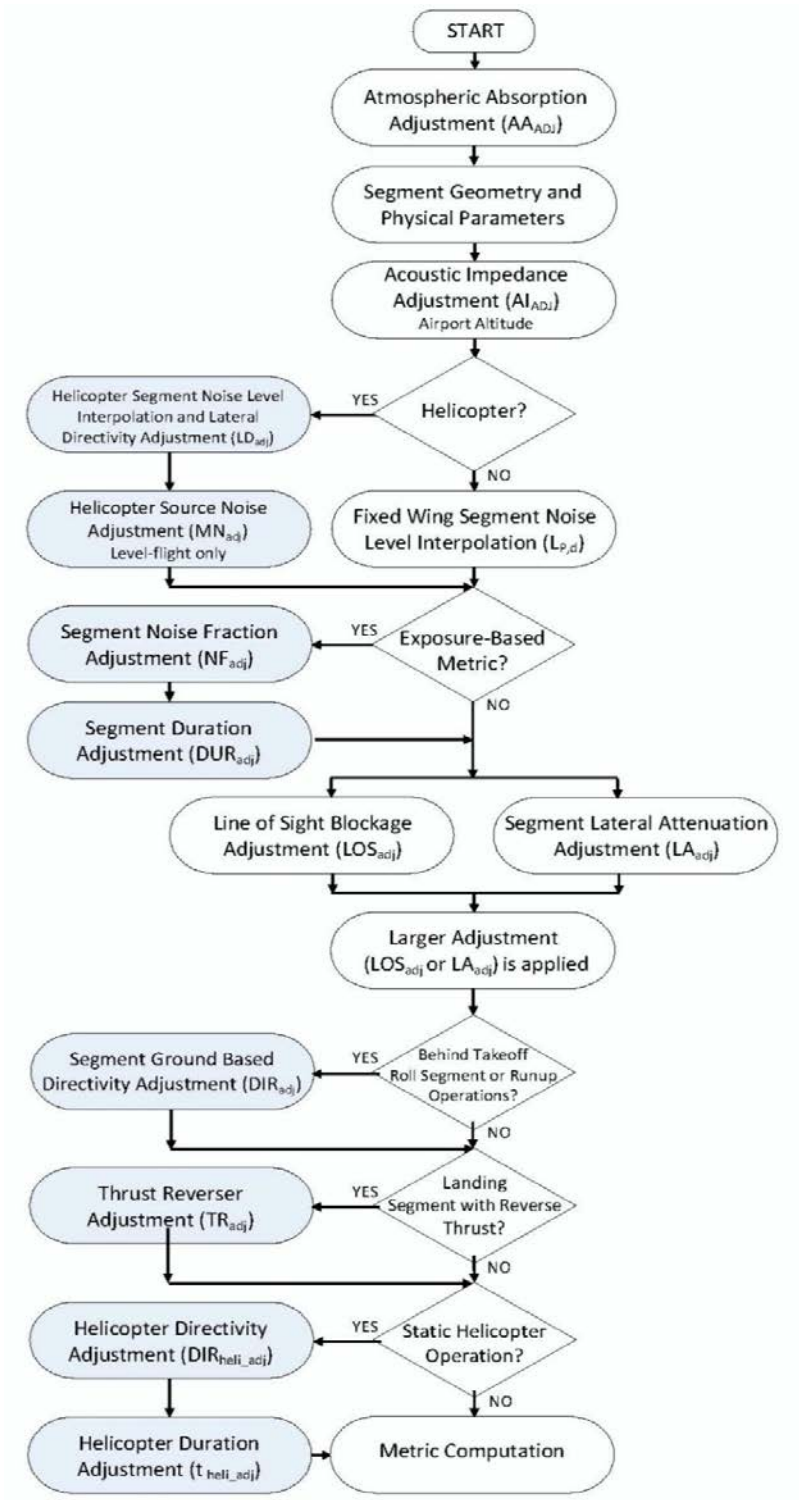

Figure 4-17 AEDT Acoustic Computation Process with Terrain for a Single Flight Segment

4.6.1 System Adjustments

AEDT applies study-wide adjustments to the interpolated NPD data. These adjustments include atmospheric absorption (AA_{ADJ} , Section 4.3.1) and acoustic impedance (AI_{ADJ} , Section 4.3.2). When terrain processing is not utilized in an analysis, both study-wide atmospheric absorption (AA_{ADJ}) and acoustic impedance (AI_{ADJ}) adjustments are applied to the NPD according to the following equations:

$$L_{E,P,d-ADJ} = L_{E,P,d} + [AA_{ADJ} + AI_{ADJ}]_{study-wide} \quad \text{Eq. 4-61}$$

$$L_{Smx,P,d-ADJ} = L_{Smx,P,d} + [AA_{ADJ} + AI_{ADJ}]_{study-wide} \quad \text{Eq. 4-62}$$

where

- $L_{E,P,d-ADJ}$ L_{AE} , L_{CE} , or L_{EPN} , in dB, resulting from the noise interpolation process using NPD data (see Section 4.2.2) and atmospheric absorption and acoustic impedance (see Sections 4.3.1 and 4.3.2);
- $L_{E,P,d}$ Exposure NPD level, in dB;
- $L_{Smx,P,d}$ Unadjusted, L_{ASmx} , L_{CSmx} , or L_{PNTSmx} , in dB, resulting from the noise interpolation process (see Section 4.2.2), where the maximum noise level is computed at each segment end and the CPA, and the maximum of the three levels is used;
- $L_{Smx,P,d}$ Maximum NPD level, in dB;
- AA_{ADJ} Atmospheric absorption adjustment, in dB (see Section 4.3.1); and
- AI_{ADJ} Acoustic impedance adjustment, in dB (see Section 4.3.2).

When terrain processing is utilized in an analysis, the acoustic impedance adjustment (AI_{ADJ}) is applied separately for each receptor, using the terrain elevation at the receptor's location instead of the airport elevation. For studies with terrain elevation processing, noise level interpolation is undertaken by first adjusting NPD curves using the study-wide atmospheric absorption adjustment (AA_{ADJ}), and then the receptor location-specific acoustic impedance adjustment is added to the sound levels after noise level interpolation:

$$L_{E,P,d-ADJ} = L_{E,P,d} + [AA_{ADJ}]_{study-wide} + [AI_{ADJ}]_{per-receptor} \quad \text{Eq. 4-63}$$

$$L_{Smx,P,d-ADJ} = L_{Smx,P,d} + [AA_{ADJ}]_{study-wide} + [AI_{ADJ}]_{per-receptor} \quad \text{Eq. 4-64}$$

It is important to note that the atmospheric absorption adjustment (AA_{ADJ}) is only applied in the noise computations if either the SAE-ARP-866A²² or SAE-ARP-5534²³ option is selected. Otherwise, the default atmospheric absorption inherent in the NPDs in the AEDT Fleet database and described in SAE-AIR-1845⁵⁹ is used. Conversely, the acoustic impedance adjustment (AI_{ADJ}) is always applied in the noise computations.

4.6.2 Computation of Exposure-Based Noise Level Metrics

The exposure-based metrics represent the total sound exposure for a given time period, often 24 hours, at a receptor location based upon average annual day conditions at an airport. AEDT standard sound exposure base metrics are:

- L_{AE} A-weighted sound exposure level (SEL);
- L_{CE} C-weighted sound exposure level (CEXP); and

L_{EPN} Effective tone-corrected perceived noise level (EPNL).

This section presents the computation of exposure-based noise level metrics for both fixed wing aircraft flight operations (Section 4.6.2.1), including runup operations (Section 4.6.2.2) and helicopter flight operations (Section 4.6.2.3), including static operations (Section 4.6.2.4). To obtain the total noise exposure at a receptor location, the contributions from all the operations in an analysis (fixed wing flight operations and runup operations, and helicopter flight and static operations) are combined (Section 4.6.5).

4.6.2.1 Fixed-Wing Aircraft Flight Operations

For the exposure-based noise metrics, the sound exposure ratio due to a single fixed path segment of a flight operation for a fixed-wing aircraft, denoted by the symbol E_{Seg} , is computed as follows:

$$E_{Seg} = 10^{\frac{[L_{E,P,d-ADJ} + NF_{ADJ} + DUR_{ADJ} - LA_{ADJ} + TR_{ADJ} + DIR_{ADJ}]}{10}} \quad \text{Eq. 4-65}$$

where

- $L_{E,P,d-ADJ}$ L_{AE} , L_{CE} , or L_{EPN} , in dB, resulting from the noise interpolation process using NPD data (see Section 4.2.2) and atmospheric absorption and acoustic impedance adjustments (see Section 4.3 and 4.6.1);
- NF_{ADJ} Noise fraction adjustment, in dB (see Section 4.3.3);
- DUR_{ADJ} Aircraft speed duration adjustment, in dB (see Section 4.3.4);
- LA_{ADJ} Lateral attenuation adjustment, in dB (see Section 4.3.5);
- TR_{ADJ} Thrust reverser adjustment, in dB, which is applied only if the fixed path segment is part of the landing ground roll during thrust reverser deployment (see Section 4.4.1); and
- DIR_{ADJ} Directivity adjustment, in dB, which is applied only if the fixed path segment is part of takeoff ground roll (see Section 4.4.2)

If line-of-sight blockage is invoked, LA_{ADJ} is compared to line-of-sight blockage adjustment, LOS_{ADJ} (see Section 4.3.6), on a segment-receiver calculation-by-calculation basis, and the larger of the two values is applied to the calculations (in place of LA_{ADJ}). If line-of-sight blockage is invoked, Equation Eq. 4-65 can be rewritten as:

$$E_{Seg} = 10^{\frac{[L_{E,P,d-ADJ} + NF_{ADJ} + DUR_{ADJ} - (\max[LOS_{ADJ}, LA_{ADJ}]) + TR_{ADJ} + DIR_{ADJ}]}{10}} \quad \text{Eq. 4-66}$$

where

- LOS_{ADJ} Line-of-sight blockage adjustment, in dB (see Section 4.3.6).

The sound exposure ratio associated with each path segment in a flight operation is computed iteratively and preserved.

4.6.2.2 Fixed-Wing Aircraft Runup Operations

For the exposure-based noise metrics, the mean-square sound-pressure ratio due to a single runup operation for a fixed-wing aircraft, denoted by the symbol P_{runup} , is computed as follows:

$$P_{runup} = 10^{\frac{[L_{Smx,P,d-ADJ} - LA_{ADJ} + DIR_{ADJ}]}{10}} \quad \text{Eq. 4-67}$$

where

$L_{Smx,P,d-ADJ}$	L_{ASmx} , L_{CSmx} , or L_{PNTSmx} , in dB, resulting from the noise interpolation process using NPD data (see Section 4.2.2) and atmospheric absorption and acoustic impedance adjustments (see Section 4.3 and 4.6.1);
DIR_{ADJ}	Directivity adjustment, in dB (see Section 4.4.2); and
LA_{ADJ}	Lateral attenuation adjustment, in dB (see Section 4.3.5).

If line-of-sight blockage is invoked, LA_{ADJ} is compared to line-of-sight blockage adjustment (LOS_{ADJ}) on a segment-receiver calculation-by-calculation basis, and the larger of the two values is applied to the calculations:

$$P_{runup} = 10^{\frac{[L_{Smx,P,d-ADJ} - (\max[LOS_{ADJ}, LA_{ADJ}]) + DIR_{ADJ}]}{10}} \quad \text{Eq. 4-68}$$

where

LOS_{ADJ}	Line-of-sight blockage adjustment, in dB (see Section 4.3.6).
-------------	---

The sound exposure ratio due to a single runup operation for a fixed-wing aircraft, E_{runup} , takes into account time duration of the runup operation. The sound exposure ratio is computed as follows:

$$E_{runup} = \left(\frac{t_{runup}}{t_0} \right) \cdot P_{runup} \quad \text{Eq. 4-69}$$

where

t_{runup}	Runup duration (seconds); and
t_0	1 second for L_{ASmx} or L_{CSmx} , or 10 seconds for L_{PNTSmx} .

The sound exposure ratio associated with each runup operation is computed iteratively and preserved.

4.6.2.3 Helicopter Flight Operations

For the exposure-based noise metrics, the sound exposure ratio due to a single fixed path segment of a flight operation for a helicopter, denoted by the symbol E_{seg_HELI} , is computed as follows:

$$E_{seg_HELI} = 10^{\frac{[L_{E,P,d-ADJ} + NF_{ADJ} + DUR_{ADJ} - LA_{ADJ} + MN_{ADJ} + LD_{ADJ}]}{10}} \quad \text{Eq. 4-70}$$

where

$L_{E,P,d-ADJ}$	L_{AE} , L_{CE} , or L_{EPN} , in dB, resulting from the noise interpolation process using NPD data (see Section 4.2.2) and atmospheric absorption and acoustic impedance adjustments (see Sections 4.3 and 4.6.1);
NF_{ADJ}	Noise fraction adjustment, in dB (see Section 4.3.3);
DUR_{ADJ}	Aircraft speed duration adjustment, in dB (see Section 4.3.4);
LA_{ADJ}	Lateral attenuation adjustment, in dB (see Section 4.3.5);
MN_{ADJ}	Helicopter source noise adjustment, in dB (see Section 4.5.1); and
LD_{ADJ}	Lateral directivity adjustment for helicopters, in dB (see Section 4.5.2).

If line-of-sight blockage is invoked, LA_{ADJ} is compared to line-of-sight blockage adjustment (LOS_{ADJ}) on a segment-receiver calculation-by-calculation basis, and the larger of the two values is applied to the calculations:

$$E_{seg_HELI} = 10^{\frac{[L_{E,P,d-ADJ} + NF_{ADJ} + DUR_{ADJ} - (\max[LOS_{ADJ}, LA_{ADJ}]) + MN_{ADJ} + LD_{ADJ}]}{10}} \quad \text{Eq. 4-71}$$

where

LOS_{ADJ} Line-of-sight blockage adjustment, in dB (see Section 4.3.6).

The sound exposure ratio associated with each path segment in a helicopter flight operation is computed iteratively and preserved.

4.6.2.4 Helicopter Static Operations

For the exposure-based noise metrics, the sound exposure ratio due to a static operation for a helicopter, denoted by the symbol $E_{seg_HELI_static}$, is computed as follows:

$$E_{seg_HELI} = t_{HELI_static} \cdot 10^{\frac{[L_{E,P,d-ADJ} + NF_{ADJ} - LA_{ADJ} + DIR_{HELI_ADJ}]}{10}} \quad \text{Eq. 4-72}$$

where

t_{HELI_static} Helicopter duration adjustment for static operations, in dB (see Section 4.5.4)

$L_{E,P,d-ADJ}$ L_{AE} , L_{CE} , or L_{EPN} , in dB, resulting from the noise interpolation process using NPD data (see Section 4.2.2) and atmospheric absorption and acoustic impedance adjustments (see Section 4.3 and 4.6.1);

NF_{ADJ} Noise fraction adjustment, in dB (see Section 4.3.3);

LA_{ADJ} Lateral attenuation adjustment, in dB (see Section 4.3.5); and

DIR_{HELI_ADJ} Helicopter directivity adjustment for static operations, in dB (see Section 4.5.3).

If line-of-sight blockage is invoked, LA_{ADJ} is compared to line-of-sight blockage adjustment (LOS_{ADJ}) on a segment-receiver calculation-by-calculation basis, and the larger of the two values is applied to the calculations:

$$E_{seg_HELI} = t_{HELI_static} \cdot 10^{\frac{[L_{E,P,d-ADJ} + NF_{ADJ} - (\max[LOS_{ADJ}, LA_{ADJ}]) + DIR_{HELI_ADJ}]}{10}} \quad \text{Eq. 4-73}$$

where

LOS_{ADJ} Line-of-sight blockage adjustment, in dB (see Section 4.3.6).

The sound exposure ratio associated with each static helicopter operation is computed iteratively and preserved.

4.6.3 Computation of Maximum Noise Level Metrics

The maximum noise level metrics represent the maximum noise level at a receptor location, taking into account a particular set of aircraft operations.

AEDT standard maximum noise level base metrics are:

LAS _{mx}	Maximum A-weighted sound level with slow-scale exponential weighting characteristics (LAMAX);
LCS _{mx}	Maximum C-weighted sound level with slow-scale exponential weighting characteristics (LCMAX); and
LPNTS _{mx}	Maximum tone-corrected perceived noise level with slow-scale, exponential weighting characteristics (PNLTM).

This section presents separately the computation of maximum noise level metrics for aircraft flight operations (Section 4.6.3.1), including runup operations (Section 4.6.3.2), and helicopter flight operations (Section 4.6.3.3), including static operations (Section 4.6.3.4). To obtain the maximum noise level at a receptor location, the contributions from all the operations in an analysis (fixed wing flight operations and runup operations, and helicopter flight and static operations) are combined (Section 4.6.5).

4.6.3.1 Fixed-Wing Aircraft Flight Operations

The maximum noise level due to a single flight path segment for a fixed wing aircraft, $L_{S_{mx,seg}}$, is computed as follows:

$$L_{S_{mx,seg}} = L_{S_{mx,P,d-ADJ}} - LA_{ADJ} + TR_{ADJ} + DIR_{ADJ} \quad \text{Eq. 4-74}$$

where

$L_{S_{mx,P,d-ADJ}}$	$L_{AS_{mx}}$, $L_{CS_{mx}}$, or $L_{PNTS_{mx}}$, in dB, resulting from the noise interpolation process (see Section 4.2.2), where the maximum noise level is computed at each segment end and the CPA, and the maximum of the three levels is used, along with atmospheric absorption and acoustic impedance adjustments (see Section 4.3 and 4.6.1);
LA_{ADJ}	Lateral attenuation adjustment, in dB (see Section 4.3.5);
TR_{ADJ}	Thrust reverser adjustment, in dB, which is applied only if the flight path segment is part of the landing ground roll during thrust reverser deployment (see Section 4.4.1); and
DIR_{ADJ}	Directivity adjustment, in dB, which is applied only if the flight path segment is part of takeoff ground roll (see Section 4.4.2).

If line-of-sight blockage is invoked, LA_{ADJ} is compared to line-of-sight blockage adjustment (LOS_{ADJ}) on a segment-receiver calculation-by-calculation basis, and the larger of the two values is applied to the calculations (in place of LA_{ADJ}). Therefore, if line-of-sight blockage is invoked, Eq. 4-74 can be rewritten as:

$$L_{S_{mx,seg}} = L_{S_{mx,P,d-ADJ}} - \max[LA_{ADJ}, LOS_{ADJ}] + TR_{ADJ} + DIR_{ADJ} \quad \text{Eq. 4-75}$$

where

LOS_{ADJ}	Line-of-sight blockage adjustment, in dB (see Section 4.3.6).
-------------	---

The maximum noise level associated with each path segment in a flight operation is computed iteratively and preserved.

4.6.3.2 Fixed-Wing Aircraft Runup Operations

The maximum noise level due to a single runup operation, denoted by the symbol $L_{S_{mx,runup}}$, is computed as follows:

$$L_{Smx,runup} = L_{Smx,P,d-ADJ} - LA_{ADJ} + DIR_{ADJ} \quad \text{Eq. 4-76}$$

where

- $L_{Smx,P,d-ADJ}$ L_{ASmx} , L_{CSmx} , or L_{PNTSmx} , in dB, resulting from the noise interpolation process (see Section 4.2.2), where the maximum noise level is computed at each segment end and the CPA, and the maximum of the three levels is used, along with atmospheric absorption and acoustic impedance adjustments (see Section 4.3 and 4.6.1);
- LA_{ADJ} Lateral attenuation adjustment, in dB (see Section 4.3.5); and
- DIR_{ADJ} Directivity adjustment, in dB, which is applied only if the flight path segment is part of takeoff ground roll (see Section 4.4.2).

If line-of-sight blockage is invoked, LA_{ADJ} is compared to line-of-sight blockage adjustment (LOS_{ADJ}) on a segment-receiver calculation-by-calculation basis, and the larger of the two values is applied to the calculations:

$$L_{Smx,runup} = L_{Smx,P,d-ADJ} - \max[LA_{ADJ}, LOS_{ADJ}] + DIR_{ADJ} \quad \text{Eq. 4-77}$$

where

- LOS_{ADJ} Line-of-sight blockage adjustment, in dB (see Section 4.3.6).

The maximum noise level associated with each runup operation is computed iteratively and preserved.

4.6.3.3 Helicopter Flight Operations

The maximum noise level due to a single flight path segment for a helicopter, L_{Smx,seg_HELI} , is computed as follows:

$$L_{Smx,seg_HELI} = L_{Smx,P,d-ADJ} - LA_{ADJ} + MN_{ADJ} + LD_{ADJ} \quad \text{Eq. 4-78}$$

where

- $L_{Smx,P,d-ADJ}$ L_{ASmx} , L_{CSmx} , or L_{PNTSmx} , in dB, resulting from the noise interpolation process (see Section 4.2.2), where the maximum noise level is computed at each segment end and the CPA, and the maximum of the three levels is used along with atmospheric absorption and acoustic impedance adjustments (see Sections 4.3.1 and 4.6.1);
- LA_{ADJ} Lateral attenuation adjustment, in dB (see Section 4.3.5);
- MN_{ADJ} Helicopter source noise adjustment (see Section 4.5.1); and
- LD_{ADJ} Lateral directivity adjustment for helicopters, in dB, (see Section 4.5.2).

If line-of-sight blockage is invoked, LA_{ADJ} is compared to line-of-sight blockage adjustment (LOS_{ADJ}) on a segment-receiver calculation-by-calculation basis, and the larger of the two values is applied to the calculations:

$$L_{Smx,seg_HELI} = L_{Smx,P,d-ADJ} - \max[LA_{ADJ}, LOS_{ADJ}] + MN_{ADJ} + LD_{ADJ} \quad \text{Eq. 4-79}$$

where

- LOS_{ADJ} Line-of-sight blockage adjustment, in dB (see Section 4.3.6).

The maximum noise level associated with each path segment of a helicopter flight operation is computed iteratively and preserved.

4.6.3.4 Helicopter Static Operations

The maximum noise level due to a static operation for a helicopter, denoted by the symbol $L_{Smx,HELI_static}$, is computed as follows:

$$L_{Smx,HELI_static} = L_{Smx,P,d-ADJ} - LA_{ADJ} + DIR_{HELI_ADJ} \quad \text{Eq. 4-80}$$

where

- $L_{Smx,P,d-ADJ}$ L_{ASmx} , L_{CSmx} , or L_{PNTSmx} , in dB, resulting from the noise interpolation process (see Section 4.2.2), where the maximum noise level is computed at each segment end and the CPA, and the maximum of the three levels is used along with atmospheric absorption and acoustic impedance adjustments (see Sections 4.3 and 4.6.1);
- LA_{ADJ} Lateral attenuation adjustment, in dB (see Section 4.3.5);
- DIR_{HELI_ADJ} Helicopter directivity adjustment for static operations, in dB (see Section 4.6.2.4)

If line-of-sight blockage is invoked, LA_{ADJ} is compared to line-of-sight blockage adjustment (LOS_{ADJ}) on a segment-receiver calculation-by-calculation basis, and the larger of the two values is applied to the calculations:

$$L_{Smx,HELI_static} = L_{Smx,P,d-ADJ} - \max[LA_{ADJ}, LOS_{ADJ}] + DIR_{HELI_ADJ} \quad \text{Eq. 4-81}$$

where

- LOS_{ADJ} Line-of-sight blockage adjustment, in dB (see Section 4.3.6).

The maximum noise level associated with each helicopter static operation is computed iteratively and preserved.

4.6.4 Computation of Time-Based Metrics

The time-based metrics represent the time (minutes) or percentage of time that the noise level is above a specified threshold, taking into account aircraft operations for a particular time period (e.g., 24 hours). The AEDT standard time-based base metrics are:

- T_{ALA} Time that the A-weighted noise level is above a user-defined sound level during the time period (TALA);
- T_{ALC} Time that the C-weighted noise level is above a user-defined sound level during the time period (TALC); and
- T_{APNL} Time that the tone-corrected perceived noise level is above a user specified noise level during the time period (TAPNL).

A subset of the time-based metrics is time audible. Time audible (or audibility) is computed based on a comparison of aircraft noise against ambient noise to determine the time duration (or percentage of time duration) that the noise may be audible to a human observer. For these calculations, the observer is assumed to have normal hearing and to be actively listening for aircraft noise. Time audible also takes into account aircraft operations for a particular time period (e.g., 24 hours). The process is based on detectability theory and is supplemented with research that has assessed human auditory detectability in different environments. In order to represent these different environments, the time audible metrics

require highly detailed inputs, including FAA AEE-approved ambient noise files. More details on ambient noise file requirements can be obtained by contacting FAA AEE (see Sections 2.2.3.6 and 2.2.3.7 for more information).

Section 11.1.5 provides additional specifics on the theory and background of the time audible computation. A detailed discussion of audibility calculations is also presented in the “Assessment of Tools for Modeling Aircraft Noise in the National Parks”²⁷. AEDT standard time audible metrics are:

T_{Aud}	Time that aircraft are audible given study specific ambient noise (TAUD), and
T_{AudSC}	Time that aircraft are audible given study specific ambient noise with simultaneously occurring aircraft events (overlapping events) are accounted for with the statistical compression method (TAUDSC). See Section 4.6.5.4.1 for description on the statistical compression method.

Time audible metrics may also be expressed as a percentage of time that aircraft are audible given study specific ambient noise during the analysis time period.

This section presents the computation of the time-based metrics for flight operations for fixed wing aircraft and helicopters (Section 4.6.4.1), as well as for ground operations (Section 4.6.4.2), which include both runup operations for fixed wing aircraft and static operations for helicopters. To obtain time-based metrics at a receptor location, the contribution from both flight operations and ground operations are combined. Although time audible takes into account adjusted noise levels for the flight and ground operations and a user-specified noise-level threshold like the other time-based metrics, the computation of time audible differs significantly from the other time-based metrics and is therefore presented separately (Section 4.6.4.3).

An important assumption inherent in time-based noise computations is that operations do not overlap in time, i.e., user-specified operations occur in a serial fashion. However, if a study includes operations occurring simultaneously (e.g., modeling an airport with parallel runways), the computed time-based noise metric may be larger than what would be measured at the airport. In such instances, a user could define operations in terms of equivalent numbers of serial operations, as compared with average annual day operations. In addition, the time audible metric includes the option to apply a statistical compression method that will account for the likelihood of overlapping events occurring in the final results (Section 4.6.5.4.1).

All time-based metrics computations in AEDT are referenced to a noise level threshold: either a fixed threshold level or a file of threshold or ambient values that may vary in noise level according to receptor location. The only caveat is for time audible, which may only be computed with a user-specified ambient file including both noise levels and spectra according to receptor location.

4.6.4.1 Flight Operations

In AEDT, the time-above metric (TA_{fit} , in minutes) can take the form of either the time above an A-weighted sound level (TA_{LA}), the time-above a C-weighted sound level (TA_{LC}), or the time above a tone-corrected perceived noise level (TA_{LPNT}). TA is expressed in minutes and is computed on a per flight basis. TA due to a single flight operation (for both fixed wing aircraft and helicopters) is computed by the equation:

$$TA_{seg} = \begin{cases} \left(\frac{4}{\pi}\right) \cdot t_0 \cdot \left[10^{\frac{L_{E,seg} - L_{Smx,seg}}{10}}\right] \cdot \left[10^{\frac{L_{Smx,seg} - L_0}{20}} - 1\right]^{1/2} \cdot \frac{1}{60} & L_{Smx,seg} > L_0 \\ 0 & L_{Smx,seg} \leq L_0 \end{cases} \quad \text{Eq. 4-82}$$

where

t_0	1 second for L_{AE} and L_{CE} , or 10 seconds for L_{EPN} ;
$L_{E,flt}$	Adjusted noise exposure level for the flight segment (dB), L_{AE} , L_{CE} , L_{EPN} (Section 4.6.2);
$L_{Smx,flt}$	Adjusted maximum noise level for the flight segment (dB), L_{ASmx} , L_{CSmx} , L_{PNTSmx} (where $L_{Smx,flt}$ must be larger than L_0) (Section 4.6.3); and
L_0	User-defined noise-level threshold (dB), expressed as A-weighted noise level, C-weighted noise level, or tone-corrected perceived noise level.

TA for each path segment of a flight operation is computed iteratively and preserved.

4.6.4.2 Ground Operations

The time-above metric for a single ground operation (either a runup operation for fixed wing aircraft or a static operation for helicopters) is the portion of the ground operation time during which the user-defined noise level threshold is exceeded by the ground operation noise. The time-above for a ground operation is computed as follows:

$$TA_{ground} = \begin{cases} t_{ground} & L_{Smx} > L_0 \\ 0 & L_{Smx} \leq L_0 \end{cases} \quad \text{Eq. 4-83}$$

where

t_{ground}	The time-above duration (minutes) of the ground operation event;
L_{Smx}	One of the tree types of adjusted maximum noise levels for ground operation (Section 4.6.3.2 for fixed wing aircraft and Section 4.6.3.4 for helicopters); and
L_0	The time-above noise threshold level.

TA for each runup operation is computed iteratively and preserved.

4.6.4.3 Time Audible Computations

Audibility compares aircraft noise against background noise to determine if noise may be detected by a human observer with normal hearing who is actively listening for aircraft noise. The process is based on detectability theory along with research that has assessed human detectability under different environments. Audibility requires highly detailed inputs and results may be very sensitive to the quality of input data. Accounting for background noise requires ambient files.

There are four different time audible metrics: TAUD (Time Audible), TAUDP (Time Audible Percent), TAUDSC (Time Audible Statistical Compression), TAUDPSC (Time Audible Percent Statistical Compression)³¹. All of these metrics are based on the base TAUD noise metric.

TAUD (in minutes) due to each aircraft segment is based on the computation of the total detectability level of that segment:

$$D' L_{total} = 10 \cdot \log_{10} [d'_{total}] \quad \text{Eq. 4-84}$$

where

$D' L_{total}$ the total detectability level of an aircraft segment, and
 d'_{total} the square root of the sum of squares of detectability over all frequency bands, as given by:

$$d'_{total} = \left[\sum_{band=17}^{40} (d'_{band})^2 \right]^{1/2} \quad \text{Eq. 4-85}$$

d'_{band} the detectability for each one-third octave frequency band:

$$d'_{band} = 10^{\frac{D' L_{band}}{10}} \quad \text{Eq. 4-86}$$

$D' L_{band}$ the detectability level for each one-third octave frequency band:

$$D' L_{band} = (L_{signal,band} - L_{noise,band}) + \{10 \cdot \log_{10} [\eta_{band}] + 0.5 \cdot 10 \cdot \log_{10} [bandwidth]\} \quad \text{Eq. 4-87}$$

where

$10 \log[\eta_{band}]$ one-third octave band specific constant,
 bandwidth the bandwidth of the one-third octave band, and
 $L_{noiseband}$ the addition of the un-weighted, measured one-third octave band ambient levels and the appropriate Equivalent Auditory System Noise (EASN) level.

Specific constants utilized in the detectability equation are presented in Section 11.1.5.

Once the total detectability level has been determined, it is compared to the following detectability criteria:

$$\begin{aligned} D' L_{total} &\geq 7 && \text{the aircraft segment is detectable.} \\ D' L_{total} &< 7 && \text{the aircraft segment is not detectable.} \end{aligned} \quad \text{Eq. 4-88}$$

For each segment of the aircraft operation that is detectable, the time it takes aircraft to travel through that flight path segment is computed:

$$segtime = \left(\frac{seglength}{segspeed} \right) \cdot \# \text{ of operations} \quad \text{Eq. 4-89}$$

where

seglength	length (in feet) of contributing flight path segment,
segspeed	average speed (in feet/s) during contributing flight path segment, and
segtime	time passed during contributing flight path segment (s).

TAUD for each operation is computed iteratively and preserved.

See Section 11.1.5 for a complete description of the time audible computation process.

4.6.5 Accumulation of Noise Metric Computations

Once all of the noise is computed for each unique aircraft operation and flight path segment at each receptor in an AEDT analysis, the noise results are accumulated and the final noise results and the appropriate analysis metrics are computed. The weighting and averaging factors used to compute the 17 different noise metrics in AEDT, as well as user-defined noise metrics, are discussed in Section 4.6.5.1. The process for accumulating exposure-based noise level metrics from all the aircraft operations at all the receptors in an AEDT analysis is presented in Section 4.6.5.2. The process for accumulating maximum noise level metrics from all the aircraft operations at all the receptors in an AEDT analysis is presented in Section 4.6.5.3. The process for accumulating time-based noise metrics from all the aircraft operations at all the receptors in an AEDT analysis is presented in Section 4.6.5.4.

Figure 4-18 graphically summarizes the acoustic computation process employed in AEDT for accumulating noise from all the aircraft operations at all the receptors in an analysis.

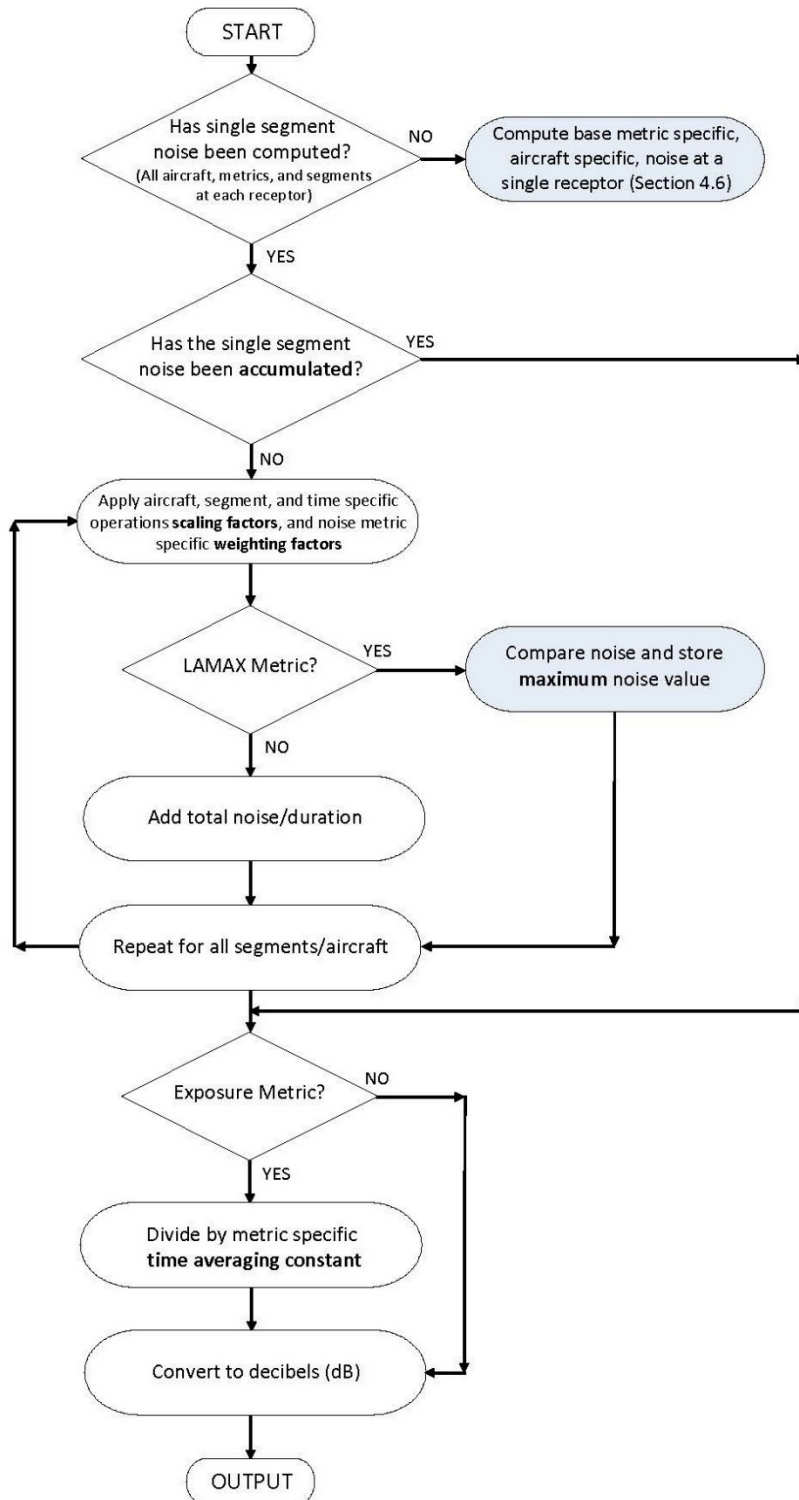

Figure 4-18 AEDT Accumulation of Acoustic Computation Process

4.6.5.1 Noise Metric Weighting and Averaging Factors

As discussed in Section 2.2.1.1, there are four base noise level metrics: L_{AE} , $L_{AS_{mx}}$, L_{EPN} , and $L_{PNTS_{mx}}$. From those base metrics, AEDT can compute 21 different noise metrics and user-defined metrics. The metrics that can be computed in AEDT can be organized into three categories:

1. Exposure-based metrics, including change in exposure;
2. Maximum noise level metrics; and
3. Time-based metrics.

These 21 noise metrics are computed in AEDT by applying metric-specific, time-averaging constants and/or day, evening, and night-time weighting factors to the base metrics. The time-averaging constant applies a metric-specific duration factor to the noise metric. For exposure metrics, the weighting factor applies time-period-specific weightings (or penalties) to events that occur during those time periods. For the maximum-level and time-based metrics, the weighting factors are either zero or unity. As such, they act as a binary switch allowing the user to select specific time periods for computation.

In addition to AEDT standard metrics, user-defined metrics for the three families are available. A user specifies the time-averaging constant and the day, evening, and nighttime weighting factors. Although there are no standard average-level metrics in the C-weighted family because such metrics are not commonplace, the user has the ability to define user-specific C-weighted metrics.

The Number Above Noise Level metric represents an accumulated operation count above a noise threshold and is available for the A-Weighted metrics, SEL and LAMAX, and the C-Weighted metrics, CEXP and LCMAX. The day, evening and night weighting factors are equivalent to the base metric selected.

Table 4-2 summarizes associated weightings and averaging times.

Table 4-2 AEDT Noise Metric-Specific Weighting and Averaging Factors

Noise Family	Metric Type	Noise Metric	Weighting Factors			Averaging Time (hr)	Time-Averaging Constant (N_T)
			Day (W_{day})	Evening (W_{eve})	Night (W_{ngt})		
A-Weighted	Exposure Based	SEL	1	1	1	-	1
		DNL	1	1	10	24	86,400
		CNEL	1	3 ^{xxi}	10	24	86,400
		LAEQ	1	1	1	24	86,400
		LAEQD	1	1	0	15	54,000
		LAEQN	0	0	1	9	32,400
		User-defined	A	B	C	T	T*3,600

^{xxi} In accordance with the technical definition, a 5 dB penalty is added to evening operations when computing the L_{den} noise metric. The 5 dB penalty, expressed in terms of a weighting factor, is equivalent to 3.16, not 3. However, in Title 21, Subchapter 6, §5001 of California state law a factor of 3 is used. Since the state of California is the primary user of the L_{den} metric, it was decided that AEDT 2c would be consistent with state law, rather than the traditional technical definition. The evening weighting factor in the LWECPN metric was changed to 3 for consistency. It is anticipated that this small difference will be of no practical consequence in the computations.

	Maximum Level	NANL	1	1	1	-	1
		LAMAX	1	1	1	-	-
		User-defined	A	B	C	-	-
	Time-Based	NANL	1	1	1	-	-
		TALA	1	1	1	-	-
		TAUD	1	1	1	-	-
		TAUDSC	1	1	1	-	-
		TAUDP	1	1	1	-	-
		TAUDPSC	1	1	1	-	-
	User-defined	A	B	C	-	-	
C-Weighted	Exposure Based	CDNL	1	1	1	24	8,6400
		CEXP	1	1	1	-	-
		User-defined	A	B	C	T	T*3,600
		NANL	1	1	1	-	-
	Maximum Level	LCMAX	1	1	1	-	-
		User-defined	A	B	C	-	-
		NANL	1	1	1	-	-
	Time-Based	TALC	1	1	1	-	-
		User-defined	A	B	C	-	-
	Tone-Corrected Perceived	Exposure Based	EPNL	1	1	1	-
NEF			1	1	16.7	24	630,957,345 ^{xxii}
WECPNL			1	3 ^{xxiii}	10	24	8,640 ^{xxiv}
User-defined			A	B	C	T	T*3,600
PNLTM		1	1	1	-	-	

^{xxii} The 630,957,345 value ($88 \text{ dB} = 10 \cdot \log_{10}(630,957,345)$) is a scaling constant inherent in the definition of the L_{NEF} metric. A 24-hour period is used to compute the metric.

^{xxiii} In accordance with the technical definition, a 5 dB penalty is added to evening operations when computing the L_{den} noise metric. The 5 dB penalty, expressed in terms of a weighting factor, is equivalent to 3.16, not 3. However, in Title 21, Subchapter 6, §5001 of California state law a factor of 3 is used. Since the state of California is the primary user of the L_{den} metric, it was decided that AEDT 2c would be consistent with state law, rather than the traditional technical definition. The evening weighting factor in the L_{WECPN} metric was changed to 3 for consistency. It is anticipated that this small difference will be of no practical consequence in the computations.

^{xxiv} The 8640 value is the number of 10-second intervals in a 24-hour period. Unlike L_{AE} and L_{CE} , which are normalized to a duration of $t_0 = 1$ second, L_{EPN} is normalized to a duration of $t_0 = 10$ seconds.

	Maximum Level	User-defined	A	B	C	-	-
	Time-Based	TAPNL	1	1	1	-	-
		User-defined	1	1	1	-	-

A, B, C, and T represent user-defined variables.

The metric-specific time-averaging constants and weighting factors are used to accumulate the noise metrics from all the aircraft operations at all the receptors in an AEDT analysis (Sections 4.6.5.2, 4.6.5.3, and 4.6.5.4).

4.6.5.2 Accumulation of Exposure-based Noise Level Metrics

This Section presents the accumulation of exposure-based noise level metrics for an AEDT analysis. Once the exposure-based noise levels from each flight path segment due to fixed-wing aircraft operations (Section 4.6.2.1 and 4.6.2.2) and helicopter operations (Section 4.6.2.3 and 4.6.2.4) are computed, the total noise exposure at a receptor location can be computed through the combination of all the individual flight path segment noise contributions at a receptor in an AEDT study.

Each flight in the case has an associated number of operations for the day, evening, and night-time periods. Also, depending upon the user-specified metric, each time period may have a weighting factor, i.e., a noise penalty, associated with it. The weighting factors for the standard exposure-based metrics, along with their associated time-averaging constants N_T , are summarized in Table 4-2, which also includes user-defined weighting factors and averaging constants.

The number of operations associated with each time period, coupled with the weighting factors, is used to compute the weighted sound exposure ratio, denoted by the symbol $E_{wt,seg}$, for a single flight path segment and operation.

$$E_{wt,seg} = [W_{day} \cdot N_{day} + W_{eve} \cdot N_{eve} + W_{ngt} \cdot N_{ngt}] \cdot E_{seg} \quad \text{Eq. 4-90}$$

where

- N_{day} Number of user-specified operations between 0700 and 1900 hours local time;
- N_{eve} Number of user-specified operations between 1900 and 2200 hours local time;
- N_{ngt} Number of user-specified operations between 2200 and 0700 hours local time;
- W_{day} Day-time weighting factor, either standard or user-defined (see Table 4-2 for the standard weighting factors associated with a particular exposure-based noise level metric);
- W_{eve} Evening weighting factor, either standard or user-defined;
- W_{ngt} Night-time weighting factor, either standard or user-defined; and
- E_{seg} Sound exposure ratio at a receptor location due to a single flight path segment of a flight operation.

The weighted sound exposure ratio for each segment, $E_{wt,seg(i)}$, is computed iteratively and preserved.

The weighted sound exposure ratio due to an entire aircraft operation is obtained by summing the ratios associated with each segment in the flight path. The weighted sound exposure ratio for a flight operation, $E_{wt,flt}$, is computed as follows:

$$E_{wt,flt} = \sum_{i=1}^{n_{seg}} E_{wt,seg(i)} \quad \text{Eq. 4-91}$$

where

- n_{seg} Number of segments in the three dimensional flight path; and
- $E_{wt,seg(i)}$ Weighted sound exposure ratio for the operation on the i-th segment of a flight path.

The weighted sound exposure ratio for all flight operations in the entire study case is obtained by summing the ratios associated with each flight operation. The weighted sound exposure ratio for all flight operations in the study case, $E_{wt,arpt}$, is computed as follows:

$$E_{wt,arpt} = \sum_{k=1}^{n_{flt}} E_{wt,flt(k)} \quad \text{Eq. 4-92}$$

where

- n_{flt} Number of flight operations in the study case; and
- $E_{wt,flt(k)}$ Ratio of each flight operation.

The mean-square sound-pressure ratio associated with a specific exposure-based noise level metric is computed by dividing the weighted sound exposure ratio for the related base metric, $E_{wt,arpt}$, by a time-averaging constant N_T , either standard or user-defined. The time-averaging constants for the standard exposure-based metrics are summarized in Table 4-2. Note that three of the exposure-base metrics (L_{AE} , L_{CE} , and L_{EPN}) are true sound exposure levels and are not divided by a time-averaging constant (the time-averaging constant is equal to 1). The average or equivalent mean-square sound-pressure ratio, P , associated with an exposure-based metric, is given by:

$$P_{wt,arpt} = \frac{E_{wt,arpt}}{N_T} \quad \text{Eq. 4-93}$$

The final step in the process is to convert $P_{wt,arpt}$ to its equivalent decibel value. The decibel value for a user-defined, exposure-based metric due to all flight operations in an airport case is computed as follows:

$$L_{E,wt,arpt} = 10 \cdot \log_{10}[P_{wt,arpt}] \quad \text{Eq. 4-94}$$

$L_{E,wt,arpt}$ is a standard exposure-based noise level metric or a user-specified exposure-based metric, depending upon the specific weighting factors and time-averaging constants selected. $L_{E,wt,arpt}$ is expressed in dB.

In addition to the above calculations, the single-event, sound exposure level, $L_{E,flt}$, for each flight operation is computed iteratively (without the day, evening and night weighting factors) and saved for use in the time-above calculation (see Section 4.6.5.4).

$$L_{E,flt} = 10 \cdot \log_{10} \left[\sum_{i=1}^{n_{seg}} E_{seg(i)} \right] \quad \text{Eq. 4-95}$$

4.6.5.3 Accumulation of Maximum Noise Level Metrics

This section presents the accumulation of maximum noise level metrics for an AEDT analysis. Once the maximum noise level from each flight path segment due to fixed-wing aircraft operations (Sections 4.6.3.1 and 4.6.3.2), and helicopter operations (Sections 4.6.3.3 and 4.6.3.4) are computed, the maximum noise level at a receptor location can be computed through the analysis of all the individual flight path segment noise contributions at a receptor in an AEDT study.

The maximum noise level associated with each flight operation, $L_{Smx,flt}$, is determined by performing a flight-segment by flight-segment comparison of $L_{Smx,seg}$ values, and preserving the largest value associated with each flight. $L_{Smx,flt}$ is computed as follows:

$$L_{Smx,flt} = \underset{i=1}{\overset{n_{seg}}{\text{Max}}} [L_{Smx,seg(i)}] \quad \text{Eq. 4-96}$$

where

n_{seg} Number of segments in the three-dimensional flight path.

The maximum noise level associated with each flight operation in the airport case, $L_{Smx,flt(k)}$, is computed iteratively and saved.

The $L_{Smx,flt(k)}$ values are grouped according to the time period within which they occur, day, evening, or night. The maximum noise level associated with each time period, t , is computed as follows:

$$L_{Smx(t)} = \underset{k=1}{\overset{n_{flt(t)}}{\text{Max}}} [L_{Smx,flt(k)}] \quad \text{Eq. 4-97}$$

where

$n_{flt(t)}$ Number of flight operations in the study case for a given time period, t .

L_{Smx} is computed for three time periods (day, evening and night). The maximum noise level equation is as follows:

$$L_{Smx} = \text{Max} [L_{Smx(day)} \cdot W_{day}, L_{Smx(eve)} \cdot W_{eve}, L_{Smx(ngt)} \cdot W_{ngt}] \quad \text{Eq. 4-98}$$

where

$\text{Max} []$ Function that returns the maximum of three noise level values;

$L_{Smx(day)}$ Maximum noise level for the time period between 0700 and 1900 hours local time;

$L_{Smx(eve)}$ Maximum noise level for the time period between 1900 and 2200 hours local time;

$L_{S_{mx}(ngt)}$	Noise level for the time period between 2200 and 0700 hours local time;
W_{day}	Day-time weighting factor, either zero or one, depending on whether that time period is considered by the Max function;
W_{eve}	Evening weighting factor, either zero or one; and
W_{ngt}	Night-time weighting factor, either zero or one.

$L_{S_{mx}}$ is equivalent to either the maximum A-weighted sound level, with slow-scale exponential weighting characteristics ($L_{AS_{mx}}$), the maximum C-weighted sound level, with slow-scale exponential weighting characteristics ($L_{CS_{mx}}$), or the tone-corrected maximum perceived noise level, with slow-scale exponential weighting characteristics ($L_{PNTS_{mx}}$). $L_{S_{mx}}$ is expressed in dB.

4.6.5.4 Accumulation of Time-based Noise Metrics

This Section presents the accumulation of time-based noise metrics for an AEDT analysis. Once the time-based noise from each flight path due to fixed-wing aircraft and helicopter operations (Sections 4.6.4.1 and 4.6.4.2) are computed, the time-based noise at a receptor location can be computed through the analysis of all the individual flight path noise contributions at a receptor in an AEDT study.

Each flight segment in the case has an associated number of operations for the day, evening, and night-time periods, along with weighting factors. In the case of the TA metric, the weighting factors act as binary switches, allowing the user to select/deselect specific time periods over which to compute TA. The number of operations associated with each time period and their assigned weighting factors are used to compute the weighted time-above value associated with an operation on a specific flight segment:

$$TA_{wt,seg} = [W_{day} \cdot N_{day} + W_{eve} \cdot N_{eve} + W_{ngt} \cdot N_{ngt}] \cdot TA_{seg} \quad \text{Eq. 4-99}$$

where

N_{day}	Number of user-specified operations between 0700 and 1900 hours local time;
N_{eve}	Number of user-specified operations between 1900 and 2200 hours local time;
N_{ngt}	Number of user-specified operations between 2200 and 0700 hours local time;
W_{day}	Day-time weighting factor, either zero or one, depending on whether that time period is considered;
W_{eve}	Evening weighting factor, either zero or one; and
W_{ngt}	Night-time weighting factor, either zero or one.

The weighted TA for each flight operation in the study case is computed iteratively and preserved.

The weighted TA due to an entire aircraft operation is obtained by summing the ratios associated with each segment in the flight path. The weighted TA for a flight operation, $TA_{wt,flt}$, is computed as follows:

$$TA_{wt,flt} = 10 \cdot \log_{10} \left[\sum_{i=1}^{n_{seg}} TA_{wt,seg(i)} \right] \quad \text{Eq. 4-100}$$

where

n_{seg}	Number of segments in the three dimensional flight path; and
$TA_{wt,seg(i)}$	Weighted time above value for the operation on the i-th segment of a flight path, in minutes.

The time-above metric for all flight operations in the entire study case is then obtained by summing the $TA_{wt,fit}$ values associated with each operation. The time above for all flight operations in the study case, $TA_{wt,arpt}$, is computed as follows:

$$TA_{wt,arpt} = \sum_{k=1}^{n_{fit}} TA_{wt,flt(k)} \quad \text{Eq. 4-101}$$

where

n_{fit} Number of flight operations in the airport case.

TA is equivalent to either the time above an A-weighted sound level (TA_{LA}), the time-above a C-weighted sound level (TA_{LC}), or the time above a tone-corrected perceived noise level (TA_{LPNT}), depending on the metric family selected, either the A-weighted, C-weighted, or the tone-corrected perceived. TA is expressed in minutes.

For percent of a time-based metric, the total time in minutes is divided by the user-defined time period of interest (in minutes) and multiplied by 100 to make percent.

4.6.5.4.1 Additional Guidance for the Accumulation of Time Audible

Time audible is a cumulative metric accumulated in the same manner as time above, as the summation of all of the segtime values of an aircraft operation that are flagged as detectable. Therefore, time audible is computed according to:

$$TAud = TAud + segtime \quad \text{Eq. 4-102}$$

Once time audible has been computed iteratively with Eq. 4-102 for all detectable segments in the study case, the time audible (in minutes) for a time period will be:

$$TAud = \frac{TAud}{\left(60 \frac{seconds}{minute}\right)} \quad \text{Eq. 4-103}$$

Time audible with statistical compression (TAUDSC) is TAUD adjusted by a method to account for the effects of simultaneously occurring aircraft events on audibility. This method is known as the overlapping events method^{xxv}. The overlapping events method is a statistically based adjustment developed by the [NPS Natural Sounds Program](http://www.nature.nps.gov/naturalsounds/)^{xxvi}, and is presented in the following equation:

^{xxv} Formerly known as the “time compression method” and the “statistical compression method”.

^{xxvi} <http://www.nature.nps.gov/naturalsounds/>

$$y = N \cdot \left[\frac{1 - e^{\left(\frac{-(N+1) \cdot x_{min}}{N \cdot T} \right)}}{N + 1} \right] \tag{Eq. 4-104}$$

where

- x_{min} the uncorrected, cumulative TAUD results (minutes);
- N the number of aircraft operations occurring during the analysis time; and
- T the analysis time (minutes).

The effects of this method on TAUD are presented in Figure 4-19. Since the time compression algorithm takes into account number of operations, the time compression results are presented in Figure 4-19 for 0.1, 1, 10, 100 and 1000 operations for a 24 hour analysis period.

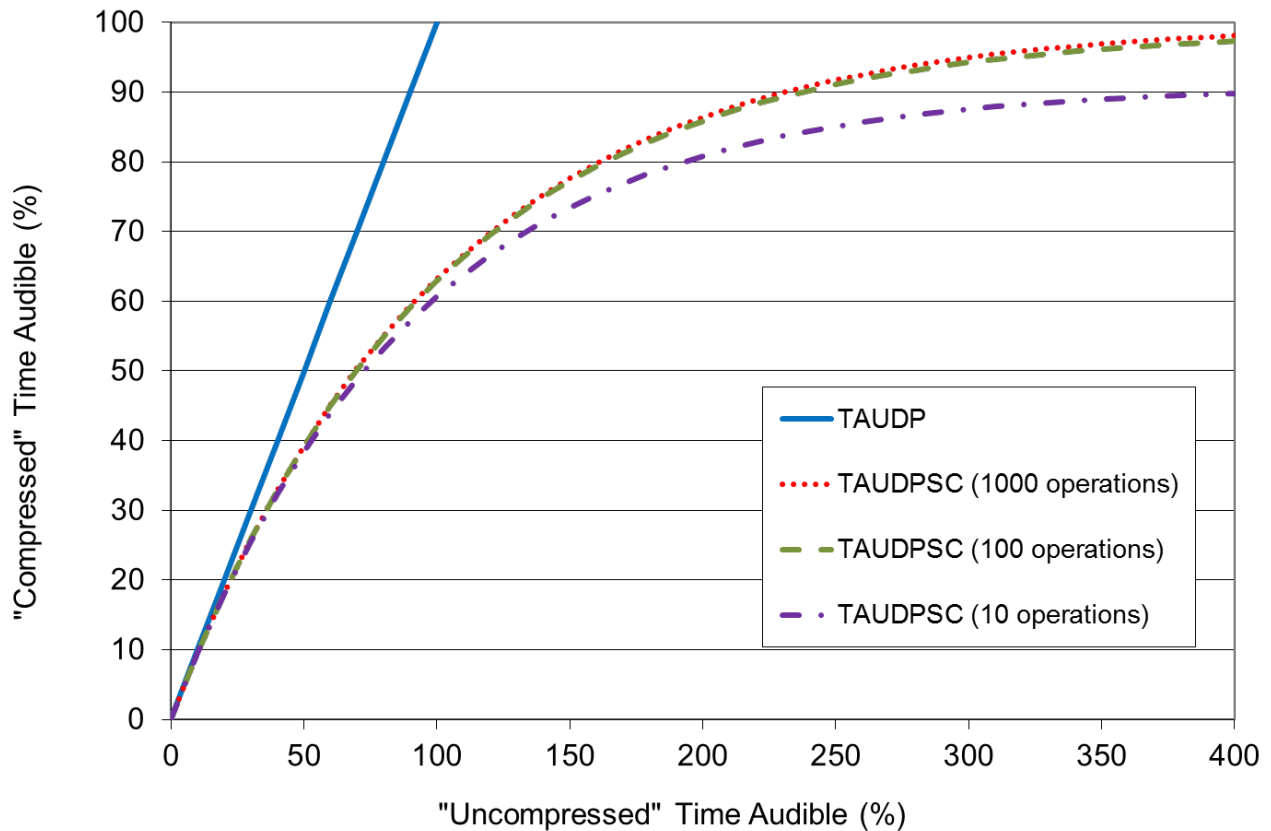

Figure 4-19 Uncompressed Time Audible

For percent time audible, the total time in minutes is divided by the user-defined time period of interest (in minutes) and multiplied by 100 percent.

See Section 11.1.5 for a complete description of the time audible computation process.

4.6.5.5 *Accumulation of Number Above Noise Level Metric*

The Number Above Noise Level metric represents the total count of operations (usually based on an average annual day) that exceed a user specified noise threshold, which is calculated from one of the four supported base metrics: SEL, LAMAX, CEXP or LCMAX.

Noise from each operation is computed for the base metric as specified in sections 4.6.2 (Exposure) and 4.6.3 (Maximum level). The computed noise values are compared to a user defined decibel noise threshold. If the computed noise value is equal to or greater than the threshold, the scaled operation count is incremented and stored for each receptor.

4.7 **Dynamic Grid Process**

As noted in Section 2.2.1.6 on Receptor Sets, AEDT supports a special type of receptor set called a dynamic grid which offers the analyst two benefits: first, only the desired minimum noise level of interest is needed to set the geographic extent of the receptor set; second, the grid resolution will automatically be increased where the spatial change of the noise increases.

The dynamic grid process is applied to a metric result when the following two conditions are set:

1. The DNL metric is selected for the metric result definition
2. A dynamic grid receptor set is chosen for the corresponding metric result of interest

When the metric result is run, AEDT will automatically process the noise calculation to build up the dynamic grid receptor set. There are four controls which govern the dynamic grid process:

- a. The initial receptor definition
- b. The minimum DNL level (dB) contour to be closed
- c. The refinement tolerance / curvature difference
- d. The refinement level limit

The first “control” is set by defining an initial receptor

Definitions > Receptors

followed by

Definitions > Receptor Sets

to add the initial receptor as a dynamic grid to the new Receptor Set and make the dynamic grid available for metric result definitions. The initial receptor should be defined as a grid that is not too big and not too small. A good guideline is to define that initial receptor to be a bounding box that just contains the runways for the airport of interest. That initial receptor will be further refined automatically by AEDT until the spatial variation of the noise contour is smooth or the refinement level limit is hit. The bounding box of the initial receptor grid also sets the minimum “step” sized when expanding the dynamic grid to meet the second control. Note that this is the inverse of the concept of the recursive grid in INM where the initial grid must be large enough to cover the noise contour of interest which is difficult to know before hand.

The second “control” is set by the analyst in the user interface,

Study > Preferences > Study > Dynamic grid contour expansion level (dB)

Enter the lowest DNL noise contour of interest for the study, by default, 50 dB. AEDT will then grow the dynamic grid receptor set by expanding in all four directions one receptor grid (or “step”) at a time until that noise level is contained.

The third “control” is set via the user interface by choosing the algorithm used to evaluate the smoothness criteria of the resulting noise grid. There are two criteria: LinearINMLegacy and SecondOrderLaplacian. The first applies the same criteria for smoothness that was implemented in the INM recursive grid function (a first difference between the evaluated noise and a linear interpolation of the noise). The latter choice applies a second difference criteria to the comparison between the evaluated noise and a quadratic interpolation of the noise and is more effective at refining the grid resolution where the contour would change significantly. The user can make a choice between these two algorithms using the pick list

Study > Preferences > Dynamic Grid > Algorithm used in dynamic grid...

The control then has respective threshold values for each algorithm’s criteria

Study > Preferences > Dynamic Grid > Refine Tolerance for LinearINMLegacy

when using the LinearINMLegacy or

Study > Preferences > Dynamic Grid > Curvature Difference Fraction for SecondOrderLaplacian in order to set the thresholds for the respective criteria. Regardless of selected algorithm, the dynamic grid process attempts to refine the grid in any area where the evaluated criteria (linear or quadratic difference) exceeds the specified threshold. If so, the grid will be refined to the next higher level of resolution.

The fourth “control” is an over-ride to the refinement criteria which allows the analyst to limit, regardless of the algorithm or smoothness of the noise process, the number of refinement levels.

The dynamic grid is only discovered from these four controls and the metric result definition when the metric result is run. However, once the associated metric result (currently only applicable on DNL noise metrics) has been run, the dynamic grid process stores the result as a point type receptor set. This resulting receptor set is then available for use in defining any other noise or emissions dispersion metric result.

5. Emissions Inventory

5.1 Aircraft Emissions

AEDT computes emissions related to aircraft operation including emissions from taxi, startup, and APU. The following pollutants are modeled gate-to-gate based on phases of flight:

- Carbon Monoxide (CO),
- Total Hydrocarbons (HC),
- Non-Methane Hydrocarbons (NMHC),
- Volatile Organic Compounds (VOC),
- Total Organic Gases (TOG),
- Oxides of Nitrogen (NO_x),
- Sulfur Oxides (SO_x),
- Particulate Matter (PM),
- Carbon Dioxide (CO₂),
- Water (H₂O), and
- Speciated Organic Gases (SOG), including hazardous air pollutants (HAPs).

5.1.1 Airborne Emissions

There are two broad flight regimes in AEDT: terminal area and en-route. The term “terminal area” refers to portions of an aircraft’s flight trajectory below 10,000 ft AFE, while the term “en-route” refers to portions of flight above 10,000 ft AFE. A runway-to-runway flight path covers both terminal area and en-route regimes. AEDT assigns the trajectory mode on each segment of the flight trajectory across both flight regimes. The terminal area trajectory modes in AEDT include takeoff ground roll, takeoff airborne, terminal climb, approach, landing ground roll, and landing ground roll with reverse thrust. En-route trajectory modes include enroute climb, cruise, and enroute descent.

The four methods used to compute airborne aircraft emissions in AEDT are described below:

- The Boeing Fuel Flow Method 2 (BFFM2)³² is used to compute NO_x, HC, and CO;
- A First Order Approximation (FOA) 3.0³³ is used to compute particulate matter below the mixing height;
- Fuel composition-based factors are used to compute SO_x, CO₂, and H₂O in addition to particulate matter above the mixing height; and
- Derivative factors are used to compute NMHC, VOC, TOG, and speciated organic gases.

These methods are publicly available and internationally recognized as adequate for aircraft emissions modeling. For emissions inventory, users can change the default value of 3,000 ft AFE for mixing height in AEDT. For emissions dispersion, 3,000 feet AFE is assumed for mixing height at all times.

5.1.1.1 Boeing Fuel Flow Method 2

Of the four methods employed within AEDT, the most complex is the BFFM2. This method requires various atmospheric parameters including engine emissions certification-type data and fuel flow/fuel burn at flight conditions. Since this method relies on fuel flow as a direct input rather than power settings, it is called a “fuel flow method.” The BFFM2⁴⁰ documentation also provides guidance for anomalous cases, e.g. when certification data do not behave according to the prescribed methodology.

BFFM2 is currently only used to model NO_x, HC, and CO because these are the only pollutants (in addition to particulates) for which data are available in the ICAO^{33, 34} jet engine emissions certification databank (EDB). Similarly, the emissions database within AEDT relies on data derived for the EDMS³⁵. These data are a superset of the ICAO EDB database, primarily due to the addition of data for turboprop and piston engines, as well as engines associated with more recent aircraft (e.g., Airbus A380). Generally these additional data are provided directly from manufacturers; the AEDT Fleet database provides a complete record of these engine data and their origins. For each engine listed, the Fleet database contains an inventory of emissions produced per fuel consumed (henceforth referred to as an emission index (EI)) and fuel flow values corresponding to the standard landing-and-takeoff (LTO) cycle modes. The four standard modes are takeoff, climbout, approach, and idle which correspond to power settings of 100%, 85%, 30%, and 7%, respectively.

The steps in the BFFM2 Model as used in AEDT are listed below:

1. The four ICAO reference fuel flows are adjusted for installation effects, that is, each of these fuel flows is multiplied by a modal-specific adjustment factor defined in BFFM2⁴⁰. These adjustment factors are shown in the table below.

Table 5-1 Adjustment Factors for Installation Effects

Mode	Power Setting (%)	Adjustment Factor
Takeoff	100	1.010
Climb-out	85	1.013
Approach	30	1.020
Idle	7	1.100

2. Using the adjusted fuel flows from step 1 and the reference EI (REI) values from the Fleet database, Log-Log relationships between EI and fuel flow values are developed that allow predictions of reference EI values for reference fuel flow values. For NO_x, a point-to-point relationship is developed. For HC and CO, a bilinear fit is established between the two lower power setting points and the two higher power setting points.
3. A non-reference fuel flow value is determined within AEDT. The fuel flow corresponds to at-altitude atmospheric conditions for a specific flight segment or mode.
4. The non-reference fuel flow from step 3 is converted to reference conditions using the following equation:

$$RWf = \frac{Wf}{\delta} \theta^{3.8} e^{0.2M^2} \quad \text{Eq. 5-1}$$

where

- RWf Fuel flow at reference conditions (kg/s);
- Wf Fuel flow at non-reference conditions (kg/s);
- M Mach number;
- θ Temperature ratio (ambient to sea level); and
- δ Pressure ratio (ambient to sea level).

5. Using the Log-Log relationships from step 2 and the reference fuel flow from step 4, reference EI values for NO_x, HC, and CO are obtained.

6. The reference EI values from step 5 are converted to non-reference (at altitude) conditions using the following equations:

$$NO_xEI = NO_xREIe^H \left[\frac{\delta^{1.02}}{\theta^{3.3}} \right]^{1/2} \quad \text{Eq. 5-2}$$

$$HCEI = HCREI \frac{\theta^{3.3}}{\delta^{1.02}} \quad \text{Eq. 5-3}$$

$$COEI = COREI \frac{\theta^{3.3}}{\delta^{1.02}} \quad \text{Eq. 5-4}$$

$$H = -19.0 \left[\frac{0.62197058\phi P_v}{(0.01P) - \phi P_v} - (6.34 \times 10^{-3}) \right] \quad \text{Eq. 5-5}$$

where

NO _x EI	NO _x EI at non-reference conditions (g/kg);
NO _x REI	NO _x EI at reference conditions (g/kg);
HCEI	HC EI at non-reference conditions (g/kg);
HCREI	HC EI at reference conditions (g/kg);
COEI	CO EI at non-reference conditions (g/kg);
COREI	CO EI at reference conditions (g/kg);
M	Mach number;
θ	Temperature ratio (ambient to sea level);
δ	Pressure ratio (ambient to sea level);
H	Humidity coefficient;
φ	Relative humidity; and
P _v	Saturation vapor pressure (millibars).

7. The non-reference fuel burn corresponding to the fuel flow in step 3 is obtained.
8. Using the non-reference EI values from step 6 and the non-reference fuel burn from step 7, the non-reference emissions of NO_x, HC, and CO are computed. These represent the final emissions for the flight segment.

5.1.1.2 First Order Approximation 3.0 Method

The FOA 3.0 method is used solely for computing PM below the mixing height in AEDT^{41,36} for jet aircraft. The FOA methodology makes use of the current engine mode and properties, as well as fuel characteristics, while fuel composition-based factors and derivative factors methodologies are based on applying constant factors to either the fuel burn or other pollutant emissions. BFFM2 is used to model NO_x, HC, and CO, while FOA 3.0 is used to model PM below the mixing height.

In order to estimate PM emissions (both volatile and non-volatile components) for commercial aircraft engines within the vicinity of the airport (i.e. during the LTO cycle), a working group within ICAO CAEP adopted and further developed the FOA 3.0 methodology⁴¹.

FOA 3.0 accounts for the formation of volatile PM components from fuel sulfur content (FSC) and hydrocarbon (fuel) organics, each component with its own modeling assumptions.

The FOA 3.0 PM EI (whether volatile or non-volatile) calculations are not directly based upon specific chord-based performance (as was the case in BFFM2), but rather, the current mode (i.e., idle, takeoff). These modes are clearly defined by ICAO, and are based upon approximate power settings (idle condition is assumed to be 7% of maximum thrust, approach 30%, climb-out 85%, and takeoff 100%).

The contributing modeled species to the volatile PM component are volatile sulfates, and fuel organics. For each contributing species, an EI value is calculated, and all EI values are summed to provide a complete estimation for the volatile PM EI.

The fuel sulfur content (FSC), a mass fraction of sulfur present in the fuel, must be input to the study. For the FOA methodology, the FSC is directly related to volatile sulfate PM emissions. It is assumed that a portion of the SO_x gaseous emissions will be converted into the compound sulfate (SO₄). Sulfate is considered a volatile sulfate PM species. The term “conversion efficiency” is used to describe the percentage of sulfur in the fuel that will be converted to a volatile sulfate PM species. Thus, the mass ratio of the volatile sulfate PM species to the amount of fuel consumed (the EI value) is found according to Equation 5-6.

Typically, the FSC is expressed as the mass of sulfur per mass of fuel, i.e. mass fraction. To derive the volatile PM EI value, defined as grams of pollutant per kilograms of fuel, the mass of the sulfur present in the fuel is calculated as the FSC multiplied by 1,000 to allow for units of kilograms of fuel. As stated earlier, the amount of sulfur converted to sulfate is known as the conversion efficiency, and may be defined as a percentage or fraction. The molecular weight of sulfur is 32 g/mole, sulfate is 96 g/mole, and sulfuric acid is 98 g/mole. The final approximation for the volatile sulfur PM is provided in the equation below.

$$PM_{Vols\ FSC\ EI} = 1,000 \cdot FSC \cdot \epsilon \cdot \frac{M_a}{32} \quad \text{Eq. 5-6}$$

where

$PM_{Vols\ FSC\ EI}$	Is expressed in (g/kg);
FSC	Fuel sulfur content (g / g);
ϵ	Conversion efficiency (%); and
M_a	Molecular weight of sulfate (96).

Both FSC and the conversion efficiency can be user-defined. However, if no values are provided, the emissions model will use a default value of 0.0006 (grams of sulfur per gram of fuel) for fuel sulfur content, and 0.024 (fraction) for conversion efficiency. These values are being used by standards bodies such as ICAO-CAEP when implementing FOA 3.0, and appear in the FOA 3.0 guidance document⁴¹.

The volatile fuel organics content of PM is based on testing and measurements from the APEX1 study⁴¹. This particular APEX study measured volatile organic PM from one engine (the CFM56-2-C1) for the four distinct LTO modes. Using the CFM56-2-5C as a surrogate (a close approximation, as the CFM56-2-C1

does not appear in the ICAO Engine Emissions Databank, the FOA methodology calculates the volatile organic PM according to Eq. 5-7. For the FOA methodology, it is assumed that volatile organic PM emissions are directly related to the mode-specific HC EI values, and that the relationship between ICAO HC EI values and the volatile organic PM emissions measured for the CFM56 is roughly the same for all engines.

Table 5-2 provides the volatile organic PM values from the APEX1 study used in FOA 3.0, as well as the CFM56-2-5C HC EI values from the ICAO databank. The equation below provides the formula used to calculate the mode-specific volatile organic PM EI

$$PM_{Vols\ Org\ EI} = \left(\frac{EI_{PMVol-orgCFM56}}{EI_{HCCFM56}} \right) \cdot \frac{HC_{EI}}{1,000} \tag{Eq. 5-7}$$

where

- PM Vols Org EI Is expressed in (g/kg);
- $EI_{PMVol-orgCFM56}$ APEX1-determined fuel organics PM (from Table 5-2)
- $EI_{HCCFM56}$ Mode-specific HC EI from ICAO EDB (for the CFM56); and
- HC_{EI} Mode-specific HC EI for engine observed.

Table 5-2 Mode Specific Values for Eq. 5-7 (FOA 3.0)

LTO Mode	$EI_{PMVol-orgCFM56}$ (mg/kg fuel)	$EI_{HCCFM56}$ (g/kg fuel)
	APEX1	ICAO Databank
Takeoff	4.6	0.04
Climb-out	3.8	0.05
Approach	4.5	0.08
Idle	11.3	1.83

FOA 3.0 approximates non-volatile PM by multiplying the concentration index (CI) of non-volatile PM by the exhaust volumetric flow rate. Both CI and the exhaust volumetric flow rate are modal dependent. In addition, for mixed turbofan engines, the exhaust volumetric flow rate includes the bypass air which can be determined by the provided ICAO bypass ratio.

The FOA 3.0 computation of CI make use of modal-dependent smoke number (SN), specific to each engine considered. Thus, across a distinct mode, the SN and the CI will remain constant. When possible, the SN is retrieved from certification, manufacturer, or derived data from within the Fleet database, which may include a different SN for each of the four modes. For some engines, there is no SN for any or all of the modes and a value of 0.0 is used ³⁷.

The FOA methodology uses one of the following two equations as appropriate to calculate CI:

- When the SN is at or below 30, Eq. 5-8 is used
- When the SN is above 30, Eq. 5-9 is used.

$$CI = (.694 \times 10^{-3}) \cdot SN^{1.234} \quad SN \leq 30 \quad \text{Eq. 5-8}$$

$$CI = (.297 \times 10^{-3}) \cdot SN^2 - 1.802 \cdot SN + 31.94 \quad SN > 30 \quad \text{Eq. 5-9}$$

where

CI Concentration index; and
SN Smoke number.

The FOA methodology uses one of two equations as appropriate to calculate the exhaust volumetric fuel rate:

- Eq. 5-10 is used when the engine being observed is indicated as an internally mixed turbofan.
- Eq. 5-11 is used when the engine is not an internally mixed turbofan, thus the bypass ratio is ignored.

$$Q = AFR \cdot 0.776 \cdot (1 + B) + 0.877 \quad \text{Mixed Flow Turbofan Engines} \quad \text{Eq. 5-10}$$

$$Q = AFR \cdot 0.776 + 0.877 \quad \text{Non - Mixed Flow Turbofan Engines} \quad \text{Eq. 5-11}$$

where

Q Exhaust volumetric fuel rate in m³/kg;
AFR Air-to-fuel ratio; and
B Bypass ratio.

The air-to-fuel ratio (AFR) was statistically estimated for each mode. As part of the FOA development, these values were reviewed by engine manufacturers and considered reasonable. The AFR is unit-less, and provided in Table 5-3.

Table 5-3 Mode Specific Values of AFR

Mode	AFR
Takeoff	45
Climbout	51
Approach	83
Idle	106

The final approximation for the non-volatile PM EI is provided in Eq. 5-12.

$$PM_{NonVols EI} = Q \cdot \frac{CI}{1,000} \quad \text{Eq. 5-12}$$

where

$PM_{NonVols EI}$ Is expressed in (g/kg);
Q Exhaust volumetric fuel rate (m³/kg fuel) (from Eq. 5-10 or Eq. 5-11); and

CI Concentration index (mg/m³) (from Eq. 5-8 or Eq. 5-9).

For all PM calculations above the mixing height, constant EI values across all aircraft and engine types are employed for sulfur, fuel organics, and non-volatile species. The default EI values are shown in Table 5-4.

Table 5-4 Default Constant PM EI Values above the Mixing Height

PM Species	EI (g/kg)
Sulfur	0.07
Fuel Organic	0.8
Non-Volatile	0.2

5.1.1.3 Sulfur Approximation

Sulfur which does not convert to the sulfur component of PM (sulfate) is assumed to convert into SO_x. Therefore, the SO_x EI approximation will use the FSC and conversion efficiency, and is linked to the FOA methodology. The process for calculating SO_x is presented in Eq. 5-13.

$$SO_xEI = 1,000 \cdot FSC \cdot (1 - \varepsilon) \cdot \left(\frac{64}{32}\right) \quad \text{Eq. 5-13}$$

where

- SO_xEI Is expressed in (g/kg);
- FSC Fuel sulfur content (g / g);
- ε Conversion efficiency (%); and
- 64 Molecular weight of SO₂ (g/mole).

When the default values of fuel sulfur content (6×10^{-4} by mass fraction) and conversion efficiency (0.024 also a fraction) are used, the SO_x EI value will be 1.1712 g / kg. Note that for above the mixing height, the sulfur component of PM is not dependent upon the conversion efficiency; instead, it is a constant factor applied to fuel consumption. The sulfur component is not speciated into SO_x and volatile sulfur PM (based on the conversion efficiency) above the mixing height; therefore the mass of sulfur in the input fuel will not equal the mass of sulfur in the output emissions.

5.1.1.4 CO₂ and H₂O Approximations

Emissions of CO₂ and H₂O are modeled based on Jet Fuel A composition. Boeing conducted a review of the available fuel composition data and developed EI values that could be used to predict emissions solely based on fuel burn^{38,39}. The values are shown in Table 5-5.

Table 5-5 Constant CO₂ and H₂O EI Values

Pollutant	EI (g/kg)
CO ₂	3,155
H ₂ O	1,237

Since these EI values were derived based on average fuel compositions, they are constants used for all modes and all atmospheric conditions. Alternative values for the CO₂ and H₂O EI values may be provided as input, replacing the values presented in Table 5-5.

5.1.1.5 Derivative Factors for Modeling VOC, NMHC, and TOG

Three pollutants, VOC, NMHC, and TOG, are calculated by applying various factors to the HC amount (HC being calculated from the BFFM2 methodology noted above)^{40,41}. The factors used to calculate VOC, NMHC, and TOG are known as derivative factors. AEDT applies the derivative factors based on the engine type (turbine, piston).

The HC calculated in the BFFM2 is presented in terms of methane equivalency. TOG and NMHC are presented in terms of their own mass (TOG as TOG and NMHC as NMHC, respectively). For turbine engines, a derivative factor ($TOG_{ConversionFactor}$) is applied to the calculated HC to compute TOG. NMHC is computed by applying a conversion factor ($NMHC_{ConversionFactor}$) to the mass of TOG. And finally, VOC is computed by subtracting the mass of ethane from TOG. Therefore, to obtain VOC in terms of its own mass (VOC as VOC), TOG is multiplied by $(1 - \text{the mass fraction of ethane in TOG})$. For the sake of simplicity, AEDT uses a derivative factor ($VOC_{ConversionFactor}$) to convert TOG to VOC. The application of the derivative factors to calculate TOG, NMHC, and VOC for turbine engines is demonstrated in Figure 5-1 and Eq. 5-14 through Eq. 5-16.

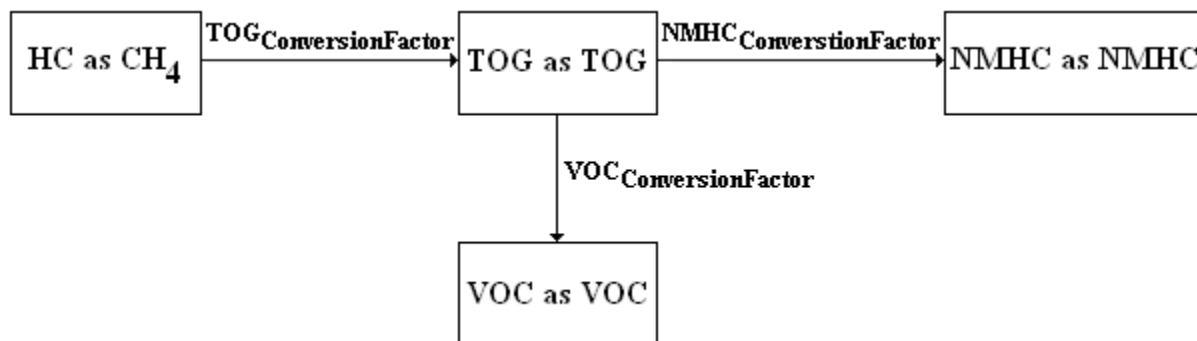

Figure 5-1 TOG, NMHC, and VOC Calculations for Turbine Engines

The equations for TOG, NMHC, and VOC for turbine engines are below:

$$TOG_{TOG} = HC_{CH_4} \cdot TOG_{ConversionFactor} \quad \text{Eq. 5-14}$$

$$NMHC_{NMHC} = TOG_{TOG} \cdot NMHC_{ConversionFactor} \quad \text{Eq. 5-15}$$

$$VOC_{VOC} = TOG_{TOG} \cdot VOC_{ConversionFactor} \quad \text{Eq. 5-16}$$

where

TOG_{TOG}	TOG emissions as TOG (g);
HC_{CH_4}	HC emissions using BFFM2 (in terms of methane equivalency) (g);
$NMHC_{NMHC}$	NMHC emissions as NMHC (g); and

VOC_{VOC} VOC emissions as VOC (g).

$TOG_{ConversionFactor}$, $VOC_{ConversionFactor}$, and $NMHC_{ConversionFactor}$ are all inputs used to compute TOG, VOC, and NMHC emissions respectively. Table 5-6 lists the default conversion factors for aircraft with turbine engines.

Table 5-6 Pollutant Conversion Factors For Turbine Engines

Conversion Factor	Default Value
$TOG_{ConversionFactor}$	$1,156,234.049 \times 10^{-6}$
$VOC_{ConversionFactor}$	$9,947.855 \times 10^{-4}$
$NMHC_{ConversionFactor}$	1.000

The default $9,947.855 \times 10^{-4}$ value for $VOC_{ConversionFactor}$, assumes a 52.145×10^{-4} value for the ethane content in TOG. The default 1.000 value for $NMHC_{ConversionFactor}$, assumes that no methane is produced; therefore, NMHC is equal to TOG.

For piston aircraft, TOG, NMHC, and VOC calculations differ from the calculations done for aircraft with turbine engines. As for turbine engines, derivative factors are applied to the computed mass of HC in methane equivalency. However, a derivative factor ($VOC_{ConversionFactor}$) is multiplied by HC to calculate VOC as VOC. Next, a derivative factor ($TOG_{ConversionFactor}$) is multiplied by VOC as VOC to calculate TOG as TOG. And finally, for piston engines, methane may be present in TOG; therefore, there is a third derivative factor ($NMHC_{ConversionFactor}$), which is multiplied by TOG as TOG to calculate NMHC as NMHC. The application of the derivative factors to calculate TOG, NMHC, and VOC for piston engines is demonstrated in Figure 5-2 and Eq. 5-17 through Eq. 5-19.

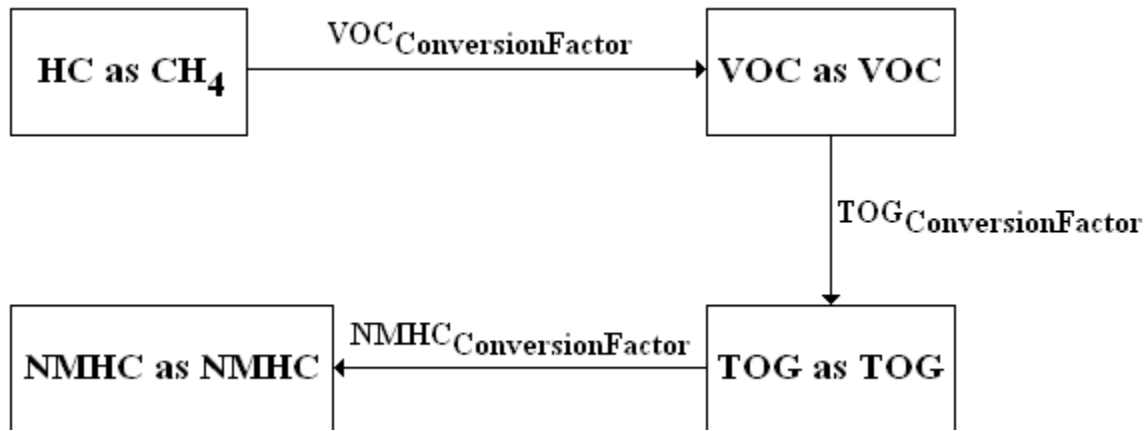

Figure 5-2 TOG, NMHC, and VOC Calculations for Piston Engines

Additionally, the equations for TOG, NMHC, and VOC (for piston engines) are below:

$$TOG_{TOG} = VOC_{VOC} \cdot TOG_{ConversionFactor} \tag{Eq. 5-17}$$

$$NMHC_{NMHC} = TOG_{TOG} \cdot NMHC_{ConversionFactor} \quad \text{Eq. 5-18}$$

$$VOC_{VOC} = TOG_{TOG} \cdot VOC_{ConversionFactor} \quad \text{Eq. 5-19}$$

where

TOG_{TOG}	TOG emissions as TOG (g);
HC_{CH4}	HC emissions using BFFM2 (in terms of methane equivalency) (g);
$NMHC_{NMHC}$	NMHC emissions as NMHC (g); and
VOC_{VOC}	VOC emissions as VOC (g).

$TOG_{ConversionFactor}$, $VOC_{ConversionFactor}$, and $NMHC_{ConversionFactor}$ are all inputs used to compute TOG, VOC, and NMHC emissions respectively. Table 5-7 lists the default conversion factors for aircraft with piston engines.

Table 5-7 Pollutant Conversion Factors For Piston Engines

Conversion Factor	Default Value
$TOG_{ConversionFactor}$	117.371×10^{-2}
$VOC_{ConversionFactor}$	83.471×10^{-2}
$NMHC_{ConversionFactor}$	8.905×10^{-1}

5.1.1.6 Derivative Factors for Speciated Organic Gases

The total mass for each speciated organic gas is computed by multiplying its mass fraction to the TOG_{TOG} emissions¹⁵. Once the TOG_{TOG} amount is calculated (from Eq. 5-14 or Eq. 5-17 above), the mass for every speciated organic gas component in its own mass is computed by multiplying its respective mass fraction by the TOG amount, as in Eq. 5-20.

$$OG_i = TOG_{TOG} \cdot MF_i \quad \text{Eq. 5-20}$$

where

OG_i	Organic gas emissions (g);
TOG_{TOG}	TOG emissions as TOG (g); and
MF_i	Mass fraction of speciated organic gas.

5.1.2 Taxi Emissions

This Section outline the process AEDT follows to compute the emissions from taxi using the AEM. When the “Apply Delay & Sequencing Model on Taxi” option is selected, AEDT will still create the non-“Delay & Sequencing Model” taxi segments. In order to only compute the emissions from taxi segments using the Delay & Sequencing Model, users need to:

- Select the “Apply Delay & Sequencing Model on Taxi” option;
- Deselect the “Enable flight-based taxi times” preference; and
- Set the airport layout taxi time to null.

1. If the “Apply Delay & Sequencing Model on Taxi” option is not selected,
 - a) And if the “Enable flight-based taxi times” preference is selected,

- Retrieve the taxi time for aircraft operation.
- b) And if the “Enable flight-based taxi times” preference is not selected, Retrieve the taxi time for the airport layout.
2. If the “Apply Delay & Sequencing Model on Taxi” option is selected,
- a) And if the “Enable flight-based taxi times” preference is selected,
- b) And if the airport layout taxi time is null:
Taxi time is set to be the difference between the operation’s time at the last taxipath node and the time at the first taxipath node.
3. Retrieve the emissions index values for the aircraft’s engine.
4. Set the following emissions input parameters:
- a) Convert the airport humidity from percent to a fraction.
- b) Set the sulfur conversion and sulfur content values:
- Set Sulfur Conversion to user-specified *Sulfur to sulfate conversion rate*.
 - Set Sulfur Content to user-specified *Fuel sulfur content*.
- c) If the aircraft uses a piston engine,
- Set NMHC Conversion Factor = 8.905×10^{-1}
 - Set TOG Conversion Factor = 117.371×10^{-2}
 - Set VOC Conversion Factor = 83.471×10^{-2}
 - Set Speciated HC Mass Ratios to the speciated OG mass fractions for piston engines.
 - Set Speciated HC Count to the number of the speciated OG mass fractions for piston engines.
- d) If the aircraft use a turbine engine,
- Set NMHC Conversion Factor = 1.0
 - Set TOG Conversion Factor = $1,156,234.049 \times 10^{-6}$
 - Set VOC Conversion Factor = $9,947.855 \times 10^{-4}$
 - Set Speciated HC Mass Ratios to the speciated OG mass fractions for turbine engines
 - Set Speciated HC Count to the number of the speciated OG mass fractions for turbine engines.
5. For each taxi segment, calculate the fuel flow, fuel burn, and emissions.
6. Set the pressure, delta, temperature, and theta values to be equal to those from the retrieved flight path segment.
7. Set the fuel flow using the following equation.
- a) If the “Apply Delay & Sequencing Model on Taxi” option is selected,

$$Fuel\ Flow = (1.1)W_{ID}\delta\theta^{-3.8} \quad \text{Eq. 5-21}$$

where

- W_{ID} The unadjusted fuel flow for the given aircraft’s engines for idle mode;
- δ Pressure ratio (ambient to sea level); and
- θ Temperature ratio (ambient to sea level).

- b) If the “Apply Delay & Sequencing Model on Taxi” option is not selected:

$$Fuel\ Flow = (1.1)W_{ID} \quad \text{Eq. 5-22}$$

8. Set fuel burn = (fuel flow)(t)(N) where t is the taxi time in seconds and N is the actual number of operating engines on the aircraft.
9. Set Mach number = 0.
10. Set the current mode to idle mode.
11. If the aircraft is user-defined and the smoke number for the current mode is 0 or "N/A",
Use the user-specified PM emission index.
Otherwise use the system PM emissions index.
12. Call the AEM.
13. Store the resulting CO, THC, NMHC, VOC, TOG, NO_x, and SO_x emissions.
14. Store the resulting PM₁₀ and PM_{2.5} emissions if and only if the aircraft is (a) user-defined; or (b) not user-defined, uses ICAO-certified engines and the applicable smoke number is greater than 0.
15. Store the fuel burn. This is used later to derive CO₂.
16. Store the resulting speciated organic gases.

5.1.3 Startup Emissions

If the operation is a departure, then AEDT models engine startup emissions which consist only of the THC, NMHC, VOC and TOG pollutants and consume no fuel. The following outlines the process AEDT follows to compute the startup emissions.

1. Use the following equation to compute the aircraft main engine startup emissions per engine⁴², if
 - The aircraft's main engine is ICAO certified; and
 - The engine's thrust rating is larger than 0.
 Else startup emissions measures are set to zero.
2. Multiply the emissions by the total number of engines of the aircraft.
3. Multiply the emissions by the number of departures of the aircraft to obtain the annual aircraft main engine startup emissions.

$$m_{p,e,a} = (0.5)RT_{e,a} + 80 \quad \text{Eq. 5-23}$$

where

- $m_{p,e,a}$ The mass (in grams) of pollutant, p , emitted in one main engine, e , startup for aircraft, a ;
and
 $RT_{e,a}$ The rated thrust (in KiloNewtons) of engine, e , of aircraft, a .

5.1.4 Auxiliary Power Units Emissions

Eq. 5-24 requires the assigned APU emission factors (in kilograms per hour). The FLT_APU table stores the emission factors for CO, THC, NO_x, SO_x, and PM (both PM₁₀ and PM₂₅) for each APU model. User-defined APU and its emissions factors are also stored in the FLT_APU table. The conversion factor of the equation below for these pollutants is unity (1). For NMHC, VOC, and TOG, the conversion factors of the turbine aircraft engines are used. APU emissions data comes from FAA and EPA documentation¹⁰ and industry correspondence¹¹. The following equation is used to calculate annual APU emissions.

$$m_{a,p} = \frac{1}{60}LTO_a t_a EF_{a,p} f_{a,p} \quad \text{Eq. 5-24}$$

where

ma,p	The mass (in kilograms) of pollutant, p , emitted annually from the APU assigned to aircraft, a ;
LTO_a	The annual number of LTO cycles performed by aircraft, a ;
t_a	The time (in minutes) the APU assigned to aircraft, a , operates during each LTO cycle;
$EF_{a,p}$	The emission factor for pollutant, p , (in kilograms/hour) for the APU assigned to aircraft, a ;
$f_{a,p}$	The conversion factor (unitless) for aircraft, a , and pollutant, p ; and
60	The number of minutes per hour.

5.2 Ground Support Equipment (GSE)

The methodologies for modeling GSE populations and GSE assigned to aircraft are identical except for the way that GSE operations are defined.

5.2.1 GSE Population Processing Algorithm

GSE populations are uniquely identified by their type (e.g., Cargo Loader), reference model (e.g., FMC Commander 15), and fuel (i.e., CNG, Diesel, Electricity, Gasoline and LPG). The following outline describes the algorithm for processing GSE population emissions.

1. Model the annual emissions for GSE populations with Eq. 5-25.

$$m_{p,g} = E_{p,g} P_g L_g N_g t_{m,d,h,g} \quad \text{Eq. 5-25}$$

where

$m_{p,g}$	The mass (in grams) of pollutant, p , emitted in a given hour from GSE, g ;
$E_{p,g}$	The emission factor for pollutant, p (in grams per horsepower-hour) for GSE, g ;
P_g	The rated power (in brake horsepower) of GSE, g ;
L_g	The load factor (unitless) of GSE, g ;
N_g	The population of GSE, g , (number of units included in the study); and
$t_{m,d,h,g}$	The number of hours (a value between 0 and 1, inclusive) one unit of GSE population g operates during hour h on day d in month m . See Eq. 5-26.

$$t_{m,d,h,g} = t_{peak,g} w_{m,g} w_{d,g} \sum_{i=1}^4 w_{q_i,g} \quad \text{Eq. 5-26}$$

where

$t_{m,d,h,g}$	The number of hours (a value between 0 and 1, inclusive) one unit of GSE population g operates during hour h on day of the week d in month m ;
$t_{peak,g}$	The peak number of hours a unit of GSE population g operates during any quarter-hour of any analysis year;
$w_{m,g}$	The weight for month m of the operational profiles assigned to GSE population g ;
$w_{d,g}$	The weight for day of the week d of the operational profiles assigned to GSE population g ; and
$w_{q_i,g}$	The weight for quarter-hour q_i of the operational profiles assigned to GSE population g where q_i is the i^{th} quarter of hour h .

2. If dispersion is enabled, then for each hour of the day, then for each gate assigned to the GSE population, add the fraction of emissions from the GSE population assigned to the gate to the gate's hourly emissions.

5.2.2 Aircraft-Assigned GSE Processing Algorithm

Each aircraft assigned GSE are uniquely identified by the combination of their type, reference model and fuel. The following outline describes the algorithm used to model the emissions of GSE assigned to aircraft. These GSE are modeled on an aircraft operation basis (specifically, only departures and arrivals).

1. Model the assigned GSE emissions with Eq. 5-27 for an arrival or a departure operation.
2. If dispersion is enabled, add the aircraft's GSE emissions to the gate of the flight operation.

$$m_{p,a} = \sum_{g \in A_a} E_{p,g} P_g L_g t_{a,g} \quad \text{Eq. 5-27}$$

where

$m_{p,a}$	The mass (in grams) of pollutant, p , emitted from all GSE assigned to aircraft a during one operation;
A_a	The set of GSE assigned to aircraft a ;
$E_{p,g}$	The emission factor for pollutant, p (in grams per horsepower-hour) for GSE, g ;
P_g	The rated power (in brake horsepower) of GSE, g ;
L_g	The load factor (unitless) of GSE, g ; and
$t_{a,g}$	For aircraft a , the number of hours GSE g operates during one operation.

5.3 Stationary Sources

This Section describes the process AEDT performs to calculate the emissions for stationary sources and training fires. For each scenario-airport combination, the stationary sources and training fires are uniquely identified by their user-specified identification and type (i.e., stationary source or training fire).

The following process is used by AEDT to update emissions totals for stationary sources.

1. If the aircraft schedule is not aggregated:
For each hour of the day,
 - a) Update the atmospheric parameter values with those corresponding to the current day and hour being processed.
 - b) For each stationary source in the in-study list of the scenario-airport combination,
 - i. If the source is not a fuel tank or is a fuel tank with annual throughput/consumption is greater than zero, for each pollutant, compute the annual emissions. See Eq. 5-28.
 - ii. If the source is a fuel tank with zero annual throughput, for each pollutant, compute the annual emissions. See Eq. 5-28.
 - iii. Allocate emissions to the appropriate AERMOD stationary source.
2. If the aircraft schedule is aggregated:
For each stationary source in the in-study list of the scenario-airport combination,
 - a) If the source is not a fuel tank or is a fuel tank with annual throughput/consumption is greater than zero, for each pollutant, compute the annual emissions. See Eq. 5-28.

- b) If the source is a fuel tank with zero annual throughput, for each pollutant, compute the annual emissions. See Eq. 5-28.
- c) Allocate emissions to the appropriate AERMOD stationary source.

The following process is used by AEDT to update emissions totals for stationary sources and training fires.

1. If the aircraft schedule is not aggregated:
 For each hour of the day,
 - a) Loop over all stationary sources and training fires in the In-study list of the scenario-airport:
 - i. For each pollutant, compute the annual emissions. See Eq. 5-28.
 - b) Allocate to the appropriate AERMOD source.

2. If the aircraft schedule is aggregated:
 - a) Loop over all stationary sources and training fires in the In-study list of the scenario-airport:
 - i. For each pollutant, compute the annual emissions. See Eq. 5-28.
 - b) Allocate to the appropriate AERMOD source.

$$m_{p,s} = (EF_{p,s}) \begin{cases} 1 & \text{if } s \text{ is a fuel tank and } N_s = 0 \\ N_s & \text{otherwise} \end{cases} \quad \text{Eq. 5-28}$$

where

- $m_{p,s}$ The mass (in kilograms) of pollutant, p, emitted annually from source, s;
- N_s The annual throughput/consumption of source, s; and
- $EF_{p,s}$ The emission factor for pollutant, p, for source, s. Note: if $N_s = 0$ then $EF_{p,s}$ will represent the annual fuel tank emissions.

Table 5-8 Units for Stationary Sources & Training Fires

Source Category	Sub-Category	Emission Factor Units	Throughput Units
Other	All	Kg per the user-specified throughput unit	User-specified
Boiler/Space Heater	Coal Burning	Kg per Metric Ton	Metric Tons
	Fuel Oil or LPG Burning	Kg per Kiloliter	Kiloliters
	Natural Gas Burning	Kg per 1,000 cubic meters	1,000's of Cubic Meters
Emergency Generator	EPA Methodology	Kg per Hour	Hours
	USAF Methodology (not Natural Gas)	Kg per Kiloliter	Kiloliters
	USAF Methodology (Natural Gas)	Kg per 1,000 cubic meters	1,000's Cubic Meters
Incinerator	All	Kg per Metric Ton	Metric Tons
Aircraft Engine Testing	All	Kg per Test Cycle	Test Cycles
Fuel Tank	With Throughput	Kg per Kiloliter	Kiloliters
	No Throughput	Kg	N/A
Surface Coating/Painting	All	Kg per Kiloliters	Kiloliters

Deicing Area	All	Kg per Kiloliters	Kiloliters
Solvent Degreaser	All	Kg per Kiloliters	Kiloliters
Sand/Salt Pilt	All	Kg per Metric Ton	Metric Tons
Training Fire	All	Kg per Gallon	Gallons

Annual emissions from a source are generally based on the source's annual throughput or consumption of a substance, time or an event. For more details on stationary sources, see Section 11.5.

6. Emissions Dispersion

The Emissions Dispersion Module (EDM) of AEDT uses the EPA atmospheric dispersion modeling system, AERMOD, for airport-related pollutants. AEDT sends input to and receives output from AERMOD and can create pollutant concentration maps near an airport.

6.1 AEDT and AERMOD Sources

In order to produce the American Meteorological Society (AMS)/EPA Regulatory Model (AERMOD)^{xxvii} input files, the EDM allocates the emissions from the AEDT operations into the spatially fixed emission sources required by AERMOD. The emissions from the AERMOD sources are collected for each modeling hour, and the respective hourly emissions rates are submitted into the AERMOD through the Hourly Emissions Rate AERMOD Input File, which is called the HRE Input File, see Section 6.12.1.1.

The aircraft and non-aircraft operations represent two major types of the AEDT operations.

Each aircraft operation is associated with respective aircraft movements and consists of a set of the flight segments. Following the EDMS guidelines, the EDM distributes a flight segment emissions between one or more rectangular AERMOD sources called AREA sources.

For the purpose of Emissions Dispersion Modeling, GSE, APU, and startup non-aircraft operations need to be associated with the appropriate gates or terminals in AEDT. Gates and terminals in AEDT are abstract concepts, which are designed in support of the Emissions Dispersion and Taxi Network modeling, and should not be mistaken with real airport gates and terminals. A gate is a point AEDT Airport Layout Component and is represented as an AERMOD VOLUME emissions source. Contrary to their name, VOLUME sources are intended to model emissions originating from a point with initial finite concentration. A terminal is a polygonal AEDT Airport Layout Component and is represented as a polygonal AERMOD emissions source called AREAPOLY source. A terminal for emissions dispersion purposes is the “apron” (the area where aircraft are parked, unloaded or loaded, refueled, or boarded, near real gates, and it is not a terminal building. EDMS regarded AEDT gates and terminals as “gates”.

Due to a variety of the geometrical and physical characteristics of stationary sources, the emissions from the respective operations could be allocated into VOLUME, AREAPOLY, and POINT sources. POINT sources are intended to model smokestacks with user-specified exhaust temperature, velocity and inside diameter.

Contrary to EDMS, AEDT currently relies on the user to estimate roadway, parking, and construction emissions separately, and produces the respective AERMOD INP and HRE input files. The user models roadway and parking emissions using the MOVES model⁴³, and construction emissions using MOVES or the standalone Non-Road model, and then prepares the MOVES emissions dispersion INP and HRE files. The user then within AEDT points to the path of the MOVES emissions dispersion files for AEDT to

^{xxvii} EPA, 2014. User’s Guide for the AMS/EPA Regulatory Model – AERMOD, Addendum, EPA-454/B-03-001, September 2004 (update May, 2014), U.S. Environmental Protection Agency, Office of Air Quality Planning and Standards, Air Quality Assessment Division, Research Triangle Park, North Carolina.

integrate these inputs along with the AERMOD INP and HRE files produced for all other sources at the airport.

According to the American Meteorological Society (AMS)/EPA Regulatory Model Improvement Committee (AERMIC) guidance, the proportions of the rectangular regions modeled as AREA sources are limited by a 10:1 ratio – no AREA should be ten times longer than its width. Therefore, when using AREA sources to model line sources (e.g., taxi segments), this stipulation should be obeyed. Table 6-1 summarizes the types of the AERMOD sources constructed for each AEDT source category.

Table 6-1 AERMOD Source Modeling

AEDT Source Type	AERMOD Source Type
Aircraft Operation: <ul style="list-style-type: none"> Airborne segments Ground roll segments Taxi segments 	1 or more AREA(s)
Stationary Source	POINT, VOLUME, or AREAPOLY
Gate	VOLUME
Terminal	AREAPOLY
Parking Facility	1 or more AREAPOLY(s)
Roadway	1 or more AREA(s)
Background Concentration	BACKGRND

6.2 AEDT Map Projection

AEDT mostly works with the geographic coordinate system (i.e. latitude and longitude), while AERMOD uses the projected coordinate system (the earth's spherical surface projected onto a two-dimensional Cartesian coordinate plane), not the geographic coordinate system. Thus it is necessary to convert coordinates between the geographic coordinate system and the projected coordinate system. Note that in this section, upper-case X,Y,Z refers to a particular coordinate system, and lower case x,y,z refers to a particular point in that system.

EDMS used UTM (Universal Transverse Mercator System) for this purpose. AEDT uses an approximate Lambert Conformal Conic projection. The projection is not exactly conformal (non-angle-preserving) but is accurate to within one hundred miles around the origin. See Section 11.6 for more details.

6.3 Emissions from Airborne and Ground Roll Flight Segments

6.3.1 Three-dimensional Voxel Grid in AEDT

Aircraft operations modeling in AEDT is always three-dimensional in space to represent a more realistic situation. On the one hand, AEDT uses the same concept of representing the aircraft airborne emissions by means of the AREA sources. On the other hand, the trajectories of AEDT flights are not typically limited to the vertical plane associated with the respective runway. To accommodate the three-dimensional nature of AEDT flights, the EDM constructs two voxel grids of the AREA emissions sources.

The three-dimensional voxel grid is designed to collect emissions from airborne segments. Its origin and coordinate axes coincide with the origin and coordinate axes of the Cartesian coordinate system associated with the AEDT projection, where the Z coordinate represents the altitude above the field elevation.

The height of the grid is equal to the mixing height, h_{mixing} . In the EDM, the mixing height is fixed at 3,000 ft. The horizontal dimensions of the grid are determined by the maximum extends of the modelled flight segments.

Each cell of the grid is a cuboid with dimensions Δx , Δy , and Δz . The dimensions of the cuboid are also known as spacings and could be changed by the user through the Emissions Dispersion Preferences pane of the Study tab (see Section 4.10.11 of the AEDT 2c User Guide¹). Following the EDMS guidelines, for cuboids located less than 300 meters above the ground, the default Δz spacing is equal to 20 meters and could be changed by the user. For the cuboids above the mixing height, the Δz extends to the mixing height, and cannot be changed by the user, $\Delta z = h_{mixing} - 300 \text{ meters}$. The default recommended value for the horizontal spacing's, Δx and Δy , is equal to 200 m.

Location and parameters of the AREA source corresponding to each cuboid of the grid are determined as follows:

- Find the (X,Y) projection of the cuboid.
- Find the location in meters, (x,y), of the lower left corner of the projection.
- Set the x_a , y_a , z_a coordinates of the AREA source respectively to $(x - \frac{\Delta x}{2})$, y , and z_0 , where z_0 is the mean sea level elevation in meters of the grid's origin.
- Note that every AREA source has the same location for each cuboid in a given column of the cuboids defined by the same (x,y) coordinates of the lower left corner of the projection.
- Set the initial vertical dispersion parameter to 4.1 meters.
- Set the width of the AREA source to Δx .
- Set the length of the AREA source to Δy .
- Set orientation angle of the AREA source to zero.
- Release height is set equal to the average of the ceiling and floor of the current cuboid plus 12 meters.

6.3.2 Two-dimensional Surface Voxel Grid

The two-dimensional voxel grid is designed to allocate the emissions from arrival and departure ground roll segments. These flight movements have more impact on the emissions concentrations close to the airport and require a finer grid compared to the airborne flight movements. The origin of the grid and its coordinate axes, X and Y, coincide with the origin and coordinate axes of the Cartesian coordinate system associated with the AEDT projection. The mean sea level elevation of each node of the grid is equal to the mean sea level elevation of the grid's origin, z_0 .

The horizontal dimensions of the grid are determined by the maximum extends of the modelled flight segments.

Each cell of the grid is a rectangle with the dimensions Δx and Δy . The dimensions of the rectangle are also known as spacings, and could be changed by the user through the Emissions Dispersion Preferences pane of the Study tab, see Section 4.10.11 of the AEDT 2c User Guide¹. The default recommended value for the horizontal spacings, Δx and Δy , is equal to 20 m.

Location and parameters of the AREA source corresponding to each rectangle of the grid are determined as follows:

- Find the location in meters, (x,y) , of the lower left corner of the rectangle.
- Set the x_a, y_a, z_a coordinates of the AREA source respectively to $(x - \frac{\Delta x}{2}), y$, and z_0 , where z_0 is the mean sea level elevation of the grid's origin in meters.
- Set the initial vertical dispersion parameter to 4.1 meters.
- Set the width of the AREA source to Δx .
- Set the length of the AREA source to Δy .
- Set orientation angle of the AREA source to zero.
- Release height is set equal to 12 meters.

6.3.3 Voxel Grids Aligned with a Runway

The AEDT unit of work is a metric result. If a metric result contains only the air operations of one type, arrival or departures, and they are all associated with one runway end, then the user has the option to align the voxel grids with the runway. This mode is recommended when comparing the AEDT and EDMS results of the emissions dispersion modeling of straight in and straight out flights.

6.3.3.1 Three-dimensional Aligned Voxel Grid

The origin of the voxel grid is placed in the departure or arrival runway end depending on the type of operations included in the metric result. The \tilde{Y} axis of the voxel grid is aligned with the runway and oriented in the direction of the other runway end. Orientation angle, φ , of the axis \tilde{Y} relative to the axis Y of the coordinate system associated with the AEDT projection, measured positive in the clockwise direction, is calculated as follows:

$$\varphi = \arctan\left(\frac{x_e - x_{e,o}}{y_e - y_{e,o}}\right) \quad \text{Eq. 6-1}$$

where (x_e, y_e) and $(x_{e,o}, y_{e,o})$ are the AEDT projection coordinates of the runway end and of the other runway end, respectively. The \tilde{Z} axis of voxel grid is parallel to the Z axis of the coordinate system associated with the AEDT projection.

The dimensions of the grid, and $\Delta \tilde{y}$ and $\Delta \tilde{z}$ dimensions of each grid's cell or cuboid are set as in Section 6.3.1. The recommended default value of the cuboid's width, $\Delta \tilde{x}$, is equal to 20 meters. In the use case of straight in or straight out flights, the grid dimension in \tilde{X} direction is equal to the cuboid's width, $\Delta \tilde{x}$.

Locations of the AREA sources need to be reported in terms of the coordinate system associated with the AEDT projection. This requirement results in the following modification of the algorithm described in Section 6.3.1:

- Find the (\tilde{X}, \tilde{Y}) projection of the cuboid.
- Find the location in meters, (\tilde{x}, \tilde{y}) , of the lower left corner of the projection.
- Note that for a straight-in or straight-out flight, the following is true: $\tilde{x} = 0$.
- Set the x_a , y_a , and z_a coordinates of the AREA source as follows:

$$\begin{aligned} x_a &= \left(\tilde{x} - \frac{\Delta\tilde{x}}{2} \right) \cos(\varphi) + \tilde{y} \sin(\varphi) + x_e \\ y_a &= - \left(\tilde{x} - \frac{\Delta\tilde{x}}{2} \right) \sin(\varphi) + \tilde{y} \cos(\varphi) + y_e \\ z_a &= z_e \end{aligned} \quad \text{Eq. 6-2}$$

where z_e is the mean sea level elevation in meters of the runway end.

Note that every AREA source has the same location for each cuboid in a given column of the cuboids defined by the same (\tilde{x}, \tilde{y}) coordinates of the lower left corner of the projection.

- Set the initial vertical dispersion parameter to 4.1 meters.
- Set the width of the AREA source to $\Delta\tilde{x}$.
- Set the length of the AREA source to $\Delta\tilde{y}$.
- Set orientation angle of the AREA source to the runway's orientation angle, φ , Eq. 6-1.
- Release height, h , is set equal to the average of the ceiling and floor of the current cuboid plus 12 meters:

$$h = \tilde{z} + \frac{\Delta\tilde{z}}{2} + 12 \quad \text{Eq. 6-3}$$

6.3.3.2 Two-dimensional Aligned Surface Voxel Grid

The EDM follows the EDMS guidelines in the construction of the aligned surface grid.

Runway ends for the given runway are ordered alphabetically, and the origin of the grid is placed into the first runway end. For example, if a runway has ends named "12" and "30", the grid origin will be placed into the runway end "12". The \tilde{Y} axis of the voxel grid is aligned with the runway and oriented in the direction of the other runway end. Orientation angle, φ , of the axis \tilde{Y} relative to the axis Y of the coordinate system associated with the AEDT projection, measured positive in the clockwise direction, is calculated according to equation Eq. 6-1.

Each cell of the grid is a rectangle with the dimensions $\Delta\tilde{x}$ and $\Delta\tilde{y}$. The default recommended value of the width of each rectangle, $\Delta\tilde{x}$, is equal to 20 m. The length of each rectangle, $\Delta\tilde{y}$, is calculated dynamically by splitting the length of the runway, L , into the whole number of segments with maximum desirable length of 50 m. Because the ground roll movements are always confined to the respective runway, the effective width and length of the surface voxel grid are equal to $\Delta\tilde{x}$ and L , respectively.

Locations of the AREA sources need to be reported in terms of the coordinate system associated with the AEDT projection. This requirement results in the following modification of the algorithm described in the Section 6.3.2:

- The location of the lower left corner of a rectangle is defined as $(0, \tilde{y})$ because this side of the rectangle resides on the runway.
- Set the x_a , y_a , and z_a coordinates of the AREA source as follows:

$$\begin{aligned} x_a &= -\frac{\Delta\tilde{x}}{2}\cos(\varphi) + \tilde{y}\sin(\varphi) + x_e \\ y_a &= \frac{\Delta\tilde{x}}{2}\sin(\varphi) + \tilde{y}\cos(\varphi) + y_e \\ z_a &= z_e \end{aligned} \quad \text{Eq. 6-4}$$

- Set the initial vertical dispersion parameter to 4.1 meters.
- Set the width of the AREA source to $\Delta\tilde{x}$.
- Set the length of the AREA source to $\Delta\tilde{y}$.
- Set orientation angle of the AREA source to the runway's orientation angle, φ , Eq. 6-1.
- Release height, h , is set equal to 12 meters.

6.3.4 Allocating Emissions from Flight Segments

This Section describes the algorithm of allocating the emissions from a flight segment between the AREA emissions sources of a voxel grid (X, Y, Z). AEDT and EDMS use conceptually the same splitting algorithm. EDMS's two-dimensional version of the algorithm is implemented in the `getDistanceFractions` method of the `CEmisSegment` class. AEDT's three-dimensional version of the algorithm is implemented in the `SplitFlightSegment` method of the `EmissionsBaseGrid2` class.

The flight vector segment \vec{S} is defined in terms of its orthogonal projection to coordinate axes:

$$\vec{S} = \{S_x, S_y, S_z\} \quad \text{Eq. 6-5}$$

Nodes of each axis splits the respective projection into sub-segments which is expressed as the respective arrays of fractions, f_x, f_y, f_z . For example, for the X projection:

$$f_x = \left\{0, f_{x,1}, f_{x,2}, \dots, f_{x,n_x}, 1\right\} = \left\{0, \frac{S_{1,x} - S_{0,x}}{|S_x|}, \frac{S_{2,x} - S_{0,x}}{|S_x|}, \dots, \frac{S_{n_x,x} - S_{0,x}}{|S_x|}, 1\right\} \quad \text{Eq. 6-6}$$

where: $S_{1,x}, S_{2,x}, \dots, S_{n_x,x}$ are the coordinates of the X axis nodes intersecting with the S_x projection of the vector \vec{S} , and the $S_{0,x}$ is the x coordinate of the vector's starting point, S_0 . According to the triangle proportionality theorem, a set of the parallel planes, which are perpendicular to the X axis and cross the nodes $S_{i,x}$, where $i = 1, 2, \dots, n_x$, intersect with the segment vector \vec{S} in the points S_i which positions along the segment could be defined as follows:

$$\frac{|\vec{S}_i|}{|\vec{S}|} = f_{x,i}, \quad i = 1, 2, \dots, n_x \quad \text{Eq. 6-7}$$

where \vec{S}_i is the vector originating in the point S_0 , and ending in the point S_i . In the same manner, the fraction arrays f_y and f_z will define the intersections of the vector \vec{S} with the node planes perpendicular to the Y and Z axes, respectively. The combined array of all the fractions values sorted in ascending order, f , comprises the list of all the flight segment vector intersections with the cuboids of the voxel grid:

$$f = \{0, f_1, f_2, \dots, f_n, 1\} = \{0, \frac{|\vec{S}_1|}{|\vec{S}|}, \frac{|\vec{S}_2|}{|\vec{S}|}, \dots, \frac{|\vec{S}_n|}{|\vec{S}|}, 1\} \tag{Eq. 6-8}$$

The intersection points are sorted in the ascending order of their distance from the vector’s starting point, S_0 , and split the segment into the sub-segments as follows:

$$\Delta S = \{\overrightarrow{\Delta S_1}, \overrightarrow{\Delta S_2}, \dots, \overrightarrow{\Delta S_n}, \overrightarrow{\Delta S_{n+1}}\} = \{\vec{S}_1, \vec{S}_2 - \vec{S}_1, \dots, \vec{S}_n - \vec{S}_{n-1}, \vec{S} - \vec{S}_n\} \tag{Eq. 6-9}$$

The above algorithm of splitting the flight segment into the sub-segments is illustrated in Figure 6-1 by an example of the departure, straight-out flight segment intersections with the cuboids of the voxel grid aligned with the runway along the axis Y:

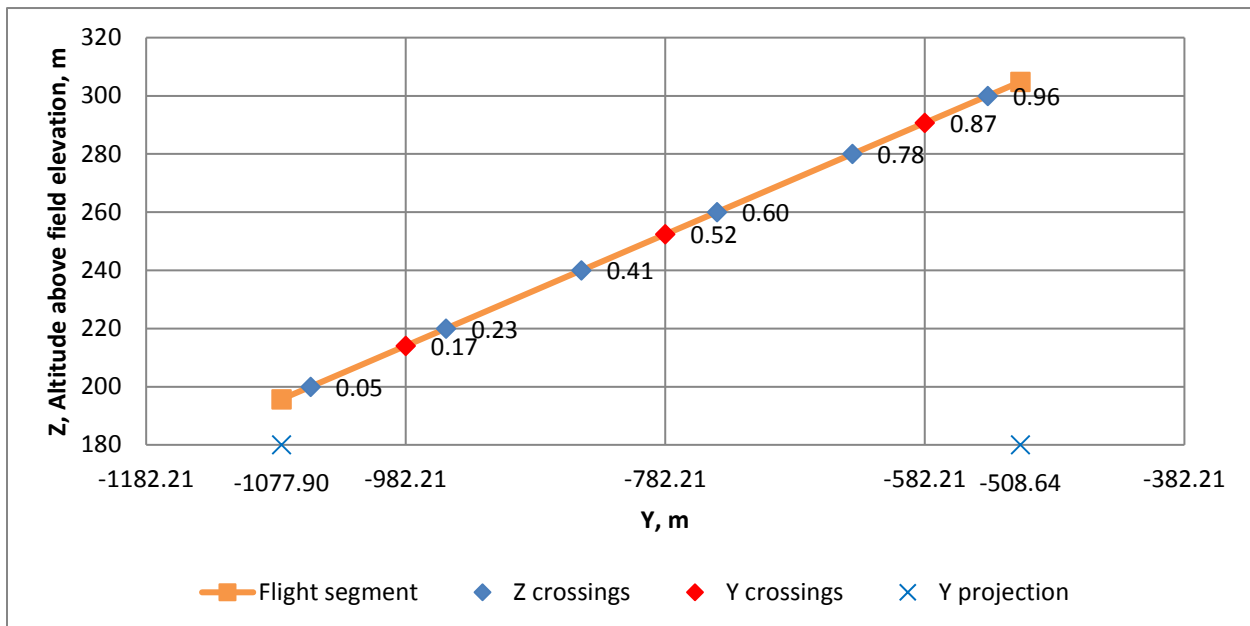

Figure 6-1 Flight Segment Splitting Algorithm

The equation to calculate the time t_i spent along each sub segment $\overrightarrow{\Delta S}_i$ is deduced in EDMS and is based on the assumption of constant acceleration along the flight segment (see the Section 3.3.1. “Aircraft Flight Emissions Allocation”, Equation 3-1, of the EDMS Technical Manual⁴⁴). Emissions of each sub-segment, E_i , is proportional to the fraction of the total segment time spent along the sub-segment:

$$E_i = \frac{\Delta t_i}{\Delta t_{seg}} E \quad \text{Eq. 6-10}$$

where

E Total segment emissions; and
 Δt_{seg} Total segment duration.

A sub-segment emissions is allocated to the AREA source associated with the cuboid containing the sub-segment. Per EDMS guidelines, the emissions are collected separately for each modeling hour, and the emissions are converted into the units of grams per second per square meter under the approximation of a continuous emissions source during each hour:

$$E_a(x, y, z, t) = \frac{1}{3600} \frac{1}{A} \sum_{C(x,y,z),t} E_i \quad \text{Eq. 6-11}$$

where

x,y,z Coordinates of the lower-left corner of a cuboid's floor;
 t Hour of the operation (1,2, ..., 24);
 $E_a(x, y, z, t)$ Hourly emissions rate of the AREA sources associated with the cuboid;
 $3,600$ Number of seconds in an hour;
 A Area of the AREA source in square meters; and
 E_i Emissions in grams, from all the sub-segments which share the same cuboid $C(x,y,z)$ and the same hour bin t are accumulated.

6.4 Emissions from Taxi Segments

In order to model the taxi emissions dispersion, the respective Emissions Dispersion metric result should have the Delay and Sequencing mode enabled. To achieve this, the user needs to check the “Apply Delay & Sequencing Model on Taxi” check box of the “Modeling Options” when defining a new Emissions Dispersion metric result.

For each flight, the Delay and Sequencing Module (DSQM) constructs the path from the gate to the respective runway end through the taxi network map, as described in Section 7.3.2.9 “Generation of the Network Map” and Section 7.6.1 “Sequencing Algorithm and Outputs”. Conceptually, the taxi network map consists of the nodes and allowed connections between the nodes, which are called links. Each network link has the following major properties: a unique id, a reference to the respective airport layout, the length, L , the width, w , and the coordinates of the connected nodes in the Cartesian coordinate system associated with the AEDT projection. Each link is also characterized with the constant speed with which an aircraft is moving along this segment. The DSQM stores the list of the possible links with respective properties into the TAXI_NETWORK_LINKS table of the Study database.

Upon the completion of the Aircraft Performance Modeling (APM), the flight's network path is transformed into the list of the taxi trajectory segments and incorporated into the list of the ground roll and airborne trajectory segments of the respective Performance Event Result. Each taxi trajectory segment includes a reference to the id of the respective network link. The Aircraft Emissions Module (AEM) processes the Performance Event Result, and computes the Emissions Event Result which contains emissions, E , of each pollutant. Both Event Results are stored in the Study database.

The EDM retrieves the Emissions and Performance Event Results from the database. The emissions from the ground roll and airborne trajectory segments get allocated to the AERMOD sources of the voxel grids as explained in Section 6.3. Allocating emissions from the taxi trajectory segments does not require a voxel grid of the AERMOD sources. In this case, the list of the taxi network links, retrieved from the TAXI_NETWORK_LINKS table of the Study database, serves as a container of the AREA AERMOD sources. Each taxi trajectory segment references a network link, and each link could be shared by more than one flight.

Each taxi network link between the nodes p and q , $\lambda_{p,q}$, gets split into a set of the AREA sources according to the algorithm described in the Section 11.4.1 Constructing AERMOD Rectangle Sources from a Line Segment. The algorithm determines the location (x,y,z) , elevation, length, and orientation of each AREA source. The release height of each AREA source is set to 12 m, and the initial vertical dispersion is set to 4.1 m. Each AREA source, constructed from a link, has the same hourly emissions rate, $E_{p,q}(x, y, z, t)$, and is expressed in the units of grams per second per square meter similar to Equation 6-12:

$$E_{p,q}(x, y, z, t) = \frac{1}{3600} \frac{1}{Lw} \sum_{\lambda_{p,q,t}} E_i \quad \text{Eq. 6-12}$$

Where L is the length and w is width of the source, and E_i is the emissions for i^{th} flight in grams, and the emissions from all the flights which share the same taxi network link, $\lambda_{p,q}$, and the same hour bin, t , are accumulated.

6.5 Emissions from Gates and Terminals

In order to model Emissions Dispersion from engine startup emissions, APU emissions, and GSE emissions, the user needs to create an emissions dispersion metric result including operations which either implicitly or explicitly reference engine startup, APU, or GSE equipment. In addition, a gate or a terminal needs to be assigned to each operation.

In AEDT, the physical gate object could be abstracted either as a point AEDT Airport Layout Component called Gate, or as a polygonal AEDT Airport Layout Component called Terminal (see Appendix H.6 : “Airports Tab” of the AEDT 2c User Guide¹). The Gate component is characterized by the location, elevation, release height, and initial vertical and horizontal dispersion parameters. The Terminal component is characterized by the location of each polygon point, the gate location which is set to the location of the first point of the Terminal, elevation, release height, and the initial vertical dispersion parameter. Please note that both the Gate and Terminal components are referred to as Gates in the Wizard dialogs in AEDT GUI where they get assigned to the respective operation. The user can either import the gates by means of ASIF process, or can create new gates in the AEDT GUI.

The engine startup emissions is computed based on the engine thrust characteristics and does not require creation of specific equipment (see Section 2.3.4.3 “Startup Emissions” of the EDMS Technical Manual⁴⁴).

As shown in Figure 6-2, the user can create a new APU using the Copy feature of the Non-Aircraft pane of the Equipment tab.

Field	Value
Name:	APU 131-9
Category:	Auxiliary Power Unit
Subcategory:	Auxiliary Power Unit
(Operation) units:	Minutes per aircraft operation
CO emission factor (kg/hour):	0.56445
HC emission factor (kg/hour):	0.04279
NOx emission factor (kg/hour):	0.76803
SOx emission factor (kg/hour):	0.11566
PM-10 emission factor (kg/hour):	0.093

Figure 6-2 Creation of a New User-Defined APU

A new APU can be also imported as a partial ASIF. In addition, if the AEDT Study is created by means of the EDMS to ASIF Converter (see Appendix C.2: “EDMS to ASIF Converter” of the AEDT 2c User Guide¹), all the user-defined APUs in the EDMS study will be transformed into the user-defined APUs in AEDT. A system or user-defined APU could be assigned to the new user-defined aircraft using the Copy feature of the Aircraft pane of the Equipment tab. Alternatively, this assignment occurs during the ASIF import process.

A new GSE can be imported as a partial ASIF. In addition, if the AEDT Study is created by means of the EDMS to ASIF Converter, all the user-defined GSE in the EDMS study will be transformed into the user-defined GSE in AEDT.

Startup emissions modeling is activated for departure operations by enabling the “Calculate aircraft engine startup emissions” processing option of a metric result. The Startup Emissions Event Result is computed by the Startup Emissions Processor. In the Accumulate Metrics Module (AMM), the Startup Emissions Event Result is encapsulated into an Emissions Model Result with Emissions Flight Mode set to Startup, and added to the Emissions Model Result Collection, which is stored into the database by the Business Logic Level (BLL) Module.

The APU emissions modeling is activated by enabling the “Use Auxiliary Power Unit (APU)” checkbox option and specifying the duration in minutes on the “Choose GSE/APU” step of the “Create Aircraft Operation” wizard (see Section 6.2.1 “Create Aircraft Operation” of the AEDT 2c User Guide¹). The APU Emissions Event Result is computed by the APU Emissions Processor, and stored into the database by the BLL Module.

The emissions modeling of the GSE associated with aircraft operations, so called GSE LTO, is activated by choosing specific equipment on the “Choose GSE/APU” step, and by specifying GSE parameters (Duration, Horse Power, Load Factor, and Manufacture Year) on the “Provide GSE Details” dialog of the “Create Aircraft Operation wizard” (see Section 6.2.1 Create Aircraft Operation of the AEDT 2c User Guide¹). The GSE LTO Emissions Event Result is computed by the GSE LTO Emissions Processor and stored into the database by the BLL Module.

The EDM requires the user to assign a gate/terminal to the aircraft operation (see Section 6.2.1.3 Step 3: Choose Gate of the AEDT 2c User Guide¹).

The emissions modeling of the GSE, so called GSE population (which is not associated with aircraft operations), is activated by creating a new non-aircraft operation (see Section 6.3 Non-Aircraft Operation of the AEDT 2c User Guide¹). In the “Choose Equipment” step, the user selects a specific GSE equipment. In the “Provide GSE Details” step, the user provides the GSE characteristics (number of units, Horsepower, load factor, and manufacture year), and defines the gate distribution. In the “Assign Operational Profiles” step, the user chooses the appropriate operational profiles, which represent the quarter-hourly/daily/monthly distribution of the GSE operation during the modeling period. The user defines the modeling period by specifying the operation’s first day and last day when combining the GSE operations in a new operation group during the creation of a new Annualization (see Section 6.6 “Annualization” of the AEDT 2c User Guide¹). The GSE Population Emissions Event Result is computed by the GSE Population Emissions Processor and stored into the database by the BLL Module.

The EDM retrieves the Startup-, APU-, and GSE-related Emissions Event Results from the database, and for each gate object, , accumulates the emissions from different sources for each hour bin. The total emissions are converted into the hourly emissions rates, which are reported to AERMOD through the HRE file. The Gate AEDT sources are modeled as the AERMOD VOLUME sources, and the total emissions are converted into the units of grams per second:

$$E_V(g, t) = \frac{1}{3600} \sum_{t,g} E_s \quad \text{Eq. 6-13}$$

where

$E_V(g, t)$ is a pollutant hourly emissions rate; for a given VOLUME gate object, G, and a given hour bin

$t = 1, 2, \dots, 24;$

3,600 number of seconds in an hour; and

the emissions in grams, E_s , from various sources, $s = \{\text{Startup, APU, GSE}\}$, which are assigned to the same gate, g , and share the same hour bin, t , are accumulated.

The Terminal AEDT sources are modeled as AERMOD AREAPOLY sources, and the total hourly emissions are converted into the units of grams per second per square meter:

$$E_A(g, t) = \frac{1}{3600} \frac{1}{A} \sum_{t,g} E_s \quad \text{Eq. 6-14}$$

where $E_A(g, t)$ is a pollutant hourly emissions rate for a given polygonal AREAPOLY gate object, g , and A is the area of the polygon in square meters.

6.6 Emissions from Stationary Sources

In order to model Emissions Dispersion from stationary sources, the user needs to create an Emissions Dispersion Metric Result which includes one or more operation groups consisting of the stationary operations only. Each stationary operation references either a system or a user-defined stationary source. In AEDT, training fires are treated as one of the stationary source categories.

The user can create a new user-defined stationary source using the copy feature of the non-aircraft pane of the Equipment tab. A new stationary source can be imported as a partial ASIF. In addition, if the AEDT Study is created by means of the EDMS to ASIF Converter, all the user-defined stationary sources in the EDMS study will be transformed into the AEDT’s user-defined stationary sources. This Section

focuses on the aspects of these processes which are essential for the Emissions Dispersion modeling of the stationary sources.

When creating a user-defined stationary source, the user specifies the following major characteristics:

- The AERMOD type of the source, which could be set to POINT, VOLUME or AREAPOLY.
- For the POINT source, define the source temperature, diameter, and exhaust velocity. Note that an option to specify the temperature as an offset to the ambient temperature is not implemented in the current release of AEDT.
- For the VOLUME sources, define initial vertical and horizontal dispersion parameters.
- For the AREAPOLY sources, define the initial vertical dispersion parameter, and the shape of the polygonal area as shown in Figure 6-3.
- Regardless of the AERMOD source type, the user specifies the release height of the source, and the required emissions characteristics, see Figure 6-3.

Boiler Terminal #1-Baseline-KPVD-2004
User-defined

Name:

Category:

Subcategory:

(Operation) units:

Source type:

Polygon area coordinates

Point #	X [meters]	Y [meters]
0	0	0
1	1	1
2	2	0

3 of 3 item(s) shown. 0 item(s) selected.

Release height (m):

Sigma Z0 (m):

CO emission index (kg/1000s of m³):

NOx emission index (kg/1000s of m³):

SOx emission index const term (kg/1000s of m³):

SOx emission index sulfur term (kg/1000s of m³ - %Sulfur):

PM-10 emission index const term (kg/1000s of m³):

PM-10 emission index ash term (kg/1000s of m³ - %Ash):

PM-10 emission index sulfur term (kg/1000s of m³ - %Sulfur):

THC emission index (kg/1000s of m³):

Fuel sulfur content (%):

Fuel ash content (%):

Fuel calcium to sulfur ratio:

CO pollution control factor (%):

TNMOC pollution control factor (%):

Figure 6-3 Creation of a New User-Defined Stationary Source

In order to be modeled by AEDT, a stationary source should be referenced by a non-aircraft operation. When creating a new operation, the user sets the location, elevation, and annual throughput/consumption of the stationary operation. Note that for an AREAPOLY stationary source, the user defines the location of the first point of its shape, Point #0 in Figure 6-3. In addition, the user chooses the appropriate operational profiles, which represent the quarter-hourly/daily/monthly distribution of the operation during the modeling period. The user defines the modeling period by specifying the operation's first day and last day when combining the stationary operations in a new operation group during the creation of a new annualization.

Hourly emissions, E , in unit of grams, are calculated by the AEDT's Stationary Emissions processor which implements the algorithms described in Section 2.6. "Stationary Sources and Training Fires" of the EDMS Technical Manual⁴⁴, and in the Section 5.3 Stationary Sources of this document. The hourly emissions values and the major characteristic of the Stationary Sources are stored in the database within the Stationary Emissions Event Results.

The EDM retrieves the Stationary Emissions Event Results from the database and converts the hourly emissions into the hourly emissions rates, which are reported to AERMOD through the HRE file. For the stationary sources modeled as AREAPOLY sources, similar to Eq. 6-11 and 6-12, the hourly emissions, E , are divided by the number of seconds in hour, and by the source's area, to convert them into units of grams per second per square meter. For stationary sources modeled as POINT or VOLUME sources, the hourly emissions, E , are divided by the number of seconds in hour only to converted them to grams per second.

6.7 Emissions from Roadways, Parking Facilities, and Construction Sources

As stated in Table 6-1, a roadway is modeled in AERMOD as one or more AREA sources. One AREAPOLY source is constructed for every level of every parking facility, except for those that have zero annual vehicular throughput, which are ignored and not constructed. AEDT relies on the user to calculate emissions and create AERMOD input INP and HRE files for roadways, parking facilities, and construction sources which are then input into AEDT processing. For regulatory purposes, MOVES shall be used.

6.8 Applying Background Concentrations

AEDT Version 2c exposes AERMOD's background concentration modeling capability and allows the user to specify concentrations as part of the metric results definition. One background concentration can be specified for each metric result definition, which consists of a pollutant, an emission/receptor set, and an annualization.

When applying background concentrations, the user specifies the following characteristics:

- The number and bounds of any wind sectors
- The bounds of the wind speed categories, if the WSPEED BGFLAG is used
- The units of the background concentration
- An hourly file name containing background concentration values, and/or...
- A non-hourly file containing a string of background concentration values to be used by a non-HOURLY BGFLAG.

AEDT relies on the user to determine background concentration values and organize them into either an hourly input file or a non-hourly file with a string of values. AEDT parses this file and determines the BGFLAG itself based on the number of values given.

6.8.1 AERMOD Background Concentrations Hourly File

An hourly input file is a comma or space-delimited file that gives a background concentration value for each hour of the study period. Each line of the file must give the year, month, day, hour, and background concentration for that hour. The hourly file should cover the entire study period, with no gaps. Specifying a -99 as the background concentration value indicates to AERMOD that the background concentration value is unknown, and AERMOD will attempt to use the non-hourly value for that hour instead, if provided. Figure 6-4 below shows an example of an hourly background concentration file.

```
2010,01,01,01,0.5
2010,01,01,02,0.5
2010,01,01,03,0.6
2010,01,01,04,0.6
2010,01,01,05,0.7
...
```

Figure 6-4 Hourly Background Concentration File Example

AEDT accepts a file name for an hourly input file as part of the metric result creation process. After specifying the file, AEDT will store the contents of the file in the Study database. When it is time to run AERMOD, AEDT re-creates the hourly input file in the output files directory for the metric result. The re-created file will be named *hourly_bg.csv* if only one wind sector is specified, or *hourly_bg_#.csv* if multiple wind sectors are specified, where # is the number of the wind sector.

6.8.2 Background Concentrations Non-Hourly File

A non-hourly input file is a simple text file used to specify background concentrations for temporal periods besides hourly. This file should provide a specific number of background concentration value in order to define background concentrations for a specific period. For example, specifying four background concentration values is a seasonal definition: one for each season. The accepted periods are listed below. The parameter n gives the total number of values expected by AERMOD.

- ANNUAL - annual background value (n=1),
- SEASON - background values vary seasonally [Winter (Dec., Jan., Feb.), Spring (Mar., Apr., May), Summer (Jun., Jul., Aug.), and Fall (Sep., Oct., Nov.)] (n=4),
- MONTH - background values vary monthly (n=12),
- HROFDY - background values vary by hour-of-day (n=24),
- WSPEED - background values vary by wind speed (n=6),
- SEASHR - background values vary by season and hour-of-day (n=96),
- HRDOW - background values vary by hour-of-day, and day-of-week [M-F, Sat, Sun] (n=72),
- HRDOW7 - background values vary by hour-of-day, and the seven days of the week [M, Tu, W, Th, F, Sat, Sun] (n=168),

- SHRDOW - background values vary by season, hour-of-day, and day-of-week [M-F, Sat, Sun] (n=288),
- SHRDOW7 - background values vary by season, hour-of-day, and the seven days of the week [M, Tu, W, Th, F, Sat, Sun] (n=672),
- MHRDOW - background values vary by month, hour-of-day, and day-of-week [M-F, Sat, Sun] (n=864), and
- MHRDOW7 - background values vary by month, hour-of-day, and the seven days of the week [M, Tu, W, Th, F, Sat, Sun] (n=2,016).

In AERMOD, this temporal period is referred to as the BGflag parameter. See *Section 2.5: Specifying Background Concentrations* in the AERMOD User's Guide for more information about the BGflag parameters.

The non-hourly file can be a single line of comma or space-delimited values, or each value can be on a separate line. The file should contain nothing but a set of background concentration values. AEDT will determine the time period based on the number of values provided and report it to the user under the file name as a TYPE.

6.8.3 Outputs of Background Concentrations

If background concentrations are applied AEDT will invoke AERMOD such that background concentrations are included in the ALL source group. The output files Output file will vary based on whether or not background concentrations concentration files are enabled:

- If background concentrations are enabled, these files will be generated:
 - PLT files with the tag WITHBACK will be generated for each required averaging period. This file contains results for the ALL source group including background concentrations.
 - CON files with the tag BACK will be generated for each required averaging period. This file contains concentration values for only the background concentrations across all receptor points and hours of the metric result.
- If background concentrations are not enabled, these files will be generated:
 - PLT files with the tag NOBACK will be generated for each required averaging period. This file contains results for the ALL source group, and does not contain background concentrations.

Reported concentrations in the AEDT user interface will display the total pollutant level, as well as the portion of that level contributed by emissions sources and results for the ALL group in two different forms - with background concentrations and without background concentration. Results for the ALL source group without background concentrations will be calculated by taking the total pollutant values from the WITHBACK PLT file, locating the corresponding background concentration entry in the CON file (taking into account both the same location and the same date/time), and subtracting the effect of the background concentration from the total concentration at that receptor point and time combination. In addition, the background concentrations themselves will be reported.

6.9 Weather Processing

6.9.1 AERMET

When conducting air quality dispersion modeling with AEDT, meteorological data must be processed with EPA's AERMET^{xxviii} in order to execute AERMOD. AEDT has an embedded version of AERMET that provides an interface to processing various types of weather data formats. Section 6.12.1 describes the data formats accepted by the AEDT interface for weather data processing by AERMET. AERMET is a general purpose meteorological preprocessor for organizing meteorological data into a format suitable for use by AERMOD. AERMET requires National Weather Service (NWS) hourly surface observation data and NWS twice-daily upper air sounding. AERMET is also capable of processing data from a site-specific meteorological measurement program.

AERMET processes the surface and upper air sounding data in a three-stage process. The first stage extracts meteorological data from archive data files and processes the data through various quality assessment checks. The second stage merges all data available for 24-hour periods (NWS and site-specific data) and stores these data together in a single file. The third stage reads the merged meteorological data and estimates the necessary boundary layer parameters for use by AERMOD. Two files are written for AERMOD: 1) a file of hourly boundary layer parameter estimates (.sfc file); and 2) a file of multiple-level observations of wind speed and direction, temperature, and standard deviation of the fluctuating components of the wind (.pfl file). The following data formats can be processed by AERMET:

- Surface weather : CD144, HUSWO, ISHD, SAMSON, SCRAM, TD3280
- Upper air weather: FSL ASCII, TD6201
- Automated Surface Observing Data (ASOS): TD-6405
 - AERMET now permits the use of the ASOS (TD-6405) wind data. The NWS and FAA began an effort in 1992 to replace the traditional observer-based system for collecting and reporting weather data with an automated system. As of 2010, there were over 900 ASOS stations located at airports across the U.S. The transition from the observer-based system to an automated system includes a two-minute average wind speed and direction. The values included in the one-minute ASOS wind data files are reported to the nearest degree for wind direction and whole knots for wind speed. Lower stall speeds for the anemometers are also included. This provides a greater resolution than the standard archives of surface observations which were based on a single two-minute average wind speed, usually reported within 10 minutes before the hour.

Historical weather data are available for free from the EPA internet site (www.epa.gov) and other locations, such as www.webmet.com. Additionally, recent weather data are available from the National

^{xxviii} EPA, 2014. User's Guide for the AERMOD Meteorological Preprocessor (AERMET), Addendum, EPA-454/B-03-002, November 2004 (update May, 2014), U.S. Environmental Protection Agency, Office of Air Quality Planning and Standards, Air Quality Assessment Division, Research Triangle Park, North Carolina.

Climactic Data Center (NCDC) internet site (www.ncdc.noaa.gov) after registration or for a fee. The document on getting the recent weather data is available upon request from AEDT support (ask for "AERMET Weather Data Retrieval.docx").

Please refer to the AERMET User Guide for more details regarding accepted data formats, which can be found at <https://www3.epa.gov/scram001/7thconf/aermod/aermetugb.pdf>.

Note that recent weather files like Integrated Surface Hourly Data (ISHD) and Forecast Systems Laboratory (FSL) are based on UTC time, not local time. AERMET produces the weather files in local time if the time difference is given. This means that January 1st in local time corresponds to e.g. the January 1st 5th hour in UTM for the US East Coast. EDMS weather data processing will drop the local-UTC time hour differences (the beginning and the end of the weather files). That is, the SFC, PFL, and MET weather files are missing the last day weather data for the amount of the local-UTC difference for east meridian location. AEDT keeps the same method for compatibility with EDMS. If the user wants to get all hours of data from raw weather, AERMET must be used with the time appropriate for local-UTC time differences. That is, in order to get the local weather data files, the user must give AERMET, for example, UTC January 1st to January 1st of the next year due to the fact that AERMET INP cannot take hour. This will produce the local time weather data from December 31st of 19th hour to January 1st of 19th hour of the next year. The user edits out the beginning and the end to make the weather file for January 1st first hour to December 31st 24th hour. Note that AERMET uses the convention of a day is from the 1st to the 24th hour, not 0th hour to 23rd hour.

6.9.2 AERMET Output Files

In order to successfully execute an 'Emissions Dispersion' metric result in AEDT, the surface (.sfc file), profile (.sfc file), and AERMET surface intermediate file (SFQAFILE.met file) are required. The 'SFQAFILE.met' file is required in order to conduct aircraft performance modeling. AEDT will not execute an 'Emissions Dispersion' metric result without the 'SFQAFILE.met' file.

6.10 Terrain Processing

When running an Emissions Dispersion metric result, AEDT will use regulatory terrain (assumed perfectly flat) by default. AEDT EDM does not currently handle terrain.

6.11 Generating Hourly Emissions Files

When running an Emissions Dispersion metric result, AEDT will automatically generate hourly emissions files for input into AERMOD. Hourly emissions files are generated for the following pollutants:

1. CO (carbon monoxide)
2. THC (total hydrocarbons) for aircraft and APUs only
3. NMHC (non-methane hydrocarbons)
4. VOC (volatile organic compounds)
5. TOG (total organic compounds)
6. NO_x (oxides of nitrogen)
7. SO_x (sulfur oxides)
8. PM₁₀ (particulate matter, 10 microns)

9. PM2.5 (particulate matter, 2.5 microns)

AEDT models CO₂ emissions, and the Emissions Event Results contain the respective emissions values. However, the EDM does not model dispersion of CO₂ emissions because it's not a criteria pollutant and not required under NEPA.

6.12 Generating AERMOD Input Files

6.12.1 Weather Files

The surface and upper-air observations are processed by AEDT with the meteorological preprocessor, AERMET, as follows: open Definitions Tab -> Generate emissions dispersion weather files; fill the appropriate text boxes to locate raw surface and upper air weather files. The process above will create the files for processing by AERMOD:

- The AERMOD surface file (.SFC)
- The AERMOD profile file (.PFL)
- The intermediate AERMET surface observation file (SFQAFILE.MET)

The surface file and the profile file are used directly by AERMOD and contain only the meteorological parameters needed for dispersion purposes. The third file, the AERMET surface observation file, is an intermediate output file by AERMET and retains all of the meteorological parameters originally contained in the user-supplied surface data file, which is used by AEDT directly to drive the aircraft performance and runway configurations.

Weather data sanctioned by EPA must be provided in one of the formats listed in Table 6-2. This may require converting the weather data into one of the formats listed. If weather for a specific location is not available, an appropriate substitution should be used.

Table 6-2 Accepted Weather Data Formats for Emissions Dispersion Modeling

File Format	Use	Description Source
TD-3280	Surface	National Climactic Data Center (NCDC) www.ncdc.noaa.gov
TD-3505 (ISHD)	Surface	National Climactic Data Center (NCDC) www.ncdc.noaa.gov Or NCAR CISL Research Data Archive (world-wide data) rda.ucar.edu/datasets/ds463.3/
CD144	Surface	National Climactic Data Center (NCDC) www.ncdc.noaa.gov
HUSWO	Surface	National Climactic Data Center (NCDC) www.ncdc.noaa.gov
SCRAM	Surface	Environmental Protection Agency (EPA) www.epa.gov
SAMSON	Surface	National Climactic Data Center (NCDC) www.ncdc.noaa.gov
ASOS (DSI-6405) – format not natively supported by AEDT, source for 1-minute weather data	Surface	National Climactic Data Center (NCDC) www.ncdc.noaa.gov
TD-6201	Upper-Air	National Climactic Data Center (NCDC) www.ncdc.noaa.gov

File Format	Use	Description Source
Radiosonde Data of North America – FSL format	Upper-Air	National Climactic Data Center (NCDC) www.ncdc.noaa.gov Or NOAA/ESRL Radiosonde database www.esrl.noaa.gov/raobs

6.12.1.1 Note to Users Outside of the United States

In order to run dispersion, surface weather data is required in one of the following formats sanctioned by EPA: TD-3280, TD-3505 (ISHD), CD-144, HUSWO, SCRAM, SAMSON.

Surface weather data must be converted to one of those formats to be used in AEDT. In addition, an early morning upper-air sounding is required in either TD-6201 or FSL format. Typically, these soundings occur at 00:00 GMT and 12:00 GMT, which does not provide a sounding at the necessary time for much of the globe. If an appropriate sounding is not available for your location, the Lakes Environmental Upper Air Estimator (available from www.weblakes.com) may be appropriate. Specific guidance regarding the AERMET data requirements is provided in the AERMET User’s Guide, available from www.epa.gov/scram001/7thconf/aermod/aermetugb.pdf.

6.12.2 AERMOD Input Files (.INP and .HRE)

The AEDT emissions dispersion process consists of two steps:

1. Run the study to generate “event” results using the MET file; and
2. Run AERMOD by generating .INP and .HRE files from the results.

The INP file points to the hourly surface weather file (.SFC) and the upper air weather file (.PFL). For aircraft operations, “segment level” results are needed. In order to produce the hourly emissions file (.HRE), event-level results are extracted from the Study database. The emissions related to startup, APU, and GSE are gathered as gate emissions. Stationary sources are gathered as point, areapoly, and volume emissions. Note that taxi emissions are gathered separately. Aircraft emissions are collected as grid emissions. After collecting all these emissions, the AERMOD .INP file is generated. AEDT does not generate runway-based labels for aircraft operations in the .INP file; instead aircraft operations have labels with “CUB” prefix.

6.12.3 AERMOD Hourly Input File for Background Concentrations

When creating metric results, the user may also specify background concentrations using hourly input files.

6.13 Running AERMOD

When running an emissions dispersion metric result, AEDT will automatically invoke AERMOD to generate the dispersion results for each receptor once the AERMOD input files are generated. Because AERMOD is a single-threaded application, it can take a considerable time to produce a year’s worth of emissions dispersion results.

AEDT produces all files necessary to run AERMOD in a single output directory for a pollutant. For example, `C:\AEDT\DATA\[User name]\[Study name]@[SQL Server Instance Name]\Output_Files\CO_J5`

directory is for the pollutant CO from Metric Result ID 5. Users can modify the AERMOD.INP in this directory and re-run AERMOD to get the desired output. For example, user can add CON outputs.

In addition to PLT files for the ALL source group, PLT files for each of the source groups in the AERMOD input file will be created. If background concentrations are enabled, the concentrations specified in those PLT files will also include background concentrations.

6.13.1 Emissions Dispersion Output Options

The following output options are set in the *Study* tab, *Preferences*, *Emissions Dispersion* screen: “Enable National Ambient Air Quality Standards” and “Output CON file”.

- “Enable National Ambient Air Quality Standards”: this option is selected by default. When this is selected, it will produce the PLT file for a pollutant using the “primary” standard by the EPA National Ambient Air Quality Standards (NAAQS, see <https://www.epa.gov/criteria-air-pollutants/naaqs-table>). When this option is not selected, it will produce the PLT files for each combination of NAAQS average time (1, 2, 3, 4, 6, 8, 12, 24, month, annual) and rank (1st through 6th) – up to a total of 55 depending on the duration of the metric result.
- “Output CON file”: when this option is selected, it will produce separate CON files for air operations, taxi operations, ground (runways) operations, gate (APU, GSE) operations, and stationary operations.

7. Ground Operations

This Section describes the multiple algorithms that combine to produce ground movements and emissions for aircraft operations. For the purposes of this section, ground movements refer to the sequenced movements performed by airplanes along the taxiway network. In AEDT, all helicopter taxi movements are from a heligate to a helipad (or vice versa). Helicopter taxi movements from a gate to a runway end (or vice versa) are not supported.

7.1 Airport Configurations

Airport configurations are used to more accurately model airport activities by preventing aircraft from erroneously landing and/or taking off with the wind direction. Each airport layout can be linked to a set of configurations. At least one configuration is required for an airport layout if that airport layout is exercised in a metric result for which sequence modeling is enabled. Airport configurations for a specific airport layout do not interact with those belonging to other airport layouts; therefore, dependencies between configurations of two different airport layouts within a given scenario cannot be modeled. The fidelity of the configuration modeling prevents accurate modeling of temporary configuration changes due to airport equipment outages or substantial precipitation (e.g., runway closure for snow removal) and is insensitive to air traffic control decisions.

Airport configurations are selected (or *activated*) based on hourly activation parameters values (i.e., wind speed, wind direction, hour of the day, ceiling, visibility and temperature). The hourly weather parameters from both hourly weather files (i.e., those necessary to run a dispersion analysis) and average airport weather are used to activate configurations for each hour of a metric result's timespan. For each hour in the timespan of a metric result, average airport weather is used whenever values from hourly weather files are not available. The active configuration can change only on the hour (with no more than 24 changes per day) due to the fact that hourly weather data is the highest temporal resolution available.

7.2 Configuration Activation Based on Activation Parameters

Airport configurations consist of the following six activation parameters:

- Wind Direction
- Wind Speed
- Hour-of-Day
- Cloud Ceiling
- Horizontal Visibility
- Temperature

For each hour, the configurations of an airport layout are evaluated, in order, starting with the first configuration until a configuration is found for which the current conditions meet its activation criteria. If such a configuration is found, it is designated the active configuration for the hour. If no configuration is found, then a configuration whose criteria most closely match the hourly conditions is selected. This method ensures that a configuration is selected for every hour; and thus, no flights are cancelled due to inclement weather.

When conditions for an hour do not meet the criteria of any configuration, configurations are matched using a metric that quantifies how distant the current conditions are from a configuration's criteria. Smaller values of this metric imply a better match (i.e., a "best fit"). Equation 7-1 and Equation 7-2 quantify criteria range and activation parameter distance, respectively, based on the two criteria bounds of a given activation parameter. If a bound is not specified for some configuration and activation parameter, then the respective extreme value is assumed to be the bound. Table 7-1 lists these extreme boundary values.

$$R_{ik} = U_{ik} - L_{ik} \quad \text{Eq. 7-1}$$

where

- R_{ik} The criteria range for configuration i of activation parameter k ;
 U_{ik} The upper bound for configuration i of activation parameter k ; and
 L_{ik} The lower bound for configuration i of activation parameter k .

$$D_{ijk} = \max\{|U_{ik} - V_{jk}|, |L_{ik} - V_{jk}|\} \quad \text{Eq. 7-2}$$

where

- D_{ijk} The distance of the value from the criteria for configuration i , hour j and activation parameter k ;
 U_{ik} The upper bound for configuration i of activation parameter k ;
 V_{jk} The value for hour j of activation parameter k ; and
 L_{ik} The lower bound for configuration i of activation parameter k .

Table 7-1 Assumed Extreme Values for Configuration Activation Parameters

Activation Parameter	Extreme Lower Bound	Extreme Upper Bound	Units
Wind Direction	0	359	Degrees
Wind Speed	0	100	Knots
Hour-of-Day	0	23	Hours
Ceiling	0	100,000	Feet
Visibility	0	100	Statute Miles
Temperature	-100	150	°F

Figure 7-1 is a graphic illustration of the relationships between the variables in Equation 7-1 and Equation 7-2.

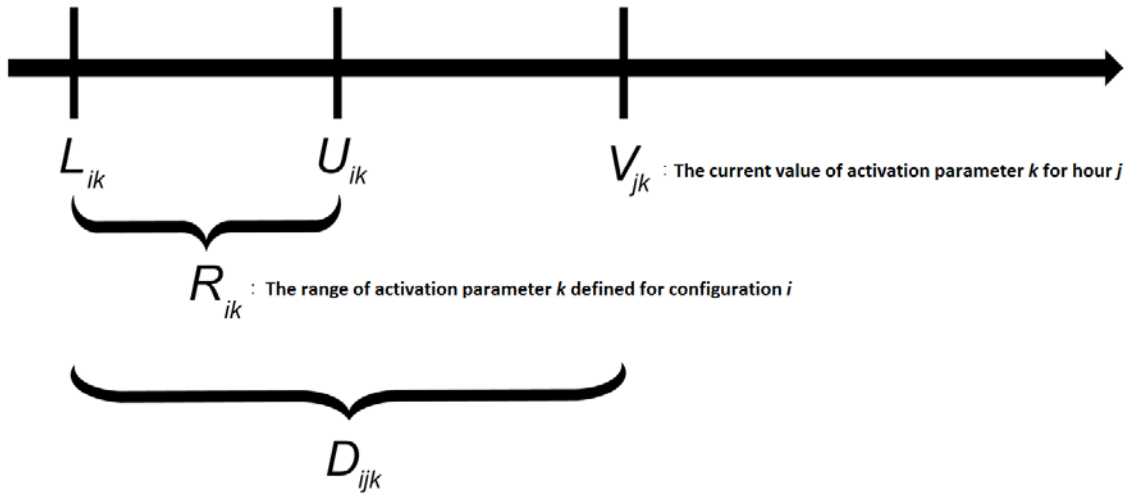

Figure 7-1 An Activation Parameter Value and its Criteria Range for Some Configuration and Hour

Equation 7-3 normalizes the distance D_{ijk} of Equation 7-2 by scaling it by the range R_{ik} of Equation 7-1. Note that by design, R_{ik} and D_{ijk} never take on negative values.

$$\delta_{ijk} = \begin{cases} \frac{D_{ijk}}{R_{ik}}, & 0 < R_{ik} < D_{ijk} \\ +\infty, & R_{ik} = 0 < D_{ijk} \\ 0, & 0 \leq D_{ijk} \leq R_{ik} \end{cases} \quad \text{Eq. 7-3}$$

where

- δ_{ijk} The normalized distance for configuration i , hour j , and activation parameter k ;
- D_{ijk} The pre-normalized distance of the value from the criteria for configuration i , hour j , and activation parameter k ; and
- R_{ik} The range for configuration i of activation parameter k .

Equation 7-4 computes the activation parameter metric by summing the normalized distances, δ_{ijk} , of Equation 7-3 over all activation parameters. The configuration with the smallest metric value for a given hour is designated the active configuration. Ties in metric value go to the configuration with higher priority (i.e., the one whose metric value was computed first). Algorithmically, for each hour j , an ordered list of configurations is evaluated until the first one whose index, \hat{i} , satisfies the condition $\hat{i} = \arg(\min_i(\delta_{ij}))$.

$$\delta_{ij} = \sum_k \delta_{ijk} \quad \text{Eq. 7-4}$$

where

δ_{ij} The activation parameter metric for configuration i and hour j ; and

δ_{ijk} The normalized distance for configuration i , hour j , and activation parameter k .

7.3 Taxiway Networks

The purpose of a taxi network is to provide a foundation for aircraft to perform temporally-sequenced ground movements. Furthermore, the taxi network provides the basis for localizing the emissions and constructing dispersion sources of these temporally-sequenced aircraft ground movements. A taxi network is composed of three physical airport layout components (gates, runways, and taxiways) as well as a relational one (taxipaths). Building a well-defined taxi network is necessary for metric results that intend on utilizing sequence modeling.

7.3.1 Taxi Network Elements and Terminology

Gates

Gates represent the starting location and ending destination for departure and arrival ground movements, respectively. The taxi network algorithm is flexible enough to interpret gates defined either as a single point or as a polygon composed of multiple points (i.e., terminal in AEDT). When resolving a taxi network for an airport layout, heligates are treated identically as regular gates.

Runways

The taxi network requires runways with two fully-defined runway ends. Without two fully-defined runway ends, it is impossible to determine the full extent of the runway. A runway end represents the ending destination of ground movements for departure operations. For arrival operations, a runway end represents the approximate start of runway ground-roll location.

Runway ends which are helipads are not considered suitable for taxi network analysis. Therefore, a runway with a child helipad runway end is not used by the taxi network algorithm.

Taxiways

Taxiways are physical components of an airport layout which aircraft use to move from a gate to a runway end and vice-versa. Each taxiway within an airport layout must be given a distinct name. A taxiway is defined by two or more points. Two consecutive points define a taxiway segment. Since each taxiway segment within a taxiway has a corresponding speed, users are allowed to define taxiways with speeds that vary by segment. Width is a property of the entire taxiway and is therefore constant across all segments.

One taxiway must not intersect another specific taxiway more than once. This rule is necessary in order to avoid ambiguity and is further described in Section 7.3.2.

Runway Exit

A runway exit represents the location on a runway (downstream of a runway end) at which a taxiway intersects the runway. A runway has as many runway exits as there are taxiways that intersect it.

Taxipaths

A taxipath is an ordered list of instructions which specify how to maneuver from a gate to a runway end (outbound taxipaths) or from a runway exit to a gate (inbound taxipaths). Users specify the ordered list of instructions as an ordered list of taxiways which they propose as a means to move from the start to the end of their taxipath. The taxi network algorithm transforms the ordered list of instructions (in the form of taxiways) into a concrete ordered list of geographical locations which an aircraft will actually follow from the start to the end location of the taxipath.

An outbound taxipath is strictly defined by the gate it where it begins, the ordered list of taxiways it traverses, and the runway end where it terminates. It is superfluous to define multiple outbound taxipaths that have the same gate/runway end pair, even if they differ in their ordered lists of taxiways. Downstream of the taxi network algorithm, the sequencing algorithm will select and assign to an air operation the first outbound taxipath it encounters that satisfies the gate/runway end pair of that air operation. The outbound taxipath selection for a particular gate/runway end pair is deterministic and will invariably reduce to the same selection each time one is requested.

In contrast, inbound taxipaths are defined by a runway exit (i.e., the taxiway used to get off the runway). Therefore, multiple inbound taxipaths with an identical runway end/gate pair but with different runway exits can be defined. The sequencing algorithm assigns an appropriate inbound taxipath at runtime based on the arrival operation's runway ground roll length.

When users create an air operation, they are responsible for assigning a gate to that air operation. For an air operation that is not expanded using operational profiles, it also becomes necessary to explicitly assign a runway end to that air operation. For an air operation that is expanded using operational profiles, runway end assignment is performed implicitly utilizing airport configurations.

Node Map

A node map is a list of all distinct calculated taxiway intersection points and user-defined taxiway points in a taxi network. User-defined points include the points that users provide to define physical taxi network elements (taxiways, runways, and gates). Calculated points include every point at which the three physical taxi network elements intersect. Each distinct point is transformed into a node.

Distinctness of the points refers to a feature of the taxi network algorithm which combines points that are near-enough to each other into a single node. The definition of nearness is context-specific and is further described in Section 7.3.2.8. Nodes have a unique integer ID and can be one of five types: Gate, Runway End, Runway Exit, Taxiway, or Intersection.

Network Link

A network link is a segment that joins two distinct nodes from the node map. Since movement from one node to another always represents movement along one taxiway segment, the network link will have a speed property equal to the taxiway segment it is moving over and a width property equal to the taxiway it is navigating.

Network Map

The network map integrates the taxipaths and node map of a taxi network and is therefore the ultimate result of the taxi network algorithm. A network map is generated by walking through each sequential pair of points in a taxipath and producing a pair of network links for that pair of points. The first network link produced represents movement from the first to the second point in the pair, while the second network link represents movement from the second point to the first. Therefore, the network map makes a connection for each pair of network nodes over which the user specifies movement (as laid down in their taxipath definitions).

7.3.2 Taxi Network Algorithm Overview

The following nine steps represent a high-level overview of the algorithm that constructs a taxi network. Each step of the taxi network algorithm is explained in the following sub-sections.

1. Load Taxi Network Elements;
2. Verify Connectivity of Taxi Network Elements;
3. Calculate Taxiway-Taxiway Intersections;
4. Calculate Taxiway-Runway Intersections;
5. Calculate Taxiway-Gate Intersections;
6. Insert Calculated Intersections into Taxiways;
7. Transform Taxipaths from Lists of Taxiways into Lists of Indices along Taxiways;
8. Generate a Node Map using User-Defined and Calculated Intersection Points; and
9. Generate a Network Map using Taxipaths and the Node Map.

7.3.2.1 Step 1 – Loading of Taxi Network Elements

Users must define at least one of each of the four taxi network elements in order to create a taxi network. If there are no members defined for any of the four elements, the Delay and Sequencing Model cannot be processed.

Gates: Both gates and heligates within an airport layout will be loaded and treated identically by the algorithm. Heligates must be excluded from the airport layout if they are not intended to be used in the resolution of the taxi network. All subsequent descriptions of the algorithm will simply refer to the gates and heligates in an airport layout as “gates”. However, this term can refer to both gates and heligates.

Runways: All runways within an airport layout will be loaded. Runways without two opposite, fully-defined runway ends will be excluded from analysis by the taxi network. A runway with one or both runway ends that are helipads will be entirely excluded from the taxi network.

Taxiways: All taxiways within an airport layout will be loaded.

Taxipaths: All taxipaths within an airport layout will be loaded.

7.3.2.2 Step 2 – Verification of Taxi Network Element Connectivity

Once the taxi network elements have been loaded, the next step is to verify the integrity of the taxiways and taxipaths. For taxiways, this comprises a check to make sure that no two taxiways excessively

intersect each other. For taxipaths, this involves an examination to ensure that the sequential members of a taxipath intersect one another.

7.3.2.2.1 Taxiway Connectivity

Each segment of each taxiway is compared against the segments that constitute every other taxiway. This is done in order to determine the number of times that one taxiway intersects another.

As an example, consider the comparison of segment q of taxiway Q and segment r of taxiway R. This comparison is presented in Figure 7-2. Segment q is defined by two endpoints (End 1 and End 2). Segment r is defined by its own endpoints (End 1 and End 2). Taxiways Q and R have their own widths (w_q and w_r , respectively). These widths correspond to the widths of the taxiways segments.

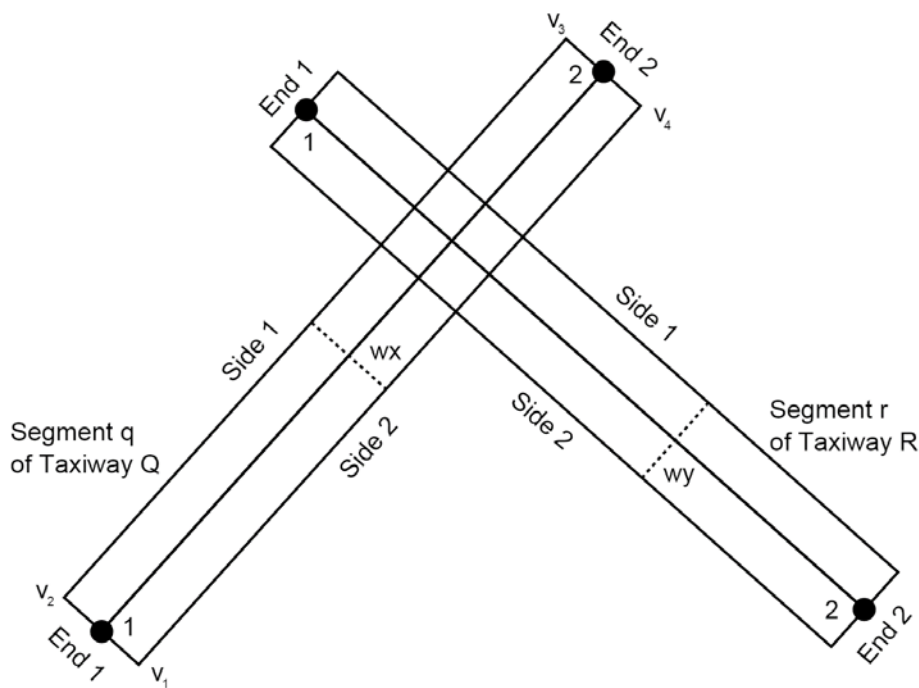

Figure 7-2 Intersection of Two Taxiway Segments (q and r)

The locations of the endpoints of the two segments (excluding altitude), combined with the widths of these two segments, are used to define the physical rectangle over which the segments extend. This is done by using Figure 7-2 to determine a unit vector normal to the straight line segment defined by a segment’s endpoints. The following equation presents the unit normal 2-D vector of a line defined by two points (x_1, y_1) and (x_2, y_2) .

$$\langle x_n, y_n \rangle = \left\langle \frac{(y_2 - y_1)}{\sqrt{(x_2 - x_1)^2 + (y_2 - y_1)^2}}, -\frac{(x_2 - x_1)}{\sqrt{(x_2 - x_1)^2 + (y_2 - y_1)^2}} \right\rangle \tag{Eq. 7-1}$$

The four vertices (v_1, v_2, v_3, v_4) that define the rectangular segment are presented in Eq. 7-2.

$$\begin{aligned}
 v_1(x, y) &= \left(x_1 + x_n \frac{w}{2}, y_1 + y_n \frac{w}{2}\right) \\
 v_2(x, y) &= \left(x_1 - x_n \frac{w}{2}, y_1 - y_n \frac{w}{2}\right) \\
 v_3(x, y) &= \left(x_2 + x_n \frac{w}{2}, y_2 + y_n \frac{w}{2}\right) \\
 v_4(x, y) &= \left(x_2 - x_n \frac{w}{2}, y_2 - y_n \frac{w}{2}\right)
 \end{aligned}
 \tag{Eq. 7-2}$$

where

w The width of a taxiway segment.

Each side of the rectangle is defined based on the vertices that make up its endpoint. The sides are defined as the following:

- End 1 is made by vertices 1 and 2;
- Side 1 is made by vertices 2 and 3;
- End 2 is made by vertices 3 and 4; and
- Side 2 is made by vertices 4 and 1.

Each side and end of a taxiway segment is then compared against each side and end of the other taxiway segment. If any of the eight combinations of sides and ends intersect, the two distinct taxiways are deemed to intersect.

AEDT must determine a potential intersection point $p(x, y)$ of one line defined by endpoints $p_1 = (x_1, y_1)$ and $p_2 = (x_2, y_2)$ and another line defined by endpoints $p_3 = (x_3, y_3)$ and $p_4 = (x_4, y_4)$. Equations in Eq. 7-3 are employed in this effort.

$$\begin{aligned}
 a_{1,2} &= y_2 - y_1 & a_{3,4} &= y_4 - y_3 \\
 b_{1,2} &= x_1 - x_2 & b_{3,4} &= x_3 - x_4 \\
 c_{1,2} &= x_2 y_1 - x_1 y_2 & c_{3,4} &= x_4 y_3 - x_3 y_4
 \end{aligned}$$

$$\alpha = \begin{bmatrix} a_{1,2} \\ a_{3,4} \\ b_{1,2} \\ b_{3,4} \end{bmatrix} = \begin{bmatrix} \alpha_1 \\ \alpha_2 \\ \alpha_3 \\ \alpha_4 \end{bmatrix} \qquad \beta = \begin{bmatrix} b_{3,4} \\ -a_{3,4} \\ -b_{1,2} \\ a_{1,2} \end{bmatrix} = \begin{bmatrix} \beta_1 \\ \beta_2 \\ \beta_3 \\ \beta_4 \end{bmatrix}
 \tag{Eq. 7-3}$$

$$\det(\alpha) = a_{1,2} b_{3,4} - b_{1,2} a_{3,4}$$

$$p(x, y) = \left(\frac{-\beta_1 c_{1,2} - \beta_3 c_{3,4}}{\det(\alpha)}, \frac{-\beta_2 c_{1,2} - \beta_4 c_{3,4}}{\det(\alpha)} \right)$$

The example presented in Figure 7-2 demonstrates this concept. There are four distinct points at which the two rectangular segments coincide. Since there is at least one point of coincidence, taxiways Q and

R are considered to intersect at segments q and r. Figure 7-3 shows a slightly different geometrical setup of the example taxiway segments presented in Figure 7-2. The straight line segments defined by the taxiway segments' endpoints do not intersect, but their rectangular representations do in fact intersect at two distinct locations. Therefore, these two modified representations of segments q and r also establish an intersection between taxiways Q and R.

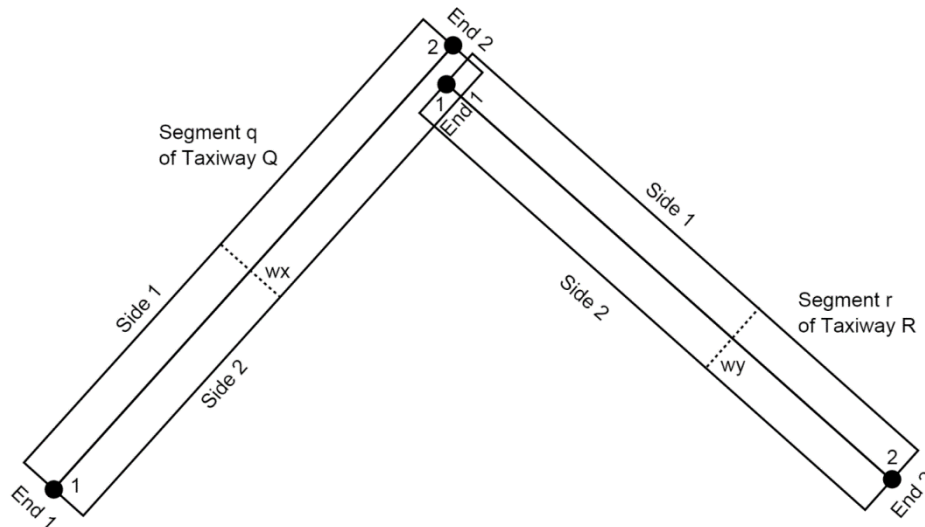

Figure 7-3 Modified Rectangular Representation of Two Taxiway Segments (q and r)

A taxiway pair that intersects more than two times counts as an intersection error. If a taxi network analysis for an airport layout accumulates three such intersection errors, the resultant taxi network is deemed to be excessively erroneous. It should be noted that the determination that a taxi network is excessively erroneous does not stop the corresponding metric result. It merely prompts an error message which suggests a review of the definitions of the taxiways.

A single taxiway pair that intersects more than ten times counts as a single intersection error, but the resultant taxi network is immediately deemed excessively erroneous.

7.3.2.2.2 Taxipath Connectivity

The integrity of each taxipath in the network is tested. The inspection is slightly different for outbound and inbound taxipaths.

For an outbound taxipath, the following checks are performed:

- The taxipath's gate intersects the first member taxiway of the taxipath;
- Each sequential pair of member taxiways intersect one another; and
- The parent runway of the taxipath's runway end intersects the last member taxiway of the taxipath.

For an inbound taxipath, the following checks are performed:

- The parent runway of the taxipath's runway end intersects the first member taxiway of the taxipath;
- Each sequential pair of member taxiways intersect one another; and
- The taxipath's gate intersects the last member taxiway of the taxipath.

If a taxipath does not satisfy any of the checks performed in its inspection, the taxipath will be removed from subsequent steps in the taxi network analysis.

7.3.2.2.2.1 Taxiway-Taxiway Connectivity in Taxipaths

The determination of whether each sequential pair of member taxiways intersect one another is performed by analyzing the taxiway segments of each sequential pair of member taxiways in the same manner described in the preceding section. If any sequential pair of member taxiways does not intersect, the corresponding taxipath is marked for exclusion in the subsequent taxi network analysis.

7.3.2.2.2.2 Taxiway-Runway Connectivity in Taxipaths

The determination of whether the last taxiway (for outbound taxipaths) or the first taxiway (for inbound taxipaths) intersects the appropriate runway is also performed using the algorithm presented in the preceding section. The only difference is that taxiway segments are compared against a single runway (instead of against another taxiway's segments). The runway is defined as a rectangular segment with the taxipath's runway end serving as one endpoint and the opposite runway end serving as the other endpoint.

7.3.2.2.2.3 Taxiway-Gate Connectivity in Taxipaths

The determination of whether the first taxiway (for outbound taxipaths) or the last taxiway (for inbound taxipaths) intersects the taxipath's gate is performed in one of two ways depending on whether the gate is a point or a polygon.

Figure 7-4 demonstrates a taxiway segment intersection with a polygon gate. The routine used in Section 7.3.2.2.1 Taxiway Connectivity is utilized to determine if any of the sides/ends of the taxiway segment intersect any of the sides of the polygon gate. AEDT starts with End 1 of the taxiway segment and compares that end to each of the sides of the polygon (starting with the segment from polygon point 1 to polygon point 2). Side 1 of the taxiway segment is then compared against the sides of the polygon. All sides and ends of the taxiway segment are examined until it is determined that an intersection does indeed exist. For the geometry presented in Figure 7-4, this would occur on the sixth iteration when Side 1 of the taxiway segment is compared against the polygon gate segment from point 2 to point 3.

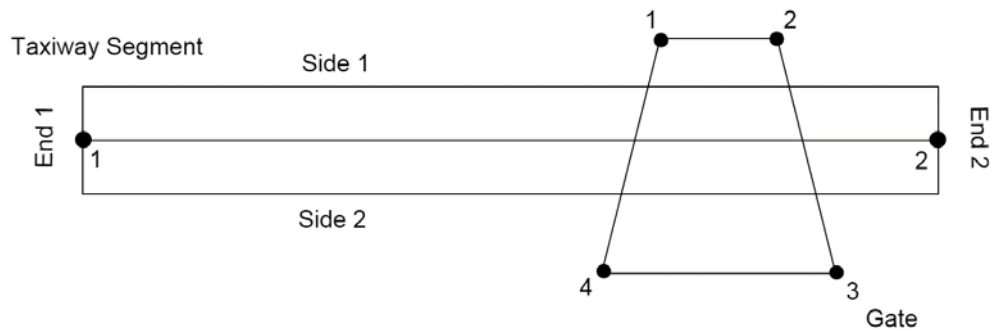

Figure 7-4 Taxiway Segment Intersection with a Polygon Gate

For gates defined by a single point, a different method is used to determine whether they intersect with a taxiway segment. Figure 7-5 shows a point gate (p) in the vicinity of a line segment defined by the endpoints (p_1 and p_2) of a taxiway segment. The relative position of the projected point p_n along the segment is denoted f . A point gate is determined to intersect a taxiway segment if it is within the rectangle defined by the taxiway segment's endpoints and width. This determination is performed by geometrically projecting the gate point (p) onto the line segment defined by the taxiway segment's endpoints (p_1 and p_2). The projected point is denoted p_n . Relative position (denoted by the symbol f) represents how far the projected point p_n is along the segment from p_1 to p_2 . A relative position of zero means that p_n is exactly perpendicular to p_1 . A relative position of unity means that p_n is exactly perpendicular to p_2 . Relative positions less than 0 or greater than 1 are interpreted to mean that the projected point lies outside of the segment from p_1 to p_2 . Relative position can be determined by computing the dot product of the vectors from p_1 to p and p_1 to p_2 , and dividing this result by the square of the magnitude of the vector from p_1 to p_2 (Eq. 7-4).

$$f = \frac{(p - p_1) \cdot (p_2 - p_1)}{|p_2 - p_1|^2} = \frac{(x - x_1)(x_2 - x_1) + (y - y_1)(y_2 - y_1)}{(x_2 - x_1)^2 + (y_2 - y_1)^2} \quad \text{Eq. 7-4}$$

The coordinates of the projected point are then determined using Eq. 7-5. This equation calculates Cartesian coordinates of a projected point p_n given relative position along two endpoints.

$$p_n(x_n, y_n) = (x_1 + f(x_2 - x_1), y_1 + f(y_2 - y_1)) \quad \text{Eq. 7-5}$$

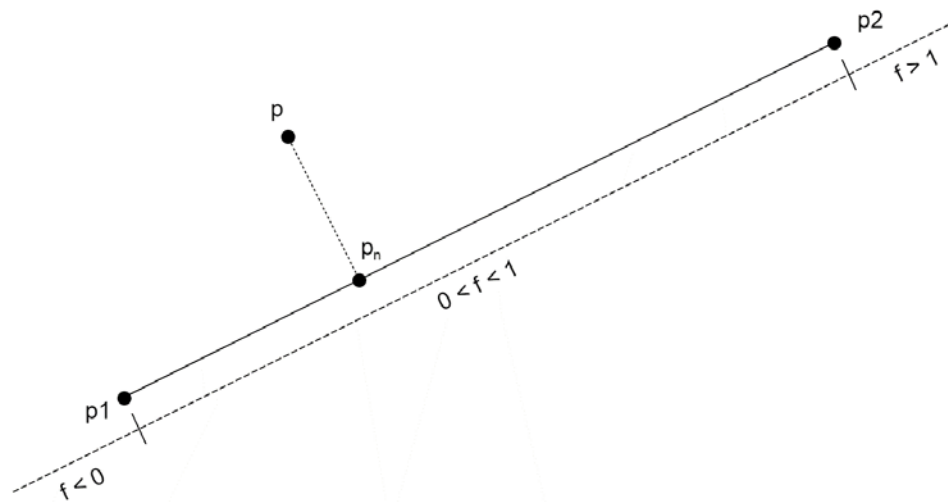

Figure 7-5 Projection of a Point p onto a Line Segment Defined by Endpoints p1 and p2

Depending on the value of the relative position determined from Eq. 7-4, the value of p_n determined from Eq. 7-5 may be reassigned. The reassigned values of p_n are summarized in Table 7-2.

Table 7-2 Reassigned Values of Projected Point p_n

Relative Position	p_n is set to:
$f < 0$	p_1
$0 \leq f \leq 1$	p_n
$f > 1$	p_2

If the distance between the reassigned value of p_n and the point gate is less than or equal to the width of the taxiway segment, the point gate is deemed to be within the taxiway segment and is considered to intersect.

7.3.2.3 Step 3 – Calculation of Taxiway-Taxiway Intersections

Taxiway intersections are calculated by comparing each combination of taxiways in the airport layout. Each pair of taxiways that actually intersect will produce two taxiway-taxiway intersection points; one point is where the first item in the pair intersects the second and the other point is where the second item intersects the first.

For illustrative purposes, take the example taxiways Q and R shown in Figure 7-6, each composed of one taxiway segment. When determining the location where taxiway R intersects taxiway Q, the intersections of the sides/ends of the two taxiways are ranked. The first-occurring side/end intersection in the following list will be used as the basis for determining the definitive location of the intersection of taxiway Q by taxiway R.

- Side 1 of Taxiway Q: Side 2, End 2, Side 1, End 1 (of Taxiway R)
- Side 2 of Taxiway Q: Side 2, End 2, Side 1, End 1 (of Taxiway R)
- End 1 of Taxiway Q: Side 2, End 2, Side 1, End 1 (of Taxiway R)
- End 2 of Taxiway Q: Side 2, End 2, Side 1, End 1 (of Taxiway R)

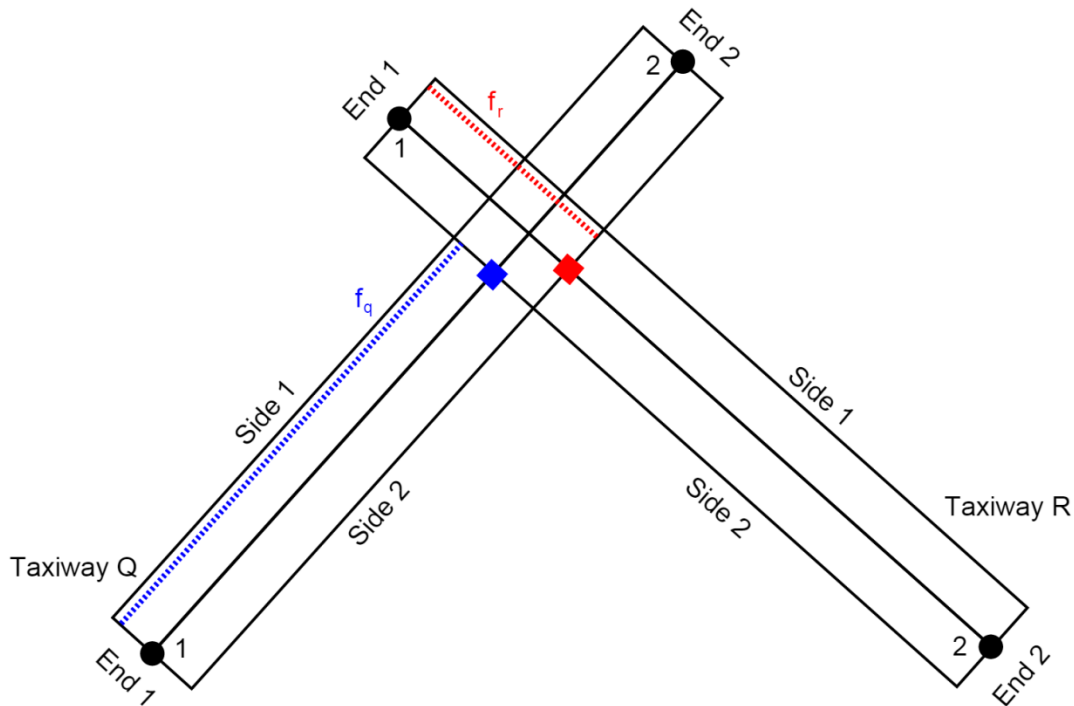

Figure 7-6 Intersection of Two Taxiways

The first pair in the list to occur is the intersection of side 1 of taxiway Q and side 2 of taxiway R. The location of the intersection of side 1 of taxiway Q and side 2 of taxiway R is then projected (using Eq. 7-4 and Eq. 7-5) onto the mid-line of taxiway Q. This point is shown as a blue square in Figure 7-6. The point is at a relative position of f_q on taxiway Q.

AEDT also determines the intersection of taxiway R by taxiway Q. Switching the references of the two taxiways in the order-of-precedence list leads to the conclusion that the location of the intersection of side 1 of taxiway R and side 2 of taxiway Q is used as the basis for the intersection of taxiway R by taxiway Q. The intersection location is projected onto taxiway R and is considered to be the location where taxiway Q intersects taxiway R. This point is shown as a red square in Figure 7-6. It occurs at a relative position of f_r along taxiway R.

Thus, each taxiway-taxiway intersection yields two intersection points. One intersection point is the relative position along the first taxiway at which the first taxiway is intersected by the second taxiway. The other taxiway intersection point is the relative position along the second taxiway at which the second taxiway is intersected by the first taxiway.

At this point-in-time in the algorithm, the definitions of taxiways only include user-defined points. The intent of calculating taxiway-taxiway intersection points is to potentially add the calculated intersection points to the definitions of the taxiways on which they occur. If a calculated intersection point's location is greater than one meter away from the user-defined points of the taxiway on which that calculated intersection point occurs, then the calculated intersection is added to a list of points (referred to as "Insert Points") which will be added to the definitions of the taxiways later on (section 7.3.2.6).

In the current example, taxiway Q consists of two (user-defined) points, point 1 and point 2. If the calculated intersection of taxiway Q by taxiway R (shown in blue in Figure 7-6) is greater than one meter away from both of the two user-defined points, it will be added to the Insert Points list. Insert Points will in turn be used later to add the blue intersection point into the definition of taxiway Q. Taxiway Q will then consist of three points, which, in order, are: point 1, blue point, point 2. A similar action will be performed on taxiway R. Taxiway R will consist of its own point 1, red point, and its own point 2.

Additionally, the locations of each corresponding pair of taxiway-taxiway intersections are added to a separate list of pairs of points referred to as "Identical Points". Pairs of points are only added to "Identical Points" if the two points in the pair are greater than 10^{-6} meters in distance from each other. The intent of Identical Points is to create a list of related taxiway-taxiway intersection locations for later use. Identical Points are pairs of points which are physically distinct, but are nonetheless functionally related. In practice, Identical Points can be tens of meters away from each other. Using the example presented in Figure 5, an entry of the form <location of blue point, location of red point> and another of the form <location of blue point, location of red point> are added to Identical Points for the intersection of Taxiways Q and R.

Furthermore, the taxi network analysis stores a list of taxiway-taxiway intersects. These intersects are stored in the form <Taxiway 1, Taxiway 2, Location 1, Location 2>. Location 1 is the location where Taxiway 2 intersects Taxiway 1 and Location 2 is the location where Taxiway 1 intersects Taxiway 2. For the example shown in Figure 7-6, taxiway-taxiway intersects will contain two entries <Q, R, location of blue point, location of red point> and <R, Q, location of red point, location of blue point>. This list is useful in quickly determining the exact location where one taxiway intersects another.

7.3.2.4 Step 4 – Calculation of Taxiway-Runway Intersections

The geographic point where runways of the airport layout intersect taxiways is determined by comparing each runway against each taxiway.

The determination of taxiway-runway intersections is performed in an analogous manner as the calculation of taxiway-taxiway intersections. The main difference is that one of the rectangular taxiway segments is replaced by a rectangular runway defined by two opposite runway ends serving as endpoints and a width equal to the runway's width. Figure 7-7 shows a basic schematic of the intersection of a runway (defined by a runway end and its opposite runway end) and a taxiway segment.

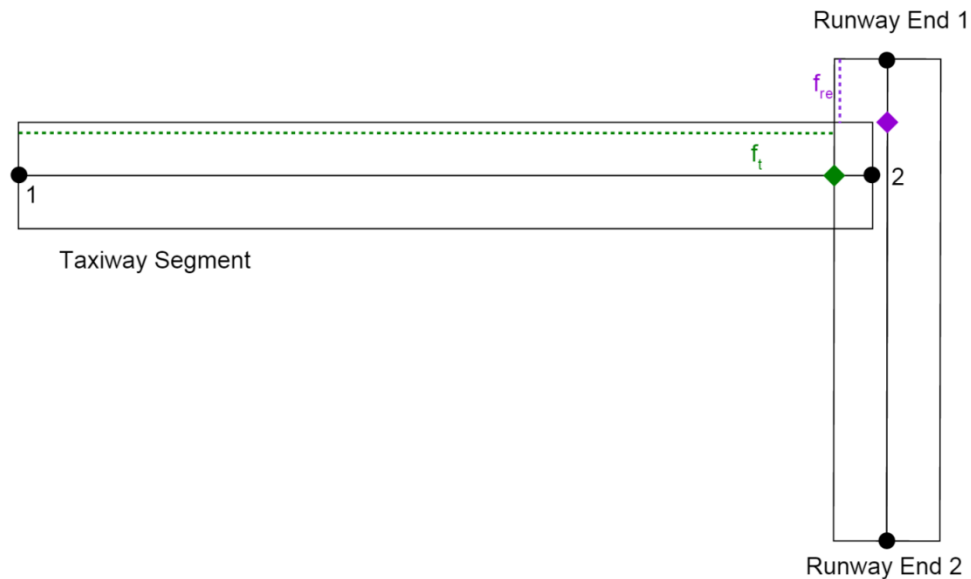

Figure 7-7 Taxiway-Runway Intersection

By applying the intersection order-of-precedence rules previously outlined (section 7.3.2.3), the runway intersects the taxiway segment at the green point in Figure 7-7. The intersection is at a relative position f_t along the taxiway. This intersection position is added to the Insert Points for the taxiway.

The purple point is the location where the taxiway intersects the runway. It occurs at a relative position f_{re} along the runway. This location is not added to Insert Points since Insert Points contains only locations where taxiways are intersected.

For each taxiway, the taxiway-runway intersections are calculated by constructing a runway using the opposite runway end of each runway end defined in the airport layout. Each intersection calculation is therefore performed twice.

For the geometry defined in Figure 7-7, the intersection point shown in green will result in the same location for the taxiway-runway intersect calculation that uses runway end 2 as the initial position of the runway. Thus, the second, identical taxiway-runway intersect will be added to Insert Points.

The taxi network analysis also maintains a list of taxiway-runway intersects. These intersects are stored in the form <Taxiway, Runway End, Taxiway Intersection Location, Taxiway Intersection Location>. For the example presented in Figure 7-7, two entries will be added: <Taxiway, Runway End 1, location of green point, location of green point > and <Taxiway, Runway End 2, location of green point, location of green point>.

7.3.2.5 Step 5 – Calculation of Taxiway-Gate Intersections

This step compares each gate in the airport layout against each taxiway in the same airport layout to determine the locations where taxiways are intersected by gates.

The intersection of gates with taxiways was introduced in Section 7.3.2.2.3. The polygon gate geometry presented in Figure 7-4 is presented once again in Figure 7-8.

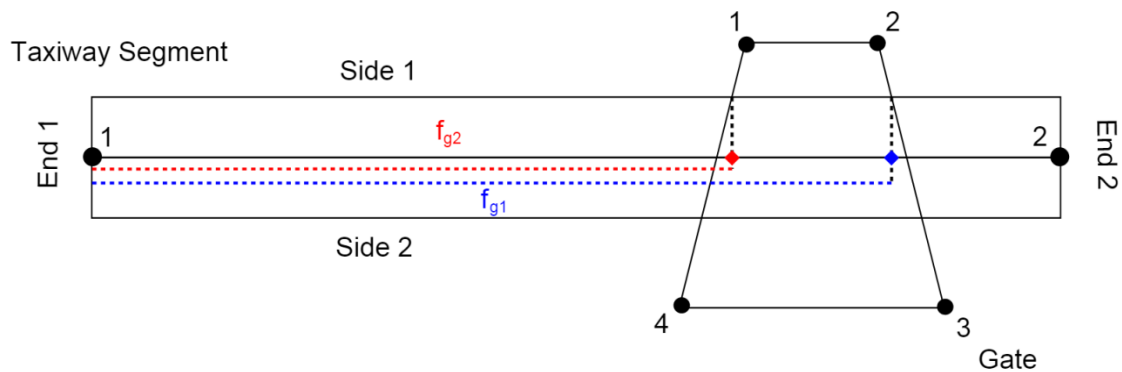

Figure 7-8 Taxiway-Gate Intersections

In order to determine the location where a gate intersects a taxiway segment, each side of a polygon gate is resolved as a rectangular segment of zero width. Thus, the same routine used in analyzing taxiway-taxiway and taxiway-runway intersections can be utilized to determine taxiway-gate intersections. Each polygon side is then compared against a taxiway segment. Using the example in Figure 7-8 and the order-of-precedence rules, one intersection is determined to occur at side 1 of the taxiway segment and the segment defined from point 2 to point 3 of the gate. Another intersection is determined to occur at side 1 of the taxiway segment and the gate segment from point 4 to point 1. Those two intersection points are projected onto the taxiway and occur at relative positions f_{g1} and f_{g2} , respectively. Both of these relative positions are added to the taxi network's Insert Points corresponding to the parent taxiway of the taxiway segment.

Similarly for taxiway-taxiway and taxiway-runway intersects, the taxi network analysis maintains a list of taxiway-gate intersects which are stored in the form <Taxiway, Gate, Taxiway Intersection Location, Taxiway Intersection Location>. For the example presented in Figure 7-8, two entries will be added to the taxiway-gate intersect list: <Taxiway, Gate, location of red point, location of red point> and <Taxiway, Gate, location of blue point, location of blue point>.

7.3.2.6 Step 6 – Insertion of Calculated Intersections into Taxiways

For each taxiway in the airport layout, this step inserts points into the definition of a taxiway where that taxiway was intersected by other taxiways, runways, and gates.

At this point taxiway-taxiway, taxiway-runway, and taxiway-gate intersections have been determined. Each taxiway in the taxi network contains entries in the Insert Points list of where it was intersected by other taxiways, runways, and gates. For each taxiway, intersection locations in Insert Points are stored in terms of relative position along that taxiway.

A simple taxi network is presented in Figure 7-9. This taxi network contains four taxiways (A, B, C, and D), one polygon gate, and one runway (defined by runway ends 1 and 2). Figure 7-9 shows points defined by the user.

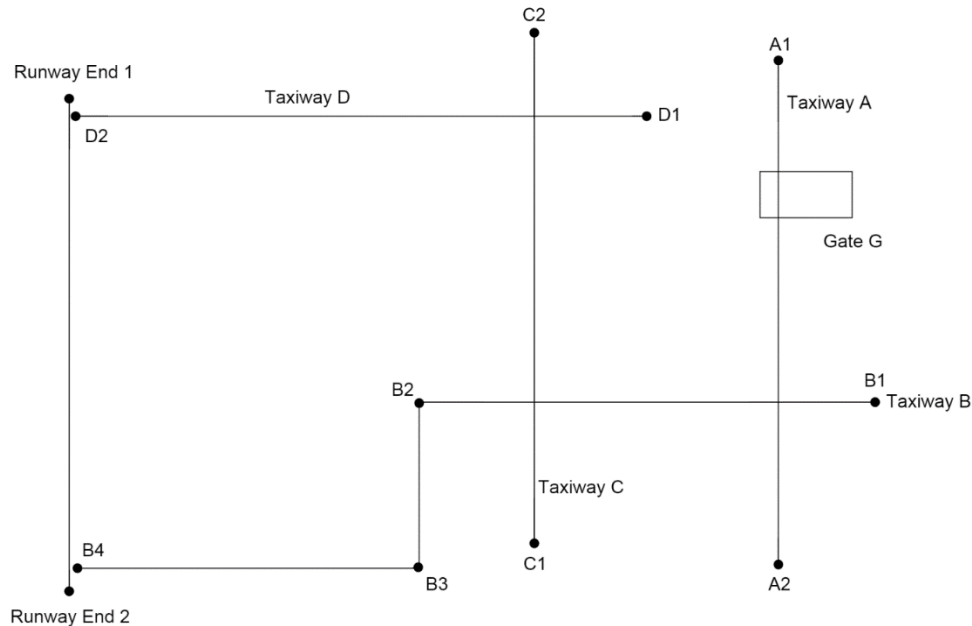

Figure 7-9 Simple Taxi Network

Before step 6 of the taxi network algorithm, taxiway definitions consist solely of the user-defined points shown in Figure 7-9. Thus, Taxiway A is defined by {A1, A2}, Taxiway B by {B1, B2, B3, B4}, etc. Figure 7-10 shows the taxiways intersection points as determined by steps 3, 4, and 5 of the taxi network algorithm.

Table Table 7-3 through Table Table 7-7 show the byproducts calculated by steps 3, 4, and 5. Table 7-6 is used to redefine the definitions of the taxi network's taxiways. Each Insert Point in Table 7-6 is inserted into the definition of its corresponding taxiway under the condition that the relative position (f) of the Insert Point being added to the taxiway is 10^{-6} greater than that of the previous point in the taxiway.

Assuming that each relative position (f) in Table 7-6 is 10^{-6} greater than the relative position of the taxiway location after which it would be placed, the new definitions of the taxiways in the example taxi network would be: {A1, GA1, GA2, AB, A2} for Taxiway A, {B1, BA, BC, B2, B3, RB, B4} for Taxiway B, {C1, CB, CD, C2} for Taxiway C, and {D1, DC, RD, D2} for Taxiway D.

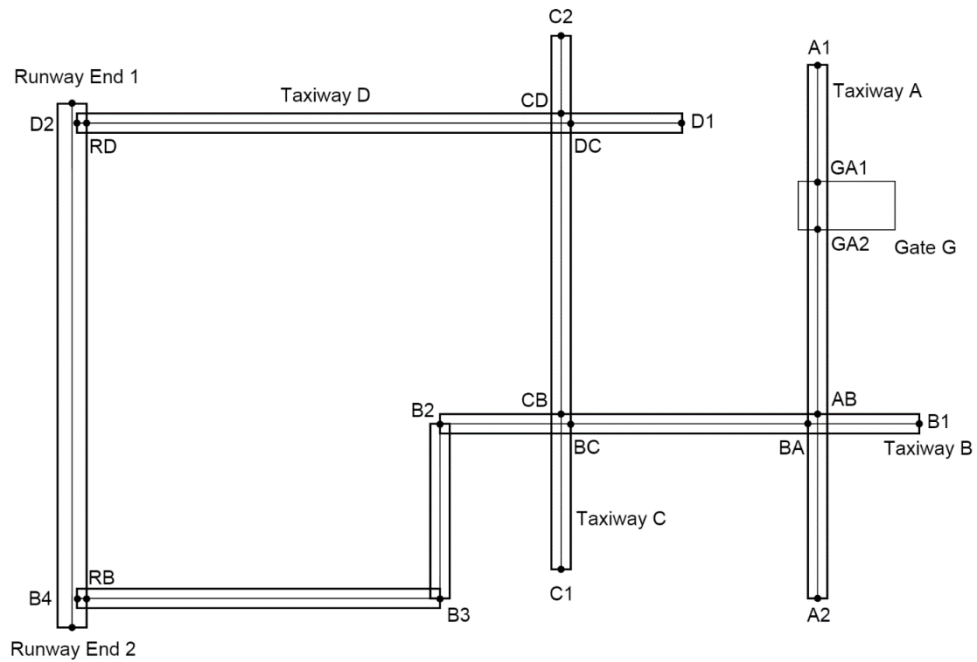

Figure 7-10 Simple Taxi Network with Intersection Points

Taxiway-Taxiway Intersections are labeled XY, where XY represents where Taxiway X is intersected by Taxiway Y. An assumption is made that each pair of taxiway-taxiway intersection points are greater than 1 meter in distance from each other.

Table 7-3 Taxiway-Taxiway Intersections Calculated for the Taxi Network Shown in Figure 7-9 and Figure 7-10

Taxiway 1	Taxiway 2	Location 1	Location 2
A	B	AB	BA
B	A	BA	AB
B	C	BC	CB
C	B	CB	BC
C	D	CD	DC
D	C	DC	CD

Table 7-4 Taxiway-Runway Intersections Calculated for the Taxi Network Shown in Figure 7-9 and Figure 7-10

Taxiway	Runway End	Intersection Location
B	Runway End 1	RB
B	Runway End 2	RB
D	Runway End 1	RD
D	Runway End 2	RD

Table 7-5 Taxiway-Gate Intersections Calculated for the Taxi Network Shown in Figure 7-9 and Figure 7-10

Taxiway	Gate	Intersection Location
A	G	GA1
A	G	GA2

Table 7-6 Insert Points for Each Taxiway in the Taxi Network Shown in Figure 7-9 and Figure 7-10

Taxiway	Relative Position on Taxiway	Location on Taxiway
A	GA1	GA1
A	GA2	GA2
A	AB	AB
B	BA	BA
B	BC	BC
B	RB	RB
C	CB	CB
C	CD	CD
D	DC	DC
D	RD	RD

Table 7-7 Identical Points for Each Taxiway in the Taxi Network Shown in Figure 7-9 and Figure 7-10

Location 1	Location 2
AB	BA
BA	AB
BC	CB
CB	BC
CD	DC
DC	CD

7.3.2.7 Step 7 – Transformation of Taxipaths

This step translates the definitions of all taxipaths in the airport layout from user-defined ordered lists of taxiways into lists of indices along the user-specified taxiways. In this context, index refers to the position of an item within a memory structure. For Taxiway A presented in the previous section, point A1 occurs at index 0, point GA1 at index 1, etc.

To aid in the description of this step, imagine an outbound taxipath from Gate G to Runway End 1 as a list of taxiways: {A, B, C, D} in the taxi network shown in Figure 7-9.

7.3.2.7.1 Determine Taxiway-Taxiway Intersections

Taxiway indices are determined where the taxipath switches from one taxiway to another. For the example taxipath, this will consist of determining the index of the position of taxiway A at which it is crossed by Taxiway B as well as the index of the position of Taxiway B at which it is crossed by Taxiway

A. Similar determinations are performed for the switch from Taxiway B to Taxiway C and for the switch from Taxiway C to Taxiway D.

The task of finding the taxiway indices for a taxiway switch is performed by searching through the taxiway-taxiway intersections determined in step 3 until the single intersection that corresponds to the taxiway that is being switched from (Taxiway 1 in taxiway-taxiway intersections) to the taxiway that is being switched to (Taxiway 2 in taxiway-taxiway intersections) is found. Next, the positions in the definition of Taxiway 1 are searched until a position in Taxiway 1 is found that is within 1 meter of location 1 in the corresponding taxiway-taxiway intersection. The index of that position in Taxiway 1 is the index of Taxiway 1 at which a switch will occur to Taxiway 2. Afterwards, the positions in the definition of Taxiway 2 are searched until a position in Taxiway 2 is found that is within 1 meter of location 2 in the corresponding taxiway-taxiway intersection. That position's index in Taxiway 2 is the index of Taxiway 2 at which a switch occurred from Taxiway 1 of the taxiway-taxiway intersection.

After the index-finding routine is applied to each of the three taxiway switches in the example taxipath, the taxipath's corresponding ordered list of taxiway indices will resemble what is shown in Table 7-8.

Table 7-8 Taxiway Indices for the new definition of the example taxipath; So far, only switches from one taxiway to the next are conveyed in the new taxipath definition

Taxiway	Index of Taxiway
A	3
B	1
B	2
C	1
C	2
D	1

The taxipath's corresponding ordered list of taxiway indices only contains taxiway indices corresponding to switches from one taxiway to another.

7.3.2.7.2 Determine Taxiway-Gate Intersections

The index of the taxiway location at which the appropriate taxiway intersects the taxipath's gate is determined, accounting for whether a taxipath is inbound or outbound. For outbound taxipaths, the appropriate taxiway is the first taxiway in the user-defined taxiway list. For inbound taxipaths, the appropriate taxiway is the last one defined in the taxiway list.

Once the appropriate taxiway is determined, a search is done to find all taxiway-gate intersections whose taxiway corresponds to the appropriate taxiway and whose gate corresponds to the taxipath's gate. In the event that the search returns multiple candidates, AEDT simply selects the first candidate as the taxiway-gate intersection.

Once the taxiway-gate intersection has been selected, the location of that taxiway-gate intersection is compared against the positions of the appropriate taxiway. The index of the first position of the

appropriate taxiway to be less than 1 meter away from the location of the intersection is considered the index of the appropriate taxiway at which that taxiway intersects a gate.

For outbound taxipaths, this index is added as the initial entry to the new definition of the taxipath. For inbound taxipaths, this index is added as the final entry to the new definition of the taxipath.

In the example taxipath, the first taxiway in the user-defined taxipath is Taxiway A. This taxiway is expected to intersect the taxipath's gate (Gate G). A search through taxi network's taxiway-gate intersections returns both entries in Table 7-5 as being taxiway-gate intersection candidates. The first item is selected as the appropriate taxiway-gate intersection. The positions of Taxiway A are searched until the position that is within 1 meter of the appropriate taxiway-gate intersection is found. The index of that position (index 1) is then added as the initial entry of the new taxipath definition. The result is shown in Table 7-9.

Table 7-9 Taxiway Indices for the new definition of the example taxipath; so far, the definition contains the switch from the gate to the first taxiway and switches from one taxiway to the next

Taxiway	Index of Taxiway
A	1
A	3
B	1
B	2
C	1
C	2
D	1

7.3.2.7.3 Determine Taxiway-Runway Intersections

The index of the position of the appropriate taxiway that intersects the taxipath's runway is determined, accounting for whether a taxipath is inbound or outbound. For outbound taxipaths, the appropriate taxiway is the last taxiway of the taxipath's user-defined ordered taxiway list, while for inbound taxipaths it is the first such item.

A search is performed in the a taxi network's taxiway-runway intersections whose taxiway is the same as the taxipath's appropriate taxiway and whose runway end is either the taxipath's runway end or the runway end opposite of the taxipath's runway end. For the first candidate taxiway-runway intersection, a search is performed on the appropriate taxiway for the position on that taxiway which is within 1 meter of the location of the candidate taxiway-runway intersection. The distance of that taxiway position to the candidate taxiway-runway intersection's runway end is calculated. A similar treatment is performed on all other candidate taxiway-runway intersections. The taxiway-runway intersection candidate with the least distance from its corresponding runway end to the taxiway-runway intersection location is selected as the actual taxiway-runway intersection.

The example taxipath's runway end is Runway End 1 and its last taxiway is Taxiway D. The runway end opposite to Runway End 1 is Runway End 2. Therefore, all elements in taxiway-runway intersections

whose taxiway is equal to Taxiway D and whose runway end is equal to either Runway End 1 or Runway End 2 are selected. These selections correspond to the last two items of Table . Both of these candidate taxiway-runway intersections have locations that correspond to point RD. A search is performed on Taxiway D for the position on Taxiway D that is less than 1 meter away from the location of the first candidate taxiway-runway intersection (point RD). A search is also performed on Taxiway D for the position on Taxiway D that is less than 1 meter away from the location of the second candidate taxiway-runway intersection. The distance from the selected position on Taxiway D to Runway End 1 is less than the distance from the selected position on Taxiway D to Runway End 2. Therefore, the taxiway-runway intersection with Taxiway D and Runway End 1 is selected as the taxiway-runway intersection for the taxipath. The index of the selected position of Taxiway D that was less than 1 meter away from the Taxiway D / Runway End 1 intersection is then added to the new taxipath definition. The result is shown in Table 7-10.

Table 7-10 Taxiway Indices for the new definition of the example taxipath; So far, the definition contains the switch from the gate to the first taxiway, switches from one taxiway to the next, and the switch from the last taxiway to the runway

Taxiway	Index of Taxiway
A	1
A	3
B	1
B	2
C	1
C	2
D	1
D	2

7.3.2.7.4 Fill in Intermediate Taxiway Indices

Missing intermediate taxiway indices for each redefined taxipath are computed.

Thus far, each redefined taxipath consists of taxiway indices corresponding to:

- The taxiway position at which the taxipath's gate intersects the first taxiway in the taxipath (for outbound taxipaths) or the last taxiway (for inbound taxipaths);
- The taxiway positions at which the taxipath switches from one taxiway to the subsequent taxiway; and
- The taxiway position at which the runway defined by the taxipath's runway end intersects the last taxiway in the taxipath (for outbound taxipaths) or the first taxiway (for inbound taxipaths).

The redefined taxipath should contain two contiguous entries for each taxiway in its original (user-defined) definition. If the indices for each pair of same-taxiway entries are not continuous, additional entries are added to the redefined taxipath in order to make the indices of same-taxiway entries

continuous. This is necessary because movement from one taxiway index to another arbitrary taxiway index requires movement through all intermediary taxiway indices.

Continuing with the example taxipath, it becomes evident that movement along Taxiway A jumps from the taxiway position at index 1 to the one at index 3. An entry is added in between these two entries corresponding to index 2 of Taxiway A. Movement along Taxiways B, C, and D are already continuous and therefore no additional entries are necessary for these taxiways. The result is shown in Table 7-11.

Table 7-11 Taxiway Indices for the new definition of the example taxipath; the definition now contains the taxiway indices for movement along the entire taxipath (from gate to each taxiway to the runway)

Taxiway	Index of Taxiway
A	1
A	2
A	3
B	1
B	2
C	1
C	2
D	1
D	2

7.3.2.8 Step 8 – Generation of Node Map

A centralized, simplified list of user-defined taxiway points and the three types of taxiway intersection points is created. Simplification of these points is achieved by combining all points that are near enough to taxiway-taxiway intersection into a single point. The simplified, potentially-fused taxiway points are referred to as nodes. Each node has a unique integer identification number (ID).

Node map generation is a two-staged process. The first stage is to create a distinct node for each taxiway point (which at this point in time can be one of the following types: user-defined, taxiway-taxiway intersection, taxiway-runway intersection, or taxiway-gate intersection) that is greater than 1 meter away from a taxiway-taxiway intersection (as defined in the “Identical Points” container introduced in step 3 of the algorithm). The first stage will create a distinct node for each user-defined taxiway point, taxiway-runway intersection, and taxiway-gate intersection that is greater than 1 meter away from a taxiway-taxiway intersection. Taxiway-taxiway intersections are excluded since they cannot, by definition, be more than a meter away from a taxiway-taxiway intersection. The second stage of the process is to create a single, distinct node for taxiway points that occur within 1 meter of either point in an entry in the Identical Points container. Distinct nodes are created by reducing each single taxiway-taxiway intersection to a single location. Additionally, user-defined taxiway points, taxiway-runway intersections, taxiway-gate intersections, and even other taxiway-taxiway intersections that are within 1 meter of a taxiway-taxiway intersection are combined using the single location of this taxiway-taxiway intersection.

The node map generation process is performed by evaluating all taxiway positions of each taxiway in the airport layout's taxi network. For each taxiway position, a search is performed on each entry of Identical Points:

- If there is no entry in Identical Points which is within 1 meter of the taxiway position currently being inspected, a node is created corresponding to this taxiway position. If no node in the node map is within 10^{-3} meters of this newly-created node, the newly created node is added to the node map.
- If there is an entry in Identical Points which is within 1 meter of the taxiway position being inspected, simply move on to the next taxiway position.

At the conclusion of this first inspection of all taxiway positions, the node map will consist of unique nodes that correspond to user-defined taxiway points, taxiway-runway intersections, and taxiway-gate intersections that are greater than 1 meter away from an Identical Point (taxiway-taxiway intersection) entry. All nodes generated by this step are marked as being "Taxiway" nodes (later portions of the algorithm will mark some of these nodes as being of a more appropriate type).

Continuing with the example taxi network layout presented in Figure 7-10, the conclusion of the first taxiway position inspection will yield a node map with 14 entries. The IDs and locations of these nodes are presented in Table 7-12. The nodes in Table 7-12 only capture taxiway positions that are user-defined, runway intersections, and gate intersections.

Table 7-12 Nodes generated after the first pass over all taxiway positions for the taxi network layout presented in Figure 7-10

Node ID	Location
0	A1
1	GA1
2	GA2
3	A2
4	B1
5	B2
6	B3
7	RB
8	B4
9	C1
10	C2
11	D1
12	RD
13	D2

Additionally, each taxiway in the taxi network generates a node ID list. The node ID list for each taxiway contains the same amount of entries as there are positions in that taxiway. The intent of this list is to create a mapping that relates each taxiway position to its corresponding node's ID number. So far, only

taxiway positions within 10^{-3} meters of an existing node have a corresponding node ID. Taxiway positions which are not yet tied to a node do not have a corresponding node ID.

The node ID lists for each of the taxiways of the layout presented in Figure 7-10 are:

- Taxiway A: [0, 1, 2, Invalid, 3]
- Taxiway B: [4, Invalid, Invalid, 5, 6, 7, 8]
- Taxiway C: [9, Invalid, Invalid, 10]
- Taxiway D: [11, Invalid, 12, 13]

Positions marked invalid correspond to positions for which a corresponding node has yet to be created.

For each taxiway position without a corresponding node, a search is performed on each entry of Identical Points until an entry in this latter list is found which is 1 meter or less in distance to the taxiway position being inspected:

- If there is no already-existing node in the node map which is within 1 meter of either location of that makes up the selected Identical Point, create a new node and add it to the node map. Add a reference to this newly-created node in the corresponding taxiway's node ID list.
- If there is an already-existing node in the node map which is within 1 meter of either location that makes up the selected Identical Point, there is no need to create a new node. Simply add a reference to the already-existing node in the corresponding taxiway's node ID list.

When all taxiway positions have been evaluated, the node map will contain unique nodes that correspond to taxiway points that are greater than 1 meter away from taxiway-taxiway intersections (generated in the first stage) and unique nodes that correspond to simplified versions of taxiway-taxiway intersections. All nodes generated in this second step are marked as being "Intersection" nodes.

Table 7-13 presents the additional nodes that are generated.

Table 7-13 Additional nodes generated after the second pass over all taxiway positions in the taxi network layout presented in Figure 7-10

Node ID	Location
14	AB (not BA)
15	BC (not CB)
16	CD (not DC)

The node ID lists of each taxiway in the example taxi network layout are:

- Taxiway A: [0, 1, 2, 14, 3]
- Taxiway B: [4, 14, 15, 5, 6, 7, 8]
- Taxiway C: [9, 15, 16, 10]
- Taxiway D: [11, 16, 12, 13]

7.3.2.9 Step 9 – Generation of Network Map

The network map is a list of segments that represent movement from one node to another. Segments will only be generated for movements that are expected to occur. Expectation of occurrence is based on the user-defined taxipaths of the airport layout.

7.3.2.9.1 Network Link Generation

Each taxiway-index version of each taxipath (see Table 7-11 for an example) is evaluated. A network link is created for the movement from the first taxiway index to the second, another network link is created for the movement from the second taxiway index to the third, and so on. Network links are also generated for reverse movements (i.e., second taxiway index to the first, third taxiway index to the second, etc.). Network links are rectangular segments whose areas serve as the basis for emissions dispersion modeling. Therefore, the outcomes of the generation of network links are propagated beyond the taxi network analysis.

Table 7-14 shows the taxiway indices for the example outbound taxipath that moves from Gate G to Runway End 1, as well as the nodes that correspond to each taxiway index. It should be noted that switches from one taxiway to another correspond to a switch from one node to the same node.

Table 7-14 Taxiway Indices of the example outbound taxipath (Gate G -> Runway End 1) along with the node IDs corresponding to each taxiway index

Taxiway	Index of Taxiway	Node ID
A	1	1
A	2	2
A	3	14
B	1	14
B	2	15
C	1	15
C	2	16
D	1	16
D	2	12

Network links are generated by evaluating the entries in the taxiway-index version of the taxipath being processed. The first entry corresponds to either a gate location (for outbound taxipaths) or a runway end/exit (for inbound taxipaths). The node corresponding to the first entry for outbound taxipaths has its type changed to “Gate”. For inbound taxipaths, the first node entry of a taxipath is either marked as “Runway End” or “Runway Exit”. If the distance from the node to the taxipath’s runway end is greater than one-and-a-half times the corresponding runway width, the node is marked as a “Runway Exit”. Otherwise, it occurs sufficiently near the taxipath’s runway end and is therefore marked as a “Runway End”.

For subsequent nodes in the taxiway-index version of the taxipath, a network link is generated which captures movement from the previous node to the current node. The properties of the network link (link width and link speed) are based off of the taxiway position corresponding to the current node (and

not the previous node). Network links have an additional property called queue capacity, which represents the amount of aircraft (regardless of actual aircraft size) that the link can support. Queue capacity is equal to the ceiling of the link length divided by 150 ft. Each network link will have the capacity to support at least one aircraft. A second network link which captures movement from the current node to the previous node is also generated. The properties of this second link are identical to the properties of the network link that captured movement from the previous node to the current node.

The first network link generated for the example taxipath will represent movement from node 1 to node 2. The width of this link will correspond to the width of Taxiway A. The speed of this link will correspond to the taxiway speed of the first taxiway position in Taxiway A whose node ID list entry is equal to 2. This reduces to the speed of the third taxiway position element for Taxiway A. The length of the link is set to the distance between the locations of node 1 to node 2. All previous steps of the taxi network algorithm used two-dimensional locations by neglecting the altitude property of airport layout elements. When determining network link length, the full three-dimensional coordinates of the nodes are used. A second network link that represents movement from node 2 to node 1 is generated and added to the network map. The properties of this second link are identical to the properties of the link from node 1 to node 2.

The node corresponding to the last entry in the taxiway-index version of the taxipath requires further processing. This last node represents either a gate location (for inbound taxipaths) or a runway end/exit (for outbound taxipaths).

7.3.2.9.2 Network Path Generation

The final manifestation of a taxipath is referred to as a network path. Among several other properties, network paths contain an ordered list of nodes (a path) that correspond to movement of the corresponding taxipath along the taxi network. The path of the example taxipath is shown in Table 7-15. The repeated node IDs in Table 7-14 are not repeated in the path shown in Table 7-15.

Table 7-15 Network Path Version of the Example Taxipath

Node ID
1
2
14
15
16
12

A network path contains several properties (gate, runway end, and opposite runway end) which correspond to the taxipath that it was created from. It also contains the additional properties of exit distance, exit angle, and maximum exit speed. These three latter properties are only valid for inbound network paths and are left undefined for outbound network paths. These properties are defined with the aid of Figure 7-11.

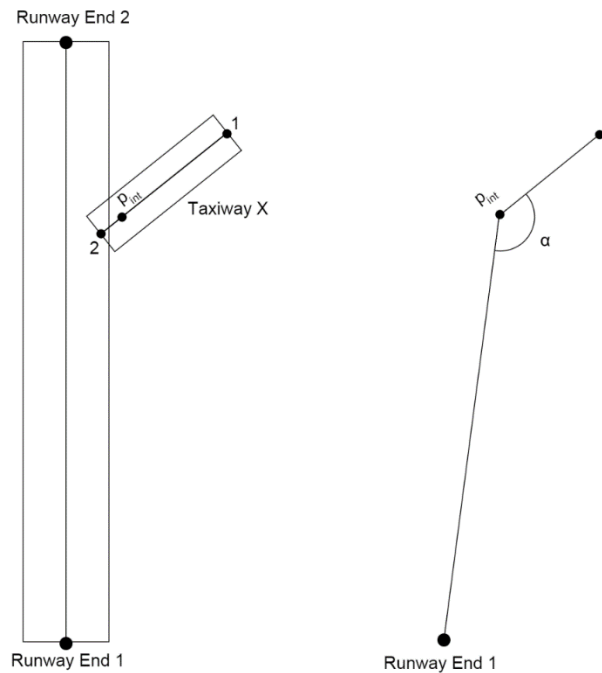

Figure 7-11 Inbound Network Path Exit Property Definitions

For an inbound network path that lands on Runway End 1 and exits the runway using Taxiway X in Figure 7-11, the first node in the network path will correspond to the intersection of Taxiway X and the runway (p_{int}). Assuming that the second node of the inbound path is point 1 in Figure 7-11, the inbound path properties are defined as follows:

Exit Distance – The two-dimensional (excluding altitude) distance from Runway End 1 to p_{int} .

Exit Angle – The counter-clockwise angle subtended by the segment running from Runway End 1 to point 1 at p_{int} . In other words, it is the counter-clockwise angle running from the ray defined by p_{int} and Runway End 1 to the ray defined by p_{int} and point 1. Eq. 7-6 is used to determine the angle by setting Runway End 1 as point a, p_{int} as point b, and point 1 as point c.

$$\alpha = \tan^{-1} \left(\frac{(x_a - x_b)(y_c - y_b) - (y_a - y_b)(x_c - x_b)}{(x_a - x_b)(x_c - x_b) + (y_a - y_b)(y_c - y_b)} \right) \quad \text{Eq. 7-6}$$

Maximum Exit Speed – The maximum exit speed of a network path is defined as the speed of the link that corresponds to movement from the first to second node in the network path. This corresponds to the network link whose endpoints are p_{int} and point 1.

When multiple inbound taxipaths are defined for a single runway end/gate combination, the three exit properties are used as the basis for selection of a network path in the sequencing algorithm for an arrival air operation with that same specific runway-end/gate combination.

7.4 Air Operation Scheduling

AEDT allows users to specify air operations for which ground movements will be computed in one of two ways:

1. **Operational-Profile Operations:** A single air operation is used to specify a larger number of operations (in annual total) which are expanded using operational profiles. The operation time for each operation is computed by AEDT.
2. **Explicit Operations:** Each air operation is explicitly specified by the user. The operation time for each operation is provided by the user.

The delay-and-sequencing algorithm processes sets of air operations one day at a time. A day is defined as a full, 24-hour calendar date. All air operations occurring within one day are grouped together. Each such grouping is referred to as a schedule.

Air operations defined using operational profiles require further processing that will assign operation times and runway ends to each expanded operation. The intermediate state in which the air operations that make up a schedule are not fully defined is referred to as a pseudo-schedule. AEDT assigns these values using pseudorandom processes. Operation times are generated using operational profiles. An expanded operation's operation time is randomly distributed within the quarter-hour it occurred in. Runway ends are assigned using the probability distributions provided in the active airport configuration for the hour-of-day in which each respective expanded air operation occurs. While operation times and runway end assignments are randomized, the random algorithm seed value is preserved so that the results are repeatable. The following sections describe the procedure used to resolve a pseudo-schedule into a fully-defined schedule.

7.4.1 Pseudorandom Number Generation

AEDT generates the pseudorandom numbers necessary for computing operation times and runway end assignments by employing the `rand()` and `srand()` functions defined in the `rand.c` file of Microsoft's Visual Studio 6 implementation of the standard C language library. The algorithm is a linear congruential generator (LCG) described by Eq. 7-7 which produces integer values between 0 and 32,767, inclusive. A seed value of 50 was chosen arbitrarily.

$$r_i = \left\lfloor \frac{(214,013)r_{i+1} + (2,531,011)}{2^{16}} \right\rfloor \text{mod}(2^{15}) \text{ for } i = 1, 2, 3, \dots \quad \text{Eq. 7-7}$$

where

r_i	The i^{th} pseudorandom number generated;
r_0	The seed value, 50;
$\lfloor x \rfloor$	The floor of x , the largest integer less than or equal to x ; and
$m \text{ mod}(n)$	The remainder from the division of integer m by integer n .

To yield pseudorandom floating point numbers between two given floating point bounds, a and b , inclusive, Eq. 7-8 is used.

$$R = a + (b - a) \left(\frac{r}{2^{15} - 1} \right) \quad \text{Eq. 7-8}$$

where

- R The scaled pseudorandom number;
- a The lower bound, a floating point number;
- b The upper bound, a floating point number; and
- r A new random number obtained from Eq. 7-7.

7.4.2 Pseudo-schedule Generation

This Section outlines the process used to generate a pseudo-schedule for air operations using operational profiles. Pseudo-schedules are generated one day at a time. It is essential to keep track of the total number of operations flown on all previous days for each aircraft throughout the process to ensure that the total number of operations for each aircraft during the analysis year of the metric result equals the values specified for each air operation by the user. The following outline describes the step-by-step process used to generate a pseudo-schedule.

1. Delete all flight operations from the pseudo-schedule for the current day.
2. Let f_a be the number of operations of type p for air operation a that are carried over from the previous day. This is equal to zero for the first day.
3. Determine the month m and day of the week d for the current day of the analysis year using the Gregorian calendar.
4. For each air operation a ,
 - a) For each quarter-hour q of the current day,
 - a.1. Let $n_{m,d,q,a}$ be the number of operations flown by air operation a during a quarter-hour q (see Eq. 7-9).
 - b) Let T_a equal the sum $\sum_{q=1}^{96} n_{m,d,q,a}$.
 - c) For each quarter-hour q of the current day,
 - c.1. Multiply $n_{m,d,q,a}$ by $\left(1 + \frac{f_a}{T_a}\right)$.
 - d) For each quarter-hour q of the current day,
 - d.1. Let $f_a = 0$.
 - d.2. Insert $\lfloor n_{m,d,q,a} \rfloor$ operations into the schedule to occur during q .
 - d.3. Increment f_a by the fraction $(n_{m,d,q,a} - \lfloor n_{m,d,q,a} \rfloor)$.
 - d.4. Subtract $\lfloor n_{m,d,q,a} \rfloor$ from $n_{m,d,q,a}$, leaving the fraction only.
 - e) For each integer 1 through $\lfloor f_a \rfloor$, inclusive,
 - e.1. Generate a random number, r , from a uniform distribution between 0 and $f_a - \lfloor f_a \rfloor$, inclusive, using the pseudorandom algorithm of Eq. 7-8.
 - e.2. Let q be the first quarter-hour such that $r \leq \sum_{i=1}^q n_{m,d,q,a}$.
 - e.3. Insert one operation into the schedule to occur during q .

- f) Subtract $\lfloor f_a \rfloor$ from f_a , leaving the fraction only.
- g) Generate a random number, r , from a uniform distribution between 10^{-6} and 1, inclusive, using the pseudorandom algorithm of Eq. 7-8.
- h) If $r \leq f_a$,
 - h.1. Generate a random number, r , from a uniform distribution between 0 and $f_a - \lfloor f_a \rfloor$, inclusive, using the pseudorandom algorithm of Eq. 7-8.
 - h.2. Let q be the first quarter-hour such that $r \leq \sum_{i=1}^q n_{m,d,q,a}$
 - h.3. Insert one operation into the schedule to occur during q .
 - h.4. Subtract 1 from f_a which could make f_a negative, but $-1 < f_a < 1$.

The number of air operations in a given quarter-hour is calculated using the equation:

$$n_{m,d,q,a} = n_{peak,a} w_{m,a} w_{d,a} w_{q,a} \quad \text{Eq. 7-9}$$

where

- $n_{m,d,q,a}$ The number of operations flown by air operation a during quarter-hour q on day d in month m ;
- $n_{peak,a}$ The peak number of operations flown by air operation a during any quarter-hour;
- $w_{m,a}$ The weight for month m of the operational profiles assigned to air operation a ;
- $w_{d,a}$ The weight for day d of the operational profiles assigned to air operation a ; and
- $w_{q,a}$ The weight for quarter-hour q of the operational profiles assigned to air operation a .

7.4.3 Schedule Generation

Once all air operations for a specific day have been gathered into a fully-defined schedule, delay-and-sequencing calculations are performed in two distinct steps:

1. The delay model, Worldwide Logistics Management Institute Network Queuing Model (WWLMINET), is used to determine, for each air operation, a (one-hour) time bin when the operation is released as well as several average delay times acquired during each (one-hour) time bin. These average delay times are outputs from WWLMINET (denoted as the Delay Model in Figure 7-12). Figure 7-12).
2. The sequencing model distributes departures and arrivals to manage the state of different queues along the network links generated by the taxi network analysis (denoted as the Sequencing Model in Figure 7-12). This model is used to determine, for each air operation, exact time instances when it reaches each node in the taxi network along its taxipath. Having assigned a gate–runway pair to an air operation is a prerequisite for a taxipath assignment.

Four distinct data sets are used to model airside aircraft movements: (see Figure 7-12)

- The air operations in a schedule;
- Results of a taxi network analysis;
- Airport configurations; and
- Weather data (either hourly-weather data or average airport weather).

For each air operation, WWLMINET determines the hourly bin in which the operation is released. This is performed by running the air operations within each hourly time bin through WWLMINET, one hour at a time. WWLMINET takes into account airport configurations (how the facility is operated and its capacity) and weather conditions in doing so. Under busy airport conditions, the hourly time bin at which an air operation is determined to occur by WWLMINET can be temporally later than the hourly bin originally requested by that air operation. Under such a situation, the air operation is considered to be delayed.

Air operations are then distributed along taxipaths and runways in space and time. A detailed description of the sequencing model is provided in Section 7.6.

The process depicted in Figure 7-12 produces two distinct types of results: airport-level and operation-level results. In addition to potentially shifting operations from one hourly time bin to a later one, WWLMINET produces summed totals for the amount of delay accrued by all air arrival and departure air operations within an hourly time bin in a schedule. These delay results can be considered airport-level results since they apply to all air operations tied to a particular airport. The sequencing model produces operation-level results. Each air operation which has taxipath assigned will move along nodes defined by the taxi network from its corresponding gate to runway-end (or vice-versa). The sequencing model will calculate the time stamps at which each air operation traversed the nodes that define its corresponding taxipath.

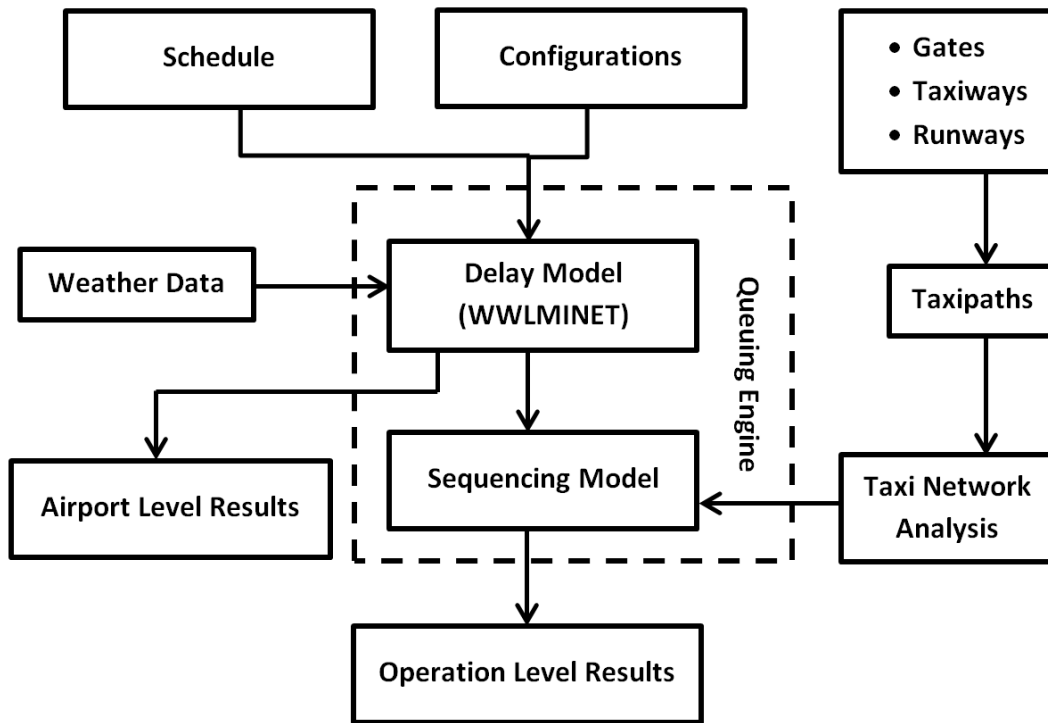

Figure 7-12 Data Flow of the Delay-and-Sequencing (Queuing) Algorithm

7.5 Delay Model

Airport delay is modeled by using the WWLMINET model. WWLMINET produces delay results by using the queuing network shown in Figure 7-13.

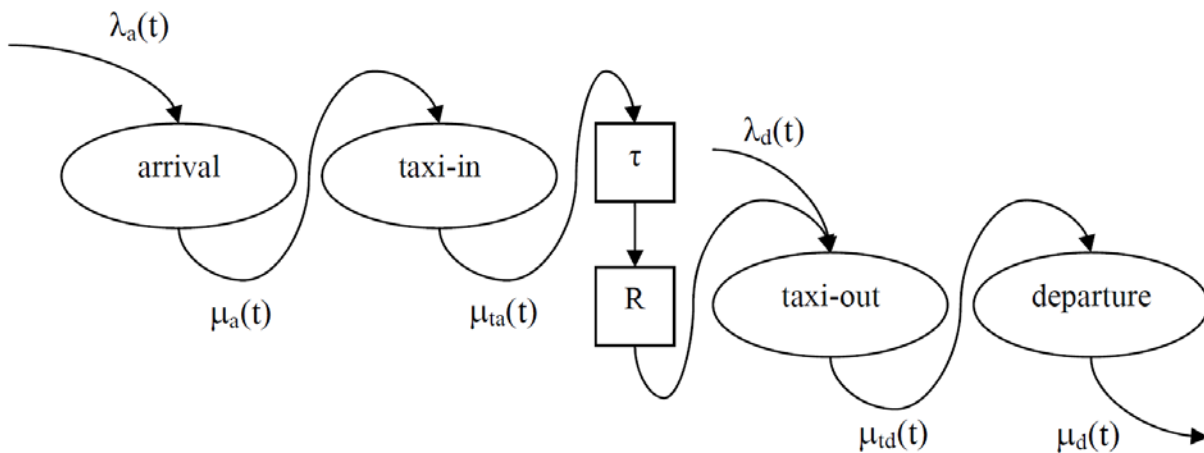

Figure 7-13 Airside Queuing Model within WWLMINET

Two queuing processes are depicted in Figure 7-13: one for arrivals and another for departures. The arrival and departure processes are not independent, and a departure may be released only if there is

an available air operation in the reservoir (R). Arriving air operations enter the arrival queue as Poisson process with parameter $\lambda_a(t)$. After being processed by the arrival server, an arriving air operation enters the taxi-in queue. Upon processing by the taxi-in server, arriving air operations are delayed for a service time (τ) and released into the reservoir (R).

Departing air operations are processed by two servers as well. The departure process is driven by not only a Poisson process with parameter $\lambda_d(t)$, but also the state of the reservoir (R). The reservoir balances the total number of arrivals and departures over time. After being processed by the taxi-out server, departure air operations enter the departure queue and, after processing, are released.

Arrival and departure servers may be modeled as M/M/1 or M/Ek/1^{xxix} queues. Taxi times (both taxi-in and taxi-out) may be modeled as M/M/1 queues only. Arrival $\lambda_a(t)$ and departure $\lambda_d(t)$ demands are determined directly from the schedule. The arrival and departure service rates are determined by taking into account the appropriate airport capacity Pareto frontier (Figure 7-14) based on the hourly surface weather observations.

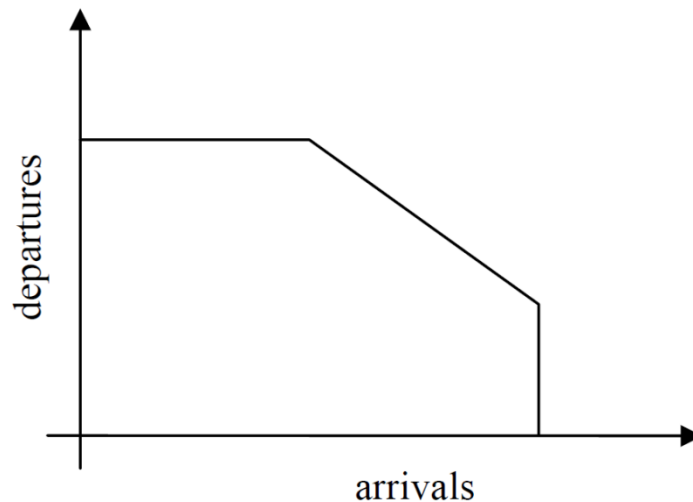

Figure 7-14 Airport Configuration Capacity Pareto Frontier

WWLMINET has a limited ability to handle taxi-in and taxi-out queuing. The model allows taxi-in and taxi-out capacities to be considered as constant values over time only.

^{xxix} The A/B/c queuing system notation (Kendall's notation) provides characteristics of the arrival process (A), the service process (B), and the number of servers (c). The codes used for A and B are: M – "Markovian" characterized, among the others, with exponential distribution of inter-arrival or service times, Ek – Erlang distributed inter-arrival or service times.

Eq. 7-10 presents the average amount of time arrival and departure operations (within a single hourly-time bin) spend performing taxi movements and the delay sustained performing those movements. The total taxi time for a single air operation can be defined to be the following:

- The duration it takes to move unimpeded along the taxiways;
- The amount of time it sits idly (without moving) along the taxiways; and
- The amount of time it sits idly at a runway end (for departures) or the airborne delay it incurs (for arrivals).

Thus, for each hourly time bin within a daily schedule, the average taxi-in and taxi-out times presented in Eq. 7-10 are the sums of the three quantities identified above divided by the amount of air operations that contributed to those sums. WWLMINET does not return taxi delay times nor airborne/runway delay times for each air operation. It merely returns the summed total for all operations within an hourly time bin. Consequently, the best approximation for the taxi delay and airborne/runway delay for a single air operation is the summed quantity returned by WWLMINET divided by the amount of air operations that went into producing that summed quantity.

The delay model allows arrival and departure operations to taxi in and out unimpeded by not applying the average taxi-in/taxi-out delay times and the average airborne/runway delay times computed by WWLMINET. The delay model may delay air operations from one hourly time bin to the next as determined by WWLMINET but does not apply other forms of delay also computed by WWLMINET.

$$\begin{aligned}\overline{t_a(t)} &= \overline{t_{u,in}} + \overline{t_{in}(t)} + \overline{t_{ad}(t)} \\ \overline{t_d(t)} &= \overline{t_{u,out}} + \overline{t_{out}(t)} + \overline{t_{dd}(t)}\end{aligned}\quad \text{Eq. 7-10}$$

where

$\overline{t_a(t)}, \overline{t_d(t)}$	The average taxi-in and taxi-out times, respectively;
$\overline{t_{u,in}}, \overline{t_{u,out}}$	The average unimpeded taxi-in and taxi-out times, respectively;
$\overline{t_{in}(t)}, \overline{t_{out}(t)}$	The average taxi-in and taxi-out delay times, respectively; and
$\overline{t_{ad}(t)}, \overline{t_{dd}(t)}$	The average airborne delay and runway delay, respectively.

7.6 Sequencing Model

The sequencing model distributes air operations along taxipaths and runways in space and time. The outcome is further used to distribute aircraft based emissions along taxipaths, runways and approach/departure segments.

The operation time provided in a schedule is considered to be push-back time for departures and touch-down time for arrivals. Furthermore, WWLMINET ultimately determines the hourly time bin when the operation is released. The i^{th} operation cannot be released before time t_i^{ready} given by Eq. 7-11. The actual time instances when operations are released depend on the state of the queues and availability of the runways. These are ultimately determined by the sequencing model.

$$t_i^{ready} = \begin{cases} \max(t_i, t_i^{WWLMINET}), & \text{if } i \text{ is an arrival} \\ \max\left(\left(t_i + \sum_{j \in P_i} \frac{s_j}{v_j}\right), t_i^{WWLMINET}\right), & \text{if } i \text{ is a departure} \end{cases} \quad \text{Eq. 7-11}$$

where

t_i^{ready}	The earliest possible release time for operation i ;
t_i	The time in the schedule assigned to operation i ;
$t_i^{WWLMINET}$	The time when operation i 's hourly time bin begins;
P_i	The set of all taxipath segments assigned to operation i ;
s_j	The length of taxipath segment j ; and
v_j	The speed assigned to taxipath segment j .

Since the airborne delay (the output of WWLMINET) occurs at altitudes higher than 3,000 ft, AEDT will not model the emissions resulting from the aircraft spending more time in the air, and the approach from 3,000 ft to the ground will be continuous without any delay during this segment. Additionally, to simplify the model, taxi-in and taxi-out operations are considered to be uninterrupted (unimpeded).

The sequencing model distributes operations among the runways and taxiways following the taxi network as defined by the user and the analysis performed by the taxi network analysis algorithm. Queues are generated starting at each runway entrance (runway nodes) and grow along the individual taxiways as more aircraft are delayed. Each air operation will experience at most one queue on taxi out and will take off immediately after exiting the queue.

Initially, all queues are assumed to be empty. The sequence of air operations entering the departure queues is determined based on the gate pushback time and the time it takes the air operation to taxi to the queue. The taxi time is determined based on speed and length of the network links that make up the air operation's network path, without taking into consideration motion dynamics. The length (in terms of distance) of the queue itself is determined based only on the average space occupied by each air operation and the number of air operations in the queue. The average space that each air operation will occupy (regardless of aircraft size), including buffer spacing between two successive air operations, will be 150 ft (as defined in Section 7.3.2.9.2 of the Taxi Network algorithm).

The exact time when an air operation is allowed to takeoff/land depends on runway occupancy times for arriving and departing operations on the same runway. Additionally, the takeoff time depends on the state of the queue the air operation joins before it is allowed to enter the runway for takeoff. The exact time when an aircraft is allowed to takeoff/land is expressed in Eq. 7-12:

$$t_i^{release} = \begin{cases} \max(t_i, t_i^{WWLMINET}, t_{r_i}^{OUT}), & \text{if } i \text{ is an arrival} \\ \max\left(t_i + \sum_{j \in P_i} \frac{s_j - s_j^{queue}}{v_j} + \sum_{j \in A_i} t_j^{ROT}, t_i^{WWLMINET}\right), & \text{if } i \text{ is a departure} \end{cases} \quad \text{Eq. 7-12}$$

where

$t_i^{release}$	The actual release time for operation i ;
t_i	The time in the schedule assigned to operation i ;
$T_i^{WWLMINET}$	The time when operation i 's hourly time bin begins ;
$t_{r_i}^{OUT}$	The "occupied until time" (OUT) of runway r_i ;
r_i	The runway assigned to operation i ;
P_i	The set of all taxipaths segments assigned to operation i ;
s_j	The length of taxipath segment j ;
s_j^{queue}	The queue length along taxipath segment j at the time i joins the queue;
v_j	The speed assigned to taxipath segment j ;
A_i	The set of air operations (arrivals, departures, TGOs) on runway r_i which occur after the air operation i joins the queue and before the operation i reached the front of the queue; and
t_j^{ROT}	The runway occupancy time of operation j determined by resolving the ANP profile of operation i .

All arrivals are allowed to taxi in unimpeded without any queue formation. The sequence of arriving aircraft is predominantly determined based on the scheduled arrival times. The release time for arrivals $t_i^{release}$ could be slightly later or equal to t_i^{ready} .

Touch-and-Go operations (TGO) are considered similarly to arrivals. These operations occupy their designated runways for the period of time determined by resolving their ANP procedural profile. Unlike arrival operations, TGOs do not occupy any taxipath segment for any period of time.

Under a single runway configuration, any runway could be used for both arrivals and departures. Therefore, while considering a single runway resource, competing requests may appear (e.g., more than one departure queue and a stream of arrivals could exist as in Figure 7-15). Among all operations requesting service, the sequencing model releases the first one based on the time of the request.

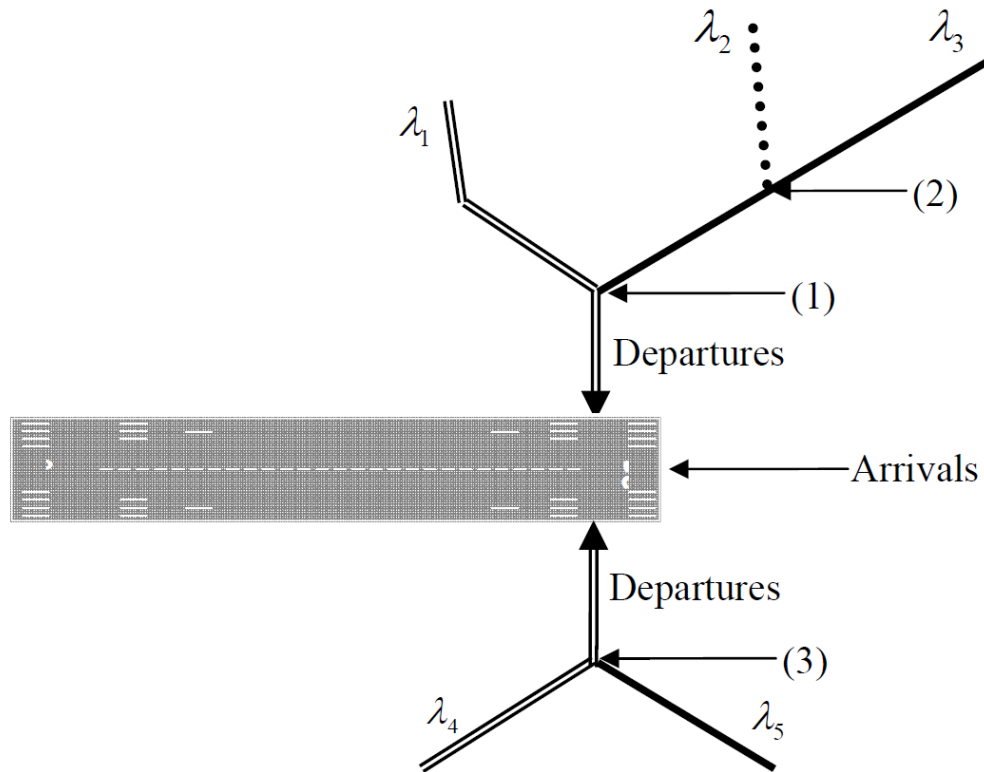

Figure 7-15 Example of a Runway End Serving Traffic from Several Queues

With the assumption that there is no priority between the different departure paths, the queues propagate according to arrival rates. For example, in Figure 7-15, once the queue exceeds node 1, it will branch along the paths proportionally according to the arrival rates λ_1 and $\lambda_2 + \lambda_3$.

When a departure operation is released (e.g., from the taxiway segment that links node 1 to the runway-end in Figure 7-15), the sequencing model updates queues such that all air operations waiting on the link (node 1, runway-end) are moved forward. If the queue is beyond node 1, a new operation will be inserted into the link. This operation is selected based on the length of the queues on individual branches. The branch with the longest queue gets service priority. Continuing with the example, let us assume that the longer queue exists on the branch that uses node 2. Thus, now the first aircraft waiting on the link (1, 2) gets inserted into the link (node 1, runway-end) and all aircraft on the link (1, 2) are moved forward. If this queue propagates beyond node 2, a new branch is formed and the procedure is repeated.

An operation (departure/arrival) may be released only when its assigned runway is not occupied. Thus, each active runway needs to be characterized by an “occupied until time” (OUT) property which is updated every time an operation is released. All runways that have operations in queues are sorted by

ascending order of their respective OUTs. The first runway in this list is the next one to have an operation released as given by Eq. 7-13.

$$r = \arg \min_{i \in R} (t_i^{OUT}) \quad \text{Eq. 7-13}$$

where

r The next runway to release an operation at any given time;
R The set of all runways; and
 t_i^{OUT} The OUT of runway i.

The sequencing algorithm performs a simplistic discrete-event simulation of airport operations. Arrival and departure operations are injected into the simulation at the time given by Eq. 7-14.

$$t_i^{inj} = \begin{cases} \max(t_i, t_i^{WWLMINET}) & \text{if } i \text{ is an arrival} \\ t_i & \text{if } i \text{ is a departure} \end{cases} \quad \text{Eq. 7-14}$$

where

t_i^{inj} The injection time of operation i;
 t_i The time in the schedule assigned to operation i; and
 $t_i^{WWLMINET}$ The time when operation i's hourly time bin begins.

All queues are updated every time a new operation is injected into the system. This means that the procedure for releasing departure operations described above is repeated until the OUT is later than t_i^{inj} , or there are no operations in any queue for any active runway. This terminating condition is summarized by Eq. 7-15. When Eq. 7-15 is true, no more departures are released.

$$N = \sum_{r \in R} \begin{cases} 1, & \text{if } t_i^{inj} \leq t_r^{OUT} \text{ or } n_r = 0 \\ 0, & \text{otherwise} \end{cases} \quad \text{Eq. 7-15}$$

where

N The number of active runways;
R The set of all runways;
 T_i^{inj} The injection time of operation i;
 T_r^{OUT} The OUT of runway r; and
 n_r The number of operations in the queue(s) feeding runway r.

The states of all queues are repeatedly updated before another operation is injected into the system. In some instances, due to high demand and/or low airport capacities, WWLMINET may push t_i^{ready} (and therefore $t_i^{release}$) into the next day. These operations are released at the very beginning of the next day.

7.6.1 Sequencing Algorithm and Outputs

The sequencing model processes one day (schedule) of operations at a time immediately after the same schedule has been processed by the delay model. Overflow of operations from one day to another is released during the first hourly time bin of the next day; thus, no operations are lost. The sequencing model processing steps are:

1. Evaluate each operation i in the schedule (the operations are provided chronologically with overflow from the previous day at the beginning of the list).
 - a) Release all departures accumulated in the queues of the taxiway network until Eq. 7-15 is true.
 - b) If the operation is not intended to be released the same calendar day, then change release time of this operation to be the first hourly time bin of the next day and go to the next operation.
 - c) Inject operation i into the system.
2. If it is a departure, propagate its movement along segments of taxiways included in its taxipath until it reaches a queue or runway-end. It will unimpededly reach a runway-end if it encounters no queues.
3. If it is an arrival, propagate the operation along the corresponding inbound taxipath. Arrival movements are considered to be unimpeded.
4. If there are operations for which release time will pass beyond the end of the metric result, change the release time of these operations to the last hourly bin of the metric result and release them all.

The ultimate result of sequencing (which itself depends on the delay model) is, for each air operation, a list of 4-dimensional points which constitute a path followed by the air operation from its corresponding gate/runway-end pair.

This 4-dimensional path is used to produce a taxi trajectory segment for each node-to-node movement specified by the path produced by the sequencing algorithm. A fuel flow rate is computed for the sequenced taxi trajectory segments. The fuel flow rate during taxiing is derived using a modified instance of unadjusted idle engine configuration. The calculation of this fuel flow rate per engine (f) is shown in Eq. 7-16.

$$f = \frac{1.1 \cdot UA_{ID} \cdot \delta}{\theta^{3.8}} \quad \text{Eq. 7-16}$$

where

- f The fuel flow rate per engine of a sequenced taxi trajectory segment (kg/s);
 UA_{ID} The unadjusted idle fuel flow rate of the operation's engine (kg/s);
 δ The pressure ratio at the initial time and initial location of the sequenced taxi trajectory segment; and
 θ The temperature ratio at the initial time and initial location of the sequenced taxi trajectory segment.

The total fuel burn for each sequenced taxi trajectory segment is computed using Eq. 7-17.

$$F = f \cdot \Delta t \cdot n_{eng} \quad \text{Eq. 7-17}$$

where

- F The total fuel burned by a sequenced taxi trajectory segment (kg);
 Δt The duration of a sequenced taxi trajectory segment (s); and
 N_{eng} The total number of engines of the operation's aircraft (ANP aircraft).

AEDT calculates the emissions resulting from this fuel burn. When calculating emissions dispersion, AEDT synthesizes the resulting emissions and localizes them along the taxiways computed by the taxi network analysis. The localized emissions are then utilized to produce dispersion sources.

8. Annualization

8.1 Overview

Annualization is the process of performing a weighted aggregation over the noise and emissions results from some or all of the cases within a scenario in order to create results that represent noise and emissions exposures over the time period of interest. Depending on the data represented by the cases and the time period of the results, annualized results can be computed by applying a user-defined weighting scheme. AEDT allows the user the flexibility to define annualization hierarchies graphically through the user interface, via ASIF or interacting directly with the SQL databases. The user must identify each case referenced for annualization and specify annualization weighting factors for each case. For information on how to setup annualizations, refer to the AEDT 2c User Guide¹.

Central to the weighting scheme is a single multiplier known as the annualization weight. The annualization weight is a multiplication factor that is typically between zero and one representing percentage use. However, it can also include a scale factor and therefore can be a number larger than 1. Annualization weights are applied to individual cases as well as groupings of cases. Individual groups represent a collection of cases or sub-groups that represent a portion of the total annual operations. For example, if an annualization consists of three groups – A, B, and C with annualization weights of 0.5, 0.25 and 0.25, respectively – then these weights indicate that group A occurs 50% of the year and groups B and C each occur 25% of the year. For National Environmental Policy Act (NEPA) related studies, the annualization weights need to be consistent with the input data so that the cumulative weighting represents the distribution of an average annual day.

Typically the annualization weight is used to represent a weighting that represents a percentage. However, it offers the flexibility to also include a scale factor to modify the number of operations and therefore the impact on resultant noise or emissions. For example, the user may apply a scale factor of 2.0 to an individual case to model a scenario where the number of operations in that case may double in a future scenario. In this example, the existing weighting for that case would be multiplied by 2.0 to provide the final annualization weight. Note that the scale factor is not specified separately, and it is up to the user to modify individual annualization weights by the relevant scale factors. See the AEDT 2c User Guide¹ Section 6.6 for information on how to create annualization in the AEDT GUI.

In its simplest form, a scenario annualization may be depicted in the following equation:

$$A(s) = \sum_c R(c, w) \quad \text{Eq. 8-1}$$

where

A(s) Annualized result for scenario, s; and
 R(c,w) Result for each case, c, weighted by weight, w.

The final annualization weight for each case, $FAW(c)$, is an aggregate factor that encompasses the annualization weights of all parent groups in the case's hierarchy – including the final annualization weight:

$$FAW(c) = AW(c) \times FAW(pg) \quad \text{Eq. 8-2}$$

where

- AW(c) Annualization weight for the case; and
- FAW(pg) Final annualization weight for the case's parent group.

Similarly, the final scale factor for each case, FSF(c), is an aggregate factor that encompasses the scale factors of all parent groups in the Case's hierarchy – including the final scale factor:

$$FSF(c) = SF(c) \times FSF(pg) \quad \text{Eq. 8-3}$$

where

- SF(c) Scale factor for the case; and
- FSF(pg) Final scale factor for the case's parent group.

The final weight applied at each case, $w(c)$, is the aggregate weight that is a combination of the annualization weight and the scale factor:

$$w(c) = FAW(c) \times FSF(c) \quad \text{Eq. 8-4}$$

where

- FAW(c) Final annualization weight for the case; and
- FSF(c) Final scale factor for the case.

For example, given the following hierarchy of user-specified annualization weights, AW, and scale factors, SF:

- Final parent group AW=1.0, SF=1.0
 - Group AW=0.9, SF=1.0
 - Group AW=0.4, SF=1.0
 - Case AW=0.5, SF=2.0

the final weight for the case, $w(c)$, is computed as:

$$\begin{aligned} FAW(c) &= (0.5 \times 0.4 \times 0.9 \times 1.0) = 0.18 \\ FSF(c) &= (2.0 \times 1.0 \times 1.0 \times 1.0) = 2.0 \\ w(c) &= 0.18 \times 2.0 = 0.36 \end{aligned}$$

If the final weight (w) for a case is computed to be zero, then the annualization will still proceed but the case will be omitted from the final annualized result (that case occurs 0% of the year). If a case that is included in an annualization tree does not have any valid results, the annualization will not proceed and an error will be logged.

When applied to emissions, the weight for each case is a simple multiplier on the case-level emissions results. When applied to noise results at receptors, the weight for each case is a simple multiplier on the raw sound energy at each point, which in effect scales the number of operations for the entire case.

8.2 Peak Month Average Day and Annual Average Day Annualizations

This Section describes how average annual day (AAD) and peak month average day (PMAD) can be calculated from an annual schedule.

For certain analyses, operations must be entered as specified in AEDT based on an average annual day (AAD). To determine the AAD from an annual schedule, the typical procedure encompasses two steps:

1. Add the number of operations for like entries in the annual schedule. Like entries can encompass a number of groupings such as type of aircraft, aircraft category (commercial air carrier, air taxi, general aviation, military), operation type, track, and time of day (daytime 0700-2200 hours local and nighttime 2200-0700 hours local).
2. After like entries are added, the total is divided by 365 for each remaining entry to represent an average day of operations in the year.

A Design Day Ratio (also known as PMAD scaling factor) is needed to create an aircraft emissions inventory. To identify the Design Day Ratio:

1. Determine the month with the most operations (i.e. peak flights) for the year.
2. Compute the average daily operations for that month (i.e., the PMAD operations):
$$\text{PMAD} = \# \text{ Operations in the month with the Most Operations} / \# \text{ Days in that Month}$$
3. Compute the AAD number of operations for the year:
$$\text{AAD} = \text{Total \# Operations in the Year} / \# \text{ Days in that Year}$$
4. Compute the Design Day Ratio:
$$\text{Design Day Ratio} = \text{PMAD}/\text{AAD}$$

9. Change Analysis and Impact Evaluation

9.1 Change Analysis

This Section describes statistical and summary calculations performed by the change analysis functionality in AEDT.

9.1.1 Change Analysis Report Statistics

The requirements to run change analysis are as follows:

- Two different annualizations run with the same receptor set;
- Metric results must be run with the DNL noise metric; and
- The metric results used must have been run through to successful completion.

The change analysis report performs two sets of calculations:

1. A threshold calculation to find the cases most responsible for the noise contributions at a given receptor point.
2. A grouping of cases and receptor points to provide the user with causality groups (or sets).

The change analysis calculations are described below.

For each receptor and case, the baseline weighted raw energy values $BRAW(c,r)$, see Eq. 9-1, and baseline DNL values $BDNL(c,r)$, see Eq. 9-2, are computed.

$$BRAW(c,r) = 10^{\left(\frac{B(c,r)}{10}\right)} \cdot AW(c) \quad \text{Eq. 9-1}$$

where

- $B(c,r)$ Baseline DNL noise for case, c , and receptor, r and
 $AW(c)$ Final annualized weighting factor for the baseline or alternative case, c .

$$BDNL(c,r) = 10\text{Log}_{10}(BRAW(c,r)) \quad \text{Eq. 9-2}$$

Similarly, the alternative equivalents are calculated. See Eq. 9-3 for the alternative weighted raw energy equation, $ARAW(c,r)$ and Eq. 9-4 for the alternative DNL equation, $ADNL(c,r)$.

$$ARAW(c,r) = 10^{\left(\frac{A(c,r)}{10}\right)} \cdot AW(c) \quad \text{Eq. 9-3}$$

where

- $A(c,r)$ Alternative DNL noise for case, c and receptor, r .

$$ADNL(c,r) = 10\text{Log}_{10}(ARAW(c,r)) \quad \text{Eq. 9-4}$$

Next, the total RAW and DNL values are computed for each receptor, see Eq. 9-5 through Eq. 9-8.

$$BRAW(r) = \sum_c BRAW(c,r) \quad \text{Eq. 9-5}$$

$$BDNL(r) = 10\text{Log}_{10}(BRAW(r)) \quad \text{Eq. 9-6}$$

$$ARAW(r) = \sum_c ARAW(c, r) \quad \text{Eq. 9-7}$$

$$ADNL(r) = 10\text{Log}_{10}(ARAW(r)) \quad \text{Eq. 9-8}$$

Then, the total differences $DRAW(c, r)$, $DDNL(c, r)$, $DRAW(r)$, and $DDNL(r)$ are computed, see Eq. 9-9 through Eq. 9-12.

$$DRAW(c, r) = BRAW(c, r) - ARAW(c, r) \quad \text{Eq. 9-9}$$

$$DDNL(c, r) = BDNL(c, r) - ADNL(c, r) \quad \text{Eq. 9-10}$$

$$DRAW(r) = BRAW(r) - ARAW(r) \quad \text{Eq. 9-11}$$

$$DDNL(r) = BDNL(r) - ADNL(r) \quad \text{Eq. 9-12}$$

Next, the percentage RAW difference, $PDR(c, r)$ for each case at a given receptor is computed, see Eq. 9-13.

$$PDR(c, r) = 100 \cdot \left| \frac{DRAW(c, r)}{DRAW(r)} \right| \quad \text{Eq. 9-13}$$

The mean percentage difference for the receptor over all the case differences, $MPDR(r)$, is computed by Eq. 9-14.

$$MPDR(r) = \sum_c \frac{PDR(c, r)}{N_c} \quad \text{Eq. 9-14}$$

Finally, the standard deviation of the percentage differences over all the cases, $PSIG(r)$, is computed by Eq. 9-15.

$$PSIG(r) = \sqrt{\sum_c \frac{(PDR(c, r) - MPDR(r))^2}{N_c}} \quad \text{Eq. 9-15}$$

Cases that have a percentage raw difference, $PDR(c, r)$, that is greater than the mean percentage, $MPDR(r)$, plus one-half the standard deviation of the percentage differences, $PSIG(r)$, are considered significant contributors of noise for a given receptor, see Eq. 9-16.

$$PDR(c, r) > MPDR(r) + 0.5 \cdot PSIG(r) \quad \text{Eq. 9-16}$$

After the statistics for each case and receptor have been computed, the receptors are organized into groups. Each group contains receptors that have the same set of significant case contributors as defined

by Eq. 9-16, therefore changes to a given significant case will affect all the receptors in that group in a similar fashion. Both the statistical information and the grouping information are displayed in the change analysis report.

9.2 Impact Evaluation

The impact evaluation functionality provides the percent contribution of each flight in a given case to a selected set of receptor points (those in a change zone). Cases must be run with detailed noise (event-level noise results) before impact evaluation can be utilized. The percentage contribution calculation is described below.

The total noise, $N(f)$, is calculated over all the receptors in the change zone for each flight in the case, see Eq. 9-17.

$$N(f) = AW(c) \cdot \sum_r N(f, r) \quad \text{Eq. 9-17}$$

where

$N(f, r)$ SEL noise for flight, f , at receptor, r ; and
 $AW(c)$ Final annualized weighting factor for the alternative case, c .

Next, the total noise, TN , is calculated by summing the total noise $N(f)$ for each flight in the case, see Eq. 9-18.

$$TN = \sum_f N(f) \quad \text{Eq. 9-18}$$

Finally, the percentage noise, $PN(f)$, of each flight is computed by dividing each flight's noise by the total noise as shown in Eq. 9-19.

$$PN(f) = 100 \cdot \frac{N(f)}{TN} \quad \text{Eq. 9-19}$$

10. Environmental Justice Capability

10.1 Overview

AEDT has been augmented to be compatible with additional US Census Bureau products, the American Community Survey (ACS), in support of the identification of potential environmental justice populations. The environmental justice (EJ) capability assists in the identification of potential environment justice populations. This Section describes environmental justice data sources and algorithms in AEDT.

10.2 American Community Survey (ACS) Data

The EJ capability uses the US Census Bureau's ACS as the underlying demographic data for all calculations and display within AEDT. The ACS data is available in 1-year, 3-year, and 5-year estimates. ACS 5-year estimates were used because they provided the necessary demographic variables at the highest spatial resolution. As of the AEDT 2c release, the latest available ACS data was the 2010-2014 ACS 5-year estimates, in which the Census collected the data between January 1, 2010 and December 31, 2014. For more details on the ACS data, see: <https://www.census.gov/programs-surveys/acs///>.

The EJ capability utilizes ACS data at the spatial resolution of block groups. Block groups are divisions of census tracts (i.e. a series of block groups make up a single census tract). They typically have a population of between 600 and 3,000 people. Block groups are further divided into blocks (i.e a series of blocks make up a block group)^{xxx}.

The following demographic tables from the ACS 5-year estimates are used by the EJ capability:

^{xxx} For more details on block groups, see: https://www.census.gov/geo/reference/gtc/gtc_bg.html

Table 10-1 ACS Data Tables

ACS Table	ACS Table ID
SEX BY AGE	B01001
RACE	B02001
WHITE ALONE OR IN COMBINATION WITH ONE OR MORE OTHER RACES	B02008
BLACK OR AFRICAN AMERICAN ALONE OR IN COMBINATION WITH ONE OR MORE OTHER RACES	B02009
AMERICAN INDIAN AND ALASKA NATIVE ALONE OR IN COMBINATION WITH ONE OR MORE OTHER RACES	B02010
ASIAN ALONE OR IN COMBINATION WITH ONE OR MORE OTHER RACES	B02011
NATIVE HAWAIIAN AND OTHER PACIFIC ISLANDER ALONE OR IN COMBINATION WITH ONE OR MORE OTHER RACES	B02012
SOME OTHER RACE ALONE OR IN COMBINATION WITH ONE OR MORE OTHER RACES	B02013
HISPANIC OR LATINO ORIGIN BY RACE	B03002
HOUSEHOLD LANGUAGE BY HOUSEHOLD LIMITED ENGLISH SPEAKING STATUS	B16002
MEDIAN HOUSEHOLD INCOME IN THE PAST 12 MONTHS (IN2010 INFLATION-ADJUSTED DOLLARS)	B19013
RATIO OF INCOME TO POVERTY LEVEL IN THE PAST 12 MONTHS	C17002

10.3 Demographic Variables

The EJ capability tracks a series of demographic variables. Key demographic variables include total population, minority population, population below the poverty level, population by race or ethnicity, etc. These variables can be divided into two groups: (1) variables that directly come from the ACS data tables (they may be mapped to a new name or use the variable ID) and (2) variables that are calculated from the ACS variables. For a full list of all variables that come directly from the ACS data and variables that are calculated, see the Appendix (Section 11.7).

The following demographic variables are calculated by the EJ capability:

$$pop_{minority} = B03002e1 - B03002e3 \tag{Eq. 10-1}$$

where

- pop_{minority} Population of minorities in the block group
- B03002e1 Total population (ACS Table B03002)
- B03002e3 Population of non-hispanic or latino, white alone (ACS Table B03002)

$$pop_{1xpov} = C17002e2 + C17002e3 \tag{Eq. 10-2}$$

where

- pop_{1xpov} Population below 1 times the Census poverty threshold

C17002e2	Population whose ratio of income to threshold is less than 0.5 (ACS Table C17002)
C17002e3	Population whose ratio of income to threshold is 0.5 to 0.99 (ACS Table C17002)

$$pop_{lang} = B16002e4 + B16002e7 + B16002e10 + B16002e13 \quad \text{Eq. 10-3}$$

where

pop_{lang}	Population that is linguistically isolated
B16002e4	Population of households primarily language Spanish with limited English (ACS Table B16002)
B16002e7	Population of households primarily languages Indo-European with limited English (ACS Table B16002)
B16002e10	Population of households primarily languages Asian and Pacific Island with limited English (ACS Table B16002)
B16002e13	Population of households primarily language Other with limited English (ACS Table B16002)

In addition to calculating the population, the EJ capability calculates the percentage population by dividing the demographic variable by the total population in that block group and converting the fraction to percentage. The naming convention is to use “pct” as a prefix, for example percentage of population below the Census poverty threshold is “pct_1xpov”.

Coloring of the EJ layer map within AEDT is done based upon the thresholds that have been exceeded. The blockgroup will be orange if pct_1xpov and any other specified attribute except for pct_minority, have exceeded the threshold. The blockgroup will be yellow if pct_minority and any other specified attribute except for pct_1xpov, have exceeded the threshold. If both pct_1xpov and pct_minority, and any other attribute, have exceeded the threshold, the blockgroup will be blue. Blockgroups will be aqua blue if any attribute except for pct_minority and/or pct_1xpov has exceeded the threshold. The blockgroups will be gray when no attribute has exceeded the threshold.

The coloring of the EJ layer map is driven by the thresholdflag column which is created or updated during the EJ Analysis. This column can be used within tools as ArcMap to do further analysis. A summary file with the postfix “_summary.txt” is created when saving the layer to a shapefile. This will contain the attributes used for analysis and their specified thresholds and associated flags. The thresholdflag is a bit field flag. For example, a flag of 3 means that both attributes with flag 1 and 2 have exceeded their threshold.

Of special note, the user should be careful when calculating custom variables based on the demographic variables by race and/or by ethnicity. The US Census allows individuals to select more than one racial group and ethnic group; therefore, the sum of the logical set of demographic variables within one census block will likely exceed the total population within that census block.

11. Appendices

11.1 Noise Adjustment and Metric Derivations

This appendix provides detailed derivations for the following noise adjustments and metrics: the acoustic impedance adjustment (Section 11.1.1), the noise exposure fraction adjustment (Section 11.1.2), and the equation to compute the time-above metric (Section 11.1.3).

11.1.1 Derivation of the Acoustic Impedance Adjustment

The majority of noise level data in the AEDT 2c FLEET database were derived from data originally measured during aircraft noise certification tests conducted in accordance with the Code of Federal Regulation, Title 14, Aeronautics and Space, Part 36, "Noise Standards: Aircraft Type and Airworthiness Certification" (14 CFR Part 36)²¹. Section B36.7 of 14 CFR Part 36 states that the noise measurements must be corrected to the following (homogeneous) noise certification reference atmospheric conditions:

1. Sea level pressure of 2116 psf (76 cm mercury);
2. Ambient temperature of 77°F (25° C);
3. Relative humidity of 70%; and
4. Zero wind.

The concept of acoustic impedance (denoted by the symbol ρc) is used in AEDT 2c to correct the reference-day NPD data to the off-reference, non-sea level conditions associated with the user-specified case airport. Acoustic impedance is the product of the density of air and the speed of sound, and is a function of temperature, atmospheric pressure, and indirectly altitude. An acoustic impedance of 409.81 newton-seconds/m³ corresponds to the reference atmospheric conditions as defined by 14 CFR Part 36. Acoustic impedance adjustments are correct for the differences between reference-day sea-level conditions to airport-specific temperature and altitude.

Harris⁴⁵ and Beranek⁴⁶ both contain empirical curves showing acoustic impedance adjustment as a function of temperature and atmospheric pressure (see Figure 11-1 and Figure 11-2). These curves can be used to obtain a general sense for the magnitude and direction of the adjustment. However they are not appropriate for correcting AEDT 2c noise-power-distance (NPD) data because the curves are referenced to an acoustic impedance of 406 and 400 newton-seconds/m³, respectively, not the 409.81 newton-seconds/m³ associated with NPD reference-day conditions in AEDT 2c.

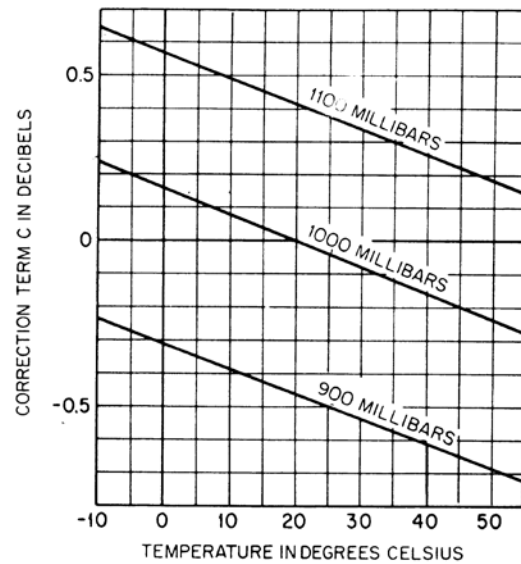

Figure 11-1 Acoustic Impedance Adjustment re. 406 newton-second/m³

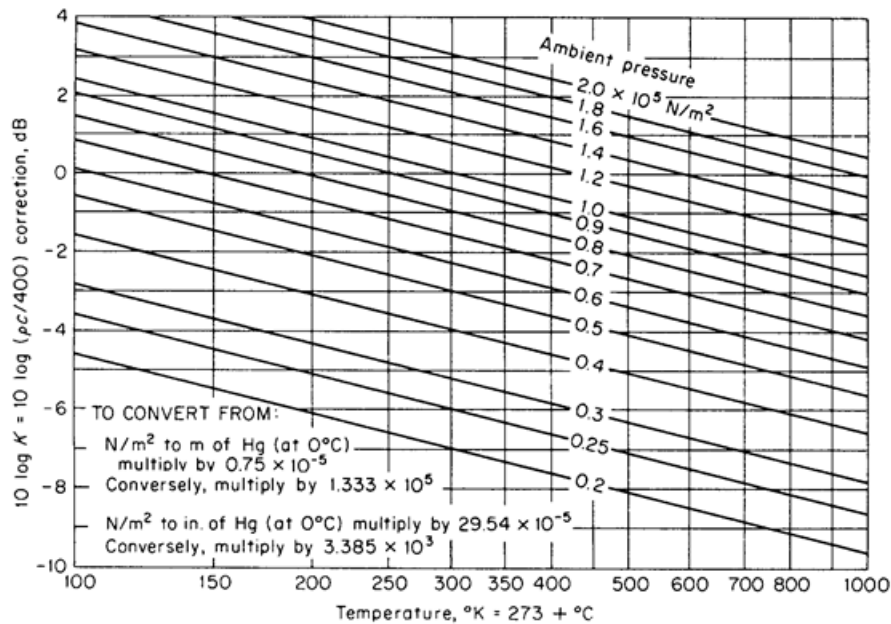

Figure 11-2 Acoustic Impedance Adjustment re. 400 newton-second/m³

The acoustic impedance adjustment is relatively small, usually less than a few tenths of a decibel. However, when there is a significant variation in temperature and atmospheric pressure relative to reference-day conditions, the adjustment can be substantial. For example, Denver International Airport is at an elevation of approximately 5,000 feet, and assuming a temperature of 70°F and an atmospheric pressure of 29.92 in-Hg, an acoustic impedance adjustment of -0.77 dB is added to NPD noise curves.

The acoustic impedance adjustment is computed by:

$$AI_{ADJ} = 10 \cdot \log_{10} \left[\frac{\rho c}{409.81} \right] \quad \text{Eq. 11-1}$$

where

- AI_{ADJ} Acoustic impedance adjustment to be added to noise level data in the AEDT 2c NPD database (dB); and
 ρc Acoustic impedance at observer altitude and pressure (newton-seconds/m³).

$$\rho \cdot c = 416.86 \cdot \left[\frac{\delta}{\theta^{1/2}} \right] \quad \text{Eq. 11-2}$$

where

- δ Ratio of atmospheric pressure at observer altitude to standard-day pressure at sea level.

$$\delta = \left[\left(\frac{P}{29.92} \right)^{\frac{1}{5.256}} - \left(\frac{3.566 \times 10^{-3} A}{518.67} \right) \right]^{5.256} \quad \text{Eq. 11-3}$$

where

- θ Ratio of absolute temperature at observer altitude to standard-day temperature at sea level.

$$\theta = \frac{[459.67 + T - (3.566 \times 10^{-3}) \cdot (A - E)]}{518.67} \quad \text{Eq. 11-4}$$

where

- A Observer elevation MSL (feet);
 E Airport elevation MSL (feet);
 T Temperature at airport (°F); and
 P Atmospheric pressure at airport relative to MSL (in-Hg).

Harris⁴⁵ and Beranek⁴⁶ explain the acoustic impedance adjustment in terms of sound intensity and sound pressure. In a free field for plane waves or spherical waves, the sound pressure and particle velocity are in phase, and the magnitude of the intensity (power per unit area) in the direction of propagation of the sound waves is related to the mean-square sound pressure by:

$$I = \frac{p^2}{\rho c} \quad \text{Eq. 11-5}$$

where

- I Sound intensity (power per unit area);
 p^2 Mean-square sound pressure; and
 ρc Acoustic impedance.

Two sound intensities at a given distance from a given acoustical power source, one measured under actual conditions and the other measured under reference-day conditions are equivalent as shown:

$$\frac{p^2}{\rho c} = \frac{p_{ref}^2}{\rho c_{ref}} \quad \text{Eq. 11-6}$$

where

$$\frac{p^2}{\rho c} \quad \text{Sound intensity, actual conditions; and}$$

$$\frac{p_{ref}^2}{\rho c_{ref}} \quad \text{Sound intensity, reference-day conditions.}$$

By rearranging terms and dividing by a constant $p_0 = 20 \mu\text{Pa}$, the equation becomes:

$$\frac{p^2}{p_0^2} = \left(\frac{p_{ref}^2}{p_0^2} \right) \left(\frac{\rho c}{\rho c_{ref}} \right) \quad \text{Eq. 11-7}$$

Converting to decibels,

$$10 \cdot \log_{10} \left[\frac{p^2}{p_0^2} \right] = 10 \cdot \log_{10} \left[\frac{p_{ref}^2}{p_0^2} \right] + 10 \cdot \log_{10} \left[\frac{\rho c}{\rho c_{ref}} \right] \quad \text{Eq. 11-8}$$

and substituting symbols, produces the noise level adjustment equation (in dB):

$$L = L_{ref} + 10 \cdot \log_{10} \left[\frac{\rho c}{\rho c_{ref}} \right] \quad \text{Eq. 11-9}$$

where

$$L \quad \text{Corrected NPD level at an airport;}$$

$$L_{ref} \quad \text{NPD level in the AEDT 2c database for reference-day conditions; and}$$

$$10 \cdot \log_{10} \left[\frac{\rho c}{\rho c_{ref}} \right] \quad \text{Acoustic impedance adjustment, } AI_{ADJ}, \text{ as seen in Eq. 11-1.}$$

11.1.2 Derivation of the Noise Exposure Fraction Adjustment^{47,48}

This Section presents a derivation of the noise exposure fraction equation used in AEDT 2c. The assumptions are that the aircraft is on a straight and level flight path flying at constant speed. The equations are based upon a fourth-power, 90 degree dipole model of sound radiation. The geometry for the derivation is shown in the figure below.

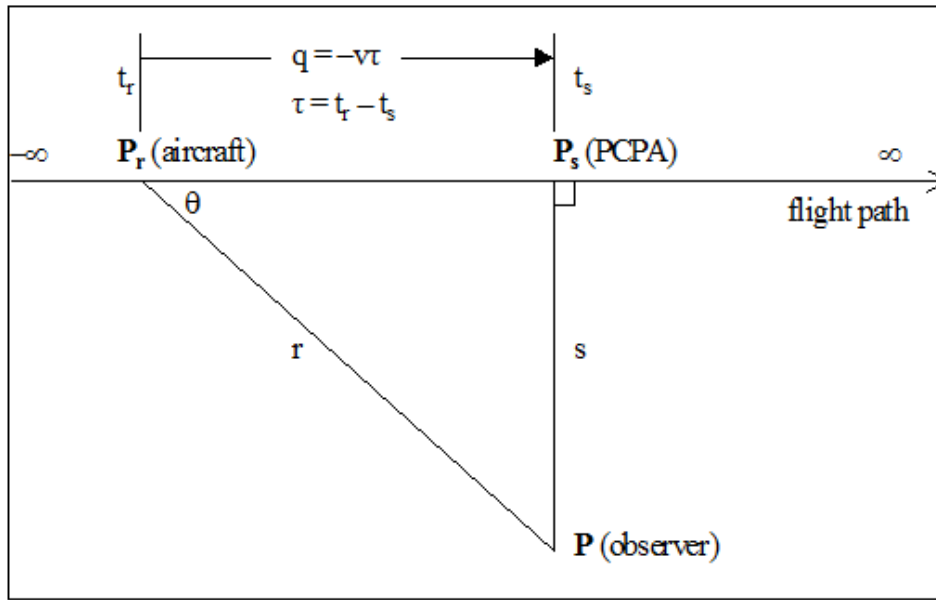

Figure 11-3 Observer/Flight Path Geometry

- r distance from the observer at point **P** to the aircraft at point **P_r** (ft);
- s perpendicular distance from the observer at point **P** to PCPA at point **P_s** (ft);
- q distance along the flight path relative to PCPA (ft);
- v speed of the aircraft (ft/s);
- t_r time at which the aircraft is located at point **P_r** (s);
- t_s time at which the aircraft is located at point **P_s** (s);
- τ time difference, t_r minus t_s (s);
- θ angle formed by the flight path and a connecting segment from the aircraft at point **P_r** to the observer at point **P**;
- p_r root-mean-square sound pressure generated by the aircraft at point **P_r**; and
- p_s root-mean-square sound pressure generated by the aircraft at point **P_s**.

The relative distance, q, along the flight path from point **P_r** to point **P_s** is computed from the scalar product of two vectors: **P_rP**, from the aircraft to the observer; and the unit vector, **u**, in the direction of the flight path.

$$q = \mathbf{P_r P} \cdot \mathbf{u} = \frac{\mathbf{P_r P} \cdot \mathbf{P_r P_s}}{|\mathbf{P_r P_s}|} \tag{Eq. 11-10}$$

The value of q is positive if the aircraft is located behind the perpendicular closest point of approach to an extended line segment, PCPA, (as pictured in Figure 11-3), and the value of q is negative if the aircraft is ahead of PCPA. In terms of speed and time,

$$q = -v \cdot \tau \tag{Eq. 11-11}$$

The sign in Eq. 11-11 is negative because τ is negative when the aircraft is behind PCPA.

The noise fraction algorithm is derived from a fourth-power, 90 degree dipole time history model. In this model, p_r^2 is the mean-square sound pressure at the observer due to the aircraft, located at point P_r ; and p_s^2 is the mean-square sound pressure at the observer when the aircraft is located at PCPA at point P_s . The mean-square pressure, p_r^2 , at the observer is expressed in terms p_s^2 by:

$$p_r^2 = p_s^2 \cdot \left(\frac{s^2}{r^2} \right) \cdot \sin^2(\theta) \quad \text{Eq. 11-12}$$

which becomes:

$$p_r^2 = p_s^2 \cdot \frac{s^4}{r^4} \quad \text{Eq. 11-13}$$

In this equation, the mean-square sound pressure for an aircraft flying along a straight path is determined by r^2 spherical spreading loss and by a $\sin^2\theta$ "90 degree dipole" term that accounts for a variety of physical phenomena. These phenomena include atmospheric absorption, which is accentuated in front of the airplane due to Doppler shift, sound refraction away from the hot gases behind the airplane, and ground attenuation. The purpose of the dipole term is to shape the sides of the time-history curve to fit empirical data⁴⁹. When the $\sin\theta$ term is replaced by s/r , the mean-square sound pressure is seen to vary inversely as r^4 ; therefore, another name for the model is the fourth-power time-history model.

The Pythagorean theorem can be used to solve for r^2

$$r^2 = s^2 + q^2 \quad \text{Eq. 11-14}$$

Which can be rewritten as follows, based on Eq. 11-11:

$$r^2 = s^2 + (v\tau)^2 \quad \text{Eq. 11-15}$$

$$\left(\frac{r}{s} \right)^2 = 1 + \left(\frac{v \cdot \tau}{s} \right)^2 \quad \text{Eq. 11-16}$$

Equation 10-16 can then be substituted into Eq. 11-13, in order to derive the mean-square pressure as a function of time:

$$p_r^2(\tau) = \frac{p_s^2}{\left(1 + \left(\frac{v \cdot \tau}{s} \right)^2 \right)^2} \quad \text{Eq. 11-17}$$

The integral of the mean-square pressure, from time τ_1 to τ_2 , is the segment noise exposure E_{12}

$$E_{12} = \int_{\tau_1}^{\tau_2} p_r^2(\tau) d\tau \quad \text{Eq. 11-18}$$

By using the substitution:

$$\alpha = \frac{v \cdot \tau}{s} \quad \text{Eq. 11-19}$$

the segment noise exposure integral becomes:

$$E_{12} = p_s^2 \cdot \left(\frac{s}{v}\right) \cdot \int_{\alpha_1}^{\alpha_2} \frac{1}{(1 + \alpha^2)^2} d\alpha \quad \text{Eq. 11-20}$$

and its solution is:

$$E_{12} = p_s^2 \cdot \left(\frac{s}{v}\right) \cdot \left(\frac{1}{2}\right) \cdot \left\{ \left[\frac{\alpha_2}{(1 + \alpha_2^2)} + \tan^{-1}(\alpha_2) \right] - \left[\frac{\alpha_1}{(1 + \alpha_1^2)} + \tan^{-1}(\alpha_1) \right] \right\} \quad \text{Eq. 11-21}$$

The total noise exposure from $\tau_1 = -\infty$ to $\tau_2 = \infty$ is:

$$E_\infty = \frac{1}{2} \cdot \pi \cdot p_s^2 \cdot \frac{s}{v} \quad \text{Eq. 11-22}$$

The noise exposure fraction, F_{12} , is the noise exposure between time τ_1 and τ_2 divided by the total noise exposure:

$$F_{12} = \frac{E_{12}}{E_\infty} \quad \text{Eq. 11-23}$$

$$F_{12} = \left(\frac{1}{\pi}\right) \cdot \left[\frac{\alpha_2}{(1 + \alpha_2^2)} + \tan^{-1}(\alpha_2) - \frac{\alpha_1}{(1 + \alpha_1^2)} - \tan^{-1}(\alpha_1) \right] \quad \text{Eq. 11-24}$$

The next part of the derivation shows how to calculate α_1 and α_2 .

The AEDT 2c NPD database contains noise exposure level data referenced to 160 kt, $L_{E,160}$, and maximum noise level data, $L_{S_{mx}}$. These noise level data are related to the parameters in the above equations by:

$$L_{E,160} = 10 \cdot \log_{10} \left[\left(\frac{v}{v_0} \right) \cdot \frac{E_\infty}{(p_0^2 \cdot t_0)} \right] \quad \text{Eq. 11-25}$$

$$L_{S_{mx}} = 10 \cdot \log_{10} \left[\frac{p_s^2}{p_0^2} \right] \quad \text{Eq. 11-26}$$

where

p_0	20 μ Pa;
t_0	1 sec for L_{AE} and L_{CE} , or 10 sec for L_{EPN} ; and
v_0	270.05 ft/s (160 ks).

To ensure that the total exposure obtained from the fourth-power time-history model in Eq. 11-22 is consistent with AEDT 2c NPD data, the following relationship must hold:

$$L_{E,160} - L_{S_{mx}} = 10 \cdot \log_{10} \left[\left(\frac{v}{v_0} \right) \cdot \frac{\left(\frac{1}{2} \cdot \pi \cdot P_s^2 \cdot \frac{s}{v} \right)}{(p_0^2 \cdot t_0)} \right] - 10 \cdot \log_{10} \left[\frac{P_s^2}{P_0^2} \right] \quad \text{Eq. 11-27}$$

therefore

$$\frac{1}{2} \cdot \pi \cdot \frac{s}{(v_0 \cdot t_0)} = 10^{\frac{[L_{E,160} - L_{S_{mx}}]}{10}} \quad \text{Eq. 11-28}$$

and the distance, s , is scaled to fit the NPD data:

$$s = \left(\frac{2}{\pi} \right) \cdot v_0 \cdot t_0 \cdot 10^{\frac{[L_{E,160} - L_{S_{mx}}]}{10}} \quad \text{Eq. 11-29}$$

Using the symbol s_L to indicate a scaled distance, rather than the actual distance, the NPD-consistency requirement becomes:

$$s_L = s_0 \cdot 10^{\frac{[L_{E,160} - L_{S_{mx}}]}{10}} \quad \text{Eq. 11-30}$$

where

- s_0 A constant dependent on the type of noise exposure level;
- s_0 171.92 feet (52.4 meters) for L_{AE} and L_{CE} ; and
- s_0 1719.2 feet (524.0 meters) for L_{EPN} .

Using the scaled distance, s_L , Eq. 11-11, and Eq. 11-19, the two α -numbers that are needed to calculate the noise exposure fraction, F_{12} , are determined by $q = q_1$ at the start of a segment:

$$\alpha_1 = \frac{-q_1}{s_L} \quad \text{Eq. 11-31}$$

$$\alpha_2 = \frac{(-q_1 + L)}{s_L} \quad \text{Eq. 11-32}$$

where

- q_1 Relative distance (ft) from segment start point to point P_s and
- L Length of segment (ft).

11.1.3 Derivation of the Time-Above Equation

The equation to compute the time-above metric in AEDT 2c can be developed by using the previously developed time-history equation and substituting $s = s_L$, the mean-square pressure is written as a function of time difference (τ) and speed (v), using Eq. 11-17:

$$p_r^2 = \frac{p_s^2}{\left(1 + \left(\frac{v \cdot \tau}{s_L}\right)^2\right)^2} \quad \text{Eq. 11-33}$$

The time-history equation is solved for τ as a function of p_r :

$$\tau = \left(\frac{s_L}{v}\right) \cdot \left(\frac{p_s}{p_r - 1}\right)^{1/2} \quad \text{Eq. 11-34}$$

Given a noise threshold level, L_x , of root-mean-square pressure, p_x :

$$L_x = 10 \cdot \log_{10} \left[\frac{p_x^2}{p_0^2} \right] \quad \text{Eq. 11-35}$$

The time duration (in seconds) during which the noise level exceeds L_x , Δt_x , is twice the τ -value at $p_r = p_x$:

$$\Delta t_x = 2 \cdot \left(\frac{s_L}{v}\right) \cdot \left[\left(\frac{p_s^2}{p_x^2}\right)^{1/2} - 1 \right] \quad \text{Eq. 11-36}$$

which can be written as:

$$\Delta t_x = \begin{cases} 2 \cdot \left(\frac{s_L}{v}\right) \cdot \left[10^{\frac{[L_{Smxadj} - L_x]}{20}} - 1 \right]^{1/2} & L_x < L_{Smxadj} \\ 0.0 & L_x \geq L_{Smxadj} \end{cases} \quad \text{Eq. 11-37}$$

where

$L_{Smx.adj}$ The adjusted maximum noise level at the observer.

Note that:

$$\frac{s_L}{v} = \left(\frac{2}{\pi}\right) \cdot \left(\frac{t_0 \cdot v_0}{v}\right) \cdot 10^{\frac{[L_{E,160,adj} - L_{Smx,adj}]}{10}} \quad \text{Eq. 11-38}$$

and that:

$$L_{E,adj} = L_{E,160,adj} + 10 \cdot \log_{10} \left[\frac{v_0}{v} \right] \quad \text{Eq. 11-39}$$

where

$L_{E,160,adj}$ Adjusted noise exposure level referenced to 160 knots;

$L_{E,adj}$ Adjusted noise exposure level at the observer; and

$L_{Smx,adj}$ Adjusted maximum noise level at the observer.

Eq. 11-36 can be written to express time-above duration (in minutes) in terms of adjusted exposure and maximum levels:

$$\Delta t_x = \left(\frac{1}{60}\right) \cdot \left(\frac{4}{\pi}\right) \cdot t_0 \cdot \left[10^{\frac{[L_{E,adj} - L_{Smx,adj}]}{10}}\right] \cdot \left[10^{\frac{[L_{Smx,adj} - L_x]}{20}} - 1\right]^{\frac{1}{2}} \quad \text{Eq. 11-40}$$

11.1.4 Recalculation of NPD Data for Non-Reference Conditions

The noise level contributions from each segment of the flight path are derived from the NPD data stored in the international ANP database. However, it is important to note that these data have been normalized using average atmospheric attenuation rates defined in SAE-AIR-1845⁵⁹ based on analysis done during the ICAO Committee on Aircraft Noise 7th meeting cycle⁵⁰. Those rates are averages of values determined during aeroplane noise certification testing in Europe and the United States. The wide variation of atmospheric conditions (temperature and relative humidity) in those tests is shown in Figure 11-1.

An atmospheric absorption adjustment accounts for changes in noise levels due to the atmospheric absorption for study or airport-specific atmospheric conditions that differ from the reference atmospheric conditions. The curves overlaid on Figure 11-1, calculated using an industry standard atmospheric attenuation model SAE-ARP-866A²², illustrate that across the test conditions a substantial variation of high frequency (8 kHz) sound absorption would be expected (although the variation of overall absorption would be less). Since SAE-ARP-5534²³ is currently being evaluated as a possible replacement for SAE-ARP-866A²² for aircraft noise certification, AEDT provides the flexibility to model non-standard atmospheric conditions with either SAE-ARP-5534²³ or SAE-ARP-866A²². Both methods are presented in this section.

Because the attenuation rates, given in Table 11-1, are arithmetic averages, the complete set cannot be associated with a single reference atmosphere (i.e. with specific values of temperature and relative humidity). They should be thought of as properties of a purely notional atmosphere – referred to as the “reference atmosphere”.

Table 11-1 Average Atmospheric Attenuation Rates from SAE-AIR-1845⁵⁹

Center Frequency of 1/3-octave band [Hz]	Attenuation Rate [dB/100m]	Center Frequency of 1/3-octave band [Hz]	Attenuation Rate [dB/100m]
50	0.033	800	0.459
63	0.033	1,000	0.590
80	0.033	1,250	0.754
100	0.066	1,600	0.983
125	0.066	2,000	1.311
160	0.098	2,500	1.705
200	0.131	3,150	2.295
250	0.131	4,000	3.115

315	0.197	5,000	3.607
400	0.230	63,00	5.246
500	0.295	8,000	7.213
630	0.361	10,000	9.836

ACTUAL DAY CONDITIONS RECORDED
DURING CERTIFICATION TESTING

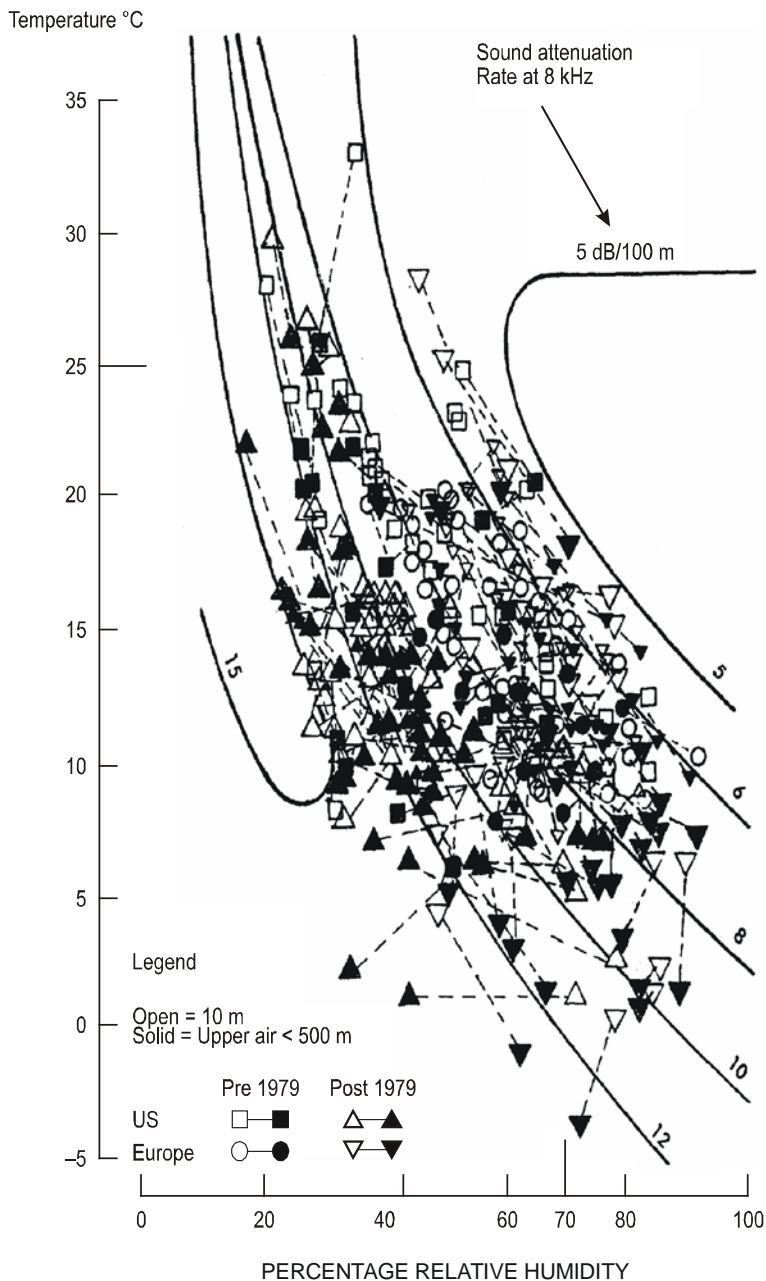

Figure 11-4 Meteorological Conditions Recorded During Noise Certification Tests⁵⁰

The attenuation coefficients in Table 11-1 should be considered valid over reasonable ranges of temperature and humidity. However, to check whether adjustments may be necessary, SAE-ARP-5534²³ or SAE-ARP-866A²² should be used to calculate the atmospheric absorption for the specific airport temperature T , relative humidity RH and atmospheric pressure p . If a comparison of these attenuation

rates with those in Table 11-1 indicates that adjustment is required, the following methodology should be used.

The ANP database provides the following NPD data for each power setting (all data being normalized to the reference atmosphere):

- maximum sound level versus slant distance, $L_{max}(d)$;
- time integrated level versus distance for the reference airspeed, $L_E(d)$; and
- unweighted reference sound spectrum at a slant distance of 305 m (1,000 ft), $L_{n,ref}(d_{ref})$ where n = frequency band (ranging from 1 to 24 for 1/3-octave bands with Center frequencies from 50 Hz to 10 kHz).

Adjustment of the NPD curves to user-specified conditions T and RH is performed in three steps:

The reference spectrum is corrected to remove the reference atmospheric attenuation $\alpha_{n,ref}$:

$$L_n(d_{ref}) = L_{n,ref}(d_{ref}) + \alpha_{n,ref} \cdot d_{ref} \quad \text{Eq. 11-41}$$

where

$L_n(d_{ref})$ The unattenuated spectrum at $d_{ref} = 305$ m (1,000 ft); and

$\alpha_{n,ref}$ The coefficient of atmospheric absorption for the frequency band n taken from Table 11-1 (but expressed in dB/m).

The corrected spectrum is adjusted to each of the ten standard NPD distances^{xxxi} d_i using attenuation rates for both the reference atmosphere and the specified atmosphere (based on either SAE-ARP-5534²³ or SAE-ARP-866A²²).

For the reference atmosphere:

$$L_{n,ref}(d_i) = L_n(d_{ref}) - 20 \cdot \log\left(\frac{d_i}{d_{ref}}\right) - \alpha_{n,ref} \cdot d_i \quad \text{Eq. 11-42}$$

For the specified atmosphere:

$$L_{n,atm}(T, p_a, h_{rel}, d_i) = L_n(d_{ref}) - 20 \cdot \log\left(\frac{d_i}{d_{ref}}\right) - \delta_n(T, p_a, h_{rel}) \cdot d_i \quad \text{Eq. 11-43}$$

where

$\delta_n(T, p_a, h_{rel})$ The coefficient of atmospheric absorption for the frequency band n (expressed in dB/m) calculated using either SAE-ARP-5534²³ or SAE-ARP-866A²² with temperature T , atmospheric pressure p_a and relative humidity h_{rel} .

At each NPD distance d_i the two spectra are A-weighted and decibel-summed to determine the resulting A-weighted levels $L_{A,atm}$ and $L_{A,ref}$, which are then subtracted arithmetically:

^{xxxi} The NPD distances are 200; 400; 630; 1,000; 2,000; 4,000; 6,300; 10,000; 16,000; and 25,000 ft.

$$\begin{aligned}
 \Delta_L(T, p_a, h_{rel}, d_i) &= L_{A,ATM}(T, p_a, h_{rel}, d_i) - L_{A,ref}(d_i) \\
 &= 10 \cdot \log \left(\sum_{n=17}^{40} 10^{(L_{n,atm}(T, p_a, h_{rel}, d_i) - A_n)/10} \right) \\
 &\quad - 10 \cdot \log \left(\sum_{n=17}^{40} 10^{(L_{n,ref}(d_i) - A_n)/10} \right)
 \end{aligned}
 \tag{Eq. 11-44}$$

The increment $\Delta_L(T, p_a, h_{rel}, d_i)$ is the difference between the NPD in the specified atmosphere and the reference atmosphere at the NPD distance d_i . This is added to the ANP database NPD data value to derive the adjusted NPD data.

Applying $\Delta_L(T, p_a, h_{rel}, d_i)$ to adjust both L_{max} and L_E NPDs effectively assumes that different atmospheric conditions affect the reference spectrum only and have no effect on the shape of the level-time-history. This may be considered valid for typical propagation ranges and typical atmospheric conditions. The following is an example of the application of the NPD spectral adjustment: adjust standard NPD data to the atmosphere 10°C, 80% relative humidity and sea level atmospheric pressure.

Using the SEL NPD data presented in the AEDT Fleet database for the V2527A, the matching spectral classes in the ANP database are 103 and 205 for departure and arrival, respectively. The spectra data are tabulated in Table 11-2.

First the spectrum levels (referenced to 305 m (1,000 ft)) are corrected back to the source to remove the reference atmosphere, ignoring spherical spreading effects. This is done using Eq. 11-41. The corresponding spectra at source are also tabulated in Table 11-2.

Table 11-2 Spectra for V2527 NPD from ANP Database and Calculated Source Spectra

Frequency (Hz)	At 1,000 ft		At source	
	DEP_103 (dB)	ARR_205 (dB)	DEP_103 (dB)	ARR_205 (dB)
50	56.7	68.3	56.8	68.4
63	66.1	60.7	66.2	60.8
80	70.1	64.6	70.2	64.7
100	72.8	67.4	73.0	67.6
125	76.6	78.4	76.8	78.6
160	73.0	74.8	73.3	75.1
200	74.5	71.4	74.9	71.8
250	77.0	72.4	77.4	72.8
315	75.3	72.0	75.9	72.6
400	72.2	72.4	72.9	73.1
500	72.2	71.6	73.1	72.5
630	71.2	72.0	72.3	73.1
800	70.2	71.0	71.6	72.4
1,000	70.0	70.0	71.8	71.8

Frequency (Hz)	At 1,000 ft		At source	
	DEP_103 (dB)	ARR_205 (dB)	DEP_103 (dB)	ARR_205 (dB)
1,250	69.6	68.9	71.9	71.2
1,600	71.1	67.2	74.1	70.2
2,000	70.6	65.8	74.6	69.8
2,500	67.1	64.4	72.3	69.6
3,150	63.4	63.0	70.4	70.0
4,000	63.5	62.0	73.0	71.5
5,000	58.2	60.6	69.2	71.6
6,300	51.5	54.4	67.5	70.4
8,000	42.3	48.5	64.3	70.5
10,000	37.7	39.0	67.7	69.0

The source spectra data are then propagated out to the standard NPD data distances using Eq. 11-42 and Eq. 11-43, together with the absorption coefficients in Table 11-1 for the reference atmosphere and using absorption coefficients calculated using SAE ARP-866A²² and SAE ARP-5534²³ for the atmosphere, 10°C, 80% relative humidity, 101.325 kPa (sea level). All three sets of absorption coefficients are listed in Table 11-3.

Table 11-3 Reference Absorption Coefficients (from Table 11-1) and Coefficients for 10°C/80% Relative Humidity/101.325 kPa Calculated using SAE-ARP-866A²² and SAE-ARP-5534²³

Frequency (Hz)	Reference absorption (dB/100 m)	ARP-866A ²² 10°C/80% relative humidity (dB/100 m)	ARP-5534 ²³ 10°C/80% relative humidity /101.325 kPa (dB/100 m)
50	0.033	0.021	0.007
63	0.033	0.027	0.011
80	0.033	0.034	0.017
100	0.066	0.043	0.026
125	0.066	0.053	0.039
160	0.098	0.068	0.056
200	0.131	0.086	0.078
250	0.131	0.107	0.104
315	0.197	0.135	0.134
400	0.230	0.172	0.166
500	0.295	0.216	0.201
630	0.361	0.273	0.241
800	0.459	0.349	0.292
1,000	0.590	0.439	0.364

1,250	0.754	0.552	0.471
1,600	0.983	0.738	0.636
2,000	1.311	0.985	0.893
2,500	1.705	1.322	1.297
3,150	2.295	1.853	1.931
4,000	3.115	2.682	2.922
5,000	3.607	3.216	4.461
6,300	5.246	4.580	6.826
8,000	7.213	6.722	10.398
10,000	9.836	9.774	15.661

At each NPD distance, the 1/3-octave band levels are A-weighted and decibel-summed to give the overall A-weighted level at each distance. This is repeated for both the departure spectrum (103) and the approach spectrum (205). For each NPD distance, the A-weighted levels are then subtracted to give the increment, ΔL . The A-weighted levels and increments Δ_{AA} are shown in Table 11-5 for SAE-ARP-866A²² and Table 11-6, Table 11-7, and Table 11-8 for SAE-ARP-5534²³.

Table 11-4 A-weighted Levels for Reference and SAE-ARP-866A²² Atmosphere and Difference Between Each Atmosphere, ΔL

Distance (ft)	DEP_103			ARR_205		
	$L_{A,ref}$ (dBA)	$L_{A,866A}$ (dBA)	ΔL (dB)	$L_{A,ref}$ (dBA)	$L_{A,866A}$ (dBA)	ΔL (dB)
200	97.0	97.2	0.2	95.8	95.9	0.1
400	90.3	90.6	0.3	88.9	89.2	0.3
630	85.6	86.0	0.4	84.2	84.6	0.4
1,000	80.6	81.2	0.6	79.2	79.8	0.5
2,000	72.5	73.4	0.9	71.3	72.2	0.8
4,000	63.6	64.9	1.3	62.7	63.9	1.2
6,300	57.4	59.0	1.5	56.4	58.0	1.6
10,000	50.7	52.5	1.8	49.5	51.4	2.0
16,000	43.3	45.5	2.2	41.8	44.1	2.3
25,000	35.3	38.2	2.8	34.0	36.7	2.7

Table 11-5 A-weighted Levels for Reference and SAE-ARP-5534²³ Atmosphere and Difference Between Each Atmosphere, ΔL

Distance (ft)	DEP_103			ARR_205		
	$L_{A,ref}$ (dBA)	$L_{A,5534}$ (dBA)	ΔL (dB)	$L_{A,ref}$ (dBA)	$L_{A,5534}$ (dBA)	ΔL (dB)
200	97.0	97.1	0.1	95.8	95.8	0.0

Distance (ft)	DEP_103			ARR_205		
	L _{A,ref} (dBA)	L _{A,5534} (dBA)	ΔL (dB)	L _{A,ref} (dBA)	L _{A,5534} (dBA)	ΔL (dB)
400	90.3	90.6	0.3	88.9	89.1	0.2
630	85.6	86.1	0.4	84.2	84.6	0.3
1,000	80.6	81.3	0.7	79.2	79.8	0.6
2,000	72.5	73.7	1.2	71.3	72.4	1.1
4,000	63.6	65.4	1.8	62.7	64.4	1.7
6,300	57.4	59.6	2.1	56.4	58.6	2.2
10,000	50.7	53.2	2.4	49.5	52.2	2.7
16,000	43.3	46.2	2.9	41.8	45.0	3.2
25,000	35.3	38.9	3.6	34.0	37.7	3.7

The departure and approach increments shown in Table 11-4 and Table 11-5 are then added to the departure and approach ANP database NPD thrust levels (Table 11-6) to construct the new NPD with SAE-AIR-866A²² shown in Table 11-7 atmospheric absorption and new NPD with SAE-AIR-5534²³ atmospheric absorption shown in Table 11-8.

Table 11-6 Original NPD Data

NPD Identifier	Noise Descriptor	Op Mode	Power Setting	Power									
				L_200ft	L_400ft	L_630ft	L_1,000ft	L_2,000ft	L_4,000ft	L_6,300ft	L_10,000ft	L_16,000ft	L_25,000ft
V2527A	SEL	A	2,000	93.1	89.1	86.1	82.9	77.7	71.7	67.1	61.9	55.8	49.2
V2527A	SEL	A	2,700	93.3	89.2	86.2	83.0	77.7	71.8	67.2	62.0	55.8	49.3
V2527A	SEL	A	6,000	94.7	90.5	87.4	83.9	78.5	72.3	67.7	62.5	56.3	49.7
V2527A	SEL	D	10,000	95.4	90.7	87.3	83.5	77.7	71.1	66.3	60.9	54.6	47.4
V2527A	SEL	D	14,000	100.4	96.1	93.0	89.4	83.5	77.0	72.2	66.7	60.1	53.0
V2527A	SEL	D	18,000	103.2	99.1	96.2	92.9	87.4	81.1	76.5	71.1	64.9	57.9
V2527A	SEL	D	22,500	105.1	101.2	98.5	95.4	90.3	84.3	79.9	74.8	68.7	62.0

Table 11-7 Revised NPD Data Using SAE-ARP-866A²²

NPD Identifier	Noise Descriptor	Op Mode	Power Setting	Power									
				L_200ft	L_400ft	L_630ft	L_1,000ft	L_2,000ft	L_4,000ft	L_6,300ft	L_10,000ft	L_16,000ft	L_25,000ft
V2527A	SEL	A	2,000	93.2	89.4	86.5	83.4	78.5	72.9	68.7	63.9	58.1	51.9
V2527A	SEL	A	2,700	93.4	89.5	86.6	83.5	78.5	73.0	68.8	64.0	58.1	52.0
V2527A	SEL	A	6,000	94.8	90.8	87.8	84.4	79.3	73.5	69.3	64.5	58.6	52.4
V2527A	SEL	D	10,000	95.6	91.0	87.7	84.1	78.6	72.4	67.8	62.7	56.8	50.2
V2527A	SEL	D	14,000	100.6	96.4	93.4	90.0	84.4	78.3	73.7	68.5	62.3	55.8

V2527A	SEL	D	18,000	103.4	99.4	96.6	93.5	88.3	82.4	78.0	72.9	67.1	60.7
V2527A	SEL	D	22,500	105.3	101.5	98.9	96.0	91.2	85.6	81.4	76.6	70.9	64.8

Table 11-8 Revised NPD Data Using SAE-ARP-5534²³

NPD Identifier	Noise Descriptor	Op Mode	Power Setting	L_200ft	L_400ft	L_630ft	L_1,000ft	L_2,000ft	L_4,000ft	L_6,300ft	L_10,000ft	L_16,000ft	L_25,000ft
V2527A	SEL	A	2,000	93.1	89.3	86.4	83.5	78.8	73.4	69.3	64.6	59.0	52.9
V2527A	SEL	A	2,700	93.3	89.4	86.5	83.6	78.8	73.5	69.4	64.7	59.0	53.0
V2527A	SEL	A	6,000	94.7	90.7	87.7	84.5	79.6	74.0	69.9	65.2	59.5	53.4
V2527A	SEL	D	10,000	95.5	91.0	87.7	84.2	78.9	72.9	68.4	63.3	57.5	51.0
V2527A	SEL	D	14,000	100.5	96.4	93.4	90.1	84.7	78.8	74.3	69.1	63.0	56.6
V2527A	SEL	D	18,000	103.3	99.4	96.6	93.6	88.6	82.9	78.6	73.5	67.8	61.5
V2527A	SEL	D	22,500	105.2	101.5	98.9	96.1	91.5	86.1	82.0	77.2	71.6	65.6

11.1.5 Calculating Audibility

This appendix provides a description of the computation of the Time Audible (TAUD) metric in AEDT.

Audibility is defined as the ability for an attentive listener to hear aircraft noise. Detectability is based on signal detection theory^{51,52}, and depends on both the actual aircraft sound level (“signal”) and the ambient sound level (or “noise”). As such, audibility is based on many factors including the listening environment in which one is located. Conversely, detectability is a theoretical formulation based on a significant body of research. For the purposes of AEDT modeling the terms “audibility” and “detectability” are used interchangeably. The detectability level (d’) calculated in AEDT is based on the signal-to-noise ratio within one-third octave band spectra for both the signal and noise, using a 10log(d’) value of 7 dB.

There are three parts to the calculation of audibility in AEDT:

1. Calculate the detectability level ($D'L_{band}$) for each one-third octave band of the signal for a single contributing flight path segment;
2. Calculate the detectability level ($D'L_{total}$) for the overall signal for a single contributing flight path segment; and
3. Calculate absolute or percentage of time a signal is audible (detectable by a human) for a flight path (TAUD or TAUDP).

Definitions

- $L_{signal,band}$ sound level of the signal (aircraft) for a particular frequency band
- $L_{noise,band}$ sound level of the ambient noise for a particular frequency band
- η_{band} efficiency of the detector (a scalar value known for each frequency band)
- bandwidth one-third octave bandwidth

D'L _{band}	detectability level for a particular frequency band
D'L _{total}	total detectability level
d' _{band}	detectability for a particular frequency band
d' _{total}	sum of squares of detectability over all frequency bands
TAUD	absolute amount of time a signal is audible by humans
TAUDP	percentage of a time period that a signal is audible

Note that values of $L_{signal,band}$ and $L_{noise,band}$ are calculated for each segment-receiver pair and then the total audibility for a given flight track is summed from the individual segments.

Part I of Calculations

Calculate the detectability level for each one-third octave frequency band, and then determine if the signal for that frequency band is detectable.

The theory of detectability level is based on the following equation:

$$D' L_{band} = 10 \cdot \log_{10} \left[\eta_{band} \cdot (bandwidth)^{\frac{1}{2}} \cdot \left(\frac{signal}{noise} \right) \right] \tag{Eq. 11-45}$$

The following one-third octave band filter characteristics are used in the calculation of detectability:

Table 11-9 One-Third Octave Band Characteristics

ANSI Band #	Nominal Center Frequency (Hz)	Bandwidth (Hz)	10 log[η_{band}]
17	50	11	-6.96
18	63	15	-6.26
19	80	19	-5.56
20	100	22	-5.06
21	125	28	-4.66
22	160	40	-4.36
23	200	44	-4.16
24	250	56	-3.96
25	315	75	-3.76
26	400	95	-3.56
27	500	110	-3.56
28	630	150	-3.56
29	800	190	-3.56
30	1000	220	-3.56
31	1250	280	-3.76
32	1600	400	-3.96
33	2000	440	-4.16
34	2500	560	-4.36
35	3150	750	-4.56
36	4000	950	-4.96
37	5000	1100	-5.36

38	6300	1500	-5.76
39	8000	1900	-6.26
40	10000	2200	-6.86

1) Calculate the detectability level for each one-third octave frequency band.

$$D' L_{band} = (L_{signal,band} - L_{noise,band}) + \{10 \cdot \log_{10}[\eta_{band}] + 0.5 \cdot 10 \cdot \log_{10}[bandwidth]\} \quad \text{Eq. 11-46}$$

where

$10\log[\eta_{band}]$ one-third octave band specific constant (see Table 11-9), and
 $L_{noiseband}$ the addition of the un-weighted, measured one-third octave band ambient levels and the appropriate EASN level (see Table 11-10).

Figure 11-5 and Table 11-10 below present the Equivalent Auditory System Noise (EASN)⁵³ levels derived for modeling audibility using one-third octave band data.

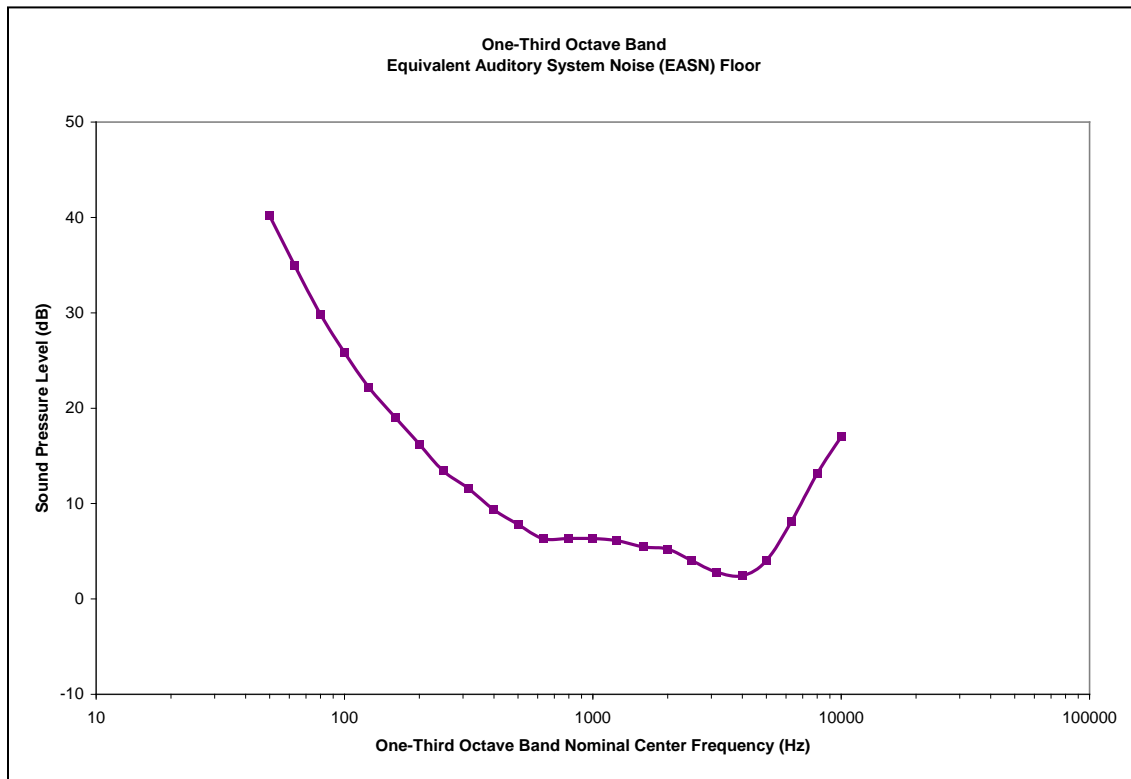

Figure 11-5 EASN Threshold

Table 11-10 EASN Threshold

One-Third Octave Band Nominal Center Frequency (Hz)	EASN Threshold (dB)
50	40.2
63	35.0
80	29.8
100	25.8
125	22.2
160	19.0
200	16.2
250	13.4
315	11.6
400	9.3
500	7.8
630	6.3
800	6.3
1000	6.3
1250	6.1
1600	5.4
2000	5.2
2500	4.0
3150	2.8
4000	2.4
5000	4.0
6300	8.1
8000	13.1
10000	17.0

- 2) Determine if the signal for that frequency band is detectable.

If $D'L_{band} \geq 7$, the signal is flagged as **detectable** for that frequency band.

Part II of Calculations

Determine if the overall signal is detectable.

- 1) Calculate the detectability for each one-third octave frequency band using the band detectability levels from Part I.

$$d'_{band} = 10^{\frac{D'L_{band}}{10}} \quad \text{Eq. 11-47}$$

- 2) Calculate the square root of the sum of squares of detectability over all frequency bands.

$$d'_{total} = \left[\sum_{band=17}^{40} (d'_{band})^2 \right]^{1/2} \quad \text{Eq. 11-48}$$

- 3) Calculate the total detectability level.

$$D'L_{total} = 10 \cdot \log_{10} [d'_{total}] \quad \text{Eq. 11-49}$$

- 4) Determine if the overall signal is detectable.

$$\begin{array}{ll} D'L_{total} \geq 7 & \text{the overall signal is detectable.} \\ D'L_{total} < 7 & \text{the overall signal is not detectable.} \end{array} \quad \text{Eq. 11-50}$$

Part III of Calculations

Calculate the absolute or percentage of time a signal is audible by a human; the time for a single contributing flight path segment is first calculated, then the absolute or percent time is calculated for an overall event or larger period of time (multiple flights for an average day or other time period).

- 1) Calculate the time audible (in seconds) for a single flight path.

For each segment, calculate time it takes aircraft to travel through flight path segment

$$segtime = \left(\frac{seglength}{segspeed} \right) \cdot \# \text{ of operations} \quad \text{Eq. 11-51}$$

where

seglength	length (in feet) of contributing flight path segment,
segspeed	average speed (in feet/s) during contributing flight path segment, and
segtime	time passed during contributing flight path segment(s).

If segment is flagged as detectable, then

$$TAud = TAud + segtime \quad \text{Eq. 11-52}$$

Once *segtime* has been totaled for all segments, the percent Time Audible over the user-specified time period will be:

$$\%TAud = \frac{TAud}{(T)} \quad \text{Eq. 11-53}$$

where

T the user-specified time period(s).

- 2) Calculate the time audible (in minutes) for a time period.

$$TAud = \frac{TAud}{\left(\frac{60 \text{ seconds}}{\text{minute}}\right)} \quad \text{Eq. 11-54}$$

11.2 Acoustic Data Development

This appendix provides detailed descriptions of the acoustic data development process for AEDT 2c: the acoustic data development criteria (Section 11.2.1), and an overview of spectral class development (Section 11.2.2).

11.2.1 Acoustic Data Development Criteria

Guidance for developing acoustic aircraft source data is presented in detail in Appendix B of SAE-AIR-1845 “Procedure for the Computation of Airplane Noise in the Vicinity of Airports”⁵⁹. While this guidance is specific for developing SEL NPDs for fixed-wing aircraft, it may be modified in order to develop NPDs for other base noise metrics (LAMAX, EPNL and PNLTM) and aircraft types (helicopters and military aircraft).

Supplemental criteria for developing fixed-wing aircraft and helicopter NPDs are presented below.

For fixed-wing aircraft, criteria for development of NPD data for use by AEDT 2c include the following¹³:

- Acoustically soft ground under the measurement microphone, similar to the terrain around the microphone during aircraft noise certification tests^{21,54}.
- For L_{AE} and L_{EPN} values, an integrated adjustment procedure (involving time integration over the full spectral time history) as compared with a simplified adjustment procedure (involving the spectrum measured at the time of maximum noise level only) for airplanes where adequate field data are available.
- Reference-day air attenuation coefficients as specified by SAE-ARP-866A²².
- L_{AE} and L_{EPN} values time-integrated over the upper 10 dB of the noise event as prescribed by FAA²¹ and SAE¹⁵. (The time interval from t_1 to t_2 designates the time in seconds, from the beginning to the end of the integration period for the sound produced by an airplane. The duration $[t_2 - t_1]$ should be long enough to include all significant contributions to the total noise exposure. Sufficient accuracy is usually achieved by integration over the time interval during which the frequency-weighted sound level is within ten dB of its maximum value.)
- L_{AE} and L_{EPN} values normalized to reference aircraft speed of 160 knots for both approach and departure NPDs.

- Noise levels specified as a function of power, in the form of corrected net thrust per engine^{xxxii}.

In addition, criteria for development of helicopter NPD data for use by AEDT 2c also include the following:

- L_{AE} and L_{EPN} values normalized to helicopter- and operation-specific reference speeds.
- Noise levels specified as a function of helicopter mode at the three microphone locations for dynamic modes. A single microphone location may be utilized for static modes. Noise levels may also be specified as a function of angle around the helicopter for static modes, in order to establish helicopter directivity during this configuration (see Section 4.5.3).

For the complete AEDT 2c Database Submittal Forms, please contact aedt-support@dot.gov.

The FAA position is to adhere closely to the above criteria both for the development and validation of the AEDT 2c NPD data. Diligent compliance is needed to ensure confidence in having consistent and comparable aircraft NPD and performance data. More information on the AEDT 2c data validation is presented in Section 11.2.3.

It is important to note that the civil fixed wing aircraft noise and performance data that make up the AEDT 2c database are also included in ICAO's Aircraft Noise and Performance (ANP) database. The ANP database is maintained by EUROCONTROL, and may be accessed via the internet at: <http://www.aircraftnoisemodel.org>.

11.2.2 Overview of Spectral Class Development

For each aircraft acoustic data submittal to the AEDT 2c Fleet database, a spectral class assignment is made by either pairing the aircraft with an appropriate existing spectral class, or developing a new spectral class for the aircraft. The original development and assignment of spectral classes was performed in 1999⁵⁵. Additional spectral classes are developed as needed, if there are no reasonable representations of that aircraft's spectral acoustic data in the current database.

This Section provides an example of the derivation of a spectral class for the AEDT 2c database. Departure spectral class #104 is used in this example. The class originally consisted of the Fokker F28-2000, the McDonnell-Douglas MD80 series aircraft (i.e., MD81, MD82 and MD83), and the Gulfstream G11B and G111 twin-engine turbofan aircraft.

The B737700 and the hushkit retrofitted B737N17 and B737N19 have NPD curves referenced to spectral class 104. They were added to the AEDT 2c database after the original derivations were performed and were found to agree with an already developed class based on the criteria described in Step 1 through Step 4 below⁵⁶. A more detailed description of the spectral class assignment process is described in Section 11.3.2.

^{xxxii} FAA AEE approval is required, in order to develop NPDs for fixed-wing aircraft for AEDT 2c with any power parameter other than net corrected thrust.

Step 1: Group Similar Aircraft/Engine Combinations

The first step in deriving a spectral class is the grouping of aircraft considered similar based on the combination of the aircraft and engine types. Considerations for grouping aircraft include the airframe, type of engine, number of engines, location of engine, and bypass ratio.

Step 2: Visual Inspection of Potential Spectral Class Data

After having grouped the aircraft by similar aircraft/engine types, the maximum-level spectra are compared. Specifically, each spectrum at the time of A-weighted Maximum Sound Level ($L_{AS_{mx}}$) is graphed on a single chart and visually inspected for similarity. Similarity is based on the shape of the spectrum and the relative location of any tones below 1,000 Hz. The spectra for class 104 are presented in Figure 11-6.

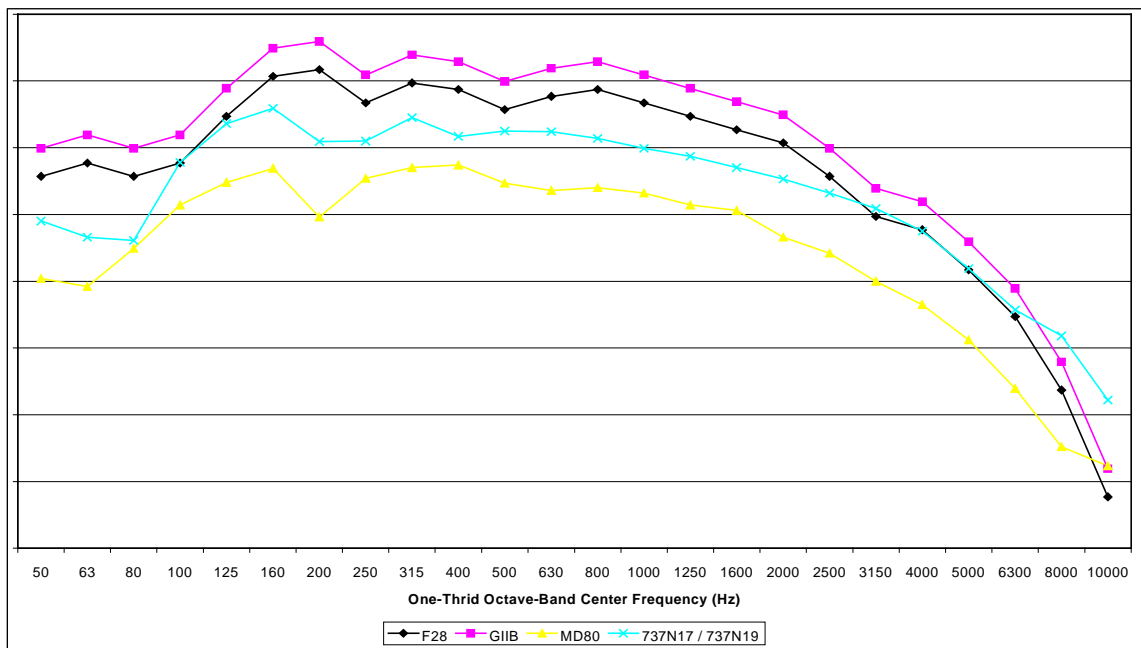

Figure 11-6 Departure Class 104

To aid in the visual inspection of the spectra, each one is normalized to a value of 70 dB at 1,000 Hz. Figure 11-7 presents the normalized spectra along with the *proposed* spectrum that would represent this spectral class. The representative spectrum for this spectral class is the weighted arithmetic average of the individual one-third octave-band spectral data. The weighting was based on a recent annual survey^{57,58} of the number of departures for each aircraft type^{xxxiii}.

^{xxxiii} The representative spectrum for commercial aircraft was determined considering operational information contained in the 1995 national operational data base [ref x]; and the representative spectrum for military aircraft was determined considering 1997 fleet inventory data [ref y].

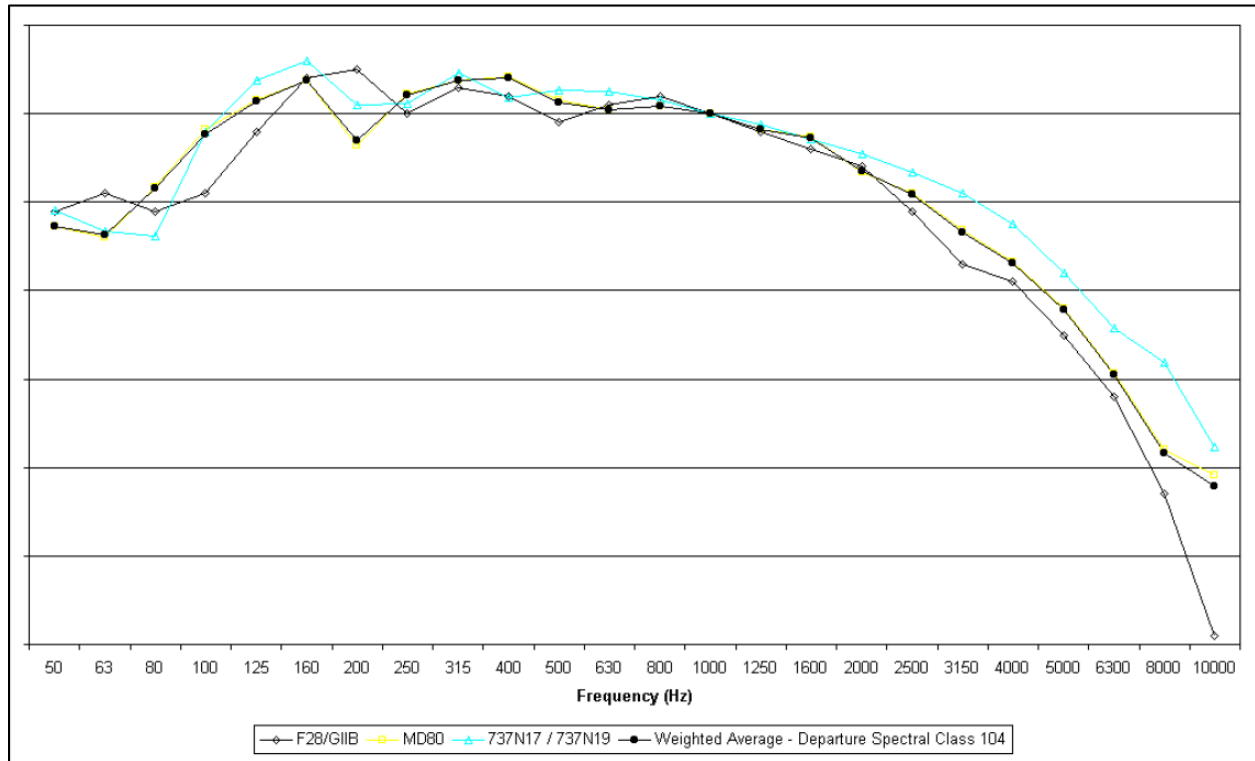

Figure 11-7 Normalized Spectral Class 104 Data

Step 3: Verification of Proposed Spectral Class

In order to verify the appropriateness of the proposed spectral class, the individual spectra and the representative were systematically evaluated using the acoustical calculations that require third-octave band spectra data: atmospheric absorption effects (Section 4.3.1), and barrier (or line of sight blockage, Section 4.3.6) effects. Testing parameters were chosen to represent the range of plausible airport conditions (temperature, humidity, slant distance, and path-length difference due to line-of-sight terrain blockage).

Step 3.A: Atmospheric Absorption Effects

The assessment of spectral classes in the calculation of atmospheric absorption adjustment (AA_{adj}) effects was conducted using a range of atmospheric conditions which are representative of realistic airport conditions. Monthly atmospheric data for the 34 Operational Evolution Plan (OEP) airports was originally obtained from the National Oceanic and Atmospheric Administration (NOAA) website by accessing the “Local Climatological Data Annual Summary” report. Reported were the 30-year average (1971-2004) monthly temperature, and a 1-year (2004) average monthly minimum and maximum relative humidity at each airport weather station. Thus, the database for this analysis contained 816 representative temperature/humidity conditions (34 airports, 12 months, 2 temperature/humidity combinations per month); 670 of these values were unique, 146 were duplicates. Table 11-11 contains the descriptive statistics of this database. Notably, the average condition at these airports closely resembles the International Standard Atmosphere, Standard Day condition of 59 °F and 70% relative humidity. Figure 11-8 graphically depicts the conditions represented in this database.

Table 11-11 OEP Airport Atmospheric Condition Statistics

	Mean	Median	Minimum	Maximum
Temperature	59 °F	61 °F	51 °F	93 °F
Relative Humidity	67%	67%	12%	93%

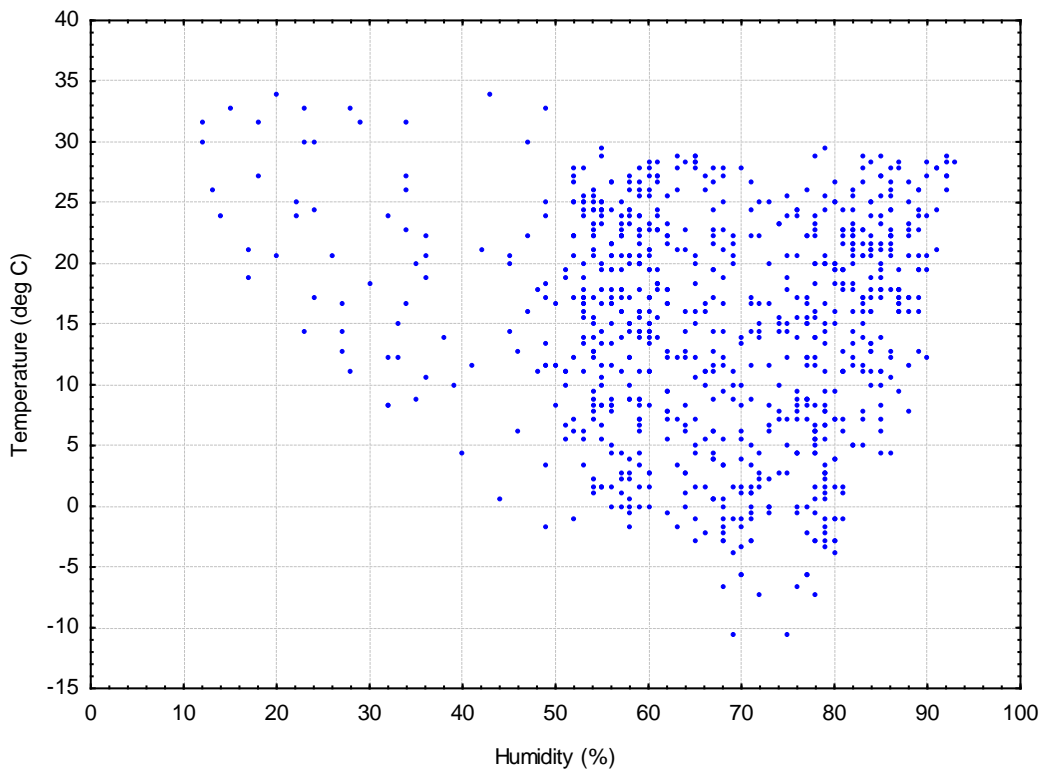

Figure 11-8 Range of Average Airport Atmospheric Conditions Represented in the AEDT Database

The AA_{adj} was calculated for each aircraft using discrete points from a uniform distribution of slant distance and the 816 values collected from the temperature and humidity condition distribution, using SAE-ARP-866A²². These discrete slant distance points correspond to the 10 standard AEDT 2c distances (200, 400, 630, 1,000, 2,000, 4,000, 6,300, 10,000, 16,000, and 25,000 ft). The uncertainties associated with the use of spectral classes in the calculation of AEDT 2c’s atmospheric absorption adjustment (ΔAA_{adj}) were computed by subtracting the AA_{adj} calculated using each individual aircraft from the AA_{adj} calculated using the representative spectrum from the associated spectral class. In this manner, a positive value indicates that the use of spectral classes results in an over-prediction of the resulting noise level. The resulting database of approximately 1.2 million ΔAA_{adj} uncertainty values is depicted in Figure 11-9. Table 11-12 presents further summary of these values grouped by aircraft power setting, aircraft type, atmospheric conditions, and slant distance. It tabulates the distribution of these values within ± 1 and ± 2 dB bounds. In general, the vast majority of these values are within ± 1 dB. Slightly larger errors occur for the following: 1) approach conditions, where SPLs in the high-frequency bands are prevalent in the source spectrum; 2) propeller-driven aircraft, where tonal components are present in the spectrum; and 3) low humidity conditions, where atmospheric absorption is most significant.

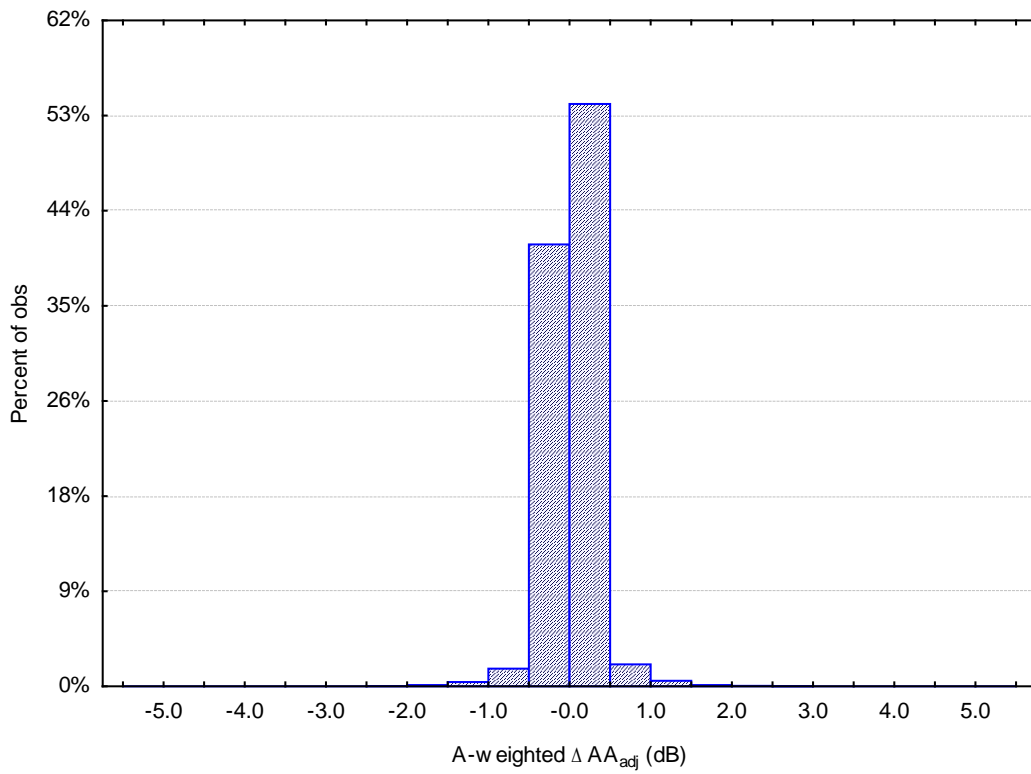

Figure 11-9 Histogram of A-weighted ΔAA_{adj}

Table 11-12 Summary of A-weighted ΔA_{adj}

Data Subset	% of Data Within ± 1 dB	% of Data Within ± 2 dB
All	98.7	99.9
Departure Power	99.4	100.0
Approach Power	98.1	99.8
Jet Aircraft	99.0	99.9
Prop Aircraft	98.0	100.0
Departure Power, Jet Aircraft	100.0	100.0
Approach Power, Jet Aircraft	98.0	99.7
Departure Power, Prop Aircraft	98.0	100.0
Approach Power, Prop Aircraft	98.4	100.0
Temp \leq 39°F, Humidity \leq 55%	97.7	99.5
Temp \geq 80.6°F, Humidity \leq 55%	99.1	99.8
Temp \leq 39°F, Humidity \geq 80%	98.1	99.3
Temp \geq 80.6°F, Humidity \geq 80%	98.7	99.9
200 ft Slant Distance	98.7	99.8
400 ft Slant Distance	97.4	99.6
630 ft Slant Distance	98.0	99.7
1,000 ft Slant Distance	99.2	100.0
2,000 ft Slant Distance	99.8	100.0
4,000 ft Slant Distance	99.6	99.9
6,300 ft Slant Distance	99.8	100.0
10,000 ft Slant Distance	99.9	100.0
16,000 ft Slant Distance	99.1	100.0
25,000 ft Slant Distance	96.0	100.0

Step 3.B: Line-of-Sight Blockage Effects

The second assessment was conducted to determine the uncertainty associated with the use of spectral classes for the calculation of the LOS_{adj} , which accounts for the attenuation due to line-of-sight blockage from terrain features. The LOS_{adj} uncertainty values (ΔLOS_{adj}) due to the use of spectral classes were computed by subtracting the LOS_{adj} calculated using each individual aircraft spectrum from the LOS_{adj} calculated using the representative spectrum from the associated spectral class. In this manner, a positive ΔLOS_{adj} represents an over-prediction of the resulting noise level.

ΔLOS_{adj} was calculated for 14 path-length differences (-1, 0.1, 0.5, 1, 2, 4, 6, 8, 10, 12, 14, 16, 18, and 20 ft)^{xxxiv} at the 816 average monthly OEP temperature and humidity conditions and the 10 standard AEDT 2c slant distances. The resulting database of approximately 17 million ΔLOS_{adj} values, or differences, associated with the use of spectral classes is depicted in Figure 11-10.

^{xxxiv} The value of $\delta_0 = -1$ ft is a value used for testing only that represents a grazing incidence case where the direct line-of-sight is not obstructed, and in turn will result in the computation of a negative Fresnel number. It is not meant to represent a realistic path length difference.

Table 11-13 summarizes the $\Delta\text{LOS}_{\text{adj}}$ with breakdowns by aircraft power setting, aircraft type, atmospheric conditions, slant distance, and path-length difference. The A-weighted $\Delta\text{LOS}_{\text{adj}}$ values are almost all within a ± 2.5 dB range, and the large majority of values (over 90%) are within a ± 1 dB range. Slightly larger errors occur for the following: 1) propeller-driven aircraft, where tonal components can dominate the spectrum; 2) shorter slant distances; and 3) path-length differences between 1 and 6 ft (near grazing incidence), where barrier attenuation is most frequency dependent.

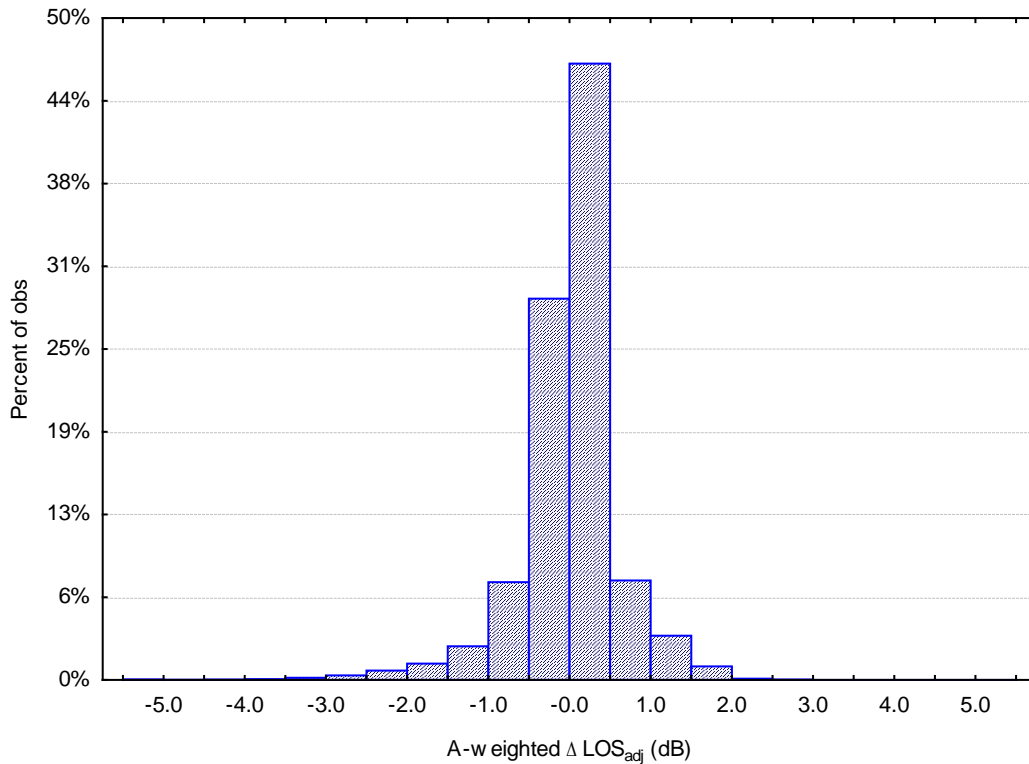

Figure 11-10 Histogram of A-Weighted $\Delta\text{LOS}_{\text{adj}}$

Table 11-13 Summary of A-Weighted $\Delta\text{LOS}_{\text{adj}}$

Data Subset	% of Data Within ± 1 dB	% of Data Within ± 2 dB
All	90.4	98.6
Departure Power	90.3	99.0
Approach Power	90.4	98.1
Jet Aircraft	93.8	99.4
Prop Aircraft	80.5	96.1
Departure Power, Jet Aircraft	92.8	99.7
Approach Power, Jet Aircraft	94.8	99.2
Departure Power, Prop Aircraft	83.0	97.0
Approach Power, Prop Aircraft	83.0	97.0
Temp \leq 39°F, Humidity \leq 55%	91.6	98.9
Temp \geq 80.6°F, Humidity \leq 55%	90.9	98.7
Temp \leq 39°F, Humidity \geq 80%	90.7	98.7
Temp \geq 80.6°F, Humidity \geq 80%	90.4	98.5
200 ft Slant Distance	87.4	96.5
400 ft Slant Distance	88.2	97.3
630 ft Slant Distance	88.8	97.8
1,000 ft Slant Distance	89.1	98.3
2,000 ft Slant Distance	89.0	98.8
4,000 ft Slant Distance	89.2	98.8
6,300 ft Slant Distance	89.9	99.0
10,000 ft Slant Distance	91.7	99.4
16,000 ft Slant Distance	94.2	99.7
25,000 ft Slant Distance	96.5	100.0
$\delta_0 = -1$ ft	100.0	100.0
$\delta_0 = 0.1$ ft	96.6	99.0
$\delta_0 = 0.5$ ft	87.4	97.6
$\delta_0 = 1$ ft	83.0	96.9
$\delta_0 = 2$ ft	80.9	96.6
$\delta_0 = 4$ ft	82.2	97.2
$\delta_0 = 6$ ft	83.9	98.0
$\delta_0 = 8$ ft	87.5	98.6
$\delta_0 = 10$ ft	89.2	98.6
$\delta_0 = 12$ ft	91.8	98.7
$\delta_0 = 14$ ft	94.3	98.9
$\delta_0 = 16$ ft	95.4	99.7
$\delta_0 = 18$ ft	96.1	100.0
$\delta_0 = 20$ ft	96.9	100.0

Step 4: Final Spectral Class

Given that the curves for each individual aircraft spectrum adjusted by the aforementioned spectral-based effects fall within the ± 1 -dB limit curves for all elevation angles, the proposed representative spectrum is considered to adequately represent the individual spectra used to derive the spectral class. Figure 11-11 presents the final spectral class.

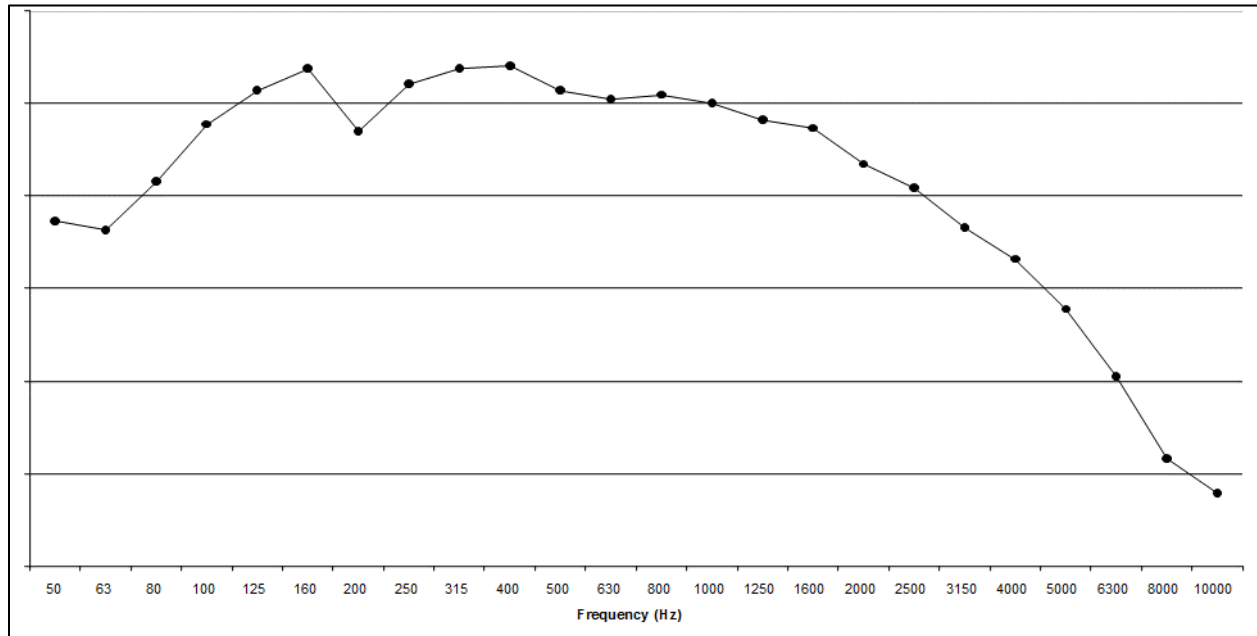

Figure 11-11 Departure Spectral Class 104

11.2.3 Performance and Acoustics

11.2.3.1 AEDT Fleet Database Submittal Guidance for Fixed Wing Aircraft

11.2.3.1.1 Data Submittal Overview

This section is a data request form for a submittal to the AEDT database. This database request form implements the fixed wing aircraft data requirements for a noise model as described in this report, as well as in the following supporting documents: SAE-AIR-1845⁵⁹, ECAC/CEAC Doc 29⁶⁰, and ICAO Doc 9911⁵⁶. The following describes the aircraft performance and noise data required for aircraft to be included in the ANP database. Additional guidance for developing aircraft performance and noise data submittals is found in SAE-AIR-1845⁵⁹ (see SAE-AIR-1845 Appendix A and Appendix B respectively).

11.2.3.1.2 Reference Conditions for Performance and Noise Data

Table 11-14 presents the standard reference conditions that are used for the development of all aircraft performance and noise data submittals to the AEDT Fleet database. The use of these reference conditions during data development ensures consistency across the ANP database. It is important to note that different atmospheric conditions are referenced for developing aircraft performance and aircraft noise data.

Table 11-14 Reference Conditions for Performance Data

Wind	4 m/s headwind, constant with height above ground (8 knots)
Runway elevation	Mean Sea Level (MSL)
Runway gradient	None
Surface Air temperature	15°C (59°F)
Number of engines supplying thrust	All
Atmosphere	For performance: International Standard Atmosphere (ISA) For noise: SAE-AIR-1845 reference atmosphere ⁵⁹

The Jet thrust coefficients of Section 11.2.3.1.6 may be validated for conditions other than 15°C sea level. For these equations, it has been shown that coefficients may be developed for temperatures of 15°C to temperatures up to the engine break point and for takeoff altitudes of sea level up until 5,000 feet above sea level.

Other input parameters such as rate-of-climb are not as flexible in their use and should be developed for a specific atmosphere. As per SAE-AIR-1845⁵⁹, the default operating procedures described in Sections 11.2.3.1.7 and 11.2.3.1.8 will be provided for airports at 15°C, sea level condition assuming the International Standard Atmosphere. As an example, the parameters for rate-of-climb, target speed, and cutback height for a procedure will be developed specifically for sea level ISA.

11.2.3.1.3 Aircraft and Engine Data

Where there are variations in certification weights and engine thrusts for a given model, provide data for the heaviest aircraft in terms of maximum gross takeoff weight in the model classification.

NOTE: Aircraft should reference a certification equivalent. Where there are variations in weight and engine thrusts for a given model, data for the heaviest aircraft that has been delivered in the model classification should be provided.

Table 11-15 General Aircraft and Engine Data Form

Aircraft model ^{xxxv}			
Engine model*			
Number of engines			
Engine type (jet, turboprop, piston)			
Propeller model, if applicable*			
Engine Installation (tail- or wing-mounted)			
Noise stage number (2, 3, 4)			
Maximum static thrust (lb/engine)			
Automated thrust restoration (yes, no)			
Weight class (small, large, heavy)			
Maximum gross takeoff weight (lb)			
Maximum gross landing weight (lb)			
Maximum landing distance (ft)			
Reference Certification Levels (dB) ^{xxxvi}	TO:	SL:	AP:

11.2.3.1.4 Guidance for Default Weights and Procedures

Default procedures should be developed for ranges suitable for representing the normal operating range of the aircraft. In this way, users may interpolate to other weights provided they have justification or other data. In the absence of more detailed data, users will resort to default weights corresponding to the trip length of the aircraft. Takeoff weights should be developed so as to increase with an increase in mission trip length. Weight assumptions should use industry planning assumptions for load factor, average passenger weight, excess cargo beyond passenger weight, and fuel required to complete mission trip length Table 11-20. Weights should be developed for the trip length ranges using the default mission planning rules below.

^{xxxv} As in the aircraft's type certificate.

^{xxxvi} TO = takeoff; SL= sideline during takeoff; and AP = approach.

Table 11-16 Departure Takeoff Weights Form

Stage number	Trip length (nmi)	Representative Range (nmi)	Weight
1	0-500	350	lb
2	500-1,000	850	lb
3	1,000-1,500	1,350	lb
4	1,500-2,500	2,200	lb
5	2,500-3,500	3,200	lb
6	3,500-4,500	4,200	lb
7	4,500-5,500	5,200	lb
8	5,500-6,500	6,200	lb
9	6,500-7,500	7,200	lb
10	7,500-8,500	8,200	lb
11	>8,500		lb
M	Maximum range at MTOW		lb

The following guidance has been established to provide common mission planning rules for determining default weights to the stage lengths given in the table above. For stage length “M”, this is maximum range with maximum fuel and no additional cargo other than what is already included in the payload assumption.

Table 11-17 Guidance for Determining Departure Takeoff Weights

Parameter	Planning Rule
Representative Trip Length	Min Range + 0.70*(Max Range – Min Range)
Load Factor	65% Total Payload.
Fuel Load	Fuel Required for Representative Trip Length + ATA Domestic up to 3,000 nmi and International Reserves for trip length > 3,000 nmi. As an example, typical domestics reserves include 5% contingency fuel, 200 nmi alternate landing with 30 minutes of holding.
Cargo	No additional cargo over and above the assumed payload percentage.

Not all trip lengths will be required for every aircraft as not all aircraft will be able to fly the higher trip length ranges. In addition to providing the trip length ranges for which an aircraft is able to fly, weights and procedures should also be developed for the aircraft maximum takeoff weight, MTOW, which is intended for modelling the maximum range (full fuel) of the aircraft. If relevant, a lower bound weight may also be provided that would be more representative of operations that would occur at weights below trip lengths of 350 nautical miles using the mission planning rules above.

11.2.3.1.5 Aerodynamic Coefficients

Aerodynamic coefficients for use with this methodology are required for available flap settings. The flap settings may be identified in degrees and abbreviations. Please provide data for all flap settings specified in Sections 11.2.3.1.7 and 11.2.3.1.8 and include separate coefficients per flap setting for cases with landing gear up and with landing gear down as appropriate.

Table 11-18 Aerodynamic Coefficients Form

Flap Configuration Identifier	Operation (A, D) ^{xxxvii}	Gear	Takeoff B (ft/lb)	Takeoff C (kt/ \sqrt{lb})	Land D (kt/ \sqrt{lb})	Drag/Lift R
	D	down			xxxviii	
	D	down				
	D	up				
	D	up				
	D	up				
	A	up				
	A	up				
	A	down				
	A	down				
	A	down				

11.2.3.1.6 Engine Coefficients

For jet aircraft, engine coefficients are required for maximum takeoff, maximum climb, and general thrust in terms of EPR or N1. The Max-Takeoff coefficients should be valid to 6,000 feet MSL, the Max-Climb, and General Thrust coefficients should be valid to 16,000 feet MSL. This is necessary so that the methodology accurately models operations at high altitude airports.

In addition, high temperature coefficients are required for operations above the thrust break temperature. AEDT uses the Max-Takeoff and Max-Climb coefficients below the breakpoint temperature and uses the Hi-Temp coefficients above the breakpoint temperature. The breakpoint temperature is at the intersection of the two curves. An example of Max-Takeoff and Hi-Temp Max-Takeoff curves is shown in Figure 11-12.

^{xxxvii} A = Approach, D = Depart

^{xxxviii} Not applicable.

Table 11-19 Jet Engine Coefficients Form

Thrust Type	E (lb)	F (lb/kt)	Ga (lb/ft)	Gb (lb/ft ²)	H (lb/°C)
Max-Takeoff					
Hi-Temp Max-Takeoff					
Max-Climb					
Hi-Temp Max-Climb					
General Thrust					
Hi-Temp General Thrust					
	K1a (lb/EPR)	K1b (lb/EPR ²)	or	K2 lb/(N1/√θ)	K3 lb/(N1/√θ) ²
General Thrust					
Hi-Temp General Thrust					

Example of MAX and HI TEMP curves

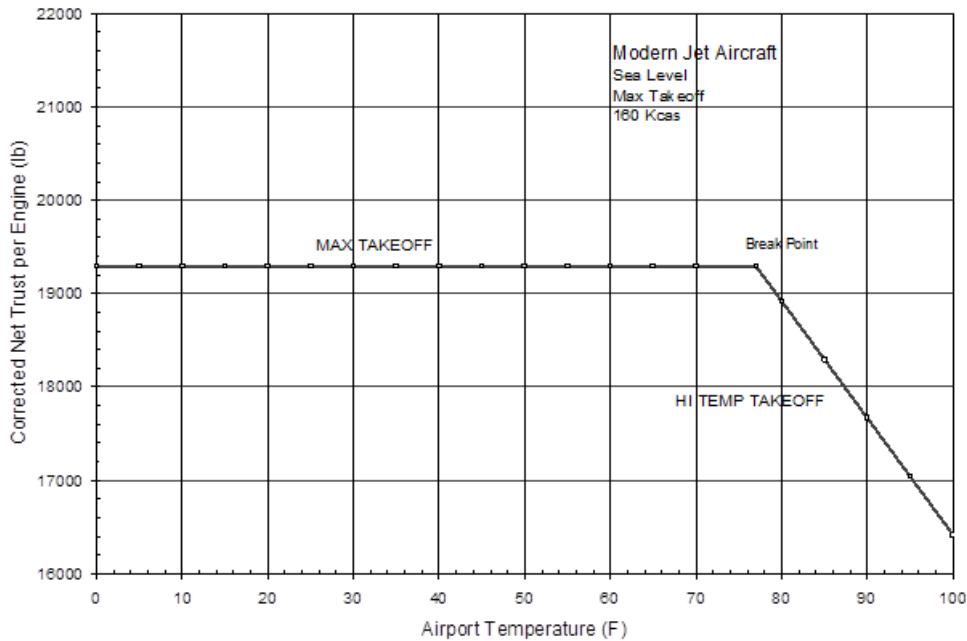

Figure 11-12 Example Maximum Takeoff Thrust vs. Temperature

For propeller-driven aircraft, engine coefficients are required for propeller efficiency and installed net propulsive power. Note that turboprop engine performance may be better modelled with the jet engine coefficients given above.

Table 11-20 Propeller Engine Coefficients Form

Thrust Type	Propeller Efficiency	Installed net propulsive horsepower (hp)
Max-Takeoff		
Max-Climb		

11.2.3.1.7 Departure Procedures

Departure procedures consist of a takeoff segment, and a combination of climb and acceleration segments up to an altitude of 10,000 feet AFE. A climb segment is defined by its endpoint altitude. An acceleration segment is defined by its rate of climb and the calibrated airspeed at its endpoint. The flap settings are indicated for endpoints of segments. These flap settings should coincide with those given in Section 4 above. Please provide procedural data for each stage length given in Section 11.2.3.1.5 above.

Default takeoff procedures include an ICAO A, an ICAO B, and a BBN/AAAI reference procedure^{xxxix}. Guidelines for the all three procedures are included below in Table 11-21. In developing these procedures, manufactures should use best judgment based on experience with their customers in determining a default takeoff flap setting and an appropriate power cutback point. Manufacturers of propeller-driven aircraft should use their own recommended procedures.

Table 11-21 Default Takeoff Procedure Descriptions

Default Procedure ^{xi} Modified BBN/AAAI Procedure	ICAO A	ICAO B
Takeoff at MaxToPower (full power) and Climb to 1,000 feet AFE	Takeoff MaxToPower (full power)	Takeoff at MaxToPower (full power)
Pitch over and cutback to climb power. Accelerate to zero flaps retracting flaps on schedule (clean configuration) ^{xli}	Climb at constant speed to 1,500 feet AFE	Climb to 1,000 feet AFE and pitch-over to accelerate at full power to clean configuration
Climb at constant speed to 3,000 feet AFE	Reduce thrust to Climb Power	At Clean Configuration, cutback top climb power
	Climb at constant speed to 3,000 ft AFE	Climb at constant speed to 3,000 ft
Upon achieving 3,000 feet AFE, accelerate to 250 knots ^{xli}	Accelerate while retracting flaps to Zero (clean configuration)	Upon achieving 3,000 feet AFE, accelerate to 250 kts
	Continue accelerating to 250 knots	
Upon achieving 250 knots, climb to 10,000 feet AFE	Upon achieving 250 knots, climb to 10,000 feet	Upon achieving 250 knots, climb to 10,000 feet

The AEDT Fleet database supports two types of departure procedures: procedural profiles and profile points. Procedural profiles utilize aircraft performance methods, and they take into account atmospheric effects on the aircraft performance. Profile points are an ordered set of fixed profile points specifies a two-dimensional trajectory for the aircraft, and they do not take into account atmospheric effects on the aircraft performance. Procedural profiles are considered to be of a higher data quality than the profile points, because they allow for more modelling flexibility. Therefore, the development of procedural profiles is recommended. If possible, both procedural profiles and the corresponding

^{xxxix} Historically, the BBN/AAAI reference procedure is known as the “DEFAULT” or “STANDARD” procedure.

^{xi} In many cases, the “Default” procedure is the same as the ICAO B procedure. Manufacturers of propeller-driven aircraft should use their own recommended procedures.

^{xli} During acceleration steps, flaps are retracted on scheduled according to the published guidance for the airplane. Power is distributed between climb and acceleration according to the flight management system for the aircraft. This distribution between climb and acceleration should be provided as part of the data submission. As an example, a parameter of 55/45 would signify that 55% power would be for climb and 45% would be for acceleration .

profile point should be submitted for each submitted takeoff procedure, to aid in the review of the data submittal.

Table 11-22 below should be completed for each submitted procedure (ICAO A, BBN/AAAI, etc.) over each takeoff weight given in Section 11.2.3.1.4. Table 11-24 should be completed for each corresponding submitted profile points. For both tables, the number and sequence of the procedure steps given below is for example purposes only and will vary depending on the aircraft and operating procedure. Additional information on CLIMB and ACCELERATION procedures steps is provided in Section 3.6.2.5.

Table 11-22 Takeoff Procedure Profile Form

Stage Number		Procedure Type (Procedural or Points)			Procedure Name		
Segment Type ^{xlii}	Thrust Type ^{xliii} (T/C)	Flap Configuration Identifier	Endpoint Altitude (ft AFE)	Rate-of-Climb (ft/min)	Endpoint Speed (KCAS)	Start Thrust ^{xliiv} (lb)	
Takeoff						lb	
Climb			ft			lb	
Climb			ft			lb	
Accelerate				fpm	kt	lb	
Accelerate				fpm	kt	lb	
Climb			ft			lb	
Climb			ft			lb	
Accelerate				fpm	kt	lb	
Accelerate				fpm	kt	lb	
Climb			10,000			lb	

Table 11-23 Takeoff Profile Points Form

^{xlii} Add, delete, and sequence the segments as necessary to represent a takeoff procedure.

Stage Number		Procedure Type (Procedural or Points)			Procedure Name	
Profile Points	Segment Type	Thrust Type (T/C)	Start Altitude (ft AFE)	Horizontal Coordinate (ft) Relative to the start-roll point on a runway	Aircraft True Airspeed (KCAS)	Start Thrust (lb)
1	Takeoff		ft	ft	kt	lb
2	Climb		ft	ft	kt	lb
3	Climb		ft	ft	kt	lb
4	Accelerate		ft	ft	kt	lb
5	Accelerate		ft	ft	kt	lb
6	Climb		ft	ft	kt	lb
7	Climb		ft	ft	kt	lb
8	Accelerate		ft	ft	kt	lb
9	Accelerate		ft	ft	kt	lb
10	Climb		10,000 ft	ft	kt	lb

11.2.3.1.8 Approach Procedures

A landing (or approach) profile should be calculated for a starting altitude of 10,000 feet above field elevation (AFE) following a 3 degree approach glide slope with a level segment at 3,000 feet AFE. The flap-setting identifiers should coincide with those given in Section 11.2.3.1.5 above. Reverse thrust distance is nominally 10% of ground roll distance, which is 90% of the stop distance minus 291 meters (954 feet). Reverse corrected net thrust is nominally 40% of maximum static thrust for narrow-body aircraft and 10% of maximum static thrust for wide-body aircraft. The idle/taxi distance is 90% of the stop distance minus 291 meters (954 feet). Stop distance can be smaller than the maximum landing distance reported in Section 11.2.3.1.3 above. Taxi/idle corrected net thrust is nominally 10% of maximum static thrust reported in Section 11.2.3.1.3 above.

Similar to the departure procedures, the ANP database supports both procedural profiles and profile points approach procedures. Procedural profiles are considered to be of a higher data quality than the profile points, because they allow for more modelling flexibility. Therefore, the development of procedural profiles is recommended. If possible, both procedural profiles and the corresponding profile

^{xliii} T = Max-Takeoff, C = Max-Climb, as defined in Section 10.2.3.1.6.

^{xliiv} These data are used to compare to computed thrust values.

point should be submitted for each submitted approach procedure, to aid in the review of the data submittal.

Table 11-24 below should be completed for each submitted landing procedure. Table 11-24 should be completed for each corresponding submitted profile points. For both tables, the number and sequence of the procedure steps given below is for example purposes only and will vary depending on the aircraft and operating procedure. Additional information on landing procedures steps is provided in Section 3.6.2.5.

Table 11-24 Approach Procedure Profile Form

Landing Weight (lb)					Stopping Distance (ft)			
Procedure Type (Procedural or Points)					Procedure Name			
Profile Point	Operation	Starting Flap Configuration	Starting Altitude (ft AFE)	Decent Angle (deg)	Start Speed ^{xlv} (KTAS)	Track Distance (Horizontal Length) (ft)	Start Thrust (% of static thrust)	Start Thrust ^{xlvi} (lb)
1	Descend							
2	Descend							
3	Descend							
4	Level-Decel							
5	Descend							
6	Land							
7	Decelerate							
8	Decelerate					0 ft		

Table 11-25 Approach Profile Points Form

Landing Weight (lb)			Stopping Distance (ft)		
Procedure Type (Procedural or Points)			Procedure Name		
Profile Points	Segment Type	Start Altitude (AFE)	Horizontal Coordinate (ft) Relative to the touchdown point ^{xlvii}	Aircraft True Airspeed (KCAS)	Start Thrust
1	Descend	ft	ft	kt	lb
2	Descend	ft	ft	kt	lb
3	Level-Decel	ft	ft	kt	lb
4	Descend	ft	ft	kt	lb
5	Land	0 ft	0 ft	kt	lb
6	Decelerate	0 ft	ft	kt	lb
7	Decelerate	0 ft	ft	kt	lb

11.2.3.1.9 Noise Data

Noise Power Distance (NPD) data are requested for noise exposure levels (Sound Exposure Level and Effective Perceived Noise Level) and maximum noise levels (Maximum A-weighted Sound Level and Maximum Tone-Corrected Perceived Noise Level). Specific guidelines⁵⁹ are followed for developing NPD data. NPDs should be provided for representative corrected net thrust values that span the procedures given in Sections 11.2.3.1.7 and 11.2.3.1.8. In general, noise measurements are collected under certification-like conditions and then are adjusted to different distances based on spherical divergence, altitude duration, time-varying aircraft speed, and atmospheric absorption. Where applicable, be sure to differentiate between approach and takeoff configuration noise data. For example, "6000-A" would be 6,000 lb. of corrected net thrust under approach configuration.

Two different SEL NPD calculation adjustment procedures⁵⁹: the integrated procedure and the simplified procedure. The integrated procedure requires a higher quality of data, where measured noise and performance data include spectral data available for the complete flyover time period of interest, whereas the simplified procedure is typical used with measured noise and performance data where spectral data are available only for the time of occurrence of the maximum sound level. The integrated procedure is recommended for computing NPDs for the data submittal form, although NPDs computed

^{xlv} Landing speed is for reference only; ICAO Doc 9911⁵⁶ methods calculate landing speed using the D coefficient and landing weight.

^{xlvi} These data are used to compare to computed thrust values.

^{xlvii} These horizontal coordinate values are negative during descent and positive during the landing ground roll.

using either integrated or simplified will be accepted. Where applicable, be sure to differentiate between NPDs generated using integrated and simplified procedures.

In general, noise measurements are collected under certification-like conditions and then are adjusted to different distances based on spherical divergence, altitude duration, time-varying aircraft speed, and atmospheric absorption. Noise data should be normalized to standard reference conditions specified in Section 11.2.3.1.2. Where applicable, be sure to differentiate between approach and takeoff configuration noise data. For example, "6000-A" would be 6,000 lb. of corrected net thrust under approach configuration.

It is important to note that SAE-AIR-1845⁵⁹ references SAE-ARP-866A²² for computing the atmospheric absorption adjustment during the NPD computation process. As mentioned in Section 11.1.4, SAE-ARP-5534²³ is being evaluated for use with noise certification, and is intended to replace SAE-ARP-866A²². In the meantime, the effects of study or airport-specific atmospheric conditions (temperature, relative humidity and atmospheric pressure) on noise levels may be accounted for using an atmospheric absorption adjustment as defined by either SAE-ARP-5534²³ or SAE-ARP-866A²² in the noise modelling. When developing NPDs from empirical data, SAE-ARP-866A²² should still be used to correct the empirical data to the source using the measurement day atmospheric conditions, and the reference atmospheric adjustment (in Section 11.1.4) should be used to compute the noise levels at the ten NPD distances using standard atmospheric conditions, as specified in SAE-AIR-1845⁵⁹.

Noise data for approach conditions should use the final approach landing speed as the reference speed for the noise data. All exposure based metrics such as EPNL and SEL should be further normalized to 160 knots using the duration correction equation⁵⁹.

Sound exposure levels should be calculated for the distances given on the tables, below which range from 200 feet to 25,000 feet. SEL values less than 75 dB at 1,000 feet may require additional extrapolation and may not be consistently derived or accessed for accuracy across all aircraft types. When modelling propeller aircraft, the propeller rotations per minute (RPM) should also be provided for each NPD.

Repeat Table 11-26 for each combination of noise type and operation (8 tables). Where applicable, be sure to differentiate between approach and takeoff configuration noise data. In each table, a minimum of two NPDs per operation mode and noise type is required, in order to have the minimum number of NPDs required for NPD interpolation and extrapolation as described in Section 4.2.2. The development of more than 2 NPDs for each combination of noise type and operation mode is strongly recommended. A larger NPD data set results in both the noise levels of the aircraft being more comprehensively represented, and noise levels being extrapolated over smaller ranges, thus improving the accuracy of the noise model utilizing those data. It is not uncommon for aircraft in the ANP database to have 3 or 4 approach NPDs and 6 or more departure NPDs for each noise metric type.

Table 11-26 NPD Data Form

Noise Type ^{xlviii}		Operation ^{xlix}				
Atmospheric Absorption Method (SAE-ARP-5534 ²³ or SAE-ARP-866A ²²)		SAE-AIR-1845 ⁵⁹ Integrated or Simplified Procedure				
Distance (ft)	Corrected Net Thrust per Engine (lb)					
	lb	lb	lb	lb	lb	lb
	RPM	RPM	RPM	RPM	RPM	RPM
200	dB	dB	dB	dB	dB	dB
400	dB	dB	dB	dB	dB	dB
630	dB	dB	dB	dB	dB	dB
1,000	dB	dB	dB	dB	dB	dB
2,000	dB	dB	dB	dB	dB	dB
4,000	dB	dB	dB	dB	dB	dB
6,300	dB	dB	dB	dB	dB	dB
10,000	dB	dB	dB	dB	dB	dB
16,000	dB	dB	dB	dB	dB	dB
25,000	dB	dB	dB	dB	dB	dB

Unweighted one-third octave-band spectral data corresponding to the time of $L_{PNTS_{mx}}$ and the time of $L_{AS_{mx}}$ should be provided for each thrust level represented in the NPDs. The spectra should be at the same corrected net thrust values as provided in the noise exposure and maximum noise tables, and span the one-third octave-bands from 50 to 10,000 Hz¹. The spectra should be measured at a speed close to 160 kts and adjusted to a reference distance of 1,000 feet using the atmospheric absorption. Repeat Table 11-27 for each combination of noise type and operation (4 tables). Where applicable, be sure to differentiate between approach and takeoff configuration noise data.

^{xlviii} NOISE TYPES:

- LAE = Sound Exposure Level (reference speed 160 kts)
- LEPN = Effective Perceived Noise Level (reference speed 160 kts)
- LAS_{mx} = Maximum A-weighted Sound Level (at speed close to 160 knots)
- LPNTS_{mx} = Maximum Tone-Corrected Perceived Noise Level (at speed close to 160 knots)

^{xlix} OPERATIONS:

- A = Approach
- D = Depart

¹ Note: if one-third octave-band spectral data are available at frequencies below 50 Hz (e.g., 20 Hz to 50 Hz), they should also be submitted, in order to support the enhancement of low frequency noise computation capabilities in future releases of AEDT.

Table 11-27 Spectral Data Form

Noise Type ^{li}		Operation				
One-Third Octave Band (Hz)	Corrected Net Thrust per Engine (lb)					
	lb	lb	lb	lb	lb	lb
50	dB	dB	dB	dB	dB	dB
63	dB	dB	dB	dB	dB	dB
80	dB	dB	dB	dB	dB	dB
100	dB	dB	dB	dB	dB	dB
125	dB	dB	dB	dB	dB	dB
160	dB	dB	dB	dB	dB	dB
200	dB	dB	dB	dB	dB	dB
250	dB	dB	dB	dB	dB	dB
315	dB	dB	dB	dB	dB	dB
400	dB	dB	dB	dB	dB	dB
500	dB	dB	dB	dB	dB	dB
630	dB	dB	dB	dB	dB	dB
800	dB	dB	dB	dB	dB	dB
1,000	dB	dB	dB	dB	dB	dB
1,250	dB	dB	dB	dB	dB	dB
1,600	dB	dB	dB	dB	dB	dB
2,000	dB	dB	dB	dB	dB	dB
2,500	dB	dB	dB	dB	dB	dB
3,150	dB	dB	dB	dB	dB	dB
4,000	dB	dB	dB	dB	dB	dB
5,000	dB	dB	dB	dB	dB	dB
6,300	dB	dB	dB	dB	dB	dB
8,000	dB	dB	dB	dB	dB	dB
10,000	dB	dB	dB	dB	dB	dB

11.2.3.2 AEDT Database Submittal Form for Propellor-Driven, Fixed-Wing Aircraft

This section is a data request form for a submittal to the AEDT database. Since the form in Section 11.2.3.1 may be used for either jet or propeller fixed-wing aircraft, it is formatted to allow for the entry of information that may be extraneous for propeller aircraft.

^{li} At time of L_{ASmx} and L_{PNTSmx}

Therefore, an abbreviated version of that form specific to propeller-driven aircraft is presented in Section 11.2.3.2. It is intended for the submittal of propeller-driven, fixed-wing aircraft noise and performance data for the AEDT database.

11.2.3.2.1 Reference Conditions For Performance Data

As per SAE-AIR-1845⁵⁹, the default operating procedures described in Section 11.2.3.2.4 will be provided for airports at 15°C, sea level condition assuming the ISA. As an example, the parameters for rate-of-climb, target speed, and cutback height for a procedure will be developed specifically for sea level ISA.

Table 11-28 Reference Conditions for Performance Data

Wind	4 m/s (8 kts) headwind, constant with height above ground
Runway elevation	Mean Sea Level (MSL)
Runway gradient	None
Surface Air temperature	15°C (59°F)
Number of engines supplying thrust	All
Atmosphere	For performance: International Standard Atmosphere (ISA) For noise: SAE-AIR-1845 atmosphere ⁵⁹

11.2.3.2.2 Aircraft and Engine Data

Where there are variations in certification weights and engine thrusts for a given model, provide data for the heaviest aircraft in terms of maximum gross takeoff weight in the model classification.

NOTE: Aircraft should reference a certification equivalent. Where there are variations in weight and engine power settings for a given model, data for the heaviest aircraft that has been delivered in the model classification should be provided. Furthermore, power should be presented in the form of horsepower.

Table 11-29 General Aircraft and Engine Data Form

Aircraft model ^{lii}			
Engine model*			
Number of engines			
Engine type (jet, turboprop, piston)			
Propeller model*			
Engine Installation (tail- or wing-mounted)			
Noise stage number (2, 3, 4)			
Sea Level rated HP (per engine)			
Automated thrust restoration (yes, no)			
Weight class (small, large, heavy)			
Maximum gross takeoff weight (lb)			
Maximum gross landing weight (lb)			
Maximum landing distance (ft)			
14 CFR Part 36 Reference Certification Levels ^{liii} , either:			
(a) Appendix B, or	TO:	SL:	AP:
(b) Appendix G	TO:		

11.2.3.2.3 Guidance for Default Weights and Procedures

Default procedures should be developed for ranges suitable for representing the normal operating range of the aircraft. In this way, users may interpolate to other weights provided they have justification or other data. In the absence of more detailed data, users will resort to default weights corresponding to the trip length of the aircraft. Takeoff weights should be developed so as to increase with an increase in mission trip length. Weight assumptions should use industry planning assumptions for load factor, average passenger weight, excess cargo beyond passenger weight, and fuel required to complete mission trip length. Weights should be developed for the trip length ranges using the default mission planning rules below. Stage “M” represents the maximum trip length (in nmi) of the individual aircraft at MTOW, and it should be submitted separately, even if the maximum trip length falls within one of the other stage number categories.

^{lii} As in the Aircraft’s type certificate.

^{liii} TO = takeoff; SL = sideline; and AP = Approach.

Table 11-30 Departure Takeoff Weights Form

Stage number	Trip length (nmi)	Representative Range	Weight
1	0-500	350	lb
2	500-1,000	850	lb
3	1,000-1,500	1,350	lb
4	1,500-2,500	2,200	lb
5	2,500-3,500	3,200	lb
6	3,500-4,500	4,200	lb
7	4,500-5,500	5,200	lb
8	5,500-6,500	6,200	lb
9	6,500-7,500	7,200	lb
10	7,500-8,500	8,200	lb
11	>8,500		lb
M	Maximum range at MTOW		lb

The following guidance has been established to provide common mission planning rules for determining default weights to the stage lengths given in the table above. For stage length “M”, this is maximum range with maximum fuel and no additional cargo other than what is already included in the payload assumption.

Table 11-31 Guidance for Determining Departure Takeoff Weights

Parameter	Planning Rule
Representative Trip Length	$\text{Min Range} + 0.70 * (\text{Max Range} - \text{Min Range})$
Load Factor	65% Total Payload.
Fuel Load	Fuel Required for Representative Trip Length + ATA Domestic up to 3,000 nmi and International Reserves for trip length > 3,000 nmi. As an example, typical domestics reserves include 5% contingency fuel, 200 nmi alternate landing with 30 minutes of holding.
Cargo	No additional cargo over and above the assumed payload percentage.

Not all nine trip lengths will be required for every aircraft as not all aircraft will be able to fly the higher trip length ranges. In addition to providing the trip length ranges for which an aircraft is able to fly, weights and procedures should also be developed for the aircraft MTOW, which is intended for modelling the maximum range (full fuel) of the aircraft. If relevant, a lower bound weight may also be

provided that would be more representative of operations that would occur at weights below trip lengths of 350 nmi using the mission planning rules above.

11.2.3.2.4 Aerodynamic Coefficients

Aerodynamic coefficients for use with the SAE-AIR-1845⁵⁹ equations are required for available flap settings. The flap settings may be identified in degrees and/or abbreviations. Please provide data for all flap settings specified in Sections 11.2.3.2.5 and 11.2.3.2.6, and include separate coefficients per flap setting for cases with landing gear up and with landing gear down as appropriate. Fixed gear aircraft do not require gear position information.

Table 11-32 Aerodynamic Coefficients Form

Flap Configuration Identifier	Operation (A, D) ^{liv}	Gear	Takeoff B (ft/lb)	Takeoff C (kt/vlb)	Land D (kt/vlb)	Drag/Lift R
	D	down				
	D	down				
	D	up				
	D	up				
	D	up				
	A	up				
	A	up				
	A	down				
	A	down				
	A	down				

11.2.3.2.5 Engine Coefficients

For propeller-driven aircraft, engine coefficients in accordance with SAE-AIR-1845⁵⁹ equations are required for propeller efficiency and installed net propulsive power. In many cases, turboprop engine performance may be better modeled with the jet engine coefficients given in the Section 11.2.3.1.

NOTE: the current version of the AEDT uses the Max-Climb power setting from the thrust reduction point up to 10,000 feet AFE. If the aircraft engine is flat-rated, no change is required. If the engine is normally aspirated, the average power in the climb should be used. Propeller efficiencies should also be averaged over the conditions when the different power settings are used.

^{liv} A = Approach, D = Depart

Table 11-33 Propeller Engine Coefficients Form

Power Setting	Propeller Efficiency	Installed net propulsive horsepower (hp)
Max-Takeoff		
Max-Climb		

11.2.3.2.6 Departure Procedures

Departure procedures consist of a takeoff segment, and a combination of climb and acceleration segments up to an altitude of 10,000 feet AFE. A climb segment is defined by its endpoint altitude. An acceleration segment is defined by its rate-of-climb and the calibrated airspeed at its endpoint. The flap settings are indicated for endpoints of segments. These flap settings should coincide with those given in Section 11.2.3.2.3 above. Please provide procedural data for each stage length given in Section 11.2.3.2.2 above.

Default takeoff procedures for jet aircraft include an ICAO A, an ICAO B, and a BBN/AAAI reference procedure, included in Section 11.2.3.1 in Table 11-21. However, these procedures may not be appropriate for propeller-driven aircraft. Manufacturers of propeller-driven aircraft should use their own recommended procedures. In developing these procedures, manufactures should use best judgment based on experience with their customers in determining a default takeoff flap setting and an appropriate power cutback point.

The ANP database supports two types of departure procedures: procedural profiles and profile points. Procedural profiles utilize aircraft performance methods, and they take into account atmospheric effects on the aircraft performance. Profile points are an ordered set of fixed profile points specifies a two-dimensional trajectory for the aircraft, and they do not take into account atmospheric effects on the aircraft performance. Procedural profiles are considered to be of a higher data quality than the profile points, because they allow for more modelling flexibility. Therefore, the development of procedural profiles is recommended. If possible, both procedural profiles and the corresponding profile point should be submitted for each submitted takeoff procedure, to aid in the review of the data submittal.

Table 11-34 below should be completed for each submitted procedural profile verses each takeoff weight given in Section 11.2.3.2.3. The number and sequence of the SAE-AIR-1845/Doc 29 procedure steps given below is for example purposes only and will vary depending on the aircraft and operating procedure. Database submittals should comply with manufacturer's recommended departure procedures. Additional information on CLIMB and ACCELERATION procedures steps is provided in SAE-AIR-1845⁵⁹. Note, certain SAE parameters such as rate-of-climb are not flexible in their use and should be developed for a specific atmosphere.

Table 11-34 Takeoff Procedural Profile Form

Stage Number		Procedure Type (Procedural or Points)			Procedure Name		
Profile Steps	Segment Type ^{iv}	Thrust Type ^{vi} (T/C)	Flap Configuration Identifier	Endpoint Altitude (ft AFE)	Rate-of-Climb (ft/min)	Endpoint Speed (KCAS)	Start Thrust ^{vii} (lb or %hp)
1	Takeoff			N/A	N/A	N/A	
2	Climb			ft	N/A	N/A	
3	Climb			ft	N/A	N/A	
4	Accelerate			N/A	ft/min	kt	
5	Accelerate			N/A	ft/min	kt	
6	Climb			ft	N/A	N/A	
7	Climb			ft	N/A	N/A	
8	Accelerate			N/A	ft/min	kt	
9	Accelerate			N/A	ft/min	kt	
10	Climb			10,000 ft	N/A	N/A	lb

^{iv} Add, delete, and sequence the segments as necessary to represent a takeoff procedure.

^{vi} T = Max-Takeoff, C = Max-Climb.

^{vii} Start thrust data may be presented in either corrected net thrust (lb) or percent horsepower (%hp). These data are used to compare to computed thrust values.

Table 11-35 Takeoff Profile Points Form

Stage Number		Procedure Type (Procedural or Points)			Procedure Name	
Profile Points	Segment Type	Thrust Type (T/C)	Start Altitude (ft AFE)	Horizontal Coordinate (m) Relative to the start-roll point on a runway	Aircraft True Airspeed (KCAS)	Start Thrust (lb or %hp)
1	Takeoff		ft	ft	kt	lb
2	Climb		ft	ft	kt	lb
3	Climb		ft	ft	kt	lb
4	Accelerate		ft	ft	kt	lb
5	Accelerate		ft	ft	kt	lb
6	Climb		ft	ft	kt	lb
7	Climb		ft	ft	kt	lb
8	Accelerate		ft	ft	kt	lb
9	Accelerate		ft	ft	kt	lb
10	Climb		10,000 ft	ft	kt	lb

11.2.3.2.7 Approach Procedures

A landing profile should be calculated for a starting altitude of 10,000 feet AFE following a 3 degree approach glide slope with a level segment at 3,000 ft AFE. The flap-setting identifiers should coincide with those given in Section 11.2.3.2.3 above. Reverse thrust distance is nominally 10% of ground roll distance, which is 90% of the stop distance minus 291 m (954 ft), if applicable. Stop distance can be smaller than the maximum landing distance reported in Section 11.2.3.2.2. Reverse corrected net thrust is nominally 40% of maximum static thrust for narrow-body aircraft and 10% of maximum static thrust for wide-body aircraft. The idle/taxi distance is 90% of the stop distance minus 291 meters (954 ft). Taxi/idle corrected net thrust is nominally 10% of maximum static thrust reported in Section 11.2.3.2.2.

Similar to the departure procedures, the ANP database supports both procedural profiles and profile points approach procedures. Procedural profiles are considered to be of a higher data quality than the profile points, because they allow for more modelling flexibility. Therefore, the development of procedural profiles is recommended. If possible, both procedural profiles and the corresponding profile point should be submitted for each submitted approach procedure, to aid in the review of the data submittal.

Table 11-36 below should be completed for each submitted landing procedure. Table 11-37 should be completed for each corresponding submitted profile points. For both tables, the number and sequence of the procedure steps given below is for example purposes only and will vary depending on the aircraft and operating procedure. Additional information on landing procedures steps is provided in Section 3.7.7.

Table 11-36 Approach Procedural Profile Form

Landing Weight (lb)					Stopping Distance (ft)			
Procedure Type (Procedural or Points)					Procedure Name			
Profile Step	Operation	Starting Flap Configuration	Starting Altitude (ft AFE)	Decent Angle (deg)	Start Speed ^{lviii} (KTAS)	Track Distance (Horizontal Length) (ft)	Start Thrust (% of static thrust)	Start Thrust ^{lix} (lb or %hp)
1	Descend		ft		kt			lb
2	Descend		ft		kt			lb
3	Descend		ft		kt			lb
4	Level-Decel		ft		kt	ft		lb
5	Descend		ft		kt			lb
6	Land		0 ft			ft		lb
7	Decelerate		0 ft		kt	ft		lb
8	Decelerate		0 ft		kt	0 ft		lb

^{lviii} Landing speed is for reference only; ICAO Doc 9911⁵⁶ methods calculate landing speed using the D coefficient and landing weight.

^{lix} These data are used to compare to computed thrust values.

Table 11-37 Approach Profile Points Form

Landing Weight (lb)			Stopping Distance (ft)		
Procedure Type (Procedural or Points)			Procedure Name		
Profile Points	Segment Type	Start Altitude (ft AFE)	Horizontal Coordinate (m) Relative to the touchdown point ^{lx}	Aircraft True Airspeed (KCAS)	Start Thrust (lb or %hp)
1	Descend	ft	ft	kt	lb
2	Descend	ft	ft	kt	lb
3	Descend	ft	ft	kt	lb
4	Level-Decel	ft	ft	kt	lb
5	Descend	ft	ft	kt	lb
6	Land	0 ft	0 ft	kt	lb
7	Decelerate	0 ft	ft	kt	lb
8	Decelerate	0 ft	ft	kt	lb

11.2.3.2.8 Noise Data

NPD data are requested for noise exposure levels (Sound Exposure Level and Effective Perceived Noise Level) and maximum noise levels (Maximum A-weighted Sound Level and Maximum Tone-Corrected Perceived Noise Level). Specific guidelines for developing NPD data are provided in SAE-AIR-1845⁵⁹. NPDs should be provided for representative corrected net thrust values that span the procedures given in Section 11.2.3.2.5 and Section 11.2.3.2.6. Corrected net thrust for propeller-driven aircraft should be calculated using the SAE-AIR-1845⁵⁹ equations (see Section 3.6.2.2.2) and the coefficients provided in this data submittal. In general, noise measurements are collected under certification-like conditions and then are adjusted to different distances based on spherical divergence, altitude duration, time-varying aircraft speed, and atmospheric absorption. Where applicable, be sure to differentiate between approach and takeoff configuration noise data. For example, "200-A" would be 200 lb. of corrected net thrust per engine under approach configuration.

Two different SEL NPD calculation adjustment procedures are defined in SAE-AIR-1845⁵⁹: the integrated procedure and the simplified procedure. The integrated procedure requires a higher quality of data, where measured noise and performance data include spectral data available for the complete flyover time period of interest, whereas the simplified procedure is typical used with measured noise and performance data where spectral data are available only for the time of occurrence of the maximum

^{lx} These horizontal coordinate values are negative during descent and positive during the landing ground roll.

sound level. The integrated procedure is recommended for computing NPDs for the data submittal form, although NPDs computed using either integrated or simplified will be accepted. Where applicable, be sure to differentiate between NPDs generated using integrated and simplified procedures.

In general, noise measurements are collected under certification-like conditions and then are adjusted to different distances based on spherical divergence, altitude duration, time-varying aircraft speed, and atmospheric absorption. Noise data should be normalized to standard reference conditions specified in Section 11.2.3.2.1. Where applicable, be sure to differentiate between approach and takeoff configuration noise data. For example, "200-A" would be 200 lb of corrected net thrust per engine under approach configuration.

It is important to note that SAE-AIR-1845⁵⁹ references SAE-ARP-866A²² for computing the atmospheric absorption adjustment during the NPD computation process. As mentioned in Section 4.3.1 SAE-ARP-5534²³ is being evaluated for use with noise certification, and is intended to replace SAE-ARP-866A²². In the meantime, the effects of study or airport-specific atmospheric conditions (temperature, relative humidity and atmospheric pressure) on noise levels may be accounted for using an atmospheric absorption adjustment as defined by either SAE-ARP-5534²³ or SAE-ARP-866A²² in the noise modelling. When developing NPDs from empirical data, SAE-ARP-866A²² should still be used to correct the empirical data to the source using the measurement day atmospheric conditions, and the reference atmospheric adjustment in Section 11.1.4 should be used to compute the noise levels at the ten NPD distances using standard atmospheric conditions, as specified in SAE-AIR-1845⁵⁹.

Noise data for approach conditions should use the final approach landing speed as the reference speed for the noise data. All exposure based metrics such as EPNL and SEL should be further normalized to 160 knots using the duration correction equation in SAE-AIR-1845⁵⁹.

Sound exposure levels should be calculated for the distances given on the tables, below which range from 200 feet to 25,000 feet. When modelling propeller aircraft, the propeller rotations per minute (RPM) should also be provided for each NPD.

Unweighted one-third octave-band spectral data corresponding to the time of $L_{PNTS_{mx}}$ and the time of $L_{AS_{mx}}$ should be provided for each thrust level represented in the NPDs. The spectral data should be measured at a reference distance of 1,000 ft, and span the one-third octave-bands from 50 to 10,000 Hz. Where applicable, be sure to differentiate between approach and takeoff configuration noise data.

Repeat Table 11-38 for each combination of noise type and operation mode (8 tables). Where applicable, be sure to differentiate between approach and takeoff configuration noise data. In each table, a minimum of two NPDs per operation mode and noise type is required, in order to have the minimum number of NPDs required for NPD interpolation and extrapolation as described in Section 11.1.4. The development of more than 2 NPDs for each combination of noise type and operation mode is strongly recommended. A larger NPD data set results in both the noise levels of the aircraft being more comprehensively represented, and noise levels being extrapolated over smaller ranges, thus

improving the accuracy of the noise model utilizing those data. It is not uncommon for aircraft in the ANP database to have 3 or 4 approach NPDs and 6 or more departure NPDs for each noise metric type.

Table 11-38 NPD Data Form

Noise Type ^{lxi}		Operation ^{lxii}					
Atmospheric Absorption Method (SAE-ARP-5534 ²³ or SAE-ARP-866A ²²)		SAE-AIR-1845 ⁵⁹ Integrated or Simplified Procedure					
Distance (ft)	Power Setting (lb or %hp)						
	lb	lb	lb	lb	lb	lb	
	RPM	RPM	RPM	RPM	RPM	RPM	
200	dB	dB	dB	dB	dB	dB	
400	dB	dB	dB	dB	dB	dB	
630	dB	dB	dB	dB	dB	dB	
1,000	dB	dB	dB	dB	dB	dB	
2,000	dB	dB	dB	dB	dB	dB	
4,000	dB	dB	dB	dB	dB	dB	
6,300	dB	dB	dB	dB	dB	dB	
10,000	dB	dB	dB	dB	dB	dB	
16,000	dB	dB	dB	dB	dB	dB	
25,000	dB	dB	dB	dB	dB	dB	

Unweighted one-third octave-band spectral data corresponding to the time of $L_{PNTS_{mx}}$ and the time of $L_{AS_{mx}}$ should be provided for each thrust level represented in the NPDs. The spectra should be at the same corrected net thrust values as provided in the noise exposure and maximum noise tables, and span the one-third octave-bands from 50 to 10,000 Hz^{lxiii}. The spectra should be measured at a speed

^{lxi} NOISE TYPES:

- LAE = Sound Exposure Level (reference speed 160 knots)
- LEPN = Effective Perceived Noise Level (reference speed 160 knots)
- LAS_{mx} = Maximum A-weighted Sound Level (at speed close to 160 knots)
- LPNTS_{mx} = Maximum Tone-Corrected Perceived Noise Level (at speed close to 160 knots)

^{lxii} OPERATIONS:

- A = Approach
- D = Depart

^{lxiii} Note: if one-third octave-band spectral data are available at frequencies below 50 Hz (e.g., 20 Hz to 50 Hz), they should also be submitted, in order to support the enhancement of low frequency noise computation capabilities in future releases of AEDT.

close to 160 knots, if possible, and adjusted to a reference distance of 1,000 feet using the atmospheric absorption table in Section 11.1.4. Repeat Table 11-39 for each combination of noise type and operation (4 tables). Where applicable, be sure to differentiate between approach and takeoff configuration spectral data.

Table 11-39 Spectral Data Form

Noise Type ^{lxiv}		Operation				
One-Third Octave Band (Hz)	Corrected Net Thrust per Engine (lb)					
	lb	lb	lb	lb	lb	lb
50	dB	dB	dB	dB	dB	dB
63	dB	dB	dB	dB	dB	dB
80	dB	dB	dB	dB	dB	dB
100	dB	dB	dB	dB	dB	dB
125	dB	dB	dB	dB	dB	dB
160	dB	dB	dB	dB	dB	dB
200	dB	dB	dB	dB	dB	dB
250	dB	dB	dB	dB	dB	dB
315	dB	dB	dB	dB	dB	dB
400	dB	dB	dB	dB	dB	dB
500	dB	dB	dB	dB	dB	dB
630	dB	dB	dB	dB	dB	dB
800	dB	dB	dB	dB	dB	dB
1,000	dB	dB	dB	dB	dB	dB
1,250	dB	dB	dB	dB	dB	dB
1,600	dB	dB	dB	dB	dB	dB
2,000	dB	dB	dB	dB	dB	dB
2,500	dB	dB	dB	dB	dB	dB
3,150	dB	dB	dB	dB	dB	dB
4,000	dB	dB	dB	dB	dB	dB
5,000	dB	dB	dB	dB	dB	dB
6,300	dB	dB	dB	dB	dB	dB
8,000	dB	dB	dB	dB	dB	dB
10,000	dB	dB	dB	dB	dB	dB

^{lxiv} At time of L_{ASmx} and L_{PNTSmx}.

11.2.3.3 AEDT Fleet Database Submittal Form for Helicopters

This section is a data request form for a submittal to the AEDT database. The following form describes the performance and noise data required for helicopters to be included in the AEDT Fleet database.

11.2.3.3.1 Reference Conditions for Performance Data

Helicopter noise data required for use in the AEDT should be corrected for the conditions contained in the following table:

Table 11-40 Reference Conditions for Performance Data

Wind	Zero
Runway/helipad elevation	Mean Sea Level (MSL)
Number of engines supplying thrust	All
Atmosphere	For performance: International Standard Atmosphere (ISA) For noise: SAE-AIR-1845 ⁵⁹ atmosphere

11.2.3.3.2 Aircraft and Engine Data

Where there are variations in certification weights for a given model, provide data for the heaviest aircraft in terms of maximum gross takeoff weight in the model classification.

NOTE: Aircraft should reference a certification equivalent. Where there are variations in weight for a given model, data for the heaviest aircraft that has been delivered in the model classification should be provided.

Table 11-41 General Helicopter and Engine Data Form

Helicopter model				
Description				
Owner category ^{lxv}				
Engine type ('turboshaft', 'piston')				
Number of main rotor blades				
Main rotor diameter (ft)				
Rotor speed (RPM)				
Maximum gross takeoff weight (lb)				
Wheels ('yes' or 'no')				
Engine model				
Number of rotors (main plus tail)				
Maximum Speed in Level Flight w/ Maximum Continuous Power, V_H (kt)				
Speed for Best Rate of Climb, V_Y (kt)				
Never Exceed Speed, V_{NE} (kt)				
14 CFR Part 36 Reference Certification Levels ^{lxvi} , either:				
(a) Appendix H, or	TO:	SL:	AP:	LF:
(b) Appendix J	TO:			LF:

11.2.3.3.3 Speed Coefficients

B_0 , B_1 , and B_2 are regression coefficients used in the calculation of a source-noise correction for level flight only, and are applied to the left, center and right NPDs. The correction accounts for changes in sound level associated with the deviation of advancing blade Mach number from that associated with the source data reference conditions. The coefficients are derived using a least-squares, 2nd order regression through measured $L_{PNTS_{mx}}$ data as a function of test speed.

To determine the sound level correction in AEDT, the relationship between the $PNLT_{max}$ (usually as-measured or corrected for distance) and the difference between the test M_{ADV} and the AEDT reference M_{ADV} ($\Delta(M_{ADV_T} - M_{ADV_R})$, computed using Eq. 4-58] must be determined. This relationship usually takes the form of a second order polynomial regression (with an upward curve that increases as the difference increases).

^{lxv} COM = commercial aviation, and GA = general aviation.

^{lxvi} TO = takeoff; SL = sideline; AP = approach; and LF = level flyover.

To determine the coefficients of the second order regression, the as-measured $PNLT_{max}$ versus $\Delta(M_{ADV_T} - M_{ADV_R})$ can be plotted in a spreadsheet or statistical analysis program, and the computed trendline computation will determine the regression coefficients (B_0 , the constant, B_1 , the first-order term, and B_2 , the second-order term). A separate regression shall be computed for each microphone position: centerline, left side, and right side, and provided in Table 11-42.

It should be noted that computing these coefficients with data taken over a limited range of airspeeds may result in an adjustment that produces unrealistic results, when applied far outside of this range of airspeeds in a modeled case.

Table 11-42 Helicopter Speed Coefficients

Position	Coefficients		
	B_0	B_1	B_2
Center			
Left			
Right			

11.2.3.3.4 Departure Procedures

Departure procedures consist of ground and flight idle segments, a combination of vertical and horizontal movement segments, and ending in a level flight segment. An idle segment is defined by its duration. A climb segment is defined by its endpoint altitude. An acceleration segment is defined by its calibrated airspeed at its endpoint. If data for additional takeoff weights are provided in addition to the maximum takeoff weight specified in Section 11.2.3.3.2, please provide procedural data for each takeoff weight.

The table below should be completed for each submitted procedure. The number and sequence of procedure steps given below is for example purposes only and will vary depending on the aircraft and operating procedure. In general taxi profiles, are modeled separately from departure profiles. Database submittals should comply with manufacturer’s recommended departure procedures.

Repeat table for each takeoff weight provided in the data submittal.

Table 11-43 Helicopter Departure Procedures Form

Takeoff Weight (lb)			lb		
Profile Steps	Segment Type ^{lxvii}	Duration (s)	Endpoint Altitude (AFE)	Track Distance	Endpoint Speed (KCAS)
1	Ground Idle	s			
2	Flight Idle	s			
3	Departure Vertical	s	ft		

^{lxvii} Add, delete, and sequence the segments as necessary to represent a takeoff procedure.

4	Departure Horizontal Accelerate			ft	kt
5	Departure Climb Accelerate		ft	ft	kt
6	Departure Constant Speed		ft	ft	
7	Departure Horizontal Accelerate	s		ft	kt
8	Level Fly			ft	

11.2.3.3.5 Approach Procedures

A landing profile should be calculated for a helicopter starting with a level flight segment, followed by a combination of vertical and horizontal movement segments (corresponding with a 6 degree approach, when appropriate) with , and ending with flight and ground idle segments. If available, profiles for additional approach angles (such as 3 degree, 9 degree, and 12 degree) should also be submitted.

Table 11-44 should be completed for each submitted procedure. The number and sequence of approach procedure steps given below is for example purposes only and will vary depending on the aircraft and operating procedure. Database submittals should comply with manufacturer's recommended approach procedures.

In general, taxi profiles are modeled separately from approach profiles. The number and sequence of taxi procedure steps given in Table 11-45 for a helicopter with wheels and in Table 11-46 for a helicopter without wheels is for example purposes only and will vary depending on the aircraft and operating procedure.

Table 11-44 Helicopter Approach Procedures Form

Approach Angle				
Segment Type ^{lxviii}	Duration (s)	Endpoint Altitude (AFE)	Track Distance (ft)	Endpoint Speed (KCAS)
Start Altitude ^{lxix}		ft		kt
Level Fly			ft	
Approach Horizontal Decelerate			ft	kt
Approach Constant Speed		ft	ft	
Approach Descend Accelerate		ft	ft	kt
Approach Vertical	s	ft		
Flight Idle	s	0 ft		
Ground Idle	s	0 ft		

Table 11-45 Helicopter Taxi Procedures for a Helicopter with Wheels Form

Segment Type ^{lxx}	Duration (s)	Endpoint Altitude (ft AFE)	Track Distance (ft)	Endpoint Speed (KCAS)
Ground Idle	s	0 ft		
Flight Idle	s	0 ft		
Taxi				kt
Flight Idle	s	0 ft		
Ground Idle	s	0 ft		

^{lxviii} Add, delete, and sequence the segments as necessary to represent a takeoff procedure.

^{lxix} Since there are no track distance and duration information associated with a “Start Altitude” segment, the endpoint speed and altitude correspond to the starting speed and altitude.

^{lxx} Add, delete, and sequence the segments as necessary to represent a takeoff procedure.

Table 11-46 Helicopter Taxi Procedures for a Helicopter without Wheels Form

Segment Type ^{lxxi}	Duration (s)	Endpoint Altitude (ft AFE)	Track Distance (ft)	Endpoint Speed (KCAS)
Ground Idle	s	0 ft		
Flight Idle	s	0 ft		
Departure Vertical	s	ft		
Taxi				kt
Approach Vertical	s	0 ft		
Flight Idle	s	0 ft		
Ground Idle	s	0 ft		

11.2.3.3.6 NOISE DATA

For helicopters, noise-operational mode-distance data consist of a set of three noise curves for dynamic operations and a single noise curve for static operations. Noise data are required for noise exposure levels (Sound Exposure Level [SEL] and Effective Perceived Noise Level [EPNL]) and maximum noise levels (Maximum A-weighted Sound Level [LAMAX] and Maximum Tone-Corrected Perceived Noise Level [PNLTM]). Noise levels should be adjusted for spherical spreading, distance duration, time-varying aircraft speed, and atmospheric absorption in accordance with the methodology presented in SAE-AIR-1845⁵⁹.

The following two tables present the noise type and operation mode used to define each noise-distance data set:

^{lxxi} Add, delete, and sequence the segments as necessary to represent a takeoff procedure.

Table 11-47 Noise Type for Each Helicopter NPD Data Set

Noise Type	Description
L _{AE}	Sound Exposure Level (note reference speed)
L _{EPN}	Effective Perceived Noise Level (note reference speed)
L _{ASmx}	Maximum A-weighted Sound Level (near reference speed)
L _{PNTSmx}	Maximum Tone-Corrected Perceived Noise Level (near reference speed)

Table 11-48 Operation Mode for Each Helicopter NPD Data Set

Operation Mode	Procedure Step Description	
A	Approach at constant speed	
D	Depart at constant speed	
X	Level flyover at constant speed	
G	Ground idle (GIDLE)	
H	Flight idle (FIDLE)	
I	Hover in ground effect (HIGE)	
J	Hover out of ground effect (HOGE)	
V	Vertical ascent in ground effect	
W	Vertical ascent out of ground effect	
B	Approach with horizontal deceleration	
C	Approach with descending deceleration	
E	Depart with horizontal acceleration	
F	Depart with climbing acceleration	
T	Taxi at constant speed	

Where available, level flyover noise-operational mode-distance data may be provided which are representative of different reference flight speeds. Similarly, approach data may be provided which are representative of different reference flight angles (i.e., 3, 6, 9 and 12degree approaches), and departure data may be provided for different takeoff weights (in addition to maximum takeoff weight).

11.2.3.3.6.1 Minimum Required Noise Data

A minimum of nine SEL NPD curves for dynamic operations and two LAMAX curves for static operations are required to model a helicopter in AEDT. Specifically, three (left, center and right) SEL curves are required for approach, departure and level flyover operations. Additionally, one hover LAMAX curve (either HIGE or HOGE, see 'Operation Types' table above for definitions) and one idle LAMAX curve (either GIDLE or FIDLE) are required.

11.2.3.3.6.2 Noise Data Tables for Dynamic Operations

Noise-operational mode-distance data should be provided for each dynamic operations (departure, approach and level flight), including left, center and right curves, representative of 45 degree, 90 degree, and 45 degree elevation angles, respectively.

Repeat the following table for each combination of noise type and dynamic operation.

Table 11-49 Helicopter NPDs for Dynamic Operations Form

Noise Type		Operation		
Distance (ft)	Speed (KCAS)			
	NPD Level (dB)			
	Left	Center	Right	
200	dB	dB	dB	
400	dB	dB	dB	
630	dB	dB	dB	
1,000	dB	dB	dB	
2,000	dB	dB	dB	
4,000	dB	dB	dB	
6,300	dB	dB	dB	
10,000	dB	dB	dB	
16,000	dB	dB	dB	
25,000	dB	dB	dB	

11.2.3.3.6.3 Noise Data Tables for Static Operations

A single curve should be provided for each static operation (ground idle, flight idle, hover in ground effect, and hover out of ground effect) collected directly in front of the helicopter (0 degree) at a nominal distance of approximately 200 feet. These data should be adjusted out to the 10 NPD distances for spherical spreading, distance duration, time-varying aircraft speed, and atmospheric absorption in accordance with the methodology presented in SAE-AIR-1845⁵⁹. Instead of the three noise curves representing helicopter directivity in dynamic operations (see Section 11.2.3.3.6.2), directivity for static operations is represented by the single noise curve plus a directivity adjustment (see Section 11.2.3.3.8).

Repeat the following table for each combination of noise type and static operation.

Table 11-50 Helicopter NPDs for Static Operations Form

Noise Type	Operation
Distance (ft)	NPD Level (dB)
200	dB
400	dB
630	dB
1,000	dB
2,000	dB
4,000	dB
6,300	dB
10,000	dB
16,000	dB
25,000	dB

11.2.3.3.6.4 NPD Adjustments

As discussed in Section 11.2.3.3.6.1, many helicopter data submittals may not consist of a comprehensive data set covering all operational modes. Therefore, the AEDT can perform noise calculations even if noise data is not available for every flight operational mode. When a flight profile uses a particular operating mode for which noise data are not available, the AEDT substitutes noise data from a similar operating mode. It also adds any dB offsets specified in the helicopter noise data set. The AEDT makes substitutions for missing NPD data sets as follows:

Table 11-51 Noise Data Substitutes for Missing Operational Modes

Missing Flight Operational Mode	Use Available Operational Mode
GndIdle	FltIdle
FltIdle	GndIdle
HovInGE	HovOutGE
HovOutGE	HovInGE
DepVertInGE	HovInGE + Vert Asc Adjustment
DepVert.OutGE	HovOutGE + Vert Asc Adjustment
AppVertInGE	HovInGE + Vert Des Adjustment
AppVert.OutGE	HovOutGE + Vert Des Adjustment
AppHorDec	Approach + Decel Hor Adjustment
AppDesDec	Approach + Decel Des Adjustment
DepHorAcc	Depart + Accel Hor Adjustment
DepClimAcc	Depart + Accel Clm Adjustment
Taxi	FltIdle (has wheels) HovInGE (no wheels)

The NPD Adjustments supplied below will only be applied to the corresponding helicopter NPD data. These NPD adjustments are typically manufacturer supplied, fixed noise level adjustments for operational modes that are not directly represented in the AEDT NPD database. Historically, these adjustments are based on empirical data, and it is up to the data supplier's discretion on how to develop these adjustments. These adjustments are always superseded by operation-specific helicopter NPDs, when available. If adjustments are not provided, then default values of 0.0 dB are used.

Table 11-52 NPD Adjustments for Helicopter Operations Form

Type of Operation	NPD Adjustment	NPD Adjustment Level (dB)
Departure Vertical (In Ground Effect and Out of Ground Effect)	Vert Asc Adjustment	dB
Approach Vertical (In Ground Effect and Out of Ground Effect)	Vert Des Adjustment	dB
Approach Horizontal Decelerate	Decel Hor Adjustment	dB
Approach Descend Decelerate	Decel Des Adjustment	dB
Departure Horizontal Accelerate	Accel Hor Adjustment	dB

11.2.3.3.7 Spectral Data

In addition to NPD data, unweighted one-third octave-band spectral data corresponding to the time of $L_{PNTS_{mx}}$ and the time of $L_{AS_{mx}}$ should be provided for each thrust level represented in the NPDs, including data corresponding to left, center and right NPD curves for dynamic operations. At a minimum, six tables

of unweighted one-third octave-band spectral data collected at the center microphone are requested that correspond to the following NPDs:

- maximum A-weighted sound level for approach,
- maximum A-weighted sound level for departure,
- maximum A-weighted sound level for level flight,
- maximum tone-corrected perceived noise level for approach,
- maximum tone-corrected perceived noise level for departure, and
- maximum tone-corrected perceived noise level for level flight.

The spectra should be for the same operational conditions provided in the noise exposure and maximum noise tables, and span the one-third octave-bands from 20 to 10,000 Hz^{lxxii}. The spectra should be measured at a speed close to the indicated reference speed and adjusted to a reference distance of 1,000 feet using the atmospheric absorption table⁵⁹. Repeat table for each combination of noise type and operation.

Table 11-53 Helicopter Spectral Data for Spectral Class Determination Form

Noise Type ^{lxxiii}	Operation ^{lxxiv}
Reference Speed (KCAS)	kt
One-Third Octave-Band Nominal Center Frequency (Hz)	One-Third Octave-Band Level (dB)
20	dB
25	dB
31.5	dB
40	dB
50	dB
63	dB
80	dB
100	dB
125	dB
160	dB
200	dB
250	dB
315	dB
400	dB

^{lxxii} Note: if one-third octave-band spectral data are available at frequencies below 50 Hz (e.g., 20 Hz to 50 Hz), they should also be submitted.

^{lxxiii} Noise type represents the third-octave band spectra at time of max (L_{ASmx} and L_{PNTSmx}).

^{lxxiv} Operations are abbreviated as follows: A = Approach, D = Depart and L = Level Flight

500	dB
630	dB
800	dB
1,000	dB
1,250	dB
1,600	dB
2,000	dB
2,500	dB
3,150	dB
4,000	dB
5,000	dB
6,300	dB
8,000	dB
10,000	dB

11.2.3.3.8 Directivity Data for Static Operations

Directivity data for static operations (HIGE, HOGЕ, GIDLE and FIDLE) shall be collected for modeling purposes, providing relative differences in sound level as a function of angle around the craft. Data for these operations shall be collected at locations representative of multiple directivity angles around the helicopter. Microphones should be placed around the helicopter at a nominal radial distance of approximately 200 feet. AEDT accommodates data in 15 degree increments, but will linearly interpolated to fill in missing data. At a minimum data should be collected at 45 degree increments around the helicopter.

Relative directivity adjustment data should be provided for static operations. If possible, directivity adjustments should be supplied for both hard ground (e.g., pavement) and soft ground (e.g., grass).

Table 11-54 Helicopter Directivity Adjustment Data Form

Helicopter Directivity Angle (deg)	Adjustment (dB)	
	Hard Ground	Soft Ground
180 (L)	dB	dB
165 (L)	dB	dB
150 (L)	dB	dB
135 (L)	dB	dB
120 (L)	dB	dB
105 (L)	dB	dB
90 (L)	dB	dB
75 (L)	dB	dB
60 (L)	dB	dB
45 (L)	dB	dB
30 (L)	dB	dB
15 (L)	dB	dB
0	dB	dB
15 (R)	dB	dB
30 (R)	dB	dB
45 (R)	dB	dB
60 (R)	dB	dB
75 (R)	dB	dB
90 (R)	dB	dB
105 (R)	dB	dB
120 (R)	dB	dB
135 (R)	dB	dB
150 (R)	dB	dB
165 (R)	dB	dB
180 (R) = 180 (L)	dB	dB

11.3 Aircraft Noise and Performance Data Verification and Validation

This Section describes the Validation and Verification (V&V) processes for new aircraft noise and performance database submittals for inclusion in AEDT 2c. Typically, the aircraft manufacturer or consultants to the manufacturer provide new database submittals. Because of the many different measurement and processing methodologies that could be employed by these parties, the quality of new submittals must always be inspected for consistency and completeness in the AEDT 2c Fleet database to ensure high data quality. This inspection process is referred to as validation and verification. As far as updated or revised database submittals are concerned, the scope of the inspection process is

specifically tailored to each submittal, based on the nature and extent of the update or revision. For in-depth updates, the full V&V process is conducted.

The format and content of a new database submittal are laid out in the AEDT Database Request Form. To request the AEDT Database Request Form, contact aedt-support@dot.gov. All database submittals should be checked against the requirements in this form for completeness. All required data must be present in order to run the submitted aircraft in AEDT 2c.

New database submittals are comprised of both noise and performance data; however, these two data sets may be evaluated independently. The noise portion of this database is divided into two major parts: the NPD data and the spectral data. Both of these data sets undergo the V&V process to insure the quality of the data. Once the quality of the data submittals has been checked, the spectral data are further processed and spectral class assignments are made.

The performance portion of this database (which also includes aircraft and engine data) also undergoes the V&V process to insure data quality. Performance data are checked for consistency with existing data and reasonableness. This includes a sensitivity analysis to determine impacts due to the new data.

After the noise and performance data have been reviewed, the entire aircraft noise and performance data set is incorporated into AEDT, and a comparison with noise certification data is conducted as a final check.

11.3.1 NPD and Spectral Data Verification and Validation

The new acoustic data for an aircraft consist of a set (or sets) of NPD data corresponding one-third octave-band data. Typically this data would be derived from aircraft certification and would consist at Effective Perceived Noise Level (L_{EPN}), Sound Exposure Level (L_{AE}), Maximum A-Weighted Sound Level (L_{ASmx}), and Maximum Tone-Corrected Perceived Noise Level (PNLT_{max} or $L_{PNLTsmx}$) NPD curves, representing each operation mode and thrust parameter values that span the range of thrust values used in the flight profiles for the aircraft^{lxxv}. The corresponding one-third octave-band data are measured at the time of the maximum A-weighted sound level, or the maximum tone-corrected perceived noise level. This data are described in SAE-AIR-1845 Appendix B⁵⁹. The data submitted by the manufacturer do not include recommended spectral class assignments, only spectral data corrected to 1,000ft assuming the SAE-AIR-1845⁵⁹ standard atmosphere^{lxxvi}.

The Verification and Validation of NPD and spectral data involves four major tasks:

- Internal consistency check
- Comparison of new NPDs to NPDs of similar aircraft
- Reprocessing of the new spectral data to produce NPDs, and the comparison of these NPDs with the new NPDs submitted by the manufacturer
- Comparison of modeled results at certification distances to the corresponding manufacturer data (either certification or NPD data)

^{lxxv} The submittal should differentiate between acoustic data for different operational modes (approach, departure, etc.).

^{lxxvi} Although previous submittals specified corrections using 25°C / 70% relative humidity or standard day sea level conditions of 15°C and 70% relative humidity, the use of these conditions is discouraged.

11.3.1.1 *Internal Consistency*

New aircraft acoustic data are checked for consistency across data files. The data must meet the AEDT 2c's requirements for completeness, consistency and must not contradict itself. For example, the aircraft NPDs must include sound pressure levels at all 10 NPD distances. The aircraft manufacturer is then contacted if significant anomalies or data gaps are observed.

11.3.1.2 *Comparison with NPDs of Similar Aircraft*

The new NPD data are compared with NPDs from similar aircraft. Aircraft are deemed to be similar based on airframe model, engine type, number of engines, static thrust, engine bypass ratio, maximum takeoff, and landing weights. The NPDs are compared for each aircraft across all thrust values, in order to evaluate the overall shape of the NPDs. Approach and departure NPDs are evaluated separately. Although NPDs from different aircraft should not necessarily be the same, the comparison aids in the identification of erroneous data points and atypical data trends. The aircraft manufacturer is then contacted if significant anomalies are observed.

11.3.1.3 *Reprocessing NPDs and Comparison with Manufacture Submitted NPDs*

The spectral data provided by the manufacturer are reprocessed using the simplified correction method from SAE-AIR-1845⁵⁹ and ICAO Annex 16 – Environmental Protection, Volume I - Aircraft Noise^{54, lxxvii}. The process takes spectral data, sound pressure level, reference environmental conditions and aircraft speed and slant distance as inputs, and generates NPDs. This process is used to generate a NPD database for use in sensitivity tests of each new aircraft.

The resulting NPD database is then compared to the corresponding new NPD database submitted by the manufacturer. If both sets of NPDs were generated with the simplified method, then they should yield very similar results, barring any problems or errors in the NPD generation process. If the manufacturer utilized the integrated method for generating the new NPDs, differences between the sets of NPD curves are expected.

Typically, these differences may be around 0 to 1 dB at shorter distances (less than 4,000ft) and around 3 to 5 dB at 16,000 to 25,000 ft. In general, larger differences may be expected for $L_{PNLTsmx}$ and L_{EPN} NPDs, because the integrated method deals with tone corrections on a record-by-record basis, as opposed to the simplified method, which applies them at the time of maximum sound level. The aircraft manufacturer is contacted if large differences are observed.

11.3.2 *Spectral Class Assignments*

The data submitted by the manufacturer do not include a recommended spectral class (SC) assignment, only the corrected spectral data. These spectral data consist of, at a minimum, two sets of unweighted, one-third octave-band sound levels measured at the time of maximum sound level (typically either L_{ASmx} or $L_{PNLTsmx}$) and corrected to a reference distance of 1,000 ft, representing thrust parameter values typical of departure and approach conditions. From these sets of data, a spectral class is assigned for each condition. When a submittal contains additional data which are representative of a range of thrust

^{lxxvii} Two methods of NPD generation are presented in ICAO Annex 16; simplified and integrated. The simplified method consists of correcting the maximum sound pressure level of an event for the test day slant distance, aircraft speed and meteorological conditions to the desired reference day conditions. The integrated method incorporates these corrections for each point on the time history of the event (0.5 second intervals) and corrects for background noise, yielding a corrected spectral time history from which NPDs are derived.

parameter values, spectral class assignments are based on the maximum departure and minimum approach thrust values.

There are three acoustic propagation phenomena in AEDT 2c which are spectrally dependent: Atmospheric absorption, excess ground attenuation, and shielding caused by barriers or terrain. As a result, spectral class assignments are based on the both the 'shape' of the spectral data and the behavior of these three effects. The assignment process has five major parts:

1. Normalization and computation of free-field effect.
2. Comparison of aircraft (AC) spectral shape to SC spectral shapes.
3. Comparison of atmospheric absorption effects calculated using AC spectra and SC spectra.
4. Comparison of ground effects calculated using AC spectra and SC spectra.
5. Comparison of barrier effects calculated using AC spectra and SC spectra.

These five processes are described in further detail below.

11.3.2.1 Normalization and Computation of Free-Field Effect

The submitted spectral data are normalized to 70 dB at 1,000 Hz. This allows for a visual shape comparison shown in Figure 11-13 and a computed comparison as detailed in Section 11.3.2.2.



Figure 11-13 Shape Comparison of Spectral Data

The submitted spectral data should be representative of free-field conditions. In most cases, however, the data were measured for certification purposes, and an adjustment is necessary to correct the data, which are typically measured by a 4 ft microphone over acoustically soft ground, to free-field conditions.

This adjustment is derived by computing the theoretical ground effect (detailed in Section 11.3.2.4) as a function of the emission angle (B) for source-to-receiver geometries using the 10 NPD slant distances,

emission angles of 30, 40, 50, 60, 70 and 80 s, and an effective flow resistivity equal to 150 cgs rays. The resulting 60 data points are summed and retained as the free-field adjustment.

11.3.2.2 *Comparison of Spectral Shape*

The normalized AC spectra are compared to all of the potential applicable SC spectral shapes (i.e., approach or departure, jet or helicopter). This comparison is accomplished by subtracting the AC SPLs in each one-third octave band from the SC SPLs in the corresponding one-third octave band. The absolute values of the individual SPL differences are summed. The resulting sums are compared and the spectral class that provides the lowest sum is retained as a possibility for the final assignment. In addition, any individual differences greater than +3 dBA (for the best-possible spectral class) are flagged. These flagged differences are examined and the possibility of the creation of a new spectral class is considered, as discussed in Section 11.2.2.

11.3.2.3 *Comparison of Atmospheric Absorption Effects*

The normalized AC spectra are used to compute the atmospheric absorption effect at the 10 NPD slant distances under 6 different temperature/humidity conditions using SAE-ARP-866A²²: the SAE standard atmosphere, the Annex 16⁵⁴ reference day (59°F /70%), and the four extremes of the Annex 16 allowable test window (86°F /35%, 86°F /85%, 50°F/55%, and 50°F /85%). These 60 points make up an atmospheric absorption profile. The individual point differences between the atmospheric absorption profile for the submitted AC and the atmospheric absorption profile for all of the SC's under consideration are summed. The resulting sums are compared and the spectral class that provides the lowest sum is retained as a possibility for the final assignment.

11.3.2.4 *Comparison of Ground Effects Calculated using AC Spectra and SC Spectra*

The normalized AC spectra are used to compute the A-weighted, excess ground attenuation effect at the 10 NPD slant distances for 12 emission angles (0.5, 1, 2, 3, 4, 5, 6, 7, 8, 9, 10, and 20 degrees). The theoretical ground effect calculation is an implementation of the model documented by Tony Embleton, Joe Piercy and Giles Daigle (the EPD Model) of the National Research Council (NRC) in Canada⁶¹. These 120 points make up a ground effect profile. The individual point differences between the ground effect profile for the submitted AC and the ground effect profile for all of the SC's under consideration are summed. The resulting sums are compared and the spectral class that provides the lowest sum is retained as a possibility for the final assignment.

11.3.2.5 *Comparison of Barrier Effects Calculated using AC Spectra and SC Spectra*

The normalized AC spectra are used to compute the A-weighted barrier effect (insertion loss) at the 10 NPD slant distances for 7 path-length differences (-4, 0, 4, 8, 12, 20, and 100 ft). The barrier effect calculation is documented in Section 4.3.6. These 70 points make up a barrier effect profile. The individual point differences between the barrier effect profile for the submitted AC and the barrier effect profile for all of the SC's under consideration are summed. The resulting sums are compared and the spectral class that provides the lowest sum is retained as a possibility for the final assignment.

11.3.2.6 *Final Assignment of Spectral Class*

Ideally, the spectral class possibilities resulting from Sections 11.3.2.2 through 0 are identical and a final assignment can be made without further analysis. If the possibilities do not agree, the reasons for disagreement are examined and either 1) a spectral class assignment is made based on a 'majority rule', or, if no clear majority exists, 2) the possibility of the creation of a new spectral class is considered.

11.3.3 Performance Data Verification and Validation

The new performance data for an aircraft consist of aircraft and engine data, default flight profiles with corresponding aircraft weights, and aerodynamic and engine coefficients. These data are described in SAE-AIR-1845 Appendix A⁵⁹.

The Verification and Validation of performance data involves four major tasks:

1. Internal consistency check
2. Consistency check with prior submittals
3. Reasonableness check
4. Suitability across different atmospheric conditions

These four tasks are described in further detail below.

11.3.3.1 Internal Consistency

New aircraft performance data are checked for consistency across data files. The data must meet the AEDT 2c's requirements for completeness, consistency and must not contradict itself. For example the aircraft weight for the highest stage-length profile must be lower than the aircraft's maximum gross takeoff weight in order to successfully run through AEDT 2c.

11.3.3.2 Consistency with Prior Submittals

The new performance data are compared with earlier submittals from the same source for consistency in content, naming conventions, etc. Comments are made to improve overall database consistency as appropriate. Although performance data from different aircraft should not necessarily be the same, the comparison aids in the identification of erroneous data points and atypical data formats. The aircraft manufacturer is then contacted if significant differences are observed.

11.3.3.3 Reasonableness

New performance data are checked for reasonableness by comparing to data from other similar aircraft types. Aircraft are deemed to be similar based on airframe model, engine (type and number of engines), static thrust, as well as maximum takeoff and landing weights. Any large deviation for a given field compared to other similar aircraft will be noted and questioned. Although performance data from different aircraft should not necessarily be the same, the comparison aids in the identification of erroneous data points and atypical data trends. In addition, single-event SEL contours are run to ensure that the data produces reasonable output in terms of contour size and shape. The aircraft manufacturer is then contacted if significant anomalies are observed.

11.3.3.4 Suitability for Varying Atmospheric Conditions

New performance data are checked to ensure they are suitable for use across the typical range of atmospheric conditions (airport elevation, temperature, etc.) encountered when modeling noise around an airport. For procedural profile data, the resultant altitude, speed, and thrust values vs. track distance are examined for a range of input atmospheric conditions to ensure that the profiles produce reasonable results. For example a defined procedural profile must be flyable from a sea-level airport on a 59°F day as well as from an airport at 5,000 ft MSL on a 90°F day.

Performance coefficients are derived from a wide range of manufacturer generated flight profiles, reflecting different operating weights, procedures and atmospheric conditions. As a final cross check,

the flight profiles are re-generated using the performance coefficients and compared with the original manufacturer-generated flight profiles.

11.3.4 Model Comparison of Submitted Data with Certification Data

Once the spectral class assignment and the performance data V&V process are completed, all of the new aircraft data (including the new NPDs) are entered into the AEDT 2c Fleet database (as either a User Defined aircraft or as updated database files). AEDT 2c is run to mimic a noise certification flight test with receivers at the certification distances for both approach and departure tracks. The AEDT 2c results at the certification locations are checked against the corresponding data submitted to the sponsoring organization by the manufacturer (either certification or NPD data). This acts as a final check of both the noise and performance data. The aircraft manufacturer is contacted if large differences are observed.

Additionally, new or updated data may be run through a sensitivity analysis to determine single-event or airport-wide noise impacts from the new data, as necessary. The level of detail and level of effort involved for a given sensitivity analysis may vary depending on the purpose of the supplemental analysis. When there are significant changes in data for single-event or airport-wide noise contours, the aircraft manufacturer is contacted, and the new data are further analyzed.

11.4 Emissions Dispersion Appendices

11.4.1 Constructing AERMOD Rectangle Sources from a Line Segment

To comply with AERMOD modeling best practices, some AEDT sources must be subdivided into smaller sub-segments while generating AERMOD rectangular “AREA” sources. This is achieved using the three-dimensional Cartesian coordinates for both ends of the line segment, its width, and the maximum desirable sub-segment length. AEDT applies the following algorithm:

1. Determine the line segment’s transverse distance, L , and width, w .
2. Define the maximum desirable sub-segment length to equal $10 w$.
3. Determine the number of sub-segments, n , by dividing the length by the maximum desirable sub-segment length and rounding the quotient up to the nearest integer.
4. For each integer i , from 1 to n , construct an AREA source as follows:
 - 4.1. Determine the position of point p_i which is $(i - 1)/n^{th}$ along the line segment.
 - 4.2. Offset p_i to left perpendicular to the segment by half the width of the line segment. p_i is now the “position” of the AREA source.
 - 4.3. Determine the elevation of source i to be the average elevation of its endpoints, $z = z_1 + (z_2 - z_1) \left(\frac{i-0.5}{n}\right)$, where z_1 is the elevation of the first point the line segment and z_2 is the elevation of the last point of the line segment.
5. Set the orientation angle of all of the AREA sources equal to $\text{atan2}(x_2 - x_1, y_2 - y_1)$ where “atan2” is the standard two-argument arctangent function (in degrees).
6. Set the length of all of the AREA sources equal to L/n .

11.5 Emissions Factor Calculation for Stationary Sources and Training Fires

This section describes the process AEDT performs to calculate the emissions for stationary sources and training fires. For each scenario-airport combination, the stationary sources and training fires are uniquely identified by their user-specified identification and type (i.e., stationary source or training fire).

11.5.1 Data Sources

To calculate the emissions for stationary sources (Section 5.3) requires the user input of annual throughput/consumption and model-generated pollutant emission factors. The methodologies for computing stationary source and training fire emission factors are presented in Appendix H of the FAA *Air Quality Procedures for Civilian Airports and Air Force Bases* (the Air Quality Handbook)⁶². THC emissions for stationary sources and training fires (except aircraft engine testing) are not reported by AEDT. They are used only to estimate the NMHC, VOC and TOG emissions. Refer to the Air Quality Handbook⁶² for more information.

The following sections describe how AEDT implements the methodologies for computing the emission factors required by Eq. 5-28.

11.5.1.1 Other Category

Eq. 11-55 is the generic equation used to compute emission factors for other category stationary sources from a raw emission factor and pollution control factor. All variables on the right hand side can be user-specified. The parameters used for VOC, TOG and NMHC are equal to those used for THC, and the parameters for PM-2.5 are the same as those used for PM-10. The THC emissions for stationary

sources and training fires are not reported by AEDT. They are used only to estimate the NMHC, VOC and TOG emissions.

Eq. 11-55. Other Category Stationary Source Emission Factors

$$EF_{p,s} = EF_{raw,p,s} \left(1 - \frac{PCF_{p,s}}{100}\right) \tag{Eq. 11-55}$$

where

- $EF_{p,s}$ The emission factor (units are user-specified) for pollutant, p , for source, s ;
- $EF_{raw,p,s}$ The raw emission factor (same units as $EF_{p,s}$) for pollutant, p , and source, s ; and
- $PCF_{p,s}$ The pollution control factor (%) for pollutant, p , and source, s .

11.5.1.2 Boilers and Space Heaters

For boilers and space heaters, Eq. 11-56 is used to compute the CO, NMHC, VOC, TOG and NOx emission factors, Eq. 11-57 is used to compute the SOx emission factor and Eq. 11-58 is used to compute the PM-10 and PM-2.5 emission factor. All variables on the right hand side (except the conversion factors) can be user-specified.

Eq. 11-56. Boilers and Space Heaters Emission Factors for CO, NMHC, VOC and NOx

$$EF_{p,s} = EF_{raw,p,s} f_{p,s} \left(1 - \frac{PCF_{p,s}}{100}\right) \tag{Eq. 11-56}$$

where

- $EF_{p,s}$ The emission factor (see Table 2.13 for units) for pollutant, p , for source, s ;
- $EF_{raw,p,s}$ The raw emission factor (same units as $EF_{p,s}$) for pollutant, p , and source, s ;
- $f_{p,s}$ The conversion factor (unitless) for pollutant, p , and source, s ; and
- $PCF_{p,s}$ The pollution control factor (%) for pollutant, p , and source, s .

Eq. 11-57. Boilers and Space Heaters Emission Factors for SOx

$$EF_{p,s} = EF_{raw,p,s} \left(1 - \frac{PCF_{p,s}}{100}\right) \begin{cases} 1 & \text{if } S_s \text{ is not specified for } s \\ S_s & \text{if } S_s \text{ is specified for } s, \text{ but not } \frac{Ca}{S_s} \\ S_s \left(\frac{Ca}{S_s}\right)^{-1.9} & \text{if } S_s \text{ and } \frac{Ca}{S_s} \text{ are specified for } s, \text{ but } \frac{Ca}{S_s} \geq 1.5 \\ \frac{31S_s}{39.6} & \text{if } S_s \text{ and } \frac{Ca}{S_s} \text{ are specified for } s, \text{ but } \frac{Ca}{S_s} < 1.5 \end{cases} \tag{Eq. 11-57}$$

where:

- $EF_{p,s}$ The emission factor (see Table 2.13 for units) for pollutant, p , for source, s ;
- $EF_{p,s,raw}$ The raw emission factor for pollutant, p , and source, s ;

$PCF_{p,s}$ The pollution control factor (%) for pollutant, p , and source, s ;
 S_s The fuel sulfur content (% by weight) for source, s ; and
 Ca/S_s The fuel molar calcium-to-sulfur ratio (unitless) for source, s .

Eq. 11-58. Boilers and Space Heaters Emission Factors for PM-10 and PM-2.5

$$EF_{p,s} = f_{p,s} \left(1 - \frac{PCF_{p,s}}{100} \right) \begin{cases} EF_{p,s,0} & \text{if } EF_{p,s,1} \text{ is not specified for } s \\ A_s EF_{p,s,1} & \text{if } EF_{p,s,0} \text{ is specified for } s, \text{ but } A_s \text{ is} \\ S_s EF_{p,s,1} & \text{if } EF_{p,s,0} \text{ is specified for } s, \text{ ut } S_s \text{ is} \\ S_s EF_{p,s,1} + EF_{p,s,0} & \text{otherwise} \end{cases} \tag{Eq. 11-58}$$

where:

$EF_{p,s}$ The emission factor (see Table 2.13 for units) for pollutant, p , for source, s ;
 $f_{p,s}$ The conversion factor (unitless) for pollutant, p , and source, s ;
 $PCF_{p,s}$ The pollution control factor (%) for pollutant, p , and source, s ;
 $EF_{p,s,0}$ The constant emission factor term for pollutant, p , and source, s ;
 $EF_{p,s,1}$ The linear emission factor term for pollutant, p , and source, s ;
 A_s The fuel ash content (% by weight) for source, s ; and
 S_s The fuel sulfur content (% by weight) for source, s .

The unitless conversion factor in Eq. 11-56 and Eq. 11-58 is unity (1) for CO, NOx and PM-10.

The molar calcium to sulfur ratio, Ca/S_s , in Eq. 11-57 is specified only for the following types: “Bituminous/Subbituminous Coal: Atmospheric Fluidized Bed, Circulating” (type 31) and “Bituminous/Subbituminous Coal: Atmospheric Fluidized Bed, Bubbling” (type 32).

Whether or not the constant and linear emission factor terms, $EF_{p,0}$ and $EF_{p,1}$, the fuel sulfur content, S_s , and the fuel ash content, A_s , in Eq. 11-57 and Eq. 11-58 are specified depends on the type. Table 11-55 summarizes for each type whether or not each of these four parameters are necessarily specified by using a “Y” for yes and “N” for no.

Table 11-55 Required Parameter Specifications for Boilers and Space Heaters

Type(s)	Description	$EF_{p,0}$	$EF_{p,1}$	S_s	A_s
1-5	Bituminous Coal: Pulverized, Dry Bottom, Wall Fired, ... Subbituminous Coal: Pulverized, Dry Bottom, Wall Fired, ...	N	Y	Y	Y
6	Bituminous Coal: Pulverized, Dry Bottom, Cell Burner Fired	Y	N	Y	N
7	Subbituminous Coal: Pulverized, Dry Bottom, Cell Burner Fired	Y	N	Y	N
8-12	Bituminous Coal: Pulverized, Dry Bottom, Tangentially Fired, ... Subbituminous Coal: Pulverized, Dry bottom, Tangentially Fired, ...	N	Y	Y	Y
13, 14	Bituminous Coal: Pulverized, Wet Bottom, Wall Fired, ...	N	Y	Y	Y

15	Subbituminous Coal: Pulverized, Wet Bottom, Wall Fired	N	Y	Y	Y
16	Bituminous Coal: Cyclone Furnace	N	Y	Y	Y
17	Subbituminous Coal: Cyclone Furnace	N	Y	Y	Y
18-23	Bituminous Coal: Spreader Stoker, ... Subbituminous Coal: Spreader Stoker, ...	Y	N	Y	N
24-27	Bituminous Coal: Overfeed Stoker, ... Subbituminous Coal: Overfeed Stoker, ...	Y	N	Y	N
28, 29	Bituminous/Subbituminous Coal: Underfeed Stoker, ...	Y	N	Y	N
30	Bituminous/Subbituminous Coal: Hand-fed Stoker	Y	N	Y	N
31, 32	Bituminous/Subbituminous Coal: Atmospheric Fluidized Bed, ...	Y	N	Y	N
33	Anthracite Coal: Stoker Fired	Y	N	Y	N
34	Culm Fuel: Fluidized Bed	Y	N	N	N
35	Anthracite Coal: Pulverized	N	Y	Y	Y
36	Anthracite Coal: Residential Space Heater	Y	N	Y	N
37	Anthracite Coal: Hand Fired	Y	N	N	N
50-56	Fuel Oil: ... >100 Million BTU/hr, No. 6 Oil, ...	Y	Y	Y	N
57-68	Fuel Oil: ... >100 Million BTU/hr, No. 5 Oil, ... Fuel Oil: ... >100 Million BTU/hr, No. 4 Oil, ... Fuel Oil: ... >100 Million BTU/hr, No. 2 Oil, ...	Y	N	Y	N
69, 70	Fuel Oil: ... <100 Million BTU/hr, No. 6 Oil	Y	Y	Y	N
71-75	Fuel Oil: Boiler <100 Million BTU/hr, No. 5 Oil Fuel Oil: Boiler <100 Million BTU/hr, No. 4 Oil Fuel Oil: ... <100 Million BTU/hr, Distillate Oil Fuel Oil: Residential Furnace	Y	N	Y	N
80-89	Natural Gas	Y	N	N	N
90-93	Liquefied Petroleum Gas	Y	N	Y	N

11.5.1.3 Emergency Generators

For emergency generators, Eq. 11-59 is used to compute the CO, NMHC, VOC, TOG, NOx, PM-10 and PM-2.5 emission factors, and Eq. 11-60 is used to compute the SOx emission factor. All variables on the right hand side except the conversion factor can be user-specified.

Eq. 11-59. Emergency Generator Emission Factors for All Pollutants except SOx

For $p \neq SOx$,

$$EF_{p,s} = EF_{s,p,raw} f_{p,s} \left(1 - \frac{PDF_{p,s}}{100}\right) \begin{cases} \frac{BHP_s}{1,000} & \text{is } BHP_s \text{ is specified for } s \\ 1 & \text{otherwise} \end{cases} \quad \text{Eq. 11-59}$$

where

- $EF_{s,p}$ The emission factor (see Table 2.13 for units) for pollutant, p , for source, s ;
- $EF_{s,p,raw}$ The raw emission factor for pollutant, p , and source, s ;
- $f_{p,s}$ The conversion factor (unitless) for pollutant, p , and source, s ;
- $PDF_{p,s}$ The pollution control factor (%) for pollutant, p , and source, s ; and

BHP_s The rated power (in horsepower) of source, s .

Eq. 11-60. Emergency Generator Emission Factors for SO_x

For $p \neq SO_x$,

$$EF_{p,s} = EF_{s,p,raw} \left(1 - \frac{PDF_{p,s}}{100}\right) \begin{cases} \frac{BHP_s}{1,000} & \text{if } BHP_s \text{ is specified for } s \\ S_s & \text{if } S_s \text{ is specified for } s \end{cases} \quad \text{Eq. 11-60}$$

where

$EF_{s,p}$ The emission factor (see Table 11-55 for units) for pollutant, p , for source, s ;

$EF_{s,p,raw}$ The raw emission factor for pollutant, p , and source, s ;

$PCFs,p$ The pollution control factor (%) for pollutant, p , and source, s ;

S_s The fuel sulfur content (% by weight) for source, s ; and

BHP_s The rated power (in horsepower) of source, s .

The unitless conversion factor in Eq. 11-59 is unity (1) for CO, NO_x and PM-10.

The rated horsepower, BHP_s , in Eq. 11-59 and Eq. 11-60 is specified only for the two (2) types employing the EPA methodology: "Gasoline Fuel (EPA Methodology)" (type 1) and "Diesel Fuel (EPA Methodology)" (type 2).

The fuel sulfur content, S_s , in Eq. 11-60 is specified for all types employing the U.S. Air Force (USAF) methodology, which are all those not employing the EPA methodology (types 3 through 8).

This methodology is consistent with methodology presented in Section H2.2 of the Air Quality Handbook⁶².

11.5.1.4 Incinerators

Eq. 11-61 is used to compute emission factors for incinerators. All variables on its right hand side can be user-specified, except the unitless conversion factor which is currently unity (1) for all pollutants. The parameters used for TOG and NMHC are equal to those used for VOC, and the parameters for PM-2.5 are the same as those used for PM-10.

Eq. 11-61. Incinerator Emission Factors.

$$EF_{p,s} = EF_{raw,p,s} f_{p,s} \left(1 - \frac{PDF_{p,s}}{100}\right) \quad \text{Eq. 11-61}$$

where

$EF_{p,s}$ The emission factor (in kilograms per metric ton) for pollutant, p , for source, s ;

$EF_{raw,p,s}$ The raw emission factor (in kilograms per metric ton) for pollutant, p , and source, s ;

$f_{p,s}$ The conversion factor (unitless) for pollutant, p , and source, s ; and

$PCF_{p,s}$ The pollution control factor (%) for pollutant, p , and source, s .

11.5.1.5 Aircraft Engine Testing

In general, aircraft engine testing emission factors are computed the same way that aircraft emissions are computed. In this case, emission factors correspond to the total emissions resulting from a single test cycle of the user-specified engine. The algorithm follows.

1. Initialize the emission factors to zero.
2. If the engine is ICAO certified and the engine's thrust rating is larger than 0, then use Eq. 5-23 to compute the startup emissions (which only consist of THC, NMHC, VOC and TOG pollutants).
3. Add the startup emissions to the emission factors.
4. Retrieve the times at each of the 4 power settings (i.e., 7%, 30%, 85% and 100% power).
5. Retrieve the EngineEIData object specific to the aircraft's engines.
6. Construct an emissionsInput object by making a copy of the default emissionsInput object.
 - 6.1. If FOA 3.0 is used (the airport country code is not "US"),
 - 6.1.1. Set FlagEPAAct = 0.
 - 6.1.2. Set Sulfur_Conversion equal to the scenario's user-specified *FOA 3.0 Sulfur-to-Sulfate Conversion Rate*.
 - 6.1.3. Set Sulfur_Content to the fuel sulfur content specified for the aircraft.
 - 6.2. Set humidity = (flight::Airport::humidity)/100 to convert from percent to a fraction.
 - 6.3. Set temperature = the current temperature in Kelvin.
 - 6.4. Set pressure = the current ambient pressure in Pascals.
 - 6.5. Set theta = θ = temperature / 288.15 degrees Kelvin.
 - 6.6. Set delta = δ = pressure / 101,325 Pascals.
 - 6.7. Set machNo = 0.
 - 6.8. If the aircraft uses a piston engine (the EngineEIData object's Flag_Piston = 1),
 - 6.8.1. Set NMHC_ConversionFactor = 8.905×10^{-1} , the NMHC conversion factor for piston engines.
 - 6.8.2. Set TOG_ConversionFactor = 117.371×10^{-2} , the TOG conversion factor for piston engines.
 - 6.8.3. Set VOC_ConversionFactor = 83.471×10^{-2} , the VOC conversion factor for piston engines.
 - 6.8.4. Set SpeciatedHC_MassRatios to the speciated OG mass fractions for piston engines.
 - 6.8.5. Set SpeciatedHC_Count to the number of the speciated OG mass fractions for piston engines.
 - 6.9. If the aircraft does not use a piston engine,
 - 6.9.1. Set NMHC_ConversionFactor = 1.0, the NMHC conversion factor for turbine engines.
 - 6.9.2. Set TOG_ConversionFactor = $1,156,234.049 \times 10^{-6}$, the TOG conversion factor for turbine engines.
 - 6.9.3. Set VOC_ConversionFactor = $9,947.855 \times 10^{-4}$, the VOC conversion factor for turbine engines.
 - 6.9.4. Set SpeciatedHC_MassRatios to the speciated OG mass fractions for turbine engines.
 - 6.9.5. Set SpeciatedHC_Count to the number of the speciated OG mass fractions for turbine engines.
7. For each of the four power settings,
 - 7.1. Set currentMode to the corresponding value.
 - 7.2. Set FlagPM = 0.
 - 7.3. If the aircraft is user-created and the smoke number for the current mode is 0 or "N/A" (the corresponding smoke number data member in the EngineEIData object is negative),

- 7.3.1. Set FlagPM = 1 to use the user-specified PM emission index.
- 7.4. Set fuelFlow = $B_m W_m \delta \theta^{-3.8}$ where B_m is the Boeing Fuel Flow Method 2 (BFFM2) installation effect coefficient for the current mode (see Table 5-1), W_m is the unadjusted fuel flow for the engine for mode, δ is the value of delta and θ is the value of theta.
- 7.5. Set fuelBurn = (fuelFlow)(t) where t is the corresponding time for the power setting in seconds.
- 7.6. Call the AEM.
- 7.7. Add the resulting CO, THC, NMHC, VOC, TOG, NOx, SOx and speciated organic gases emissions to the emission factors.
- 7.8. Add the resulting PM10 and PM2.5 emissions to the emission factors if and only if the aircraft is (a) user-created or (b) not user-created, uses ICAO certified engines and the applicable smoke number is greater than 0.

11.5.1.6 Fuel Tanks

Fuel tanks only emit NMHC, TOG and VOC emissions; moreover in this case, all three pollutants are equivalent. Therefore, the following equations apply to all three pollutants.

Eq. 11-62. Fuel Tank Emission Factor for Emission Inventories

$$EF_s = \begin{cases} SL_s + RSL_s + DFL_s + DSL_s & \text{if } N_s = 0 \\ \frac{SL_s + RSL_s + DFL_s + DSL_s}{N_s} + WL_s + TL_s & \text{otherwise} \end{cases} \quad \text{Eq. 11-63}$$

where

EF_s	The emission factor (see Table 5-8 for units) for source, s ; Note: if $N_s = 0$, then the EF_s will represent the annual emissions of the fuel tank
N_s	The user-specified annual throughput (in kiloliters) of source, s ;
SL_s	The annual standing loss (in kilograms) for source, s (see Eq. 11-64);
RSL_s	The annual rim seal loss (in kilograms) for source, s (see Eq. 11-72);
DFL_s	The annual deck fitting loss (in kilograms) for source, s (see Eq. 11-91);
DSL_s	The annual deck seem loss (in kilograms) for source, s (see Eq. 11-80);
WL_s	The working loss (in kilograms per kiloliter) for source, s (see Eq. 11-81); and
TL_s	The withdrawal loss rate (in kilograms per kiloliter) for source, s (see Eq. 11-84).

Eq. 11-64. Fuel Tank Annual Standing Loss

$$SL_s = \begin{cases} (365)(45,359.237 \times 10^{-5})V_s\rho_sE_sS_s & \text{if } s \text{ is horizontal or vertical fixed roof} \\ 0 & \text{otherwise} \end{cases} \quad \text{Eq. 11-64}$$

where

SL_s	The annual standing loss (in kilograms) for source, s ;
V_s	The vapor volume (in cubic feet) of source, s , (see Eq. 11-65);
ρ_s	The vapor density (in pounds per cubic foot) of source, s (see Eq. 11-66);
E_s	The expansion factor (unitless) of source, s (see Eq. 11-69);
S_s	The saturation factor (unitless) of source, s (see Eq. 11-71);
365	The number of days in a standard year; and
$45,359.237 \times 10^{-5}$	The number of kilograms in a pound (exact).

Eq. 11-65. Horizontal and Vertical Fixed Roof Fuel Tank Vapor Volume

$$V_s = \left(\frac{d_s^2}{(3.048 \times 10^{-1})^3} \right) \left\{ \begin{array}{l} \frac{l_s}{2} \text{ is } s \text{ is horizontal} \\ \frac{\pi}{4} (h_s - \bar{h}_{s,liquid}) \text{ is } s \text{ is vertical fixed roof} \end{array} \right. \quad \text{Eq. 11-65}$$

where

V_s	The vapor volume (in cubic feet) of source, s ;
l_s	The user-specified length (in meters) of source, s ;
d_s	The user-specified diameter (in meters) of source, s ;
h_s	The user-specified height (in meters) of source, s ;
$\bar{h}_{s,liquid}$	The user-specified average liquid height (in meters) of source, s ; and
0.3048	The number of meters in a foot (exact).

Eq. 11-66. Fuel Tank Vapor Density

$$\rho_s = \frac{W_s P_s}{(10.731) T_s} \quad \text{Eq. 11-66}$$

where

ρ_s	The vapor density (in pounds per cubic foot) of source, s ;
W_s	The vapor molecular weight (per mole) of source, s (see Table 11-56);
P_s	The true vapor pressure (in PSI) of source, s (see Eq. 11-67);
T_s	The liquid temperature (in degrees Rankine) of source, s (see Eq. 11-68); and
10.731	The universal gas constant (in PSI-cubic feet per lb-mol-°R).

Table 11-56 Fuel Tank Vapor Molecular Weight and Liquid Density

Fuel	Reid Vapor Pressure, RVP _s (in PSI)	Vapor Molecular Weight (mol ⁻¹)	Liquid Density, ρ_s , (lbs per gallon)
Jet Naphtha	N/A	80	6.4
Jet kerosene	N/A	130	7.0
Gasoline	6	69	5.6
	7	68	
	8	68	
	9	67	
	10	66	
	11	65	
	12	64	
	13	62	
Distillate Fuel Oil No. 2	N/A	130	7.1
Residual Fuel Oil No. 6	N/A	190	7.9

The Reid vapor pressure, RVP_s , in Table 11-56 is user-specified.

Eq. 11-67. Fuel Tank True Vapor Pressure

$$P_s = e^{(A_s - \frac{B_s}{T_s})} \quad \text{Eq. 11-67}$$

where

- P_s The true vapor pressure (in PSI) of source, s ;
- A_s The first pressure constant (unitless) of source, s (see Table 11-57);
- B_s The second pressure constant (in degrees Rankine) of source, s (see Table 11-57); and
- T_s The liquid temperature (in degrees Rankine) of source, s (see Eq. 11-68).

Table 11-57 Fuel Tank Pressure Constants

Fuel	A_s	B_s
Jet Naphtha (JP-4)	11.368	5,784.3
Jet Kerosene	12.39	8,933
Gasoline	$(15.64 - 1.854\sqrt{3}) - ((8.742 \times 10^{-1}) - 03.28\sqrt{3}) \ln(RVP_s)$	$(8,742 - 1,042\sqrt{3}) - (1,049 - 179.4\sqrt{3}) \ln(RVP_s)$
Distillate Fuel Oil No. 2	12.101	8,907
Residual Fuel Oil No. 6	10.104	10,475

The Reid vapor pressure, RVP_s , in Table 11-57 is user-specified.

Eq. 11-68. Fuel Tank Liquid Temperature

$$T_s = T_{amb} + 459.67 + 1.8 \quad \text{Eq. 11-68}$$

where

- T_s The liquid temperature (in degrees Rankine) of source, s ; and
- T_{amb} The ambient temperature (in degrees Fahrenheit) specified in the Study Setup window.

In Eq. 11-68, one (1) degree Celsius is added to the ambient temperature for solar insolation effects. This assumption is used consistently throughout all fuel tank equations.

Eq. 11-69. Fuel Tank Expansion Factor

$$E_s = \frac{(21.304)}{T_s} + \frac{[(21.304) \frac{B_s P_s}{2T_s^2} - (0.06)]}{P_{amb} - P_s} \quad \text{Eq. 11-69}$$

where

- E_s The expansion factor (unitless) of source, s ;

- T_s The liquid temperature (in degrees Rankine) of source, s (see Eq. 11-68);
 B_s The second pressure constant (in degrees Rankine) of source, s (see Table 11-57);
 P_s The true vapor pressure (in PSI) of source, s (see Eq. 11-67);
 P_{amb} The average ambient atmospheric pressure (in PSI) of source, s (see Eq. 11-70);
 21.304 The default daily vapor temperature range (in degrees Rankine); and
 0.06 The default breather vent pressure setting range (in PSI).

Eq. 11-70. Ambient Atmospheric Pressure^{lxxviii}

$$P_{amb} = (14,695.949 \times 10^{-3}) \left(1 - \frac{ALT}{145,450}\right)^{52.561 \times 10^{-1}} \quad \text{Eq. 11-70}$$

where

- P_{amb} The ambient atmospheric pressure (in PSI);
 ALT The study airport elevation (in feet) above MSL specified in the Study Setup window; and
 $14,695.949 \times 10^{-3}$ One atmosphere (in PSI) with 8 significant digits.

Eq. 11-71. Horizontal and Vertical Fixed Roof Fuel Tank Saturation Factor

$$S_s = \begin{cases} (1 + (0.053)P_s \frac{d_s}{2})^{-1} & s \text{ is horizontal} \\ (1 + (0.053)P_s (h_s - \overline{h_{s,liquid}}))^{-1} & s \text{ is vertical fixed roof} \end{cases} \quad \text{Eq. 11-71}$$

where

- S_s The saturation factor (unitless) of source, s ;
 P_s The true vapor pressure (in PSI) of source, s (see Eq. 11-67);
 d_s The user-specified diameter (in meters) of source, s ;
 h_s The user-specified height (in meters) of source, s ; and
 $\overline{h_{s,liquid}}$ The user-specified average liquid height (in meters) of source, s .

Eq. 11-72. Fuel Tank Annual Rim Seal Loss

$$RSL_s = \frac{(45,359.237 \times 10^{-5})P_s W_s d_s}{P_{amb} \left(1 - \sqrt{1 - \frac{P_s}{P_{amb}}}\right)^2} \begin{cases} 0 & \text{if } s \text{ is horizontal or vertical fixed roof} \\ 6.7 & \text{if } s \text{ is an internal floating roof} \\ 5.8 + 0.3 \left(\frac{(3,600)v_s}{(1,609.344)}\right)^{2.1} & \text{if } s \text{ is an external floating roof} \\ 5.8 & \text{if } s \text{ is a domed external floating roof} \end{cases} \quad \text{Eq. 11-72}$$

where

- RSL_s The annual rim seal loss (in kilograms) for source, s ;
 d_s The user-specified diameter (in meters) of source, s ;

^{lxxviii} PRATT & WHITNEY, Aeronautical Vestpocket Handbook, 20th Edition, August 1986, page 38.

P_s	The true vapor pressure (in PSI) of source, s (see Eq. 11-67);
P_{amb}	The ambient atmospheric pressure (in PSI) of source, s (see Eq. 11-70);
W_s	The vapor molecular weight (per mole) of source, s (see Table 11-56);
v_s	The user-specified mean wind speed (in meters per second) for source, s ;
$45,359.237 \times 10^{-5}$	The number of kilograms in a pound (exact);
3,600	The number of seconds in an hour; and
1,609.344	The number of meters per mile (exact).

Eq. 11-91. Fuel Tank Annual Deck Fitting Loss

$$DFL_s = \frac{((45,359.237 \times 10^{-5})P_s W_s}{P_{amb}(1 - \sqrt{1 - P_s/P_{amb}})^2} DF_s \quad \text{Eq. 11-73}$$

where

DFL_s	The annual deck fitting loss (in kilograms) for source, s ;
P_s	The true vapor pressure (in PSI) of source, s (see Eq. 11-67);
P_{amb}	The ambient atmospheric pressure (in PSI) of source, s (see Eq. 11-70);
W_s	The vapor molecular weight (per mole) of source, s (see Table 11-56);
DF_s	The deck fitting loss factor of source, s (see Eq. 11-74); and
$45,359.237 \times 10^{-5}$	The number of kilograms in a pound (exact).

Eq. 11-74. Fuel Tank Deck Fitting Factor

$$DF_s = \begin{cases} 0 \\ 144.2 + (47)C_s + (7.9)DL_s + (1.2)\left[\frac{1}{125}\left(\frac{d_s}{3.048 \times 10^{-1}}\right)^2\right] \\ 47.78 + 0.02V_s^{0.97} + 0.1V_s + 5.4V_s^{1.1} + 150V_s^{1.4} + (6.2 + 1.2V_s^{0.94})VB_s + (2 + 0.37V_s^{0.91})PL_s \\ + (0.82 + 0.53V_s^{0.14})CL_s + (1.5 + 0.21V_s^{1.7})DD_s \\ 47.78 + 6.2VB_s + 2PL_s + 0.82CL_s + 1.5DD_s \end{cases} \quad \text{Eq. 11-74}$$

where

DSL_s	The annual rim seal loss (in kilograms) for source, s ;
C_s	The number of roof support columns assumed in source, s (see Eq. 11-75);
DL_s	The number of deck legs assumed in source, s (see Eq. 11-76);
$[x]$	The ceiling of the real value, x ;
V_s	The correct wind speed (in miles per hour) for source, s (see Eq. 11-77);
VB_s	The number of vacuum breakers assumed in source, s (see Table 11-56);
PL_s	The number of pontoon legs assumed in source, s (see Eq. 11-78);
CL_s	The number of center legs assumed in source, s (see Eq. 11-79); and
DD_s	The number of deck drains assumed in source, s (see Table 11-58).

Eq. 11-75. Fuel Tank Roof Support Column Count.

$$C_s = \text{rint}\left(\frac{1}{1,699.02}\left(\frac{d_s}{3.048 \times 10^{-1}}\right)^2\right) \quad \text{Eq. 11-75}$$

where

- C_s The number of roof support columns assumed in source, s ;
- $nint(x)$ The integer nearest to the real value, x ;
- d_s The user-specified diameter (in meters) of source, s ; and
- 3.048×10^{-1} The number of meters per foot (exact).

Eq. 11-76. Fuel Tank Deck Leg Count

$$DL_s = \left[5 + \frac{1}{10} \left(\frac{d_s}{3.048 \times 10^{-1}} \right) + \frac{1}{600} \left(\frac{d_s}{3.048 \times 10^{-1}} \right)^2 \right] \tag{Eq. 11-76}$$

where

- DL_s The number of deck legs assumed in source, s ;
- $[x]$ The ceiling of the real value, x ;
- d_s The user-specified diameter (in meters) of source, s ; and
- 3.048×10^{-1} The number of meters per foot (exact).

Eq. 11-77. Fuel Tank Corrected Wind Speed

$$V_s = \frac{(0.7)(3,600)}{(1,609.344)} v_s \tag{Eq. 11-77}$$

where

- V_s The correct wind speed (in miles per hour) for source, s ;
- v_s The user-specified mean wind speed (in meters per second) for source, s ;
- 0.7 The correction factor (unitless);
- 3600 The number of seconds in an hour; and
- 1,609.344 The number of meters per mile (exact).

Table 11-58 Fuel Tank Vacuum Breaker and Deck Drain Counts

Diameter, d_s , (in Meters)	Vacuum Breaker Count	Deck Drain Count
$d_s < 38.1$	1	1
$38.1 \leq d_s < 53.34$	2	2
$53.34 \leq d_s < 68.58$	3	3
$68.58 \leq d_s < 83.82$	4	5
$83.82 \leq d_s < 99.06$	5	7
$99.06 \leq d_s < 114.3$	6	
$114.3 \leq d_s$	7	

Eq. 11-78. Fuel Tank Pontoon Leg Count

$$PL_s = \max \left\{ 4, \left[130.445 \times 10^{-3} \right] \left(\frac{d_s}{3.048 \times 10^{-1}} \right) \right\} \tag{Eq. 11-78}$$

where

- PL_s The number of pontoon legs assumed in source, s ;
- $[x]$ The ceiling of the real value, x ; and
- ds The user-specified diameter (in meters) of source, s .

Eq. 11-79. Fuel Tank Center Leg Count

$$CL_s = \max \left\{ 2, [174.504 \times 10^{-3}] \left(\frac{d_s}{3.048 \times 10^{-1}} \right)^2 \right\} \quad \text{Eq. 11-79}$$

where

- CL_s The number of center legs assumed in source, s ;
- $[x]$ The ceiling of the real value, x ;
- ds The user-specified diameter (in meters) of source, s ; and
- 3.048×10^{-1} The number of meters per foot (exact).

Eq. 11-80. Fuel Tank Annual Deck Seam Loss

$$DSL_s = \frac{(0.028)(45,359.237 \times 10^{-5})P_s W_s}{P_{amb}(1 - \sqrt{1 - P_s/P_{amb}})^2} \begin{cases} \left(\frac{d_s}{3.048 \times 10^{-1}} \right)^2 & \text{if } s \text{ has an internal floating roof} \\ \text{otherwise} & \end{cases} \quad \text{Eq. 11-80}$$

where

- DSL_s The annual deck seam loss (in kilograms) for source, s ;
- P_s The true vapor pressure (in PSI) of source, s (see Eq. 11-67);
- P_{amb} The ambient atmospheric pressure (in PSI) of source, s (see Eq. 11-70);
- W_s The vapor molecular weight (per mole) of source, s (see Table 11-56);
- ds The user-specified diameter (in meters) of source, s ;
- 3.048×10^{-1} The number of meters per foot (exact); and
- $45,359.237 \times 10^{-5}$ The number of kilograms in a pound (exact).

Eq. 11-81. Fuel Tank Working Loss Rate

$$DSL_s = \frac{(45,359.237 \times 10^{-5})(1,000)}{(42)(3,785,411.784 \times 10^{-6})} \begin{cases} P_s W_s K_s & \text{if } s \text{ is horizontal or has a vertical fixed roof} \\ 0 & \text{otherwise} \end{cases} \quad \text{Eq. 11-81}$$

where

- WL_s The working loss (in kilograms per kiloliter) for source, s ;
- P_s The true vapor pressure (in PSI) of source, s (see Eq. 11-67);
- W_s The vapor molecular weight (per mole) of source, s (see Table 11-56);
- K_s The turnover factor (unitless) of source, s (see Eq. 11-82);

45,359.237x10 ⁻⁵	The number of kilograms in a pound (exact);
1,000	The number of liters per kiloliter;
42	The number of gallons per barrel; and
3,785,411x10 ⁻⁶	The number of liters per gallon (exact).

Eq. 11-82. Fuel Tank Turnover Factor

$$K_s = \begin{cases} 1 & T_s \leq 36 \\ \frac{180 + T_s}{6T_s} & T_s > 36 \end{cases} \quad \text{Eq. 11-82}$$

where

K_s	The turnover factor (unitless) of source, s ; and
T_s	The number of annual turnovers of source, s (see Eq. 11-83)

Eq. 11-83. Fuel Tank Annual Turnovers

$$T_s = \frac{4N_s}{\pi d_s^2} \begin{cases} l_s & \text{if } s \text{ is horizontal} \\ h_{s,liquid,max} & \text{otherwise} \end{cases} \quad \text{Eq. 11-83}$$

where

T_s	The number of annual turnovers of source, s ;
N_s	The user-specified annual throughput (in kiloliters) of source, s ;
d_s	The user-specified diameter (in meters) of source, s ;
l_s	The user-specified length (in meters) of source, s ; and
$h_{s,liquid,max}$	The user-specified maximum liquid height (in meters) in source, s .

Eq. 11-84. Fuel Tank Withdrawal Loss Rate

$$TL_s = (4) \frac{(45,359.237 \times 10^{-5})(42)}{(0.3048)^3(1,000)} (.015) \times 10^{-1} \begin{cases} 0 & \text{if } s \text{ is horizontal or has a vertical fixed roof} \\ \rho_s \frac{3.048 \times 10^{-1}}{d_s} \left(1 + C_s \frac{3.048 \times 10^{-1}}{d_s} \right) & \text{if } s \text{ has an internal floating roof} \\ \rho_s \frac{3.048 \times 10^{-1}}{d_s} & \text{otherwise} \end{cases} \quad \text{Eq. 11-84}$$

where

TL_s	The withdrawal loss rate (in kilograms per kiloliter) for source, s ;
ρ_s	The density (in pounds per gallon) of the stored liquid of source, s (see Table 11-56);
d_s	The user-specified diameter (in meters) of source, s ;
C_s	The number of roof support columns assumed in source, s (see Eq. 11-75);
$.015 \times 10^{-1}$	The default shell clingage factor (in barrels per 1,000 cubic feet);

4	The product of the diameter and the ratio of sidewall surface area to volume (unitless);
$45,359.237 \times 10^{-5}$	The number of kilograms in a pound (exact);
42	The number of gallons per barrel;
3.048×10^{-1}	The number of meters per foot (exact); and
1,000	The number of cubic feet per 1,000 cubic feet.

11.5.1.7 Surface Coating

Surface coatings only emit NMHC, TOG and VOC emissions; and in this case, all three pollutants are regarded as equivalent. Eq. 11-85 is used to compute emission factors for surface coatings and applies to all three pollutants. Both variables on its right hand side can be user-specified.

Eq. 11-85. Surface Coating Emission Factors

$$EF_s = EF_{s,raw} \left(1 - \frac{PCF_s}{100}\right) \quad \text{Eq. 11-85}$$

where

EF_s	The emission factor (in kilograms per kiloliter) for source, s ;
$EF_{s,raw}$	The raw emission factor (in kilograms per kiloliter) for source, s ; and
PCF_s	The pollution control factor (%) for source, s .

11.5.1.8 Deicing

Deicing fluids only emit NMHC, TOG and VOC emissions. Eq. 11-86 is used to compute the emission factors of deicing operations. All variables on its right-hand side can be user-specified. Eq. 11-86 assumes that the deicing solution only consists of pure water and a deicing chemical (e.g., ethylene glycol).

Eq. 11-86. Deicing Emission Factors

$$EF_s = EI_s \left[\left(\frac{\rho_s}{1,000} \right) \left(\frac{F_s}{100} \right) + \left(1 - \frac{F_s}{100} \right) \right] \left(\frac{F_s}{100} \right) \quad \text{Eq. 11-86}$$

where

EF_s	The emission factor (in kilograms per kiloliter) for source, s ;
EI_s	The emission index (in grams per kilogram) for source, s ;
ρ_s	The density (in grams per liter) of the deicing chemical of source, s ; and
F_s	The concentration (% by mass) of the deicing chemical dissolved in solution for source, s .

11.5.1.9 Solvent Degreasers

Solvent degreasers only emit NMHC, TOG and VOC emissions. Eq. 11-87 is used to compute the emission factors of solvent degreasers. All variables on its right-hand side can be user-specified.

Eq. 11-87. Solvent Degreaser Emission Factors

$$EF_s = \rho_s \left(1 - \frac{PCF_s}{100} \right) \quad \text{Eq. 11-87}$$

11.5.1.10 *Particulate Piles*

Piles of sand and salt only emit PM emissions. Eq. 11-88 is used to compute the PM emission factors for piles.

Equation 10-77. Particulate Pile Emission Factors

$$EF_{s,p} = TEF_{s,p} + WEF_{s,p} \quad \text{Eq. 11-88}$$

where

- EF_s The emission factor (in kilograms per metric ton) for source, s ;
- $TEFs$ The emission factor due to throughput for source, s (see Eq. 11-89); and
- $WEFs$ The emission factor due to wind for source, s (see Eq. 11-90).

Eq. 11-89. Particulate Pile Throughput Emission Factors

$$TEF_s = (2)(.016 \times 10^{-1}) \frac{\left(\frac{V_s}{2.2}\right)^{1.3}}{\left(\frac{M_s}{2}\right)^{1.4}} \begin{cases} 0.35 & p = PM_{10} \\ 0.11 & p = PM_{2.5} \end{cases} \quad \text{Eq. 11-89}$$

where

- $TEFs$ The throughput emission factor (in kilograms per metric ton) for source, s ;
- v_s The user-specified mean wind speed (in meters per second) for source, s ; and
- M_s The user-specified moisture content (%) for source, s ;

Eq. 11-90. Particulate Pile Wind Emission Factors

$$WEF_{s,p} = \frac{1}{1,000} \frac{A_s}{m_s} \left[\begin{array}{l} 58 \left(\frac{0.4f_s}{\ln\left(\frac{1,000}{z_s}\right)} v_{s,mile} - v_{s,friction} \right)^2 \\ + 25 \left(\frac{0.4f_s}{\ln\left(\frac{1,000}{z_s}\right)} v_{s,mile} - v_{s,friction} \right) \end{array} \right] \begin{cases} 0.5 & p = PM_{10} \\ 0.2 & p = PM_{2.5} \end{cases} \quad \text{Eq. 11-90}$$

where

- $WEFs$ The wind emission factor (in kilograms per metric ton) for source, s ;
- A_s The user-specified eroded surface area (in square meters) for source, s ;
- m_s The user-specified mass disturbed per disturbance (in metric tons) for source, s ;
- $v_{s,mile}$ The user-specified fastest mile of wind (in meters per second) for source, s ;
- f_s The user-specified surface wind speed fraction (unitless) for source, s ;
- z_s The user-specified surface roughness (in centimeters) for source, s ; and
- $v_{s,friction}$ The user-specified friction threshold velocity (in meters/second) for source, s .

11.5.1.11 Training Fires

The THC emissions for training fires are not reported by AEDT.

11.6 Map Projection Method

The mapping of latitude-longitude coordinates to and from x,y coordinates is accomplished by projecting a small portion of the earth's surface onto a cone. The transformation equations are outlined below.

Let $A = 6378137.000$ m = radius of the equator circle (WGS-84 spheroid);
 $B = 6356752.314$ m = distance from earth center to a pole (WGS-84 spheroid);
 $\phi_0 \lambda_0$ = latitude and longitude of the origin of the x,y coordinate system (radians);
 $\phi \lambda$ = latitude and longitude of a point on the earth (radians, $180/\pi$ degrees/radian); and
 $x y$ = coordinate values of the same point (meters, 1852 m/nmi).

North latitude is positive and south latitude is negative. East longitude is positive and west longitude is negative. Positive x is toward the east, and positive y is toward the north.

The two principal radii of curvature at latitude ϕ_0 are:

$$R_p = A^2 / \sqrt{A^2 \cos^2 \phi_0 + B^2 \sin^2 \phi_0}; \text{ and}$$

$$R_m = R_p^3 B^2 / A^4.$$

where

R_p = radius of curvature (m) in a plane perpendicular to a meridian plane; and
 R_m = radius of curvature (m) in a meridian plane.

A cone is constructed with its vertex on the line of poles, tangent to the earth spheroid along a latitude circle at ϕ_0 . The cone is cut from edge to vertex and unfolded so that it lies flat. An x,y coordinate system is constructed on the unfolded cone. The x-axis is tangent to the latitude circle at ϕ_0 , and the y-axis is tangent to the longitude ellipse at λ_0 .

For conic projections, latitude circles (parallels) map into circles centered on the vertex of the unfolded cone, and longitude ellipses (meridians) map into straight lines that converge at the vertex of the unfolded cone.

For points on the y-axis, the y-coordinate is accurately approximated by the meridian arc-distance:

$$x = 0; \text{ and}$$

$$y = R_m (\phi - \phi_0).$$

For points off the y-axis, the $y = \text{constant}$ coordinates lie on a conic circle centered at the vertex of the unfolded cone. For this case, the x-coordinate is approximated by the arc-distance along a conic circle; and the y-coordinate is approximated by the y-value at $x=0$ plus a parabolic correction:

$$x = (R_p \cos \phi_0 - y_0 \sin \phi_0)(\lambda - \lambda_0) \quad \text{Eq. 11-91}$$

$$y = y_0 + E_0 x^2$$

where

$$y_0 = R_m (\phi - \phi_0); \text{ and}$$
$$E_0 = \frac{1}{2} \tan \phi_0 / R_p.$$

An exact inverse transformation is provided by the following equations:

$$\begin{aligned} \phi &= \phi_0 + y_0 / R_m \\ \lambda &= \lambda_0 + x / (R_p \cos \phi_0 - y_0 \sin \phi_0) \end{aligned} \quad \text{Eq. 11-92}$$

where

$$y_0 = y - E_0 x^2.$$

The above conic projection method provides a simple and very quick transformation between latitude-longitude and x,y coordinates. (The radii of curvature R_p , R_m , the sine and cosine terms $\cos \phi_0$, $\sin \phi_0$, and the off-axis correction coefficient E_0 are constants that are calculated only once.) A computationally quick transformation is required because lat/long values are calculated and displayed for every movement of the mouse pointer when in lat/long mode in a graphics window.

The conic projection method is not exactly conformal (angles on the earth do not exactly map into the same angles in the x,y coordinate system). However, the method is very accurate within an area of approximately one hundred miles around the origin of coordinates.

For example, if the origin is at 45°N 90°E, a 1-km square on the earth's surface located at 46°N 91°E (about 73 nmi from the origin), when mapped into x,y coordinates, is 23 cm longer in the east-west direction and 25 cm shorter in the north-south direction. By comparison, the same 1-km square mapped by the standard Mercator projection method is 1786 cm larger in both directions.

11.7 Environmental Justice Demographic Variables

This appendix provides details on the demographic variables used by the Environmental Justice capability.

Of special note, the user should be careful when calculating custom variables based on the demographic variables by race and/or by ethnicity. The US Census allows individuals to select more than one racial group and ethnic group; therefore, the sum of the logical set of demographic variables within one census block will likely exceed the total population within that census block.

The following is a list of variables either taken directly from the ACS data source or calculated from the ACS data.

Table 11-59 Environmental Justice Demographic Variables

Variable	EJ and ACS Field Description	Calculation	Notes
Object ID	ESRI unique object identifier	n/a	
STATEFP	State FIPS code	n/a	
COUNTYFP	Count FIPS code	n/a	
TRACTCE	Census Tract Code	n/a	
BLKGRPCE	Block Group Code	n/a	
GEOID	Geographic Identifier	n/a	
NAMELSAD	Full Name	n/a	
MTFCC	MAF/TIGER Feature Classification Code (G5030 = Block Group)	n/a	
FUNCSTAT	Functional Status (S = Statistical)	n/a	
ALAND	Land Area (square meters)	n/a	
AWATER	Water Area (square meters)	n/a	
INTPTLAT	Internal Point Latitude	n/a	
INTPTLON	Internal Point Longitude	n/a	
GEOID_Data	Unique Identifier of Summary Level, Characteristic Iteration, US, State, County, Tract, Block Group Code	n/a	
origArea	n/a	n/a	a copy of field 'Shape Area (sq m)'
B01001e1	SEX BY AGE: Total: Total population -- (Estimate)	n/a	
B03002e1	HISPANIC OR LATINO ORIGIN BY RACE: Total: Total population -- (Estimate)	n/a	
B03002e3	HISPANIC OR LATINO ORIGIN BY RACE: Not Hispanic or Latino: White alone: Total population -- (Estimate)	n/a	

Variable	EJ and ACS Field Description	Calculation	Notes
C17002e1	RATIO OF INCOME TO POVERTY LEVEL IN THE PAST 12 MONTHS: Total: Population for whom poverty status is determined -- (Estimate)	n/a	
C17002e2	RATIO OF INCOME TO POVERTY LEVEL IN THE PAST 12 MONTHS: Under .50: Population for whom poverty status is determined -- (Estimate)	n/a	
C17002e3	RATIO OF INCOME TO POVERTY LEVEL IN THE PAST 12 MONTHS: .50 to .99: Population for whom poverty status is determined -- (Estimate)	n/a	
C17002e4	RATIO OF INCOME TO POVERTY LEVEL IN THE PAST 12 MONTHS: 1.00 to 1.24: Population for whom poverty status is determined -- (Estimate)	n/a	
C17002e5	RATIO OF INCOME TO POVERTY LEVEL IN THE PAST 12 MONTHS: 1.25 to 1.49: Population for whom poverty status is determined -- (Estimate)	n/a	
C17002e6	RATIO OF INCOME TO POVERTY LEVEL IN THE PAST 12 MONTHS: 1.50 to 1.84: Population for whom poverty status is determined -- (Estimate)	n/a	
C17002e7	RATIO OF INCOME TO POVERTY LEVEL IN THE PAST 12 MONTHS: 1.85 to 1.99: Population for whom poverty status is determined -- (Estimate)	n/a	
C17002e8	RATIO OF INCOME TO POVERTY LEVEL IN THE PAST 12 MONTHS: 2.00 and over: Population for whom poverty status is determined -- (Estimate)	n/a	

Variable	EJ and ACS Field Description	Calculation	Notes
B19013e1	MEDIAN HOUSEHOLD INCOME IN THE PAST 12 MONTHS (IN 2013 INFLATION-ADJUSTED DOLLARS): Median household income in the past 12 months (in 2013 inflation-adjusted dollars): Households -- (Estimate)	n/a	
B16002e1	HOUSEHOLD LANGUAGE BY HOUSEHOLD LIMITED ENGLISH SPEAKING STATUS: Total: Households -- (Estimate)	n/a	
B16002e4	HOUSEHOLD LANGUAGE BY HOUSEHOLD LIMITED ENGLISH SPEAKING STATUS: Spanish: Limited English speaking household: Households -- (Estimate)	n/a	
B16002e7	HOUSEHOLD LANGUAGE BY HOUSEHOLD LIMITED ENGLISH SPEAKING STATUS: Other Indo-European languages: Limited English speaking household: Households -- (Estimate)	n/a	
B16002e10	HOUSEHOLD LANGUAGE BY HOUSEHOLD LIMITED ENGLISH SPEAKING STATUS: Asian and Pacific Island languages: Limited English speaking household: Households -- (Estimate)	n/a	
B16002e13	HOUSEHOLD LANGUAGE BY HOUSEHOLD LIMITED ENGLISH SPEAKING STATUS: Other languages: Limited English speaking household: Households -- (Estimate)	n/a	
B02001e1	RACE: Total: Total population -- (Estimate)	n/a	
B02001e2	RACE: White alone: Total population -- (Estimate)	n/a	
B02001e3	RACE: Black or African American alone: Total population -- (Estimate)	n/a	
B02001e4	RACE: American Indian and Alaska Native alone: Total population -- (Estimate)	n/a	

Variable	EJ and ACS Field Description	Calculation	Notes
B02001e5	RACE: Asian alone: Total population -- (Estimate)	n/a	
B02001e6	RACE: Asian alone: Total population -- (Estimate)	n/a	
B02001e7	RACE: Some other race alone: Total population -- (Estimate)	n/a	
B02001e8	RACE: Two or more races: Total population -- (Estimate)	n/a	
B02001e9	RACE: Two or more races: Two races including Some other race: Total population -- (Estimate)	n/a	
B02001e10	RACE: Two or more races: Two races excluding Some other race, and three or more races: Total population -- (Estimate)	n/a	
B02008e1	WHITE ALONE OR IN COMBINATION WITH ONE OR MORE OTHER RACES: Total: White alone or in combination with one or more other races -- (Estimate)	n/a	
B02009e1	BLACK OR AFRICAN AMERICAN ALONE OR IN COMBINATION WITH ONE OR MORE OTHER RACES: Total: Black or African American alone or in combination with one or more other races -- (Estimate)	n/a	
B02010e1	AMERICAN INDIAN AND ALASKA NATIVE ALONE OR IN COMBINATION WITH ONE OR MORE OTHER RACES: Total: People who are American Indian or Alaska Native alone or in combination with one or more other races -- (Estimate)	n/a	
B02011e1	ASIAN ALONE OR IN COMBINATION WITH ONE OR MORE OTHER RACES: Total: Asian alone or in combination with one or more other races -- (Estimate)	n/a	

Variable	EJ and ACS Field Description	Calculation	Notes
B02012e1	NATIVE HAWAIIAN AND OTHER PACIFIC ISLANDER ALONE OR IN COMBINATION WITH ONE OR MORE OTHER RACES: Total: Native Hawaiian and Other Pacific Islander alone or in combination with one or more other races -- (Estimate)	n/a	
B02013e1	SOME OTHER RACE ALONE OR IN COMBINATION WITH ONE OR MORE OTHER RACES: Total: Some other race alone or in combination with one or more other races -- (Estimate)	n/a	
B03002e12	HISPANIC OR LATINO ORIGIN BY RACE: Total: Hispanic or Latino	n/a	
pop_total	n/a	n/a	a copy of field 'B01001e1'
pop_white	n/a	n/a	a copy of field 'B02008e1'
pop_afam	n/a	n/a	a copy of field 'B02009e1'
pop_native	n/a	n/a	a copy of field 'B02010e1'
pop_asian	n/a	n/a	a copy of field 'B02011e1'
pop_hawaii	n/a	n/a	a copy of field 'B02012e1'
pop_other	n/a	n/a	a copy of field 'B02013e1'
pop_hispanic	n/a	n/a	a copy of field 'B03002e12'

Variable	EJ and ACS Field Description	Calculation	Notes
pop_minority	n/a	B03002e1 - B03002e3	Total population of block group minus the non-hispanic white only population
pct_minority	n/a	round(pop_minority/ B03002e1 * 100, 1)	Percent of total population that is minority
pop_1xpov	n/a	C17002e2 + C17002e3	
pct_1xpov	n/a	round(pop_1xpov/ C17002e1 * 100, 1)	
min_hh_income	n/a	n/a	a copy of field 'B19013e1'
pop_lang	n/a	B16002e4 + B16002e7 + B16002e10 + B16002e13	
pct_lang	n/a	round(pop_lang/ B16002e1 * 100, 1)	
thresholdflag	n/a	n/a	A bit field representation of the exceeded thresholds, 0 if no thresholds were exceeded
Shape Length (m)	Length of polygon line (in miles)	n/a	
Shape Area (sq m)	Area covered by polygon (in square miles)	n/a	

12. References

1. Koopmann, Jonathan, et. al, Aviation Environmental Design Tool (AEDT) User Guide Version 2c, Report No. DOT-VNTSC-FAA-16-16, Washington, D.C.: Federal Aviation Administration, September 2016.
2. International Civil Aviation Organization (ICAO), Manual of the ICAO Standard Atmosphere, Doc 7488/3, 1993.
3. Preferred Frequencies, Frequency Levels and Band Numbers for Acoustical Measurements, American National Standard, ANSI S1.6-1984 (R2006), New York, NY: American National Standards Institute, 2006.
4. Specification for Octave-Band and Fractional-Octave-Band Analog and Digital Filters, American National Standard, ANSI S1.11-2004, New York, NY: American National Standards Institute, 2004.
5. AEDT Development Team, AEDT Database Description Document Study Database, Version 1.46.0, September 2016.
6. AEDT Development Team, AEDT Database Description Document Airport Database, Version 2.16.0, May 2016.
7. International Civil Aviation Organization (ICAO), ICAO Engine Exhaust Emissions Databank, <http://www.caa.co.uk/default.aspx?catid=702&pagetype=90>. April 2008.
8. Eurocontrol ANP Database v2.0, <http://www.aircraftnoisemodel.org/>, December 2012.
9. Eurocontrol Experimental Center (EEC). User Manual for the Base of Aircraft Data (BADA), Revision 3.9. EEC Note No. 11/06/15-25. June 2011.
10. ICAO Document 8643, 40th ed., <http://www.icao.int/publications/DOC8643/Pages/Doc8643.aspx>, 2011.
11. IATA Airline code search, <http://www.iata.org/ps/publications/pages/code-search.aspx>, 2011.
12. AEDT Development Team, AEDT Database Description Document Fleet Database, Version 3..21.0, September 2016.
13. Spectral Classes For FAA's Integrated Noise Model, Report No. DTS-34-FA065-LR1, Cambridge, MA, John A. Volpe National Transportation Systems Center, December 1999.
14. Bishop, D. E., et. al, Revision of Civil Aircraft Noise Data for the Integrated Noise Model (INM), Report No. 6039, Canoga Park, CA: BBN Laboratories Incorporated, September 1986.
15. European Civil Aviation Conference (ECAC) Report on Standard Method of Computing Noise Contours around Civil Airports, Doc 29 (3rd Edition), July 2005.

-
16. Senzig, D., et. al, Fuel Consumption Modeling in Support of ATM Environmental Decision-Making. Joint Meeting of FAA and EUROCONTROL on Air Traffic Management, Napa, California, June 25-29, 2009.
 17. Senzig, et. al, Modeling of Terminal-Area Airplane Fuel Consumption, Journal of Aircraft, Vol. 46, No. 4, July-August 2009, pp 1089-1093.
 18. Eurocontrol Experimental Center (EEC). User Manual for the Base of Aircraft Data (BADA), Revision 3.6. EEC Note No. 10/04. Project ACE-C-E2. September 2004.
 19. Eldred, Kenneth M. and Robert L. Miller. 1980. Analysis of Selected Topics in the Methodology of the Integrated Noise Model, November 1980, DOT-TSC-1782.
 20. Koopmann, Jonathan, et. al, Aviation Environmental Design Tool (AEDT) Version 2c AEDT Standard Input File (ASIF) Reference Guide, Report No. DOT-VNTSC-FAA-15-08, Washington, D.C.: Federal Aviation Administration, September 2016.
 21. Code of Federal Regulations, Title 14: Aeronautics and Space, Part 36, Noise Standards: Aircraft Type and Airworthiness Certification (14 CFR Part 36), Washington, D.C.: Federal Aviation Administration, September 1992.
 22. SAE International, Committee A-21, Aircraft Noise, Standard Values of Atmospheric Absorption as a Function of Temperature and Humidity, Aerospace Research Report No. 866A, Warrendale, PA: SAE International, March 1975.
 23. SAE International, Committee A-21, Aircraft Noise, Application of Pure-Tone Atmospheric Absorption Losses to One-Third Octave-Band Data, Aerospace Information Report No. 5534, Warrendale, PA: SAE International, August 2013.
 24. SAE International, Committee A-21, Aircraft Noise, Method for Predicting Lateral Attenuation of Airplane Noise, Aerospace Information Report No. 5662, Warrendale, PA: SAE International, April 2006.
 25. Moulton, C.L., Air Force Procedure for Predicting Aircraft Noise Around Airbases: Noise Exposure Model (NOISEMAP), User's Manual, Report No. AAMRL-TR-90-011, Wright- Patterson Air Force Base, Ohio: United States Air Force, February 1990.
 26. Barry, T.M. et al, FHWA Highway Traffic Noise Prediction Model, Appendix B, FHWA-RD-77-108, Washington, D.C., 1978.
 27. Fleming, et. al., Assessment of Tools for Modeling Aircraft Noise in the National Parks, FICAN report, Cambridge, MA: John A. Volpe National Transportation Systems Center, Arlington, VA: Wyle Laboratories, Winchester, MA: Senzig Engineering, March 2005.
 28. Sutherland, et. al., Atmospheric Sound Propagation, Encyclopedia of Acoustics, Vol. 1, 1979, p. 351 – 353.

-
29. Noel, George, et al., Thrust Reverser Analysis for Implementation in Aviation Environmental Development Tool (AEDT), RTV-4F-FA4T-LR1; PB2007-111124, Cambridge, MA: John A. Volpe National Transportation Systems Center, June 2007.
 30. Rickley, Ed, et. al., Noise Measurement Flight Test of Five Light Helicopters. Report No. DOT-VNTSC-FAA-93-5, Cambridge, MA: John A. Volpe National Transportation Systems Center, July 1993.
 31. Boeker, Eric, et. Al., Analysis of Modeling Cumulative Noise from Simultaneous Flights; Volume 1: Analysis at Four National Parks, Report No. DOT-VNTSC-FAA-12-08.I, DOT-FAA-AEE-2012-07, December 2012. <http://ntl.bts.gov/lib/46000/46500/46551/DOT-VNTSC-FAA-12-08.I.pdf>.
 32. DuBois, Douglass, et. al., Fuel Flow Method for Estimating Aircraft Emissions, SAE Technical Papers, Warrendale, Pa, 2006.
 33. International Civil Aviation Organization (ICAO), ICAO Engine Exhaust Emissions Databank, First Edition, 1995.
 34. International Civil Aviation Organization (ICAO), ICAO Engine Exhaust Emissions Databank, <http://www.caa.co.uk/default.aspx?categoryid=702&pagetype=90>, April 2008.
 35. Emissions and Dispersion and Modeling System (EDMS) User's Manual Version 5.0, Document FA-AEE-07-01, prepared for the Federal Aviation Administration, Office of Environment and Energy, by CSSI, Inc., Washington, DC, 2007.
 36. Kinsey, J., Wayson, R.L, EPA PM Methodology Discussion Paper, 2007.
 37. Recommended Best Practice for Quantifying Speciated Organic Gas Emissions from Aircraft Equipped with Turbofan, Turbojet, and Turboprop Engines Version 1.0. May 27, 2009.
 38. Hadaller, O. J., and A. M. Momenty. The Characteristics of Future Fuels. Boeing publication D6-54940. 1989.
 39. Hadaller, O. J., and A. M. Momenty. Characteristics of Future Aviation Fuels. Chapter 10 in Transportation and Global Climate Change, (D. L. Greene and D. J. Santini, Eds.). American Council for an Energy-Efficient Economy. Washington, DC. 1993.
 40. Recommended Best Practice for Quantifying Speciated Organic Gas Emissions from Aircraft Equipped with Turbofan, Turbojet, and Turboprop Engines Version 1.0. May 27, 2009.
 41. KB Environmental Sciences, Inc. and Aerodyne Research, Inc., Quality Assurance Project Plan for the Development of a Commercial Aircraft Hazardous Air Pollutants Emissions Inventory Methodology, Environmental Protection Agency and the Federal Aviation Administration, Washington D.C., March 2008.
 42. International Civil Aviation Organization (ICAO), Airport Air Quality Manual, Doc 9889, 2011.
 43. AEDT 2c Documentation, Using MOVES with AEDT 2c, https://aedt.faa.gov/2c_information.aspx,

September 6, 2016.

44. Emissions and Dispersion and Modeling System (EDMS) Technical Manual Version 5.0, Document FA-AEE-07-07, prepared for the Federal Aviation Administration, Office of Environment and Energy, by CSSI, Inc., Washington, DC, November, 2010.
45. Harris, C. M. (ed.), Handbook of Acoustical Measurements and Noise Control, Third Edition, New York, NY: McGraw-Hill, 1991.
46. Beranek, L. L., (ed.), Noise and Vibration Control, Revised Edition, New York, NY: McGraw-Hill, 1988.
47. Eldred, K. M., Approximating Aircraft Noise Using a Model of a Moving Source with a 90° Dipole Radiation Pattern, Memorandum to Dr. R. G. Gados, The Mitre Corporation, Cambridge, MA: Bolt Beranek and Newman, Inc., March 1980.
48. Olmstead, J., INM 6.0 Exposure Fraction Algorithm, Memorandum to John Guiding, ATAC Corporation, Sunnyvale, CA, December 14, 1998.
49. Eldred, K. M., Miller, R. L., Analysis of Selected Topics in the Methodology of the Integrated Noise Model, Report No. 4413, BBN Project No. 09611, Cambridge, MA: Bolt Beranek and Newman Inc., September 1980.
50. Committee on Aircraft Noise (CAN): *Seventh Meeting Report on Agenda Item 3*. ICAO CAN/7-WP/59, May 1983. (Referring to: ICAO CAN/7-WP/19: *A revision to the definition of the reference atmosphere in Annex 16 to improve data quality and reliability and ease technical problems*. March 1983.
51. Green, David M. and Swets, John A., Signal Detection Theory and Psychophysics, New York: John Wiley and Sons, Inc, 1966.
52. Fidell, et. al., Predicting Annoyance from Detectability of Low-Level Sounds, Journal of the Acoustical Society of America, 66(5), November 1979, p. 1427 – 1434.
53. Horonjeff, Richard D., Comparison of ISO Human Threshold of Hearing Standards: ISO R226:1961 and ISO 389-7:1998, Plus Equivalent Auditory System Noise (EASN) 1/3 Octave Band Spectra Therefrom Derived, Plus Modified FORTRAN Implementation of d'Algorithm Using EASN in Place of Threshold of Hearing, December 7, 2004.
54. International Civil Aviation Organization (ICAO), Environmental Protection, Annex 16, Volume 1, Aircraft Noise. Fourth Edition - 2005. (Amendment 8, Applicable 24 November, 2005).
55. Bishop, D. E., Beckmann, J. M., Bucka, M. P., Revision of Civil Aircraft Acoustic data for the Integrated Noise Model (INM), Report No. 6039, Canoga Park, CA: BBN Laboratories Incorporated, September 1986.
56. International Civil Aviation Organization (ICAO), Recommended Method for Computing Noise Contours around Airports, Doc 9911, First Edition, 2008.

57. Airport Activity Statistics of Certificated Air Carriers, Washington, D.C.: U.S. Department of Transportation Statistics, Office of Airline Information, December 1995.
58. Aerospace Source Book, Aviation Week & Space Technology, McGraw-Hill Companies, January 12, 1998.
59. SAE International, Committee A-21, Aircraft Noise, Procedure for the Calculation of Airplane Noise in the Vicinity of Airports, Aerospace Research Report No. 1845, Warrendale, PA: SAE International, September 1995.
60. European Civil Aviation Conference (EA, Report of Standard Method of Computing Noise Contours around Civil Airports, ECAC.CEAC DOC 29, 1987.
61. Embleton, Tony F.W., Piercy, Joe E., Daigle, Giles A., Effective Flow Resistivity of Ground Surfaces Determined by Acoustical Measurements, J. Acoust. Soc. Am. Vol. 74, No. 4, pp 1239-1243, 1983.
62. Air Quality Procedures for Civilian Airports & Air Force Bases. Federal Aviation Administration, U.S. Air Force. FAA-AEE-97-03. AL/EQ-TR-1996-0017. April 1997.