

---

# **Seismic Damage Assessment of Rail Structures in Japan after the January 1995 Kobe Earthquake**

**Parsons Brinckerhoff Quade & Douglas, Inc.  
San Francisco, California**

**April 1995**



**U.S. Department of Transportation  
Federal Railroad Administration  
Office of Research and Development  
Washington, DC 20590**

## TABLE OF CONTENTS

Section	Page
EXECUTIVE SUMMARY	1
ACKNOWLEDGMENTS	6
1.0 INTRODUCTION	7
1.1 Background	
1.2 Seismicity	
2.0 DAMAGE AND REPAIR TO WEST JAPAN RAILROAD COMPANY FACILITIES	9
2.1 Tokaido Main Line Viaducts	
2.2 Tokaido Main Line Retained Structures	
2.3 Tokaido Main Line Stations	
2.4 Tokaido Shinkansen Viaducts	
2.5 Tokaido Shinkansen Tunnels	
2.6 Rolling Stock	
3.0 DAMAGE AND REPAIR TO HANSHIN OSAKA KOBE MAIN LINE FACILITIES	12
3.1 Hanshin Main Line Viaducts	
3.2 Hanshin Main Line Retained Structures	
3.3 Hanshin Main Line Subway	
3.4 Hanshin Main Line Stations	
4.0 DAMAGE AND REPAIR TO HANKYU KOBE MAINLINE FACILITIES	13
4.1 Hankyu Main Line Viaducts	
4.2 Hankyu Main Line Retained Structures	
4.3 Hankyu Main Line Stations	
4.4 Hankyu Imazu Line	
5.0 DAMAGE TO PORT ISLAND PEOPLE MOVER	14
6.0 DAMAGE AND REPAIR TO KOBE MUNICIPAL SUBWAY	14
6.1 Daikaidori Station	
6.2 Sannomiya Station	
7.0 CONCLUSIONS	16
7.1 Observations Relevant to U.S. Design Practice	
APPENDIX - Photo Record	
GENERAL KOBE	A-1
JRT West Japan Railroad Company Tokaido Mainline	A-4
JRS West Japan Railroad Company Shinkansen	A-28
SS West Japan Railroad Company Sannomiya Station	A-44
HER Hanshin Electric Railway Hanshin Mainline	A-48
HC- Hankyu Corporation Kobe Line	A-67
PI Port Island Line - Peoplemover	A-77
KMS Kobe Municipal Subway Daikai-Dori Station	A-86

## EXECUTIVE SUMMARY

In the six weeks following the January 17, 1995 Great Hanshin Earthquake (also called the 1995 Hyogo-Ken-Nanbu Earthquake or the Kobe Earthquake) an enormous effort has been expended in the cleanup, demolition, repair and rebuilding of the damaged rail facilities. It is a credit to the rail owners, contractors and workers to have accomplished so much in so little time under very adverse conditions. Nearly every type of facility was damaged or destroyed in the peoplemover, freight, passenger rail and high speed rail lines. We observed examples of most of the damage and where all traces of the facilities were already removed we managed to receive photographs and comments from other observers.

The majority of damage was observed in the four rail line viaducts between Kobe and Nishinomaya. The aerial structures were all constructed in the 1960's and early 1970's. The typical structure is composed of reinforced concrete girders in three span frames with span lengths of 10 to 15 meters. The substructures are meter square reinforced concrete columns, usually two or more per bent at about 5 meter centers. The girders are monolithic or composite with the concrete deck. All the viaducts support ballast, ties and rail. No direct fixation fasteners were observed in the aerial structures. There were some steel plate girders and some prestressed precast girders all used as drop-in spans over streets and other rail lines where falsework could not be installed. The reinforced concrete details are quite similar to the details used in California highway bridges built in the same era.

Some of the inherent weakness results from the use of details used at the time that now have been proven to be inadequate for seismic ductile performance and/or to resist realistic earthquake forces, such as minimal lateral column reinforcing in the square columns, with no crossties. The columns are weak in shear and have no confinement in the high moment zones. The beam to column joints are not fully confined (by current American Concrete Institute definitions) and underreinforced. The lap splices and embedments of the main column reinforcing are not adequately developed.

Damage observed in the viaducts may be generally assessed as weak column strong beam behavior. The shorter column structures failed by column shear which is inherently brittle and sometimes result in catastrophic events. The very long column structures started to form plastic hinges from the high moments. Longitudinal response and the corresponding damage was evident over long continuous stretches of long column structure. Ballasted track provided no seismic resistance, restraint or continuity, on the contrary the ballast contributed to an increase in the vibratory mass. Column shear cracks were often more inclined than 45 degrees.

Damage was also observed in two separate retained embankments, one with unreinforced concrete gravity retaining walls and the other with reinforced concrete cantilever walls. Both slid open and started to lean outwards up to .5 meter in 3 meter high walls. The unreinforced walls had some horizontal cracks about 1 meter up from the low side. We were unable to determine if the failed walls alone would have caused an interruption in service since the adjoining aerial structures were so severely damaged that rail service had to be terminated. Had the walls been supporting a cut rather than a fill the large displacement and encroachment could have caused closure in many instances.

At least three subway stations in Kobe were damaged: Daikai-dori Station, Nagata Station and Sannomiya Station. One station is undergoing repair to spalled and cracked columns and walls. The second station roof collapsed when the center supporting row of columns failed a number of hours after the earthquake. The roof collapse caused a 2.5 meter depression in the surface street. The station is being excavated, demolished and replaced. Another section of cut-and-cover line structure was damaged and repaired within two weeks of the earthquake. Damage in a few tunnels was reported but we couldn't verify the extent or cause of damage.

A large number of stations suffered damage. At least a half dozen stations, from simple at-grade platform stations to major combined use multi-story facilities, were demolished. Many at-grade platforms moved and had to be jacked back into position. Many station covers collapsed totally or partially.

**JAPAN**

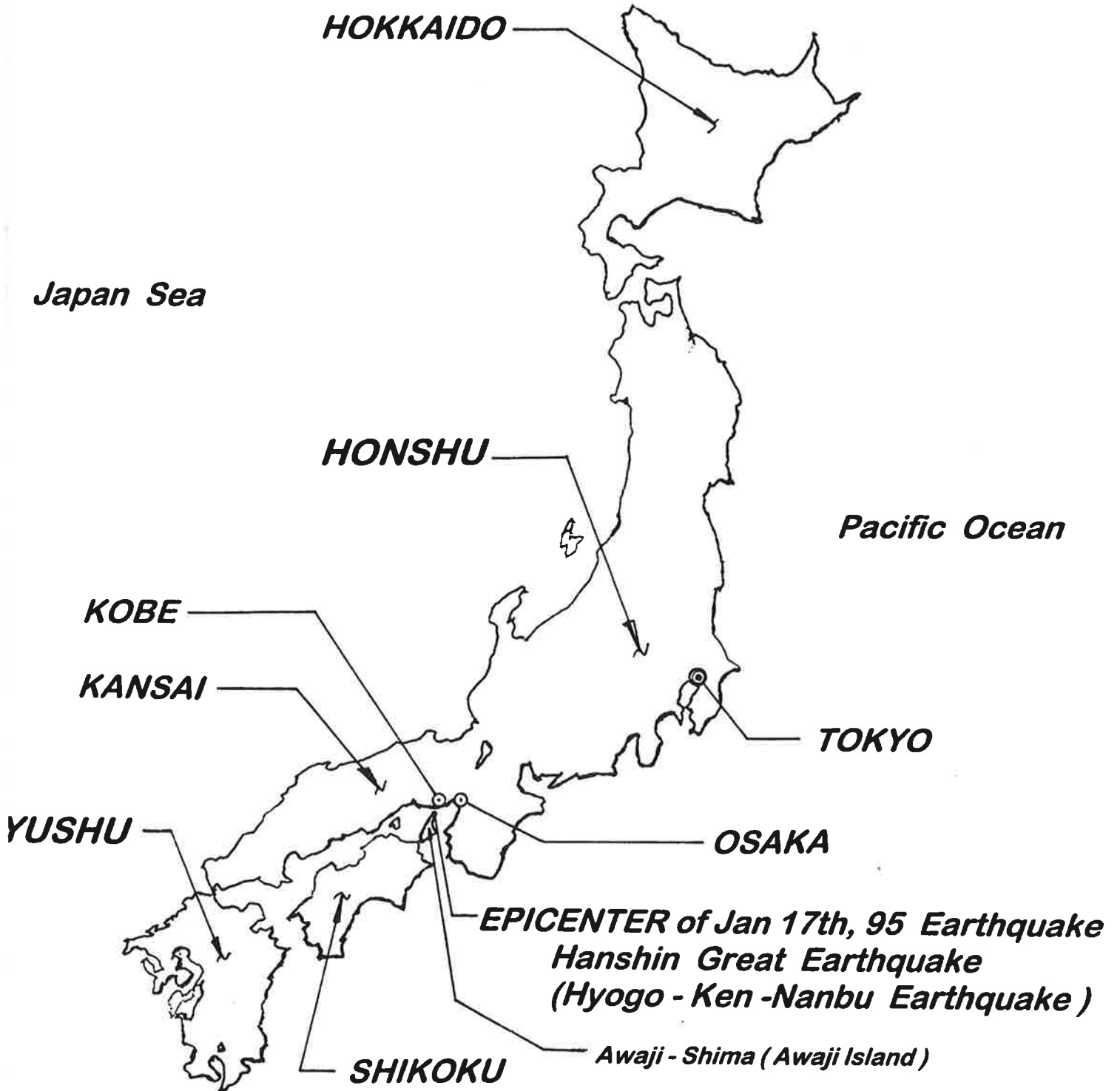

Figure 1

**Supports for the overhead electrification were bent, buckled and collapsed. Cable anchors attached to deadman foundations were pulled loose allowing the towers to topple.**

**Earthen embankments failed with slopes falling. Many crews of workers were repairing the slope failures along the serviceable tracks. Many hundreds of meters of new sheet piles were driven along the embankments to stabilize the slopes.**

**A significant number of trains derailed on both aerial structures and at-grade, in rail yards and on running track.**

## ACKNOWLEDGMENTS

Mr. Hiromichi Umayahara of Western Japan Railway Company provided us with a general damage report and the repair methods to be used. The report also included rolling stock lost in the earthquake. He suggested that after May 1995 and the reopening of West Japan Railway Company facilities that he may be more available to answer questions

Mr. Shozo Okuno of the U.S. Consulate provided us with the construction costs and schedules as well as some very useful maps of the rail system. Being a resident of Port Island in Kobe, he provided excellent information about local conditions. He has also been very helpful in answering follow-up questions.

Mark Yashinsky of the California Department of Transportation was attending a seismic conference in Osaka when the January 17, 1995 Earthquake occurred. He observed the damage to the highway system in great detail. He provided us with some photographs of damaged facilities that were removed prior to our visit to observe the railway facilities. He compiled and published a report entitled *"Performance of Bridges During the January 17 1995 Kobe Earthquake"* for Caltrans.

Li-hong Sheng of the California Department of Transportation was part of a Federal Highway Administration team who visited the Kobe area to observe the damaged facilities in mid-February. He provided us with a report of the Strong Motion Instrumentation Program dated February 8, 1995 written by Nakamura, Hidaka, Saita and Sato for the Railway Terminal Research Institute. He also provided some guidance on how to travel locally to Kobe.

## 1.0 INTRODUCTION

### 1.1 Background

On January 17, 1995 a large earthquake struck the southern coast of Japan (Figure 1). The epicenter was located on the north end of Awaji Island about 40 kilometers west of Osaka. The magnitude of the earthquake was 7.2 on the Japan Richter scale which is roughly 6.9 on the U.S. Richter scale. The earthquake was felt most heavily in the Kobe area.

Kobe is a port city in Hyogo Province with a population well over 1.5 million. It is a major industrial center with manufacturing and electronics. It is also a major transportation hub with critically important highway rail and marine centers. Prior to the earthquake the Port of Kobe handled thirty percent (30%) of Japan's container shipping.

The earthquake has been called the Great Hanshin Earthquake, the Hyogo-Ken-Nambu Earthquake and the Kobe Earthquake. This event took over 5,300 lives, left some 35,000 people injured and severely damaged or destroyed approximately 160,000 homes and buildings. Over 200,000 people were relocated to public shelters. The three railways linking Kobe to Osaka and the two highways were all disrupted.

The Center for Industrial Renovation of Kansai announced in February 1995 that total damage from the earthquake was estimated at over \$100 billion (using an exchange rate of 100 yen to \$1). They further predicted about \$210 billion in new economic activity over a three-year period.

The cost to repair the transportation system was estimated as follows:

Railways	\$3.53 billion
Expressways	\$6.00 billion
Port facilities	\$10.40 billion

The railway service is expected to be restored by May 1995 for J.R. West and August 1995 for Hankyu Corporation. Hanshin Electric Railway had not announced a schedule by the end of February 1995.

A general map showing locations of some of the damage is presented in Figures 2 and 3. The maps delineate zones of high seismic intensity and liquefaction. They also provide a brief description of the damage.

Finally a street map of the Kobe area presents more precise locations of damage to the rail system (Figure 4).

### 1.2 Seismicity

The Great Hanshin Earthquake was given a Richter magnitude of 6.9 on the U.S. scale. (It received a 7.2 on the Japan scale). The event lasted approximately 10 to 20 seconds. The peak acceleration was north-south in the immediate Kobe area. The peak accelerations were nearly equal north-south and east-west near Nishinomiya. The vertical accelerations were as much as 60% of the horizontal accelerations in the heavily impacted areas.

The maximum recorded horizontal ground surface acceleration from a station at Takatori, about 6 km west of Kobe, was approximately .64 g. The maximum recorded vertical acceleration of about 0.4 g occurred at Takarazuka about 14 km east of Kobe and north of Nishinomiya. Estimates of peak ground acceleration approached 2 g. Figure 5 presents the location of the epicenter in relation to seismologic reporting stations and some sites mentioned in this report.









Kobe 神戸

Figure 4

# Hanshin Great Earthquake = Hyogo Ken Nanbu Earthquake

January 17, 1995

HYOGO KEN



Kobe

Kobe

Main

SEISMOLOGY Recording Stations

OSAKA BAY  
大阪湾

## **2.0 DAMAGE AND REPAIR TO WEST JAPAN RAILWAY COMPANY FACILITIES**

The damaged West Japan Railway Co. facilities extend from Osaka to Kobe, which is covered by the general location maps, Figures 3, 4 and company. Damage assessment is illustrated by the photos in the Appendix from A-4 to A-4-7 where the headings and the captions locate the facilities and explain the sustained damage, respectively.

### **2.1 JR Tokaido Main Line (About 25 km from epicenter to Rokkomichi Station)**

JR Tokaido Main Line offers local, express and freight service. Formerly known as Japan Railway this line is owned by the Western Japan Railway Company.

The Tokaido Main Line is the center of the three rail lines between Kobe and Osaka and is the main freight line in the corridor. It should be noted that coupled with the loss of the Hanshin Expressway the damage to the Tokaido main line makes it very difficult to move freight and commerce in and out from a very industrialized port facility. Currently all service is interrupted between Sannomiya and Sumiyoshi Stations. Passengers are transferred to buses for transport between stations. The queue for buses was well over 500 meters long, 2 to 4 people wide and caused at least 1-1/2 hour delay at non peak commute hours.

The structures supporting the rail lines are all being replaced or repaired in this segment (Photos JRT-8 to JRT-43).

Approximately 2000 meters of aerial viaduct was damaged. A few spans were lost but these are being jacked back into place. The viaduct structure is a reinforced concrete tee girder superstructure with square concrete columns. The typical bents have four columns at approximately 5 meter spacing. The typical span is 10 to 15 meters and expansion joints are every 3 spans. The expansion joints are at center span.

A couple of hundred meters of the structure is very short with 4 to 5 meter headroom beneath the pier caps. This shorter section at the west end of the viaduct seems to have been much more seriously damaged than the slightly fallen section eastwards. The observed damage was typically located at the top of columns with spalling, cracked concrete and buckled column main reinforcing bars. We were unable to observe much of the damage simply because the contractor had completed significant amount of work among the needs for demolition, jacking, temporary supports and reconstruction. This is a truly commendable feat given that we visited the site only 6 weeks after the January 17, 1995 Earthquake. Many columns were removed from the temporarily supported structure with their main bars cut 800 to 900 mm below the pier cap. New reinforcing bars were being mechanically spliced to these dowels and new square column ties added to the 1 meter square columns. Finally a 9 mm plate steel jacket was installed around the connection. In some cases the steel plate jacket extended full height.

It appeared that some new superstructure construction was underway leading us to believe that some superstructure had collapsed and was being replaced. (This assumption is supported by the Western Japan Railway Company report.)

### **2.2 Tokaido Main Line Retained Structures (Photos JRT-1 to JRT-7)**

At the west end of the aerial section is a retained embankment. The reinforced concrete walls are leaning outwards over 300 mm, based on an observed plumb bob. The reinforced concrete is still intact and the contractor is coring holes through the walls and embankment and installing 35 mm through bolts with 300 mm square plate bearings. The through bolts are placed about 2 meters apart. It is unknown if the displaced retaining walls endangered the adjacent track enough to warrant interruption of service.

### **2.3 Tokaido Main Line Stations (Photos JRT-44 to JRT-46 and SS-1 to SS-8)**

The Rokkomichi Station had collapsed and was being entirely replaced with new platforms, covers, access, etc. Further west on the JR Tokaido Main Line we observed more damage to the aerial portion of Sannomiya Station that is owned and operated by West Japan Railway Company. Some steel plate girders slipped into the street. There appeared to be some damage to a very large structure just west of the station that may have been a maintenance facility with many tracks passing through the structure. We could not approach the structure.

The area just west of Sannomiya Station showed much damage perpendicular to the rail line for about 100-200 meters along the line. The Hanshin Subway was damaged in this area and the Kobe Municipal Subway Sannomiya Station was closed to repair damage in the same area. About 1500 meters to the left the Port Island Peoplermover (or Monorail) collapsed for about 300 meters. Just to the right (north) of the station a high-rise building was cut in half, and about 1000 meters further north there was some damage to the JR Shinkansen Shin-Kobe Station.

### **2.4 Tokaido Shinkansen (Bullet Train) Viaducts (Photos JRS-1 to JRS-31) (Viaduct about 35 km from epicenter)**

The Shinkansen is the highspeed line that traverses nearly the entire length of Japan. In the Osaka-Kobe area this rail line is owned by the West Japan Railway Company. Between Osaka and Kobe where the Shinkansen crosses over the Hankyu Imazu line near Kotoyen Station approximately 600 meters of the viaduct was damaged including about 9 spans that slipped from their supports onto the local streets and the Imazu Line.

The structure is another reinforced concrete tee girder viaduct with 1 meter square concrete columns forming two column bents 7 meters on center and 5 to 15 meters high with spans typically about 15 meters. Special precast, prestressed concrete girders were constructed for street and rail crossings. The seat length or the dropped spans was over 300 mm. The foundations were unknown, however, the uncovered column footings appeared to be connected by transverse grade beams. The west end of the segment ends at an abutment while to the east there is more viaduct, this portion undamaged. Most of the observed damage was limited to columns and column joints, although there was some superstructure pounding.

Due to speedy work by the contractor, nearly half the columns were covered with full height 9 mm plate steel jackets. During our 3 hour visit two full jackets were erected while welders were closing up a half dozen. Most of the concrete surface cracks were already epoxy grout injected and closed. The tops of nearly all the columns were spalled and cracked indicating a primary longitudinal response of the 600 meter section. A couple of exposed foundations toward the east end revealed spalling consistent with longitudinal response and a dangerous looking shear crack inclined about 30 degrees from vertical starting to develop. There was also some notable spalling due to transverse response, particularly on the unconfined outside face of the tee girder-column joint where the column bars were exposed through the joint revealing the total loss of development. During the era of design, no ties or cross-ties were extended into the joint zone to help confine the joint zone. The confined joint faces appeared to have little or no damage.

This section was very important to see because it was highly stressed but intact so we could observe the damage caused by the earthquake. This will allow us to fine tune some approaches to seismic design. The signs of potential collapse were present, but the structure remained standing and repairable. It should be noted that this structure is the furthest distance from the epicenter and of all the railroad structures we visited, this was also the newest structure we visited, built in 1972.

There was other damage to the Shinkansen further west. The Shin-Kobe Station suffered some damage as girders slipped.

## **2.5 Tokaido Shinkansen Tunnels** (Average about 25 km from epicenter)

There was some tunnel damage in the Kobe Tunnel, the Rokko Tunnel, the Tokazuka Tunnel and the Summa Tunnel. We were unable to observe since no one would allow us underground for safety reasons. We are trying to find if the tunnels were in rock or soft ground and if fault crossing was a possible cause.

## **2.6 Rolling Stock**

The West Japan Railway Company had 10 trains in service that experienced some derailed cars, including some whole trains especially a 22-car freight train. The train and vehicle restoration effort is expected to cost WJRC alone nearly 1,900 man days.

All told, the cost to repair West Japan Railroad Company facilities will cost \$1.2 billion. Reopening of all facilities is expected by May 1995.

## **3.0 DAMAGE AND REPAIR TO HANSHIN ELECTRIC RAILWAY OSAKA KOBE MAIN LINE FACILITIES** (Average about 25 km from epicenter)

Hanshin Main Line is a private railroad that offers Local and Express service between Osaka and Kobe where the line continues as the Sanyo Dentetsu. This line roughly parallels the Hanshin Expressway highway viaduct (which will be closed until at least 1998). Currently the service is interrupted between Mikage and Nishinada Stations. Passengers are transferred to bus to make the connection to the stations about three kilometers apart. The delay waiting for a bus is 15 minutes to 45 minutes. The structures supporting the rail lines and stations are collapsed, heavily damaged and being demolished, or lightly damaged and awaiting repair for over 2 km.

### **3.1 Hanshin Main Line Viaducts (Photos HER-10 to HER-28 and HER-32 to HER-37)**

West of the retained embankment was a long viaduct structure. The structure was a reinforced concrete girder superstructure supporting the ballasted track. The girders were cast monolithic with reinforced concrete columns and pier caps. The columns were square or rectangular and nearly square. The pier caps span 5 to 6 meters and the span length is 10 to 15 meters. The foundation type is unknown. Expansion joints are about 3 to 4 bents part or 30 to 60 meters between joints. Longer span crossings over major streets were steel girders that dropped from supports and were removed prior to our visit. The details of construction are consistent with the 1960's when the designs were completed.

The viaduct was heavily damaged for well over 1.5 km. Substructures failed by column shear, bending failures and foundation failures. Super structures fell off of supports while whole frame segments overturned. In some cases we could see the results of details similar to some of California's retrofit program. Because of the development of commercial/residential use between the columns below the viaduct a number of structure modifications were introduced. There were solid masonry walls that turned bents into solid piers. The columns had major shear cracks. There were steel beams between columns about 3 meters above the street. In many cases the damage to the concrete columns was concentrated above the steel beams.

Along a 500 to 1000 meter length the structure was widened to accommodate train storage. It appeared the north side of the structure collapsed then the south side overturned into the collapsed portion. Fifty eight rail cars were derailed and damaged at this location.

### **3.2 Hanshin Main Line Retained Structures (Photos HER-1 to HER-9)**

Between Umeda Station in Osaka and Mikage Station there is some station damage and embankment damage. West from Mikage Station about 300 meters the rail line was supported on a retained fill

approximately 4 to 5 meters high and 100 to 300 meters long. The retaining structures were unreinforced concrete gravity walls. The walls were leaning outwards over the entire length and were broken in some cases. Included in this retained embankment is an arch culvert. The crown of the arch was damaged at the southern entrance. Whether this damage to the retaining structures alone would have caused closure of rail service is unknown.

### **3.3 Hanshin Main Line Subway (In Kobe Area)**

One other segment of the Hanshin Line was damaged and repaired just west of Hanshin Subway Sannomiya Station in downtown Kobe. The cut-and-cover subway box was damaged. Since the line was back in revenue service with trains at 5 to 8 minute headways we were denied access to this portion. More of this area is mentioned in the JR Line description.

### **3.4 Hanshin Main Line Stations (Photos HER-29 to HER-31)**

The Shinzaike Station included a major mixed use development with 5 to 10-story buildings. The entire complex structure was damaged, closed and will probably be demolished and rebuilt.

West of the Shinzaike Station is more viaduct with slightly less damage. This part of the viaduct which was charred by the residential fires will probably be repaired with some local replacements.

It should be noted that access to the structure was very difficult especially the collapsed portions. The concrete rubble was mounded with the residential debris many meters high for whole city blocks.

The estimated reconstruction cost is \$800 million and the work is expected to be completed by September 1995.

## **4.0 DAMAGE AND REPAIR TO HANKYU KOBE MAIN LINE FACILITIES** (Average about 30 km from epicenter)

The Hankyu Kobe Main Line is the northern most rail line between Osaka and Kobe that offers local and express service. Similar to Hanshin Line, Hankyu has always been privately owned. In Kobe the Hankyu connects with the Hanshin Line and continues as the Sanyo Dentetsu. From Osaka the Hankyu Line is interrupted at Nishinomiya Kitaguchi Station. From Nishinomiya-Kitaguchi Station, a transfer is available north/south along the Imazu Line.

### **4.1 Hankyu Main Line Viaducts (Photos HC-1, HC-2, HC-7 to HC-9)**

The damage and removal of the mainline track between Nishinomiya Kitaguchi Station and Shukugawa Station was nearly complete. By the time of our visit nearly the entire section of the 1.5 kilometers was demolished and removed. The steel through-girder street crossings are all that remains and the pier wall one of these is leaning significantly. By the new construction and discussion with neighbors we assume the failure was influenced by liquefaction. Photographs we received from Mark Yashinsky of Caltrans who visited the site on January 20 show that there were two parallel structures. Each structure was composed of single column piers with a reinforced concrete girder and a concrete deck supporting the ballast. The structures were constructed side-by-side but not connected. The northern structure was destroyed and fell on its side. The southern structure was damaged beyond repair. The spans are about 10 to 15 meters and the bents are about 5 or 6 meters wide. The structure was a long viaduct about 5 to 6 meters high. We cannot ascertain if a mixed usage substructure similar to the Hanshin Line was employed since nothing remains.

The reconstruction effort is starting with soil improvement. Sheet piles are being driven along the edges of the right-of-ways to 15-17 meters. New 1 m to 1.5 m drilled shaft foundations are being constructed. The reinforcing cages on site indicate a depth of 10 to 12 meters. It appears the sheet piling is proposed to limit or control liquefaction while the drilled shafts will not buckle but should maintain friction in the upper strata.

#### **4.2 Hankyu Main Line Retained Structures (Photos HC-3, HC-10)**

In the heavily damaged aerial section there were few retained structures. There was some new sheet piling supporting the embankments. The displacements in the retaining structures were limited to 100-to-200 millimeters.

#### **4.3 Hankyu Main Line Stations (Photos HC-11, HC-13)**

The station facility at Shukugawa Station is being demolished. A median level 8 to 10 story building over the station is being demolished. We observed displacements of 300 to 400 mm horizontal and vertical in the station. A 15-20 story building within 100 meters of the station and downhill towards Osaka Bay shows no damage from the outside at all. It is relatively new, with 1980's construction at the east end of the damaged area. Near Nishinomiya Station a number of 1970's 10-15 story residential buildings were left with little or no damage alongside the destroyed rail viaduct.

A section of station platform displaced nearly 500 millimeters laterally and 300 millimeters vertically. Another of Yashinskyk's photographs shows a Hankyu Corporation passenger car derailed. From its location the car was evidently not in service, as it was parked at the end of a siding at-grade. The adjacent Buildings do not appear damaged.

The cost to reopen the Hankyu Line will be over \$800 million. It is projected to reopen by August 1995.

#### **5.0 PORT ISLAND PEOPLEMOVER (Photos PI-1 to PI-13) (About 20 km from epicenter)**

The Port Island Line is a peplemover that connects Port Island to Sannomiya Station in Kobe. The structure supported light automated rubber tired vehicles around Port Island and across to Honshu Island and Kobe. Approximately 300 meters of the structure between Port Island and Kobe was destroyed. All that remained of this segment were the foundations with 100 mm diameter bolts in a 2 meter circle. We do not know what type of structure was there but from the boundary structures and foundations it appears that a steel superstructure with circular steel columns, possibly concrete filled best fits the evidence. The failed structure is in a nest of multi-ramp, multi-level, multideck highway viaducts that suffered repairable damage. The longspan arch to Port Island was affected while the double-deck highway ramp into the Port of Kobe terminal and peplemover station dropped its final tightly curved spans.

As an interesting side note, a pedestrian/highway ramp parallel to the failed peplemover and about 3 meters apart is leaning westward. The superstructure is steel girders on what look like seismic isolation bearings. Walking up the ramp the lean is very noticeable as is pounding with adjacent structures. The double-deck steel girder, concrete bent highway bridge shows some distress at the top of the lower level columns, but traffic is moving on both levels. Some of the approach structures show some damage such as horizontal shear cracks in columns 3 meters above the foundations.

#### **6.0 DAMAGE AND REPAIR TO KOBE MUNICIPAL SUBWAY FACILITIES**

##### **6.1 Daikaidori Station (Photos KMS-1 to KMS-9) (About 16 km from epicenter)**

Daikaidori Station is located in the median of Daikaidori Street about 3 blocks north of JR Tokaido's Hyogo Station. It was constructed by cut-and-cover methods. The neighborhood was but not as badly affected as Mikage since most buildings are still standing. On both sides of Daikaidori Street which is 3 lanes each direction plus the median plus bus lanes there is some damage but the buildings are standing, although a few will have to be demolished. Many buildings adjacent to the collapsed station appear



# DAIKAI DORI SUBWAY STATION

HYOGO KU, KOBE

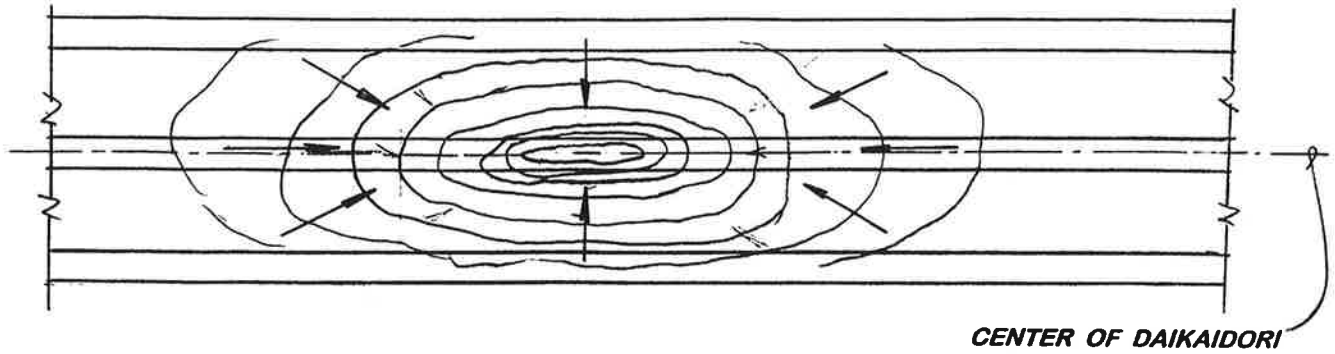

## PARTIAL PLAN

NOT TO SCALE

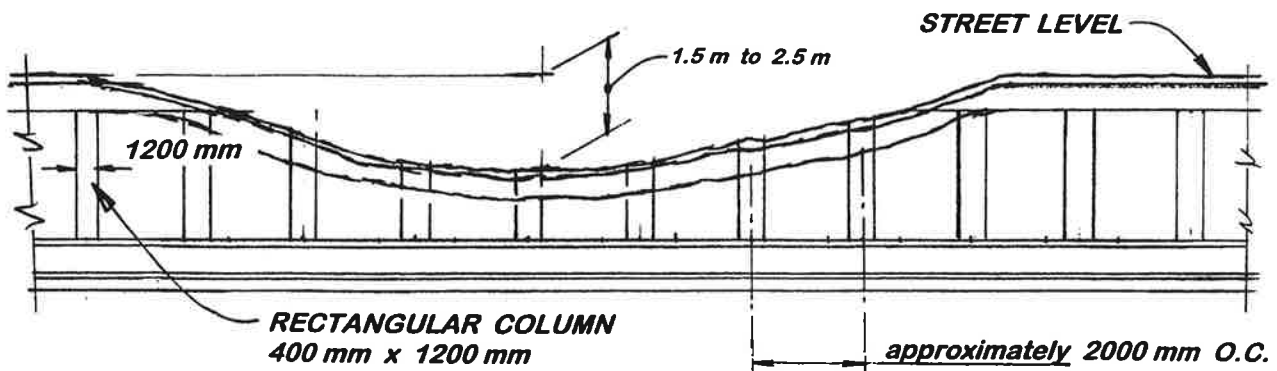

## LONGITUDINAL SECTION

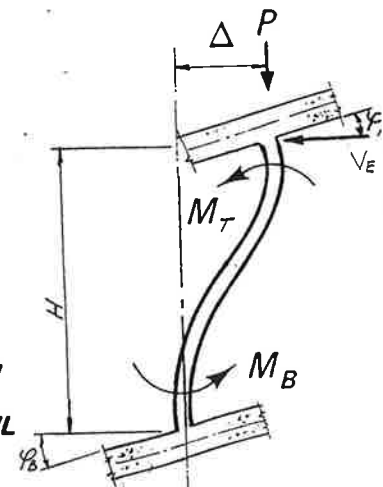
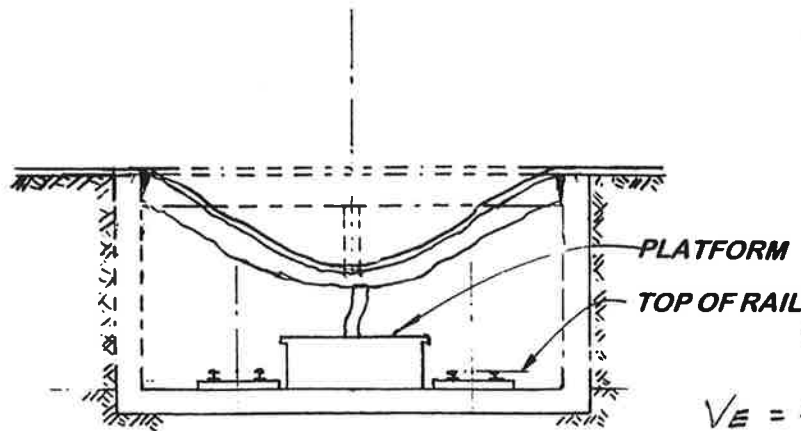

$$V_E = \frac{M_T + M_B + P\Delta}{H}$$

$V_E >$  COLUMN SHEAR CAPACITY

## CROSS SECTION

$M_T + P\Delta$  OR  $M_B + P\Delta >$  COLUMN MOMENT CAPACITY

Figure 6

undamaged. It's a very nice, quiet residential neighborhood with buildings typically only 2-3 stories. The neighborhood adjacent to the subway showed some signs of subsurface disturbance.

The municipal subway station had a row of center columns dimensioned 1000 mm longitudinal by 400 mm transverse. The columns were spaced about 2 meters on center. This was a center platform station. The columns failed during the earthquake and the roof fell in. We heard it took 5 or 6 hours until the failure stopped. We were not allowed access underground by the contractor. Currently there is a 2-3 meter depression in Daikaidori Street.

The contractor's representative said the columns buckled in the weak direction. He also said the outside walls are still vertical within 7 degrees.

The only explanation is some lateral transverse displacement had to occur which would increase moments at the corners of the cut-and-cover box structure. This would cause an increase in shear in the roof and floor of the box. This exceeded the design moment/axial load capacity of the columns and with minimal shear reinforcing allowed the collapse. This mechanism is possible with as little as 10 to 15 mm distortion to the box structure especially if the columns are not properly reinforced with ties and crossies. Compared to the strength and stiffeners of the roof and floor, the columns are weak and flimsy and one might think, "They would just go along for the ride". But proper detailing is still necessary to allow the movement.

The contractor is going to excavate around the entire station and demolish the roof, walls, platform, stairs, etc. He will then rebuild the entire station.

A final word: the contractor's representative's final statement was, "We believed that this was not possible". We replied that the possibility of a subway station collapse was also a matter of some controversy in the U.S.

## **6.2 Sannomiya Station (Photos SS-4, SS-6 to SS-8)**

The third rail system with a station at Sannomiya is the Kobe Municipal Subway Station. This station is located beneath the JR maintenance facility. The buildings nearby are all high-rise (10 to 25 stories), commercial buildings. Many of these buildings were heavily damaged and they are being demolished. Access to the subway station is not permitted by the contractor. We spoke with a worker who explained that the columns were damaged with cracks and spalling but they were being repaired. It is probably safe to assume that the Sannomiya Subway Station is similar to Daikaidori Station in the Municipal Subway and that similar though less serious damage occurred.

It is also interesting to note that subway trains are running and bypassing the stations. There were tunnels below the stations that were not damaged. The trains are currently using the tunnels to avoid the stations from Daikaidori to Sannomiya.

## **7.0 CONCLUSIONS**

### **7.1 Observations Relevant to U.S. Design Practice**

A number of conclusions can be made based on observed damages that either affirm or question the codes used for design of rail structures in the United States. This applies both to seismic design and seismic retrofit of aerial structures, retaining structures, embankments, stations, catenary electrification supports, underground cut-and-cover and tunnel structures. These observations and conclusions follow an itemized form.

- Flexible is better than strong. Taller structures like the damaged Shinkansen started to form their plastic hinges. While shorter structures such as the Hanshin and Hankyu suffered brittle shear fractures.

- Ballasted rail does not restrain seismic response (Photos HC-2, HER-12, JRS-16, JRT-41).
- There is a minimum shear capacity required of infill walls used as a seismic retrofit technique (Photos HER-16, HER-17, HER-20 to HER-22). The stiffness of these infill walls will attract significant initial response.
- Details of secondary use of the structures should be checked to either provide the necessary force or displacement capacity. Secondary attachments can cause primary structure failures in undetermined directions (Photos HER-16, HER-17).
- Trains at-grade can be derailed, even parked trains (Photo HC-3).
- Seat type joints should be restrained or checked to meet maximum travel demand. This is an AASHTO requirement since 1990.
- Cut-and-cover subway stations can collapse (Photos KMS-1 to KMS-9).
- The supporting elements in subways must be checked for displacement capacity. It can't be assumed anything goes along for the ride unless it's detailed properly. Significant curvature and shear can be imposed on these elements (Figure 6).
- Don't splice column reinforcing bars in potential plastic hinge zones. This is not allowed in California.
- If a concrete column is expected to be able to form a plastic hinges the joint must be properly detailed. ACI requires the special reinforcing. Caltrans also has requirements. (JRS-3, JRS-5, JRS-9, JRT-24).
- Confining the face of a joint zone by the ACI definition shows very positive results. An unconfined face of a joint appears very vulnerable (Photos JRS-11 and JRS-14).
- Rectangular columns need ties and cross-ties. This is an ACI, Caltrans, and AASHTO requirement (Photos - All Viaducts).
- Bridges by proportion want to perform a strong beam weak column seismic response. Buildings in the United States are designed for weak beam strong column response (Photos - All Viaducts).
- Bridge columns shear cracks are more vertical than 45 degrees. The American Concrete Institute Building Code Requirements for Reinforced Concrete (ACI 318) assumes a 45 degree failure. (Photos JRS-19, HER-19, HER-22).
- Grade beams between foundations seem to help. A more general statement would be to tie structural elements together (Photo JRS).
- Longitudinal response does occur and can be more significant than transverse response. There has been some discussion of the possibility of longitudinal response of long viaducts being slowed by incoherence (Photo JRS-18, JRS-28).
- We did not notice any obvious foundation pile failures. We did observe liquefaction failures.
- Retaining walls can be moved significantly by seismic pressure. This should be accounted in any tight depressed retained cut. The new AASHTO code provides a method. (Photos JRT-1 to JRT-7, HER-1 to HER-5, HER-8, HER-9).
- Catenary supports and stays should be checked for seismic lateral forces (Photo HC-6, HER-3, HER-7).

- Whole station platforms can be displaced Station platforms are subject to structural failure (Photos HC-6, HER-3, HER-7).
- Slope stability is affected by strong ground actions (Photo HC-5).
- Station canopies are subject to structure failures in earthquakes (Photo JRT-45).
- The load path of lateral forces must be verified for forces and displacements For example, using same set of assumptions to determine a seismic load on a column then dividing that load by an arbitrary moment reduction factor to develop a design moment is not the end of the process. The rest of the structure must be designed to be stronger than the weak column. Other elements in the load path may include shear in the columns, foundation connections, superstructure, pier cap beams, beam to column joints, bearings, abutments, etc.
- Elements assumed to go along for the ride and absorb damage may fail or cause other failures by creating an alternate although temporary load path (Photos HER-16, HER-20, HER-22, KMS-2, Figure 6).
- Underground subway stations in seismic zones with center supports should be checked for shear and confinement and retrofit if needed. The potential cost to repair this type of structure is extreme (Photos KMS-1 to KMS-6).
- Lifeline transportation systems need to be designed to a minimum level of service for seismic performance. All intersecting systems and utilities should meet the same performance criteria. A failed bridge can damage a water main that provides water to fight fires.
- Linear facilities like viaducts and embankments should provide crossings with a very high service level (for emergency access) (Photos HER-6, HER-12, 35-5, JRS-23, JRT-12, JRT-8).
- Clear service roads should be provided along railroads so failures of other structures can be cleared easily from the trackways (Photos HER-21, HER-27, HER-33, HER-36).

**KOBE**

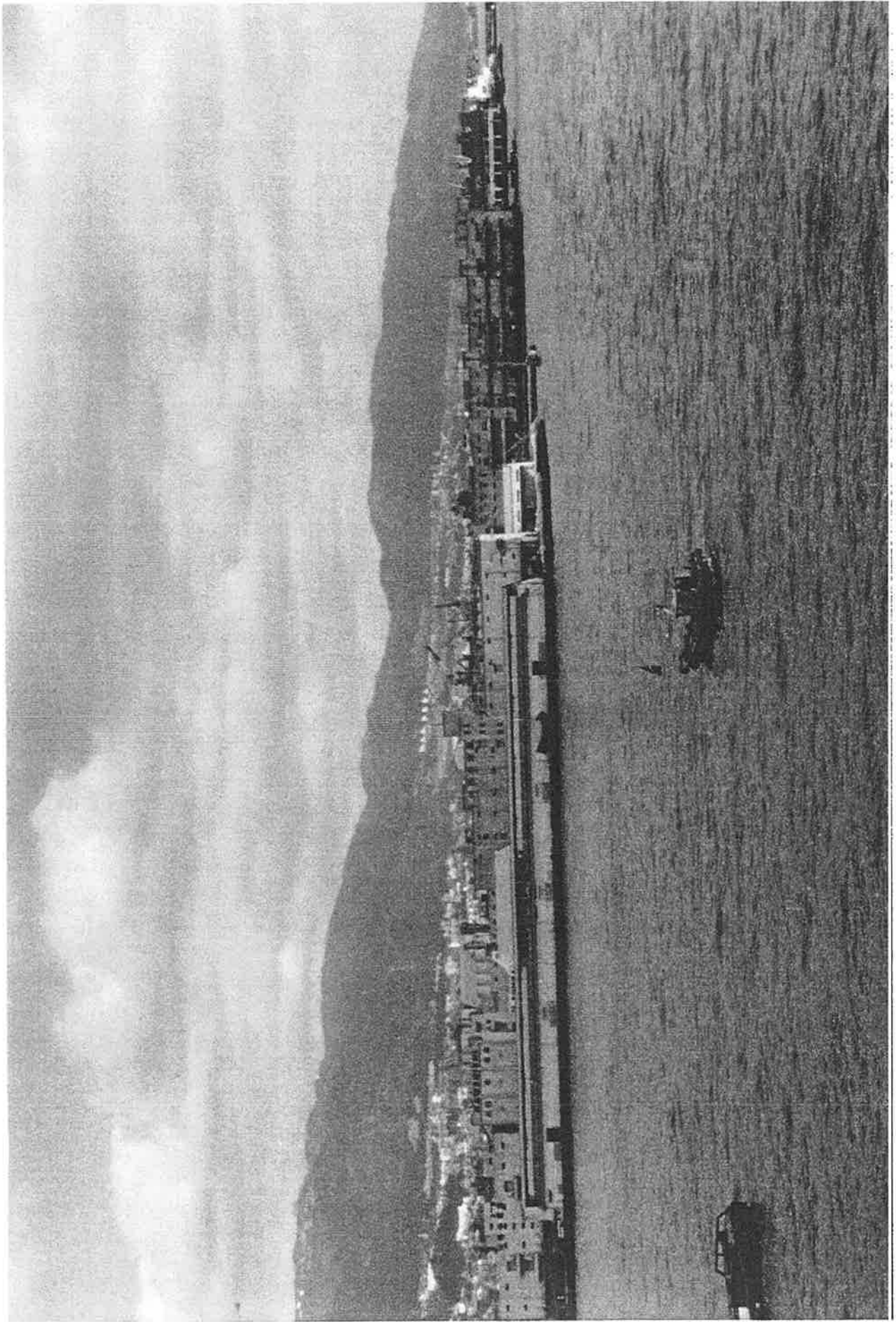

*Eastern Kobe waterfront towards Nada-ku; Much of the damage was just beyond the port facilities.*

# KOBE

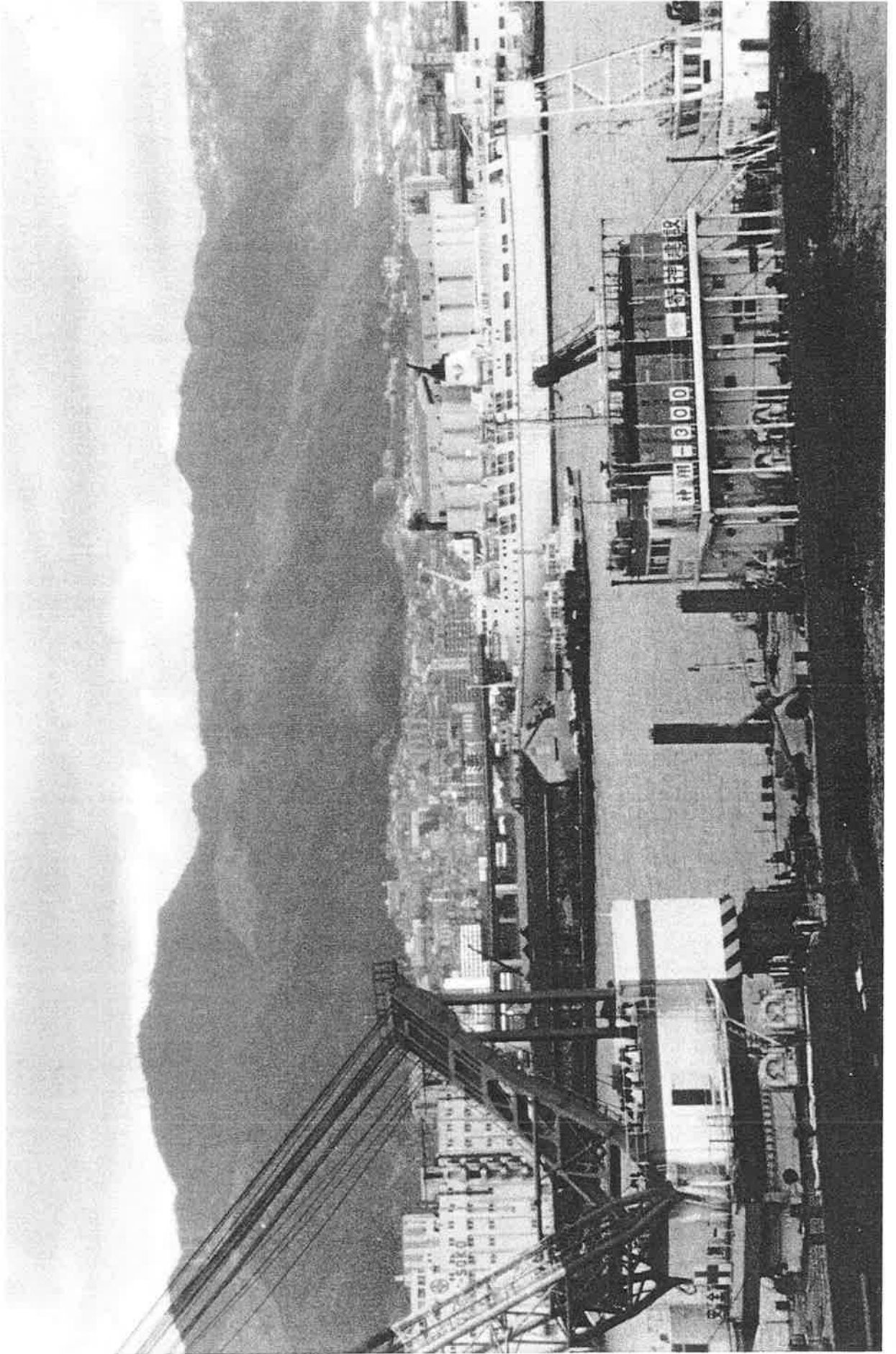

*The eastern portion of central Kobe seen from the waterfront to the hills. The rugged hills are a national park, hence all rail lines pass through this narrow corridor. The barge in the foreground is for repairing some port facilities.*

**KOBE**

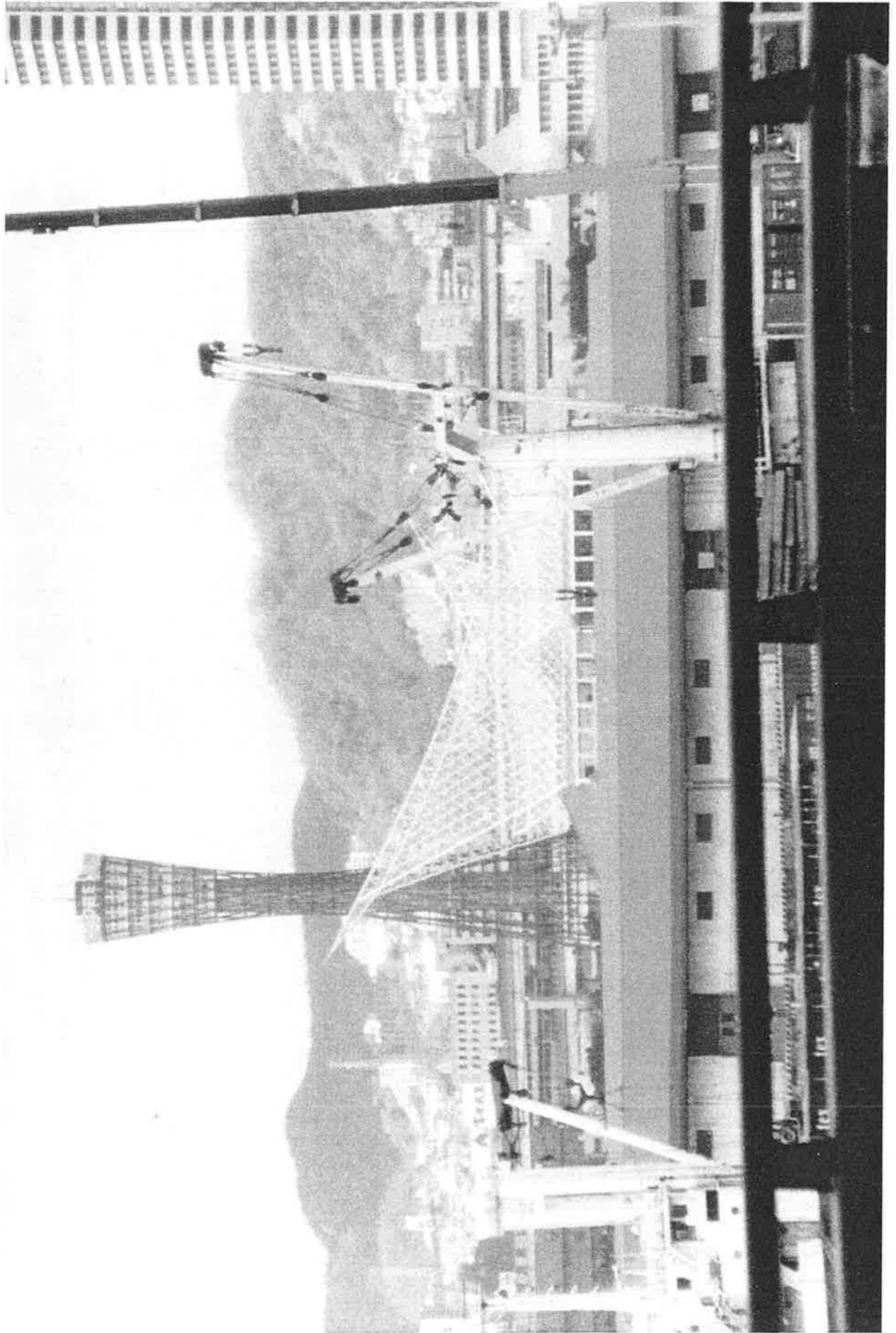

*Western Kobe towards Hyogo-ku; The tower is visible from Daikai-dori Station.*

**West Japan Railway Company – TOKAIDO MAIN LINE**

---

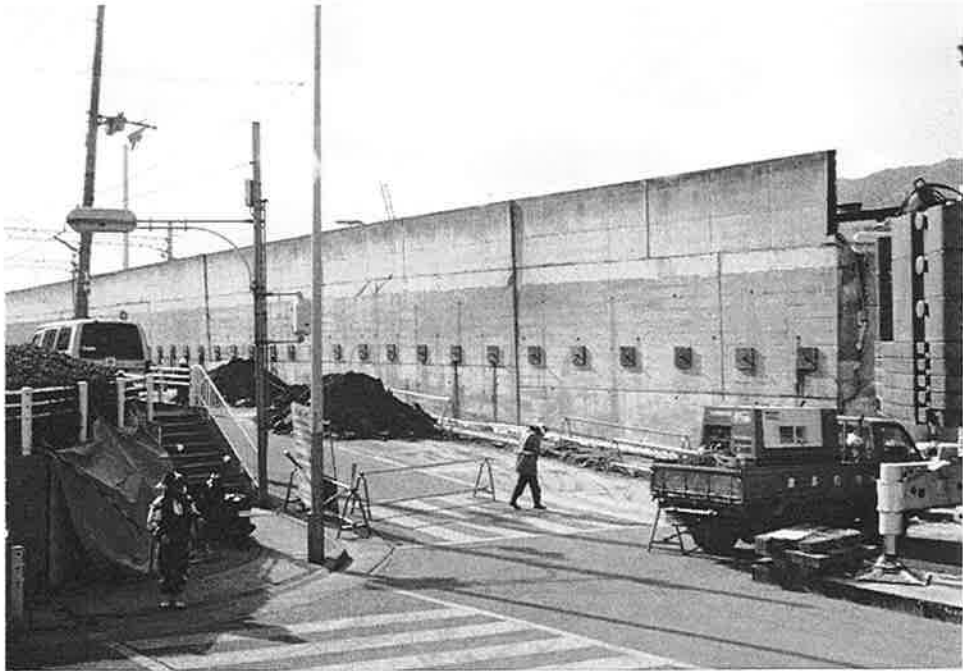

*JRT-1. This retaining wall supporting about 4 meters of fill failed, over a length of 300-400 meters.*

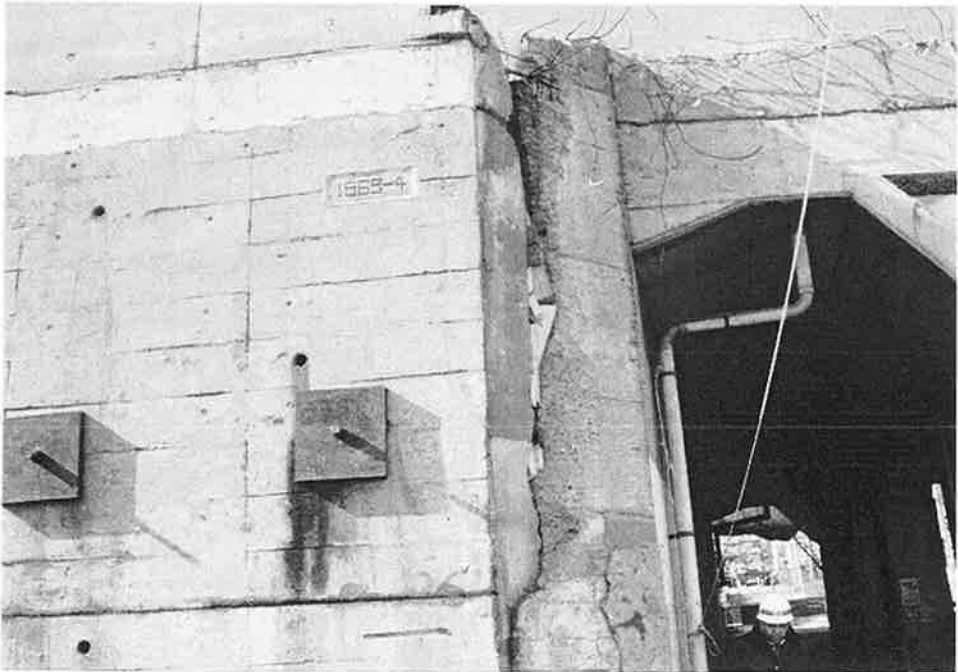

*JRT-2. The failed retaining wall opened at this abutment.*



**West Japan Railway Company – TOKAIDO MAIN LINE**

---



*JRT-3. This concrete plumb bob indicates a 400mm lean in the retaining wall.*



*JRT-4. Retaining embankment through bolts as seen from the back face of the wall.*

## ***West Japan Railway Company – TOKAIDO MAIN LINE***

---

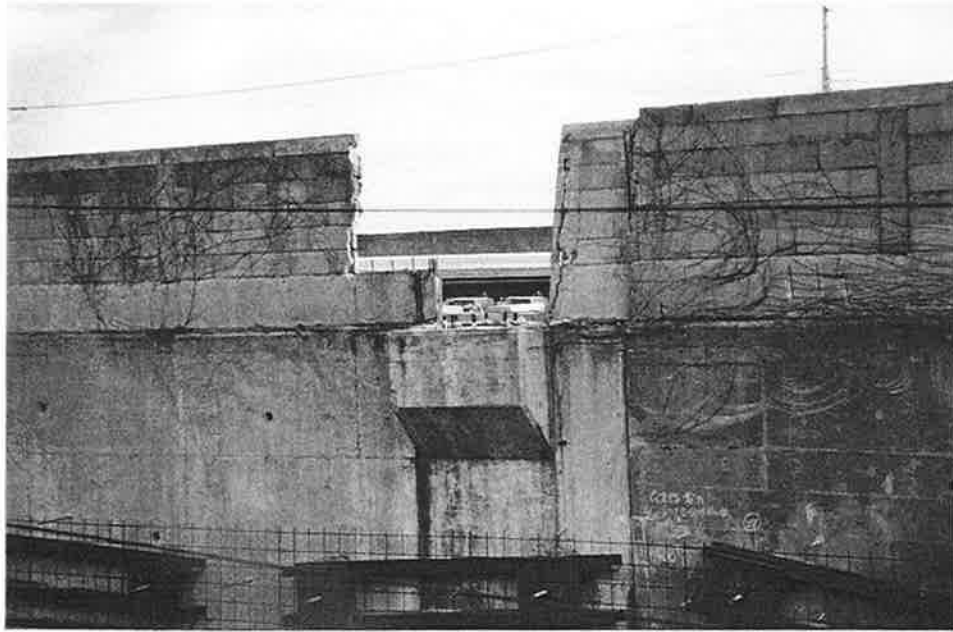

*JRT-5. The catenary support is removed from the top of retaining wall. The core drilling doesn't have the vertical control on this side of the retaining embankment.*

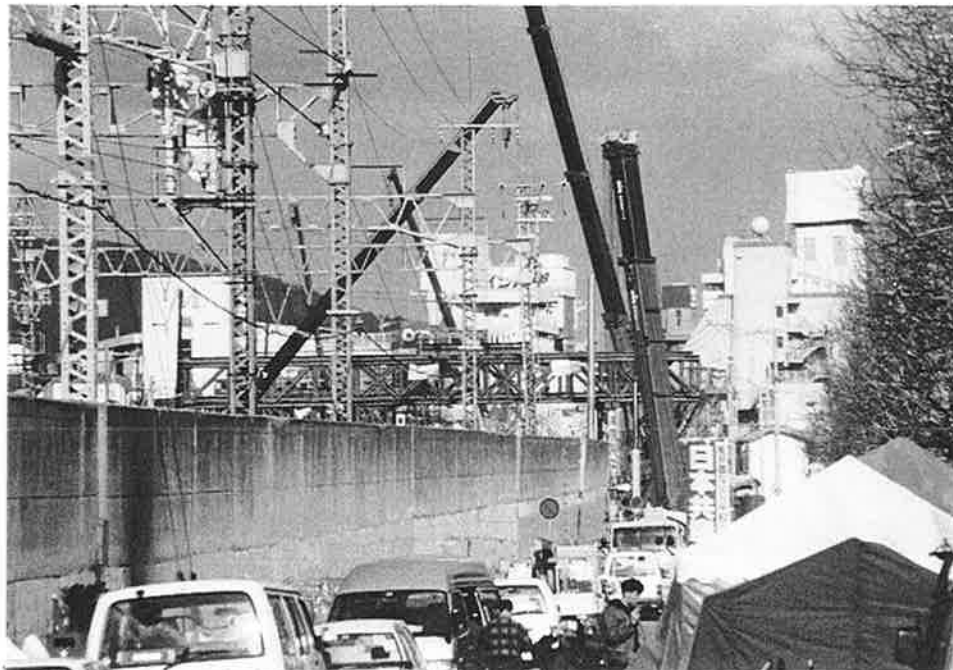

*JRT-6. The jacking frames support the viaduct in the background. The leaning retaining wall is the center. The tents to the right are local relief volunteers, staffed by college students.*

## **West Japan Railway Company – TOKAIDO MAIN LINE**

---

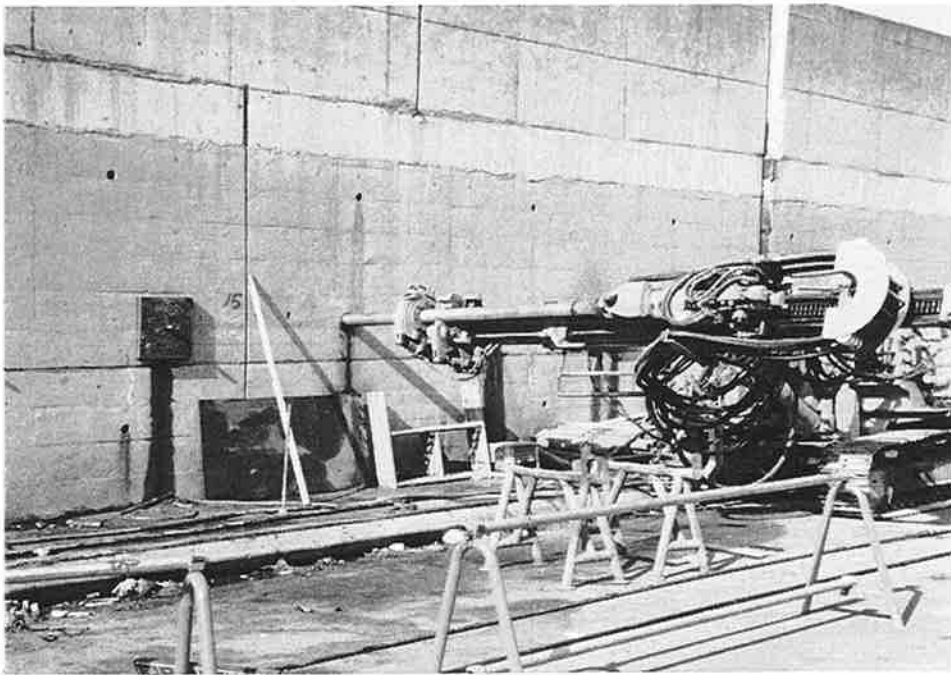

*JRT-7. The retaining walls are being repaired by coring through the wall, the embankment and the wall on the opposing side and installing high strength bars through the cored hole..*

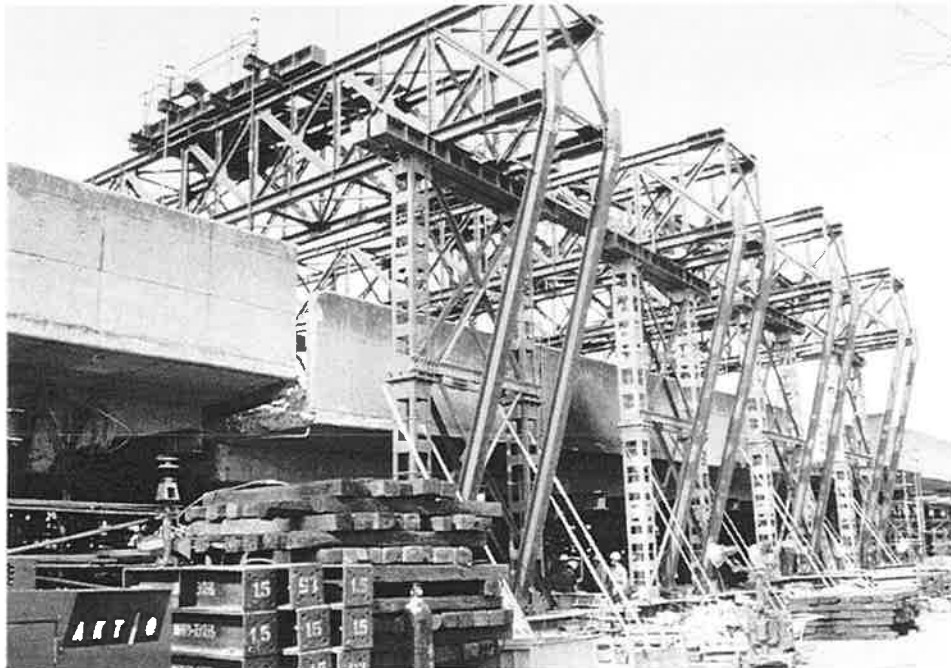

*JRT-8. This section of superstructure is being jacked into place with these jacking towers.*

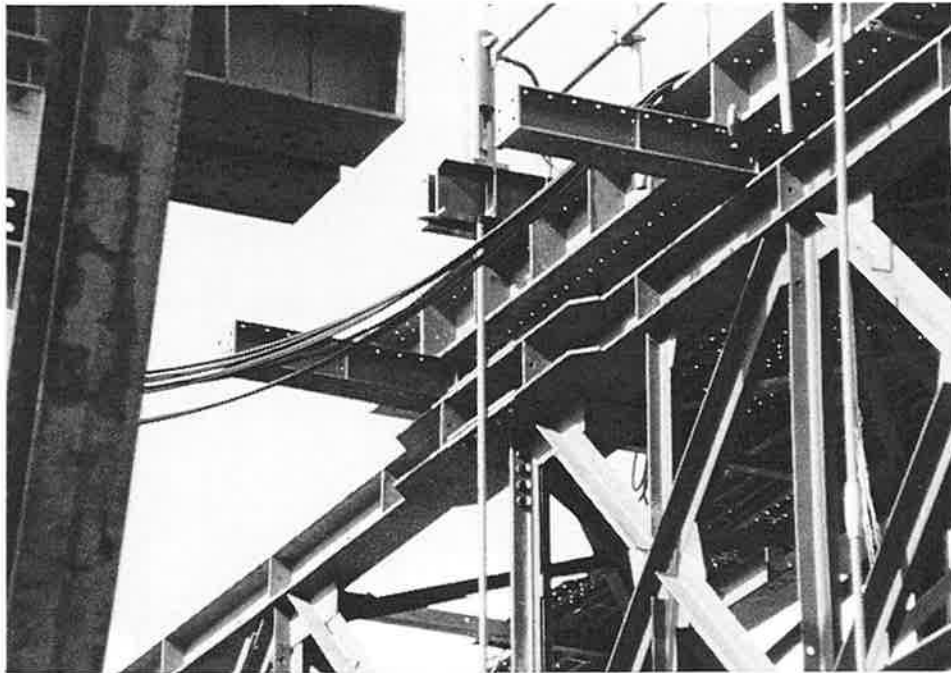

*JRT-9. The hydraulic jacks lift the vertical rods which are cored through the girders. The rods look like high strength rebar.*

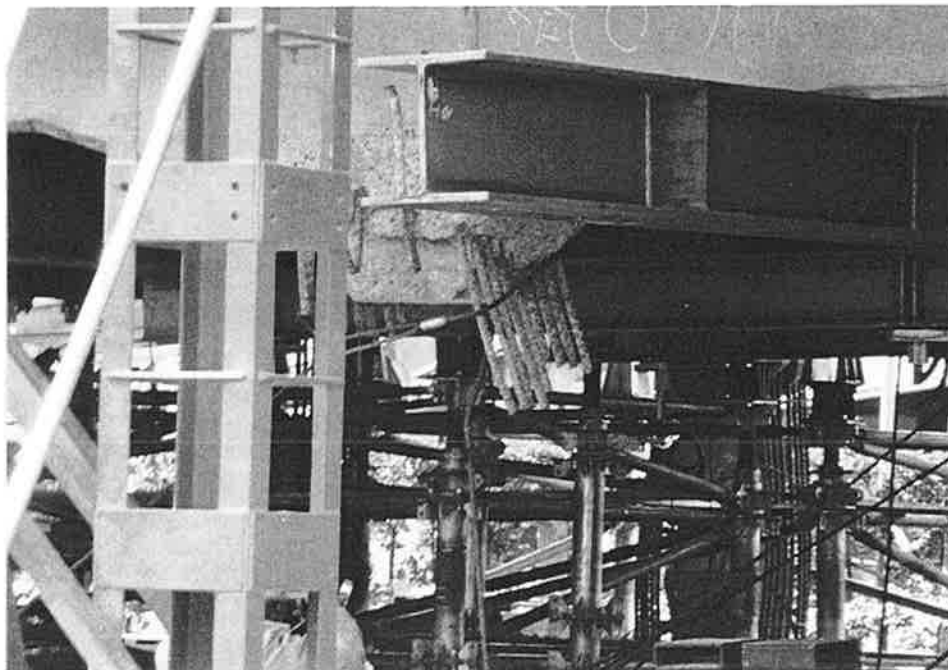

*JRT-10. Part of the jacking tower vertical support system is columns constructed of four angles with stiffeners. Note the cut off column and the temporary supports below the jacked superstructure.*

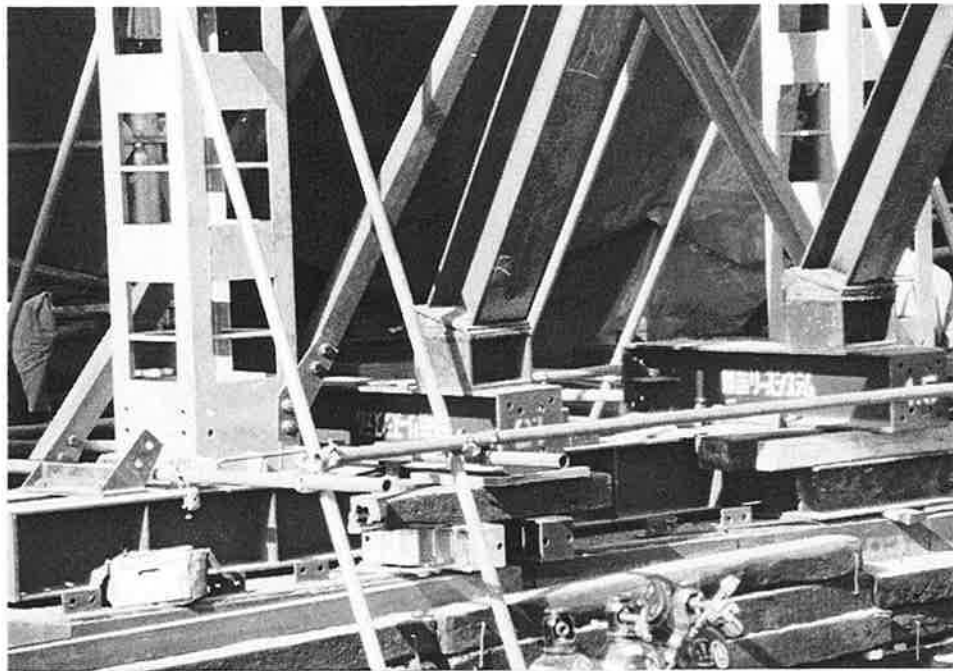

*JRT-11. Jacking frame supports and leveling shims.*



*JRT-10. Construction of additional jacking frames.*

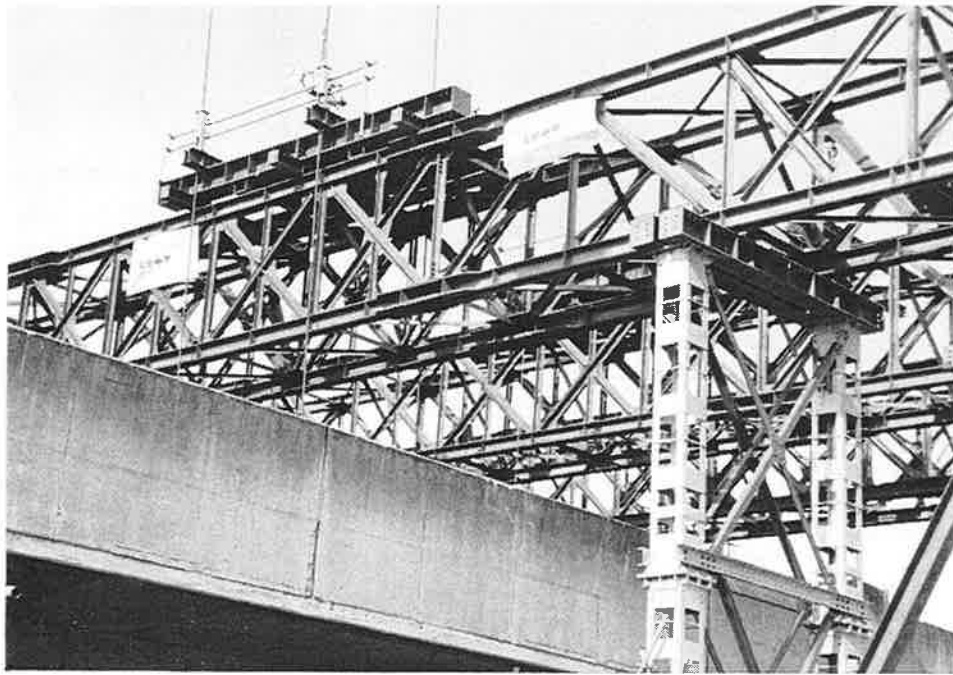

*JRT-13. A second jacking frame with the hydraulic jacks.*

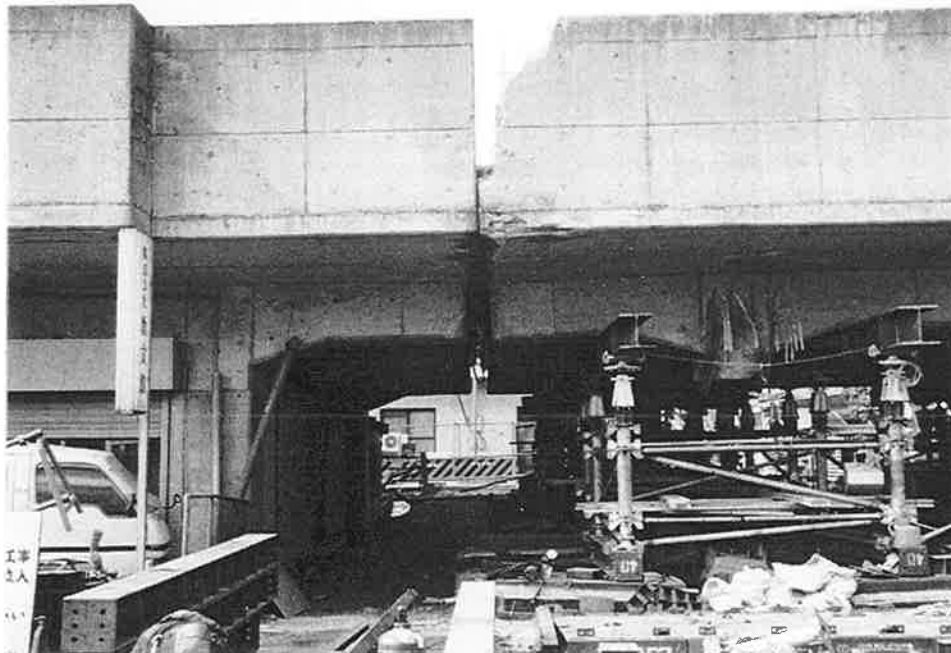

*JRT-14. A typical expansion joint at mid span. The frame on the right was severely damaged.*

## ***West Japan Railway Company – TOKAIDO MAIN LINE***

---



***JRT-15. The viaduct here is very short and susceptible to shear forces. The collapsed sections are consistent with high shear force demand.***

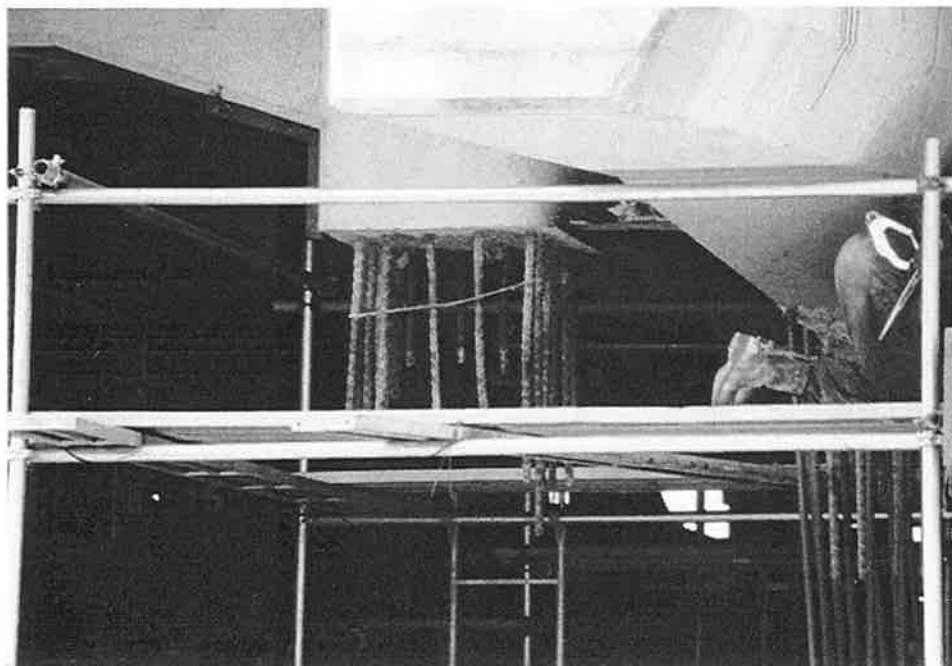

***JRT-16. In some areas the columns were cut at the top with 500mm left of the main reinforcing.***

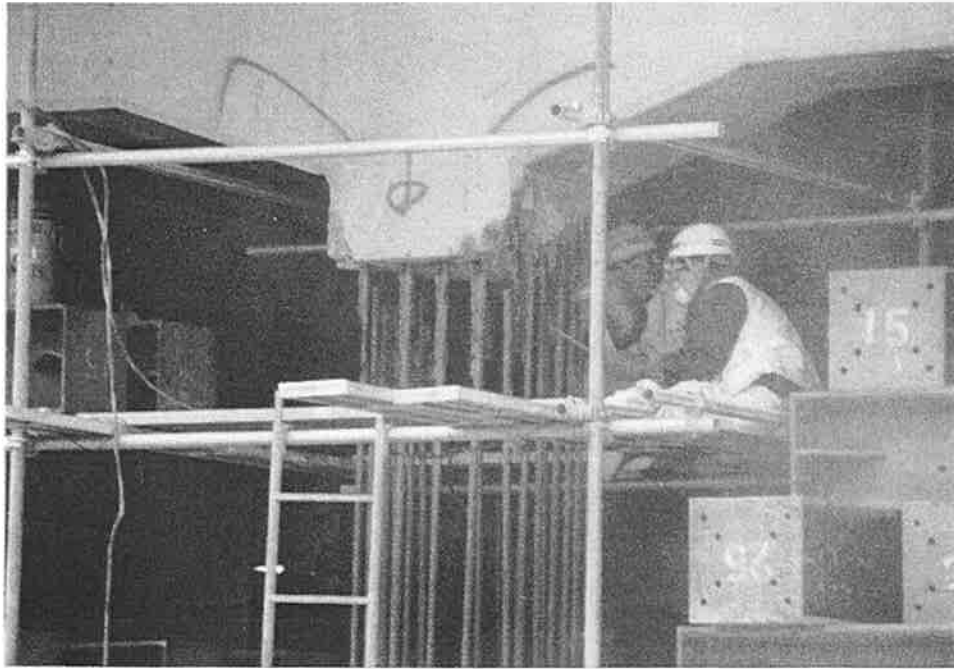

*JRT-17. New column reinforcing is being welded to existing bars to repair damaged columns.*

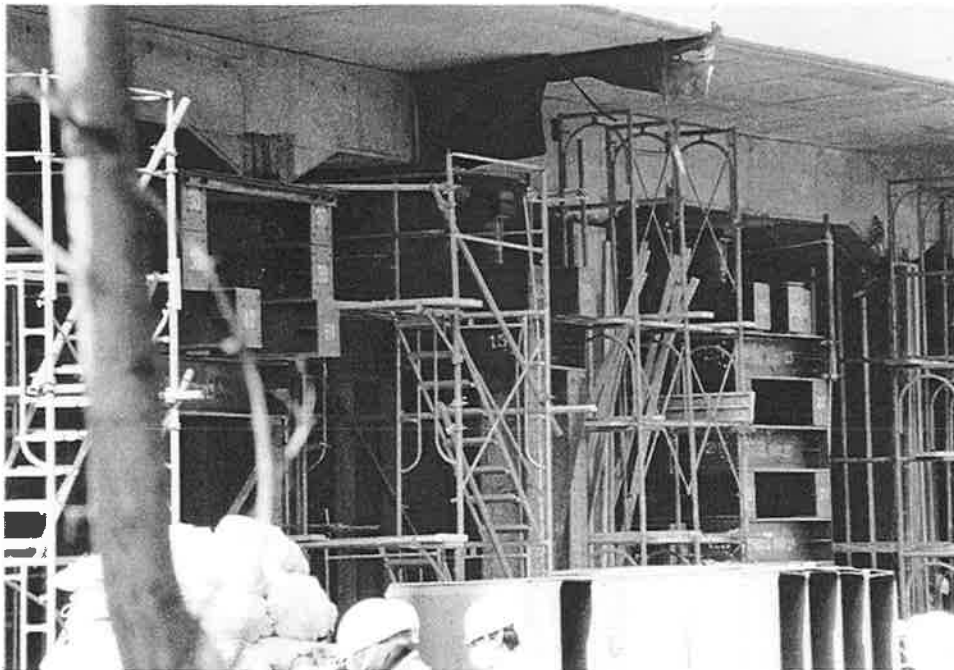

*JRT-18. Temporary supports under the viaduct while columns are replaced.*



**West Japan Railway Company – TOKAIDO MAIN LINE**

---

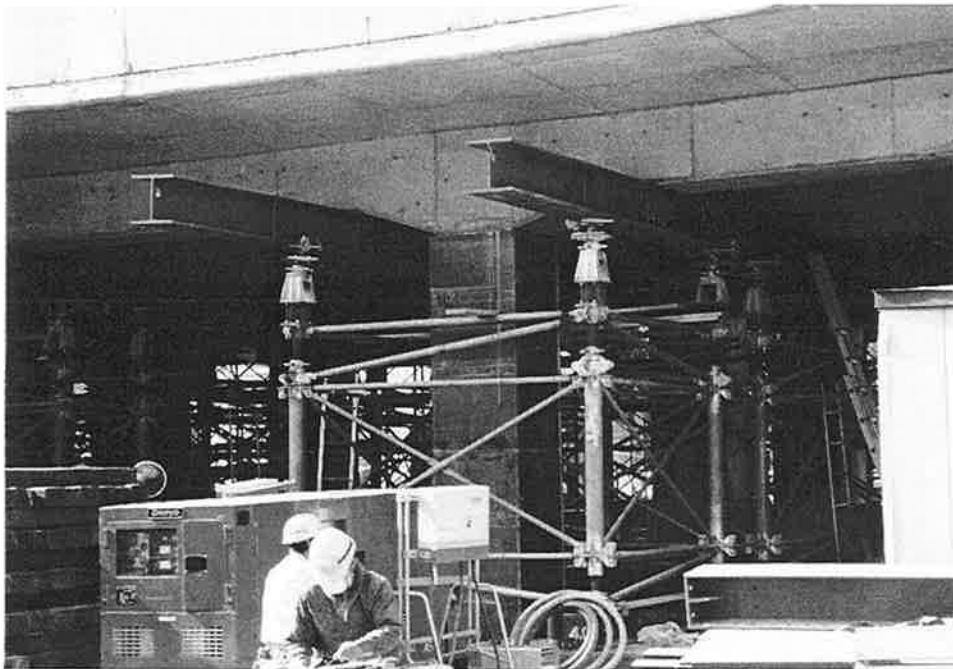

*JRT-19. Another type of temporary support is used here. Note the plate steel jacket on the column.*

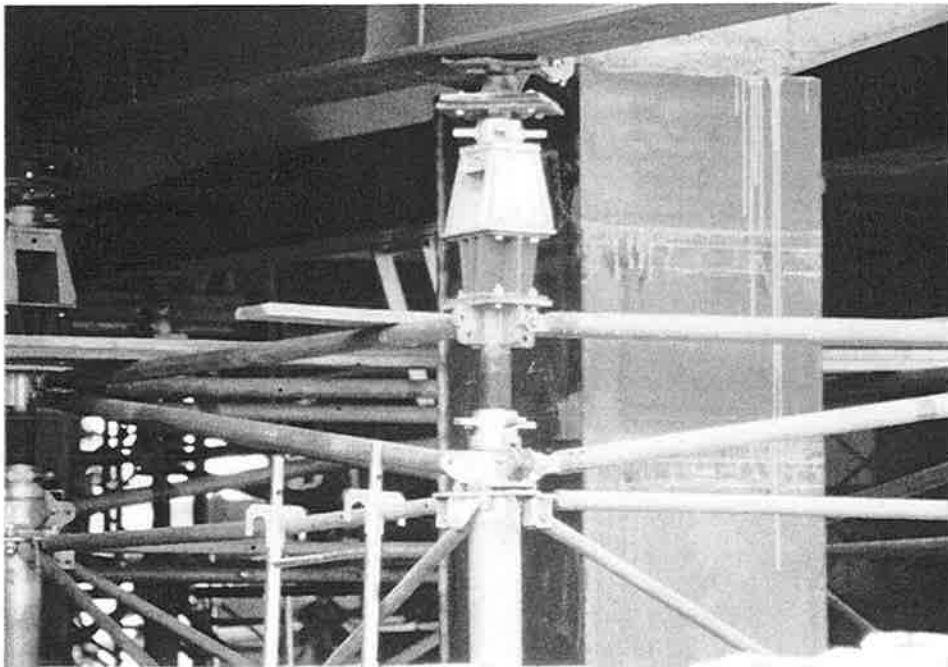

*JRT-20. Close up of the temporary support and the steel jacket.*

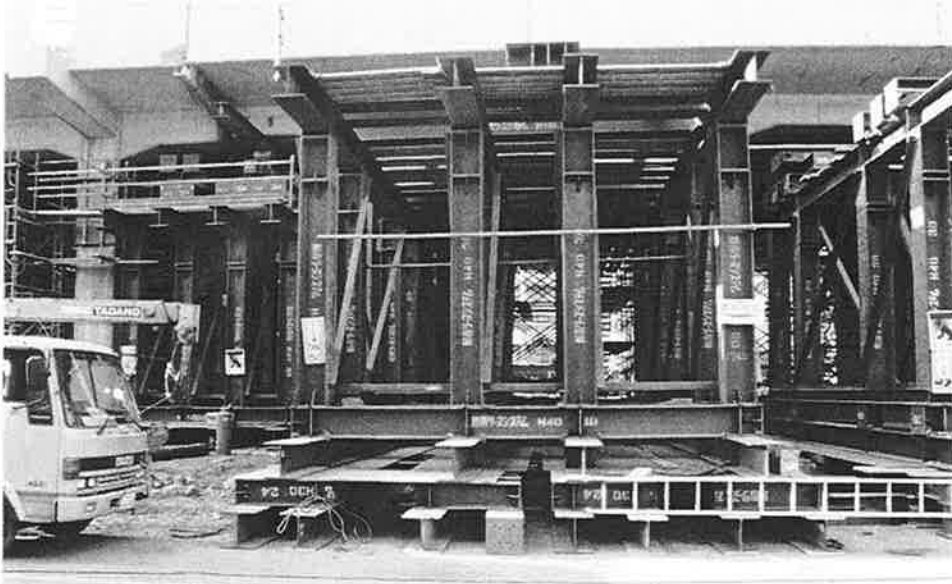

*JRT-21. Another type of temporary support.*



*JRT-22. Lateral restraint on this temporary support appears by C-clamp.*

**West Japan Railway Company – TOKAIDO MAIN LINE**

---

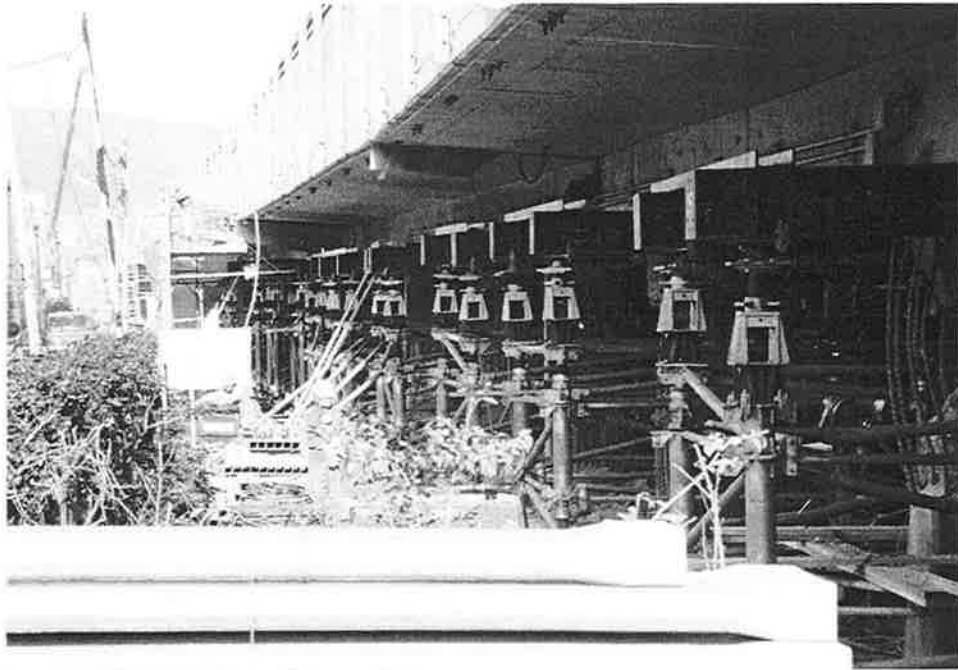

*JRT-23. Length of viaduct supported for repair.*



*JRT-24. The square steel plate jacket extends to the top of column. The column bars are exposed through the joint to the termination.*

**West Japan Railway Company – TOKAIDO MAIN LINE**

---

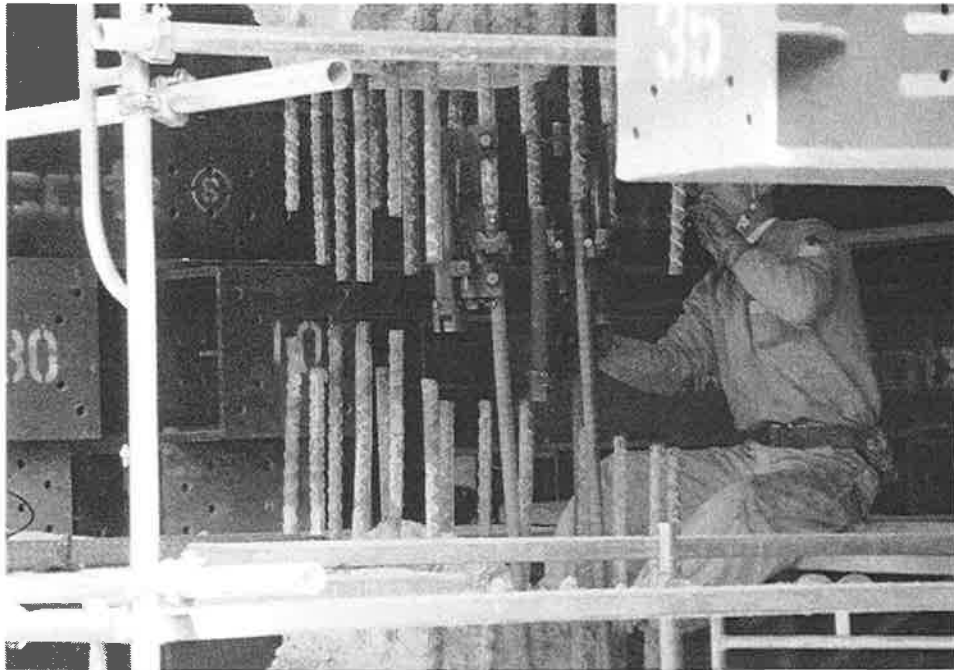

*JRT-25. An ironworker is splicing new rebar in this column about 500mm below the top of column.*



*JRT-26. The center two column bars (transverse) appear ruptured while the left side (longitudinal) bars appear to have been flame cut.*

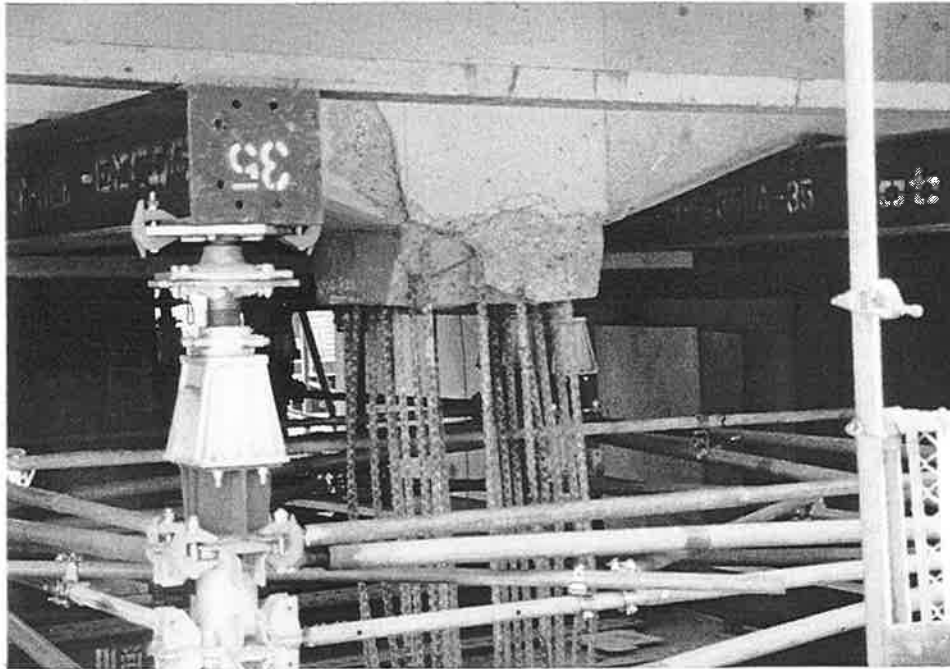

*JRT-27. These existing column rebars are being used in the repair.*

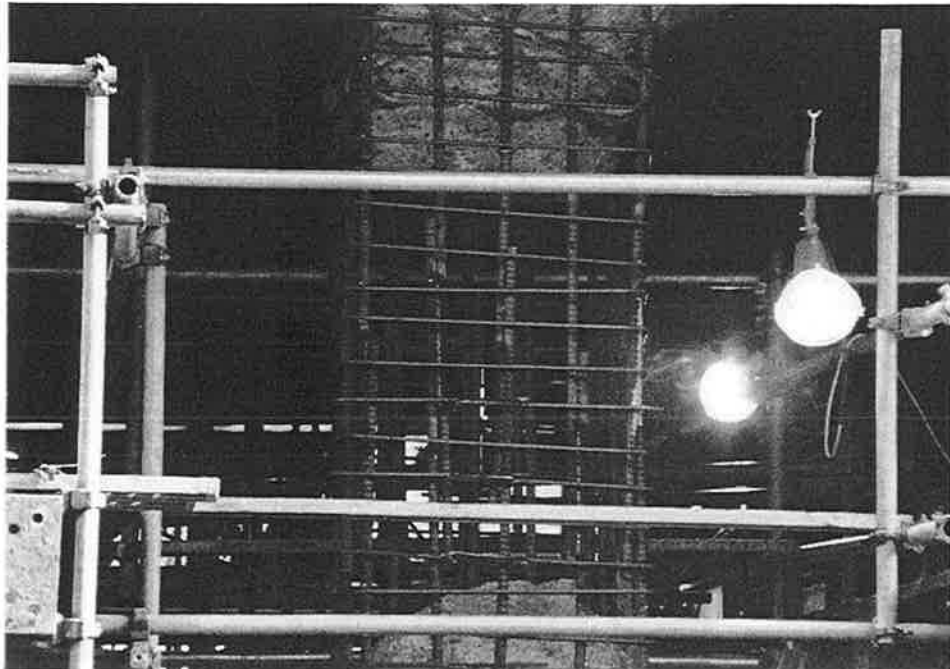

*JRT-28. Typical column repair. Note the tie spacing, splices and lack of cross ties.*

## ***West Japan Railway Company – TOKAIDO MAIN LINE***

---

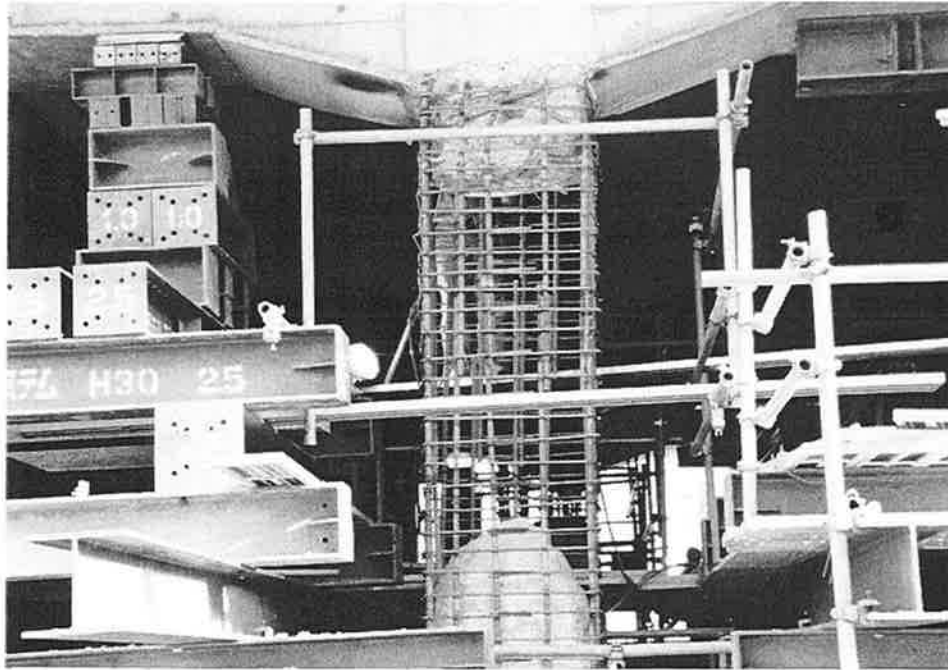

*JRT-29. Typical column repair. Note the typical supports using steel sections as cribbing.*

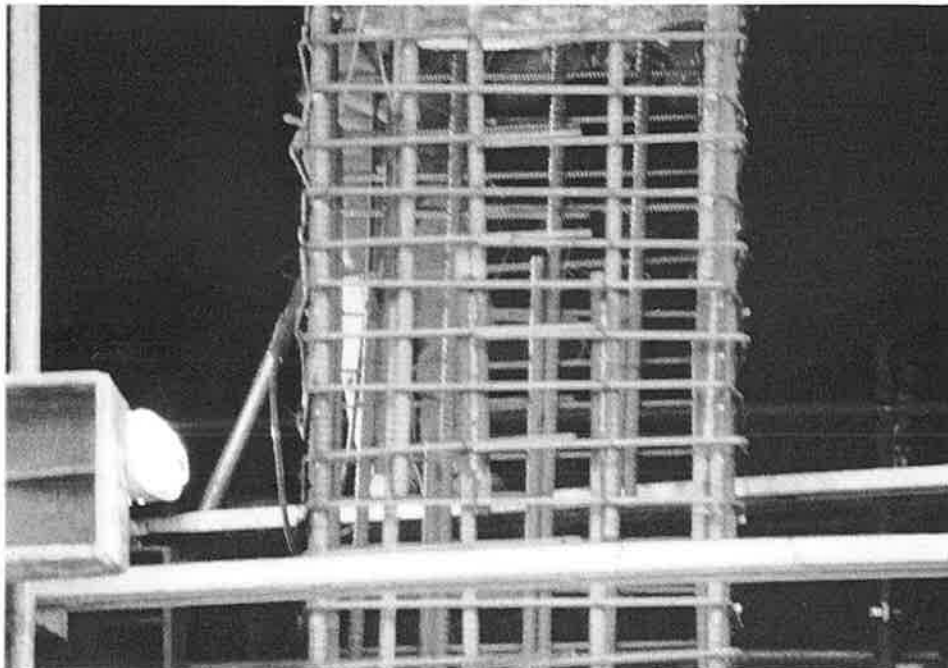

*JRT-30. Close up of reinforced column. Note the main bar splices and the tie splices.*

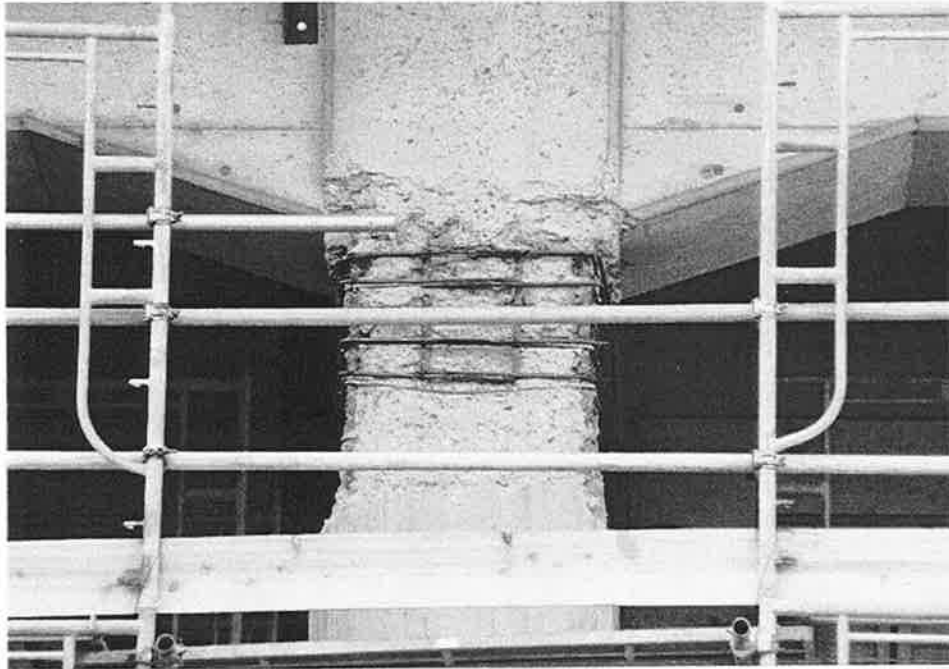

*JRT-31. A plastic hinge started to form at the top of this column. Additional ties and a vertical stirrup are being added.*

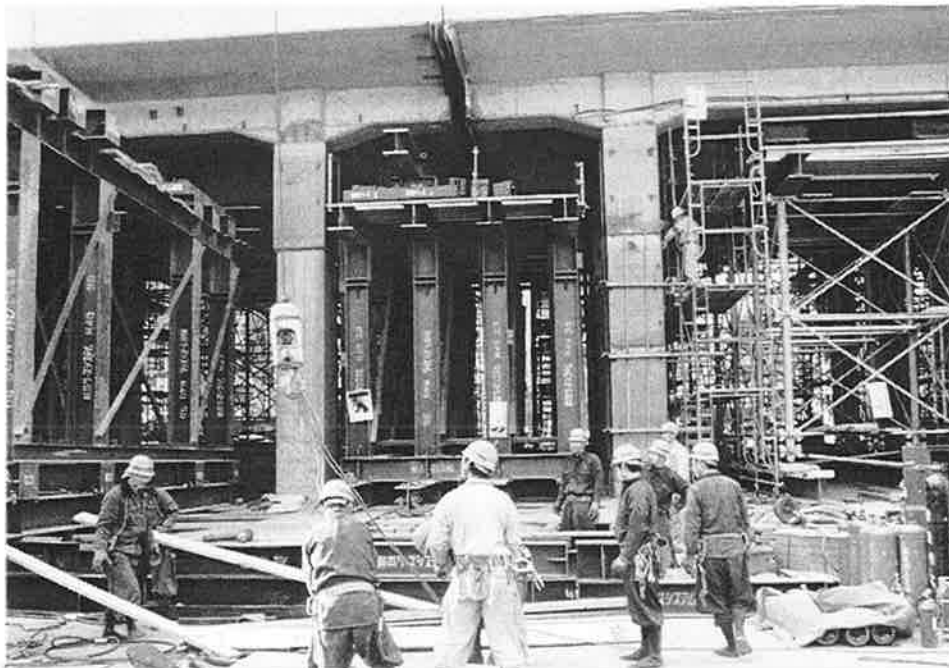

*JRT-32. Construction crew at work. Note the welder on the scaffold.*

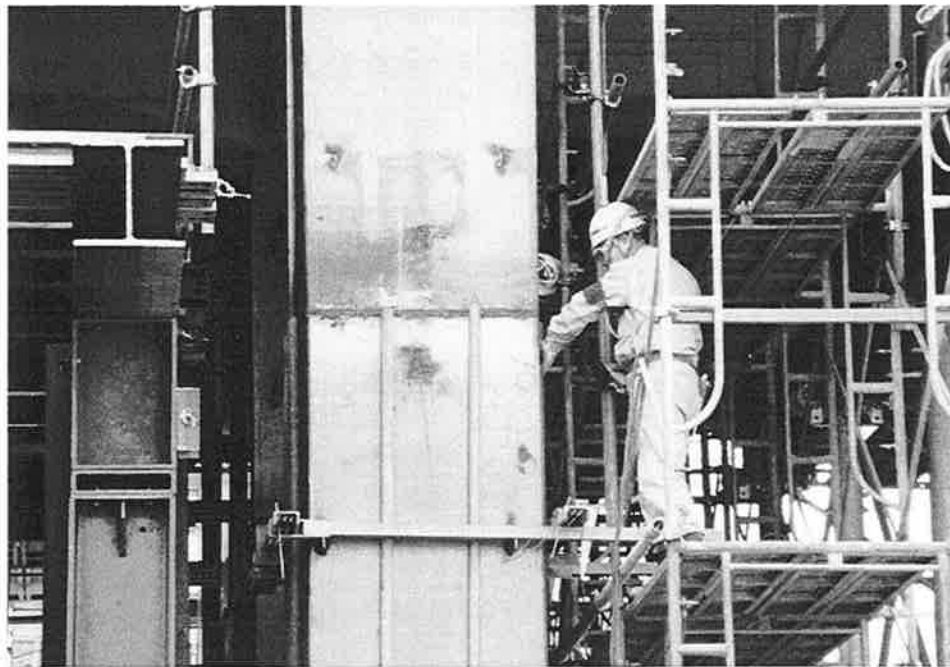

*JRT-33. Welder is preparing to seal steel plate jacket.*

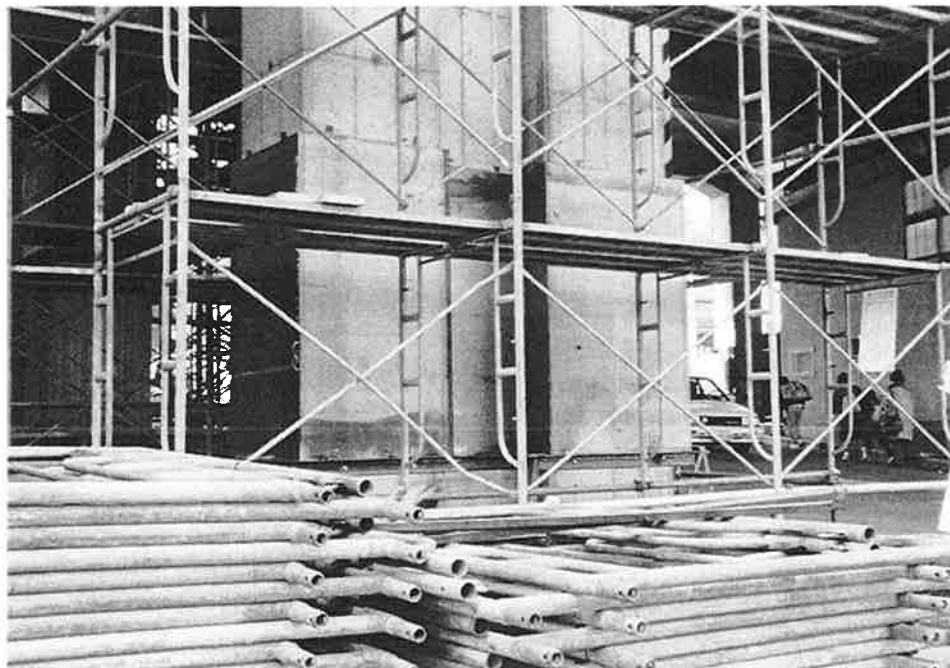

*JRT-34. Unusual shaped steel plate jacket on this pier wall.*



**West Japan Railway Company – TOKAIDO MAIN LINE**

---

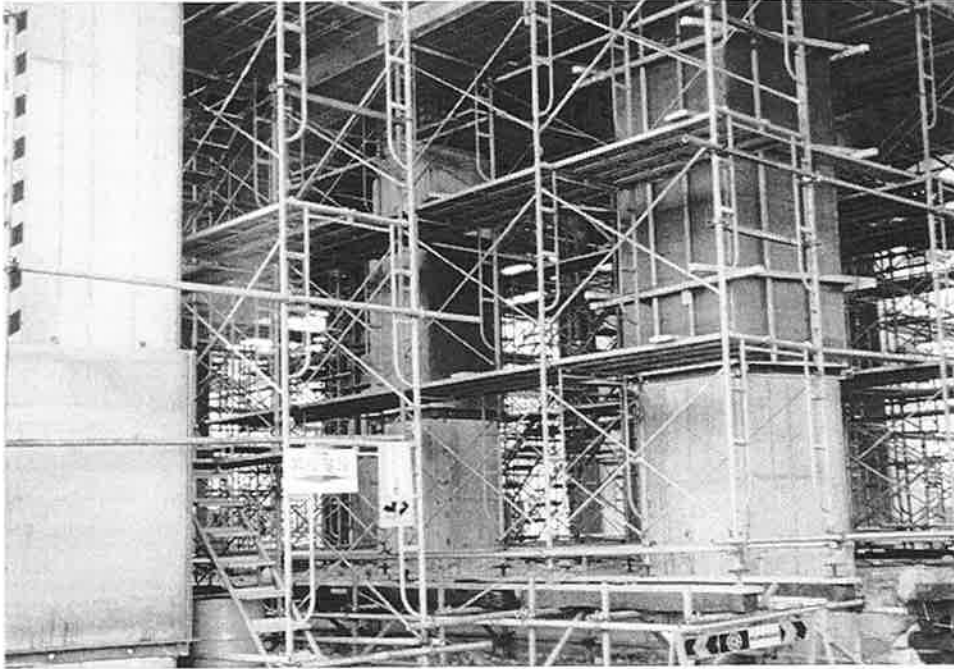

*JRT-35. Steel plate jacket at mid-column on the left column. The right column is jacketed at the top 2/3 column.*

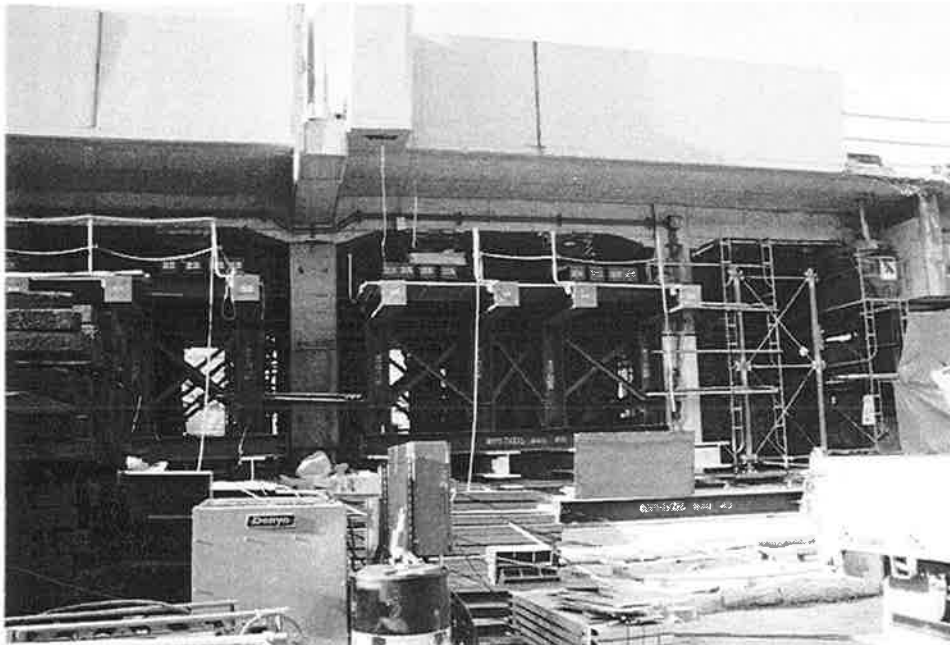

*JRT-36. More temporary supports and steel plate jacket repair.*

## ***West Japan Railway Company – TOKAIDO MAIN LINE***

---



*JRT-37. Steel jacket repairs at the tops of the columns.*

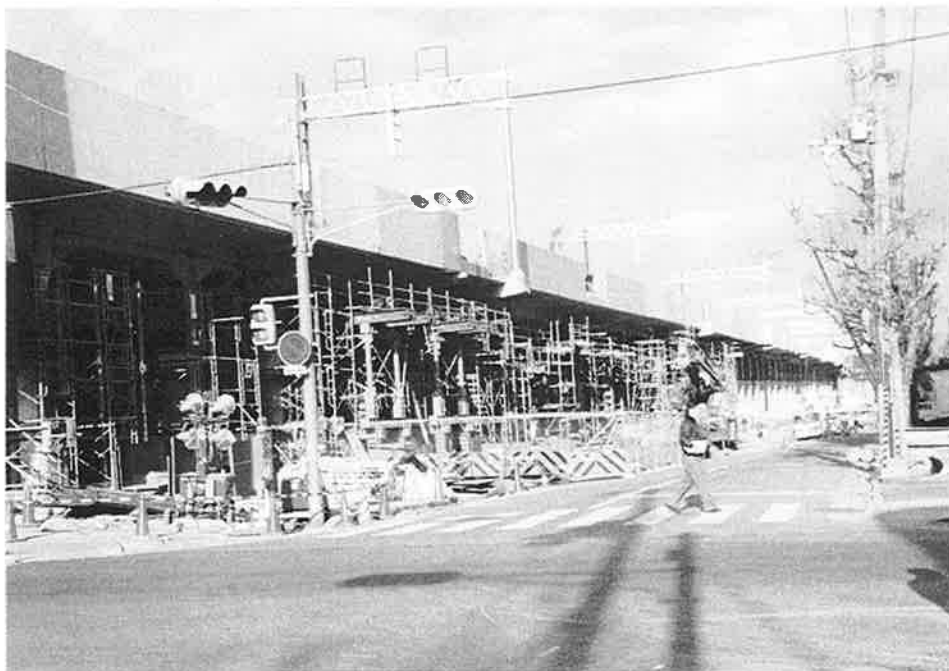

*JRT-38. Much more of the viaduct under repair.*

**West Japan Railway Company – TOKAIDO MAIN LINE**

---



*JRT-39. Rows of bents supported.*

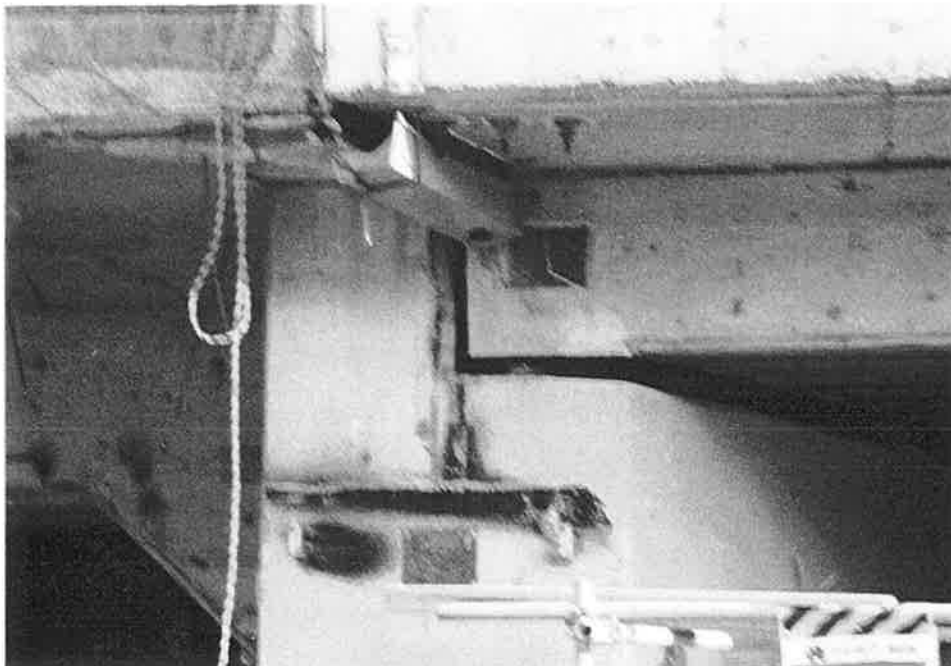

*JRT-40. Seat length of a drop-in span.*

## West Japan Railway Company – TOKAIDO MAIN LINE

---

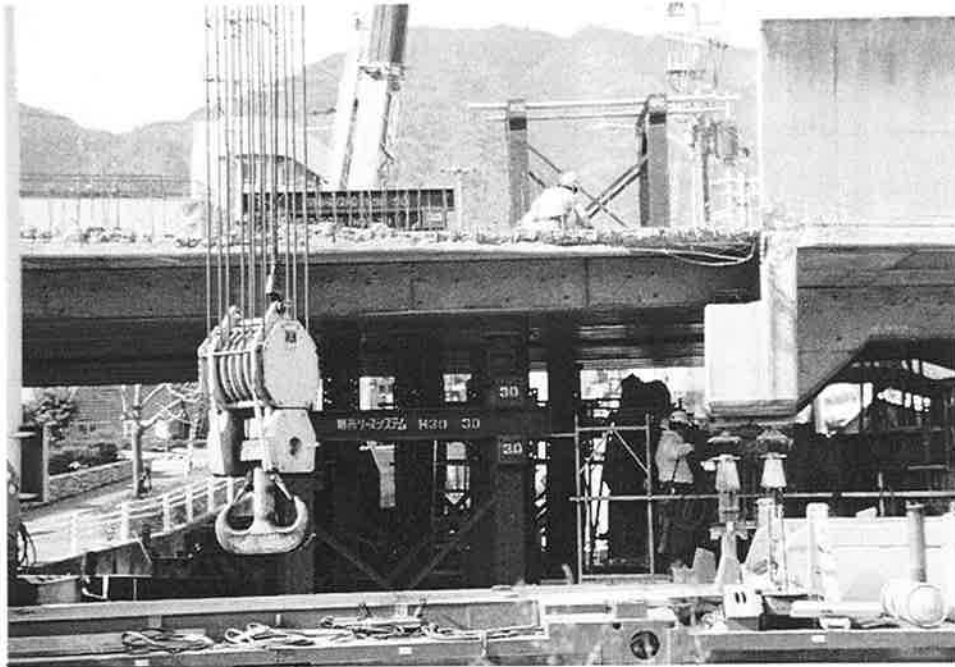

*JRT-41. This section of drop-in span is lifted and supported back into place. Note the seat length of the existing pier of over 500mm.*



*JRT-42. This drop-in span was lifted back into position. Note the seat lengths.*

## West Japan Railway Company – TOKAIDO MAIN LINE

---

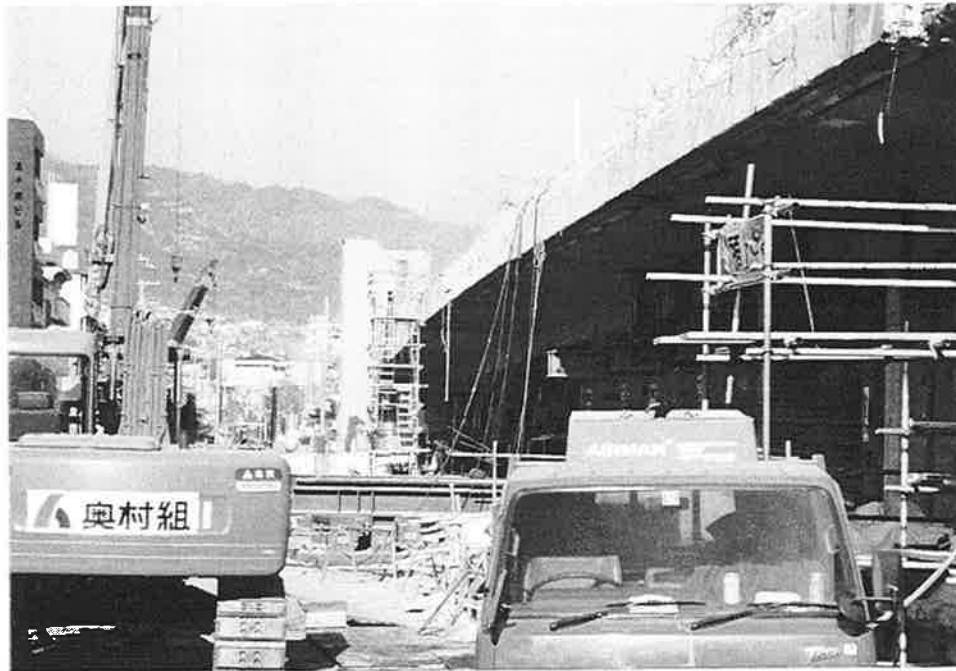

JRT-43. Viaduct under repair for more hundreds of meters.



JRT-44. Sign at Rocomichi Station.



*JRT-45. Rokkomichi Station replacement.*



*JRT-46. Construction of the new platform for Rokkomichi Station.*

## ***West Japan Railway Company – TOKAIDO MAIN LINE***

---



***JRT-47. Housing adjacent to the viaduct was damaged but still standing. The viaduct partially collapsed in this area. Note the jacking frames in the background.***

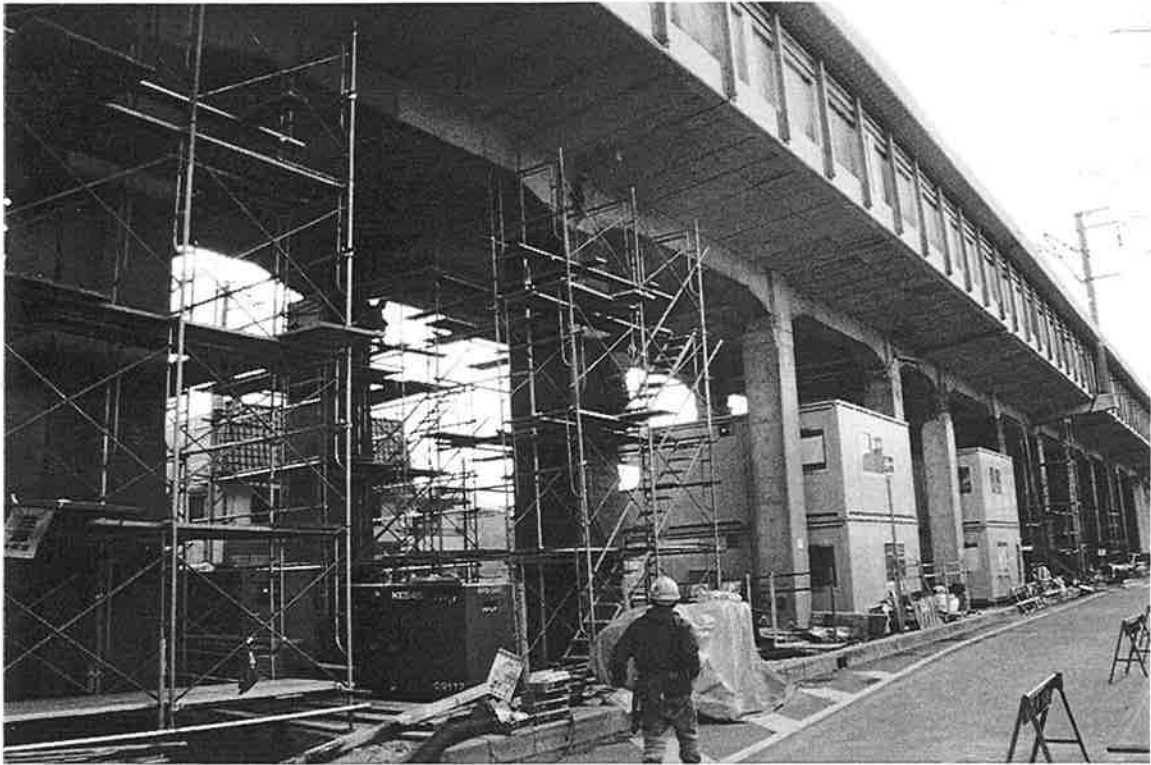

*JRS-1. Many consecutive columns were damaged.*



*JRS-2. Another column damaged and grouted*



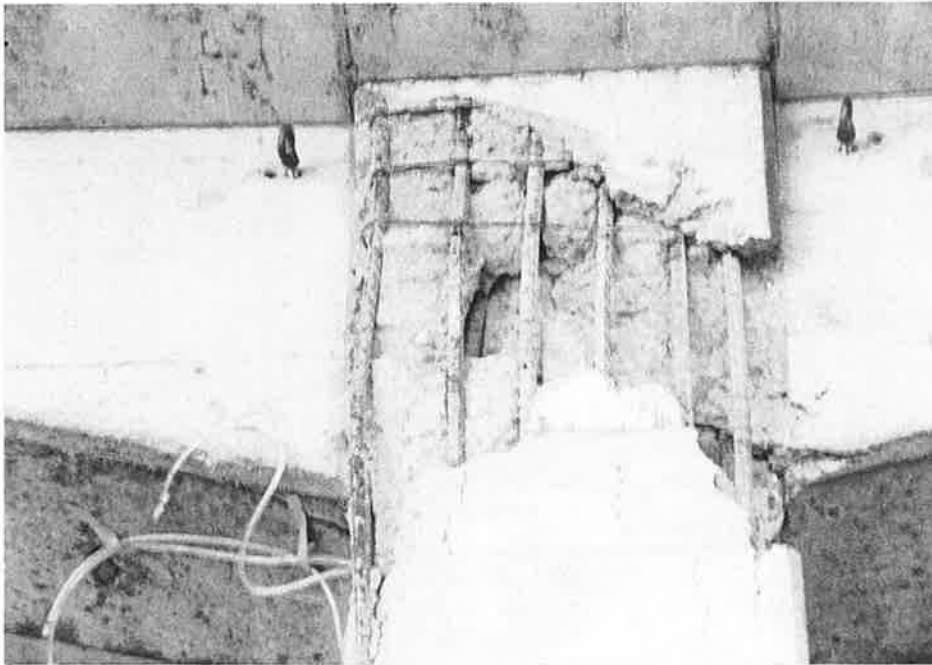

*JRS-3. Another failed top of column and joint zone*



*JRS-4. These columns show primarily transverse damage, but also some horizontal spalling.*



*JRS-5. Column very close to collapse with diagonal cracks through the joint zone and ties ruptured; the joint is badly deteriorated.*

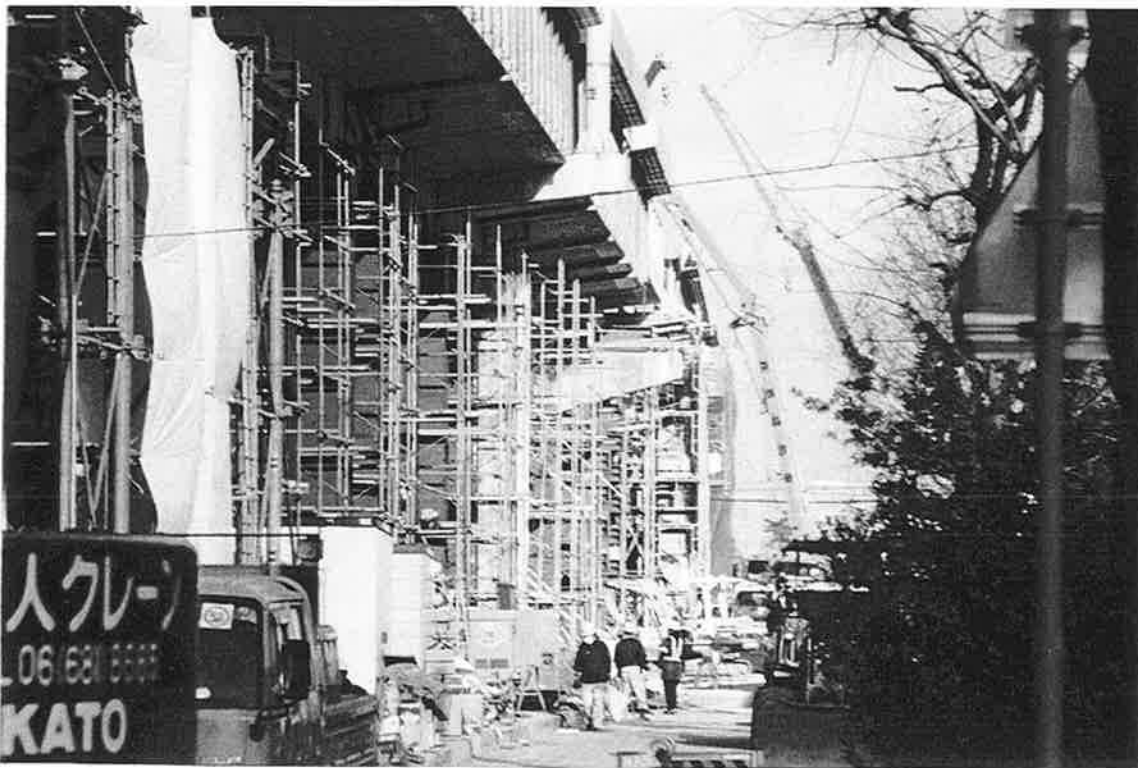

*JRS-6. A long section under repair*

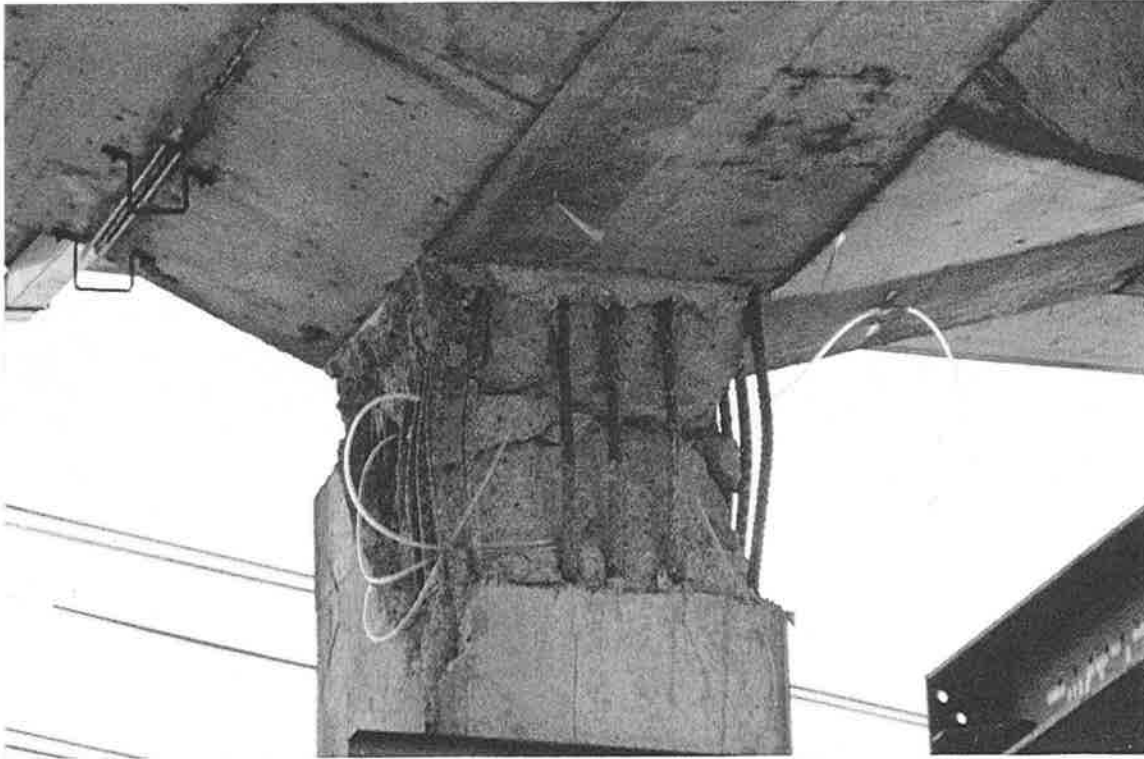

*JRS-7. Another column near collapse with buckled reinforcing ties gone with no cross ties.*



*JRS-8. The cracking in this joint is limited to the zone below the confining catenary support beam at the top of the photo and the top of the column.*

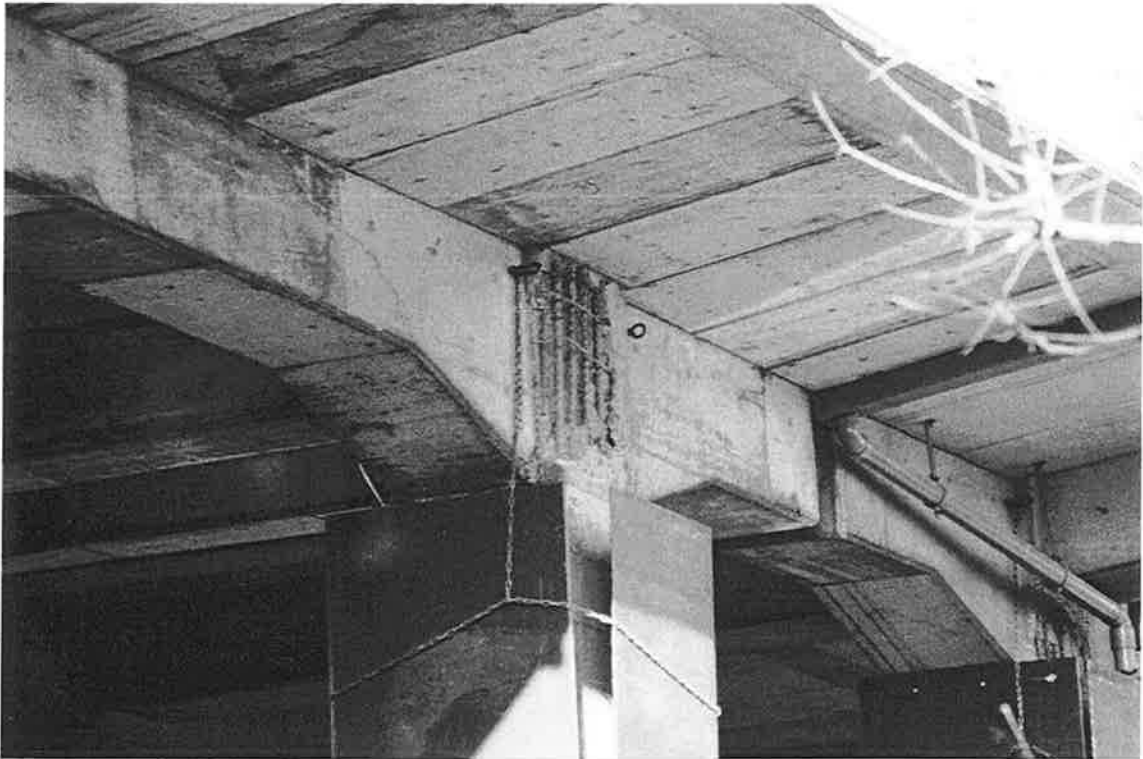

*JHS-9. A steel plate jacket installation; note the column bars exposed in a joint zone. A joint repair method was not observed. The column had almost no moment capacity in this transverse direction.*

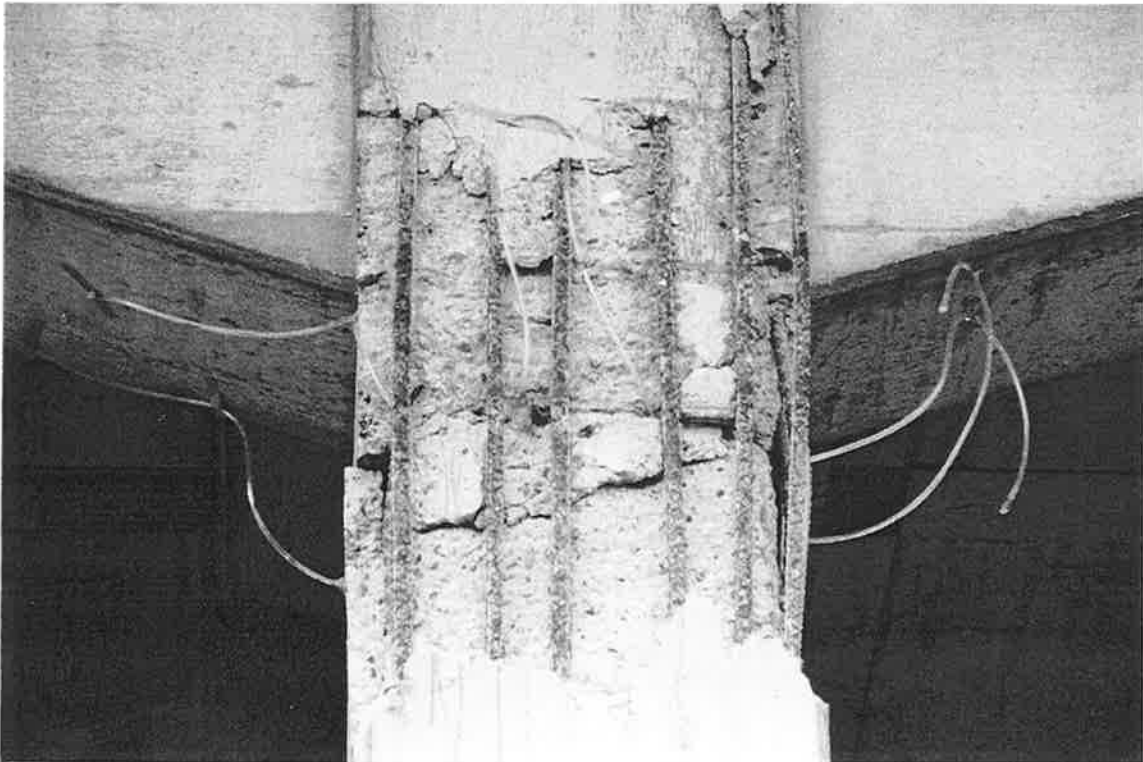

*JRS-10. Damage at the top of column and into the unconfined joint zone; the ties are no longer present. The cracks are being epoxy grouted.*

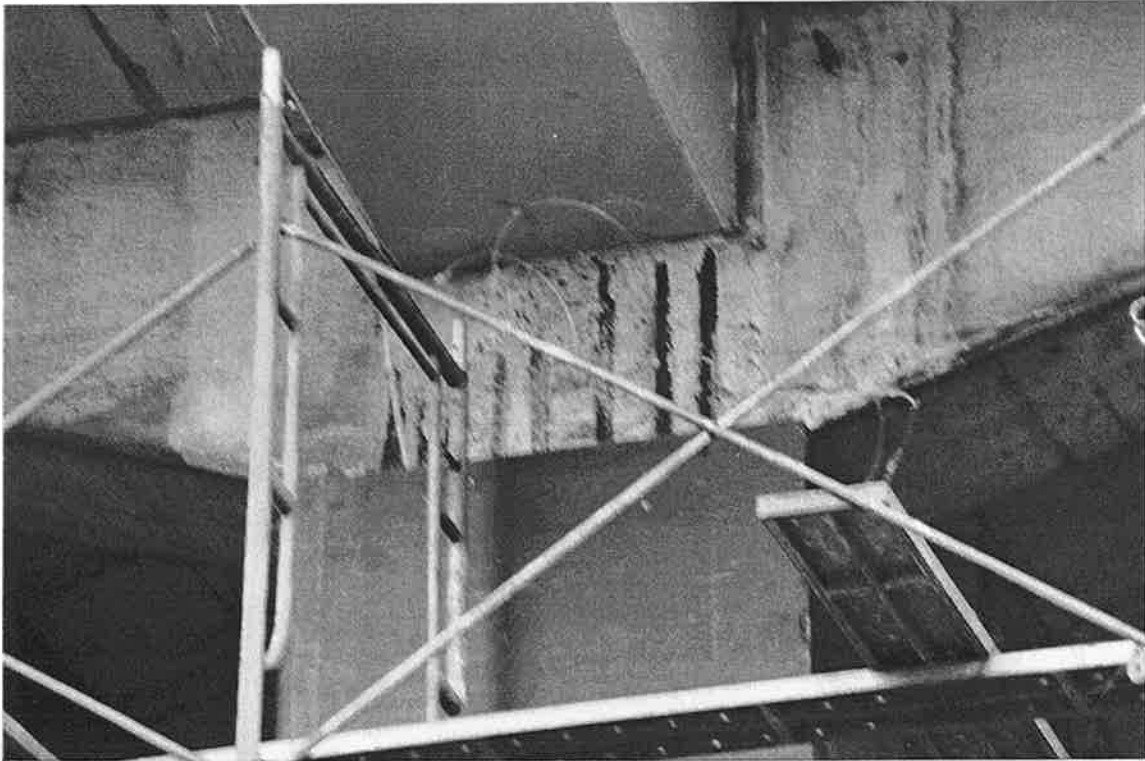

*JRS-11. Catenary support beam provides some confinement to the joint zone. The joint has degraded from the top of the column.*

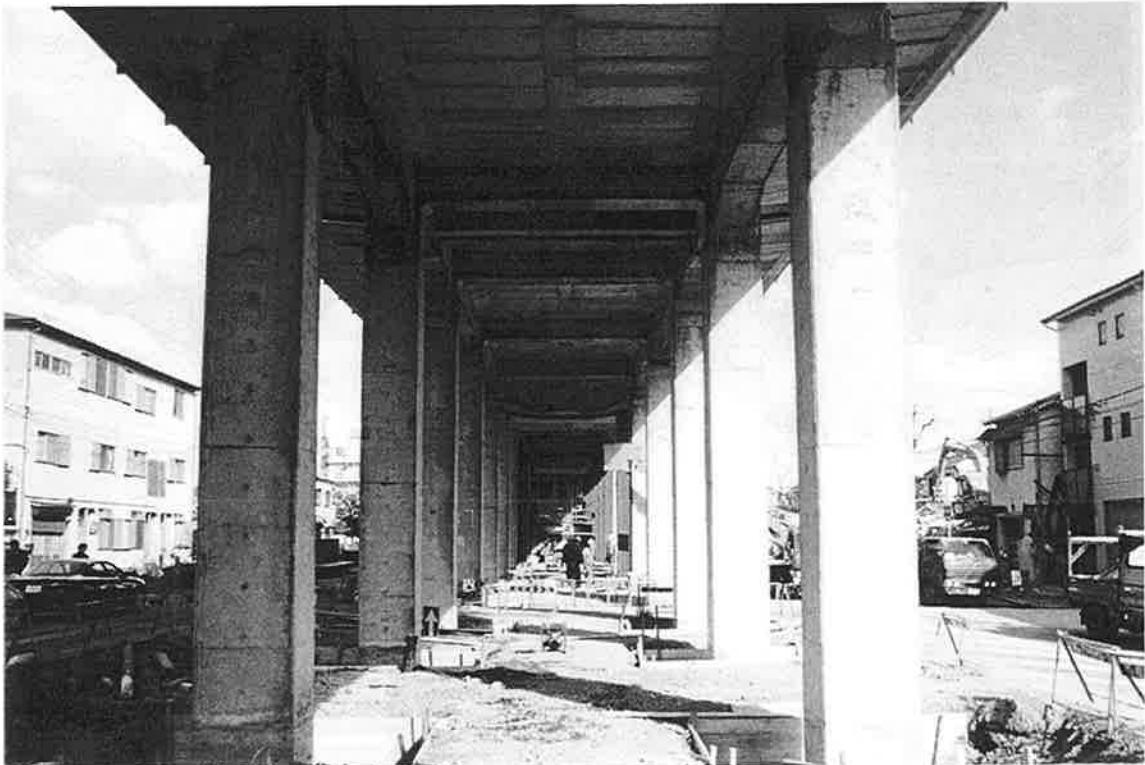

*JRS-12. Damage to the tops of consecutive column in the longitudinal direction.*



*JRS-13. Column damage in the longitudinal direction*



*JRS-14. Column is damaged in both directions in addition to joint damage.*



*JRS-15. Many steel jackets are installed.*



*JRS-16. The drop-in span has been lifted from the ground while the superstructure is finished.*



*JRS-17. This construction worker is standing on a steel jacket. The jacket is nearly 1.5 meters on a side and only 9 mm thick.*



*JRS-18. Some spalling is evident at the bottom of this column. Note the tie size and spacing.*



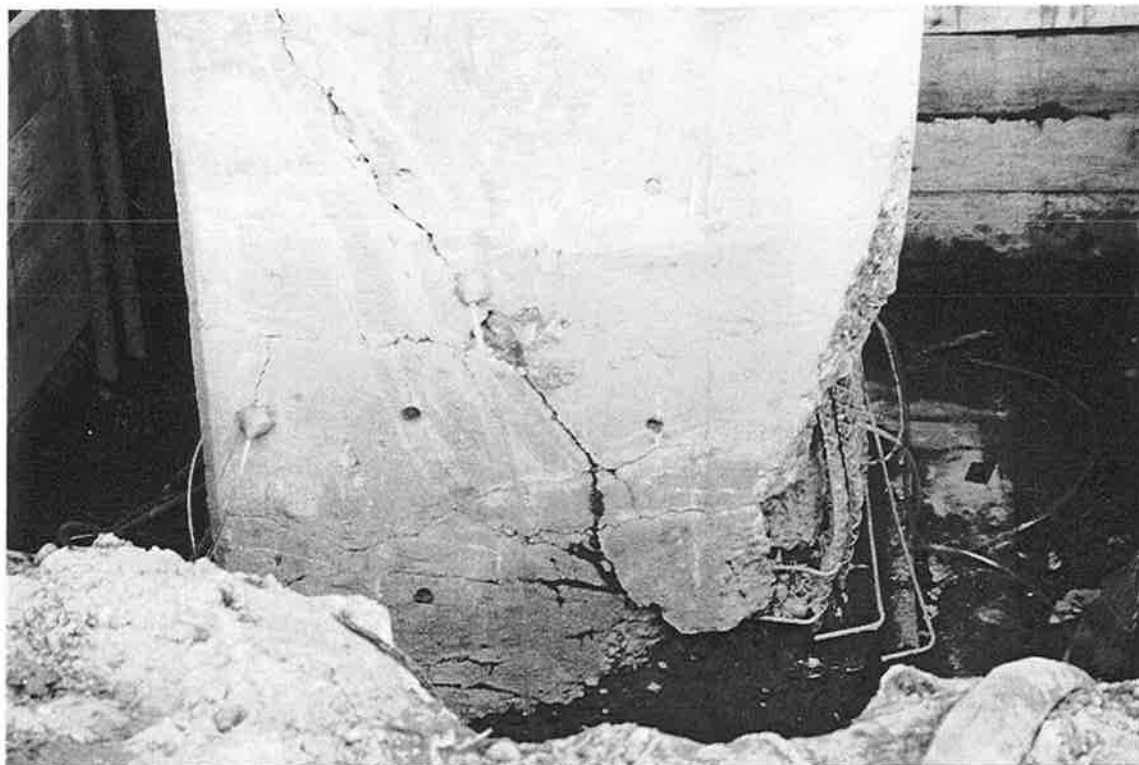

*JRS-19. This column was close to failure. The ties are opening, main bars are buckled and the shear crack is opened. Note the angle of the shear crack is more vertical than 45 degrees. Response was in the longitudinal direction.*



*JRS-20. The drop in span on the right was lifted off the ground and relocated on the piers. The adjacent spans were stiffened with the additional girder. Steel jackets were applied to columns.*

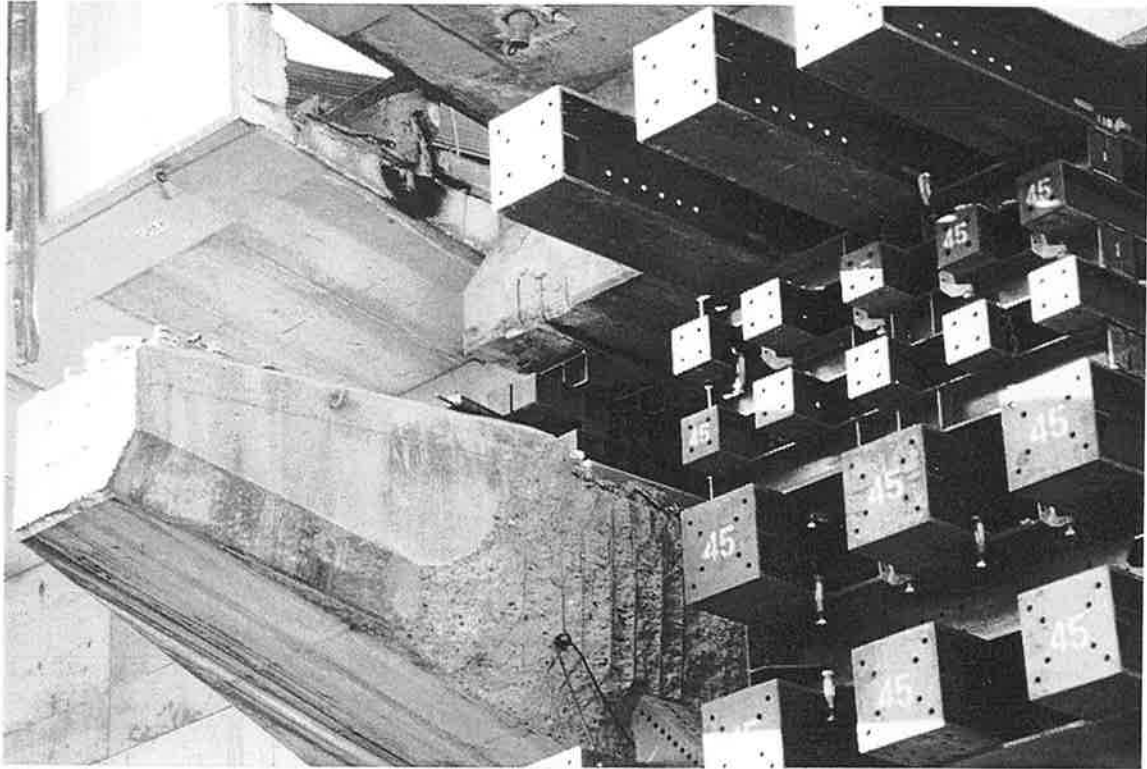

*JRS-21. The precast-prestressed concrete drop-in girder to the right is supported while the pier and adjacent span is repaired.*

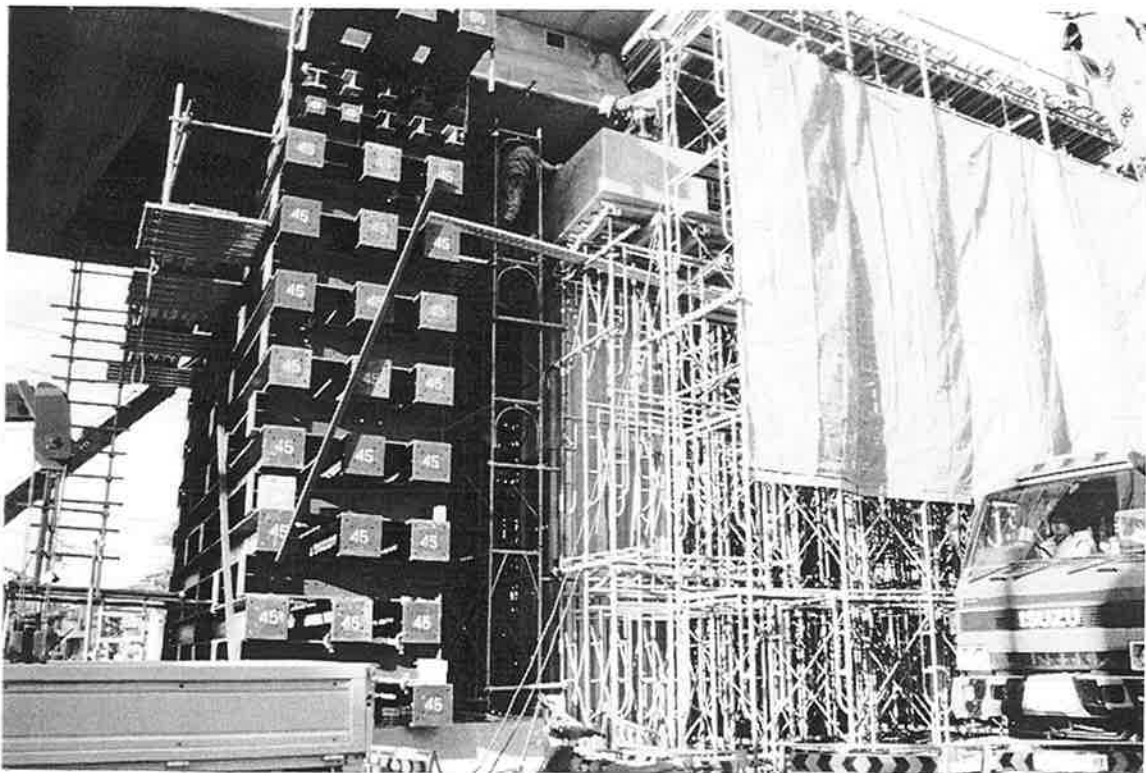

*JRS-22. Temporary supports are on the left of the drop-in span, and falsework is on the left.*

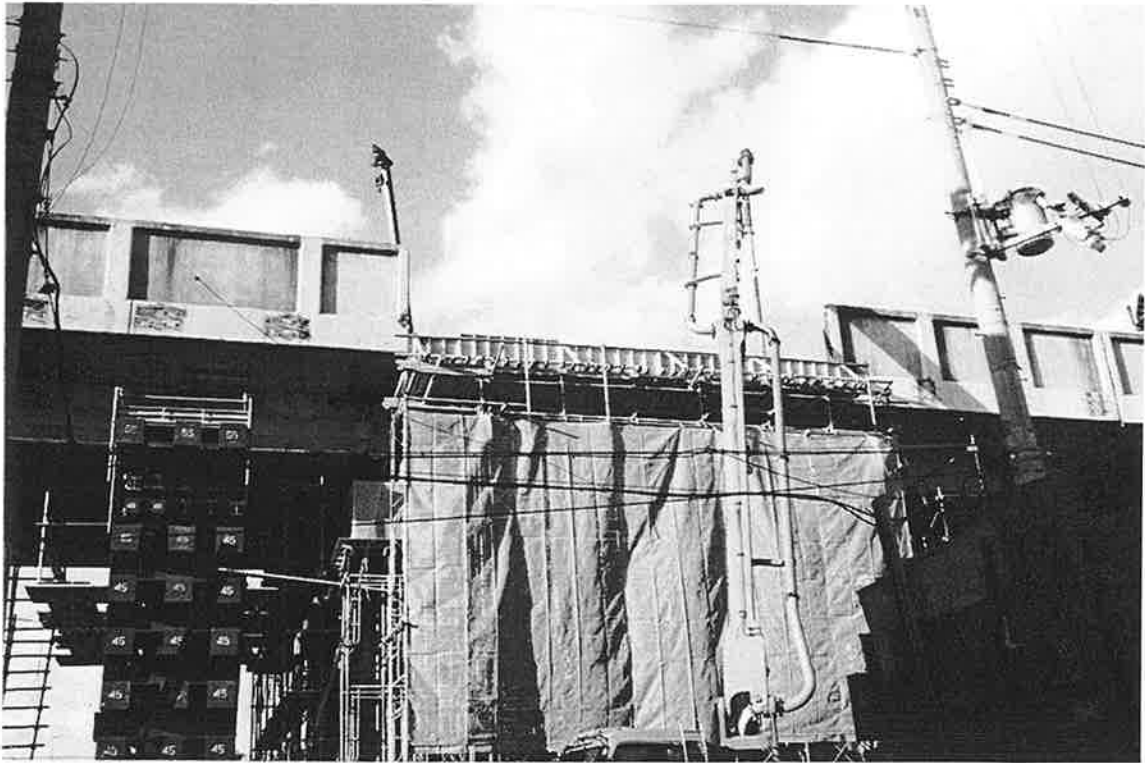

*JRS-23. The deck of this drop-in span is being replaced.*



*JRS-24. An expansion joint that is typical at mid span.*



*JRS-25. The cracks have been epoxy grouted. The external spalling still needs repair.*

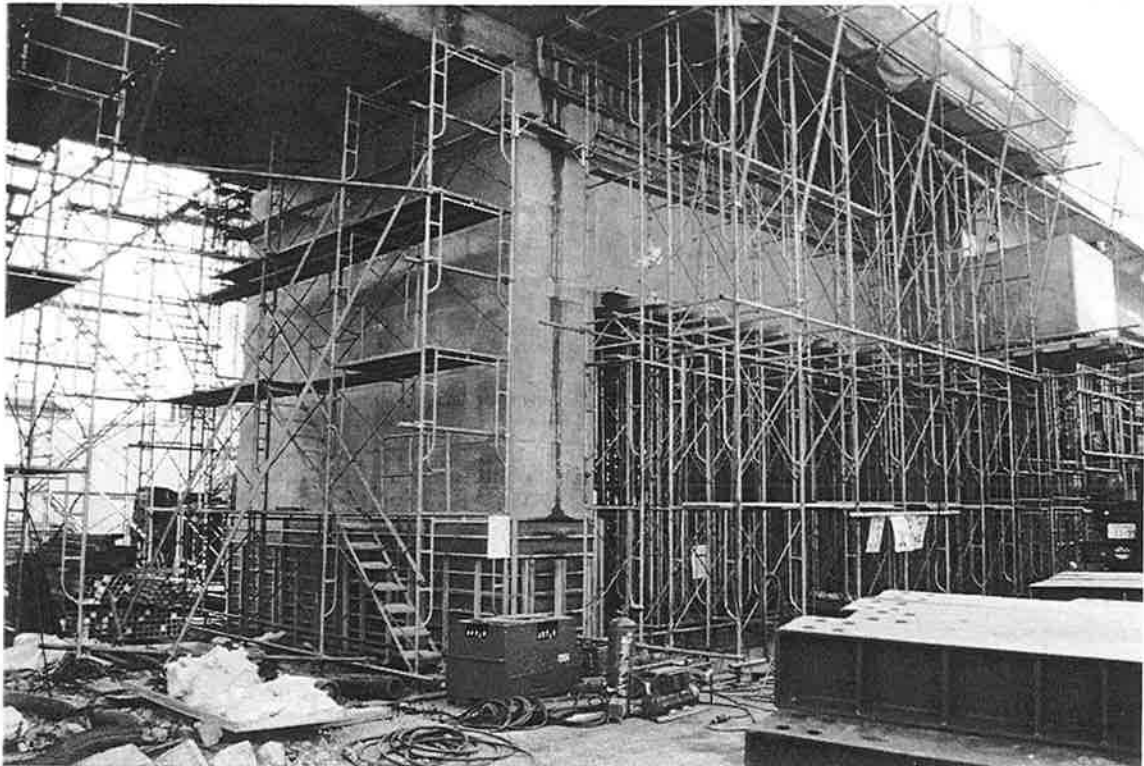

*JRS-26. A new stiffened pier to resist longitudinal forces*



*JRS-27. More than 5 cranes are visible on this side over 200 meters of structure. The houses to the left suffered minimal damage.*



*JRS-28. Longitudinal response is shown by the damage in consecutive columns. There is minimal transverse damage.*



*JRS-29. Steel plate jacket installation; note damage at the top of column.*



*JRS-30. A close up photo of minor longitudinal damage on the column*

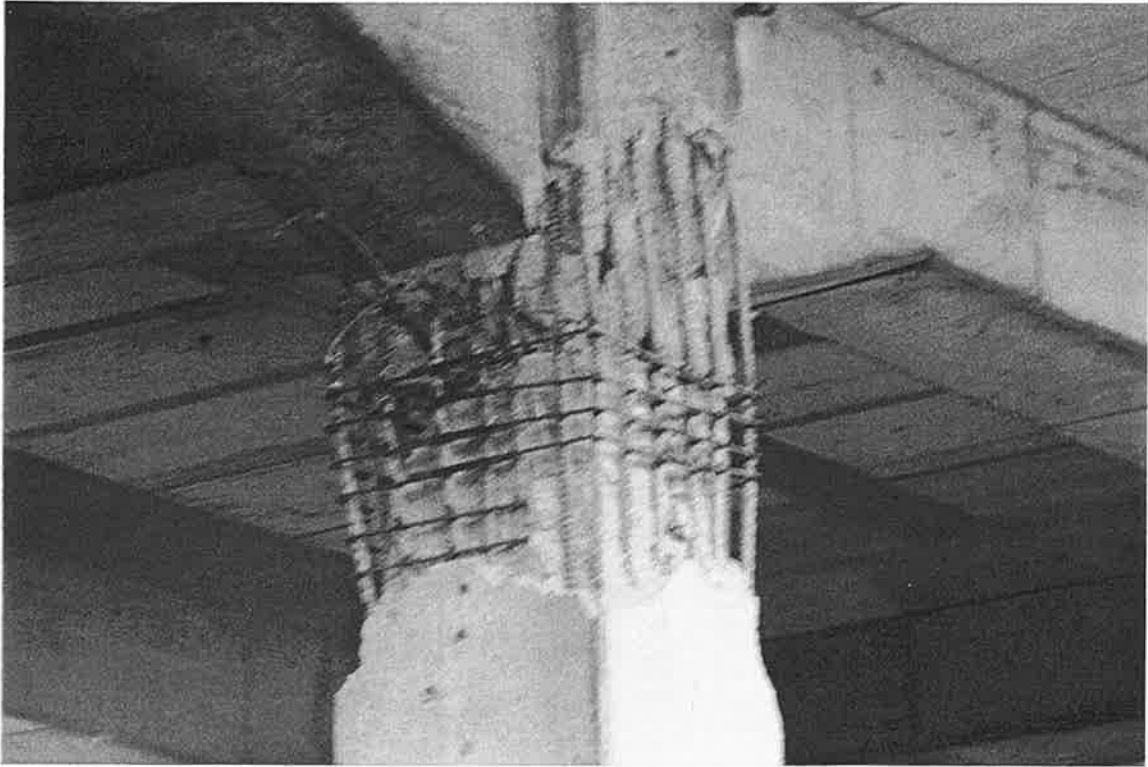

*JRS-31. Damage at top of column and into the joint; note the column ties and their spacing and their lack of cross ties*

**West Japan Railway Company – Tokaido Main Line – SANNOMIYA STATION**

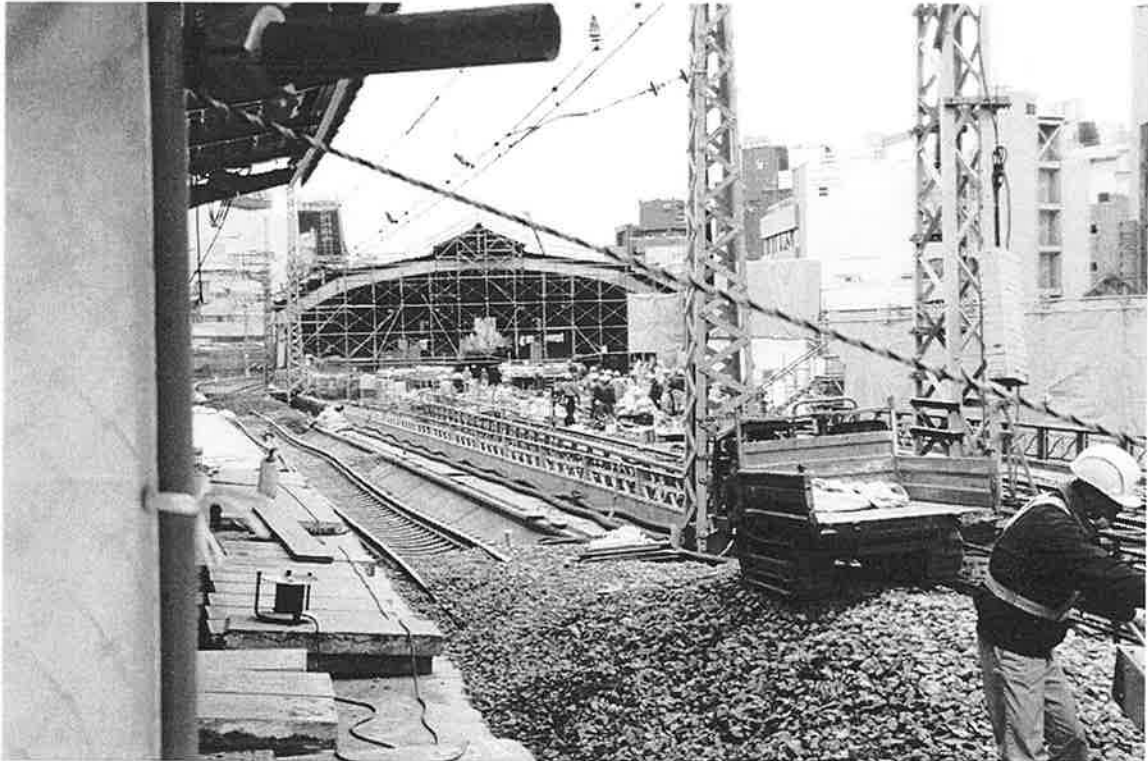

*SS-1. A train derailed as it entered Sannomiya Station from the west. The rail displacement was either caused by the derailment or it caused the derailment. The building in the background is a maintenance facility.*



*SS-2. The ballast is being replaced and recompact on the westbound track. Note the damage to the building to the left.*



## West Japan Railway Company – Tokaido Main Line – SANNOMIYA STATION



*SS-3. The ballast and trackwork has been replaced on the turnouts leading into the maintenance facility. The supporting girders fell to the street.*



*SS-4. This area of Kobe was very heavily damaged. The JR Sannomiya Station is elevated crossing the street. The Kobe Municipal Subway Station is closed for repair behind the barriers to the far left. The Hanshin Subway was damaged below the street just beyond the bridge. The Port Island Peoplemover is down this street about 1km.*

**West Japan Railway Company – Tokaido Main Line – SANNOMIYA STATION**

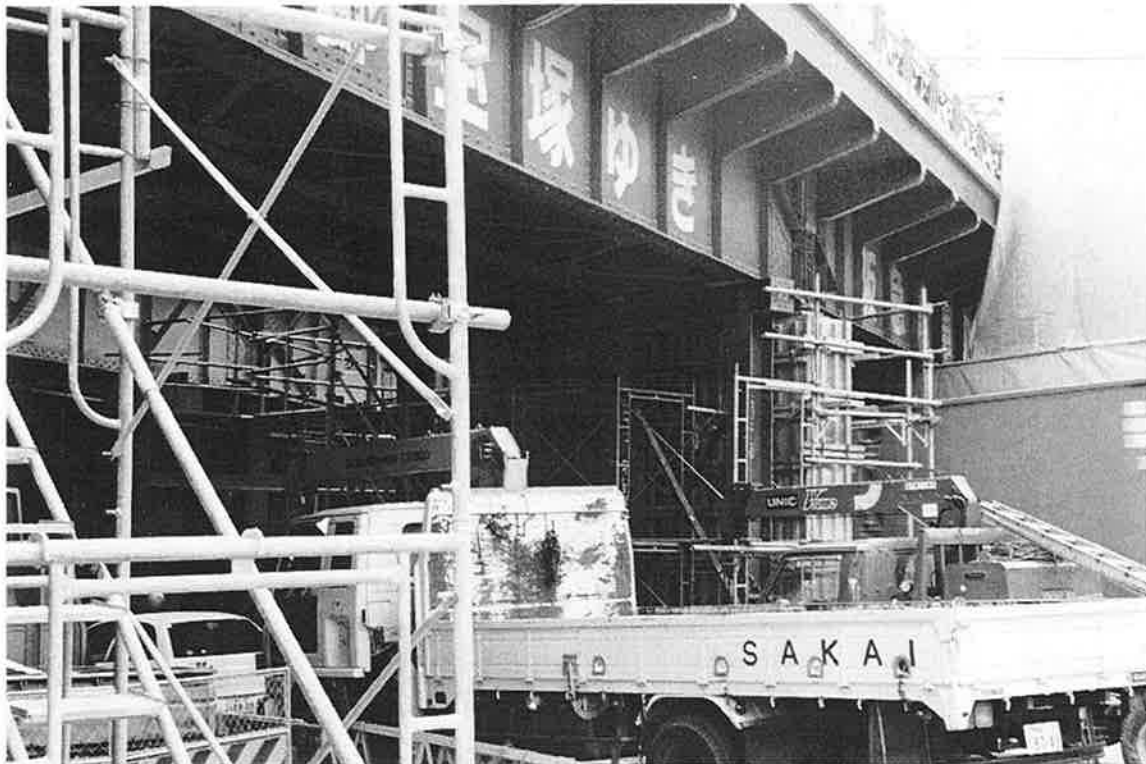

*SS-5. The new girders are supported in place while the substructure is being repaired and the trackwork above is completed.*



*SS-6. This access to Kobe Municipal Subway Sannomiya Station is closed.*

**West Japan Railway Company – Tokaido Main Line – SANNOMIYA STATION**



*SS-7 & SS-8. These buildings next to Sannomiya Station were also heavily damaged. The one to the left is leaning. The darker building sheared about 2 meters at the fourth floor and appears quite dangerous.*





*HER-1. Retaining wall west of Mikage Station; the steel frames resist additional leaning.*



*HER-2. More failed retaining walls; the embankment is being lowered to allow replacement of the walls.*

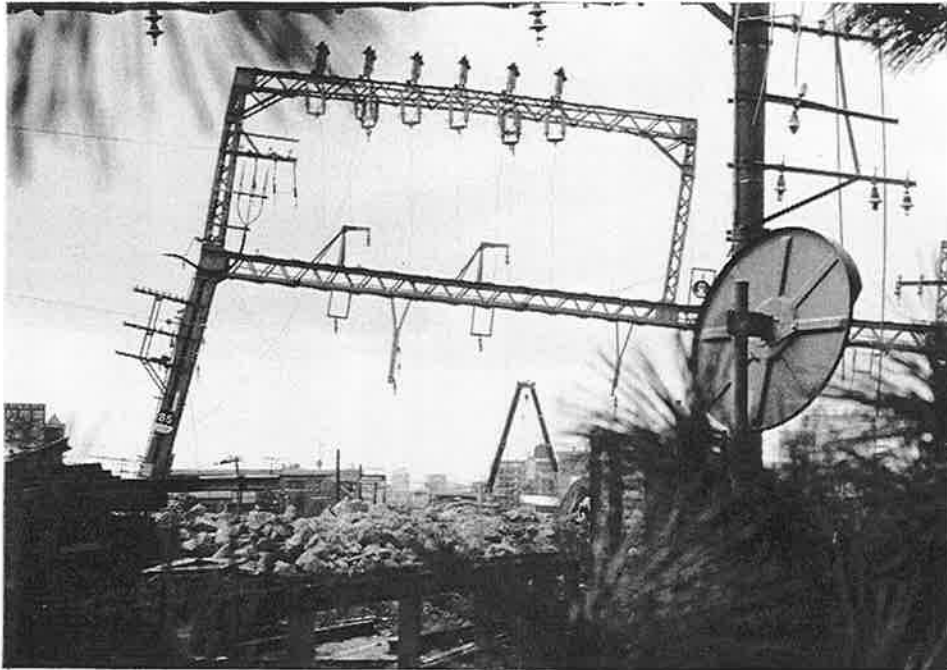

*HER-3. Just west of the failed retained embankment the damage is much more intense. A failed catenary support is in the foreground.*



*HER-4. This 150 mm wide crack is in an abutment wall at the west end of the failed retained embankment. The steel column is supporting the superstructure of the street crossing.*



*HER-5. Another section of failed gravity retaining wall; there is another failed section above the sandbags in the background. Note the horizontal crack above the parked vehicle.*



*HER-6. The crown of this arch culvert shows some distress.*



*HER-7. The column of the catenary support observed earlier has buckled.*



*HER-8. Another retaining wall failure*

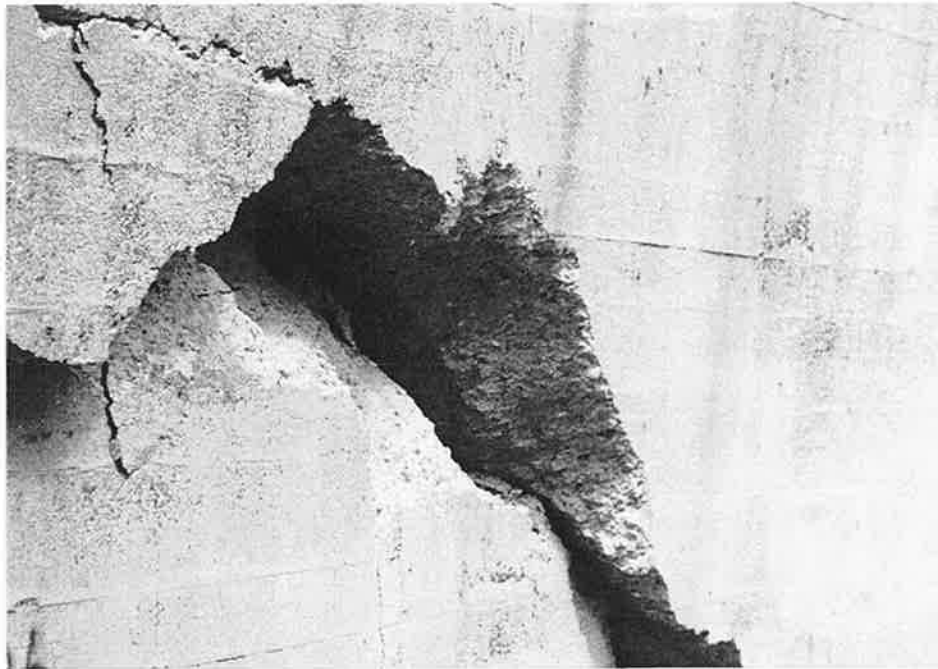

**HER-9.** *The crack in the retaining wall shows that the wall is unreinforced concrete.*



**HER-10.** *Beginning of the failed viaduct; the steel members were used for residential and commercial buildings constructed under the viaduct.*





*HER-11. The viaduct collapsed to the left of the expansion joint but was destroyed to the right. The joints were located at midspan. The ballasted rail provided no restraint.*



*HER-12. This pier supported a steel plate girder span across the four lane street. The plate girder dropped to the street and was removed. The rails are still on the ballast on top.*



*HER-13. Close up of the center column of the pier; the concrete wasn't properly confined and the untied reinforcing buckled.*



*HER-14. Close up of the left column of the pier. The structure has not settled much with respect to the door inside the garage. The glass in the door appears intact. This column shows a few ties were present.*



*HER-15. Same pier as already observed; the bearing ledge is 300 to 500 mm wide. Any restraint would have kept the girders up.*



*HER-16. This section is completely destroyed above the steel beams. The steel beams were installed for secondary uses of this facility. The beams seem to have concentrated the damage at the tops of the columns. This section was some sort of siding ending at the building.*



*HER-17. Another section that collapsed above the steel beams; the fore span was a steel girder street crossing that fell and was removed. The truck at the right is being used to clear rubble so construction equipment can gain access.*

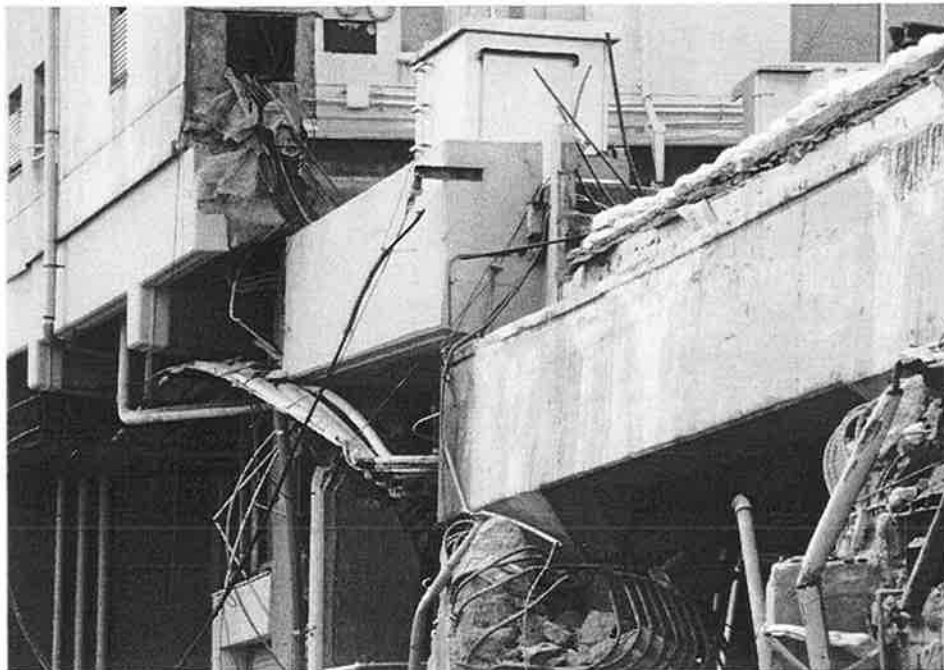

*HER-18. The progressive collapse here is unusual.*



*HER-21. The secondary framing and shear walls have had a very positive impact on this frame. The rubble and debris starting up the street prohibited our access and observation for the next three or four blocks.*

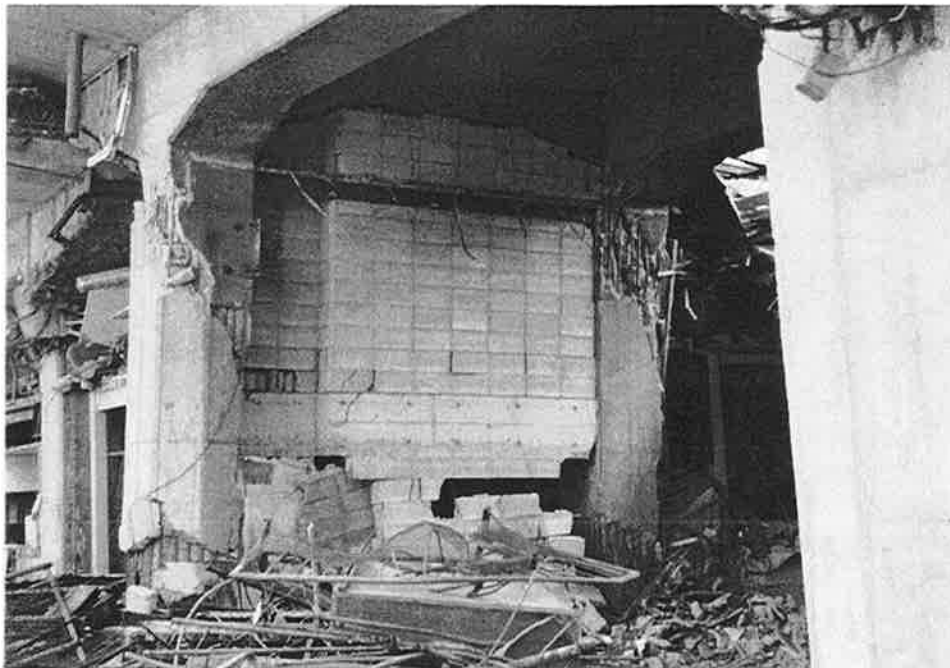

*HER-22. This unreinforced infill wall did not have adequate shear capacity. Note the shear cracks in both columns at greater than 45 degree angles and the flexure damage at the base of the columns.*

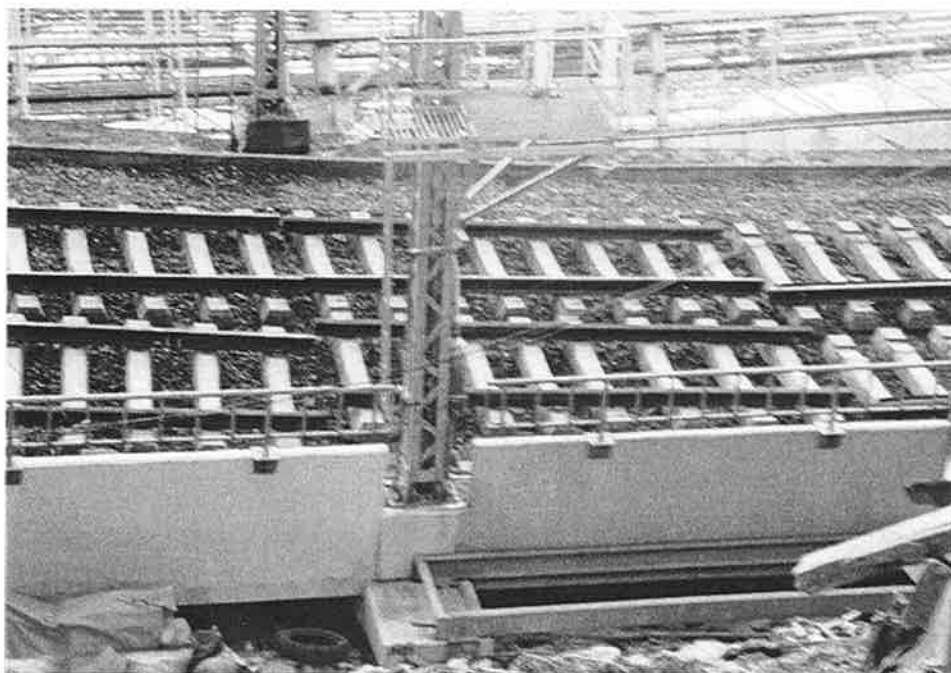

*HER-23. The parallel structure fell over with the superstructure nearly intact. The rails were cut to assist removal.*



*HER-24. The viaduct fell in the foreground. The train parking area in the background collapsed derailing 58 cars.*



*HER-25. Broken columns and disjointed superstructure will require demolition.*



*HER-26. Another failed viaduct section; some of the debris is consistent with the additional use of the facility.*



*HER-27. More damage and debris is adjacent to the viaduct.*



*HER-28. Demolition is underway at Shinzaike Station.*





*HER-29. A severely damaged column near Shinzaike Station entrance.*

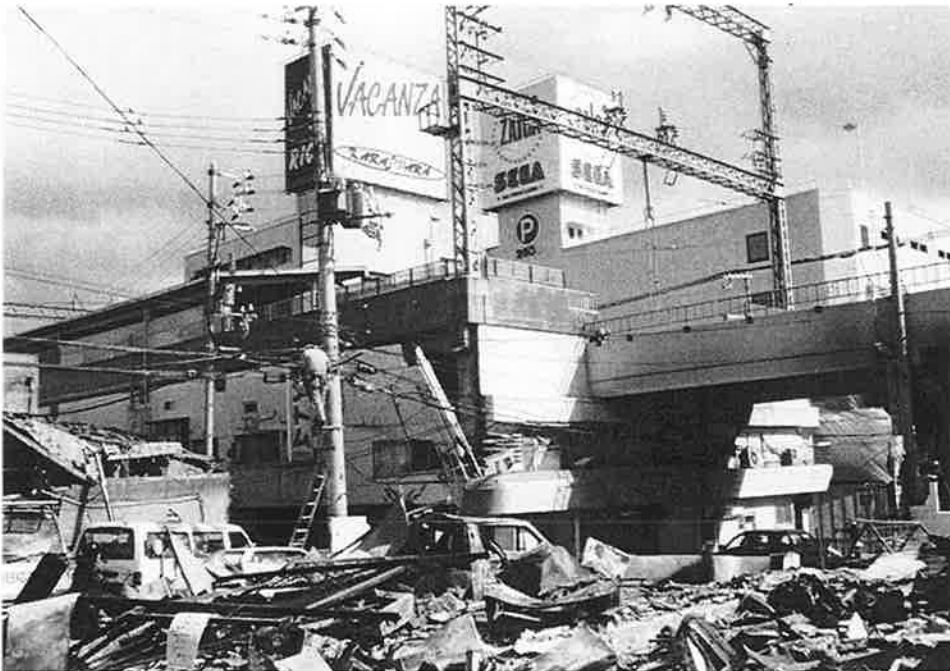

*HER-30. The damaged Shinzaike Station; note the destroyed and burned housing in the foreground and the electrician working on the power lines.*

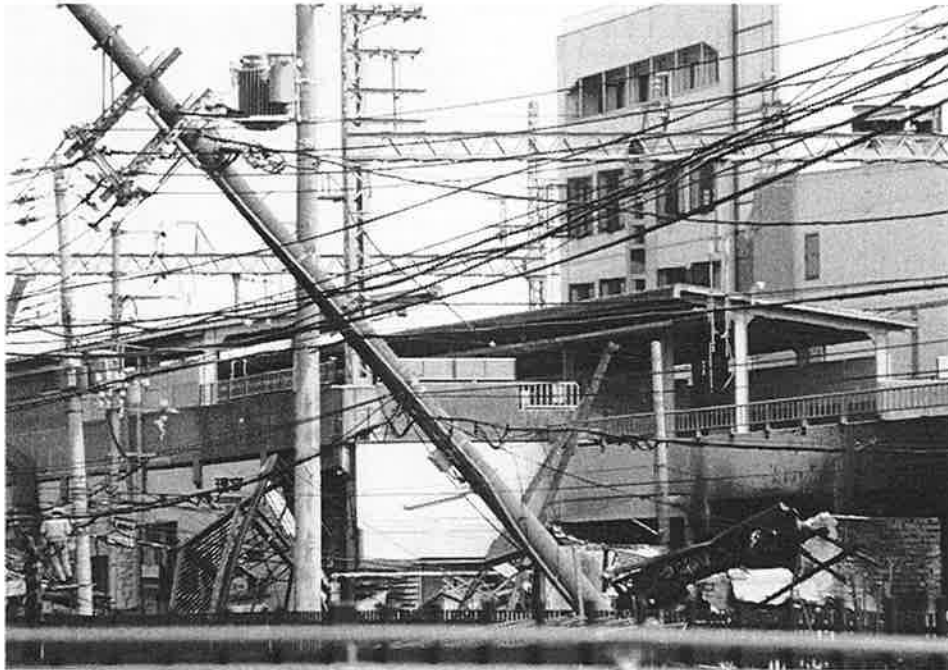

*HER-31. Close up of Shinzaike Station; over the remains of a burned up neighborhood. The leaning power pole in the foreground is typical of the infrastructure in the area.*



*HER-32. Damage to a column west of Shinzaike Station; major transverse shear cracking and longitudinal spalling are evident.*



*HER-33. This barrier is visible in following photograph. There is minimal damage to the viaduct but residential damage prevents our access. This is the western limit of the viaduct damage.*



*HER-34. West of the station the damaged viaduct continues for at least another kilometer. The structure was blackened by fires that consumed many blocks. There isn't as much damage here. The structure is a little taller.*



*HER-35. Viaduct is seen over the remains of a residential block.*



*HER-36. The viaduct to the left is undamaged, but our progress is stopped by the damage to lighter construction.*



*HER-37. Substructuring adjacent to the Mikage Station is undamaged.*

**Hankyu Corporation – KOBE LINE**

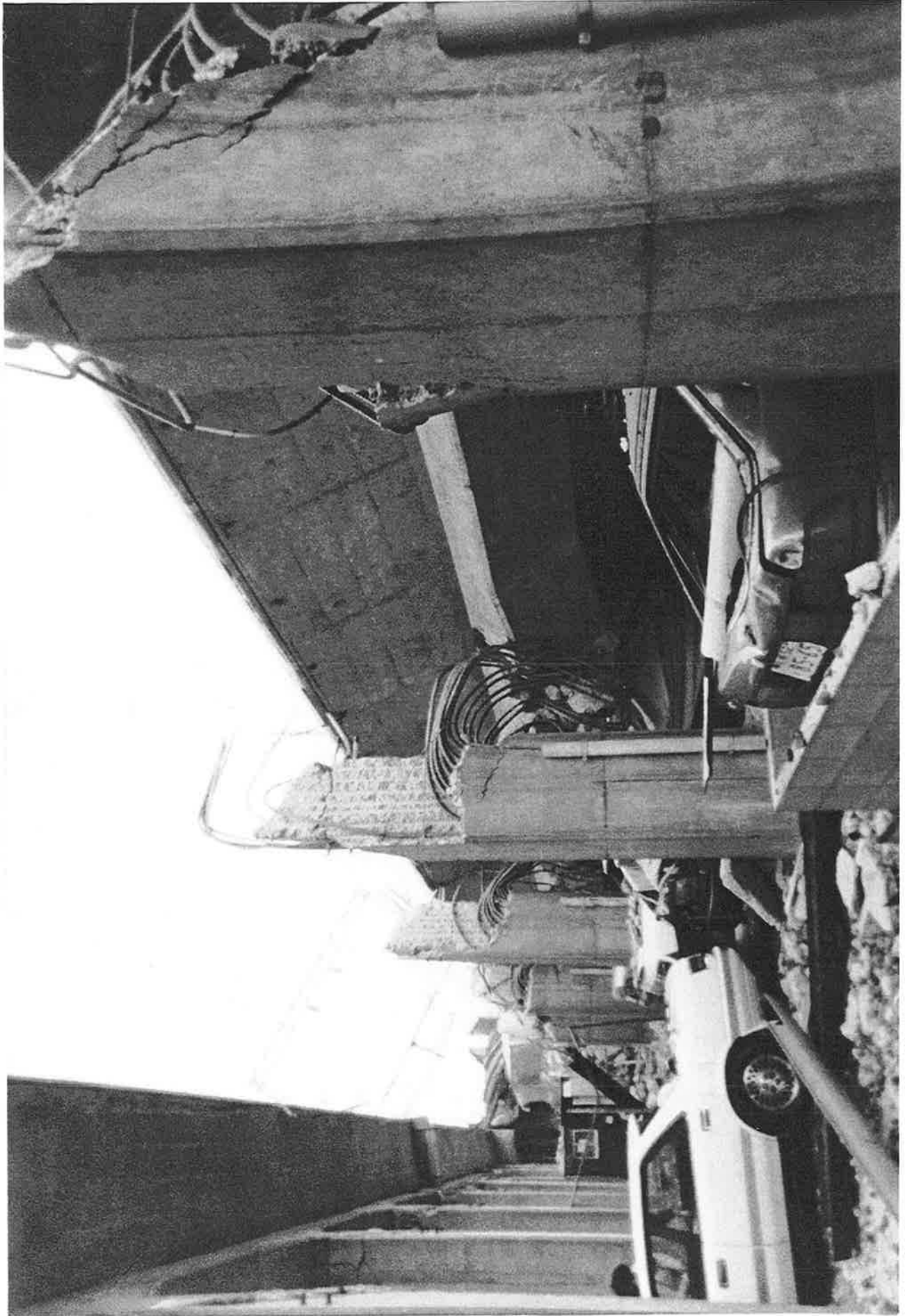

*HC-1. Hankyu parallel concrete viaducts. Northern viaduct was more heavily damaged. The joint between viaducts appears smooth and clean as there was no restraint between structures, or any pounding damage. (photo courtesy of M. Yashinsky)*

**Hankyu Corporation – KOBE LINE**



*HC-2. Once again the northern viaduct is totally collapsed. The southern viaduct is collapsed at an expansion joint. Notice the ballast and track have provided no restraint. (photo courtesy of M. Yashinsky)*

**Hankyu Corporation – KOBE LINE**

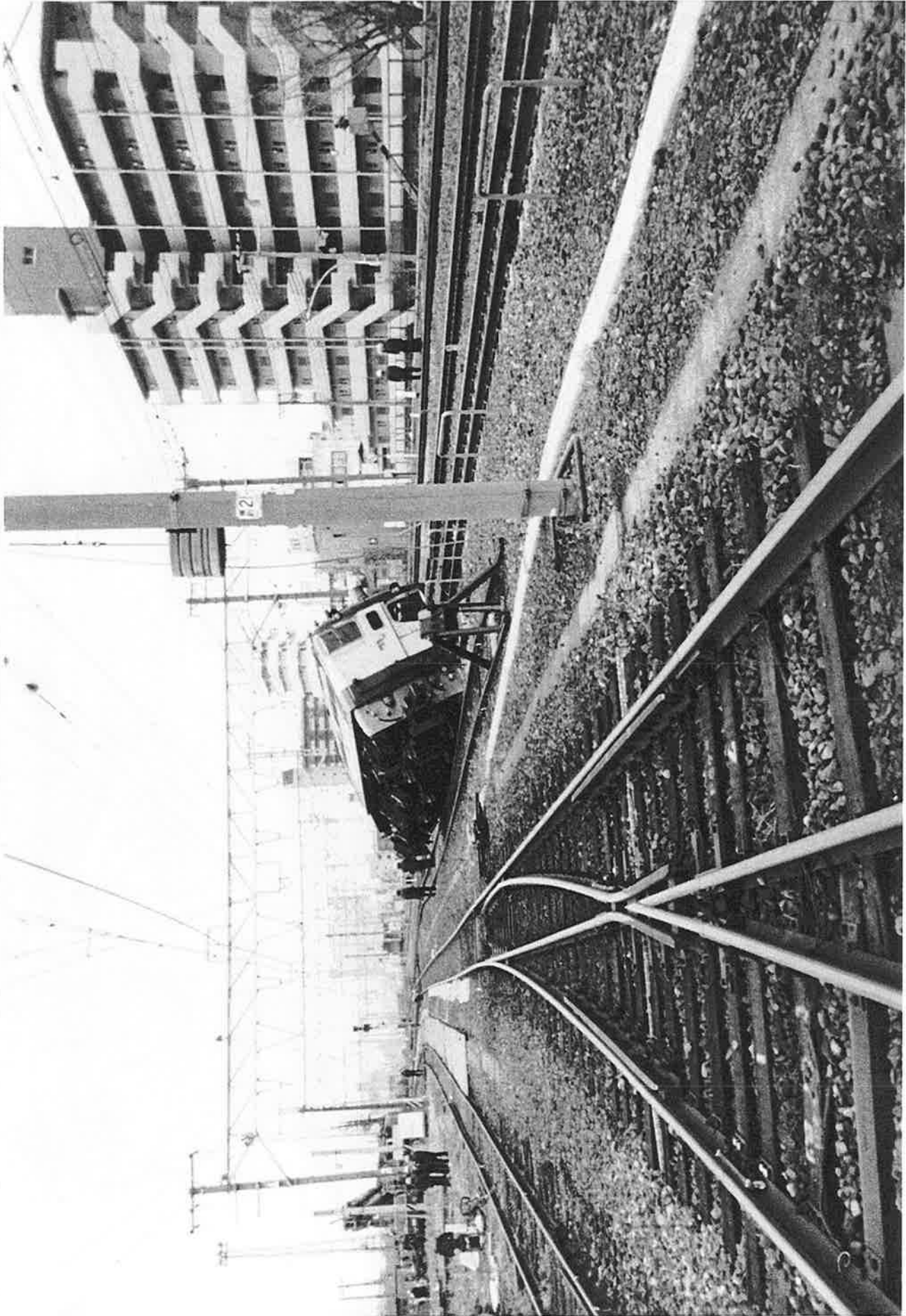

A69

HC-3. Hankyu Corporation passenger car derailed from its out-of-service siding. Notice the buildings appear undamaged. (photo courtesy of M. Yashinsky)





*HC-4. Displacement in rail near Nishinomiya Station*



*HC-5. Embankment failure undercutting concrete ties at an abutment near Nishinomiya Station*



*HC-6. Anchors pulled out of this electrification support stay allow the support tower to sway freely.*



*HC-7. Steel through girders at street crossing are the only remaining elements of the viaduct.*



*HC-8. Demolition of the final section of concrete viaduct. Note the clean edge separating the parallel structures.*



*HC-9. The pier wall supporting this steel through girder is leaning significantly only at this end indicating the bearings slipped. The adjoining concrete structure was removed entirely.*



*HC-10. Failed retaining walls near Shukugawa Station*



*HC-11. Shukugawa Station demolition*



*HC-12. Undamaged medium rise residential buildings adjacent to demolished Hankyu viaduct.*

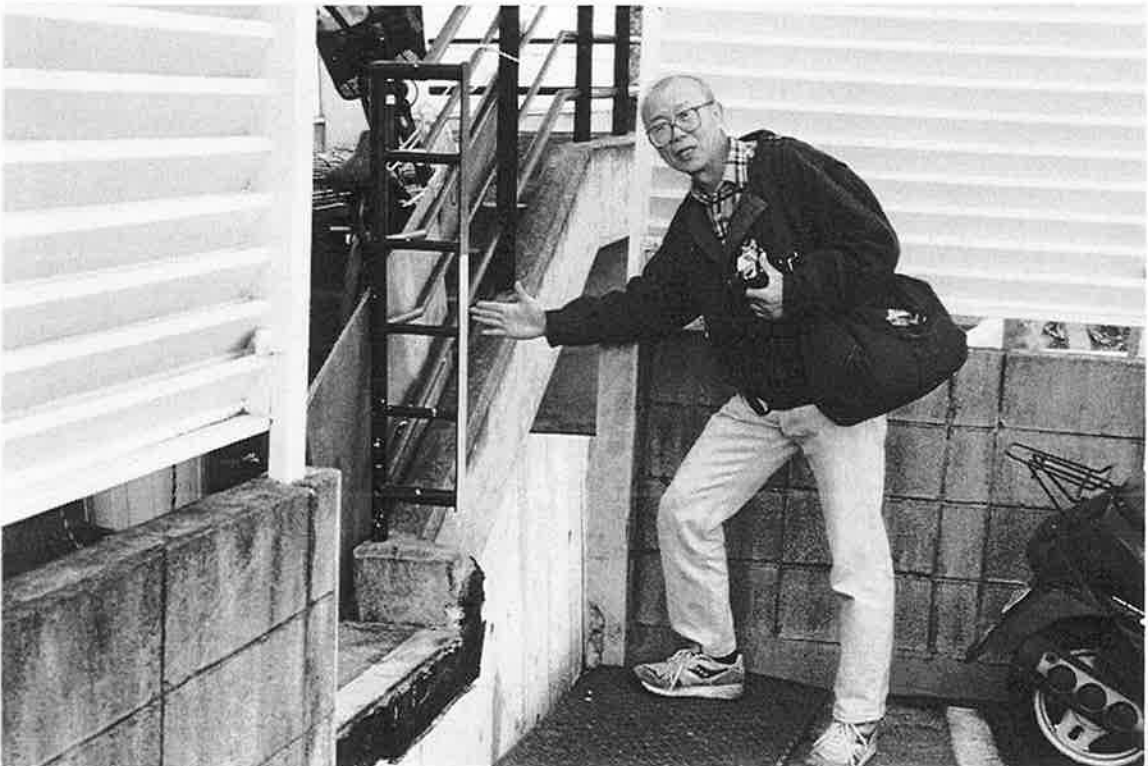

*HC-13. Kenneth Liu is demonstrating the settlement and displacement caused by the earthquake at Shukugawa Station. The settlement is nearly 300 mm and the displacement is 400 mm.*



*HC-14. This very crowded new construction to replace the demolished viaduct is between minimally damaged residential and light commercial use buildings.*



*HC-15. New sheet piles being driven on the north side of the demolished viaduct.*

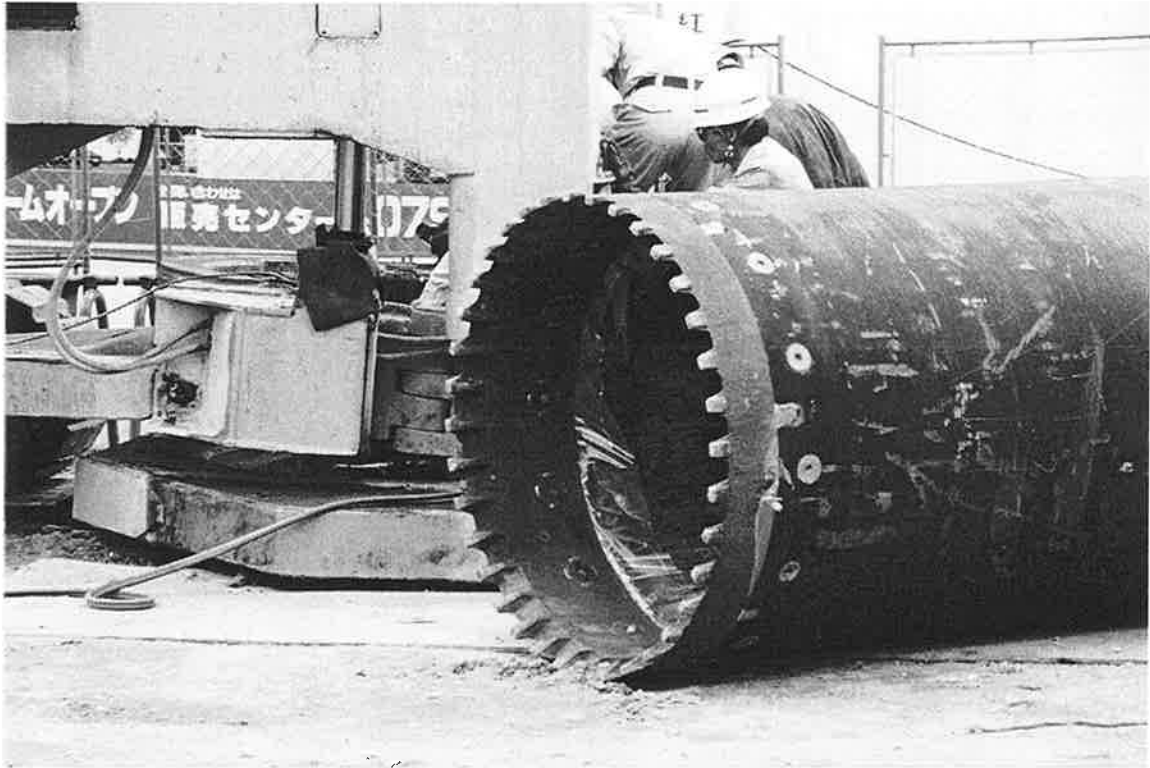

*HC-16. Foundations for the new viaduct will be about 1.3 m diameter drilled shafts. The reinforcing cages were near by.*



*HC-17. Remnants of the failed viaduct*

## Port Island Line - PEOPLEMOVER

---

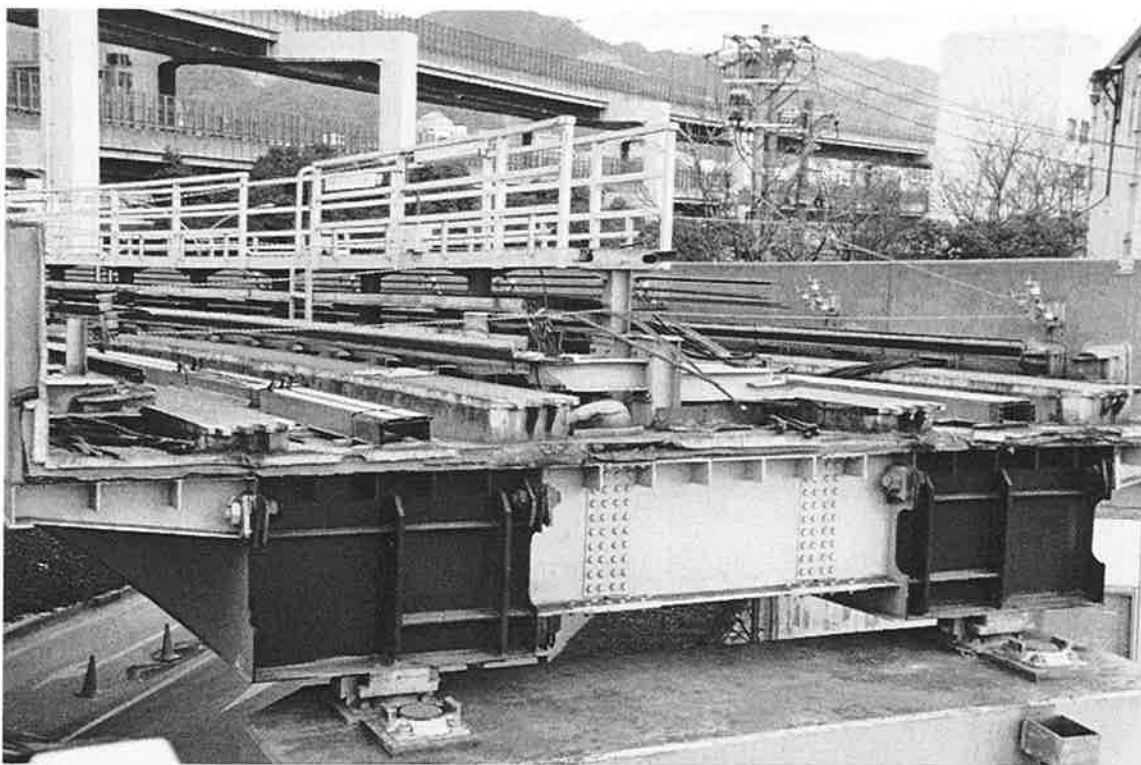

*PI-1. This shows a typical section of the peoplemover guideway. Unfortunately, the 300 meters south of this pier were destroyed and removed.*

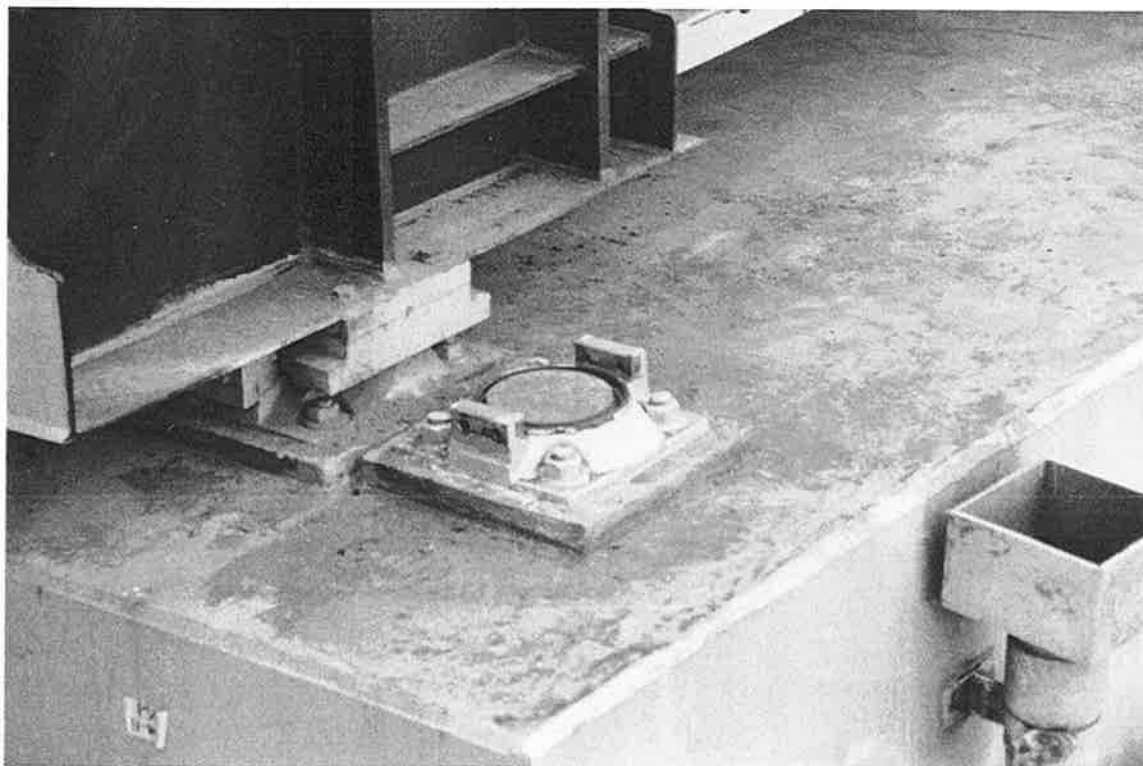

*PI-2. The bearings remain from the lost spans.*



## Port Island Line - PEOPLEMOVER

---

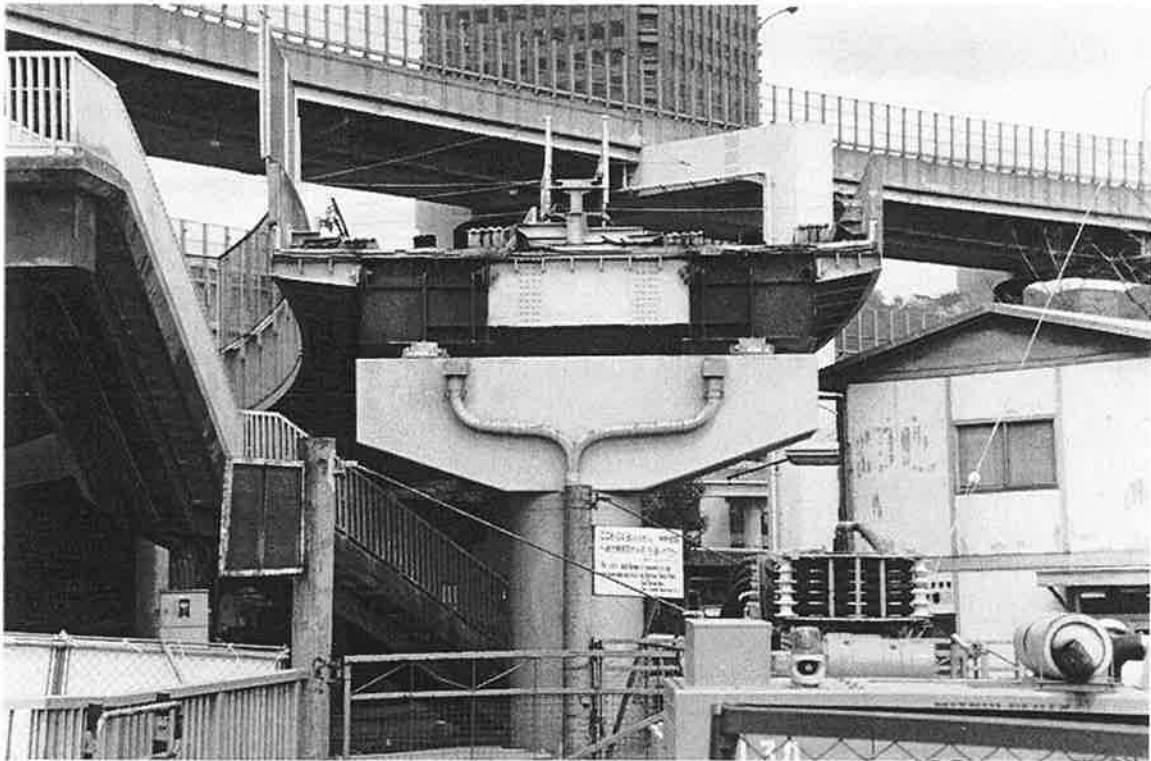

*PI-3. This may be the architecture used in the removed position of the peplemover. The single column is supporting a concrete pier cap.*



*PI-4. The people mover line is one of many structures in the narrow peninsula.*

## Port Island Line - PEOPLEMOVER

---



PI-5. The foundations like the bolt circle in the center are all that remain of the Port Island peplemover. A pedestrian bridge is to the left. Downtown Kobe is in the background.

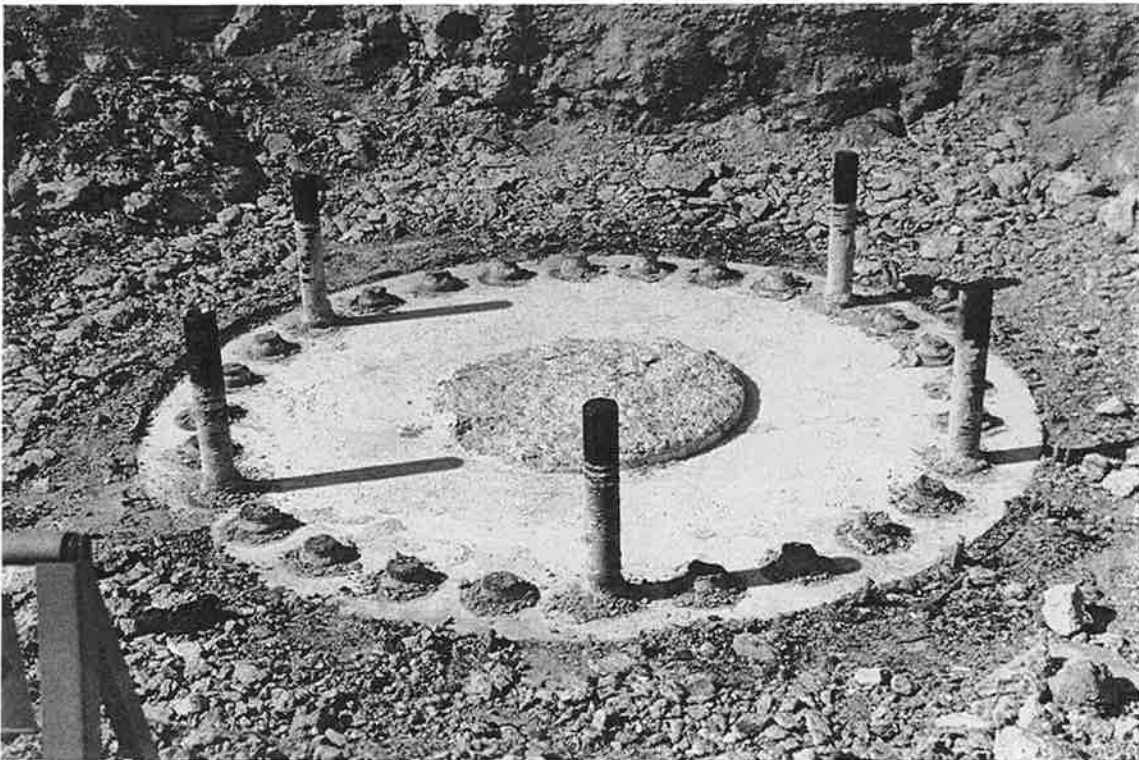

PI-6. The bolt circle remains from the peplemover pier. This indicates a circular steel column. The bolt circle is about 2 meters in diameter.

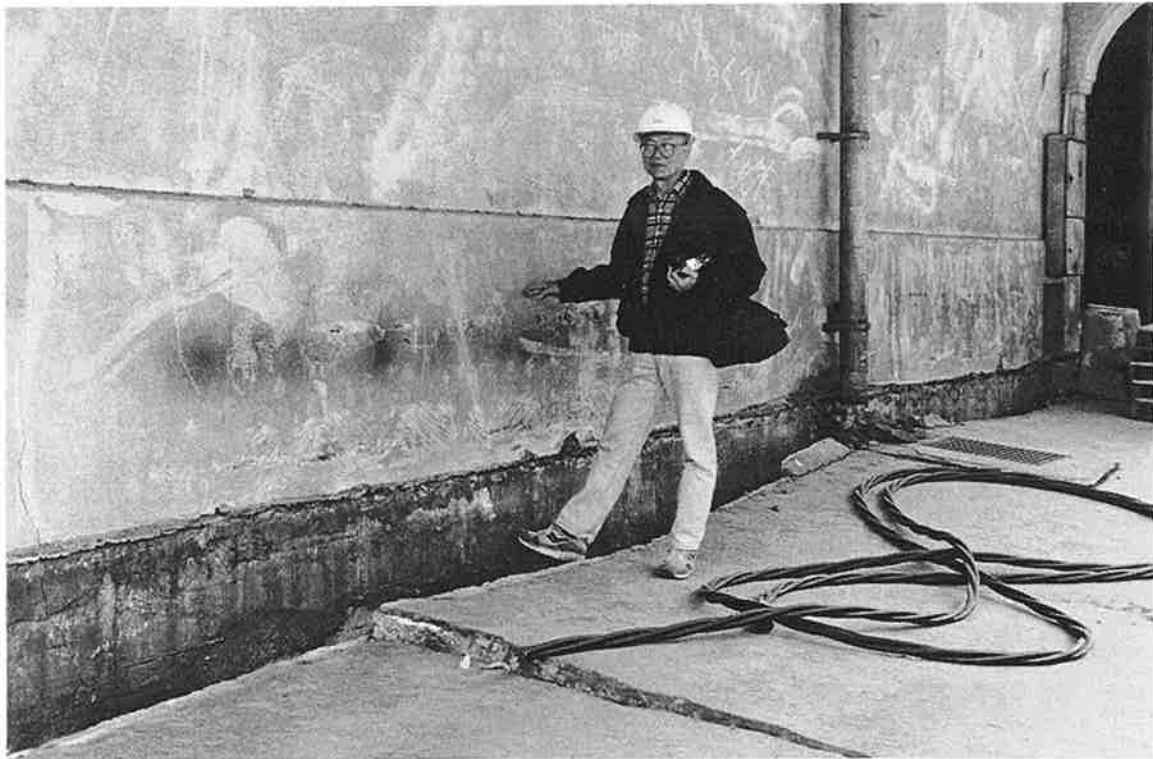

*PI-7. This loading dock adjacent to the people mover displaced over 300 mm horizontally and over 400 mm vertically from the side of the warehouse.*



*PI-8. After a missing 300 meters, the peplemover resumes at the tower in the center. Port Island is in the background.*

## Port Island Line - PEOPLEMOVER

---



PI-9. A close-up of the tower shows it is the Port Island Station.



PI-10. The pedestrian bridge approaches the Port Island Peoplemover Terminal Station that is integral with the marine terminal. Note the slope and settlement.

## ***Port Island Line - PEOPLEMOVER***

---



*PI-11. The steel box girder span approaching the arch span was undamaged.*

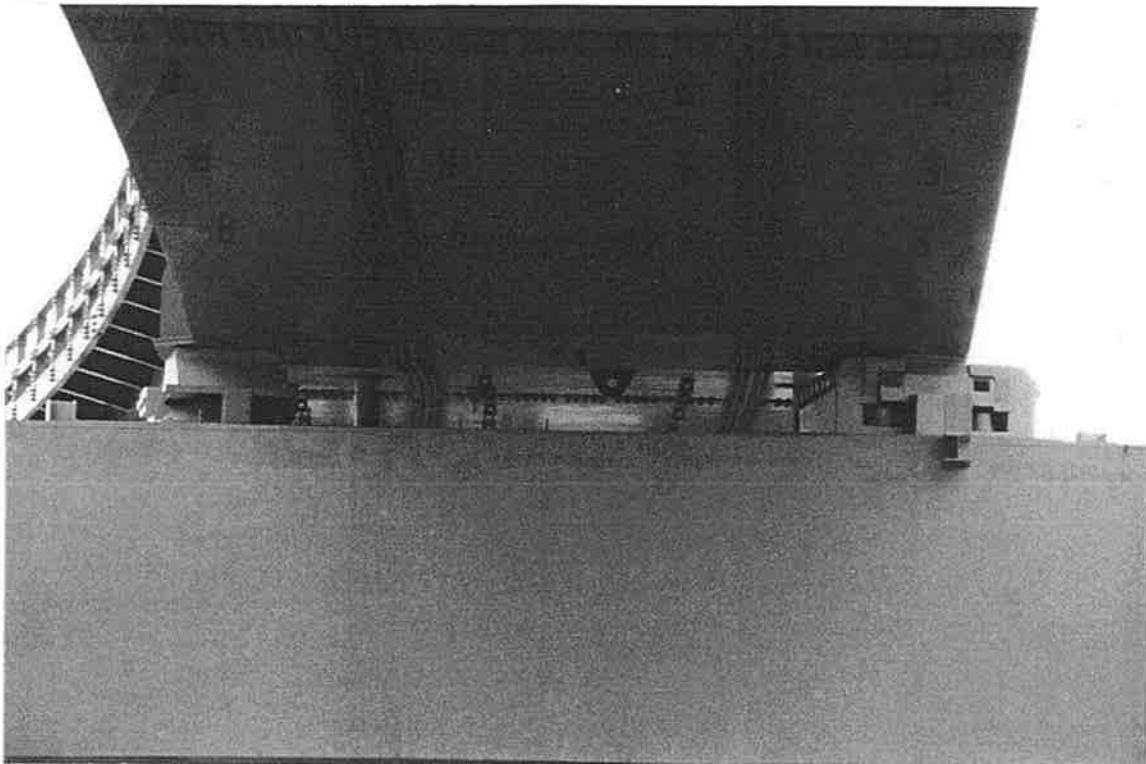

*PI-12. Bearings supporting the steel box girder*

## ***Port Island Line - PEOPLEMOVER***

---



*PI-13. The single arch bridge in the foreground carried the people mover south to Port Island. It appeared undamaged. The highway bridge at the bottom right was severely damaged in the next span. The double deck arch in the background supports highway traffic.*



*PI-14. These spans of the double deck highway bridge fell from the short span bridge seats. The arch bridge pier is at the top.*

## Port Island Line - PEOPLEMOVER

---

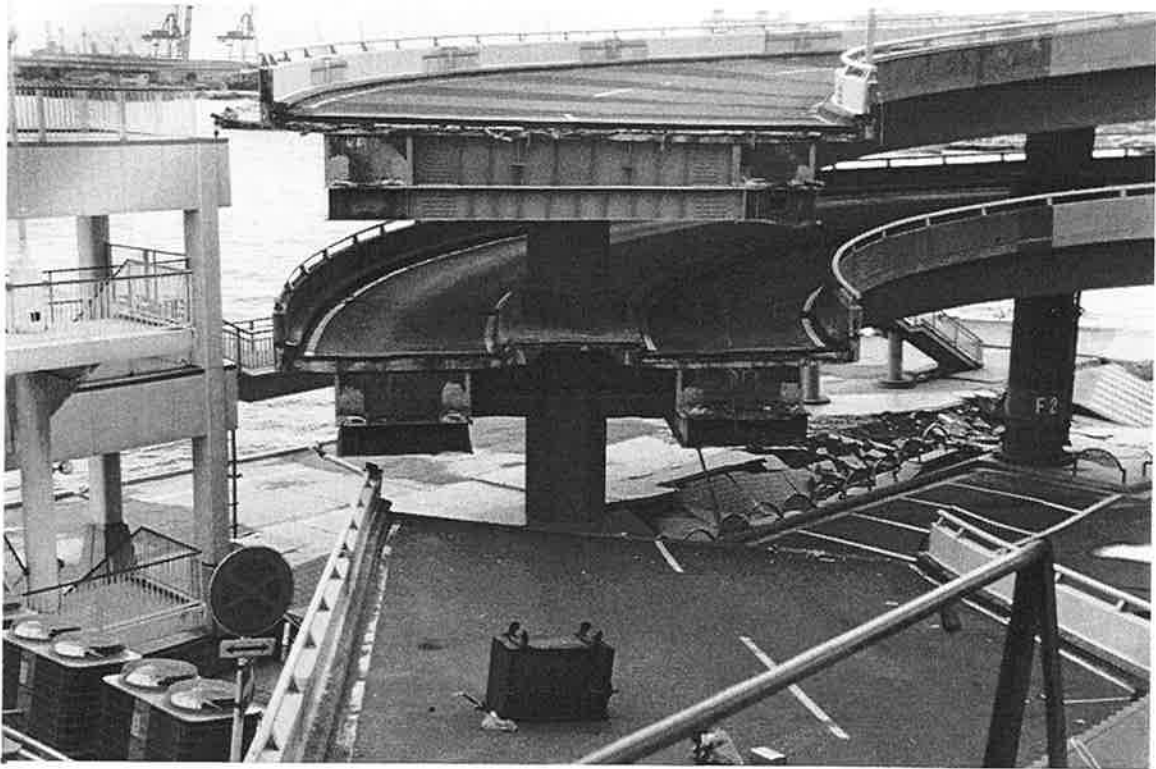

*PI-15. The last span of both decks dropped from their seats. The near support is the Port Island to harbor terminal, a massive and very stiff building. Note the empty container terminal at the top left.*

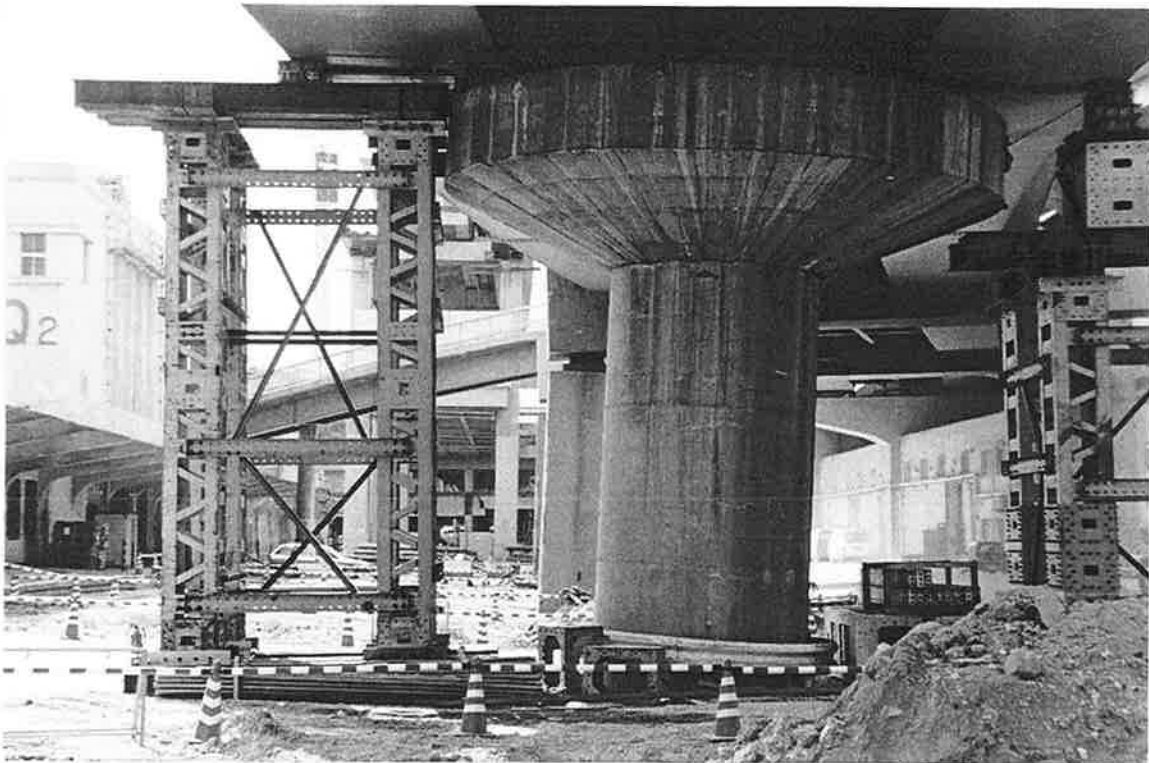

*PI-16. Adjacent to the failed peoplemover is an immense stiff pier supporting roadway and pedestrian bridges. Note the lean in the successive piers. Some foundation failure is evident.*



*PI-17. This highway ramp adjacent to the peplemover appears to be supported on a seismic isolation bearing. The deck was damaged here and demolished. The concrete substructure of the double viaduct sustained significant damage.*

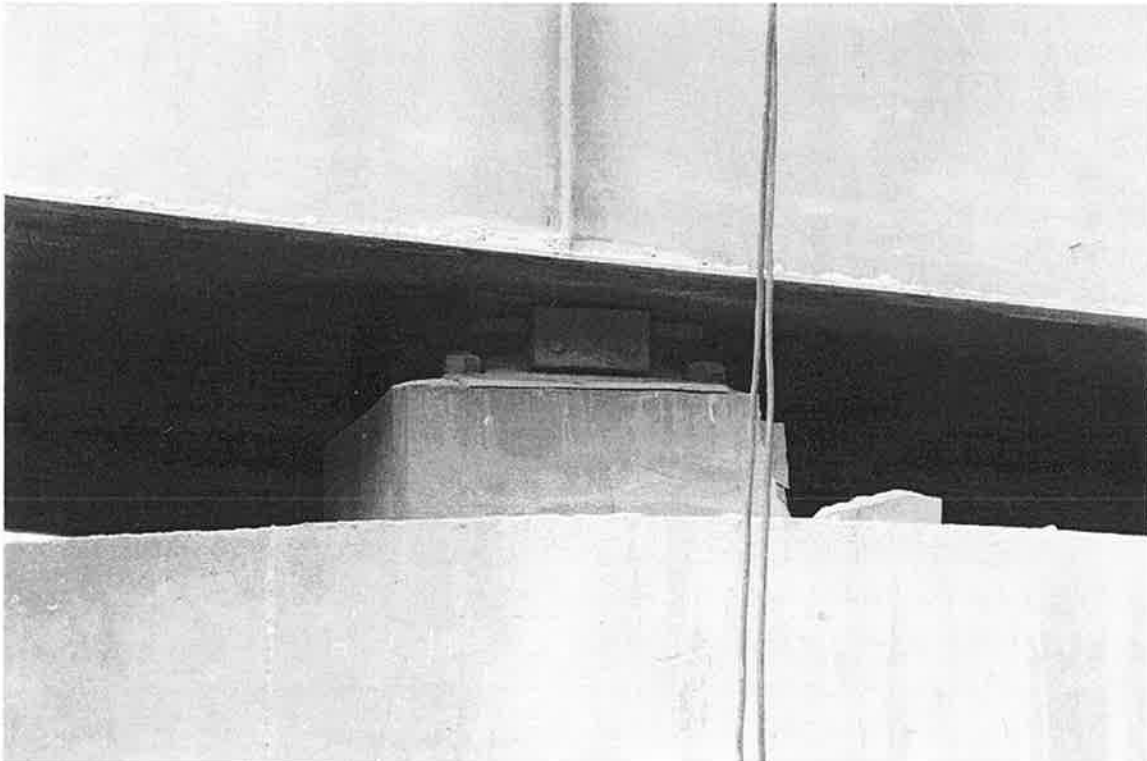

*PI-18. A close-up of the the isolation bearing*



## ***Kobe Municipal Subway - DAIKAI-DORI STATION***

---



*KMS-1. Depression in the street is above the Daikai-dori Station.*



*KMS-2. The steel sections over the depression are being used as soldier piles.*

## ***Kobe Municipal Subway - DAIKAI-DORI STATION***

---



*KMS-3. A street sign marks the intersection at Daikai-dori.*



*KMS-4. Construction in the middle of Daikai-dori Street*



***KMS-5. The contractor is constructing a soil cement wall with soldier piles to support the excavation of the station.***



***KMS-6. The new soldier piles are driven to 17 meters in the soil cement.***

## ***Kobe Municipal Subway - DAIKAI-DORI STATION***

---



***KMS-9. JR Tokaido Mainline - Hyogo Station is about 3 blocks down the opposite tree lined street.***