

REFERENCE

FRA-76-35

REPORT NO. FRA/ORD-76/304

RAILROAD CLASSIFICATION YARD TECHNOLOGY
A Survey and Assessment

S. J. Petracek
A. E. Moon
R. L. Kiang
M. W. Siddiquee

Stanford Research Institute
333 Ravenswood Avenue
Menlo Park CA 94025



RETURN TO
DOT/TSC
TECHNICAL INFORMATION CENTER

JANUARY 1977
FINAL REPORT

RETURN TO
DOT/TSC
TECHNICAL INFORMATION CENTER

DOCUMENT IS AVAILABLE TO THE U.S. PUBLIC
THROUGH THE NATIONAL TECHNICAL
INFORMATION SERVICE, SPRINGFIELD,
VIRGINIA 22161

Prepared for
U.S. DEPARTMENT OF TRANSPORTATION
FEDERAL RAILROAD ADMINISTRATION
Research and Development
Washington DC 20590

NOTICE

This document is disseminated under the sponsorship of the Department of Transportation in the interest of information exchange. The United States Government assumes no liability for its contents or use thereof.

NOTICE

The United States Government does not endorse products or manufacturers. Trade or manufacturers' names appear herein solely because they are considered essential to the object of this report.

1. Report No. FRA/ORD-76/304		2. Government Accession No.		3. Recipient's Catalog No.	
4. Title and Subtitle RAILROAD CLASSIFICATION YARD TECHNOLOGY A Survey and Assessment				5. Report Date January 1977	
				6. Performing Organization Code	
7. Author(s) S. J. Petracek, A. E. Moon, R. L. Kiang M. W. Siddiquee				8. Performing Organization Report No. DOT-TSC-FRA-76-35 SRI Project 3983	
9. Performing Organization Name and Address Stanford Research Institute 333 Ravenswood Avenue Menlo Park CA 94025				10. Work Unit No. (TRAIS) RR716/R7308	
				11. Contract or Grant No. DOT-TSC-968	
12. Sponsoring Agency Name and Address U.S. Department of Transportation Federal Railroad Administration Research and Development Washington DC 20590				13. Type of Report and Period Covered Final Report Jan. 1975 - July 1976	
				14. Sponsoring Agency Code	
15. Supplementary Notes					
16. Abstract <p>This report documents a survey and assessment of the current state of the art in rail freight-car classification yard technology. The major objective was the identification of research and development necessary for technological improvements in railroad classification yards. This involved a projection of future classification yard needs and a comparison of these requirements of existing technology. Separate tasks included a description of the hardware, costs, performance characteristics, and operational practices of existing yards; formulation of general yard-network interaction concepts; collection of in-depth background information concerning the yard population in the United States (categorized by type, technology, and function); estimation of the demands likely to be placed on the nation's network of freight-car terminals during the foreseeable future; and an assessment and prioritization of those areas of terminal operations that warrant further research or development.</p>					
17. Key Words Classification Yard Technology, Yard Design, Operational Procedures, Hump Yards, Flat Yards, Train-Terminal Interaction				18. Distribution Statement <p>DOCUMENT IS AVAILABLE TO THE U.S. PUBLIC THROUGH THE NATIONAL TECHNICAL INFORMATION SERVICE, SPRINGFIELD, VIRGINIA 22161</p>	
19. Security Classif. (of this report) Unclassified		20. Security Classif. (of this page) Unclassified		21. No. of Pages 346	22. Price

PREFACE

The research reported here was performed by Stanford Research Institute, Menlo Park, California under Contract DOT-TSC-968. The project's technical monitor was Dr. John Hopkins of the Transportation Systems Center. The project supervisor was Dr. Robert S. Ratner of SRI. Stephen J. Petracek was the project leader and principal investigator.

Other SRI personnel who contributed to this research were Albert Moon, Robert Kiang, Waheed Siddiquee, Rilla Reynolds, Peter J. Wong, and Bjorn Conrad. Mr. Moon was responsible for the evaluation of future railroad-yard requirements; he also participated in the technology survey and contributed to the cost analysis. Dr. Kiang performed a major role in the yard technology survey. Dr. Siddiquee was responsible for analyzing the impact and interrelationships of railroad classification yards and railroad-system operations. Ms. Reynolds was a key contributor in the development of the SRI national yard inventory and was responsible for most of the computer programs used in the data reduction and analysis. Dr. Wong and Dr. Conrad provided technical expertise, as needed, during the course of the project.

Members of the SRI project team spent much time examining classification yard operations throughout the country and engaging in technical and operational discussions with railroad personnel. Special appreciation is due the people in the Federal Railroad Administration, the United States Railway Association, and the following railroad companies: Boston and Maine, The Chessie System, Grand Trunk Western, Illinois Central Gulf, Kansas City Southern, Louisville and Nashville, Missouri Pacific, Norfolk and Western, Penn Central, Southern, Southern Pacific, and the Union Pacific. Although space precludes the listing of all individuals who were contacted during this research, we do wish to identify and acknowledge those who provided continuing contribution and support; these included Louis Hill and Donald Nelson of the USRA, James Page of the Penn Central Transportation Company, and Albert Hines of the Federal Railway Administration.

METRIC CONVERSION FACTORS

Approximate Conversions to Metric Measures

Symbol	When You Know	Multiply by	To Find	Symbol
LENGTH				
in	inches	2.5	centimeters	cm
ft	feet	30	centimeters	cm
yd	yards	0.9	meters	m
mi	miles	1.6	kilometers	km
AREA				
in ²	square inches	6.5	square centimeters	cm ²
ft ²	square feet	0.09	square meters	m ²
yd ²	square yards	0.8	square meters	m ²
mi ²	square miles	2.6	square kilometers	km ²
	acres	0.4	hectares	ha
MASS (weight)				
oz	ounces	28	grams	g
lb	pounds	0.45	kilograms	kg
	short tons (2000 lb)	0.9	tonnes	t
VOLUME				
teaspoons	teaspoons	5	milliliters	ml
fluid ounces	fluid ounces	15	milliliters	ml
cup	cup	30	milliliters	ml
pt	pints	0.24	liters	l
qt	quarts	0.47	liters	l
gal	gallons	0.95	liters	l
ft ³	cubic feet	2.8	liters	l
yd ³	cubic yards	0.03	cubic meters	m ³
		0.76	cubic meters	m ³
TEMPERATURE (exact)				
°F	Fahrenheit temperature	5/9 (after subtracting 32)	Celsius temperature	°C

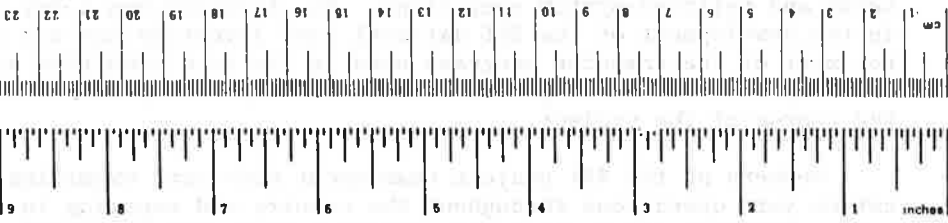

Approximate Conversions from Metric Measures

Symbol	When You Know	Multiply by	To Find	Symbol
LENGTH				
mm	millimeters	0.04	inches	in
cm	centimeters	0.4	inches	in
m	meters	3.3	feet	ft
km	kilometers	1.1	yards	yd
		0.6	miles	mi
AREA				
cm ²	square centimeters	0.16	square inches	in ²
m ²	square meters	1.2	square yards	yd ²
km ²	square kilometers	0.4	square miles	mi ²
ha	hectares (10,000 m ²)	2.5	acres	ac
MASS (weight)				
g	grams	0.035	ounces	oz
kg	kilograms	2.2	pounds	lb
t	tonnes (1000 kg)	1.1	short tons	st
VOLUME				
ml	milliliters	0.03	fluid ounces	fl oz
l	liters	2.1	pints	pt
l	liters	1.06	quarts	qt
m ³	cubic meters	0.26	gallons	gal
m ³	cubic meters	35	cubic feet	ft ³
		1.3	cubic yards	yd ³
TEMPERATURE (exact)				
°C	Celsius temperature	9/5 (then add 32)	Fahrenheit temperature	°F

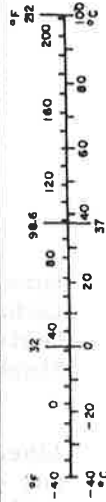

TABLE OF CONTENTS

<u>Section</u>	<u>Page</u>
1. INTRODUCTION.....	1
1.1 Objective.....	1
1.2 Background and Scope.....	1
1.3 Method of Approach.....	1
1.4 Organization of the Report.....	5
2. FUNCTIONAL ANALYSIS OF CLASSIFICATION YARDS.....	7
2.1 Role of Yards In Railroad Operations.....	7
2.2 Types of Railroad Yards.....	9
2.2.1 Classification Yards.....	10
2.2.2 Industrial Yards.....	11
2.2.3 Passenger Terminals.....	12
2.2.4 TOFC/COFC Yards.....	12
2.2.5 Storage Yards.....	13
2.2.6 Interchange Yards.....	13
2.3 Description of Classification Yard Operations.....	13
2.4 SRI Inventory of U.S. Railroad Yards.....	21
2.4.1 Information Sources.....	21
2.4.2 Inventory Methodology.....	22
2.4.3 Summary of Yard Inventory.....	25
2.4.4 Reliability of Inventory Information.....	34
2.5 SRI Survey of U.S. Railroad-Yard Operators.....	37
2.5.1 Questionnaire Distribution.....	37
2.5.2 Yard Visits and Technical Discussions.....	38
2.6 Categorization of Classification Yards.....	40
3. FUTURE SWITCHYARD CONSTRUCTION.....	47
3.1 Present-Trends Scenario.....	49
3.1.1 Economic Conditions.....	49
3.1.2 Demand for Railroad Transportation.....	49
3.1.3 Length of Haul.....	51
3.1.4 Freight Tons Originated.....	52

TABLE OF CONTENTS (CONTINUED)

<u>Section</u>	<u>Page</u>
3.1.5 Tons per Carload.....	53
3.1.6 Carloads Originated.....	54
3.1.7 Switching Operations.....	55
3.1.8 Unit Trains.....	56
3.1.9 Ownership and Cooperative Changes.....	57
3.1.10 Mergers.....	58
3.1.11 Line, Branch and Terminal Rationalization...	60
3.1.11.1 Mainline Rationalization.....	61
3.1.11.2 Branchline Abandonment.....	61
3.1.11.3 Better Blocking Strategies.....	61
3.1.11.4 Improved Car Utilization.....	62
3.1.11.5 Intermodal Operations.....	62
3.1.12 Number of Cars to Be Switched.....	62
3.1.13 Network Changes.....	63
3.1.14 Relocation of Urban Railroads.....	64
3.1.15 Operating Company Finances.....	64
3.1.16 Switchyard Age and Condition.....	64
3.1.17 Yard Construction under Present-Trends Scenario.....	65
3.2 Super-Rationalization Scenario.....	66
3.2.1 Ownership and Cooperative Changes.....	66
3.2.2 Line, Branch and Terminal Rationalization....	67
3.2.2.1 Mainline Rationalization.....	67
3.2.2.2 Branchline Abandonment.....	67
3.2.2.3 Improved Blocking Strategies.....	67
3.2.2.4 Improved Car Utilization.....	67
3.2.2.5 Improved Intermodal System.....	68
3.2.3 Number of Cars to Be Switched.....	68
3.2.4 Network Changes.....	68
3.2.5 Urban Railroad Relocation.....	69
3.2.6 Operating Company Finances.....	70
3.2.7 Yard Construction under Super-Rationalization Scenario.....	70

TABLE OF CONTENTS (CONTINUED)

<u>Section</u>	<u>Page</u>
3.3 Energy-Crisis Scenario.....	70
3.3.1 Economic Conditions.....	70
3.3.2 Railroad Carloadings.....	71
3.3.3 Transfer of Truck Traffic.....	71
3.3.4 Financial Condition of Operating Railroads...	73
3.3.5 Rationalization and Cooperation.....	73
3.3.6 Number of Cars to Be Switched.....	74
3.3.7 Network Changes.....	75
3.3.8 Urban Railroad Relocation.....	75
3.3.9 Wearout and Obsolescence.....	75
3.3.10 Switchyard Construction in the Energy-Crisis Scenario.....	75
4. SURVEY OF CLASSIFICATION YARD EQUIPMENT AND HARDWARE.....	77
4.1 Yard-Facility Hardware.....	77
4.1.1 Weigh Scales.....	77
4.1.2 Weigh Rails.....	79
4.1.3 Automatic Car-Identification System.....	80
4.1.3.1 Association of American Railroads Standards.....	80
4.1.3.2 Other ACI Systems.....	83
4.1.4 Detectors.....	84
4.1.4.1 Wheel Detectors.....	84
4.1.4.2 Hot-Box Detectors.....	85
4.1.4.3 Dragging-Equipment Detectors.....	86
4.1.4.4 Broken-Flange and Loose-Wheel Detectors.....	86
4.1.4.5 Presence Monitors.....	87
4.1.4.6 Wheel-Flaw Detectors.....	87
4.1.5 Speed-Control Devices.....	90
4.1.5.1 Clasp-Type Devices.....	90
4.1.5.2 Non-Clasp-Type.....	94
4.1.6 Skates.....	99

TABLE OF CONTENTS (CONTINUED)

<u>Section</u>	<u>Page</u>
4.1.7 Radar Speedometers.....	99
4.1.8 Turnouts.....	99
4.1.9 Distance-To-Couple Measurement Systems.....	100
4.1.10 Safety-Derail Devices.....	101
4.1.11 Pin-Pulling Devices.....	101
4.1.12 Closed-Circuit Television.....	102
4.1.13 Concrete Ties.....	103
4.1.14 Continuous Welded Rail.....	103
4.2 Yard Computer Systems.....	104
4.2.1 Process Control.....	104
4.2.2 Information Processing.....	107
4.2.3 Computer-System Configuration.....	109
4.3 Rolling-Stock Technology.....	116
4.3.1 Freight Cars.....	116
4.3.1.1 Design Limit Cars.....	116
4.3.1.2 Equipment That Minimizes Impact- Related Lading Damange.....	116
4.3.2 Automatic Coupler Systems.....	118
4.3.2.1 Existing Coupler System.....	118
4.3.2.2 Proposed Coupler System.....	119
4.3.3 Switch Engines.....	120
4.3.3.1 Motive-Power Technology.....	121
4.3.3.2 Diesel-Electric Switching Units.....	122
4.3.3.3 Diesel-Hydraulic Locomotive....	122
4.3.3.4 Electric Switch Engines.....	124
4.3.3.5 Gas-Turbine Locomotive.....	125
4.3.3.6 Energy-Storage Flywheel Switch Engines.....	126
4.3.3.7 Switching Mules.....	126

TABLE OF CONTENTS (CONTINUED)

<u>Section</u>	<u>Page</u>
4.3.4 Switch Engine Control Technology.....	127
4.3.4.1 Remote Speed Control of Hump Engines.....	127
4.3.4.2 Remote Control of Switch Engines...	127
4.3.4.3 Dead-Man Control.....	127
4.3.4.4 Automatic Wheel-Slip Control.....	128
4.4 Operating Procedures and Processes.....	128
4.4.1 Dynamic Assignment of Classification Tracks.....	129
4.4.2 Multistage Switching.....	130
4.4.2.1 Initial Sorting by Block Sequence.....	130
4.4.2.2 Initial Sorting by Outbound Trains.....	132
4.4.2.3 Triangular Switching.....	134
4.4.2.4 Geometric Switching.....	137
4.4.3 Preblocking.....	140
4.5 Yard Geometric Design.....	141
4.5.1 Flat Yards.....	141
4.5.2 Hump Yards.....	142
4.5.3 Minihump Yards.....	145
4.5.4 Multistage Classification Yards.....	145
4.5.5 Herringbone Tracks.....	147
4.6 Technological Change in the Railroad Industry.....	150
4.6.1 Process of Technological Change.....	150
4.6.1.1 Research.....	150
4.6.1.2 Invention.....	151
4.6.1.3 Development.....	151
4.6.1.4 Innovation.....	151
4.6.1.5 Diffusion.....	151

TABLE OF CONTENTS (CONTINUED)

<u>Section</u>	<u>Page</u>
4.6.2 Factors Influencing Technological Change....	153
4.6.2.1 Industry Structure.....	153
4.6.2.2 Market Structure.....	158
4.6.2.3 Government Regulation.....	160
4.6.2.4 Captial-Investment Requirements....	165
4.6.2.5 Labor Relations.....	168
4.6.2.6 Railway Suppliers.....	173
5. IMPACT OF TRAIN-TERMINAL INTERACTIONS.....	175
5.1 Function of a Yard.....	175
5.2 System Factors Affecting Yard Loadings and Operations.....	176
5.2.1 Composition and Delivery Times of Cars from Industry and Interchange Railroads.....	176
5.2.2 Time Allowances for Delivery of Cars to Their Destination.....	177
5.2.3 Constraints Associated With Train Size.....	177
5.2.4 Availability of Advance Information Related to Incoming Traffic.....	179
5.2.5 Work Rules and Regulations.....	180
5.2.6 Blocking and Train-Formation Strategies in Other System Yards.....	180
5.3 A Case Study.....	183
5.3.1 Network Trophy and O/D Demand Data.....	185
5.3.2 The Problem to Be Studied.....	188
5.3.3 Policy Alternatives.....	189
5.3.4 Comparison of Three Alternative Policies for Five Yards.....	190
5.3.4.1 Assumed Scenarios.....	192
5.3.4.2 Assumptions Related to Calculations of Various Measures of Effective- ness.....	193
5.3.5 Analysis of the Alternative Policies.....	196
6. MEANS OF IMPROVEMENT.....	199
6.1 Costs of Railroad Yard Operations.....	199

TABLE OF CONTENTS (CONTINUED)

<u>Section</u>	<u>Page</u>
6.1.1 Potential Areas for Yard Cost Reduction.....	201
6.1.2 Labor-Related Costs.....	201
6.1.3 Car-Time Expenses.....	201
6.1.4 Other Yard Costs.....	204
6.2 Analysis of Yard Operations.....	204
6.2.1 Statistical Analyses of Yard Survey Data....	204
6.2.2 Computer Simulations of Classification Yards.....	205
6.3 Potential Means for Improvement.....	208
6.3.1 Yard Expenses.....	208
6.3.2 Quality of Service.....	208
6.4 Summary.....	212
6.4.1 Rolling-Stock Technology.....	212
6.4.2 Yard Hardware and Facilities.....	213
6.4.3 Yard Computer, Communications, and Control Technology.....	214
6.4.4 Yard/Network Operational Procedures.....	214
6.4.5 Yard Design.....	214
APPENDIX A - YARD MECHANIZED INFORMATION-PROCESSING SYSTEMS.....	A-1
APPENDIX B - SRI QUESTIONNAIRES AND RESPONSES.....	B-1
APPENDIX C - SRI YARD-INVENTORY DATA.....	C-1
APPENDIX D - REFERENCES.....	D-1
APPENDIX E - REPORT OF INVENTIONS.....	E-1

LIST OF ILLUSTRATIONS

<u>Figure</u>		<u>Page</u>
1	ORGANIZATION OF THE RESEARCH EFFORT.....	3
2	TYPICAL LOADED-CAR MOVEMENTS.....	9
3	TYPICAL FREIGHT-CAR CYCLE (IN DAYS).....	10
4	TYPICAL FLAT-YARD TRACK CONFIGURATION.....	14
5	A TYPICAL ARRANGEMENT OF SUBYARDS IN A HUMP YARD.....	15
6	GEOMETRIC PATTERN OF CLASSIFICATION TRACKS IN A HUMP YARD.....	15
7	CAR HANDLING PROCESSES IN CLASSIFICATION YARDS.....	17
8	INTERCHANGES.....	32
9	JUNCTIONS.....	32
10	END OF LINES.....	33
11	LAND USE AND DEMOGRAPHIC SUMMARY.....	36
12	GEOGRAPHIC DISTRIBUTION OF YARD QUESTIONNAIRES.....	39
13	AGE DISTRIBUTION OF CLASSIFICATION YARDS.....	44
14	SIMPLIFIED DIAGRAM SHOWING INTERRELATIONSHIPS OF FACTORS AFFECTING SWITCHYARD CONSTRUCTION.....	48
15	GROSS NATIONAL PRODUCT IN 1958 DOLLARS.....	50
16	FREIGHT DEMAND.....	51
17	AVERAGE LENGTH OF RAILROAD HAUL.....	52
18	TONS OF FREIGHT ORIGINATED.....	53
19	AVERAGE LOADING PER CARLOAD.....	54

LIST OF ILLUSTRATIONS (CONTINUED)

<u>Figure</u>		<u>Page</u>
20	FREIGHT CARLOADS ORIGINATED.....	55
21	CLASS-I RAILROAD MERGER ACTIVITIES.....	58
22	AGE DISTRIBUTION OF HUMP YARDS.....	65
23	BROKEN-FLANGE AND LOOSE-WHEEL DETECTOR.....	88
24	PRINCIPLE OF RETARDATION.....	91
25	PRINCIPLE OF WEIGHT-RESPONSIVE RETARDER.....	93
26	DOWTY CYLINDER UNIT.....	95
27	HYDRAULIC RETARDER.....	96
28	PRINCIPLE OF ELECTRODYNAMIC RETARDER.....	97
29	SIMPLIFIED CONFIGURATION OF AN ELECTRODYNAMIC RETARDER...	98
30	RESULT OF JAPANESE NATIONAL RAILWAYS' SIMULATION USING CONSTANT HUMP SPEED.....	107
31	RESULT OF JAPANESE NATIONAL RAILWAYS' SIMULATION USING VARIABLE HUMP SPEED.....	107
32	BASIC MINICOMPUTER PRICE TREND.....	111
33	DIGITAL-COMPUTER HUMP-YARD INSTALLATION TREND.....	112
34	PATTERN OF DIESELIZATION BY MAJOR RAILROADS.....	121
35	STRATEGY 1: CAR GROUPING AFTER FIRST-STAGE SWITCHING....	131
36	STRATEGY 1: ARRANGEMENT OF GROUPS FOR SECOND SWITCHING..	131
37	STRATEGY 1: BLOCK ORDER AFTER SECOND-STAGE SWITCHING....	131

LIST OF ILLUSTRATIONS (CONTINUED)

<u>Figure</u>		<u>Page</u>
38	STRATEGY 2: CAR GROUPING AFTER FIRST-STAGE SWITCHING....	133
39	STRATEGY 2: CAR GROUPING AFTER RESWITCHING ONE TRACK....	134
40	STRATEGY 3: CAR GROUPING AFTER FIRST-STAGE SWITCHING....	136
41	STRATEGY 3: CAR GROUPING AFTER RESWITCHING TRACK 1.....	136
42	STRATEGY 3: CAR GROUPING AFTER RESWITCHING TRACK 2.....	137
43	STRATEGY 3: CAR GROUPING AFTER RESWITCHING TRACK 3.....	137
44	STRATEGY 4: CAR GROUPING AFTER FIRST-STAGE SWITCHING....	138
45	STRATEGY 4: CAR GROUPING AFTER RESWITCHING TRACK 1.....	139
46	STRATEGY 4: CAR GROUPING AFTER RESWITCHING TRACK 2.....	139
47	STRATEGY 4: CAR GROUPING AFTER RESWITCHING TRACK 3.....	139
48	STRATEGY 4: CAR GROUPING AFTER RESWITCHING TRACK 4.....	140
49	TYPICAL FLAT-YARD TRACK CONFIGURATION.....	141
50	TOP VIEW AND PROFILE VIEW OF A HUMP YARD.....	143
51	TANDEM OR IN-LINE ARRANGEMENT OF SUBYARDS.....	144
52	TWO-STAGE HUMP YARD (CONFIGURATION 1).....	146
53	TWO-STAGE HUMP YARD (CONFIGURATION 2).....	146
54	TWO-STAGE HUMP YARD (CONFIGURATION 3).....	147
55	DOUBLE HERRINGBONE TRACKS.....	148
56	SINGLE HERRINGBONE TRACKS.....	149
57	PROCESS OF TECHNOLOGICAL CHANGE.....	151
58	PATTERNS OF TECHNOLOGICAL IMITATION IN THE RAILROAD INDUSTRY.....	156

LIST OF ILLUSTRATIONS (CONTINUED)

<u>Figure</u>		<u>Page</u>
59	RAILROAD EMPLOYMENT AND WAGE TRENDS.....	171
60	FUNCTION OF A YARD.....	175
61	HYPOTHETICAL RELATIONSHIP BETWEEN TRAIN LENGTH, REVENUE, AND COSTS.....	178
62	HYPOTHETICAL ENGINE ASSIGNMENTS RELATED TO YARD WORK- LOAD.....	180
63	A CONVENIENT FORMAT TO SPECIFY BLOCKING STRATEGIES.....	181
64	THREE BLOCKING STRATEGIES WITH CONSTRAINTS ON BLOCK MAKING CAPACITIES AND THE ASSOCIATED SWITCHING MATRICES.....	182
65	BLOCKS AND SWITCHING LOADS FOR STRATEGIES IN FIGURE 64 ($N_{ij} = 10$ for all i, j).....	184
66	NETWORK FOR THE CASE STUDY.....	185
A-1	INFORMATION FLOW IN MECHANIZED YARDS.....	A-2

LIST OF TABLES

<u>Table</u>		<u>Page</u>
1	SUMMARY OF YARD INVENTORY.....	26
2	SUMMARY OF YARD LOCATIONS ("CLASSIFICATION/INDUSTRIAL" YARDS).....	28
3	SUMMARY OF YARD LOCATIONS ("CLASSIFICATION" YARDS).....	29
4	SUMMARY OF YARD LOCATIONS ("INDUSTRIAL" YARDS).....	30
5	SUMMARY OF YARD LOCATIONS ("SMALL INDUSTRIAL" YARDS).....	31
6	RAILROAD LAND USE IN AMERICAN CITIES.....	34
7	SUMMARY OF YARD LOCATIONS (ALL YARDS).....	35
8	SRI ESTIMATES OF NUMBER OF YARDS IN EACH YARD CATEGORY...	41
9	SAMPLES OF CHARACTERIZATION DESCRIPTORS FOR FLAT YARDS.....	42
10	SAMPLES OF CHARACTERIZATION DESCRIPTORS FOR HUMP YARDS.....	43
11	SRI ESTIMATES OF YARD-CLASSIFICATION VOLUMES.....	46
12	ESTIMATES OF COMMODITY MOVEMENTS BY UNIT TRAINS.....	56
13	ESTIMATES OF ANNUAL SWITCHING OPERATIONS BY COMMODITY-- 1973.....	57
14	RAILROADS UNDER COMMON CONTROL AND 1974 GROSS OPERATION REVENUES.....	59
15	PROJECTED NUMBER OF CARS TO BE SWITCHED FOR THE PRESENT-TRENDS SCENARIO.....	63
16	YARD REQUIREMENTS UNDER PRESENT-TRENDS SCENARIO.....	66
17	PROJECTED NUMBER OF CARS TO BE SWITCHED FOR THE SUPER- RATIONALIZATION SCENARIO.....	69

LIST OF TABLES (CONTINUED)

<u>Table</u>		<u>Page</u>
18	YARD REQUIREMENTS FOR SUPER-RATIONALIZATION SCENARIO.....	71
19	IMPACT OF TRUCK-TRAFFIC DIVERSION ON SWITCHING ACTIVITY.....	73
20	PROJECTED NUMBER OF CARS TO BE SWITCHED FOR THE ENERGY-SHORTAGE SCENARIO.....	74
21	YARDS, EXPANDED, RECONFIGURED, REEQUIPPED, OR CONSTRUCTED NEW.....	75
22	YARD COMPUTER-SYSTEM CONFIGURATIONS.....	114
23	DIESEL-ELECTRIC SWITCH ENGINES IN THE UNITED STATES.....	123
24	AGE OF SWITCH ENGINES IN 1967 FLEET.....	123
25	MAINLINE CAPACITY UTILIZATION IN SELECTED AREAS.....	157
26	DISTRIBUTION OF UNITED STATES INTERCITY FREIGHT VOLUME IN MILLIONS OF FREIGHT TON-MILES AND PERCENTAGE OF TOTAL (INCLUDING MAIL AND EXPRESS).....	159
27	RAILROAD UNIONS.....	170
28	TYPICAL BLOCKING AND SWITCHING CAPABILITIES OF THE YARDS IN THE CASE STUDY.....	186
29	O/D TABLE FOR THE CASE STUDY ON A FLOW-HOUR BASIS, DELIVERED BY INDUSTRY AND INTERCHANGE RAILROADS.....	186
30	COMPARISON OF THREE VARIATIONS IN OPERATING POLICIES AT YARDS 1,2,3,4, AND 5.....	191
31	NATIONWIDE SWITCHYARD EXPENSES (1973 CALENDER YEAR).....	200
32	CLASSIFICATION YARD EXPENSES (1973).....	202
33	CLASSIFICATION YARD EXPENSES (1980-2000).....	203
34	DISTRIBUTION OF CAR-DETENTION TIME IN CLASSIFICATION YARDS (CALENDAR YEAR 1973).....	206

EXECUTIVE SUMMARY

Within the last 20 years, the railroad industry generally has not been known for its development and introduction of dramatic or revolutionary changes in technology. Instead, there has been an evolutionary development of new technology largely based on, compatible with, and not too dissimilar from existing technology. Such a pattern of technological change is considered typical in mature industries. It has been postulated that, as an industry matures, it develops features that resist change. There are certainly a number of characteristics that the railroads share with other mature industries, including relatively low profit levels, large fixed investment, and a strong highly organized labor force. These characteristics represent significant constraints to the process of technological change. The railroad industry, however, has many other unique characteristics, such as the large extent of government regulation, that can also constrain technological change.

If past railroad research and development trends continue, as expected, it is anticipated that few revolutionary changes in technology will diffuse throughout the industry within the next 10 to 20 years. It is expected that, despite increasing competitive pressures from other transportation technologies, the railroads will be even more reluctant than in the past to fund research and development and to foster technological change within the industry. This reluctance to change will be caused primarily by a shortage of financial resources that will adversely affect all stages of the process of technological change.

It appears, therefore, that some definite opportunities and requirements for railroad research will not be fulfilled within the industry itself. This implies that government-sponsored R&D should be welcomed by the railroad industry. This is supported by the railroads' ASTRO report which requested a ten-year, \$100 million, federally funded, rail-research program.

To aid in structuring the research program, FRA has initiated a study of switchyard technology that was conducted by SRI through TSC. The objectives of the project are to evaluate the magnitude of the problems occurring at classification yards and to determine the extent to which these problems can be reduced through the development and/or implementation of appropriate technology. Based on these analyses, SRI has identified those areas that would benefit most from an advancement in the state of the art in yard technology or from the deployment of additional hardware, policy, or procedures.

The Research Program

The research was performed in four principal task areas that were concerned with:

Classification yard operations.

State of the art in classification yard technology.

Impact of the interactions between classification yard and rail system operations.

Means of improvement.

Classification Yard Operations

This task analyzed and described the extent of classification yard operations within the United States. The SRI project team developed a national inventory of railroad classification and industrial yards. The inventory identified 4161 yards within the coterminous United States. Classification yards, which build and break down road trains, accounted for 1229 of the yards; the remainder were industrial yards that serve as collection or distribution points for cars going to or from industrial customers. Other characteristics of the yards, such as location, owner, and method of classification (flat switching or gravity), were also noted in the inventory.

The remainder of the project work was directed at the examination of the 1229 classification yards identified in the inventory. SRI conducted a questionnaire survey of yard operators, examined field sites, and held technical discussions with a variety of railroad personnel to define six categories of classification yards. These categories were defined in terms of the type of yard design (hump or flat) and the volume of classification activity (cars classified per day) which we had previously determined to be among the most important yard-characterization parameters. These categories of classification yards were then further characterized by deriving nominal values for number of employees, number of switch-engine shifts, average car delays, and other factors. These nominal descriptors were subsequently used to describe and represent all of the yards within each category. Future classification yard requirements until the year 2000 were also evaluated as part of this task area. Because of the uncertainty associated with the economic and institutional environment within which the railroads will have to operate, three scenarios were developed to describe conditions that may occur which could produce variations in switchyard-construction activities. These include a "present-trends" scenario (or extrapolation of current level of operation and rates of change), a "super-rationalization" scenario wherein proposals for industry and institutional changes are implemented to the maximum extent possible, and an "energy-crisis" scenario that describes activity in a fuel-short depressed economy with many governmental controls on transportation.

The analysis included a projection of traffic that indicated an increase in ton-miles of approximately 50 percent by the year 2000 for both the present-trends and super-rationalization scenarios, while trends toward longer hauls and larger freight cars resulted in a 20 percent increase in carloadings over that period. Improvements in system operations caused an increase of only 5 percent in the number of cars switched in the present-trends scenario and a reduction of 30 percent in the super-rationalization scenario. Reduction of demand, but with more truck traffic being carried by the railroads in the energy-crisis scenario, resulted in only a 10 to 12 percent increase in cars switched in that scenario. As a consequence, overall switching capacity requirements will not require substantial new yard construction. On the other hand, expected consolidations of networks, relocation of urban yards so as to sell valuable property, modification of urban land use, and the wearout and obsolescence of yards and yard equipment will all contribute to the need to retire yards, expand capacity in other places, and reequip old yards. A summary of the projected yard abandonments or downgradings and new construction, expansion, or rehabilitation are shown below:

Yards abandoned or downgraded	<u>1975-1985</u>	<u>1986-2000</u>
Present trends	200	230
Super rationalization	290	310
Energy crisis	0	0
Yards constructed, expanded, or rehabilitated		
Present trends	87	85
Super rationalization	102	100
Energy crunch	33	29

State of the Art in Classification Yard Technology

The term "classification yard technology" was defined broadly and included five principal categories--yard facility equipment and hardware, yard computer, communications and control technology; rolling stock technology; operational processes and procedures; and yard design. Information regarding the performance and operational characteristics of current yard technology was obtained from railroad personnel, railroad equipment suppliers, and published literature. Information concerning the cost characteristics and current deployment of the various elements of classification yard technology was obtained, as available. To complement the information gained relating to the state of the art in classification yard technology, we also examined the process of technological change within the railroad industry and the factors that influence this process.

The survey and analysis indicated that, with a few exceptions, the state of the art in classification yard technology within the United

States is fairly stable. The recent trend has been to implement technological improvements in a small number of yards while most of the yards have remained relatively unchanged. This trend is, to a large degree, the result of a number of factors that have influenced the process of technological change within the railroad industry. Some of the major factors are the structure of the industry, structure of the transportation service market, impact of government regulation, capital availability and requirements, labor agreements, and the relationship between the railroads and their suppliers. Capital availability and requirements, and labor agreements have had the most substantial influence on the implementation of new technology within this time period and will probably continue to have the greatest influence on technological change within the next 10 to 15 years.

Impact of Railroad System/Classification Yard Interactions

A case study was performed, based on car movements in a portion of a rail system operated by a United States Class-I railroad. The analysis made use of SRI's railroad network simulation model to compare the impacts that three different system operating policies would have on yard operations. The results of this study and other related SRI work support the widespread feeling that changes in railroad systemwide operational policies can significantly affect yard operations. Scheduling of inbound and outbound trains, train length, and other factors generally determine the efficiency of the yard operation and the car detention time in yards. This work, however, indicates that it is probably not possible to develop any standard operational policies or procedures that will reduce the impact of system/yard interactions in all cases. The specific rail-network topology, demand patterns, individual yard capacities, and other factors can cause each such system to exhibit individual characteristics that should be accounted for when developing systemwide operating policies.

Means of Improvement

The first portion of this task involved the determination of the magnitude and impact of the problems associated with classification yard operations. Using available ICC and AAR information, we estimated that the cost of all yard operations during 1973 was nearly \$4 billion (1973 dollars). Information collected during the yard-questionnaire survey was used to estimate that the cost associated with classification yards alone during 1973 was approximately \$3 billion (1973 dollars), or 75 percent of the total yard cost and 25 to 26 percent of the total railroad expenses during that year. We then estimated that the national costs associated with classification yard operations from 1980 to the year 2000 would be over \$75 billion (1975 dollars). This estimate was based on the projections of future switching and yard requirements developed in the present-trends scenario.

A breakdown of this cost projection reveals that the major expense in operating classification yards is labor-related. The cost breakdown associated with our present-trends projections indicate that labor-related classification yard expenses would be nearly \$50 billion or two-thirds of the total costs associated with classification yards. The next most expensive item is related to the amount of car time spent in yards; these costs will amount to approximately \$11.8 billion over the 20-year study period, thereby accounting for nearly 16 percent of the total classification yard costs. The remaining 18 percent of yard costs is related to materials, property taxes, lading loss and damage, and others.

A detailed breakdown of the elements of the yard-cost projections roughly identified and isolated those operational areas where technological changes would reduce classification yard costs. Engineering analysis was used to define these areas more precisely and to examine their sensitivity to change. Selected elements of existing and proposed yard technologies were then evaluated to estimate the potential savings that would accrue over the 1980 to 2000 time period if that technological element can be completely developed and implemented by 1980. The derivation of these cost estimates required that certain assumptions be made regarding the operational and technical characteristics and feasibility of the postulated items of technology. These estimates were then used as first-order indicators of the relative cost-savings impact of the various technological features. Examination of these estimates indicates that the most significant class yard cost reductions would be achieved through the implementation of less labor-intensive technology. Such elements would typically reduce the size or number of yard switch-engine crews, inspection crews, or clerical personnel. Although a number of the technologies examined did reduce manpower requirements, the most significant savings tended to occur in the areas of freight-car and switch-engine technology, yard hardware technology, and yard computer, communications, and control technology. The second major area of cost savings was found to result from a reduction of car time spent in yards. In many cases, the labor-reduction technologies also reduced car time expenses; however, car delays in yards can also be reduced through the implementation of new yard and network operating procedures. The cost reductions associated with less consumption of materials (such as switch-engine fuel) and other savings were found to be less spectacular than the estimated cost saving associated with labor and car time reductions, although in some cases they may be more attainable.

Another incentive for introducing new technology is the improvement of the quality of transportation service offered to the shipper. Seven major elements of service quality were examined to determine areas where technology would be most effective in improving quality. These areas were O-D transit time, O-D transit time reliability, equipment availability, schedule adaptability, correct delivery of cars, lading loss and damage, and availability of car and load status information. It was not feasible, within the scope of this project, to associate costs with improvements in these areas of service quality. Instead, a relative rating

procedure was developed and used to indicate generally how service improvements could be made.

Conclusions and Recommendations

The actual development of any federally sponsored research program is heavily based on policies that may have been established for broader reasons at higher levels of government. Our research, however, indicates that the development of R&D plans related to classification yard technology should take account of the basic considerations described below.

- Railroad-related R&D should, at least in the near future, be applications oriented. It is clear to us, from both our technology survey and discussions with railroad personnel, that much basic research and technological knowledge are available; however, they must be developed or transformed to the point where they can be successfully introduced by the railroads.
- Future rail-oriented R&D programs should extend beyond the actual stages of research, invention, and development. The major benefits of research and development are generally achieved only after the newly developed technology has diffused throughout the industry. An important stage in the process of technological change is innovation, or the initial introduction of new technology into operational use. Innovation essentially involves testing and evaluating the operational effectiveness of previously unused technology. Because innovation often requires a large financial commitment and may also entail a high risk of failure, it is often an effective barrier to technological change. As a result, government-sponsored testing and evaluation of new technology in an operational environment may significantly improve its chances of acceptance by the railroad industry, thereby improving the effectiveness of the original research and development.
- The relatively high proportion of railroad expenses attributed to classification yard operations, which are typically nonrevenue-producing, indicates that the development and implementation of cost-reducing yard technology should be highly emphasized. In particular, technology designed to reduce the labor intensiveness of yard operations would have the greatest impact on reducing yard costs although there are constraints that may significantly reduce the feasibility of this approach. For this reason, it may be that research related to these labor-reducing technologies should be limited to feasibility analyses, pending the relaxation of factors that would constrain their implementation. The development of technologies that will substantially reduce car delays in yards would also significantly reduce yard costs. With the exception of yard and

network operating procedures, however, the technologies that successfully reduce car delays, also tend to reduce yard labor requirements as well.

- Railroad-related research and development, at least in the near term, should place more emphasis on operational improvements which usually can be implemented more easily and quickly than hardware improvements. Operational improvements characteristically require much smaller capital investment and, therefore, much less financial risk is involved in their implementation. Additionally, because of the smaller initial investment, operational improvements have much shorter payback periods and achieve tangible returns more rapidly.

Based on our analyses, we believe that examination of feasibility design and implementation of the following types of technologies would be worthwhile on the basis of their potential for reducing classification yard costs and/or improving the quality of service offered to the railroad shipper.

Rolling Stock Technology

Remote-controlled switch engines
Advanced car coupler and brake systems
Switch-engine sizing design
Switch-engine energy efficiency
Car-cushioning devices

Yard Hardware and Facilities

Automatic air-hose connection device
Switch design and control
Track and roadbed design and maintenance
Improved car-inspection devices and facilities

Yard Computer, Communications, and Control Technology

Automatic car-identification systems
Computer-based yard-inventory systems
Computer-based operations monitoring and planning systems

Yard/Network Operational Procedures

Empty-car distribution system
Systemwide blocking and train-formation strategies

Train scheduling and dispatching
Dynamic assignment of class tracks, crews, and other yard resources

Yard Design

Yard geometric layout

1. INTRODUCTION

1.1 OBJECTIVE

The objective of this research has been to assess the state of the art in classification yard technology. In particular, we have attempted to estimate the economic costs associated with classification yard operations and the savings that may result from the development and/or implementation of various yard technologies. We have also developed a relative ranking of yard technologies, based on the improvement of the quality of service offered by the railroads.

1.2 BACKGROUND AND SCOPE

This report documents SRI's work under Contract DOT-TSC-968. This research was principally directed toward the construction of an information base to be used for the evaluation of research and development plans and activities in the area of classification yard technology.

Separate work areas included:

- Collection of background information concerning the railroad yard population within the United States, categorized by functional, technological, and operational characteristics.
- Estimation of the demands likely to be placed on the nation's network of switchyards during the next 25 years.
- Survey of the current state of the art and the degree of deployment of rail freight-car classification yard technology, including a detailed description of the hardware, costs, performance characteristics, and operational practices of existing yards.
- Formulation and examination of general yard-network interaction concepts.
- Assessment and prioritization of those areas of classification yard operations that warrant further technological research or development.

1.3 METHOD OF APPROACH

The project structure is organized by the following four major tasks defined in the statement of work:

Task I--Classification Yard Functional Analysis

Task II--Survey of the State of the Art in Classification Yard Technology

Task III--Impact of Train-Terminal Interactions

Task IV--Means of Improvement

During the course of the work, however, the SRI project staff modified the structure and interrelationships of these task areas so as to meet more closely the project requirements. The organizational structure of the research approach is depicted in Figure 1, and each of the major task and subtask areas are described below.

Task I--Classification Yard Functional Analysis. This task was designed to obtain background information on the individual yards that comprise the national population of railroad yards. As shown in Figure 1, this task is divided into a number of interrelated subtasks.

Selection of Yard-Characterization Parameters. This subtask entailed the selection of parameters that would be most useful in describing or categorizing yards in support of project requirements. The initial selection process was based on discussions with FRA, USRA, and railroad personnel, previous SRI railroad-related project work, and examination of available literature. The principal output of this subtask was SRI's initial survey and sampling plan.* Unanticipated conditions and factors forced SRI to subsequently modify this original plan, however, although most of the basic concepts remained the same. The survey and sampling plan that resulted was composed of the following elements or phases.

Inventory of U.S. Railroad Yards. SRI interviewed FRA personnel to develop a comprehensive and accurate inventory of U.S. railroad yards. In the inventory, the yards were uniquely identified by location, name, and owning railroad. Each was further described by a number of functional characteristics such as whether it performs classification or industrial-distribution work and whether it is an interchange point, junction point, repair point, or an end of line. The inventory also includes other related information concerning land use, demographic characteristics, and yard type (either hump or flat).

Questionnaire Distribution. Using the information obtained from the yard inventory, SRI sent

*B. Conrad, S. Petracek, and R. Ratner, "Railroad Classification Yard Survey and Sampling Plan," SRI Project 3983, 4 March 1975.

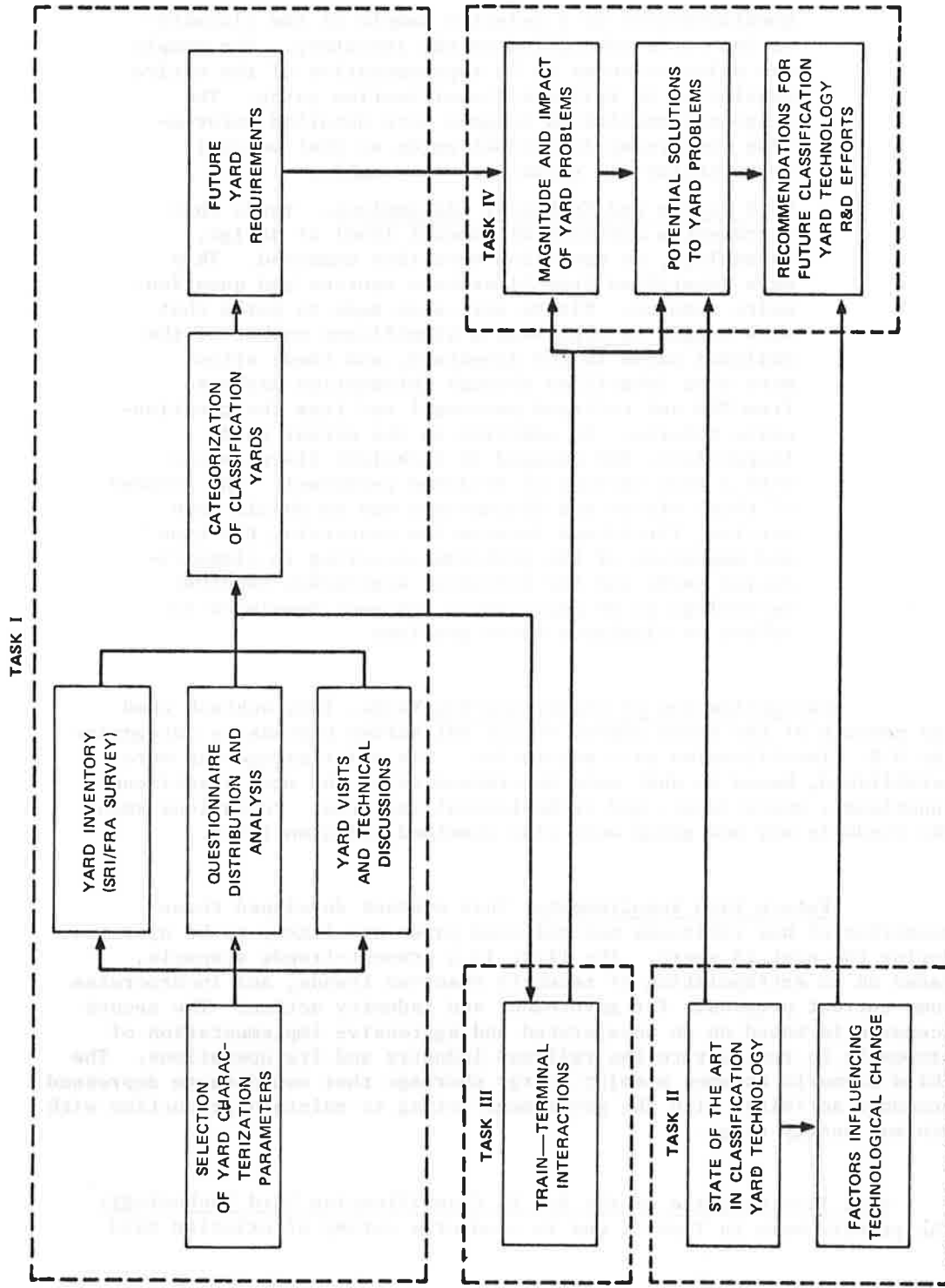

FIGURE 1 ORGANIZATION OF THE RESEARCH EFFORT

questionnaires to a selected sample of the classification yards identified in the inventory. The sample was selected so as to be representative of the entire population of railroad classification yards. The responses enabled us to gain more detailed information concerning individual yards so that we could characterize all yards more thoroughly.

Yard Visits and Technical Discussions. Yards that represent a distinct or unusual level of design, technology, or operation were then examined. They were identified from literature sources and questionnaire returns. Visits were also made to yards that were judged to represent a significant number of the railroad yards in the inventory, and these sites were also identified through information gathered from FRA and railroad personnel and from the questionnaire returns. In addition to the actual yard inspections, SRI engaged in technical discussions with a wide variety of railroad personnel. The purpose of these visits and discussions was to obtain more precise, first-hand information concerning the type and magnitude of the problems occurring in classification yards and the different approaches (whether technological or operational changes) developed to reduce or eliminate these problems.

Categorization of Classification Yards. This subtask used the results of the three phases of the SRI survey process to categorize the U.S. classification yard population. Six major categories were established, based on what were determined to be the most significant functional, operational, and technological features. Variations among the yards in any one group were also examined and quantified.

Future Yard Requirements. This subtask developed three scenarios of how railroads and railroad yards are likely to be operated during the next 25 years. The first is a present-trends scenario, based on an extrapolation of recently observed trends, and incorporates some current proposals for government and industry action. The second scenario is based on an accelerated and aggressive implementation of proposals to restructure the railroad industry and its operations. The third scenario assumes a major energy shortage that could cause depressed economic activity, with the government acting to maintain production with minimal energy usage.

Task II--The State of the Art in Classification Yard Technology. The primary work in Task II was to conduct a survey of existing yard

technologies. The information gathered included performance and operational capabilities, cost characteristics of the individual hardware elements, and the current deployment of the various elements of yard technology to complement the data gained from the yard-survey process.

Factors Influencing Technological Change. This subtask examined those factors that influence technological change within the railway industry.

Task III--Impact of Train-Terminal Interactions. The primary output of this task was an assessment of how and to what extent railroad-system operations interact with classification yard operations.

Task IV--Means of Improvement. This task used the information obtained from the other three tasks to identify the areas of yard operations that would benefit most from an advance in the state of the art in yard technology or from the implementation of additional hardware, policy, or procedures. This phase involved two subtasks.

Magnitude and Impact of Yard Problems. This subtask was designed to identify the magnitude and impact of the problems associated with classification yard operations. By quantifying the magnitude of these problem areas, the relative importance of developing and implementing solutions could be determined.

Potential Solutions to Yard Problems. SRI used the information gained from the yard survey to develop potential solutions to yard problems. In areas where existing technology can solve the problem, we attempted to identify the factors that constrain the implementation of this technology and to determine whether additional research, development, testing, and evaluation could eliminate or reduce these constraints. We also pinpointed those problem areas where, at present, no technical solution exists. An attempt was also made to identify problems that can be circumvented by changing operational procedures rather than by introducing additional automation.

1.4 ORGANIZATION OF THE REPORT

The remainder of this report describes in detail the research approach and findings. This description is separated into the major functional task areas. Section II reviews the work accomplished in support of most of the Classification Yard Functional Analysis task. Section III describes the Future Yard Requirements subtask. Section IV is a summary of the state of the art in classification yard technology. Section V documents the work performed on the examination of the

interactions between railroad-system and classification yard operations. Section VI presents the results of the Means of Improvements task. Further information is included in the appendices.

1.4 ORGANIZATION OF THE REPORT

The remainder of this report is divided into four major sections and five appendices. This division is reported in the section organization task report. Section V contains the work accomplished in support of each of the elements of the study. The first part of the report is devoted to the background and objectives of the study. The second part of the report is devoted to the description of the study. The third part of the report is devoted to the description of the study. The fourth part of the report is devoted to the description of the study.

2. FUNCTIONAL ANALYSIS OF CLASSIFICATION YARDS

2.1 ROLE OF YARDS IN RAILROAD OPERATIONS

Railroad operations are responsible for more than 38 percent¹ of the total intercity freight transportation in this country. A significant portion of these operations takes place in railroad yards. A railroad yard is simply a set of tracks that is used as a point for accumulating cars that have been collected or are going to be distributed and for sorting, assembling, and disassembling groups of cars. The number, length, and precise layout of the tracks depend on such factors as the number of cars it is intended to handle during any given period, the amount of sorting and distribution work to be performed, and the terrain features of the yard location.

The magnitude of the role of yards in railroad operations should be made evident by the following overview description of the railroad freight-transportation process. This process begins when a shipper places an order for a certain type of freight car. On receiving that order, railroad personnel attempt to locate and select an available car that will meet the shipper's requirements; empty cars may be stored on sidings or in other yards or storage locations. After inspection to ensure that it meets the shipper's needs and is in good mechanical condition, the car is then delivered to the shipper's loading facilities by an industrial switch engine whose function is to distribute groups of cars from a yard to the various industries located within a specific area. The industrial switch engine generally delivers the cars in one of two ways. They may be placed on public team tracks where the shipper is given access to load his goods, or they may be placed on private loading sidings beside the shipper's establishment. Delivery of cars onto these industrial sidings is the obligation of the railroad, and extra charges are not permitted if the service is a substitute for comparable team-track delivery. Although this delivery obligation is usually fulfilled when the car is switched onto the industrial siding, most railroads will provide the extra service of spotting the cars in the appropriate position for loading or unloading. A notable exception occurs in larger industrial plants that have complex track systems and switching requirements; cars are then often delivered to a specified location, and the industry itself will distribute them throughout the plant.

After the car has been placed on the appropriate team track or industrial siding, the shipper is given a certain amount of time to load the car. He is charged a demurrage fee for the amount of time required over an allotted period of "free time." The shipper then notifies the railroad that the car is loaded and is ready to be picked

up. The loaded car, along with others, is picked up by an industrial switch engine. These cars may be taken to an industry yard where they are accumulated until they are picked up by a local train or until enough of them have been gathered to make up a drag of cars to a larger yard. Instead of being taken to an industry yard, they may be delivered by the industrial switch engine directly to a classification yard.

At the classification yard, the car is sorted along with others into groups of cars called blocks consisting of cars whose next destination is generally similar. These blocks are then assembled into trains that travel to other yards. At such yards, the train makeup may be modified by setting off cars, picking up additional ones, or being completely resorted so as to make up other trains. A car, therefore, may actually travel on a number of trains and be processed through many intermediate yards before reaching the final classification yard.

After reaching the final classification yard, the train on which the car has been traveling is usually disaggregated and the cars are sorted according to which industrial areas they are to be distributed. Some cars may be delivered directly to the appropriate industrial sidings or team tracks for unloading. Others, however, may first be transferred to an industry yard, from which industrial switch engines will deliver them to the consignee's unloading tracks. After receiving a loaded car, the consignee has a certain period of free time in which to unload and then notify the railroad that the car is available for other uses. If this period of free time is exceeded, the railroads are entitled to charge a demurrage fee. After the car has been unloaded and released to the railroad, it may be distributed to other locations requiring empty freight cars or it may be stored until a need arises. If the car belongs to another railroad, it will be sent back to that railroad even if it has not yet been loaded. Figure 2 depicts this car-movement process.

This rather generalized description of the movement of railroad cars and freight should demonstrate that yard operations are an integral part of the overall freight-transportation operations of the railroads. The importance and impact of yard operations on railroad operations are further emphasized in Figure 3, from a 1974 Department of Transportation (DOT) study.² This study shows that, out of a 25.6-day car cycle, a typical freight car will spend an average of 7.3 days (29 percent of the average cycle time) in terminal yards and another 8.5 days (33 percent of its time) in intermediate yards. According to the DOT study, therefore, a typical car spends a total of 15.8 days per car cycle (or 62 percent of its time) in switchyards. In contrast, only 14 percent of its time is spent in line-haul operations; of this, only two days (less than 8 percent of its time) is spent in hauling freight in revenue-producing operations. These statistics are particularly distressing because yard operations, although representing a significant railroad cost, do not generally produce revenue. Instead, yard operations are only a necessary phase of the total railroad transportation process.

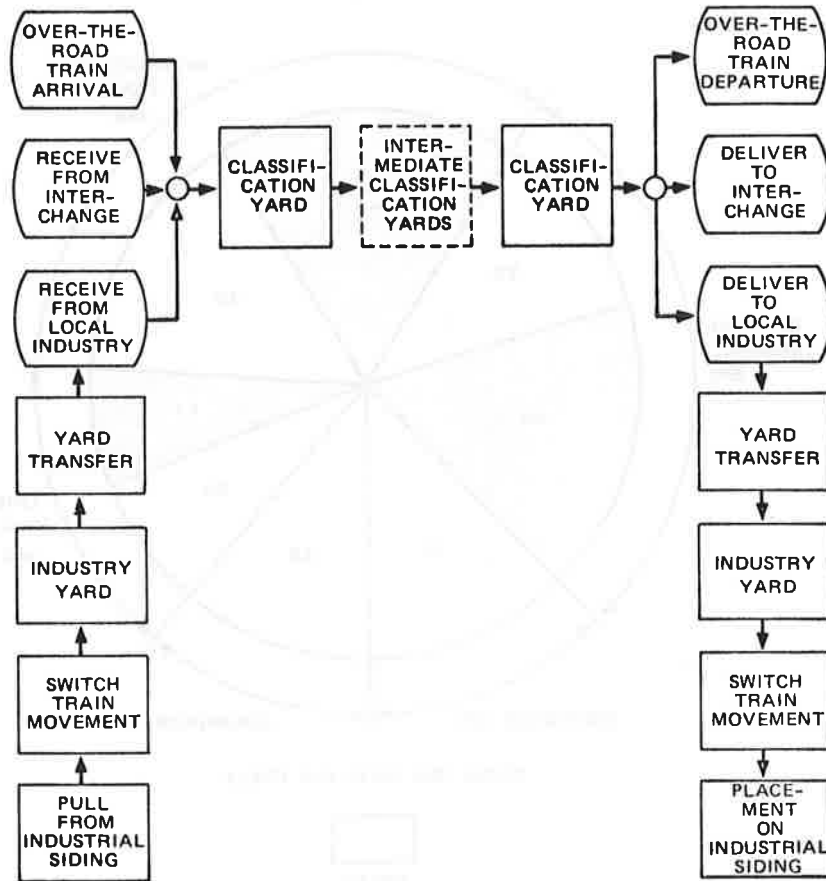
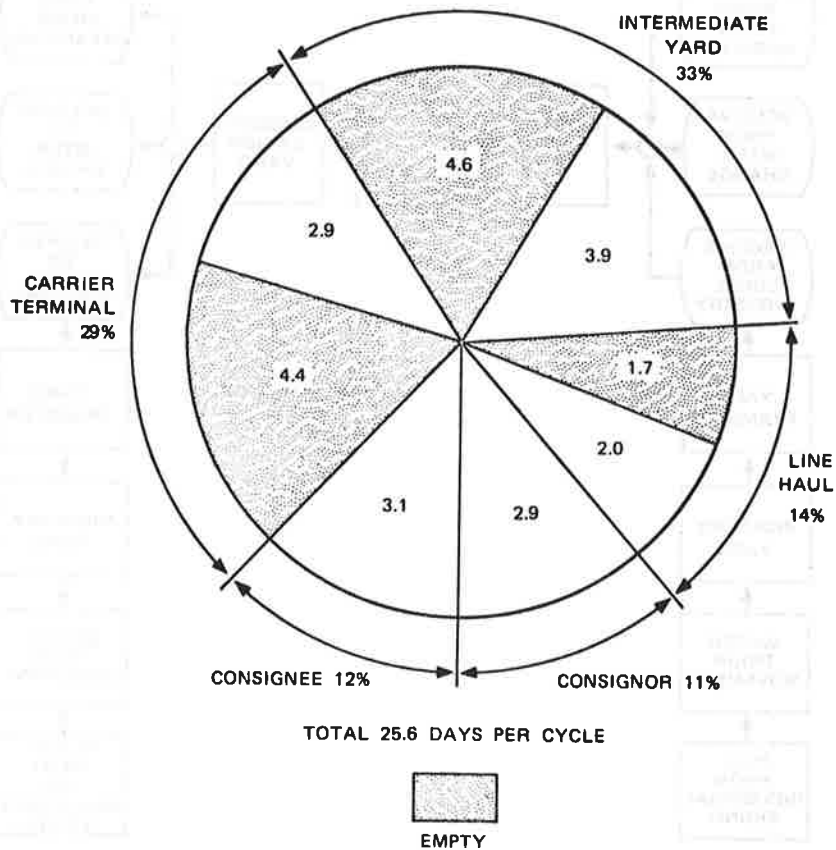

FIGURE 2 TYPICAL LOADED-CAR MOVEMENTS

2.2 TYPES OF RAILROAD YARDS

This study is primarily concerned with classification yards; however, industrial yards, passenger terminals, TOFC/COFC yards, storage yards, and interchange yards are also maintained by railroads for their operations. In this section, these yards are classified and described by the functions they perform.



SOURCE: "Rail Service in the Midwest and Northeast Region," a Report by the Secretary of Transportation (1 February 1974).

FIGURE 3 TYPICAL FREIGHT-CAR CYCLE (IN DAYS)

2.2.1 Classification Yards

Classification yards are used primarily for the assembly and/or disassembly of road-haul trains. Such yards will perform at least one and generally all three of the following operations:

- Receive outbound cars from local industries, industrial yards, or interchange, sort into

groups of cars with similar destinations or according to a given blocking (car grouping) strategy, and make up outbound road-haul trains to other classification yards.

- Receive inbound road-haul trains from other classification yards, disassemble the trains and sort the cars into groups destined for local industries, industrial yards, or interchange, and distribute the cars to the appropriate tracks, sidings, or yards.
- Receive inbound road-haul trains from other classification yards, disassemble the trains, and sort and assemble the cars into outbound blocks and road-haul trains.

Many other activities that support railroad operations are also performed at classification yards. For example, most classification yards are capable of servicing locomotives, freight cars, and cabooses, inspecting cars for mechanical defects, and weighing cars for revenue purposes. Several major classification yards also have facilities for major repairs on freight cars and locomotives.

2.2.2 Industrial Yards

Industrial yards are used as central points for the collection and distribution of freight cars. Local destination cars are often transferred from a classification yard to a local industrial yard for final delivery. In these yards, the cars are resorted (as required), made up into local or industrial switch trains, and then dispatched for placement and spotting at industrial sidings, team tracks, interchange sidings, or other industrial yards.

Industrial yards will also receive outbound cars from the returning **switch** trains. These cars may or may not be sorted prior to being forwarded to the appropriate classification yard. Many industrial yards are used to perform the switching in specific industrial areas such as ports, steel mills, mines, or large industrial plant complexes. Others are used to collect and distribute cars to many diverse areas within cities and towns.

Although local branchline trains are often assembled in industrial yards, there is little large-scale classification activity involving the makeup or breakup of road-haul trains. Industrial yards are also used for other support activities such as storing empty cars until required or inspecting, repairing, weighing, or cleaning them.

Most industrial yards are constructed as flat yards and, generally, are smaller and less complex than the flat yards used for classification; however, a few have been constructed as hump yards.

2.2.3 Passenger Terminals

Major railroad passenger terminals resemble other railroad yards because of the close grouping of tracks for receiving and dispatching passenger trains. Their function and operation, however, is quite different from freight switchyards. The major difference is that trains operate into and out of these terminals as units and very little switching of cars is necessary; instead, the commodity (the passengers) is responsible for classifying itself; that is, selecting the correct outbound train or transferring from one train to another. These terminals are generally also single points of origin or destination, and the passengers are responsible for movement to or from the terminals.

Passenger terminals represent a large capital investment which, at present, generates little or no return. Because, in the past, intercity rail-passenger operations were conducted by many railroads, some cities have a number of passenger terminals. With the consolidation and reduction of passenger operations by Amtrak, many of these terminals may become available for other, more profitable, uses.

2.2.4 TOFC/COFC Yards

Recently, many yards have been constructed to handle trailer-on-flatcar (TOFC) or container-on-flatcar (COFC) loading or unloading. The actual design of such yards can vary widely, depending on volume, type of traffic, or railroad operating practices. Yards that load trailers exclusively can use ramps to drive the trailers onto or off the flatcars; however, this method is time-consuming when loading or unloading an entire train and is becoming rarer at high-volume facilities. At yards that process a large number of trailers and containers, overhead cranes and/or specialized tractor equipment are used for loading and unloading.

The operational use of TOFC/COFC yards depends, to a large extent, on each railroad's procedure for handling TOFC/COFC traffic. If the railroad segregates this type of traffic on special TOFC or COFC trains, it may bypass a number of intermediate classification yards. If, however, TOFC/COFC traffic is handled like other carload traffic and placed on mixed trains, it must be processed through classification yards the same as regular freight. In either case, based on SRI site inspections, it appears that TOFC/COFC yards are generally collocated with other railroad freight yards and are not isolated facilities.

Because of the rapid growth of TOFC/COFC traffic, it is conceivable that the design and operation of TOFC/COFC yards may change radically over the next 25 years. It has been suggested that future TOFC/COFC yards may be operated in a manner analogous to passenger terminals. The TOFC/COFC trains would be operated as units and the flatcars should not be disaggregated and classified; instead, it is proposed that the containers and trailers should be unloaded, sorted or classified, and reloaded on other trains. New equipment technology may be required to operate efficiently in this manner.

2.2.5 Storage Yards

Storage yards are used to store rolling stock (generally, empty cars) not currently required or usable. Such conditions often occur because of seasonal variations in the demand for certain specialized equipment such as autoracks or refrigerator cars or because of general downturns in traffic. At times, even loaded cars are stored-- such as grain, ore, or coal cars waiting for in-transit milling or processing or waiting to be unloaded onto ships or elevators. Storage yards are also used to store cabooses, outmoded or unused locomotives, cars in disrepair and special-purpose rolling stock such as snow plows, wrecking equipment, and maintenance-of-way equipment.

2.2.6 Interchange Yards

Many of the above yards are also used as points for the interchange of cars between connecting railroads. There are many yards, however, that are used exclusively for interchange movements and operations. Generally, these are small yards, consisting of only a few tracks. Cars are brought from one classification or industrial yard and placed on a track in the interchange yard, as specified in an interchange agreement. A switch engine from a connecting railroad will then pull the cars from the track and transfer them to another classification or industrial yard to be sorted. Depending on agreements and operating practices, the interchange yard may be used as a point of interchange between a number of railroads.

2.3 DESCRIPTION OF CLASSIFICATION YARD OPERATIONS

Railroad yards can be described and characterized by a large number of descriptive factors. Because this study is specifically oriented toward railroad yards that perform classification work, however, a moderately detailed description of the operations and processes at classification yards may be of value to the remainder of this report.

The design and physical track layout of classification yards vary widely. The two major categories, however, are flat yards and hump yards.

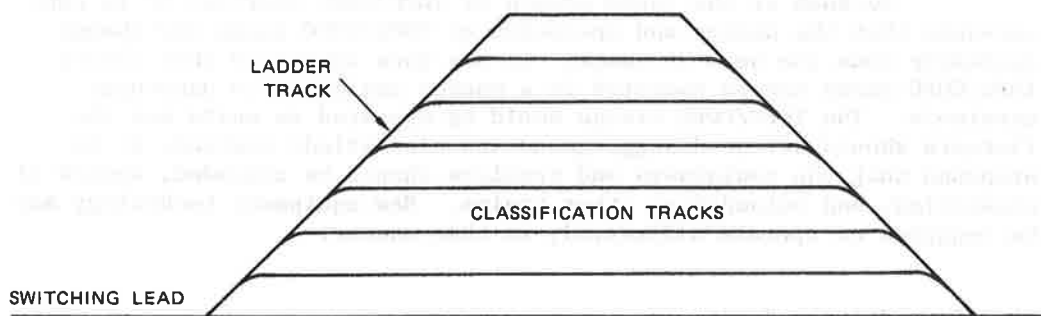

FIGURE 4 TYPICAL FLAT-YARD TRACK CONFIGURATION

A flat yard generally consists of a series of tracks connected by a ladder track and switching lead, as shown in Figure 4. Most flat yards use the same tracks for receiving, classifying, and dispatching trains although many such yards do have separate receiving and/or departure tracks. The car-sorting process requires that a group of cars be pulled out to the switch lead where the switch engine will accelerate quickly toward the yard and then decelerate. Just prior to deceleration, a car or group of cars will be uncoupled and the deceleration of the switch engine and the cars coupled to it will cause one or more of the uncoupled cars to separate from the rest. This procedure is called giving the cars a "kick." The switch engine generally continues kicking cars toward the classification tracks until reaching the ladder track, at which point it will pull the remaining cars back along the switch lead and resume the process. The cars and groups of cars that have been kicked will travel along the switch lead and ladder track until being switched onto the appropriate classification track. Switches in most flat yards are generally manually thrown. To improve operations, flat yards are often somewhat saucer-shaped so that the cars will tend to accumulate in the center of the yard. Such gradients also reduce the frequency of cars stopping short on the switch lead, ladder track, or classification track.

Hump yards are used to classify more efficiently a large number of cars. The geometric characteristics and typically large volume throughput of most hump yards dictate that separate subyards be constructed for receiving, classifying, and dispatching trains. A typical arrangement of these subyards is illustrated in Figure 5. Generally, an inbound train is placed on one of the tracks in the receiving yard, and certain operations (such as inspecting the cars' mechanical systems and bleeding the air from the brakes) are performed. The car-sorting process requires a switch engine to push a group of cars to be sorted along the hump lead and over a raised portion of trackage called the

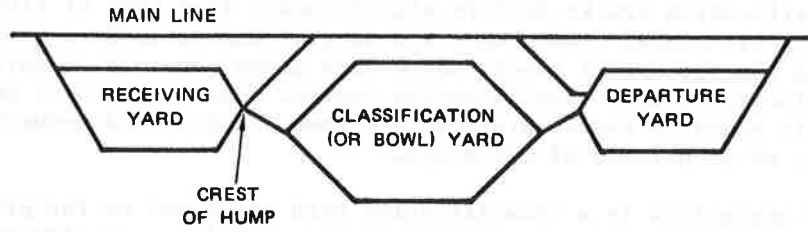

FIGURE 5 A TYPICAL ARRANGEMENT OF SUBYARDS IN A HUMP YARD

hump crest. Cars are uncoupled just prior to reaching the hump crest and begin to accelerate down the incline on the other side of the hump crest, thereby separating from the switch engine and the remaining cars. The crest of the hump is 12 to 20 ft above the level of the classification tracks. As can be seen in Figure 6, the geometric track pattern of

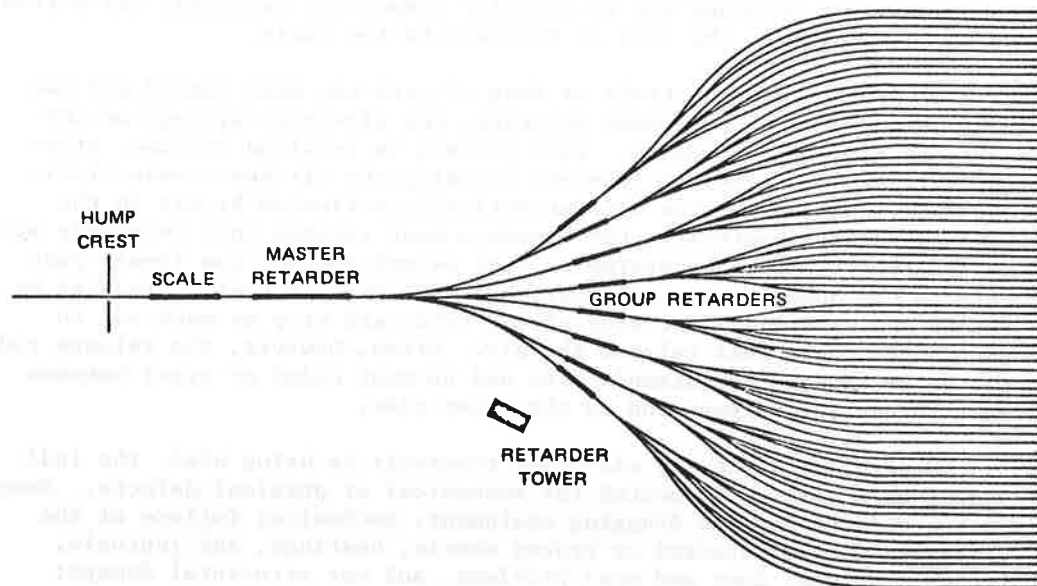

FIGURE 6 GEOMETRIC PATTERN OF CLASSIFICATION TRACKS IN A HUMP YARD

the classification tracks differs significantly from that of flat yards. Instead of all tracks branching off a single lead or ladder, they are organized into groups of tracks where each group generally consists of six to nine individual classification tracks. This pattern is used because it requires fewer retarders for speed control and reduces the frequency of occurrence of catch-ups.

The operations in a classification yard are keyed to the processes involved in receiving and breaking up inbound trains, classifying or sorting cars, and making up outbound trains. Most of the major processes involved in moving a car through a classification yard are depicted in Figure 7. Referring to this flowchart, it can be seen that the individual freight cars usually arrive with other cars on road-haul trains, transfer trains, or industrial drags, and they are placed on one of the yard tracks, if available. Most hump yards and a number of flat yards will dedicate certain tracks or groups of tracks for receiving inbound trains. If a yard does not have a track available for yarding the inbound train, it will be held on the mainline. If the incoming train is too long to be yarded on one track, it will be broken up and yarded on two tracks. This "doubling" process requires between 10 and 20 minutes and can often be performed by the road-haul crew, depending on labor agreements and other considerations. After an incoming road-haul train has been yarded, the locomotive units and caboose are detached and moved to a service area. In some yards, however, the caboose is not detached but is actually humped (or switched) and sorted at the same time as the rest of the cars on the train.

After the incoming train or drag of cars has been yarded and the engines and caboose have been detached, the air-brake systems on the cars are ready for bleeding. This process is required because, after the engines are uncoupled (thereby breaking the air-hose connection), the individual car brakes are automatically activated by air in the compressed-air reservoir. Car bleeders must release this reservoir air to deactivate the brake system so that switch engines can freely push cars to the hump or along the switch lead. The air brakes are bled by carmen who walk along one side of the train and stop at each car to open angle cocks that release the air. Often, however, the release rod may be broken on the carman's side and he must climb or crawl between cars to use the release rod on the other side.

Generally, while the air-brake reservoir is being bled, the individual cars will be inspected for mechanical or physical defects. Some common defects include dragging equipment, mechanical failure of the air-brake system, cracked or broken wheels, bearings, and journals, broken couplers, door and seal problems, and car structural damage; other defects, such as damaged or shifted loads, are also identified. After the "bad order" cars are identified they are sorted out from the others during the normal switching or classification process. Car identification and train consist information are also checked during this walk-by inspection.

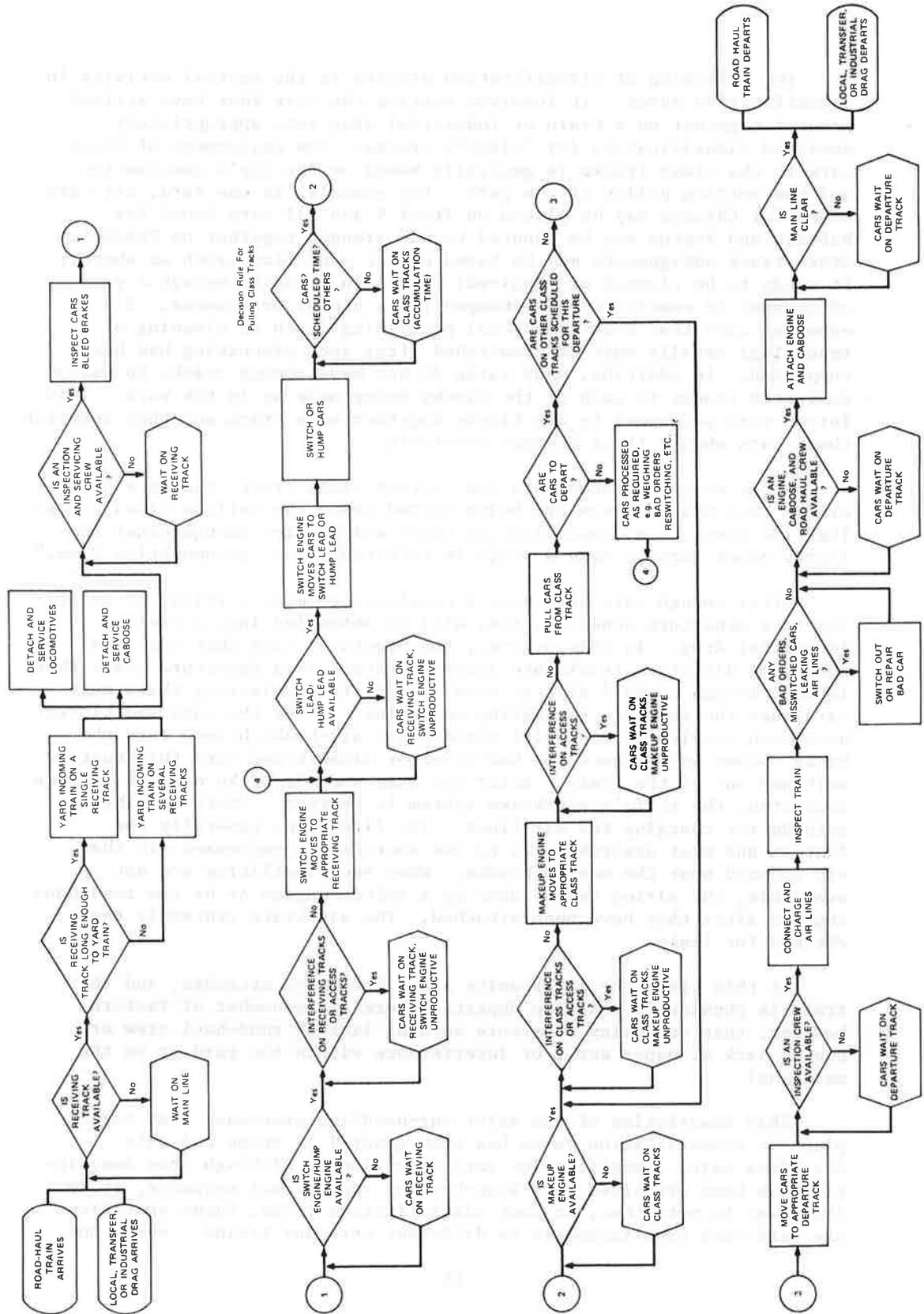

FIGURE 7 CAR HANDLING PROCESSES IN CLASSIFICATION YARDS

The switching or classification process is the central activity in classification yards. It involves sorting the cars that have arrived grouped together on a train or industrial drag into appropriately assigned classification (or "class") tracks. The assignment of these cars to the class tracks is generally based on the car's destination and the sorting policy of the yard. For example, in one yard, all cars bound for Chicago may be placed on Track 9 and all cars bound for Buffalo and Boston may be shunted to and grouped together on Track 4. Other track assignments may be based on car condition (such as whether it needs to be cleaned or repaired). Cars in transit through a yard often must be reswitched or rehung for a number of reasons. For example, cars that require special processing (such as cleaning or repairing) usually must be reswitched after such processing has been completed. In addition, many yards do not have enough tracks to assign dedicated tracks to each of the blocks being made up in the yard. This forces yard personnel to mix blocks together on a track and then reswitch these cars when a track becomes available.

After being switched onto the correct class track, the cars generally wait while others are being sorted among the various class tracks. The time spent on a classification track waiting for enough other similarly bound cars to make a train is referred to as "accumulation time."

After enough cars have been accumulated to make a train, or according to a departure schedule, they will be assembled into a train or industrial drag. In this process, the blocks of cars that are on a number of different tracks are joined together on a departure track that is long enough to hold all the cars for the train; lacking that, many yards use the mainline for making up trains. After the cars and blocks have been coupled, carmen will connect the air-brake hoses, turn the brake valves and inspect for bad-order or misswitched cars that must be switched out of the train. After the cars and air-brake hoses have been connected, the train's air-brake system is charged. There are three methods for charging the air lines. The first, and generally the fastest and most desirable, is to use sources of compressed air that are located near the makeup tracks. When such facilities are not available, the airing can be done by a switch engine or by the road-haul engines after they have been attached. The air-brake system is then checked for leaks.

At this time, the power units and caboose are attached, and the train is physically ready to depart. There are a number of factors however, that can delay departure such as lack of road-haul crew or power, lack of paper work, or interference within the yard or on the mainline).

This description of the major car-handling processes that take place in classification yards has been general in scope and only describes major classification yard operations. Although this description has been organized in a step-by-step operational sequence, it is important to note that, in most classification yards, these operations are performed simultaneously on different cars and trains. While one

train is being received into a yard, another train or group of cars may be in the process of being classified while still other cars are being assembled into an outbound train.

The actual movement of cars through a classification yard is usually paralleled by the processing of information and paperwork within the yard. In fact, the transference and processing of information is an essential supportive part of the car-classification and train-makeup processes. The purpose of these activities is to obtain a timely and accurate inventory of which cars are located on what tracks. Without such information, these processes could not be adequately controlled.

The handling of yard information and paperwork is generally related to the movement of trains and cars through the yard. For reasons of clarity and continuity, the following description of information-handling processes tends to follow that form.

The first information received by a yard concerning an inbound train is its inbound consist which is a description of the makeup of the train. At most large and moderate-size yards within modernized railroad networks, this consist information is received before the actual arrival of the train. Although this may allow the yardmaster some advance operational planning, this capability is often limited by the quality of the information or the amount of confidence the yardmaster has in it. The advance inbound consist is composed of the outbound consist of the last yard at which the train had stopped, and this yard has the capability of revising that consist information. If the train picked up or set out any cars or blocks of cars after passing that terminal, the advance consist would be in error.

Additional information is obtained with the actual arrival of the train. The identification numbers of the cars in the train are noted and recorded using closed-circuit television and video tape, audio tape, or by pencil and paper. These numbers can be checked against the advance consist information, and corrections can be made on an exception basis. Waybills and/or bills of lading also arrive with the train. A bill of lading is the agreement between the shipper and the railroad concerning the transportation of the shipper's goods. A waybill is a receipt that details the shipment and routing inventories. Locally originated traffic is often accompanied only by bills of lading, thereby requiring the preparation of waybills; inbound road-haul traffic is generally accompanied only by waybills. All of this paper work is the responsibility of the train conductor until reaching the yard, at which time it is turned over to a yard office clerk. Waybills are then prepared from bills of lading for those cars that require them and, in some yards, IBM cards are also prepared. The waybill and the other recorded information are then used to update the advance consist information. From this enhanced information, class tracks are assigned and the switch lists are prepared. A switch list (also known as a cut list or hump list in hump yards) assigns a classification track for each car or cut of cars. From this procedure, it can be seen that the actual switching

of a train cannot begin until all of the above information processing has been accomplished. There is a potential for delay, therefore, if the information processing takes longer than the brake bleeding and car inspection; it also would tend to limit the speed of processing high-priority trains. Slow rates of information processing may also limit the effectiveness of certain automation features such as high-speed car-inspection systems or automatic coupler and brake systems.

After the switch lists have been completed, they are distributed to the yardmasters, hump foremen, retarder operators, switchmen, and the switch-engine crews. Any changes are then manually recorded on them; an example of such a change would be the reassignment of a car from a specific class track to a bad-order track because of deficiencies discovered during the initial car inspection. After all cars in a particular inbound train have been classified, the final edited switch list and waybills are received by an outbound clerk who uses the edited switch list to "rack" the waybills into an array of pigeonholes so that they accurately represent the contents and sequence of cars in each classification track.

The next step in the classification yard procedure is the assembling of cars from different class tracks into an outbound train. In an analogous manner, the waybills for the cars from each of these class tracks are also assembled. The car numbers and waybills are then compared by an outbound check, and the necessary corrections to the consist are completed. The waybills are then transferred to the outbound train conductor. When the train departs, the outbound consist is transmitted to a central processing location or to the next yard where it becomes the advance inbound consist for that train.

This has been a general overview of the information flow relating to the movement of freight cars through a typical classification yard. Certain operational details may vary significantly between yards, and other details, such as the processing of information related to mis-switched cars have not been addressed. Part of this variance is the result of the differences in the systemwide information-processing procedures used by the various railroad companies. There can even be dramatic differences in the information-processing procedures in other yards operated by the same railroad company. One factor that can account for these differences, for example, is that some information-processing systems exhibit economies of scale that preclude their installation at smaller classification yards.

SRI's examination of different classification yard facilities revealed that there are three major categories of yard information-processing systems currently in use (however, we have found large variations in system hardware and procedures even within these categories). The first is a manual system in which track inventory and car-location information is initiated and updated by hand. The arrival, movement, and departure of all cars are accounted for in a handwritten bookkeeping or accounting system where each car's number is recorded in a large table or ledger to correspond with its location in the yard.

Other information, such as car placement time, may also be noted. Yards that process their information manually often have a limited interyard communication system and do not have access to high quality or detailed advance consist information.

The next major category is a mechanized system that has facilities for data and voice communication between other yards plus such basic data processing equipment as accounting machines. The operational processes of a typical mechanized information-processing system are described more fully in Appendix A. The third major category is a computer-based system which has much more data-processing and information-storage capability and flexibility than the mechanized systems. They also require less manual support because of the direct processing of information received from and sent to other yards and facilities.

Although most of these systems have been implemented only within the last five years, it is becoming evident that computer-based information systems offer many advantages over other types of information-processing systems under certain conditions. The design of such systems, however, has not yet stabilized and will continue to evolve within the foreseeable future.

2.4 SRI INVENTORY OF U.S. RAILROAD YARDS

It was recognized by both SRI and the contracting agency that a valid assessment of the national impact of the deployment of various technological and yard automation features would require an accurate inventory of U.S. classification yards. After much investigative work, SRI found that an up-to-date inventory was not accessible although discussions with several people indicated that such information would be desirable. Because of this lack of reliable information, SRI developed a survey plan that included the identification and initial characterization of all U.S. railroad yards that perform classification and/or industrial distribution work. This section presents a description and summary of that inventory.

2.4.1 Information Sources

The most direct approach for obtaining a small amount of key information concerning all U.S. railroad yards would have been to request this data directly from the railroads. This was not considered to be the most desirable technique, however, for a number of reasons. First, this approach would have required contacting almost every U.S. railroad so as to include all existing classification and industrial distribution yards in the inventory, and many major (and minor) yards are owned and operated by railroads other than Class-I line-haul roads. Such a massive inventory effort was not considered feasible within the constraints and objectives of the project. In addition, cooperation from

the financially troubled railroad community, during this economically depressed period, was not expected to be sufficient to establish a comprehensive inventory.

As a result, SRI explored the possibilities of utilizing information from government regulatory agencies, including the Interstate Commerce Commission and the Federal Railroad Administration (FRA). Investigation revealed that the FRA did catalog a number of facilities in the U.S. railroad system as a part of their safety-inspection process. This catalog included all yards that were of interest to this study in addition to a number of other rail facilities. SRI personnel then interviewed FRA regional supervisors and inspectors who were familiar with local inspection points to identify and categorize the classification and industrial distribution yards on the inspection lists.* The interviews with the supervisors were conducted in person at each of the eight regional offices of the FRA. In a number of regions, however, it was found that the safety supervisors were unfamiliar with yards in certain parts of the region or that their familiarity was based on inspection visits that had taken place many years ago. In these cases, the safety inspectors were questioned about the inspection points in their areas of responsibility. Some of them were interviewed in person at FRA regional offices in the same manner as were the regional supervisors; however, because most of them work from offices that are remote from the regional headquarters and because they are generally out on inspections, it was impractical to interview all of them in person. Instead, SRI developed and distributed a short questionnaire to these inspectors plus a cover letter with detailed instructions (Appendix B). The inspectors were requested to answer on special coding forms that were returned to SRI. After receiving the completed forms, SRI reviewed the answers and contacted individual inspectors by telephone to resolve any further questions or problems. All of the collected data concerning the yards identified and characterized during the FRA survey were then transferred to a computer readable form to ease the subsequent data-reduction work (see Appendix C).

2.4.2 Inventory Methodology

One of the most important steps in the yard-inventory process was to uniquely identify each railroad yard included in the inventory. This identification was accomplished by collecting information concerning their location in relation to political and other jurisdiction boundaries, individual yard names, and the owning railroad. The location is described in terms of which FRA region is responsible for its inspection and the city and state in which it is located; this regional information is probably of little future value although it was useful during the development and editing of the yard inventory. For example, it was very helpful when checking for yards that were listed on more

*Safety Inspector's Assignment List, FRA Form F6180-26.

than one region's inspection lists. The city and state information further describes the yard location and was found to be quite reliable.

We also collected information concerning individual yard names and the owning railroad to differentiate among the railroad yards located in any one city because, in many cities, a railroad may own a number of yards. To specify a particular yard it is generally designated by a specific name. The assignment of individual yard names can be based on such factors as location (12th Street Yard, City Yard, Bayshore Yard), nearby landmarks (Tunnel Yard, Bridge Yard, Park Yard), principal yard commodity (Coal Yard, Produce Yard), major yard function (Classification Yard, Storage Yard, Industry Yard), or even names of persons (Perlman Yard, R.R. Young Yard, Brosnan Yard). Because of SRI's reliance on the FRA as the source of yard-inventory information, the yard names listed on FRA safety inspection lists were used. Subsequent SRI work to edit and validate the collected yard information indicated that the majority of FRA yard names corresponds to the yard names used by the owning railroads; in some cases, the name was similar (34th Street Yard instead of 33rd Street Yard). Unfortunately, in a number of cases, the FRA yard name bore no relationship to the owning railroad's designation for the yard; however, the railroad could almost always identify the yard when given its location and name.

Information concerning the owning railroad is often required to uniquely specify a certain yard because yards owned by different railroads in the same city can be designated by the same yard name. For example, a number of railroads may own and operate separate yards located near the dock area in a particular city. It would not be unusual for each one to be called the Dock Yard by the owning railroad and its employees. In the compilation of this inventory, we used the railroad designated by the FRA as the owning railroad. We also attempted to make corrections for major changes in yard ownership resulting from mergers or acquisitions, such as the Lehigh-Valley takeover of the Central of New Jersey's lines and terminal in Pennsylvania. It is anticipated, however, that the restructuring of the Northeast railroad system with the beginning of ConRail operations and the potential restructuring of the Midwest rail system will cause significant changes in the yard-ownership information listed in this inventory. In a number of cases, the FRA inspection lists indicated that a yard was jointly owned by more than one railroad, and the term "JOINT" was used in place of the abbreviation of the owning railroad. It should be noted, however, that this term was applied only to those yards that the FRA had classified as being jointly owned and may not truly reflect the actual number of jointly owned yards.

The information obtained from the FRA included more than was required for the identification of yards within the inventory. Other information was collected that could be used to categorize the yards according to certain functional characteristics. Four functional yard groups were developed, and FRA personnel was asked to determine to which group each individual yard belongs. The first two included all yards that perform classification work (yards that sort and group outgoing

cars into the correct blocks for road-haul trains, assemble outbound road-haul trains, and/or disassemble inbound road-haul trains). These yards were further grouped according to whether the local and industrial distribution and collection work comprises a significant portion of their function. As a result, these facilities were categorized as "classification/industrial" yards if they were used to:

Sort inbound cars into groups that were then distributed to local industries or to industrial or interchange yards.

Collect and/or receive cars from local industries or from industrial and interchange yards.

Yards that did not perform a significant amount of this industrial distribution work were categorized as "classification" yards, used principally for resorting and reblocking cars and groups of cars received from inbound road-haul trains and then reassembling them into outbound road-haul trains.

The other two groups were composed of those yards that are used primarily for local switching associated with the collection and distribution of freight cars. These were categorized as "industrial" yards if they were worked by at least one assigned switcher or by road switchers whose total time spent working the yard averaged one or more tricks per day. Those worked by road switchers less than one trick per day were categorized as "small industrial" yards. There is no large-scale classification activity involving the makeup or breakup of road-haul trains in these yards.

These definitions of functional yard categories eliminated from the inventory a number of FRA inspection points whose functional characteristics did not match those of any of the defined groups. Among those omitted were points that operated only as passenger stations, storage yards, repair and shop facilities, and interchange yards.

Another functional characteristic developed from FRA information was whether the yard was a part of a multiyard complex which is defined as a group of two or more yards operated interdependently by the same railroad. Generally, these yards are located in urbanized areas within a few miles of one another, and the complex does both classification and industrial work. Typical multiyard operations include pre- and postclassification of cuts of cars for one or more classification yards. In these complexes, one yard may receive and break up all inbound trains and distribute the cars to industries, industrial yards, and interchange points, and the other yard will collect cars from these locations and then classify and assemble them into outbound trains.

SRI also attempted to collect information concerning whether an interchange point is located within the yard and to determine whether the yard is able to perform major repairs on freight cars or locomotives. The information on yard interchange points was found to be acceptably reliable; however, the responses to repair capabilities were inconsistent,

probably as the result of our failure to define explicitly what was considered to be a major repair effort, and the question was omitted during the later stages of the survey.

In addition to the functional characteristics described above, SRI also attempted to identify whether a yard was a hump yard or a flat yard. This information allows differentiation between the two major types of physical yard configurations in use in the United States today.

SRI also obtained information from the FRA regarding the type of area in which each yard is located. The respondent was asked to select one of five land uses to best describe the predominant land use of the area adjacent to and surrounding the yard. The answers were somewhat subjective because a yard may be surrounded by several different types of land uses, and the FRA respondents were not trained city or regional planners. The five possible land uses included:

- Industrial --Land used for manufacturing or processing products and materials.
- Commercial --Land used for the conduct of trade and business, including merchandizing, business offices, amusement, and personal service.
- Residential --Land used for single or multiple family dwellings.
- Agricultural--Land used to raise crops or livestock.
- Undeveloped --Forest and desert areas are examples.

To complement this information, we also tabulated population data concerning the cities in which each yard was located, based on the 1970 census.

We also gathered information concerning the physical location of the yard within the railroad's system. Yards located at the end or at a junction of a railroad's mainline were so designated. This information was assembled through the use of railroad maps, the Rand McNally Railroad Atlas of the United States, and the Official Railway Guide, and much of it was subsequently verified through questions directed to the FRA supervisors and inspectors.

2.4.3 Summary of Yard Inventory

This section summarizes the information gathered in the inventory. It should be noted that the U.S. yard population is not static; new yards are constructed and others are shut down or relocated. Perhaps the most significant changes will occur in yard ownership and function because of the reorganization and consolidation of the northeast rail system. SRI believes, however, that this inventory (see Table 1) offers the most reliable and current information available concerning the U.S. yard population.

Table 1
SUMMARY OF YARD INVENTORY

Inventory	Class./Indus. Yards		Classification Yards		Industrial Yards		Small Indus. Yards		All Yards	
	#	%	#	%	#	%	#	%	#	%
Yard Design	930	90	183	91	1381	99	1551	100	4045	97
Flat yards	98	10	18	9	8	1	0	0	124	3
Hump yards										
Adjacent Land Use	424	41	40	20	602	43	419	27	1485	36
Industrial area	245	24	41	20	339	24	353	23	978	23
Commercial area	216	21	57	28	318	23	516	33	1107	27
Residential area	42	4	25	13	45	3	160	10	272	7
Agricultural area	101	10	38	19	85	6	103	7	327	8
Undeveloped area	0	0	0	0	0	0	0	0	0	0
Other										
Population	150	15	59	29	296	21	623	40	1128	27
Less than 5,000	375	37	93	47	557	40	639	41	1664	40
5,001 to 50,000	249	14	8	4	136	10	85	6	378	9
50,001 to 100,000	127	12	10	5	105	8	48	3	290	7
100,001 to 250,000	86	8	6	3	106	8	58	4	254	6
250,001 to 500,000	141	14	25	12	189	14	100	6	455	11
More than 500,000										
Other Inventory Information	534	51	81	41	505	37	452	29	1574	38
Interchanges	276	27	41	20	177	14	159	10	653	16
Junctions	117	11	21	10	154	11	190	12	482	12
End-of-lines										
Total Number of Yards in Category	1028		201		1389		1551		4169	

The inventory includes 4169 yards. FRA safety-inspection personnel also identified 199 multiyard systems. This study is primarily interested in those yards that classify road-haul freight. The SRI survey of FRA safety supervisors and inspectors identified 1229 such yards; 1028 of these (or approximately 25 percent of all yards in the inventory) were described as "classification/industrial" yards because they perform both road-haul classification and industrial-distribution work. The survey identified 930 of these as flat yards and 98 as hump yards, and 527 in this group are used as interchange points. In describing the location of these yards in relation to the owning railroad's system, 116 are located at end of lines and 274 are located at mainline junctions. The distribution of yard location in relation to adjacent land use and city population is listed in Table 2.

The remaining 201 yards that perform classification work were described as doing little or no industrial distribution. These were labeled "classification" yards, and they comprise approximately 5 percent of all yards in the inventory; 183 of them were identified as flat yards and 18 as hump yards. Of these, 81 are used as interchange points, 21 are located at end of lines, and 41 are located at mainline junctions. Table 3 details their distribution in relation to adjacent land use and city population.

The industrial yards in the inventory were divided into two categories. The yards in one group were labeled "industrial" and are worked by at least one assigned switcher or by road switchers whose total time in the yard averages one or more tricks per day. The survey identified 1389 such yards in the inventory, out of which 1381 were identified as flat yards and 8 as hump yards. Of these, 513 are used as interchange points, 156 are located at end of lines, and 179 are located at mainline junctions. The distribution of these yards in relation to types of adjacent land use city population is presented in Table 4.

The remaining 1551 yards have been categorized as "small industrial" yards, worked by road switchers whose total time in the yard averages less than one trick per day. These are all flat yards; 452 of them are used as interchange points, 190 are located at end of lines, and 159 are located at mainline junctions. Table 5 shows their distribution in relation to adjacent land use and population.

Many interesting speculations and comparisons can be made when examining the entire yard inventory and the differences between groups. For example, as shown in Figure 8, there is a significant variation in the location of interchange points. More than 50 percent of the classification/industrial yards have interchanges located at the yard, which is nearly double the 29 percent of the small industrial yards with interchanges.

The location of yards in relation to mainline junctions (Figure 9) reveals a variation similar to that of the location of interchange points. Although 27 percent of the classification/industrial yards and

Table 2
 SUMMARY OF YARD LOCATIONS ("CLASSIFICATION/INDUSTRIAL" YARDS)

Land Use	Population (000's)													
	Lt 5		5 to 50		50 to 100		100 to 250		250 to 500		GT 500		Total	
	Hump	Flat	Hump	Flat	Hump	Flat	Hump	Flat	Hump	Flat	Hump	Flat	Hump	Flat
Agricultural	1	18	1	12	0	2	0	3	2	2	1	0	5	37
Commercial	2	29	5	91	3	30	5	25	3	20	5	27	23	222
Industrial	1	29	14	122	6	74	6	51	5	32	9	75	41	383
Residential	2	38	5	90	2	31	4	16	0	9	1	18	14	202
Undeveloped	3	27	3	32	0	1	4	13	4	9	1	4	15	86
Total	9	141	28	347	11	138	19	108	14	72	17	124	98	930

Table 3
SUMMARY OF YARD LOCATIONS ("CLASSIFICATION" YARDS)

Land Use	Population (000's)														
	Lt 5		5 to 50		50 to 100		100 to 250		250 to 500		GT 500		Total		
	Hump	Flat	Hump	Flat	Hump	Flat	Hump	Flat	Hump	Flat	Hump	Flat	Hump	Flat	
Agricultural	1	11	4	8	0	1	0	0	0	0	0	0	0	5	20
Commercial	0	8	3	19	0	0	1	4	0	1	0	5	4	4	37
Industrial	0	6	0	14	0	2	0	1	0	1	2	14	2	2	38
Residential	0	13	2	29	0	4	0	3	0	2	2	2	4	4	53
Undeveloped	0	20	1	13	0	1	1	0	1	1	0	0	3	3	35
Total	1	58	10	83	0	8	2	8	1	5	4	21	18	183	

Table 4
SUMMARY OF YARD LOCATIONS ("INDUSTRIAL" YARDS)

Land Use	Population (000's)													
	Lt 5		5 to 50		50 to 100		100 to 250		250 to 500		GT 500		Total	
	Hump	Flat	Hump	Flat	Hump	Flat	Hump	Flat	Hump	Flat	Hump	Flat	Hump	Flat
Agricultural	0	29	0	16	0	0	0	0	0	0	0	0	0	45
Commercial	0	43	0	140	0	42	0	21	0	45	0	48	0	339
Industrial	0	109	0	190	1	61	1	67	1	46	1	125	4	598
Residential	2	68	1	180	0	28	0	14	0	11	0	14	3	315
Undeveloped	1	44	0	30	0	4	0	2	0	3	0	1	1	84
Total	3	293	1	556	1	135	1	104	1	105	1	188	8	1381

Table 5
SUMMARY OF YARD LOCATIONS ("SMALL INDUSTRIAL" YARDS)

Land Use	Population (000's)														
	Lt 5		5 to 50		50 to 100		100 to 250		250 to 500		GT 500		Total		
	Hump	Flat	Hump	Flat	Hump	Flat	Hump	Flat	Hump	Flat	Hump	Flat	Hump	Flat	
Agricultural	0	132	0	25	0	1	0	0	0	0	2	0	0	0	160
Commercial	0	81	0	184	0	31	0	14	0	20	0	0	23	0	353
Industrial	0	114	0	162	0	34	0	20	0	22	0	0	67	0	419
Residential	0	220	0	247	0	16	0	12	0	12	0	0	9	0	516
Undeveloped	0	76	0	21	0	3	0	2	0	0	0	0	1	0	103
Total	0	623	0	639	0	85	0	48	0	56	0	0	100	0	1551

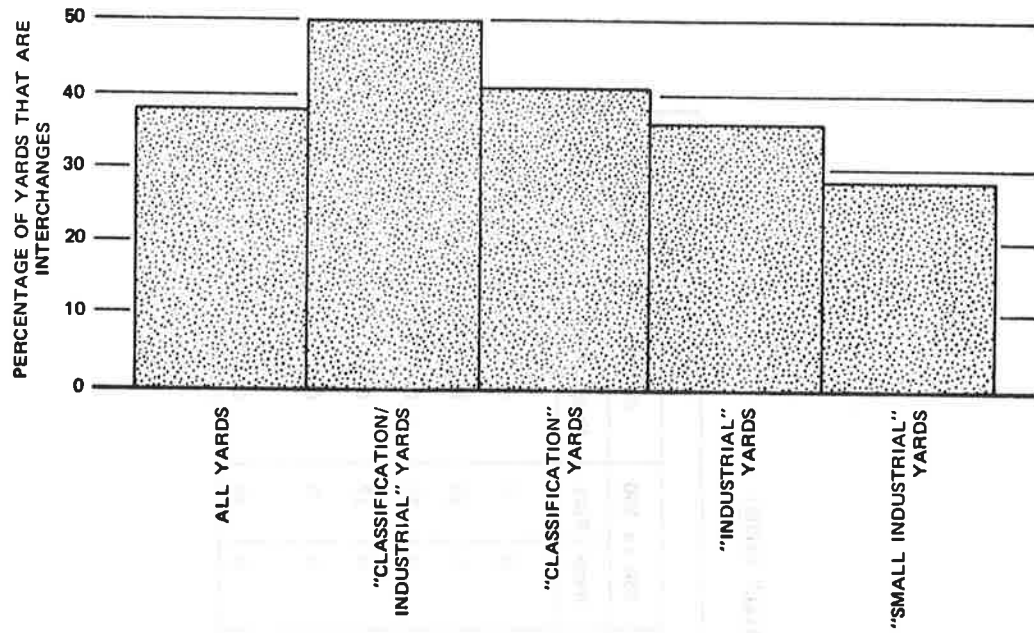

FIGURE 8 INTERCHANGES

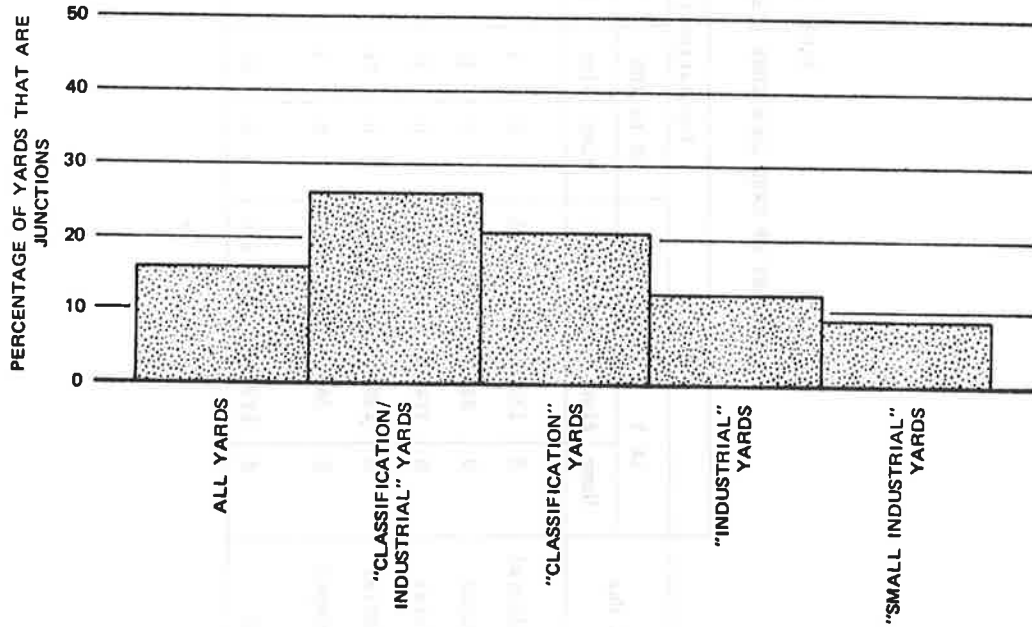

FIGURE 9 JUNCTIONS

20 percent of the classification yards are at mainline junctions, only 11 to 13 percent of the industrial yards are so located. In sharp contrast, the distribution of the different categories of yards at end-of-lines (Figure 10) remains fairly constant at approximately 11 percent, irregardless of yard group.

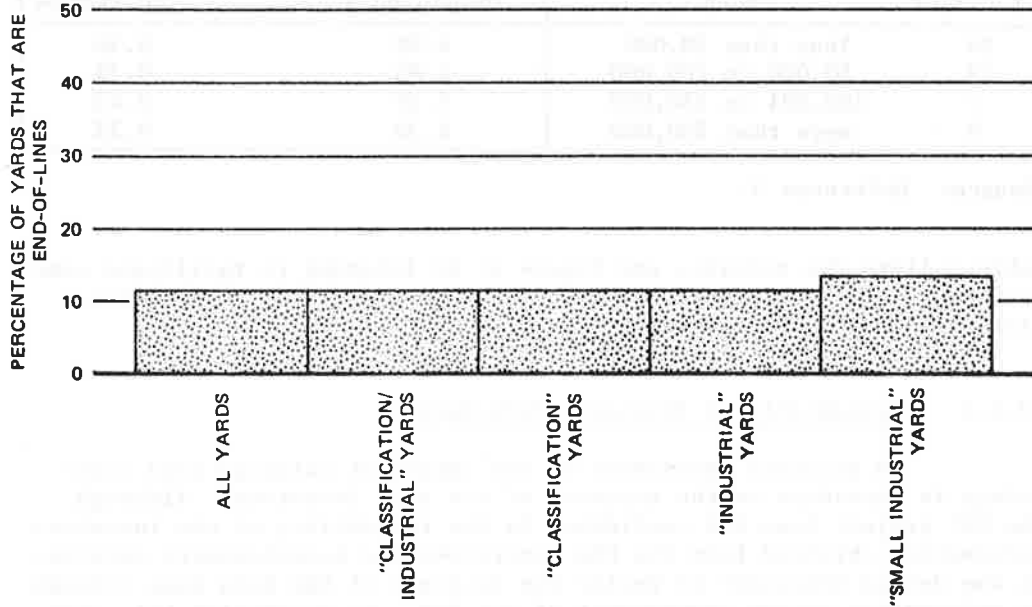

FIGURE 10 END OF LINES

The relationship between the operation of railroad facilities (such as yards) and other community activities is often characterized by conflict. Although railroads were necessary for the establishment and growth of many communities and are still required for continued sustenance, their operations frequently have a negative impact on other community activities. One major undesirable impact is the large land requirements. In a sample of cities with railroads within their boundaries (Table 6), railroad operations require nearly 5 percent of the total developed area; in some cities, such as Kansas City, these operations require more than 10 percent of the total developed areas. Other examples of undesirable railroad impact on communities include congested street traffic caused by interference at grade crossings, noise intrusion, and air and water pollution. For these reasons, it was determined necessary to include information concerning land use and population characteristics of the areas surrounding railroad yards.

Table 6

RAILROAD LAND USE IN AMERICAN CITIES

Number of Cities	Population Group	Railroad Property	
		Percentage of Total Developed Area	Acres Per 100 People
28	less than 50,000	4.99	0.50
13	50,000 to 100,000	4.85	0.39
7	100,001 to 250,000	5.39	0.43
5	more than 250,000	4.38	0.22

Source: Reference 3.

Table 7 lists the results, and Figure 11 is intended to facilitate comparisons of the distributions of the adjacent land uses and the populations of the yard groups.

2.4.4 Reliability of Inventory Information

An accurate assessment of the impact of railroad yard technology is dependent on the accuracy of the yard inventory. Although the SRI project team had confidence in the reliability of the inventory information obtained from the FRA interviews and questionnaire returns, it was deemed necessary to verify the accuracy of the data base through an information source independent of the FRA. To accomplish this verification, we enlisted the assistance of Mr. Lou Hill, Manager of Terminal Operations of the USRA, who has a vast range of knowledge concerning the operations of many of the yards located on the proposed ConRail system. Members of the SRI team reviewed with him the inventory information obtained from the FRA regarding 120 yards located on the Penn Central system. The extensive Penn Central system which comprises the bulk of the proposed ConRail system, extends into the inspection areas of five FRA regions. It was believed that using this multiregional system would tend to minimize the effects of local biases in survey accuracy and would provide a good check on the overall reliability of the yard inventory.

With Mr. Hill's assistance, SRI checked the accuracy of the inventory information related to land use, yard type (hump or flat), yard group, yard interchange, and multiyard systems. The results were very encouraging. Out of 600 possible errors (5 times 120), only 12 were identified, thereby indicating an overall survey accuracy of 98.0 percent. The lowest accuracy was associated with land-use information. Five errors were identified out of the 120 yards in the sample, thus producing an accuracy of 95.8 percent.

Table 7
SUMMARY OF YARD LOCATIONS (ALL YARDS)

Land Use	Population (000s)													
	Lt 5		5 to 50		50 to 100		100 to 250		250 to 500		GT 500		Total	
	Hump	Flat	Hump	Flat	Hump	Flat	Hump	Flat	Hump	Flat	Hump	Flat	Hump	Flat
Agricultural	2	190	5	61	0	4	0	3	2	4	1	0	10	262
Commercial	2	161	8	434	3	103	6	64	3	86	5	103	27	951
Industrial	1	258	14	488	7	171	7	139	6	101	12	281	47	1438
Residential	4	339	8	546	2	79	4	45	0	34	3	43	21	1086
Undeveloped	4	167	4	96	0	9	5	17	5	13	1	6	19	308
Total	13	1115	39	1625	12	366	22	268	16	238	22	433	124	4045

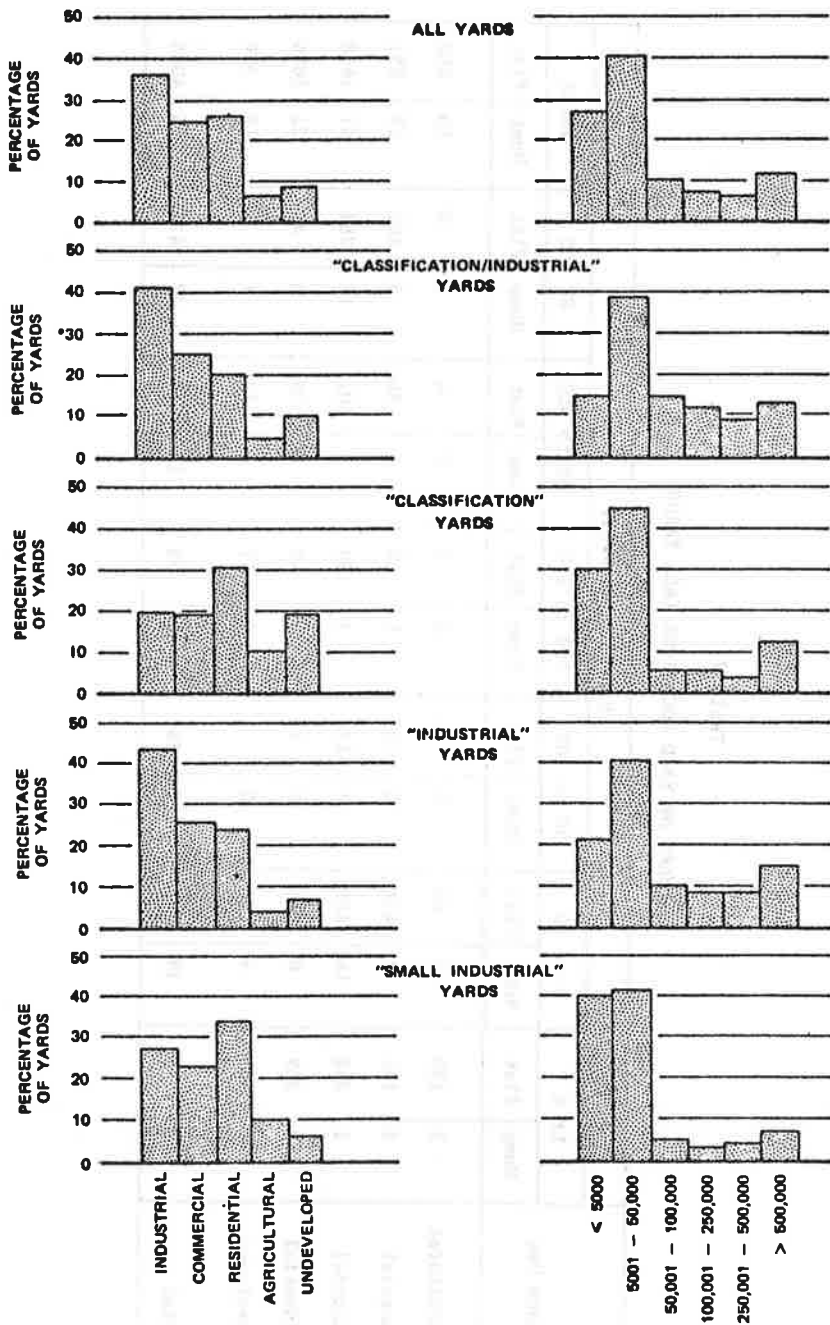

FIGURE 11 LAND USE AND DEMOGRAPHIC SUMMARY

Subsequent SRI surveys and discussions with members of the rail community indicate that the overall accuracy of the yard inventory may be somewhat less than the above 98.0 percent; however, none of the additional checks has resulted in accuracy levels less than 95 percent. It should be remembered, however, that although this inventory is a static entity, the actual yard population is dynamic and continually conforming to a new and developing railroad environment based on changing traffic patterns and switching requirement. A yard that is heavily used to service industry during peak economic periods, therefore, may be only lightly used during periods of economic decline. Normal seasonal variations in the shipment of many commodities by rail can also cause very substantial differences in the operation of individual yards throughout the year. Perhaps the greatest change in the reliability of the inventory information within the next five years will be caused by railroad mergers and consolidations, which would certainly produce errors in the yard-ownership data. Of greater importance is that mergers and consolidations of railroad systems may dramatically change the role of the yard within the railroad's system. The current pattern of end-to-end mergers (with the exception of ConRail), however, should not change the functional roles of a significant number of yards. We estimate that, by 1980, the inventory information regarding yard functions will still be 85 to 95 percent reliable although the reliability of the ownership data will probably drop to between 70 and 75 percent.

2.5 SRI SURVEY OF U.S. RAILROAD-YARD OPERATORS

The development of the national inventory of railroad yards enabled us to identify those yards that perform classification work and to obtain additional information concerning each of these yards. During the FRA interviews, SRI also collected information about the daily number of cars classified and number of switch engines operating in a large sample of yards.⁴ To assess the magnitude of yard-related problems on a national scale, however, more detailed information was required regarding a number of functional, operational, and technological yard descriptive parameters. We gained most of this data through a survey of U.S. railroad yard operators, based on questionnaires sent to a small number of Class-1 line-haul railroads.

2.5.1 Questionnaire Distribution

The questionnaire formats were developed by the SRI project staff after consulting with railroad operating, planning, and management staffs. They were then pretested through the cooperation of USRA personnel. Samples are presented in Appendix B.

The classification yard questionnaire packets were sent to each railroad's Vice President of Operations or to his designated representative. Each questionnaire was prominently labeled with the appropriate yard name and location, and a cover letter explained the

purpose and sponsorship of the survey and enclosed detailed instructions for the completion and return of the questionnaires.

The decision as to which level of railroad operations should be responsible for the completion of the questionnaires was left up to the individual railroads. Some of the questionnaires were filled out by division or main-office personnel, and others were completed by the yard operational personnel; most railroads relied on a mix of operating and planning staffs. After receipt of the completed questionnaires the SRI project team checked their accuracy and completeness and called the respondents when necessary to resolve any queries, discrepancies, and/or omissions. The results were then coded and reproduced in computer-readable format to facilitate subsequent data reduction and analysis.

The railroads undergoing financial reorganization in the Northeast were not included because of the small likelihood of their participation. It was desired, however, to receive information from some of the yards operated by these railroads so that the selected sample would be more representative of the total population. For this reason SRI obtained as much relevant information as possible from USRA yard questionnaires whose format was, in fact, more detailed than the SRI forms.

Figure 12 is a map of the actual geographic distribution of the yards to which SRI sent questionnaires (including USRA data). We requested information from 284 individual classification yards (207 flat yards and 77 hump yards) and received responses from 233 (170 flat yards and 63 hump yards). After reviewing the questionnaire returns, we used the information obtained from 214 yards (153 flat yards and 61 hump yards). This yard sample represents approximately 14 percent of the flat and 52 percent of the hump classification yards identified in the inventory.

2.5.2 Yard Visits and Technical Discussions

The third phase of the SRI survey and sampling plan involved field inspections of switchyards, including a large number of hump and flat classification yards and a smaller number of industrial yards. The primary purpose of these inspections was to obtain information not requested in the questionnaires. These visits also gave the project team a better understanding of the operational differences among classification yards.

During this phase of the survey, the SRI project staff examined several yards that represented a distinct or unusual level of design, technology, or operation. These yards were identified from literature sources, conversations with railroad personnel, and questionnaire returns. Visits were also made to sites that were judged to represent a significant number of yards in the U.S. inventory. These yards were also identified through information gained from FRA and railroad personnel and from the questionnaire returns.

In addition to the actual yard inspections, SRI engaged in technical discussions with a wide variety of railroad personnel. The purpose of these discussions was to obtain additional information concerning yard operations, type and magnitude of the problems occurring in classification yards, and the different approaches (whether technological or operational changes) used to reduce or eliminate these problems

2.6 CATEGORIZATION OF CLASSIFICATION YARDS

We used the information obtained from the questionnaire returns, yard inspections, and technical discussions to categorize the 1229 classification yards identified in the SRI national yard inventory. This process involved defining yard groupings on the basis of a few important parameters selected so as to ensure as much homogeneity as possible within each category. Each yard group was then further characterized by a more detailed list of parameters or descriptors which were then used to describe a composite or nominal yard that would represent all of the yards within each category. The number of yards in each group were estimated, and the extent of the variations between yards in each category was examined.

A fundamental problem encountered when attempting to select the parameters used to define the various yard categories is the many variables and factors in the yard-categorization process. The definition of yard categories by any more than a few selected factors can lead to a large combinational number of categories to be examined. For example, assume each category is to be defined in terms of three factors (such as degree of automation, number of persons working in the yard, and average car detention time) and assume further that each descriptive factor has three levels or groupings (such as for retarder control in hump yards where the three levels of automation have been described as manual, semiautomatic, and fully automatic). From these descriptive factors, 27 distinct yard categories could be defined. The addition of another three-level factor would increase the number of categories to 81; the disuse of one of the factors would reduce the categories to nine, certainly a more manageable number.

The definition of many yard categories would dramatically increase the analysis and evaluation effort. In addition, the establishment of a large number of yard categories would tend to lessen the accuracy of any SRI use of survey data to make national estimates because the size and statistical significance of the survey sample associated with each category would be reduced. For these reasons, we attempted to define a minimal number of yard categories while, at the same time, trying to achieve a large degree of homogeneity between the yards within each category. These objectives required the identification of those factors most responsible for the variations between classification yards. Our criterion for assessing the differences was the cost of individual yard operations (although, in many cases, surrogate measures

of such yard costs as daily switch-engine assignments were used). Based on numerous discussions with railroad personnel and on a limited amount of data analysis, we determined that yard geometric design and switching volumes were probably two of the most significant factors influencing yard costs. Using these two factors, we developed the following categories.

- Low-volume flat yard (less than 501 cars classified per day)
- Medium-volume flat yard (between 501 to 1000 cars classified per day)
- High-volume flat yard (more than 1000 cars classified per day)
- Low-volume hump yard (less than 1001 cars classified per day)
- Medium-volume hump yard (between 1001 to 2000 cars classified per day)
- High-volume hump yard (more than 2000 cars classified per day).

We then estimated the number of yards within each category through the use of the SRI inventory and survey data. These estimates are shown in Table 8.

Table 8

SRI ESTIMATES OF NUMBER OF YARDS IN EACH YARD CATEGORY

Daily Yard Volume \ Yard Type	Low Volume	Medium Volume	High Volume	Total
Flat yards	564	361	188	1113
Hump yards	42	40	34	116
Total				1229

The yards within each of these categories were further characterized by other technological, functional, and operational descriptors. The average values of these factors defined a nominal yard that represented all yards within each group. The values of some of the descriptors used in developing these representative yards are listed in Tables 9 and 10.

Table 9

SAMPLES OF CHARACTERIZATION DESCRIPTORS FOR FLAT YARDS

Descriptors	Less than 500 Cars/Day	500 to 1000 Cars/Day	More than 1000 Cars/Day
Number of classification tracks	14	20	25
Standing capacity of classification yard	653	983	1185
Cars classified/day	288	711	1344
Local cars dispatched/day	72	93	182
Industrial cars dispatched/day	47	69	121
Road-haul cars dispatched/day	218	472	942
Cars reclassified/day	60	196	348
Cars weighed/day	14	21	16
Cars repaired/day	13	28	31
Trailers and containers loaded or unloaded/day	22	22	76
Average time in yards (hours)	19	19	18
Inbound road-haul trains/day	3	6	10
Outbound road-haul trains/day	3	7	11
Local trains dispatched/day	2	3	2
Switch-engine tricks/day	4	7	10
Industrial-engine tricks/day	2	3	4
Roustabout-engine tricks/day	0	1	2

Table 10

SAMPLES OF CHARACTERIZATION DESCRIPTORS FOR HUMP YARDS

Descriptors	Less than 1000 Cars/Day	1001 to 2000 Cars/Day	More than 2000 Cars/Day
Number of classification tracks	26	43	57
Receiving tracks	11	11	13
Departure tracks	9	12	14
Standing capacity of classification yard	1447	1519	2443
Standing capacity of receiving yard	977	1111	1545
Standing capacity of departure yard	862	969	1594
Cars classified/day	689	1468	2386
Local cars dispatched/day	86	250	315
Industrial cars dispatched/day	74	86	220
Road-haul cars dispatched/day	632	1050	2297
Cars reclassified/day	94	195	275
Cars weighed/day	74	42	149
Cars repaired/day	38	43	153
Trailers and containers loaded or unloaded/day	36	30	39
Average time in yard (hours)	21	22	22
Inbound road-haul trains/day	8	14	27
Outbound road-haul trains/day	8	14	25
Local trains dispatched/day	2	3	5
Hump-engine tricks/day	3	5	6
Makeup-engine tricks-day	3	6	11
Industrial-engine tricks/day	2	2	10
Roustabout-engine tricks-day	2	1	4

Because of the project's reliance on information gained from questionnaire returns, a major concern of the SRI team was the accuracy of this data. For this reason, we attempted to verify the questionnaire results by comparing them to information obtained from other sources. Most of these comparisons confirmed the accuracy and usability of this information. For example, Figure 13 plots the cumulative distribution of hump-yard and flat-yard ages as developed from the SRI survey, plus the distribution of hump-yard ages developed from the WABCO list. Very good agreement can be seen between the two hump-yard age distributions for the last 25 to 30 years. Beyond that time, the divergence can be explained by the fact that the SRI distribution is based on the time since the original yard construction while the WABCO age distribution is based on the time since the original installation of speed-control equipment. In the early hump yards, the retarders were often installed many years after the yard was built.

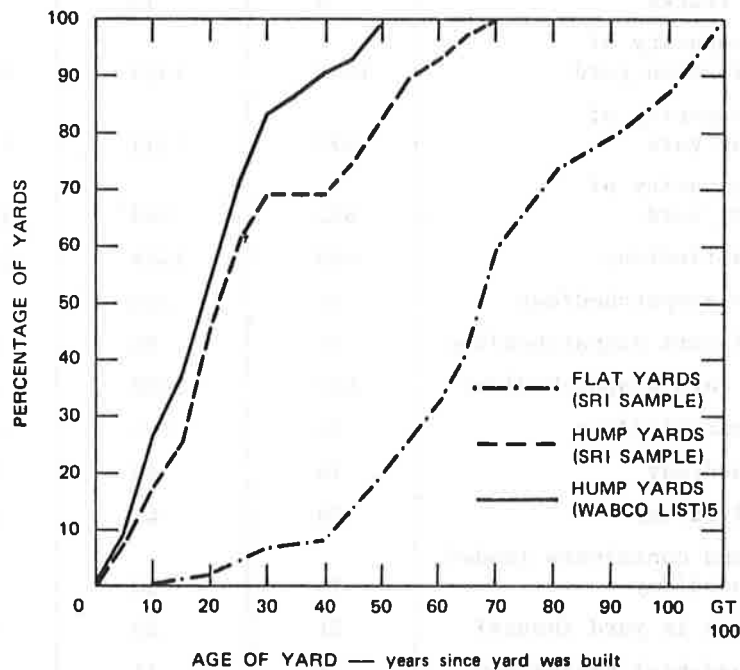

FIGURE 13 AGE DISTRIBUTION OF CLASSIFICATION YARDS

A comparison of perhaps more useful information can be made between estimates of yard switching volumes. A breakdown of switching volumes, as estimated from SRI questionnaire data, is shown in Table 11. The average national daily switching volume is estimated to be 1,080,000 cars

per day. This compares favorably with a previous estimate of 1,040,000, based on a survey of FRA inspectors.⁴

The project team also evaluated the variations of a large number of factors within each yard category. The results of these evaluations were used to better understand the differences between individual yards within each group and to make adjustments to the values selected to define the representative yards.

Yard Category	Yard Name	Yard Type	Yard Size (sq ft)	Yard Capacity (cars)	Yard Age (years)	Yard Location	Yard Status
Yard Category 1	Yard 1.1	Yard Type 1	100,000	100	10	Location 1	Active
	Yard 1.2	Yard Type 2	200,000	200	20	Location 2	Active
	Yard 1.3	Yard Type 3	300,000	300	30	Location 3	Active
	Yard 1.4	Yard Type 4	400,000	400	40	Location 4	Active
Yard Category 2	Yard 2.1	Yard Type 1	150,000	150	15	Location 5	Active
	Yard 2.2	Yard Type 2	250,000	250	25	Location 6	Active
	Yard 2.3	Yard Type 3	350,000	350	35	Location 7	Active
	Yard 2.4	Yard Type 4	450,000	450	45	Location 8	Active
Yard Category 3	Yard 3.1	Yard Type 1	200,000	200	20	Location 9	Active
	Yard 3.2	Yard Type 2	300,000	300	30	Location 10	Active
	Yard 3.3	Yard Type 3	400,000	400	40	Location 11	Active
	Yard 3.4	Yard Type 4	500,000	500	50	Location 12	Active

Table 11

SRI ESTIMATES OF YARD-CLASSIFICATION VOLUMES

Yard Category	Number of Yards	Average Daily Volume/Yard	Daily Volume	Annual Volume	Percentage of Total Volume	Percentage of Class Yard Volume
Classification Yards						
Flat Yards						
Low Volume	564	288	162,432	58,475,520	15.03	19.32
Medium Volume	361	711	156,671	92,401,560	23.76	30.54
High Volume	188	1344	151,671	90,961,920	23.29	30.06
Subtotal			671,775	241,839,000	62.18	79.92
Hump Yards						
Low Volume	42	689	28,938	10,417,680	2.68	3.44
Medium Volume	40	1468	58,720	21,139,200	5.43	6.99
High Volume	34	2386	81,124	29,204,640	7.51	9.65
Subtotal			168,782	60,761,520	15.62	20.08
Volume (All classification Yards)			840,557	302,600,520	77.80	100
Industrial Yards	1381	140	193,340	69,602,400	17.89	---
Small Industrial Yards	1551	30	46,530	16,750,800	4.31	---
Total Volume (all yards)			1,080,427	388,953,720	100	---

3. FUTURE SWITCHYARD CONSTRUCTION

Decisions by railroad companies to rebuild, upgrade, or construct new switchyards will depend on the capacity required to classify cars on their system and on the expected cost savings that will result from the construction investment. Factors that will affect capacity are overall volume of freight shipment, routing of these shipments, and the requirements for classification in particular locations along those routings. Economic conditions will govern the general level of freight shipments, and changes in the structure of the railroad network as a result of mergers or cooperative arrangements will affect routings. The number of cars switched will also depend on policies related to light-density line abandonment and on decisions to promote services such as container-on-flatcar (COFC) or trailer-on-flatcar (TOFC) intermodal operations. Expected cost savings include relocation of urban switchyards and shops so as to sell the land for more intensive land use, refurbishment of old yards to increase their efficiency, or the development of new technology.

Other highly interrelated factors that bear on these decisions are governmental policies and economic conditions. The economic conditions affect the levels of traffic and the availability of funds for investment. Some of the interrelationships are indicated in Figure 14 where the primary factors are near the righthand side, and the factors that influence these conditions are developed toward the left.

The complex interactions of governmental policy, national economic action, and railroad-industry operations can be analyzed most effectively through the use of scenarios in which a mutually consistent path of development is depicted, with alternative scenarios to derive the impact of differing assumptions concerning future growth. For this analysis, we have created the following scenarios:

- a) Present trends--An extrapolation of the recent past and a modest incorporation of current proposals for governmental and industrial action
- b) Super rationalization--An economic scene similar to the present-trends scenario, but with accelerated and aggressive implementation of proposals to restructure the railroad industry and its operations
- c) Energy crisis--An economically depressed scene, with governmental activity directed toward maintaining production with minimal energy outlays.

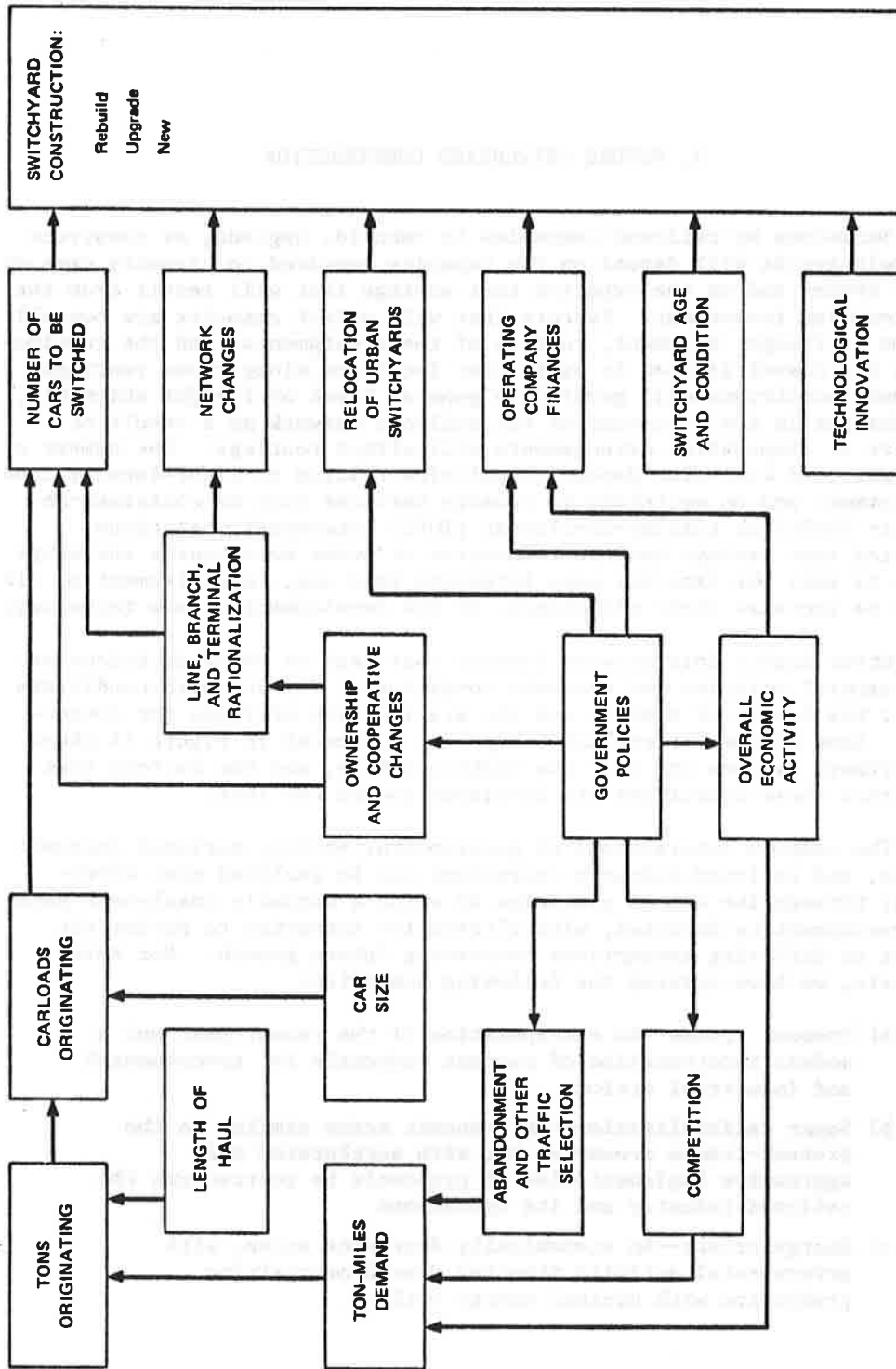

FIGURE 14 SIMPLIFIED DIAGRAM SHOWING INTERRELATIONSHIPS OF FACTORS AFFECTING SWITCHYARD CONSTRUCTION

In this chapter, each scenario will be developed, and the resulting switchyard construction will be estimated.

3.1 PRESENT-TRENDS SCENARIO

3.1.1 Economic Conditions

After the difficulties in the early 1970s that resulted from the scarcity of raw materials and energy, the economy of the United States will resume its steady growth through the 1980s and 1990s. Figure 15 shows the historical points and projected annual growth rate of goods and services (the Gross National Product) at 3.5 percent annually which corresponds to the rate achieved during the late 1960s and early 1970s. It is estimated that, by 1980, the total production of goods and services will have grown from an average of approximately \$830 billion (1958 dollars) in the 1973-1974 era to \$1020 billion by 1980 and \$2030 billion by the year 2000. Although these are average trend values, continued boom and recession years will make certain years higher or lower than the trend value.

Underlying the assumption of a 3.5 percent growth rate is an assumed annual population growth of 0.85 percent to 1990, 0.65 percent thereafter, and declining to zero sometime during the 21st century. Unemployment is projected at a low 4 percent, productivity per hour worked will be in the 2.9 to 3.0 percent range, and average hours worked will decline approximately 25 percent.

3.1.2 Demand for Railroad Transportation

With production rising faster than population, the nation will enjoy unprecedented prosperity by the year 2000. The railroads will share in that prosperity although the mix of products will mean that railroad growth rates will lag those of the economy as a whole.

A projection of railroad freight traffic was made for the Department of Transportation in 1973,⁶ based on a model calibrated with 1965 and 1968 data and on 1967 tables of the input and output of the economy. Despite the somewhat changed conditions and the resulting variation in the product mix, these projections are used to interpret railroad demand implied in the growth of production. The points plotted in Figure 16 are the results of Class-I railroad operations,¹ and the line is the projection based on this study. The original analysis extended only to 1980 and has been extrapolated to the year 2000 by maintaining the same growth rate.

The projection of freight growth assumes that growth in the transportation of certain commodities will continue at its historical rate. Changing conditions, however, may alter the rail carriage of some commodities. For example, since the base years of the forecast,

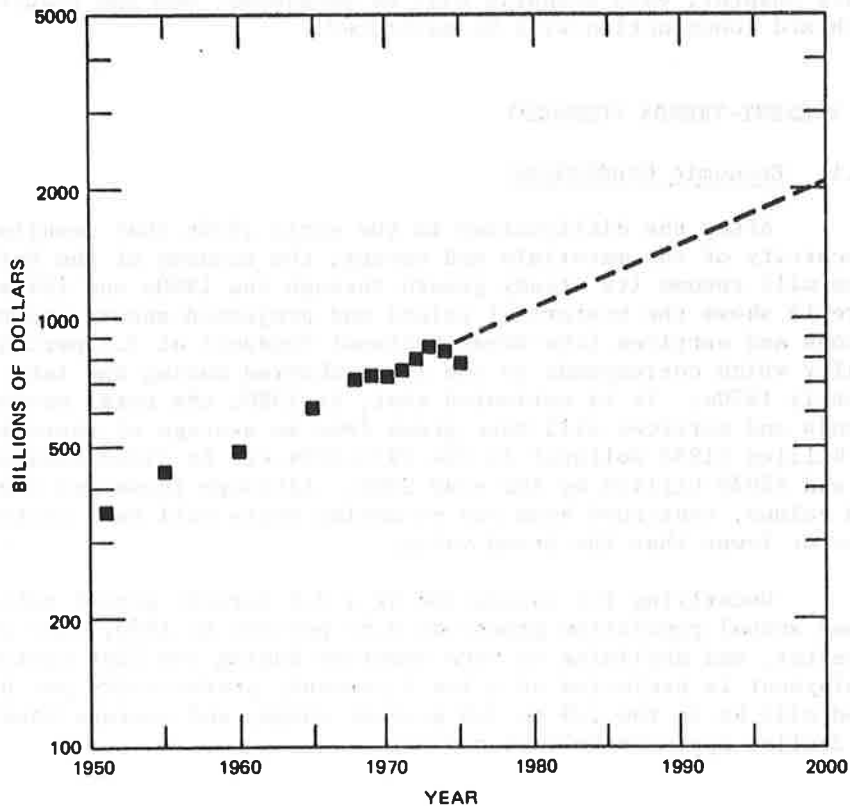
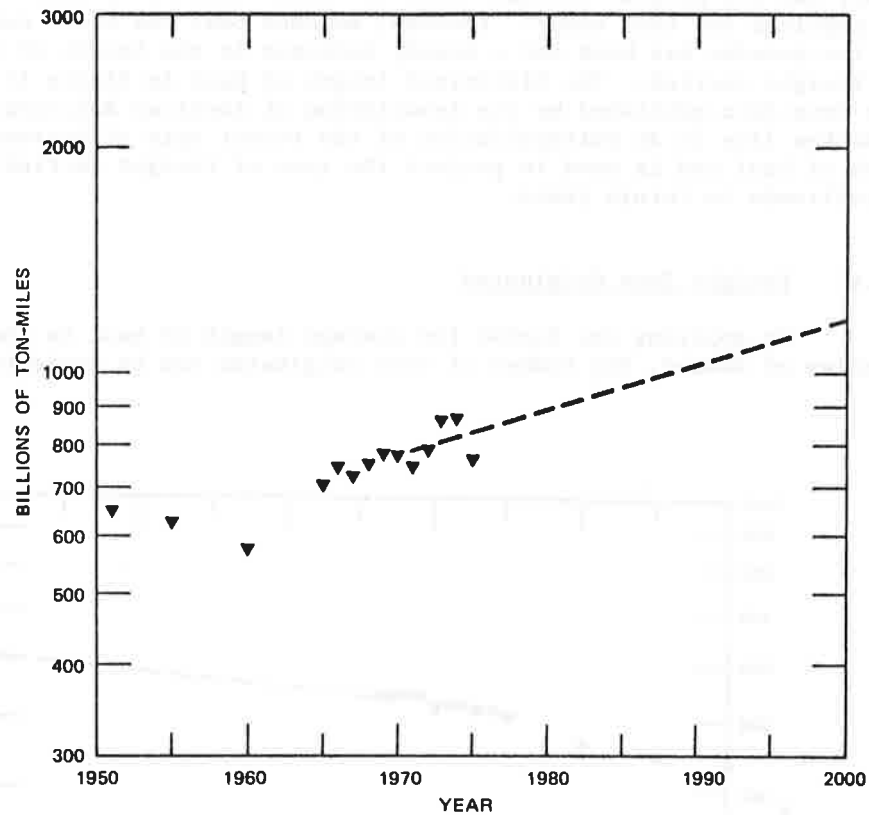

FIGURE 15 GROSS NATIONAL PRODUCT IN 1958 DOLLARS

grain export and coal utilization have risen rapidly--both commodities are hauled extensively by rail. It will be shown later that such departures from the projections do not seriously affect the number of cars switched.

The projection also implies stability in the competitive position of the railroads with respect to other modes of transportation. In fact, several changes in policy or regulation are being considered that would significantly change the competitive structure of transporting some commodities in certain regions. Proposals for levying user charges for waterway freight carriage will raise the cost of inland water transportation and improve the railroad's competitive position in those markets. On the other hand, proposals for larger



SOURCE: SRI Projection Based on Woelcke (Ref. 6) and Historical Data From AAR (Ref. 1).

FIGURE 16 FREIGHT DEMAND

trucks, especially for operation on interstate highways, will inevitably increase their size, thereby making them highly competitive with the railroads.

3.1.3 Length of Haul

The length of haul determines how many tons are carried to provide the ton-miles of service that are forecast. The length of haul is obtained by the pattern of origins and destinations of the freight tendered to the railroads. Economic studies are under way that will identify freight flows between major metropolitan areas in the United

States, but the project schedule does not allow time for processing the data required for this study. Instead, we note that the trend over the past two decades has been for a steady increase in the length of railroad freight carried. The historical length of haul in Figure 17 is taken from data published by the Association of American Railroads.¹ The broken line is an extrapolation of the recent rate of increase in length of haul and is used to project the tons of freight carried by the railroads in future years.

3.1.4 Freight Tons Originated

By applying the factor for average length of haul to the total ton-miles of demand, the number of tons originated can be projected.

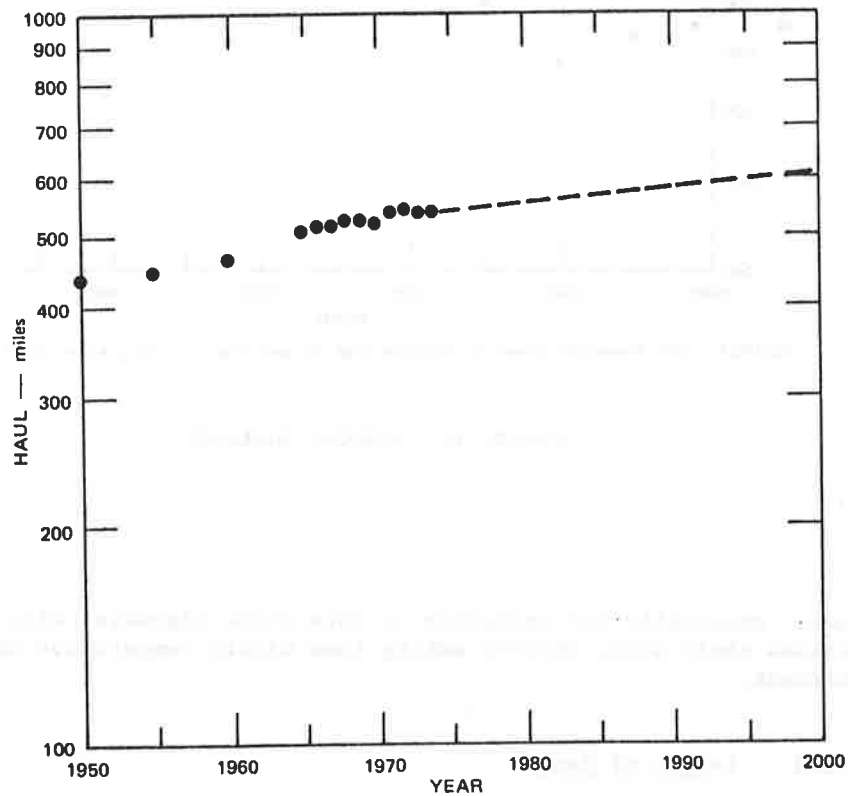

FIGURE 17 AVERAGE LENGTH OF RAILROAD HAUL

Historical data and the results of the projection are illustrated in Figure 18. Historical data are reported by AAR.¹

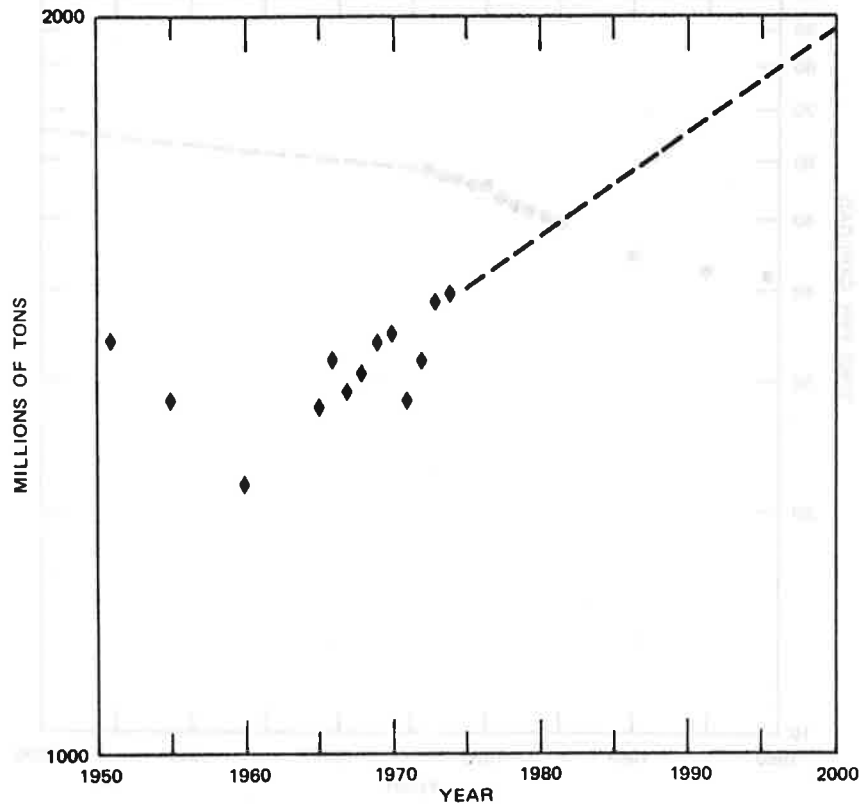

FIGURE 18 TONS OF FREIGHT ORIGINATED

3.1.5 Tons per Carload

The next step in estimating the number of carloads originated and, subsequently, the number of cars switched is the estimation of tons per carload. The size of a carload shipment has risen dramatically over the past decade, from an average of approximately 45 tons per car in 1960 to 55 tons in 1970, an increase of 22 percent. Further increases at this rate will depend on new car-suspension techniques and new track structures (this research is now under way) and major construction programs to implement the research findings. Because this implementation is likely to consume a large part of the next 25 years, increases in car size and load should slow down from the recent fast pace. The

historical carload size and the projection for the next 25 years are shown by Figure 19. The historical data are reported by the AAR.¹

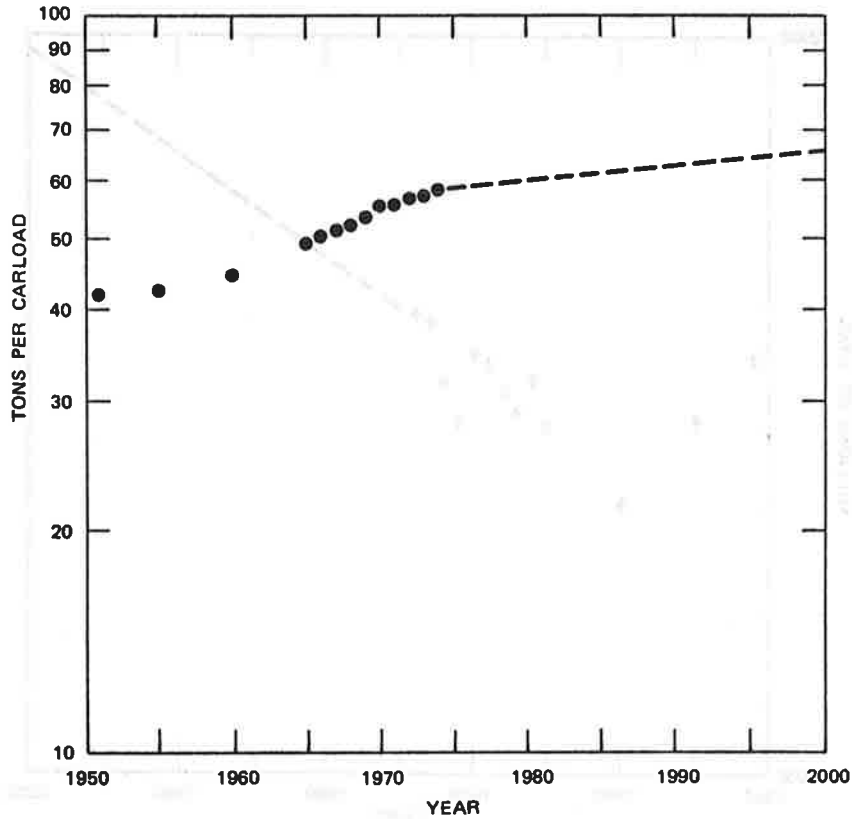

FIGURE 19 AVERAGE LOADING PER CARLOAD

3.1.6 Carloads Originated

By applying the projections of future railroad ton-miles of demand, length of haul, and tons per carload, the number of carloads originated can be estimated. This number has been in a downtrend since the early 1960s primarily because the sizes of loads have increased faster than ton-miles. The historical record of carloads originated and the projection developed from the foregoing analysis are displayed in Figure 20. Because the projection is for a slower growth in load size, the number of cars originated increases to the year 2000.

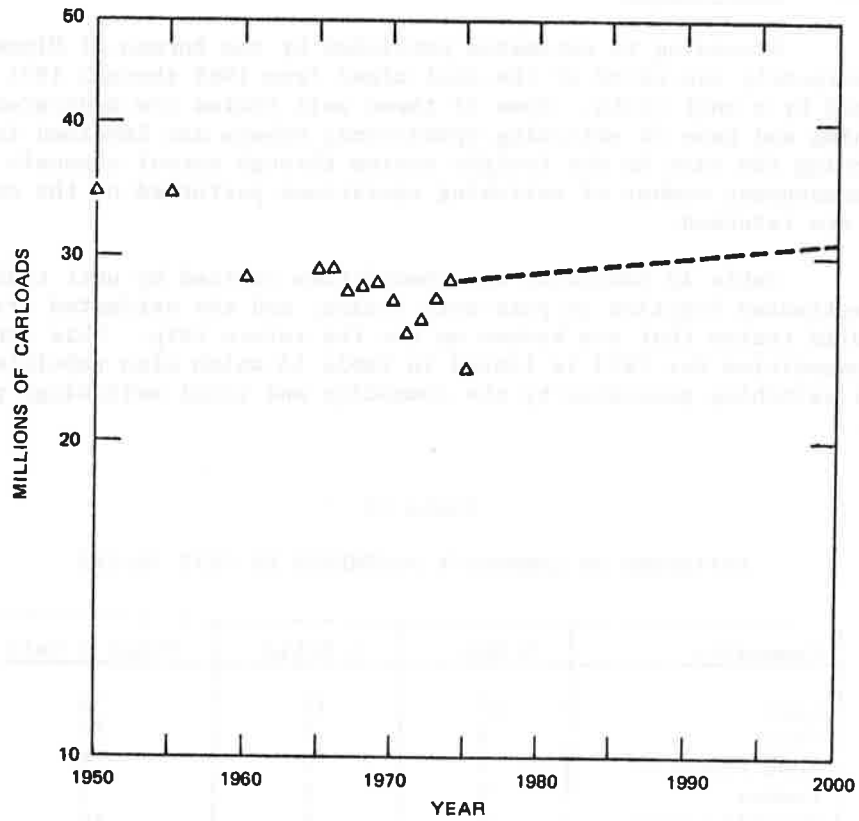

FIGURE 20 FREIGHT CARLOADS ORIGINATED

3.1.7 Switching Operations

Initially, we assume that each loaded car is switched six times in transit (once at origin, once at destination, twice at interchanges, and twice at intermediate yards) and that their operations represent 45 percent of total operations. Each load, therefore, would generate 13 switching operations. Unit and solid trains would need less handling; a load in a unit train would require no switchings, and a load in a solid train would generate seven switching operations (similar to any other empty).

3.1.8 Unit Trains

According to estimates published by the Bureau of Mines, approximately one-third of the coal mined from 1969 through 1971 was shipped by a unit train. Some of these unit trains are dedicated to shipping and have no switching operations; others are involved in returning the cars in the freight system through normal channels with the consequent number of switching operations performed on the cars as they are returned.

Table 12 tabulates the commodities carried by unit trains, the estimated fraction in pure unit trains, and the estimated fraction in solid trains that are broken up for the return trip. This traffic in commodities for 1973 is listed in Table 13 which also tabulates total switching generated by the commodity and total switchings per year.

Table 12

ESTIMATES OF COMMODITY MOVEMENTS BY UNIT TRAINS

Commodity	% Unit	% Solid	Total % Unit
Coal	15	15	30
Grain	5	5	10
Food products	5	0	5
Lumber	5	0	5
Metallic ores	5	5	10
Motor vehicles	0	10	10
Sand and gravel	0	5	5

A comparable number of carloads (26,727,459) were originated in 1974. In 1973, it was estimated that 1,040,000 cars were handled daily.⁴ The total handlings, when reduced to a daily average (using a 360 day year), were 930,680 which is well within the range of the estimate derived from the inventory. As a result, the assumption for the number of switchings per car appears reasonable. The projected number of cars switched will be proportional to the number of cars loaded if the commodity mix and the characteristics of the system remain the same.

Grain and coal movements are likely to increase over those that are projected in their proportion of the traffic-growth estimate (17 percent for coal and 5 percent for grain), based on 1972. We assume, however, that increases in shipments of these commodities will not result in additional car handlings because they will be offset by an equivalent increase in unit trains. Cars in the unit trains will not require switching.

Table 13

ESTIMATES OF ANNUAL SWITCHING OPERATIONS BY COMMODITY--1973

Commodity	Thousands of Carloads	Thousands of Total Switchings
Coal	4,487	45,319
Grain	1,682	20,268
Food products	1,176	14,524
Lumber and forest products	2,107	26,021
Metallic ores	1,930	23,257
Motor vehicles	1,355	16,802
Sand and gravel	1,476	18,229
All others	13,125	170,625
Total	27,338	335,045

Source: Reference 1.

3.1.9 Ownership and Cooperative Changes

Changes in railroad ownership may affect the number of cars switched by eliminating the need for interchange switching, as would result from series or end-to-end mergers. They could also result in network reconfigurations that would alter the role of certain yards and perhaps create the need for new yards in different locations to meet the requirements of the revised networks.

Cooperative changes include operational arrangements such as preblocking and run-through trains and the joint use of facilities. Because run-through trains and preblocking would eliminate interchange switching, the total number of cars switched would be reduced. Joint use of facilities means that underutilized yards may be the sites for combined operations, thereby eliminating the need for new yards.

In a run-through operation, an entire train, including power, is turned over from the crews of one railroad to the continuing one to avoid delay and additional handling to send the cars on their way toward their final destination. Switching is eliminated at intermediate points because the cars are usually classified for their final destination at the originating point of the train. Several premium freight trains travel from coast to coast without being uncoupled.

Preblocking allows the delivery of cars at the interchange in such an order that further classification by the receiving railroad at the interchange point is unnecessary; the blocks of cars are coupled into outbound trains as if they had been switched at the yard. Preblocking is done on a reciprocal basis--the railroads preblock for the receiver of the interchange freight in exchange for similar

consideration for cars traveling in the reverse direction. Preblocking makes switching operations unnecessary by eliminating classification at the interchange because a sufficient enough volume of cars originates at points along the road to permit blocking beyond the original railroad's territory. The reduction is comparable to that achieved by merged operations.

3.1.10 Mergers

Table 14 lists the affiliations of some of the 68 Class-I railroads and the 1974 gross operating earnings of the companies. It can be seen that there was substantial centralization among these railroads, and the asterisks indicate that the CONRAIL proposal will further centralize operations.

When substantial control is exercised, these groupings tend to emerge eventually and to rationalize operations of the merged railroads over a long period of time. The 22 groups of railroads with 1974 revenue exceeding \$100 million covered 44 of the 68 Class-I railroads. Of those not now in a group, the Rock Island is in bankruptcy and the Milwaukee is feeling financial pressures. ConRail will result in a further grouping of three in the \$100 million groups and will include several of the smaller railroads. The total number of "railroad entities," therefore, is expected to decline. Figure 21 indicates how such a trend might continue.

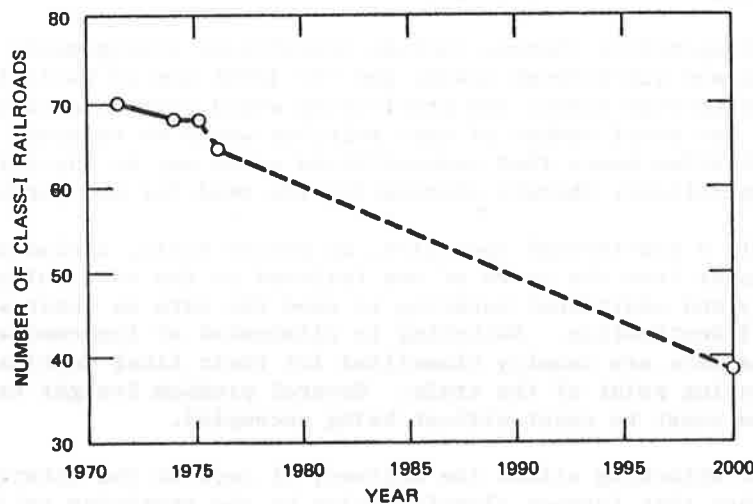

FIGURE 21 CLASS-I RAILROAD MERGER ACTIVITIES

Table 14

RAILROADS UNDER COMMON CONTROL AND
1974 GROSS OPERATION REVENUES

Railroad	1974 Operation Revenue (\$ Millions)	Group Total Revenue (\$ Millions)
Penn Central	2247	2369
PRS	12	
PLE	53	
DTI	48	
AA	9	
SP	1323	1519
NWP	12	
SSW	184	
SCL	680	1368
L&N	607	
A&WP	8	
Clinchfield	50	
GA	15	
WRRALA	8	
BN	1291	1363
C&C	36	
FW&D	35	
OE	1	
Chessie System		1291
C&O	569	
B&O	648	
WM	74	
AT&SF	1072	1072
N&W	983	1045
D&H	53	
ACY	9	
UP	989	
SI	7	996
SOU	909	909

Table 14 (Concluded)

Railroad	1974 Operation Revenue (\$ Millions)	Group Total Revenue (\$ Millions)
MO PAC	634	845
C&EI	54	
Mo-Ill	8	
TP	149	
ICG	578	578
C&NW	485	485
CMSP	395	395
CRIP	367	367
*EL	323	323
SLSF	284	284
SOO	180	180
U.S. Steel	175	175
B&LE	66	
DMIR	6	
EJE	103	
READING	150	150
RIO GRANDE	141	141
KCS	132	132
WP	105	105

This merger activity will have some effect on the number of switching operations because interchange switching will be reduced. Based on an USRA analysis of the Northeast where substantial rationalization takes place, an estimated 4 percent of switching operations will be eliminated as a result of the merger trend described above.

3.1.11 Line, Branch, and Terminal Rationalization

Rationalization of the system and operations affects both the network and, in turn, the need for and location of switchyards; it also affects the level of traffic and the need for switching operations. These latter reductions in switching are the result of branchline abandonment, better blocking strategies, improvement of car utilization and intermodal operation.

3.1.11.1 Mainline Rationalization

Elimination of unnecessary mainline trackage will probably change not only the number but also the location of switchyards required to service a different network. Estimates made several years ago indicate that, of the 82,000 miles of signalized mainline trackage, no more than 30,000 miles of high-density mainline is needed to carry the traffic. These 30,000 miles would still only be utilized at a 30 percent level by 1980, and the remaining 50,000 would be downgraded to feeder status. The pattern of travel over this reduced network would be such that the loads on switchyards would be altered to the point of needing new yards or significant expansion of existing yards to handle the traffic flows.

This process will not happen all at once, however, and the degree to which the rationalization of the mainline network will occur is one of the variables that distinguishes the present-trends scenario from that of the super-rationalization scenario. In the present-trends scenario, a measure of the degree of mainline rationalization might be the reduction of mainline miles to 10,000 by 1990 and another 10,000 by the year 2000. This 25-percent nationwide reduction compares to a 40 percent reduction by the ConRail system and is estimated to be less because of the lack of duplication in other parts of the country.

3.1.11.2 Branchline Abandonment

The national railroad network has been shrinking for a number of years because of the abandonment of light-density lines, usually branch lines serving remote locations. A study by the Federal Railroad Administration revealed that 96 percent of the freight traffic in the 17-state northeast and midwestern regions affected by the Regional Railroad Reorganization Act of 1973 originated on 75 percent of the railroad mileage, leaving potentially 25 percent of the trackage as excess.² A less drastic reduction of route mileage actually resulted because all of the carriers were not involved in the reorganization, and states agreed to subsidize some low-density lines that the railroad companies believed could not be operated profitably. A slow process of branchline abandonment is seen in the present-trends scenario, therefore, with a total reduction of traffic of approximately 2 percent resulting from an estimated 10 percent reduction in mileage by the year 2000. In this scenario, none of this traffic is captured by TOFC or COFC service.

3.1.11.3 Better Blocking Strategies

As part of a systems plan for restructuring the bankrupt northeastern railroads, the USRA sponsored the development of a process for analyzing blocking and train-scheduling strategies. The process

uses a historical traffic data base to aid in the structuring of a blocking strategy and to analyze the strategy in terms of number of cars switched and size of loads at critical points. This blocking strategy resulted in an 8 percent reduction in the number of cars switched when compared to the classification instructions currently in force at the Penn Central Company. Use of the planning tool nationwide is estimated to result in an improvement of approximately 4 percent because the process will only be partially used and other networks are not as complex as the ConRail system under consideration in the study.

3.1.11.4 Improved Car Utilization

Improved car utilization will reduce the need to switch empty cars because the railroad will have a plan for their disposition before they are unloaded. It will no longer be necessary to shuttle cars from yard to yard. The improved utilization of cars is not expected to affect the present-trends scenario but will have a significant impact on the super-rationalization scenario.

3.1.11.5 Intermodal Operations

Intermodal operations have a potential for greatly altering the operations of the railroads. Instead of the costly need for spotting cars on customer sidings, the loads would be trucked in containers from the shipper to a terminal where they would then be loaded onto railroad cars. The cost of owning and maintaining switching leads could be eliminated, as could many grade crossings. The equipment and manpower requirements for pickup and setout of small numbers of cars by truck are much less than by train.

By offering the flexibility of highway delivery and pickup, intermodal operations can substantially reduce the amount of switching required to deliver a load at the consignee's dock. In addition, many trailer and container trains are solid trains with run-through operations.

Growth of intermodal operations is estimated to be small and will have a negligible effect on the number of switching operations. In this scenario, it will be at the expense of truckers, will offer premium service, and will not contribute to the switching load.

3.1.12 Number of Cars to Be Switched

The net effect of the traffic forecasts and the line, branch, and terminal rationalization is a negligible increase in the number of cars to be switched over the next 25 years despite the assumed rise in production and growth in economy. Table 15 summarizes the results of

the above discussion regarding the number of cars to be switched in the present-trends scenario.

Table 15

PROJECTED NUMBER OF CARS TO BE SWITCHED FOR
THE PRESENT-TRENDS SCENARIO

	1974	1985	2000
Freight carloads originated (000) annually	26,727	29,063	30,729
Projected daily switching operations	909,867	989,392	1,046,107
Less:			
Light-density line abandonments	--	(1%) 9,894	(2%) 20,922
Reduction of interchange	--	(2%) 19,788	(4%) 41,844
Improved blocking	--	(2%) 19,788	(4%) 41,844
Total improvements	--	49,470	104,610
Number of daily switching operations	909,867	939,922	941,497

It is believed that new switchyards will not be necessary to meet traffic growth because the existing ones are generally capable of handling the average 4 percent increase shown in the analysis. There may be localized bottlenecks, however, because of a shift in traffic patterns or when yards are loaded at current traffic levels and the work cannot be performed at some other location. Under these conditions, a modest estimate of ten yards requiring expansion because of traffic growth by 1985 would be made, and this capacity should be sufficient up to the year 2000.

3.1.13 Network Changes

The line, branch, and terminal rationalization process will have some influence on network configuration which, in turn, will affect the desired location for switchyards. Changes in the network, especially those that involve consolidation of mainline trackage and/or new routing, will require switchyard relocations; otherwise, traffic may have to be hauled to existing switchyards. The demand for new and expanded switchyards as a result of these network changes is likely to have a profound effect. The cumulative 25 percent reduction in mainline trackage forecast by the year 2000 may mean that a comparable number of classification yards could be abandoned or downgraded to industrial

yards. Of the 1200 classification yards in the inventory, therefore, approximately 300 of them would be downgraded to industrial yards. Other yards would then have to be expanded to handle the rerouted and growing traffic. We estimate that 50 to 75 yards would be required for this purpose.

3.1.14 Relocation of Urban Railroads

A survey of urban-planning department heads in all American cities with populations greater than 100,000 was made as part of a study of Urban Railroad Relocation.⁷ The results indicated that 167 urban yards in these areas are located on land that could be better used for other purposes. The pressure for these relocations stems from community complaints regarding noise, zoning changes, and other conflicts and from the fact that the land is more valuable as real estate than as railroad property.

The project team estimated that approximately 80 (or one-half) of these yards could be moved. The rate at which they could be replaced would depend on forecasted future traffic levels, degree of rationalization that could be achieved, and availability of investment funds to finance such relocation projects. In the present-trends scenario, it is assumed that 65 of these 80 projects will be undertaken by the year 2000. Approximately 15 of them are estimated to be among the 300 that will be downgraded because of network changes.

3.1.15 Operating Company Finances

In the present-trends scenario, operating company finances will be limited, as they are today, when an estimated \$3 to \$4 billion is required to restore the railroad plant, and the 1974 cash flow was only \$1.7 billion. Because of this shortage and the relatively long payout of yard investments, this deficiency will be the most significant deterrent in the upgrading and construction of yards over the forecast period. Although federal financing is available as a result of recent legislation, the amount is small compared to the amount needed. The financial considerations have been taken into account in estimating the speed at which mainline rationalization and urban yard relocation would take place.

3.1.16 Switchyard Age and Condition

The equipment installed in flat yards is durable and long lasting; however, the equipment in hump yards tends to wear out and become obsolescent faster, and these yards are likely to need major reequipping over the next 25 years. It can be seen in Figure 22 that, by 1985, 54 of the hump yards will be more than 30 years old and that

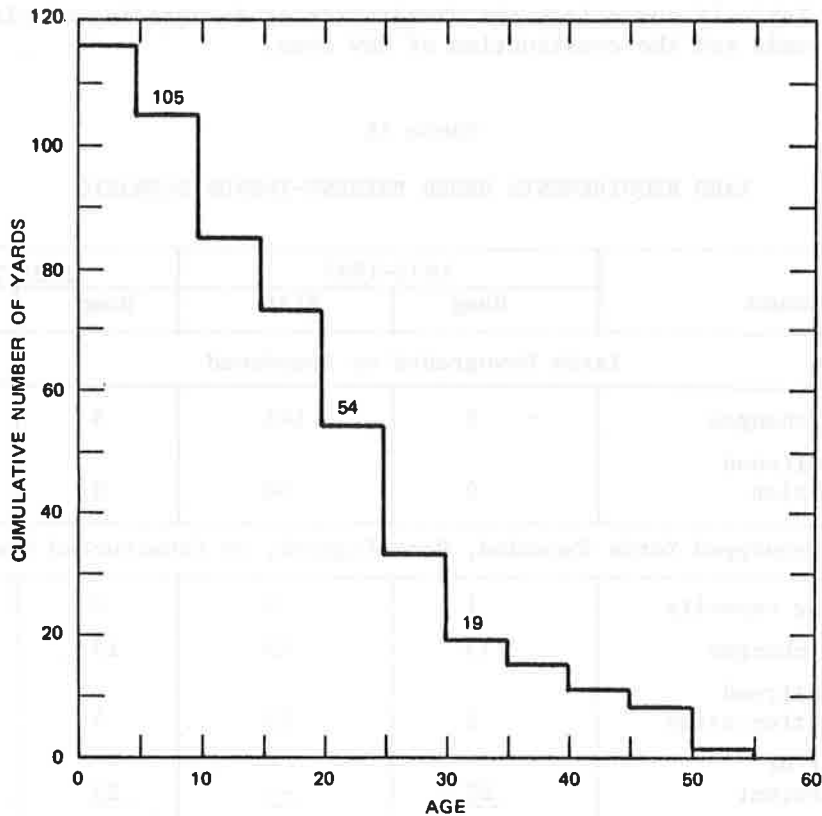

SOURCE: Reference 5

FIGURE 22 AGE DISTRIBUTION OF HUMP YARDS

another 51 will enter the "over 30" status by 2000. Because of financial limitations, approximately one-half of these yards will be upgraded at that point.

Technological advances in computing equipment and retarders will contribute to the obsolescence. Improved yard layout procedures and yard-analysis capabilities will also pressure the upgrading of existing yards to meet added system requirements.

3.1.17 Yard Construction under Present-Trends Scenario

Switching activity, network changes, urban railroad relocation, wearout, and obsolescence all contribute to the construction of

yards. Table 16 summarizes the abandonment or downgrading of classification yards and the construction of new ones.

Table 16
YARD REQUIREMENTS UNDER PRESENT-TRENDS SCENARIO

Cause	1975-1985		1985-2000	
	Hump	Flat	Hump	Flat
Yards Downgraded or Abandoned				
Network changes	5	145	5	145
Urban railroad relocation	0	50	0	80
Reequipped Yards Expanded, Reconfigured, or Constructed New				
Switching capacity	1	9	0	0
Network changes	15	15	15	15
Urban railroad relocation sites	5	15	5	25
Worn out or obsolescent	<u>27</u>	<u>--</u>	<u>25</u>	<u>--</u>
Total Construction	48	39	45	40

The project team estimates that most of the new construction will occur at existing yard sites because there is no new trackage in the forecast. The number of yards built from the ground up will be on the order of three to five by the end of the century.

3.2 SUPER-RATIONALIZATION SCENARIO

In this scenario, the economic growth of the country is the same as in the present-trends scenario, as is the number of carloads originated except for some changes caused by diversion from other modes to railways. In this scenario, however, all of the proposals for improving the railroads are incorporated, and a means for financing them is found so that there is a fully rationalized network of operations.

3.2.1 Ownership and Cooperative Changes

In this scenario, the number of railroad entities is further reduced to two competitive lines serving each region. The model for

this configuration is the southeastern part of the United States where the Southern Railway and the Seaboard Coast Line Railway dominate but compete for the rail service in the region. End-to-end mergers between regions also reduce the number of major railroads to between 5 and 12. The major effects of this configuration are to drastically lessen the amount of interchange switching and to make possible high-order network rationalization.

By eliminating one-half of the interchange switching, approximately one-sixth of the total switching will be eliminated. This will also account for improvements achieved by preblocking and run-through trains.

3.2.2 Line, Branch and Terminal Rationalization

Mainline rationalization, branchline abandonment, improvements in blocking strategies and car utilization, and an effective intermodal system will greatly affect both the number of switching operations and the configuration of the railroad network in this scenario.

3.2.2.1 Mainline Rationalization

In this scenario, the full potential for consolidating mainlines is achieved, and the total mainline mileage is reduced to approximately 35,000 miles of high-density railroad. The remainder of the mainline system is either downgraded to branchline or abandoned.

3.2.2.2 Branchline Abandonment

Branchline abandonment will be accelerated in this scenario so that the full 4 percent of traffic from light-density lines is achieved. It is assumed, however, that half of the lost branchline traffic is regained as a result of an effective intermodal system.

3.2.2.3 Improved Blocking Strategies

In this scenario, a 6 percent reduction in the number of cars switched is expected because all railroads will operate to reduce car handling as much as possible. This reduction, however, will occur only after other changes have been made.

3.2.2.4 Improved Car Utilization

An improved car-utilization system will reduce the empty-car handlings to the same number as the loaded cars.

3.2.2.5 Improved Intermodal System

In this scenario, an improved intermodal system is expected. Its principal advantage is high-speed nonstop service between designated city pairs, with no intermediate switching in the primary service mode. Increases in traffic diverted from other modes by the system, therefore, will not add to the switching load; however, a significant amount of rail carload traffic would be diverted from carload freight. The Federal Railroad Administration contracted for a major study of a national intermodal system,⁸ with a detailed analysis of traffic, routes, and schedules that would produce competitive services. Using data from the study, the SRI project team estimates that approximately 2.5 million 40-ft container equivalents would be diverted from carload freight by 1980 and that as many as six million containers would be diverted from carload to intermodal freight by the year 2000.

Assuming that this containerizable traffic has a lower density than the average freight carload (such that two 40-ft containers are approximately equivalent to a freight car), the diversion would be 1.25 million carloads in 1980 and three million by the year 2000. These carloads will directly reduce the need to switch cars by 4.3 percent in 1985 and 9.7 percent in the year 2000.

3.2.3 Number of Cars to Be Switched

The effect of ownership changes and line, branch, and terminal rationalization is a decrease in the number of cars switched by the year 2000. Table 17 tabulates the impact of the events described in the super-rationalization scenario on the number of cars to be switched. The reductions in switching operations indicate that there will be very little pressure to build or expand yard capacity if the railroads are successful in instituting the changes described in this super-rationalization scenario.

3.2.4 Network Changes

The reduction in mainline track mileage will potentially affect 60 percent of the 1200 classification yards that now serve the mainline track to be downgraded; however, many of the yards may be located close enough to the new system to be usable. It is assumed, therefore, that approximately 500 yards would be downgraded in this scenario. Because the nationwide switching load is only 60 percent of that now being experienced, the expansion of only 150 yards will handle localized capacity bottlenecks.

Table 17

PROJECTED NUMBER OF CARS TO BE SWITCHED FOR THE
SUPER-RATIONALIZATION SCENARIO

Item	1974	1985	2000
1. Projected daily switching operations	909,867	989,392	1,046,107
2. Reductions			
a. Light-density line abandonment (% of line 1)	--	2%	4%
	--	19,788	41,844
b. Diversion to intermodal system (% of line 1)	--	4.3%	9.7%
	--	<u>42,544</u>	<u>101,472</u>
c. Subtotal (line 1 net of 2a and 2b)		927,060	902,791
d. Blocking improvements (% of line 2c)	--	4%	6%
	--	37,082	54,167
e. Interchange reduction (% of line 2 c)	--	8%	17%
	--	74,165	153,474
f. Car utilization (% of line 2c)	--	5.0%	7.6%
	--	46,353	68,612
g. Net reduction (total of lines 2a-f)	--	<u>219,932</u>	<u>419,569</u>
		769,460	626,538

3.2.5 Urban Railroad Relocation

Because the high-density mainlines created by the rationalization will intensify conflicts between the railroads and communities, they will have to be relocated close to urbanized areas. In this scenario, however, most of the switchyards associated with these lines are among those to be abandoned, and the new construction can take place in the estimated 150 expanded yards.

3.2.6 Operating Company Finances

Changes to the railroad industry that are part of the super-rationalization scenario depend largely on the availability of funds. These include the upgrading of track, roadbed, signaling, and grade separation of the high-density lines, installation of computers and communications to achieve the needed freight-car utilization, provision for terminal facilities and management of intermodal operations, new containers for the system, and upgrading of switchyards when needed. Because this scenario is assumed to be feasible, it must also be assumed that these changes can be financed, most likely from a combination of public and private sources. After they are completed, the railroad industry should be very profitable as a result of less switching of cars, elimination of light-density lines, and better freight-car utilization.

3.2.7 Yard Construction under Super-Rationalization Scenario

Obsolescence and technological changes in the super-rationalization scenario will require the rehabilitation of approximately the same number of yards. Because half of these yards are abandoned, it will be assumed that half of the hump yards needing rehabilitation will also be among this number. In this scenario, however, it will be assumed that all yards over 30 years old will be reequipped if they are to be used. Table 18 summarizes the switchyard activity implied in the super-rationalization scenario. It follows from this analysis, therefore, that switchyard work will be greater under the super-rationalization scenario than under the present-trends scenario, primarily because of the need to switch cars in different locations.

3.3 ENERGY-CRISIS SCENARIO

Two effects that a severe energy shortage would have on railroad operations and switchyards are:

- Economic depression while the economy adjusts to new patterns of consumption, distribution, and manufacture of goods.
- Probable legal requirements that all shipments between cities be made over railroads (rather than by truck) because they use only one-sixth of the energy of a truck.

3.3.1 Economic Conditions

It is not possible to forecast the extent of the economic impact of a severe energy shortage or the locations and industries that would be affected; however, railroad traffic would decline significantly.

Table 18

YARD REQUIREMENTS FOR SUPER-RATIONALIZATION SCENARIO

Cause	1975 to 1985		1986 to 2000	
	Hump	Flat	Hump	Flat
Yards Downgraded or Abandoned				
Network changes	25	225	25	225
Urban railroad relocation	--	40	--	60
Yards Expanded, Reconfigured, Reequipped, or Constructed New				
Switching capacity	0	0	0	0
Network changes	35	40	40	35
Urban railroad relocation sites	0	0	0	0
Worn out or obsolescent	<u>27</u>	<u>0</u>	<u>25</u>	<u>0</u>
Total construction	62	40	65	35

Whether the economy will continue to operate at a stable low level or whether the continued low level of activity will cause it to decline further are open questions. In this analysis, however, it will be assumed that the economy will not rise under these conditions.

3.3.2 Railroad Carloadings

Because of the depressed economy in 1975, projected carloads are 22.9 million, linearly extrapolated from a 34-week cumulative report in Railway Age which is less than the estimated 27.5 million used in the base case. Carloads in 1974 approximated this 27.5 million figure. To analyze the effects of an energy shortage, this 22.9 million carloads will serve as the basis of a forecast of switchyard activities. Additional carloads of coal will certainly take place in this scenario, but they will not generate additional switching activity.

3.3.3 Transfer of Truck Traffic

It is assumed that there will be rulings and legislation that will prohibit all intercity truck hauls over 200 miles and that there will be a railroad substitute for all of these. Woehlcke⁶ breaks down

the projections for 1970 into distance classifications, showing the following distribution of truck traffic over 200 miles:

	(tons × 10 ⁶)	
	<u>For Hire</u>	<u>Private</u>
200 to 399	130	31
400 to 599	52	11
over 600	65	9
	<u>247</u>	<u>51</u>

Because the 1970 level of 300 million tons is assumed to approximate the depressed 1975 level, these distributions will be used in the forecast. The truck traffic may be taken by the railroads either as carloads or trailerloads. Two assumptions will be made; the first is that one-third of the traffic will be captured in carloads and two-thirds in trailerloads, and the second is that two-thirds of the traffic will be taken in carloads and only one-third in trailerloads. We will further assume that the average carload equivalent of this traffic is 50 tons, compared to the railroad average load of 55 tons. This results in six million carload equivalents that are diverted. Between two and four million carloads of traffic will be added to the railroad carloadings in conventional service, and 100 million and 200 million tons will be added as TOFC/COFC traffic.

The requirement that all shipments between cities be carried by railroads would result in a surge in both traffic and switching operations. Instead of the flexibility of trucking used in developing the national container system (when trucks are used to deliver the load to an appropriate point in the system where switching would be eliminated), hauling the load to the nearest point will mean an increase in the number of switching operations as small numbers of loads destined for remote locations are placed in the system. This type of traffic generates the greatest amount of switching because it cannot be blocked for long-distance moves as a result of its diverse originating and terminating points.

In the present-trends analysis, it was assumed that the 1974 level of 26,727,000 carloads per year would result in 909,867 switching operations per day. The railroad traffic of 22.9 million carloads will be switched at the same rate. The carload traffic converted from trucking, however, will have a 10 percent higher switching rate because of the remoteness of the delivery points, and the TOFC/COFC traffic will result in approximately half as many as the normal switchings because it is assumed that half of the intermodal traffic will move in unit trains. These carloading factors are summarized in Table 19.

Table 19

IMPACT OF TRUCK-TRAFFIC DIVERSION ON SWITCHING ACTIVITY

Cause	Carloads/Year (millions)	Factor	Daily Switching Operations (000)
Railroad base	22.9	1/29.4	780
Diverted from truck to carload			
Low TOFC/COFC	4.0	1/32.3	124
High TOFC/COFC	2.0	1/32.3	62
to TOFC/COFC			
Low TOFC/COFC	3.3	1/39.2	84
High TOFC/COFC	6.7	1/39.2	171
Total			
Low TOFC	30.2		988
High TOFC	31.6		1,013

3.3.4 Financial Condition of Operating Railroads

The level of traffic that results from the addition of truck traffic will mean that the railroads will enjoy relatively high gross revenues, probably enough to offset the rise in fuel costs, and these factors plus increased coal traffic will mean that most of the railroads will be relatively profitable. The mix of traffic, however, will vary such that some railroads may be badly hurt. This unevenness is illustrated by the effects of the recession of 1974-1975 which affected some western carriers adversely and some eastern coal-hauling railroads to a much lesser degree. This will mean that some of the more prosperous roads may merge with some of the less profitable ones and that services will be cut back on the unprofitable roads.

3.3.5 Rationalization and Cooperation

Over a long period of time the effects of the mergers will be some rationalization above that predicted for the base case. A decline to 30 Class-I railroads by 2000 (ten less than the present-trends scenario) is predicted. This rationalization will produce an additional 2 percent reduction in switching activity in 1985 and 4 percent in 2000.

The profits generated by the railroads will probably first be invested in upgrading tracks and facilities to handle coal in higher volumes and perhaps at higher speeds. In the event of a surge in

merchandise traffic, yards will be modernized to handle the increased loads.

The energy shortage will bring pressures to reduce circuitry, probably resulting in more interchanges as regulators attempt to transfer freight over the shortest route, regardless of railroad ownership. This practice will hurt some railroads and help others. An additional 5 per cent switching is estimated to result from this increase interchange.

3.3.6 Number of Cars to Be Switched

The diversion of truck traffic, increased interchange, and mergers will result in a level of switching activity not significantly different from that at the present time. Table 20 lists the results of the analysis.

Table 20

PROJECTED NUMBER OF CARS TO BE SWITCHED FOR
THE ENERGY-SHORTAGE SCENARIO

Item	Cars Switched (thousands per day)		
	1974	1985	2000
Basic switching requirement (including diverted truck traffic)	910	1000	1000
Added interchange to reduce circuitry	--	--	--
Percent change		5	5
Switchings		50	50
Reductions caused by rationalization	--		
Percent change		2	4
Switchings		-20	-40
Total switching operations	910	1030	1010

As in the other scenarios, the number of switching operations demanded by the system will not exceed the total capacity of the switchyards. Localized bottlenecks will probably develop, however, because of the different transportation patterns created by the assumed diversion of truck traffic. The judgment of the project team is that only ten yards will require expansion because of the added loads.

3.3.7 Network Changes

In the energy-crisis scenario, only minimal downgrading of the mainline network is assumed because of the desire to make it appear that circuitry is being minimized. Light-density line abandonment is also at a standstill because of a widespread assumption that all rail traffic is more efficient than other modes. The result is that switchyard activity brought about by network changes is minimal.

3.3.8 Urban Railroad Relocation

The depressed economy will remove a major impetus to railroad location--namely, the potential profit in switchyard land for more profitable and better uses. Unless a public works program is initiated not many of these relocations will be accomplished.

3.3.9 Wearout and Obsolescence

In this scenario, it will be assumed that the upgrading of old and obsolescent yards will continue at the same pace as in the present-trends scenario; that is, half of the yards that are 30 years old or more will be reequipped. New technology will not be incorporated to a large extent, however, because of the general pessimistic outlook concerning the future.

3.3.10 Switchyard Construction in the Energy-Crisis Scenario

The economic, political, and social unrest in the energy-crisis scenario combine to minimize the amount of switchyard activity in this environment. Table 21 tabulates the results. No yards are downgraded or abandoned in this scenario.

Table 21

YARDS EXPANDED, RECONFIGURED, REEQUIPPED, OR CONSTRUCTED NEW

Cause	1975 to 1985		1986 to 2000	
	Hump	Flat	Hump	Flat
Switching requirements	1	5	1	3
Wearout and obsolescence	27		25	
Total construction	28	5	26	3

4. SURVEY OF CLASSIFICATION YARD EQUIPMENT AND HARDWARE

This section is a summary of SRI's survey of equipment, hardware, systems, and operational practices used in classification yards. It describes generalized technologies which have been or are being developed that have or may have significant impact on classification yard operations. These descriptions are based on information acquired from railroad operators, suppliers, and published literature. Some of the descriptions that rely extensively on published literature as an information source may be incomplete or out of date due to lack of more recent technical literature on the subject. Any references to equipment suppliers and specific devices are included only as examples and are not intended to imply a recommendation or endorsement. Particular hardware items were not extensively analyzed, although the performance characteristics, advantages, disadvantages, and potential drawbacks, as reported by the information sources, are included without necessarily implying SRI concurrence or validation. This section is not intended to serve as a definitive discussion of each device, but rather represents a general overview of equipment types and their uses.

4.1 YARD-FACILITY HARDWARE

4.1.1 Weigh Scales

An accurate knowledge of the weight of each car is essential to any railroad operation because commodities shipped by railroad are usually billed by their weight, detection of overloaded cars is directly related to safety, and proper matching of locomotive horsepower to train tonnage is important to operations over grades.

A railroad weigh scale consists of a pit that lies underneath a section of a track that has been severed, a weigh bridge that serves as a floating platform of the severed section, and load cells that support the weigh bridge and perform the weighing. The commonly used load cells utilize strain gauges as the sensing elements. The electrical output of the strain gauges are amplified and processed electronically to give the weight of each car. Scale output in the form of an electrical signal facilitates visual display and interfacing with other electronic devices such as an automatic car identification (ACI) system or a computer. A permanent record of the weight can also be provided by a teletype printer.

The following three types of weigh scales are commonly used in classification yards.

- a) The conventional static-weight scale-- This scale requires a car to be uncoupled and placed at rest on the scale. If the weigh bridge is shorter than the car, the two ends of the car are weighed separately and the two weights are then added to produce a total car weight. This two-stage process requires additional time (three to four minutes per car)⁹ and introduces the potential for arithmetic errors. The cars to be weighed usually must be sorted out before weighing and this often means that they must be reclassified, thereby causing extra work. In some yards that use conventional scales, an entire engine crew may be dedicated to weighing cars. Despite these disadvantages, however, conventional static-weighing scales have certain advantages. They are much cheaper than in-motion scales and are, therefore, potentially more suitable for low-volume applications. They are also more accurate than in-motion scales and, in fact, are used as the basis for calibrating other types of scales.¹⁰
- b) Uncoupled in-motion scale--With this scale, a car must be uncoupled but is allowed to drift across the weigh bridge at a speed less than some maximum. This scale can be either single draft or two draft. The length of the weigh bridge can vary from 20 ft for a two-draft scale to 100 ft for a single-draft scale, which can accommodate an entire car on the weigh bridge. Uncoupled in-motion systems that use two-draft scales eliminate potential arithmetic errors by automatically summing and recording the weights of each end of the car. A major advantage of these systems is that they can be built by modifying conventional scales and at substantially lower cost than that associated with the installation of coupled in-motion systems.
- c) Coupled in-motion scale-- This is the most advanced scale and can be constructed to operate entirely automatically and unattended. It permits the rapid weighing of individual cars, even when coupled together. Cars can be drawn or pushed over the weigh bridge at 5 to 6 mph. The coupled in-motion scale, therefore, is particularly applicable for use on a hump lead where speeds are generally slower. Because the speed of the scale allows it to be used during normal yard operations, individual cars need not be sorted before being weighed. The length of the weigh scale is approximately 5 ft. Generally, the load on each axle of the car is weighed separately, and gross car weights are obtained by summing

the individual axle loads. Two-draft scales can also be used for coupled in-motion weighing.

In the more advanced in-motion scale systems, the effects of ambient temperature variations are automatically compensated for; bi-directional weighing can also be designed. Another important feature is an improved algorithm that can perform reverse detection and count, which allows the system to keep track of the cars already weighed if a train should stop and back up before the last car is weighed.

Although in-motion scales are a major improvement over the conventional scales, they do have limitations. One of the major limitations, as explained by Stein,¹¹ is that the up and down oscillations of cars and trucks moving along a less than perfect roadbed have the overall effect of varying the force exerted by the axles on the road surface. At times, dynamic forces can be as high as 30 to 40 percent of the static load. One solution to this problem is to make the approach track to the scale and the junction between the scale and the adjoining track as even as possible. Another solution is to measure the weight of an axle over a time period that encompasses several cycles of the oscillations and to average the result. In other words, the accuracy of the scale could be improved if the length of the weigh bridge is increased, or the speed of the drifting car is decreased, or both. For a scale that weighs one axle at a time, the length of the weigh bridge is limited by the wheel base of a truck. Improvement in accuracy, therefore, can be made only by slowing down the car. Most manufacturers of in-motion scales recommend a maximum speed of 5 mph; an overspeed indicator is usually incorporated into the system. The accuracy figures claimed by the manufacturers are impressive, provided that the in-motion weighing is done below the specified speed limit and without excessive slack action in the couplers. Typical accuracy figures of a coupled in-motion scale are:

0.2%	for	80% of the cars
0.3%	for	90% of the cars
0.5%	for	100% of the cars.

We do not know whether these figures have been substantiated; however, they probably represent accuracy achievable under nearly ideal conditions. In the event of a poorly maintained track and heavily loaded cars with worn wheels (which lowers the natural frequency of the oscillations), it appears that the weights measured by in-motion scales could involve a large percentage of error.

4.1.2 Weigh Rails

Unlike a weigh scale which requires substantial track modification for installation, a weigh rail is a relatively simple device that replaces a short section of a running rail. A weigh rail, however, does not produce as accurate weight figures as does a weigh scale; instead, it is designed to differentiate a few weight ranges.

In a Westinghouse Air Brake Company (WABCO) unit, the weigh rail is a rectangular cross-sectioned steel beam in which a horizontal slot has been milled. The weight of a passing wheel deflects a portion of the weigh rail. This deflection then activates a set of levers which, in turn, closes different electrical contacts to signify the weight class of the passing car. The four weight classes detected by the WABCO unit cover the following weight ranges:

Light	14 to 35 tons
Medium	35 to 52 tons
Heavy	52 to 110 tons
Extra heavy	110 tons and over

Because a weigh rail is a weigh-in-motion device, it is used in automatic classification yards to determine weight classes of cars about to be retarded by computer-controlled retarders.

4.1.3 Automatic Car-Identification Systems

One of the major problems historically associated with railroad operations is the inefficient utilization of rolling stock. The magnitude of this problem becomes apparent when one considers the large number and high mobility of the railroads' rolling stock. In the 1960s, numerous computer systems were developed to assist in maintaining accurate up-to-date car location and inventory information files. These systems, however, were often found to be somewhat limited by the lack of precise and timely input of information regarding car location and identification. The conventional method typically required recording the identification number of each vehicle by hand and then entering the data into the computer system. Such processes are time consuming, labor intensive, and often inaccurate because of human error. Consequently, there was a great incentive for the development of a system to identify automatically cars that pass by certain key locations and to input these data into railroad computer systems where they could be used to improve railroad operations. Many applications of automatic car identification (ACI) in railroad yards and terminals have been identified or developed.

4.1.3.1 Association of American Railroads Standards

Recognizing the need for a standard ACI system, the railroads in the United States began investigating such systems during the early 1960s. In October 1967, the Association of American Railroads (AAR) chose the Sylvania Kar-Trak as the industry's ACI standard. This system is an optical system where light reflected from especially designed identification labels on cars is interpreted by a roadside scanner. The U.S. railroads were already somewhat accustomed to the Sylvania optical ACI system because the Duluth, Missabe and Iron Range Railroad and the

Boston and Maine Railroad had already been using it. The basic ACI system is composed of the following components.

(1) Label--The standard label contains a series of multi-colored strips, each measuring $1 \times 5\text{-}3/4$ inches. These strips are made of retroreflective material that reflects incident light back to the direction of incidence. Red, blue, white, and black are used in the Sylvania system. Coded information on the label includes cues for information start and stop, an equipment code for identifying the type of vehicle (such as freight car, locomotive, caboose), owner identification, vehicle identification number, and a validity check digit that ensures the integrity of the information acquired by the scanner.

The ACI labels can be quickly and easily applied by railroad shop personnel and are relatively inexpensive. A set of ACI labels, consisting of one for each side of the car, can be applied at an estimated cost of \$25 to \$50.¹² Although the lifetime of the labels may vary, it has been estimated that they may last 7 to 15 years.¹²

A limiting performance characteristic encountered with this system has been the accumulation of dirt on the surface of the ACI labels, which reduces reflectivity and thereby lessens label readability. The scanners on the U.S. railroads are typically reading approximately 80 percent of the labels.¹² To improve readability, labels are being cleaned at regular intervals, but the cleaning process can also damage them. This problem is now being solved by treating the surface of the label with a thin coating of Teflon which protects the colored strip components. The Teflon film resists chemicals and abrasions but does not reduce reflectivity, thereby promoting better cleaning without damage to the labels.

The problem of dirt accumulation is particularly acute on those labels mounted close to the ground--on flatcars and other low-riding cars, for example, where their design does not facilitate the mounting of labels at a higher position. It also has been found that, even on low-riding cars, dirt accumulates principally on the bottom portion of the label. Servo Corporation of America, therefore, has developed a smaller label that uses standard-size ACI colored strip components.¹³ These labels can be mounted so that the bottom of the label is 6 to 6-1/2 inches above the point where the bottom of a standard label would be located.

(2) Scanner--The ACI scanner is usually located in a way-side box. It produces an intense beam of white light that is swept across the passing label by rotating mirrors. The white light is then reflected back from the label, received by the scanner unit, filtered (for color separation), and converted into electrical signals. The rotational speed of the mirror allows the scanner to recognize information on a label even when a freight car passes at speeds of up to 80 mph. Because

the location of the label on individual cars or vehicles varies widely, the AAR specifications require that the scanner be able to scan up to a height of 9 ft and have a depth of field of 3 ft. Additional research is being performed to improve the design and operation of the scanners.^{14,15}

The cost of an ACI scanner is approximately \$25,000.¹⁶ It can also be leased, and it has been reported that the eight ACI scanners used in Norfolk and Western's (N&W) Roanoke Yard are leased at a cost of \$4800 per month.¹⁷ Annual maintenance (either by the railroads or contractors) can vary between \$900 and \$1800, depending on the complexity of the installation.

(3) Wheel Detectors--Wheel detectors activate and deactivate the scanner as trains or cars approach and depart, establish train direction, account for motion reversal, and help to identify unlabeled cars.

(4) Decoder--This unit is housed separately and is connected to the scanner by a special cable to receive and process the electrical signals from the scanner. Processing involves decoding, verification, logic decision, and information storage and transmission.

(5) Utilization of the ACI System--The above described ACI system used by American railroads has not achieved the degree of success that was originally forecast primarily because of the readability problems. Although some railroads report that label readability is approaching 90 percent, other railroads report percentages in the low 80s. These figures tend to discourage the use of ACI in many applications where a more accurate and reliable form of automatic car identification would be desirable. Future developments in scanner and label technology and changes in maintenance practices, however, may eventually increase readability to such a point that the current ACI system can be better utilized. In addition, automatic data-enhancement features used by certain railroads provide acceptably accurate and reliable operating information. This is essentially a software package that matches raw scanner data with advance consist information. In one case, this automatic double-checking process improved data accuracy to 99.6 percent after using raw scanner data that was only 87 percent accurate.¹⁸

Another reason why the U.S. ACI system has not achieved the levels of success originally forecast is that, although essentially all U.S. freight cars have labels, the fixed-scanner portion of the system has not been widely deployed. It was originally estimated that the railroad industry might require as many as 10,000 scanner units;¹⁹ a more recent estimate is 4000 units.²⁰ At the beginning of 1976, however, there were less than 500 scanners in use; readability problems associated with the ACI system probably account for this small number.

The capital-investment requirements may also severely constrain their purchase and installation.

The railroad industry's reaction to the present ACI system, is divided. Some railroads, such as Grand Trunk Western (GTW) and N&W, have expressed belief and commitment, others have resisted its continued use, and still others have adopted a "wait-and-see" approach.

4.1.3.2 Other ACI Systems

A number of other ACI systems have been developed or proposed. None have been extensively tested in U.S. rail service, and cost estimates are therefore highly uncertain. The operations of some of these systems²¹⁻²⁴ are described below.

(1) Optical Systems--Other optical ACI systems have been developed. Their basic principle of operation is similar to the standard ACI system; light is reflected from car identification labels and interpreted by a roadside scanner. They also have the advantage of using rather inexpensive car-identification units. The roadside units may be fairly expensive, however, and the accuracy of the system can be diminished by dirt, smoke, ice, or snow.

(2) Microwave Systems--Microwave ACI systems have been developed and tested in both the United States and Germany. A microwave transmitter and receiver unit is used as the roadside element instead of the current ACI scanner. They transmit microwave electromagnetic radiation to the car unit which is a transponder unit instead of a light reflective identification label. Depending on the system, the transponder can be designed in either of two ways. In the German system, it takes the form of a number of resonant cavities that can be tuned to absorb any frequency within a designated frequency range. Other frequencies are reflected to the trackside receiver unit to identify the car. In certain types of U.S. systems, the transponder contains circuitry powered by the interrogator signal that retransmits a coded signal.

The developers of both types of transponders, claim that the operation of their system is not appreciably affected by dirt or ice accumulation. The production price is estimated to be \$20 to \$40 for the U.S. system and \$30 for the German system.¹⁶ While the total installed cost of these units cannot be stated with certainty it undoubtedly will be higher than the present optical label.

(3) Ultrasonic Systems--The ultrasonic system requires that several ultrasonic reflectors and absorbers be arranged on the cars in accordance with the car code. Accuracy problems may be caused by interference from external noise and wind.

(4) Permanent Magnet Systems--In this system, small permanent magnets representing numbers are fastened to the cars. To be effective, however, the magnetic reader must pass within a fraction of an inch of the magnets. Such small spacings or tolerances generally are not practical in railroad operations.

(5) Piezoelectric Responder System--A piezoelectric responder system has been developed in the United States. The roadside element is a transmitting and receiving unit with an aerial mounted on the track between the rails even with the railhead. The car unit is a piezoelectric responder mounted approximately 5 in. above the rails. The responder contains one or two piezoelectric crystals for each decimal digit within the car's identification number. The trackside oscillator produces a variable frequency output for the transmitting aerial. The transmitted signal sweeps through the range of frequencies to which all the piezoelectric crystals in the responder could be sensitive. As the varying frequency corresponds to each crystal frequency, a pulse of energy is transmitted back to the aerial on the track.

4.1.4 Detectors

4.1.4.1 Wheel Detectors

Wheel detectors are indispensable in the performance of a number of automated functions in a yard. They are an integral part of an ACI system, in-motion scale, power switch, or hot-box detection system. They are also installed to perform car-velocity measurement and many other tasks.

The operation principle of a wheel detector is simple. The passage of a ferric wheel will alter the magnetic field that exists in the neighborhood of a rail section. The change in magnetic field will then induce a current in a nearby coil, and electronic detection of this induced current signifies a passing wheel. In a wheel detector made by General Railway Signal Company (GRS), the magnetic field is supplied by a permanent magnet. The pickup coil and the permanent magnet are enclosed in a single package mounted on one side of a rail. The WABCO wheel detector features an electromagnet. It has a transmitter section that houses a field-generating coil and a receiver section that contains the pickup coil(s). The two sections are bolted on opposite sides of a rail. Two pickup coils are embedded in the receiver section in WABCO's directional wheel detector.

The simplicity of the magnetic wheel detector should make it a very rugged and reliable instrument. Surprisingly, however, the SRI project team has heard a number of complaints about its frequent failures. Although the statistics of the breakdown frequency and the nature of these failures are unknown, we suspect that they may be the result of physical damage such as that caused by dragging equipment. Another common complaint is excessive initial cost.

4.1.4.2 Hot-Box Detectors

A hot-box detector is a thermal sensing device that detects impending failures in wheel bearings. Because a bad bearing has to be in normal operating condition for some time before it will show signs of overheating, hot-box detectors are usually installed on a running track miles away from a classification yard. Because most yards have computers and data-processing facilities, however, it is a common practice to install hot-box detectors in the periphery of a yard and to monitor their outputs in the yard.

The operation principle of a GRS hot-box detector (called a "wheel thermo-scanner unit" by GRS) is that infrared radiation from a hot-box detector is focused onto a small photoconductive crystal that changes its resistance when exposed to electromagnetic radiations. Electronics in the system senses this change and transforms it into a voltage signal that then drives the pen of a strip-chart recorder. To produce a practical device, the following features must be incorporated into the detector:

- a) Alignment such that the scanner always senses radiation from the identical spot of each wheel bearing.
- b) Automatic ambient temperature compensation so that the detector can operate under a wide range of ambient temperatures, typically from -20° to 140°F .
- c) Accommodation of train speeds from 5 to 85 mph, accomplished by using a short-time window for sensing, typically a couple of milliseconds.
- d) Sensing of train approach, accomplished by wheel detectors. Additional wheel detectors facilitate bidirectional sensing.
- e) Snow removal.
- f) Lightning protection.
- g) Lens cleaning.

The technology of the hot-box detector is well developed and its reliability has been proven. Its only shortcoming is its inability to distinguish between a journal bearing and a roller bearing. Because a roller bearing under normal operation runs hotter than a journal bearing, it is difficult to determine the alarm-threshold setting. If a low-level alarm setting for early detection of an overheated journal bearing is employed, too many false alarms will be encountered on the roller bearing. A higher setting consistent with the roller-bearing operating temperature would allow the failing journal bearing to go undetected. Servo Corporation of America, another major manufacturer of hot-box detective systems, recently announced a solution to this problem. The

heat-transfer characteristics of journal and roller bearings produce different radiation signatures. By using split-wave analysis, the detective system is able to distinguish between a roller and a journal bearing. Two different thresholds, therefore, can be employed.

4.1.4.3 Dragging-Equipment Detectors

This detector consists of a set of vertically standing steel plates, called "blades," which span the track from the field side of one rail to another. The blades are spring loaded to maintain their vertical standing but are pivoted near their roots so that they will be deflected when any dragging equipment comes along. The deflected blade closes an electrical contact and sends a warning signal. The detector is bidirectional and self-restoring and has an adjustable torque to minimize accidental tripping (such as by wind pressure) and an adjustable blade height to accommodate different sizes of rail. When installed on the mainline, the two outer blades are adjusted to the same height as the railhead, and the inner blades (usually four in number) are set at 1 in. below the railhead. In classification yards, the two blades flanking each rail are set at 2 in. above the railhead, and the middle blade(s) remains at 1 in. below the railhead.

Although the dragging-equipment detector will detect any low-hanging equipment on either side of each rail, any object dragged along the top of the rail (such as a dangling brake shoe) will go undetected. Wheel Checkers of Denver, Colorado, has marketed a patented electronic dragging-equipment detector which, in addition to the deflectable blades of a conventional detector, is equipped with two infrared beams scanning the top of each rail. When the two beams are intercepted simultaneously, such as by the two wheels of one axle, no alarm is sounded; if one beam is intercepted, the alarm is triggered.

The new detector, with its top-of-the-rail detection, undoubtedly contributes significantly to the state of the art. The additional feature, however, greatly increases its cost. Unless the cost-benefit can be demonstrated, its wide acceptance by the railroad industry is in doubt.

4.1.4.4 Broken-Flange and Loose-Wheel Detectors

A broken-flange and loose-wheel detector, available from Wheel Checkers, was first marketed 22 years ago. Its configuration and function were described by Gary Leadley of AAR.²⁵

The sensor system consists of a series of 124 spring loaded detector fingers oriented normal to a slightly offset section of rail. The opposite rail section is fitted with a guard rail to keep passing vehicles tight against it, establishing the necessary clearance between the inspected wheel and the

offset rail. The operation of the detector fingers is illustrated schematically in Figure 23. The approach of a train triggers the application of an electrical potential between the detector fingers and the rail. A normal wheel of proper gage will ride down the rail with the flange depressing the fingers sequentially by contacting the insulated wear plates. Since the flange prevents the finger points from touching the tread, the circuit remains open and no signal is generated. Should one of the fingers contact the wheel where the flange is missing its point would touch the tread and close the alarm circuit. When a wheel set that is out of gage, due to wheel looseness, improper mounting or excessive flange wear, passes over the detector finger, contact is made with either the finger point or the 1A03 spring depending on the direction of gage error. In either case, the circuit is closed and an alarm signal is generated.

Although the basic effectiveness of this sensor has been proven, the following two factors are thought to be responsible for its limited usage. (1) Broken flanges and loose wheels are relatively rare and do not constitute a major problem, and (2) because the sensor is an intricate device, it is susceptible to failures caused by insufficient maintenance and physical damage.

4.1.4.5 Presence Monitors

This is an electronic device designed to detect the presence of railroad cars and locomotives on a short length of track (30 to 100 ft). The operation principle of the WABCO device is that a wire loop in a figure-eight configuration is an inductive element that controls the frequency of an oscillator. The presence of a car, or any metallic mass, over this wire loop reduces the inductance of the loop, thereby increasing the frequency of the oscillator.

The amount of frequency shift is typically 1 to 2 percent. This small frequency shift is more easily detected by a heterodyne process that capitalizes on the phenomenon of beat frequency.

The figure-eight loop is fastened to the ties. Unlike a track circuit, it requires no electric connection to the track. Common applications of the presence monitor are electric switch locking, switch-lock release, and track-occupancy or track-clearance indication.

4.1.4.6 Wheel-Flaw Detectors

Railroad freight-car wheels often undergo severe stresses and heating. As a consequence, after a period of service, flaws can develop in a wheel that, if undetected, could lead to catastrophes. The wheel and axle manual of the AAR lists more than 20 wheel defects; among

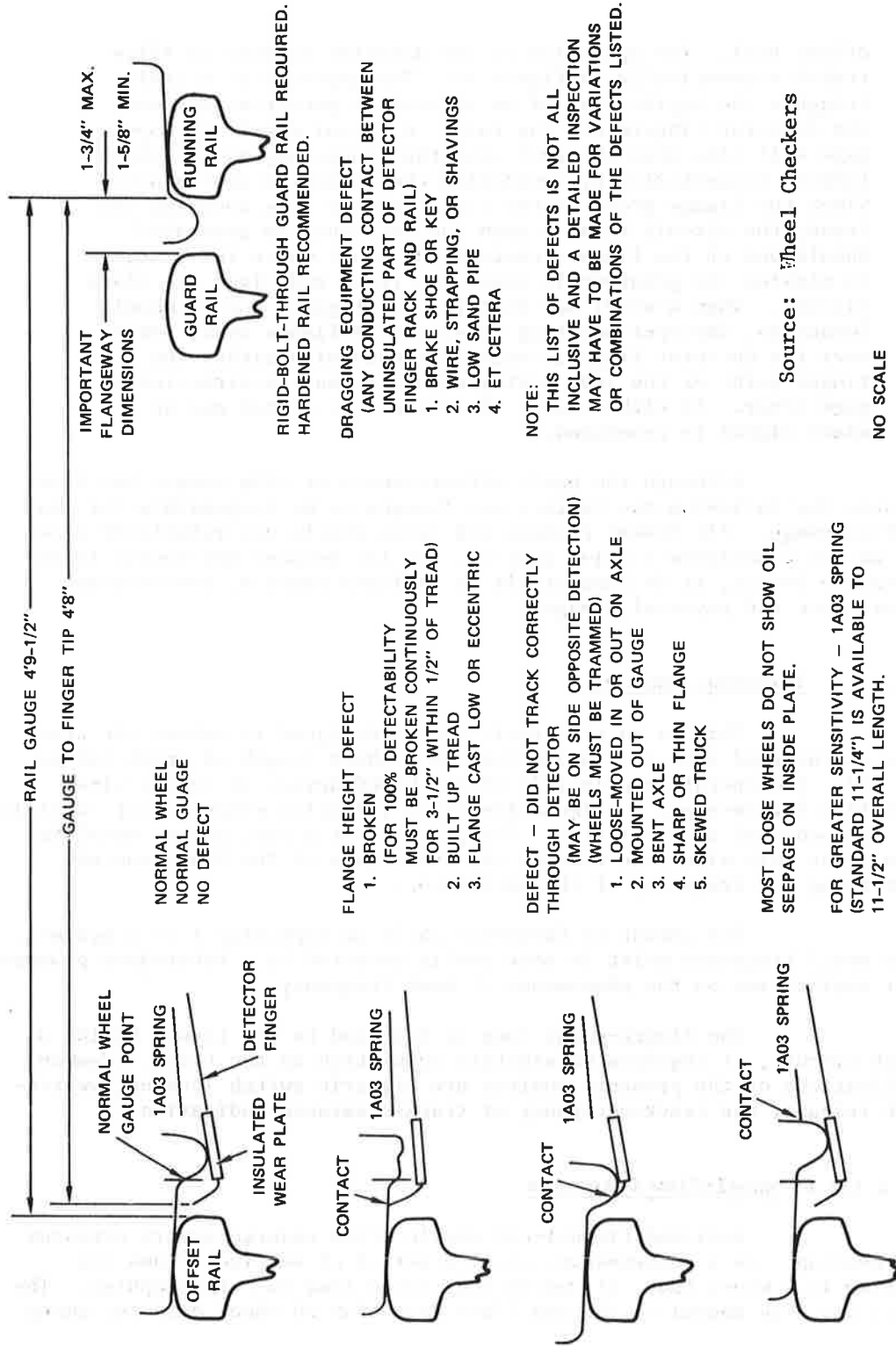

FIGURE 23 BROKEN-FLANGE AND LOOSE-WHEEL DETECTOR

the most common are burnt or shattered rim, shelled thread, thermal crack, broken flange, cracked or broken plate, and various subsurface flaws. Wheel defects have always been detected by visual inspection, supplemented at times by magnetic particle tests. Over the years, a number of wheel-flaw detectors have been developed but they are still in the experimental stage; some may eventually find their way into automated yards. Four wheel-flaw detection techniques are described below; for further details, see Reference 25.

(1) Ultrasonic Inspection--This technique is used primarily for the detection of cracks in wheels. The underlying principle is that cracks in an otherwise homogeneous medium would diffract stress waves, and these waves can be detected electronically. As a general rule, the shorter the wavelength or, equivalently, the higher the frequency, the better the resolution. This is why ultrasonic frequencies are used. Ultrasonic waves, however, have a fundamental shortcoming, they attenuate quickly in air. For this reason, in all in-motion ultrasonic detectors, a fluid-filled transducer boot (made of rubberized material) is needed to couple the ultrasonic-wave generator to the steel wheel. It is our opinion that such a fragile component cannot survive for long in a rugged railroad environment. In addition to the detection of cracks, ultrasonic waves also have been used to detect adverse stress conditions. Such detection relies on the fact that the propagation speed of waves is a function of stress. By a simple measurement of the transit time of a wave, therefore, the average stress level in the propagating medium can be inferred.

(2) Barkhausen Noise Analysis--The phenomenon that forms the basis of this technique is that the magnetization hysteresis loop of a magnetic material (such as steel) is not a smooth curve but is superimposed with noise. This Barkhausen noise level is a function of the stress within the material. By using an electromagnet and pickup coil, the feasibility of detecting residual surface stress in an overheated wheel has been demonstrated.

(3) Acoustic Signature Analysis--This technique is an attempt to transform the age-old method of listening to wheel ringing into a more scientific detection system. The experimental device consists of a trackside impactor and a microphone. The acoustic sound picked up by the microphone is spectrally analyzed to differentiate between a good wheel and a defective one. To develop this device into a practical detector, it is necessary to use an impactor, which can deliver uniform excitation, and a real-time sound analyzer.

(4) Magnetic Perturbation--This is a patented device offered by Wheel Checkers. It is analogous to a giant magnetic tape recorder. A continuous loop of magnetic steel tape comes in contact with

a magnetized rolling wheel that serves as an erasing head. Any nonuniformity in the wheel erases the signal recorded on the magnetic tape.

4.1.5 Speed-Control Devices

Most major hump yards in the United States and abroad use devices to control the speed of free-rolling freight cars within the switching and classification areas of the yards. There are two principal reasons for using speed-control devices. The first is to create and maintain sufficient separation (generally 50 ft) between consecutive cars in the switching area. This 50-ft separation requirement is a function of switch length, time required to move the switch, velocity of cars over the switch, and a safety factor. If the 50-ft separation is not achieved, the switch cannot be thrown for the following car, which causes that car to be switched to the wrong classification track. The second reason for speed control is to minimize the impacts between cars when they couple on the classification tracks. Impacts between cars with a velocity difference of 4 mph or more is undesirable because of potential damage to lading or to the cars themselves. The control of freight-car speeds is further compounded by a number of other factors, such as differences between the rolling characteristics of individual cars.

Most speed-control devices in classification yards used to slow freight-car speeds are called "retarders." Others are used to accelerate speed. These speed-retarding and speed-accelerating systems can be classified into clasp-type and nonclasp-type devices.²⁶

4.1.5.1 Clasp-Type Devices

Clasp-type devices are retarders that consist of two long steel beams or rails that flank the track rails and rely on friction to dissipate the kinetic energy of a rolling car. As a car rolls down the track, the steel beams are forced toward each other to compress the lower portion of each wheel. The friction between the contacting surfaces of the wheel and the beams causes retardation. Figure 24 shows the basic principle of retardation in clasp-type devices. The braking force achieved by these devices is proportional to the height h of the brake shoe (the steel-retarding beam) divided by the wheel radius r . The retardation force can be increased by either raising the height of the brake shoe or decreasing the wheel diameter of the car. The retardation force also varies directly with the contact pressure between the retarder shoes and the wheel rims.

The clasp-type device is fairly simple and is not as expensive as other speed-control devices. It can be purchased off-the-shelf from a number of major railroad suppliers. It is widely used throughout the world, and its operational capabilities have been thoroughly tested.

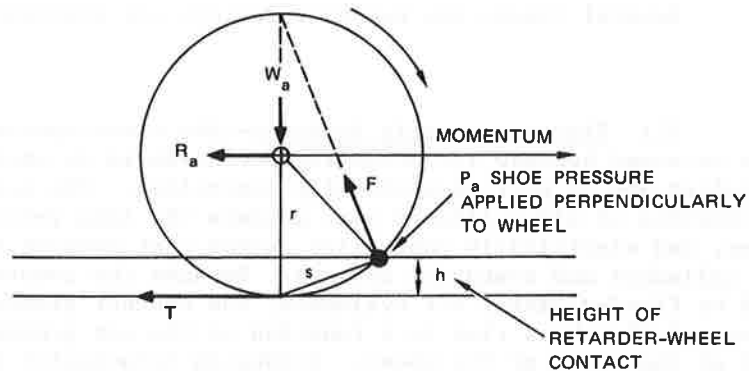

FIGURE 24 PRINCIPLE OF RETARDATION

Nonetheless, they do have some limitations and disadvantages. They can be used only to retard or stop cars, not to accelerate them. Because these devices are dependent on friction, slippery substances can contaminate the friction surfaces and reduce the effectiveness of the retarders. The consequence of this is overspeed cars that can and do cause damage. In fact, the National Transportation and Safety Board (NTSB) stated that contaminated wheels were responsible for the overspeed accident in the Southern Pacific's (SP) Englewood Yard that resulted in \$13 million worth of damages. Another limitation of clasp-type devices is their tendency to excite piercing wheel squeals. In recent years, many studies have been undertaken to understand the nature of retarder-induced noise and to investigate means for reducing the noise level and frequency of occurrence.²⁷⁻³⁴ Promising solutions and their shortcomings are listed below:

- a) Use ductile iron shoes instead of cast-steel shoes. The higher rate of wear of the softer iron shoes requires more frequent shoe replacement.
- b) Set up sound barriers on either side of a retarder. The 8-ft high barrier cuts off visual contact between the retarder and its operator.
- c) Apply controlled lubrication between the wheels and retarder. Lubrication reduces the effectiveness of the retarder.

Because these solutions are not 100-percent effective in eliminating squeal noise, better solutions may be found when more stringent noise standards are legislated.

Several clasp-type retarder devices are described below.

(1) Electropneumatic Retarder--The electropneumatic retarder is so named because its actuating mechanism is in part electrically controlled and in part pneumatically controlled. The actuating mechanism consists of air cylinders that actuate the long retarder beams, pipes, hoses, and electrically controlled valves that provide high-pressure air to the cylinders and restoring springs. Because the compressive force is supplied by fixed-diameter air cylinders, the contact pressure between the retarder and the wheel rims is a function of the air pressure and is independent of the width of the wheel. Graduated retardation is achieved by controlling the air pressure in the cylinders.

Electropneumatic retarders are found in most major hump yards and are commonly used for heavy-duty jobs. Some of them are designed to handle cars in excess of 160 tons. Heavy use means fast wear and, as a result, most of these retarders are equipped with replaceable shoes usually made of a softer grade of steel. Recently, to reduce the wheel-squeal noise caused by wheel-clamping devices, ductile iron shoes were installed on the gauge side of the retarder beam at the SP West Colton Yard. This appears to be the least awkward way of reducing retarder noise.

Because the control system on an electropneumatic retarder is electrical, it allows remote operation and an easy interface with automatic operation. In some new yards, such as the West Colton Yard, these retarders are controlled by a computer. Parameters, such as cut length, weight of cut, rollability, distance to couple, instantaneous speed, are input to the computer. The computer then calculates a target retarder exit speed and commands appropriate retarder action to achieve the exit speed. An electropneumatic retarder is sufficiently responsive and versatile to play such a role.

(2) Electric Retarder--This has the external appearance of an electropneumatic retarder but without the conspicuous air cylinders. The beams are actuated by mechanical linkages which, in turn, are driven by an electric motor. Low-power consumption is claimed because energy is converted directly from electrical to mechanical. Like the electropneumatic retarders, these devices are used for heavy-duty jobs and are adaptable to automatic operations.

(3) Spring-Loaded Retarder--This is the simplest of all retarders. The beams are biased in a closed position by mechanical springs and are forced open by approaching wheels. Because the squeezing force results from compressed springs, retardation is proportional to wheel width. To keep spring-loaded retarders as simple and inexpensive as possible, "abrasion" rails are used as retarder beams and no separate

shoes are necessary. The spring-loaded retarders are usually installed at the ends of classification tracks in a hump yard to bring the rolling cars to a stop and to prevent further movement caused by the impact of succeeding cars. This eliminates skates and skatemen previously used for this purpose.

(4) Spring-Loaded Retarder with Hydraulic Release--

Although a spring-loaded retarder does a satisfactory job of stopping the rolling cars at the end of a classification track, it nevertheless has a few shortcomings resulting from the fact that it is permanently biased in its closed position. As a result, when it is time to pull the train away after it has been assembled, one has to work against the force of the closed retarder. This creates:

Excitation of wheel-squeal noise

Excessive wear on the abrasion rails of the retarder

The need for extra power from the locomotive to overcome retardation force.

To eliminate these problems a spring-loaded retarder is furnished with a hydraulic system that forces open the retarder on command. Kits are available for converting to retarders with hydraulic releases.

(5) Weight-Responsive Retarder--A weight-responsive retarder is designed to provide retardation proportional to the weight of each car. The operation principle is shown in Figure 25. Because the device is symmetrical about a vertical plane, one needs to examine only one-half of the retarder.

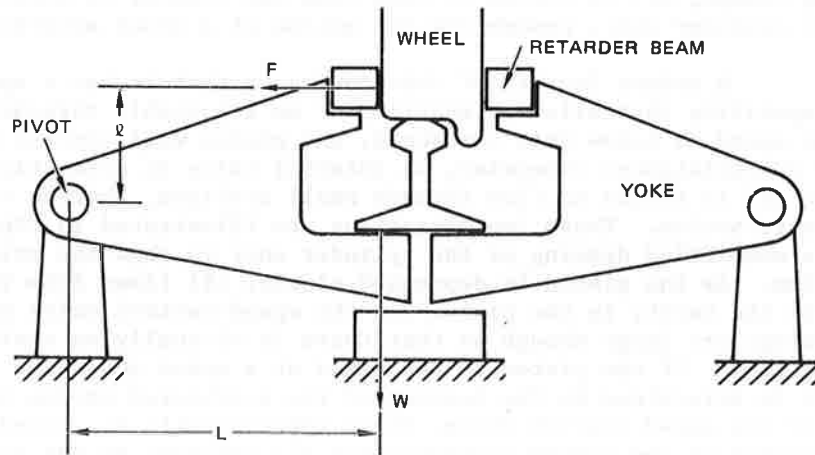

FIGURE 25 PRINCIPLE OF WEIGHT-RESPONSIVE RETARDER

The running rail is supported on the lower fork of a pivoted yoke; the upper fork bears the retarder beam. The compression force F is related to the weight W by

$$F = \frac{L}{\ell} W$$

Because F is proportional to W , so is the retardation force. Hydraulic release can be added to a weight-responsive retarder so that it can be opened when the car is ready to be pulled out or when the speed has been reduced to a desired level.

4.1.5.2 Non-Clasp-Type

Non-clasp-type speed-control devices use hydraulic resistance and eddy current (among other principles) to dissipate the kinetic energy of a car. Most of these devices are still in the experimental stage. Development work is being carried out almost exclusively in foreign countries, such as Japan, Germany, and England. Many of these devices do not have the drawbacks of clasp-type devices; however, their cost effectiveness and technical suitability have not been determined. With appropriate modifications, many of them will be able to accelerate as well as decelerate cars.

Non-clasp-type speed-control devices are described below.

(1) Dowty System--This is a non-clasp-type device first devised by Dowty Mining Equipment, Limited of England. It is also called an "oil pressure" retarder. It consists of a series of hydraulic cylinders bolted to the gauge side of the rail. A sliding piston in each cylinder contacts the approaching wheel flange. As the piston is depressed by the moving flange, oil is forced to flow from one chamber to another within the cylinder unit, resembling the action of a shock absorber.

A unique feature of this device is that it has a speed-sensing capability that allows presetting of an adjustable threshold. If the car speed is below this threshold, the piston will depress with virtually no resistance; otherwise, an internal valve is automatically closed and oil is forced to flow through small orifices, thereby creating resistance to motion. These two operations are illustrated in Figure 26 which is a simplified drawing of the cylinder unit to show the principle of operation. As the piston is depressed slowly, oil flows from the cylinder to the cavity in the piston via the speed-control valve openings. These openings are large enough so that there is virtually no resistance to the oil flow. If the piston is depressed at a speed above the threshold, which is determined by the loading of the calibrated spring and the openings of the speed-control valve, these openings will be closed. Further depression of the piston increases the oil pressure in the cylinder, which raises the pressure-relief valve. Exposure of the orifices allows oil to flow again to the cavity in the piston but with increased resistance.

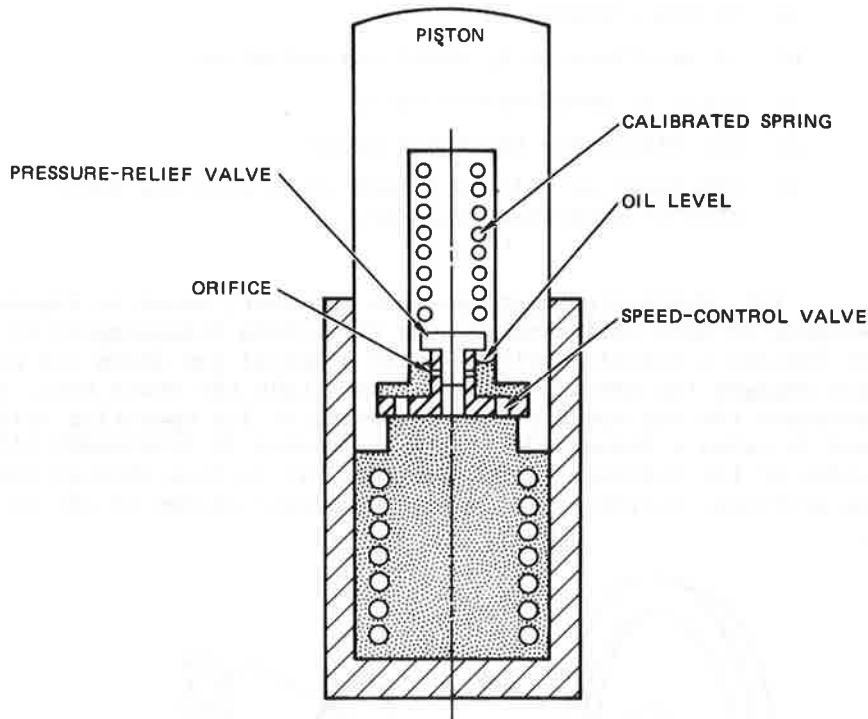

FIGURE 26 DOWTY CYLINDER UNIT

The Dowty unit illustrated in Figure 26 acts only as a retarder. With a modified unit called a "booster" retarder, cars can be propelled as well as retarded,^{35,36} and such a system has full control over car speed. A high-pressure hydraulic pump is required. This is demonstrated at Tinsley Yard near Sheffield, England,^{37,38} which consists of a main yard and a secondary yard with its own hump 3300 ft away from the main yard. Cars are moved from the first hump to and over the second hump without locomotive assistance. The Dowty booster-retarder system installed at Tinsley, however, has developed many problems related to the leakage of hydraulic fluid, and the newer yard installations generally do not use these units.

The Dowty system has been installed in classification yards in England, Australia, South Africa, and Japan.^{39,40} The Burlington Northern (BN) has also experimented with these retarders on test tracks in flatyards at Spokane and Denver. Their operational use has led to some modifications and improvements in the design and specifications, and these have reportedly increased the service life and reduced the maintenance cost of the units. The special features and merits of the Dowty system are that it:

- a) Is non-clasping
- b) Is uninfluenced by wheel contamination
- c) Emits no wheel-squeal noise
- d) Has adjustable threshold speed
- e) Can boost as well as retard speed with the addition of a booster-retarder.

(2) Hydraulic Retarder--This retarder, shown in Figure 27, was designed by ASEA (Allmänna Svenska Elektriska Atiegolager) of Sweden. It employs a rotating cylinder with a spiral cam along its periphery, which engages the passing wheel flange. Like the Dowty unit, this retarder measures the car speed at the beginning of its operating cylinder. If the speed is below a threshold, little resistance is developed; otherwise, rotation of the cylinder forces internal oil to flow through the restricting orifices, thereby converting the kinetic energy of the car into heat.

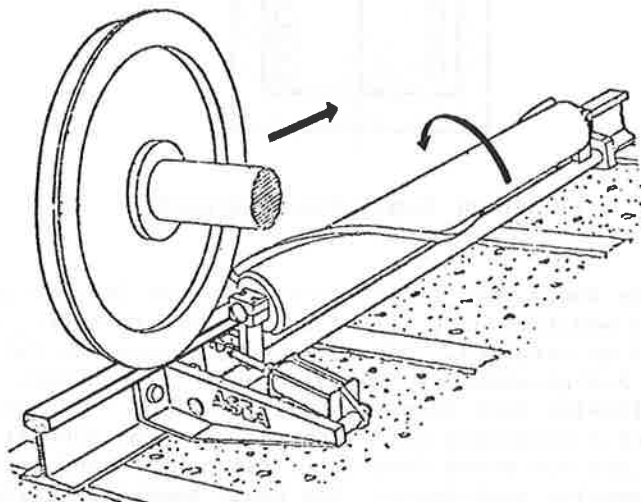

SOURCE: Reference 28.

FIGURE 27 HYDRAULIC RETARDER

In the Swedish design, the retarder cylinder is forced to rotate one revolution for each wheel passage. The rated capacity is 7240 ft-lb per wheel, roughly ten times that of a Dowty unit, but its high degree of complexity probably makes it difficult to compete with the cost-effectiveness of the Dowty system. It also does not have the flexibility for easy conversion into a booster retarder.

(3) Cable Device--Because the hydraulic retarder cannot propel cars, ASEA has developed a cable device to augment the hydraulic retarder.³⁸ This device is an endless cable looped between two driving capstans placed in pits under the track. The cable runs along the inner webs of the running rails. A carriage is attached to the cable and is equipped with retractable arms that contact the wheel flange with a pair of rollers. When a wheel overtakes the arm, the arm is pushed into its retracted position, thereby allowing the wheel to roll over the carriage.

Similar cable devices, capable of accelerating as well as decelerating cars, were built in Germany. It is our opinion that these cable devices are too complex, fragile, and expensive to become practical hardware in a railroad yard.

(4) Electrodynamic Retarder--The electrodynamic retarder was first developed in England in 1930,²⁶ and later in Germany^{37,38} and Japan.³⁹⁻⁴¹ Its principle of operation is a basic electrodynamic phenomenon. As shown in Figure 28, when a disk of conducting material is made to rotate in a perpendicular magnetic field, eddy current is induced in the disk in such a way as to oppose the motion.

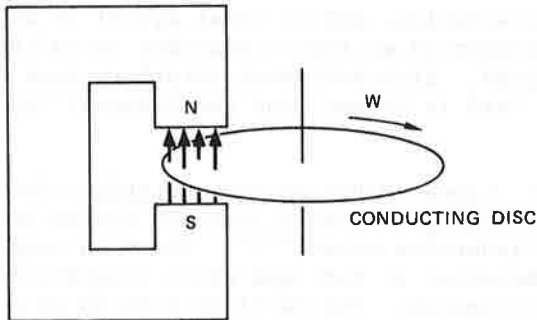

FIGURE 28 PRINCIPLE OF ELECTRODYNAMIC RETARDER

As a result, such a retarder is sometimes called an electromagnetic or "eddy current" retarder.

Among the various configurations of this retarder, a simple one developed by the Japanese is shown in Figure 29. Insulated conductors carrying direct current create a strong electromagnetic field. The wheel, modified rail, channel, and brake beam (all made of ferric material) concentrate the magnetic field so that a maximum field strength is achieved. As the rolling wheel cuts across the magnetic field, eddy current is induced and the wheel motion is retarded. This retardation is proportional to the current and the wheel speed. The only moving part in the retarder is the brake beam brought in contact with the wheel rim to

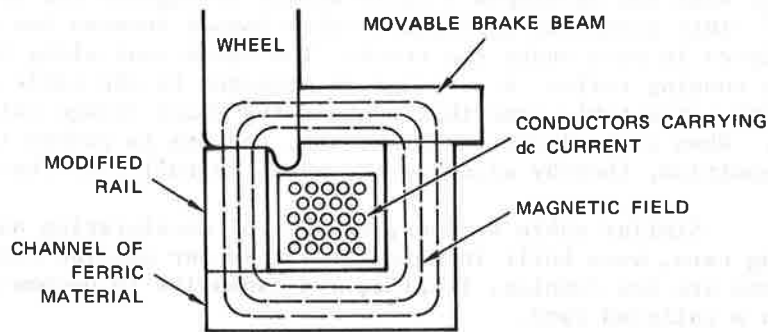

FIGURE 29 SIMPLIFIED CONFIGURATION OF AN ELECTRODYNAMIC RETARDER

ensure continuity of the magnetic circuit. Only 20 percent of the retardation comes from friction between the brake beam and the wheel. As a result, brake wear is minimal, contaminants on wheel rims have a negligible effect on retardation, and no wheel squeal is excited. The brake beam can also be segmented so that a retarder installable on a curved track can be designed. Electrodynamic retarders have been installed at the Basel-Muttenz Yard in Germany and the Takasaki Yard in Japan.

(5) Linear-Motor Booster Retarder--Since 1967, the Japanese have been developing a booster-retarder system utilizing the principle of the linear-induction motor.^{42,43} The main component of the system is a low-profile motorcar or carriage which constitutes the primary side of the linear-motor system. The carriage runs on an aluminum-clad reaction rail. The entire device is located in a bowl track in between the two running rails. As a humped car goes over this device, the carriage engages its wheels and the car will be either retarded or accelerated to the desired speed. The carriage then disengages itself from the car and returns to the starting point, ready to handle another car. This system is relatively complicated. Carriage return limits the number of cars one unit can handle within a given period of time. It is doubtful that this device can be developed into a practical booster retarder for yard operation in the near future.

(6) Rubber Retarder--Another non-clasp-type device is the rubber retarder.³⁷ The freight car moves on a rubber rail to effect retardation, and braking force is based on the elastic deformation energy of the rail. Retardation is controlled by hydraulically moving the rubber rail up or down. When it is in the down position, the car rolls normally on a steel rail; when it is in the up position, it contacts the wheel and causes retardation.

A major advantage of the rubber retarder is its noise-free operation. At the present time, however, it is believed to be impractical for U.S. applications because of the characteristically high wheel loads in this country.

4.1.6 Skates

A skate is a sturdy steel frame that fits and slides on top of the rails to stop a slow-rolling car on a track. There is no moving part. After a pair of wheels rolls onto a standing skate, their rotational motion is stopped and forward momentum of the wheels is transferred to the skate, causing it to slide along the rails. Because the wheels sit on top of the skate as it slides, the load carried by the wheels acts as a downward normal force. The frictional force between the skate and the rails produces retardation.

Before intercepting a moving car, the skate is positioned manually on the track. The consumption of manpower and the potential hazard to the skate operator have made them nearly obsolete. They have been replaced in most hump yards by spring-loaded retarders, weight-responsive retarders with or without hydraulic release, or by remote-controlled skate retarders.

4.1.7 Radar Speedometers

In a manually operated yard, retarder operators make visual estimates of car speeds and act accordingly to control the flow of traffic within the yard. As yards are converted into automatic operation, it is necessary for car speeds at various locations to be in the form of electrical inputs to the computer. In some instances, car speed is indirectly measured by a pair of wheel detectors. More reliable and continuous information can be obtained, however, by the use of a radar speedometer which sends out a beam of radio waves and measures the reflection of the waves from a moving target (utilizing the principle of doppler frequency shift). Radar speedometers are relatively simple devices; some of the smaller models can be hand held and are operated on batteries although these types are not used for yard process-control applications.

4.1.8 Turnouts

They are used at the branching or merging of two tracks to permit the movement of railroad cars, engines, or other track-mounted vehicles from one track to another. Because the major function of classification yards involves the movement of cars from one track to another, turnouts are an indispensable element in yard design and operation.

Although a number of turnout designs have been developed, the split switch is by far the most widely used.⁴⁴ This type of turnout switches cars from one track to another by moving a tapered switch rail (called the switch point) up against a stock rail on the track from which the car is to be switched. The railvehicle wheel flange is thereby diverted away from the stock rail as it passes along the turnout assembly and onto the route established by the switch point.

In the past, all turnouts were manually operated, generally by throwing a switch lever that was mechanically linked to the turnout assembly. Today, however, many turnouts, referred to as power switches, are remotely controlled either by electrical or electropneumatic linkages. One of the most important design and performance specifications of a power switch is its response time because this directly determines the allowable spacing between consecutive cars or cuts of cars. Most modern power switches have response times on the order of 1/2 second.

Almost all hump yards use remotely controlled power switches between the hump crest and the tangent points of the class tracks. In many modern hump yards, the operation of these switches in the switching areas is controlled by analog or digital computers. In a number of yards, the turnouts located in areas other than the switching are also remotely controlled power switches. Nearly all of the turnouts located in flat yards, however, are still manually operated at the switch location.

Although turnouts are necessary elements in a yard, they are expensive to buy, install, and maintain. The adjustment of the movement (or throw) of the switch point is sensitive, and misadjustments can cause misroutings and derailings. The various parts of the turnout are also susceptible to breakage or other damage that may render the turnout unusable.

4.1.9 Distance-To-Couple Measurement Systems

A major element of most automatic retardation systems is the determination of how far a car must travel before coupling with another car on its designated classification track. This information is used to calculate a retarder let-out speed, which will ensure that coupling speeds are below an appropriate level and, at the same time, will minimize the number of cars that stop short before coupling.

The earliest distance-to-couple (DTC) systems would count the cars entering each classification track and would then update the track inventory as an indication of how much space was still available on the track. This method, however, had a number of disadvantages primarily because the distance to couple was not actually measured. For example, the earliest systems could not detect when a car stopped short of coupling, which reduces the distance to couple for the next car. Additionally, some value of car length is required to convert car counts to a measure of the length of track occupied.

To overcome these and other problems, a number of yards have installed systems that actually measure the distance to couple, based on track circuits on the classification tracks. One method for determining the distance to couple is to measure the impedance of a classification track from the clearance point to the nearest axle of the car that last entered the track (the axle acts as a shunt across the track circuit). Because the impedance of the rails varies directly with the distance from the circuit origin to the nearest shunt, it is possible to correlate impedance with distance to couple. Variations and elaborations of DTC measurement systems can be found at individual yards.

4.1.10 Safety-Derail Devices

A safety-derail device can be installed at any point on a track where the intrusion of an unwanted rolling car can cause substantial damage. When activated remotely, it can cause an approaching car to derail, thereby avoiding a more serious consequence. This device is not a new design; it is simply a one-sided power switch.

4.1.11 Pin-Pulling Devices

In hump yards, uncoupling cars or cuts of cars at the crest of the hump is performed manually. The operator is called a pin puller. Pin pullers walk alongside a slow-moving train that is being humped and uncouples cars by lifting a long-handled lever bar that sticks out from between two coupled cars. The uncoupling action must occur before there is any tension in the coupling devices between the two cars; that is, uncoupling must be performed before the leading car is over the crest of the hump and begins to accelerate.

There are many problems associated with the pin-pulling operation. For example, in some of the newer yards, the speed at which the train is humped is limited by the performance of the pin puller because its speed must not exceed the walking pace of the pin puller. Experience at SP's West Colton Yard indicates that this speed is approximately 3.5 mph, or 6 cars per minute (based on 50-ft cars), although humping rates of eight to ten cars per minute (roughly 4.5 to 5.75 mph) are possible. Another problem associated with manual pin pulling is the inability of pin pullers to uncouple all cars successfully. This may occur for any of a number of reasons; some of the longer railroad cars are particularly susceptible to this problem. Other operational problems have been cited, and the safety level of manual pin-pulling operations has been criticized.

A number of devices have been suggested to reduce the problems associated with the pin-pulling operation. One such device, installed at the West Colton Yard, is an automatic pin-pulling unit that used rotating brushes, similar to those on street sweepers, to lift the uncoupling levers to uncouple the cars. This prototype system was manually activated and controlled. It appears, however, that the system could

be controlled automatically by the existing process-control computer located at the yard. After the original tests were performed, this prototype was dismantled and is not in operation.

The reliability, or successful uncoupling rate, of a single device was found to be 97 percent. The installation of another such device would allow those couplings not broken from one side to be uncoupled from the other side. Using such a system, the probability of successfully uncoupling a car would be 99.91 percent, implying several unsuccessful attempts per day at a large hump yard.

4.1.12 Closed-Circuit Television

Closed-circuit television (CCTV) systems are being used to assist in the performance of many functions in railroad classification yards. The major advantage of CCTV is that it is a relatively inexpensive means of inspecting and monitoring diverse and physically remote yard operations from a central location. This can save time and eliminate redundant intrayard transportation or communication of information.

Closed-circuit television is most commonly used in railroad classification yards to check car identification against consist information during inbound and outbound train movements. This procedure is meant to eliminate or reduce the need for walk-by inspections, thereby reducing manpower requirements. It has been postulated that ACI systems will eventually eliminate this particular use of CCTV. At this time, however, the readability (as low as 80 percent) of ACI labels is considered by a number of railroads to be too low to be useful in the performance of this function. Other surveys indicate that CCTV systems also may suffer from readability problems. Southern Railway, using CCTV to read car stenciling, found that, of 2569 cars surveyed, 8.8 percent had stenciling that was unreadable.¹⁸

Besides checking inbound and outbound consist information, CCTV systems can be used for the remote inspection of freight cars approaching the hump in retarder classification yards. Cameras can be mounted to view tops, sides, and undersides of passing cars. Outbound trains could be inspected by CCTV to ensure that cargo has been properly loaded. The CCTV cameras could also enable yardmasters to exercise general surveillance of the freight yard to facilitate identification, assessment, and correction of problem situations. The capability of monitoring operations in all parts of the yard is extremely valuable, especially when portions of the yard are not visible from the tower. A general yard-surveillance system could also be useful in controlling theft and vandalism although, in many cases, elements of CCTV systems have themselves been stolen or damaged. Many other freight-yard applications of CCTV have been suggested. The major problem encountered is limited usefulness during periods of reduced visibility.

4.1.13 Concrete Ties

The concept of using concrete ties in railroad construction was initially developed more than 50 years ago. Since that time, the development and testing of different tie and tie-fastening designs has made sporadic progress. A major reason for the continued development and testing of concrete ties is the desire for a more durable track structure capable of handling the increased stress caused by larger axle loads and faster train speeds. These factors can result in accelerated and excessive wear, crushing of wood ties under tie plates, widening of track gauge, and general misalignments of the track. Other reasons for the continued development of concrete-tie technology are the unavailability and increased cost of wood ties.

A number of concrete-tie and tie-fastener designs have been installed by U.S. railroads.⁴⁵⁻⁴⁹ Most of these installations are being used to test and evaluate different designs under various operating conditions although certain large-scale applications have been attempted. The majority of these test installations have been on mainlines; however, some have been installed in yard areas in an effort to determine their effectiveness in type of application.

At this time, the suitability of concrete ties in yard areas has not been conclusively demonstrated. Although it has been postulated that the life of concrete ties will eventually exceed 50 years, many have had to be replaced in less than five years because of various types of failures or problems. The most common problems associated with concrete ties include poor initial concrete, concrete deterioration, hair-line expansion cracks, and breakage and pullout of the tie-fastener devices. Concrete ties are also more expensive to purchase than wood ties, and their heavier weight increases the labor and machinery costs associated with their installation and maintenance.

4.1.14 Continuous Welded Rail

One of the most significant advances in railroad-track design has been the introduction of the continuous-welded-rail (CWR) process where individual standard 39-ft rails are welded together, thereby eliminating the requirements for joint bars or rail joints. The cost of this rail-welding process is reduced through the use of specially built rail-welding complexes in which individual rails are welded together to form single rails that can be hundreds or even thousands of feet in length (1440-ft lengths have become fairly standard). The rails are generally joined together by means of an electric flash butt-welding method although oxyacetylene butt-welding is also employed. Thermit welding is generally only used when making field welds.

After the rails have been welded into the appropriate lengths, special trains and equipment transport and lay these rails in remote locations. Ideally, to reduce expansion or contraction problems, CWR

should be laid at the average temperature within the range of measured or expected temperatures at the site. It has been claimed that CWR is much less expensive to install than normal jointed track.

The use of CWR minimizes the physical discontinuities at rail joints, thereby eliminating the familiar clicking sound associated with rail travel and providing a smoother ride. The major advantages associated with CWR are longer track-service life and lower track-maintenance costs because it dramatically reduces rail-end batter and abrasive wear. The elimination or large reduction of rail joints also reduces rail-joint maintenance such as tamping joint ties, replacing or tightening bolts, renewing joint bars, and renewing insulated joints and/or insulation. Such activities are said to account for 50 percent of *track* maintenance.⁴⁴ Railroads estimate that CWR reduces annual maintenance expenditures by at least \$200 to as much as \$1200 per track mile.

4.2 YARD COMPUTER SYSTEMS

The use of computer systems has become a major area of yard technology. Computers are used to perform two principal functions in switchyards: process control and information processing.

4.2.1 Process Control

The three basic processes that have been computer controlled in hump yards are switch operation, retarder operation, and hump engine speed. Switch operation is controlled by manual inputs, as an operator keys in the track assignments for cars, or by a punched paper-tape list. Retarder operation is controlled by the computer to assure a high enough impact speed for positive coupling but a low enough speed to avoid impact damage. Computer systems compute the retarder let-out speed from such inputs as car weight, car rollability, weather conditions, distance to couple, and the required time-spacing between cars. Computer control of hump engine speed is more precise and flexible than manual control.

Computers in hump yards installed before the mid-1960s were analog computers that used signal input quantities represented by voltage levels in the circuit. Analog computers use gears, motors, potentiometers, switches, and relays to perform the necessary computations on the input voltages and to actuate the switches and retarders. Analog systems have several disadvantages, however; they are sensitive to noise and have limited ability to store data in an easily accessible form. This can severely limit their effectiveness in hump yard applications. For example, analog-computer yards can often detect that a car has been misswitched but cannot identify the misswitched car. Additionally, much desirable statistical information about yard operations and control cannot be stored and retrieved. Therefore, corrections to the yard control system must be made without accurate knowledge regarding the historic performance of the existing yard control system. Another significant

drawback associated with the use of analog computers in hump yards is their inability to maintain the inventory of cars within a yard.

The development and refinement of digital computers during the 1960s dramatically increased their speed, reliability, computing capabilities, and storage capacities. At the same time, the price of storing a bit of information and executing an instruction was significantly reduced. During this period, U.S. industries found many diverse uses for digital computers. One of their numerous uses by the railroad industry was in the operation of freight-car classification yards. The first hump yard controlled by a digital computer was the Gateway Yard in East St. Louis, which began operation in 1964.

Since 1964, digital computers have usually been used instead of analog computers to provide process control in classification yards for reasons. For example, digital computers can control processes more precisely than analog computers. Because they are also more reliable, maintenance requirements are reduced. In addition, digital computers used in classification yards are general purpose, while analog computers are designed for specific purposes or applications. Related to this factor is the greater flexibility of digital computers; changes to the control system or strategies require only software modification rather than the redesign and/or modification of the hardware unit.

The digital computer, like the analog computers that preceded it, has been used to control the classification processes of speed retardation and switch operation. Beginning in the late 1960s, computerized control of hump-engine speed was also implemented at many yards.

The control of yard car retarders by digital computers does not differ substantially from the control by analog computers although the methods vary significantly. Car rollability characteristics are obtained from the measurement of such variables as weight, speed, and acceleration. Because some of these measurements are made by analog devices, it is often necessary to install analog-to-digital conversion equipment that accepts the analog signals and converts them to digital form so that the data can be processed by the digital computer. The characteristics of the individual classification tracks (gradient, curvature, and turnout configuration) can be permanently stored for use by the computer. Information concerning car rollability and track characteristics plus such factors as wind, cut length, and distance-to-couple is then utilized to determine the proper retarder exit speed.

The control of yard switches by digital computers is usually limited to the switching area between the hump and the classification tracks. To control the switching process, the computer must have access to information regarding the classification (or "class") track to which each car or cut of cars is assigned. This information can be input by an operator, using conventional pushbuttons corresponding to specific tracks, through the use of paper tape, or the information can be stored in the form of a switch list. Additional hardware elements required

for automatic switching are wheel detectors, presence detectors, and switch machines, all of which are track mounted. These devices allow individual cars or cuts of cars to be tracked through the switching area and switches to be automatically thrown when appropriate. The software associated with the automatic switching process determines when individual turnouts must be thrown to shunt the cars to the appropriate class tracks. The software also provides switch protection against fouling and catch-up. The computer switching software can also be designed to perform other functions, such as automatically swinging class tracks as they fill up or switching overweight or oversized cars to a specified track.

Automatic control of hump-engine speed was developed in the late 1960s in an effort to improve throughput over the hump.⁵⁰ Requested hump-engine speeds are compared to actual speeds measured by axle tachometers to provide control commands for locomotive propulsion, brake, and emergency systems. In this system, a desired speed is maintained accurately even while the number of cars being pushed is progressively reduced. Although most yards use a standard speed as the requested hump speed, some yards permit the requested speed to vary, depending on the tracks to which the remaining cars are going. If cars are going to the same or adjacent tracks the requested speed is lowered; if not, the speed is increased. This procedure allows higher overall hump rates because the speed is not always set to minimize catch-ups in the worst case (where cars are going to adjacent tracks in the same group). Variable humping speed can also be used to take advantage of the differences in cut size.

A simulation comparing the effects of variable humping speeds to those of constant humping speeds has been performed at various hump speeds by the Japanese National Railways.⁵¹ Some of the results of this simulation are plotted in Figures 30 and 31. Overall results indicate that the total time saved by using variable humping speeds is approximately one-third to one-half of the time required using a constant humping speed. These benefits appear to be substantially greater than those observed by SRI staff in a U.S. yard that utilizes variable speed humping.

In addition to controlling switch operation, retarder operation, and hump-engine speed, digital computers can be used as process controllers. For example, at Burlington Northern's Northtown Yard, the computer controls the spray of a solution of emulsified oil and water at the retarders. This emulsion, intended to inhibit retarder screech, is sprayed on the retarders just before the car enters the retarder section.

The flexibility of control offered by digital computers is likely to influence the development of other specialized process-control applications in railroad classification yards.

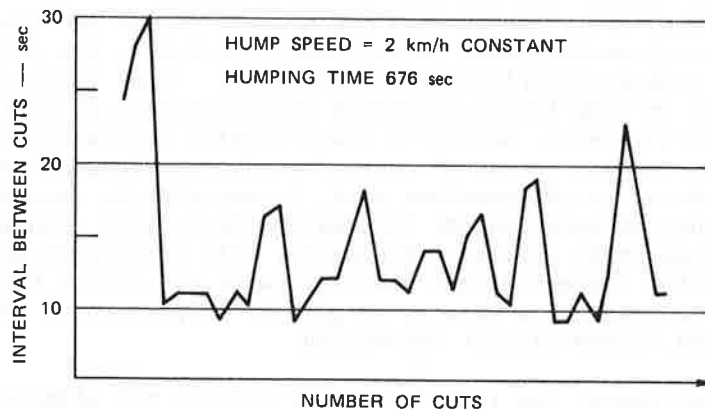

SOURCE: Reference 40.

FIGURE 30 RESULT OF JAPANESE NATIONAL RAILWAYS' SIMULATION USING CONSTANT HUMP SPEED

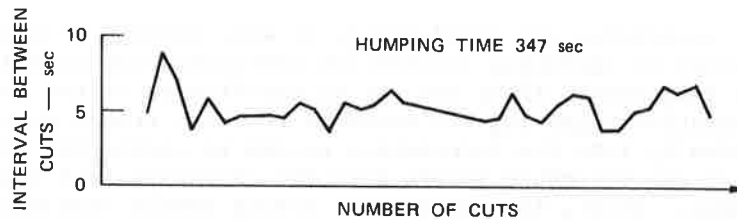

SOURCE: Reference 40.

FIGURE 31 RESULT OF JAPANESE NATIONAL RAILWAYS' SIMULATION USING VARIABLE HUMP SPEED

4.2.2 Information Processing

Digital computers can perform an information-processing function. The design of computer-based information-processing systems varies widely between yards. Generally, however, the primary function of such systems is to provide a perpetual yard inventory identifying which cars are located on what tracks or in what yard areas or zones. Inventories of most newer yards are kept in standing track order, at least for the classification yard, and often for the receiving and departure yard and the shop and industrial areas. Besides car identification and location, the inventory can also include information regarding load status, car length, tonnage, car processing, and event times.

The actual yard and track inventories change with the arrival or departures of trains from the yard or the movement of cars and cuts of cars within the yard. The process and procedures for updating the computerized yard-inventory data to represent accurately the actual yard inventory varies significantly between yards. Many yards utilize advanced consist information to establish the foundation of their inventory data base; however, because a train consist is subject to change caused by the pickup and setout of cars, the advanced consist can be in error. When made up in the previous yard, it may also be incorrect. For these reasons, advance consist information is usually updated on an exception basis on train arrival. Typically, this correction process requires inspection through direct observation of the actual train arrival. This may require a walk-by or pull-by inspection or may be done remotely via closed-circuit television.

In most cases, the introduction of ACI has not eliminated the consist inspection and correction process. The error rate of ACI input may be greater than the error rate of the advance consist information. The low-readability rate discourages the use of ACI scanner data in the input process; however, this problem has been reduced at GTW's Elsdon yard in Chicago and Kansas City Southern's (KCS) Deramus Yard in Shreveport.^{18,52} Data-enhancement procedures have been developed that enable the yard computer to utilize both train consist and ACI input to develop acceptably accurate inventory information, thereby significantly reducing manual inspection and correction processes.

The procedures described above, or some variant of them, are fairly successful in capturing information concerning car arrivals and updating yard inventory. After the car is established in the inventory, however, information regarding its movement to other tracks or yard areas is entered manually into the information system to update the inventory. Manual updating can introduce errors into the inventory data base in two primary ways. First, the majority of errors result from mistakes in the manual data-entry process; although the error rate will vary because of the complexity of the input procedures and other factors, error rates as high as 15 percent have been reported.⁵³ Second, errors can be introduced as a result of the incorrect movement of cars within the yard, including such actions as moving too many or too few cars, taking cars from the wrong tracks, and switching them over to the wrong track. The error rate caused by these problems is generally around 1 to 2 percent in most flat-switching operations.

In newer hump yards, given the sequence of cars to be humped (the hump list), the computer automatically updates the classification-track inventories. This process generally uses information from the process-control computer that follows individual cars through the switching area. The class-track inventory produced through this method will accurately account for misswitched cars.

Another process designed to update yard inventory information automatically is being implemented at the KCS's Deramus Yard in

Shreveport and at a number of GTW flatyards.⁵² This procedure requires that the yard have wheel detectors at the entrance and exit of every class track and along the switch lead. By detecting and counting the number of cars taken from or added to specific tracks, the track inventories can be adjusted. This requires the initialization of track inventories in standing track order and fairly complex software and processing capabilities. Because neither the KCS nor the GTW system has been fully implemented, their effectiveness remains unproven.

With the availability of accurate inventory information, the digital computer can perform other functions that assist railroad and yard management. One of the principal functions is the generation of yard-performance evaluation and operational reports. These reports provide management with such data as the cost of various types of car movements, the time required to process cars through the yard, and the reliability of cars in meeting schedule commitments. From this information, management is able to evaluate yard performance and analyze the effect of change in yard or system operations. Accurate computerized inventory information also facilitates intercomputer communications and rapid processing and exchange of data related to billing, demurrage, and car interchange. One railroad has reported that the additional income gained from more accurate and rapid processing of billing, demurrage, and interchange information has more than covered the cost of the data-processing equipment used to perform this function.

Digital computers can also be used to plan yard operations and assist management in making operational decisions. Some of the possible functions of such computer-augmented planning and control systems could include selection of receiving tracks to be used, sequence of trains to be classified, dynamic assignment of classification tracks, selection of departure tracks, scheduling of outbound train makeup and departure, and optimal assignment of road power. Most computer-augmented yard-planning systems are in the developmental stages, and the overall effectiveness of such systems has not yet been proven.

4.2.3 Computer-System Configurations

The use of digital computers to perform yard control functions and to store and process operational data and management information has been widely accepted throughout the railroad industry. No standard computer-system configuration to accomplish these functions, however, has yet been widely adopted. Even separate yards operated by the same railroad have radically different computer-system configurations.

One reason for these differences is that not all yards utilize their computers to perform the same functions. For example, in a number of flat yards, digital computers are used for information processing in support of operations and management functions but are not used to control yard processes. Even among similar hump yards, the tasks performed by digital computers vary significantly. For example, in nearly

one-fourth of U.S. digital-computer-controlled hump yards, the computer does not perform inventory functions, and these hump yards use ACI input for inventory processing.

A more significant factor that has influenced the development of different computer-system configurations is the dramatic advance in computer technology since the first digital-computer hump yard in the United States was completed in 1964 (Gateway Yard in East St. Louis). This advancement is partially illustrated by the dramatic decrease in minicomputer prices since 1964. As shown in Figure 32, the cost of a functional 16-bit word machine with 4096 words of memory has decreased over the past decade at an annual rate of approximately 20 percent.^{54,55} The general decrease in hardware costs over this period brought many more machines with greater computing capabilities into a price range that was acceptable for yard applications. This increasingly wider choice of machines and computer capabilities facilitated more sophisticated data processing and control at recently constructed or modified yards than at the earlier digital-computer hump yards.

During the past decade, digital computers have been installed in U.S. hump yards at the rate of approximately two per year (see Figure 33). According to a survey by the American Railway Engineering Association (AREA), more than half of these installations utilize a single computer with a relay backup that can be used to restart and maintain semi-automatic yard operations after failure of the computer.⁵⁶

The AREA survey also indicates that two yards have only one computer. In both yards, the computer is primarily used for process control; it does not perform yard inventory functions. A major disadvantage of such systems is that the operation must revert to a completely manual mode in the event of a computer failure. The other yards have some variation of a multiple-processor systems. One example of such a system is when two or more processor units share the total processing load until one of the machines fails. If one processor fails, the other will perform as much of the processing load as possible. If the single processor is capable of performing all required tasks, the system is essentially a "fail safe" system. If the single processor is not capable of performing all required tasks, certain of the less essential tasks may have to be performed manually, and this system is referred to as a "fail soft" system. Another example is when backup processors operate in "hot standby," in which a secondary processor actually duplicates the work of the primary processor. The secondary processor is not used for offline processing. If the primary processor fails, therefore, the secondary processor is capable of continuing yard operations with little delay. When both processors are functioning, additional error checks can be performed. The SP West Colton Yard uses this type of system for its process-control system.⁵⁷

In still other types of computer systems, the backup computer is used for off-line processing when the primary computer is operating normally. If the primary computer fails, however, such off-line processing

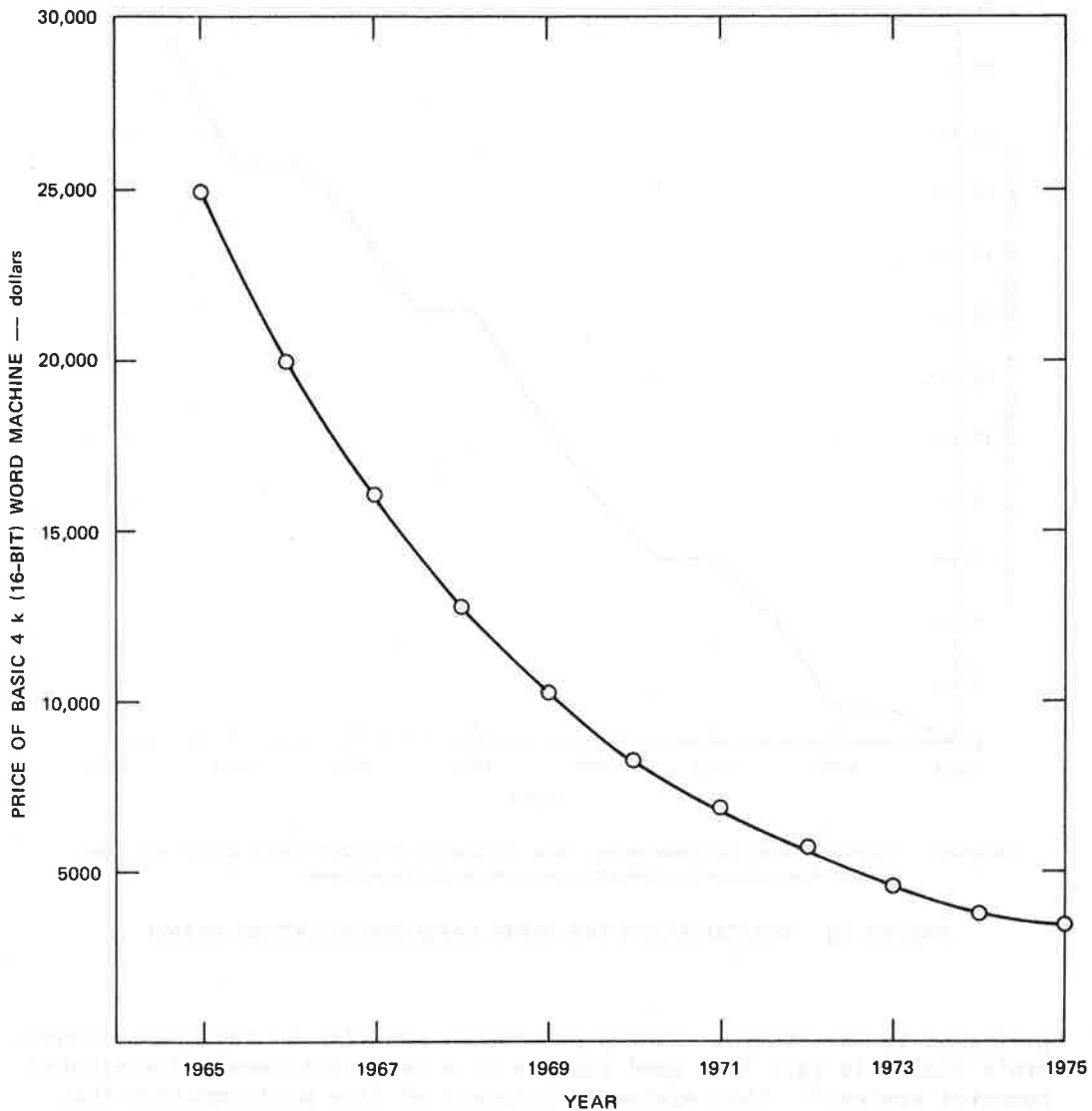

SOURCE: Datamation, May 15, 1971 and July 1974.

FIGURE 32 BASIC MINICOMPUTER PRICE TREND

is discontinued and the backup computer starts performing the functions of the primary computer after only a slight delay caused by the switch-over process.

Another variation of a multiple-processor system is the distributed computer system in which each processor is dedicated to the performance of a limited number of functions.^{58,59} The failure of any one processor, therefore, does not interfere with the tasks or functions

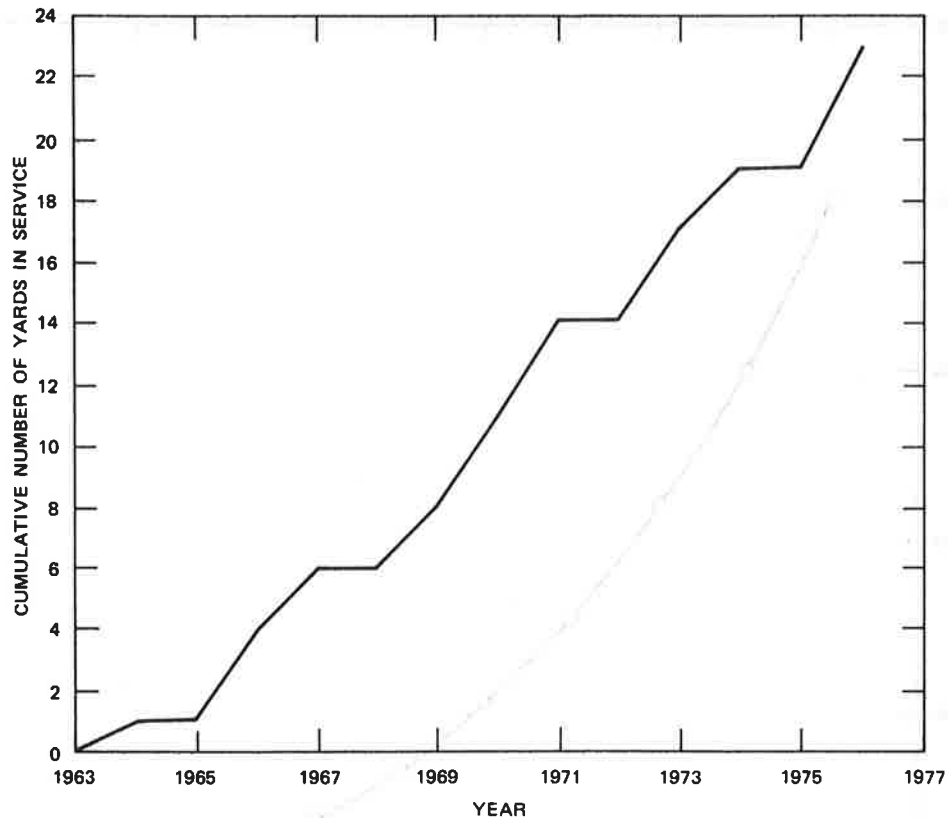

SOURCE: "Railroad Freight Car Classification Yards: Installation 1976-1924" Union Switch and Signal Division, Westinghouse Air Brake Company, Swissvale, Pennsylvania.

FIGURE 33 DIGITAL-COMPUTER HUMP-YARD INSTALLATION TREND

performed by the others. Backup processors can also be included. Southern's Sheffield Yard is a good example of a yard that uses a distributed computer system.⁶⁰ This system is composed of five minicomputers that perform the following functions:

Operational Information System (OIS)

- One computer for inventory control
- One for OIS backup.

Process Control System (PCS)

- One computer for automatic retardation and hump-engine speed control

- One for automatic switch operation
- One for PCS backup.

A more detailed summary of yard computer-system configurations is presented in Table 22.

Another aspect of computer-system configurations that varies among yards is the relationship between yard computers and the railroad's centralized computing system. It is generally not practical to use a remotely located centralized computing system to perform such process-control functions as retarder control, switching control, or hump-engine speed control. Computer systems at many yards, however, often share the processing of management and operations information with a centralized computer system that is not located within the yard and may even be hundreds of miles away. In other yards, nearly all information processing is done by computers located at the yard. The design of the processing interface between the yard computer system and the railroad's central computer facility will depend on many factors, such as whether the central computer is currently underutilized or whether data links already exist.

The type of digital equipment selected for yard computer installations is influenced by the type of tasks or functions the computer system is to perform and by the performance capabilities of equipment within an acceptable cost range. Historically, the price of yard computing systems has been a fairly small portion of the total yard cost. The decreasing cost of computers and improved technology have greatly increased the capabilities of those computers within a price range that is acceptable for most yard applications.

The types of digital computers selected for the early digital-computer hump yards were designed principally for process-control applications. Early models, such as the Honeywell X16 series, were characterized by a large number of I/O channels, small-to-medium size memory (12 to 24K) words, small word size (generally 8- to 16-bit words) to allow faster memory access, and limited software capabilities. In the more recently constructed hump yards (in service since 1972), there is a definite trend toward the newer minicomputers that are more capable of performing inventory processing and other operational and management information-system functions. These machines tend to have larger memories (typically 32K) than their predecessors and a larger word size (up to 32-bit words) to allow more accuracy in the storage and processing of information. They are also generally faster. These minicomputers can be mounted in racks or even on desk tops, whereas the older process-control machines are large and must be housed in a freestanding enclosure. The newer minicomputers can also be connected with a wide variety of peripherals that can be used in support of yard operations. Most of the relatively few flat yards that utilize digital computers for information processing have installed these more powerful minicomputer systems.

The trend in classification yard computer hardware tends to be toward faster, more powerful, and more flexible machines. The yard

computer systems installed during the next few years should be capable of performing more of the operations-planning, decision-making, and analyses functions than are currently performed. The software packages (such as yard simulation, train scheduling, and power and crew assignment programs) required to support these functions, however, will also become more complex and possibly more yard specific. The development of this supportive software will probably require an increasingly larger share of the total computer-system development cost.

4.3 ROLLING-STOCK TECHNOLOGY

The principal operations performed in railroad switchyards generally involve some processing of rolling stock. For this reason, certain technology associated with railroad rolling stock can influence significantly in the design and operation of switchyards. This chapter describes rolling-stock technology that may have significant influence on the operation of railroad switchyards.

4.3.1 Freight Cars

Freight-car design often has an impact on the difficulty or ease with which cars are handled in a switchyard. For example, freight cars that approach or exceed the accepted design limits of length, height, or width or especially equipped freight cars often require special and/or additional hand'ing within a yard.

4.3.1.1 Design Limit Cars

To reduce costs and to provide good customer services, railroads are using cars that equal or exceed the limits specified for interchange operation.⁶¹ Long cars and those with high centers of gravity must be carefully positioned in relation to other heavy or long cars within a train, thereby necessitating switching in addition to that required when all cars for a single destination are blocked in random order.

Long cars occupy more space as they roll through a hump yard and take up further space on the classification tracks. The truck location on long cars results in a significant overhang. This overhang results in a displacement of the car end if it comes to rest on a curved section of track and makes coupling to a conventional car impossible. As a result, additional foresight, effort, and time are required to handle cars that approach or exceed the design limits.

4.3.1.2 Equipment That Minimizes Impact-Related Lading Damage

Two devices designed to minimize lading damage resulting from high-speed coupling impacts in yards and impacts and vibrations along the road are:

Car cushioning

Internal bracing and restraint.

An experimental unit, called "Sonicar," also protects lading by preventing high-speed impacts in yards.

(1) Car Cushioning--Two types of car-cushioning devices designed to absorb impacts that result from a car striking or being struck by another car during the switching process are the sliding sill and end-of-car cushions.

In sliding-sill cushioning, the couplers at both ends of the car are attached to a single sliding member that travels inside the center-sill member of the car for its entire length. This movable device is restrained to the main body of the car by means of sliding friction plates, hydraulic dampers, and springs members. The impact on the couplers initially results in a displacement of the sliding sill, which is gradually transmitted to the car. The installation of this device is relatively costly because the undercarriage of the car must be designed to accommodate it. The sliding action also affects the longitudinal characteristics of load handling on the road, especially on rolling terrain.

End-of-car cushioning devices constrain the travel of the coupler in the draft-gear pocket by means of friction plates and rubber springing that will absorb a limited degree of impact on the coupler. Variations on end-of-car cushioning include a device that provides more coupler travel by means of a specifically designed draft-gear pocket and a device that utilizes hydraulic snubbers that extend from the end of the car for a sufficient distance to contact the body of the oncoming (or stationary) car, thereby providing a shock-absorbing action.

The widespread use of sliding-sill and end-of-car cushioning would lessen the damage caused by high-speed impacts and thus give switchyard operations wider latitude in controlling the speed of cars. Acceptance of higher speed impacts would also enlarge the capacity of hump yards by allowing faster humping rates. The high cost of sliding sills, however, discourages their uses, and the end-of-car devices are not completely effective because of their limited travel. At this time, only a small fraction of the boxcar fleet has any cushioning. As a result, switchyard operations are conducted as if cushioned cars were as sensitive to high-speed impact as those not so equipped.

(2) Internal Bracing and Restraint--Effects of shocks incurred during switching impacts are amplified if there is free space in or around lading, which allows individual units (such as cartons of canned goods) to gain considerable velocity before impacting adjacent units. Several approaches are used to minimize free space--internal bracing, inflatable dunnage, and movable car partitions.

Internal bracing dates back to wooden boxcars, when wooden bracing could be nailed crosswise to the sides of the cars to prevent the loaded cartons or barrels from moving. Modern steel boxcars are sometimes equipped with special "nailable" floor sections that can serve as anchor points for the bracing.

Inflatable dunnage consists of airtight bags of paper, plastic, or rubber that can be inflated between endwalls and lading or in open spaces near the center of the load. Inflation of these bags forces lading snugly against adjacent lading or the endwalls to minimize excessive clearances.

So-called dunnage-free (DF) cars include movable doors or bulkheads that can be positioned across the car to segment the load and minimize free play. The bulkheads operate on their own tracks and jacking devices apply additional force for installation.

Other restraint devices include straps or bars anchored to points permanently installed in the car to restrain lading movement. Some lading, particularly newsprint rolls and coiled steel, are carried on special racks to provide restraint and support that will reduce the effect of impact. These items are particularly susceptible to damage in transit; damage to the rolls or coils will badly unbalance them, and they will not be able to be fed into high-speed processing machines.

Racks and other restraint devices allow normal, but not abnormal, handling of the cars. That is, without the restraint, a car might not be able to be humped or kicked, but would have to be ridden by a brakeman or shoved to rest or to couple by the engine.

(3) Sonicar--A different and unique approach to the prevention of high-speed impacts in freight yards was utilized in an experimental device called the Sonicar,⁶² based on an additional air-brake reservoir to provide braking power after the angle cocks are opened. A sonic unit measures the distance to the stationary car, and a wheel-connected alternator produces power and measures car speed. These signals are connected to logic circuitry that operates the air brakes in such a way as to bring the car to a position about 25 ft behind a stationary car at a speed of approximately 3 mph, at which point the unit disengages and the car rolls to a positive and reliable coupling. Economic considerations have prevented widespread use of the Sonicar.

4.3.2 Automatic Coupler Systems

4.3.2.1 Existing Coupler System

The current system of coupling cars together to make up a train consists of a mechanical connection that transmits drawbar forces

throughout the train and an air-brake connection that controls the brakes on each car.

The air-brake system is charged to a pressure of approximately 90lbs and is maintained by a reservoir in each car. After the reservoirs are charged, reduction of the pressure in the supply line would actuate the brakes on the cars by the force of the air stored in the reservoir. If the train becomes disconnected on the road, the open air line immediately causes the pressure in the line to drop, and the brakes on the uncoupled cars will be applied. The air-line attachment between cars is a fitting that connects with a rotation between the two parts but is disconnected by the separation of the cars. When cars must be classified, the reservoirs must be emptied, or "bled," an operation accomplished by manually opening angle cocks at the end of each car. The trainman must step between cars to perform this operation.

Cars can be connected mechanically by a yoke pivoted on each coupler and locked into place by a pin. The coupler usually remains in an open position until it is mated with that of another car, at which time the pin drops into place. Cars are uncoupled by operating a lever at the side of the car that lifts the pin from one of the couplers.

In the current system of car coupling, an inbound train must wait for some time on a receiving track while a crew opens the angle cocks on each car. The train is then broken up after classification, either by flat switching or on a hump. In either case, the pins must be pulled by manually operating a lever to separate the cars as needed. (The air hoses are pulled apart when the cars separate.) When blocks of cars are made into a train, the angle cocks must be closed and the air hoses coupled together in an operation that train crews call "lacing the air." Then the reservoirs are charged by connecting the train to a supply of air. After charging, air flow is measured to assure that there are no leaks in the system.

The bleeding, charging, and testing of the air-brake system consume not only time but also labor, performed under dangerous conditions to open and close angle cocks, lace air, and pull pins.

4.3.2.2 Proposed Coupler System

To alleviate some of the problems inherent in the existing coupler system, automatic couplers have been proposed. The most rudimentary system would provide for the automatic connection of the air lines at the same time that the mechanical connection is being made. The air connection would be affixed to the couplers, and guides would direct the couplers to a positive mating of the air lines while the couplers were being mated. European passenger trains and rapid-transit cars in the United States have used such systems for many years although coupling and uncoupling does not occur frequently in these applications. Automatic air coupling and the saving of air in the reservoirs would

eliminate the labor and time involved in bleeding, lacing the air, and charging the brake system.

After the concept of making an automatic air connection was well established, engineers began to consider the potential for making automatic electrical connections between cars.⁶³ These connections are about as complex as air coupling.

With an electrical connection, several new control concepts are possible, such as an electric rather than a pneumatic brake signal. The electrical brake signal would act almost instantaneously on all cars, rather than having to control the train that has a signal lag for brake application between the engine and the point of application. A 100-car train, the brakes on the last car are not fully applied until 93 seconds after the command is given by the engineer.⁶⁴ With suitable sensors, more electrical signals could be transmitted between car and engine to describe the condition of the load, the condition of bearings and wheels, or the quality of ride. These signals may augment an engineer's feel of train handling and allow him to handle the train better and prevent damage to lading.

When electrical control of braking becomes possible, such a system could be adapted to operations in the yard. Ditmeyer and Lang⁶³ proposed that the angle cocks be rigged to store the air in reservoirs in a "yard" position of the cock that would allow the car to roll freely with the air connection unfastened. At the same time, the electrical control of the brakes could be actuated remotely to act as a retarder to control the impact velocity of the cars in much the same way as in the Sonicar. If electrical control signals were provided for each car, an operator on the train could remotely pull the pin on any coupler in the train and the need for manual pin-pulling operations would be eliminated.

The implementations of any of these concepts would change significantly, the operation of a switchyard; the amount of labor, costs, and delay time would be reduced, and the complexity of the yard and its equipment would increase. If only part of the car fleet is equipped with automatic couplers or remote control of pins or brakes, it may be necessary to set up separate yards to handle trains with equipped and nonequipped cars, and this would add operational and financial complications to railroad systems. The FRA and AAR are studying advanced concepts in coupling and braking systems

4.3.3 Switch Engines

Switch engines are an integral part of the operation of freight-car classification yards. Because they are the principal power used to move cars from one portion of the yard to another, they are an important element in the sorting and classification of railroad cars within the yard and in the movement of cars to and from industries located nearby.

It is highly unlikely that stationary devices within the yard, (such as hydraulic boosters, cable devices, or linear-motor booster) will eliminate the need for motive yard power before the end of this century.

4.3.3.1 Motive-Power Technology

The majority of the U.S. switch-engine fleet is composed of diesel-electric locomotives although some electric switch engines are in operation. Any future changes in motive-power technology used in yard switching operations will come about through improved operating economies (such as decreased fuel or manpower requirements), service, and availability, lower maintenance costs, decreases in damage to track structure, higher power output per unit weight, and better adhesion qualities. Some alternative motive-power technologies that may be applicable to switchyard operations are described in the following sections. It is unlikely that the introduction of any motive-power technology radically different from the diesel-electric unit will be widely adopted before the year 2000. There are many constraints to the replacement of tried and proven motive-power technology. This is partly evidenced by the amount of time that was required by the railroads to become fully dieselized (see Figure 34). Changes in switch-engine motive-power technology will be an evolutionary process over at least the next 10 to 20 years.

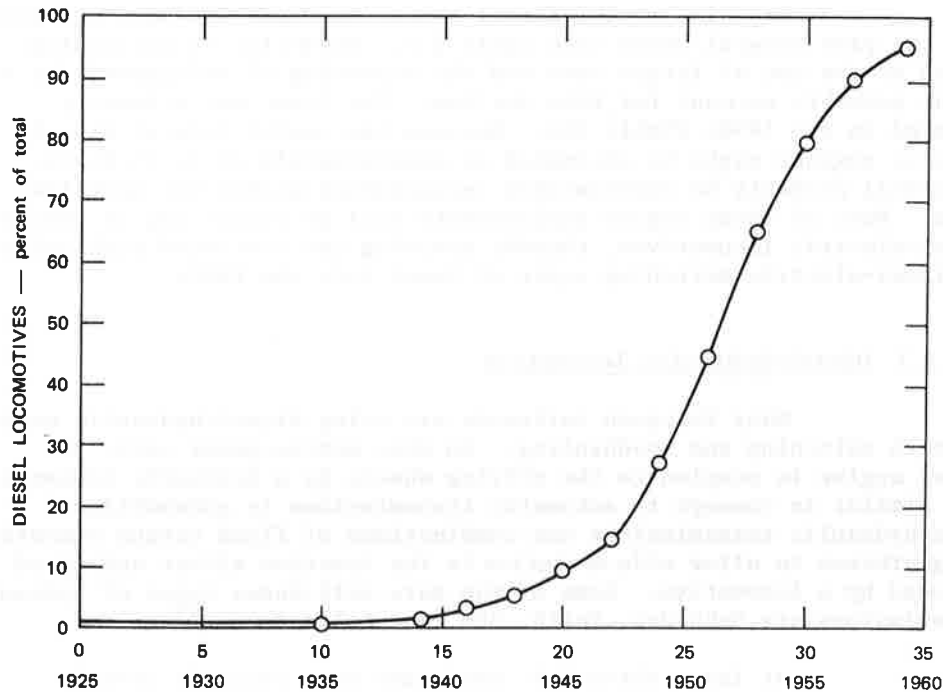

FIGURE 34 PATTERN OF DIESELIZATION BY MAJOR RAILROADS

4.3.3.2 Diesel-Electric Switching Units

Virtually all switching activity in the United States is performed by diesel-electric locomotives. In these units, a diesel engine drives an alternator that provides electric power to electric traction motors on the wheels. The engine is controlled by a throttle that selects the ranges of power and speed. Exciter controls govern the power fed to the traction motors, and they control current and slip in addition to maximum power draft from the diesel to prevent stalling.

The first diesel-electric locomotive manufactured in the United States was a switching unit built for the Central Railway of New Jersey in 1925. Until the advent of the streamliners in the mid-1930s, most diesel-electric locomotives were used for yard switching only, primarily because of their low horsepower-to-weight ratios and slow speeds.⁶⁵ Their advantages over steam locomotives for switching activities, however, included greater thermal efficiency, cleanliness, one-man operation, less frequent maintenance and repair, and smaller consumption of water. Continued development of diesel-engine technology has also dramatically improved their horsepower-to-weight ratios and speed characteristics. Currently, switching units are commonly in the 1000 to 1500 horsepower range although remotely controlled "B" units are often used in conjunction with controlled units to provide extra power.

The size of the diesel switching fleet has been declining over the past several years (see Table 23). Reduction in carloadings caused by the use of larger cars and the bypassing of switchyards by unit trains probably account for this decline. The fleet was primarily procured in the 1950s (Table 24). Because the useful life of diesel-electric engines might be estimated at approximately 20 to 25 years, there will probably be considerable replacements within the next few years. Most of these engine replacements will be either new or rebuilt diesel-electric locomotives, thereby assuring the continued high reliance on diesel-electric switching units at least into the 1990s.

4.3.3.3 Diesel-Hydraulic Locomotive

Many European railroads are using diesel-hydraulic units for both switching and roadhauling. In this motive-power unit, the diesel engine is coupled to the driving wheels by a hydraulic transmission similar in concept to automatic transmissions in automobiles. These hydraulic transmissions use combinations of fluid torque converters and gearboxes to allow wide variation in the tractive effort and speed produced by a locomotive. Some of the more well-known types of hydraulic transmissions are Mekhydro, Voith, SRM, and Rolls Royce.⁶⁷

At least three U.S. railroads have recently tested European-built 1250-hp diesel-hydraulic units in both yard switching and road-haul environments. Approximately 1100 such units are in

Table 23

DIESEL-ELECTRIC SWITCH ENGINES IN THE UNITED STATES
(Class I Railroads)

Year	Unit Type	Additions	Retirements	Balance at End of Year
1971	A	147	397	5,495
	B	6	49	48
1970	A	152	352	5,756
	B	4	1	91
1969	A	210	1,019	5,961
	B	3	4	88
1968	--	--	--	--
	--	--	--	--
1967	A	311	679	6,980
	B	5	6	81
1966	A	379	650	7,347
	B	--	--	84
1965	A	382	421	7,624
	B	6	1	84

Source: Reference 66.

Table 24

AGE OF SWITCH ENGINES IN 1967 FLEET

Date Originally Built	Number of Units
1967	63
1966	120
1965	94
1960-64	158
1955-59	1,161
1950-54	2,725
1945-49	1,724
1940-44	810
Before 1940	125

Source:
Reference 66.

service in Europe.⁶⁸ It is reported that the 1250-hp diesel-hydraulic locomotive uses about nine gallons of fuel per working hour.

Some of the claimed advantages of the diesel-hydraulic locomotive include:^{69,70}

- a) Continuous low-speed operation at full load without overheating.
- b) The high-torque conversion ratio available with the hydraulic transmission produces the high starting tractive effort required in many locomotive applications.
- c) Ease of maintenance and repair and a reduction in repair costs.
- d) Ability to exert full tractive effort at standstill without damage or overheating.
- e) Shut-off and quick-start capabilities that avoid long idling periods, thereby reducing fuel consumption, noise intrusion, and air pollution.
- f) Lower unsprung weight on axles than the electric-drive.
- g) Hydraulic braking to reduce wear and other problems connected with the normal locomotive braking system.

A number of U.S. railroads tested diesel-hydraulic locomotives during the early 1960s (a European-built 3600-hp unit and an American-built 4000-hp unit); however, neither was ever adopted by a major U.S. railroad on a large or even moderate scale. This early rejection of diesel-hydraulic locomotives may lend some credence to the theory that diesel-hydraulic engines rated over 1500 hp are not competitive with diesel-electric engines of similar horsepower. This small penetration into the U.S. market may also be the result of other factors, such as the U.S. railroads' desire to maintain some uniformity within their motive-power fleets or their reluctance to rely on overseas suppliers.

4.3.3.4 Electric Switch Engines

An electric switch engine has characteristics that make it superior to other engines when high power is required for such intermittent applications as kicking cars in flat switching. During these brief periods, the unit has the almost unlimited power of the central station from which to draw. The traction motors and associated equipment need only be sized for the average power that they will generate; the heat dissipation limits the length of time that they can be overloaded.

The disadvantage of the electric switch engine is that it must follow the source of electrical power. This means that either the entire terminal area and yard must be equipped with catenaries or electrified rails. An additional drawback is that the electric unit must hand over its cars to a diesel-electric or other self-powered unit if a move is to be made outside the electrified area. Both of these types of electrical distribution systems are costly and pose safety problems. Electrified rails can be particularly hazardous to yard workers who walk along the tracks to examine cars and loads. For these reasons, only 13 electric switch engines were reported in service in the U.S. at the end of 1971.

4.3.3.5 Gas-Turbine Locomotive

Perhaps the most frequently considered alternative to the diesel-electric engine is the gas-turbine locomotive. The gas-turbine could have many advantages over a diesel-electric in that it is smaller, lighter in weight, and mechanically simpler to operate.⁷⁰ It requires no cooling water and is much easier to lubricate than diesel locomotives. Another advantage is that they can be designed to burn various types of fuel such as oil, kerosene, and propane; even the use of coal as a fuel has been researched.

The gas-turbine locomotive also exhibits many adverse features, however, that tend to make its use less attractive than diesel locomotives. Its principal disadvantage is high fuel consumption. Primarily because of this factor, a 6000-hp gas-turbine locomotive developed by Electro-Motive Division (EMD) of General Motors was considered by the manufacturer to be not economically competitive with diesel-electric locomotives. The idling fuel-consumption rate of the EMD gas-turbine was approximately 30 to 35 percent of its full-load fuel-consumption rate,⁷¹ which would be highly undesirable in a yard switch engine because of the great variation in loads. In addition to poor efficiency at low power, the gas-turbine also loses much power when operated during warm weather and at high altitudes.⁶⁴

Because of these efficiency characteristics, the gas-turbine engines will probably not be used within our study period to power switchyard locomotives. The stop-and-go low power/full power characteristics of switch-engine operations are perhaps the worst type of operating conditions for gas-turbine locomotives. One possible exception that may allow the efficient operation of gas-turbine engines to power switchyard locomotives is the use of relatively small gas-turbines in conjunction with energy-storage flywheel devices. It is more likely that gas-turbine locomotives will be used on long-distance freight and passenger trains. Gas-turbine locomotives are already operating on passenger trains both here and abroad and have found limited use in hauling heavy long-distance freight trains in this country (on the Union Pacific Railroad).

4.3.3.6 Energy-Storage Flywheel Switch Engines

The duty cycle on a switch engine is highly variable. It has been estimated that an average yard switch engine works under load only ten out of 24 hours. The diesel engine does not operate extremely efficiently under low or no-load conditions and, in fact, a substantial fraction of the full-load fuel-consumption rate occurs during engine idle. One possibility for increasing switch-engine efficiency is the inclusion of an energy-storage flywheel^{68,69} to store energy generated by the engine during what would normally be low or no-load conditions. This energy would be in the form of kinetic energy and could be employed to provide additional power under full-load conditions. In addition, the use of regenerative braking, where braking requirements could be used to recharge flywheel energy, would greatly improve the efficiency of such a power unit in switchyard operations. In this regenerative braking application, the flywheel can be used to recycle energy as a result of a repetitive duty cycle of high accelerations and decelerations needed to classify freight cars in a flat yard. In cooperation with the manufacturer of a flywheel energy-storage device and several railroads, the FRA is considering an investigation of the practicality of such units in the regenerative braking application for switch engines.

The feasibility of using flywheels as energy-storage devices has been demonstrated recently in the operation of rapid-transit vehicles. In addition, flywheel-type locomotives of slightly different designs have been used for mining and industrial switching work in England, France, Belgium, and South Africa.⁶⁹

4.3.3.7 Switching Mules

A "mule" is a prime mover that, with limited tractive effort, can move one loaded car or a few empty cars at very low speeds. Mules are normally used in rail-customer facility where operations may require moving loaded cars or spotting empties and when an industrial user does not want to invest in a switch engine that may cost on the order of a quarter of a million dollars. Instead, a gasoline or diesel-powered mule, operated by one person at a cost of approximately \$10,000 or less, is used for this operation. Some of these units are able to apply an upward force against the coupler of the car they are handling, thereby borrowing weight from the load to increase their tractive work.

Although mules have several applications in a switchyard, they are infrequently used. They could handle single cars, such as at scales, or move bad-order cars to the rip tracks. Both applications require the movement of only one car at a time and over small distances. A larger mule may deliver single or empty cars to industrial customers to reduce engine and crew costs, and the transfer could be made at a cost comparable to that of motor trucks.

4.3.4 Switch Engine Control Technology

In addition to motive-power technology, other technologies related to the control of yard switch engines have been developed. This section describes some of this switch-engine control technology.

4.3.4.1 Remote Speed Control of Hump Engines

Precise control of hump-engine speeds is important to ensure the proper spacing of cars as they roll down the hump through the yard switching area and to ensure that the pin-puller speed is not exceeded. The accurate maintenance of a constant speed requires continuous throttle adjustments to compensate for the fact that the number of cars being pushed is progressively reduced. The throttles of hump engines, therefore, are often supplemented with a rheostat that gives a fine control of excitation on the generator, thereby providing vernier control within the throttle positions.

Remote control of the excitation is also possible when an appropriate hump-speed request is sent by radio to the locomotive. The requested engine speeds (either manually or automatically by a computer) are compared to actual rates measured by axle tachometers to achieve accurate control of the hump-engine propulsion system. The locomotive brake and emergency system can also be remotely controlled. At present, the locomotive operator remains aboard the hump engine to observe abnormalities, perform coarse throttle settings, and back the engine when necessary. The cost of modifying existing hump engines to include remote speed control has been estimated at approximately \$30,000.⁶⁷

4.3.4.2 Remote Control of Switch Engines

Equipment is available to perform all operations necessary for the remote control of switch engines. Multiple-channel radio controllers allow the operator to perform switching activities and to move cars from a remote location. Railroads are not using this equipment for switching, however, because of the possible danger to men and equipment and because of labor-management agreements. Applications are limited to several installations in mining operations and in a steel mill where the switcher moves cars around in a limited area, in a routine pattern, and where access can be controlled.

4.3.4.3 Dead-Man Control

The dead-man control is an air-operated device installed on some of the newer switch engines used in yard. It is an on-board safety system that automatically stops a moving locomotive when the

engine is not attended after a certain period of time. The engineer aboard such a locomotive must periodically reactivate a switch to keep the locomotive in motion.

4.3.4.4 Automatic Wheel-Slip Control

The large amount of sand typically found around switchyard tracks attests to the tractive-effort requirements of yard switch engines. To suppress locomotive wheel-slip and thereby increase tractive effort capabilities, various wheel-slip control systems have been developed by both locomotive manufacturers and individual railroads. One such system, recently developed by Canadian National Railways, has been found to produce a consistent 20 percent increase in tractive effort over a locomotive's speed range because of better utilization of available adhesion.⁷² In this unit, an axle generator on each axle provides the basic wheel-slip input. Electronic circuits then develop individual wheel speeds and accelerations. Circuits also detect wheel slip, based on absolute acceleration, absolute wheel speed (overspeed), and relative wheel speed. The corrective action is dependent on the magnitude of the slip and the number of slipping axles. Power to the traction motors is reduced only enough to eliminate the slip without reducing drawbar pull more than necessary.

The advantages of improved wheel-slip control systems include increased tractive effort, reduced slack action, and the improved lifetime of wheels and traction motors.

4.4 OPERATING PROCEDURES AND PROCESSES

Railroad classification yards and terminals often represent large investments of time and capital. Once built, they generally are not easily modified unless provisions for change were incorporated into the original design. Traffic demand at a yard can vary significantly over time. For example, the construction of new plants and/or the abandonment of older ones can cause a radical change not only in the amount of traffic handled in a yard but also in the distribution patterns associated with the traffic. Railroad mergers, market fluctuations, new services, revisions in system-operating strategies, and other factors can also change the demand for switching services at individual yards. Although some changes may develop over many years, others occur rapidly; even seasonal variations in the amount and distribution of a yard's traffic can be significant.

A yard's capabilities can be exceeded by changes in traffic demand and distribution patterns. For example, system operations may require that a yard switch and classify more cars than it is able to, or that it sort cars into more blocks than the number of available class tracks. One solution to this problem is to modify yard design to handle the additional processing requirements. Building more class tracks,

converting a flat yard to a hump yard; or adding better signaling and communication systems can increase yard capabilities although such changes are expensive. Many railroads have avoided the expense associated with yard modifications by using different operating procedures that can be structured to alleviate specific problems. It has been stated that the modification of yard operating procedures could increase classification yard productivity by 50 percent without any additional capital investment.⁷³ In this section, some of the processes specifically related to yard operations are discussed.

4.4.1 Dynamic Assignment of Classification Tracks

Railroad classification yards are used for disassembling incoming trains into individual cars and groups of cars, sorting these cars to form blocks of cars to distinct destinations, and sequencing and assembling these blocks into outgoing trains. In the past, the sorting process required that cars be switched to a track dedicated to the accumulation of cars slated for a certain destination or purpose. For example, a yard might reserve one track for the accumulation of those destined for Chicago, another for Detroit, and others for cars requiring special processing, such as repairs or weighing. Because the pairing of class tracks and destinations does not vary from day to day or within a given day, it is referred to as a "static assignment of classification tracks." The major problems associated with this process are that the number of classifications or blocks made up by the yard cannot exceed the number of class tracks, changes to the systemwide blocking strategy may be difficult to implement rapidly, and the utilization of the class tracks may be inefficient.

To overcome these problems, most of the newer hump yards and many older ones are dynamically assigning or "swinging" class tracks based on switching and train-service requirements. For example, if a train is scheduled to depart at 8 P.M., class tracks may not be assigned to the blocks that make up the train until 11 A.M. so that they can be used for making up other blocks during the rest of the day. As a result, the dynamic assignment of class tracks can effectively increase not only the number of blocks or classifications but also the utilization of those tracks. It is also an integral part of such other yard processes as multistage switching.

The implementation and operation of the dynamic class-track assignment process varies among yards because its efficient use depends on many yard-specific factors. Among these factors are the availability and reliability of advance consist information, train arrival and departure patterns, and the distribution of the traffic processed through the yard.

4.4.2 Multistage Switching

Multistage switching describes the process of sorting and sequencing cars and groups of cars by more than one classification operation per car.⁷⁴⁻⁷⁸ Multistage switching allows a given yard to make up many more classifications than for which it has tracks. Many U.S. railroads have used some form of multistage switching to increase the classification capabilities of various yards. Most of the yards in the United States that use multistage switching techniques are either hump yards or flat yards with standard geometric features. The construction of new yards specifically designed to facilitate multistage switching, however, has been advocated. A portion of the Sante Fe hump yard at Barstow, California, has been so designed.^{78,79}

Four strategies for sorting and sequencing cars by multistage switching are described below. Throughout most of our description we use the following definitions and symbols, which are keyed to individual outbound trains that are to be formed and dispatched from the yard. Uppercase letters (such as A, B, C, ...) denote specific outbound trains. Each outbound train is made up of cars that have been sorted and grouped into blocks that are then sequenced to form the train. These blocks are identified by subscripted uppercase letters that denote which outbound train the block of cars is to depart with, and the subscript specifies the sequence or location of the block within the train; thus, A₁ refers to the first block from the head end of outbound Train A, and D₃ refers to the third block of cars from the head end of outbound Train D. Subscripted lowercase letters denote individual cars that will ultimately be formed into the correspondingly labeled blocks; thus, b₃ is a car that will be grouped with other b₃ cars to make up the third block from the head end of outbound Train B. Subscripted lowercase letters enclosed in parentheses indicate that the cars are randomly mixed.

4.4.2.1 Initial Sorting by Block Sequence

In the first stage of the multistage-switching strategy, all cars with the same block-sequence number, or subscript, are grouped together on the same track, irrespective of outbound-train designations. As a result, all cars that will ultimately make up the first (or head end) block on all outbound trains will be grouped together in random fashion on a common track, cars that will make up the second blocks will be assigned to another track, and so on. After the initial switching has been completed, the individual tracks may contain cars as shown in Figure 35. At this point, the first stage of the switching process has been completed.

The groups of cars are pulled back onto the switch or hump lead so that those having lowest subscript precedes the group with the next lowest, as shown in Figure 36. The cars are then reswitched

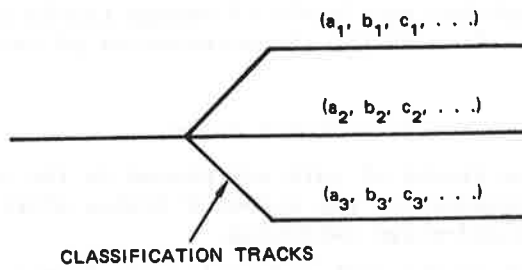

FIGURE 35 STRATEGY 1: CAR GROUPING AFTER FIRST-STAGE SWITCHING

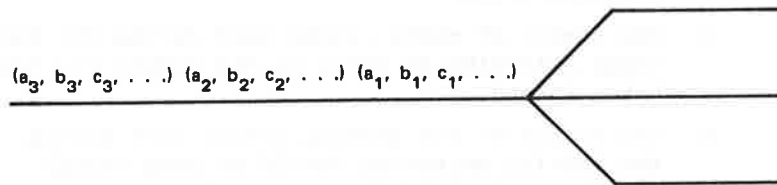

FIGURE 36 STRATEGY 1: ARRANGEMENT OF GROUPS FOR SECOND SWITCHING

according to outbound-train order. All cars for Train A will be grouped in correct block order on one track, cars for Train B on another track, and so on, as shown in Figure 37.

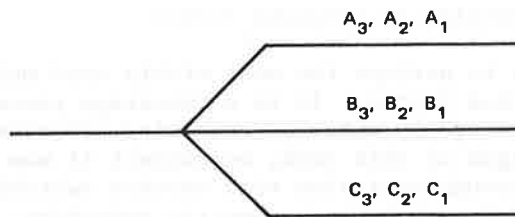

FIGURE 37 STRATEGY 1: BLOCK ORDER AFTER SECOND-STAGE SWITCHING

The second stage of the switching process can be performed alternately on a track-by-track basis if enough tracks are available for the reswitched cars. Some of the characteristics of this switching strategy are:

- a) Each car is switched twice.
- b) The blocks of cars are placed in the correct sequence for the outbound trains after the second-stage switching.
- c) All of the outbound trains are formed simultaneously.
- d) The number of classification tracks required during the initial sorting or switching process is equal to the maximum number of blocks in any outbound train.
- e) The number of empty tracks used during the second-stage switching is equal to the number of trains being formed.
- f) The length of the sorting tracks used during the initial switching should be long enough to adequately hold the groups of cars as sorted by block sequence number. If they are not long enough, additional tracks can be used. The length of the tracks required for the second-stage switching should be long enough to hold the assigned and assembled outbound train.

This strategy may be useful when the number of blocks of cars on each train is roughly equal to the number of trains to be made up. Because this strategy can simultaneously form a number of trains, it may also be of value to those yards in which interference and other problems are caused by peaks in the outbound-train schedule.

4.4.2.2 Initial Sorting by Outbound Trains

This is perhaps the most widely used multistage-switching strategy in the United States. It is a two-stage process referred to as "geometric switching" by railroad operating personnel. Although we do not know the origin of this term, we suspect it was mistakenly applied to this strategy through confusion with another switching strategy that was more appropriately labeled as geometric switching. Extreme care must be taken to avoid confusing the two strategies because their characteristics differ significantly.

In the initial-sorting-by-outbound-train strategy, cars that are to be dispatched in the same train are initially grouped together on the same track; thus, all cars for Train A would be grouped on one track, all cars for Train B on another track, and so forth. (In a variation of this strategy, cars for two outbound trains may be grouped on one track--cars for Trains A and B on one track, cars for Trains C and D on another track, and so on. Because this variation subsequently requires more available class tracks during the second stage or additional switching and sorting, it is not generally used). As shown in Figure 38, the cars, although sorted by outbound trains, are randomly mixed and are not separated or sequenced in block order.

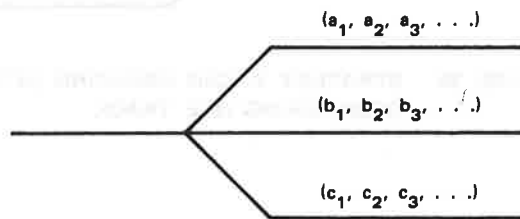

FIGURE 38 STRATEGY 2: CAR GROUPING AFTER FIRST-STAGE SWITCHING

In the second stage of this switching process, cars are pulled from one track onto the switch lead and are then reswitched by blocks; that is, all cars in the first block are grouped together, all cars in the second block are grouped together, etc. The cars for one outbound train are now grouped as shown in Figure 39, and the cars for the other outbound trains remain in somewhat random order on their originally assigned tracks. Train A can now be formed by either doubling or transferring Blocks A₁, A₂, and A₃ in the correct sequence to a makeup or departure track. Trains B and C can similarly be reswitched and made up.

The most prominent characteristics of this particular sorting strategy are:

- a) Each car is switched twice.
- b) Blocks of cars are formed on separate tracks, thus requiring additional transfer and coupling of the blocks to make up trains.

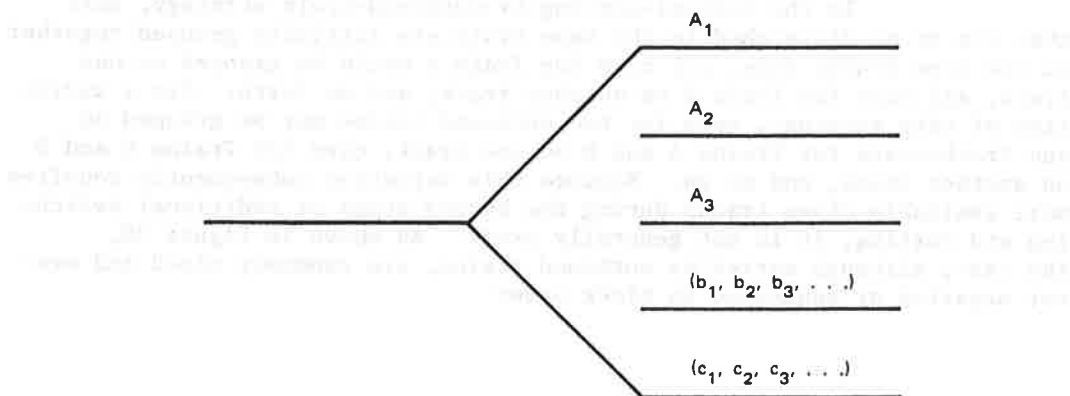

FIGURE 39 STRATEGY 2: CAR GROUPING AFTER RESWITCHING ONE TRACK

- c) Trains can be formed at different times and in different sequences.
- d) The minimum number of available tracks required during the first stage of switching depends on the number of outbound trains to be formed and how they are grouped.
- e) The number of available tracks required when reswitching any one track is equal to the number of blocks contained on that track.
- f) Insufficient track length is a problem encountered more often in the first than in the second stage of the switching process.

This switching strategy is useful when outbound trains do not have to be formed simultaneously or when time priorities have been established for making up outbound trains. It is also of value when the number of blocks in the outbound trains does not exceed the number of available tracks or when the number of tracks initially available is small.

4.4.2.3 Triangular Switching

Triangular switching is a multistage process frequently used in European classification yards. Unlike the above two strategies, this is more than a two-stage process and many cars may require three

or more switching operations. Triangular switching involves initially sorting cars according to car subscripts arranged in the following patterns:

1	3	5	8	12
2	6	9	13	
4	10	14		
7	15			
11				

In this switching process, the definitions of block subscripts are changed somewhat. Although the first block in the first train (say Train A) is still labeled A_1 , the first block in the second train (Train B) is labeled B_2 , and the remaining blocks continue to be numbered in an ordered sequence (B_3, B_4, B_5, \dots). The first block in Train C is C_4 , and the first block in Train D is D_7 ; the remaining blocks in both trains are labeled in ascending order (C_5, C_6, C_7, \dots and D_8, D_9, \dots). The numbers used to label, or subscript, the first blocks of the different trains (1, 2, 4, and 7) are the numbers that appear in the first column of the sorting pattern. If a fifth outbound train was to be formed, its first block would be subscripted by an 11 (E_{11}). The advantage of modifying the block labeling should become apparent during the discussion of this strategy.

The following example illustrates how the triangular strategy is used to make up four outbound trains (A, B, C, and D) that have, respectively, 10, 9, 7, and 4 blocks each. Train A, therefore, is made up of blocks A_1, A_2, \dots, A_{10} , Train B is made up of blocks B_2, B_3, \dots, B_{10} , Train C is made up of blocks C_4, C_5, \dots, C_{10} , and Train D is made up of blocks D_7, D_8, \dots, D_{10} .

The first stage of triangular switching involves grouping together all cars whose subscripts are located on the same row of the sorting pattern. All cars having the subscripts 1, 3, 5, or 8 (the first row of subscripts) are grouped on one track; cars with the subscripts 2, 6, or 9 (the second row of subscripts) are grouped together on another track. Cars with subscripts 4 or 10 are gathered on a third track, and cars having subscript 7 are collected on a fourth track. After this first stage has been completed, the cars are grouped as shown in Figure 40.

In the second stage of triangular switching, cars on Track 1 are pulled back and reswitched. The a_1 cars are directed to Track 1. The a_3, b_3 cars are collected on Track 2 and the a_5, b_5, c_5 cars are collected on Track 3 behind the existing cars. The a_8, b_8, c_8, d_8 cars are switched to Track 4. Figure 41 shows the grouping of cars within the yard after reswitching Track 1.

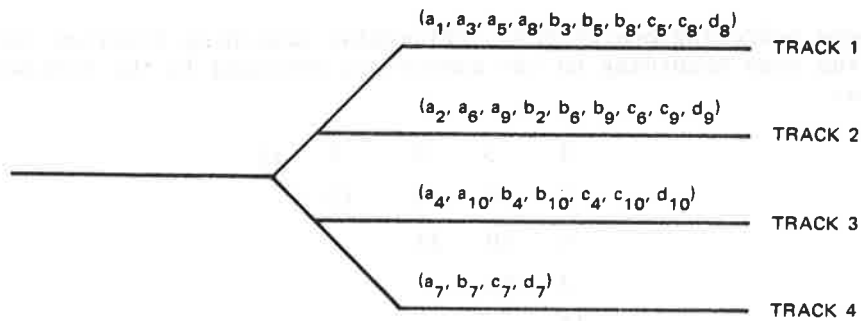

FIGURE 40 STRATEGY 3: CAR GROUPING AFTER FIRST-STAGE SWITCHING

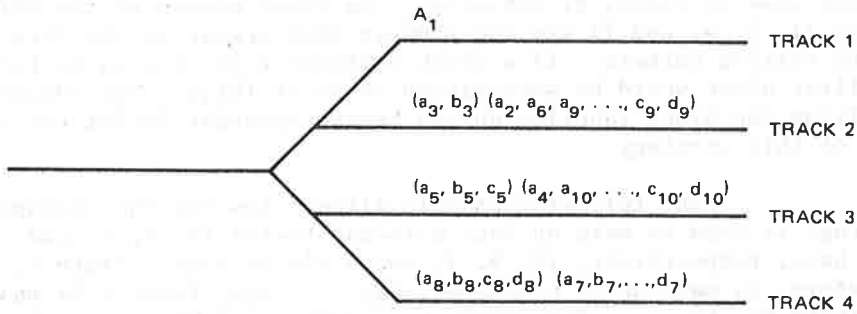

FIGURE 41 STRATEGY 3: CAR GROUPING AFTER RESWITCHING TRACK 1

Track 2 cars are now pulled back and reswitched. The a_2 cars are directed to Track 1, the b_2 cars are directed to Track 2, and the a_6, b_6, c_6 cars are switched to Track 3. The a_9, c_9, d_9 cars are collected on Track 4. The a_3 cars are collected behind the a_2 cars on Track 1, and the b_3 cars are collected behind the b_2 cars on Track 2. Figure 42 shows the groupings of cars after reswitching Track 2.

The cars in Track 3 are now pulled back and reswitched. The a_4, a_5, a_6 cars are switched in sequence behind the A_3 block on Track 1 and the b_4, b_5, b_6 cars are grouped in block order behind the B_3 block on Track 2. The c_4, c_5, c_6 cars are collected in correct block sequence on Track 3. The remaining cars ($a_{10}, b_{10}, c_{10}, d_{10}$) are switched to Track 4. The resulting distribution is shown in Figure 43.

Cars on Track 4, already grouped by subscripts, are next pulled back and reswitched with all a-cars going to Track 1, all b-cars

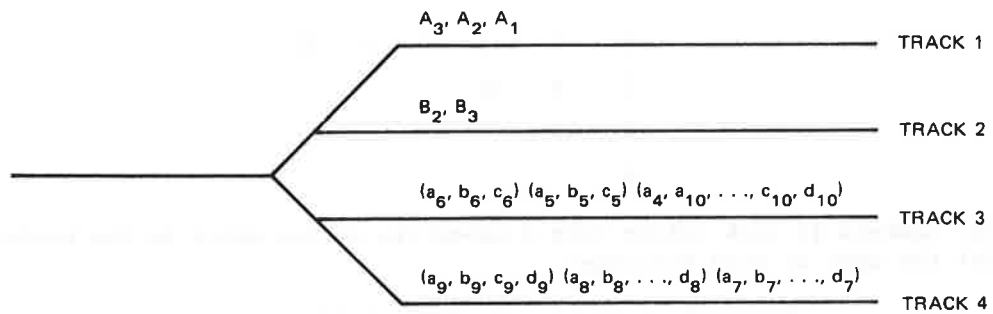

FIGURE 42 STRATEGY 3: CAR GROUPING AFTER RESWITCHING TRACK 2

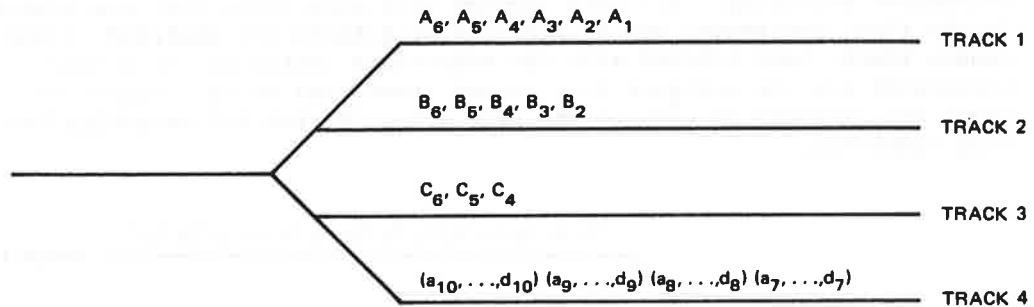

FIGURE 43 STRATEGY 3: CAR GROUPING AFTER RESWITCHING TRACK 3

Cars on Track 4, already grouped by subscripts, are next pulled back and reswitched with all a-cars going to Track 1, all b-cars to Track 2, all c-cars to Track 3, and all d-cars to track 4. The four outbound trains have now been formed, using only four classification tracks.

4.4.2.4 Geometric Switching

Geometric switching is a car-sorting strategy similar to triangular switching. The principal difference between the two strategies is the following sorting pattern:

1	3	5	7	9	11
2	6	10			
4	12				
8					

The numbers in each column form a geometric series which is the basis for the name of this strategy.

Geometric switching is described by the same example used to explain triangular switching. The first blocks of Trains A, B, C, and D are subscripted with the appropriate numbers found in the first column of the sorting pattern. The first blocks of Trains A, B, and C are designated as A_1 , B_2 , and C_4 , respectively. The first block of Train D, however, is labeled D_8 instead of D_7 , and its remaining three blocks are D_9 , D_{10} , and D_{11} .

The initial switching of cars is analogous to that in triangular switching. All cars labeled with subscripts that are listed in the first horizontal row of the sorting pattern are assigned to one common track, cars labeled with the subscripts listed in the second horizontal row are assigned to a second track, and so on. Figure 44 shows the grouping of cars in the yard after the initial switching has been completed.

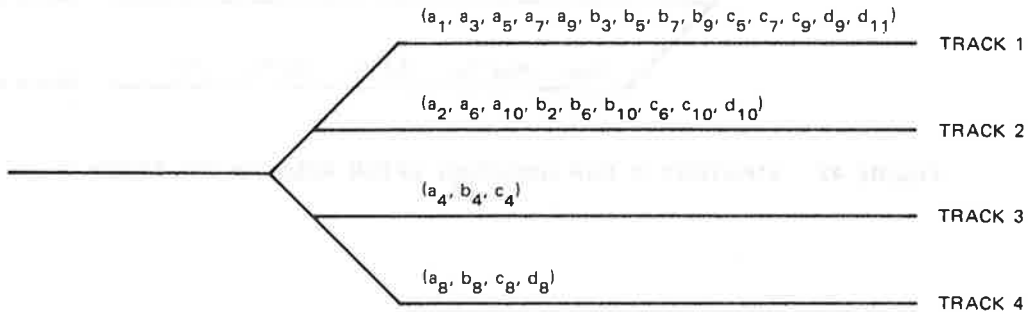

FIGURE 44 STRATEGY 4: CAR GROUPING AFTER FIRST-STAGE SWITCHING

The subsequent reswitching of Tracks 1, 2, 3, 4, is again analogous to the reswitching in the triangular strategy. The groupings of cars and blocks of cars on the class tracks after reswitching are shown in Figures 45-48.

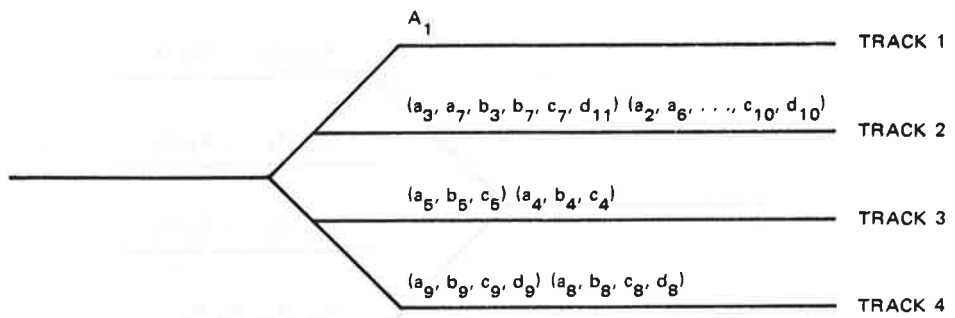

FIGURE 45 STRATEGY 4: CAR GROUPING AFTER RESWITCHING TRACK 1

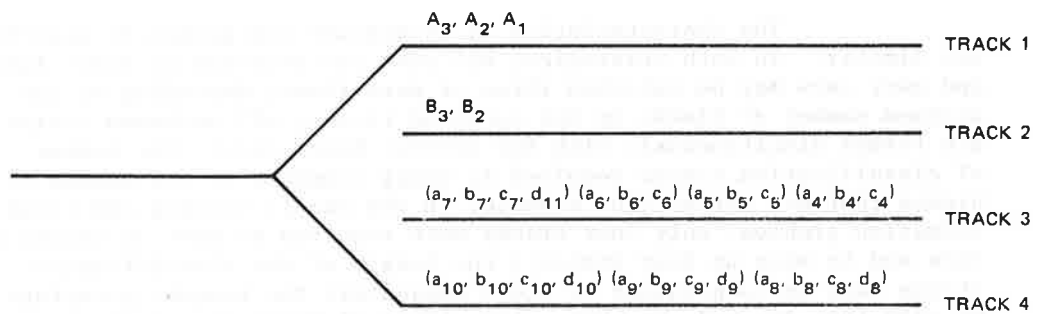

FIGURE 46 STRATEGY 4: CAR GROUPING AFTER RESWITCHING TRACK 2

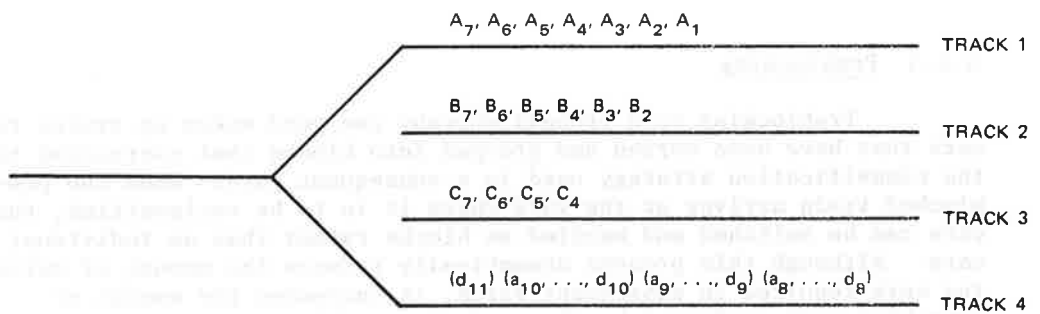

FIGURE 47 STRATEGY 4: CAR GROUPING AFTER RESWITCHING TRACK 3

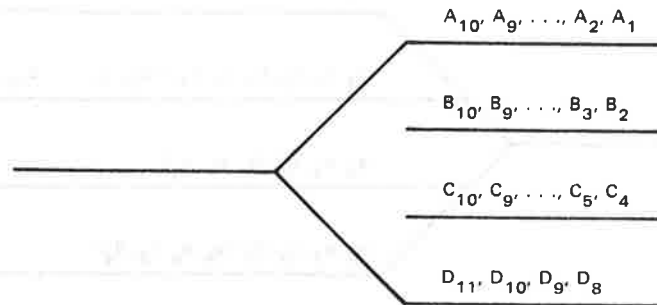

FIGURE 48 STRATEGY 4: CAR GROUPING AFTER RESWITCHING TRACK 4

The characteristics of triangular and geometric switching are similar. In both strategies, all cars are switched at least twice and many cars may be switched three or more times, depending on the maximum number of blocks in the outbound trains; all outbound trains are formed simultaneously with the correct block order; the number of classification tracks required is small compared to the number of blocks that are sorted (for example, in the sample sorting and train-formation problem, only four tracks were required to sort 30 blocks of cars and to make up four trains); the length of the classification tracks must be long enough to store adequately the lengthy groupings of cars that are made up when using either of these two strategies.

Both strategies are particularly suitable in situations where a large number of blocks must be sorted and where the available classification tracks are few but long. Generally, triangular switching is preferred over geometric switching because it requires less re-switching.

4.4.3 Preblocking

Preblocking is a process whereby one yard makes up trains from cars that have been sorted and grouped into blocks that correspond to the classification strategy used in a subsequent yard. When the pre-blocked train arrives at the yard where it is to be reclassified, the cars can be switched and handled as blocks rather than as individual cars. Although this process dramatically reduces the amount of switching work required in subsequent yards, it increases the amount of switching work performed by the yard that preblocks the train.

The benefits of preblocking are not always easily defined or discerned at the yard level because of the trade-off of switching

work and costs between yard facilities. Preblocking could be advantageous, however, in those situations where it reallocated the switching and classification work load from inefficient high-cost switchyards to more efficient yards having lower costs per switch.

An additional factor that must be considered is the relative operating characteristics of different yards and types of yards. In a hump yard, for example, the switching rate (hump speed) is generally constant and is not normally dependent on the sequence or grouping of cars being humped. In a flat yard, however, the switching rate is related to the number of cuts within the group of cars being switched. Because preblocking can significantly reduce the number of cuts, it can reduce the switching time and work in flat yards. Preblocking, therefore, should generally be performed at hump yards because these yards can switch and classify single car cuts nearly as efficiently as they classify pregrouped multicar cuts. On the other hand, preblocking should generally be done for subsequent flat yards rather than for subsequent hump yards because of its potential for decreasing switching time and effort in flat-yard switching facilities.

4.5 YARD GEOMETRIC DESIGN

Within the United States, the two fundamentally different geometric track patterns used in the design of railroad classification yards are the flat yard and the hump yard.

4.5.1 Flat Yards

The flat yard is composed of a series of tracks joined together by a ladder track and a switching lead (Figure 49). Cars are sorted by

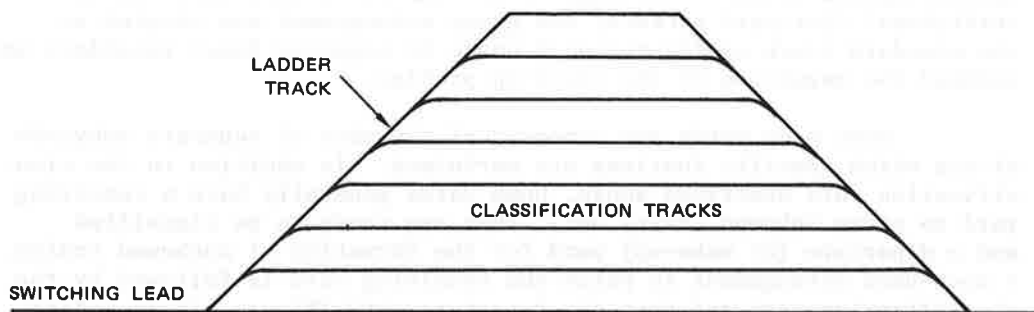

FIGURE 49 TYPICAL FLAT-YARD TRACK CONFIGURATION

being pushed generally by a switch engine until reaching a certain speed and then uncoupled and allowed to roll freely into the correct classification track. To prevent premature car stoppages on switching leads, ladder tracks, or classification tracks, flat-yard tracks are constructed with slight grades to improve rollability. Flat yards are designed and constructed to be somewhat saucer shaped, a shape that tends to cause free-rolling cars to accumulate in the middle of the yard.

In most flat yards, classification tracks are used not only for sorting cars but also for receiving inbound trains and making up outbound trains. This mixing of track functions can cause considerable interference within the yard and much operational inefficiency when operating near capacity.

4.5.2 Hump Yards

Figure 50 is a stylized track configuration of the classification portion of a hump yard. The hump lead (analogous to the switching lead in a flat yard) usually slopes gently up from the receiving yard to the crest of the hump. The trackage then slopes sharply downward through the yard switching area and the classification tracks. The crest of the hump is generally 12 to 20 ft above the level of the classification tracks. In many yards, the slope of the lower segment of the tracks changes to a slight positive grade to prevent free-rolling cars from rolling out of the classification yard. (For a more complete discussion of the design of track gradients in classification yards, see the AREA Manual for Railway Engineering, Chapter 14.)

From the overhead view of a typical hump-yard layout (Figure 50), it can be seen that the geometric track pattern of hump yards differs significantly from that of flat yards. Instead of all classification tracks branching off a single lead or ladder track, they are organized in groups generally consisting of six to nine individual classification tracks. Although early hump yards were built in the traditional flat-yard pattern, the group arrangement was adopted as the standard track configuration because it required fewer retarders and reduced the magnitude of the catch-up problem.

Most hump yards are composed of a number of separate subyards within which specific functions are performed. In addition to the classification yard described above, hump yards generally have a receiving yard to store inbound trains until they are ready to be classified and a departure (or make-up) yard for the formation of outbound trains. A much-used arrangement in which the receiving yard is followed by the classification yard and then the departure yard (Figure 51) is called a "tandem" or "inline" arrangement. Other alternatives include the wrap-around yard where the receiving and departure yards are placed next to the classification yard, thereby sandwiching or wrapping around the classification yard. Other variations of the basic tandem and

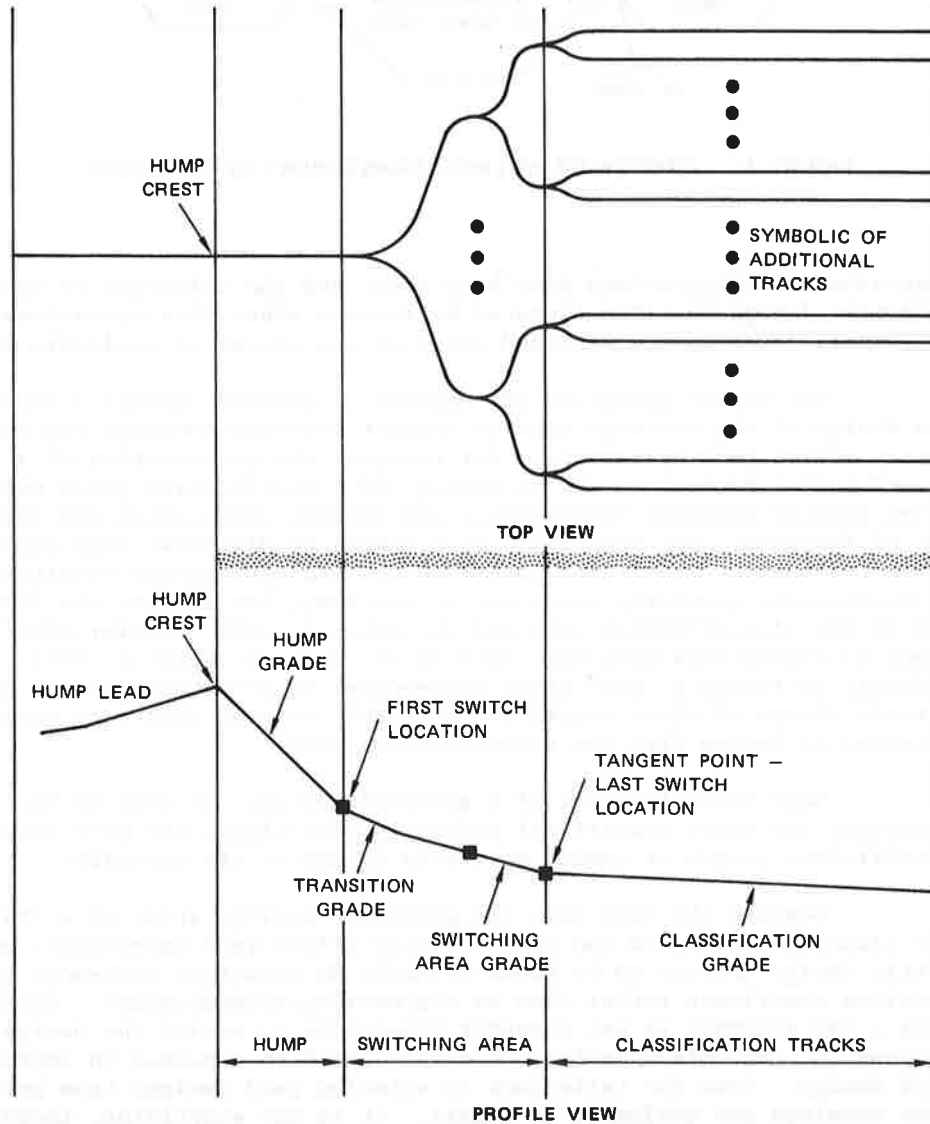

FIGURE 50 TOP VIEW AND PROFILE VIEW OF A HUMP YARD



FIGURE 51 TANDEM OR IN-LINE ARRANGEMENT OF SUBYARDS

wrap-around configurations have been used, and the selection of the geometric design is often dictated by factors other than operational requirements (such as the size and shape of the parcel of available land).

The actual geometric arrangement of subyards within a yard and the design of the trackage used to connect separate subyards can significantly affect yard operations. For example, the construction of a second hump lead between the receiving and classification yards can often greatly decrease interference and improve utilization and throughput of the hump. Our inspection of a number of different hump yards, however, revealed that major interferences and operational problems or bottlenecks generally occur not at the hump, but between the lower end of the classification yard and the make-up yard. Several other track configurations have been used in attempts to alleviate this problem, including a "key" track arrangement at SP's Colton Yard, where certain groups of class tracks are extended into the departure yard situated in tandem with the classification yard.

Many other features of a geometric design can also be responsible for major operational inefficiencies within the yard (such as insufficient length or number of tracks in any of the subyards).

Despite the fact that the geometric configuration of a freight-car classification yard can significantly affect yard operations, geometric design appears to be based primarily on intuitive judgement and previous experience rather than on engineering methodologies. Aside from a few attempts to use computer simulation to assist the design process, no determined analytical effort has been expended to improve yard design. Even the variations in existing yard designs have not been examined and evaluated in detail. It is not surprising, therefore, that the geometric design of new yards does not vary significantly from the design of other recently constructed yards. With few exceptions, changes in the geometric design of yards have been evolutionary rather than revolutionary. Some of the more radical changes are described below.

4.5.3 Minihump Yards

In the past, it has been generally accepted that flat yards were more economically attractive than hump yards for handling traffic up to about 900 cars per day. For traffic levels between 900 and 1300 cars per day, the historical economic differences between flat and hump yards have been somewhat marginal; for levels above 1300 cars per day, the hump yard has clear advantages.

The minihump is a recently introduced variation of the hump yard. Also known as poor-man's hump yards, pint-sized gravity yards, or economical hump yards, these minihumps can perform yard switching more economically, in many cases, than either flat or major hump yards at traffic levels between 500 and 1500 cars per day. Some of these yards are used as industrial yards, and others are used to perform a substantial amount of classification work.

The overall configuration of the minihump yard is similar to that of a major hump yard except for size. The crest of a minihump yard is much lower than that of a regular hump yard, normally between 5 and 10 ft. The distance from the crest to the clear point is generally less than 550 ft. as opposed to as much as 1800 ft. in a large hump yard. Minihumps generally have less than 20 classification tracks, while some conventional hump yards have over 60 such tracks.

The location and control of retarders in minihump yards vary significantly. Some yards have only a master retarder; others have group retarders as well. Some minihumps use tangent point retarders. The control of the retarders and the switches can be manual or automatic. Most of the minihump yards use hydraulically actuated clasp-type retarders, and the leakage of hydraulic fluid has been reported as a major problem.

The cost of such yards is generally much lower than that of conventional hump yards and does not greatly exceed the cost of a comparable flat yard. Minihumps are capable of achieving humping rates of 2.5 to 3 cars per minute which does not differ substantially from the humping rates of many major hump yards and is approximately two times faster than switching operations in flat yards.

4.5.4 Multistage Classification Yards

Many railroads are using multistage switching techniques to increase yard capabilities for classifying cars for more destinations than the number of available classification tracks. (Multistage switching strategies were described in the previous chapter.) The increasing popularity of multistage switching has led to the advocacy of reducing or eliminating the pull-back operation generally associated with reswitching or rehumping⁷⁸⁻⁸¹ in the design of future classification of yards.

Although it is not inconceivable that future flat yards could be constructed as multistage classification yards, emphasis has been placed on the design of multistage hump yards. Several of the two-stage hump-yard configurations suggested by Christianson⁷⁷ are described below.

The first such configuration is illustrated in Figure 52. It consists of four sets of tracks (or subyards) situated in an in-line or tandem arrangement. The receiving tracks are used to yard incoming trains. Each train is humped and sorted according to the first-stage of the sorting strategy. Each train in the first stage yard is then rehumped over the second hump and sorted into the second-stage yard where the cars are then pulled into the departure yard for the formation of outbound trains.



FIGURE 52 TWO-STAGE HUMP YARD (CONFIGURATION 1)

A variation of this configuration (Figure 53) uses the second-stage yard for departure. Many existing hump yards have similar configurations that, with certain modifications, could be used as two-stage hump yards.

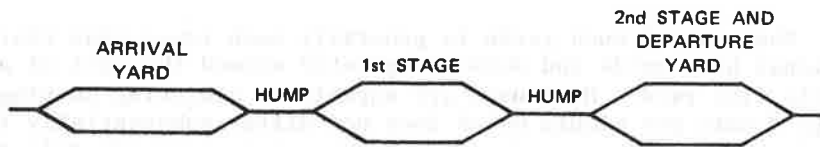

FIGURE 53 TWO-STAGE HUMP YARD (CONFIGURATION 2)

Still another two-stage hump-yard configuration is the folded two-stage hump yard (Figure 54) in which the first group of tracks is used for receiving and departing trains and for the second stage of sorting cars and the second group is used for the first stage of sorting. The two groups of tracks, or subyards, are connected by a bidirectional hump (an untried and unproven concept). If found to be operationally feasible and efficient, this configuration would require the least amount of land area, trackage, and hardware.

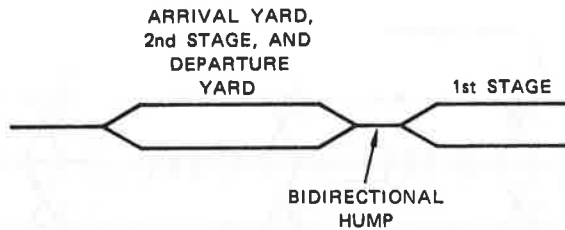

FIGURE 54 TWO-STAGE HUMP YARD (CONFIGURATION 3)

The design of an actual yard configuration should be based on planned sorting strategy, network blocking requirements, arrival and departure schedules, and traffic-distribution patterns. The design of yards on the basis of the current traffic environments, however, can severely limit operational flexibility. It should be noted that changes in one or more of these and other factors can cause the selected multi-stage yard configuration to become inappropriate, ineffective, and inefficient. To minimize these adverse effects, future large classification yards probably should not be constructed solely as multi-stage switching yards. Instead, multistage (predominantly two-stage) switching should be performed on appropriate track areas operating as a small integrated portion of the entire classification yard. This, in fact, appears to have been the philosophy behind the design of Santa Fe's Barstow Yard, the first U.S. yard constructed specifically for multistage switching.

4.5.5 Herringbone Tracks

The major traffic bottleneck in most hump yards generally occurs in those portions of the yards used for the makeup and departure of outbound trains. The process of making up outbound trains often causes substantial interference and congestion in the departure yard, thereby lowering the efficiency of train-makeup operations. To eliminate or reduce such problems, the Japanese National Railways have utilized a pattern of track layout known as the herringbone.⁸²⁻⁸⁴ Trains are made up in block order, and cars are classified in a simultaneous process during the first stage of switching, thereby eliminating reswitching or rehandling.

Two variations of the herringbone track configuration are the double (D-type) herringbone and the single (S-type) herringbone. The double herringbone, shown in Figure 55, involves the construction of classification tracks in groups of three. The middle track is used only by cars in motion to pass other cars stored on the two outside tracks; the outside tracks are used to store cars that have been

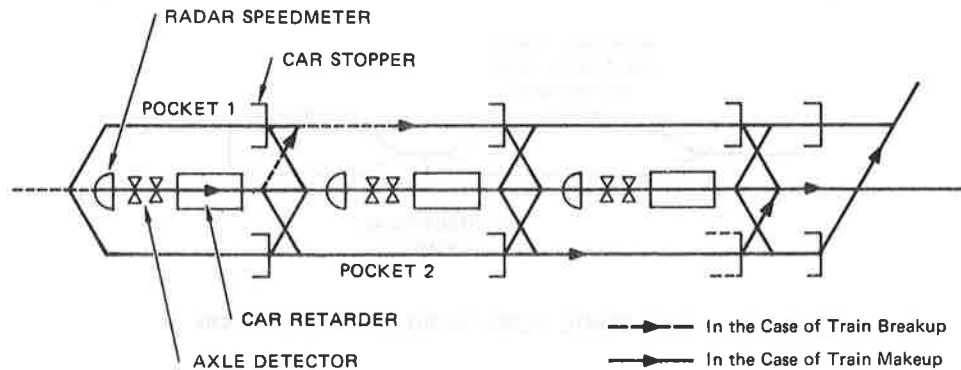

FIGURE 55 DOUBLE HERRINGBONE TRACKS

classified for the trains being made up on these tracks. Crossovers from the middle track to the two outside tracks are constructed at intervals along the running track. There are additional crossovers from the two outside tracks to the middle track. The track sections (or pockets) formed on the outside tracks by the crossovers from the middle track correspond to the position of blocks of cars within the trains being made up on the outside tracks.

The double herringbone can be used to classify cars and make up trains in the following manner: Cars destined for the various blocks or classifications are switched to travel along the appropriate passing track. Retarders regulate the speed of cars or cuts of cars rolling down the passing track to prevent catch-ups on the passing track and to reduce coupling impact. As the cars approach the pocket where cars are stored according to their destination, they are switched to cross over to the appropriate outside track after having passed other cars that will ultimately be behind them on the outbound train. The cars are restrained from rolling out of the appropriate pocket by car stoppers located as shown in Figure 55. When the classification process has been completed, all cars have been sorted into the correct blocks and the blocks of cars have been correctly sequenced for the outbound train. The formation of the outbound train merely requires coupling the blocks of cars together and attaching the caboose and motive power. This process eliminates the need for a separate departure track and the additional switching generally associated with the makeup of outbound trains. In addition to facilitating train-makeup operations, the double herringbone track allows any block of cars or any ordered group of blocks to be taken out of the outside tracks.

The single herringbone, shown in Figure 56, is distinguished from the double herringbone by having only single crossover sets. This configuration can be used to sort cars and sequence blocks in the same manner as the double herringbone pattern. The single herringbone, however, limits the flexibility associated with pulling individual blocks of cars because they can only be pulled in one direction.

The concept of the herringbone tracks dates back to 1912 and was strongly advocated in the United States by George Billmeyer in 1957. Only recently, however, has the design been constructed and tested in an operating classification yard, the Koriyama hump yard of the Japanese National Railways completed in late 1968. The two groups of double herringbone tracks in the Koriyama yard are used for the classification and formation of road-haul trains, and they are installed among the standard classification tracks in the main portion of the yard. These double herringbones are composed of eight pockets in each direction. The single herringbone tracks in the Koriyama yard are used to make up local trains in destination-ordered sequence. These single herringbones are composed of ten track sections or pockets.

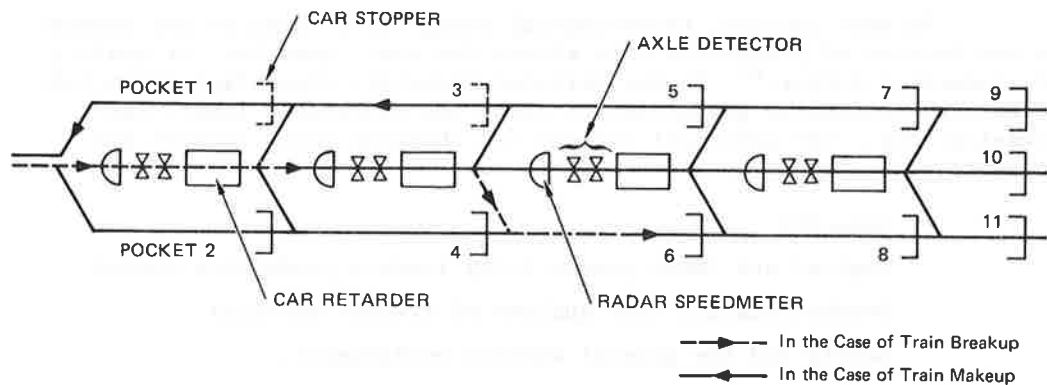

FIGURE 56 SINGLE HERRINGBONE TRACKS

Herringbone track layouts eliminate much of the switching work generally required to make up outbound trains. They also enable a yard to make up smaller blocks of cars (8 to 10 cars) efficiently. The minimum block size in most U.S. yards is currently 20 to 30 cars. This capability allows a finer sort or classification of cars, thereby reducing the need for subsequent reclassification.

A major disadvantage of the herringbone track design is that successive cars must travel greater distances on the same passing track

to form long trains. For this reason catch-up between cars on the same track can become a significant problem.

4.6 TECHNOLOGICAL CHANGE IN THE RAILROAD INDUSTRY

It is widely believed, both inside and outside the railroad industry, that U.S. railroad companies are unduly reluctant and overly cautious about introducing or adopting new technology. After surveying existing yard technology, much of which has been introduced on only a limited basis by the railroad industry, we have found that product research and development do not ensure that technological change will occur. We believe that an essential prerequisite for R&D priorities, plans, and programs is a general understanding of the major factors that influence the development and utilization of new railroad technology. For this reason a simple generalized discussion of the process of technological change is presented and some of the major factors that influence technology in the railroad industry are examined.

4.6.1 Process of Technological Change

In this section, technological change is defined as any change in the factors of production that alters the cost, quantity, or quality of production output.⁸⁵ In the railroad industry, these factors include materials, equipment, production or operating processes, labor, and organizations. The principal reasons for changing these factors are to improve:

Capacity

Capital and labor productivity (reduce production costs)

Product quality (the quality of freight service)

Safety and the general working environment.

Technological change should not be viewed as a single event but rather as a continuous process of interrelated progressive actions.⁸⁶⁻⁸⁸ Figure 57 is a simplified framework of the process of technological change. Although it is somewhat incomplete because it does not account for the communication or feedback mechanisms between the different stages of the process, this framework can serve as a basis for a general discussion of technological change.

4.6.1.1 Research

In the context of this discussion of technological change, the term research refers primarily to applied research--that is, to investigations principally directed toward the application of known scientific and technological principles and developments to the solution

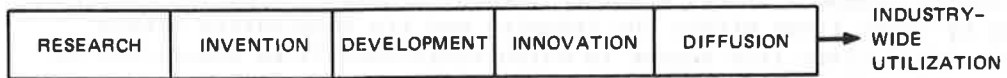

FIGURE 57 PROCESS OF TECHNOLOGICAL CHANGE

of problems. This stage of the process is often characterized by turmoil, reexamination and reappraisal of the research approach, misdirected efforts, and a great deal of frustration.

4.6.1.2 Invention

The second stage of technological change is invention. This is the point at which the concepts, ideas, and information developed during the research stage coalesce into a plan or design for a new product or process. The term invention, as used herein, describes an act of insight whereby the creative human-thought processes break through the barriers encountered during the research stage and establish a technically feasible approach to solving a problem.

4.6.1.3 Development

Development is that stage in the process of technological change where the basic plan or design is developed into an actual product, process, or technique that can be used as a potential solution to a problem.

4.6.1.4 Innovation

Innovation is an initial adoption of a technology that is different from the current technologies used in an industry. It is perhaps the most important stage in the process of technological change. Innovation by individual firms within a competitive multifirm industry is usually characterized by a certain hoped-for potential for increasing profits or improving operations in some respect. Because it entails a certain amount of risk of failure, however, this stage also involves the initial testing and evaluation of the new technology. Innovation, as the term is used in this report, does not specifically imply a full-scale adoption of a new technology by any individual firm; instead, the term denotes a general pioneering effort in its utilization.

4.6.1.5 Diffusion

Diffusion of the new technology throughout the industry is the next stage of the process of technological change. Diffusion is

actually composed of two separate elements--imitation of the new technology by other firms within the industry and its penetration within individual firms (the degree to which individual firms substitute an innovation for current technology).

The rate of imitation of one firm's innovations by other firms can vary significantly, depending on such factors as the nature of the industry, type of innovation and intraindustry communication levels. Generally, however, the rate of imitation tends to be higher for more profitable innovations and for those that require relatively small capital investments. As the number of firms in an industry using an innovation increases, the probability of its adoption by a nonuser also increases, in part because, as experience and information regarding an innovation accumulate, the risks associated with its introduction become less and competitive pressures rise.

The penetration of an innovation throughout individual firms depends on firm size, management and organizational structure, and the expected profitability of the innovation. The substitution of new technology for current technology often starts slowly and increases with the firm's experience and confidence in it. The rate of penetration of an innovation can be much greater if the new technology exhibits potentially large positive economics of scale.

The time required for the diffusion of new technology throughout an industry is determined to a large degree by (1) its economic advantages over current technology, (2) the uncertainty associated with using it, and (3) the commitment required to introduce and adopt it.

The objective of solving problems can motivate the process of technological change in two ways. The first is the "demand-pull" approach.⁸⁹ This entails working with the knowledge of the problem and searching for a technology that could be developed or adapted to yield a solution. This could also be labeled the "necessity is the mother of invention" approach to problem solving. An example of this approach in the railroad industry is the development of the current ACI system, where a problem was fairly well defined and a search was made to determine the most appropriate technology. The second type of motivation for technological change can be called the "supply push" approach. In this approach, a technological property, process, or mechanism has been discovered or developed and a search is made to find a problem that can be solved by applying the new discovery or development; in other words, one starts with a tool and then looks for an appropriate application. An example of this approach to problem solving, which motivated technological change within the railroad industry, is the conversion from steam to diesel-electric motive power.

4.6.2 Factors Influencing Technological Change

The U.S. railroad system represents the first use of modern transportation technology in this country. This form of transportation technology dominated the intercity freight-transportation market for more than 100 years. This dominance has been greatly diminished in recent years, however, through the development of other competing transportation technologies such as motorized highway carriers, air carriers, inland-waterway carriers, and pipelines. These competing technologies have successfully diverted more than half of the intercity freight traffic (in terms of ton-miles) from the railroads. Although the railroad industry has introduced certain technological changes, the rate of change has been much lower than that of competing modes. In this section, some of the more important factors that influence the process of technological change within the U.S. railway industry are identified and examined.

4.6.2.1 Industry Structure

The structure of the U.S. railroad industry can significantly influence the process of technological change. The railway system within the United States is composed of approximately 200,000 miles of roadway, 328,000 miles of track, 1.7 million freight cars, 27,000 locomotive units, and over one-half million employees.¹ Unlike nearly all of the world's other large railway systems, the U.S. rail system is not owned and operated by the government. Instead, it is a conglomeration of about 350 privately owned and operated railroad companies.⁹⁰ Although some of these companies own and operate extensive rail networks that serve large sections of the country, the majority serve only small regional or local areas.

(1) System Compatibility--Because of the aggregate structure of the U.S. railway system and the long-distance freight-transportation demand patterns, a large portion of the freight shipped by railroad travels over the lines of more than one railroad. The efficient handling of such shipments requires that individual rail companies use compatible rail technology. The necessity for such compatibility is demonstrated by the problems and inefficiencies encountered by those rail systems that are made up of incompatible components. For example, a system that contains track sections of different gauges will waste a large amount of manpower and time in the additional handling of freight during the interchange process.

The requirements to maintain rail-system compatibility can severely constrain the introduction of new technology that is not compatible with existing rail technology. A major reason for this constraint is the railroad industry's large investment in current technology associated with its fixed plant and rolling stock, and the introduction of incompatible new technology would require large-scale

replacement of the existing plant and equipment. This, in turn, would require a massive investment of capital and the writeoff of a substantial amount of railroad investment in fixed plant and/or equipment because of the typically long life of rail technology.

The integrity and compatibility of the U.S. railroad system was initially developed, with some difficulty, during the late 1800s. The continued maintenance and ensurance of this compatibility is accomplished through organized programs of self-regulation within the industry in such areas as equipment standards, safety standards, and car movements. The coordination of these programs is one of the functions of the AAR which was organized in 1934 through the consolidation of other railroad industrial organizations to represent the common interests of the railroad industry. Within the United States, 116 line-haul railroads, 72 switching and terminal railroads, and one leased line belong to the AAR; five Canadian and five Mexican railroads also belong to the AAR.

The AAR attempts to maintain the compatibility of the railroad system by establishing equipment standards. Because AAR member railroads operate approximately 95 percent of the U.S. railway mileage and carry 99 percent of U.S. freight ton-miles, any regulation or standard adopted by the AAR generally becomes an industry standard.⁹¹ Through its regulatory and standard-setting activities, therefore, the AAR significantly influences the process of technological change in the railroad industry. It is generally believed that the AAR promulgation of regulations and standards has had a positive effect on the introduction and diffusion of new technology throughout the industry. For example, AAR regulations accelerated the conversion from journal bearings to roller bearings, and the rapid industry-wide application of ACI labels on freight cars may not have been possible without AAR action. Having established a standard, however, AAR regulations can also inhibit the development, testing, and adoption of new and different technologies. For example, the AAR national code of weighing rules was established in 1914 and prohibited weighing freight cars while coupled or in motion. This code of rules has been cited as a major factor in delaying the introduction of coupled weigh-in-motion scale technology into the railroad industry.

Not only can equipment standards delay or inhibit the development and introduction of new technology, but they also can cause the introduction of technology that does not perform as well as required. For example, many railroads still do not believe that the present optical-scanning ACI system is accurate and reliable enough to be used to perform many desirable ACI functions. Conceivably, some other type of ACI technology would have provided a more appropriate industrial standard.

As can be seen, the need for rail-system compatibility and the resultant industrywide standards used to achieve this compatibility can greatly influence the introduction of new railroad technology.

(2) Interfirm Relationships--The relationships among the different railroads within the industry can be contradictory. On one hand, all railroads are elements of a common system and, therefore, tend to complement the services of each other. For this reason, a high degree of cooperation is often evident in the relationship between separate rail carriers. On the other hand, railroads frequently compete with each other for rail traffic between certain market areas. This competition generally is not based on prices because of the regulation of railroad rates; instead, it is largely based on quality of service. The quality of railroad service is difficult to define quantitatively but includes such factors as freight-car availability, transit time, service reliability, and prevention of lading damage. The nature of the competition between railroads is such that there may be certain incentives for introducing technology that will improve the quality of an individual railroad's service.

Relationships between railroad companies can affect the process of technological change in another way. Historic patterns of the introduction of new technology within the railroad industry indicate that, during the diffusion stage, some railroads serve as leaders while others become followers; that is, after the initial technological innovation, some railroads will rapidly adopt the new technology, at least on a trial basis, while other railroads will tend to delay adoption until the leading railroads have had a chance to test and evaluate the new technology. After the initial risks have been reduced, other railroads imitate the leaders and introduce the new technology. The patterns of technological imitation within the railroad industry are plotted in Figure 58 for three separate and distinct technological changes. It can be seen that, after the initial technological innovation, approximately 40 percent of the major railroads will rapidly imitate the innovative company and introduce the new technology. The rate of technological imitation then reaches a plateau where it requires considerable time for the next 10 to 20 percent of the firms to adopt the new technology. After reaching about 60 percent introduction, however, the remaining firms tend to accept it at a more rapid rate.

Previous research indicated that companies with certain characteristics tend to lead in the introduction of new technology. Mansfield^{85,86} reports that the speed at which a firm introduces a new technology is directly related to its size and the expected or perceived profitability of its investment. It would be expected that large railroads would be more progressive and would introduce new technology more

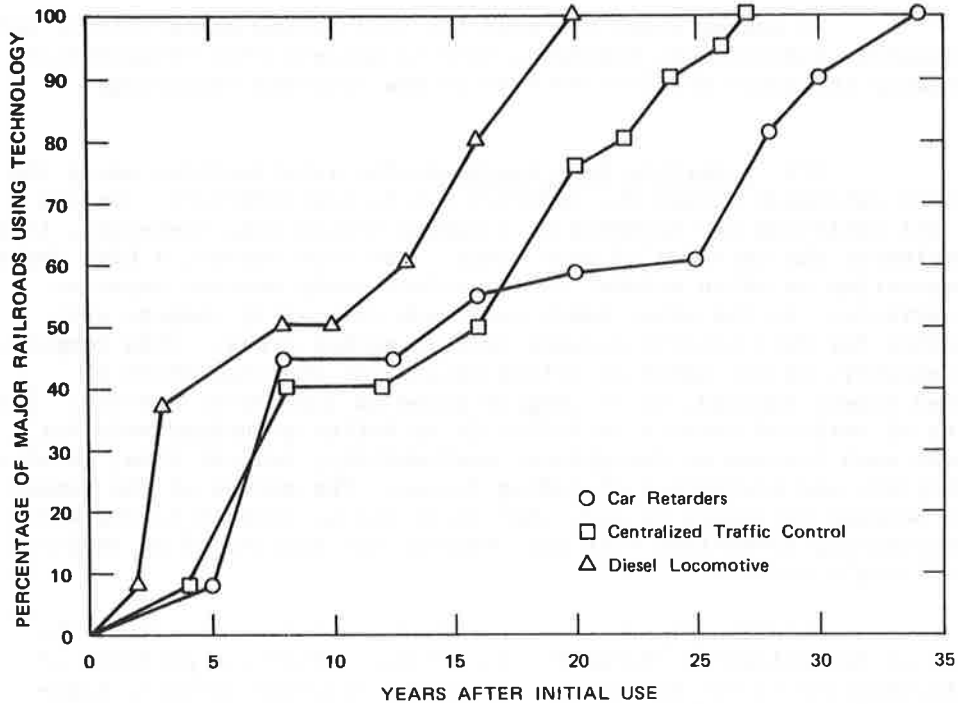

FIGURE 58 PATTERNS OF TECHNOLOGICAL IMITATION IN THE RAILROAD INDUSTRY

rapidly because of their greater financial resources, larger research and engineering departments, better experimental facilities, and closer economically stronger ties with equipment suppliers. Another important factor is the expected profitability of the new technology or, in effect, how its adoption is expected to influence profits. Small railroads, therefore, may adopt a new technology more quickly than larger roads if their expected return on investment is greater. This may partially explain why many small railroads that perform a large amount of switching, classification, and interchange work, such as GTW, KCS, and the railroads operating in the Chicago terminal area, have adopted the current ACI technology while other larger, more line-haul-oriented railroads have not. This factor also explains why railroads that lead the industry in introducing one type of technology may be reluctant to introduce other types as rapidly.

Surprisingly, Mansfield also concludes that the financial prosperity of a firm, as measured by its profitability, liquidity, and growth rate, is not closely related to the speed with which it adopts new technology.^{85,86} This conclusion implies that, if a new technology is clearly profitable, the capital required for investment will be

obtained. Although this may have been true in the past, it is certainly questionable, under present conditions, whether many railroads can obtain capital so easily.

(3) Utilization of Facility Capacity--In a number of industries, one of the primary reasons for introducing new technology is to increase productive capacity in the most cost-effective manner as a result of encountering a production stage of decreasing returns to scale. It has been suggested, however, that the U.S. railway industry suffers from overcapacity rather than undercapacity in its fixed facilities. This is supported by statistics such as those in Table 25, which shows typical mainline capacity utilization of trackage located in various parts of the country.⁹² These figures indicate that there is little need for the development and implementation of new technology designed to increase the capacity of railroad facilities. The data in Table 25, however, describe only the capacity utilization of mainline trackage; they do not reflect the utilization of the capacity of railroad terminals.

Table 25

MAINLINE CAPACITY UTILIZATION IN SELECTED AREAS

Selected Area	Estimated Typical Utilization (Percent)
Eastern Seaboard to the Alleghenies (Harrisburg/Cumberland)	25%
Mainlines through the Alleghenies to Pittsburgh	40
New York and New England to Buffalo	20
East-West mainlines in central Ohio	30
North-South mainlines in central Ohio and central Indiana	25
Mainlines into St. Louis	25
Mainlines into Chicago	30
Mainlines through Rocky Mountains	45
Los Angeles to the North	40
Los Angeles to the East	45
Source: Reference 92.	

In fact, results fo the SRI survey indicate that the average daily utilization of railroad classification yards is between 60 and 80 percent of capacity.

Because near-term increases in rail traffic probably will not be constrained by the lack of mainline capacity, there is little incentive to increase it. Such near-term rail-traffic increases may overload numerous railroad classification yards. Development of technology to expand terminal capacity may avert widespread yard congestion and its associated problems. Other potential solutions include constructing more yards (an expensive and perhaps self-defeating approach) or modifying rail-network operating strategies to take advantage of increased traffic volumes by running more direct trains and improving system blocking.

4.6.2.2 Market Structure

The structure and intermodal relationships of the transportation service market have changed dramatically during the last 50 years. Fifty years ago, essentially no other form of intercity transportation could compete effectively with railroads for the bulk transportation of goods, a factor that caused the railroads to dominate the intercity freight-transportation market. This can be seen in Table 26, which shows that, in 1929, the railroads accounted for 75 percent of all U.S. intercity freight ton-miles. Since that time, however, transportation technology in other modes has developed rapidly. A large portion of this technology was made possible by financial support from the federal government as part of a long-standing national policy to support the development and establishment of new modes of transportation. Competing transportation technologies and such factors as economic regulation, demographic variations, and changes in the nature and location of industries have caused the railroads to lose their overwhelming dominance of the intercity freight-transportation market. Although the total volume of U.S. intercity freight transportation rose approximately 266 percent from 1929 to 1973, railroad intercity freight volume increased only 89 percent during that same period. In 1973, therefore, the railroads carried only about 39 percent of the total intercity freight volume.

Because the intercity freight transportation market is highly competitive in nature, there is substantial incentive to introduce new technology that would enhance the competitive position of the railroads within that market. Competition may be in the areas of (1) price competition where the low-cost carrier has the advantage and (2) quality of service competition where the speediest, most reliable and flexible, and least damage-prone carrier has the advantage. Although the railroads have been shown to be the low-cost producers of intercity transportation services, rate regulation by the Interstate Commerce Commission does not allow the railroads to compete freely with other modes on the basis of price; instead, they have been forced to

Table 26

DISTRIBUTION OF UNITED STATES INTERCITY FREIGHT VOLUME
IN MILLIONS OF FREIGHT TON-MILES AND PERCENTAGE OF TOTAL
(Including Mail and Express)

Year	Railroads	Trucks	Great Lakes	Rivers and Canals	Oil Pipelines	Air	Percent	Total Freight Ton-Miles
	Percent	Percent	Percent	Percent	Percent	Percent	Percent	
1929	454,800	19,689	97,322	8,661	26,990	3	--	607,375
1939	338,850	52,821	76,312	19,937	55,602	12	--	543,534
1944	746,912	58,264	118,769	31,386	132,864	71	--	1,088,266
1950	596,940	172,860	11,687	51,657	129,175	318	--	1,062,637
1960	579,130	285,483	99,468	120,785	228,626	778	--	1,314,270
1973	860,000b	510,000	114,000	237,000	495,000	4,200	0.2	2,220,200

Source: Yearbook of Railroad Facts, Association of American Railroads, Washington, D.C. (1974).

compete largely on a quality-of-service basis for certain traffic. For this reason, it is believed that future emphasis will be focused on introducing new technology that will increase the quality of railroad transportation services, thereby enhancing their competitive position in the market.

4.6.2.3 Government Regulation

The self-regulation of the railroads through the AAR is only one aspect of the regulation of this industry. The railroad industry is also regulated by various federal, state, and local government agencies; in fact, it is one of the most heavily government-regulated industries in the United States. The two major areas of government regulatory activity that most influence technological change are economic and safety regulations. Other types of government regulation also influence technological change to a somewhat lesser extent.

(1) Economic Regulation--The government agency principally responsible for economic regulation of the railroad industry is the ICC. State regulatory commissions also have been established in 47 of the 50 states and in certain local areas. The regulatory authority of these state and local agencies, however, is limited because of the interstate nature of most railway operations, and they have less effect on technological change than does the ICC.

The ICC is composed of a chairperson and ten members, all appointed by the president, with the consent of the Senate, for seven-year terms. The commission was set up through the enactment of the Interstate Commerce Act in 1887 and was the first major regulatory agency established by the federal government. The charter and powers of the ICC have been modified several times since its establishment, most notably by the Elkins Act in 1903, the Hepburn Act in 1910, the Emergency Transportation Act of 1933, and the Transportation Acts of 1920, 1940 and 1958.⁹³ At present, railroads are regulated by the ICC primarily in the areas of rates, market entry and exit, and utilization of plants and equipment. Economic regulation in all of these areas can significantly influence the direction, amount, and rate of technological change within the railroad industry.

The highly regulated rate structure of the railroads has been cited as a major barrier to the innovative process within this industry. The regulatory policy currently used by the ICC to establish shipment rates is heavily committed to maintaining stability within the U.S. surface freight-transportation system. The commission is extremely adverse to establishing rates that may foster a dramatic reallocation of traffic between competing railroad companies or between railroads and other competing modes of transportation. For example, the ICC attempts to maintain the present distribution of traffic among competing carriers and modes through such techniques as umbrella rate making and

by setting rates that approximately compensate for the differences in the quality of the service offered by competing regulated modes.

Such rate-making policies and techniques tend to inhibit innovations within the railroad industry because one of the major reasons for encouraging railroad innovation is the attraction of additional traffic to improve the utilization of a railroad's fixed plant. An example of the impact of ICC regulatory procedures upon technological innovation is the "Big John" rate case of Southern Railways. In 1961, Southern attempted to ship, inexpensively, large quantities of grain through the use of newly designed 100-ton aluminum-covered hopper (Big John) cars. Southern proposed to utilize these unconventional light-weight cars in a manner that would reduce railroad grain rates to approximately 60 percent. To qualify for the lower rates, the shipper could not request transit privileges and had to make larger shipments than required for the normal boxcar load rate. The free-time period associated with the newer cars was reduced from 48 to 24 hours. Southern believed that this service would regain a large portion of the grain traffic they had lost to barge and truck operators. The regulatory review and final approval of the Big John rates lasted until 1965, and extensive legal efforts by Southern were required to reverse an earlier ICC disapproval of the rates. This is one example of the difficulties involved in obtaining ICC approval of innovations that reallocate traffic among carriers and modes. It also shows the amount of delay that the regulatory review process can cause between the conception and implementation of an innovation that requires rate approval. Because regulatory review can result in a significant time lag before an innovation can be implemented, the attractiveness of the innovation is reduced when competing firms have time to devise strategies that would counter the effectiveness of the innovation. Although this is probably not an influential factor in the competition among railroads, it can affect competition between railroads and other modes.

Another aspect of ICC rate regulation that has often been criticized is its methodology for evaluating costs. In general, ICC formulas for determining costs are based heavily on historical data concerning average costs, and the use of such data for determining costs can often inhibit the introduction of new technology for which no historical cost data are available. The actual operating economies or diseconomies associated with new technology often are not fully recognized or understood until long after such technology has been introduced. This occurred in the airline industry after the introduction of jet aircraft; the introduction of diesel locomotives offers a similar example in the railroad industry where the overall economic advantages of diesels were not recognized until long after their initial use in 1925.

It also has been argued that ICC cost formulas can, under certain circumstances, represent an inappropriate method or procedure for correctly evaluating the costs associated with new technology. For example, a number of persons have felt that in many cases the use of a

methodology based on marginal costs rather than average costs would result in a better allocation of investment resources in new technology. Gellman details an example about the introduction of double-length piggy-back equipment that supports his contention that ICC cost formulas, in particular Rail Form A, not only inhibit or delay the introduction of new technology but also often cause the adoption of inefficient technology.⁹⁴

The ICC also regulates and establishes other railroad rates besides actual shipment rates. Among these are the per diem rates paid by one railroad for the use of another road's cars and the demurrage fees that shippers pay for the excessive retention of a car for loading or unloading.⁹² The setting of per diem or demurrage rates that do not accurately reflect the worth of modern or technologically advanced cars provides little incentive for any individual railroad to upgrade its rolling stock.

The regulation by the ICC of railroad entry and exit of market areas can also affect technological change within the railroad industry. The three principal methods of market entry or exit that are fully regulated by the ICC are:

Entry or exit through carrier expansion and contraction.

Entry through the merger or acquisition of carriers within the same mode.

Entry through the merger or acquisition of carriers in different modes.

The regulation of market entry through the expansion of a railroad's network probably has little impact on technological change. The regulation of a railroad's desire to exit a market by abandoning its trackage and right-of-way can force a railroad to continue an unprofitable service and lessen the availability of capital for investment in new technology. The regulation of mergers and acquisitions within the railroad industry probably does not greatly affect the pattern of technological change in the railroad industry although ICC disapproval of such mergers or acquisitions may limit the introduction of certain operating and marketing innovations. Technological change is more restricted by ICC regulation of intermodal mergers and acquisitions than by the other methods of regulating market entry or exit. This is supported by the fact that far more innovations in intermodal transportation have been attempted by the Canadian railroads than by the United States rail industry, despite the relatively small Canadian market for transportation services.

Besides the regulation of rail rates and rail mergers and acquisitions, the ICC regulates, to a certain degree, the utilization of railroad plants and equipment. The commission, when necessary, can:

- Suspend railroad car service rules
- Require pooling of equipment
- Require joint use of terminals
- Route rail traffic to avoid congestion
- Establish embargoes and commodity priorities
- Establish car supply requirements.⁹²

These regulatory powers of the ICC can have a severe impact on the railroad's capability or desire to introduce new technology. For example, the establishment of car supply requirements by the ICC can force railroads to invest in existing rather than new car technology that may, in fact, better serve the needs of both railroads and shippers.

(2) Safety Regulation--One of the major constraints on any transportation system is the achievement and maintenance of a fairly high level of safety. To ensure that an acceptably high level of safety is maintained, various government agencies have been given the responsibility to regulate the safety of the different transportation modes. Railroad safety is regulated principally by the FRA which exercises jurisdiction over such areas of railway safety as track maintenance, inspection standards, equipment standards, locomotives, signals, safety appliances, and power brakes. The FRA has the authority to require that railroads install and utilize equipment designed to increase or enhance safety, and such safety regulations certainly can influence the pattern of technological change within the railroad industry.

This influence can be quite direct and overwhelming because it forces the introduction and diffusion of new equipment throughout the rail industry. If the new equipment fosters more efficiency in addition to greater safety, the regulations can have a positive impact on technological change. Because FRA safety regulations generally specify the equipment required to enhance safety, however, they do tend to inhibit the development of other possibly more efficient equipment or techniques to achieve the same end. (For example, many people within the railroad industry believed that equipment other than head shields could have been developed to resolve more efficiently the tank-car safety problem.) The requirement for safe railroad operations and the consequent need for FRA safety regulations may cause the development and utilization of nonoptimal equipment technology. The use of scarce railroad capital to introduce the required safety technology can also limit the capability of the railroads to invest in other desired technologies not required by FRA safety regulations.

The FRA can also require the railroads to change or modify operating procedures considered by the agency to be unsafe or can require that new procedures be adopted. The regulation of railroad

operating procedures by the FRA may encourage or discourage efficient railroad operations while increasing safety. The general opinion within the railroad industry, however, appears to be that safety regulations have tended to impede efficient operations. For example, many persons feel that the FRA car-inspection requirements have had significant impacts on yard operations.

(3) Other Forms of Government Regulation--There are a number of other areas besides economics and safety where the activities of government regulatory agencies other than the ICC and FRA can influence the process of technological change in the railroad industry.

Government regulation can influence technological change in the investment and capital-generation activities of railroads. Several laws have been enacted that are specifically oriented toward regulating railroad activities in these areas. Because the availability of capital is often important to the introduction of new technology, regulation of investment and capital-generation activities can greatly influence whether new technology will be introduced and how rapidly it will diffuse throughout the industry.

The emerging public concern over the environment has caused the development of numerous regulations that impact technological change within the railroad industry. The principal regulatory agency in this area is the federal Environmental Protection Agency (EPA). Other federal, state, regional, and local agencies are also involved in regulating activities that affect environmental quality. The form of environmental protection regulations generally differs from the FRA railroad-safety regulations in that individual hardware items and operating procedures are not specified. Instead, environmental protection regulations usually specify an acceptable standard level of performance that must be achieved, and the means for achieving this standard is often the responsibility of the regulated firm or industry.

This type of regulation often spurs the development of numerous competing designs and technological improvements. There is thus a smaller chance of "freezing" technology at a less than optimal level. For example, the problem of retarder screech has been encountered in a number of railroad classification yards located in noise-sensitive areas. The noise levels generated by friction retarders often do not comply with local noise-abatement ordinances or noise-exposure levels allowed by the Occupational Safety and Health Act (OSHA). To comply with these ordinances, a number of technical approaches to resolving the retarder noise problem have been tested. Some yards have issued special earplugs to yard employees to comply with OSHA. One yard attempted to resolve the problem through the use of special noise barriers placed next to the retarder. Another approach is the use of different materials in the construction of the retarders; another

is to spray the retarder with an oil and water emulsion that modifies its friction characteristics. This example demonstrates how the establishment of a level of acceptable performance by a regulatory agency can induce the development of alternative and competing technologies.

There are other areas where government regulation can influence railroad technological change. Regulations in the areas of economics, safety, investment and capital-generation activities, and environmental protection, however, probably have the most pervasive influence on the process of technological change in the railroad industry.

4.6.2.4 Capital-Investment Requirements

The prospective user of a technological innovation usually must make an investment--an outlay of funds made in anticipation of receiving increased income or reduced operating costs from the use of the innovation. The prospective user, therefore, must have investment funds available if he is to receive the benefits of the innovation. The railroads, like many other industries, have multiple sources of funds and many demands on their use. Relatively long capital turnover times (the ratio of capital to revenues), low earnings on investment, deferred maintenance, and inflation are placing a squeeze on railroads and their ability to generate the capital necessary for their operations. It is likely that the railroads will have to discover new methods for financing if a large-scale technological change is to be inaugurated in a brief period of time. Funds for railroad investments come from the following sources:

Internally generated funds

Borrowing and leasing

Sale of equity.

(1) Internally Generated Funds--The net income after taxes earned by the railroad, noncash charges against income, disposition of assets, and reductions of working capital requirements are the sources of internally generated funds.

The net income of a company is its revenues minus expenses, including interest and taxes. In 1974 (12 months ending September 30), railroad net income was approximately \$798 million for all Class-I line-haul railroads, up from \$559 million for a comparable period in 1973.⁹⁵ Within the industry, however, the profitability of lines varies widely.

Noncash charges against income include depreciation and reserve additions, such as deposits against freight and damage losses and net of actual charges against the loss and damage account. These items are charged as expenses when computing net income but constitute an additional source of cash to the company because they are not actually spent. For the 12 months ending 30 September 1974, these charges were \$358 million, compared to \$405 million for calendar year 1973.⁹⁵

The sum of net profit and noncash charges, frequently referred to as cash flow, is the total of the internally generated funds. The net cash flow of Class-I line-haul railroads in the 12 months ending 30 September 1974 was approximately \$1.7 billion, up from \$1.4 billion in 1973.⁹⁶ The cash flow for 1974 was the highest since 1966.

Sale of land, scrap, or equipment that is no longer needed is a potential source of funds. Generally, however, the railroads consider the land they own to have earning power in excess of its use to the railroad and thus retain it in land-management companies as part of railroad holding companies. Sale of equipment and scrap is a small part of capital generated.

The generation of funds by reducing working-capital requirements is not a significant source of funds. Cash can be generated by speeding collections and billings, slowing payments, and reducing inventories.

(2) Borrowing and Leasing--Railroads borrow large sums on the capital markets in the form of debentures, mortgages, and equipment trust obligations. The railroads had approximately \$11.2 billion outstanding in long-term debt at the end of 1973. Debentures have no security associated with them because they rely on the earning power and general unsecured assets of a company. Mortgage borrowing pledges specific assets against the borrowing, such as land, buildings, or other tangible improvements. Equipment obligations are mortgages on rolling stock. Equipment trusts have been the most easily available funds to railroads in recent years because the security (locomotives or cars) is easily repossessed by the lender and has a ready market to other railroads. Of the \$11.2 billion debt in 1973, equipment obligations represent \$4.6 billion.⁹⁵

Lenders are becoming reluctant to lend money to railroads because of recent bankruptcies. The railroads, unlike other businesses, are obligated to continue operations during bankruptcies. Creditors, therefore, cannot readily repossess assets used to secure mortgages or liquidate other assets for security against unsecured borrowings. As a result, collection of principal and interest on defaulted borrowings is difficult. Furthermore, some large financial lending institutions recently stated that the method of asset valuation of the Penn Central Company and other northeastern railroads in liquidation is unsatisfactory and, therefore, they do not intend to make further loans to railroads unless the valuation of assets is improved.⁹⁷

Leasing involves borrowing equipment, usually rolling stock, instead of money with which to buy the equipment. Leasing under today's tax incentives is advantageous for the lessor and the railroad because of the investment tax credit. Although an unprofitable railroad would not benefit greatly from a tax credit, a profitable leasing company can obtain the tax credit and pass the savings along to the railroad in the form of lower lease payments. Railroad rents are primarily charges for leased equipment. In 1974, rents amounted to over \$1 billion.

(3) Sale of Equity--Another source of investment funds is the sale of additional shares of stock in the company. In practice, selling additional shares would be very difficult in today's capital markets because the bankruptcies of the northeastern railroads and the Rock Island Line have made investors wary of railroad stocks. In bankruptcy, the common stockholders stand to lose virtually all of their investment. The depressed stock prices that result from these two factors indicate that the common stock of most railroads is selling at or below the book value of the company. In other words, the companies are worth more in liquidation than as going concerns. Because dividends that must be paid to maintain the values of the common stock are not tax deductible (as is the interest paid on borrowing), the net cost of selling stock is higher than that of borrowing. At the end of 1974, railroads had 38 cents of debt for each dollar of equity on their books.

(4) Uses of Railroad Funds--The competing demands for funds generated internally and for borrowed money are great. Dividends and expenditures to replace and upgrade plant and equipment are the primary demands.

The payment of dividends consumed over \$400 million of the \$1.7 billion in cash flow generated in 1974. On significantly reduced net income, dividends were over \$700 million in 1971.

Expenditures for plant and equipment include replacing rails, ties, and other parts of the railroad and replacing or rebuilding locomotives and cars. Expenditures for plant and equipment in 1974 are estimated at \$1.5 billion, two thirds of which was expended for rolling stock and the remainder for other facilities, mainly rail and tie replacements. Railroads estimate that a capital expenditure level of \$3 to \$4 billion--approximately two to two-and-one-half the 1974 rate--is required to replace ties and rails that are overage and to create a rail system capable of providing good service and an adequate return on investment.

Some of the capital expenditures are going for technologically advanced equipment. Innovative equipment, however, is usually installed only when replacement is required.

(5) Financial Policy for Investment in New Technology-- Because the demands for capital expenditures exceed the supply of internally generated funds and the sources of external funds for borrowing or stock ownership are limited, the railroads must carefully budget their capital resources. The budgeting process involves assessing the rate of return of alternative investments available to the company and the relative earning power of these investments. These are usually ranked in descending order, and the cumulative cost of installing them in decreasing rank is computed. The initial estimate of the cost of these projects to be undertaken will be made at the point where the funds required equal the funds available. Additional considerations are then applied, such as the length of time that will be required to recoup an investment, the need for safety and other mandatory expenditures, and community- and public-related expenditures.

This is a highly competitive environment in which to encourage railroads to invest their scarce funds in new, and perhaps unproven, technology. Those technological changes that may produce more capital and earning power, however, are not made because of capital shortage. As a result, new methods of financing or new sources of funds will be required to support the introduction and utilization of new technology that will be beneficial to the industry, its customers, and the public.

4.6.2.5 Labor Relations

The reactions of labor to technological change can have a major influence on the success or failure of the change. If labor, acting as either individual workers or an organized union, resists change, the chances that the change will not succeed are generally increased.^{98,99} To understand why labor may resist certain technological changes, it is important to know the labor structure within the railroad industry and to determine how labor perceives the impact of a technological change on their interests.

The labor force of the U.S. railroad industry is characterized by a high degree of labor organization and a history of negotiating strong collective bargaining agreements, many of which are supported by government legislation. The strong movement by railroad labor toward union representation was partly fostered by the fact that the railroad industry has been and continues to be highly labor-intensive. Labor costs generally represent approximately 50 percent of total railroad costs. In addition, the railroad industry is one of the oldest large U.S. industries and the organization of railway labor, having developed for over more than a century, is firmly established.

Historically, railroad labor generally has organized along craft lines, with individual seniority lists for each organization. Many of these individual craft unions, although small, wielded a great

amount of labor and political power. The adoption of new technology, however, often eliminated or drastically reduced the need for workers in certain craft areas, and this encouraged many small craft unions to merge with other unions. This movement toward merging has developed a different type of union representation within the railroad over the last few decades. Currently, two unions represent railroad operating personnel--the United Transportation Union (UTU) and the Brotherhood of Locomotive Engineers (BLE, Independent). The unions representing nonoperating railroad employees have also been affected by union consolidation and merger. As can be seen in Table 27, these unions often represent workers in other industries besides the railroads.¹⁰⁰

The merger of railroad unions with other railroad or nonrailroad unions can lead to potential changes in union negotiating policies with the introduction of new technology. The increased size of the membership of the consolidated unions tends to strengthen the union's bargaining power. The increased diversity of representation within a single union also can affect union reaction to new technology. For example, a union representing many diverse crafts or skills can allow both horizontal and vertical mobility within its membership. This enables railroad employees who are displaced by mechanization, automation, or other technological changes to be retrained for another skill or craft without reducing union membership. In contrast, the smaller craft unions offer railroad employees little mobility, especially horizontally. The retraining of employees in these smaller unions might force them to transfer to another union that represents their new craft. Such action occurring on a large scale could decimate the membership of a union that represented only one skill or craft. It is understandable, therefore, why smaller craft unions might object more vigorously to the introduction of new technology than would larger more diversified unions. Additionally, the consolidation of small craft unions can potentially reduce jurisdictional problems in that, if a technological change affects a number of skill areas, negotiation procedures can be more effective when separate agreements do not have to be developed with each of a number of separate unions.

A major concern of railroad labor unions is the impact of new technology on job security. Job security has long been considered a critical issue by railroad labor. This is understandable because of the numerous economic recessions that have occurred since World War II that have affected railway labor in a more adverse manner than they have affected labor in other industries. In addition, past railroad mergers have resulted in mass elimination of railroad jobs. Previous technological changes within the railroad industry have been uncommonly labor saving. Because the growth rate of rail traffic generally has been small, the introduction of labor-saving technological changes often reduces railway labor-force requirements. This is evidenced by the fact that the railroad labor force has declined from 1,352,000 in 1947 to 526,000 in 1972¹⁰¹ (Figure 59). This 61 percent decline in railway employment over a 25-year period spanned many diverse employment categories. Another

Table 27

RAILROAD UNIONS

Operating Brotherhoods *	
BLE	Brotherhood of Locomotive Engineers (Independent)
UTU	United Transportation Union
Nonoperating Unions	
RASA	American Railway and Airline Supervisors Association
TDA	American Train Dispatchers Association
BBF	International Brotherhood of Boilermakers, Iron Shipbuilders, Blacksmiths, Forgers and Helpers
BMWE	Brotherhood of Maintenance of Way Employees
BRASC†	Brotherhood of Railway, Airline and Steamship Clerks, Freight Handlers, Express and Station Employees
BRC	Brotherhood of Railways Carmen of America
BRS	Brotherhood of Railroad Signalmen
SCP	Brotherhood of Sleeping-Car Porters
HREU†	Hotel and Restaurant Employees and Bartenders International Union
IAM	International Association of Machinists and Aerospace Workers
IBEW	International Brotherhood of Electrical Workers
IBFO	International Brotherhood of Firemen and Oilers
RYA	Railroad Yardmasters of America
SMW	Sheet Metal Workers' International Association
TWU†	Transport Workers Union of America, Railroad Division
DIST 50	International Union of District 50, Allied and Technical Workers of the United States and Canada (Independent)
UTSE	United Transport Service Employees
USA	United Steel Workers of America
Marine Unions in Railroading	
BRASC	Brotherhood of Railway, Airline and Steamship Clerks, Freight Handlers, Express and Station Employees
GLLO	Great Lakes Licensed Officers Organization (Independent)
HREU	Hotel and Restaurant Employees and Bartenders International Union
ILA	International Longshoremen's Association
IUOE	International Union of Operating Engineers
MMP	International Organization of Masters, Mates, and Pilots
MEBA	National Marine Engineers Beneficial Association
NMU	National Maritime Union of America
RMU	Railroad Marine Union
SIU	Seafarers International Union of North America
TWU	Transport Workers Union of America
DIST 50	International Union of District 50, Allied and Technical Workers of the United States and Canada (Independent)

Source: "Railroad Technology and Manpower in the 1970s," U.S. Department of Labor (1972).

* All unions listed are AFL-CIO, unless otherwise designated.

† Also appears in Marine Union List.

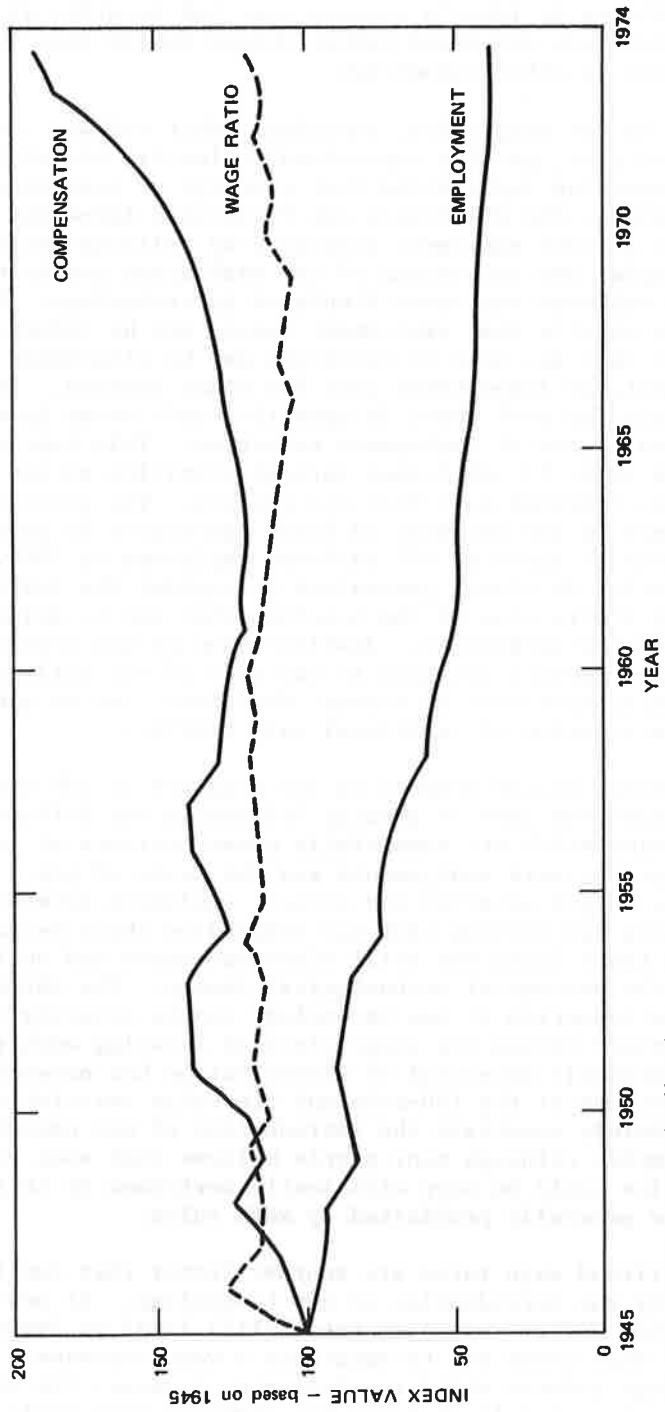

SOURCE: Moody Transportation Manual

FIGURE 59 RAILROAD EMPLOYMENT AND WAGE TRENDS

factor that contributes to labor's concern over job security is that many railway workers have developed rather unique skills that have little direct applicability in other industries.

It is not surprising, therefore, that railway labor unions have, in the past, greatly emphasized collective bargaining agreements and supporting legislation that protects or guarantees job security. For example, the Washington Job Protection Agreement of 1936 was established to protect employees displaced by railroad mergers. Some of the principles and provisions of the Washington Act have been extended to cover railroad employees displaced by technology. Many labor agreements already specify that employment levels may be reduced only through attrition; that is, jobs or positions may be eliminated only as workers retire, quit, or leave their jobs for other reasons. Some agreements also stabilize the work force in specific craft areas by establishing allowable annual rates of employment reduction. This type of agreement requires that, if job losses through attrition exceed the specified rate, the railroad must hire new workers. The practice of including guarantees of job security in labor agreements is quite widespread and is likely to apply to all railroad employees by 1980. The fact that job security is widely guaranteed throughout the railroad industry obviously limits some of the benefits that may be gained through the introduction of new technology. Justification of new technology can rarely include any immediate decrease in the size of the railroad labor force. Short-term productivity increases, therefore, can be achieved only through the attraction of additional rail traffic.

Another factor related to job security is job structure. The structure of railroad jobs is greatly influenced and defined by the railroads' work rules which are essentially those portions of labor agreements that specify work assignments and the basis of pay. Work rules tend to provide job security and protect employees from arbitrary managerial decisions and actions that may jeopardize their welfare and safety. Although these rules are still often necessary and useful, they also can inhibit the process of technological change. The advantages gained from the introduction of new technology can be severely constrained if it must be operated within the constraints of existing work rules. For example, the economic potential of dieselization has never been truly achieved partly because of the 100-mile and crew-size restrictions. Work rules also can severely constrain the introduction of new operating procedures. For example, although many people believe that some yard switching activities could be more efficiently performed by train crews, such practices are generally prohibited by work rules.

Railroad wage rates are another factor that can influence or be influenced by the introduction of new technology. If new technology requires that workers increase their skill level or learn new skills, the union will often try to negotiate a wage increase. If a technological change reduces skill requirements, however, the union generally attempts to maintain at least the previous wage scale. If a technological change raises efficiency and earnings, unions will often

try to garner a share of the benefits gained through increased wage rates. The success of these bargaining strategies is partially demonstrated by the fact that the index of railroad wage rates rose at an average annual rate of 5.9 percent between 1950 and 1971. This is somewhat higher than the 5.5 percent rate at which the average hourly compensation of all employees in the private sector grew during this period. In 1971, the average hourly earnings of all production workers in the private sector were \$3.43, and the average hourly earnings of railroad production workers were \$4.36.¹⁰⁰

Such railroad wage increases generally have offset the gains caused by reducing the size of the railroad work force. Despite the 61 percent decline in overall railroad employment levels between 1947 and 1972, the percentage of rail operating revenues used for employee compensation has not decreased significantly. From 1947 to 1950, employee compensation required 49.9 percent of total railroad operating revenues, and 47.6 percent was required from 1970 to 1972. In terms of labor productivity gains, railroad labor has essentially received nearly the total benefits accrued from the introduction of labor-saving technology. In fact, it has been stated that railroad wage increases actually have exceeded the gains in total railroad productivity (productivity gains when considering capital and materials input as well as labor input).

4.6.2.6 Railway Suppliers

Railroad companies are fundamentally service rather than manufacturing companies and, therefore, depend rather heavily on railway suppliers for the development of new-equipment technology.¹⁰² As a consequence, the railway-supplier industry can have significant impact on the amount and type of technology offered to the railroads because suppliers function in the areas of research, invention, and product development. For this reason, it is important to establish good communications between the two industries so that the technology requirements of the railroads are understood by suppliers of that technology. There is limited incentive for railroad suppliers to finance private research and development if there is little prospect for large-scale adoption of the developed technology, which is usually the case because of the above limitations.

As a result, the structure of the railway-supplier industry and its relationship to the railroad industry does not appear to foster the invention and development of radically new technologies in all areas of railroad operations. A National Science Foundation survey indicates that one-half of the technological items developed by railway suppliers were modifications of items already being produced by them.¹⁰³ In addition, nearly three-quarters of the equipment developed by railway suppliers represented so slight a technological change that no major modifications were required in the production process. It also appears that suppliers are unwilling to undertake the development of low-margin technology unless it is associated with the development and sale of

more profitable technology. Although this reluctance is understandable, it can cause certain special-purpose technologies to remain undeveloped. For example, it has been reported that some suppliers have seen little benefit in developing yard process-control systems unless they could be associated with the sale of other more profitable equipment such as track switches and retarders.

The development of the railway-supplier industry to its present state is presumably a natural consequence of the basic structure and operating history of the railroad industry itself. The historical economic peaks and valleys of the railroad industry generally cause corresponding peaks and valleys in railroad spending. In the past, this pattern has often caused feast-or-famine conditions within the railway-supplier industry. To reduce the effects of extreme fluctuations in railroad-buying patterns, many suppliers have diversified or aligned themselves with other nonrailroad-related companies. Although it appears that the railroads are becoming more dependent on the suppliers, therefore, many of the suppliers have become less dependent on railroad business and possibly less responsive to the railroads' desires and needs for the development of new technology.

5. IMPACT OF TRAIN-TERMINAL INTERACTIONS

The operation of an individual classification yard represents only a portion of the railroad's total operation. It is important, therefore, to identify and examine the interaction of system operations with individual-yard operations. This chapter identifies and describes those system factors that most impact on yard operations. A simple case study demonstrates the potential magnitude of the impact of systemwide policies and strategies on yards.

5.1 FUNCTION OF A YARD

Railroad classification yards are used for collecting cars from local industries and interchanging railroads, disassembling incoming trains into individual cars or group of cars, sorting individual cars and groups to form blocks of cars scheduled for specific destinations, and sequencing and assembling these blocks into outgoing trains. A yard, therefore, can be regarded as a black box (Figure 60) that processes a given set of incoming trains and produces another set of outgoing trains.

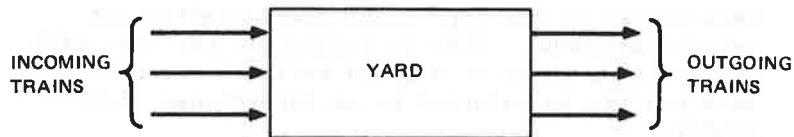

FIGURE 60 FUNCTION OF A YARD

"What" a yard should do and "how best" it can do it depends to a great degree on the set of incoming trains it is to handle, and the set of outgoing trains it is to make up and on the extent of advance consist information received by individual yards in relation to incoming trains and other yards. Determination of what trains are to arrive in and depart from a yard is more a system-level responsibility than it is an individual yard's. As a result, the loads placed on individual yards, thereby affecting their operations, can be influenced to a significant degree by decisions made on a system basis and can possibly result in a systemwide improvements both in yard operations and train movements.

5.2 SYSTEM FACTORS AFFECTING YARD LOADINGS AND OPERATIONS

The system-level factors that can affect individual-yard loadings in a railroad network include:

- a) Composition and delivery times of cars from industry, interchanging railroads, and other system yards.
- b) Time allowances for delivery of cars to their destinations.
- c) Constraints associated with the size of trains.
- d) Availability of advance-consist information related to incoming traffic.
- e) Rules and regulations associated with yard and train crews.
- f) Blocking and train-formation strategies employed at other system yards.

5.2.1 Composition and Delivery Times of Cars from Industry and Interchange Railroads

Cars in various yards of a railroad network destined for other locations typically appear at the originating yards as follows:

- g) Trains from other railroads deliver either mixed or pure blocks to the yard under consideration for further movement. This is frequently the case with the outlying yards of a given railroad network. Such traffic is referred to as interchange (I/C) traffic.
- h) Nearby local industries deliver or request pick up of cars from their plant.
- i) Within the network, local and line-haul trains deliver cars from one yard to another, based on scheduling and blocking policies.

The delivery of cars at the originating yards is a dynamic process (originating cars appear at the yard during a 24-hour period in various combinations at various times of the day). It would be impractical and uneconomical to wait an entire day for all cars to be collected and then sorted and blocked for a specific destination. Considerably more space would be required to store all cars simultaneously in the yard, and many customers will not welcome the idea of their goods being delayed a whole day and not being forwarded as soon as possible. It is necessary, therefore, for cars to be sorted, blocked, and forwarded dynamically throughout the day.

There are basically two extreme philosophies concerning the dynamic movement of cars. The first is to have a fixed time schedule of departure of trains selected suitably (based on experience and historical data) so that there are enough cars to be included in the out-bound trains; the arrival and departing times of trains remain approximately constant, but the number of cars and their destinations and contents may vary considerably. The second philosophy is to wait until enough cars are collected so that a suitable train can be formed; the number of cars will be approximately constant, but the arrival and departure times of trains might vary considerably. For a large network, it is imperative to have at least a nominal fixed schedule of arrivals and departures, with provisions for a finite wait time to make certain important connections; otherwise, system yards would not be able to plan because they would not know what to expect and when, and the whole operation would tend to become inefficient.

5.2.2 Time Allowances for Delivery of Cars to Their Destination

There are always certain limitations on the amount of delay customers would tolerate in the delivery of their commodities to their respective destinations. The amount of tolerable delay depends on such factors as type of commodity, season of the year, day of the week, and the cost associated with delays. Because of these considerations, various system yards are sometimes required to operate in a seemingly inefficient mode from an individual yard's point of view but may be necessary on a systemwide basis. Operating strategies, therefore, must be based not just on the consideration of local efficiency but also on a total systemwide basis to accomplish the most desirable overall car-movement schedule.

5.2.3 Constraints Associated with Train Size

Acceptable train size is a factor closely related to train scheduling and dispatching policies and to railroad systemwide blocking strategies. It has generally been accepted within the railroad industry that road-haul costs decrease as the size of the train increases. This is usually true because, as trains become larger, crew costs per ton of freight hauled and the requirements for cabooses and (over a certain range) power units will also decrease. In addition, the operation of longer (and thus fewer) trains improves track capacity and reduces the need for sidings, additional main tracks, and track signals.¹⁰⁴ Within limits, therefore, both road-haul and fixed-plant expenses are reduced as train length increases. As trains continue to lengthen, however, these savings level off, and it is hypothesized that the road-haul operating costs will eventually again begin to escalate because of additional train derailments, broken knuckles and drawbars, burst air hoses, and train separations.¹⁰⁵

Train-length selection also can have a profound effect on yard operating procedures and costs.^{105,106} Long trains (over 130 cars) generally require more time to inspect (whether walk-by or pull-by), charge air lines, and service power units. In addition, long trains often cause additional switching work (such as doubling in or out of yard tracks or switching slave units or air-brake repeater cars in and out of the train). The unwieldiness of long trains will also increase the time, and thus the expense, associated with switching movements.

It has also been postulated that train length has a significant effect on the quality of service provided to railroad shippers and, therefore, is related to railroad revenues. Figure 61 graphically depicts a hypothetical relationship between road-haul costs, yard costs, and railroad revenues. This relationship, however, can differ significantly, depending on such factors as commodity mix or length of haul. Even on individual origin-destination train routes, the allocation of costs to specific train operating strategies or scenarios cannot be absolutely accurate because of the many assumptions required which can significantly influence the results. The relationship between train length and revenue is probably understood even less although it is fairly evident that commodity mix is a very important factor.

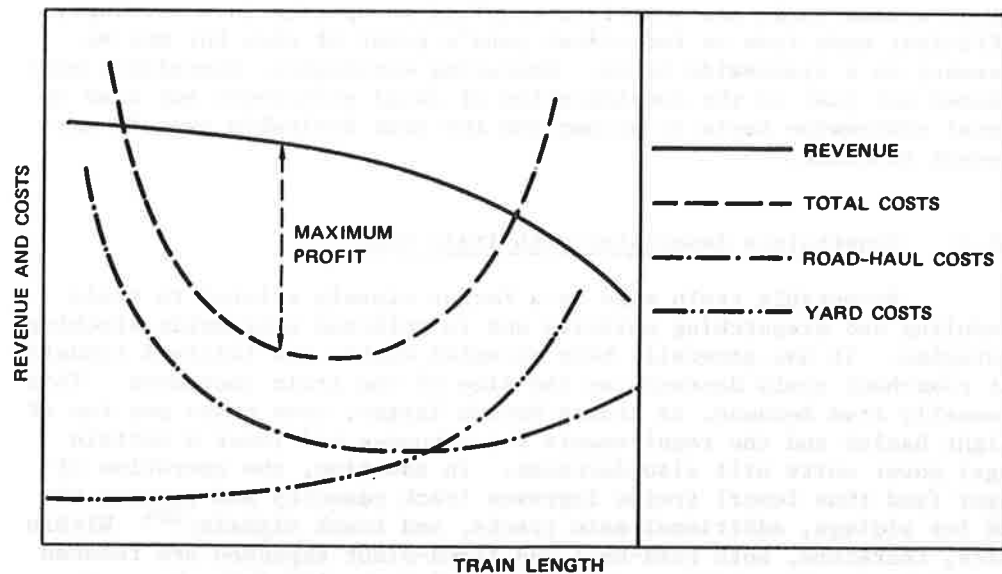

SOURCE: J. C. Martin et al, "Study of Optimum Length, Speed, and Weight of Freight Trains", Bulletin 639, American Railway Engineering Association

FIGURE 61 HYPOTHETICAL RELATIONSHIP BETWEEN TRAIN LENGTH, REVENUE, AND COSTS

Because of the inherent difficulties associated with determining optimal train lengths, railroad companies generally establish a minimum economically justifiable train size, and this requirement can significantly constrain yard operating strategies and tactics. For example, a yard may receive 30 cars for onward movement at a certain time and then no cars for the next eight hours, after which another 50 cars are received. If train size is not a constraint, the preferred strategy (from the yard's viewpoint) would be to forward the 30 cars as soon as possible without waiting eight hours to receive the additional 50. Running a 30 car train and then another train with 50 cars eight hours later, however, would require two engines and two train crews instead of one engine and one train crew. Under many conditions, the two-train strategy would be considered uneconomical.

5.2.4 Availability of Advance Information Related to Incoming Traffic

If the traffic originating at various areas in a network is repetitive on a daily or weekly basis, it will not be difficult to develop an efficient blocking and train strategy which could also be used repetitively. There will be no need to transmit daily the information related to incoming trains and their contents because the same pattern will repeat itself each day. There are always some inherent variations, however, in the number of originating cars and their times of arrival at various yard, on daily, weekly, and seasonal bases. The daily variations in terms of number of cars or arriving times in some instances may be 15 to 25 percent, and the weekly and seasonal variations may be even higher. It would be impracticable to follow a new blocking and train-formation strategy every day because:

Yard resources (crews, switch engines, etc.) cannot be manipulated that quickly.

Using a new strategy each day would necessitate continuously changing delivery times of cars, which may not be very appealing to many customers.

An extremely extensive and fast information system and a very efficient algorithm would be necessary to establish a strategy for each day.

In view of these considerations, the practical solution to the problem of daily variations is the design of a nominal blocking and train-formation strategy for each season, based on the constant traffic, and then small daily adjustments in the strategy, based on the information associated with daily perturbations. The basic utility of advance consist information, therefore, is in providing the system operators with data concerning perturbations in nominal operations so that they can make corresponding modifications and adjustments in line-haul and yard activities. For example, if a yard is informed that a certain train is delayed by two hours, this information can be used to employ the yard resources (crews, classification tracks, switch engines) in a more efficient manner on that particular day.

5.2.5 Work Rules and Regulations

A number of work rules associated with yard and train crews can have a significant effect on yard and train operations. For example, crews typically must be called for a minimum of eight hours and should be informed one or two days in advance. In addition, engine-crew personnel cannot be incremented in one-man units. As a result, if the switching workload exceeds the capabilities of one crew (say by 50 per cent), a complete second crew must be called instead of just half a crew. Other work agreements tend to limit the amount of yard switching that can be performed by road-haul train crews. Generally, such a crew is limited to one switching or "doubling" movement when entering into or departing from a yard. Work rules also specify the times when engine assignments can begin. If, as shown in Figure 62, these start times coincide with yard switching workload peaks, less than optimal engine-crew utilization may result.

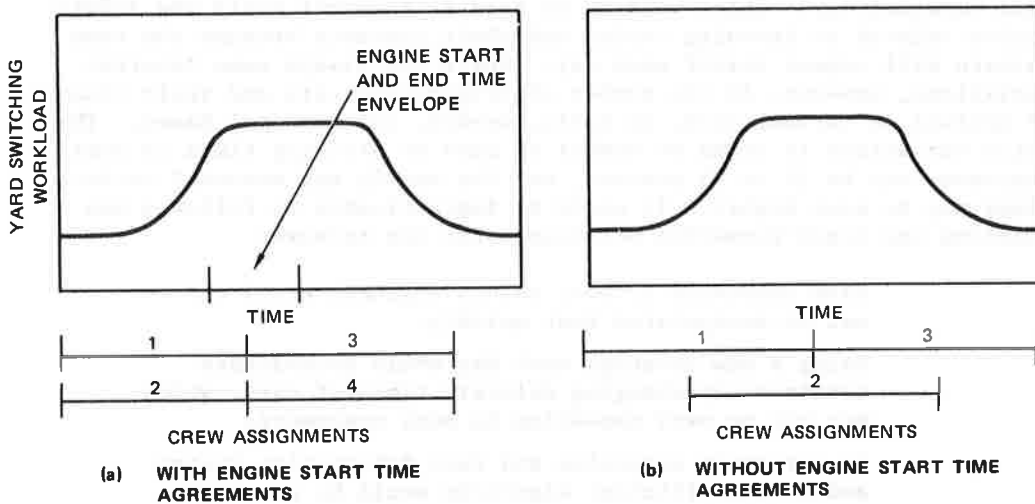

FIGURE 62 HYPOTHETICAL ENGINE ASSIGNMENTS RELATED TO YARD WORKLOAD

5.2.6 Blocking and Train-Formation Strategies in Other System Yards

Blocking and train-formation strategies in individual system yards are influenced by two factors. First, each yard has certain inherent features in terms of its geometry and resources, such as:

- a) Number of receiving, sorting, and departure tracks
- b) Hump or flat yard
- c) Limitations on availability of yard manpower
- d) Degree of process-control automation
- e) Level of information-processing technology

These are local factors that cannot be changed on a short-term basis. Their effect is to limit the number of cars and the number and type of blocks a yard can handle on an hourly, daily, or weekly basis.

The second type of factors that influence blocking and train-formation strategies is the strategy used by neighboring yards that affect individual-yard operations directly or indirectly. To determine how the blocking and train-formation strategy used at one yard can effect the operations at other yards, consider the following simple example of five yards connected linearly:

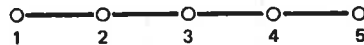

Let the average daily traffic from nodes i to j be denoted by N_{ij} , and assume that Yards 1 and 5 can only make three blocks (because of i - j class track limitations) and that Yards 2, 3, and 4 can make only four blocks each. Further assume that there is no constraint on the size of the blocks. The format in Figure 63 will be used to specify the blocking strategies at various yards.

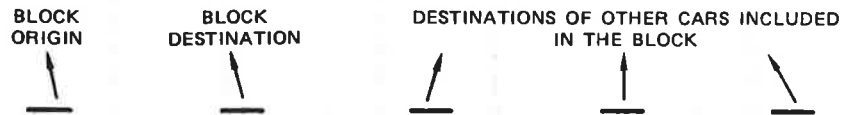
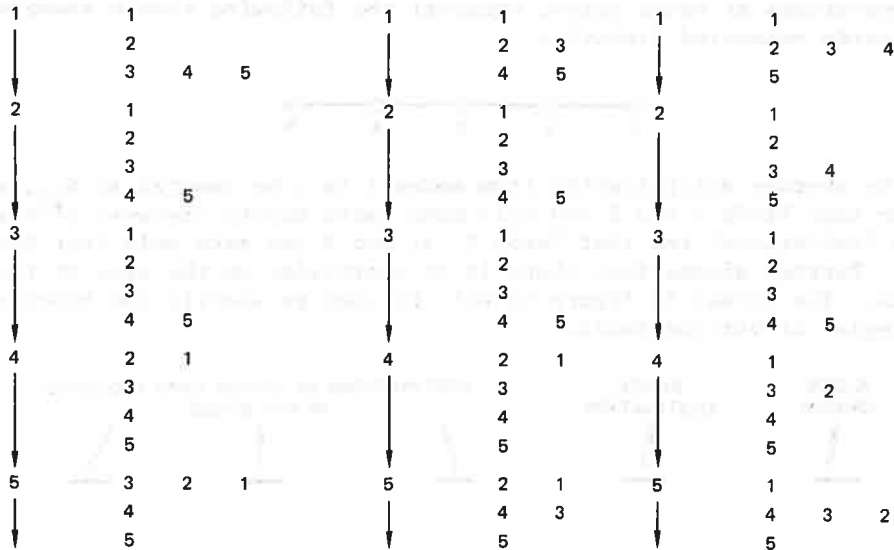
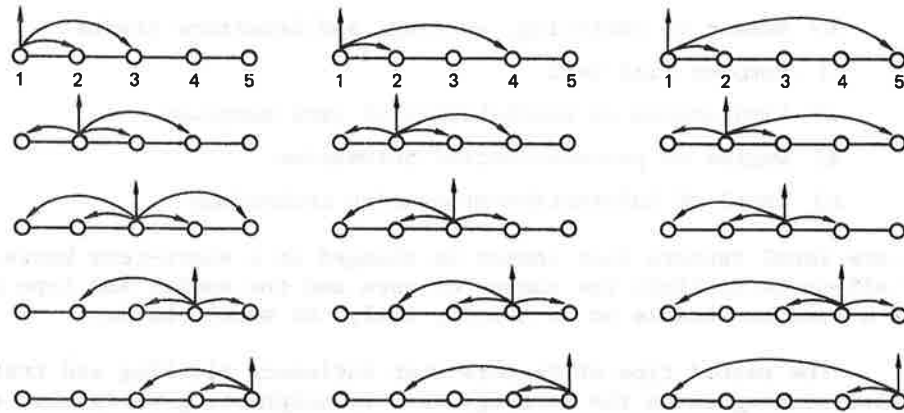

FIGURE 63 A CONVENIENT FORMAT TO SPECIFY BLOCKING STRATEGIES

Many blocking-strategy combinations are possible within the given constraints and each results in different car switchings, yard loadings, and block combinations, depending on the strategy and the traffic flows N_{ij} . No systematic approach has been developed to obtain continuously improving results. Variations are based mainly on judgment and experience. For the five-yard example, three reasonably different blocking strategies and their associated switching matrices are shown in Figure 64 both in schematic form and in the format shown in Figure 63. To understand these blocking strategies, consider Strategy 1 for Yard 1. At Yard 1, a local block is made for Yard 1, a pure block for Yard 2, and cars for 3, 4, and 5 are combined in one block and are sent to Yard 3. In Strategy 2 for Yard 1, a local block is made for Yard 1, cars for 2 and 3 are combined and sent to Yard 2, and cars for 4 and 5 are combined and sent to Yard 4. Other blocking strategies are to be interpreted similarly.



To \ From	1	2	3	4	5
1	1	1	2	3	3
2	1	1	1	2	2
3	1	1	1	2	2
4	2	2	1	1	1
5	2	2	2	1	1

STRATEGY 1

To \ From	1	2	3	4	5
1	1	2	2	2	2
2	1	1	1	2	2
3	1	1	1	2	2
4	2	2	1	1	1
5	2	2	2	2	1

STRATEGY 2

To \ From	1	2	3	4	5
1	1	2	3	4	1
2	1	1	2	3	1
3	1	1	1	2	2
4	1	2	2	1	1
5	1	3	3	2	1

STRATEGY 3

NOTE: Yards 1 and 5 can make only three blocks; 2, 3, and 4 can make only four blocks.

FIGURE 64 THREE BLOCKING STRATEGIES WITH CONSTRAINTS ON BLOCK MAKING CAPACITIES AND THE ASSOCIATED SWITCHING MATRICES

The switching matrices associated with each strategy indicates how many times cars going from i to j are switched before reaching their destination as a result of the specified blocking strategy. For example, considering the switching matrix for Strategy 1 and referring to cars originating at Yard 1 and going to other yards, local cars are sorted by a single switching operation, and cars for Yard 2 are sorted as a pure block through a single switching at Yard 1. Cars for Yard 3, however, are switched once at Yard 1 to become a part of the mixed block (with cars for 4 and 5) and are switched again at Yard 3 to form a pure block. The cars from Yard 1, to Yard 3 in Strategy 1, therefore, are switched two times, as shown in the associated matrix. Similar explanations apply to other entries.

It is not correct to compare the various blocking strategies based only on the switching matrices because the actual number of car handlings and loads in different yards depends also on the values of N_{ij} for each i, j pair. As a result, to calculate the total system switchings for each strategy, each element S_{ij} of the associated switching matrix must be multiplied by the corresponding values of N_{ij} and the summation $\sum_{\text{all } i, j} S_{ij} N_{ij}$ must be calculated for each strategy to compare them on the basis of total systemwide switchings. For example, assuming $N_{ij} = 10$ for all i, j , the switching loads, blocks, and block sizes for the three strategies (shown in Figure 64) are indicated in Figure 65. It can be seen that both Strategies 1 and 2 result in 390 car switchings but the yard loadings in Yards 2, 3, and 4 are significantly different. Strategy 3 produces more car switchings under the assumed N_{ij} flows, but may result in less car switchings for some other N_{ij} flows.

Different blocking strategies can be used to distribute the switching and blocking loads among available yards. If certain yards are overloaded or unable to operate efficiently in a railroad network consisting of several yards, changing the blocking strategies at neighboring yards and redistributing the yard loads may resolve the problem without incurring significant additional costs; this is a better solution than attempting to improve the yard capacities by adding additional tracks or installing costly new equipment. In other words, the problem of yard operations and capacities should be solved on a systemwide basis and not in individual yards.

5.3 A CASE STUDY

In this section, the results of a case study are presented by considering a section of an actual demand data obtained from the corresponding railroad. The purpose of the case study is to demonstrate the possibilities of using suitable blocking strategies to improve the overall operations; however, the development of efficient blocking and train-formation strategies is a complex process influenced to a great degree by the demand data, network topology, and mix of traffic. The results of this study should not be treated as generalized principles of blocking and train-formation processes but only as examples of techniques that can be employed to develop efficient operating strategies.

STRATEGY 1

YARD	BLOCK SIZES	SWITCHING LOAD
1	10, 10, 30	50
2	30, 30, 10, 20	90
3	20, 20, 30, 40	110
4	20, 10, 30, 30	90
5	30, 10, 10	50

STRATEGY 2

YARD	BLOCK SIZES	SWITCHING LOAD
1	10, 20, 20	50
2	30, 40, 20, 20	110
3	10, 10, 10, 20	50
4	20, 20, 50, 40	130
5	20, 20, 10	50

STRATEGY 3

YARD	BLOCK SIZES	SWITCHING LOAD
1	10, 30, 10	50
2	10, 20, 40, 10	80
3	10, 30, 50, 40	130
4	10, 40, 50, 20	120
5	10, 30, 10	50

FIGURE 65 BLOCKS AND SWITCHING LOADS FOR STRATEGIES IN FIGURE 64
 $(N_{ij} = 10 \text{ for all } i, j)$

5.3.1 Network Topology and O/D Demand Data

Figure 66 is a configuration of a section of a railroad network in the Midwest, represented by 11 connecting yards. The approximate

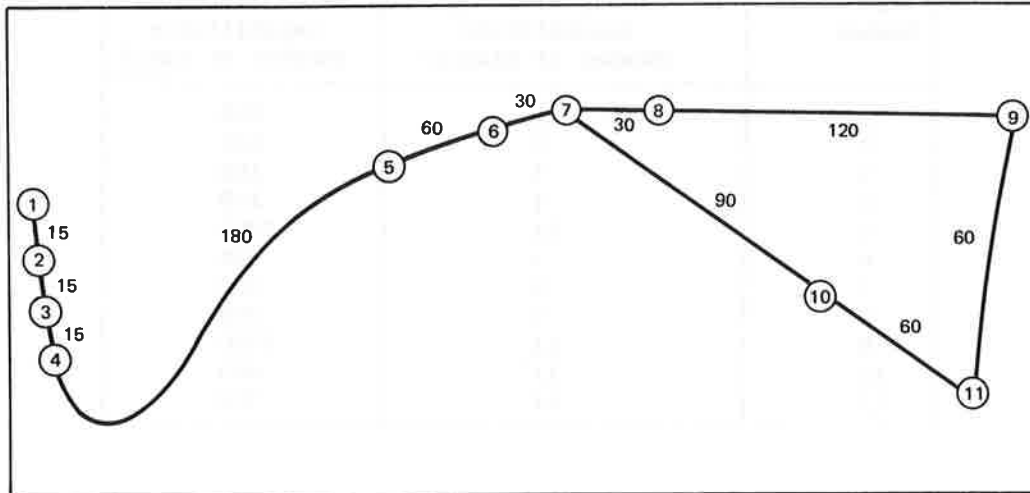

NOTE: Numbers in circles represent yard numbers, numbers in between yards represent approximate link transit times in minutes.

FIGURE 66 NETWORK FOR THE CASE STUDY

link transit times between consecutive yards are based on an average speed of 30 mph. Typical capabilities of the yards in terms of daily switching and block formations are as listed in Table 28, based on yard geometries and their resources and historical data.

Table 29 is an O/D table based on 4-hour periods. It tabulates the traffic delivered to and from various yards by industry and inter-change railroads within the network. Daily totals are listed in the last column.

Table 28

TYPICAL BLOCKING AND SWITCHING CAPABILITIES
OF THE YARDS IN THE CASE STUDY

Yard Number	Daily Blocking Capabilities (Number of blocks)	Daily Switching Capabilities (Number of cars)
1	11	700
2	3	100
3	3	100
4	3	100
5	11	2000
6	5	300
7	5	300
8	5	200
9	11	1500
10	11	400
11	11	300

Table 29

O/D TABLE FOR THE CASE STUDY ON A FLOW-HOUR
BASIS, DELIVERED BY INDUSTRY AND INTERCHANGE RAILROADS

From	To	00:00	04:00	08:00	12:00	16:00	20:00	00:00	Daily Total
1	2		1				1		2
	5			3		6	21		30
	6			1					1
	7			1		4	2		7
	8			2			24		26
	9			17		20	37		74
	10			2		2	3		7
	11			4		7	11		22
2	1				2				2
	5				3	3			6
	6				2	5			7
	8				5	9			14
	9				16	14			30
	10				4	4			8
	11				2	19			21

Table 29 (Continued)

From	To	00:00	04:00	08:00	12:00	16:00	20:00	00:00	Daily Total
3	5				14		6		20
	6				10		6		16
	7				1		1		2
	8				28		16		44
	9				18		11		29
	10				27		1		28
	11				11		5		16
4	1				2				2
	5				2				2
	6				1				1
	8				6	12			18
	9				7				7
	10				3	1			4
	11				3	1			4
5	1			5	10	5	10		30
	8	1	26				1		28
	9	10		22	14	22	14		82
6	1			11	11	23	13		58
	3					7	1		8
	8					1			1
	9			4	4	13			21
	10					1			1
	11			5	5	15			25
7	3						1		1
	4	2					1		3
	5	7					6		13
	6	5							5
	7	11					7		18
	8						3		3
	9	8					5		13
	11	6							6
8	1	17		51	17	51	34		170
	4					1			1
	5					2			2
	9	6		18	6	18	12		60
	10					1			1
	11	14		42	14	42	28		140

Table 29 (Continued)

From	To	00:00	04:00	08:00	12:00	16:00	20:00	00:00	Daily Total
9	1	50	44	6		37	10		147
	2	12	9	6		8	17		52
	3	7	9	5		3	9		33
	4	5	3	1		8	2		19
	5	5	2	15		13	3		38
	6	2			1				3
	7	3	5	8		6	1		23
	8	2		13		2	6		23
	10	1			2		3	3	9
	11	48	8	9		35	21		121
	10	1	24		24		24		
9		6		6		6			18
11		15		15		15			15
11	1			40	42	41	46		169
	2				3				3
	3			1			2		3
	4				1		2		3
	5				3		16		19
	6				2		9		11
	7				6		1		7
	8				8		24		32
	9			35	19	14	49		117
	10				9		13		22
	11			8	9	8	8		33

5.3.2 The Problem to Be Studied

The problem to be studied is how best to form blocks and trains at various yards and how to move the cars to their destinations. Unfortunately, manual calculations and analyses associated with possible alternatives, even for a limited network such as the one under consideration, are time consuming and no single criterion of "goodness" can be realistically defined. The following measures of effectiveness of blocking and train-operating strategies are used by operators and system designers to compare the alternatives:

- a) Delays in movement of cars.
- b) Number of times cars are switched before reaching their destinations.
- c) Number and sizes of blocks to be made up at various yards.

- d) Total train and car miles, train and car hours, and ton-miles on a per-day basis.
- e) Trains per day on various links (railroad tracks).

It may be possible to translate these measures into a common set of units (such as delays and costs); however, defining suitable equivalent delays or costs for them is difficult and may even be misleading because some of them cannot be treated on an equivalent basis. A better approach may be to calculate the various measures individually and use them as a set of criteria for comparing alternatives.

In view of the above considerations, three limited but reasonably different alternatives for operations at Yards 1, 2, 3, 4, and 5 will be studied and the results will be compared in terms of car delays, switchings, and departures of traffic originating at these yards.

5.3.3 Policy Alternatives

Examination of Table 29 makes it immediately clear that several policy alternatives exist because of the way traffic appears at these yards. Some of the possibilities associated with various yards are described below to indicate the variety and extent of the alternatives.

At Yard 1

Alternative 1

Send cars received during 04:00 to 08:00 and during 16:00 to 20:00 hours to Yard 2, unsorted, as soon as possible for onward movement to Yard 5. Send cars received during 20:00 to 00:00 unsorted to Yard 5 for sorting and onward movement.

Alternative 2

Sort out cars in pure blocks for Yards 5, 8, 9, and 11 on a 24-hr basis. Combine cars for Yards 6, 7, and 10 in a mixed block on a 24-hr basis and send to Yard 6 for fine sorting.

At Yard 2

Alternative 1

Combine locally originating cars received from Yard 1 and send unsorted to Yard 5.

Alternative 2

Sort out cars in pure blocks for Yards 8, 9, and 11 and combine cars for Yards 5, 6, and 10 in mixed blocks on a 24-hr basis and send to Yard 5 for fine sorting

At Yard 3

Alternative 1

Send cars unsorted to Yard 5 for fine sorting as soon as possible.

Alternative 2

Sort out cars in pure blocks for Yards 5, 6, 7, 8, 9, 10, and 11 on a 24-hr basis.

At Yard 4

Alternative 1

Send cars unsorted to Yard 3.

Alternative 2

Send cars unsorted to Yard 5.

At Yard 5

Alternative 1

If Yards 1, 2, 3, and 4 send their cars unsorted to Yard 5, then 5 sorts out the cars in pure blocks for Yards 5, 6, 7, 8, 9, 10, and 11.

Alternative 2

If Yards 1, 2, 3, and 4 do not send their cars to 5, then Yard 5 will make pure blocks only for Yards 1, 8, and 9 at suitable times to move its own originating traffic.

Policy alternatives for Yards 6, 7, 8, 9, 10, and 11 can be similarly formulated. However, it is difficult and time consuming to study the consequences of various combinations of policy alternatives for all the yards without the help of a computer program. The results of three alternatives only for Yards 1, 2, 3, 4, and 5 based on some simplifying assumptions and an existing computer program augmented by hand calculations are presented to demonstrate the methodology.

5.3.4 Comparison of Three Alternative Policies for Five Yards

The three variations considered are concerned with the movement of cars originating at Yards 1, 2, 3, and 4 and destined for Yard 5 and beyond. This is only part of the total problem, but it is sufficiently independent and interesting to discuss the results of various policy alternatives on yard loadings, car handlings, crew requirement, and extra car hours generated by these cars.

Table 30 summarizes the results of three variations in blocking and train-operating strategies used at Yards 1, 2, 3, 4, and 5 based on the following scenarios and assumptions.

Table 30
COMPARISON OF THREE VARIATIONS IN OPERATING POLICIES AT YARDS 1, 2, 3, 4, AND 5

Policy Description	Yard Loadings and Crew Requirements															Total Car handling	Extra Car Hours	Average Extra Hours/Car	Trains/Day	Switch-Engine Crews Required		
	YARD 1			YARD 2			YARD 3			YARD 4			YARD 5									
	Cars Switched	Blocks Made	Crews Needed	Cars Switched	Blocks Made	Crews Needed	Cars Switched	Blocks Made	Crews Needed	Cars Switched	Blocks Made	Crews Needed	Cars Switched	Blocks Made	Crews Needed							
Policy 1 Yards 1, 2, 3, 4 send all cars unsorted to Yard 5 as soon as possible, where they are sorted into pure blocks and combined with other cars for onward movement Average train size: 80 to 120 cars	0	1	0	0	1	0	0	0	0	1	0	0	0	1	0	446	7	5	2433	5.4	5	5
Policy 2 Yards 1, 2, 3, 4 sort out cars into pure blocks if there are at least 15 cars in the block on a daily basis; otherwise, mixed blocks are formed Train size: 80 to 120 cars	167	5	2	86	4	1	155	6	2	0	1	0	74*	4	1	484	4	1	4840	10.9	5	6
Policy 3 Same as in Policy 1 except that the train size is as small as 40 to 50 cars	0	1	0	0	1	0	0	1	0	0	1	0	446	7	5	446	7	5	1748	3.9	5	5

*The 74 cars are sent from Yards 1, 2, 3, and 4 as mixed blocks to yard 5. They contain the following destinations and associated quantities:

Destination	No. of Cars
5	8
6	9
7	9
8	18
9	7
10	19
11	4

It is assumed that Yard 5 forms three pure blocks (one local block for 5 and one each for 8 and 10 because 8 and 10 have block-size quantities - more than 15). A fourth mixed block contains cars for Destinations 6, 7, 9, and 11.

5.3.4.1 Assumed Scenarios

The following scenarios were assumed for the three alternative policies.

Scenario for Alternative 1

- Train A-1 leaves Yard 1 at 20:00 with 69 cars (received during 04:00 to 08:00 and 16:00 to 20:00) and picks up 36 cars at Yard 4 (received during 12:00 to 20:00).
- Train A-2 leaves Yard 1 at 00:00 with 98 cars (received during 20:00 to 00:00).
- Train B-1 leaves Yard 2 with 86 cars (received during 08:00 to 12:00 and 16:00 to 20:00).
- Train C-1 leaves Yard 3 at 16:00 with 90 of the 119 cars (received during 12:00 to 16:00 hours).
- Train C-2 leaves Yard 3 at 00:00 carrying the remaining 29 of the 119 cars and 46 cars received during 20:00 to 00:00.

Scenario for Alternative 2

- Train A-1 leaves Yard 1 at 03:00 carrying a pure block of 74 cars for Yard 9, accumulated during 24 hours.
- Train A-2 leaves Yard 1 at 04:00 carrying pure blocks for Yards 5, 8, and 11 and a mixed block of 15 cars for 6, 7, and 10.
- Train B-1 leaves Yard 2 at 23:00 carrying pure blocks for Yards 8, 9, and 11 and a mixed block of 21 cars for 5, 6, and 10.
- Train C-1 leaves Yard 3 at 03:00 with 82 cars in pure blocks for Yards 5, 6, and 8 and also two cars for 7.
- Train C-2 leaves Yard 3 at 05:00 with 73 cars in pure blocks for Yards 9, 10, and 11, and picks up 36 unsorted cars at Yard 4.

All of the above trains stop at Yard 5 and are regrouped to form outbound trains carrying pure blocks.

Scenario for Alternative 3

- Train A-1 leaves at 08:00 from Yard 1 carrying 30 cars (received during 04:00 to 08:00), picks up 34 cars at Yard 2 (received during 08:00 to 12:00) and another 36 cars at Yard 4 (received during 12:00 to 20:00).
- Train A-2 leaves at 20:00 from Yard 1 carrying 39 cars (received during 16:00 to 20:00), picks up 46 cars at Yard 3 (received during 20:00 to 00:00).
- Train A-3 leaves Yard 1 at 00:00 carrying 98 cars (received during 20:00 to 00:00).
- Train B-1 leaves Yard 2 at 20:00 carrying 54 cars (received during 16:00 to 20:00).
- Train C-1 leaves Yard 3 at 16:00 carrying 119 cars (received during 12:00 to 16:00).

5.3.4.2 Assumptions Related to Calculations of Various Measures of Effectiveness

The various measures indicated in Table 30 have been calculated as follows:

(1) Number of cars switched at various yards is the number of cars switched to form pure blocks. In Variations 1 and 3, Yards 1, 2, 3, and 4 do not sort out cars in pure blocks. In Scenarios 1 and 3, therefore, the switching load at these yards is zero. In Variations 1 and 3, all cars are sorted at Yard 5.

(2) Number of blocks formed is the total number of pure and mixed blocks into which the yard sorts the cars it receives. In Variations 1 and 3, Yards 1, 2, 3, and 4 all form only one mixed block into which they place any car they receive. In Variation 2, Yard 1 forms five blocks--four pure blocks (for 5, 8, 9, and 11) and one mixed block (for 6, 7, and 10). Similar explanation applies to other yards.

(3) Switch-engine crews needed for switching are calculated by assuming that one yard engine crew working for eight hours can classify up to 100 cars, two crews working eight hours can classify up to 200 cars, and so on. This is an approximate relationship for flat-yard switching operations, based on limited SRI questionnaire returns. (It should be noted that the classification process in flat yards typically involves a large amount of reswitching of cars.)

(4) Total number of car handlings is

$$\sum_{i,j} N_{ij} S_{ij}$$

where N_{ij} is the number of cars originating at i going to j , and S_{ij} is the number of times each car included in N_{ij} is switched at originating, intermediate, and destination yards. For example, in Scenario 1, cars from Yards 1, 2, 3, and 4 are switched only once at Yard 5 where they are sorted into pure blocks. The number of total car handlings, therefore, is

$$(446)(1) = 446$$

where 446 is the sum of cars originating at Yards 1, 2, 3, and 4 destined for Yard 5 and beyond.

(5) Extra car hours are calculated as the sum of delay incurred by waiting for a train or for pickups and the delay incurred as a result of switching. For example, considering Variation 1 and the movement of cars by Train A-1, the extra car hours associated with the cars in this train have been calculated as follows.

The 29 cars received during 04:00 to 08:00 should ideally have left at 08:00 but, because of train-size considerations, they are held until 20:00 when the total number of cars at the yard becomes 69 which is the minimum size of a train. This is a waiting delay of 12 hours; instead of leaving Yard 1 at 08:00, these cars leave at 20:00. The extra car hours accounting for delay due to waiting for a train associated with the 29 cars is

$$29 \times 12 = 348 \text{ car hours.}$$

At Yard 4, the 36 cars picked up by Train A-1 consist of 22 received during 12:00 to 16:00 and 14 received during 16:00 to 20:00 hours. Assuming that Train A-1 arrives at Yard 4 at 20:45 (adding link transit times) and departs at 21:45 (after pickup operations at Yard 4), the following additional extra car hours at Yard 4 result:

69 cars delayed by one hour for pickup = 69 car hours
22 cars delayed by 5-3/4 hours = 126.5 car hours
(ideally should depart at 16:00 but leave at 21:45)
14 cars delayed by 1-3/4 hours = 24.5 car hours

When the train reaches Yard 5, it disbands and is switched to form pure blocks. The time required to sort out cars in pure blocks is calculated through the following empirical relationship derived from the study of switching operations at some yards:

$$\text{time needed to switch a batch of cars} = 0.57c + 0.35 \text{ minutes}$$

where c is the number of cars in batch. This is again an approximation; more exact relationships must be developed, and this will require further research. Using the above relationship, the time needed to sort out the 105 cars is 60.20 minutes (about one hour). After sorting operations, the cars brought by Train A-1 are formed into the following blocks and associated quantities:

<u>Destination</u>	<u>Number of Cars</u>
5	11
6	2
7	5
8	20
9	44
10	8
11	15

Eleven cars for Yard 5 have reached their destination after an additional delay of one hour caused by switching. The number of cars brought by Train A-1 destined for 6, 7, and 10 are not in block-size quantities (less than 15) and, therefore, must be combined in a mixed block or must be held at Yard 5 until other trains deliver the rest of the cars for these destinations from Yards 1, 2, 3, and 4. For simplicity, it has been assumed that the 15 cars (2 + 5 + 8) for destinations 6, 7, and 10 are held at Yard 5 for an average of 12 hours to be combined with other cars that have been brought in. The cars for destinations 8, 9, and 11 are in block-size quantities and can be sent onward by a train starting from Yard 5 approximately one hour after switching operations are completed because one hour is the time required to form the train. The delays at Yard 5 imposed on the 105 cars brought by Train A-1 can be summarized as follows:

105 cars delayed by one hour for switching = 105 car hours

15 cars delayed by 12 hours for waiting = 180 car hours for other trains

90 cars delayed by one hour for train formulation = 90 car hours.

The total delay in car hours associated with the 105 cars brought by Train A-1 including delays at Yards 1, 2, 3, and 4, therefore, is

$$348 + 69 + 126.5 + 24.5 + 105 + 180 + 90 = 943.$$

The extra car delays for other cars have been similarly calculated.

5.3.5 Analysis of the Alternative Policies

Although limited to a part of the total traffic, the three alternatives considered emphasize several useful aspects of system level factors affecting yard loadings and operations. Following are some of the important points.

- a) Under the assumed scenarios and delay calculations, Variation 3 appears to provide the least average delay per car although, in other respects, this variation is similar to Variation 1. Variation 2 results in relatively higher delay per car.
- b) In Variations 1 and 3, the total switching load is placed in Yard 5; however, the load is within the capacity of the yard. Referring to Table 28, the capacity of Yard 5 is 2000 car switchings per day. Assuming that this capacity is equal in both directions, the total number of cars to be switched by Yard 5 that are going to yards 6, 7, ..., 11 is

$$444 + 28 + 82 = 554$$

where 28 and 82 are the number of cars originating at 5 that are going to Yards 8 and 9. (Refer to Table 29. At Yard 5, the cars originating are only for 8 and 9 going to yards with higher than 5 numbers.) This number is within the capacity of Yard 5. As a result, Variations 1 and 3 do not violate the capacity constraints and provide a better overall car-delivery time compared to Variation 2.

- c) Generally, the number of trains increases if a small train size is allowed (such as a 50-car train). If the traffic patterns are such that not too many small trains can efficiently be formed, however, the total number of trains may not change, as was evident in the present case study. Because the number of trains in all three variations was the same although their composition and departure times were different, the crew costs and other train-associated expenses

will be approximately the same for the three variations. This appears to be generally true because, for a given desirable length (such as 80 cars), the total number of trains in the system is essentially fixed. It is the variations in composition and departure times that affect delivery times and yard loadings.

- d) The major differences in the three variations are car hours, average delay per car, and individual yard loadings. Various blocking policies, train compositions, and schedules can be used to produce several different operating scenarios. The designer can then select those scenarios that appear to offer a suitable combination of yard loadings, car delivery times, and other attributes of interest.
- e) It is difficult to establish universally applicable guidelines for blocking and train-operating policies. The specific O/D table, network geometry, and yard capacities associated with each policy must be considered on an individual basis. Generally, there is a need for an established set of realistic calculable measures of effectiveness, associated costs, and some agreeable criteria for comparing various blocking and train-operating strategies. In addition, a suitable computer program is also required to perform a large number of repetitive calculations, such as car switchings, block sizes, and car delays.

6 MEANS OF IMPROVEMENT

As discussed in Chapter IV, the process of technological change is significantly related to the solution of perceived problems. The organization of a meaningful applied research and development program is highly contingent, therefore, on the identification of the major problem areas and the determination of the relative magnitude of those problems. During our discussions with railroad personnel, it became evident that two major categories of yard-related problems have provided, in the past, the motivation to improve yard operations. One is related to the economic costs associated with yard operations, another is the effect of classification yard operations on the quality of transportation service offered to the railroad user.

6.1 COSTS OF RAILROAD YARD OPERATIONS

Our discussions with railroad personnel indicated that the costs associated with yard operations are a major area of concern. Railroad revenues are related to the movement of freight over some distance. As a result, yard operations, which typically involve the accumulation and sorting of freight cars in one location, usually do not generate revenue, but they can be considered generators of costs or expenses.

Despite the concern about railroad yard costs, we could find no complete agreement as to their magnitude and impact. Estimates by railroad personnel and in the literature ranged from 10 to 65 percent of all railroad costs. In many cases, these estimates could not be broken down into their components.

To develop an acceptable estimate of the total U.S. yard costs, we utilized ICC account information. When the ICC statistics did not define yard costs, SRI project personnel used other information plus their own experienced judgment to determine the appropriate allocation. The major items of yard expense are shown in Table 31. It can be seen that the cost of operating the nation's railroad yards during 1973 is estimated to have been \$3.96 billion which is more than one-third of total railroad expenses during that year. This estimate includes all types of yards and is not restricted to classification yards only. As such, this estimate is an indication of the overall magnitude of nationwide yard costs and serves as a rough upper bound for any estimates of classification yard costs.

The development of our cost estimate of railroad classification yards during 1973 relied heavily on the information obtained during the survey process. Although the questionnaire survey was primarily

Table 31

NATIONWIDE SWITCHYARD EXPENSES
(1973 Calendar Year)

Item	Expense (Millions of 1973 Dollars)	Percent of Yard Expenses
Class-I line-haul railroad		
Yard conductors and brakemen	\$ 679	17.1%
Yardmasters and clerks	325	8.2
Yard enginemen	306	7.7
Payroll taxes	231	5.8
Maintenance of yard locomotives and equipment	191	4.8
Car inspectors	182	4.5
Property taxes	175	4.4
Yard maintenance of way and structures	136	3.4
Superintendence (transportation)	124	3.1
Freight loss and damage and clearing of wrecks	97	2.4
Employee health-and-welfare benefits (transportation)	89	2.2
Yard switch-engine fuel	53	1.3
Insurance and injuries (transportation)	49	1.2
Stationery, printing, and communication (transportation)	41	1.0
Yard supplies and expenses	40	.9
Servicing locomotives	28	.7
Yard switch and signal tenders	<u>26</u>	<u>.6</u>
Yard expenses, Class-I line-haul railroads	\$2,773	69.3%
Gross operating expenses of switching and terminal railroads		
Class I	\$ 277	6.9%
Class II	86	2.1
Class-II line-haul railroads		
Estimated yard expense	<u>39</u>	<u>.9</u>
Total yard-operation expense	\$3,175	9.9%
Car-ownership cost		
Assignable to yards	<u>786</u>	<u>19.8</u>
Total Yard Cost	\$3,961	100%

*Source: Reference 107. Amount shown is SRI allocation of ICC freight service accounts.

performed during the last few months of 1975, the general traffic system during that period made these data more representative of an annual average for 1973 rather than for 1975 because of seasonal and economic factors. From this collected data, we estimate that the costs associated with classification yard operations in 1973 were nearly \$3 billion (1973 dollars) or 75 percent of the total yard costs and 25 to 26 percent of the total railroad expense for that year. Table 32 is a breakdown of the 1973 classification yard costs.

We then used this 1973 breakdown to estimate the national costs associated with classification yards from 1980 through 1989 and from 1990 through 1999. The costs for the entire 20-year period (1980 through 1999) are detailed in Table 33 in 1975 dollars. We predicted that the total national classification yard costs for this period would be over \$75 billion (1975 dollars), based primarily on the projections of future switching and yard requirements developed in the present-trends scenario.

6.1.1 Potential Areas for Yard Cost Reduction

The breakdown of the items of the classification yard cost projections was used to roughly identify and isolate those operational areas where an advance in the state of the art in yard technology would significantly reduce costs. Additionally, further engineering analysis was performed to define these areas more precisely and to examine their sensitivity to change. A major element of this analysis was the use of SRI's previously validated yard simulation model to examine the effects of various changes on yard operations and costs.

6.1.2 Labor-Related Costs

The breakdown of cost projections reveals that the major expense in operating classification yards is labor-related. The projections based on the present-trends scenario indicate that labor-related classification yard expense would be nearly \$50 billion or two-thirds of the total costs. Approximately 65 percent of these labor-related costs are associated with the use of switch engines. Almost 9 percent are related to car inspectors, 8 percent to yard clerks, 6 percent to maintenance-of-way personnel, 4 percent to yardmasters, and an additional 4 percent to yard and terminal superintendence. From this breakdown, it is clear that the major labor-related expense is the operation of switch engines.

6.1.3 Car-Time Expenses

The time cars spend in yards is generally regarded as unproductive because they are not generating freight-ton miles which are the basis of railroad-revenue production; however, the railroads are paying for the car whether it is on a train or in a yard. Based on present

Table 32

CLASSIFICATION YARD EXPENSES (1973)

Item	1973 Expenses (Millions of 1973 dollars)
Personnel-related costs	\$2,076
Yard superintendents	\$ 81
Yardmasters	72
Yard clerks	148
Yard engineers	282
Yard conductors and foremen	282
Hostlers and helpers	25
Other trainmen	512
Car inspectors	153
Other maintenance of equipment	83
Maintenance of way	101
Payroll taxes	199
Employee health-and-welfare benefits	87
Insurance and injuries	50
Yard material expenses	\$ 255
Maintenance of equipment	\$ 64
Maintenance of way	86
Switch-engine fuel	38
Stationery, printing, and communication	33
Other yard supplies and expenses	34
Other classification yard expenses	\$ 662
Property taxes	\$ 53
Loss and damage	82
Equipment depreciation	24
Car depreciation and rental	503
Total 1973 classification yard expenses	\$2,994

Table 33

CLASSIFICATION YARD EXPENSES (1980-2000)

Item	Expenses (Percentage of Total) (Millions of 1975 Dollars)
Personnel-Related Costs	\$49,951 (66.2%)
Yard Superintendents	\$ 1,898 (2.5)
Yardmasters	1,683 (2.2)
Yard Clerks	3,464 (4.6)
Yard Engineers	6,579 (8.7)
Yard Conductors and Foremen	6,590 (8.7)
Hostlers and Helpers	580 (0.8)
Other Trainmen	11,966 (15.9)
Car Inspectors	3,573 (4.7)
Other Maintenance of Equipment	1,945 (2.6)
Maintenance of Way	2,356 (3.1)
Payroll Taxes	6,095 (8.1)
Employee Health-and-Welfare	
Benefits	2,041 (2.7)
Insurance and Injuries	1,179 (1.6)
Yard Material Expenses	\$ 7,942 (10.5%)
Maintenance of Equipment	\$ 1,495 (2.0)
Maintenance of Way	2,017 (2.7)
Switch-Engine Fuel	2,863 (3.8)
Stationery, Printing, and	
Communication	769 (1.0)
Other Yard Supplies and Expenses	798 (1.0)
Other Classification Yard Expenses	\$17,496 (23.3%)
Property Taxes	\$ 1,230 (1.6)
Loss and Damage	1,928 (2.6)
Equipment Depreciation	569 (0.8)
Car Depreciation and Rental	11,753 (15.6)
New Yard Construction	2,016 (2.7)
Total 1980 to 2000 Classification	
Yard Expenses	\$75,389 (100%)

trends, our cost projections showed that car time in yards will cost the railroads almost \$12 billion (1975 dollars) during the 1980-2000 time period. This prediction is based on an allocation of current railroad car-rental and depreciation expenses and averages out at approximately \$2.07 per car day, which is an extremely low figure. The opportunity costs associated with car detention in yards could be considered to be more than three times this amount because the average per diem rate is about \$7/day. In addition, certain railroads believe that the true replacement costs of cars are actually nearer to \$12/car day. Despite the low unit cost associated with car time in our projections, it accounts for nearly 16 percent of the total yard expenses. This cost figure is based on questionnaire responses about average car-detention time in yards.

6.1.4 Other Yard Costs

Switch-engine fuel is the next highest single factor in classification yard expenses, accounting for nearly 4 percent of the total. This can be reduced through the design and development of more energy-efficient switch engines.

It is estimated that the materials used for yard maintenance of way account for 3 percent of the total costs. Improved track and roadbed designs could reduce this expense. For example, continuous welded rails and more durable turnouts would significantly lessen this cost.

The construction or rebuilding of classification yards will also amount to an estimated 3 percent of the total yard expenses. New design and construction techniques and machinery may be able to reduce this cost.

The number of claims resulting from loss and damage in classification yards is expected to be another major expense during the study period. This could possibly be reduced through the development of low-cost end-of-car cushioning, improved packing and dunnage devices and techniques, or improved speed-control equipment in yards.

6.2 ANALYSIS OF YARD OPERATIONS

In addition to estimating the costs associated with classification yard operations, we examined yard processing activities to delineate more fully those operations that are most sensitive to technological change. To analyze yard operations we performed (1) statistical analyses of yard survey data, and (2) a series of computer simulations of classification yard operations.

6.2.1 Statistical Analyses of Yard Survey Data

The data obtained from the yard survey were transferred to a computer-readable form and analyzed with special computer programs. The

primary purpose of these analyses was to identify yard operational problems that can be reduced through technology. The results of these analyses were mixed. A number of strong relationships between various factors of yard operations were verified. In addition, we noted certain patterns in the data, which assisted subsequent analyses. However, we found many of our postulated relationships to be statistically insignificant and some of the collected data inconsistent.

6.2.2 Computer Simulations of Classification Yards

In these computer simulations we used the SRI classification yard model to simulate the effects various technologies have on classification yard operations. The SRI model was originally developed and validated under USRA sponsorship and was modified slightly to better meet the objectives of this project. The model is particularly appropriate for analyzing the effects of changing yard resources (e.g., number and length of tracks, number of switch engines, number of inspection crews), in response to yard operational requirements. We used the model to simulate the operations of six different yards, which were nominally defined to represent the six yard categories described in Chapter II.

The initial simulation of each yard category established a basis of comparison for subsequent simulations of yard operations after implementing various technologies. It also provided additional information about the potential for decreasing car-detention time in yards and improving the utilization of yard resources. Table 34 summarizes the estimated distributions of car-detention time in classification yards during 1973. Based on these distributions, the major element of car-detention time is the delay caused by waiting for the accumulation of cars prior to the makeup and departure of a train. Consequently, the most significant gains in minimizing the time cars spend in yards are achieved by reducing this delay. The accumulation time, however, is directly related to many factors over which the yard has little control. Among the most important is the formation and scheduling of inbound and outbound trains. For example, if shorter trains could be formed, train departures would be more frequent, thereby reducing the amount of time spent waiting for enough cars to make up an outbound train. In the extreme case, if one-car trains were allowed, there would be no delay caused by accumulation.

Next to car-accumulation time, special car handling accounts for the longest car-detention time in yards. Special car handling includes such activities as weighing, repairing, and cleaning. Another element of car-detention time is related to the preparation of outbound trains--inspecting the cars, connecting air hoses, and charging and testing the air-brake system. Including the time spent waiting for processing, these activities account for nearly 8 percent of the total car-detention time in yards. The installation of systems that could automatically lace the air hoses when used with pull-by inspections (using an inspection pit) would significantly reduce this time, as would some type of automatic coupling and a non-air-brake system. The analogous inbound-train

Table 34
DISTRIBUTION OF CAR-DETENTION TIME IN CLASSIFICATION YARDS
(Calendar Year 1973)

Car Time in Yards	Flat Yards		Hump Yards		Total Yards	
	Per- cent	Car Days/Year	Per- cent	Car Days/Year	Per- cent	Car Days/Year
Receiving delay	0.9%	1,781,635	0.5%	276,320	0.8%	2,057,955
Yarding time	1.8	3,331,691	1.5	838,076	1.7	4,169,767
Inspection delay	0.5	938,329	0.8	442,692	0.6	1,381,021
Inspection/brake-bleeding time	6.2	11,718,119	4.7	2,595,176	5.9	14,313,295
Switching delay	0.6	1,084,632	0.8	436,945	0.6	1,521,577
Switching time	5.0	9,434,797	2.2	1,246,022	4.4	10,680,819
Reswitching time	0.8	1,479,398	0.5	276,320	0.7	1,755,718
Accumulation time	60.5	113,581,832	50.1	27,672,374	58.1	141,254,206
Departure pull delay	2.5	4,744,906	3.4	1,877,868	2.7	6,622,774
Departure pull time	3.7	6,948,393	3.6	1,970,701	3.7	8,919,094
Train-preparation delay	1.5	2,876,013	1.9	1,031,293	1.6	3,907,306
Outbound-train preparatio	6.1	11,534,588	6.0	3,311,315	6.1	14,845,903
Departure time	0.9	1,688,992	0.8	422,734	0.9	2,111,726
Special car handling	7.4	13,800,124	12.3	6,803,092	8.5	20,603,216
Car time not accounted for	1.5	2,722,344	11.0	6,063,059	3.6	8,785,403
Total time	99.9%	187,665,793	100.1%	55,263,987	99.9%	242,929,780

preparation activities account for approximately 7 percent of the car-detention time in classification yards. By minimizing or eliminating the time required for inbound inspection and brake bleeding, car-detention time can be significantly lessened.

Based on both the results of the initial simulation runs and the analyses of the yard survey data, we selected technologies that appeared to have the potential for improving the operational effectiveness of the six defined yard types. We then simulated with the SRI model the effects that the implementation of these technologies would have on classification yards. In addition to enabling us to evaluate specific technologies, this series of simulation runs provided enough information for us to identify many general characteristics of yard operations.

The simulations indicated that the stages of flat-yard operations are generally well balanced; no single activity acts as a bottleneck to the flow of cars through the yard. For example, an increase in the switching rate at most flat yards would not significantly increase yard capacity or reduce car-detention time unless train arrival and departure processing activities are also increased.

Most hump yards, however, are not well balanced because certain activities act as operational bottlenecks. Contrary to popular opinion, our analyses and observations indicate that, in most moderate or large hump yards, the major bottleneck occurs during the makeup of an outbound train rather than during classification or humping operations. Improvements in the train-makeup process are therefore likely to have more significant effects on increasing yard capacity or reducing car-detention time than would improvements in the humping process. Some potential improvements in the train-makeup process include:

Improved physical train-makeup process (such as remote-controlled switches or an improved coupler/brake system).

Improved geometric design to reduce interference between switch engines and to eliminate additional switching or doubling.

Improved yard management, planning, and communications to reduce the interference between switch engines.

Our analyses thus indicate that it is necessary to implement improvements in most flat yards in parallel in order to improve operations. For most hump yards, however, improvements in train-makeup activities tend to have the most substantial impact on yard operations.

Our analyses of yard processes and procedures revealed, in many cases, that changes in procedures significantly affect yard operations. For example, changing train schedules reduces the amount of car-detention time in classification yards. This reduction was found to be significant in small and medium classification yards and somewhat marginal in larger classification yards.

We also examined the different categories of classification yards and observed that their operational efficiency varies significantly. Generally, the medium and large hump yards were the most efficient (when judged in terms of labor productivity). Many of the newer, small hump yards were more efficient than flat yards with comparable throughput; however, most of these low-volume hump yards were operating at a relatively low level of efficiency. Based on other yard survey data, such as hump-yard age and capacity, we postulate that most of the less efficient, low-volume hump yards are older yards that are not being operated at their optimal throughput volume. In many cases, the efficiency of these yards can be improved by reducing the number of yard crews, re-scheduling trains and crew assignments, or operating with only one or two shifts a day. Their efficiency can also be improved by converting them to flat switching yards.

The low-volume flat yards were also often operating at a relatively low level of efficiency. Although certain operational changes can increase this level of efficiency, it was still generally lower than the level of efficiency in the other types of yards. In some geographical areas this problem can be overcome by consolidating a number of smaller classification yards.

These remarks are general in nature and scope. Although they represent the overall conditions of classification yard operations in the United States, there are many exceptions to what we have categorized as typical.

6.3 POTENTIAL MEANS FOR IMPROVEMENT

Using the information gained from the analyses described above, we estimated the effects that the implementation of certain types of technology would have on yard expenses and on the quality of service offered.

6.3.1 Yard Expenses

The economic benefits that would be gained from the implementation of selected elements of yard technology are shown in Table 35. These cost savings are based on the present-trends scenario over the 1980 to 2000 time period and on the assumption that each element could be fully implemented by 1980 to form a common basis for comparison. The derivation of these cost estimates are also based on certain assumptions regarding the operational and technical characteristics and feasibility of the postulated items of technology. Because the values of these estimates are highly dependent on the assumptions made, they should be used not as absolute measures of cost-savings potential but rather as first-order indicators of the relative cost-savings impact of the various technological features.

6.3.2 Quality of Service

We also examined the effects that the implementation of various types of technology would have on the quality of service offered to the railroad user. Our examination identified seven major elements of service quality including O-D transit time, O-D transit-time reliability, equipment availability, schedule adaptability, correct delivery and spotting of cars, lading loss and damage, and the availability of car and load-status information. It is extremely difficult to measure or quantify the quality of railroad service, partly because the variations between the seven identified elements of service quality make it impossible to develop a single measurement scale. The relative importance of each element will also vary between shippers, depending on such factors as commodities and inventory surpluses. For example, a shipper of lettuce or glass will probably be more concerned over lading damage than would a shipper of steel or coal.

Table 35
POTENTIAL YARD-TECHNOLOGY IMPROVEMENTS

Areas of Improvement Means of Improvement	1980-2000 Cost Savings (Millions of 1975 Dollars)			
	Labor-Related Savings	Car-Time-Related Savings	Other Savings	Total Savings
Rolling-Stock Technology				
Remote-controlled hump engine	\$ 241	\$ 0	\$ 0	\$ 241
Remote-controlled switch engine	5,752	0	85	5,837
Cab-operated coupling/uncoupling system	5,719	1,410	0	7,129
Energy-storage flywheel switch engine	0	0	385	385
Switching mules	547	0	58	605
Smaller switch engines (15 to 25 car movement capacity)	0	0	390	390
Car-cushioning devices	0	0	626	626
Internal bracing and restraint devices	0	0	626	626
Car-security systems	0	0	90	90
Self-bleeding brake	659	705	0	1,364
Yard/Network Operational Procedures				
Car distribution	\$ 0	\$1,175	\$ 0	\$1,175
Train scheduling, and dispatching	0	1,293	0	1,293
Systemwide blocking and train formation	1,040	823	79	1,942
Yard Design				
Herringbone-track layout (hump yards)	\$ 954	\$ 210	\$ 80	\$1,173
Yard Hardware				
Speed-control devices (flat yards)	\$ 0	\$ 0	\$ 880	\$ 880
Speed-control devices (hump yards)	0	0	587	587
Power switches (flat yards)	3,052	0	0	3,052
Automatic air-hose connection devices	659	588	0	1,247
Pin-puller cut indicator (hump yards)	0	31	0	31
Automatic pin puller (hump yards)	190	41	0	231
Continuous welded rail	319	0	228	547
Computer, Control, and Communication System				
Car-movement information and location	2,771	0	0	2,771
Automatic car identification	1,879	0	0	1,879
Computerized operations monitoring and planning system	4,279	588	143	5,010
Yard security systems	0	0	45	45

Table 36
RELATIVE ASSESSMENT OF SERVICE-QUALITY IMPROVEMENT

Areas of Improvement Means of Improvement	O-D Transit Time	O-D Transit Time Reliability	Availability of Acceptable Equipment	Adaptability of Schedules	Correct Delivery and Spotting of Cars	Freight Loss and Damage	Availability of Car Information	Total Service Quality Index
Yard Computer/Communication Systems								
CCTV (general yard observation)	0.0	0.0	0.3	0.3	0.3	2.3	1.7	4.9
CCTV (car inspection)	0.0	0.3	1.7	0.7	0.0	1.8	2.3	6.8
Car-movement information and location	2.0	2.7	1.7	3.0	2.5	1.3	4.0	17.2
Rollability measurement and prediction	0.0	0.0	0.0	0.0	0.0	0.8	0.0	0.8
Automatic car identification	1.8	2.0	0.3	2.3	2.0	1.4	3.3	13.1
Voice data entry	0.7	0.7	0.3	0.7	0.7	0.0	3.0	6.1
Radio X-mission of hard copy switch list to switch engine	0.8	1.0	0.3	2.0	1.7	0.0	1.3	7.1
Computerized yard-operations monitoring and planning system	2.8	3.5	3.0	4.0	3.0	1.5	3.7	21.5
Yard security systems	0.0	0.2	1.0	0.0	0.0	3.0	0.0	4.2
Yard Hardware								
Coupled-in-motion scales	0.8	0.7	0.0	0.3	0.0	0.2	0.0	2.0
Uncoupled-in-motion scales	0.8	0.7	0.0	0.3	0.0	0.0	0.0	1.8
Weigh rails	0.0	0.0	0.0	0.0	0.3	0.3	0.0	0.6
Car safety-inspection devices	0.3	0.7	1.3	0.0	0.0	2.2	1.3	5.8
Wheel detectors	0.3	0.3	0.0	0.0	0.3	0.0	0.3	1.2
Presence detector and track circuits	0.0	0.0	0.0	0.0	0.3	0.3	0.3	0.9
Speed-control devices	0.0	0.2	0.0	0.0	0.0	3.3	0.0	3.5
Power switches (cab controlled)	0.7	0.5	0.0	0.2	0.0	0.2	0.0	1.6
Power switches (tower controlled)	0.3	0.2	0.0	0.0	0.0	0.0	0.0	0.5
Yard air devices	0.7	0.5	0.0	0.0	0.0	0.0	0.0	1.2
Automatic air-hose connection devices	1.5	1.0	0.0	0.0	0.0	0.0	0.0	2.5
Pin-puller cut indicator (hump yards)	0.3	0.5	0.0	0.0	0.0	0.0	0.0	0.8
Pin-puller Platform (Hump Yard)	0.3	0.3	0.0	0.0	0.0	0.0	0.0	0.6

Table 36
(Concluded)

Areas of Improvement Means of Improvement	O-D Transit Time	O-D Transit Time Reliability	Availability of Acceptable Equipment	Adaptability of Schedules	Correct Delivery and Spotting of Cars	Freight Loss and Damage	Availability of Car Information	Total Service Quality Index
Yard Hardware (Concluded)								
Automatic pin puller (hump yards)	0.3	0.5	0.0	0.2	0.0	0.0	0.0	1.0
Weather-sealed switches	0.5	0.3	0.0	0.3	0.0	0.3	0.0	1.4
Continuous welded rail	0.0	0.0	0.0	0.0	0.0	0.0	0.0	0.0
Concrete ties	0.0	0.0	0.0	0.0	0.0	0.0	0.0	0.0
Track-maintenance equipment	0.0	0.2	0.0	0.0	0.0	0.0	0.0	0.2
Yard lighting	0.3	0.0	0.0	0.7	0.0	0.2	0.0	1.2
Rolling Stock Technology								
Remote-controlled hump engine	0.0	0.2	0.0	0.0	0.0	0.2	0.0	0.4
Remote-controlled switch engine	0.0	0.0	0.0	0.0	0.0	0.7	0.0	0.7
Cab-operated coupling/uncoupling system	0.3	0.5	0.0	0.0	0.3	0.0	0.0	1.1
Energy-storage fly-wheel switch engine	0.0	0.0	0.0	0.0	0.0	0.0	0.0	0.0
Switching mules	0.3	0.3	0.0	0.0	0.7	0.2	0.0	1.5
Smaller switch engines (15 to 25 car-movement capacity)	0.3	0.3	0.0	0.0	1.0	0.0	0.0	1.6
Car-cushioning devices	0.0	0.0	0.0	0.0	-0.2	3.0	0.0	2.8
Internal bracing and restraint devices	-0.3	-0.3	0.0	0.0	-0.2	3.3	0.0	2.5
Car-security systems	0.0	0.0	0.0	0.0	0.0	2.7	0.0	2.7
Self-bleeding brake	1.0	1.2	0.0	0.0	0.0	0.0	0.0	2.2
Yard/Network Operational Procedures								
Empty-car distribution system	2.8	1.8	4.3	0.5	1.0	0.0	1.7	12.1
Train scheduling, and dispatching	3.0	3.8	1.7	3.0	0.7	0.0	0.7	12.9
Systemwide blocking and train formation	3.8	3.0	0.3	0.7	0.3	0.7	0.7	9.5
Dynamic assignment of class tracks	0.8	0.3	0.0	2.7	0.0	0.0	0.0	3.8
Multipass switching	0.0	0.0	0.0	1.3	0.0	-0.7	0.0	0.6
Unit trains	3.7	4.7	0.0	-0.7	0.0	1.0	0.7	9.4
Runthrough trains	3.7	4.7	0.0	-1.0	0.0	2.0	0.0	9.4
TOFC/COFC Trains	3.0	2.7	0.0	0.7	0.0	1.7	0.0	8.1

For these reasons, a relative rating procedure was developed to indicate generally how service could be improved. A number of SRI researchers were asked to rate subjectively (on a scale from -5 to 5) the effect certain technologies would have on the various elements of service quality. All of the researchers involved in this rating procedure had had extensive experience in analyzing railroad operations and were familiar with the technology items that were being examined. The ratings were then averaged and the results are shown in Table 36.

6.4 SUMMARY

The results of our analyses reveal a number of areas where the development and/or implementation of technology would have significant benefits. The technologies recommended for further study are described below.

6.4.1 Rolling-Stock Technology

The development and implementation of an advanced car-coupling and brake system could greatly reduce labor-related and car-detention costs in classification yards. To be truly effective, however, such a system should be installed on all cars. The requirements for design compatibility both during and after the changeover is a significant constraint to the effective use of such systems. Another serious constraint to the nationwide implementation of such a system would be the capital-investment requirements.

Because the operation of switch engines accounts for more than 50 percent of all yard-related expenses, efforts to improve the design and operational efficiency of switch engines appear to be warranted. Certain technology (such as remote-controlled switch engines) has the potential to reduce dramatically the labor requirements within yards; it can also increase switch-engine utilization and efficiency. (For example, the engines would not necessarily have to be brought to a central yard location for crew changes.) Such technology is expected to be relatively inexpensive and does not need to be universally implemented to derive benefits. Existing labor-protection agreements, however, would probably delay the benefits to be gained from such technology.

The development of improved switch-engine designs can increase the energy-efficiency of many types of switching activities. Most industrial distribution engine assignments (which account for approximately 30 percent of all switch engine hours) could be performed by smaller switch engines or mules because more than 65 percent of these assignments handle less than 40 cars per shift. In addition, most roustabout-type engine assignments (such as those working at scales or in repair shops) could also be accomplished by smaller more energy-efficient engines.

Improved car-cushioning technology could potentially reduce lading-damage claims and improve the quality of service offered to the rail user. Typical improvements would include increasing the effectiveness and decreasing the cost of internal bracing and dunnage devices and car impact-absorbing devices.

6.4.2 Yard Hardware and Facilities

The development of new or improved yard hardware was not found to significantly increase service quality. Implementation of certain types of hardware, however, can reduce yard costs.

A device to connect air hoses automatically, could reduce both labor-related and car-detention costs; however, these savings would be, for the most part, redundant with those associated with advanced car-coupler and brake systems. The advantage of such a device would be that it is a fixed facility and is not as difficult to implement although its technical and operational feasibility has not yet been demonstrated.

Improved track and roadbed design and maintenance also offer potential for reducing yard costs and increasing the efficiency of operations. This is an issue that has not been addressed in depth because we could find no definitive or widely accepted data on optimal maintenance policies for yards. In addition, the applicability of continuous welded rail, concrete ties, different rail weights, and other related technologies has not been completely assessed.

The design and control of yard turnouts should be examined. Our first-order analysis of the use of power switches in flat yards reveals a large potential for manpower cost reduction over the period from 1980 to 2000. Many factors, however, can constrain the effectiveness of this technology. More efficient turnout design and control could also improve yard operations by decreasing the number of misswitched cars and derailments and reducing weather-related problems. Improved designs have also been shown to greatly reduce maintenance costs. Improved safety is another potential benefit.

Improved car-inspection devices and facilities at classification yards may significantly enhance the level of railroad safety. Facilities for pull-by inspections of cars would also be essential to achieve the potential manpower savings that could result from the implementation of advanced car-coupler and brake systems. Such facilities (inspection pits) already exist at several yards, and their feasibility has been demonstrated.

6.4.3 Yard Computer, Communications, and Control Technology

The elements of technology in this area generally were found to exhibit a high potential for improving service quality and reducing yard expenses. In particular, the investigation of an inexpensive highly reliable automatic car-identification system should be continued because it is an almost essential prerequisite to the development of more sophisticated computer systems both at the yard and system levels. Our analyses also indicates that these new computer systems show great promise for reducing yard costs although some of these analyses are based on somewhat speculative assumptions because of the uniqueness of such systems. The pioneering computer-based yard-inventory systems, however have been shown to improve service quality, reduce costs, and enhance demurrage accounting procedures. Future systems that facilitate the monitoring and planning of yard operation also appear to have significant potential.

6.4.4 Yard/Network Operational Procedures

A number of different types of operational procedures were found to have a positive impact on both yard costs and service quality. A major advantage of implementing operational changes rather than hardware-related changes is that the required initial investment is usually much lower. The most dramatic overall improvements were achieved through changes in network operational procedures. Three principal areas that should be further investigated are the development of an empty-car distribution system on either a nationwide or individual systemwide basis, the development and use of systemwide blocking and train-formation strategies, and train-scheduling and dispatching policies.

At the yard level, operational changes were observed to have a less significant impact. In certain yards that are currently being underutilized, however, greater efficiency can be achieved by such changes as rescheduling crews, reducing hours of operation, or terminating yard operations. The capability to dynamically assign crews, tracks, and other yard resources has a good potential for reducing yard costs and improving service.

6.4.5 Yard Design

During our research, the design of classification yards was determined to have a significant impact on the effectiveness of yard operations. For example, the number and/or length of the yard tracks are a major problem at more than one-third of all classification yards. We were often told by railroad employees that geometric modifications to existing yards could substantially reduce operating costs. At present, however, there is no clearly accepted methodology to evaluate the effects of changes such as additional classification tracks to reduce reswitching requirements. When evaluating new yard technologies through the use of SRI's yard simulation model, certain design concepts, such as herringbone tracks in hump yards, also showed great promise for reducing yard costs. As a result, further investigation of the geometric design of classification yards is recommended.

Appendix A

YARD MECHANIZED INFORMATION-PROCESSING SYSTEMS

Mechanized information-processing systems (as defined by SRI) can vary significantly among yards. Generally, however, these yards have the equipment to transmit and receive train consist and car data and often certain other limited data-processing capabilities. The paperwork and information processing, therefore, are keyed to the available equipment. The most common types of mechanized information-processing systems are those that rely on IBM cards to maintain a more-or-less real-time inventory of freight cars in a yard or terminal area. These are generally referred to as PICL systems (perpetual-inventory and car-location systems) although individual railroads may use other terms to describe similar systems. For example, Penn Central's IBM accounting system was known as the DICCS system (demurrage industrial car control system). Despite the differences in terminology, SRI has observed that most IBM card systems are similar, with only slight variations among yards. The information processing and paperwork for a typical IBM card system (Figure 67) is described below. This description generally parallels the sequence of car-handling processes in classification yards.

Classification yards with mechanized information-processing systems generally receive advance-consist information regarding incoming trains. For each inbound train, this information will contain a listing of the cars on the train and/or a set of IBM cards with individual car identification, load, and other data punched on a separate card. The advance-consist listing of cars should be received by the yard in the same order as the cars on the inbound train. On actual arrival, a physical check of the train is made to discover errors in the advance-consist information. Waybills for the cars on the train are also received by the yard office at this time. If the yard office has not previously received IBM cards for all cars on the train, they will be prepared by the yard office clerks. The IBM cards and waybills are then sorted into the same order as the cars in the train. The train consist information is then used to prepare a switch list which is forwarded to the appropriate yard personnel. The train can then be classified and the cars sorted into the appropriately assigned classification tracks. The yardmaster will denote on the switch list which tracks the cars are actually sorted onto and the "as switched" list is sent back to the yard office. Using the as-switched list, a yard office clerk manually sorts the waybills and IBM cards into pigeonholes corresponding to the tracks onto which the individual cars were switched. By this time, the cards and waybills have been sorted and ordered in such a way that they represent the

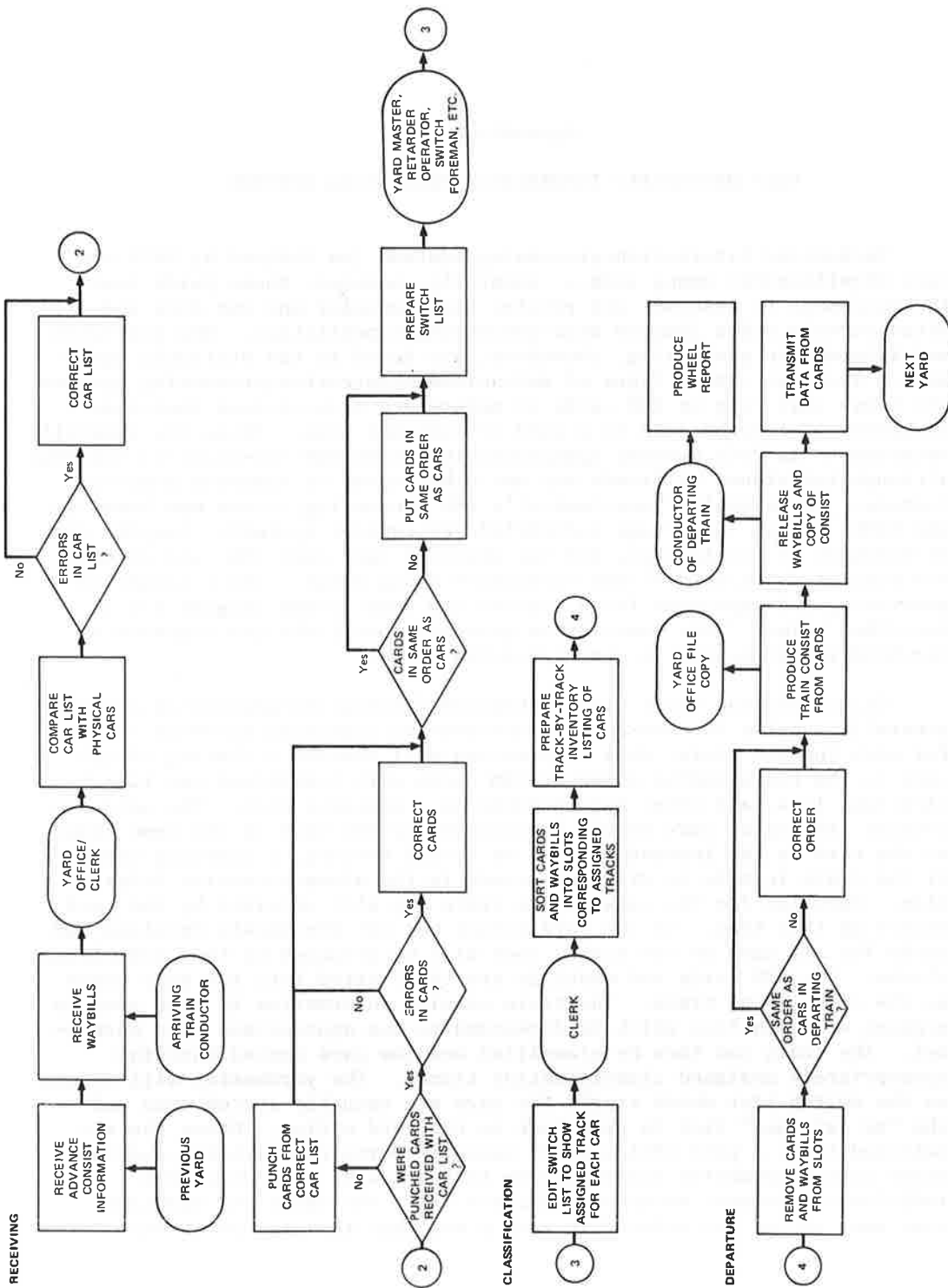

FIGURE A-1 INFORMATION FLOW IN MECHANIZED YARDS

actual location of cars on the classification tracks. Periodically (typically at the beginning of each trick), the IBM cards are used to prepare a track-by-track inventory listing of the cars within the yard.

The outbound car process involves coupling cars and attaching a caboose and power units to form an outbound train. If the cars from two or more class tracks are doubled together to make an outbound train, a yard clerk will take the waybills and IBM cards from the pigeonholes corresponding to those tracks and bundle them together in the proper train order. At this time, a physical check of the train is made to ensure that the cars are in the same order as the waybills and IBM cards and to ascertain that there is a waybill and an IBM card for each car in the train. The IBM cards are then used to prepare copies of the train consist, one of which will be stored temporarily in the yard office. The waybills and other copies of the train consist are then given to the outbound train conductor for use as a wheel report. The cards are then run into a card-reader device that transmits the data to the next yard where a similar set of cards is produced. Besides using the IBM cards to develop a yard-inventory listing, they are also sometimes employed to generate yard transit-time statistics.

The PICL system is also utilized to maintain an inventory of the cars located at industrial sidings and tracks within the terminal area. Probably the major advantage of the PICL system is that it can serve as an accurate basis for demurrage accounting; however, this advantage generally accrues to agency rather than yard operations.

Appendix B

SRI QUESTIONNAIRES AND RESPONSES

This appendix contains copies of the questionnaires used by SRI during the data-collection phase of this project. The first two forms are the SRI questionnaire and questionnaire response sheet sent to the FRA safety inspectors. The information obtained from this data collection was used to develop a comprehensive national inventory of railroad classification and industrial yards. Also included are copies of the SRI questionnaire sent to owners and operators of railroad classification yards. The information obtained from this survey was the key element in the SRI yard characterization and problem analysis.

	<u>Column</u>
1. In what FRA region is this yard located?	1
2. In what state is this yard located? Please use standard U.S. Postal Service two-letter abbreviations.	2-3
3. In what city is this yard located?	4-21
4. What is the commonly used name of this yard? For example, Train Yard, 12th Street Yard, Perlman Yard, Northtown Yard, etc.	22-38
5. What railroad operates this yard? Please abbreviate. If more than one railroad operates this yard, enter the word "JOINT".	39-43
6. In what type of area is this yard located?	44
Industrial (I) - Land which is used principally for manufacturing or processing products and materials.	
Commercial (C) - Land which is used principally for the conduct of trade and business. This would include merchandising, business offices, amusement, and personal service uses.	
Residential (R) - Land which is used principally for single or multiple family dwellings.	
Agricultural (A) - Land which is used principally to raise crops or livestock.	
Undeveloped (U) - Land which has not been developed or altered to accomodate any of the land uses defined above. Forest and desert areas are examples of undeveloped land.	
7. Is this yard a humpyard (H) or a flatyard (F)?	46
8. To which general yard grouping does this yard belong?	47
(A) Yards that do a significant amount of <u>both</u> classification work (i.e. breaking up incoming and making up outgoing line haul trains) and industrial work.	
(B) Classification yards that serve industry very little but classify at a center point on a road or at endpoints to direct incoming and outgoing interchange traffic.	
(C) Industrial yards worked by at least one assigned switcher or by road switchers whose total time there averages one or more tricks/day.	
(D) Smaller industrial yards, which are worked by road switchers less than one trick/day.	
9. Is there an interchange point located within this yard? ("I" if interchange exists, leave blank if not.)	48
10. Is this yard located at a junction of three or more main lines of of owning railroad (J) or at the end of a main line of the owning railroad (E)?	49
11. Does this yard have heavy car repair facilities (R)?	50
12. If this yard is part of a multiyard complex, what would you consider to be the major or most significant yard in this complex?	51-80
SRI defines a multiyard complex to be a group of <u>two or more yards operated in an interdependent manner by the same railroad</u> . Generally these yards are located within a few miles of one another, and the complex does both classification and industrial work. These complexes are most often found in urbanized areas.	
Note: For the purposes of this study, the receiving, classification, and departure yards of a humpyard are considered as elements of one yard rather than a multiyard system. However if the humpyard is composed of two opposite direction humps, it is considered to be two yards, each composed of its own receiving, classification, and departure areas (e.g. Enola East and Enola West).	

Classification Yard Questionnaire

Flat Yards

1. During which year was this yard originally built?_____.
When was the last major physical modification made, if any (i.e., a modification that substantially changed the operation or configuration of the yard)?_____. What was this modification?_____
2. Briefly describe the role and significance of this yard in relation to the operation of the railroad's system. _____
3. Briefly describe any plans to change the operation, physical plant, or system status of this yard. _____
4. How many tracks are presently used for classification?_____, receiving trains?_____, making up outbound trains?_____. (Please explain if certain tracks are used for more than one function.) _____
5. How long are the longest _____ and shortest _____ classification tracks; the longest _____ and shortest _____ receiving tracks; and the longest _____ and shortest _____ departure tracks?
6. How many cars (in terms of fifty-foot cars) can be held in the receiving yard?_____, the classification yard?_____, and the departure yard?_____.
7. What types of scales does this yard have?_____. What is each scale used for?_____
8. How many ACI scanners does this yard have?_____. What are they used for?_____

9. Does this yard have (check as applicable)

- An industrial car location and inventory system
- Computerized yard inventory system
- Radio or intercom communication with personnel in yard area
- Radio communication with switch engine crews
- Radio communication with road haul crews
- Advanced consist information
- Yard air

10. How many cars did this yard classify during the last 7 days? _____,
How many cars were classified on the highest day _____ and the
lowest day _____ during that period.
11. What is the maximum number of cars ever classified during one day? _____
12. What is the average car detention time within this yard? _____ hours.
13. How many inbound road haul trains per day are broken up and classified in
this yard? _____ or are preblocked? _____. How many outbound
road haul trains per day are made up and dispatched from this yard? _____
14. How many blocks to distinct destinations are made up in this yard? _____
15. What is the usual number of engine tricks per day worked in this yard by
switch engines _____, industrial engines _____, and
roustabout engines _____.
16. What is the usual number of locals per day dispatched from this yard? _____
17. How many cars per day dispatched from this yard are local? _____,
industrial? _____, or road-haul? _____.
18. How many containers and trailers per day does this terminal load? _____,
and unload? _____.
19. How many cars processed through this yard per day are classified more than
once? _____, weighed for revenue purposes? _____,
repaired? _____, interchanged directly to other roads? _____.
20. What are this yard's normal hours of operation? _____.
21. Is the amount of local and industrial switching work in this yard highly
seasonal? moderately seasonal? or not seasonal?
22. Is the primary mechanical inspection of cars performed on train arrival?
or just before train departure?
23. What is the maximum cut size that can be switched? _____

24. How many people work in this yard? Supervisors _____,
 Train Service _____, Maintenance of Equipment (excluding
 locomotive maintenance) _____, Clerical _____,
 Maintenance of Way _____.

25. How do the following factors affect the operation of this yard? (Check
 as applicable)

Major Problem	Minor Problem	No Problem	
<input type="checkbox"/>	<input type="checkbox"/>	<input type="checkbox"/>	Grade crossings within the yard boundaries
			Insufficient number (mark N) or length (mark L) of:
<input type="checkbox"/>	<input type="checkbox"/>	<input type="checkbox"/>	Classification tracks
<input type="checkbox"/>	<input type="checkbox"/>	<input type="checkbox"/>	Receiving tracks
<input type="checkbox"/>	<input type="checkbox"/>	<input type="checkbox"/>	Departure tracks
<input type="checkbox"/>	<input type="checkbox"/>	<input type="checkbox"/>	Lack of radio communications within the yard
<input type="checkbox"/>	<input type="checkbox"/>	<input type="checkbox"/>	Excessive or insufficient track gradients
<input type="checkbox"/>	<input type="checkbox"/>	<input type="checkbox"/>	Deteriorated track condition
<input type="checkbox"/>	<input type="checkbox"/>	<input type="checkbox"/>	Shortage of road-haul engines
<input type="checkbox"/>	<input type="checkbox"/>	<input type="checkbox"/>	Shortage of yard engines
<input type="checkbox"/>	<input type="checkbox"/>	<input type="checkbox"/>	Clearances between tracks
<input type="checkbox"/>	<input type="checkbox"/>	<input type="checkbox"/>	Poor lighting
<input type="checkbox"/>	<input type="checkbox"/>	<input type="checkbox"/>	Insufficient number of entrance and exit leads
<input type="checkbox"/>	<input type="checkbox"/>	<input type="checkbox"/>	Excessive vegetation on rights of way
<input type="checkbox"/>	<input type="checkbox"/>	<input type="checkbox"/>	Insufficient horsepower in yard engines
<input type="checkbox"/>	<input type="checkbox"/>	<input type="checkbox"/>	Lack of clearance for high and wide cars
<input type="checkbox"/>	<input type="checkbox"/>	<input type="checkbox"/>	Inaccurate consist information
<input type="checkbox"/>	<input type="checkbox"/>	<input type="checkbox"/>	Interference between yard and line-haul operations
<input type="checkbox"/>	<input type="checkbox"/>	<input type="checkbox"/>	Train arrival peaks
<input type="checkbox"/>	<input type="checkbox"/>	<input type="checkbox"/>	Train departure peaks
<input type="checkbox"/>	<input type="checkbox"/>	<input type="checkbox"/>	Coupling and switching noise
<input type="checkbox"/>	<input type="checkbox"/>	<input type="checkbox"/>	Weather

Classification Yard Questionnaire

Hump Yards

1. During which year was this yard originally built?_____.
When was the last major physical modification made, if any (i.e., a
modification that substantially changed the operation or configuration
of the yard)?_____. What was this modification?_____

2. Briefly describe the role and significance of this yard in relation
to the operation of the railroad's system. _____

3. Briefly describe any plans to change the operation, physical plant,
or system status of this yard. _____

4. How many tracks are presently used for classification?_____,
receiving trains?_____, making up outbound trains?_____.
(Please explain if certain tracks are used for more than one function.)

5. How long are the longest_____ and shortest _____
classification tracks; the longest_____ and shortest _____
receiving tracks; and the longest_____ and shortest _____
departure tracks?
6. How many cars (in terms of fifty-foot cars) can be held in the receiving
yard?_____, the classification yard?_____, and
the departure yard?_____.
7. What types of scales does this yard have?_____. What is
each scale used for? _____

8. How many ACI scanners does this yard have?_____. What are
they used for? _____

9. Describe this yard's retarder system

	Number	Manual	Analog	Digital
Master	_____	<input type="checkbox"/>	<input type="checkbox"/>	<input type="checkbox"/>
Group	_____	<input type="checkbox"/>	<input type="checkbox"/>	<input type="checkbox"/>
Intermediate	_____	<input type="checkbox"/>	<input type="checkbox"/>	<input type="checkbox"/>
Target Point	_____	<input type="checkbox"/>	<input type="checkbox"/>	<input type="checkbox"/>
Inert Skate	_____			

10. Are the switches between the hump and the class tracks operated manually at the switch manually from a remote location or automatically by an analog computer or digital computer

11. Does this yard have (check as applicable)

- An industrial car location and inventory system
- Computerized yard inventory system
- Radio or intercom communication with personnel in yard area
- Radio communication with switch engine crews
- Radio communication with road haul crews
- Advanced consist information
- Distance to coupling measurement system
- Automatic hump engine speed control
- Yard air

12. How many cars did this yard hump during the last 7 days? _____.
How many cars were humped on the highest day _____ and the lowest day _____ during that period.

13. What is the maximum number of cars ever humped during one day? _____.

14. What is the average car detention time within this yard? _____ hours.

15. How many inbound road haul trains per day are broken up and classified in this yard? _____ or are preblocked? _____. How many outbound road haul trains per day are made up and dispatched from this yard? _____

16. How many blocks to distinct destinations are made up in this yard? _____
17. What is the usual number of engine tricks per day worked in this yard by hump engines _____, makeup engines _____, industrial engines _____, and roustabout engines _____.
18. What is the usual number of locals per day dispatched from this yard? _____
19. How many cars per day dispatched from this yard are local? _____, industrial? _____, or road-haul? _____.
20. How many containers and trailers per day does this terminal load? _____, and unload? _____.
21. How many cars processed through this yard per day are rehumpped? _____, weighed for revenue purposes? _____, repaired? _____, interchanged directly to other roads? _____.
22. What are this yard's normal hours of operation? _____
23. Is the amount of local and industrial switching work in this yard highly seasonal? moderately seasonal? or not seasonal?
24. Is the primary mechanical inspection of cars performed on train arrival? during humping? or just before train departure?
25. What is the humping speed used in this yard? _____ mph.
26. What is the maximum cut size that can be humpped? _____ 50' cars.
27. How many people work in this yard? Supervisors _____, Train Service _____, Maintenance of Equipment (excluding locomotive maintenance) _____, Clerical _____, Maintenance of Way _____.
28. How do the following factors affect the operation of this yard? (Check as applicable)

Major Problem	Minor Problem	No Problem	
<input type="checkbox"/>	<input type="checkbox"/>	<input type="checkbox"/>	Grade crossings within the yard boundaries Insufficient number (mark N) or length (mark L) of:
<input type="checkbox"/>	<input type="checkbox"/>	<input type="checkbox"/>	Classification tracks
<input type="checkbox"/>	<input type="checkbox"/>	<input type="checkbox"/>	Receiving tracks
<input type="checkbox"/>	<input type="checkbox"/>	<input type="checkbox"/>	Departure tracks
<input type="checkbox"/>	<input type="checkbox"/>	<input type="checkbox"/>	Lack of radio communications within the yard
<input type="checkbox"/>	<input type="checkbox"/>	<input type="checkbox"/>	Excessive or insufficient track gradients

28. (Continued)

How do the following factors affect the operation of this yard? (Check as applicable)

Major Problem	Minor Problem	No Problem	
<input type="checkbox"/>	<input type="checkbox"/>	<input type="checkbox"/>	Deteriorated track condition
<input type="checkbox"/>	<input type="checkbox"/>	<input type="checkbox"/>	Shortage of road-haul engines
<input type="checkbox"/>	<input type="checkbox"/>	<input type="checkbox"/>	Shortage of yard engines
<input type="checkbox"/>	<input type="checkbox"/>	<input type="checkbox"/>	Clearances between tracks
<input type="checkbox"/>	<input type="checkbox"/>	<input type="checkbox"/>	Poor lighting
<input type="checkbox"/>	<input type="checkbox"/>	<input type="checkbox"/>	Insufficient number of entrance and exit leads
<input type="checkbox"/>	<input type="checkbox"/>	<input type="checkbox"/>	Excessive vegetation on rights of way
<input type="checkbox"/>	<input type="checkbox"/>	<input type="checkbox"/>	Insufficient horsepower in yard engines
<input type="checkbox"/>	<input type="checkbox"/>	<input type="checkbox"/>	Lack of clearance for high and wide cars
<input type="checkbox"/>	<input type="checkbox"/>	<input type="checkbox"/>	Inaccurate consist information
<input type="checkbox"/>	<input type="checkbox"/>	<input type="checkbox"/>	Interference between yard and road-haul operations
<input type="checkbox"/>	<input type="checkbox"/>	<input type="checkbox"/>	Train arrival peaks
<input type="checkbox"/>	<input type="checkbox"/>	<input type="checkbox"/>	Train departure peaks
<input type="checkbox"/>	<input type="checkbox"/>	<input type="checkbox"/>	Coupling and switching noise
<input type="checkbox"/>	<input type="checkbox"/>	<input type="checkbox"/>	Retarder noise
<input type="checkbox"/>	<input type="checkbox"/>	<input type="checkbox"/>	Weather

29. Please describe the effects of any of the major problem areas that are of particular importance in this yard and describe any other factors that adversely affect this yard's operations. (Please use additional paper, if necessary.)

Appendix C

SRI YARD-INVENTORY DATA

This appendix presents a detailed listing of the data contained in the SRI yard inventory. The reader is referred to Chapter II for information concerning the development and reliability of this inventory and for a summary description of the inventory data.

INVENTORY OF RAILROAD YARDS IN THE CONTIGUOUS UNITED STATES

7/6/07/09.

REF.	ST.	CITY	YARD	RAIL- ROAD	YARD FUNCTION	LOCATION TYPE	YARD TYPE	I/C	MAJOR YARD OR MULTI-YARD COMPLEX
3	AL	AKRON	AKRON	STU	SMALL INDUS.	RESIDENTIAL	FLAT		
3	AL	ALICEVILLE	ALICEVILLE	SLSF	SMALL INDUS.	AGRICULTURAL	FLAT		
3	AL	ANNISTON	ANNISTON	LN	INDUSTRIAL	UNDEVELOPED	FLAT		
3	AL	ANNISTON	ANNISTON	SJU	INDUSTRIAL	RESIDENTIAL	FLAT		
3	AL	BELLAMY	BELLAMY	SC	SMALL INDUS.	RESIDENTIAL	FLAT		
3	AL	BESSEMER	BESSEMER	LN	INDUSTRIAL	INDUSTRIAL	FLAT	I/C	
3	AL	BESSEMER	BESSEMER	SCL	SMALL INDUS.	RESIDENTIAL	FLAT	I/C	
3	AL	BESSEMER	BESSEMER	SLSF	SMALL INDUS.	COMMERCIAL	FLAT	I/C	
3	AL	BESSEMER	BESSEMER	SJU	INDUSTRIAL	RESIDENTIAL	FLAT	I/C	
3	AL	BIRMINGHAM	BIRMINGHAM	'95	INDUSTRIAL	INDUSTRIAL	FLAT		
3	AL	BIRMINGHAM	BIRMINGHAM	IC	CLASS./INDUS.	RESIDENTIAL	FLAT	I/C	
3	AL	BIRMINGHAM	BIRMINGHAM	LN	INDUSTRIAL	INDUSTRIAL	FLAT		18TH STREET
3	AL	BIRMINGHAM	BIRMINGHAM	LN	INDUSTRIAL	INDUSTRIAL	FLAT		18TH STREET
3	AL	BIRMINGHAM	BIRMINGHAM	LN	INDUSTRIAL	COMMERCIAL	FLAT		
3	AL	BIRMINGHAM	BIRMINGHAM	LN	INDUSTRIAL	AGRICULTURAL	FLAT		
3	AL	BIRMINGHAM	BIRMINGHAM	ML	INDUSTRIAL	INDUSTRIAL	FLAT		
3	AL	BIRMINGHAM	BIRMINGHAM	SCL	SMALL INDUS.	RESIDENTIAL	FLAT		
3	AL	BIRMINGHAM	BIRMINGHAM	SLSF	CLASS./INDUS.	RESIDENTIAL	FLAT	I/C	
3	AL	BIRMINGHAM	BIRMINGHAM	SJU	SMALL INDUS.	RESIDENTIAL	FLAT		
3	AL	BIRMINGHAM	BIRMINGHAM	SOU	SMALL INDUS.	RESIDENTIAL	FLAT		
3	AL	BIRMINGHAM	BIRMINGHAM	LN	INDUSTRIAL	UNDEVELOPED	FLAT		
3	AL	BIRMINGHAM	BIRMINGHAM	LN	INDUSTRIAL	AGRICULTURAL	FLAT		
3	AL	BIRMINGHAM	BIRMINGHAM	MG	SMALL INDUS.	AGRICULTURAL	FLAT		
3	AL	BIRMINGHAM	BIRMINGHAM	SOU	SMALL INDUS.	AGRICULTURAL	FLAT		
3	AL	BIRMINGHAM	BIRMINGHAM	WYN	SMALL INDUS.	AGRICULTURAL	FLAT		
3	AL	CALERA	CALERA	LN	INDUSTRIAL	AGRICULTURAL	FLAT		CALERA
3	AL	CALERA	CALERA QUARRY	LN	INDUSTRIAL	AGRICULTURAL	FLAT		CALERA
3	AL	CALERA	CALERA QUARRY	SOU	INDUSTRIAL	AGRICULTURAL	FLAT		
3	AL	CARBON HILL	CARBON HILL	SLSF	SMALL INDUS.	AGRICULTURAL	FLAT		
3	AL	CATHERINE	CATHERINE	LN	SMALL INDUS.	RESIDENTIAL	FLAT		
3	AL	CHAPMAN	CHAPMAN	LN	SMALL INDUS.	RESIDENTIAL	FLAT		
3	AL	CHILDERSBURG	CHILDERSBURG	JOINT	SMALL INDUS.	INDUSTRIAL	FLAT	I/C	
3	AL	CROMWELL	CROMWELL	JOINT	SMALL INDUS.	RESIDENTIAL	FLAT		
3	AL	CULLMAN	CULLMAN	LN	INDUSTRIAL	RESIDENTIAL	FLAT	I/C	
3	AL	DECATUR	DECATUR	LN	INDUSTRIAL	RESIDENTIAL	FLAT	I/C	
3	AL	DECATUR	DECATUR	SOU	INDUSTRIAL	RESIDENTIAL	FLAT	I/C	
3	AL	DEPOLIS	DEPOLIS	SLSF	CLASSIFICATION	RESIDENTIAL	FLAT	I/C	
3	AL	DEPOLIS	DEPOLIS	SOU	CLASSIFICATION	RESIDENTIAL	FLAT	I/C	
3	AL	DOLANAH	DOLANAH	'95	SMALL INDUS.	RESIDENTIAL	FLAT	I/C	
3	AL	DOTHAN	DOTHAN	ASH	INDUSTRIAL	RESIDENTIAL	FLAT	I/C	
3	AL	DOTHAN	DOTHAN	CGA	SMALL INDUS.	RESIDENTIAL	FLAT	I/C	
3	AL	DOTHAN	DOTHAN	SCL	INDUSTRIAL	RESIDENTIAL	FLAT	I/C	
3	AL	ELMORE	ELMORE	LN	SMALL INDUS.	RESIDENTIAL	FLAT	I/C	
3	AL	ENSLEY	ENSLEY	'05	INDUSTRIAL	INDUSTRIAL	FLAT	I/C	FAIRFIELD
3	AL	ENSLEY	ENSLEY	LN	INDUSTRIAL	INDUSTRIAL	FLAT	I/C	
3	AL	ENSLEY	ENSLEY	SLSF	SMALL INDUS.	INDUSTRIAL	FLAT	I/C	
3	AL	ENSLEY	ENSLEY	SOU	INDUSTRIAL	INDUSTRIAL	FLAT	I/C	
3	AL	ENSLEY	ENSLEY	CGA	INDUSTRIAL	RESIDENTIAL	FLAT	I/C	
3	AL	FUFAULA	FUFAULA	CHV	SMALL INDUS.	RESIDENTIAL	FLAT	I/C	
3	AL	FAIRFAX	FAIRFAX	ELL	INDUSTRIAL	INDUSTRIAL	FLAT	I/C	FAIRFIELD
3	AL	FAIRFIELD	FAIRFIELD	H5	INDUSTRIAL	INDUSTRIAL	FLAT	I/C	FAIRFIELD
3	AL	FAIRFIELD	FAIRFIELD	35	INDUSTRIAL	INDUSTRIAL	FLAT	I/C	FAIRFIELD
3	AL	FLOMATON	FLOMATON	LN	CLASSIFICATION	UNDEVELOPED	FLAT	I/C	
3	AL	FLORENC	FLORENC	LN	INDUSTRIAL	RESIDENTIAL	FLAT	I/C	
3	AL	FLORENC	FLORENC	LN	INDUSTRIAL	RESIDENTIAL	FLAT	I/C	
3	AL	GADSDEN	GADSDEN	LN	INDUSTRIAL	INDUSTRIAL	FLAT	I/C	GADSDEN
3	AL	GADSDEN	GADSDEN	LN	INDUSTRIAL	INDUSTRIAL	FLAT	I/C	GADSDEN
3	AL	GADSDEN	GADSDEN	LN	INDUSTRIAL	RESIDENTIAL	FLAT	I/C	GADSDEN
3	AL	GADSDEN	GADSDEN	LN	INDUSTRIAL	RESIDENTIAL	FLAT	I/C	GADSDEN

76/07/08.

REG.	ST.	CITY	YARD	RAIL-ROAD	YARD FUNCTION	LOCATION TYPE	YARD TYPE	T/C	MAJOR YARD IF MULTI-YARD COMPLEX
3	AL	GADSDEN	GADSDEN	TAG	SMALL INDUS.	UNDEVELOPED	FLAT		
3	AL	GUNTERSVILLE	GUNTERSVILLE	LN	INDUSTRIAL	RESIDENTIAL	FLAT	1/C	
3	AL	HALEYVILLE	HALEYVILLE	ICG	INDUSTRIAL	RESIDENTIAL	FLAT	1/C	
3	AL	HOLT	HOLT	ICG	SMALL INDUS.	INDUSTRIAL	FLAT		
3	AL	HOLT	HOLT	LN	INDUSTRIAL	AGRICULTURAL	FLAT		
3	AL	TRINDALE	ERNEST NORRIS	SOU	CLASS-/INDUS.	RESIDENTIAL	HUMP		
3	AL	MAHT	PAPER MILL	CGA	SMALL INDUS.	INDUSTRIAL	FLAT		REAUPEGARD
3	AL	MOBILE	REAUPEGARD	ICG	CLASS-/INDUS.	INDUSTRIAL	FLAT		REAUPEGARD
3	AL	MOBILE	FRASCATI	LN	INDUSTRIAL	INDUSTRIAL	FLAT		STREPT
3	AL	MOBILE	CHOCTAW	LN	INDUSTRIAL	INDUSTRIAL	FLAT		STREPT
3	AL	MOBILE	GOVERNMENT	LN	CLASS-/INDUS.	INDUSTRIAL	FLAT		
3	AL	MOBILE	STREPT	LN	CLASS-/INDUS.	INDUSTRIAL	FLAT		
3	AL	MOBILE	MOBILE	SLSF	CLASS-/INDUS.	COMMERCIAL	FLAT		
3	AL	MOBILE	MOBILE	SOU	CLASS-/INDUS.	INDUSTRIAL	FLAT		
3	AL	MOBILE	CLASSIFICATION	TASD	INDUSTRIAL	INDUSTRIAL	FLAT		TERMINAL
3	AL	MOBILE	TERMINAL	TASD	INDUSTRIAL	INDUSTRIAL	FLAT		TERMINAL
3	AL	MOBILE	INTERCHANGE	ICG	INDUSTRIAL	UNDEVELOPED	FLAT	1/C	
3	AL	MONTGOMERY	INTERCHANGE	LN	CLASS-/INDUS.	UNDEVELOPED	FLAT	1/C	
3	AL	MONTGOMERY	INTERCHANGE	SCL	CLASS-/INDUS.	UNDEVELOPED	FLAT	1/C	
3	AL	MONTGOMERY	CHESTER	WA	CLASS-/INDUS.	UNDEVELOPED	FLAT	1/C	
3	AL	MYRTLEWOOD	INTERCHANGE	JOINT	SMALL INDUS.	AGRICULTURAL	FLAT	1/C	
3	AL	OPELIKA	OPELIKA	CGA	SMALL INDUS.	COMMERCIAL	FLAT	1/C	
3	AL	OPELIKA	OPELIKA	WA	SMALL INDUS.	COMMERCIAL	FLAT	1/C	
3	AL	PARRISH	PARRISH	SOU	INDUSTRIAL	UNDEVELOPED	FLAT		
3	AL	PENNINGTON	NAHOLIA	MORR	SMALL INDUS.	RESIDENTIAL	FLAT		
3	AL	PINE HILL	MACMILLAN	SLSF	SMALL INDUS.	INDUSTRIAL	FLAT		
3	AL	PORT BIRMINGHAM	PORT BIRMINGHAM	BS	SMALL INDUS.	UNDEVELOPED	FLAT		
3	AL	PRATT CITY	PRATT CITY	ICG	SMALL INDUS.	RESIDENTIAL	FLAT	1/C	
3	AL	PRATT CITY	PRATT CITY	SLSF	SMALL INDUS.	RESIDENTIAL	FLAT		
3	AL	REFORN	REFORN	SLSF	SMALL INDUS.	RESIDENTIAL	FLAT	1/C	
3	AL	RUSSELLVILLE	RUSSELLVILLE	SOU	SMALL INDUS.	RESIDENTIAL	FLAT	1/C	
3	AL	SELMA	SELMA	JOINT	CLASSIFICATION	UNDEVELOPED	FLAT		
3	AL	SELMA	SELMA	SOU	CLASSIFICATION	UNDEVELOPED	FLAT		
3	AL	SHEFFIELD	TVA	LN	SMALL INDUS.	RESIDENTIAL	FLAT	1/C	
3	AL	SHEFFIELD	SHEFFIELD	SOU	CLASS-/INDUS.	AGRICULTURAL	HUMP	1/C	
3	AL	SYLACAUGA	SYLACAUGA	CGA	SMALL INDUS.	RESIDENTIAL	FLAT	1/C	
3	AL	SYLACAUGA	GANTS QUARRY	LN	INDUSTRIAL	AGRICULTURAL	FLAT		GANTS QUARRY
3	AL	SYLACAUGA	SYLACAUGA	LN	SMALL INDUS.	RESIDENTIAL	FLAT		GANTS QUARRY
3	AL	TARRANT CITY	BOYLES RECEIVING	JOINT	CLASS-/INDUS.	UNDEVELOPED	HUMP	1/C	BOYLES RECEIVING
3	AL	TARRANT CITY	BOYLES SOUTH	JOINT	CLASS-/INDUS.	UNDEVELOPED	HUMP	1/C	BOYLES RECEIVING
3	AL	TUSCALOOSA	TUSCALOOSA	ICG	CLASS-/INDUS.	UNDEVELOPED	FLAT	1/C	
3	AL	TUSCALOOSA	TUSCALOOSA	LN	CLASS-/INDUS.	RESIDENTIAL	FLAT	1/C	
3	AL	TUSCALOOSA	TUSCALOOSA	SOU	SMALL INDUS.	RESIDENTIAL	FLAT		
3	AL	UNION SPRINGS	UNION SPRINGS	CGA	SMALL INDUS.	RESIDENTIAL	FLAT		
3	AL	WILSONVILLE	WILSONVILLE	SOU	INDUSTRIAL	AGRICULTURAL	FLAT		
3	AL	WILSONVILLE	WILSONVILLE	SOU	INDUSTRIAL	AGRICULTURAL	FLAT		
3	AL	YORK	YORK	SLSF	INDUSTRIAL	RESIDENTIAL	FLAT	1/C	
3	AL	YORK	YORK	SOU	INDUSTRIAL	RESIDENTIAL	FLAT	1/C	
7	AZ	AJO	AJO	ICG	SMALL INDUS.	UNDEVELOPED	FLAT		
7	AZ	ASHFORK	TRAIN	ATSF	SMALL INDUS.	RESIDENTIAL	FLAT		
7	AZ	BLISDEF	BLISDEF	SP	SMALL INDUS.	INDUSTRIAL	FLAT		
7	AZ	DOUGLAS	DOUGLAS	SP	INDUSTRIAL	RESIDENTIAL	FLAT	1/C	

76/07/04

REF.	ST.	CITY	YARD	RAIL-ROAD	YARD FUNCTION	LOCATION TYPE	YARD TYPE	I/C	MAJOR YARD IF MULTI-YARD COMPLEX
7	AZ	FLAGSTAFF	TRAIN	AT&P	INDUSTRIAL	RESIDENTIAL	FLAT		
7	AZ	GILLESPIE	TRAIN	SP	SMALL INDUS.	UNDEVELOPED	FLAT	T/C	
7	AZ	GLENDALE	GLENDALE	AT&P	INDUSTRIAL	COMMERCIAL	FLAT		
7	AZ	GLORIE	GLORIE	SP	SMALL INDUS.	COMMERCIAL	FLAT		
7	AZ	HAYDEN	HAYDEN	SP	INDUSTRIAL	UNDEVELOPED	FLAT	T/C	
7	AZ	HOLBROOK	APACHE	AT&P	SMALL INDUS.	COMMERCIAL	FLAT	T/C	
7	AZ	MAGWA	TRAIN	SP	SMALL INDUS.	UNDEVELOPED	FLAT		
7	AZ	MENAPY	MENAPY	ADA	INDUSTRIAL	INDUSTRIAL	FLAT		
7	AZ	MIAMI	MIAMI	SP	SMALL INDUS.	INDUSTRIAL	FLAT		
7	AZ	MOGALLS	MOGALLS	SP	INDUSTRIAL	COMMERCIAL	FLAT	T/C	
7	AZ	PHOENIX	PHOENIX	AT&P	INDUSTRIAL	INDUSTRIAL	FLAT		
7	AZ	PHOENIX	PHOENIX	SP	INDUSTRIAL	INDUSTRIAL	FLAT	T/C	
7	AZ	SAN MANUEL	SAN MANUEL	S&A	SMALL INDUS.	UNDEVELOPED	FLAT		
7	AZ	SUPERIOR	SUPERIOR	AAA	SMALL INDUS.	RESIDENTIAL	FLAT		
7	AZ	TUCSON	TRAIN	SP	SMALL INDUS.	COMMERCIAL	FLAT		
7	AZ	WILLIAMS	TRAIN	AT&P	SMALL INDUS.	COMMERCIAL	FLAT		
7	AZ	WINONA-DALLING	CINCINNATI	AT&P	SMALL INDUS.	UNDEVELOPED	FLAT		
7	AZ	WINSLOW	TRAIN	AT&P	INDUSTRIAL	RESIDENTIAL	FLAT		
7	AZ	YUMA	TRAIN	SP	INDUSTRIAL	COMMERCIAL	FLAT		
5	AR	BALD KNOB	BALD KNOB	MP	SMALL INDUS.	COMMERCIAL	FLAT		
5	AR	BATESVILLE	BATESVILLE	MP	SMALL INDUS.	COMMERCIAL	FLAT		
5	AR	BAUXITE	INDUSTRIAL	UXN	SMALL INDUS.	INDUSTRIAL	FLAT	T/C	
5	AR	BENTON	TRAIN	MO	SMALL INDUS.	INDUSTRIAL	FLAT		
5	AR	BLYTHEVILLE	BLYTHEVILLE	SLSF	SMALL INDUS.	INDUSTRIAL	FLAT		
5	AR	HOONEVILLE	TRAIN	CRIP	CLASS./INDUS.	INDUSTRIAL	FLAT	T/C	
5	AR	BRINKLEY	TRAIN	CRIP	SMALL INDUS.	INDUSTRIAL	FLAT	T/C	
5	AR	BRINKLEY	TRAIN	SSW	SMALL INDUS.	INDUSTRIAL	FLAT	T/C	
5	AR	CAMDEN	TRAIN	CRIP	SMALL INDUS.	INDUSTRIAL	FLAT	T/C	
5	AR	CAMDEN	CULLESDALE	VP	SMALL INDUS.	INDUSTRIAL	FLAT	T/C	
5	AR	CAMDEN	TRAIN	SSW	SMALL INDUS.	INDUSTRIAL	FLAT	T/C	
5	AR	COTTON PLANT	TRAIN	CPF	SMALL INDUS.	INDUSTRIAL	FLAT	T/C	
5	AR	CROSSETT	SYSTEM	ADN	INDUSTRIAL	INDUSTRIAL	FLAT	T/C	
5	AR	CROSSETT	TRAIN	CRIP	SMALL INDUS.	COMMERCIAL	FLAT	T/C	
5	AR	DARDANELLE	TRAIN	DP	SMALL INDUS.	INDUSTRIAL	FLAT	T/C	
5	AR	DE QUEEN	TRAIN	DOE	CLASS./INDUS.	INDUSTRIAL	FLAT	T/C	
5	AR	DIERKS	TRAIN	DOE	SMALL INDUS.	COMMERCIAL	FLAT		
5	AR	EAST CAMDEN	FAST CAMDEN	EACH	SMALL INDUS.	COMMERCIAL	FLAT		
5	AR	EL DORADO	TRAIN	CRIP	SMALL INDUS.	INDUSTRIAL	FLAT	T/C	
5	AR	EL DORADO	SYSTEM	UDW	INDUSTRIAL	INDUSTRIAL	FLAT	T/C	
5	AR	EL DORADO	SYSTEM	UDW	SMALL INDUS.	INDUSTRIAL	FLAT	T/C	
5	AR	FAVETEVILLE	TRAIN	SLSF	SMALL INDUS.	INDUSTRIAL	FLAT		
5	AR	FORDYCE	SYSTEM	FP	SMALL INDUS.	INDUSTRIAL	FLAT	T/C	
5	AR	FORT SMITH	TRAIN	ACS	SMALL INDUS.	INDUSTRIAL	FLAT	T/C	
5	AR	FORT SMITH	TRAIN	4P	SMALL INDUS.	INDUSTRIAL	FLAT	T/C	
5	AR	FORT SMITH	TRAIN	SLSF	CLASS./INDUS.	INDUSTRIAL	FLAT	T/C	
5	AR	GUNDOON	TRAIN	MP	INDUSTRIAL	INDUSTRIAL	FLAT		
5	AR	HELENA	HOPE	MO	SMALL INDUS.	INDUSTRIAL	FLAT	T/C	
5	AR	HOPE	HOPE	KCS	SMALL INDUS.	COMMERCIAL	FLAT		
5	AR	HOPE	TRAIN	LA	SMALL INDUS.	INDUSTRIAL	FLAT	T/C	
5	AR	HOPE	TRAIN	MO	SMALL INDUS.	INDUSTRIAL	FLAT	T/C	
5	AR	HOPE	TRAIN	SLSF	SMALL INDUS.	INDUSTRIAL	FLAT	T/C	
5	AR	HOT SPRINGS	HOT SPRINGS	MO	CLASS./INDUS.	COMMERCIAL	FLAT		

76/07/08

REG.	ST.	CITY	YARD	TAIL-ROAD	YARD JUNCTION	LOCATION TYPE	YARD TYPE	I/C	MAJDD YARD IF MULTI-YARD COMPLEX
5	AR	HUTTIG	SYSTEM	L03	SMALL INDUS.	INDUSTRIAL	FLAT		
5	AR	JONESBORO	TRAIN	SLSF	SMALL INDUS.	INDUSTRIAL	FLAT	I/C	
5	AR	JONESBORO	TRAIN	SSW	SMALL INDUS.	INDUSTRIAL	FLAT	I/C	
5	AR	LITTLE ROCK	HIDDLE	CRIP	CLASS-/INDUS.	RESIDENTIAL	FLAT		
5	AR	LITTLE ROCK	CITY	CRIP	SMALL INDUS.	COMMERCIAL	FLAT	I/C	
5	AR	LITTLE ROCK	LITTLE ROCK TRAM.	LRP	INDUSTRIAL	INDUSTRIAL	FLAT		
5	AR	LITTLE ROCK	E-6TH STREET	MP	SMALL INDUS.	COMMERCIAL	FLAT	I/C	
5	AR	MALVERN	TRAIN	CRIP	SMALL INDUS.	COMMERCIAL	FLAT		
5	AR	MALVERN	MALVERN	MP	SMALL INDUS.	COMMERCIAL	FLAT		
5	AR	MC GEEZ	TRAIN	MP	CLASS-/INDUS.	COMMERCIAL	FLAT		
5	AR	NASHVILLE	TRAIN	GNA	SMALL INDUS.	INDUSTRIAL	FLAT		
5	AR	NASHVILLE	TRAIN	MP	INDUSTRIAL	INDUSTRIAL	FLAT		
5	AR	NORTH LITTLE ROCK	CRST	MP	CLASS-/INDUS.	INDUSTRIAL	HUMP	I/C	
5	AR	NORTH LITTLE ROCK	TRAIN	SSW	CLASS-/INDUS.	INDUSTRIAL	FLAT	I/C	
5	AR	PINE BLUFF	NEWAY	WIA	INDUSTRIAL	INDUSTRIAL	FLAT	I/C	
5	AR	PINE BLUFF	GRAVITY	SSW	CLASS-/INDUS.	INDUSTRIAL	HUMP	I/C	
5	AR	PRESCOTT	TRAIN	MP	INDUSTRIAL	AGRICULTURAL	FLAT		
5	AR	RUSSELLVILLE	TRAIN	MP	SMALL INDUS.	INDUSTRIAL	FLAT		
5	AR	SPRINGDALE	TRAIN	SLSF	SMALL INDUS.	INDUSTRIAL	FLAT		
5	AR	STUTTGART	STUTTGART	CRIP	SMALL INDUS.	COMMERCIAL	FLAT		
5	AR	STUTTGART	TRAIN	SSW	SMALL INDUS.	INDUSTRIAL	FLAT		
5	AR	VAN BUREN	TRAIN	MP	CLASS-/INDUS.	RESIDENTIAL	FLAT	I/C	
5	AR	WARREN	SYSTEM	WVW	SMALL INDUS.	INDUSTRIAL	FLAT	I/C	
5	AR	WARREN	SYSTEM	WSR	SMALL INDUS.	INDUSTRIAL	FLAT	I/C	
5	AR	WEST HELENA	WEST HELENA	HSW	SMALL INDUS.	COMMERCIAL	FLAT	I/C	
5	AR	WILSON	SYSTEM	DVS	SMALL INDUS.	INDUSTRIAL	FLAT	I/C	
5	AR	WYNNE	TRAIN	MP	SMALL INDUS.	INDUSTRIAL	FLAT		
7	CA	ALAMEDA	TRAIN	ABL	INDUSTRIAL	INDUSTRIAL	FLAT		
7	CA	ALTURAS	TRAIN	SP	SMALL INDUS.	RESIDENTIAL	FLAT		
7	CA	ANAHIM	LONG PASS	SP	SMALL INDUS.	COMMERCIAL	FLAT		
7	CA	ANAHIM	SOUTH	SP	SMALL INDUS.	COMMERCIAL	FLAT		
7	CA	ARCATA	TRAIN	NWP	SMALL INDUS.	UNDEVELOPED	FLAT		
7	CA	AVON	TRAIN	SP	SMALL INDUS.	UNDEVELOPED	FLAT		
7	CA	BAKERSFIELD	TRAIN	ATSF	CLASS-/INDUS.	COMMERCIAL	FLAT		
7	CA	BAKERSFIELD	TRAIN	SP	CLASS-/INDUS.	COMMERCIAL	FLAT		
7	CA	BARSTOW	TRAIN	ATSF	CLASS-/INDUS.	COMMERCIAL	FLAT		
7	CA	BLACK BUTTE	TRAIN	SP	SMALL INDUS.	UNDEVELOPED	FLAT		
7	CA	BLOOMINGTON	WEST COLTON	SP	CLASS-/INDUS.	RESIDENTIAL	HUMP		
7	CA	BLYTHE	TRAIN	ATSF	SMALL INDUS.	COMMERCIAL	FLAT		
7	CA	BUENA PARK	BUENA PARK	SP	SMALL INDUS.	COMMERCIAL	FLAT	I/C	
7	CA	CALEXICO	CALEXICO	SP	SMALL INDUS.	COMMERCIAL	FLAT		
7	CA	CAMINO	INDUSTRY	CPLT	SMALL INDUS.	UNDEVELOPED	FLAT		
7	CA	CHICO	TRAIN	SN	SMALL INDUS.	RESIDENTIAL	FLAT	I/C	
7	CA	CHICO	TRAIN	SP	SMALL INDUS.	RESIDENTIAL	FLAT	I/C	
7	CA	CITY OF INDUSTRY	INDUSTRY	SP	CLASS-/INDUS.	INDUSTRIAL	HUMP		
7	CA	COLTON	COLTON	SP	SMALL INDUS.	COMMERCIAL	FLAT	I/C	
7	CA	COLTON	TRAIN	UP	INDUSTRIAL	COMMERCIAL	FLAT		
7	CA	COMPTON	COMPTON	SP	SMALL INDUS.	COMMERCIAL	FLAT		
7	CA	CURENA	MORPHRY	ATSF	SMALL INDUS.	RESIDENTIAL	FLAT		
7	CA	CROCKETT	TRAIN	SP	SMALL INDUS.	INDUSTRIAL	FLAT		
7	CA	DU PONT	TRAIN	ATSF	SMALL INDUS.	INDUSTRIAL	FLAT		
7	CA	EPLEASANTON	TRAIN	SP	INDUSTRIAL	INDUSTRIAL	FLAT		
7	CA	EL CENTRO	TRAIN	SP	INDUSTRIAL	INDUSTRIAL	FLAT	I/C	

REG.	ST.	CITY	YARD	RAIL-ROAD	YARD FUNCTION	LOCATION TYPE	YARD TYPE	I/C	MAJOR YARD IF MULTI-YARD COMPLEX
7	CA	EUREKA	TRAIN	NWP	CLASS./INDUS.	COMMERCIAL	FLAT		
7	CA	FONTEANA	KATSECO	INDUS	INDUS	INDUS	FLAT		
7	CA	FORT BRAGG	TRAIN	CWR	INDUS	COMMERCIAL	FLAT		
7	CA	FRESNO	CALMA	ATSF	CLASS./INDUS	COMMERCIAL	FLAT		
7	CA	FRESNO	CITY	SP	CLASS./INDUS	COMMERCIAL	FLAT		FRESNO SP TRAIN
7	CA	FRESNO	TRAIN	SP	CLASS./INDUS	RESIDENTIAL	FLAT		FRESNO SP TRAIN
7	CA	FULLERTON	FULLERTON	ATSF	INDUS	COMMERCIAL	FLAT		
7	CA	GREENVILLE	TRAIN	WP	SMALL INDUS.	RESIDENTIAL	FLAT		
7	CA	GUADALUPE	TRAIN	SP	SMALL INDUS.	UNDEVELOPED	FLAT		
7	CA	HAYWARD	TRAIN	SP	SMALL INDUS.	COMMERCIAL	FLAT		
7	CA	HAYWARD	TRAIN	WP	SMALL INDUS.	COMMERCIAL	FLAT		
7	CA	HEALDSBURG	TRAIN	NWP	SMALL INDUS.	RESIDENTIAL	FLAT		
7	CA	INDIO	TRAIN	SP	INDUS	COMMERCIAL	FLAT		
7	CA	KEDDIE	TRAIN	WP	SMALL INDUS.	UNDEVELOPED	FLAT		
7	CA	KIRKEL	TRAIN	AMS	SMALL INDUS.	RESIDENTIAL	FLAT		
7	CA	LA MIRADA	LA MIRADA	ATSF	INDUS	RESIDENTIAL	FLAT		
7	CA	LODI	TRAIN	SP	INDUS	RESIDENTIAL	FLAT		
7	CA	LOMBARD	TRAIN	SP	SMALL INDUS.	COMMERCIAL	FLAT		
7	CA	LONG BEACH	EAST	SP	SMALL INDUS.	COMMERCIAL	FLAT		
7	CA	LONG BEACH	TRAIN	SP	INDUS	INDUS	FLAT		LONG BEACH TRAIN
7	CA	LOS ANGELES	HOBART	ATSF	CLASS./INDUS	INDUS	FLAT		LONG BEACH TRAIN
7	CA	LOS ANGELES	EAST SAN PEDRO	HRL	SMALL INDUS.	INDUS	FLAT		HOBART
7	CA	LOS ANGELES	PEDRO	HBL	SMALL INDUS.	INDUS	FLAT		PIER A
7	CA	LOS ANGELES	PIER A	HBL	SMALL INDUS.	INDUS	FLAT		PIER A
7	CA	LOS ANGELES	BULL KING	SP	SMALL INDUS.	INDUS	FLAT		PIER A
7	CA	LOS ANGELES	8TH STREET	SP	SMALL INDUS.	INDUS	FLAT		TAYLOR
7	CA	LOS ANGELES	FIRESTONE PARK	SP	INDUS	INDUS	FLAT		
7	CA	LOS ANGELES	J	SP	SMALL INDUS.	INDUS	FLAT		
7	CA	LOS ANGELES	TAYLOR	UP	CLASS./INDUS	INDUS	FLAT		TAYLOR
7	CA	LOS ANGELES	EAST LA	SP	CLASS./INDUS	INDUS	FLAT		
7	CA	MARTELL	TRAIN	AMC	SMALL INDUS.	COMMERCIAL	HUMP		
7	CA	MARYSVILLE	TRAIN	SP	INDUS	INDUS	FLAT		
7	CA	MARYSVILLE	TRAIN	SN	SMALL INDUS.	COMMERCIAL	FLAT		
7	CA	MARYSVILLE	TRAIN	SP	SMALL INDUS.	COMMERCIAL	FLAT		
7	CA	MC CLOUD	TRAIN	WCR	SMALL INDUS.	COMMERCIAL	FLAT		
7	CA	MILPITAS	TRAIN	SP	INDUS	INDUS	FLAT		
7	CA	MILPITAS	TRAIN	WP	INDUS	INDUS	FLAT		
7	CA	MODESTO	TRAIN	ATCF	SMALL INDUS.	INDUS	FLAT		
7	CA	MODESTO	TRAIN	MFT	SMALL INDUS.	COMMERCIAL	FLAT		
7	CA	MODESTO	TRAIN	TS	SMALL INDUS.	COMMERCIAL	FLAT		
7	CA	MODESTO	TRAIN	TS	SMALL INDUS.	COMMERCIAL	FLAT		
7	CA	MONTAGUE	INTERCHANGE	SP	SMALL INDUS.	UNDEVELOPED	FLAT		
7	CA	MT. SHASTA	TRAIN	SP	INDUS	INDUS	FLAT		
7	CA	NAPLES	TRAIN	SP	INDUS	COMMERCIAL	FLAT		
7	CA	NEPULFE	TRAIN	ATSF	SMALL INDUS.	UNDEVELOPED	FLAT		
7	CA	NILES	TRAIN	SP	SMALL INDUS.	RESIDENTIAL	FLAT		
7	CA	OAKDALE	TRAIN	SP	SMALL INDUS.	COMMERCIAL	FLAT		
7	CA	OAKDALE	TRAIN	SP	SMALL INDUS.	RESIDENTIAL	FLAT		
7	CA	OAKLAND	INDUS	HUMAT	INDUS	INDUS	FLAT		
7	CA	OAKLAND	TRAIN	OTR	INDUS	INDUS	FLAT		
7	CA	OAKLAND	DESENT	SP	INDUS	INDUS	FLAT		
7	CA	OAKLAND	WEST OAKLAND	SP	SMALL INDUS.	INDUS	FLAT		WEST OAKLAND
7	CA	OAKLAND	FRUITVALE	SP	SMALL INDUS.	INDUS	FLAT		WEST OAKLAND
7	CA	OAKLAND	WEST OAKLAND	SP	CLASS./INDUS	INDUS	FLAT		WEST OAKLAND

76/07/04.

REG.	ST.	CITY	YARD	RAILROAD	YARD FUNCTION	LOCATION TYPE	YARD TYPE	I/C	MAJOR YARD IF MULTI-YARD COMPLEX
7	CA	OAKLAND	ADELPHI STREET	WP	SMALL INDUS.	INDUSTRIAL	FLAT	I/C	NEW
7	CA	OAKLAND	NEW	WP	CLASS./INDUS.	INDUSTRIAL	FLAT	I/C	NEW
7	CA	OCEANSIDE	OCEANSIDE	ATSF	SMALL INDUS.	COMMERCIAL	FLAT		
7	CA	OAKVILLE	TRAIN	WP	CLASSIFICATION	COMMERCIAL	FLAT	I/C	
7	CA	OXNARD	TRAIN	SP	INDUSTRIAL	COMMERCIAL	FLAT		
7	CA	PALMDALE	TRAIN	SP	SMALL INDUS.	COMMERCIAL	FLAT		
7	CA	PETALUMA	TRAIN	NWP	SMALL INDUS.	COMMERCIAL	FLAT		
7	CA	PICO RIVERA	RIVERA	ATSF	INDUSTRIAL	INDUSTRIAL	FLAT	I/C	HOBART
7	CA	PITTSBURG	TRAIN	ATSF	INDUSTRIAL	INDUSTRIAL	FLAT		
7	CA	PITTSBURG	TRAIN	SN	INDUSTRIAL	INDUSTRIAL	FLAT		
7	CA	PITTSBURG	TRAIN	SP	SMALL INDUS.	INDUSTRIAL	FLAT		
7	CA	PITTSBURG	TRAIN	SP	SMALL INDUS.	COMMERCIAL	FLAT	I/C	
7	CA	PLACERVILLE	TRAIN	CPLT	SMALL INDUS.	COMMERCIAL	FLAT	I/C	
7	CA	PLACERVILLE	TRAIN	SP	SMALL INDUS.	COMMERCIAL	FLAT		
7	CA	QUINCY	TRAIN	OPR	SMALL INDUS.	UNDEVELOPED	FLAT		
7	CA	QUINCY	TRAIN	SP	SMALL INDUS.	COMMERCIAL	FLAT		
7	CA	REDWOOD CITY	TRAIN	ATSF	INDUSTRIAL	INDUSTRIAL	FLAT		ATSF TRAIN
7	CA	REDWOOD CITY	PLUGSACK	ATSF	INDUSTRIAL	INDUSTRIAL	FLAT		ATSF TRAIN
7	CA	RICHMOND	TRAIN	ATSP	CLASS./INDUS.	INDUSTRIAL	FLAT		
7	CA	RICHMOND	PICMOND TRANSFER	SP	INDUSTRIAL	INDUSTRIAL	HUMP		
7	CA	RIVERDANK	TRAIN	SP	SMALL INDUS.	RESIDENTIAL	FLAT		
7	CA	RIVERDANK	TRAIN	SP	SMALL INDUS.	COMMERCIAL	FLAT		
7	CA	ROSEVILLE	TRAIN	SN	INDUSTRIAL	COMMERCIAL	FLAT		
7	CA	SACRAMENTO	HAGGIN-WESTGATE	SP	INDUSTRIAL	COMMERCIAL	FLAT		
7	CA	SACRAMENTO	FRUITRIDGE	SP	SMALL INDUS.	COMMERCIAL	FLAT		
7	CA	SACRAMENTO	PROCTOR-GAMBLE	SP	INDUSTRIAL	INDUSTRIAL	FLAT		12TH STREET
7	CA	SACRAMENTO	12TH STREET	SP	INDUSTRIAL	INDUSTRIAL	FLAT		12TH STREET
7	CA	SACRAMENTO	SOUTH SACRAMENTO	WP	CLASS./INDUS.	COMMERCIAL	FLAT		
7	CA	SALINAS	SALINAS	SP	SMALL INDUS.	INDUSTRIAL	FLAT		
7	CA	SALINAS	SPECKELS	SP	SMALL INDUS.	COMMERCIAL	FLAT		
7	CA	SAN BERNARDINO	TRAIN	SP	SMALL INDUS.	COMMERCIAL	FLAT		
7	CA	SAN BERNARDINO	TRAIN	ATSP	CLASS./INDUS.	COMMERCIAL	FLAT		
7	CA	SAN DIEGO	TRAIN	ATSF	INDUSTRIAL	INDUSTRIAL	FLAT	I/C	
7	CA	SAN DIEGO	SAN DIEGO	SDAE	INDUSTRIAL	INDUSTRIAL	FLAT		
7	CA	SAN FRANCISCO	CHINA HASIN	ATSF	INDUSTRIAL	INDUSTRIAL	FLAT		
7	CA	SAN FRANCISCO	POWELL STREET	SFBLT	SMALL INDUS.	COMMERCIAL	FLAT		
7	CA	SAN FRANCISCO	SPEAR STREET	SFBLT	SMALL INDUS.	COMMERCIAL	FLAT		
7	CA	SAN FRANCISCO	HAYSHIRE	SP	SMALL INDUS.	INDUSTRIAL	FLAT	I/C	SO. SAN FRANCISCO
7	CA	SAN FRANCISCO	MISSION HAY	SP	CLASS./INDUS.	INDUSTRIAL	FLAT		
7	CA	SAN FRANCISCO	25TH STREET	WP	INDUSTRIAL	INDUSTRIAL	FLAT		
7	CA	SAN FRANCISCO	COLLEGE PARK	SP	INDUSTRIAL	INDUSTRIAL	FLAT	I/C	SANTA CLARA
7	CA	SAN JOSE	TRAIN	SP	SMALL INDUS.	COMMERCIAL	FLAT		SANTA CLARA
7	CA	SAN JOSE	TRAIN	WP	SMALL INDUS.	COMMERCIAL	FLAT		
7	CA	SAN LEANDRO	MULFORD	SP	SMALL INDUS.	COMMERCIAL	FLAT		
7	CA	SAN LEANDRO	TRAIN	SP	SMALL INDUS.	COMMERCIAL	FLAT		
7	CA	SAN LUIS OBISPO	TRAIN	SP	SMALL INDUS.	RESIDENTIAL	FLAT		
7	CA	SANTA ANA	TRAIN	SP	SMALL INDUS.	COMMERCIAL	FLAT		
7	CA	SANTA ANA	TRAIN	SP	SMALL INDUS.	COMMERCIAL	FLAT		
7	CA	SANTA CRUZ	OIL INDUSTRY	ATSF	SMALL INDUS.	COMMERCIAL	FLAT		
7	CA	SANTA FE SPRINGS	CARMENITA	SP	SMALL INDUS.	INDUSTRIAL	FLAT		
7	CA	SANTA FE SPRINGS	LUS NIETOS	SP	SMALL INDUS.	INDUSTRIAL	FLAT		
7	CA	SANTA FE SPRINGS	SANTA MARIA	SP	INDUSTRIAL	INDUSTRIAL	FLAT		
7	CA	SCOTIA	TRAIN	WP	INDUSTRIAL	INDUSTRIAL	FLAT		
7	CA	SCOTIA	KALISER	NWP	SMALL INDUS.	COMMERCIAL	FLAT		
7	CA	SOUTH FONTANA	TRAIN	SP	INDUSTRIAL	INDUSTRIAL	FLAT		
7	CA	SOUTH GATE	TRAIN	SP	INDUSTRIAL	INDUSTRIAL	FLAT		
7	CA	SOUTH GATE	TRAIN	SP	INDUSTRIAL	INDUSTRIAL	FLAT		
7	CA	SO. SAN FRANCISCO	MORMON	SP	INDUSTRIAL	INDUSTRIAL	FLAT		SO. SAN FRANCISCO
7	CA	STOCKTON	TRAIN	ATSF	CLASS./INDUS.	INDUSTRIAL	FLAT		
7	CA	STOCKTON	TRAIN	CCT	INDUSTRIAL	INDUSTRIAL	FLAT		
7	CA	STOCKTON	PIPET	J/INT	INDUSTRIAL	INDUSTRIAL	FLAT	I/C	

76/07/08.

REG.	ST.	CITY	YARD	RAIL-ROAD	YARD FUNCTION	LOCATION TYPE	YARD TYPE	I/C	MAJOR YARD IF MULTI-YARD COMPLEX
8	CO	LONGMONT	TRAIN	CS	INDUSTRIAL	RESIDENTIAL	FLAT	I/C	
8	CO	LOVELAND	TRAIN	GWR	INDUSTRIAL	INDUSTRIAL	FLAT	I/C	
8	CO	MINTURN	TRAIN	DRGW	SMALL INDUS.	RESIDENTIAL	FLAT	I/C	
8	CO	MONTE VISTA	TRAIN	DRGW	SMALL INDUS.	UNDEVELOPED	FLAT	I/C	
8	CO	MONTE VISTA	TRAIN	SLC	SMALL INDUS.	UNDEVELOPED	FLAT	I/C	
8	CO	MONTRUSE	TRAIN	DRGW	SMALL INDUS.	RESIDENTIAL	FLAT	I/C	
8	CO	OAK CREEK	TRAIN	DRGW	SMALL INDUS.	RESIDENTIAL	FLAT	I/C	
8	CO	PHIPPSSBURG	TRAIN	DRGW	INDUSTRIAL	INDUSTRIAL	FLAT	I/C	
8	CO	PUEBLO	TRAIN	ATSF	CLASS./INDUS.	INDUSTRIAL	HUMP	I/C	
8	CO	PUEBLO	TRAIN	DRGW	CLASS./INDUS.	INDUSTRIAL	FLAT	I/C	
8	CO	RIFLE	TRAIN	DRGW	SMALL INDUS.	RESIDENTIAL	FLAT	I/C	
8	CO	SALIDA	TRAIN	DRGW	SMALL INDUS.	RESIDENTIAL	FLAT	I/C	
8	CO	SOMERSET	TRAIN	DRGW	SMALL INDUS.	UNDEVELOPED	FLAT	I/C	
8	CO	STEELE	TRAIN	BN	INDUSTRIAL	COMMERCIAL	FLAT	I/C	
8	CO	STEELE	TRAIN	OP	INDUSTRIAL	COMMERCIAL	FLAT	I/C	
8	CO	TRINIDAD	TRAIN	CS	INDUSTRIAL	INDUSTRIAL	FLAT	I/C	
8	CO	WALSLEBURG	TRAIN	CS	SMALL INDUS.	AGRICULTURAL	FLAT	I/C	
8	CO	WALSLEBURG	TRAIN	DRGW	SMALL INDUS.	INDUSTRIAL	FLAT	I/C	
8	CO	WINDSOR	TRAIN	CS	SMALL INDUS.	UNDEVELOPED	FLAT	I/C	
1	CT	ANSONIA	ANSONIA	PC	SMALL INDUS.	COMMERCIAL	FLAT		
1	CT	BRIDGEPORT	EAST BRIDGEPORT	PC	INDUSTRIAL	COMMERCIAL	FLAT		
1	CT	DANBURY	DANBURY	PC	INDUSTRIAL	COMMERCIAL	FLAT		
1	CT	DERBY SHELTON	DERBY SHELTON	PC	INDUSTRIAL	COMMERCIAL	FLAT		
1	CT	EAST HARTFORD	EAST HARTFORD	PC	INDUSTRIAL	COMMERCIAL	FLAT		
1	CT	HARTFORD	HARTFORD	PC	CLASS./INDUS.	COMMERCIAL	FLAT		
1	CT	MERIDEN	MERIDEN	PC	SMALL INDUS.	COMMERCIAL	FLAT		
1	CT	NAUGATUCK	NAUGATUCK	PC	INDUSTRIAL	COMMERCIAL	FLAT		
1	CT	NEW BRITAIN	NEW BRITAIN	PC	INDUSTRIAL	COMMERCIAL	FLAT		
1	CT	NEW HAVEN	BELLE DOCK	PC	INDUSTRIAL	COMMERCIAL	FLAT		
1	CT	NEW HAVEN	CEDAR HILL	PC	CLASS./INDUS.	COMMERCIAL	FLAT		
1	CT	NEW HAVEN	WATER STREET	PC	INDUSTRIAL	UNDEVELOPED	FLAT		
1	CT	NEW LONDON	NEW LONDON	PC	INDUSTRIAL	COMMERCIAL	FLAT		
1	CT	NEW LONDON	FORT	CV	INDUSTRIAL	COMMERCIAL	HUMP	I/C	CEDAR HILL
1	CT	SOUTH NORWALK	SOUTH NORWALK	PC	INDUSTRIAL	COMMERCIAL	FLAT	I/C	CEDAR HILL
1	CT	STAMFORD	STAMFORD	PC	SMALL INDUS.	COMMERCIAL	FLAT		
1	CT	WATERBURY	WATERBURY	PC	INDUSTRIAL	COMMERCIAL	FLAT		
2	DE	CLAYTON	TRAIN	PC	CLASSIFICATION	RESIDENTIAL	FLAT		
2	DE	DPLMAP	TRAIN	PC	CLASS./INDUS.	AGRICULTURAL	FLAT		
2	DE	DOVER	TRAIN	PC	INDUSTRIAL	COMMERCIAL	FLAT		
2	DE	HARRINGTON	TRAIN	PC	INDUSTRIAL	AGRICULTURAL	FLAT		
2	DE	MILFORD	POWER PLANT	PC	SMALL INDUS.	UNDEVELOPED	FLAT		
2	DE	N#ARK	CHRYSLER	PC	INDUSTRIAL	UNDEVELOPED	FLAT		
2	DE	SEAFORD	TRAIN	PC	SMALL INDUS.	INDUSTRIAL	FLAT		
2	DE	WILMINGTON	EDGEWOOD	PC	CLASS./INDUS.	AGRICULTURAL	FLAT		
2	DE	WILMINGTON	WEST	HOG	INDUSTRIAL	INDUSTRIAL	FLAT	I/C	
2	DE	WILMINGTON	WEST	RD	CLASS./INDUS.	INDUSTRIAL	FLAT	I/C	
2	DC	WASHINGTON, D.C.	ECKINGTON	JN	INDUSTRIAL	COMMERCIAL	FLAT		
2	DC	WASHINGTON, D.C.	GEORGETOWN	JD	SMALL INDUS.	COMMERCIAL	FLAT		
2	DC	WASHINGTON, D.C.	JENNING	PC	CLASS./INDUS.	RESIDENTIAL	FLAT		
2	DC	WASHINGTON, D.C.	IVY CITY	PC	SMALL INDUS.	COMMERCIAL	FLAT		
2	DC	WASHINGTON, D.C.	UNTON APT.	PC	SMALL INDUS.	COMMERCIAL	FLAT		

76/07/09

REG.	ST.	CITY	YARD	RAIL-ROAD	YARD FUNCTION	LOCATION TYPE	YARD TYPE	I/C	MAJOR YARD IF MULT-YARD COMPLEX
3	FL	PENSACOLA	GOULDING	LN	CLASS./INDUS.	COMMERCIAL	FLAT	I/C	GOULDING
3	FL	PENSACOLA	WHARF	LN	INDUSTRIAL	INDUSTRIAL	FLAT		GOULDING
3	FL	PENSACOLA	DICK	SLSF	INDUSTRIAL	INDUSTRIAL	FLAT		PENSACOLA
3	FL	PENSACOLA	PENSACOLA	SLSF	CLASS./INDUS.	COMMERCIAL	FLAT	I/C	PENSACOLA
3	FL	PERRY	BUCKEYE PAPERMILL	LPSG	INDUSTRIAL	INDUSTRIAL	FLAT	I/C	
3	FL	PERRY	BUCKEYE PAPERMILL	LPSG	INDUSTRIAL	INDUSTRIAL	FLAT	I/C	
3	FL	PEPPI	PERRY	SCL	INDUSTRIAL	INDUSTRIAL	FLAT	I/C	
3	FL	PIERCE	IMROC	SCL	SMALL INDUS.	UNDEVELOPED	FLAT		
3	FL	PIERCE	PIERCE	SCL	SMALL INDUS.	UNDEVELOPED	FLAT		
3	FL	PIERCE	WEST POLK	SCL	SMALL INDUS.	UNDEVELOPED	FLAT		
3	FL	PLANT CITY	CENTRAL	SCL	INDUSTRIAL	RESIDENTIAL	FLAT		
3	FL	PLANT CITY	PLANT CITY	SCL	INDUSTRIAL	RESIDENTIAL	FLAT		
3	FL	PORT ST. JOE	NEW	AN	INDUSTRIAL	INDUSTRIAL	FLAT		
3	FL	ST. PETERSBURG	TRAIN	SCL	CLASSIFICATION	RESIDENTIAL	FLAT		
3	FL	SANFORD	SANDS	SCL	INDUSTRIAL	RESIDENTIAL	FLAT		
3	FL	SARASOTA	CITY	SCL	SMALL INDUS.	RESIDENTIAL	FLAT		
3	FL	TAFT	PIGGY-BACK	SCL	INDUSTRIAL	UNDEVELOPED	FLAT		
3	FL	TALLAHASSEE	B	SCL	CLASSIFICATION	COMMERCIAL	FLAT		
3	FL	TAMPA	EAST TAMPA	SCL	INDUSTRIAL	UNDEVELOPED	FLAT		ROCKPORT
3	FL	TAMPA	HOOBERS POINT	SCL	INDUSTRIAL	UNDEVELOPED	FLAT		ROCKPORT
3	FL	TAMPA	PORT SUTTON	SCL	INDUSTRIAL	UNDEVELOPED	FLAT		ROCKPORT
3	FL	TAMPA	PT. TAMPA TANK CAR	SCL	INDUSTRIAL	UNDEVELOPED	FLAT		ROCKPORT
3	FL	TAMPA	ROCKPORT	SCL	INDUSTRIAL	UNDEVELOPED	HUMP		ROCKPORT
3	FL	TAMPA	TAMPA	SCL	CLASS./INDUS.	RESIDENTIAL	FLAT		ROCKPORT
3	FL	TAMPA	UCETA NEW	SCL	INDUSTRIAL	UNDEVELOPED	FLAT		ROCKPORT
3	FL	TAMPA	YEDMAN	SCL	CLASS./INDUS.	UNDEVELOPED	FLAT		ROCKPORT
3	FL	TAVARES	TAVARES	SCL	INDUSTRIAL	UNDEVELOPED	FLAT		ROCKPORT
3	FL	TITUSVILLE	JJ	FEC	INDUSTRIAL	RESIDENTIAL	FLAT		ROCKPORT
3	FL	TITUSVILLE	WILSON	FEC	INDUSTRIAL	RESIDENTIAL	FLAT		ROCKPORT
3	FL	TRILBY	TRILBY	SCL	SMALL INDUS.	RESIDENTIAL	FLAT		
3	FL	WEST LAKE WALES	WEST LAKE WALES	SCL	SMALL INDUS.	RESIDENTIAL	FLAT		
3	FL	WEST PALM BEACH	WEST PALM BEACH	PFC	INDUSTRIAL	UNDEVELOPED	FLAT		
3	FL	WEST PALM BEACH	WEST PALM BEACH	PFC	INDUSTRIAL	UNDEVELOPED	FLAT		
3	FL	WEST PALM BEACH	WEST PALM BEACH	SCL	SMALL INDUS.	COMMERCIAL	FLAT	I/C	
3	FL	WEST PALM BEACH	WEST PALM BEACH	#PBT	INDUSTRIAL	COMMERCIAL	FLAT	I/C	
3	FL	WILWOOD	EAST	SCL	CLASSIFICATION	UNDEVELOPED	FLAT		
3	FL	WILLISTON	WILLISTON	SCL	SMALL INDUS.	UNDEVELOPED	FLAT		
3	FL	WINSTON	WINSTON	SCL	SMALL INDUS.	UNDEVELOPED	FLAT		
3	GA	ADEL	ADEL	LPSG	SMALL INDUS.	RESIDENTIAL	FLAT	I/C	
3	GA	ALBANY	ALBANY	CGA	CLASS./INDUS.	INDUSTRIAL	FLAT	I/C	
3	GA	ALBANY	ALBANY	SCL	CLASS./INDUS.	INDUSTRIAL	FLAT	I/C	
3	GA	ALBANY	ALBANY	SOU	SMALL INDUS.	INDUSTRIAL	FLAT	I/C	
3	GA	AMERICUS	AMERICUS	CGA	INDUSTRIAL	RESIDENTIAL	FLAT	I/C	
3	GA	AMERICUS	AMERICUS	SCL	INDUSTRIAL	RESIDENTIAL	FLAT	I/C	
3	GA	ATHENS	TRAIN	CGA	SMALL INDUS.	RESIDENTIAL	FLAT	I/C	
3	GA	ATHENS	TRAIN	CGA	SMALL INDUS.	RESIDENTIAL	FLAT	I/C	
3	GA	ATHENS	TRAIN	SCL	SMALL INDUS.	RESIDENTIAL	FLAT	I/C	
3	GA	ATLANTA	HULSEY	AJT	SMALL INDUS.	RESIDENTIAL	FLAT	I/C	
3	GA	ATLANTA	TILFORD	LN	CLASS./INDUS.	RESIDENTIAL	FLAT	I/C	
3	GA	ATLANTA	HOWELL	SCL	CLASS./INDUS.	UNDEVELOPED	HUMP		TILFORD
3	GA	ATLANTA	ARMOUR	SOU	INDUSTRIAL	RESIDENTIAL	FLAT		TILFORD
3	GA	ATLANTA	INMAN	SOU	INDUSTRIAL	UNDEVELOPED	HUMP		INMAN
3	GA	ATLANTA	INMAN PIGGYBACK	SJU	CLASSIFICATION	UNDEVELOPED	HUMP		INMAN

RES.	ST.	CITY	YACD	441L- R/D	YARD FUNCTION	LOCATION TYPE	YARD TYPE	T/C	MAJOR YARD IF MULTI-YARD COMB EX
3	GA	ATLANTA	NORTH AVENUE	SOU	SMALL INDUS.	RESIDENTIAL	FLAT		INMAN
3	GA	ATLANTA	SOUTH	SOU	INDUSTRIAL	RESIDENTIAL	FLAT		INMAN
3	GA	AUGUSTA	WE 4 YFKA	CGA	INDUSTRIAL	RESIDENTIAL	FLAT		NEW YDFK
3	GA	AUGUSTA	SOUTH AUGUSTA	CGA	INDUSTRIAL	RESIDENTIAL	FLAT		NEW YDFK
3	GA	AUGUSTA	TRAIN	CGA	INDUSTRIAL	RESIDENTIAL	FLAT		NEW YDFK
3	GA	AUGUSTA	HAPPISBORVILLE	CGA	INDUSTRIAL	RESIDENTIAL	FLAT		NEW YDFK
3	GA	AUGUSTA	PARA	SCL	CLASS./INDUS.	RESIDENTIAL	FLAT		
3	GA	AUGUSTA	TRAIN	SCL	SMALL INDUS.	RESIDENTIAL	FLAT		
3	GA	HAINESBORO	OLD ACL TRAIN	SCL	INDUSTRIAL	RESIDENTIAL	FLAT		OLD SAL
3	GA	GAITHERSBURG	OLD SAL	SCL	INDUSTRIAL	RESIDENTIAL	FLAT		OLD SAL
3	GA	BREMEN	BREMEN	CGA	INDUSTRIAL	RESIDENTIAL	FLAT		
3	GA	BRUNSWICK	BRUNSWICK	SCL	INDUSTRIAL	RESIDENTIAL	FLAT		
3	GA	BRUNSWICK	BRUNSWICK	SCL	INDUSTRIAL	RESIDENTIAL	FLAT		
3	GA	BRUNSWICK	BRUNSWICK	SOU	INDUSTRIAL	RESIDENTIAL	FLAT		
3	GA	CAMAK	TRAIN	GA	SMALL INDUS.	RESIDENTIAL	FLAT		
3	GA	CARTERSVILLE	JUNTA	LN	INDUSTRIAL	RESIDENTIAL	FLAT		
3	GA	CARTERSVILLE	NORTH	LN	INDUSTRIAL	RESIDENTIAL	FLAT		
3	GA	CARTERSVILLE	TRAIN	SCL	SMALL INDUS.	RESIDENTIAL	FLAT		
3	GA	CECILSVILLE	CEDAR SPRINGS	CLRP	INDUSTRIAL	RESIDENTIAL	FLAT		
3	GA	CECILSVILLE	CECILSVILLE	CGA	SMALL INDUS.	RESIDENTIAL	FLAT		
3	GA	CECILSVILLE	TRAIN	CGA	SMALL INDUS.	RESIDENTIAL	FLAT		
3	GA	CECILSVILLE	TRAIN	SCL	SMALL INDUS.	RESIDENTIAL	FLAT		
3	GA	CHAMBLEE	TRAIN	SOU	SMALL INDUS.	UNDEVELOPED	FLAT		
3	GA	CHAMBLEE	TRAIN	VE	SMALL INDUS.	RESIDENTIAL	FLAT		
3	GA	CLAYTONVILLE	CLAYTONVILLE	VE	SMALL INDUS.	RESIDENTIAL	FLAT		
3	GA	COCHRAN	COCHRAN	SOU	INDUSTRIAL	COMMERCIAL	FLAT		
3	GA	COLUMBUS	COLUMBUS	CGA	INDUSTRIAL	RESIDENTIAL	FLAT		
3	GA	COLUMBUS	COLUMBUS	SCL	INDUSTRIAL	RESIDENTIAL	FLAT		
3	GA	CORDELE	TRAIN	SCL	INDUSTRIAL	RESIDENTIAL	FLAT		
3	GA	CORDELE	TRAIN	SOU	INDUSTRIAL	RESIDENTIAL	FLAT		
3	GA	DECATUR	DECATUR	GA	INDUSTRIAL	RESIDENTIAL	FLAT		
3	GA	DOUGLAS	DOUGLAS	GSF	SMALL INDUS.	RESIDENTIAL	FLAT		
3	GA	DOUGLAS	DOUGLAS	CGA	SMALL INDUS.	RESIDENTIAL	FLAT		
3	GA	DOVER	DOVER	CGA	SMALL INDUS.	RESIDENTIAL	FLAT		
3	GA	DUBLIN	DUBLIN	CGA	INDUSTRIAL	RESIDENTIAL	FLAT		
3	GA	EAST POINT	INDUSTRY	CGA	INDUSTRIAL	RESIDENTIAL	FLAT		
3	GA	FITZGERALD	WESTWOOD	SOU	SMALL INDUS.	RESIDENTIAL	FLAT		
3	GA	FITZGERALD	WESTWOOD	SCL	SMALL INDUS.	RESIDENTIAL	FLAT		
3	GA	FORT VALLEY	TRAIN	CGA	SMALL INDUS.	RESIDENTIAL	FLAT		
3	GA	GAINESVILLE	TRAIN	GM	SMALL INDUS.	RESIDENTIAL	FLAT		
3	GA	GAINESVILLE	TRAIN	SOU	SMALL INDUS.	RESIDENTIAL	FLAT		
3	GA	GAINESVILLE	NEW HOLLAND	CGA	SMALL INDUS.	COMMERCIAL	FLAT		
3	GA	GAINESVILLE	TRAIN	CGA	SMALL INDUS.	RESIDENTIAL	FLAT		
3	GA	GRIFFIN	TRAIN	CGA	SMALL INDUS.	RESIDENTIAL	FLAT		
3	GA	HARTWELL	TRAIN	HRT	INDUSTRIAL	RESIDENTIAL	FLAT		
3	GA	HILTON	INTERCHANGE	CGA	SMALL INDUS.	RESIDENTIAL	FLAT		
3	GA	HILTON	INTERCHANGE	CGA	SMALL INDUS.	RESIDENTIAL	FLAT		
3	GA	HILTON	INTERCHANGE	CIFR	SMALL INDUS.	RESIDENTIAL	FLAT		
3	GA	HUBER	HUBER	SJU	SMALL INDUS.	RESIDENTIAL	FLAT		
3	GA	JESUP	PAPEP MILL	SCL	INDUSTRIAL	RESIDENTIAL	FLAT		
3	GA	JESUP	JESUP	SOU	INDUSTRIAL	UNDEVELOPED	FLAT		
3	GA	JESUP	JESUP	SOU	INDUSTRIAL	UNDEVELOPED	FLAT		
3	GA	JESUP	JESUP	SOU	INDUSTRIAL	UNDEVELOPED	FLAT		
3	GA	KINGSLAND	PAPER MILL	SCL	SMALL INDUS.	INDUSTRIAL	FLAT		
3	GA	KINGSLAND	KINGSLAND	SCL	SMALL INDUS.	INDUSTRIAL	FLAT		
3	GA	KINGSLAND	KINGSLAND	SM	SMALL INDUS.	INDUSTRIAL	FLAT		
3	GA	KRANNERT	KRANNERT	CGA	SMALL INDUS.	INDUSTRIAL	FLAT		
3	GA	KRANNERT	KRANNERT	CGA	SMALL INDUS.	INDUSTRIAL	FLAT		
3	GA	KRANNERT	KRANNERT	SOU	SMALL INDUS.	RESIDENTIAL	FLAT		
3	GA	KRANNERT	KRANNERT	SOU	SMALL INDUS.	RESIDENTIAL	FLAT		
3	GA	LA GRANGE	LONG	AWP	INDUSTRIAL	RESIDENTIAL	FLAT		
3	GA	LA GRANGE	TRAIN	AWP	INDUSTRIAL	RESIDENTIAL	FLAT		
3	GA	LA GRANGE	TRAIN	AWP	INDUSTRIAL	RESIDENTIAL	FLAT		
3	GA	LITHONIA	TRAIN	SCL	SMALL INDUS.	RESIDENTIAL	FLAT		
3	GA	LITHONIA	TRAIN	SCL	SMALL INDUS.	RESIDENTIAL	FLAT		
3	GA	LITHONIA	LITHONIA	ASVH	INDUSTRIAL	RESIDENTIAL	FLAT		
3	GA	LITHONIA	LITHONIA	GA	SMALL INDUS.	AGRICULTURAL	FLAT		

76/07/08.

REF.	ST.	CITY	YASD	RAIL-ROAD	YASD FUNCTION	LOCATION TYPE	YARD TYPE	I/C	MAJOR YARD IF MULTI-YARD COMPLEX
3	GA	LITHIAVILLE	WACLEY	LW	SMALL INDUS.	RESIDENTIAL	FLAT		
3	GA	MACON	BAY STREET	CGA	INDUSTRIAL	RESIDENTIAL	FLAT		
3	GA	MACON	DLD CG	CGA	SMALL INDUS.	UNDEVELOPED	FLAT		
3	GA	MACON	TRAIN	SCL	INDUSTRIAL	RESIDENTIAL	FLAT		
3	GA	MACON	PROSMAN	SOU	CLASS./INDUS.	UNDEVELOPED	W/HP		
3	GA	MACON	GS#F	SOU	SMALL INDUS.	RESIDENTIAL	FLAT		
3	GA	MANCHESTER	TRAIN	SCL	INDUSTRIAL	UNDEVELOPED	FLAT		
3	GA	MC DONOUGH	MC DONOUGH	SOU	SMALL INDUS.	UNDEVELOPED	FLAT		
3	GA	MC INTYSE	MC INTYSE	CGA	SMALL INDUS.	RESIDENTIAL	FLAT		
3	GA	WILLEDGEVILLE	MARLEE	GA	SMALL INDUS.	RESIDENTIAL	FLAT		
3	GA	WILLEDGEVILLE	MOULTRIE	GANO	SMALL INDUS.	RESIDENTIAL	FLAT		
3	GA	MOULTRIE	MOULTRIE	SCL	SMALL INDUS.	RESIDENTIAL	FLAT		
3	GA	RICKLAND	TRAIN	SCL	INDUSTRIAL	RESIDENTIAL	FLAT		
3	GA	ROCKMART	TRAIN	SOU	SMALL INDUS.	RESIDENTIAL	FLAT		
3	GA	ROME	FORRESTVILLE	SOU	SMALL INDUS.	RESIDENTIAL	FLAT		
3	GA	ST. MARYS	ST. MARYS	SM	SMALL INDUS.	RESIDENTIAL	FLAT		
3	GA	SANDERSVILLE	SANDERSVILLE	SAN	SMALL INDUS.	RESIDENTIAL	FLAT		
3	GA	SAVANNAH	PAPER MILL	CGA	SMALL INDUS.	INDUSTRIAL	FLAT		
3	GA	SAVANNAH	SAVANNAH	SCL	CLASS./INDUS.	UNDEVELOPED	FLAT		
3	GA	SAVANNAH	SOUTHOWER	SCL	CLASS./INDUS.	UNDEVELOPED	FLAT		
3	GA	SAVANNAH	DILLARD	SOU	CLASS./INDUS.	UNDEVELOPED	FLAT		
3	GA	SWAINSBORO	SWAINSBORO	CGA	SMALL INDUS.	RESIDENTIAL	FLAT		
3	GA	TENNILLE	TRAIN	CGA	SMALL INDUS.	RESIDENTIAL	FLAT		
3	GA	THOMASVILLE	THOMASVILLE	SCL	CLASS./INDUS.	UNDEVELOPED	FLAT		
3	GA	TIFTON	TRAIN	SCL	SMALL INDUS.	RESIDENTIAL	FLAT		
3	GA	TOCCOA	TRAIN	SOU	SMALL INDUS.	RESIDENTIAL	FLAT		
3	GA	TUCKER	INDUSTRIAL	SCL	SMALL INDUS.	RESIDENTIAL	FLAT		
3	GA	VALDOSTA	LANGSDALE	SCL	SMALL INDUS.	UNDEVELOPED	FLAT		
3	GA	VALDOSTA	VALDOSTA	GSF	CLASS./INDUS.	UNDEVELOPED	FLAT		
3	GA	VALDOSTA	VALDOSTA	SCL	INDUSTRIAL	RESIDENTIAL	FLAT		
3	GA	VIDALIA	VALDOSTA	VS	SMALL INDUS.	RESIDENTIAL	FLAT		
3	GA	VIDALIA	VIDALIA	GSF	SMALL INDUS.	RESIDENTIAL	FLAT		
3	GA	VIDALIA	HERCO	SCL	SMALL INDUS.	RESIDENTIAL	FLAT		
3	GA	WAYCROSS	MIDDLE	SCL	INDUSTRIAL	UNDEVELOPED	FLAT		
3	GA	WAYCROSS	WEST	SCL	CLASS./INDUS.	UNDEVELOPED	FLAT		
3	GA	WAYCROSS	WEST POINT	AS?	SMALL INDUS.	UNDEVELOPED	FLAT		MIDDLE
3	GA	WEST POINT	WEST POINT	AS?	SMALL INDUS.	UNDEVELOPED	FLAT		MIDDLE
3	GA	WEST POINT	WEST POINT	CHV	INDUSTRIAL	RESIDENTIAL	FLAT		
6	ID	ASHTON	TRAIN	UP	SMALL INDUS.	INDUSTRIAL	FLAT		
6	ID	BLACKEFOOT	TRAIN	UP	SMALL INDUS.	AGRICULTURAL	FLAT		
6	ID	BONNERS FERRY	TRAIN	BN	SMALL INDUS.	AGRICULTURAL	FLAT		
6	ID	BOVILL	TRANSFER	CR-SPP	SMALL INDUS.	UNDEVELOPED	FLAT		
6	ID	BOVILL	TRANSFER	WIM	SMALL INDUS.	UNDEVELOPED	FLAT		
6	ID	CASCADE	TRANSFER	UP	SMALL INDUS.	RESIDENTIAL	FLAT		
6	ID	CASCADE	TRAIN	UP	SMALL INDUS.	AGRICULTURAL	FLAT		
6	ID	CLARKIA	TRAIN	CR-SPP	SMALL INDUS.	RESIDENTIAL	FLAT		
6	ID	COEUR D'ALENE	TRAIN	BN	SMALL INDUS.	COMMERCIAL	FLAT		
6	ID	COEUR D'ALENE	TRAIN	CR-SPP	SMALL INDUS.	COMMERCIAL	FLAT		
6	ID	CJEMP D'ALPS-VL	TRAIN	SI	SMALL INDUS.	COMMERCIAL	FLAT		
6	ID	COUNCIL	TRAIN	UP	SMALL INDUS.	AGRICULTURAL	FLAT		
6	ID	EASTPORT	TRANSFER	SI	SMALL INDUS.	AGRICULTURAL	FLAT		
6	ID	E-WETT	TRAIN	UP	SMALL INDUS.	AGRICULTURAL	FLAT		
6	ID	GAY-MIN	WINE	UP	SMALL INDUS.	INDUSTRIAL	FLAT		
6	ID	HAUSER	TRAIN	BN	CLASS./INDUS.	INDUSTRIAL	FLAT		

76/07/20.

REG.	ST.	CITY	YARD	RAIL- QUAD	YARD FUNCTION	LOCATION TYPE	YARD TYPE	I/C	MAJOR YARD IF MULTI-YARD COMPLEX
6	13	HEADQUARTERS	TRAIN	CSP	SMALL INDUS.	AGRICULTURAL	FLAT		
6	10	HILL CITY	TRAIN	UP	SMALL INDUS.	AGRICULTURAL	FLAT		
6	10	IDAH0 FALLS	TRAIN	UP	CLASS-/INDUS.	COMMERCIAL	FLAT		
6	13	KELLOGG	TRAIN	UP	INDUSTRIAL	INDUSTRIAL	FLAT		
6	10	LEWISTON	FURHAY	CSP	SMALL INDUS.	INDUSTRIAL	FLAT		
6	10	LEWISTON	TRAIN	CSP	CLASS-/INDUS.	INDUSTRIAL	FLAT		
6	10	MAHSTING	TRAIN	UP	SMALL INDUS.	AGRICULTURAL	FLAT		
6	10	MC CALL	TRAIN	UP	SMALL INDUS.	AGRICULTURAL	FLAT		
6	10	MONTPELIER	TRAIN	UP	SMALL INDUS.	AGRICULTURAL	FLAT		
6	10	MOSCOW	TRAIN	34	INDUSTRIAL	RESIDENTIAL	FLAT	I/C	
6	10	MOSCOW	TRAIN	UP	INDUSTRIAL	RESIDENTIAL	FLAT	I/C	
6	10	NAMPA	TRAIN	UP	CLASS-/INDUS.	INDUSTRIAL	FLAT		
6	10	NEPAQUAS	TRAIN	UP	SMALL INDUS.	AGRICULTURAL	FLAT		
6	10	NEPERECE	TRAIN	NEZP	SMALL INDUS.	AGRICULTURAL	FLAT		
6	10	OROFINO	TRAIN	CSP	INDUSTRIAL	AGRICULTURAL	FLAT		
6	10	PAYETTE	TRAIN	UP	SMALL INDUS.	AGRICULTURAL	FLAT		
6	10	PIERCE	TRAIN	CSP	SMALL INDUS.	AGRICULTURAL	FLAT		
6	10	PLUMMER	TRAIN	CMSPP	SMALL INDUS.	RESIDENTIAL	FLAT		
6	10	POCATELLO	HUMP	UP	CLASS-/INDUS.	INDUSTRIAL	HUMP		
6	10	POTLATCH	TRANSFER	WIM	SMALL INDUS.	AGRICULTURAL	FLAT	I/C	
6	10	RUPERT	STATION	UP	SMALL INDUS.	AGRICULTURAL	FLAT		
6	10	SAINT ANTHONY	TRAIN	UP	SMALL INDUS.	AGRICULTURAL	FLAT		
6	10	SAINT MARIES	TRAIN	UP	SMALL INDUS.	AGRICULTURAL	FLAT		
6	10	SANDPOINT	TRAIN	CMSPP	INDUSTRIAL	RESIDENTIAL	FLAT	I/C	
6	10	SANDPOINT	TRANSFER	HV	INDUSTRIAL	RESIDENTIAL	FLAT	I/C	
6	10	SANDPOINT	STATION	UP	SMALL INDUS.	RESIDENTIAL	FLAT		
6	10	SODA SPRINGS	TRANSFER	UP	SMALL INDUS.	RESIDENTIAL	FLAT		
6	10	STODDARD	TRAIN	UP	SMALL INDUS.	AGRICULTURAL	FLAT		
6	10	TWIN FALLS	TRAIN	UP	INDUSTRIAL	RESIDENTIAL	FLAT		
6	10	WALLACE	TRAIN	BV	SMALL INDUS.	RESIDENTIAL	FLAT	I/C	
6	10	WALLACE	TRAIN	UP	SMALL INDUS.	RESIDENTIAL	FLAT	I/C	
8	11	ALTON	TRAIN	I/C	CLASS-/INDUS.	INDUSTRIAL	FLAT	I/C	
4	11	ARGO	TRAIN	IHB	CLASS-/INDUS.	INDUSTRIAL	FLAT	I/C	
4	11	AUROHA	ARGO	BN	SMALL INDUS.	COMMERCIAL	FLAT		
4	11	BARRINGTON	TRAIN	CNW	SMALL INDUS.	RESIDENTIAL	FLAT	I/C	
4	11	BARTON	TRAIN	BN	CLASS-/INDUS.	UNDEVELOPED	FLAT		
4	11	BARTONVILLE	TRAIN	CNW	CLASS-/INDUS.	UNDEVELOPED	FLAT	I/C	
4	11	BARTONVILLE	TRAIN	PT	SMALL INDUS.	RESIDENTIAL	FLAT	I/C	
4	11	BEARDSTOWN	BEARDSTOWN	BN	CLASSIFICATION	RESIDENTIAL	FLAT	I/C	
4	11	BEARDSTOWN	LYONS	PC	CLASS-/INDUS.	UNDEVELOPED	FLAT	I/C	
4	11	BEVDESF	TRAIN	CNW	CLASS-/INDUS.	UNDEVELOPED	FLAT	I/C	
4	11	BENSVILLE	TRAIN	CMSPP	CLASS-/INDUS.	INDUSTRIAL	HUMP	I/C	
4	11	BENTON	TRAIN	ICG	INDUSTRIAL	RESIDENTIAL	FLAT	I/C	
4	11	BLOOMINGTON	TRAIN (GM+D)	ICG	CLASS-/INDUS.	COMMERCIAL	FLAT	I/C	
4	11	BLOOMINGTON	TRAIN (ICG)	ICG	SMALL INDUS.	COMMERCIAL	FLAT	I/C	
4	11	BLOOMINGTON	CITY	NW	SMALL INDUS.	COMMERCIAL	FLAT	I/C	
4	11	BLOOMINGTON	CITY	PC	SMALL INDUS.	COMMERCIAL	FLAT	I/C	
4	11	BLUE ISLAND	BURR JAK	CRIP	CLASS-/INDUS.	RESIDENTIAL	FLAT	I/C	
4	11	BLUE ISLAND	TRAIN	STW	CLASS-/INDUS.	COMMERCIAL	FLAT	I/C	
4	11	BLUE ISLAND	BLUE ISLAND	IHD	CLASS-/INDUS.	INDUSTRIAL	FLAT	I/C	
4	11	BROOKLYN	TRAIN	NW	CLASS-/INDUS.	INDUSTRIAL	FLAT	I/C	
4	11	BUPEAU	TRAIN	CRIP	INDUSTRIAL	UNDEVELOPED	FLAT	I/C	
4	11	BUSH	TRAIN	4P	INDUSTRIAL	UNDEVELOPED	FLAT	I/C	
4	11	BUSHNELL	CITY	HN	SMALL INDUS.	RESIDENTIAL	FLAT	I/C	

76/07/08.

REG.	ST.	CITY	YARD	RAIL - ROAD	YARD FUNCTION	LOCATION TYPE	YARD TYPE	I/C	MAJOR YARD IF MULTI-YARD COMPLEX
4	IL	BUSHNELL	CITY	TPW	SMALL INDUS.	RESIDENTIAL	FLAT	1/C	
8	IL	CAIRO	TRAIN	ICG	INDUSTRIAL	RESIDENTIAL	FLAT	1/C	
4	IL	CANTON	TRAIN	PC	INDUSTRIAL	COMMERCIAL	FLAT	1/C	NORTH CAIRO
4	IL	CANTON	TRAIN	DN	SMALL INDUS.	RESIDENTIAL	FLAT	1/C	
4	IL	CARDINAL	TRAIN	TPW	SMALL INDUS.	RESIDENTIAL	FLAT	1/C	
4	IL	CENTRALIA	TRAIN	ICG	CLASS./INDUS.	COMMERCIAL	FLAT	1/C	
4	IL	CENTRALIA	TRAIN	HN	CLASSIFICATION	RESIDENTIAL	FLAT	1/C	
4	IL	CHAMPAGNE	TRAIN	ICG	CLASS./INDUS.	AGRICULTURAL	FLAT	1/C	
4	IL	CHAMPAIGN	TRAIN	ICG	CLASS./INDUS.	INDUSTRIAL	FLAT	1/C	
4	IL	CHESTER	TRAIN	ND	INDUSTRIAL	AGRICULTURAL	FLAT	1/C	
4	IL	CHESTER	TRAIN	ND	INDUSTRIAL	AGRICULTURAL	FLAT	1/C	
4	IL	CHICAGO	CORNITH	ATSF	CLASS./INDUS.	COMMERCIAL	HUMP	1/C	CORNITH
4	IL	CHICAGO	NERSKA	ATSF	CLASS./INDUS.	COMMERCIAL	HUMP	1/C	CORNITH
4	IL	CHICAGO	22ND ST. + MORGAN	BN	INDUSTRIAL	COMMERCIAL	FLAT	1/C	
4	IL	CHICAGO	CICERO	BN	INDUSTRIAL	INDUSTRIAL	HUMP	1/C	
4	IL	CHICAGO	WESTERN AVENUE	BN	INDUSTRIAL	INDUSTRIAL	FLAT	1/C	
4	IL	CHICAGO	48TH AVENUE	UDCT	INDUSTRIAL	INDUSTRIAL	FLAT	1/C	
4	IL	CHICAGO	54TH AVENUE	HOCT	INDUSTRIAL	INDUSTRIAL	FLAT	1/C	
4	IL	CHICAGO	79TH + WESTERN	HOCT	CLASSIFICATION	COMMERCIAL	FLAT	1/C	BARR
4	IL	CHICAGO	ROBEY STREET	HOCT	CLASS./INDUS.	COMMERCIAL	FLAT	1/C	CLAREING
4	IL	CHICAGO	22ND STREET	HRC	INDUSTRIAL	INDUSTRIAL	FLAT	1/C	JEFFERY
4	IL	CHICAGO	87TH STREET	HRC	INDUSTRIAL	INDUSTRIAL	FLAT	1/C	JEFFERY
4	IL	CHICAGO	EB CLEARING	BR	CLASS./INDUS.	INDUSTRIAL	FLAT	1/C	
4	IL	CHICAGO	JEFFERY AVENUE	BR	INDUSTRIAL	INDUSTRIAL	FLAT	1/C	CLEARING
4	IL	CHICAGO	SOUTH CHICAGO	BR	CLASS./INDUS.	INDUSTRIAL	HUMP	1/C	
4	IL	CHICAGO	WB CLEARING	BR	CLASS./INDUS.	INDUSTRIAL	HUMP	1/C	
4	IL	CHICAGO	37TH STREET	CEI	INDUSTRIAL	INDUSTRIAL	FLAT	1/C	
4	IL	CHICAGO	47TH STREET	CEI	INDUSTRIAL	INDUSTRIAL	FLAT	1/C	
4	IL	CHICAGO	CRAWFORD	CIW	INDUSTRIAL	INDUSTRIAL	FLAT	1/C	
4	IL	CHICAGO	DIVISION STREET	CMSP	SMALL INDUS.	INDUSTRIAL	FLAT	1/C	
4	IL	CHICAGO	GALEWOOD	CMSP	CLASS./INDUS.	RESIDENTIAL	FLAT	1/C	
4	IL	CHICAGO	WESTERN AVENUE	CMSP	CLASS./INDUS.	INDUSTRIAL	FLAT	1/C	
4	IL	CHICAGO	40TH STREET	CNW	CLASS./INDUS.	INDUSTRIAL	FLAT	1/C	
4	IL	CHICAGO	IRONDALE	CNW	INDUSTRIAL	INDUSTRIAL	FLAT	1/C	
4	IL	CHICAGO	NORTH AVENUE	CNW	INDUSTRIAL	INDUSTRIAL	FLAT	1/C	
4	IL	CHICAGO	STATE STREET	CNW	INDUSTRIAL	COMMERCIAL	FLAT	1/C	
4	IL	CHICAGO	WEST CHICAGO	CNW	CLASS./INDUS.	UNDEVELOPED	FLAT	1/C	
4	IL	CHICAGO	WOOD STREET	CNW	CLASS./INDUS.	INDUSTRIAL	FLAT	1/C	
4	IL	CHICAGO	ROCKWELL STREET	CO	CLASS./INDUS.	RESIDENTIAL	FLAT	1/C	
4	IL	CHICAGO	PRORUCE	CPTC	INDUSTRIAL	COMMERCIAL	FLAT	1/C	
4	IL	CHICAGO	12TH STREET	CR1	INDUSTRIAL	INDUSTRIAL	FLAT	1/C	ASHLAND AVE.
4	IL	CHICAGO	37TH STREET	CR1	CLASS./INDUS.	INDUSTRIAL	FLAT	1/C	ASH AND AVE.
4	IL	CHICAGO	ASHLAND AVENUE	CR1	CLASS./INDUS.	COMMERCIAL	FLAT	1/C	ASHLAND AVE.
4	IL	CHICAGO	HALSTED STREET	CR1	INDUSTRIAL	INDUSTRIAL	FLAT	1/C	
4	IL	CHICAGO	STATE STREET	CR1	INDUSTRIAL	INDUSTRIAL	FLAT	1/C	
4	IL	CHICAGO	16TH STREET	CRIP	INDUSTRIAL	COMMERCIAL	FLAT	1/C	RUPP OAK
4	IL	CHICAGO	43RD STREET	CRIP	INDUSTRIAL	INDUSTRIAL	FLAT	1/C	BURR OAK
4	IL	CHICAGO	51ST STREET	CRIP	INDUSTRIAL	INDUSTRIAL	FLAT	1/C	BURR OAK
4	IL	CHICAGO	97TH STREET	CRIP	INDUSTRIAL	INDUSTRIAL	FLAT	1/C	
4	IL	CHICAGO	PORT STREET	CRIP	INDUSTRIAL	INDUSTRIAL	FLAT	1/C	
4	IL	CHICAGO	500TH CHICAGO	CRIP	CLASS./INDUS.	INDUSTRIAL	FLAT	1/C	
4	IL	CHICAGO	SOUTH CHICAGO	CSL	INDUSTRIAL	INDUSTRIAL	FLAT	1/C	
4	IL	CHICAGO	SOUTH CHICAGO	CMPS	INDUSTRIAL	INDUSTRIAL	FLAT	1/C	
4	IL	CHICAGO	530TH CHICAGO	EJ	INDUSTRIAL	INDUSTRIAL	FLAT	1/C	

76/07/03.

RFQ#	SI#	CITY	YARD	PAIL-ROAD	YARD FUNCTION	LOCATION TYPE	YARD TYPE	I/C	MULTI-YARD COMPLEX
4	IL	CHICAGO	51ST STREET	EL	CLASS./INDUS.	RESIDENTIAL	FLAT	I/C	
4	IL	CHICAGO	14TH STREET	GT#	SMALL INDUS.	INDUSTRIAL	FLAT	I/C	ELSDON
4	IL	CHICAGO	ELSDON	GT#	CLASS./INDUS.	RESIDENTIAL	FLAT	I/C	ELSDON
4	IL	CHICAGO	CRAMFORD	ICG	CLASS./INDUS.	INDUSTRIAL	FLAT	I/C	
4	IL	CHICAGO	HAWTHORNE	ICG	CLASS./INDUS.	RESIDENTIAL	FLAT	I/C	
4	IL	CHICAGO	19X	ICG	CLASSIFICATION	COMMERCIAL	FLAT	I/C	
4	IL	CHICAGO	KENACOD	ICG	INDUSTRIAL	COMMERCIAL	FLAT	I/C	
4	IL	CHICAGO	26TH STREET	IN	INDUSTRIAL	INDUSTRIAL	FLAT	I/C	
4	IL	CHICAGO	PRODUCE TERMINAL	JOINT	INDUSTRIAL	INDUSTRIAL	FLAT	I/C	
4	IL	CHICAGO	47TH STREET	N#	CLASS./INDUS.	RESIDENTIAL	FLAT	I/C	
4	IL	CHICAGO	CALOVET	N#	CLASS./INDUS.	INDUSTRIAL	FLAT	I/C	
4	IL	CHICAGO	LANDEX	N#	CLASS./INDUS.	COMMERCIAL	FLAT	I/C	
4	IL	CHICAGO	35TH STREET	PC	INDUSTRIAL	COMMERCIAL	FLAT	I/C	
4	IL	CHICAGO	43RD STREET	PC	SMALL INDUS.	COMMERCIAL	FLAT	I/C	
4	IL	CHICAGO	55TH STREET	PC	CLASSIFICATION	RESIDENTIAL	FLAT	I/C	
4	IL	CHICAGO	59TH STREET	PC	CLASS./INDUS.	RESIDENTIAL	HUNG	I/C	
4	IL	CHICAGO	110TH STREET	PC	INDUSTRIAL	INDUSTRIAL	FLAT	I/C	
4	IL	CHICAGO	CAMPBELL SOUP	PC	INDUSTRIAL	INDUSTRIAL	FLAT	I/C	
4	IL	CHICAGO	GOLFFOUR	PC	CLASS./INDUS.	INDUSTRIAL	FLAT	I/C	
4	IL	CHICAGO	DAMEN AVENUE	PC	INDUSTRIAL	INDUSTRIAL	FLAT	I/C	
4	IL	CHICAGO	ENGLEWOOD	PC	CLASS./INDUS.	RESIDENTIAL	FLAT	I/C	
4	IL	CHICAGO	RYERSON STEEL CO.	PC	INDUSTRIAL	INDUSTRIAL	FLAT	I/C	
4	IL	CHICAGO	HEIGHTS	RO	INDUSTRIAL	INDUSTRIAL	FLAT	I/C	
4	IL	CHICAGO	CHICAGO HEIGHTS	CEI	INDUSTRIAL	INDUSTRIAL	FLAT	I/C	
4	IL	CHICAGO	FORD	CHTT	INDUSTRIAL	INDUSTRIAL	FLAT	I/C	
4	IL	CHICAGO	NORTH	CHTT	SMALL INDUS.	INDUSTRIAL	FLAT	I/C	TRAIN
4	IL	CHICAGO	TRAIN	CHTT	CLASS./INDUS.	INDUSTRIAL	FLAT	I/C	TRAIN
4	IL	CHICAGO	WENTWORTH	CHTT	SMALL INDUS.	INDUSTRIAL	FLAT	I/C	TRAIN
4	IL	CHICAGO	TRAIN	EJE	SMALL INDUS.	INDUSTRIAL	FLAT	I/C	
4	IL	CHICAGO	TRAIN	ATSF	CLASS./INDUS.	COMMERCIAL	FLAT	I/C	
4	IL	CLINTON	WESTERN ELECTRIC	MJ	SMALL INDUS.	INDUSTRIAL	FLAT	I/C	
4	IL	CLINTON	NORTH	ICG	CLASS./INDUS.	UNDEVELOPED	FLAT	I/C	OUTBOUND
4	IL	CREVE COEUR	CITY	PPH	SMALL INDUS.	INDUSTRIAL	FLAT	I/C	OUTBOUND
4	IL	CREVE COEUR	UTTBUND	PPH	SMALL INDUS.	INDUSTRIAL	FLAT	I/C	
4	IL	CRYSTAL LAKE	TRAIN	CNW	CLASS./INDUS.	INDUSTRIAL	FLAT	I/C	
4	IL	DANVILLE	BREWER	CEI	CLASS./INDUS.	RESIDENTIAL	FLAT	I/C	
4	IL	DANVILLE	HOUSE	CEI	CLASS./INDUS.	UNDEVELOPED	FLAT	I/C	BREWER
4	IL	DANVILLE	NORTH	CEI	SMALL INDUS.	COMMERCIAL	FLAT	I/C	BREWER
4	IL	DANVILLE	BREWER	CEI	SMALL INDUS.	INDUSTRIAL	FLAT	I/C	
4	IL	DANVILLE	HOUSE	LY	CLASS./INDUS.	INDUSTRIAL	FLAT	I/C	
4	IL	DANVILLE	HOUSE	PC	SMALL INDUS.	COMMERCIAL	FLAT	I/C	
8	IL	DECATUR	TRAIN	CMSPP	CLASS./INDUS.	AGRICULTURAL	FLAT	I/C	
8	IL	DECATUR	TRAIN	BO	CLASS./INDUS.	INDUSTRIAL	FLAT	I/C	
8	IL	DECATUR	TRAIN	ICG	CLASS./INDUS.	RESIDENTIAL	FLAT	I/C	
8	IL	DECATUR	TRAIN	ITC	CLASS./INDUS.	COMMERCIAL	FLAT	I/C	
8	IL	DECATUR	TRAIN	N#	CLASS./INDUS.	RESIDENTIAL	FLAT	I/C	
4	IL	DEKALB	TRAIN	PC	CLASS./INDUS.	RESIDENTIAL	FLAT	I/C	
4	IL	DEPUÉ	TRAIN	CNW	INDUSTRIAL	COMMERCIAL	FLAT	I/C	
4	IL	DIXON	TRAIN	CRIP	SMALL INDUS.	INDUSTRIAL	FLAT	I/C	
4	IL	DIXON	TRAIN	CNW	SMALL INDUS.	INDUSTRIAL	FLAT	I/C	
4	IL	DIXON	TRAIN	CNW	SMALL INDUS.	INDUSTRIAL	FLAT	I/C	
4	IL	DOLTON	YARC CENTER	ICG	INDUSTRIAL	RESIDENTIAL	FLAT	I/C	
8	IL	DUNDEE	TRAIN	CEI	CLASS./INDUS.	RESIDENTIAL	FLAT	I/C	
8	IL	DUNDEE	TRAIN	MP	CLASS./INDUS.	COMMERCIAL	FLAT	I/C	
8	IL	DUNDEE	TRAIN	ICG	INDUSTRIAL	RESIDENTIAL	FLAT	I/C	
4	IL	DWIGHT	DWIGHT	ICG	SMALL INDUS.	AGRICULTURAL	FLAT	I/C	

76/07/98.

REG	ST	CITY	YARD	RAIL-ROAD	YARD FUNCTION	LOCATION TYPE	YARD TYPE	I/C	MAJOR YARD IF MULTI-YARD COMPLEX
8	IL	EAST ALTON	TRAIN	PC	INDUSTRIAL	INDUSTRIAL	FLAT	I/C	
4	IL	EAST DUNDEE	TRAIN	ICG	SMALL INDUS.	UNDEVELOPED	FLAT	I/C	
4	IL	EAST DUNDEE	TRAIN	BN	SMALL INDUS.	UNDEVELOPED	FLAT	I/C	
4	IL	EAST MOLINE	TRAIN	CRIP	CLASS./INDUS.	INDUSTRIAL	FLAT	I/C	F. MOLINE TRAIN
4	IL	EAST MOLINE	TRAIN	CRIP	INDUSTRIAL	INDUSTRIAL	FLAT	I/C	SILVTS
4	IL	EAST MOLINE	EAST MOLINE	ORI	INDUSTRIAL	INDUSTRIAL	FLAT	I/C	
4	IL	EAST PEKIN	TRAIN	ATSF	CLASS./INDUS.	RESIDENTIAL	FLAT	I/C	
4	IL	EAST PEKIN	TRAIN	PE	CLASS./INDUS.	RESIDENTIAL	FLAT	I/C	
4	IL	EAST PEKIN	TRAIN	TPW	CLASS./INDUS.	RESIDENTIAL	FLAT	I/C	
4	IL	EAST PEORIA	TRAIN	ALS	CLASS./INDUS.	RESIDENTIAL	FLAT	I/C	
8	IL	EAST ST. LOUIS	GATEWAY	BN	CLASS./INDUS.	RESIDENTIAL	HUMP	I/C	
8	IL	EAST ST. LOUIS	TRAIN	RO	CLASS./INDUS.	COMMERCIAL	FLAT	I/C	
8	IL	EAST ST. LOUIS	TRAIN	ICG	CLASS./INDUS.	COMMERCIAL	FLAT	I/C	
8	IL	EAST ST. LOUIS	TRAIN	LN	CLASS./INDUS.	COMMERCIAL	HUMP	I/C	
8	IL	EAST ST. LOUIS	TRAIN	SOU	CLASS./INDUS.	INDUSTRIAL	FLAT	I/C	
8	IL	EAST ST. LOUIS	TRAIN	SSW	CLASS./INDUS.	RESIDENTIAL	FLAT	I/C	
8	IL	EAST ST. LOUIS	TRAIN	TRRA	CLASS./INDUS.	COMMERCIAL	FLAT	I/C	
8	IL	EAST ST. LOUIS	TRAIN	TRRA	CLASS./INDUS.	INDUSTRIAL	HUMP	I/C	
8	IL	EAST ST. LOUIS	MADISON	TRRA	CLASS./INDUS.	INDUSTRIAL	HUMP	I/C	
8	IL	EAST ST. LOUIS	WIGGANS NO 2	TRRA	CLASS./INDUS.	INDUSTRIAL	HUMP	I/C	
8	IL	EAST ST. LOUIS	TRAIN	ICG	INDUSTRIAL	INDUSTRIAL	FLAT	I/C	
8	IL	EFFINGHAM	TRAIN	TPW	SMALL INDUS.	UNDEVELOPED	FLAT	I/C	
4	IL	ELGIN	TRAIN	CHSPP	SMALL INDUS.	RESIDENTIAL	FLAT	I/C	
4	IL	ELGIN	TRAIN	CNW	SMALL INDUS.	RESIDENTIAL	FLAT	I/C	
4	IL	ELGIN	TRAIN	CNW	SMALL INDUS.	RESIDENTIAL	FLAT	I/C	
4	IL	ELK GROVE VILLAGE	ELK GROVE	CNW	INDUSTRIAL	INDUSTRIAL	FLAT	I/C	
4	IL	EOLA	TRAIN	BN	CLASS./INDUS.	UNDEVELOPED	FLAT	I/C	
4	IL	EVANSTON	WEBER	CNW	SMALL INDUS.	COMMERCIAL	FLAT	I/C	
4	IL	FAIRMONT CITY	TRAIN	PC	CLASS./INDUS.	RESIDENTIAL	FLAT	I/C	
9	IL	FAIRMONT CITY	TRAIN	HO	CLASSIFICATION	RESIDENTIAL	FLAT	I/C	
4	IL	FORRE ST	TRAIN	NW	SMALL INDUS.	RESIDENTIAL	FLAT	I/C	
4	IL	FOX LAKE	FOX LAKE	CHSPP	SMALL INDUS.	RESIDENTIAL	FLAT	I/C	
4	IL	FRANKLIN PARK	NORPAUL	THB	CLASS./INDUS.	COMMERCIAL	FLAT	I/C	
4	IL	FREEDPORT	WALLACE	CHSPP	SMALL INDUS.	RESIDENTIAL	FLAT	I/C	
4	IL	FREEDPORT	WALLACE	ICG	SMALL INDUS.	RESIDENTIAL	FLAT	I/C	
4	IL	GALESBURG	TRAIN	ATSF	INDUSTRIAL	INDUSTRIAL	FLAT	I/C	
4	IL	GALESBURG	E.H. WILLIS	BN	CLASS./INDUS.	INDUSTRIAL	FLAT	I/C	
4	IL	GALESBURG	E.H. WILLIS	BN	CLASS./INDUS.	INDUSTRIAL	HUMP	I/C	
4	IL	GIBSON CITY	TERMINAL	ICG	SMALL INDUS.	INDUSTRIAL	HUMP	I/C	
4	IL	GILMAN	TRAIN	ICG	SMALL INDUS.	INDUSTRIAL	FLAT	I/C	
8	IL	GRANITE CITY	TRAIN	TTC	INDUSTRIAL	RESIDENTIAL	FLAT	I/C	
8	IL	HARRISBURG	TRAIN	PC	CLASS./INDUS.	RESIDENTIAL	FLAT	I/C	
4	IL	HARVARD	TRAIN	CNW	CLASS./INDUS.	COMMERCIAL	FLAT	I/C	
4	IL	HARVEY	TRAIN	SOCT	INDUSTRIAL	COMMERCIAL	FLAT	I/C	
4	IL	HARVEY	TRAIN	GT#	INDUSTRIAL	COMMERCIAL	FLAT	I/C	
4	IL	HAVANA	TRAIN	CIM	INDUSTRIAL	UNDEVELOPED	FLAT	I/C	
4	IL	HENNEPIN	INTERLAKE	CHSPP	INDUSTRIAL	INDUSTRIAL	FLAT	I/C	
4	IL	HENNEPIN	INTERLAKE	PC	INDUSTRIAL	INDUSTRIAL	FLAT	I/C	
8	IL	HERRIN	TRAIN	BN	INDUSTRIAL	RESIDENTIAL	FLAT	I/C	
8	IL	HERRIN	TRAIN	ICG	INDUSTRIAL	AGRICULTURAL	FLAT	I/C	
4	IL	HILLERY	TRAIN	PC	INDUSTRIAL	INDUSTRIAL	FLAT	I/C	
4	IL	HILLERY	TRAIN	PE	CLASS./INDUS.	RESIDENTIAL	FLAT	I/C	
8	IL	HILLSBORO	TRAIN	PC	CLASS./INDUS.	INDUSTRIAL	FLAT	I/C	
8	IL	HILLSBORO	TRAIN	PC	CLASS./INDUS.	INDUSTRIAL	FLAT	I/C	
4	IL	HODGKINS	GW	ATSF	SMALL INDUS.	COMMERCIAL	FLAT	I/C	
4	IL	HODGKINS	TRAIN	CEI	SMALL INDUS.	RESIDENTIAL	FLAT	I/C	
4	IL	HODGKINS	TRAIN	CEI	SMALL INDUS.	RESIDENTIAL	FLAT	I/C	
4	IL	HODGKINS	TRAIN	NW	SMALL INDUS.	RESIDENTIAL	FLAT	I/C	

76/07/00.

REC.	ST.	CITY	YARD	PAIL- ROAD	YARD FUNCTION	LOCATION TYPE	YARD TYPE	I/C	MAJOR YARD IF MULTI-YARD COMPLEX
4	IL	PEKIN	TRAIN	ICG	SMALL INDUS.	RESIDENTIAL	FLAT	I/C	
4	IL	PEKIN	TRAIN	PPU	INDUSTRIAL	INDUSTRIAL	FLAT	I/C	
4	IL	PEORIA	TRAIN	BN	CLASS./INDUS.	INDUSTRIAL	FLAT	I/C	
4	IL	PEORIA	TRAIN	CNW	CLASS./INDUS.	INDUSTRIAL	FLAT	I/C	
4	IL	PEORIA	LIMIT	CRIP	CLASS./INDUS.	INDUSTRIAL	FLAT	I/C	
4	IL	PEORIA	93-01	PPU	INDUSTRIAL	INDUSTRIAL	FLAT	I/C	
4	IL	PEORIA HEIGHTS	PEORIA HEIGHTS	CRIP	INDUSTRIAL	INDUSTRIAL	FLAT	I/C	
4	IL	PERCY	TRAIN	ICG	INDUSTRIAL	UNDEVELOPED	FLAT	I/C	PERU
4	IL	PERU	TRAIN	CRIP	INDUSTRIAL	INDUSTRIAL	FLAT	I/C	
4	IL	PICKENVILLE	TRAIN	WP	CLASS./INDUS.	UNDEVELOPED	FLAT	I/C	
4	IL	PIOMBERTON	TRAIN	CIW	SMALL INDUS.	UNDEVELOPED	FLAT	I/C	
4	IL	QUINCY	CITY	BN	CLASSIFICATION	COMMERCIAL	FLAT	I/C	
4	IL	QUINCY	CITY	NW	CLASSIFICATION	COMMERCIAL	FLAT	I/C	
4	IL	RANKIN	TRAIN	NW	SMALL INDUS.	COMMERCIAL	FLAT	I/C	
4	IL	RANTOUL	TRAIN	ICG	SMALL INDUS.	COMMERCIAL	FLAT	I/C	
4	IL	RIVERDALE	HARR	HOCT	CLASS./INDUS.	RESIDENTIAL	FLAT	I/C	
4	IL	RIVERDALE	BLUE ISLAND	IHR	CLASS./INDUS.	INDUSTRIAL	HUMP	I/C	BARR
4	IL	ROCHELLE	TRAIN	HN	INDUSTRIAL	INDUSTRIAL	FLAT	I/C	
4	IL	ROCHELLE	TRAIN	CASPP	INDUSTRIAL	INDUSTRIAL	FLAT	I/C	
4	IL	ROCHELLE	TRAIN	CNW	INDUSTRIAL	INDUSTRIAL	FLAT	I/C	
4	IL	ROCK FALLS	TRAIN	BN	SMALL INDUS.	RESIDENTIAL	FLAT	I/C	
4	IL	ROCK ISLAND	TRAIN	BN	INDUSTRIAL	INDUSTRIAL	FLAT	I/C	
4	IL	ROCK ISLAND	TRAIN	BN	INDUSTRIAL	INDUSTRIAL	FLAT	I/C	
4	IL	ROCKFORD	TRAIN	CRIP	INDUSTRIAL	INDUSTRIAL	FLAT	I/C	
4	IL	ROCKFORD	TRAIN	BN	CLASS./INDUS.	RESIDENTIAL	FLAT	I/C	
4	IL	ROCKFORD	TRAIN	CMSPP	CLASS./INDUS.	RESIDENTIAL	FLAT	I/C	
4	IL	ROCKFORD	ROCKFORD	CNW	SMALL INDUS.	COMMERCIAL	FLAT	I/C	
4	IL	ROCKFORD	TRAIN	ICG	SMALL INDUS.	RESIDENTIAL	FLAT	I/C	
4	IL	PONDOUT	TRAIN	CMSPP	CLASS./INDUS.	UNDEVELOPED	FLAT	I/C	
4	IL	RODDHOUSE	TRAIN	ICG	CLASS./INDUS.	RESIDENTIAL	FLAT	I/C	
4	IL	SALEM	TRAIN	CEI	CLASSIFICATION	UNDEVELOPED	FLAT	I/C	
4	IL	SAVANNA	TRAIN	BN	CLASSIFICATION	UNDEVELOPED	FLAT	I/C	
4	IL	SAVANNA	TRAIN	CMSPP	CLASSIFICATION	UNDEVELOPED	FLAT	I/C	
4	IL	SCHILLER PARK	TRAIN	500	CLASS./INDUS.	RESIDENTIAL	FLAT	I/C	
4	IL	SENECA	TRAIN	CRIP	SMALL INDUS.	RESIDENTIAL	FLAT	I/C	
4	IL	SILVIS	TRAIN	CRIP	CLASS./INDUS.	INDUSTRIAL	HUMP	I/C	SILVTS
4	IL	SOUTH BELT	WEST	CMSPP	CLASS./INDUS.	RESIDENTIAL	FLAT	I/C	
4	IL	SOUTH PEKIN	TRAIN	CNW	CLASSIFICATION	RESIDENTIAL	FLAT	I/C	
4	IL	SPARTA	TRAIN	MI	INDUSTRIAL	UNDEVELOPED	FLAT	I/C	
4	IL	SPAUDING	TRAIN	CMSPP	SMALL INDUS.	UNDEVELOPED	FLAT	I/C	
4	IL	SPAUDING	TRAIN	EJE	SMALL INDUS.	UNDEVELOPED	FLAT	I/C	
4	IL	SPRING VALLEY	TRAIN	CRIP	SMALL INDUS.	RESIDENTIAL	FLAT	I/C	
4	IL	SPRINGFIELD	TRAIN	CIW	CLASS./INDUS.	COMMERCIAL	FLAT	I/C	
4	IL	SPRINGFIELD	TRAIN	ICG	INDUSTRIAL	COMMERCIAL	FLAT	I/C	
4	IL	SPRINGFIELD	TRAIN	ITC	CLASS./INDUS.	RESIDENTIAL	FLAT	I/C	
4	IL	SPRINGFIELD	TRAIN	NW	INDUSTRIAL	COMMERCIAL	FLAT	I/C	
4	IL	STERLING	STERLING	HN	INDUSTRIAL	INDUSTRIAL	FLAT	I/C	
4	IL	STERLING	TRAIN	CNW	INDUSTRIAL	INDUSTRIAL	FLAT	I/C	
4	IL	STREATON	CITY	ATSF	SMALL INDUS.	COMMERCIAL	FLAT	I/C	
4	IL	STREATON	CITY	HN	SMALL INDUS.	COMMERCIAL	FLAT	I/C	
4	IL	STREATON	NORTH	HN	CLASSIFICATION	RESIDENTIAL	FLAT	I/C	NORTH
4	IL	STREATON	TRAIN	ICG	CLASS./INDUS.	RESIDENTIAL	FLAT	I/C	
4	IL	STREATON	TRAIN	NW	CLASS./INDUS.	RESIDENTIAL	FLAT	I/C	
4	IL	STREATON	TRAIN	PC	CLASS./INDUS.	RESIDENTIAL	FLAT	I/C	
4	IL	TAMMS	TRAIN	ICG	INDUSTRIAL	AGRICULTURAL	FLAT	I/C	

76/07/CA*

REG.	ST.	CITY	YARD	RAIL-ROAD	YARD FUNCTION	LOCATION TYPE	YARD TYPE	I/C	MAJOR YARD IF MULTI-YARD COMPLEX
8	IL	TAYLORVILLE	TRAIN	CIH	INDUSTRIAL	RESIDENTIAL	FLAT	I/C	
8	IL	TAYLORVILLE	TRAIN	NW	INDUSTRIAL CLASS-//INDUS.	COMMERCIAL	FLAT	I/C	
4	IL	TILTON	TRAIN	ND	INDUSTRIAL	RESIDENTIAL	FLAT	I/C	
8	IL	TUSCOLA	TRAIN	SD	INDUSTRIAL	INDUSTRIAL	FLAT	I/C	
4	IL	URBANA	TRAIN	PC	CLASS-//INDUS.	INDUSTRIAL	FLAT	I/C	
4	IL	URBANA	TRAIN	PE	CLASSIFICATION	COMMERCIAL	FLAT	I/C	
4	IL	UTICA	TRAIN	CP IP	SMALL INDUS.	AGRICULTURAL	FLAT	I/C	
9	IL	VENICE	TRAIN	ICG	CLASS-//INDUS.	INDUSTRIAL	FLAT	I/C	
8	IL	VILLA GRUVE	TRAIN	CFI	CLASSIFICATION	RESIDENTIAL	FLAT	I/C	
4	IL	WASHINGTON	TRAIN	ICG	INDUSTRIAL	RESIDENTIAL	FLAT	I/C	
4	IL	WAUKEGAN	TRAIN	CNB	CLASS-//INDUS.	INDUSTRIAL	FLAT	I/C	
4	IL	WAUKEGAN	TRAIN	EJF	CLASS-//INDUS.	INDUSTRIAL	FLAT	I/C	
4	IL	WEDRON	TRAIN	BN	INDUSTRIAL	UNDEVELOPED	FLAT	I/C	
4	IL	WEST CHICAGO	TRAIN	RY	SMALL INDUS.	RESIDENTIAL	FLAT	I/C	
4	IL	WEST CHICAGO	TRAIN	CNW	CLASS-//INDUS.	UNDEVELOPED	FLAT	I/C	
4	IL	WEST CHICAGO	TRAIN	EJC	SMALL INDUS.	UNDEVELOPED	FLAT	I/C	
8	IL	WEST FRANKFORT	TRAIN	CEI	INDUSTRIAL	RESIDENTIAL	FLAT	I/C	
4	IL	WESTVILLE	LYONS	PC	CLASS-//INDUS.	INDUSTRIAL	FLAT	I/C	
4	IL	WILLOW SPRINGS	WILLOW SPRINGS	ATSF	INDUSTRIAL	INDUSTRIAL	FLAT	I/C	
8	IL	WOODRIVER	TRAIN	ICG	INDUSTRIAL	COMMERCIAL	FLAT	I/C	
8	IL	WOODRIVER	TRAIN	ITC	INDUSTRIAL	INDUSTRIAL	FLAT	I/C	
4	IL	ZEARING	TRAIN	BN	SMALL INDUS.	AGRICULTURAL	FLAT	I/C	
4	IN	ANDERSON	SOUTH ANDERSON	PC	CLASS-//INDUS.	RESIDENTIAL	FLAT	I/C	
4	IN	ANDERSON	TRAIN	PC	SMALL INDUS.	RESIDENTIAL	FLAT	I/C	
4	IN	BEDFORD	BEDEFORD	CSBPP	INDUSTRIAL	RESIDENTIAL	FLAT	I/C	
4	IN	BICKNELL	BICKNELL	PC	CLASS-//INDUS.	RESIDENTIAL	FLAT	I/C	
4	IN	BLOOMINGTON	BLOOMINGTON	ICG	INDUSTRIAL	AGRICULTURAL	FLAT	I/C	
4	IN	BLOOMINGTON	MCDELL	LN	INDUSTRIAL	RESIDENTIAL	FLAT	I/C	
4	IN	HURON HARBOR	HURON HARBOR	PC	CLASS-//INDUS.	INDUSTRIAL	FLAT	I/C	
4	IN	COLUMBIA CITY	TIE-UP TRACK	PC	SMALL INDUS.	INDUSTRIAL	FLAT	I/C	
4	IN	COLUMBUS	NORTH	PC	INDUSTRIAL	RESIDENTIAL	FLAT	I/C	
4	IN	COLUMBUS	SOUTH	PC	INDUSTRIAL	RESIDENTIAL	FLAT	I/C	
4	IN	CONNERSVILLE	TIE-UP TRACK	BD	INDUSTRIAL	RESIDENTIAL	FLAT	I/C	
4	IN	CONNERSVILLE	TIE-UP TRACK	PC	SMALL INDUS.	INDUSTRIAL	FLAT	I/C	
4	IN	CORYDON	CORYDON	LNAC	SMALL INDUS.	RESIDENTIAL	FLAT	I/C	
4	IN	DECATUR	DECATUR	PC	INDUSTRIAL	RESIDENTIAL	FLAT	I/C	
4	IN	DUNKIRK	TIF-UP TRACK	PC	SMALL INDUS.	INDUSTRIAL	FLAT	I/C	
4	IN	EAST CHICAGO	EAST CHICAGO	BN	CLASS-//INDUS.	INDUSTRIAL	FLAT	I/C	
4	IN	EAST CHICAGO	TRANSFER	BDCT	INDUSTRIAL	INDUSTRIAL	FLAT	I/C	
4	IN	EAST CHICAGO	LAKE FRONT	EJF	INDUSTRIAL	INDUSTRIAL	FLAT	I/C	
4	IN	EAST CHICAGO	LAKE FRONT	IMB	INDUSTRIAL	INDUSTRIAL	FLAT	I/C	
4	IN	EAST CHICAGO	MICHIGAN AVE.	IMB	INDUSTRIAL	INDUSTRIAL	FLAT	I/C	
4	IN	ELKHART	GRT-UP YOUNG HUMP	PC	CLASS-//INDUS.	UNDEVELOPED	HUMP		
4	IN	ELWOOD	TRAIN	NW	SMALL INDUS.	COMMERCIAL	FLAT	I/C	
4	IN	ELWOOD	TRAIN	PC	SMALL INDUS.	RESIDENTIAL	FLAT	I/C	
4	IN	ENOS MINE	ENOS MINE	AWW	INDUSTRIAL	RESIDENTIAL	FLAT	I/C	
4	IN	EVANSVILLE	HARWOOD	ICG	INDUSTRIAL CLASS-//INDUS.	AGRICULTURAL	FLAT	I/C	
4	IN	EVANSVILLE	SELT	LN	INDUSTRIAL	INDUSTRIAL	FLAT	I/C	
4	IN	EVANSVILLE	CITY	LN	INDUSTRIAL	INDUSTRIAL	FLAT	I/C	
4	IN	EVANSVILLE	HOWELL	LN	INDUSTRIAL	RESIDENTIAL	FLAT	I/C	
4	IN	EVANSVILLE	WANSFORD	LN	CLASSIFICATION	RESIDENTIAL	FLAT	I/C	
4	IN	EVANSVILLE	EVANSVILLE	LN	SMALL INDUS.	RESIDENTIAL	FLAT	I/C	
4	IN	EVANSVILLE	EVANSVILLE	SDJ	SMALL INDUS.	RESIDENTIAL	FLAT	I/C	
4	IN	EVANSVILLE	FERDINAND	FR/N	SMALL INDUS.	AGRICULTURAL	FLAT	I/C	

76/07/08

REG.	ST.	CITY	YARD	RAIL-ROAD	YARD FUNCTION	LOCATION TYPE	YARD TYPE	T/C	MAJOR YARD IF MULTI-YARD COMPLEX
4	IN	FORT WAYNE	DIESEL TRACK	LEPW	SMALL INDUS.	RESIDENTIAL	FLAT		
4	IN	FORT WAYNE	EAST/WEST WAYNE	NW	CLASSIFICATION	RESIDENTIAL	FLAT	1/C	
4	IN	FORT WAYNE	TRAIN	NW	CLASSIFICATION	RESIDENTIAL	FLAT	1/C	
4	IN	FRANKFORT	FRANKFORT	PC	CLASS-/INDUS.	INDUSTRIAL	FLAT	1/C	
4	IN	GARY	KIPK HUMP	NW	CLASS-/INDUS.	INDUSTRIAL	HUMP	1/C	
4	IN	GARY	MILL	EJE	INDUSTRIAL	INDUSTRIAL	FLAT	1/C	
4	IN	GRIFFITH	TRAIN	CO	INDUSTRIAL	COMMERCIAL	FLAT	1/C	
4	IN	GRIFFITH	TRAIN	EJF	INDUSTRIAL	COMMERCIAL	FLAT	1/C	
4	IN	GRIFFITH	TRAIN	EL	INDUSTRIAL	COMMERCIAL	FLAT	1/C	
4	IN	HAMMOND	GIBSON EAST HUMP	IHE	CLASS-/INDUS.	COMMERCIAL	HUMP	1/C	
4	IN	HAMMOND	GIBSON WEST HUMP	IHR	CLASS-/INDUS.	COMMERCIAL	HUMP	1/C	
4	IN	HAMMOND	SOUTH HAMMOND	LN	SMALL INDUS.	INDUSTRIAL	FLAT	1/C	
4	IN	HAMMOND	OSCRN	NW	CLASSIFICATION	COMMERCIAL	FLAT	1/C	
4	IN	HUNTINGBURG	HUNTINGBURG	SOU	CLASS-/INDUS.	RESIDENTIAL	FLAT	1/C	
4	IN	HUNTINGBURG	TRAIN	EL	INDUSTRIAL	RESIDENTIAL	FLAT	1/C	
4	IN	HUNTINGBURG	TRAIN	NW	SMALL INDUS.	RESIDENTIAL	FLAT	1/C	
4	IN	INDIANA HARBOR	RIELLY ROAD	IHR	INDUSTRIAL	INDUSTRIAL	FLAT	1/C	
4	IN	INDIANA HARBOR	TRAIN	PC	SMALL INDUS.	INDUSTRIAL	FLAT	1/C	
4	IN	INDIANA HARBOR	INDIANAPOLIS	PC	CLASS-/INDUS.	INDUSTRIAL	FLAT	1/C	
4	IN	INDIANAPOLIS	INDIANAPOLIS	RD	INDUSTRIAL	INDUSTRIAL	FLAT	1/C	
4	IN	INDIANAPOLIS	STATE STREET	BO	INDUSTRIAL	RESIDENTIAL	FLAT	1/C	
4	IN	INDIANAPOLIS	WISCONSIN ST	ICG	CLASS-/INDUS.	RESIDENTIAL	FLAT	1/C	
4	IN	INDIANAPOLIS	HAMILTON JCT	IU	INDUSTRIAL	INDUSTRIAL	FLAT	1/C	
4	IN	INDIANAPOLIS	PANHANDLE JCT	IU	INDUSTRIAL	INDUSTRIAL	FLAT	1/C	
4	IN	INDIANAPOLIS	STOCK	IU	CLASSIFICATION	INDUSTRIAL	FLAT	1/C	
4	IN	INDIANAPOLIS	VAN JCT	IU	INDUSTRIAL	INDUSTRIAL	FLAT	1/C	
4	IN	INDIANAPOLIS	BELT JUNCTION	LN	INDUSTRIAL	RESIDENTIAL	FLAT	1/C	
4	IN	INDIANAPOLIS	AVON	PC	CLASS-/INDUS.	UNDEVELOPED	HUMP	1/C	AVON
4	IN	INDIANAPOLIS	CAVEN	PC	SMALL INDUS.	INDUSTRIAL	FLAT	1/C	AVON
4	IN	INDIANAPOLIS	HAWTHORNE	PC	CLASS-/INDUS.	INDUSTRIAL	FLAT	1/C	AVON
4	IN	INDIANAPOLIS	HILL	PC	INDUSTRIAL	INDUSTRIAL	FLAT	1/C	AVON
4	IN	INDIANAPOLIS	TRANSFER	PC	INDUSTRIAL	RESIDENTIAL	FLAT	1/C	AVON
4	IN	INDIANAPOLIS	WEST SIDE	PC	SMALL INDUS.	RESIDENTIAL	FLAT	1/C	AVON
4	IN	JASONVILLE	LATTA	CSPP	CLASS-/INDUS.	RESIDENTIAL	FLAT	1/C	LATTA
4	IN	JEFFERSONVILLE	JEFFERSONVILLE	RD	INDUSTRIAL	RESIDENTIAL	FLAT		
4	IN	JEFFERSONVILLE	CT	PC	INDUSTRIAL	RESIDENTIAL	FLAT		
4	IN	JEFFERSONVILLE	JEFFERSONVILLE	PC	CLASSIFICATION	RESIDENTIAL	FLAT		
4	IN	KOKOMO	TRAIN	PC	SMALL INDUS.	RESIDENTIAL	FLAT		
4	IN	LA PORTE	LA PORTE	PC	SMALL INDUS.	RESIDENTIAL	FLAT		
4	IN	LAFAYETTE	LAFAYETTE	LN	CLASS-/INDUS.	RESIDENTIAL	FLAT		
4	IN	LAFAYETTE	LAFAYETTE	NW	INDUSTRIAL	RESIDENTIAL	FLAT		
4	IN	LAFAYETTE	LAFAYETTE	PC	SMALL INDUS.	INDUSTRIAL	FLAT		
4	IN	LOGANSPORT	LOGANSPORT	PC	CLASS-/INDUS.	INDUSTRIAL	FLAT		
4	IN	MARION	MARION	NW	INDUSTRIAL	COMMERCIAL	FLAT		
4	IN	MARION	GODDMAN	PC	CLASS-/INDUS.	AGRICULTURAL	FLAT		GODDMAN
4	IN	MARION	MARION	PC	INDUSTRIAL	COMMERCIAL	FLAT	1/C	GODDMAN
4	IN	MICHIGAN CITY	MICHIGAN CITY	CS	SMALL INDUS.	INDUSTRIAL	FLAT	1/C	
4	IN	MICHIGAN CITY	MICHIGAN CITY	NW	SMALL INDUS.	INDUSTRIAL	FLAT		
4	IN	MICHIGAN CITY	MICHIGAN CITY	PC	SMALL INDUS.	INDUSTRIAL	FLAT		
4	IN	MT. VERNON	MT. VERNON	LN	INDUSTRIAL	INDUSTRIAL	FLAT		
4	IN	MUNCIE	TRAIN	CO	SMALL INDUS.	COMMERCIAL	FLAT	1/C	
4	IN	MUNCIE	MUNCIE	NWR	SMALL INDUS.	INDUSTRIAL	FLAT	1/C	
4	IN	MUNCIE	EAST	NW	INDUSTRIAL	UNDEVELOPED	FLAT		WEST

76/07/DR.

REG.	ST.	CITY	YARD	RAIL-ROAD	YARD FUNCTION	LOCATION TYPE	YARD TYPE	I/C	MAJOR YARD IF MULTI-YARD COMPLEX
4	IN	MUNCIE	SOUTH TRAIN	NW	SMALL INDUS.	INDUSTRIAL	FLAT		WFST
4	IN	MUNCIE	WEST	NW	SMALL INDUS.	INDUSTRIAL	FLAT		WFST
4	IN	MUNCIE	HAPT	PC	CLASS./INDUS.	COMMERCIAL	FLAT	I/C	
4	IN	MUNCIE	TOWN	PC	SMALL INDUS.	INDUSTRIAL	FLAT		
4	IN	NEW ALBANY	TIE-UP TRACK	LN	INDUSTRIAL	INDUSTRIAL	FLAT		
4	IN	NEWCASTLE	TRAIN	NW	SMALL INDUS.	RESIDENTIAL	FLAT	I/C	
4	IN	OAKLAND CITY	TRAIN	AWW	INDUSTRIAL	UNDEVELOPED	FLAT	I/C	
4	IN	PERU	TRAIN	CO	SMALL INDUS.	RESIDENTIAL	FLAT	I/C	
4	IN	PERU	EAST	PC	CLASS./INDUS.	RESIDENTIAL	FLAT	I/C	
4	IN	PERU	PERU	NW	CLASS./INDUS.	RESIDENTIAL	FLAT	I/C	FAST
4	IN	PERU	TRAIN	NW	INDUSTRIAL	RESIDENTIAL	FLAT	I/C	FAST
4	IN	PETERSBURG	ASHBY	PC	INDUSTRIAL	RESIDENTIAL	FLAT	I/C	
4	IN	PRINCETON	PRINCETON	PC	INDUSTRIAL	AGRICULTURAL	FLAT	I/C	
4	IN	RICHMOND	RICHMOND	CO	CLASS./INDUS.	COMMERCIAL	FLAT	I/C	
4	IN	RICHMOND	DOWNTOWN	PC	CLASS./INDUS.	COMMERCIAL	FLAT	I/C	
4	IN	RICHMOND	TRAIN	PC	SMALL INDUS.	INDUSTRIAL	FLAT		TRAIN
4	IN	SCHERERVILLE	HARTSDALE	EJE	CLASSIFICATION	UNDEVELOPED	FLAT	I/C	
4	IN	SCHERERVILLE	HARTSDALE	PC	CLASS./INDUS.	UNDEVELOPED	FLAT	I/C	
4	IN	SELLERSBURG	SELLERSBURG	SIRK	SMALL INDUS.	RESIDENTIAL	FLAT		
4	IN	SHOALS	SHOALS	HO	SMALL INDUS.	RESIDENTIAL	FLAT		
4	IN	SINCLAIR	WHITTING	BU	SMALL INDUS.	INDUSTRIAL	FLAT		
4	IN	SOUTH DENN	SOUTH DENN	PC	SMALL INDUS.	INDUSTRIAL	FLAT		
4	IN	SPEED	SPEED	PC	SMALL INDUS.	RESIDENTIAL	FLAT		
4	IN	TERRE HAUTE	HULWAN	STND	SMALL INDUS.	RESIDENTIAL	FLAT	I/C	LATTA
4	IN	TERRE HAUTE	VAN	CWSPP	INDUSTRIAL	INDUSTRIAL	FLAT	I/C	LATTA
4	IN	TERRE HAUTE	BAKER	LN	SMALL INDUS.	RESIDENTIAL	FLAT	I/C	
4	IN	TERRE HAUTE	DUANE	PC	CLASS./INDUS.	RESIDENTIAL	FLAT	I/C	DUANE
4	IN	TERRE HAUTE	EAST	PC	CLASS./INDUS.	RESIDENTIAL	FLAT	I/C	DUANE
4	IN	TERRE HAUTE	GREENWOOD	PC	CLASS./INDUS.	INDUSTRIAL	FLAT		DUANE
4	IN	TIPTON	TRAIN	NW	INDUSTRIAL	INDUSTRIAL	FLAT	I/C	
4	IN	VINCENNES	VINCENNES	RD	INDUSTRIAL	INDUSTRIAL	FLAT	I/C	
4	IN	VINCENNES	ALICE	LN	INDUSTRIAL	RESIDENTIAL	FLAT		
4	IN	WADASH	TRAIN	PC	INDUSTRIAL	RESIDENTIAL	FLAT		
4	IN	WASHINGTON	SHOPS	HO	SMALL INDUS.	RESIDENTIAL	FLAT		
4	IN	WATERLOO	TIE-UP TRACK	PC	SMALL INDUS.	INDUSTRIAL	FLAT	I/C	
4	IN	WATSON	WATSON JCT	RD	SMALL INDUS.	INDUSTRIAL	FLAT	I/C	
4	IN	WHITING	TRAIN	EJE	SMALL INDUS.	INDUSTRIAL	FLAT	I/C	
4	IN	WHITING	TRAIN	EJE	SMALL INDUS.	INDUSTRIAL	FLAT	I/C	
4	IN	WHITING	WHITING	IMH	SMALL INDUS.	INDUSTRIAL	FLAT	I/C	
4	IN	WHITING	WHITING	PC	INDUSTRIAL	INDUSTRIAL	FLAT	I/C	
8	IA	AMES	TRAIN	CNW	SMALL INDUS.	RESIDENTIAL	FLAT		
8	IA	ATLANTIC	TRAIN	CRIP	INDUSTRIAL	RESIDENTIAL	FLAT		
8	IA	HIVELY	TRAIN	CNW	CLASS./INDUS.	AGRICULTURAL	FLAT	I/C	
8	IA	RODIE	TRAIN	CNW	INDUSTRIAL	INDUSTRIAL	FLAT		
8	IA	HURLINGTON	TRAIN	GN	CLASS./INDUS.	RESIDENTIAL	FLAT	I/C	
8	IA	HURLINGTON	TRAIN	GN	INDUSTRIAL	INDUSTRIAL	FLAT		
8	IA	CALMAR	TRAIN	CRIP	SMALL INDUS.	RESIDENTIAL	FLAT		
8	IA	CEDAR RAPIDS	TRAIN	CWSPP	INDUSTRIAL	INDUSTRIAL	FLAT	I/C	
8	IA	CEDAR RAPIDS	TRAIN	CWSPP	CLASS./INDUS.	INDUSTRIAL	FLAT	I/C	
8	IA	CEDAR RAPIDS	TRAIN	CRIP	CLASS./INDUS.	INDUSTRIAL	FLAT	I/C	

76/07/08.

REG.	ST.	CITY	YARD	RAIL-ROAD	YARD FUNCTION	LOCATION TYPE	YARD TYPE	I/C	MAJDP YARD IF MULTI-YARD COMPLEX
8	IA	CEDAR RAPIDS	TRAIN	ICG	INDUSTRIAL	INDUSTRIAL	FLAT	I/C	
8	IA	CENTERVILLE	TRAIN	BN	SMALL INDUS*	RESIDENTIAL	FLAT	I/C	
8	IA	CHARLES CITY	TRAIN	IAT	INDUSTRIAL	RESIDENTIAL	FLAT	I/C	
8	IA	CHARLTON	TRAIN	BN	INDUSTRIAL	RESIDENTIAL	FLAT	I/C	
8	IA	CHEPOTAKE	TRAIN	ICG	INDUSTRIAL	RESIDENTIAL	FLAT	I/C	
8	IA	CLARION	TRAIN	CNW	INDUSTRIAL	INDUSTRIAL	FLAT	I/C	
8	IA	CLINTON	TRAIN	CNSPP	INDUSTRIAL	INDUSTRIAL	FLAT	I/C	
8	IA	COLUMBUS JUNCTION	TRAIN	CNW	CLASS./INDUS*	INDUSTRIAL	FLAT	I/C	
8	IA	COUNCIL BLUFFS	TRAIN	CRIP	SMALL INDUS*	RESIDENTIAL	FLAT	I/C	
8	IA	COUNCIL BLUFFS	TRAIN	BN	INDUSTRIAL	COMMERCIAL	FLAT	I/C	
8	IA	COUNCIL BLUFFS	TRAIN	CNSPP	CLASS./INDUS*	INDUSTRIAL	FLAT	I/C	
8	IA	COUNCIL BLUFFS	TRAIN	CNW	CLASS./INDUS*	RESIDENTIAL	FLAT	I/C	
8	IA	COUNCIL BLUFFS	TRAIN	CRIP	CLASS./INDUS*	INDUSTRIAL	FLAT	I/C	
8	IA	COUNCIL BLUFFS	TRAIN	ICG	CLASS./INDUS*	INDUSTRIAL	FLAT	I/C	
8	IA	COUNCIL BLUFFS	EAST/WEST TRAIN	UP	CLASS./INDUS*	INDUSTRIAL	FLAT	I/C	
8	IA	CRESTON	TRAIN	BN	CLASS./INDUS*	INDUSTRIAL	FLAT	I/C	NW C BLUFFS TRAIN
8	IA	DAVENPORT	TRAIN	CNSPP	INDUSTRIAL	INDUSTRIAL	FLAT	I/C	NW C BLUFFS TRAIN
8	IA	DAVENPORT	TRAIN	CRIP	INDUSTRIAL	INDUSTRIAL	FLAT	I/C	
8	IA	DAVENPORT	TRAIN	DRI	SMALL INDUS*	RESIDENTIAL	FLAT	I/C	
8	IA	DES MOINES	TRAIN	BN	INDUSTRIAL	RESIDENTIAL	FLAT	I/C	
8	IA	DES MOINES	BELL AVE.	CNW	CLASS./INDUS*	AGRICULTURAL	FLAT	I/C	
8	IA	DES MOINES	HULL AVE.	CNW	INDUSTRIAL	INDUSTRIAL	FLAT	I/C	BELL AVE.
8	IA	DES MOINES	TRAIN	CNW	INDUSTRIAL	INDUSTRIAL	FLAT	I/C	BELL AVE.
8	IA	DES MOINES	TRAIN	CRIP	CLASS./INDUS*	INDUSTRIAL	FLAT	I/C	
8	IA	DUBUQUE	TRAIN	DNU	CLASS./INDUS*	INDUSTRIAL	FLAT	I/C	
8	IA	DUBUQUE	TRAIN	CNSPP	INDUSTRIAL	INDUSTRIAL	FLAT	I/C	
8	IA	DUBUQUE	TRAIN	CNW	INDUSTRIAL	RESIDENTIAL	FLAT	I/C	
8	IA	DUBUQUE	TRAIN	ICG	INDUSTRIAL	INDUSTRIAL	FLAT	I/C	
8	IA	EAGLE GROVE	TRAIN	ICG	INDUSTRIAL	INDUSTRIAL	FLAT	I/C	
8	IA	EMERY	TRAIN	CNW	INDUSTRIAL	INDUSTRIAL	FLAT	I/C	
8	IA	ESTHERVILLE	TRAIN	IAT	INDUSTRIAL	RESIDENTIAL	FLAT	I/C	
8	IA	FORT DODGE	TRAIN	CRIP	INDUSTRIAL	AGRICULTURAL	FLAT	I/C	
8	IA	FORT DODGE	TRAIN	CRIP	INDUSTRIAL	RESIDENTIAL	FLAT	I/C	
8	IA	FORT DODGE	TRAIN	CNW	INDUSTRIAL	RESIDENTIAL	FLAT	I/C	
8	IA	FORT MADISON	TRAIN	ICG	INDUSTRIAL	INDUSTRIAL	FLAT	I/C	
8	IA	FORT MADISON	SHOPTON DSL TERM	ATSF	CLASS./INDUS*	INDUSTRIAL	FLAT	I/C	
8	IA	IOWA CITY	TRAIN	HN	INDUSTRIAL	COMMERCIAL	FLAT	I/C	
8	IA	IOWA CITY	TRAIN	CIC	INDUSTRIAL	INDUSTRIAL	FLAT	I/C	
8	IA	IOWA CITY	TRAIN	CRIP	INDUSTRIAL	COMMERCIAL	FLAT	I/C	
8	IA	IOWA FALLS	TRAIN	CRIP	SMALL INDUS*	RESIDENTIAL	FLAT	I/C	
8	IA	JEWELL	TRAIN	CNW	INDUSTRIAL	RESIDENTIAL	FLAT	I/C	
8	IA	KEOKUK	TRAIN	BN	CLASS./INDUS*	RESIDENTIAL	FLAT	I/C	
8	IA	KEOKUK	TRAIN	CRIP	INDUSTRIAL	COMMERCIAL	FLAT	I/C	
8	IA	KEOKUK	TRAIN	TPW	INDUSTRIAL	COMMERCIAL	FLAT	I/C	
8	IA	MAHLY	TRAIN	CRIP	CLASS./INDUS*	AGRICULTURAL	FLAT	I/C	
8	IA	MARQUETTE	TRAIN	CNSPP	CLASS./INDUS*	INDUSTRIAL	FLAT	I/C	
8	IA	MARSHALLTOWN	TRAIN	CNW	CLASS./INDUS*	INDUSTRIAL	FLAT	I/C	
8	IA	MASON CITY	TRAIN	CNSPP	CLASS./INDUS*	RESIDENTIAL	FLAT	I/C	
8	IA	MASON CITY	TRAIN	CNW	CLASS./INDUS*	INDUSTRIAL	FLAT	I/C	
8	IA	MASON CITY	TRAIN	CRIP	INDUSTRIAL	RESIDENTIAL	FLAT	I/C	
8	IA	MISSOURI VALLEY	TRAIN	CNW	INDUSTRIAL	RESIDENTIAL	FLAT	I/C	
8	IA	MOULTON	TRAIN	NA	CLASS./INDUS*	RESIDENTIAL	FLAT	I/C	
8	IA	MUSCATINE	TRAIN	CRIP	INDUSTRIAL	RESIDENTIAL	FLAT	I/C	
8	IA	NEWTON	TRAIN	CRIP	INDUSTRIAL	RESIDENTIAL	FLAT	I/C	
8	IA	UJELWEIN	TRAIN	CNW	CLASS./INDUS*	COMMERCIAL	FLAT	I/C	

76/07/04.

REG.	ST.	CITY	YARD	RAIL-ROAD	YARD FUNCTION	LOCATION TYPE	YARD TYPE	I/C	MAJOR YARD IF MULTI-YARD COMPLEX
8	IA	OTTUMWA	TRAIN	UN	CLASS./INDUS.	COMMERCIAL	FLAT	I/C	
8	IA	OTTUMWA	TRAIN	CNSPP	CLASS./INDUS.	INDUSTRIAL	FLAT	I/C	
8	IA	PACIFIC JCT.	TRAIN	UN	CLASS./INDUS.	UNDEVELOPED	FLAT	I/C	
8	IA	PERRY	TRAIN	CASPP	CLASS./INDUS.	INDUSTRIAL	FLAT	I/C	
8	IA	RED OAK	TRAIN	UN	INDUSTRIAL	RESIDENTIAL	FLAT	I/C	
8	IA	SERGEANT BLUFF	TRAIN	CNW	SMALL INDUS.	AGRICULTURAL	FLAT	I/C	
8	IA	SIoux CITY	TRAIN	UN	CLASS./INDUS.	RESIDENTIAL	FLAT	I/C	
8	IA	SIoux CITY	TRAIN	CMSPP	CLASS./INDUS.	RESIDENTIAL	FLAT	I/C	
8	IA	SIoux CITY	TRAIN	CNW	INDUSTRIAL	INDUSTRIAL	FLAT	I/C	
8	IA	SIoux CITY	TRAIN	ICG	SMALL INDUS.	RESIDENTIAL	FLAT	I/C	
8	IA	SPENCER	TRAIN	CNSPP	SMALL INDUS.	RESIDENTIAL	FLAT	I/C	
8	IA	SPIRIT LAKE	TRAIN	CNSPP	SMALL INDUS.	RESIDENTIAL	FLAT	I/C	
8	IA	TAMA	TRAIN	CNW	INDUSTRIAL	RESIDENTIAL	FLAT	I/C	
8	IA	WATERLOO	TRAIN	CNW	SMALL INDUS.	RESIDENTIAL	FLAT	I/C	
8	IA	WATERLOO	TRAIN	CRIP	INDUSTRIAL	RESIDENTIAL	FLAT	I/C	
8	IA	WATERLOO	TRAIN	ICG	CLASS./INDUS.	RESIDENTIAL	FLAT	I/C	
8	KS	AMILENA	ARTIFINE	ATSF	SMALL INDUS.	RESIDENTIAL	FLAT	I/C	
8	KS	ARKANSAS CITY	ARKANSAS CITY	ATSF	CLASS./INDUS.	RESIDENTIAL	FLAT	I/C	
8	KS	ARKANSAS CITY	ARKANSAS CITY	SLSF	SMALL INDUS.	RESIDENTIAL	FLAT	I/C	
8	KS	ATCHEISON	ATCHEISON	ATSF	INDUSTRIAL	INDUSTRIAL	FLAT	I/C	
8	KS	ATCHEISON	ATCHEISON	UN	SMALL INDUS.	UNDEVELOPED	FLAT	I/C	
8	KS	ATCHEISON	ATCHEISON	MP	CLASS./INDUS.	INDUSTRIAL	FLAT	I/C	
8	KS	ATTICA	ATTICA	ATSF	SMALL INDUS.	COMMERCIAL	FLAT	I/C	
8	KS	AUGUSTA	AUGUSTA	ATSF	INDUSTRIAL	RESIDENTIAL	FLAT	I/C	
8	KS	BAXTER SPRINGS	AUGUSTA	ATSF	INDUSTRIAL	INDUSTRIAL	FLAT	I/C	
8	KS	BELLEVILLE	TRAIN	SLSF	INDUSTRIAL	INDUSTRIAL	FLAT	I/C	
8	KS	CHANUTE	TRAIN	CRIP	CLASS./INDUS.	INDUSTRIAL	FLAT	I/C	
8	KS	COFFEYVILLE	TRAIN	ATSF	CLASS./INDUS.	INDUSTRIAL	FLAT	I/C	
8	KS	COFFEYVILLE	TRAIN	ATSF	INDUSTRIAL	RESIDENTIAL	FLAT	I/C	
8	KS	COFFEYVILLE	TRAIN	MKT	SMALL INDUS.	INDUSTRIAL	FLAT	I/C	
8	KS	COLUMBUS	TRAIN	SLSF	CLASS./INDUS.	INDUSTRIAL	FLAT	I/C	
8	KS	CONCORDIA	CONCORDIA	ATSF	INDUSTRIAL	COMMERCIAL	FLAT	I/C	
8	KS	CONCORDIA	CONCORDIA	ATSF	INDUSTRIAL	COMMERCIAL	FLAT	I/C	
8	KS	CONWAY SPRINGS	CONWAY SPRINGS	MP	SMALL INDUS.	COMMERCIAL	FLAT	I/C	
8	KS	DODGE CITY	DODGE CITY	ATSF	CLASS./INDUS.	COMMERCIAL	FLAT	I/C	
8	KS	DURAND	TRAIN	MP	SMALL INDUS.	UNDEVELOPED	FLAT	I/C	
8	KS	EAST EL DORADO	EAST EL DORADO	MP	INDUSTRIAL	AGRICULTURAL	FLAT	I/C	
8	KS	EL DORADO	EL DORADO	ATSF	SMALL INDUS.	UNDEVELOPED	FLAT	I/C	
8	KS	EMPIRIA	EMPIRIA	ATSF	CLASS./INDUS.	RESIDENTIAL	FLAT	I/C	
8	KS	FORT SCOTT	TRAIN	SLSF	SMALL INDUS.	INDUSTRIAL	FLAT	I/C	
8	KS	FREDONA	TRAIN	MP	INDUSTRIAL	INDUSTRIAL	FLAT	I/C	
8	KS	GARDEN CITY	GARDEN CITY	ATSF	SMALL INDUS.	COMMERCIAL	FLAT	I/C	
8	KS	GARDEN CITY	GARDEN CITY	SCW	SMALL INDUS.	AGRICULTURAL	FLAT	I/C	
8	KS	GENESE	GENESE	MP	SMALL INDUS.	RESIDENTIAL	FLAT	I/C	
8	KS	GOJDLAND	TRAIN	CRIP	INDUSTRIAL	RESIDENTIAL	FLAT	I/C	
8	KS	GREAT BEND	GREAT BEND	ATSF	SMALL INDUS.	COMMERCIAL	FLAT	I/C	
8	KS	HERINGTON	HERINGTON	COIP	CLASS./INDUS.	UNDEVELOPED	FLAT	I/C	
8	KS	HULSTINGTON	HULSTINGTON	MP	INDUSTRIAL	COMMERCIAL	FLAT	I/C	
8	KS	HUTCHINSON	WAY	ATSF	CLASS./INDUS.	INDUSTRIAL	FLAT	I/C	
8	KS	HUTCHINSON	HUTCHINSON	CRIP	CLASS./INDUS.	INDUSTRIAL	FLAT	I/C	
8	KS	HUTCHINSON	HUTCHINSON	UN	SMALL INDUS.	COMMERCIAL	FLAT	I/C	
8	KS	HUTCHINSON	HUTCHINSON	MP	SMALL INDUS.	COMMERCIAL	FLAT	I/C	

76/07/06

REG.	ST.	CITY	YARD	RAIL-ROAD	YARD-FUNCTION	LOCATION TYPE	YARD TYPE	I/C	MAJOR YARD IF MULTI-YARD COMPLEX
8	KS	KANSAS CITY	E-B. ARGENTINE	ATSF	CLASS./INDUS.	COMMERCIAL	HUMP	I/C	
8	KS	KANSAS CITY	W-9. ARGENTINE	ATSF	CLASS./INDUS.	COMMERCIAL	HUMP	I/C	
8	KS	KANSAS CITY	ARMOURDALE	CRIP	CLASS./INDUS.	INDUSTRIAL	FLAT	I/C	
8	KS	KANSAS CITY	TRAIN	WKT	CLASS./INDUS.	UNDEVELOPED	FLAT	I/C	ARMSTRONG TRAIN
8	KS	KANSAS CITY	ARMSTRONG TRAIN	UP	INDUSTRIAL	INDUSTRIAL	FLAT	I/C	ARMSTRONG TRAIN
8	KS	KANSAS CITY	FAIRFAX	UP	INDUSTRIAL	COMMERCIAL	FLAT	I/C	
8	KS	KIOWA	KIOWA	ATSF	SMALL INDUS.	COMMERCIAL	FLAT	I/C	
8	KS	LAWRENCE	LAWRENCE	ATSF	SMALL INDUS.	RESIDENTIAL	FLAT	I/C	
8	KS	LAWRENCE	LAWRENCE	UP	INDUSTRIAL	COMMERCIAL	FLAT	I/C	
8	KS	LEAVENWORTH	LEAVENWORTH	BN	INDUSTRIAL	COMMERCIAL	FLAT	I/C	
8	KS	LIBERAL	LIBERAL	CRIP	INDUSTRIAL	RESIDENTIAL	FLAT	I/C	
8	KS	LYONS	LYONS	ATSF	SMALL INDUS.	RESIDENTIAL	FLAT	I/C	
8	KS	MARYSVILLE	TRAIN	UP	CLASS./INDUS.	RESIDENTIAL	FLAT	I/C	
8	KS	MC PHERSON	MC PHERSON	ATSF	SMALL INDUS.	RESIDENTIAL	FLAT	I/C	
8	KS	MC PHERSON	MC PHERSON	CRIP	SMALL INDUS.	RESIDENTIAL	FLAT	I/C	
8	KS	MOLINE	MOLINE	ATSF	SMALL INDUS.	UNDEVELOPED	FLAT	I/C	
8	KS	NEDDESHA	TRAIN	SLSF	INDUSTRIAL	COMMERCIAL	FLAT	I/C	
8	KS	NEWTON	NEWTON	ATSF	CLASS./INDUS.	AGRICULTURAL	FLAT	I/C	
8	KS	OAKLEY	OAKLEY	UP	SMALL INDUS.	COMMERCIAL	FLAT	I/C	
8	KS	OAKLEY	OAKLEY	BN	SMALL INDUS.	RESIDENTIAL	FLAT	I/C	
8	KS	OLATHE	OLATHE	ATSF	SMALL INDUS.	RESIDENTIAL	FLAT	I/C	
8	KS	OSBORNE	OSBORNE	ATSF	SMALL INDUS.	RESIDENTIAL	FLAT	I/C	
8	KS	PARSONS	TRAIN	WKT	CLASS./INDUS.	INDUSTRIAL	FLAT	I/C	
8	KS	PHILLIPSBURG	TRAIN	CRIP	SMALL INDUS.	INDUSTRIAL	FLAT	I/C	
8	KS	PITTSBURG	TRAIN	KCS	CLASS./INDUS.	RESIDENTIAL	FLAT	I/C	
8	KS	PITTSBURG	TRAIN	SLSF	INDUSTRIAL	INDUSTRIAL	FLAT	I/C	
8	KS	PLAINVILLE	PLAINVILLE	UP	SMALL INDUS.	RESIDENTIAL	FLAT	I/C	
8	KS	SALINA	SALINA	ATSF	INDUSTRIAL	RESIDENTIAL	FLAT	I/C	
8	KS	SALINA	SALINA	MP	INDUSTRIAL	RESIDENTIAL	FLAT	I/C	
8	KS	SALINA	SALINA	UP	INDUSTRIAL	COMMERCIAL	FLAT	I/C	
8	KS	SATANTA	SATANTA	ATSF	SMALL INDUS.	RESIDENTIAL	FLAT	I/C	
8	KS	SCOTT CITY	SCOTT CITY	ATSF	SMALL INDUS.	RESIDENTIAL	FLAT	I/C	
8	KS	TOPEKA	TOPEKA	ATSF	SMALL INDUS.	AGRICULTURAL	FLAT	I/C	
8	KS	TOPEKA	TOPEKA	CRIP	CLASS./INDUS.	COMMERCIAL	FLAT	I/C	
8	KS	TOPEKA	TOPEKA	UP	INDUSTRIAL	INDUSTRIAL	FLAT	I/C	
8	KS	WELLINGTON	WELLINGTON	ATSF	CLASS./INDUS.	RESIDENTIAL	FLAT	I/C	
8	KS	WICHITA	WICHITA	ATSF	CLASS./INDUS.	COMMERCIAL	FLAT	I/C	
8	KS	WICHITA	CLINE	CRIP	CLASS./INDUS.	INDUSTRIAL	FLAT	I/C	
8	KS	WICHITA	WICHITA	MP	CLASS./INDUS.	COMMERCIAL	FLAT	I/C	
8	KS	WICHITA	NORTH WICHITA	SLSF	CLASS./INDUS.	INDUSTRIAL	FLAT	I/C	
8	KS	WICHITA	STOCK	WTA	SMALL INDUS.	INDUSTRIAL	FLAT	I/C	
8	KS	WINFIELD	WINFIELD	ATSF	CLASS./INDUS.	UNDEVELOPED	FLAT	I/C	
3	KY	ASHLAND	5TH STREET	CO	INDUSTRIAL	RESIDENTIAL	FLAT		24TH STREET
3	KY	ASHLAND	13TH STREET	CO	INDUSTRIAL	RESIDENTIAL	FLAT		24TH STREET
3	KY	ASHLAND	24TH STREET	CO	CLASS./INDUS.	RESIDENTIAL	FLAT		24TH STREET
3	KY	BADGERTT	TVA	ICG	SMALL INDUS.	UNDEVELOPED	FLAT		
3	KY	HURLING GREFN	TRAIN	LN	INDUSTRIAL	RESIDENTIAL	FLAT		
3	KY	CADIZ	CADIZ	CAD	SMALL INDUS.	RESIDENTIAL	FLAT		
3	KY	CARRLTON	CARRLTON	CARR	SMALL INDUS.	RESIDENTIAL	FLAT		
3	KY	CENTRAL CITY	TRAIN	ICG	CLASS./INDUS.	UNDEVELOPED	FLAT		
3	KY	CHAD	CHAD	LN	SMALL INDUS.	RESIDENTIAL	FLAT		
3	KY	CHILES	TVA	BN	SMALL INDUS.	UNDEVELOPED	FLAT		
3	KY	CHILDS	TRAIN	ICG	SMALL INDUS.	UNDEVELOPED	FLAT		

7/6/07/34

REG.	ST.	CITY	YARD	RAIL-ROAD	YARD FUNCTION	LOCATION TYPE	YARD TYPE	I/C	MAJOR YARD, IF MULTI-YARD COMPLEX
3	KY	CLEARFIELD	CLEARFIELD	CLEAR	SMALL INDUS.	RESIDENTIAL	FLAT		
3	KY	CORBIN	14TH STREET	CJ	SMALL INDUS.	COMMERCIAL	FLAT	I/C	
3	KY	COWINGTON	CORBIN	LN	CLASS./INDUS.	UNDEVELOPED	FLAT	I/C	
3	KY	CRAWFORD	HOIDE	LN	SMALL INDUS.	RESIDENTIAL	FLAT		
3	KY	DANVILLE	TRAIN	LN	SMALL INDUS.	RESIDENTIAL	FLAT		
3	KY	DE COURSEY	DE COURSEY	SOU	CLASS./INDUS.	UNDEVELOPED	HUMP		
3	KY	ELKHORN CITY	FLKORN	LN	SMALL INDUS.	RESIDENTIAL	FLAT		
3	KY	ELKHORN CITY	FLKORN	CCO	SMALL INDUS.	RESIDENTIAL	FLAT		
3	KY	ERLANGER	ERLANGER	SOU	SMALL INDUS.	RESIDENTIAL	FLAT		
3	KY	FULTON	TRAIN	ICG	CLASSIFICATION	RESIDENTIAL	FLAT		
3	KY	HAZARD	HAZARD	LN	INDUSTRIAL	INDUSTRIAL	FLAT		
3	KY	HOPKINSVILLE	TRAIN	ICG	INDUSTRIAL	RESIDENTIAL	FLAT		
3	KY	HYLTON	PIKE WINE 26	LN	SMALL INDUS.	UNDEVELOPED	FLAT		
3	KY	JENKINS	JENKINS	CO	SMALL INDUS.	AGRICULTURAL	FLAT		
3	KY	LATONIA	LATONIA	LN	SMALL INDUS.	RESIDENTIAL	FLAT		
3	KY	LEXINGTON	NETZLAND	LN	CLASS./INDUS.	COMMERCIAL	FLAT	I/C	
3	KY	LEXINGTON	LEXINGTON	LN	INDUSTRIAL	COMMERCIAL	FLAT	I/C	
3	KY	LEXINGTON	LEXINGTON	SOU	INDUSTRIAL	COMMERCIAL	FLAT	I/C	
3	KY	LOUISVILLE	CANE RUN	LN	SMALL INDUS.	COMMERCIAL	FLAT		
3	KY	LOUISVILLE	FLOYD ST.	ICG	INDUSTRIAL	COMMERCIAL	FLAT		
3	KY	LOUISVILLE	MALBACK	ICG	INDUSTRIAL	COMMERCIAL	FLAT		PAK ST.
3	KY	LOUISVILLE	OAK ST.	ICG	CLASS./INDUS.	COMMERCIAL	FLAT	I/C	PAK ST.
3	KY	LOUISVILLE	PRESTON ST.	ICG	INDUSTRIAL	COMMERCIAL	FLAT	I/C	PAK ST.
3	KY	LOUISVILLE	K	KIT	CLASSIFICATION	COMMERCIAL	FLAT		
3	KY	LOUISVILLE	L	LN	INDUSTRIAL	COMMERCIAL	FLAT		
3	KY	LOUISVILLE	YOUNGTOWN	KIT	INDUSTRIAL	COMMERCIAL	FLAT		
3	KY	LOUISVILLE	E. LOUISVILLE	LN	CLASS./INDUS.	COMMERCIAL	FLAT		
3	KY	LOUISVILLE	KNAPP ST.	LN	INDUSTRIAL	COMMERCIAL	FLAT		
3	KY	LOUISVILLE	MAPTHER	LN	INDUSTRIAL	COMMERCIAL	FLAT		
3	KY	LOUISVILLE	OAK STREET	LN	INDUSTRIAL	RESIDENTIAL	FLAT		
3	KY	LOUISVILLE	SO LOUISVILLE	LN	INDUSTRIAL	COMMERCIAL	FLAT		
3	KY	LOUISVILLE	STRAWBERRY	LN	CLASS./INDUS.	UNDEVELOPED	FLAT		STRAWBERRY
3	KY	LOUISVILLE	UNION STATION	LN	CLASS./INDUS.	UNDEVELOPED	FLAT		STRAWBERRY
3	KY	LOUISVILLE	WASER STREET	LN	INDUSTRIAL	COMMERCIAL	FLAT		
3	KY	LOUISVILLE	14TH STREET	PC	SMALL INDUS.	COMMERCIAL	FLAT		
3	KY	LOUISVILLE	MAPLE ST.	PC	SMALL INDUS.	COMMERCIAL	FLAT		
3	KY	LOUISVILLE	PRESTON ST.	LN	SMALL INDUS.	COMMERCIAL	FLAT		
3	KY	LOUISVILLE	APPLIANCE PK	SOU	INDUSTRIAL	COMMERCIAL	FLAT		
3	KY	LOUISVILLE	LOYALL	LN	CLASSIFICATION	UNDEVELOPED	FLAT		
3	KY	MADISONVILLE	ATKINSON	LN	CLASSIFICATION	UNDEVELOPED	FLAT		ATKINSON
3	KY	MADISONVILLE	WEST	LN	INDUSTRIAL	UNDEVELOPED	FLAT		ATKINSON
3	KY	MARTIN	MARTIN	CO	SMALL INDUS.	AGRICULTURAL	FLAT		
3	KY	MAYSVILLE	MAYSVILLE	LN	SMALL INDUS.	AGRICULTURAL	FLAT		
3	KY	MIDDLEBORO	MIDDLEBORO	CO	SMALL INDUS.	AGRICULTURAL	FLAT		
3	KY	MIDDLEBORO	MIDDLEBORO	SOU	SMALL INDUS.	AGRICULTURAL	FLAT		
3	KY	PHANNON	PHANNON	LN	SMALL INDUS.	AGRICULTURAL	FLAT		
3	KY	OLIVE HILL	OLIVE HILL	CO	SMALL INDUS.	AGRICULTURAL	FLAT		
3	KY	OWENSBORO	DWYLE	ICG	SMALL INDUS.	UNDEVELOPED	FLAT		
3	KY	OWENSBORO	OWENSBORO	ICG	INDUSTRIAL	UNDEVELOPED	FLAT		
3	KY	OWENSBORO	OWENSBORO	LN	INDUSTRIAL	UNDEVELOPED	FLAT		
3	KY	PADUCAH	PADUCAH	ICG	CLASS./INDUS.	INDUSTRIAL	FLAT		
3	KY	PADUCAH	TRAIN	LN	INDUSTRIAL	COMMERCIAL	FLAT		

76/07/08.

REG.	ST.	CITY	YARD	RAIL-ROAD	YARD FUNCTION	LOCATION TYPE	YARD TYPE	I/C	MAJOR YARD IF MULTI-YARD COMPLEX
3	KY	PAINTSVILLE	PAINTSVILLE	CO	INDUSTRIAL	RESIDENTIAL	FLAT		
3	KY	PARIS	PARIS	LN	SMALL INDUS.	RESIDENTIAL	FLAT		
3	KY	PRESTONBERG	PRESTONBERG	LN	SMALL INDUS.	AGRICULTURAL	FLAT		
3	KY	PRINCETON	TRAIN	ICG	CLASSIFICATION	UNDEVELOPED	FLAT		
3	KY	RAVENA	RAVENA	LN	INDUSTRIAL	RESIDENTIAL	FLAT		
3	KY	RUSSELL	COAL CLASS	CO	INDUSTRIAL	UNDEVELOPED	HUMP		WESTBOUND
3	KY	RUSSELL	WESTBOUND	CO	SMALL INDUS.	UNDEVELOPED	FLAT		WESTBOUND
3	KY	RUSSELLVILLE	TRAIN	LN	INDUSTRIAL	RESIDENTIAL	FLAT		
3	KY	SHELBY	SHELBY	CO	SMALL INDUS.	RESIDENTIAL	FLAT		
3	KY	SILVER	N.J. CABIN	CO	SMALL INDUS.	UNDEVELOPED	FLAT		
3	KY	SILVER GROVE	STEWENS	CU	INDUSTRIAL	UNDEVELOPED	HUMP		
3	KY	SOMERSET	SOMERSET	SOU	INDUSTRIAL	RESIDENTIAL	FLAT		
3	KY	STEARNS	TRAIN	KIT	SMALL INDUS.	AGRICULTURAL	FLAT	I/C	
3	KY	STEARNS	TRAIN	SOU	INDUSTRIAL	RESIDENTIAL	FLAT	I/C	
3	KY	WINNS	WINNS	CO	SMALL INDUS.	RESIDENTIAL	FLAT		
5	LA	ADDIS	TRAIN	TP	CLASS./INDUS.	AGRICULTURAL	FLAT		
5	LA	ALEXANDRIA	TRAIN	CRIP	SMALL INDUS.	RESIDENTIAL	FLAT	I/C	
5	LA	ALEXANDRIA	ALEXANDRIA	KCS	INDUSTRIAL	COMMERCIAL	FLAT	I/C	
5	LA	ALEXANDRIA	TRAIN	LA	SMALL INDUS.	RESIDENTIAL	FLAT	I/C	
5	LA	ALEXANDRIA	TRAIN	MP	SMALL INDUS.	COMMERCIAL	FLAT	I/C	
5	LA	ALEXANDRIA	TRAIN	SP	SMALL INDUS.	RESIDENTIAL	FLAT	I/C	
5	LA	ALGIER	ALEXANDRIA	TP	CLASS./INDUS.	INDUSTRIAL	FLAT	I/C	
5	LA	ANCHORAGE	ALGIER	NLC	SMALL INDUS.	RESIDENTIAL	FLAT		
5	LA	AVONDALE	AVONDALE	MP	SMALL INDUS.	COMMERCIAL	FLAT	I/C	
5	LA	AVONDALE	AVONDALE	SP	CLASS./INDUS.	UNDEVELOPED	FLAT	I/C	
5	LA	BALDWIN	TRAIN	TP	SMALL INDUS.	UNDEVELOPED	FLAT	I/C	
5	LA	BASTROP	TRAIN	ALW	SMALL INDUS.	INDUSTRIAL	FLAT	I/C	
5	LA	BASTROP	TRAIN	MP	SMALL INDUS.	INDUSTRIAL	FLAT	I/C	
5	LA	BATON ROUGE	NORTH	ICG	SMALL INDUS.	INDUSTRIAL	FLAT	I/C	
5	LA	BATON ROUGE	BATON ROUGE	KCS	CLASS./INDUS.	INDUSTRIAL	FLAT	I/C	
5	LA	BATON ROUGE	NORTH	LA	CLASS./INDUS.	INDUSTRIAL	FLAT	I/C	
5	LA	BOKALUSA	SOUTH	ICG	SMALL INDUS.	INDUSTRIAL	FLAT	I/C	
5	LA	BUNKIE	BUNKIE	TP	SMALL INDUS.	COMMERCIAL	FLAT		
5	LA	CHALMETTE	CHALMETTE	SOU	INDUSTRIAL	INDUSTRIAL	FLAT	I/C	
5	LA	DE QUINCY	TRAIN	KCS	SMALL INDUS.	INDUSTRIAL	FLAT	I/C	
5	LA	DE QUINCY	TRAIN	MP	SMALL INDUS.	INDUSTRIAL	FLAT	I/C	
5	LA	DE STREHAN	DE STREHAN	ICG	SMALL INDUS.	INDUSTRIAL	FLAT		
5	LA	DONALDSONVILLE	DONALDSONVILLE	TP	SMALL INDUS.	COMMERCIAL	FLAT	I/C	
5	LA	EUNICE	STORAGE	MP	SMALL INDUS.	INDUSTRIAL	FLAT		
5	LA	EUNICE	TRAIN	SP	SMALL INDUS.	COMMERCIAL	FLAT	I/C	
5	LA	FERRIAY	TRAIN	VP	SMALL INDUS.	INDUSTRIAL	FLAT	I/C	
5	LA	GETSWAR	HELLE HELENE	ICG	CLASS./INDUS.	UNDEVELOPED	HUMP		
5	LA	GIBSLAND	TRAIN	LNW	SMALL INDUS.	COMMERCIAL	FLAT	I/C	
5	LA	GIBSLAND	TRAIN	NLG	SMALL INDUS.	COMMERCIAL	FLAT	I/C	
5	LA	GODDMOPE	GODDMOPE	ICG	SMALL INDUS.	INDUSTRIAL	FLAT		
5	LA	GRAMERCY	GRAMERCY	KCS	SMALL INDUS.	INDUSTRIAL	FLAT		
5	LA	GRETNA	GRETNA	SP	SMALL INDUS.	COMMERCIAL	FLAT		
5	LA	HAMMOND	HAMMOND	ICG	SMALL INDUS.	INDUSTRIAL	FLAT		
5	LA	HARAHAN	HARAHAN	ICG	CLASS./INDUS.	INDUSTRIAL	FLAT		
5	LA	HODGE	TRAIN	CRIP	SMALL INDUS.	INDUSTRIAL	FLAT	I/C	
5	LA	HODGE	TRAIN	NLG	SMALL INDUS.	INDUSTRIAL	FLAT	I/C	

76/07/CR

REG.	ST.	CITY	YARD	RAIL- ROAD	YARD FUNCTION	LOCATION TYPE	YARD TYPE	I/C	MAJOR YARD IF MULTI-YARD COMPLEX
5	LA	JENA	JENA	ICG	SMALL INDUS.	COMMERCIAL	FLAT		
5	LA	KINDER	TRAIN	NP	SMALL INDUS.	COMMERCIAL	FLAT		
5	LA	LAFAYETTE	TRAIN	SP	CLASS./INDUS.	COMMERCIAL	FLAT		
5	LA	LAKE CHARLES	TRAIN	KCS	INDUSTRIAL	RESIDENTIAL	FLAT	I/C	
5	LA	LAKE CHARLES	LAKE CHARLES	NP	INDUSTRIAL	RESIDENTIAL	FLAT	I/C	
5	LA	LAKE CHARLES	TRAIN	SP	CLASS./INDUS.	INDUSTRIAL	FLAT	I/C	
5	LA	LEFESVILLE	LEFESVILLE	KCS	INDUSTRIAL	INDUSTRIAL	FLAT	I/C	
5	LA	MINDEN	MINDEN	KCS	INDUSTRIAL	COMMERCIAL	FLAT		
5	LA	MINDEN	TRAIN	LA	INDUSTRIAL	COMMERCIAL	FLAT		
5	LA	MONROE	TRAIN	ALM	INDUSTRIAL	COMMERCIAL	FLAT		
5	LA	MONROE	TRAIN	ICG	CLASS./INDUS.	COMMERCIAL	FLAT	I/C	
5	LA	MONROE	TRAIN	AP	INDUSTRIAL	RESIDENTIAL	FLAT	I/C	
5	LA	MORGAN CITY	CITY	SP	INDUSTRIAL	RESIDENTIAL	FLAT		
5	LA	NEW IBERIA	TRAIN	NP	INDUSTRIAL	UNDEVELOPED	FLAT	I/C	
5	LA	NEW IBERIA	TRAIN	SP	INDUSTRIAL	RESIDENTIAL	FLAT	I/C	
5	LA	NEW ORLEANS	CANAL	ICG	SMALL INDUS.	INDUSTRIAL	FLAT	I/C	
5	LA	NEW ORLEANS	HARAHAN	ICG	SMALL INDUS.	INDUSTRIAL	FLAT		
5	LA	NEW ORLEANS	MAYS	ICG	CLASS./INDUS.	COMMERCIAL	FLAT		MAYS
5	LA	NEW ORLEANS	PUYDRAS	ICG	INDUSTRIAL	COMMERCIAL	FLAT		MAYS
5	LA	NEW ORLEANS	WEST	ICG	INDUSTRIAL	INDUSTRIAL	FLAT	I/C	MAYS
5	LA	NEW ORLEANS	WESTVESANT DRCKS	LA	CLASS./INDUS.	UNDEVELOPED	FLAT		
5	LA	NEW ORLEANS	GENTILLY	LN	SMALL INDUS.	INDUSTRIAL	FLAT	I/C	
5	LA	NEW ORLEANS	CHALMETTE	LSD	INDUSTRIAL	INDUSTRIAL	FLAT	I/C	
5	LA	NEW ORLEANS	BELF CHASSE	NLC	INDUSTRIAL	INDUSTRIAL	FLAT	I/C	
5	LA	NEW ORLEANS	CLATBORNE	NDPB	SMALL INDUS.	INDUSTRIAL	FLAT	I/C	CLATBORNE
5	LA	NEW ORLEANS	COTTON WHSE	NDPB	SMALL INDUS.	INDUSTRIAL	FLAT	I/C	CLATBORNE
5	LA	NEW ORLEANS	FRANCE	NDPB	SMALL INDUS.	INDUSTRIAL	FLAT	I/C	CLATBORNE
5	LA	NEW ORLEANS	PAULINE	NDPB	SMALL INDUS.	INDUSTRIAL	FLAT	I/C	CLATBORNE
5	LA	NEW ORLEANS	RACE	NDPB	SMALL INDUS.	INDUSTRIAL	FLAT		CLATBORNE
5	LA	NEW ORLEANS	HAZIN	SOU	SMALL INDUS.	INDUSTRIAL	FLAT		CLATBORNE
5	LA	NEW ORLEANS	BERNARDITTE	SOU	SMALL INDUS.	INDUSTRIAL	FLAT		CLATBORNE
5	LA	NEW ORLEANS	OLIVES	SOU	SMALL INDUS.	INDUSTRIAL	FLAT		CLATBORNE
5	LA	NEW ORLEANS	POBIN	SOU	CLASS./INDUS.	INDUSTRIAL	FLAT		CLATBORNE
5	LA	NEW ORLEANS	AVONDALE	SP	SMALL INDUS.	INDUSTRIAL	FLAT		CLATBORNE
5	LA	NEW ORLEANS	AVONDALE	TRMP	CLASSIFICATION	INDUSTRIAL	FLAT	I/C	CLATBORNE
5	LA	NEW ORLEANS	RACE	TRMP	INDUSTRIAL	INDUSTRIAL	FLAT	I/C	CLATBORNE
5	LA	NEW ORLEANS	WESTWEGC	TRMP	SMALL INDUS.	INDUSTRIAL	FLAT		CLATBORNE
5	LA	NEW ORLEANS	TRAIN	WP	SMALL INDUS.	INDUSTRIAL	FLAT		CLATBORNE
5	LA	NEW ORLEANS	RACELAND	SP	SMALL INDUS.	COMMERCIAL	FLAT		CLATBORNE
5	LA	NEW ORLEANS	RESERVE	ICG	SMALL INDUS.	INDUSTRIAL	FLAT		CLATBORNE
5	LA	NEW ORLEANS	CITY	SP	SMALL INDUS.	INDUSTRIAL	FLAT		CLATBORNE
5	LA	SHREVEPORT	UNDESIED CITY	ICG	CLASS./INDUS.	INDUSTRIAL	FLAT	I/C	ROSSIER CITY
5	LA	SHREVEPORT	JUNCTION	ICG	INDUSTRIAL	COMMERCIAL	FLAT		ROSSIER CITY
5	LA	SHREVEPORT	MARKET STREET	ICG	INDUSTRIAL	COMMERCIAL	FLAT		ROSSIER CITY
5	LA	SHREVEPORT	CFDAR GROVE	KCS	SMALL INDUS.	COMMERCIAL	FLAT		DEBAMUS
5	LA	SHREVEPORT	CITY	KCS	SMALL INDUS.	COMMERCIAL	FLAT		DEBAMUS
5	LA	SHREVEPORT	DEBAMUS	KCS	CLASS./INDUS.	UNDEVELOPED	FLAT		DEBAMUS
5	LA	SHREVEPORT	HARRIET STREET	KCS	SMALL INDUS.	COMMERCIAL	FLAT		DEBAMUS
5	LA	SHREVEPORT	DUSSIER	SSW	INDUSTRIAL	COMMERCIAL	FLAT		DEBAMUS
5	LA	SHREVEPORT	TRAIN	TP	CLASS./INDUS.	COMMERCIAL	FLAT		DEBAMUS
5	LA	SHREVEPORT	HOLLYWOOD	TP	INDUSTRIAL	RESIDENTIAL	FLAT	I/C	
5	LA	SHREVEPORT	CULLEN	KCS	INDUSTRIAL	INDUSTRIAL	FLAT		
5	LA	SHREVEPORT	CULLEN	LA	SMALL INDUS.	INDUSTRIAL	FLAT		
5	LA	SHREVEPORT	INDUSTRIAL	NP	SMALL INDUS.	INDUSTRIAL	FLAT		

76/07/03

REG.	ST.	CITY	YARD	RAIL-ROAD	YARD FUNCTION	LOCATION TYPE	YARD TYPE	I/C	MAJOR YARD TYPE MULTI-YARD COMPLEX
5	LA	VIDALIA	TRAIN	MP	SMALL INDUS.	INDUSTRIAL	FLAT		
5	LA	WESTLAK	ROSE HUFF	KCS	INDUSTRIAL	UNDEVELOPED	FLAT	1/C	
5	LA	WINNFELD	WINNFELD	CRIP	SMALL INDUS.	COMMERCIAL	FLAT	1/C	
5	LA	WINNFELD	CITY	ICG	SMALL INDUS.	INDUSTRIAL	FLAT	1/C	
5	LA	WINNFELD	WINNFELD	KCS	SMALL INDUS.	COMMERCIAL	FLAT	1/C	
5	LA	WINNFELD	WINNFELD	LA	INDUSTRIAL	COMMERCIAL	FLAT	1/C	
5	LA	ZEE PAPER MILL	SERVING	ICG	SMALL INDUS.	INDUSTRIAL	FLAT		
1	MC	AUGUSTA	AUGUSTA	MFC	SMALL INDUS.	COMMERCIAL	FLAT	1/C	
1	ME	BANGOR	NO. MAINE JCT.	HAR	CLASSIFICATION	UNDEVELOPED	FLAT		
1	ME	BANGOR	BANGOR	MFC	CLASS./INDUS.	COMMERCIAL	FLAT	1/C	
1	ME	BELFAST	BELFAST	RML	INDUSTRIAL	INDUSTRIAL	FLAT		
1	ME	BRUNSWICK	BRUNSWICK	MFC	SMALL INDUS.	COMMERCIAL	FLAT		
1	ME	BUCKSPORT	BUCKSPORT	MFC	INDUSTRIAL	INDUSTRIAL	FLAT		
1	ME	HOULTON	HOULTON	HAR	INDUSTRIAL	COMMERCIAL	FLAT		
1	ME	RILEYS	RILEYS	MFC	INDUSTRIAL	COMMERCIAL	FLAT		
1	ME	LIVERMORE FALLS	MILLINOCKET	HAR	CLASS./INDUS.	RESIDENTIAL	FLAT		
1	ME	MILLINOCKET	DAKFIELD	BAR	CLASS./INDUS.	UNDEVELOPED	FLAT		
1	ME	PORTLAND	PORTLAND	BAR	INDUSTRIAL	COMMERCIAL	FLAT	1/C	
1	ME	PORTLAND	YARD B	PTM	INDUSTRIAL	COMMERCIAL	FLAT	1/C	
1	ME	PRESCOTT ISL	PRESCOTT ISLE	AVL	SMALL INDUS.	COMMERCIAL	FLAT		
1	ME	SEAFORD	SEAFORD	MFC	SMALL INDUS.	INDUSTRIAL	FLAT		
1	ME	SOUTH PORTLAND	RUMFORD	HAR	SMALL INDUS.	UNDEVELOPED	FLAT	1/C	
1	ME	RIGBY	RIGBY	PTM	CLASS./INDUS.	COMMERCIAL	FLAT	1/C	
1	ME	VAN BUREN	VAN BUREN	BAR	INDUSTRIAL	COMMERCIAL	FLAT	1/C	
1	ME	VANCEBORO	VANCEBORO	MFC	SMALL INDUS.	UNDEVELOPED	FLAT	1/C	
1	ME	WATERVILLE	WATERVILLE	MFC	CLASS./INDUS.	COMMERCIAL	FLAT		
2	MD	BALTIMORE	BAVVIEW	BO	CLASS./INDUS.	INDUSTRIAL	FLAT	1/C	
2	MD	BALTIMORE	CURTIS BAY	BO	CLASSIFICATION	INDUSTRIAL	HUMP		
2	MD	BALTIMORE	HAWKIN PT.	BO	SMALL INDUS.	INDUSTRIAL	FLAT		
2	MD	BALTIMORE	JONES STREET	BO	INDUSTRIAL	INDUSTRIAL	FLAT		
2	MD	BALTIMORE	LOCUST PT.	BO	CLASS./INDUS.	INDUSTRIAL	FLAT		
2	MD	BALTIMORE	MT. CLARE	BO	CLASS./INDUS.	INDUSTRIAL	FLAT	1/C	
2	MD	BALTIMORE	PIVERSIDE	BO	CLASS./INDUS.	INDUSTRIAL	FLAT		
2	MD	BALTIMORE	SEASALL	BO	INDUSTRIAL	INDUSTRIAL	FLAT		
2	MD	BALTIMORE	WICRICO	BO	SMALL INDUS.	COMMERCIAL	FLAT		
2	MD	BALTIMORE	CLINTON STREET	CTN	INDUSTRIAL	INDUSTRIAL	FLAT	1/C	
2	MD	BALTIMORE	SAYVIEW	PC	CLASS./INDUS.	INDUSTRIAL	FLAT	1/C	
2	MD	BALTIMORE	CANTON	PC	CLASS./INDUS.	INDUSTRIAL	FLAT	1/C	
2	MD	BALTIMORE	FIFTH AVE	PC	INDUSTRIAL	INDUSTRIAL	FLAT	1/C	
2	MD	BALTIMORE	GRYNNIS RUN	PC	INDUSTRIAL	COMMERCIAL	FLAT	1/C	
2	MD	BALTIMORE	HOLABIRD	PC	INDUSTRIAL	INDUSTRIAL	FLAT	1/C	
2	MD	BALTIMORE	MT. VERNON	PC	INDUSTRIAL	COMMERCIAL	FLAT	1/C	
2	MD	BALTIMORE	FERRY HAR	WM	CLASSIFICATION	INDUSTRIAL	FLAT		
2	MD	BALTIMORE	LEIGH	WM	INDUSTRIAL	COMMERCIAL	FLAT	1/C	
2	MD	BALTIMORE	PT. COVINGTON	WM	CLASS./INDUS.	INDUSTRIAL	FLAT		
2	MD	BUNSWICK	TRAIN	WM	SMALL INDUS.	RESIDENTIAL	FLAT		
2	MD	CHAULK POINT	PEP CO.	PC	SMALL INDUS.	UNDEVELOPED	FLAT		
2	MD	CUMBERLAND	EASTJUNI	BO	CLASSIFICATION	COMMERCIAL	HUMP	1/C	CUMBERLAND WESTBOUND
2	MD	CUMBERLAND	OLD WESTBOUND	BO	SMALL INDUS.	COMMERCIAL	FLAT	1/C	CUMBERLAND WESTBOUND
2	MD	CUMBERLAND	WESTJUNI	BO	CLASSIFICATION	COMMERCIAL	HUMP	1/C	CUMBERLAND WESTBOUND
2	MD	DICKERSON	PEP CO.	BO	SMALL INDUS.	AGRICULTURAL	FLAT		
2	MD	OWINGS MILLS	MARYLAND	WM	SMALL INDUS.	COMMERCIAL	FLAT		

76/07/00.

REG.	ST.	CITY	YARD	RAIL-ROAD	YARD FUNCTION	LOCATION TYPE	YARD TYPE	I/C	MAJOR YARD IF MULTI-YARD COMPLEX
2	MD	FREDERICK	FRT. HOUSE	RM	SMALL INDUS.	COMMERCIAL	FLAT		
2	MD	HAGERSTOWN	VARCO	WM	CLASS./INDUS.	COMMERCIAL	FLAT	I/C	
2	MD	HAGERSTOWN	SHCMJ	PC	CLASSIFICATION	COMMERCIAL	FLAT	I/C	
2	MD	HAGERSTOWN	WEST	WM	CLASS./INDUS.	COMMERCIAL	HUMP		
2	MD	HANCOCK	TRAIN	WM	SMALL INDUS.	INDUSTRIAL	FLAT		
2	MD	INDIANHEAD	POWER PLANT	PC	SMALL INDUS.	AGRICULTURAL	FLAT		
2	MD	JESSUP	HO-CAR TERM.	RM	INDUSTRIAL	AGRICULTURAL	FLAT		
2	MD	LYNE KILN	SOU CEMENT	GU	SMALL INDUS.	INDUSTRIAL	FLAT		
2	MD	MARGLOP	FRT. HOUSE	PC	SMALL INDUS.	COMMERCIAL	FLAT		
2	MD	MIDDLE RIVER	PEP CO.	PC	SMALL INDUS.	INDUSTRIAL	FLAT		
2	MD	MORGANTOWN	PE CO. POWER PL.	PC	SMALL INDUS.	AGRICULTURAL	FLAT	I/C	
2	MD	PERPVILLE	TRAIN	PC	INDUSTRIAL	COMMERCIAL	FLAT	I/C	
2	MD	SALISBURY	SIDING	PC	SMALL INDUS.	RESIDENTIAL	FLAT		
2	MD	SECURITY	MARQUETTA CEMENT	WM	SMALL INDUS.	INDUSTRIAL	FLAT		
2	MD	SPARROWS POINT	GRAYS	BM	CLASSIFICATION	COMMERCIAL	FLAT	I/C	
2	MD	SPARROWS POINT	GRAYS	BM	CLASSIFICATION	COMMERCIAL	FLAT	I/C	
2	MD	SPARROWS POINT	JFK	PUP	INDUSTRIAL	COMMERCIAL	FLAT		
2	MD	SPARROWS POINT	GRAYS	PC	CLASSIFICATION	INDUSTRIAL	FLAT	I/C	
2	MD	SPARROWS POINT	WISE AVENUE	PC	CLASSIFICATION	COMMERCIAL	FLAT	I/C	
2	MD	SPARROWS POINT	GRAYS	PC	CLASSIFICATION	UNDEVELOPED	FLAT	I/C	
2	MD	UNION BRIDGE	TRAIN	WM	SMALL INDUS.	COMMERCIAL	FLAT	I/C	
2	MD	VIENNA	POWER PLANT	PC	SMALL INDUS.	COMMERCIAL	FLAT		
2	MD	WESTMINISTER	FRT. HOUSE	WM	SMALL INDUS.	COMMERCIAL	FLAT		
1	MA	ADAMS	RENFREW	PC	SMALL INDUS.	COMMERCIAL	FLAT	I/C	BEACON PARK
1	MA	ALLSTON	REACON PARK	PC	CLASS./INDUS.	COMMERCIAL	FLAT		
1	MA	AYER	HILL	BM	INDUSTRIAL	UNDEVELOPED	FLAT		
1	MA	BILLERICA	SHOF	WM	SMALL INDUS.	INDUSTRIAL	FLAT		
1	MA	BOSTON	MYSTIC WHARF	BM	INDUSTRIAL	COMMERCIAL	FLAT		
1	MA	BOSTON	YARD A	BM	INDUSTRIAL	COMMERCIAL	FLAT	I/C	YARD A
1	MA	BOSTON	YARD 21	BM	INDUSTRIAL	COMMERCIAL	FLAT	I/C	YARD A
1	MA	BOSTON	SOUTHAMPTON ST.	PC	INDUSTRIAL	COMMERCIAL	FLAT		BEACON PARK
1	MA	BOSTON	YARD A	PC	INDUSTRIAL	COMMERCIAL	FLAT		BEACON PARK
1	MA	CHELSEA	PRODUCE	PC	INDUSTRIAL	COMMERCIAL	FLAT		
1	MA	EAST DEERFIELD	E. DEERFIELD	WM	CLASSIFICATION	AGRICULTURAL	FLAT		
1	MA	EAST FITCHBURG	EAST FITCHBURG	WM	INDUSTRIAL	COMMERCIAL	FLAT		
1	MA	FALL RIVER	FERRY STREET	PC	INDUSTRIAL	RESIDENTIAL	FLAT		
1	MA	FRAMINGHAM	FRANK	PC	INDUSTRIAL	UNDEVELOPED	FLAT		
1	MA	FRAMINGHAM	FRAMINGHAM	PC	INDUSTRIAL	INDUSTRIAL	FLAT		
1	MA	FRAMINGHAM	FRAMINGHAM	PC	INDUSTRIAL	INDUSTRIAL	FLAT		
1	MA	HULLYRKE	NEVINS	PC	CLASS./INDUS.	RESIDENTIAL	FLAT	I/C	NEVINS
1	MA	HULLYRKE	HOLYRKE	BM	INDUSTRIAL	COMMERCIAL	FLAT	I/C	NEVINS
1	MA	HOPEDALE	HOPEDALE	PC	INDUSTRIAL	COMMERCIAL	FLAT		
1	MA	LAWRENCE	ANDOVER STREET	GU	INDUSTRIAL	INDUSTRIAL	FLAT		
1	MA	LOWELL	PLFACHEPY	BM	INDUSTRIAL	COMMERCIAL	FLAT		
1	MA	LYNN	LYNN	WM	CLASS./INDUS.	COMMERCIAL	FLAT	I/C	
1	MA	NE. BEDFORD	NE. BEDFORD	PC	INDUSTRIAL	INDUSTRIAL	FLAT		
1	MA	NORTH ADAMS	NORTH ADAMS	WM	CLASS./INDUS.	COMMERCIAL	FLAT	I/C	
1	MA	PALMER	PALMER	CV	SMALL INDUS.	COMMERCIAL	FLAT	I/C	
1	MA	PALMER	PALMER	PC	SMALL INDUS.	COMMERCIAL	FLAT	I/C	
1	MA	PITTSFIELD	PITTSFIELD	PC	CLASS./INDUS.	INDUSTRIAL	FLAT		
1	MA	QUINCY	F-DE RIVER	PC	CLASS./INDUS.	INDUSTRIAL	FLAT		
1	MA	READVILLE	READVILLE	PC	CLASS./INDUS.	INDUSTRIAL	FLAT		
1	MA	SALEM	SALEM	BM	INDUSTRIAL	COMMERCIAL	FLAT		

76/07/08.

REG.	ST.	CITY	YARD	PAVIL-ROAD	YARD FUNCTION	LOCATION TYPE	YARD TYPE	I/C	MAJOR YARD IF MULTI-YARD COMPLEX
1	MA	SPRINGFIELD	BRIGHTWOOD	BM	CLASS./INDUS.	COMMERCIAL	FLAT	I/C	
1	MA	SPRINGFIELD	SPRINGFIELD	PC	CLASS./INDUS.	COMMERCIAL	FLAT	I/C	WEST SPRINGFIELD
1	MA	WEST CAMBRIDGE	WEST SPRINGFIELD	BN	INDUSTRIAL	COMMERCIAL	FLAT	I/C	YARD H
1	MA	WEST SPRINGFIELD	WEST SPRINGFIELD	PC	CLASS./INDUS.	COMMERCIAL	FLAT	I/C	WEST SPRINGFIELD
1	MA	WESTFIELD	WESTFIELD	PC	INDUSTRIAL	INDUSTRIAL	FLAT	I/C	
1	MA	WORCESTER	WORCESTER	PM	CLASS./INDUS.	INDUSTRIAL	FLAT	I/C	
1	MA	WORCESTER	EAST WORCESTER	PC	CLASS./INDUS.	COMMERCIAL	FLAT	I/C	
1	MA	WORCESTER	WORCESTER	PM	CLASS./INDUS.	INDUSTRIAL	FLAT	I/C	
4	MI	ADRIAN	TRAIN	NW	SMALL INDUS.	COMMERCIAL	FLAT	I/C	
4	MI	ADRIAN	TRAIN	PC	INDUSTRIAL	RESIDENTIAL	FLAT	I/C	
4	MI	ALBION	TRAIN	PC	SMALL INDUS.	RESIDENTIAL	FLAT	I/C	
4	MI	ALMA	TRAIN	CO	SMALL INDUS.	COMMERCIAL	FLAT	I/C	
4	MI	ALPENA	TRAIN	D4	INDUSTRIAL	COMMERCIAL	FLAT	I/C	
4	MI	ANN ARBOR	ANN ARBOR	AA	INDUSTRIAL	RESIDENTIAL	FLAT	I/C	
4	MI	HAD AXE	TRAIN	CO	SMALL INDUS.	RESIDENTIAL	FLAT	I/C	
4	MI	BATTLE CREEK	BATTLE CREEK	GTW	CLASS./INDUS.	INDUSTRIAL	FLAT	I/C	
4	MI	BATTLE CREEK	CITY	PC	INDUSTRIAL	RESIDENTIAL	FLAT	I/C	
4	MI	BATTLE CREEK	HINMAN	PC	INDUSTRIAL	COMMERCIAL	FLAT	I/C	
4	MI	BATTLE CREEK	DUMLEY	PC	SMALL INDUS.	RESIDENTIAL	FLAT	I/C	
4	MI	DAY CITY	MURPHY	DM	CLASS./INDUS.	INDUSTRIAL	FLAT	I/C	
4	MI	DAY CITY	MENDNA	PC	INDUSTRIAL	INDUSTRIAL	FLAT	I/C	
4	MI	BENTON HARBOR	INDUSTRIAL	CO	INDUSTRIAL	INDUSTRIAL	FLAT	I/C	
4	MI	BENTON HARBOR	TRAIN	PC	SMALL INDUS.	COMMERCIAL	FLAT	I/C	
4	MI	CADILLAC	NORTH	PC	SMALL INDUS.	COMMERCIAL	FLAT	I/C	
4	MI	CHANNING	TRAIN	PC	SMALL INDUS.	COMMERCIAL	FLAT	I/C	
4	MI	CHEBOYGAN	TRAIN	DM	INDUSTRIAL	UNDEVELOPED	FLAT	I/C	
4	MI	CRUSSELL	TRAIN	CO	SMALL INDUS.	RESIDENTIAL	FLAT	I/C	
4	MI	DEARBORN	ROUGE/ERE	CO	INDUSTRIAL	INDUSTRIAL	FLAT	I/C	
4	MI	DEARBORN	RIVER ROUGE	DTI	INDUSTRIAL	INDUSTRIAL	FLAT	I/C	
4	MI	DETROIT	FULLETON	CO	INDUSTRIAL	RESIDENTIAL	FLAT	I/C	
4	MI	DETROIT	OAK	CO	CLASS./INDUS.	INDUSTRIAL	FLAT	I/C	
4	MI	DETROIT	ROUGE/ERE	CO	INDUSTRIAL	INDUSTRIAL	FLAT	I/C	
4	MI	DETROIT	WEST END AVENUE	DC	INDUSTRIAL	COMMERCIAL	FLAT	I/C	
4	MI	DETROIT	DAVIS/UN AVE.	DT	SMALL INDUS.	INDUSTRIAL	FLAT	I/C	
4	MI	DETROIT	WARREN AVE.	DT	SMALL INDUS.	INDUSTRIAL	FLAT	I/C	
4	MI	DETROIT	FLAT ROCK	DTI	CLASS./INDUS.	COMMERCIAL	FLAT	I/C	
4	MI	DETROIT	D+M JCT.	DTM	INDUSTRIAL	RESIDENTIAL	HIMP	I/C	
4	MI	DETROIT	EAST	DTM	CLASS./INDUS.	INDUSTRIAL	FLAT	I/C	
4	MI	DETROIT	17TH STREET	NW	CLASS./INDUS.	INDUSTRIAL	FLAT	I/C	
4	MI	DETROIT	UNION BELT	NW	CLASS./INDUS.	COMMERCIAL	FLAT	I/C	
4	MI	DETROIT	FULLETON	PC	INDUSTRIAL	COMMERCIAL	FLAT	I/C	
4	MI	DETROIT	HARPER	PC	SMALL INDUS.	COMMERCIAL	FLAT	I/C	
4	MI	DETROIT	HURER	PC	SMALL INDUS.	INDUSTRIAL	FLAT	I/C	
4	MI	DETROIT	JUNCTION	PC	CLASS./INDUS.	INDUSTRIAL	HIMP	I/C	JUNCTION
4	MI	DETROIT	ROUND ROAD	PC	INDUSTRIAL	INDUSTRIAL	FLAT	I/C	
4	MI	DETROIT	NORTH	PC	INDUSTRIAL	INDUSTRIAL	FLAT	I/C	
4	MI	DETROIT	PALMER	PC	SMALL INDUS.	RESIDENTIAL	FLAT	I/C	
4	MI	DETROIT	TRAIN	PC	SMALL INDUS.	RESIDENTIAL	FLAT	I/C	
4	MI	DETROIT	WEST DETROIT	PC	CLASS./INDUS.	COMMERCIAL	FLAT	I/C	JUNCTION
4	MI	DETROIT	FULLETON	PC	CLASS./INDUS.	COMMERCIAL	FLAT	I/C	JUNCTION
4	MI	DETROIT	PRODUCE TERM.	DUILT	INDUSTRIAL	INDUSTRIAL	FLAT	I/C	
4	MI	DETROIT	TRAIN	DTM	CLASS./INDUS.	RESIDENTIAL	FLAT	I/C	

76/07/08.

REG.	ST.	CITY	YARD	RAIL-ROAD	YARD FUNCTION	LOCATION TYPE	YARD TYPE	I/C	MAJOR YARD, IF MULTI-YARD COMPLEX
4	MI	EAGLE WILLS	EAGLE WILLS	LSI	INDUSTRIAL	COMMERCIAL	FLAT		
4	MI	EAST TAVAS	TRAIN	DM	CLASS./INDUS.	RESIDENTIAL	FLAT		
4	MI	ECORSE	ZUG ISLAND	PC	INDUSTRIAL	INDUSTRIAL	FLAT		
4	MI	ECORSE	SOUTH	DTI	INDUSTRIAL	RESIDENTIAL	FLAT		
4	MI	ESCANABA	LUNEB FORTIGHT	CNW	CLASSIFICATION	COMMERCIAL	FLAT	I/C	
4	MI	ESCANABA	NEWZUPPER ORE	CNW	INDUSTRIAL	INDUSTRIAL	FLAT	I/C	
4	MI	EWEN	TRAIN	SOO	CLASSIFICATION	UNDEVELOPED	FLAT		
4	MI	FLINT	FISHER	CU	INDUSTRIAL	INDUSTRIAL	FLAT		
4	MI	FLINT	MC GREW	CO	CLASS./INDUS.	COMMERCIAL	FLAT		
4	MI	FLINT	BRISTOL ROAD	GTW	INDUSTRIAL	INDUSTRIAL	FLAT		
4	MI	FLINT	CHV-3 LEFT PLANT	GTW	INDUSTRIAL	INDUSTRIAL	FLAT		
4	MI	FLINT	TORNEY	GTW	INDUSTRIAL	INDUSTRIAL	FLAT		
4	MI	FRANKFJRT	ALBERTA	AA	INDUSTRIAL	RESIDENTIAL	FLAT		
4	MI	GLADSTONE	TRAIN	SDO	CLASS./INDUS.	RESIDENTIAL	FLAT		
4	MI	GRAND BLAIE	TRAIN	CO	INDUSTRIAL	COMMERCIAL	FLAT		
4	MI	GRAND RAPIDS	WYOMING	CD	CLASS./INDUS.	UNDEVELOPED	FLAT	I/C	
4	MI	GRAND RAPIDS	FISHER	PC	INDUSTRIAL	INDUSTRIAL	FLAT		
4	MI	GRAND RAPIDS	HUGABY	PC	CLASS./INDUS.	COMMERCIAL	FLAT	I/C	
4	MI	HAMTRACK	NORTH	PC	INDUSTRIAL	INDUSTRIAL	FLAT	I/C	
4	MI	HILLSDALE	TRAIN	PC	INDUSTRIAL	RESIDENTIAL	FLAT		
4	MI	HOLLAND	TRAIN	PC	CLASS./INDUS.	COMMERCIAL	FLAT		
4	MI	HOUGHTON	E HOUGHTON	SOO	CLASSIFICATION	UNDEVELOPED	FLAT		
4	MI	IONIA	TRAIN	CO	SMALL INDUS.	RESIDENTIAL	FLAT	I/C	
4	MI	IPON MOUNTAIN	TRAIN	CMSPP	SMALL INDUS.	RESIDENTIAL	FLAT	I/C	
4	MI	IRON MOUNTAIN	ANTICNE	CNW	SMALL INDUS.	RESIDENTIAL	FLAT	I/C	
4	MI	IRONWOOD	TRAIN	CNW	SMALL INDUS.	RESIDENTIAL	FLAT	I/C	
4	MI	ISHPEMING	EUCLID	CNW	INDUSTRIAL	UNDEVELOPED	FLAT	I/C	
4	MI	ISHPEMING	EUCLID	LSI	INDUSTRIAL	UNDEVELOPED	FLAT	I/C	
4	MI	ISHPEMING	EUCLID	SOO	INDUSTRIAL	UNDEVELOPED	FLAT	I/C	
4	MI	JACKSON	JACKSON JCT.	PC	CLASS./INDUS.	COMMERCIAL	FLAT		
4	MI	KALAMAZOO	KILGORE	GTW	INDUSTRIAL	COMMERCIAL	FLAT		
4	MI	KALAMAZOO	TRAIN	GTW	INDUSTRIAL	INDUSTRIAL	FLAT		
4	MI	KALAMAZOO	WDFSPD	PC	CLASS./INDUS.	INDUSTRIAL	FLAT		
4	MI	KALAMAZOO	NORTH	PC	INDUSTRIAL	RESIDENTIAL	FLAT		
4	MI	LANSING	EVANS	SOO	INDUSTRIAL	UNDEVELOPED	FLAT	I/C	
4	MI	LANSING	EVANS	CO	INDUSTRIAL	RESIDENTIAL	FLAT		
4	MI	LANSING	LANSING	GTW	INDUSTRIAL	RESIDENTIAL	FLAT		
4	MI	LANSING	SAGINAW	PC	CLASS./INDUS.	COMMERCIAL	FLAT	I/C	
4	MI	LANSING	SOUTH	PC	CLASS./INDUS.	INDUSTRIAL	FLAT	I/C	
4	MI	LANSING PARK	LINGCLN PARK	PC	INDUSTRIAL	COMMERCIAL	FLAT		
4	MI	LANSING PARK	MIDDLEBELT	CO	INDUSTRIAL	COMMERCIAL	FLAT		
4	MI	LUDINGTON	BOAT DOCK	CO	INDUSTRIAL	RESIDENTIAL	FLAT		
4	MI	LUDINGTON	TRAIN	LUN	SMALL INDUS.	RESIDENTIAL	FLAT	I/C	
4	MI	LUDINGTON	TRAIN	PC	INDUSTRIAL	RESIDENTIAL	FLAT		
4	MI	MANISTIQUE	TRAIN	CO	INDUSTRIAL	RESIDENTIAL	FLAT		
4	MI	MANISTIQUE	TRAIN	SOO	SMALL INDUS.	RESIDENTIAL	FLAT	I/C	
4	MI	MARQUETTE	WEST	LSI	CLASS./INDUS.	UNDEVELOPED	FLAT	I/C	
4	MI	MARQUETTE	EAST	SOO	CLASS./INDUS.	COMMERCIAL	FLAT	I/C	
4	MI	MARQUETTE	ORE	SOO	SMALL INDUS.	INDUSTRIAL	FLAT	I/C	
4	MI	MARQUETTE	CAK&JD	NW	SMALL INDUS.	COMMERCIAL	FLAT	I/C	
4	MI	MARQUETTE	MENIMNET	CMSPP	SMALL INDUS.	INDUSTRIAL	FLAT	I/C	
4	MI	MENIMNET	INDUSTRIAL	CU	INDUSTRIAL	INDUSTRIAL	FLAT	I/C	
4	MI	MENIMNET	INDUSTRIAL	CU	INDUSTRIAL	INDUSTRIAL	FLAT	I/C	
4	MI	MUNROE	TRAIN	C7	INDUSTRIAL	RESIDENTIAL	FLAT		

76/37/38

REG.	ST.	CITY	YARD	RAIL-ROAD	YARD FUNCTION	LOCATION TYPE	YARD TYPE	I/C	MAJOR YARD IF MULTI-YARD COMPLEX
4	MI	NONPOE	WARREN	PC	CLASS-/INDUS.	COMMERCIAL	FLAT		
4	MI	MUSKIEG	MUSKIEG	LSI	SMALL INDUS.	RESIDENTIAL	FLAT		
4	MI	MUSKIEGUN	TRAIN	CO	INDUSTRIAL	RESIDENTIAL	FLAT		
4	MI	NEW BUFFALO	TRAIN	GTW	CLASSIFICATION	RESIDENTIAL	FLAT		
4	MI	NILES	NILES	CO	SMALL INDUS.	INDUSTRIAL	FLAT		
4	MI	ONCSCO	TRAIN	AA	CLASS-/INDUS.	RESIDENTIAL	FLAT	I/C	
4	MI	PAPTRIDJF	TRAIN	LSI	INDUSTRIAL	COMMERCIAL	FLAT		
4	MI	PLYMOUTH	TRAIN	CO	CLASS-/INDUS.	COMMERCIAL	FLAT		
4	MI	PONTIAC	TRAIN	GTW	INDUSTRIAL	RESIDENTIAL	FLAT		
4	MI	PONTIAC	TRAIN	CO	CLASS-/INDUS.	RESIDENTIAL	FLAT		
4	MI	PONTIAC	WEST END	GTW	CLASS-/INDUS.	RESIDENTIAL	FLAT		
4	MI	PORT HURON	CITY	CO	SMALL INDUS.	COMMERCIAL	FLAT		
4	MI	PORT HURON	TAPPAN	CO	SMALL INDUS.	RESIDENTIAL	FLAT		
4	MI	PORT HURON	TUNELL	CO	SMALL INDUS.	RESIDENTIAL	FLAT	I/C	
4	MI	PORT HURON	TRAIN	PHD	CLASS-/INDUS.	RESIDENTIAL	FLAT	I/C	
4	MI	PULVERS	TRAIN	CNW	SMALL INDUS.	UNDEVELOPED	FLAT		
4	MI	RIVER ROUGE	RIVER ROUGE	PC	CLASS-/INDUS.	RESIDENTIAL	FLAT		
4	MI	SAGINAW	TRAIN	CO	CLASS-/INDUS.	RESIDENTIAL	FLAT		
4	MI	SAGINAW	SAGINAW	GTW	CLASS-/INDUS.	RESIDENTIAL	FLAT		
4	MI	SAGINAW	CITY	PC	SMALL INDUS.	RESIDENTIAL	FLAT		
4	MI	ST. IGNACE	TRAIN	SDD	SMALL INDUS.	COMMERCIAL	FLAT	I/C	
4	MI	SAUTE STE MARIE	TRAIN	SDD	SMALL INDUS.	COMMERCIAL	FLAT	I/C	
4	MI	STAMBAUGH	TRAIN	CNW	INDUSTRIAL	COMMERCIAL	FLAT		
4	MI	STERLING	TRAIN	PC	INDUSTRIAL	INDUSTRIAL	FLAT		
4	MI	THREE RIVERS	TRAIN	PC	SMALL INDUS.	RESIDENTIAL	FLAT		
4	MI	TRAVERSE CITY	TRAIN	CU	INDUSTRIAL	RESIDENTIAL	FLAT		
4	MI	TRENTON	EDISON	DYS	INDUSTRIAL	COMMERCIAL	FLAT	I/C	
4	MI	TRENTON	INDUSTRIAL	PC	INDUSTRIAL	RESIDENTIAL	FLAT		
4	MI	WARREN	ROUND RD.	PC	INDUSTRIAL	INDUSTRIAL	FLAT		
4	MI	WAYNE	INDUSTRIAL	JOINT	INDUSTRIAL	INDUSTRIAL	FLAT		
4	MI	WELLS	WELLS	ELS	INDUSTRIAL	COMMERCIAL	FLAT		
4	MI	WILLOW RUN	INDUSTRIAL	PC	CLASS-/INDUS.	COMMERCIAL	FLAT		
4	MI	WYANDOTTE	FORD	DTI	INDUSTRIAL	COMMERCIAL	FLAT		
4	MI	WYANDOTTE	TRAIN	PC	SMALL INDUS.	RESIDENTIAL	FLAT		
4	MI	WYANDOTTE	INDUSTRIAL	WYS	INDUSTRIAL	RESIDENTIAL	FLAT	I/C	
4	MI	WYANDOTTE	INDUSTRIAL	WYT	INDUSTRIAL	INDUSTRIAL	FLAT	I/C	
4	MN	ALBERTA LCA	CITY	CMSHP	SMALL INDUS.	RESIDENTIAL	FLAT	I/C	
4	MN	ALBERTA LCA	TRAIN	CNW	INDUSTRIAL	RESIDENTIAL	FLAT	I/C	
4	MN	ALBERTA LCA	CITY	CRIP	INDUSTRIAL	RESIDENTIAL	FLAT	I/C	
4	MN	AUSTIN	TRAIN	CMSHP	CLASS-/INDUS.	RESIDENTIAL	FLAT	I/C	
4	MN	AUSTIN	CITY	CNW	SMALL INDUS.	RESIDENTIAL	FLAT	I/C	
4	MN	HEMLOCK	NORTH BEMIDJI	BN	CLASSIFICATION	UNDEVELOPED	FLAT		
4	MN	HEMLOCK	DRE	DMR	SMALL INDUS.	UNDEVELOPED	FLAT		
4	MN	HOVEY	HOVEY	UN	SMALL INDUS.	UNDEVELOPED	FLAT		
4	MN	BRAINEW	TRAIN	BN	CLASSIFICATION	UNDEVELOPED	FLAT		
4	MN	BRAINEW	TRAIN	BN	INDUSTRIAL	RESIDENTIAL	FLAT		
4	MN	BECKERING	TRAIN	UN	SMALL INDUS.	UNDEVELOPED	FLAT		
4	MN	CALUMET	TRAIN	UN	SMALL INDUS.	UNDEVELOPED	FLAT		
4	MN	CANISTIC	TRAIN	BN	SMALL INDUS.	UNDEVELOPED	FLAT		
4	MN	CALITON	TRAIN	BN	SMALL INDUS.	UNDEVELOPED	FLAT		
4	MN	CASS LAKE	TRAIN	HN	SMALL INDUS.	RESIDENTIAL	FLAT		
4	MN	CHASKA	TRAIN	CNW	SMALL INDUS.	INDUSTRIAL	FLAT	I/C	

76/07/09.

REG.	ST.	CITY	YARD	RAIL-ROAD	YARD FUNCTION	LOCATION TYPE	YARD TYPE	I/C	MAJOR YARD IF MULTI-YARD COMPLEX
4	MN	RED WING	CITY	MSPP	INDUSTRIAL	RESIDENTIAL	FLAT	I/C	
4	MN	ROCHESTER	TRAIN	CNW	INDUSTRIAL	RESIDENTIAL	FLAT	I/C	
4	MN	ST. CLOUD	CITY	CNW	INDUSTRIAL	RESIDENTIAL	FLAT	I/C	
4	MN	ST. JAMES	TRAIN	BN	CLASSIFICATION	RESIDENTIAL	FLAT	I/C	
4	MN	ST. PAUL	PAIXONS HLUFF	CNW	CLASS-/INDUS.	RESIDENTIAL	FLAT	I/C	
4	MN	ST. PAUL	CHYSTNUT STREET	BN	INDUSTRIAL	INDUSTRIAL	FLAT	I/C	
4	MN	ST. PAUL	NEW	MSPP	CLASS-/INDUS.	INDUSTRIAL	FLAT	I/C	
4	MN	ST. PAUL	OLD	MSPP	INDUSTRIAL	INDUSTRIAL	FLAT	I/C	
4	MN	ST. PAUL	WESTERN AVENUE	CNW	INDUSTRIAL	INDUSTRIAL	FLAT	I/C	
4	MN	ST. PAUL	TRANSFER	WTR	INDUSTRIAL	INDUSTRIAL	FLAT	I/C	
4	MN	ST. PAUL	7TH STREET	SOU	INDUSTRIAL	COMMERCIAL	FLAT	I/C	
4	MN	SAVAGE	VALLEY	CNW	INDUSTRIAL	INDUSTRIAL	FLAT	I/C	
4	MN	SHAKOPEE	TRAIN	CNW	INDUSTRIAL	INDUSTRIAL	FLAT	I/C	
4	MN	SLEEPY EYE	TRAIN	CNW	SMALL INDUS.	RESIDENTIAL	FLAT	I/C	
4	MN	SOUTH ST PAUL	TRAIN	CNW	INDUSTRIAL	INDUSTRIAL	FLAT	I/C	
4	MN	STAPLES	TRAIN	BN	CLASSIFICATION	AGRICULTURAL	FLAT	I/C	
4	MN	THIEF RIVER FALLS	TRAIN	SOU	CLASS-/INDUS.	RESIDENTIAL	FLAT	I/C	
4	MN	TRACY	TRAIN	CNW	INDUSTRIAL	RESIDENTIAL	FLAT	I/C	
4	MN	TWO HARBORS	TRAIN	DMR	INDUSTRIAL	COMMERCIAL	FLAT	I/C	
4	MN	VIRGINIA	RAINY JCT.	MSPP	INDUSTRIAL	UNDEVELOPED	FLAT	I/C	
4	MN	WABASHA	CITY	CNW	CLASS-/INDUS.	RESIDENTIAL	FLAT	I/C	
4	MN	WASECA	TRAIN	BN	INDUSTRIAL	AGRICULTURAL	FLAT	I/C	
4	MN	WILLMAR	TRAIN	BN	CLASSIFICATION	INDUSTRIAL	FLAT	I/C	
4	MN	WINONA	CITY	MSPP	INDUSTRIAL	RESIDENTIAL	FLAT	I/C	
4	MN	WINONA	TRAIN	CNW	INDUSTRIAL	RESIDENTIAL	FLAT	I/C	
4	MN	WINONA	TRAIN	GRW	CLASSIFICATION	RESIDENTIAL	FLAT	I/C	
4	MN	WINTHROP	WINTHROP	CNW	INDUSTRIAL	RESIDENTIAL	FLAT	I/C	
4	MN	WORTHINGTON	WORTHINGTON	CNW	CLASS-/INDUS.	RESIDENTIAL	FLAT	I/C	
3	MS	ABERDEEN	ABERDEEN	ICG	INDUSTRIAL	RESIDENTIAL	FLAT		
3	MS	ABERDEEN	ABERDEEN	SLSF	SMALL INDUS.	RESIDENTIAL	FLAT		
3	MS	ANDRY	ANDRY	WSS	SMALL INDUS.	RESIDENTIAL	FLAT		
3	MS	ANDRY	ANDRY	SLSF	CLASSIFICATION	RESIDENTIAL	FLAT		
3	MS	ARTESIA	ARTESIA	ICG	INDUSTRIAL	RESIDENTIAL	FLAT		
3	MS	CLARKSDALE	CLARKSDALE	ICG	INDUSTRIAL	RESIDENTIAL	FLAT	I/C	
3	MS	CLEVELAND	CLEVELAND	ICG	SMALL INDUS.	RESIDENTIAL	FLAT	I/C	
3	MS	COLUMBUS	COLUMBUS	CAGY	INDUSTRIAL	RESIDENTIAL	FLAT	I/C	
3	MS	COLUMBUS	COLUMBUS	ICG	INDUSTRIAL	RESIDENTIAL	FLAT	I/C	
3	MS	COLUMBUS	COLUMBUS	SLSF	SMALL INDUS.	RESIDENTIAL	FLAT	I/C	
3	MS	COLUMBUS	SOU	SOU	SMALL INDUS.	RESIDENTIAL	FLAT	I/C	
3	MS	CORINTH	CORINTH	CCP	INDUSTRIAL	UNDEVELOPED	FLAT	I/C	
3	MS	CORINTH	CORINTH	ICG	INDUSTRIAL	RESIDENTIAL	FLAT	I/C	
3	MS	CORINTH	CORINTH	SOU	INDUSTRIAL	RESIDENTIAL	FLAT	I/C	
3	MS	DURANT	DURANT	ICG	INDUSTRIAL	RESIDENTIAL	FLAT	I/C	
3	MS	EVANSTON	EVANSTON	MSE	SMALL INDUS.	RESIDENTIAL	FLAT	I/C	
3	MS	GREENVILLE	GREENVILLE	CAGY	SMALL INDUS.	RESIDENTIAL	FLAT	I/C	
3	MS	GREENWOOD	GREENWOOD	CAGY	INDUSTRIAL	UNDEVELOPED	FLAT	I/C	
3	MS	GREENWOOD	GREENWOOD	ICG	SMALL INDUS.	RESIDENTIAL	FLAT	I/C	
3	MS	LAUFEL	LAUFEL	ICG	CLASS-/INDUS.	RESIDENTIAL	FLAT	I/C	
3	MS	LAUFEL	LAUFEL	SOU	CLASS-/INDUS.	RESIDENTIAL	FLAT	I/C	
3	MS	LAUFEL	LAUFEL	ICG	INDUSTRIAL	RESIDENTIAL	FLAT	I/C	
3	MS	LOUISVILLE	LOUISVILLE	ICG	INDUSTRIAL	RESIDENTIAL	FLAT	I/C	
3	MS	MERIDIAN	MERIDIAN	ICG	INDUSTRIAL	RESIDENTIAL	FLAT	I/C	

76/07/08.

REG.	ST.	CITY	YARD	RAIL-ROAD	YARD FUNCTION	LOCATION TYPE	YARD TYPE	I/C	MAJOR YARD IF MULTI-YARD COMPLEX
3	MS	MERIDIAN	NEW	ICG	INDUSTRIAL	RESIDENTIAL	FLAT		
3	MS	MERIDIAN	SOUTH	ICG	CLASS./INDUS.	RESIDENTIAL	FLAT	1/C	
3	MS	MERIDIAN	MORP	MBRP	SMALL INDUS.	RESIDENTIAL	FLAT	1/C	
3	MS	MERIDIAN	MERIDIAN	ICG	INDUSTRIAL	RESIDENTIAL	FLAT	1/C	
3	MS	OKALONA	SOU	ICG	SMALL INDUS.	RESIDENTIAL	FLAT	1/C	
3	MS	PASCAGOULA	MSE	ICG	INDUSTRIAL	UNDEVELOPED	FLAT	1/C	
3	MS	TUPELO	TUPELO	ICG	INDUSTRIAL	COMMERCIAL	FLAT	1/C	
3	MS	TUPELO	ICG	SLSF	INDUSTRIAL	RESIDENTIAL	FLAT	1/C	
3	MS	UNION	UNION	ICG	SMALL INDUS.	RESIDENTIAL	FLAT	1/C	
3	MS	WEST POINT	WEST POINT	CAGY	INDUSTRIAL	RESIDENTIAL	FLAT	1/C	
3	MS	WEST POINT	WEST POINT	ICG	INDUSTRIAL	RESIDENTIAL	FLAT	1/C	
8	MO	BEVIER	TRAIN	BVS	INDUSTRIAL	UNDEVELOPED	FLAT	1/C	
8	MO	BISMARCK	TRAIN	MP	INDUSTRIAL	RESIDENTIAL	FLAT	1/C	
8	MO	BROOKFIELD	TRAIN	BN	INDUSTRIAL	COMMERCIAL	FLAT	1/C	
8	MO	CAPE GIRARDEAU	TRAIN	MP	INDUSTRIAL	COMMERCIAL	FLAT	1/C	
8	MO	GARROLLTON	TRAIN	ATSF	SMALL INDUS.	INDUSTRIAL	FLAT	1/C	
8	MO	CARTHAGE	TRAIN	MP	SMALL INDUS.	INDUSTRIAL	FLAT	1/C	
8	MO	CHAFFEE	TRAIN	SLSF	SMALL INDUS.	RESIDENTIAL	FLAT	1/C	
8	MO	CRANE	TRAIN	MP	SMALL INDUS.	AGRICULTURAL	FLAT	1/C	
8	MO	CUBA	TRAIN	SLSF	SMALL INDUS.	RESIDENTIAL	FLAT	1/C	
8	MO	DE SOTO	TRAIN	MP	INDUSTRIAL	UNDEVELOPED	FLAT	1/C	
8	MO	ELDON	TRAIN	CRIP	SMALL INDUS.	RESIDENTIAL	FLAT	1/C	
8	MO	FRANKLIN	TRAIN	MKT	SMALL INDUS.	RESIDENTIAL	FLAT	1/C	
8	MO	GIDEON	TRAIN	BN	SMALL INDUS.	UNDEVELOPED	FLAT	1/C	
8	MO	HANNIBAL	TRAIN	GIDAN	INDUSTRIAL	COMMERCIAL	FLAT	1/C	
8	MO	HANNIBAL	TRAIN	BN	CLASS./INDUS.	RESIDENTIAL	FLAT	1/C	
8	MO	HANNIBAL	TRAIN	BN	CLASS./INDUS.	AGRICULTURAL	FLAT	1/C	
8	MO	HANYSI	TRAIN	BN	CLASS./INDUS.	RESIDENTIAL	FLAT	1/C	
8	MO	MERCURANEUM	TRAIN	SLSF	INDUSTRIAL	RESIDENTIAL	FLAT	1/C	
8	MO	JEFFERSON CITY	TRAIN	NI	INDUSTRIAL	RESIDENTIAL	FLAT	1/C	
8	MO	JEFFERSON CITY	TRAIN	NI	INDUSTRIAL	COMMERCIAL	FLAT	1/C	
8	MO	JUPLIN	TRAIN	MP	INDUSTRIAL	COMMERCIAL	FLAT	1/C	
8	MO	JUPLIN	TRAIN	MKT	SMALL INDUS.	INDUSTRIAL	FLAT	1/C	
8	MO	KANSAS CITY	TRAIN	SLSF	INDUSTRIAL	UNDEVELOPED	FLAT	1/C	
8	MO	KANSAS CITY	TRAIN	CNW	INDUSTRIAL	UNDEVELOPED	FLAT	1/C	
8	MO	KANSAS CITY	TRAIN	ICG	CLASS./INDUS.	INDUSTRIAL	FLAT	1/C	
8	MO	KANSAS CITY	HENNING ST	JOINT	INDUSTRIAL	INDUSTRIAL	FLAT	1/C	
8	MO	KANSAS CITY	TRAIN	JOINT	INDUSTRIAL	INDUSTRIAL	FLAT	1/C	
8	MO	KANSAS CITY	TRAIN	XCT	CLASS./INDUS.	INDUSTRIAL	FLAT	1/C	
8	MO	KANSAS CITY	MATTON	MATTS	SMALL INDUS.	UNDEVELOPED	FLAT	1/C	
8	MO	KANSAS CITY	KANSAS CITY	MP	SMALL INDUS.	COMMERCIAL	FLAT	1/C	
8	MO	KANSAS CITY	KAW VALLEY BRIDGE	MP	INDUSTRIAL	COMMERCIAL	FLAT	1/C	NEFF E-B. HUMP
8	MO	KANSAS CITY	LEEDS	MP	SMALL INDUS.	COMMERCIAL	FLAT	1/C	NEFF E-B. HUMP
8	MO	KANSAS CITY	NEFF E-B. HUMP	MP	CLASS./INDUS.	COMMERCIAL	HUMP	1/C	NEFF E-B. HUMP
8	MO	KANSAS CITY	NEFF W-B. HUMP	MP	CLASS./INDUS.	COMMERCIAL	HUMP	1/C	NEFF E-B. HUMP
8	MO	KANSAS CITY	TRAIN	SLSF	SMALL INDUS.	INDUSTRIAL	FLAT	1/C	
8	MO	KANSAS CITY	KANSAS CITY	MP	SMALL INDUS.	UNDEVELOPED	FLAT	1/C	
8	MO	LEXINGTON	TRAIN	S/C	SMALL INDUS.	UNDEVELOPED	FLAT	1/C	
8	MO	WALDEN	TRAIN	MP	SMALL INDUS.	UNDEVELOPED	FLAT	1/C	
8	MO	MARCELINE	TRAIN	SSW	SMALL INDUS.	RESIDENTIAL	FLAT	1/C	
8	MO	MARQUETTE	TRAIN	ATSF	SMALL INDUS.	AGRICULTURAL	FLAT	1/C	
8	MO	MEXICO	TRAIN	MAROC	INDUSTRIAL	INDUSTRIAL	FLAT	1/C	
8	MO	MEXICO	TRAIN	BN	SMALL INDUS.	RESIDENTIAL	FLAT	1/C	
8	MO	MEXICO	TRAIN	ICG	INDUSTRIAL	RESIDENTIAL	FLAT	1/C	
8	MO	MEXICO	TRAIN	ICG	INDUSTRIAL	RESIDENTIAL	FLAT	1/C	
8	MO	MORRIS	TRAIN	NW	INDUSTRIAL	RESIDENTIAL	FLAT	1/C	
8	MO	MORRIS	TRAIN	NW	CLASS./INDUS.	RESIDENTIAL	FLAT	1/C	
8	MO	MONETT	TRAIN	SLSF	INDUSTRIAL	COMMERCIAL	FLAT	1/C	

76/07/CR.

REG.	ST.	CITY	YARD	RAIL-ROAD	YARD FUNCTION	LOCATION TYPE	YARD TYPE	1/C	MAJOR YARD IF MULTI-YARD COMPLEX
8	MO	MONTGOMERY	TRAIN	NW	SMALL INDUS.	RESIDENTIAL	FLAT	1/C	
8	MO	MEOSHO	TRAIN	KCS	SMALL INDUS.	COMMERCIAL	FLAT	1/C	
8	MO	NEVADA	TRAIN	MP	SMALL INDUS.	INDUSTRIAL	FLAT		
8	MO	NEWBURG	TRAIN	SLSF	SMALL INDUS.	RESIDENTIAL	FLAT		
8	MO	N. KANSAS CITY	TRAIN	BN	CLASS./INDUS.	INDUSTRIAL	FLAT	1/C	
8	MO	N. KANSAS CITY	TRAIN	NW	CLASS./INDUS.	INDUSTRIAL	FLAT	1/C	
8	MO	OSAWATOMIE	TRAIN	MP	SMALL INDUS.	RESIDENTIAL	FLAT		
8	MO	OSAWATOMIE	TRAIN	CRIP	SMALL INDUS.	RESIDENTIAL	FLAT		
8	MO	POPLAR BLUFF	TRAIN	MI	INDUSTRIAL	RESIDENTIAL	FLAT	1/C	
8	MO	RINER MINES	TRAIN	ATSF	CLASS./INDUS.	COMMERCIAL	FLAT	1/C	
8	MO	ST. JOSEPH	TRAIN	BN	CLASS./INDUS.	INDUSTRIAL	FLAT	1/C	
8	MO	ST. JOSEPH	TRAIN	CNW	INDUSTRIAL	COMMERCIAL	FLAT	1/C	
8	MO	ST. JOSEPH	TRAIN	CRIP	INDUSTRIAL	INDUSTRIAL	FLAT	1/C	
8	MO	ST. JOSEPH	TRAIN	MP	INDUSTRIAL	INDUSTRIAL	FLAT	1/C	
8	MO	ST. JOSEPH	TRAIN	SJR	SMALL INDUS.	INDUSTRIAL	FLAT	1/C	
8	MO	ST. JOSEPH	TRAIN	SJT	CLASS./INDUS.	INDUSTRIAL	FLAT	1/C	
8	MO	ST. JOSEPH	TRAIN	UP	CLASS./INDUS.	INDUSTRIAL	FLAT	1/C	
8	MO	ST. JOSEPH	TRAIN	UT	INDUSTRIAL	INDUSTRIAL	FLAT	1/C	
8	MO	ST. LOUIS	DEKALB ST	ACFI	INDUSTRIAL	INDUSTRIAL	FLAT	1/C	
8	MO	ST. LOUIS	TRAIN	BN	CLASS./INDUS.	INDUSTRIAL	FLAT	1/C	
8	MO	ST. LOUIS	TRAIN	CRIP	CLASS./INDUS.	INDUSTRIAL	FLAT	1/C	
8	MO	ST. LOUIS	TRAIN	MPS	INDUSTRIAL	INDUSTRIAL	FLAT	1/C	
8	MO	ST. LOUIS	TRAIN	MKT	CLASS./INDUS.	INDUSTRIAL	FLAT	1/C	
8	MO	ST. LOUIS	TRAIN	MP	CLASS./INDUS.	INDUSTRIAL	FLAT	1/C	
8	MO	ST. LOUIS	21ST STREET	MP	CLASS./INDUS.	INDUSTRIAL	FLAT	1/C	
8	MO	ST. LOUIS	IVORY STREET	MP	INDUSTRIAL	INDUSTRIAL	FLAT	1/C	
8	MO	ST. LOUIS	LESPERANCE STREET	MP	CLASS./INDUS.	INDUSTRIAL	FLAT	1/C	
8	MO	ST. LOUIS	BERKELEY	NW	INDUSTRIAL	INDUSTRIAL	FLAT		12TH STREET
8	MO	ST. LOUIS	BRANCH STREET	NW	INDUSTRIAL	INDUSTRIAL	FLAT		12TH STREET
8	MO	ST. LOUIS	LUTHER	NW	INDUSTRIAL	INDUSTRIAL	FLAT		12TH STREET
8	MO	ST. LOUIS	VANDEVENTER	NW	INDUSTRIAL	INDUSTRIAL	FLAT		LUTHER
8	MO	ST. LOUIS	TRAIN	NW	CLASS./INDUS.	COMMERCIAL	FLAT		LUTHER
8	MO	ST. LOUIS	TRAIN	SLSF	CLASS./INDUS.	RESIDENTIAL	FLAT	1/C	LUTHER
8	MO	ST. LOUIS	11TH STREET	TRRA	INDUSTRIAL	COMMERCIAL	FLAT	1/C	
8	MO	ST. LOUIS	BREMAN	TRRA	INDUSTRIAL	COMMERCIAL	FLAT	1/C	
8	MO	ST. LOUIS	CARRIE AVENUE	TRRA	INDUSTRIAL	COMMERCIAL	FLAT	1/C	
8	MO	ST. LOUIS	PICKREL	TRRA	INDUSTRIAL	INDUSTRIAL	FLAT	1/C	
8	MO	SEDALIA	TRAIN	MKT	SMALL INDUS.	RESIDENTIAL	FLAT	1/C	
8	MO	SEDALIA	TRAIN	SFA	SMALL INDUS.	COMMERCIAL	FLAT	1/C	
8	MO	SIKESTON	TRAIN	MP	SMALL INDUS.	RESIDENTIAL	FLAT	1/C	
8	MO	SPRINGFIELD	TRAIN	SFA	INDUSTRIAL	INDUSTRIAL	FLAT	1/C	
8	MO	SPRINGFIELD	TRAIN	SLSF	CLASS./INDUS.	RESIDENTIAL	FLAT	1/C	
8	MO	SPRINGFIELD	TRAIN	SLSF	SMALL INDUS.	RESIDENTIAL	FLAT	1/C	
8	MO	THAYER	TRAIN	MI	SMALL INDUS.	AGRICULTURAL	FLAT		
8	MO	THONURE	TRAIN	CRIP	INDUSTRIAL	INDUSTRIAL	FLAT		
8	MO	TRENTON	TRAIN	CRIP	INDUSTRIAL	INDUSTRIAL	FLAT		
8	MO	UNION	TRAIN	CRIP	INDUSTRIAL	INDUSTRIAL	FLAT		
8	MO	VIBURNUM	TRAIN	SLSF	SMALL INDUS.	RESIDENTIAL	FLAT		
8	MO	WEBB CITY	TRAIN	SLSF	SMALL INDUS.	RESIDENTIAL	FLAT		
8	MO	WEST QUINCY	TRAIN	SFA	INDUSTRIAL	INDUSTRIAL	FLAT		
8	MO	WILLOW SPRINGS	TRAIN	BN	CLASS./INDUS.	AGRICULTURAL	FLAT	1/C	
8	MO	WILLOW SPRINGS	TRAIN	SLSF	SMALL INDUS.	RESIDENTIAL	FLAT		
6	MT	ANACONDA	TRAIN	BAP	CLASS./INDUS.	INDUSTRIAL	FLAT		NW/DLO
6	MT	HILLINGS	HUMBLE	BN	SMALL INDUS.	INDUSTRIAL	FLAT		NW/DLO
4	MT	HILLINGS	NEW/DLO	BN	CLASS./INDUS.	INDUSTRIAL	FLAT		NW/DLO

76/07/09

REG.	ST.	CITY	YARD	RAIL-ROAD	YARD FUNCTION	LOCATION TYPE	YARD TYPE	I/C	MAJTR YARD IF MULTI-YARD COMPLEX
6	MT	BILLINGS	STOCK	BN	SMALL INDUS.	INDUSTRIAL	FLAT		
6	MT	BILLINGS	SUGAR	BN	SMALL INDUS.	INDUSTRIAL	FLAT		NEW/OLD
6	MT	BOZEMAN	TRAIN	BN	INDUSTRIAL	RESIDENTIAL	FLAT	I/C	
6	MT	BOZEMAN	ROCKER	CMSP	INDUSTRIAL	RESIDENTIAL	FLAT	I/C	
6	MT	BUTTE	TRAIN	BAP	SMALL INDUS.	INDUSTRIAL	FLAT		TRAIN
6	MT	BUTTE	TRANSFER	BAP	CLASS-/INDUS.	INDUSTRIAL	FLAT		TRAIN
6	MT	BUTTE	TRAIN	BAP	SMALL INDUS.	INDUSTRIAL	FLAT	I/C	
6	MT	BUTTE	TRAIN	BN	SMALL INDUS.	INDUSTRIAL	FLAT	I/C	
6	MT	BUTTE	TRAIN	CMSP	SMALL INDUS.	INDUSTRIAL	FLAT	I/C	
6	MT	BUTTE	TRAIN	UP	SMALL INDUS.	UNDEVELOPED	FLAT		
6	MT	CECIL MINE	MINE	BN	SMALL INDUS.	RESIDENTIAL	FLAT		
6	MT	CHENOK	STATION	BN	SMALL INDUS.	RESIDENTIAL	FLAT		
6	MT	COLUMBUS	TRAIN	BN	SMALL INDUS.	RESIDENTIAL	FLAT		
6	MT	COW CREEK	TRAIN	BN	SMALL INDUS.	RESIDENTIAL	FLAT		
6	MT	CUT BANK	TRAIN	BN	SMALL INDUS.	RESIDENTIAL	FLAT		
6	MT	DEER LODGE	TRAIN	BN	SMALL INDUS.	AGRICULTURAL	FLAT		
6	MT	DILLON	TRAIN	CMSP	CLASS-/INDUS.	INDUSTRIAL	FLAT		
6	MT	FORSYTH	TRAIN	UP	SMALL INDUS.	INDUSTRIAL	FLAT		
6	MT	GLASGOW	TRAIN	BN	INDUSTRIAL	INDUSTRIAL	FLAT		
6	MT	GLENDIVE	TRAIN	BN	SMALL INDUS.	RESIDENTIAL	FLAT		
6	MT	GREAT FALLS	EMERSON	BN	INDUSTRIAL	INDUSTRIAL	FLAT		BN TRAIN
6	MT	GREAT FALLS	MILL	BN	INDUSTRIAL	INDUSTRIAL	FLAT		BN TRAIN
6	MT	GREAT FALLS	SOUTH	BN	INDUSTRIAL	INDUSTRIAL	FLAT		BN TRAIN
6	MT	GREAT FALLS	STORAGE	BN	INDUSTRIAL	INDUSTRIAL	FLAT		BN TRAIN
6	MT	GREAT FALLS	TOWN	BN	INDUSTRIAL	INDUSTRIAL	FLAT		BN TRAIN
6	MT	GREAT FALLS	TRAIN	BN	CLASS-/INDUS.	INDUSTRIAL	FLAT		BN TRAIN
6	MT	GREAT FALLS	FALLS	CMSP	INDUSTRIAL	RESIDENTIAL	FLAT	I/C	
6	MT	HARDIN	STATION	BN	SMALL INDUS.	RESIDENTIAL	FLAT	I/C	
6	MT	HARLOWTON	TRAIN	CMSP	SMALL INDUS.	RESIDENTIAL	FLAT		
6	MT	HAVRE	TRAIN	BN	CLASS-/INDUS.	RESIDENTIAL	FLAT		
6	MT	HELENA	TRAIN	BN	CLASS-/INDUS.	RESIDENTIAL	FLAT		
6	MT	HUNTLEY	TRAIN	BN	CLASS-/INDUS.	RESIDENTIAL	FLAT		
6	MT	LAUREL	TRAIN	BN	SMALL INDUS.	AGRICULTURAL	FLAT		
6	MT	LEWISTON	EAST/IDOLE/WEST	BN	CLASS-/INDUS.	INDUSTRIAL	FLAT		
6	MT	LEWISTON	TRAIN	BN	SMALL INDUS.	RESIDENTIAL	FLAT	I/C	
6	MT	LEWISTON	TRAIN	CMSP	SMALL INDUS.	RESIDENTIAL	FLAT	I/C	
6	MT	LIBBY	TRAIN	BN	SMALL INDUS.	RESIDENTIAL	FLAT		
6	MT	LIMA	TRAIN	UP	SMALL INDUS.	RESIDENTIAL	FLAT		
6	MT	LIVINGSTON	TRAIN	BN	SMALL INDUS.	INDUSTRIAL	FLAT		
6	MT	MACON	REFINERY	BN	SMALL INDUS.	INDUSTRIAL	FLAT		
6	MT	MILES CITY	TRAIN	BN	SMALL INDUS.	INDUSTRIAL	FLAT		
6	MT	MILES CITY	TRAIN	CMSP	SMALL INDUS.	INDUSTRIAL	FLAT	I/C	
6	MT	MISSOULA	TRAIN	BN	CLASS-/INDUS.	INDUSTRIAL	FLAT	I/C	
6	MT	MISSOULA	TRAIN	CMSP	CLASS-/INDUS.	INDUSTRIAL	HUMP	I/C	
6	MT	PARADISE	TRAIN	BN	INDUSTRIAL	INDUSTRIAL	FLAT	I/C	
6	MT	PLAINS	TRAIN	BN	SMALL INDUS.	RESIDENTIAL	FLAT		
6	MT	PLENTYWOOD	TRAIN	BN	SMALL INDUS.	RESIDENTIAL	FLAT		
6	MT	RINGLING	STATION	BN	SMALL INDUS.	AGRICULTURAL	FLAT		
6	MT	ROUNDUP	TRAIN	CMSP	SMALL INDUS.	AGRICULTURAL	FLAT		
6	MT	SCOBEE	TRAIN	BN	SMALL INDUS.	RESIDENTIAL	FLAT		
6	MT	SHELBY	TRAIN	BN	SMALL INDUS.	AGRICULTURAL	FLAT		
6	MT	STONE	TRAIN	BN	SMALL INDUS.	RESIDENTIAL	FLAT		
6	MT	SILVER BOW	TRANSFER	BN	SMALL INDUS.	RESIDENTIAL	FLAT		
6	MT	SILVER BOW	TRANSFER	CMSP	SMALL INDUS.	INDUSTRIAL	FLAT	I/C	
6	MT	SILVER BOW	TRANSFER	UP	SMALL INDUS.	INDUSTRIAL	FLAT	I/C	
6	MT	SILVER BOW	TRANSFER	UP	SMALL INDUS.	INDUSTRIAL	FLAT	I/C	

76/07/08.

REG.	ST.	CITY	YARD	RAIL-ROAD	YARD FUNCTION	LOCATION TYPE	YARD TYPE	I/C	MAJOR YARD IF MULTI-YARD COMPLEX
6	MT	SWEET GRASS	TRANSFER	BN	SMALL INDUS.	RESIDENTIAL	FLAT	1/C	
6	MT	THOMPSON FALLS	TRAIN	BN	SMALL INDUS.	RESIDENTIAL	FLAT	1/C	
6	MT	THREE FORKS	STATION	BN	INDUSTRIAL	RESIDENTIAL	FLAT	1/C	
6	AT	THREE FORKS	TRAIN	CNSPP	SMALL INDUS.	RESIDENTIAL	FLAT	1/C	
6	MT	WHITE SULPHUR SPR.	TRAIN	MSVP	SMALL INDUS.	RESIDENTIAL	FLAT	1/C	
6	MT	WHITEFISH	TRAIN	BN	CLASS./INDUS.	RESIDENTIAL	FLAT	1/C	
6	MT	WHITETAIL	STATION	SOU	SMALL INDUS.	RESIDENTIAL	FLAT	1/C	
6	MT	WOLF POINT	STATION	BN	SMALL INDUS.	RESIDENTIAL	FLAT	1/C	
8	NE	ALLIANCE	DIESEL TEPH.	BN	CLASS./INDUS.	UNDEVELOPED	FLAT	1/C	
8	NE	ASHLAND	TRAIN	BN	SMALL INDUS.	RESIDENTIAL	FLAT	1/C	
8	NE	BEATRICE	HOAC	BN	INDUSTRIAL	COMMERCIAL	FLAT	1/C	
8	NE	BEATRICE	TRAIN	HW	INDUSTRIAL	RESIDENTIAL	FLAT	1/C	
8	NE	BEATRICE	TRAIN	CRIP	SMALL INDUS.	RESIDENTIAL	FLAT	1/C	
8	NE	BEATRICE	TRAIN	UP	INDUSTRIAL	COMMERCIAL	FLAT	1/C	
8	NE	CENTRAL CITY	TRAIN	BN	SMALL INDUS.	RESIDENTIAL	FLAT	1/C	
8	NE	CENTRAL CITY	TRAIN	UP	SMALL INDUS.	RESIDENTIAL	FLAT	1/C	
8	NE	COLUMBUS	TRAIN	BN	SMALL INDUS.	RESIDENTIAL	FLAT	1/C	
8	NE	COZAD	TRAIN	UP	INDUSTRIAL	COMMERCIAL	FLAT	1/C	
8	NE	CRETE	TRAIN	BN	SMALL INDUS.	RESIDENTIAL	FLAT	1/C	
8	NE	DAVID CITY	TRAIN	MP	SMALL INDUS.	RESIDENTIAL	FLAT	1/C	
8	NE	DAVID CITY	TRAIN	BN	SMALL INDUS.	RESIDENTIAL	FLAT	1/C	
8	NE	ENDICOTT	TRAIN	UP	SMALL INDUS.	RESIDENTIAL	FLAT	1/C	
8	NE	FAIRBURY	TRAIN	BN	SMALL INDUS.	RESIDENTIAL	FLAT	1/C	
8	NF	FAIRBURY	TRAIN	UP	SMALL INDUS.	RESIDENTIAL	FLAT	1/C	
8	NE	FAIRMONT	TRAIN	CRIP	INDUSTRIAL	RESIDENTIAL	FLAT	1/C	
8	NE	FALLS CITY	TRAIN	BN	INDUSTRIAL	COMMERCIAL	FLAT	1/C	
8	NE	FREMONT	TRAIN	BN	CLASS./INDUS.	RESIDENTIAL	FLAT	1/C	
8	NF	FREMONT	FREIGHT HOUSE	CNW	CLASS./INDUS.	RESIDENTIAL	FLAT	1/C	
8	NF	FREMONT	TRAIN	UP	INDUSTRIAL	COMMERCIAL	FLAT	1/C	
8	NE	GERING	ENGINE HOUSE	UP	SMALL INDUS.	AGRICULTURAL	FLAT	1/C	
8	NE	GRAND ISLAND	TRAIN	BN	CLASS./INDUS.	INDUSTRIAL	FLAT	1/C	
8	NE	GRAND ISLAND	TRAIN	UP	CLASS./INDUS.	COMMERCIAL	FLAT	1/C	
8	NE	HASTINGS	GAINES	BN	CLASS./INDUS.	COMMERCIAL	FLAT	1/C	
8	NE	HASTINGS	TRAIN	MP	SMALL INDUS.	RESIDENTIAL	FLAT	1/C	
8	NE	HASTINGS	TRAIN	UP	INDUSTRIAL	RESIDENTIAL	FLAT	1/C	
8	NE	HOLDREGE	TRAIN	BN	SMALL INDUS.	RESIDENTIAL	FLAT	1/C	
8	NE	KEARNEY	TRAIN	RY	INDUSTRIAL	COMMERCIAL	FLAT	1/C	
8	NE	KEARNEY	TRAIN	UP	INDUSTRIAL	COMMERCIAL	FLAT	1/C	
8	NE	LEXINGTON	TRAIN	UP	SMALL INDUS.	RESIDENTIAL	FLAT	1/C	
8	NE	LEXINGTON	E-B. HUMP	BN	CLASS./INDUS.	UNDEVELOPED	HUMP	1/C	
8	NE	LINCOLN	TRAIN	CRIP	INDUSTRIAL	INDUSTRIAL	FLAT	1/C	
8	NE	LINCOLN	TRAIN	MP	INDUSTRIAL	COMMERCIAL	FLAT	1/C	
8	NE	LINCOLN	TRAIN	OLB	INDUSTRIAL	INDUSTRIAL	FLAT	1/C	
8	NE	LINCOLN	TRAIN	UP	INDUSTRIAL	COMMERCIAL	FLAT	1/C	
8	NE	LINCOLN	FREIGHT STATION	CNW	SMALL INDUS.	AGRICULTURAL	FLAT	1/C	
8	NE	LONG PINE	TRAIN	BN	SMALL INDUS.	RESIDENTIAL	FLAT	1/C	
8	NE	LOUISVILLE	TRAIN	CRIP	INDUSTRIAL	RESIDENTIAL	FLAT	1/C	
8	NE	LOUISVILLE	TRAIN	MP	INDUSTRIAL	RESIDENTIAL	FLAT	1/C	
8	NE	LOUISVILLE	TRAIN	BN	INDUSTRIAL	RESIDENTIAL	FLAT	1/C	
8	NE	MC CORD	TRAIN	BN	INDUSTRIAL	COMMERCIAL	FLAT	1/C	
8	NE	NEBRASKA CITY	TRAIN	SN	INDUSTRIAL	RESIDENTIAL	FLAT	1/C	
8	NE	NEBRASKA CITY	TRAIN	MP	SMALL INDUS.	RESIDENTIAL	FLAT	1/C	

76/07/08.

REG.	ST.	CITY	YARD	RAIL-ROAD	YARD FUNCTION	LOCATION TYPE	YARD TYPE	1/C	MAJOR YARD IF MULTI-YARD COMPLEX
1	NH	NORTH WALPOLE	BELLOWS FALLS	GMRC	CLASS./INDUS.	COMMERCIAL	FLAT		
1	NH	NORTH WALPOLE	TRAIN	GMRC	CLASS./INDUS.	COMMERCIAL	FLAT		
1	NH	PORTSMOUTH	PORTSMOUTH	BM	INDUSTRIAL	COMMERCIAL	FLAT		
2	NJ	ATLANTIC CITY	ATLANTIC CITY	PRSL	SMALL INDUS.	RESIDENTIAL	FLAT		
1	NJ	ATLANTIC CITY	BEESLEY'S POINT	PRSL	SMALL INDUS.	INDUSTRIAL	FLAT		
1	NJ	BARITAN	BARITAN	CNJ	INDUSTRIAL	RESIDENTIAL	FLAT		
1	NJ	BAYDNNE	8TH STREET	CNJ	INDUSTRIAL	INDUSTRIAL	FLAT	1/C	
1	NJ	BAYDNNE	SYSTEM*8AYDNNE	EJR	INDUSTRIAL	INDUSTRIAL	FLAT	1/C	
1	NJ	BODMONT	BODMONT	EL	SMALL INDUS.	RESIDENTIAL	FLAT	1/C	
1	NJ	BROOK BROOK	BROOK BROOK	CNJ	SMALL INDUS.	COMMERCIAL	FLAT	1/C	
2	NJ	BRIDGETON	BRIDGETON	CNJ	INDUSTRIAL	RESIDENTIAL	FLAT	1/C	
2	NJ	BRIDGETON	BRIDGETON JCT.	CNJ	INDUSTRIAL	AGRICULTURAL	FLAT	1/C	
2	NJ	BRIDGETON	BRIDGETON JCT.	PRSL	SMALL INDUS.	RESIDENTIAL	FLAT	1/C	
2	NJ	BRIDGETON	BRIDGETON JCT.	PRSL	SMALL INDUS.	RESIDENTIAL	FLAT	1/C	
2	NJ	BURLINGTON	BURLINGTON	PC	SMALL INDUS.	INDUSTRIAL	FLAT		
2	NJ	CAMDEN	CAMDEN	PC	SMALL INDUS.	INDUSTRIAL	FLAT		
2	NJ	CAMDEN	PAVENIA	PC	CLASS./INDUS.	INDUSTRIAL	H/WP	1/C	PAVENIA
2	NJ	CAMDEN	BULSON ST.	PRSL	INDUSTRIAL	INDUSTRIAL	FLAT	1/C	PAVENIA
2	NJ	CAMDEN	BULSON	RDG	SMALL INDUS.	INDUSTRIAL	FLAT	1/C	
2	NJ	CAMDEN	CAPE MAY	PRSL	SMALL INDUS.	RESIDENTIAL	FLAT		
2	NJ	CAMDEN	CAPE MAY	PRSL	SMALL INDUS.	INDUSTRIAL	FLAT		
2	NJ	CAMDEN	CARNEYS POINT	PRSL	SMALL INDUS.	COMMERCIAL	FLAT		
1	NJ	CRANFORD	CRANFORD	CNJ	INDUSTRIAL	COMMERCIAL	FLAT	1/C	
1	NJ	DOVER	DOVER	EL	INDUSTRIAL	COMMERCIAL	FLAT		
1	NJ	EDGEWATER	EDGEWATER	NYSM	INDUSTRIAL	INDUSTRIAL	FLAT		
1	NJ	ELIZABETH	ELIZABETHPORT	CNJ	CLASS./INDUS.	INDUSTRIAL	FLAT		
2	NJ	GIBBSTOWN	GIBBSTOWN	PRSL	SMALL INDUS.	INDUSTRIAL	FLAT		
1	NJ	HARRISON	TRAIN	EL	SMALL INDUS.	INDUSTRIAL	FLAT	1/C	
1	NJ	HARRISON	HUDSON	PC	INDUSTRIAL	INDUSTRIAL	FLAT	1/C	
1	NJ	HIGHTSTOWN	HIGHTSTOWN	UTR	SMALL INDUS.	INDUSTRIAL	FLAT	1/C	
1	NJ	HOBOKEN	FREIGHT	EL	CLASS./INDUS.	AGRICULTURAL	FLAT		
1	NJ	HOBOKEN	SYSTEM	HBS	INDUSTRIAL	INDUSTRIAL	FLAT		
1	NJ	HOBOKEN	FREIGHT	CNJ	INDUSTRIAL	COMMERCIAL	FLAT		
1	NJ	JERSEY CITY	CROXTON	EL	CLASS./INDUS.	UNDEVELOPED	FLAT		
1	NJ	JERSEY CITY	PAVENIA	EL	SMALL INDUS.	INDUSTRIAL	FLAT		
1	NJ	JERSEY CITY	EAST CLAREMONT	LV	INDUSTRIAL	INDUSTRIAL	FLAT	1/C	
1	NJ	JERSEY CITY	JERSEY CITY	LV	INDUSTRIAL	INDUSTRIAL	FLAT	1/C	
1	NJ	JERSEY CITY	MARION	NYSM	SMALL INDUS.	INDUSTRIAL	FLAT	1/C	
1	NJ	JERSEY CITY	GREENVILLE	PC	CLASS./INDUS.	INDUSTRIAL	FLAT	1/C	
1	NJ	JERSEY CITY	HARINUS COVE	PC	INDUSTRIAL	COMMERCIAL	FLAT	1/C	
1	NJ	JERSEY CITY	MARION	PC	SMALL INDUS.	INDUSTRIAL	FLAT	1/C	
1	NJ	JERSEY CITY	MEADOWS	PC	CLASS./INDUS.	INDUSTRIAL	FLAT	1/C	MEADOWS
1	NJ	JERSEY CITY	MEADOWS	RV	CLASS./INDUS.	COMMERCIAL	FLAT	1/C	MEADOWS
1	NJ	KENILWORTH	SYSTEM	PC	INDUSTRIAL	COMMERCIAL	FLAT	1/C	
1	NJ	LINDEN	STILES STREET	PC	INDUSTRIAL	INDUSTRIAL	FLAT	1/C	
1	NJ	LITTLE FERRY	LITTLE FERRY	NYSM	CLASS./INDUS.	INDUSTRIAL	FLAT	1/C	
1	NJ	LITTLE FERRY	LITTLE FERRY	PC	INDUSTRIAL	INDUSTRIAL	FLAT	1/C	
1	NJ	MAHWAH	BELLMANS	EL	INDUSTRIAL	INDUSTRIAL	FLAT	1/C	
1	NJ	MAHWAH	FORD	EL	INDUSTRIAL	INDUSTRIAL	FLAT	1/C	
1	NJ	MANVILLE	MANVILLE	RDG	INDUSTRIAL	COMMERCIAL	FLAT	1/C	
1	NJ	METUCHEN	FORD	PC	INDUSTRIAL	INDUSTRIAL	FLAT	1/C	
2	NJ	MILLVILLE	MILLVILLE	PRSL	INDUSTRIAL	INDUSTRIAL	FLAT		
1	NJ	MORRISTOWN	MORRISTOWN	ME	INDUSTRIAL	INDUSTRIAL	FLAT	1/C	
1	NJ	NEWARK	SHILLS	CNJ	INDUSTRIAL	COMMERCIAL	FLAT		
1	NJ	NEWARK	NEWARK	CNJ	INDUSTRIAL	INDUSTRIAL	FLAT		
1	NJ	NEWARK	FREIGHT HOUSE	LV	INDUSTRIAL	COMMERCIAL	FLAT		

76/077.03.

REG.	ST.	CITY	YARD	RAIL-ROAD	YARD FUNCTION	LOCATION TYPE	YARD TYPE	1/C	MAJDP YARD IF MULTI-YARD COMPLEX
1	NJ	NEWARK	PAK ISLAND	LV	CLASS./INDUS.	INDUSTRIAL	HUMP		
1	NJ	NEWARK	WAVERLY	PC	SMALL INDUS.	UNDEVELOPED	FLAT		
2	NJ	NEWPORT	NEWFURT	CNJ	CLASS./INDUS.	INDUSTRIAL	FLAT		
1	NJ	NORTH BERGEN	NORTH BERGEN	PC	CLASS./INDUS.	INDUSTRIAL	FLAT		
1	NJ	OLD BRIDGE	BROWNS	PC	CLASS./INDUS.	INDUSTRIAL	FLAT		
2	NJ	PATERSON	PALERMO	PRSL	SMALL INDUS.	AGRICULTURAL	FLAT		
1	NJ	PATERSON	IRON HOLE	EL	INDUSTRIAL	INDUSTRIAL	FLAT		
2	NJ	PAULSDORF	PAULSDORF	PRSL	SMALL INDUS.	INDUSTRIAL	FLAT		
2	NJ	PENNS GROVE	PENNS GROVE	PRSL	SMALL INDUS.	INDUSTRIAL	FLAT		
1	NJ	PERTH AMBOY	PERTH AMBOY	LV	CLASS./INDUS.	INDUSTRIAL	FLAT	1/C	
1	NJ	PHILLIPSBURG	TRAIN	CNJ	CLASS./INDUS.	COMMERCIAL	FLAT	1/C	
1	NJ	PHILLIPSBURG	HUDSON	LHR	INDUSTRIAL	RESIDENTIAL	FLAT	1/C	
1	NJ	PHILLIPSBURG	PHILLIPSBURG	PC	INDUSTRIAL	RESIDENTIAL	FLAT	1/C	
1	NJ	PHILLIPSBURG	PHILLIPSBURG	PC	CLASS./INDUS.	INDUSTRIAL	FLAT	1/C	PHILLIPSBURG
1	NJ	PHILLIPSBURG	PORT READING	RDG	CLASS./INDUS.	INDUSTRIAL	FLAT	1/C	PHILLIPSBURG
1	NJ	RED BANK	TRAIN	CNJ	CLASS./INDUS.	COMMERCIAL	FLAT		
2	NJ	SALEN	SALEN	PRSL	INDUSTRIAL	AGRICULTURAL	FLAT		
1	NJ	SOUTH AMBOY	JOHN STREET	JOINT	INDUSTRIAL	COMMERCIAL	FLAT	1/C	
1	NJ	SOUTH AMBOY	SOUTH AMBOY	JOINT	INDUSTRIAL	COMMERCIAL	FLAT	1/C	
1	NJ	SOUTH AMBOY	SOUTH AMBOY	PC	INDUSTRIAL	INDUSTRIAL	FLAT		
1	NJ	SOUTH PLAINFIELD	TRAIN	LV	INDUSTRIAL	COMMERCIAL	FLAT		
2	NJ	TRENTON	BARBACKS	PC	INDUSTRIAL	INDUSTRIAL	FLAT		
2	NJ	TRENTON	COALPORT	PC	INDUSTRIAL	INDUSTRIAL	FLAT		
2	NJ	TRENTON	TRENTON	RDG	SMALL INDUS.	INDUSTRIAL	FLAT		
1	NJ	WEHAWKEN	FREIGHT	PC	CLASS./INDUS.	INDUSTRIAL	FLAT		
2	NJ	WEST TRENTON	WEST TRENTON	RDG	INDUSTRIAL	INDUSTRIAL	FLAT		
2	NJ	WINSLOW	WINSLOW	CNJ	SMALL INDUS.	AGRICULTURAL	FLAT	1/C	
2	NJ	WINSLOW	WINSLOW JCT.	PRSL	SMALL INDUS.	AGRICULTURAL	FLAT	1/C	
5	NM	ALBUQUERQUE	ABAJO	ATSF	CLASS./INDUS.	INDUSTRIAL	FLAT		
5	NM	APTESIA	TRAIN	ATSF	SMALL INDUS.	INDUSTRIAL	FLAT		
5	NM	BELEN	BELEN	ATSF	CLASS./INDUS.	COMMERCIAL	FLAT		
5	NM	CARLSBAD	NEW TRAIN	ATSF	CLASS./INDUS.	AGRICULTURAL	FLAT		NEW TRAIN
5	NM	CARLSHAD	OLD TRAIN	ATSF	CLASS./INDUS.	COMMERCIAL	FLAT		NEW TRAIN
5	NM	CLOVIS	CLOVIS	ATSF	SMALL INDUS.	RESIDENTIAL	FLAT		
5	NM	DEMING	TRAIN	ATSF	SMALL INDUS.	COMMERCIAL	FLAT	1/C	
5	NM	DEMING	TRAIN	SP	SMALL INDUS.	COMMERCIAL	FLAT	1/C	
5	NM	GALLUP	GALLUP	ATSF	INDUSTRIAL	COMMERCIAL	FLAT		
5	NM	HURLEY	TRAIN	ATSF	SMALL INDUS.	INDUSTRIAL	FLAT		
5	NM	LAS CRUCES	TRAIN	ATSF	SMALL INDUS.	COMMERCIAL	FLAT		
5	NM	LAS VEGAS	DEPOT	ATSF	SMALL INDUS.	COMMERCIAL	FLAT		
5	NM	LORDSBURG	TRAIN	SP	SMALL INDUS.	COMMERCIAL	FLAT		
8	NM	RATON	TRAIN	ATSF	SMALL INDUS.	INDUSTRIAL	FLAT		
5	NM	PINCON	TRAIN	ATSF	SMALL INDUS.	UNDEVELOPED	FLAT		
5	NM	ROSMELL	TRAIN	ATSF	SMALL INDUS.	AGRICULTURAL	FLAT		
5	NM	SANTA FE	DEPOT	ATSF	SMALL INDUS.	COMMERCIAL	FLAT		
5	NM	SANTA RITA	TRAIN	ATSF	SMALL INDUS.	INDUSTRIAL	FLAT		
5	NM	SOCORRO	TRAIN	ATSF	SMALL INDUS.	AGRICULTURAL	FLAT		
5	NM	TUCUMCARI	TRAIN	CATP	CLASSIFICATION	COMMERCIAL	FLAT	1/C	
5	NM	WHITEWATER	TRAIN	ATSF	SMALL INDUS.	UNDEVELOPED	FLAT		
1	NY	ADDISON	TRAIN	EL	SMALL INDUS.	RESIDENTIAL	FLAT	1/C	
1	NY	ALBANY	PORT OF ALBANY	ADD	INDUSTRIAL	INDUSTRIAL	FLAT	1/C	
1	NY	ALBANY	KENWOOD	DH	CLASS./INDUS.	INDUSTRIAL	FLAT	1/C	

76/07/08.

REG.	ST.	CITY	YARD	RAIL-ROAD	YARD FUNCTION	LOCATION TYPE	YARD TYPE	T/C	MAJOR YARD TYPE
1	NY	ALBANY	NJ- ALBANY	DH	INDUSTRIAL	COMMERCIAL	FLAT		SELKTPK
1	NY	ALBANY	WEST ALSANY	PC	INDUSTRIAL	COMMERCIAL	FLAT		
1	NY	AMSTERDAM	AMSTERDAM	PC	INDUSTRIAL	COMMERCIAL	FLAT	1/C	
1	NY	ARCADIA	TRAYN	ARA	INDUSTRIAL	RESIDENTIAL	FLAT	1/C	
1	NY	AUBURN	AUBURN	LV	INDUSTRIAL	COMMERCIAL	FLAT	1/C	
1	NY	AUBURN	AUBURN	PC	INDUSTRIAL	COMMERCIAL	FLAT	1/C	
1	NY	UATAVIA	RATAVIA	PC	CLASS-7/INDUS.	COMMERCIAL	FLAT	1/C	
1	NY	BEACON	TRAIN	PC	INDUSTRIAL	COMMERCIAL	FLAT	1/C	
1	NY	BINGHAMTON	YD	DH	CLASS-7/INDUS.	COMMERCIAL	FLAT	1/C	00
1	NY	BINGHAMTON	QJ	EL	CLASS-7/INDUS.	COMMERCIAL	FLAT	1/C	00
1	NY	BINGHAMTON	WF	EL	INDUSTRIAL	COMMERCIAL	FLAT	1/C	00
1	NY	BINGHAMTON	YD	EL	INDUSTRIAL	COMMERCIAL	FLAT	1/C	
1	NY	BREWSTER	BREWSTER	PC	SMALL INDUS.	COMMERCIAL	FLAT	1/C	
1	NY	BROOKLYN	AFF TERMINALS	NYD	INDUSTRIAL	INDUSTRIAL	FLAT	1/C	
1	NY	BROOKLYN	SYSTEM	SKB	INDUSTRIAL	INDUSTRIAL	FLAT	1/C	
1	NY	BUFFALO	TURNPIKE	BCK	INDUSTRIAL	INDUSTRIAL	FLAT	1/C	
1	NY	BUFFALO	ABBLT ROAD	EL	INDUSTRIAL	COMMERCIAL	FLAT	1/C	
1	NY	BUFFALO	BLACK ROCK	EL	INDUSTRIAL	COMMERCIAL	FLAT	1/C	
1	NY	BUFFALO	CANADA	EL	INDUSTRIAL	COMMERCIAL	FLAT	1/C	
1	NY	BUFFALO	EAST BUFFALO	EL	INDUSTRIAL	COMMERCIAL	FLAT	1/C	
1	NY	BUFFALO	HAMBURG STREET	EL	INDUSTRIAL	COMMERCIAL	FLAT	1/C	BISON
1	NY	BUFFALO	NIAGARA FOOD TERM	EL	INDUSTRIAL	COMMERCIAL	FLAT	1/C	BISON
1	NY	BUFFALO	EAST BUFFALO	JOINT	CLASS-7/INDUS.	COMMERCIAL	HUMP	1/C	BISON
1	NY	BUFFALO	TIFFT TERMINAL	LV	INDUSTRIAL	COMMERCIAL	FLAT	1/C	TIFFT TERMINAL
1	NY	BUFFALO	TIFFT JCT.	LV	CLASS-7/INDUS.	UNDEVELOPED	FLAT	1/C	TIFFT TERMINAL
1	NY	BUFFALO	TIFFT EB&WH	NW	INDUSTRIAL	INDUSTRIAL	FLAT	1/C	
1	NY	BUFFALO	WEST SENECA	NW	INDUSTRIAL	COMMERCIAL	FLAT	1/C	
1	NY	BUFFALO	ALABAMA	PC	INDUSTRIAL	COMMERCIAL	FLAT	1/C	FRONTIER
1	NY	BUFFALO	BABCOCK ST.	PC	INDUSTRIAL	COMMERCIAL	FLAT	1/C	FRONTIER
1	NY	BUFFALO	BURDOWS LOT	PC	INDUSTRIAL	COMMERCIAL	FLAT	1/C	FRONTIER
1	NY	BUFFALO	CARROLL STREET	PC	INDUSTRIAL	COMMERCIAL	FLAT	1/C	FRONTIER
1	NY	BUFFALO	FRONTIER	PC	CLASS-7/INDUS.	INDUSTRIAL	FLAT	1/C	
1	NY	BUFFALO	HARRIET	PC	INDUSTRIAL	RESIDENTIAL	HUMP		
1	NY	BUFFALO	KENMORE	PC	CLASS-7/INDUS.	INDUSTRIAL	FLAT		
1	NY	BUFFALO	LOUISIANA	PC	INDUSTRIAL	COMMERCIAL	FLAT		
1	NY	BUFFALO	PENN	PC	INDUSTRIAL	COMMERCIAL	FLAT		
1	NY	BUFFALO	SENECA	PC	CLASS-7/INDUS.	INDUSTRIAL	FLAT	1/C	
1	NY	BUFFALO	SOUTH BUFFALO	PC	INDUSTRIAL	COMMERCIAL	FLAT	1/C	
1	NY	BUFFALO	STOCK	PC	INDUSTRIAL	COMMERCIAL	FLAT	1/C	
1	NY	BUFFALO	TINAMANDA	PC	INDUSTRIAL	INDUSTRIAL	FLAT	1/C	
1	NY	BUFFALO	SYSTEM 4	SB	INDUSTRIAL	INDUSTRIAL	FLAT		
1	NY	CARTHAGE	CARTHAGE	PC	SMALL INDUS.	AGRICULTURAL	FLAT		
1	NY	CARTHAGE	CHATHAM	PC	SMALL INDUS.	RESIDENTIAL	FLAT		
1	NY	COHOES	COHOES	DH	INDUSTRIAL	INDUSTRIAL	FLAT		
1	NY	COLOMBIE	COLOMBIE	DH	CLASS-7/INDUS.	INDUSTRIAL	FLAT		
1	NY	COOPERSTOWN	COOPERSTOWN	CACV	INDUSTRIAL	AGRICULTURAL	FLAT	1/C	
1	NY	COENING	GANG MILLS	EL	INDUSTRIAL	AGRICULTURAL	FLAT		
1	NY	CORNING	COENING	PC	CLASSIFICATION	UNDEVELOPED	FLAT		
1	NY	CORNING	NORTH	PC	INDUSTRIAL	UNDEVELOPED	FLAT	1/C	
1	NY	CHUTUN-HARMON	WEST	PC	INDUSTRIAL	RESIDENTIAL	FLAT	1/C	
1	NY	DANVILLE	TSAIN	GM	INDUSTRIAL	RESIDENTIAL	FLAT	1/C	
1	NY	DUNKIRK	DUNKIRK	PC	INDUSTRIAL	COMMERCIAL	FLAT	1/C	
1	NY	EAST SALAMANCA	EAST SALAMANCA	MJ	CLASS-7/INDUS.	AGRICULTURAL	FLAT	1/C	

76/07/08.

REG.	ST.	CITY	YARD	RAIL-ROAD	YARD FUNCTION	LOCATION TYPE	YARD TYPE	I/C	MAJDE YARD IF MULTI-YARD COMPLEX
1	NY	ELMIRA	ELMIRA	EL	CLASS./INDUS.	COMMERCIAL	FLAT		
1	NY	ENDICOTT	ENDICOTT	EL	INDUSTRIAL	INDUSTRIAL	FLAT		
1	NY	FORT EDWARD	FORT EDWARD	DH	INDUSTRIAL	UNDEVELOPED	FLAT		
1	NY	FULTON	FULTON	PC	INDUSTRIAL	INDUSTRIAL	FLAT		
1	NY	GENEVA	GENEVA	LV	SMALL INDUS.	COMMERCIAL	FLAT	1/C	
1	NY	GENEVA	GENEVA	PC	INDUSTRIAL	COMMERCIAL	FLAT	1/C	
1	NY	GLEN FALLS	FREIGHT	DH	SMALL INDUS.	COMMERCIAL	FLAT		
1	NY	GLENVILLE	GLENVILLE	DH	CLASS./INDUS.	COMMERCIAL	FLAT		
1	NY	GLOVERSVILLE	GLOVERSVILLE	FJG	INDUSTRIAL	RESIDENTIAL	FLAT	1/C	
1	NY	GOVERNEUR	GOVERNEUR	PC	CLASS./INDUS.	AGRICULTURAL	FLAT		
1	NY	GOWANDA	GOWANDA	FL	SMALL INDUS.	COMMERCIAL	FLAT		
1	NY	GREEN ISLAND	GREEN ISLAND	DH	INDUSTRIAL	INDUSTRIAL	FLAT		
1	NY	GREENWICH	GREENWICH	GJ	INDUSTRIAL	RESIDENTIAL	FLAT	1/C	
1	NY	GREIGSWILF	EL	EL	SMALL INDUS.	RESIDENTIAL	FLAT		
1	NY	GRDWELAND	TRAIN	EL	SMALL INDUS.	AGRICULTURAL	FLAT		
1	NY	HAMMONDSPORT	TRAIN	DH	INDUSTRIAL	RESIDENTIAL	FLAT	1/C	
1	NY	HERKIMER	HERKIMER	PC	INDUSTRIAL	AGRICULTURAL	FLAT		
1	NY	HIGHLAND LAKES	HIGHLAND LAKES	PC	INDUSTRIAL	COMMERCIAL	FLAT	1/C	
1	NY	HILLBURN	FREIGHT	EL	SMALL INDUS.	AGRICULTURAL	FLAT		
1	NY	HORNELL	EASTBOUND	EL	SMALL INDUS.	COMMERCIAL	FLAT		
1	NY	HUDSON	HUDSON	PC	INDUSTRIAL	AGRICULTURAL	FLAT		
1	NY	ITHACA	ITHACA	LV	SMALL INDUS.	COMMERCIAL	FLAT		
1	NY	JAMESTOWN	TRAIN	EL	CLASS./INDUS.	COMMERCIAL	FLAT		
1	NY	JAMESVILLE	JAMESVILLE	EL	INDUSTRIAL	COMMERCIAL	FLAT	1/C	GENDES ST.
1	NY	KINGSTON	KINGSTON	PC	INDUSTRIAL	COMMERCIAL	FLAT		
1	NY	LEROY	TRAIN	PC	INDUSTRIAL	COMMERCIAL	FLAT		
1	NY	LIVONIA	LIVONIA	BD	SMALL INDUS.	AGRICULTURAL	FLAT	1/C	
1	NY	LOCKPORT	LOCKPORT	EL	INDUSTRIAL	AGRICULTURAL	FLAT	1/C	
1	NY	LORVILLE	LORVILLE	LRR	INDUSTRIAL	INDUSTRIAL	FLAT	1/C	
1	NY	MANCHESTER	MANCHESTER	LV	SMALL INDUS.	AGRICULTURAL	FLAT	1/C	
1	NY	MASSENA	MASSENA	WSTR	INDUSTRIAL	INDUSTRIAL	FLAT		
1	NY	MASSENA	MASSENA	PC	CLASS./INDUS.	INDUSTRIAL	FLAT	1/C	
1	NY	MAYBROOK	MAYBROOK	PC	CLASSIFICATION	AGRICULTURAL	FLAT	1/C	
1	NY	MECHANICVILLE	EAST/WESTBOUND	PC	CLASSIFICATION	AGRICULTURAL	FLAT	1/C	
1	NY	MECHANICVILLE	HUMP	BP	CLASSIFICATION	COMMERCIAL	HUMP	1/C	
1	NY	MIDDLETON	TRAIN	DH	SMALL INDUS.	COMMERCIAL	FLAT	1/C	
1	NY	MOUNT VERNON	MOUNT VERNON	MNJ	SMALL INDUS.	COMMERCIAL	FLAT	1/C	
1	NY	MOUNT VERNON	MOUNT VERNON	PC	SMALL INDUS.	COMMERCIAL	FLAT	1/C	
1	NY	NEW ROCHELLE	TRAIN	PC	SMALL INDUS.	RESIDENTIAL	FLAT		
1	NY	NEW YORK	BROOKLYN	HEDT	SMALL INDUS.	COMMERCIAL	FLAT		
1	NY	NEW YORK	26TH STREET	BD	INDUSTRIAL	INDUSTRIAL	FLAT	1/C	
1	NY	NEW YORK	28TH STREET	BD	INDUSTRIAL	COMMERCIAL	FLAT		
1	NY	NEW YORK	ARLINGTON-S.I.	EL	CLASS./INDUS.	COMMERCIAL	FLAT		
1	NY	NEW YORK	ST. GEORGE-S.I.	JTNT	INDUSTRIAL	INDUSTRIAL	FLAT		
1	NY	NEW YORK	9TH ST. I CITY	LI	INDUSTRIAL	INDUSTRIAL	FLAT		
1	NY	NEW YORK	"A" L.I. CITY	LI	CLASS./INDUS.	COMMERCIAL	FLAT	1/C	
1	NY	NEW YORK	FRESH POND	LI	INDUSTRIAL	COMMERCIAL	FLAT		
1	NY	NEW YORK	HOLBAN	LI	INDUSTRIAL	COMMERCIAL	FLAT	1/C	
1	NY	NEW YORK	37TH STREET	PC	INDUSTRIAL	COMMERCIAL	HUMP	1/C	
1	NY	NEW YORK	B.N.	PC	INDUSTRIAL	COMMERCIAL	FLAT		
1	NY	NEW YORK	URUNK TSPM. MKT.	PC	INDUSTRIAL	COMMERCIAL	FLAT		W. 72ND ST.
1	NY	NEW YORK	HARLEM RIVER	PC	INDUSTRIAL	COMMERCIAL	FLAT		OAK POINT
1	NY	NEW YORK	HUNTS POINT WKT.	PC	INDUSTRIAL	COMMERCIAL	FLAT		OAK POINT
1	NY	NEW YORK	OAK POINT	PC	CLASS./INDUS.	COMMERCIAL	FLAT		OAK POINT
1	NY	NEW YORK	OAK POINT	PC	CLASS./INDUS.	COMMERCIAL	FLAT		OAK POINT

76/07/38.

REG.	ST.	CITY	YARD	RAIL-ROAD	YARD FUNCTION	LOCATION TYPE	YARD TYPE	I/C	MAJOP YARD IF MULTI-YARD COMPLEX
1	NY	NEW YORK	PORT MORRIS	PC	INDUSTRIAL	COMMERCIAL	FLAT		OAK POINT
1	NY	NEW YORK	W. 33RD ST.	PC	INDUSTRIAL	COMMERCIAL	FLAT		W. 72ND ST.
1	NY	NEW YORK	W. 72ND ST.	PC	CLASS-/INDUS.	COMMERCIAL	FLAT		W. 72ND ST.
1	NY	NEW YORK	WESTCHESTER AVE.	PC	INDUSTRIAL	COMMERCIAL	FLAT		OAK POINT
1	NY	NEWARK	NEWARK	PC	INDUSTRIAL	AGRICULTURAL	FLAT		
1	NY	NEWBURGH	NEWBURGH	EL	SMALL INDUS.	COMMERCIAL	FLAT	I/C	
1	NY	NEWBURGH	NEWBURGH	PC	SMALL INDUS.	COMMERCIAL	FLAT	I/C	
1	NY	NIAGARA FALLS	SUSPENSION BRIDGE	EL	SMALL INDUS.	COMMERCIAL	FLAT		
1	NY	NIAGARA FALLS	SUSPENSION BRIDGE	LV	CLASS-/INDUS.	INDUSTRIAL	FLAT		
1	NY	NIAGARA FALLS	FOOTE ST.	LV	CLASS-/INDUS.	INDUSTRIAL	FLAT		
1	NY	NIAGARA FALLS	EASTROUND	PC	INDUSTRIAL	INDUSTRIAL	FLAT	I/C	
1	NY	NIAGARA FALLS	NIAGARA	PC	CLASS-/INDUS.	INDUSTRIAL	FLAT	I/C	
1	NY	NORFOLK	NORFOLK	NSL	INDUSTRIAL	AGRICULTURAL	FLAT		
1	NY	NORTH CREEK	NORTH CREEK	DH	INDUSTRIAL	INDUSTRIAL	FLAT		
1	NY	NO. TONAWANDA	NO. TONAWANDA	PC	INDUSTRIAL	INDUSTRIAL	FLAT		
1	NY	OAKFIELD	OAKFIELD	PC	INDUSTRIAL	COMMERCIAL	FLAT	I/C	
1	NY	OGDENSBURG	OGDENSBURG	PC	INDUSTRIAL	COMMERCIAL	FLAT		
1	NY	OLEAN	OLEAN	EL	SMALL INDUS.	COMMERCIAL	FLAT	I/C	
1	NY	OLEAN	OLEAN	PC	SMALL INDUS.	COMMERCIAL	FLAT	I/C	
1	NY	ONEIDA	ONEIDA	PC	SMALL INDUS.	COMMERCIAL	FLAT	I/C	
1	NY	ONEONTA	NORTH/SOUTH	DH	CLASS-/INDUS.	INDUSTRIAL	FLAT	I/C	
1	NY	OSWEGO	OSWEGO	EL	SMALL INDUS.	RESIDENTIAL	FLAT	I/C	
1	NY	OSWEGO	OSWEGO	PC	INDUSTRIAL	RESIDENTIAL	FLAT	I/C	
1	NY	PEESKILL	TRAIN	PC	SMALL INDUS.	COMMERCIAL	FLAT		
1	NY	PLATTSBURGH	BLUFF POINT	DH	SMALL INDUS.	COMMERCIAL	FLAT		
1	NY	PLATTSBURGH	PLATTSBURGH	DH	INDUSTRIAL	COMMERCIAL	FLAT		
1	NY	PORT CHESTER	TRAIN	PC	SMALL INDUS.	COMMERCIAL	FLAT		
1	NY	PORT HENRY	PORT HENRY	DH	SMALL INDUS.	COMMERCIAL	FLAT		
1	NY	PORT JERVIS	WEST/EASTBOUND	DH	INDUSTRIAL	COMMERCIAL	FLAT		
1	NY	POUGHKEEPSIE	POUGHKEEPSIE	PC	CLASS-/INDUS.	COMMERCIAL	FLAT		
1	NY	RENSELAER	HUDSON RIVER	PC	INDUSTRIAL	RESIDENTIAL	FLAT		SELKIPK
1	NY	ROCHESTER	TRAIN	GMR	INDUSTRIAL	INDUSTRIAL	FLAT	I/C	
1	NY	ROCHESTER	BROOKS AVE.	BD	CLASS-/INDUS.	COMMERCIAL	FLAT		BROOKS AVE.
1	NY	ROCHESTER	CHARLOTTE DOCK	BD	SMALL INDUS.	COMMERCIAL	FLAT		BROOKS AVE.
1	NY	ROCHESTER	LINCOLN PARK	BD	SMALL INDUS.	COMMERCIAL	FLAT	I/C	BROOKS AVE.
1	NY	ROCHESTER	W. SHORE JCT.	BD	SMALL INDUS.	COMMERCIAL	FLAT		BROOKS AVE.
1	NY	ROCHESTER	TERMINAL	EL	SMALL INDUS.	COMMERCIAL	FLAT	I/C	
1	NY	ROCHESTER	SURWAY INT.	JOINT	INDUSTRIAL	COMMERCIAL	FLAT	I/C	
1	NY	ROCHESTER	TERMINAL	LV	INDUSTRIAL	COMMERCIAL	FLAT	I/C	
1	NY	ROCHESTER	CHARLOTTE	PC	INDUSTRIAL	RESIDENTIAL	FLAT		STATE ST.
1	NY	ROCHESTER	GENESEE JCT.	PC	SMALL INDUS.	INDUSTRIAL	FLAT	I/C	STATE ST.
1	NY	ROCHESTER	GOODMAN ST.	PC	INDUSTRIAL	COMMERCIAL	FLAT		STATE ST.
1	NY	ROCHESTER	OTIS	PC	INDUSTRIAL	COMMERCIAL	FLAT		STATE ST.
1	NY	ROCHESTER	STATE ST.	PC	INDUSTRIAL	COMMERCIAL	FLAT		STATE ST.
1	NY	ROME	ROME	PC	INDUSTRIAL	COMMERCIAL	FLAT		
1	NY	ROUSE POINT	ROUSE POINT	CN	INDUSTRIAL	COMMERCIAL	FLAT		
1	NY	ROUSE POINT	ROUSE POINT	DH	CLASS-/INDUS.	COMMERCIAL	FLAT	I/C	
1	NY	SALAMANCA	TRAIN	DH	CLASS-/INDUS.	COMMERCIAL	FLAT		
1	NY	SARATOGA SPRINGS	SARATOGA	EL	INDUSTRIAL	COMMERCIAL	FLAT		
1	NY	SELKIRK	SAND BANK	PC	INDUSTRIAL	COMMERCIAL	FLAT		
1	NY	SELKIRK	PERLMAN HUMP	PC	CLASSIFICATION	AGRICULTURAL	HUMP		SELKIRK
1	NY	SKANEATELES	SKANEATELES	SSL	SMALL INDUS.	INDUSTRIAL	FLAT		
1	NY	STAR LAKE	ROSEN MINE	PC	CLASS-/INDUS.	INDUSTRIAL	FLAT		
1	NY	SUFFERN	FORB	EL	CLASSIFICATION	COMMERCIAL	FLAT		

76/07/05.

REG.	ST.	CITY	YARD	RAIL-ROAD	YARD FUNCTION	LOCATION TYPE	YARD TYPE	I/C	MAJOR YARD IF MULTI-YARD COMPLEX
1	NY	SYRACUSE	GEDDES ST.	FL	CLASS./INDUS.	INDUSTRIAL	FLAT	I/C	GEDDES ST.
1	NY	SYRACUSE	MIDDLE	EL	INDUSTRIAL	COMMERCIAL	FLAT	I/C	GEDDES ST.
1	NY	SYRACUSE	SOLVEY	EL	INDUSTRIAL	INDUSTRIAL	FLAT	I/C	GEDDES ST.
1	NY	SYRACUSE	STATION	EL	INDUSTRIAL	COMMERCIAL	FLAT	I/C	DEWITT
1	NY	SYRACUSE	DEWITT	PC	CLASSIFICATION	UNDEVELOPED	HUMP	I/C	DEWITT
1	NY	SYRACUSE	FLEXI-VAN DEWITT	PC	INDUSTRIAL	UNDEVELOPED	FLAT	I/C	DEWITT
1	NY	SYRACUSE	SALINA	PC	INDUSTRIAL	COMMERCIAL	FLAT	I/C	DEWITT
1	NY	TAHAMUS	TRAIN	PC	INDUSTRIAL	COMMERCIAL	FLAT	I/C	SFLKPK
1	NY	TROY	TROY	PC	INDUSTRIAL	INDUSTRIAL	FLAT	I/C	
1	NY	UTICA	UTICA	EL	CLASS./INDUS.	COMMERCIAL	FLAT	I/C	
1	NY	UTICA	FREIGHT	PC	CLASS./INDUS.	COMMERCIAL	FLAT	I/C	
1	NY	WARWICK	WARWICK	LHR	CLASS./INDUS.	AGRICULTURAL	FLAT	I/C	
1	NY	WATERTOWN	MASSEY	PC	CLASS./INDUS.	UNDEVELOPED	FLAT	I/C	
1	NY	WELLSVILLE	WELLSVILLE	PC	CLASS./INDUS.	UNDEVELOPED	FLAT	I/C	
1	NY	WHITEHALL	TRAIN	EL	SMALL INDUS.	RESIDENTIAL	FLAT	I/C	
1	NY	YONKERS	TUB MOUNTAIN	DH	CLASSIFICATION	COMMERCIAL	FLAT	I/C	
1	NY	YONKERS	YONKERS	PC	INDUSTRIAL	INDUSTRIAL	FLAT	I/C	W. 72ND ST.
3	NC	ADERDEFN	TRAIN	AR	SMALL INDUS.	RESIDENTIAL	FLAT		
3	NC	APEX	TRAIN	SCL	SMALL INDUS.	RESIDENTIAL	FLAT		
3	NC	APEX	TRAIN	DS	SMALL INDUS.	RESIDENTIAL	FLAT		
3	NC	ASHEVILLE	TRAIN	SOU	CLASSIFICATION	RESIDENTIAL	FLAT		
3	NC	BARBER	TRAIN	SOU	SMALL INDUS.	RESIDENTIAL	FLAT		
3	NC	BEAUFORT	TRAIN	BEAUM	INDUSTRIAL	COMMERCIAL	FLAT		
3	NC	BELMONT	TRAIN	SOU	SMALL INDUS.	RESIDENTIAL	FLAT		
3	NC	BUSTIC	TRAIN	JOINT	CLASSIFICATION	UNDEVELOPED	FLAT		
3	NC	BYSTON CITY	TRAIN	SOU	SMALL INDUS.	RESIDENTIAL	FLAT		
3	NC	RURLINGTON	TRAIN	SOU	SMALL INDUS.	RESIDENTIAL	FLAT		
3	NC	BURNSVILLE	TRAIN	YAN	SMALL INDUS.	RESIDENTIAL	FLAT		
3	NC	CANTON	TRAIN	SOU	SMALL INDUS.	RESIDENTIAL	FLAT		
3	NC	CHADBDURN	TRAIN	SCL	SMALL INDUS.	RESIDENTIAL	FLAT		
3	NC	CHARLOTTE	TRAIN	NS	CLASSIFICATION	AGRICULTURAL	FLAT	I/C	
3	NC	CHARLOTTE	EAST CHARLOTTE	SCL	INDUSTRIAL	UNDEVELOPED	FLAT	I/C	
3	NC	CHARLOTTE	PINCOCK	SCL	INDUSTRIAL	INDUSTRIAL	FLAT	I/C	
3	NC	CHARLOTTE	ARROWOOD	SOU	INDUSTRIAL	INDUSTRIAL	FLAT	I/C	
3	NC	CHARLOTTE	MAIN	SOU	INDUSTRIAL	INDUSTRIAL	FLAT	I/C	
3	NC	CHOCUMINITY	TRAIN	NS	INDUSTRIAL	INDUSTRIAL	FLAT		
3	NC	CLIFFSIDE	TRAIN	CLIF	INDUSTRIAL	RESIDENTIAL	FLAT		
3	NC	DUNN	TRAIN	DS	SMALL INDUS.	RESIDENTIAL	FLAT		
3	NC	DURHAM	TRAIN	DS	SMALL INDUS.	RESIDENTIAL	FLAT		
3	NC	DURHAM	TRAIN	DUKE	SMALL INDUS.	COMMERCIAL	FLAT		
3	NC	DURHAM	TRAIN	NW	CLASS./INDUS.	COMMERCIAL	FLAT		
3	NC	DURHAM	TRAIN	SCL	INDUSTRIAL	COMMERCIAL	FLAT		
3	NC	DURHAM	EAST DURHAM	SOU	SMALL INDUS.	COMMERCIAL	FLAT		
3	NC	FAYETTEVILLE	MILAN	SCL	INDUSTRIAL	RESIDENTIAL	FLAT		
3	NC	FORT BRAGG	HONEYCUTT MARSH	CFR	SMALL INDUS.	UNDEVELOPED	FLAT		
3	NC	GASTONIA	TRAIN	NS	SMALL INDUS.	RESIDENTIAL	FLAT		
3	NC	GASTONIA	TRAIN	SCL	INDUSTRIAL	RESIDENTIAL	FLAT		
3	NC	GASTONIA	TRAIN	SOU	SMALL INDUS.	UNDEVELOPED	FLAT		
3	NC	GOLDSDRFO	ROYALL	SCL	INDUSTRIAL	UNDEVELOPED	FLAT		
3	NC	GOLDSDRFO	TRAIN	SOU	SMALL INDUS.	UNDEVELOPED	FLAT		
3	NC	GOLDSRHO	TRAIN	SOU	SMALL INDUS.	UNDEVELOPED	FLAT		
3	NC	GPPFNSHORN	POMONA	SOU	CLASS./INDUS.	RESIDENTIAL	FLAT		
3	NC	HAWLET	HAWLET	SCL	CLASSIFICATION	UNDEVELOPED	HUMP		
3	NC	HENDERSON	TRAIN	SCL	INDUSTRIAL	RESIDENTIAL	FLAT		
3	NC	HENDERSON	TRAIN	SOU	SMALL INDUS.	RESIDENTIAL	FLAT		
3	NC	HICKORY	OYAMA	SOU	INDUSTRIAL	UNDEVELOPED	FLAT		

76/07/08.

REG.	ST.	CITY	YARD	RAIL-ROAD	YARD FUNCTION	LOCATION TYPE	YARD TYPE	I/C	MAJOR YARD IF MULTI-YARD COMPLEX
3	NC	HIGH POINT	TRAIN	HPTD	INDUSTRIAL	RESIDENTIAL	FLAT		
3	NC	KANNAPOLIS	TRAIN	SOU	INDUSTRIAL	RESIDENTIAL	FLAT		
3	NC	KINSTON	TRAIN	SOU	SMALL INDUS.	RESIDENTIAL	FLAT		
3	NC	KINSTON	TRAIN	AEC	SMALL INDUS.	RESIDENTIAL	FLAT		
3	NC	LAURINBURG	TRAIN	SCL	SMALL INDUS.	RESIDENTIAL	FLAT		
3	NC	LELAND	DAVIS	LPS	SMALL INDUS.	UNDEVELOPED	FLAT		
3	NC	LENOIR	TRAIN	SCL	INDUSTRIAL	UNDEVELOPED	FLAT		
3	NC	LILESVILLE	GRAVELTON	NS	SMALL INDUS.	INDUSTRIAL	FLAT		
3	NC	LUMBERTON	TRAIN	SCL	SMALL INDUS.	UNDEVELOPED	FLAT		
3	NC	MARION	CLINCHCROSS	SCL	SMALL INDUS.	RESIDENTIAL	FLAT		
3	NC	MARION	TRAIN	CCD	INDUSTRIAL	RESIDENTIAL	FLAT		
3	NC	MONROE	TRAIN	SOU	CLASS./INDUS.	RESIDENTIAL	FLAT		
3	NC	MOREHEAD CITY	TRAIN	SCL	SMALL INDUS.	UNDEVELOPED	FLAT		
3	NC	MORGANTON	TRAIN	AEC	SMALL INDUS.	RESIDENTIAL	FLAT		
3	NC	MOUNT HOLLY	DUTCHMAN	SOU	SMALL INDUS.	RESIDENTIAL	FLAT		
3	NC	MURPHY	INTERCHANGE	SCL	INDUSTRIAL	RESIDENTIAL	FLAT		
3	NC	NEW BERN	TRAIN	NS	INDUSTRIAL	RESIDENTIAL	FLAT	I/C	
3	NC	NEW BERN	TRAIN	SCL	SMALL INDUS.	RESIDENTIAL	FLAT		
3	NC	NEWTON	TRAIN	SOU	SMALL INDUS.	RESIDENTIAL	FLAT		
3	NC	PLYMOUTH	TRAIN	NS	SMALL INDUS.	RESIDENTIAL	FLAT		
3	NC	PLYMOUTH	HALEY	SCL	SMALL INDUS.	RESIDENTIAL	FLAT		
3	NC	RALEIGH	TRAIN	SCL	CLASS./INDUS.	COMMERCIAL	FLAT		
3	NC	RALEIGH	GLENWOOD	SOU	CLASS./INDUS.	COMMERCIAL	FLAT		
3	NC	REIDSVILLE	TRAIN	SOU	SMALL INDUS.	RESIDENTIAL	FLAT		
3	NC	REIDSVILLE	TRAIN	SCL	INDUSTRIAL	UNDEVELOPED	FLAT		
3	NC	ROANOKE RAPIDS	TRAIN	SCL	INDUSTRIAL	RESIDENTIAL	FLAT		
3	NC	ROCKINGHAM	TRAIN	SCL	SMALL INDUS.	RESIDENTIAL	FLAT		
3	NC	ROCKY MOUNT	TRAIN	SCL	CLASS./INDUS.	RESIDENTIAL	FLAT		
3	NC	SANFORD	TRAIN	SCL	SMALL INDUS.	RESIDENTIAL	FLAT		
3	NC	SANFORD	TRAIN	SOU	SMALL INDUS.	RESIDENTIAL	FLAT		
3	NC	SHELBY	TRAIN	SCL	SMALL INDUS.	RESIDENTIAL	FLAT		
3	NC	SHELBY	TRAIN	SOU	SMALL INDUS.	RESIDENTIAL	FLAT		
3	NC	SPENCER	TRAIN	SOU	CLASSIFICATION	UNDEVELOPED	FLAT		
3	NC	SPRUCE PINE	TRAIN	CCD	INDUSTRIAL	RESIDENTIAL	FLAT		
3	NC	STAR	TRAIN	NS	SMALL INDUS.	RESIDENTIAL	FLAT		
3	NC	STATESVILLE	TRAIN	ARC	SMALL INDUS.	RESIDENTIAL	FLAT		
3	NC	STATESVILLE	TRAIN	SOU	INDUSTRIAL	RESIDENTIAL	FLAT		
3	NC	STATESVILLE	TRAIN	SCL	INDUSTRIAL	RESIDENTIAL	FLAT		
3	NC	TARBORO	TRAIN	SCL	INDUSTRIAL	RESIDENTIAL	FLAT		
3	NC	TAYLORSVILLE	TRAIN	ARC	SMALL INDUS.	RESIDENTIAL	FLAT		
3	NC	TOPTON	TRAIN	SOU	SMALL INDUS.	RESIDENTIAL	FLAT		
3	NC	WADESBORO	TRAIN	SCL	INDUSTRIAL	UNDEVELOPED	FLAT	I/C	
3	NC	WADESBORO	TRAIN	WSS	INDUSTRIAL	UNDEVELOPED	FLAT	I/C	
3	NC	WARRENTON	TRAIN	WAR	SMALL INDUS.	RESIDENTIAL	FLAT		
3	NC	WASHINGTON	TRAIN	SCL	INDUSTRIAL	RESIDENTIAL	FLAT		
3	NC	WILMINGTON	NAVASSA	SCL	CLASS./INDUS.	UNDEVELOPED	FLAT		
3	NC	WILMINGTON	SMITHS CREEK	SCL	CLASS./INDUS.	UNDEVELOPED	FLAT		
3	NC	WILSON	TRAIN	NS	SMALL INDUS.	RESIDENTIAL	FLAT		
3	NC	WILSON	TRAIN	SCL	SMALL INDUS.	RESIDENTIAL	FLAT		
3	NC	WINSTON-SALEM	SALEM	SOU	INDUSTRIAL	RESIDENTIAL	FLAT		
3	NC	WINSTON-SALEM	SALEM	WSS	CLASSIFICATION	COMMERCIAL	FLAT		
3	NC	WINSTON-SALEM	NORTH WINSTON	WSS	CLASSIFICATION	COMMERCIAL	FLAT		
4	ND	BISMARCK	TRAIN	SOU	INDUSTRIAL	COMMERCIAL	FLAT	I/C	
4	ND	DEVILS LAKE	TRAIN	BN	INDUSTRIAL	COMMERCIAL	FLAT	I/C	

REG.	ST.	CITY	YARD	RAIL- ROAD	YARD FUNCTION	LOCATION TYPE	YARD TYPE	I/C	MAJOR YARD IF MULTI-YARD COMPLEX
4	ND	DRAKE	TRAIN	500	SMALL INDUS.	AGRICULTURAL	FLAT		
4	ND	ENDERLIN	TRAIN	500	INDUSTRIAL	COMMERCIAL	FLAT		
4	ND	FARGO	CITY	BN	INDUSTRIAL	INDUSTRIAL	FLAT		
4	ND	FARGO	FARGO JCT.	BN	CLASS./INDUS.	INDUSTRIAL	FLAT		
4	ND	FARGO	FARGO	CMSPP	SMALL INDUS.	COMMERCIAL	FLAT	I/C	
4	ND	GRAND FURKS	TRAIN	BN	CLASS./INDUS.	INDUSTRIAL	FLAT		
4	ND	HANKINSON	HANKINSON	500	SMALL INDUS.	AGRICULTURAL	FLAT		
4	ND	HARVEY	TRAIN	500	INDUSTRIAL	COMMERCIAL	FLAT		
4	ND	JAMESTOWN	TRAIN	BN	SMALL INDUS.	RESIDENTIAL	FLAT		
4	ND	MANDAN	TRAIN	BN	CLASS./INDUS.	COMMERCIAL	FLAT		
4	ND	MINOT	GAYIN	BN	CLASS./INDUS.	UNDEVELOPED	HUMP		
4	ND	MINOT	OLD	BN	INDUSTRIAL	COMMERCIAL	FLAT		
4	ND	MINOT	TRAIN	500	SMALL INDUS.	COMMERCIAL	FLAT		
4	ND	WILLISTON	TRAIN	BN	SMALL INDUS.	COMMERCIAL	FLAT		
2	OH	ADDYSTON	VALLEY	PC	SMALL INDUS.	RESIDENTIAL	FLAT		
2	OH	ADENA	ADENA	NW	INDUSTRIAL	RESIDENTIAL	FLAT		
2	OH	AKRON	BRITTAIN	ACV	CLASS./INDUS.	COMMERCIAL	FLAT	I/C	
2	OH	AKRON	HASEL	BO	INDUSTRIAL	COMMERCIAL	FLAT	I/C	HASEL
2	OH	AKRON	HILL	BO	CLASS./INDUS.	COMMERCIAL	FLAT		HASEL
2	OH	AKRON	VALLEY	BO	CLASS./INDUS.	COMMERCIAL	FLAT		HASEL
2	OH	AKRON	MC COY STREET	EL	CLASS./INDUS.	COMMERCIAL	FLAT	I/C	
2	OH	AKRON	MILL STREET	EL	INDUSTRIAL	INDUSTRIAL	FLAT		
2	OH	AKRON	SOUTH AKPCN	PC	CLASS./INDUS.	INDUSTRIAL	FLAT	I/C	
2	OH	AKRON	CITY	PC	INDUSTRIAL	COMMERCIAL	FLAT		
2	OH	ALLIANCE	TRAIN	PC	INDUSTRIAL	COMMERCIAL	FLAT		
2	OH	ANSONIA	TRAIN	PC	SMALL INDUS.	AGRICULTURAL	FLAT		
2	OH	ASHLAND	ASHLAND	EL	SMALL INDUS.	COMMERCIAL	FLAT		
2	OH	ASHTABULA	WEST	PC	CLASS./INDUS.	RESIDENTIAL	FLAT		
2	OH	ASHTABULA	CEICO	PC	INDUSTRIAL	INDUSTRIAL	FLAT		
2	OH	ASHTABULA	HARBOR	PC	INDUSTRIAL	RESIDENTIAL	FLAT		
2	OH	ATHENS	TRAIN	BO	SMALL INDUS.	COMMERCIAL	HUMP		
2	OH	ATHENS	HOUSE	CO	SMALL INDUS.	COMMERCIAL	FLAT	I/C	
2	OH	AUSTINBURG	TRAIN	PC	SMALL INDUS.	AGRICULTURAL	FLAT	I/C	
2	OH	HARBERTON	HARBERTON	ADR	INDUSTRIAL	COMMERCIAL	FLAT		
2	OH	HARBERTON	CASE	ABG	INDUSTRIAL	INDUSTRIAL	FLAT		
2	OH	HARBERTON	UPPER	EL	INDUSTRIAL	INDUSTRIAL	FLAT		
2	OH	BARNESVILLE	BARNESVILLE	BN	SMALL INDUS.	COMMERCIAL	FLAT		
2	OH	BELLEFONTAINE	EASTBOUND	PC	CLASS./INDUS.	RESIDENTIAL	FLAT		
2	OH	BELLEFONTAINE	GEST	PC	CLASS./INDUS.	RESIDENTIAL	FLAT		
2	OH	BELLEFONTAINE	EASTBOUND	PC	CLASS./INDUS.	RESIDENTIAL	HUMP		
2	OH	BELLEVEU	BLANCFE	BO	SMALL INDUS.	COMMERCIAL	FLAT		
2	OH	BLANCHESTER	BLANCHESTER	BO	SMALL INDUS.	AGRICULTURAL	FLAT		
2	OH	BRADFORD	BRADFORD	PC	SMALL INDUS.	AGRICULTURAL	FLAT		
2	OH	BREWSTER	WESTBOUND	PC	SMALL INDUS.	RESIDENTIAL	FLAT		
2	OH	BUCYRUS	REASON	NW	SMALL INDUS.	INDUSTRIAL	FLAT		
2	OH	BUCYRUS	REASON	NW	SMALL INDUS.	INDUSTRIAL	FLAT		
2	OH	BUCYRUS	OLD	PC	SMALL INDUS.	INDUSTRIAL	FLAT		
2	OH	BUCYRUS	CABLE	PC	SMALL INDUS.	INDUSTRIAL	FLAT		
2	OH	CADIZ	RAW CREAL	NW	INDUSTRIAL	AGRICULTURAL	FLAT		
2	OH	CADIZ	ASSEMBLY	PC	CLASS./INDUS.	INDUSTRIAL	FLAT	I/C	
2	OH	CADIZ	CLEAN CREAL	PC	INDUSTRIAL	AGRICULTURAL	FLAT	I/C	
2	OH	CAMBRIDGE	CAMBRIDGE	BO	INDUSTRIAL	COMMERCIAL	FLAT	I/C	

76/07/08.

REC.	ST.	CITY	YARD	RAIL-ROAD	YARD FUNCTION	LOCATION TYPE	YARD TYPE	I/C	MAJOR YARD IF MULTI-YARD COMPLEX
2	OH	CAMBRIDGE	TRAIN	PC	INDUSTRIAL	COMMERCIAL	FLAT	1/C	
2	OH	CANTON	CANTON	BD	SMALL INDUS.	COMMERCIAL	FLAT	1/C	
2	OH	CANTON	CAMPBURN	NW	CLASS./INDUS.	COMMERCIAL	FLAT	1/C	
2	OH	CANTON	FURNANCE	NW	INDUSTRIAL	COMMERCIAL	FLAT		
2	OH	CANTON	CANTON	PC	INDUSTRIAL	COMMERCIAL	FLAT		
2	OH	CANTON	CHERRY ST.	PC	SMALL INDUS.	COMMERCIAL	FLAT	1/C	
2	OH	CAREY	CAREY	ACV	CLASS./INDUS.	INDUSTRIAL	FLAT		
2	OH	CAREY	CAREY	CO	INDUSTRIAL	INDUSTRIAL	FLAT		
2	OH	CAREY	CAREY	PC	SMALL INDUS.	INDUSTRIAL	FLAT		
2	OH	CARSON	TRAIN	PC	SMALL INDUS.	AGRICULTURAL	FLAT	1/C	
2	OH	CELINA	CELINA	NW	SMALL INDUS.	COMMERCIAL	FLAT	1/C	
2	OH	CELINA	CELINA	PC	SMALL INDUS.	COMMERCIAL	FLAT	1/C	
2	OH	CHEVIOT	CHEVIOT	CO	INDUSTRIAL	COMMERCIAL	FLAT		
2	OH	CHILLICOTHE	MAIN STREET	HO	INDUSTRIAL	INDUSTRIAL	FLAT	1/C	
2	OH	CHILLICOTHE	PAINT STREET	HO	INDUSTRIAL	INDUSTRIAL	FLAT		
2	OH	CHILLICOTHE	RENNICK OHIO DIV	BD	CLASS./INDUS.	INDUSTRIAL	FLAT		
2	OH	CHILLICOTHE	RENNICK TELEODIV	HO	INDUSTRIAL	INDUSTRIAL	FLAT		
2	OH	CHILLICOTHE	CHILLICOTHE	NW	INDUSTRIAL	INDUSTRIAL	FLAT		PENNICK
2	OH	CINCINNATI	BRIGHTON	BD	CLASS./INDUS.	INDUSTRIAL	FLAT	1/C	
2	OH	CINCINNATI	FARMONT	BD	SMALL INDUS.	COMMERCIAL	FLAT	1/C	
2	OH	CINCINNATI	WARSHALL	BD	INDUSTRIAL	INDUSTRIAL	FLAT		BRIGHTON
2	OH	CINCINNATI	WILLCREEK	BD	INDUSTRIAL	INDUSTRIAL	FLAT		BRIGHTON
2	OH	CINCINNATI	PLUM STREET	HO	CLASS./INDUS.	INDUSTRIAL	FLAT	1/C	
2	OH	CINCINNATI	STOPS	BD	INDUSTRIAL	INDUSTRIAL	FLAT		BRIGHTON
2	OH	CINCINNATI	WOOD STREET	BD	INDUSTRIAL	INDUSTRIAL	FLAT		BRIGHTON
2	OH	CINCINNATI	LIBERTY STREET	CU	INDUSTRIAL	INDUSTRIAL	FLAT		BRIGHTON
2	OH	CINCINNATI	TERMINAL	LN	INDUSTRIAL	INDUSTRIAL	FLAT		
2	OH	CINCINNATI	WEST END	LN	INDUSTRIAL	COMMERCIAL	FLAT	1/C	
2	OH	CINCINNATI	BERRYS	NW	SMALL INDUS.	COMMERCIAL	FLAT		RIVERSIDE
2	OH	CINCINNATI	COURT STREET	PC	SMALL INDUS.	COMMERCIAL	FLAT		RIVERSIDE
2	OH	CINCINNATI	MARSHALL AVE.	PC	SMALL INDUS.	COMMERCIAL	FLAT		RIVERSIDE
2	OH	CINCINNATI	OASIS	PC	SMALL INDUS.	INDUSTRIAL	FLAT	1/C	
2	OH	CINCINNATI	RIVERSIDE	PC	CLASS./INDUS.	RESIDENTIAL	FLAT		
2	OH	CINCINNATI	UNDERCLIFF 100	PC	CLASSIFICATION	RESIDENTIAL	FLAT	1/C	
2	OH	CINCINNATI	GEST STREET	SDU	INDUSTRIAL	INDUSTRIAL	FLAT	1/C	
2	OH	CINCINNATI	CIRCLEVILLE	NW	INDUSTRIAL	INDUSTRIAL	FLAT	1/C	
2	OH	CINCINNATI	CIRCLEVILLE	PC	INDUSTRIAL	INDUSTRIAL	FLAT	1/C	
2	OH	CINCINNATI	SIDING	PC	SMALL INDUS.	COMMERCIAL	FLAT		
2	OH	CINCINNATI	CLAYBANK	PC	INDUSTRIAL	INDUSTRIAL	FLAT	1/C	
2	OH	CINCINNATI	CLARK AVENUE	BD	CLASS./INDUS.	INDUSTRIAL	FLAT	1/C	
2	OH	CINCINNATI	PARVA	BD	INDUSTRIAL	INDUSTRIAL	FLAT	1/C	
2	OH	CINCINNATI	RIVERBEND	CUVA	INDUSTRIAL	INDUSTRIAL	FLAT	1/C	
2	OH	CINCINNATI	EAST 55TH STREET	EL	CLASS./INDUS.	INDUSTRIAL	FLAT	1/C	
2	OH	CINCINNATI	NEWBURGH	EL	INDUSTRIAL	INDUSTRIAL	FLAT	1/C	
2	OH	CINCINNATI	RIVERBEND	EL	INDUSTRIAL	INDUSTRIAL	FLAT	1/C	
2	OH	CINCINNATI	CLARK	NSS	SMALL INDUS.	INDUSTRIAL	FLAT	1/C	
2	OH	CINCINNATI	MARCELENE	NSS	CLASS./INDUS.	COMMERCIAL	FLAT	1/C	MARCELENE
2	OH	CINCINNATI	NEWBURGH	NSS	SMALL INDUS.	COMMERCIAL	FLAT	1/C	MARCELENE
2	OH	CINCINNATI	ROADWAY	NW	CLASS./INDUS.	INDUSTRIAL	FLAT		
2	OH	CINCINNATI	CAMPBELL ROAD	NW	CLASS./INDUS.	COMMERCIAL	FLAT	1/C	CAMPBELL ROAD
2	OH	CINCINNATI	EAST 55TH ST.	NW	CLASS./INDUS.	COMMERCIAL	FLAT	1/C	EAST 55TH STREET
2	OH	CINCINNATI	FOOD TERMINAL	NW	INDUSTRIAL	COMMERCIAL	FLAT		EAST 55TH STREET

76/07/08.

REG.	ST.	CITY	YARD	RAIL-ROAD	YARD FUNCTION	LOCATION TYPE	YARD TYPE	I/C	MAJOR YARD IF MULTI-YARD COMPLEX
2	OH	CLEVELAND	IVANHUE	NW	INDUSTRIAL	COMMERCIAL	FLAT		
2	OH	CLEVELAND	WHE DOUBLE TRACK	NW	SMALL INDUS.	INDUSTRIAL	FLAT		FAST 55TH STREET
2	OH	CLEVELAND	AETNA	PC	SMALL INDUS.	RESIDENTIAL	FLAT		CAMPBELL ROAD
2	OH	CLEVELAND	COLLWOOD	PC	CLASS./INDUS.	INDUSTRIAL	FLAT		
2	OH	CLEVELAND	EAST 26TH ST.	PC	INDUSTRIAL	INDUSTRIAL	FLAT		
2	OH	CLEVELAND	EAST 55TH ST	PC	INDUSTRIAL	INDUSTRIAL	FLAT	I/C	WHISKEY ISLAND
2	OH	CLEVELAND	FORD BODICKPARK	PC	INDUSTRIAL	INDUSTRIAL	FLAT		
2	OH	CLEVELAND	LINDALC	PC	INDUSTRIAL	INDUSTRIAL	FLAT	I/C	
2	OH	CLEVELAND	LOWER FLATS	PC	SMALL INDUS.	INDUSTRIAL	FLAT		
2	OH	CLEVELAND	MADY	PC	INDUSTRIAL	INDUSTRIAL	FLAT	I/C	
2	OH	CLEVELAND	ROCKPORT	PC	CLASS./INDUS.	INDUSTRIAL	FLAT		
2	OH	CLEVELAND	WEST 65TH ST.	PC	SMALL INDUS.	INDUSTRIAL	FLAT		
2	OH	CLEVELAND	WEST PARK	PC	INDUSTRIAL	INDUSTRIAL	FLAT		
2	OH	CLEVELAND	WHISKEY ISLAND	PC	CLASS./INDUS.	INDUSTRIAL	FLAT		
2	OH	CLEVELAND	CLARK AVE.	RT	SMALL INDUS.	INDUSTRIAL	FLAT	I/C	WHISKEY ISLAND
2	OH	CLEVELAND	EAST 49TH ST.	RT	CLASS./INDUS.	INDUSTRIAL	FLAT	I/C	ISLAND
2	OH	CLEVELAND	HARVARD AVE.	ST	INDUSTRIAL	INDUSTRIAL	FLAT		ISLAND
2	OH	CLEVELAND	ISLAND	ST	INDUSTRIAL	INDUSTRIAL	FLAT		ISLAND
2	OH	CLEVELAND	WEST	RT	SMALL INDUS.	INDUSTRIAL	FLAT	I/C	
2	OH	CLYDE	TRAIN	NW	SMALL INDUS.	INDUSTRIAL	FLAT		
2	OH	COLUMBUS	PORT COLUMBUS	PC	SMALL INDUS.	INDUSTRIAL	FLAT		
2	OH	COLUMBUS	MASON	BO	CLASSIFICATION	INDUSTRIAL	FLAT	I/C	
2	OH	COLUMBUS	MOSEL	CO	CLASS./INDUS.	INDUSTRIAL	FLAT	I/C	PARSONS
2	OH	COLUMBUS	PARSONS	CO	CLASS./INDUS.	INDUSTRIAL	FLAT	I/C	PARSONS
2	OH	COLUMBUS	PARSONS NEW	CO	CLASS./INDUS.	INDUSTRIAL	FLAT	I/C	PARSONS
2	OH	COLUMBUS	PIGGYHACK L/R	CO	CLASS./INDUS.	INDUSTRIAL	FLAT		
2	OH	COLUMBUS	JOYCE AVE	CO	SMALL INDUS.	INDUSTRIAL	FLAT		
2	OH	COLUMBUS	PIGGYHACK L/R	NW	INDUSTRIAL	INDUSTRIAL	FLAT	I/C	JOYCE AVE.
2	OH	COLUMBUS	WATKINS	NW	CLASS./INDUS.	RESIDENTIAL	FLAT	I/C	JOYCE AVE.
2	OH	COLUMBUS	BUCKEYE	PC	CLASS./INDUS.	RESIDENTIAL	FLAT		BUCKEYE
2	OH	COLUMBUS	EAST COLUMBUS	PC	INDUSTRIAL	AGRICULTURAL	HUMP		BUCKEYE
2	OH	COLUMBUS	FAIRGROUNDS	PC	INDUSTRIAL	INDUSTRIAL	FLAT		BUCKEYE
2	OH	COLUMBUS	GENERAL MCTORS	PC	INDUSTRIAL	INDUSTRIAL	FLAT		BUCKEYE
2	OH	COLUMBUS	GRANDVIEW	PC	INDUSTRIAL	INDUSTRIAL	HUMP	I/C	BUCKEYE
2	OH	COLUMBUS	GROGAN	PC	INDUSTRIAL	INDUSTRIAL	FLAT		BUCKEYE
2	OH	COLUMBUS	PIGGYHACK L/P	PC	INDUSTRIAL	COMMERCIAL	FLAT		BUCKEYE
2	OH	COLUMBUS	SO. COLUMBUS	PC	INDUSTRIAL	INDUSTRIAL	FLAT		BUCKEYE
2	OH	COLUMBUS	WESTINGHOUSE	PC	INDUSTRIAL	INDUSTRIAL	FLAT		BUCKEYE
2	OH	CORNFUT	HARBOR	BLF	CLASSIFICATION	RESIDENTIAL	FLAT		BUCKEYE
2	OH	CORNING	COJNING	PC	SMALL INDUS.	RESIDENTIAL	FLAT		
2	OH	COSHCTION	COSHCTION	NW	CLASS./INDUS.	INDUSTRIAL	FLAT	I/C	
2	OH	COSHCTION	COSHCTION	PC	CLASS./INDUS.	INDUSTRIAL	FLAT	I/C	
2	OH	CRESTON	CRESTON	NW	SMALL INDUS.	AGRICULTURAL	FLAT		
2	OH	CROOKSVILLE	CROOKSVILLE	PC	SMALL INDUS.	INDUSTRIAL	FLAT		
2	OH	CUMBERLAND	NINE	BO	SMALL INDUS.	INDUSTRIAL	FLAT		
2	OH	DANSBURY	TRAIN	PC	SMALL INDUS.	AGRICULTURAL	FLAT		
2	OH	DAYTON	EAST	AD	INDUSTRIAL	INDUSTRIAL	FLAT		NFFDMDF
2	OH	DAYTON	LED STREET	BO	CLASS./INDUS.	INDUSTRIAL	FLAT	I/C	NFFDMDF
2	OH	DAYTON	NEEMLRE	BO	CLASS./INDUS.	INDUSTRIAL	FLAT	I/C	NFFDMDF
2	OH	DAYTON	EAST	FL	INDUSTRIAL	INDUSTRIAL	FLAT		
2	OH	DAYTON	RULK	PC	INDUSTRIAL	INDUSTRIAL	FLAT		
2	OH	DAYTON	CLEPENT	PC	INDUSTRIAL	INDUSTRIAL	FLAT		
2	OH	DAYTON	EAST	PC	INDUSTRIAL	INDUSTRIAL	FLAT	I/C	

76/07/04.

REG.	ST.	CITY	YARD	RAIL-ROAD	YARD FUNCTION	LOCATION TYPE	YARD TYPE	I/C	MAJOR YARD IF MULTI-YARD COMPLEX
2	OH	HUBBARD	TRAIN	PC	SMALL INDUS.	RESIDENTIAL	FLAT		
2	OH	HUNTON	SOUTH	NW	CLASS./INDUS.	INDUSTRIAL	FLAT	I/C	
2	OH	IRONTON	TRAIN	DTI	SMALL INDUS.	RESIDENTIAL	FLAT	I/C	
2	OH	IRONTON	AETNA	NW	CLASS./INDUS.	RESIDENTIAL	FLAT	I/C	
2	OH	IVORYDALE	TRAIN	HO	INDUSTRIAL	INDUSTRIAL	FLAT	I/C	
2	OH	IVORYDALE	IVORYDALE	NW	INDUSTRIAL	INDUSTRIAL	FLAT	I/C	
2	OH	IVORYDALE	IVORYDALE	PC	INDUSTRIAL	INDUSTRIAL	FLAT	I/C	
2	OH	JACKSON	JACKSON	BD	CLASSIFICATION	INDUSTRIAL	FLAT	I/C	
2	OH	JACKSON	JACKSON	CO	CLASSIFICATION	INDUSTRIAL	FLAT	I/C	
2	OH	JACKSON	JACKSON	DTI	CLASSIFICATION	INDUSTRIAL	FLAT	I/C	
2	OH	KENT	KENT	BD	SMALL INDUS.	COMMERCIAL	FLAT	I/C	
2	OH	KENTON	KENTON	FL	SMALL INDUS.	COMMERCIAL	FLAT	I/C	
2	OH	KENTON	KENTON	FL	CLASSIFICATION	INDUSTRIAL	FLAT	I/C	
2	OH	KENTON	KENTON	PC	CLASSIFICATION	INDUSTRIAL	FLAT	I/C	
2	OH	KENWOOD	KENWOOD	NW	CLASS./INDUS.	AGRICULTURAL	FLAT	I/C	
2	OH	KENWOOD	KENWOOD	NW	CLASS./INDUS.	UNDEVELOPED	FLAT	I/C	
2	OH	KENWOOD	WELLS MINE	NW	CLASS./INDUS.	INDUSTRIAL	FLAT	I/C	
2	OH	LANCASTER	LANCASTER	CO	CLASS./INDUS.	INDUSTRIAL	FLAT	I/C	
2	OH	LANCASTER	LANCASTER	PC	CLASS./INDUS.	INDUSTRIAL	FLAT	I/C	
2	OH	LEAVITTSBURG	LEAVITTSBURG	EL	CLASS./INDUS.	COMMERCIAL	FLAT	I/C	
2	OH	LIMA	NORTH LIMA	BD	CLASS./INDUS.	INDUSTRIAL	FLAT	I/C	NORTH LIMA
2	OH	LIMA	SOUTH LIMA	BD	CLASS./INDUS.	INDUSTRIAL	FLAT	I/C	NORTH LIMA
2	OH	LIMA	FORD PARK	DTI	CLASS./INDUS.	INDUSTRIAL	FLAT	I/C	
2	OH	LIMA	LIMA	EL	CLASS./INDUS.	INDUSTRIAL	FLAT	I/C	
2	OH	LIMA	LIMA	NW	CLASS./INDUS.	INDUSTRIAL	FLAT	I/C	
2	OH	LIMA	LIMA	PC	CLASS./INDUS.	INDUSTRIAL	FLAT	I/C	
2	OH	LIMA	LIMA	PC	CLASS./INDUS.	AGRICULTURAL	FLAT	I/C	
2	OH	LOGAN	OLD TOWN	CO	CLASS./INDUS.	RESIDENTIAL	FLAT	I/C	
2	OH	LONDON	LONDON	PC	CLASSIFICATION	COMMERCIAL	FLAT	I/C	
2	OH	LORAIN	28TH STREET	HO	CLASS./INDUS.	INDUSTRIAL	FLAT	I/C	28TH STREET
2	OH	LORAIN	CLASSIFICATION	HO	CLASS./INDUS.	INDUSTRIAL	FLAT	I/C	28TH STREET
2	OH	LORAIN	COAL + OIL DOCK	BD	INDUSTRIAL	COMMERCIAL	FLAT	I/C	28TH STREET
2	OH	LORAIN	EAST	LT	INDUSTRIAL	INDUSTRIAL	FLAT	I/C	
2	OH	LORAIN	SOUTH	LT	CLASS./INDUS.	INDUSTRIAL	FLAT	I/C	
2	OH	LORAIN	OAK POINT	NW	SMALL INDUS.	INDUSTRIAL	FLAT	I/C	
2	OH	LORAIN	FAIRLANE	PC	SMALL INDUS.	INDUSTRIAL	FLAT	I/C	
2	OH	LORDSTOWN	SIDING	PC	SMALL INDUS.	INDUSTRIAL	FLAT	I/C	
2	OH	LORDSTOWN	LORDSTOWN	BD	SMALL INDUS.	INDUSTRIAL	FLAT	I/C	
2	OH	LORDSTOWN	LORDSTOWN	PC	SMALL INDUS.	INDUSTRIAL	FLAT	I/C	
2	OH	MANSFIELD	HARGING	EL	INDUSTRIAL	INDUSTRIAL	FLAT	I/C	
2	OH	MANSFIELD	MANSFIELD	EL	CLASS./INDUS.	INDUSTRIAL	FLAT	I/C	
2	OH	MANSFIELD	MANSFIELD	EL	INDUSTRIAL	INDUSTRIAL	FLAT	I/C	
2	OH	MANSFIELD	MANSFIELD	PC	INDUSTRIAL	INDUSTRIAL	FLAT	I/C	
2	OH	MAPLE GROVE	MAPLE GROVE	NW	SMALL INDUS.	AGRICULTURAL	FLAT	I/C	
2	OH	MAPLE GROVE	MAPLE GROVE	PC	SMALL INDUS.	AGRICULTURAL	FLAT	I/C	
2	OH	MARIEMONT	MARIEMONT	PC	SMALL INDUS.	AGRICULTURAL	FLAT	I/C	
2	OH	MARIETTA	MARIETTA	NW	SMALL INDUS.	RESIDENTIAL	FLAT	I/C	
2	OH	MARIETTA	MARIETTA	BD	SMALL INDUS.	INDUSTRIAL	FLAT	I/C	
2	OH	MARIETTA	MARIETTA	PC	SMALL INDUS.	INDUSTRIAL	FLAT	I/C	
2	OH	MARION	NORTH	CO	CLASSIFICATION	RESIDENTIAL	FLAT	I/C	
2	OH	MARION	EASTBUND	EL	CLASS./INDUS.	INDUSTRIAL	FLAT	I/C	
2	OH	MARION	WESTBUND	EL	CLASS./INDUS.	INDUSTRIAL	FLAT	I/C	
2	OH	MARION	MARION	NW	CLASSIFICATION	INDUSTRIAL	FLAT	I/C	
2	OH	MARION	MARION	PC	SMALL INDUS.	INDUSTRIAL	FLAT	I/C	
2	OH	MARION	MARION	PC	SMALL INDUS.	INDUSTRIAL	FLAT	I/C	
2	OH	MARTINS FERRY	TRAIN	BD	SMALL INDUS.	RESIDENTIAL	FLAT	I/C	
2	OH	MARTINS FERRY	TRAIN	NW	SMALL INDUS.	RESIDENTIAL	FLAT	I/C	
2	OH	MARTINS FERRY	TRAIN	PC	SMALL INDUS.	RESIDENTIAL	FLAT	I/C	
2	OH	MARYSVILLE	MARYSVILLE	PC	INDUSTRIAL	COMMERCIAL	FLAT	I/C	
2	OH	MASSILLON	MASSILLON	BD	SMALL INDUS.	COMMERCIAL	FLAT	I/C	

76/07/03.

REG.	ST.	CITY	YARD	RAIL-ROAD	YARD FUNCTION	LOCATION TYPE	YARD TYPE	I/C	MAJOR YARD, IF MULTI-YARD COMPLEX
2	OH	MASSILLON	MASSILLON	NW	SMALL INDUS.	COMMERCIAL	FLAT		
2	OH	MASSILLON	FACE JCT.	PC	INDUSTRIAL	INDUSTRIAL	FLAT		
2	OH	MIDDLETOWN	EXCELLO NEW REED	BD	INDUSTRIAL	AGRICULTURAL	FLAT		
2	OH	MINERVA	TRAIN	PC	INDUSTRIAL	INDUSTRIAL	FLAT		
2	OH	MINGO JUNCTION	MINCO	NW	CLASS./INDUS.	RESIDENTIAL	FLAT		
2	OH	MINGO JUNCTION	TRAIN	PC	CLASS./INDUS.	RESIDENTIAL	FLAT		
2	OH	MONROE	TRAIN	PC	SMALL INDUS.	COMMERCIAL	FLAT		
2	OH	MONTPELIER	TRAIN	NW	CLASS./INDUS.	AGRICULTURAL	FLAT		
2	OH	MORROW	MORATNE	PC	INDUSTRIAL	RESIDENTIAL	FLAT		
2	OH	MORROW	THAIN	PC	INDUSTRIAL	AGRICULTURAL	FLAT		
2	OH	MT. VERNON	TRAIN	BD	INDUSTRIAL	AGRICULTURAL	FLAT	I/C	
2	OH	MT. VERNON	TRAIN	PC	INDUSTRIAL	RESIDENTIAL	FLAT		
2	OH	NEW BOSTON	TRAIN	PC	SMALL INDUS.	COMMERCIAL	FLAT	I/C	
2	OH	NEW LEXINGTON	TRAIN	PC	INDUSTRIAL	COMMERCIAL	FLAT		
2	OH	NEW LEXINGTON	NEW LEXINGTON	PC	INDUSTRIAL	RESIDENTIAL	FLAT		
2	OH	NEW MIAMI	NEW RIVER	BD	INDUSTRIAL	INDUSTRIAL	FLAT		
2	OH	NEWARK	COAL	BD	CLASS./INDUS.	COMMERCIAL	FLAT		NEWARK
2	OH	NEWARK	NEWARK	BD	SMALL INDUS.	INDUSTRIAL	FLAT		NEWARK
2	OH	NEWARK	FREIGHT HOUSE	BD	CLASS./INDUS.	COMMERCIAL	FLAT		NEWARK
2	OH	NEWARK	NEWARK	BD	CLASS./INDUS.	COMMERCIAL	FLAT		NEWARK
2	OH	NEWCOMERTOWN	NEWCOMERTOWN	PC	SMALL INDUS.	RESIDENTIAL	FLAT	I/C	
2	OH	NILES	NILES	PC	SMALL INDUS.	COMMERCIAL	FLAT	I/C	
2	OH	NILES	NILES	EL	CLASSIFICATION	RESIDENTIAL	FLAT		
2	OH	NORTH RANDALL	NORTH RANDALL	PC	CLASS./INDUS.	COMMERCIAL	FLAT		
2	OH	NORWALK	NORWALK	FL	CLASS./INDUS.	RESIDENTIAL	FLAT		
2	OH	NORWOOD	NORWOOD	NW	INDUSTRIAL	COMMERCIAL	FLAT		
2	OH	NORWOOD	IDLEWOOD	BD	INDUSTRIAL	COMMERCIAL	FLAT		
2	OH	NORWOOD	NORWOOD	NW	INDUSTRIAL	RESIDENTIAL	FLAT		
2	OH	OAK HILL	MC CULLOUGH	PC	INDUSTRIAL	RESIDENTIAL	FLAT		
2	OH	OAKLEY	OAK HILL	BD	SMALL INDUS.	INDUSTRIAL	FLAT		
2	OH	OAKLEY	OAKLEY	BD	INDUSTRIAL	INDUSTRIAL	FLAT		
2	OH	PAINESVILLE	PAINESVILLE	NW	SMALL INDUS.	RESIDENTIAL	FLAT	I/C	
2	OH	PAINESVILLE	NEW	PC	CLASS./INDUS.	AGRICULTURAL	FLAT		
2	OH	PAINESVILLE	PAINESVILLE	PC	SMALL INDUS.	COMMERCIAL	FLAT		
2	OH	PHILO	PHILO	BD	SMALL INDUS.	RESIDENTIAL	FLAT		
2	OH	PIQUA	PIQUA	BD	INDUSTRIAL	COMMERCIAL	FLAT	I/C	
2	OH	PIQUA	PIQUA	PC	INDUSTRIAL	COMMERCIAL	FLAT	I/C	
2	OH	PORTSMOUTH	E.B. HUMP	NW	CLASS./INDUS.	INDUSTRIAL	HUMP	I/C	
2	OH	PORTSMOUTH	FLAT	NW	CLASS./INDUS.	INDUSTRIAL	FLAT	I/C	
2	OH	PORTSMOUTH	M.B. HUMP	NW	CLASS./INDUS.	INDUSTRIAL	HUMP	I/C	
2	OH	PORTSMOUTH	PORTSMOUTH	PC	CLASS./INDUS.	INDUSTRIAL	FLAT	I/C	
2	OH	PORTSMOUTH	PORTSMOUTH	PC	CLASS./INDUS.	INDUSTRIAL	FLAT	I/C	
2	OH	RAVENNA	RAVENNA	BD	SMALL INDUS.	COMMERCIAL	FLAT		
2	OH	RAVENNA	RAVENNA	EL	SMALL INDUS.	COMMERCIAL	FLAT		
2	OH	RAVENNA	BLACK HCFSE	PC	SMALL INDUS.	COMMERCIAL	FLAT		
2	OH	RAVENNA	CITY	PC	SMALL INDUS.	COMMERCIAL	FLAT		
2	OH	READING	VAUGHN	PC	INDUSTRIAL	INDUSTRIAL	FLAT		
2	OH	READING	RIDGEWAY	PC	SMALL INDUS.	AGRICULTURAL	FLAT		
2	OH	RETTMAN	RETTMAN	BD	SMALL INDUS.	COMMERCIAL	FLAT		
2	OH	RETTMAN	RETTMAN	BD	SMALL INDUS.	COMMERCIAL	FLAT		
2	OH	ROSSFORD	CLASSIFICATION	EL	SMALL INDUS.	COMMERCIAL	FLAT	I/C	
2	OH	ROSSFORD	HARRIS	BD	SMALL INDUS.	INDUSTRIAL	FLAT		
2	OH	SAINT BERNARD	ROSS ESTATE	BD	SMALL INDUS.	COMMERCIAL	FLAT		
2	OH	SAINT MARYS	SAINT MARYS	NW	SMALL INDUS.	RESIDENTIAL	FLAT	I/C	
2	OH	SAINT MARYS	SAINT MARYS	PC	SMALL INDUS.	RESIDENTIAL	FLAT	I/C	
2	OH	SALLEN	TRAIN	PC	SMALL INDUS.	COMMERCIAL	FLAT		
2	OH	SANDUSKY	CUTTER	BD	SMALL INDUS.	COMMERCIAL	FLAT	I/C	

76/37/00*

REG.	ST.	CITY	YARD	RAIL-ROAD	YARD FUNCTION	LOCATION TYPE	YARD TYPE	I/C	MAJUP YARD IF MULTI-YARD COMPLEX
2	OH	SANDUSKY	HAYSIDE	NW	CLASS./INDUS.	INDUSTRIAL	FLAT		
2	OH	SANDUSKY	SANDUSKY	PC	INDUSTRIAL	RESIDENTIAL	FLAT		
2	OH	SARDINIA	SARDINIA	NW	SMALL INDUS.	AGRICULTURAL	FLAT	I/C	
2	OH	SHARINVILLE	HUMP	PC	CLASS./INDUS.	INDUSTRIAL	HUMP	I/C	
2	OH	SHELBY	SHELBY JCT	PC	SMALL INDUS.	INDUSTRIAL	FLAT		
2	OH	SHELBY	SHELBY JCT	PC	SMALL INDUS.	INDUSTRIAL	FLAT		
2	OH	STONEY	SIDNEY	PC	INDUSTRIAL	COMMERCIAL	FLAT	I/C	
2	OH	STONEY	SIDNEY	PC	INDUSTRIAL	COMMERCIAL	FLAT	I/C	
2	OH	SILICA	TRAIN	TAW	SMALL INDUS.	AGRICULTURAL	FLAT		
2	OH	SOUTH LORAIN	SOUTH LORAIN	PC	SMALL INDUS.	INDUSTRIAL	FLAT		
2	OH	SOUTH LORAIN	SOUTH LORAIN	PC	SMALL INDUS.	INDUSTRIAL	FLAT		
2	OH	SPRINGFIELD	SPRINGFIELD	DTI	INDUSTRIAL	INDUSTRIAL	FLAT		0T1 SPRINGFIELD
2	OH	SPRINGFIELD	SPRINGFIELD	DTI	INDUSTRIAL	INDUSTRIAL	FLAT		DT1 SPRINGFIELD
2	OH	SPRINGFIELD	SPRINGFIELD	PC	INDUSTRIAL	INDUSTRIAL	FLAT		PC SPRINGFIELD
2	OH	SPRINGFIELD	SPRINGFIELD	PC	INDUSTRIAL	INDUSTRIAL	FLAT		PC SPRINGFIELD
2	OH	STUBENVILLE	RIVER	PC	SMALL INDUS.	COMMERCIAL	FLAT		
2	OH	STUBENVILLE	UPICW	PC	SMALL INDUS.	RESIDENTIAL	FLAT		
2	OH	STUBENVILLE	THURSTON	PC	SMALL INDUS.	RESIDENTIAL	FLAT		
2	OH	TIEFIN	TIEFIN	PC	SMALL INDUS.	RESIDENTIAL	FLAT		
2	OH	TIEFIN	TIEFIN	PC	SMALL INDUS.	RESIDENTIAL	FLAT		
2	OH	TOLEDO	OTTAWA	AA	CLASS./INDUS.	INDUSTRIAL	FLAT		
2	OH	TOLEDO	PRESQUE ISLE	CD	CLASS./INDUS.	UNDEVELOPED	FLAT		
2	OH	TOLEDO	TEMPERANCE	DTI	SMALL INDUS.	AGRICULTURAL	FLAT		
2	OH	TOLEDO	LANG	DTI	SMALL INDUS.	AGRICULTURAL	FLAT		
2	OH	TOLEDO	OUTBOUND	LFDRT	SMALL INDUS.	UNDEVELOPED	FLAT		
2	OH	TOLEDO	F H	NW	SMALL INDUS.	RESIDENTIAL	FLAT		
2	OH	TOLEDO	GOULD	NW	SMALL INDUS.	RESIDENTIAL	FLAT		
2	OH	TOLEDO	HONESTFAD	NW	CLASS./INDUS.	AGRICULTURAL	FLAT		
2	OH	TOLEDO	IRONVILLE	NW	INDUSTRIAL	INDUSTRIAL	FLAT		
2	OH	TOLEDO	SUMNER STREET	NW	SMALL INDUS.	RESIDENTIAL	FLAT		
2	OH	TOLEDO	AIRLINE JCT	PC	INDUSTRIAL	INDUSTRIAL	FLAT	I/C	
2	OH	TOLEDO	STANLEY	PC	CLASS./INDUS.	AGRICULTURAL	HUMP	I/C	
2	OH	TOLEDO	BOULEVARD	TT	INDUSTRIAL	INDUSTRIAL	FLAT		
2	OH	TOLEDO	HILL	TT	INDUSTRIAL	RESIDENTIAL	FLAT		
2	OH	TRINWAY	TRINWAY	NW	INDUSTRIAL	INDUSTRIAL	FLAT		
2	OH	TRINWAY	TRINWAY	PC	INDUSTRIAL	INDUSTRIAL	FLAT		
2	OH	TROY	TROY	PC	CLASS./INDUS.	INDUSTRIAL	FLAT	I/C	
2	OH	TROY	TROY	PC	CLASS./INDUS.	INDUSTRIAL	FLAT	I/C	
2	OH	TWINSBURG	CHRYSLER TOWNBURG	PC	INDUSTRIAL	INDUSTRIAL	FLAT		
2	OH	WHPICHSVILLE	TRAIN	PC	SMALL INDUS.	RESIDENTIAL	FLAT		
2	OH	UNION CITY	UNION CITY	PC	SMALL INDUS.	AGRICULTURAL	FLAT		
2	OH	UNION CITY	UNION CITY	PC	SMALL INDUS.	AGRICULTURAL	FLAT		
2	OH	UPPER SANDUSKY	HOUSE	CO	SMALL INDUS.	AGRICULTURAL	FLAT		
2	OH	UPPER SANDUSKY	HOUSE	PC	SMALL INDUS.	COMMERCIAL	FLAT		
2	OH	URBANA	URBANA	EL	CLASS./INDUS.	INDUSTRIAL	FLAT	I/C	
2	OH	URBANA	URBANA	PC	SMALL INDUS.	INDUSTRIAL	FLAT	I/C	
2	OH	VAN VALLEY JCT.	VALLEY JCT.	PC	SMALL INDUS.	AGRICULTURAL	FLAT		
2	OH	VAN VALLEY JCT.	VALLEY JCT.	PC	SMALL INDUS.	AGRICULTURAL	FLAT		
2	OH	WALBRIDGE	HUMP	CO	SMALL INDUS.	RESIDENTIAL	FLAT	I/C	
2	OH	WALBRIDGE	WALBRIDGE	TT	SMALL INDUS.	AGRICULTURAL	HUMP	I/C	
2	OH	WALTON HILLS	WALTON HILLS	PC	SMALL INDUS.	AGRICULTURAL	FLAT		
2	OH	WALTON HILLS	WALTON HILLS	PC	INDUSTRIAL	INDUSTRIAL	FLAT		
2	OH	WARREN	WARREN	EL	SMALL INDUS.	COMMERCIAL	FLAT		

76/07/08.

REG.	ST.	CITY	YAPD	RAIL-ROAD	YARD FUNCTION	LOCATION TYPE	YARD TYPE	I/C	MAJOR YARD IF MULTI-YARD COMPLEX
2	OH	WARREN	TRAIN	PC	SMALL INDUS.	COMMERCIAL	FLAT		
2	OH	WARRENTON	TRAIN	PC	SMALL INDUS.	RESIDENTIAL	FLAT		
2	OH	WARWICK	WARWICK	BD	SMALL INDUS.	AGRICULTURAL	FLAT		
2	OH	WASHINGTON CT-HSE.	TRAIN	BD	INDUSTRIAL	COMMERCIAL	FLAT	1/C	
2	OH	WASHINGTON CT-HSE.	TRAIN	DTI	INDUSTRIAL	COMMERCIAL	FLAT	1/C	
2	OH	WASHINGTON CT-HSE.	TRAIN	PC	INDUSTRIAL	COMMERCIAL	FLAT	1/C	
2	OH	WAVERLY	TRAIN	DTI	INDUSTRIAL	COMMERCIAL	FLAT	1/C	
2	OH	WAVERLY	TRAIN	NW	INDUSTRIAL	RESIDENTIAL	FLAT		
2	OH	WAVERLY	WAVELY	PC	SMALL INDUS.	COMMERCIAL	FLAT		
2	OH	WELLSTON	MEADOW SUN	BD	SMALL INDUS.	COMMERCIAL	FLAT		
2	OH	WELLSTON	WELLSTON	BD	SMALL INDUS.	COMMERCIAL	FLAT		
2	OH	WELLSTON	WELLSTON	CO	SMALL INDUS.	COMMERCIAL	FLAT		
2	OH	WELLSVILLE	EAST LIVERPOOL	PC	SMALL INDUS.	INDUSTRIAL	FLAT		
2	OH	WEST CARROLLTON	WEST CARROLLTON	PC	INDUSTRIAL	INDUSTRIAL	FLAT		
2	OH	WILLARD	EASTBOUND	BD	CLASSIFICATION	AGRICULTURAL	HUMP		
2	OH	WILLARD	WESTBOUND	BD	CLASSIFICATION	AGRICULTURAL	HUMP		
2	OH	WILLARD	WILLARD	BD	INDUSTRIAL	INDUSTRIAL	FLAT		
2	OH	WILMINGTON	WILMINGTON	BD	INDUSTRIAL	INDUSTRIAL	FLAT		
2	OH	WOODSTER	WOODSTER	BD	SMALL INDUS.	COMMERCIAL	FLAT		
2	OH	WOODSTER	WOODSTER	PC	SMALL INDUS.	COMMERCIAL	FLAT		
2	OH	XENIA	XENIA	PC	INDUSTRIAL	COMMERCIAL	FLAT	1/C	
2	OH	YORKVILLE	TRAIN	PC	INDUSTRIAL	RESIDENTIAL	FLAT	1/C	
2	OH	YOUNGSTOWN	HASELTON	BD	SMALL INDUS.	COMMERCIAL	FLAT		
2	OH	YOUNGSTOWN	OHIO JCT.	BD	SMALL INDUS.	COMMERCIAL	FLAT		
2	OH	YOUNGSTOWN	BRIER HILL	EL	INDUSTRIAL	INDUSTRIAL	FLAT		HASELTON
2	OH	YOUNGSTOWN	MC GUFFEY STREET	EL	SMALL INDUS.	INDUSTRIAL	FLAT		BRIER HILL
2	OH	YOUNGSTOWN	NK	EL	SMALL INDUS.	INDUSTRIAL	FLAT		BRIER HILL
2	OH	YOUNGSTOWN	HASELTON	PC	SMALL INDUS.	INDUSTRIAL	FLAT	1/C	HASELTON
2	OH	YOUNGSTOWN	MC GUFFEY STREET	PC	SMALL INDUS.	RESIDENTIAL	FLAT	1/C	HASELTON
2	OH	YOUNGSTOWN	BRIER HILL	PC	SMALL INDUS.	RESIDENTIAL	FLAT	1/C	HASELTON
2	OH	YOUNGSTOWN	GATEWAY	PLE	SMALL INDUS.	RESIDENTIAL	FLAT	1/C	GATEWAY
2	OH	YOUNGSTOWN	LANSTINGVILLE	JOINT	SMALL INDUS.	RESIDENTIAL	FLAT	1/C	GATEWAY
2	OH	YOUNGSTOWN	OHIO WORKS	PLE	INDUSTRIAL	INDUSTRIAL	HUMP		GATEWAY
2	OH	YOUNGSTOWN	MC DONALD	PLE	SMALL INDUS.	INDUSTRIAL	FLAT		GATEWAY
2	OH	YOUNGSTOWN	OHIO WORKS	YN	INDUSTRIAL	INDUSTRIAL	FLAT		
2	OH	ZANESVILLE	EAST SIDE	YN	INDUSTRIAL	INDUSTRIAL	FLAT		
2	OH	ZANESVILLE	WEST SIDE	BD	CLASS./INDUS.	INDUSTRIAL	FLAT		
2	OH	ZANESVILLE	ZANESVILLE	BD	CLASS./INDUS.	COMMERCIAL	FLAT		
2	OH	ZANESVILLE	SO. ZANESVILLE	NW	SMALL INDUS.	INDUSTRIAL	FLAT		
2	OH	ZANESVILLE	TRAIN	PC	SMALL INDUS.	COMMERCIAL	FLAT		
5	OK	ADA	TRAIN	ATSF	SMALL INDUS.	INDUSTRIAL	FLAT	1/C	
5	OK	ADA	ADA	OCAA	SMALL INDUS.	COMMERCIAL	FLAT	1/C	
5	OK	ADA	TRAIN	SLSF	SMALL INDUS.	INDUSTRIAL	FLAT		
5	OK	ALTUS	ALTUS	HE	SMALL INDUS.	COMMERCIAL	FLAT		
5	OK	ARMORE	TRAIN	ATSF	INDUSTRIAL	INDUSTRIAL	FLAT		
5	OK	BARTLESVILLE	BARTLESVILLE	ATSF	SMALL INDUS.	COMMERCIAL	FLAT		
5	OK	BLACKWELL	BLACKWELL	ATSF	SMALL INDUS.	COMMERCIAL	FLAT		
5	OK	BOISE CITY	BOISE CITY	ATSF	SMALL INDUS.	COMMERCIAL	FLAT		
5	OK	CHICKESHA	TRAIN	CRIP	SMALL INDUS.	INDUSTRIAL	FLAT		
5	OK	CUSHING	TRAIN	ATSF	SMALL INDUS.	INDUSTRIAL	FLAT		
5	OK	CUSHING	TRAIN	MKT	SMALL INDUS.	INDUSTRIAL	FLAT		
5	OK	D'OUVERTY	TRAIN	ATSF	SMALL INDUS.	INDUSTRIAL	FLAT		
5	OK	EL RENO	TRAIN	CRIP	SMALL INDUS.	INDUSTRIAL	FLAT		

76/07/08.

REG.	ST.	CITY	YAPO	RAIL - ROAD	YARD FUNCTION	LOCATION TYPE	YARD TYPE	MAJOR YARD IF MULTI-YARD COMPLEX
5	OK	ELK CITY		MKT	SMALL INDUS.	COMMERCIAL	FLAT	
5	OK	ENID	TRAIN	ATSF	INDUSTRIAL	INDUSTRIAL	FLAT	1/C
5	OK	ENID	NORTH ENID	CRIP	CLASS./INDUS.	INDUSTRIAL	FLAT	1/C
5	OK	ENID	TRAIN	SLSF	CLASS./INDUS.	INDUSTRIAL	FLAT	1/C
5	OK	FORGAN	FORGAN	MKT	SMALL INDUS.	INDUSTRIAL	FLAT	
5	OK	HARTSHORNE	HARTSHORNE	CRIP	SMALL INDUS.	COMMERCIAL	FLAT	
5	OK	HEAVENER	TRAIN	KCS	CLASS./INDUS.	INDUSTRIAL	FLAT	
5	OK	HENRYETTA	TRAIN	SLSF	SMALL INDUS.	INDUSTRIAL	FLAT	
5	OK	HUGO	TRAIN	SLSF	INDUSTRIAL	INDUSTRIAL	FLAT	
5	OK	LAWTON	LAWTON	CRIP	SMALL INDUS.	COMMERCIAL	FLAT	
5	OK	LAWTON	TRAIN	SLSF	SMALL INDUS.	INDUSTRIAL	FLAT	
5	OK	MADILL	TRAIN	SLSF	SMALL INDUS.	INDUSTRIAL	FLAT	1/C
5	OK	MCALISTER	TRAIN	CRIP	SMALL INDUS.	INDUSTRIAL	FLAT	1/C
5	OK	MCALISTER	TRAIN	MKT	SMALL INDUS.	COMMERCIAL	FLAT	
5	OK	MIAMI	MIAMI	NEOK	SMALL INDUS.	INDUSTRIAL	FLAT	
5	OK	MIAMI	TRAIN	SLSF	SMALL INDUS.	INDUSTRIAL	FLAT	1/C
5	OK	MUSKOGEE	TRAIN	MKT	INDUSTRIAL	COMMERCIAL	FLAT	
5	OK	MUSKOGEE	TRAIN	SLSF	SMALL INDUS.	COMMERCIAL	FLAT	1/C
5	OK	MUSKOGEE	TRAIN	SLSF	SMALL INDUS.	COMMERCIAL	FLAT	1/C
5	OK	OKLAHOMA CITY	SHORTON	TP	CLASS./INDUS.	INDUSTRIAL	FLAT	
5	OK	OKLAHOMA CITY	CITY	ATSF	SMALL INDUS.	COMMERCIAL	FLAT	
5	OK	OKLAHOMA CITY	NOMERS	ATSF	INDUSTRIAL	COMMERCIAL	FLAT	1/C
5	OK	OKLAHOMA CITY	PACKINGTOWN	ATSF	SMALL INDUS.	INDUSTRIAL	FLAT	
5	OK	OKLAHOMA CITY	HARTER	CRIP	CLASS./INDUS.	INDUSTRIAL	FLAT	1/C
5	OK	OKLAHOMA CITY	WEST	CRIP	SMALL INDUS.	INDUSTRIAL	FLAT	1/C
5	OK	OKLAHOMA CITY	TURNER	MKT	INDUSTRIAL	COMMERCIAL	FLAT	1/C
5	OK	OKLAHOMA CITY	EAST	SLSF	CLASS./INDUS.	COMMERCIAL	FLAT	1/C
5	OK	OKLAHOMA CITY	TRAIN	SLSF	SMALL INDUS.	COMMERCIAL	FLAT	1/C
5	OK	PAULS VALLEY	TRAIN	ATSF	INDUSTRIAL	INDUSTRIAL	FLAT	
5	OK	PAMHUSKA	PAMHUSKA	MIDL	SMALL INDUS.	COMMERCIAL	FLAT	1/C
5	OK	PONCA CITY	TRAIN	ATSF	SMALL INDUS.	INDUSTRIAL	FLAT	1/C
5	OK	PONCA CITY	TRAIN	CRIP	SMALL INDUS.	INDUSTRIAL	FLAT	1/C
5	OK	PRYOR	SMITH	MKT	SMALL INDUS.	COMMERCIAL	FLAT	
5	OK	PURCELL	PURCELL	ATSF	CLASS./INDUS.	COMMERCIAL	FLAT	
5	OK	SALLISAW	TRAIN	KCS	SMALL INDUS.	COMMERCIAL	FLAT	
5	OK	SAND SPRINGS	SAND SPRINGS	SS	SMALL INDUS.	COMMERCIAL	FLAT	1/C
5	OK	SAPULPA	SAPULPA	TSU	INDUSTRIAL	INDUSTRIAL	FLAT	
5	OK	SHATTUCK	TRAIN	ATSF	SMALL INDUS.	COMMERCIAL	FLAT	
5	OK	SHAWNEE	TRAIN	CRIP	SMALL INDUS.	COMMERCIAL	FLAT	
5	OK	SUNRAY	TRAIN	CRIP	SMALL INDUS.	COMMERCIAL	FLAT	
5	OK	TULSA	TRAIN	ATSF	CLASS./INDUS.	INDUSTRIAL	FLAT	1/C
5	OK	TULSA	LAFEBER	MIDL	INDUSTRIAL	COMMERCIAL	FLAT	1/C
5	OK	TULSA	TRAIN	MKT	SMALL INDUS.	INDUSTRIAL	FLAT	1/C
5	OK	TULSA	CHEERKFE	SLSF	CLASS./INDUS.	COMMERCIAL	HMP	1/C
5	OK	TULSA	TULSA	SLSF	INDUSTRIAL	COMMERCIAL	FLAT	1/C
5	OK	TULSA	LEFEBER	TP	SMALL INDUS.	INDUSTRIAL	FLAT	1/C
5	OK	WATTS	WATTS	KCS	SMALL INDUS.	COMMERCIAL	FLAT	1/C
6	OR	ALBANY	TRAIN	HN	CLASS./INDUS.	INDUSTRIAL	FLAT	1/C
6	OR	ALBANY	TRAIN	SP	SMALL INDUS.	INDUSTRIAL	FLAT	1/C
6	OR	ARLINGTON	TRAIN	UP	SMALL INDUS.	INDUSTRIAL	FLAT	
6	OR	ASHLAND	TRAIN	SP	INDUSTRIAL	INDUSTRIAL	FLAT	
6	OR	HAKED	TRAIN	UP	SMALL INDUS.	INDUSTRIAL	FLAT	1/C
5	OR	PHIND	TRAIN	OR	INDUSTRIAL	INDUSTRIAL	FLAT	1/C
4	OR	PHIND	TRAIN	UP	INDUSTRIAL	INDUSTRIAL	FLAT	1/C

76/07/09.

REG.	ST.	CITY	YARD	RAIL-ROAD	YARD FUNCTION	LOCATION TYPE	YARD TYPE	I/C	MAJOR YARD IF MULTI-YARD COMPLEX
6	OR	ELY	INDUSTRY	OCE	SMALL INDUS.	RESIDENTIAL	FLAT		
6	OR	BURNS	TRAIN	UP	INDUSTRIAL	RESIDENTIAL	FLAT		
6	OR	CANBY	CLEAN OUT	SP	SMALL INDUS.	AGRICULTURAL	FLAT		
6	OR	CONDON	TRAIN	UP	INDUSTRIAL	AGRICULTURAL	FLAT		
6	OR	COOS BAY	TRAIN	SP	SMALL INDUS.	RESIDENTIAL	FLAT		
6	OR	CORVALLIS	TRAIN	SP	SMALL INDUS.	RESIDENTIAL	FLAT	I/C	
6	OR	COTTAGE GROVE	TRAIN	DPE	SMALL INDUS.	RESIDENTIAL	FLAT		
6	OR	DALLAS	TRAIN	SP	SMALL INDUS.	RESIDENTIAL	FLAT	I/C	
6	OR	EUGENE	TRAIN	BN	CLASS./INDUS.	INDUSTRIAL	HUMP		
6	OR	EUGENE	TRAIN	SP	CLASS./INDUS.	INDUSTRIAL	FLAT		
6	OR	GARDNER	TRAIN	LPN	SMALL INDUS.	AGRICULTURAL	FLAT		
6	OR	GILCHRIST	TRAIN	KNOR	SMALL INDUS.	AGRICULTURAL	FLAT		
6	OR	GLENDALE	TRAIN	SP	SMALL INDUS.	AGRICULTURAL	FLAT		
6	OR	GOLD HILL	INDUSTRY	SP	SMALL INDUS.	AGRICULTURAL	FLAT		
6	OR	GRANTS PASS	TRAIN	SP	SMALL INDUS.	RESIDENTIAL	FLAT		
6	OR	HEPPNER	TRAIN	UP	SMALL INDUS.	AGRICULTURAL	FLAT		
6	OR	HILLSBORO	TRAIN	SP	SMALL INDUS.	RESIDENTIAL	FLAT		
6	OR	HINES	INDUSTRY	DNW	INDUSTRIAL	INDUSTRIAL	FLAT		
6	OR	HINKLE	TRAIN	UP	CLASS./INDUS.	RESIDENTIAL	FLAT	I/C	
6	OR	HOOD RIVER	MT. HOOD	MH	SMALL INDUS.	RESIDENTIAL	FLAT		
6	OR	HOOD RIVER	TRAIN	UP	SMALL INDUS.	INDUSTRIAL	FLAT		
6	OR	HUNTINGTON	TRAIN	UP	SMALL INDUS.	INDUSTRIAL	FLAT	I/C	
6	OR	KLAMATH FALLS	TRAIN	BN	CLASS./INDUS.	INDUSTRIAL	FLAT	I/C	
6	OR	KLAMATH FALLS	TRAIN	BN	CLASS./INDUS.	INDUSTRIAL	FLAT	I/C	
6	OR	KLAMATH FALLS	TRAIN	SP	CLASS./INDUS.	INDUSTRIAL	FLAT	I/C	
6	OR	LA GRANDE	TRAIN	UP	CLASS./INDUS.	INDUSTRIAL	FLAT		
6	OR	LAKE OSWEGO	TRAIN	SP	SMALL INDUS.	RESIDENTIAL	FLAT	I/C	
6	OR	LEBANON	INDUSTRY	BN	SMALL INDUS.	RESIDENTIAL	FLAT	I/C	
6	OR	LEBANON	TRAIN	SP	SMALL INDUS.	RESIDENTIAL	FLAT	I/C	
6	OR	MC MINNVILLE	TRAIN	SP	SMALL INDUS.	RESIDENTIAL	FLAT		
6	OR	MEDFORD	TRAIN	SP	SMALL INDUS.	RESIDENTIAL	FLAT		
6	OR	MYRTLE POINT	TRAIN	SP	SMALL INDUS.	RESIDENTIAL	FLAT		
6	OR	NEWBERG	TRAIN	SP	SMALL INDUS.	RESIDENTIAL	FLAT		
6	OR	OAK RIDGE	TRAIN	SP	SMALL INDUS.	RESIDENTIAL	FLAT		
6	OR	ONTARIO	TRAIN	UP	SMALL INDUS.	RESIDENTIAL	FLAT		
6	OR	PENDLETON	TRAIN	BN	INDUSTRIAL	INDUSTRIAL	FLAT	I/C	
6	OR	PORTLAND	TRAIN	UP	INDUSTRIAL	INDUSTRIAL	FLAT	I/C	
6	JR	PORTLAND	EAST PORTLAND	BN	SMALL INDUS.	INDUSTRIAL	FLAT	I/C	HOYT WILBRIDGE
6	OR	PORTLAND	EAST ST. JOHN	BN	SMALL INDUS.	INDUSTRIAL	FLAT	I/C	HOYT WILBRIDGE
6	OR	PORTLAND	FRT. HOUSE	BN	SMALL INDUS.	INDUSTRIAL	FLAT		HOYT WILBRIDGE
6	OR	PORTLAND	HOUSE + TEAN	BN	SMALL INDUS.	INDUSTRIAL	FLAT		HOYT WILBRIDGE
6	OR	PORTLAND	HOYT + RIP TRACK	HN	CLASS./INDUS.	INDUSTRIAL	FLAT		HOYT WILBRIDGE
6	OR	PORTLAND	INDUSTRIAL	HN	SMALL INDUS.	INDUSTRIAL	FLAT		HOYT WILBRIDGE
6	OR	PORTLAND	WILBRIDGE TP.	BN	CLASS./INDUS.	INDUSTRIAL	FLAT		HOYT WILBRIDGE
6	OR	PORTLAND	DEPOT	PRTO	CLASS./INDUS.	INDUSTRIAL	FLAT		HOYT WILBRIDGE
6	OR	PORTLAND	LAKE	PRTO	CLASS./INDUS.	INDUSTRIAL	FLAT		HOYT WILBRIDGE
6	OR	PORTLAND	GROCKLYN	SP	CLASS./INDUS.	INDUSTRIAL	FLAT		HOYT WILBRIDGE
6	OR	PORTLAND	EAST PORTLAND	SP	CLASS./INDUS.	INDUSTRIAL	FLAT		HOYT WILBRIDGE
6	OR	PORTLAND	ALBINA	UP	SMALL INDUS.	INDUSTRIAL	FLAT	I/C	BROOKLYN
6	OR	PORTLAND	BURNS	UP	CLASS./INDUS.	INDUSTRIAL	FLAT		BROOKLYN
6	OR	PORTLAND	EAST PORTLAND	UP	CLASS./INDUS.	INDUSTRIAL	FLAT		BROOKLYN
6	OR	PORTLAND	TEP. 4	UP	SMALL INDUS.	INDUSTRIAL	FLAT		BROOKLYN
6	OR	PORTLAND	EAST PORTLAND	UP	SMALL INDUS.	INDUSTRIAL	FLAT		BROOKLYN
6	OR	PORTLAND	TEP. 4	UP	SMALL INDUS.	INDUSTRIAL	FLAT		BROOKLYN
6	OR	PRINCIVILLE	TRAIN	COP	SMALL INDUS.	INDUSTRIAL	FLAT	I/C	ALBINA
6	OR	PRINCIVILLE	TRAIN	SP	SMALL INDUS.	INDUSTRIAL	FLAT	I/C	ALBINA
6	OR	PRINCIVILLE	TRAIN	SP	SMALL INDUS.	AGRICULTURAL	FLAT		ALBINA

76/07/DR.

REG.	ST.	CITY	YARD	RAIL-ROAD	YARD FUNCTION	LOCATION TYPE	YARD TYPE	I/C	MAJOR YARD IF MULTI-YARD COMPLEX
6	OK	REDMOND	TRAIN	BN	SMALL INDUS.	RESIDENTIAL	FLAT	I/C	
6	OK	REDMOND	TRAIN	UP	SMALL INDUS.	RESIDENTIAL	FLAT	I/C	
6	OP	REDSFORT	TRAIN	SP	SMALL INDUS.	RESIDENTIAL	FLAT	I/C	
6	OR	RIDOLE	TRAIN	SP	SMALL INDUS.	RESIDENTIAL	FLAT	I/C	
6	OR	ROSEBURG	TRAIN	SP	INDUSTRIAL	INDUSTRIAL	FLAT	I/C	
6	JR	ST. HELENS	TRAIN	BN	SMALL INDUS.	INDUSTRIAL	FLAT	I/C	
6	JR	SALE	TRAIN	BN	INDUSTRIAL	INDUSTRIAL	FLAT	I/C	
6	UC	SALEM	TRAIN	SP	INDUSTRIAL	INDUSTRIAL	FLAT	I/C	
6	OM	SWEET HOME	TRAIN	BN	SMALL INDUS.	RESIDENTIAL	FLAT	I/C	
6	OR	THE DALLES	TRAIN	UP	CLASSIFICATION	INDUSTRIAL	FLAT	I/C	
6	OR	TILLAMOOK	TRAIN	PJTB	SMALL INDUS.	RESIDENTIAL	FLAT	I/C	
6	OK	TILLAMOOK	TRAIN	SP	SMALL INDUS.	RESIDENTIAL	FLAT	I/C	
6	OK	TOLEDO	INDUSTRY+TRAIN	SP	SMALL INDUS.	RESIDENTIAL	FLAT	I/C	
6	UT	TROUTDALE	TRAIN	UP	SMALL INDUS.	RESIDENTIAL	FLAT	I/C	
6	UR	UNION	TRAIN	UD	SMALL INDUS.	AGRICULTURAL	FLAT	I/C	
6	OR	UNION	TRAIN	UP	SMALL INDUS.	RESIDENTIAL	FLAT	I/C	
2	PA	ABRAMS	NORTH ABRAMS	RDG	CLASS-/INDUS.	RESIDENTIAL	FLAT	I/C	
2	PA	ALBION	ALBION	BLE	CLASS-/INDUS.	AGRICULTURAL	FLAT	I/C	
2	PA	ALTOUIPPA	TRAIN	ALOS	INDUSTRIAL	INDUSTRIAL	FLAT	I/C	
2	PA	ALTOUIPPA	TRAIN	PLE	INDUSTRIAL	INDUSTRIAL	FLAT	I/C	
2	PA	ALLENTOWN	ALLENTOWN E. HUMP	LV	CLASS-/INDUS.	RESIDENTIAL	HUMP	I/C	ALLENTOWN
2	PA	ALLENTOWN	ALLENTOWN W. HUMP	LV	CLASS-/INDUS.	RESIDENTIAL	HUMP	I/C	ALLENTOWN
2	PA	ALLENTOWN	EAST PENN. JCT.	LV	SMALL INDUS.	RESIDENTIAL	FLAT	I/C	
2	PA	ALLENTOWN	GORDON STREET	LV	SMALL INDUS.	RESIDENTIAL	FLAT	I/C	
2	PA	ALTCONA	BRUSH-EAST	PC	SMALL INDUS.	COMMERCIAL	FLAT	I/C	
2	PA	ALTCONA	WORKS	PC	SMALL INDUS.	COMMERCIAL	FLAT	I/C	
2	PA	AVIS	TRAIN	PC	INDUSTRIAL	INDUSTRIAL	HUMP	I/C	
2	PA	BEAVER FALLS	TRAIN	PC	SMALL INDUS.	INDUSTRIAL	FLAT	I/C	
2	PA	BELLEFRONTE	TRAIN	PC	SMALL INDUS.	INDUSTRIAL	FLAT	I/C	
2	PA	BELLEFRONTE	BC	PC	CLASSIFICATION	COMMERCIAL	FLAT	I/C	
2	PA	BELLEFRONTE	TRAIN	PC	CLASSIFICATION	INDUSTRIAL	FLAT	I/C	
2	PA	BERWICK	TRAIN	PC	SMALL INDUS.	INDUSTRIAL	FLAT	I/C	
2	PA	BERWICK	BERWICK	PC	SMALL INDUS.	INDUSTRIAL	FLAT	I/C	
2	PA	BETHLEHEM	BETHLEHEM	LV	INDUSTRIAL	RESIDENTIAL	FLAT	I/C	ALLENTOWN
2	PA	BETHLEHEM	FLORENCE	LV	INDUSTRIAL	RESIDENTIAL	FLAT	I/C	ALLENTOWN
2	PA	BETHLEHEM	BETHLEHEM	PBNE	INDUSTRIAL	INDUSTRIAL	FLAT	I/C	
2	PA	BETHLEHEM	SAUCON CREEK	RDG	CLASS-/INDUS.	INDUSTRIAL	FLAT	I/C	
2	PA	BETHLEHEM	SAUCON CREEK	PC	CLASS-/INDUS.	INDUSTRIAL	FLAT	I/C	
2	PA	BIRDSPURD	BIRDSPURD	RDG	SMALL INDUS.	INDUSTRIAL	FLAT	I/C	
2	PA	BIRDSPURD	BIRDSPURD	RDG	SMALL INDUS.	INDUSTRIAL	FLAT	I/C	
2	PA	BLADEFORD	TRAIN	EL	SMALL INDUS.	COMMERCIAL	FLAT	I/C	
2	PA	BOSTON	BOSTON	PC	INDUSTRIAL	RESIDENTIAL	HUMP	I/C	
2	PA	BROCKWAY	TRAIN	JOINT	CLASSIFICATION	COMMERCIAL	FLAT	I/C	
2	PA	BROCKWAY	FUSTER MINE	PC	SMALL INDUS.	INDUSTRIAL	FLAT	I/C	
2	PA	BROCKWAY	FUSTER MINE	PC	SMALL INDUS.	INDUSTRIAL	FLAT	I/C	
2	PA	BROWNVILLE	BIG MEADOW	MGA	INDUSTRIAL	INDUSTRIAL	FLAT	I/C	
2	PA	BROWNVILLE	BIG MEADOW	MRY	CLASSIFICATION	RESIDENTIAL	FLAT	I/C	
2	PA	BROWNVILLE	WB JUNCTION	PC	CLASSIFICATION	RESIDENTIAL	FLAT	I/C	
2	PA	BROWNVILLE	WB JUNCTION	PC	CLASSIFICATION	RESIDENTIAL	FLAT	I/C	
2	PA	BROWNVILLE	WB JUNCTION	PC	CLASSIFICATION	RESIDENTIAL	FLAT	I/C	
2	PA	BUTLER	CALVIN	RD	SMALL INDUS.	INDUSTRIAL	FLAT	I/C	
2	PA	BUTLER	CALVIN	BLE	SMALL INDUS.	INDUSTRIAL	FLAT	I/C	
2	PA	BUTLER	ROTLER JCT.	RD	SMALL INDUS.	INDUSTRIAL	FLAT	I/C	
2	PA	BUTLER	ROTLER JCT.	RD	SMALL INDUS.	INDUSTRIAL	FLAT	I/C	
2	PA	CAJUGAN	JINE	HO	SMALL INDUS.	INDUSTRIAL	FLAT	I/C	
2	PA	CAJUGAN	JINE	HO	SMALL INDUS.	INDUSTRIAL	FLAT	I/C	
2	PA	CANDONSBURG	TRAIN	PC	SMALL INDUS.	INDUSTRIAL	FLAT	I/C	
2	PA	CANDONSBURG	TRAIN	PC	SMALL INDUS.	INDUSTRIAL	FLAT	I/C	
2	PA	CEMENTON	CEMENTON	PC	SMALL INDUS.	AGRICULTURAL	FLAT	I/C	
2	PA	CEMENTON	PBS MINE	LV	SMALL INDUS.	AGRICULTURAL	FLAT	I/C	
2	PA	CEMENTON	PBS MINE	LV	SMALL INDUS.	AGRICULTURAL	FLAT	I/C	
2	PA	CENTRAL CITY	TRAIN	PC	SMALL INDUS.	INDUSTRIAL	FLAT	I/C	
2	PA	CENTRAL CITY	TRAIN	PC	SMALL INDUS.	INDUSTRIAL	FLAT	I/C	
2	PA	CHAMBERBURG	CHAMBERBURG	PC	SMALL INDUS.	COMMERCIAL	FLAT	I/C	

76/07/08.

REG.	ST.	CITY	YARD	RAIL-ROAD	YARD FUNCTION	LOCATION TYPE	YARD TYPE	I/C	MAJOR YARD IF MULTI-YARD COMPLEX
2	PA	CHAMBERSBURG	FRT. HOUSE	M	SMALL INDUS.	COMMERCIAL	FLAT	I/C	
2	PA	CHAMPLIN	TRAIN	MTR	SMALL INDUS.	INDUSTRIAL	FLAT	I/C	
2	PA	CHESTNY TREE	TRAIN	PC	CLASS./INDUS.	COMMERCIAL	FLAT		
2	PA	CHESTER	EDDYSTONE	PC	SMALL INDUS.	INDUSTRIAL	FLAT	I/C	THURLOW
2	PA	CHESTER	STONEY CREEK	PC	INDUSTRIAL	INDUSTRIAL	FLAT		THURLOW
2	PA	CHESTER	THURLOW	PC	CLASS./INDUS.	INDUSTRIAL	FLAT		DARBY CREEK
2	PA	CHESTER	DARBY CREEK	RDG	SMALL INDUS.	INDUSTRIAL	FLAT		DARBY CREEK
2	PA	CHESTER	EDDYSTONE	RDG	SMALL INDUS.	INDUSTRIAL	FLAT		DARBY CREEK
2	PA	CHESTER	MARKET STREET	RDG	SMALL INDUS.	RESIDENTIAL	FLAT		DARBY CREEK
2	PA	CHESTER	TRAIN	LEF	SMALL INDUS.	RESIDENTIAL	FLAT		
2	PA	CHESTER	TRAIN	PC	CLASS./INDUS.	COMMERCIAL	FLAT	I/C	
2	PA	CLEARFELLO	COATESVILLE	RDG	SMALL INDUS.	COMMERCIAL	FLAT	I/C	
2	PA	COLUMBIA	FRT. HOUSE	PC	SMALL INDUS.	COMMERCIAL	FLAT		
2	PA	COLVER	TRAIN	CI	SMALL INDUS.	COMMERCIAL	FLAT		
2	PA	CONNELLSVILLE	TRAIN	RDG	CLASSIFICATION	RESIDENTIAL	HUMP		
2	PA	CONSHOHOCKEN	CONSHOHOCKEN	RDG	SMALL INDUS.	RESIDENTIAL	FLAT		
2	PA	CONSHOHOCKEN	CONSHOHOCKEN	PC	SMALL INDUS.	RESIDENTIAL	FLAT		
2	PA	CORADAPOLIS	TRAIN	RDG	SMALL INDUS.	INDUSTRIAL	FLAT	I/C	
2	PA	CORRY	CORRY	MTR	SMALL INDUS.	INDUSTRIAL	FLAT		
2	PA	COUDERSPORT	TRAIN	PC	SMALL INDUS.	COMMERCIAL	FLAT		
1	PA	COXTON	COXTON EAST	WAG	CLASSIFICATION	AGRICULTURAL	FLAT		
2	PA	CRESSON	TRAIN	LV	INDUSTRIAL	COMMERCIAL	FLAT		
2	PA	CULBERTSON	LETTERKENNY	PC	SMALL INDUS.	INDUSTRIAL	FLAT		
2	PA	DELANO	DELANO	WM	SMALL INDUS.	UNDEVELOPED	FLAT		
2	PA	DERRY	TRAIN	LV	SMALL INDUS.	COMMERCIAL	FLAT		
2	PA	DOYLESTOWN	DOYLESTOWN	PC	SMALL INDUS.	RESIDENTIAL	FLAT		
2	PA	DU BOIS	TRAIN	RDG	SMALL INDUS.	COMMERCIAL	FLAT		
2	PA	DUNBAR	BOWEST	WM	SMALL INDUS.	UNDEVELOPED	FLAT		
2	PA	EAST PITTSBURGH	TRAIN	PC	SMALL INDUS.	COMMERCIAL	FLAT	I/C	
2	PA	EAST PITTSBURGH	FURNACE	URR	INDUSTRIAL	INDUSTRIAL	FLAT		
2	PA	EAST PITTSBURGH	FAIR	URR	INDUSTRIAL	INDUSTRIAL	FLAT		
2	PA	EAST PITTSBURGH	VALLEY	URR	INDUSTRIAL	INDUSTRIAL	FLAT		
2	PA	EASTON	EASTON	LV	SMALL INDUS.	RESIDENTIAL	FLAT		
2	PA	EASTON	RICHARDS	LV	CLASSIFICATION	AGRICULTURAL	FLAT		RICHARDS
2	PA	ERENSHURG	SCAPE	CT	INDUSTRIAL	INDUSTRIAL	FLAT		RICHARDS
2	PA	ELK LANA	SCALE	PC	CLASS./INDUS.	UNDEVELOPED	FLAT		
2	PA	ELK LANA	TRAIN	PC	CLASS./INDUS.	UNDEVELOPED	FLAT		
2	PA	EMPHORIUM	TRAIN	PC	INDUSTRIAL	COMMERCIAL	FLAT		
2	PA	ERIE	TRAIN	BLE	INDUSTRIAL	RESIDENTIAL	FLAT		
2	PA	ERIE	PLANT	SEC	SMALL INDUS.	RESIDENTIAL	FLAT		
2	PA	ERIE	TRAIN	WM	SMALL INDUS.	RESIDENTIAL	FLAT		
2	PA	ERIE	DICK JUNCTION	PC	SMALL INDUS.	RESIDENTIAL	FLAT	I/C	OD
2	PA	ERIE	ERIE EAST	PC	CLASS./INDUS.	RESIDENTIAL	FLAT	I/C	OD
2	PA	ERIE	OD	PC	SMALL INDUS.	RESIDENTIAL	FLAT		OD
2	PA	ESSINGTON	WANAPAKER	PC	INDUSTRIAL	RESIDENTIAL	FLAT		
2	PA	FAIRLESS HILLS	FAIRLESS	PC	INDUSTRIAL	INDUSTRIAL	FLAT		
2	PA	FAIRLESS HILLS	FAIRLESS	RDG	INDUSTRIAL	INDUSTRIAL	FLAT		
1	PA	FOUL RIFT	FOUL RIFT	PC	INDUSTRIAL	INDUSTRIAL	FLAT		
2	PA	GALETON	TRAIN	WAG	SMALL INDUS.	COMMERCIAL	FLAT		
2	PA	GETTYSBURG	FRT. HOUSE	WM	SMALL INDUS.	COMMERCIAL	FLAT		
2	PA	GLENWOOD	TRAIN	RDG	SMALL INDUS.	COMMERCIAL	FLAT		
2	PA	GORDON	GORDON	PC	SMALL INDUS.	RESIDENTIAL	FLAT		
2	PA	GREENVILLE	SHEMANGO	BLE	CLASS./INDUS.	RESIDENTIAL	FLAT	I/C	

76/07/06*

REG.	ST.	CITY	YARD	RAIL-ROAD	YARD FUNCTION	LOCATION TYPE	YARD TYPE	I/C	MAJOR YARD IF MULTI-YARD COMPLEX
2	PA	GREENVILLE	SHERANGO	EL	SMALL INDUS.	RESIDENTIAL	FLAT		
2	PA	GREENVILLE	SHERANGO	PC	SMALL INDUS.	RESIDENTIAL	FLAT	I/C	
2	PA	HACKENSACK	HACKENSACK	IRN	SMALL INDUS.	AGRICULTURAL	FLAT		
2	PA	HANDWER	FRY HOUSE	WM	SMALL INDUS.	COMMERCIAL	FLAT		
2	PA	HARRISBURG	DIVISION STREET	PC	CLASS-/INDUS.	COMMERCIAL	FLAT		ENOLA WEST
2	PA	HARRISBURG	REILLY STREET	PC	CLASS-/INDUS.	COMMERCIAL	FLAT		ENOLA WEST
2	PA	HARRISBURG	ENOLA EAST	PC	CLASS-/INDUS.	COMMERCIAL	HUMP		ENOLA WEST
2	PA	HARRISBURG	ENOLA WEST	PC	CLASS-/INDUS.	COMMERCIAL	HUMP		ENOLA WEST
2	PA	HAUCKS	HAUCKS	PC	SMALL INDUS.	UNDEVELOPED	FLAT		
2	PA	HAYS	U.S. STEEL	URR	INDUSTRIAL	INDUSTRIAL	FLAT		
1	PA	HAZELTON	HAZELTON COAL	LV	INDUSTRIAL	INDUSTRIAL	FLAT		
2	PA	HERSHEY	HERSHEY	RDG	SMALL INDUS.	INDUSTRIAL	FLAT		
2	PA	HOLLIDAYSHURG	TRAIN	RDG	CLASS-/INDUS.	COMMERCIAL	FLAT		
2	PA	HOMESTEAD	TRAIN	PC	INDUSTRIAL	INDUSTRIAL	FLAT		
2	PA	HUDSON	HUDSON	PLE	INDUSTRIAL	INDUSTRIAL	FLAT		
1	PA	HUDSON	HUDSON	DH	CLASS-/INDUS.	COMMERCIAL	FLAT	I/C	
2	PA	IVY ROCK	IVY ROCK	PC	CLASSIFICATION	COMMERCIAL	FLAT	I/C	
2	PA	JEANNETTE	TRAIN	UMP	INDUSTRIAL	INDUSTRIAL	FLAT	I/C	SWEDELAND
2	PA	JERSEY SHORE	TRAIN	PC	SMALL INDUS.	INDUSTRIAL	FLAT		
2	PA	JOANNA	JOANNA	RDG	SMALL INDUS.	RESIDENTIAL	FLAT		
2	PA	JOHNSBURG	CLAIFUN JCT.	RDG	SMALL INDUS.	AGRICULTURAL	FLAT	I/C	
2	PA	JOHNSBURG	TRAIN	EL	SMALL INDUS.	COMMERCIAL	FLAT	I/C	
2	PA	JOHNSBURG	TRAIN	PC	SMALL INDUS.	COMMERCIAL	FLAT	I/C	
2	PA	JOHNSBURG	TRAIN	PC	SMALL INDUS.	COMMERCIAL	FLAT	I/C	
2	PA	JOHNSTOWN	FERDALE	PC	INDUSTRIAL	INDUSTRIAL	FLAT	I/C	
2	PA	JOHNSTOWN	TRAIN	BO	INDUSTRIAL	INDUSTRIAL	FLAT	I/C	
2	PA	JOHNSTOWN	10 ACRE	CBL	INDUSTRIAL	INDUSTRIAL	FLAT		
2	PA	JOHNSTOWN	BSC	CBL	CLASS-/INDUS.	INDUSTRIAL	FLAT		
2	PA	JOHNSTOWN	PARKHILL	CBL	INDUSTRIAL	INDUSTRIAL	FLAT	I/C	
2	PA	JOHNSTOWN	WOODVLF	CBL	CLASS-/INDUS.	COMMERCIAL	FLAT		
2	PA	JOHNSTOWN	TRAIN	JSC	INDUSTRIAL	INDUSTRIAL	FLAT	I/C	
2	PA	JOHNSTOWN	CONEWAUGH	PC	CLASS-/INDUS.	COMMERCIAL	FLAT	I/C	
2	PA	JOHNSTOWN	MORRELLVILLE	PC	CLASS-/INDUS.	COMMERCIAL	FLAT	I/C	
1	PA	KINGSTON	KINGSTON	PC	SMALL INDUS.	COMMERCIAL	FLAT		
2	PA	KISKI JCT.	LANEVILLE	PC	SMALL INDUS.	COMMERCIAL	FLAT	I/C	KISKI VALLEY
2	PA	KISKI JCT.	VALLEY	PC	SMALL INDUS.	COMMERCIAL	FLAT		KISKI VALLEY
2	PA	KITTANNING	TRAIN	PC	CLASS-/INDUS.	COMMERCIAL	FLAT		KISKI VALLEY
2	PA	LANCASTER	DILLERVILLE	PS	INDUSTRIAL	COMMERCIAL	FLAT		DILLERVILLE
2	PA	LANCASTER	LANCASTER	PC	INDUSTRIAL	INDUSTRIAL	FLAT	I/C	DILLERVILLE
2	PA	LANCASTER	LANCASTER	RDG	INDUSTRIAL	RESIDENTIAL	FLAT	I/C	
2	PA	LANSDALE	LANSDALE	RDG	SMALL INDUS.	INDUSTRIAL	FLAT		
2	PA	LEBANON	LEBANON	PC	SMALL INDUS.	INDUSTRIAL	FLAT	I/C	
2	PA	LEBANON	LEBANON	RDG	SMALL INDUS.	INDUSTRIAL	FLAT	I/C	
2	PA	LEWISTOWN	TRAIN	PC	INDUSTRIAL	COMMERCIAL	FLAT		
2	PA	LOCK HAVEN	TRAIN	PC	CLASS-/INDUS.	COMMERCIAL	FLAT		
2	PA	LUCUST SUMMIT	LUCUST SUMMIT	RDG	SMALL INDUS.	UNDEVELOPED	FLAT		
2	PA	LUCERNE	WINE	RDG	SMALL INDUS.	INDUSTRIAL	FLAT		
2	PA	MADONEY CITY	MADONEY CITY	RDG	SMALL INDUS.	INDUSTRIAL	FLAT		
2	PA	MARTINS CREEK	MARTINS CREEK	RDG	SMALL INDUS.	RESIDENTIAL	FLAT		
2	PA	MARTINS CREEK	MARTINS CREEK	LV	SMALL INDUS.	AGRICULTURAL	FLAT		
2	PA	MC ADDO	CANDELTON	RDG	SMALL INDUS.	AGRICULTURAL	FLAT		
2	PA	MC KEES CREEK	TRAIN	PCY	INDUSTRIAL	UNDEVELOPED	FLAT		
2	PA	MC KEES CREEK	TRAIN	PCY	INDUSTRIAL	COMMERCIAL	FLAT	I/C	
2	PA	MEADVILLE	T-RAIN	EL	CLASS-/INDUS.	COMMERCIAL	FLAT		
2	PA	MEADVILLE	T-RAIN	EL	CLASS-/INDUS.	RESIDENTIAL	FLAT		

76/07/04

REG.	ST.	CITY	YARD	RAIL - ROAD	YARD FUNCTION	LOCATION TYPE	YARD TYPE	I/C	MAJOR YARD IF MULTI-YARD COMPLEX
2	PA	MIDLAND	TRAIN	PC	CLASS./INDUS.	INDUSTRIAL	FLAT		
2	PA	MILTON	TRAIN	PC	SMALL INDUS.	COMMERCIAL	FLAT		
2	PA	KUNESSEN	TRAIN	NW	SMALL INDUS.	INDUSTRIAL	FLAT	I/C	
2	PA	MONESSEN	SHIPPERS	PLE	INDUSTRIAL	INDUSTRIAL	FLAT	I/C	
2	PA	MORRISVILLE	A	PC	CLASS./INDUS.	RESIDENTIAL	HUMP		
2	PA	NANTICOK	HONEY POT	PC	INDUSTRIAL	UNDEVELOPED	FLAT	I/C	
2	PA	NAZARETH	TADMORE	LNE	INDUSTRIAL	AGRICULTURAL	FLAT		
2	PA	NEW CASTLE	TRAIN	BT	INDUSTRIAL	INDUSTRIAL	FLAT		
2	PA	NEW CASTLE	TRAIN	EL	SMALL INDUS.	INDUSTRIAL	FLAT		
2	PA	NEW CASTLE	TRAIN	PLE	SMALL INDUS.	INDUSTRIAL	FLAT		
2	PA	NEW CUMBERLAND	TRAIN	PC	SMALL INDUS.	COMMERCIAL	FLAT		
2	PA	NEW KENSINGTON	TRAIN	PC	INDUSTRIAL	INDUSTRIAL	FLAT		
2	PA	NORRISTOWN	EARNST	PC	INDUSTRIAL	INDUSTRIAL	FLAT		FARNEST EARNST
2	PA	NORRISTOWN	NORRIS	PC	SMALL INDUS.	INDUSTRIAL	FLAT		
2	PA	NORTHAMPTON	NORTHAMPTON	PC	SMALL INDUS.	INDUSTRIAL	FLAT	I/C	
2	PA	NORTHAMPTON	NORTHAMPTON	NB	INDUSTRIAL	RESIDENTIAL	FLAT		
2	PA	NORTHAMPTON	NORTHAMPTON+BATH	LV	INDUSTRIAL	RESIDENTIAL	FLAT		
2	PA	NORTHAMPTON	TRAIN	PC	CLASS./INDUS.	COMMERCIAL	FLAT	I/C	
2	PA	NORTHAMPTON	OIL CITY	EL	SMALL INDUS.	UNDEVELOPED	FLAT		
2	PA	ORFELAND	SOUTH OIL CITY	PC	INDUSTRIAL	RESIDENTIAL	FLAT		
2	PA	ORFELAND	ORELAND	RDG	SMALL INDUS.	RESIDENTIAL	FLAT	I/C	
1	PA	PALMERTON	PALMERTON	CHR	INDUSTRIAL	INDUSTRIAL	FLAT	I/C	
1	PA	PALMERTON	PALMERTON	LV	INDUSTRIAL	INDUSTRIAL	FLAT	I/C	
2	PA	PHILADELPHIA	EASTSIDE	RD	CLASS./INDUS.	INDUSTRIAL	FLAT		EASTSIDE
2	PA	PHILADELPHIA	PIER 62+PROD.+TERM	RD	INDUSTRIAL	INDUSTRIAL	FLAT	I/C	
2	PA	PHILADELPHIA	44TH ST.	PC	CLASS./INDUS.	INDUSTRIAL	FLAT	I/C	
2	PA	PHILADELPHIA	C STREET	PC	SMALL INDUS.	INDUSTRIAL	FLAT		NEW GREENWICH FRANKFORD JCT.
2	PA	PHILADELPHIA	CREEK BRANCH	PC	INDUSTRIAL	INDUSTRIAL	FLAT		
2	PA	PHILADELPHIA	ESTES	PC	SMALL INDUS.	INDUSTRIAL	FLAT		
2	PA	PHILADELPHIA	FAIRHILL	PC	SMALL INDUS.	INDUSTRIAL	FLAT		
2	PA	PHILADELPHIA	FEDERAL STREET	PC	SMALL INDUS.	INDUSTRIAL	FLAT		
2	PA	PHILADELPHIA	FRANKFORD JCT.	PC	INDUSTRIAL	INDUSTRIAL	FLAT		NEW GREENWICH FRANKFORD JCT.
2	PA	PHILADELPHIA	GRAND POINT	PC	INDUSTRIAL	INDUSTRIAL	FLAT		
2	PA	PHILADELPHIA	GRAYS FERRY	PC	INDUSTRIAL	RESIDENTIAL	FLAT		
2	PA	PHILADELPHIA	MARGIE	PC	SMALL INDUS.	INDUSTRIAL	FLAT		
2	PA	PHILADELPHIA	MIDVALE	PC	INDUSTRIAL	INDUSTRIAL	FLAT		
2	PA	PHILADELPHIA	NEW GREENWICH	PC	CLASS./INDUS.	INDUSTRIAL	HUMP		NEW GREENWICH
2	PA	PHILADELPHIA	PENROSE	PC	INDUSTRIAL	INDUSTRIAL	FLAT		NEW GREENWICH
2	PA	PHILADELPHIA	SHACKAMAXON	PC	SMALL INDUS.	RESIDENTIAL	FLAT		
2	PA	PHILADELPHIA	3RD + BERKS	RDG	SMALL INDUS.	INDUSTRIAL	FLAT		
2	PA	PHILADELPHIA	RELMONT	RDG	SMALL INDUS.	RESIDENTIAL	FLAT		
2	PA	PHILADELPHIA	BROAD+CALLOWHILL	RDG	SMALL INDUS.	RESIDENTIAL	FLAT		
2	PA	PHILADELPHIA	PENNYD	RDG	SMALL INDUS.	INDUSTRIAL	FLAT		
2	PA	PHILADELPHIA	PORT RICHMOND	RDG	SMALL INDUS.	INDUSTRIAL	FLAT		
2	PA	PHILADELPHIA	WAYNE JCT.	RDG	CLASS./INDUS.	INDUSTRIAL	FLAT		
2	PA	PHILADELPHIA	WOODLANE	RDG	INDUSTRIAL	INDUSTRIAL	FLAT		
2	PA	PHILADELPHIA	TRAIN	PC	SMALL INDUS.	INDUSTRIAL	FLAT		
2	PA	PHOENIXVILLE	PHOENIXVILLE	PC	CLASSIFICATION	RESIDENTIAL	FLAT		
2	PA	PHOENIXVILLE	PHOENIXVILLE	PC	INDUSTRIAL	INDUSTRIAL	FLAT		
2	PA	PITCAIRN	TRAIN	PC	CLASSIFICATION	INDUSTRIAL	FLAT		
2	PA	PITTSBURGH	2ND AVE.	RD	INDUSTRIAL	COMMERCIAL	FLAT		WILLOW GROVE
2	PA	PITTSBURGH	36TH ST.	RD	SMALL INDUS.	INDUSTRIAL	FLAT		WILLOW GROVE
2	PA	PITTSBURGH	ALLEGHENY	RD	INDUSTRIAL	INDUSTRIAL	FLAT		WILLOW GROVE
2	PA	PITTSBURGH	DENVER	RD	INDUSTRIAL	UNDEVELOPED	FLAT		GLENNWOOD
2	PA	PITTSBURGH	PORT PERRY	BU	CLASSIFICATION	COMMERCIAL	FLAT		WILLOW GROVE

76/07/04.

REG.	ST.	CITY	YARD	RAIL-ROAD	YARD FUNCTION	LOCATION TYPE	YARD TYPE	I/C	MAJOR YARD IF MULTI-YARD COMPLEX
2	PA	PITTSBURGH	WILLOW GROVE	RD	CLASS./INDUS.	COMMERCIAL	FLAT	I/C	WILLOW GROVE
2	PA	PITTSBURGH	MCKEESPORT	WCK	INDUSTRIAL	INDUSTRIAL	FLAT	I/C	
2	PA	PITTSBURGH	TRAIN	WCR	INDUSTRIAL	INDUSTRIAL	FLAT	I/C	
2	PA	PITTSBURGH	CLAIRTON	NW	SMALL INDUS.	RESIDENTIAL	FLAT	I/C	
2	PA	PITTSBURGH	RJOK	NW	SMALL INDUS.	COMMERCIAL	FLAT	I/C	
2	PA	PITTSBURGH	30TH STREET	PC	INDUSTRIAL	RESIDENTIAL	FLAT	I/C	
2	PA	PITTSBURGH	43RD ST.	PC	CLASSIFICATION	COMMERCIAL	FLAT	I/C	CONWAY
2	PA	PITTSBURGH	CONWAY EB.	PC	CLASSIFICATION	COMMERCIAL	FLAT	I/C	43RD ST.
2	PA	PITTSBURGH	CONWAY WB.	PC	CLASSIFICATION	HUMP	CONWAY		CONWAY
2	PA	PITTSBURGH	DALLAS	PC	INDUSTRIAL	RESIDENTIAL	FLAT	I/C	CONWAY
2	PA	PITTSBURGH	ISLAND AVE.	PC	INDUSTRIAL	COMMERCIAL	FLAT	I/C	43RD ST.
2	PA	PITTSBURGH	KENNY	PC	INDUSTRIAL	INDUSTRIAL	FLAT	I/C	CONWAY
2	PA	PITTSBURGH	RIVERTON	PC	INDUSTRIAL	INDUSTRIAL	FLAT	I/C	43RD ST.
2	PA	PITTSBURGH	SCULLY	PC	INDUSTRIAL	COMMERCIAL	FLAT	I/C	CONWAY
2	PA	PITTSBURGH	SOUTH DUQUESNE	PC	SMALL INDUS.	INDUSTRIAL	FLAT	I/C	CONWAY
2	PA	PITTSBURGH	THOMSON	PC	INDUSTRIAL	INDUSTRIAL	FLAT	I/C	CONWAY
2	PA	PITTSBURGH	TRUNK TRAIN TER-4.	PC	CLASSIFICATION	COMMERCIAL	FLAT	I/C	43RD ST.
2	PA	PITTSBURGH	WILSON	PC	INDUSTRIAL	INDUSTRIAL	FLAT	I/C	
2	PA	PITTSBURGH	NEVILLE ISLAND	PCY	CLASSIFICATION	INDUSTRIAL	FLAT	I/C	RIVERTON
2	PA	PITTSBURGH	GLASSPORT	PLE	INDUSTRIAL	COMMERCIAL	FLAT	I/C	
2	PA	PITTSBURGH	POINT BRIDGE	PLE	SMALL INDUS.	INDUSTRIAL	FLAT	I/C	
2	PA	PITTSBURGH	RANKIN	PLE	INDUSTRIAL	INDUSTRIAL	FLAT	I/C	RIVERTON
2	PA	PITTSBURGH	RIVERTON	PLE	CLASSIFICATION	INDUSTRIAL	FLAT	I/C	RIVERTON
2	PA	PITTSBURGH	TRAIN	PLE	SMALL INDUS.	COMMERCIAL	FLAT	I/C	RIVERTON
2	PA	PITTSBURGH	WYLIE	PLE	INDUSTRIAL	INDUSTRIAL	FLAT	I/C	RIVERTON
2	PA	PITTSBURGH	NEVILLE ISLAND	POV	INDUSTRIAL	INDUSTRIAL	FLAT	I/C	RIVERTON
2	PA	PITTSBURGH	CLAIRTON	URR	INDUSTRIAL	INDUSTRIAL	FLAT	I/C	RIVERTON
2	PA	PITTSBURGH	DUQUESNE	URR	INDUSTRIAL	INDUSTRIAL	FLAT	I/C	RIVERTON
2	PA	PITTSBURGH	EAST PITTSBURGH	URR	INDUSTRIAL	INDUSTRIAL	FLAT	I/C	MONON JCT.
2	PA	PITTSBURGH	HOMESTEAD	URR	INDUSTRIAL	INDUSTRIAL	FLAT	I/C	MONON JCT.
2	PA	PITTSBURGH	IRVIN WORKS	URR	CLASSIFICATION	INDUSTRIAL	FLAT	I/C	MONON JCT.
2	PA	PITTSBURGH	WELFELIN JUNCTION	URR	INDUSTRIAL	INDUSTRIAL	FLAT	I/C	MONON JCT.
2	PA	PITTSBURGH	MONON JUNCTION	URR	INDUSTRIAL	INDUSTRIAL	FLAT	I/C	MONON JCT.
2	PA	PITTSBURGH	MUNHALL	URR	INDUSTRIAL	INDUSTRIAL	FLAT	I/C	MONON JCT.
2	PA	PITTSBURGH	PORT PERRY	URR	CLASS./INDUS.	INDUSTRIAL	FLAT	I/C	MONON JCT.
2	PA	PITTSBURGH	RANKIN	URR	CLASSIFICATION	INDUSTRIAL	FLAT	I/C	MONON JCT.
2	PA	PITTSBURGH	SOUTH DUQUESNE	URR	INDUSTRIAL	INDUSTRIAL	FLAT	I/C	MONON JCT.
2	PA	PITTSBURGH	TRAIN	URR	SMALL INDUS.	INDUSTRIAL	FLAT	I/C	MONON JCT.
1	PA	PORT ALLEGANY	PORTLAND	PC	INDUSTRIAL	COMMERCIAL	FLAT	I/C	
2	PA	PITTSBURGH	POTTSTOWN	EL	INDUSTRIAL	INDUSTRIAL	FLAT	I/C	
2	PA	PITTSBURGH	STONE	PC	INDUSTRIAL	INDUSTRIAL	FLAT	I/C	
2	PA	PUNXSUTAWNEY	FLIKER	RDG	CLASS./INDUS.	COMMERCIAL	FLAT	I/C	
2	PA	READING	EAST READING	PC	INDUSTRIAL	INDUSTRIAL	FLAT	I/C	
2	PA	RENOVO	OLEY ST.	RDG	CLASS./INDUS.	INDUSTRIAL	FLAT	I/C	
2	PA	REYNOLDSVILLE	TRAIN	PC	SMALL INDUS.	RESIDENTIAL	FLAT	I/C	
2	PA	RIDGWAY	TRAIN	PC	INDUSTRIAL	COMMERCIAL	FLAT	I/C	
2	PA	RINGGOLD	TRAIN	PS	INDUSTRIAL	INDUSTRIAL	FLAT	I/C	
2	PA	RUTHERFORD	EAST	RDG	SMALL INDUS.	COMMERCIAL	HUMP	I/C	RUTHERFORD EAST
2	PA	RUTHERFORD	WEST	RDG	CLASS./INDUS.	COMMERCIAL	HUMP	I/C	RUTHERFORD EAST
2	PA	SAINTE CLAIRE	ST. CLAIR	RDG	SMALL INDUS.	RESIDENTIAL	FLAT	I/C	
2	PA	SAINTE MARYS	TRAIN	PC	INDUSTRIAL	COMMERCIAL	FLAT	I/C	
2	PA	SAINTE NICOMAS	ST. NICOMAS	RDG	INDUSTRIAL	INDUSTRIAL	FLAT	I/C	
2	PA	SALINA	TRUAILL	PC	SMALL INDUS.	COMMERCIAL	FLAT	I/C	

76/07/09.

REG.	ST.	CITY	YARD	RAIL-ROAD	YARD FUNCTION	LOCATION TYPE	YARD TYPE	T/C	MAJOR YARD IF MULTI-YARD COMPLEX
2	PA	SAXONBURG	BLANT	BLE	INDUSTRIAL	INDUSTRIAL	FLAT		
1	PA	SAYRE	GREEN RIDGE	LV	CLASS-/INDUS.	COMMERCIAL	FLAT		
1	PA	SCRANTON	SCRANTON	DH	INDUSTRIAL	COMMERCIAL	FLAT		
1	PA	SCRANTON	WEIGH SCALES	EL	CLASS-/INDUS.	COMMERCIAL	FLAT		
2	PA	SHAPKIN	SHAPKIN	LWV	INDUSTRIAL	COMMERCIAL	FLAT		
2	PA	SHAPKIN DAM	SHAPKIN	RDG	INDUSTRIAL	INDUSTRIAL	FLAT		
2	PA	SHARON	POWER PLANT	PC	SMALL INDUS.	AGRICULTURAL	FLAT		
2	PA	SHARON	FERRONA	EL	INDUSTRIAL	INDUSTRIAL	FLAT		
2	PA	SHARON	RO	FL	SMALL INDUS.	INDUSTRIAL	FLAT		
2	PA	SHARPSVILLE	TRAIN	PC	SMALL INDUS.	INDUSTRIAL	FLAT		
2	PA	SHIREMANSTOWN	TRAIN	PC	CLASS-/INDUS.	COMMERCIAL	FLAT		
2	PA	SMITHFIELD	TRAIN	PC	SMALL INDUS.	COMMERCIAL	FLAT		
2	PA	SOMERSET	TRAIN	BD	RESIDENTIAL	COMMERCIAL	FLAT		
2	PA	SOUTH FORK	TRAIN	BO	CLASS-/INDUS.	COMMERCIAL	FLAT		
2	PA	STEELTON	TRAIN	PC	CLASS-/INDUS.	COMMERCIAL	FLAT		
2	PA	STEELTON	STEELTON	PC	INDUSTRIAL	INDUSTRIAL	FLAT		
2	PA	STEELTON	STEEL PLANT	RDG	INDUSTRIAL	INDUSTRIAL	FLAT		
2	PA	STONEHORO	TRAIN	SH	SMALL INDUS.	RESIDENTIAL	FLAT		
2	PA	SWEDELAND	SWEDELAND	RDG	SMALL INDUS.	INDUSTRIAL	FLAT		
2	PA	SWEDELAND	SWEDELAND	UMP	INDUSTRIAL	INDUSTRIAL	FLAT		
2	PA	SWEDELAND	SWEDELAND	UNE	UNDEVELOPED	INDUSTRIAL	FLAT		
2	PA	TAMAQUA	ARLINGTON	PC	INDUSTRIAL	COMMERCIAL	FLAT		
1	PA	TAYLOR	TAYLOR	EL	CLASS-/INDUS.	AGRICULTURAL	FLAT		
2	PA	THORNDALE	THORNDALE	PC	INDUSTRIAL	AGRICULTURAL	FLAT		
2	PA	TUNNELTON	MINE	PC	SMALL INDUS.	INDUSTRIAL	FLAT		
2	PA	TYRONE	TRAIN	PC	INDUSTRIAL	COMMERCIAL	FLAT		
2	PA	UNIONTOWN	TRAIN	PC	SMALL INDUS.	RESIDENTIAL	FLAT		
2	PA	UNIONTOWN	TRAIN	URR	INDUSTRIAL	INDUSTRIAL	FLAT		
2	PA	UNIONTOWN	TRAIN	PC	SMALL INDUS.	INDUSTRIAL	FLAT		
2	PA	VANDERGRIFT	TRAIN	PC	INDUSTRIAL	RESIDENTIAL	FLAT		
2	PA	WARREN	WARREN	PC	SMALL INDUS.	RESIDENTIAL	FLAT		
2	PA	WATSONTOWN	TRAIN	PC	SMALL INDUS.	COMMERCIAL	FLAT		
2	PA	WAYNESBORO	TRAIN	PC	SMALL INDUS.	COMMERCIAL	FLAT		
2	PA	WAYNESBORO	TRAIN	WM	SMALL INDUS.	COMMERCIAL	FLAT		
2	PA	WEST NEWTON	W. CRESSONA	RDG	CLASSIFICATION	RESIDENTIAL	FLAT		
2	PA	WEST NEWTON	TRAIN	PLE	SMALL INDUS.	COMMERCIAL	FLAT		
2	PA	WEST TARENTUM	TRAIN	PC	INDUSTRIAL	COMMERCIAL	FLAT		
2	PA	WHEATLAND	TRAIN	PC	SMALL INDUS.	RESIDENTIAL	FLAT		
1	PA	WILKES-BARRE	WILKES-BARRE	LV	INDUSTRIAL	COMMERCIAL	FLAT		
1	PA	WILKES-BARRE	WILKES-BARRE	LWV	INDUSTRIAL	COMMERCIAL	FLAT		
2	PA	WILLIAMSPORT	NEWBERRY JCT.	PC	INDUSTRIAL	COMMERCIAL	FLAT		
2	PA	WOODRURNE	WOODRURNE	RDG	SMALL INDUS.	RESIDENTIAL	FLAT		
2	PA	YORK	FRT + PDRHOUSE	PC	SMALL INDUS.	COMMERCIAL	FLAT		
2	PA	YORK	NORTH	PC	SMALL INDUS.	INDUSTRIAL	FLAT		
2	PA	YORK	LINCLEN	WM	SMALL INDUS.	AGRICULTURAL	FLAT		
2	PA	YORK	PP+L CO.	PC	SMALL INDUS.	INDUSTRIAL	FLAT		
2	PA	YOUNGWOOD	TRAIN	PC	INDUSTRIAL	RESIDENTIAL	FLAT		
1	RI	CRANSTON	CRANSTON	PC	SMALL INDUS.	INDUSTRIAL	FLAT		
1	RI	PEACEDALE	PEACEDALE	NAP	SMALL INDUS.	INDUSTRIAL	FLAT		
1	RI	PROVIDENCE	NORTHUP AVENUE	PC	CLASS-/INDUS.	COMMERCIAL	FLAT		
1	RI	SAVESVILLE	SAVESVILLE	MOV	SMALL INDUS.	INDUSTRIAL	FLAT		
1	RI	VALLEY FALLS	FREIGHT HOUSE	PM	CLASS-/INDUS.	RESIDENTIAL	FLAT		
3	SC	ANNEVILLE	TAIN	SCL	INDUSTRIAL	RESIDENTIAL	FLAT		

76/07/21

REG.	ST.	CITY	YARD	RAIL-ROAD	YARD FUNCTION	LOCATION TYPE	YARD TYPE	I/C	MAJOR YARD IF MULTI-YARD COMPLEX
3	SC	AIKEN	TRAIN	SOU	SMALL INDUS.	RESIDENTIAL	FLAT		
3	SC	ALSTON	TRAIN	CRN	SMALL INDUS.	RESIDENTIAL	FLAT		
3	SC	ANDERSON	TRAIN	SCL	SMALL INDUS.	RESIDENTIAL	FLAT		
3	SC	ANDERSON	TRAIN	SCL	INDUSTRIAL	RESIDENTIAL	FLAT		
3	SC	ANDREWS	TRAIN	SOU	SMALL INDUS.	RESIDENTIAL	FLAT		
3	SC	BLACKSBURG	TRAIN	SCL	SMALL INDUS.	RESIDENTIAL	FLAT		
3	SC	CAMDEN	TRAIN	SCL	SMALL INDUS.	RESIDENTIAL	FLAT		
3	SC	CATAMBA	BOATERS	SOU	INDUSTRIAL	INDUSTRIAL	FLAT		
3	SC	CATAMBA	BOATERS	SOU	INDUSTRIAL	INDUSTRIAL	FLAT		
3	SC	CAYCE	TRAIN	SCL	SMALL INDUS.	RESIDENTIAL	FLAT		
3	SC	COLUMBIA	GERVAIS STREET	SCL	SMALL INDUS.	RESIDENTIAL	FLAT		
3	SC	COLUMBIA	ANDREWS	SOU	INDUSTRIAL	RESIDENTIAL	FLAT		
3	SC	DARLINGTON	TRAIN	SCL	INDUSTRIAL	RESIDENTIAL	FLAT		
3	SC	DENMARK	TRAIN	SCL	SMALL INDUS.	RESIDENTIAL	FLAT		
3	SC	DENMARK	TRAIN	SOU	SMALL INDUS.	RESIDENTIAL	FLAT	I/C	
3	SC	EHRHARDT	TRAIN	SCL	SMALL INDUS.	RESIDENTIAL	FLAT	I/C	
3	SC	FLORENCE	TRAIN	SCL	CLASSIFICATION	COMMERCIAL	FLAT		
3	SC	GAFFNEY	TRAIN	SOU	SMALL INDUS.	RESIDENTIAL	FLAT		
3	SC	GEORGETOWN	TRAIN	SCL	SMALL INDUS.	RESIDENTIAL	FLAT		
3	SC	GREENVILLE	TRAIN	SCL	CLASSIFICATION	RESIDENTIAL	FLAT		
3	SC	GREENVILLE	TRAIN	SOU	CLASSIFICATION	UNDEVELOPED	FLAT		
3	SC	GREENVILLE	NORTH	SOU	SMALL INDUS.	UNDEVELOPED	FLAT		
3	SC	GREENVILLE	SOUTH	SOU	SMALL INDUS.	UNDEVELOPED	FLAT		
3	SC	GREENWOOD	TRAIN	SCL	INDUSTRIAL	RESIDENTIAL	FLAT		
3	SC	GREENWOOD	TRAIN	SOU	SMALL INDUS.	RESIDENTIAL	FLAT		
3	SC	HAMPTON	TRAIN	SCL	SMALL INDUS.	RESIDENTIAL	FLAT		
3	SC	HARTSVILLE	TRAIN	SCL	SMALL INDUS.	RESIDENTIAL	FLAT		
3	SC	LANCASTER	TRAIN	LC	SMALL INDUS.	UNDEVELOPED	FLAT		
3	SC	LAURENS	TRAIN	SCL	INDUSTRIAL	RESIDENTIAL	FLAT		
3	SC	MC BEE	TRAIN	SCL	INDUSTRIAL	RESIDENTIAL	FLAT		
3	SC	MC CORMICK	TRAIN	SCL	SMALL INDUS.	RESIDENTIAL	FLAT		
3	SC	MULLENS	TRAIN	SCL	INDUSTRIAL	RESIDENTIAL	FLAT		
3	SC	MYRTLE BEACH	TRAIN	SCL	INDUSTRIAL	RESIDENTIAL	FLAT		
3	SC	NORTH CHARLESTON	PORT TERMINAL	PTRSC	INDUSTRIAL	RESIDENTIAL	FLAT		
3	SC	NORTH CHARLESTON	PORT UTILITIES	PUCSC	INDUSTRIAL	INDUSTRIAL	FLAT		
3	SC	NORTH CHARLESTON	BENNETT	SCL	INDUSTRIAL	UNDEVELOPED	FLAT		
3	SC	NORTH CHARLESTON	7-MILE	SOU	CLASS-/INDUS.	UNDEVELOPED	FLAT		
3	SC	PORT ROYAL	TRAIN	SCL	INDUSTRIAL	UNDEVELOPED	FLAT		
3	SC	ROCK HILL	TRAIN	SOU	INDUSTRIAL	INDUSTRIAL	FLAT		
3	SC	RUSSELLVILLE	TRAIN	SCL	SMALL INDUS.	RESIDENTIAL	FLAT		
3	SC	SPARTANBURG	BEAUMONT	CCO	SMALL INDUS.	RESIDENTIAL	FLAT		
3	SC	SPARTANBURG	TRAIN	SCL	CLASSIFICATION	COMMERCIAL	FLAT		
3	SC	SPARTANBURG	HAYNE	SOU	CLASSIFICATION	COMMERCIAL	FLAT		
3	SC	SUMTER	TRAIN	SCL	INDUSTRIAL	UNDEVELOPED	FLAT		
3	SC	WARE SHOALS	TRAIN	WS	INDUSTRIAL	RESIDENTIAL	FLAT		
3	SC	WATERHORO	TRAIN	SCL	INDUSTRIAL	RESIDENTIAL	FLAT		
3	SC	YEMASSEE	TRAIN	SCL	INDUSTRIAL	RESIDENTIAL	FLAT		
8	SD	ADERDEEN	TRAIN	C4SPD	CLASS-/INDUS.	COMMERCIAL	FLAT	I/C	
8	SD	BELLE FOURCHE	TRAIN	CNW	INDUSTRIAL	UNDEVELOPED	FLAT		
8	SD	DEADWOOD	TRAIN	3N	INDUSTRIAL	RESIDENTIAL	FLAT	I/C	
8	SD	EDEMONT	TRAIN	HN	SMALL INDUS.	UNDEVELOPED	FLAT		
8	SD	HURON	TRAIN	HN	SMALL INDUS.	RESIDENTIAL	FLAT		
8	SD	HURON	TRAIN	CNW	CLASS-/INDUS.	RESIDENTIAL	FLAT	I/C	
8	SD	MADISON	FREIGHT HOUSE	CMSPP	SMALL INDUS.	RESIDENTIAL	FLAT		

76/07/C3.

REG.	ST.	CITY	YARD	RAIL-ROAD	YARD FUNCTION	LOCATION TYPE	YARD TYPE	I/C	MAJDD YARD IF MULTI-YARD COMPLEX
8	SD	MILBRANK	FREIGHT HOUSE	CMSPP	SMALL INDUS.	RESIDENTIAL	FLAT		
8	SD	MITCHELL	TRAIN	CMSPP	CLASS-//INDUS.	UNDEVELOPED	FLAT		
8	SD	MURBRIDGE	TRAIN	CNW	SMALL INDUS.	RESIDENTIAL	FLAT	I/C	
8	SD	PIERRE	PASS STATION	CMSPP	SMALL INDUS.	COMMERCIAL	FLAT		
8	SD	RAPID CITY	TRAIN	CNW	SMALL INDUS.	RESIDENTIAL	FLAT	I/C	
8	SD	RAPID CITY	TRAIN	CMSPP	SMALL INDUS.	COMMERCIAL	FLAT		
8	SD	SIoux FALLS	TRAIN	CNW	INDUSTRIAL	COMMERCIAL	FLAT	I/C	
8	SD	SIoux FALLS	TRAIN	BN	INDUSTRIAL	RESIDENTIAL	FLAT	I/C	
8	SD	SIoux FALLS	TRAIN	CMSPP	CLASS-//INDUS.	RESIDENTIAL	FLAT	I/C	
8	SD	SIoux FALLS	TRAIN	CNW	INDUSTRIAL	RESIDENTIAL	FLAT	I/C	
8	SD	WATERLOO	FREIGHT HOUSE	ICG	SMALL INDUS.	COMMERCIAL	FLAT	I/C	
8	SD	WATERTOWN	TRAIN	BN	SMALL INDUS.	RESIDENTIAL	FLAT	I/C	
8	SD	WATERTOWN	TRAIN	CNW	SMALL INDUS.	RESIDENTIAL	FLAT	I/C	
8	SD	WANKTON	TRAIN	CMSPP	SMALL INDUS.	RESIDENTIAL	FLAT		
3	TN	BRUXTON	TRAIN	LN	CLASSIFICATION	RESIDENTIAL	FLAT		
3	TN	HULLS GAP	TRAIN	SOU	CLASSIFICATION	AGRICULTURAL	FLAT		
3	TN	CHARLESTON	TRAIN	SOU	SMALL INDUS.	RESIDENTIAL	FLAT		
3	TN	CHATTANOOGA	CITY	CGA	CLASS-//INDUS.	INDUSTRIAL	HUMP		
3	TN	CHATTANOOGA	WAUATCHIE	LN	CLASS-//INDUS.	UNDEVELOPED	FLAT	I/C	
3	TN	CHATTANOOGA	DE BUTTS	SOU	CLASS-//INDUS.	INDUSTRIAL	HUMP		
3	TN	CLEVELAND	TRAIN	SOU	INDUSTRIAL	RESIDENTIAL	FLAT		
3	TN	COLUMBIA	TRAIN	LN	INDUSTRIAL	RESIDENTIAL	FLAT		
3	TN	COMPELL	TRAIN	LN	SMALL INDUS.	INDUSTRIAL	FLAT		
3	TN	COWAN	TRAIN	LN	INDUSTRIAL	RESIDENTIAL	FLAT		
3	TN	EMORY GAP	TRAIN	CNTP	INDUSTRIAL	RESIDENTIAL	FLAT		
3	TN	ERWIN	TRAIN	CCD	CLASS-//INDUS.	UNDEVELOPED	FLAT		
3	TN	ETOWAH	TRAIN	LN	CLASSIFICATION	RESIDENTIAL	FLAT		
3	TN	FRANKLIN	TRAIN	LN	SMALL INDUS.	UNDEVELOPED	FLAT		
3	TN	GALLATIN	TRAIN	LN	SMALL INDUS.	RESIDENTIAL	FLAT		
3	TN	HARRIMAN	TRAIN	LN	SMALL INDUS.	RESIDENTIAL	FLAT		
3	TN	HARRIMAN	TRAIN	SOU	SMALL INDUS.	RESIDENTIAL	FLAT		
3	TN	JACKSON	FROGHOOD	ICG	SMALL INDUS.	RESIDENTIAL	FLAT		
3	TN	JACKSON	ISELIN	ICG	CLASS-//INDUS.	UNDEVELOPED	FLAT		
3	TN	JACKSON	ISELIN	ICG	CLASS-//INDUS.	UNDEVELOPED	FLAT		
3	TN	JELICO	TRAIN	LN	INDUSTRIAL	RESIDENTIAL	FLAT		
3	TN	JELICO	TRAIN	LN	SMALL INDUS.	RESIDENTIAL	FLAT		
3	TN	JOHNSON CITY	TRAIN	SOU	SMALL INDUS.	RESIDENTIAL	FLAT		
3	TN	JOHNSON CITY	JOHNSON CITY	CCD	SMALL INDUS.	RESIDENTIAL	FLAT		
3	TN	JOHNSON CITY	JOHNSON CITY	ETN	SMALL INDUS.	INDUSTRIAL	FLAT		
3	TN	KINGSBURT	TRAIN	SOU	SMALL INDUS.	RESIDENTIAL	FLAT		
3	TN	KINGSBURT	TRAIN	CCD	SMALL INDUS.	RESIDENTIAL	FLAT		
3	TN	KNOXVILLE	SHERIFF CORP.	SOU	INDUSTRIAL	UNDEVELOPED	FLAT		
3	TN	KNOXVILLE	WEST KNOXVILLE CITY	LN	CLASS-//INDUS.	RESIDENTIAL	FLAT		
3	TN	KNOXVILLE	CITY	SOU	INDUSTRIAL	COMMERCIAL	FLAT		
3	TN	KNOXVILLE	JOHN SEVIER	SOU	CLASS-//INDUS.	UNDEVELOPED	HUMP		
5	TN	MEMPHIS	4TH STREET	CRIP	SMALL INDUS.	COMMERCIAL	FLAT		JOHNSTON
5	TN	MEMPHIS	HOLLYWOOD	ICG	CLASS-//INDUS.	COMMERCIAL	FLAT		JOHNSTON
5	TN	MEMPHIS	JOHNSTON	ICG	CLASS-//INDUS.	COMMERCIAL	FLAT		JOHNSTON
5	TN	MEMPHIS	NORTH	ICG	INDUSTRIAL	COMMERCIAL	FLAT		JOHNSTON
5	TN	MEMPHIS	SOUTH	ICG	INDUSTRIAL	COMMERCIAL	FLAT		JOHNSTON
5	TN	MEMPHIS	LEEWOOD	LN	CLASS-//INDUS.	INDUSTRIAL	FLAT		
5	TN	MEMPHIS	NORTH	WP	CLASS-//INDUS.	COMMERCIAL	FLAT		
5	TN	MEMPHIS	SARGENT	WP	CLASS-//INDUS.	COMMERCIAL	FLAT		
5	TN	MEMPHIS	CAPLEVILLE	SLSF	CLASS-//INDUS.	INDUSTRIAL	FLAT		CAPLEVILLE

76/07/06

REG.	ST.	CITY	YARD	RAIL-ROAD	YARD FUNCTION	LOCATION TYPE	YARD TYPE	I/C	MAJOR YARD IF MULTI-YARD COMPLEX
5	TN	MEMPHIS	PARKWAY	SLSF	CLASS./INDUS.	INDUSTRIAL	FLAT	1/C	CARLVILLE
5	TN	MEMPHIS	YALE	SLSF	INDUSTRIAL	RESIDENTIAL	FLAT	1/C	CARLVILLE
5	TN	MEMPHIS	FREST	SOU	CLASSIFICATION	RESIDENTIAL	FLAT	1/C	CARLVILLE
3	TN	MOUNT PLEASANT	TRAIN	LN	INDUSTRIAL	RESIDENTIAL	FLAT		
3	TN	NASHVILLE	CITY	LN	CLASS./INDUS.	COMMERCIAL	HUMP		RADNOR
3	TN	NASHVILLE	RADNOR	LN	CLASS./INDUS.	UNDEVELOPED	FLAT		RADNOR
3	TN	NASHVILLE	SOUTH NASHVILLE	LN	CLASS./INDUS.	UNDEVELOPED	FLAT		RADNOR
3	TN	NASHVILLE	WEST NASHVILLE	LN	INDUSTRIAL	RESIDENTIAL	FLAT		
3	TN	JAK DALE	TRAIN	CNTP	SMALL INDUS.	RESIDENTIAL	FLAT		
3	TN	ONEIDA	TRAIN	TENN	INDUSTRIAL	RESIDENTIAL	FLAT		
3	TN	RUCKWOOD	TRAIN	CNTP	INDUSTRIAL	RESIDENTIAL	FLAT		
5	TN	WEST MEMPHIS	WEST MEMPHIS	SLSF	CLASS./INDUS.	COMMERCIAL	FLAT	1/C	CARLVILLE
5	TX	ABILENE	TRAIN	ALOS	SMALL INDUS.	INDUSTRIAL	FLAT	1/C	
5	TX	ABILENE	TRAIN	FMD	SMALL INDUS.	INDUSTRIAL	FLAT	1/C	
5	TX	ABILENE	ABILENE	TP	INDUSTRIAL	COMMERCIAL	FLAT	1/C	
5	TX	ALICE	TRAIN	SP	SMALL INDUS.	COMMERCIAL	FLAT	1/C	
5	TX	ALVIN	TRAIN	ATSF	SMALL INDUS.	INDUSTRIAL	FLAT	1/C	
5	TX	AMARILLO	JUATCR	ATSF	CLASS./INDUS.	COMMERCIAL	FLAT	1/C	
5	TX	AMARILLO	TRAIN	CDTP	CLASS./INDUS.	COMMERCIAL	FLAT	1/C	
5	TX	AMARILLO	TRAIN	FMD	CLASS./INDUS.	COMMERCIAL	FLAT	1/C	
5	TX	ANGLETON	TRAIN	MP	CLASSIFICATION	INDUSTRIAL	FLAT		
5	TX	AUSTIN	TRAIN	MP	SMALL INDUS.	COMMERCIAL	FLAT		
5	TX	AUSTIN	MILBY SIDING	SP	SMALL INDUS.	RESIDENTIAL	FLAT	1/C	
5	TX	BAY CITY	BAY CITY	ATSF	SMALL INDUS.	COMMERCIAL	FLAT	1/C	
5	TX	HAY CITY	BAY CITY	MP	SMALL INDUS.	COMMERCIAL	FLAT	1/C	
5	TX	DAYTOWN	DURHAM	MP	INDUSTRIAL	INDUSTRIAL	FLAT		
5	TX	DAYTOWN	TRAIN	SP	INDUSTRIAL	INDUSTRIAL	FLAT	1/C	
5	TX	BEAUMONT	CALDER AVE.	ATSF	CLASS./INDUS.	INDUSTRIAL	FLAT		
5	TX	BEAUMONT	BEAUMONT	KCS	INDUSTRIAL	INDUSTRIAL	FLAT		
5	TX	BEAUMONT	CHAISON	KCS	CLASS./INDUS.	INDUSTRIAL	FLAT		CHAISON
5	TX	BEAUMONT	WALL ST.	KCS	INDUSTRIAL	INDUSTRIAL	FLAT	1/C	CHAISON
5	TX	BEAUMONT	TRAIN	MP	CLASS./INDUS.	INDUSTRIAL	FLAT	1/C	
5	TX	BEAUMONT	DCKCS	SP	INDUSTRIAL	INDUSTRIAL	FLAT		SP TRAIN
5	TX	BEAUMONT	SOUTH	SP	INDUSTRIAL	INDUSTRIAL	FLAT		SP TRAIN
5	TX	BEAUMONT	TRAIN	SP	CLASS./INDUS.	UNDEVELOPED	HUMP	1/C	
5	TX	BECKMAN	QUARRY STORAGE	SP	SMALL INDUS.	UNDEVELOPED	FLAT		
5	TX	BELLEVILLE	BELMEAD	MKT	SMALL INDUS.	INDUSTRIAL	FLAT		
5	TX	BELLEVILLE	TRAIN	ATSF	SMALL INDUS.	AGRICULTURAL	FLAT		
5	TX	HIG SPRING	TRAIN STORAGE	TP	SMALL INDUS.	INDUSTRIAL	FLAT		TP TRAIN
5	TX	HIG SPRING	ZILLER STORAGE	TP	SMALL INDUS.	INDUSTRIAL	FLAT		TP TRAIN
5	TX	BISHOP	CELANESE STORAGE	MP	SMALL INDUS.	INDUSTRIAL	FLAT		
5	TX	BLOOMINGTON	TRAIN	MP	SMALL INDUS.	INDUSTRIAL	FLAT		
5	TX	BONHAM	BONHAM	TP	SMALL INDUS.	COMMERCIAL	FLAT		
5	TX	BORGER	BORGER	ATSF	INDUSTRIAL	INDUSTRIAL	FLAT		
5	TX	BRADY	TRAIN	ATSF	SMALL INDUS.	COMMERCIAL	FLAT		
5	TX	BROWNSVILLE	PORT BROWNSVILLE	MP	SMALL INDUS.	COMMERCIAL	FLAT		
5	TX	BROWNSVILLE	TRAIN	MP	SMALL INDUS.	INDUSTRIAL	FLAT	1/C	
5	TX	BROWNSVILLE	NEW TRAIN	SP	SMALL INDUS.	RESIDENTIAL	FLAT	1/C	
5	TX	BROWNSVILLE	TRAIN	ATSF	SMALL INDUS.	AGRICULTURAL	FLAT		
5	TX	CALDWELL	CALDWELL	SP	SMALL INDUS.	COMMERCIAL	FLAT	1/C	
5	TX	CAMPEN	TRAIN	MCSA	SMALL INDUS.	INDUSTRIAL	FLAT		
5	TX	CHILDRESS	CHILDRESS	FMD	CLASS./INDUS.	COMMERCIAL	FLAT		
5	TX	CLEBURNE	CLEBURNE	ATSF	CLASS./INDUS.	COMMERCIAL	FLAT		

76/07/08

REG.	ST.	CITY	YARD	RAIL-ROAD	YARD FUNCTION	LOCATION TYPE	YARD TYPE	I/C	MAJOR YARD IF MULTI-YARD COMPLEX
5	TX	FORT WORTH	FORT WORTH	SP	CLASS./INDUS.	COMMERCIAL	FLAT		
5	TX	FORT WORTH	HODGE	CSW	CLASS./INDUS.	AGRICULTURAL	FLAT		
5	TX	FORT WORTH	CENTENIAL HUMP	TP	CLASS./INDUS.	COMMERCIAL	HUMP		
5	TX	FORT WORTH	EAST	MP	SMALL INDUS.	COMMERCIAL	FLAT	1/C	
5	TX	FREEDOM	VCLASCO	MP	CLASS./INDUS.	INDUSTRIAL	FLAT		
5	TX	GAINESVILLE	NORTH	ATSF	CLASSIFICATION	AGRICULTURAL	FLAT	1/C	
5	TX	GALVESTON	59TH ST.	ATSF	CLASS./INDUS.	INDUSTRIAL	FLAT		59TH ST.
5	TX	GALVESTON	GALVESTON	ATSF	SMALL INDUS.	INDUSTRIAL	FLAT		59TH ST.
5	TX	GALVESTON	VALLEY	ATSF	CLASS./INDUS.	INDUSTRIAL	FLAT		59TH ST.
5	TX	GALVESTON	WEST	ATSF	INDUSTRIAL	INDUSTRIAL	FLAT		
5	TX	GALVESTON	TRAIN	GHH	CLASS./INDUS.	INDUSTRIAL	FLAT	1/C	
5	TX	GALVESTON	B	GWCO	CLASS./INDUS.	INDUSTRIAL	FLAT	1/C	
5	TX	GALVESTON	CRI+P	GWCO	CLASS./INDUS.	INDUSTRIAL	FLAT		CRI+P
5	TX	GALVESTON	GALVESTON	GWCO	SMALL INDUS.	INDUSTRIAL	FLAT		CRI+P
5	TX	GALVESTON	MALLCOP	GWCO	SMALL INDUS.	INDUSTRIAL	FLAT	1/C	
5	TX	GALVESTON	TRAIN	SP	INDUSTRIAL	INDUSTRIAL	FLAT		
5	TX	GALVESTON	TRAIN	MP	SMALL INDUS.	AGRICULTURAL	FLAT	1/C	
5	TX	GEORGETOWN	FELC PLANT	GPP	SMALL INDUS.	AGRICULTURAL	FLAT	1/C	
5	TX	GLIDDEN	TRAIN	SP	SMALL INDUS.	AGRICULTURAL	FLAT		
5	TX	GONZALES	TRAIN	SP	SMALL INDUS.	AGRICULTURAL	FLAT	1/C	
5	TX	GREAT SOUTHWEST	GREAT SOUTHWEST	GSW	INDUSTRIAL	COMMERCIAL	FLAT	1/C	
5	TX	GREENSBAY	AMERICAN	PTRA	INDUSTRIAL	INDUSTRIAL	FLAT		
5	TX	GREENVILLE	HUNT	LA	CLASS./INDUS.	COMMERCIAL	FLAT	1/C	
5	TX	HAMLIN	TRAIN	SP	SMALL INDUS.	AGRICULTURAL	FLAT		
5	TX	HARLINGEN	HAMLIN	ATSF	SMALL INDUS.	AGRICULTURAL	FLAT		
5	TX	HASKINS JCT.	TRAIN	MP	CLASS./INDUS.	RESIDENTIAL	FLAT		
5	TX	HEARNE	TRAIN	MP	SMALL INDUS.	INDUSTRIAL	FLAT	1/C	
5	TX	HENDERSON	TRAIN	MP	CLASS./INDUS.	COMMERCIAL	FLAT		
5	TX	HEPEFORD	TRAIN	MP	SMALL INDUS.	COMMERCIAL	FLAT		
5	TX	HERTY	HEREFORD	ATSF	INDUSTRIAL	INDUSTRIAL	FLAT	1/C	
5	TX	HOUSTON	AMERICAN CON.	ANR	INDUSTRIAL	INDUSTRIAL	FLAT		
5	TX	HOUSTON	BASIN SIDING	HBT	SMALL INDUS.	INDUSTRIAL	FLAT		SETTEGAST
5	TX	HOUSTON	BOOTH	HBT	INDUSTRIAL	INDUSTRIAL	FLAT		SETTEGAST
5	TX	HOUSTON	CONGRESS AVE.	HBT	INDUSTRIAL	INDUSTRIAL	FLAT		SETTEGAST
5	TX	HOUSTON	DOLLARUP	HBT	INDUSTRIAL	INDUSTRIAL	FLAT		
5	TX	HOUSTON	EAST 3CLT	HBT	SMALL INDUS.	INDUSTRIAL	FLAT		
5	TX	HOUSTON	NEW SOUTH	HBT	CLASS./INDUS.	INDUSTRIAL	FLAT		NEW SOUTH
5	TX	HOUSTON	OLD SOUTH	HBT	SMALL INDUS.	INDUSTRIAL	FLAT		NEW SOUTH
5	TX	HOUSTON	SETTEGAST	HBT	CLASS./INDUS.	INDUSTRIAL	FLAT		SETTEGAST
5	TX	HOUSTON	CITY	SETTEGAST	CLASS./INDUS.	INDUSTRIAL	FLAT		SETTEGAST
5	TX	HOUSTON	EUREKA	MKT	SMALL INDUS.	COMMERCIAL	FLAT		EUREKA
5	TX	HOUSTON	HARRISBURG	MKT	CLASSIFICATION	INDUSTRIAL	FLAT	1/C	FUFKA
5	TX	HOUSTON	WK	MP	SMALL INDUS.	INDUSTRIAL	FLAT	1/C	FUFKA
5	TX	HOUSTON	HOUSTON	PTRA	INDUSTRIAL	INDUSTRIAL	FLAT		HOUSTON
5	TX	HOUSTON	MANCHESTER	PTRA	INDUSTRIAL	INDUSTRIAL	FLAT	1/C	HOUSTON
5	TX	HOUSTON	NORTHSIDE	PTFA	SMALL INDUS.	INDUSTRIAL	FLAT		HOUSTON
5	TX	HOUSTON	PENN CITY	PTRA	SMALL INDUS.	INDUSTRIAL	FLAT		HOUSTON
5	TX	HOUSTON	WASIN	SP	SMALL INDUS.	INDUSTRIAL	FLAT		
5	TX	HOUSTON	BELL	SP	SMALL INDUS.	INDUSTRIAL	FLAT		
5	TX	HOUSTON	PELLAIRE	SP	SMALL INDUS.	INDUSTRIAL	FLAT		
5	TX	HOUSTON	CRANFAY	SP	SMALL INDUS.	INDUSTRIAL	FLAT		
5	TX	HOUSTON	ENGLERWOOD	SP	CLASS./INDUS.	INDUSTRIAL	FLAT		
5	TX	HOUSTON	SCOUTH	SP	SMALL INDUS.	INDUSTRIAL	FLAT	1/C	ENGLERWOOD
5	TX	HOUSTON	STORAF	CP	SMALL INDUS.	INDUSTRIAL	FLAT		ENGLERWOOD

76/07/03.

REG.	ST.	CITY	YARD	RAIL-ROAD	YARD FUNCTION	LOCATION TYPE	YARD TYPE	I/C	MAJOR YARD IF MULTI-YARD COMPLEX
5	TX	HOUSTON	HARDY ST.	SP	SMALL INDUS.	INDUSTRIAL	FLAT		
5	TX	HOUSTON	NAVIGATION	SP	INDUSTRIAL	INDUSTRIAL	FLAT		
5	TX	HUGHES SPRINGS	HUGHES SPRINGS INTERCHANGE	KCS	SMALL INDUS.	COMMERCIAL	FLAT		
5	TX	IRVING	JACKSONVILLE	SLF	SMALL INDUS.	INDUSTRIAL	FLAT		
5	TX	JACKSONVILLE	JACKSONVILLE	SP	SMALL INDUS.	INDUSTRIAL	FLAT	I/C	
5	TX	KINGSVILLE	INTERCHANGE	MP	SMALL INDUS.	AGRICULTURAL	FLAT		
5	TX	LARGO	TRAIN	JOINT	CLASS./INDUS.	RESIDENTIAL	FLAT	I/C	
5	TX	LAREDO	TRAIN	MP	CLASS./INDUS.	AGRICULTURAL	FLAT	I/C	
5	TX	LAREDO	TRAIN	TM	CLASS./INDUS.	RESIDENTIAL	FLAT	I/C	
5	TX	LCLITA	TRAIN+INTERCHANGE	PCN	SMALL INDUS.	AGRICULTURAL	FLAT		
5	TX	LOMETA	TRAIN	ATSF	SMALL INDUS.	COMMERCIAL	FLAT		
5	TX	LOME STAR	CLASSIFICATION	TN	INDUSTRIAL	INDUSTRIAL	FLAT	I/C	
5	TX	LONGVIEW	TRAIN	ATSF	CLASS./INDUS.	COMMERCIAL	FLAT		
5	TX	LONGVIEW	TRAIN	MP	INDUSTRIAL	INDUSTRIAL	FLAT	I/C	
5	TX	LONGVIEW	LUNGVIE#	TP	CLASS./INDUS.	COMMERCIAL	FLAT	I/C	
5	TX	LUBBOCK	LUBBOCK	ATSF	SMALL INDUS.	COMMERCIAL	FLAT		
5	TX	LUBBOCK	LUBBOCK	FMD	SMALL INDUS.	COMMERCIAL	FLAT		
5	TX	LUBBOCK	PROSSER	ANR	SMALL INDUS.	INDUSTRIAL	FLAT	I/C	
5	TX	LUFKIN	SSW	SP	CLASS./INDUS.	INDUSTRIAL	FLAT	I/C	
5	TX	LUFKIN	LUFKIN	SSW	CLASS./INDUS.	INDUSTRIAL	FLAT	I/C	
5	TX	LUFKIN	LUFKIN	SP	SMALL INDUS.	UNDEVELOPED	FLAT		
5	TX	MARATHON	CITY	PS	SMALL INDUS.	AGRICULTURAL	FLAT	I/C	
5	TX	MARJORIE	TRAIN+INTERCHANGE	TP	INDUSTRIAL	RESIDENTIAL	FLAT		
5	TX	MARSHALL	TRAIN	MP	SMALL INDUS.	INDUSTRIAL	FLAT		
5	TX	MAURICEVILLE	MAURICEVILLE	MP	SMALL INDUS.	COMMERCIAL	FLAT		
5	TX	MCALLEN	TRAIN	SP	SMALL INDUS.	COMMERCIAL	FLAT		
5	TX	MCALLEN	TRAIN	SP	SMALL INDUS.	COMMERCIAL	FLAT		
5	TX	MENARD	TRAIN	ATSF	SMALL INDUS.	AGRICULTURAL	FLAT		
5	TX	MIDLAND	TRAIN	TP	SMALL INDUS.	COMMERCIAL	FLAT		
5	TX	MINEOLA	MINEOLA	TP	SMALL INDUS.	COMMERCIAL	FLAT		
5	TX	MISSION	TRAIN	MP	SMALL INDUS.	COMMERCIAL	FLAT		
5	TX	MISSION	TRAIN	MP	SMALL INDUS.	COMMERCIAL	FLAT		
5	TX	MONAHANS	TRAIN	TNM	SMALL INDUS.	COMMERCIAL	FLAT		
5	TX	MOUNT PLEASANT	MOUNT PLEASANT	SSW	SMALL INDUS.	COMMERCIAL	FLAT	I/C	
5	TX	MOUNT PLEASANT	TRAIN	SP	SMALL INDUS.	COMMERCIAL	FLAT		
5	TX	NACOGDOCHES	TRAIN	NKT	SMALL INDUS.	COMMERCIAL	FLAT		
5	TX	NEW BRAUNFELS	TRAIN	MP	SMALL INDUS.	COMMERCIAL	FLAT		
5	TX	NEW BRAUNFELS	TRAIN	MP	SMALL INDUS.	COMMERCIAL	FLAT		
5	TX	NEW GULF	STORAGE	ATSF	SMALL INDUS.	COMMERCIAL	FLAT		
5	TX	NEW GULF	STORAGE	MP	SMALL INDUS.	INDUSTRIAL	FLAT		
5	TX	NEW GULF	STORAGE	MP	SMALL INDUS.	INDUSTRIAL	FLAT		
5	TX	ODEN	TRAIN	MP	SMALL INDUS.	AGRICULTURAL	FLAT		
5	TX	ODESSA	TRAIN	TP	INDUSTRIAL	COMMERCIAL	FLAT	I/C	
5	TX	ODGEN	TRAIN	MP	SMALL INDUS.	AGRICULTURAL	FLAT	I/C	
5	TX	ORANGE	TRAIN	MP	SMALL INDUS.	INDUSTRIAL	FLAT	I/C	
5	TX	ORANGE	TRAIN	MP	SMALL INDUS.	INDUSTRIAL	FLAT	I/C	
5	TX	ORANGE	TRAIN	SP	SMALL INDUS.	INDUSTRIAL	FLAT		
5	TX	ORANGE	TRAIN	SRN	SMALL INDUS.	INDUSTRIAL	FLAT		
5	TX	ORANGE	MULCRID	MP	CLASS./INDUS.	COMMERCIAL	FLAT		
5	TX	PALESTINE	PALESTINE	ATSF	SMALL INDUS.	INDUSTRIAL	FLAT	I/C	
5	TX	PAMPA	PAMPA	MP	SMALL INDUS.	INDUSTRIAL	FLAT		
5	TX	PARIS	TRAIN	ATSF	INDUSTRIAL	INDUSTRIAL	FLAT	I/C	
5	TX	PARIS	TRAIN	SLF	INDUSTRIAL	INDUSTRIAL	FLAT	I/C	
5	TX	PARIS	TRAIN	TP	INDUSTRIAL	INDUSTRIAL	FLAT		
5	TX	PASADENA	TRAIN	PTA	INDUSTRIAL	INDUSTRIAL	FLAT		
5	TX	PASADENA	PASADENA	SP	INDUSTRIAL	COMMERCIAL	FLAT		
5	TX	PASADENA	PASADENA	SP	INDUSTRIAL	INDUSTRIAL	FLAT		
5	TX	PASADENA	STRANG	MP	SMALL INDUS.	INDUSTRIAL	FLAT	I/C	
5	TX	PERDOL	TRAIN	PVS	SMALL INDUS.	COMMERCIAL	FLAT	I/C	
5	TX	PERDOL	TRAIN	TP	SMALL INDUS.	COMMERCIAL	FLAT	I/C	
5	TX	PLAINVIEW	PLAINVIEW	ATSF	SMALL INDUS.	INDUSTRIAL	FLAT	I/C	

76/07/04

REG.	ST.	CITY	YARD	PAVE-ROAD	YARD FUNCTION	LOCATION TYPE	YARD TYPE	I/C	MAJOR YARD IF MULTI-YARD COMPLEX
5	TX	PLAINVIEW		FWD	SMALL INDUS.	INDUSTRIAL	FLAT	I/C	
5	TX	PORT ARTHUR	PLAINVIEW	KCS	CLASS./INDUS.	INDUSTRIAL	FLAT	I/C	
5	TX	PORT ARTHUR	TRAIN	SP	SMALL INDUS.	UNDEVELOPED	FLAT	I/C	
5	TX	PRESDON	TRAIN	ATSF	SMALL INDUS.	AGRICULTURAL	FLAT	I/C	
5	TX	QUANAH	QUANAH	OAP	SMALL INDUS.	COMMERCIAL	FLAT	I/C	
5	TX	QUANAH	QUANAH	SLSF	SMALL INDUS.	COMMERCIAL	FLAT	I/C	
5	TX	RANGER	TRAIN	TP	SMALL INDUS.	COMMERCIAL	FLAT	I/C	
5	TX	ROSCOP	SYSTEM	RSP	INDUSTRIAL	COMMERCIAL	FLAT	I/C	
5	TX	SAN ANGELO	SAYARD	ATSF	CLASS./INDUS.	AGRICULTURAL	FLAT	I/C	SLOAN
5	TX	SAN ANTONIO	SLCAN	MKT	CLASS./INDUS.	COMMERCIAL	FLAT	I/C	SLOAN
5	TX	SAN ANTONIO	YOAKUM BEND	MKT	SMALL INDUS.	COMMERCIAL	FLAT	I/C	SLOAN
5	TX	SAN ANTONIO	SAN FERNANDO	MP	SMALL INDUS.	COMMERCIAL	FLAT	I/C	SO. SAN ANTONIO
5	TX	SAN ANTONIO	SO. SAN ANTONIO	MP	CLASS./INDUS.	INDUSTRIAL	FLAT	I/C	SO. SAN ANTONIO
5	TX	SAN ANTONIO	EAST	SP	CLASS./INDUS.	RESIDENTIAL	FLAT	I/C	
5	TX	SAN ANTONIO	YGAKUM BEND	SP	SMALL INDUS.	INDUSTRIAL	FLAT	I/C	
5	TX	SAN ANTONIO	INDUSTPY	TTCU	SMALL INDUS.	INDUSTRIAL	FLAT	I/C	
5	TX	SANDERS	TRAIN	SP	INDUSTRIAL	UNDEVELOPED	FLAT	I/C	
5	TX	SEALY	SEALY	ATSF	SMALL INDUS.	INDUSTRIAL	FLAT	I/C	
5	TX	SHERMAN	SHERMAN	MKT	SMALL INDUS.	INDUSTRIAL	FLAT	I/C	
5	TX	SHERMAN	ND. SHERMAN	SLSF	CLASS./INDUS.	INDUSTRIAL	FLAT	I/C	
5	TX	SHERMAN	SHERMAN	SP	SMALL INDUS.	INDUSTRIAL	FLAT	I/C	
5	TX	SILSHEE	TRAIN	ATSF	SMALL INDUS.	COMMERCIAL	FLAT	I/C	
5	TX	SINTON	SINTON	SP	SMALL INDUS.	COMMERCIAL	FLAT	I/C	
5	TX	SKIDMORC	TRAIN	SP	SMALL INDUS.	INDUSTRIAL	FLAT	I/C	
5	TX	SLATON	SLATON	ATSF	CLASS./INDUS.	COMMERCIAL	FLAT	I/C	
5	TX	SMITHVILLE	TRAIN	MKT	CLASS./INDUS.	RESIDENTIAL	FLAT	I/C	
5	TX	SOMERVILLE	TRAIN	ATSF	CLASS./INDUS.	RESIDENTIAL	FLAT	I/C	
5	TX	SPOFFORD	TRAIN	SP	CLASS./INDUS.	RESIDENTIAL	FLAT	I/C	
5	TX	STAMFORD	STAMFORD	FWD	SMALL INDUS.	INDUSTRIAL	FLAT	I/C	
5	TX	STAMFORD	STAMFORD	MKT	SMALL INDUS.	INDUSTRIAL	FLAT	I/C	
5	TX	SUGAR LAND	TRAIN	MP	SMALL INDUS.	INDUSTRIAL	FLAT	I/C	
5	TX	SWEENEY	TRAIN	MP	SMALL INDUS.	INDUSTRIAL	FLAT	I/C	
5	TX	SWEETWATER	SWEETWATER	ATSF	SMALL INDUS.	AGRICULTURAL	FLAT	I/C	
5	TX	SWEETWATER	SWEETWATER	TP	SMALL INDUS.	COMMERCIAL	FLAT	I/C	
5	TX	TAYLOR	TRAIN	MP	SMALL INDUS.	INDUSTRIAL	FLAT	I/C	
5	TX	TEAGUE	TEAGUE	FWD	CLASSIFICATION	COMMERCIAL	FLAT	I/C	
5	TX	TEMPLE	TRAIN	ATSF	CLASS./INDUS.	RESIDENTIAL	FLAT	I/C	
5	TX	TEXARKANA	TRIGG STREET	KCS	INDUSTRIAL	COMMERCIAL	FLAT	I/C	
5	TX	TEXARKANA	TEXARKANA	ND	CLASS./INDUS.	COMMERCIAL	FLAT	I/C	
5	TX	TEXARKANA	TRAIN	SSW	CLASS./INDUS.	INDUSTRIAL	FLAT	I/C	
5	TX	TEXARKANA	TRAIN	TP	CLASS./INDUS.	INDUSTRIAL	FLAT	I/C	
5	TX	TEXAS CITY	SEATRIN	TCT	SMALL INDUS.	INDUSTRIAL	FLAT	I/C	
5	TX	TEXAS CITY	TRAIN	TCT	INDUSTRIAL	INDUSTRIAL	FLAT	I/C	
5	TX	TOYAH	TRAIN	TP	SMALL INDUS.	UNDEVELOPED	FLAT	I/C	
5	TX	TYLER	TYLER	MP	SMALL INDUS.	COMMERCIAL	FLAT	I/C	
5	TX	TYLER	TYLER	SSW	CLASS./INDUS.	INDUSTRIAL	FLAT	I/C	
5	TX	JVALDF	TRAIN	SP	SMALL INDUS.	COMMERCIAL	FLAT	I/C	
5	TX	VALLEY JUNCTION	TRAIN	MP	SMALL INDUS.	RESIDENTIAL	FLAT	I/C	
5	TX	VANDERJILT	TRAIN	MP	SMALL INDUS.	RESIDENTIAL	FLAT	I/C	
5	TX	VICTORIA	TRAIN	SP	CLASS./INDUS.	RESIDENTIAL	FLAT	I/C	
5	TX	WACO	HELLMFPAD	MKT	CLASS./INDUS.	INDUSTRIAL	FLAT	I/C	
5	TX	WACO	EAST WACO	SSW	CLASS./INDUS.	INDUSTRIAL	FLAT	I/C	
5	TX	WHARTON	WHARTON	SP	INDUSTRIAL	COMMERCIAL	FLAT	I/C	
5	TX	WICHITA FALLS	OKLAHOMA	FWD	SMALL INDUS.	INDUSTRIAL	FLAT	I/C	FWD TRAIN

76/07/04*

REG.	ST.	CITY	YARD	RAIL- ROAD	YARD FUNCTION	LOCATION TYPE	YARD TYPE	I/C	MAJOR YARD IF MULTI-YARD COMPLEX
5	TX	WICHITA FALLS	TRAIN	FWD	CLASS./INDUS.	INDUSTRIAL	FLAT		
5	TX	WICHITA FALLS	NORTH	NKT	CLASS./INDUS.	INDUSTRIAL	FLAT		
5	TX	YOKUM	YOKUM	SP	SMALL INDUS.	INDUSTRIAL	FLAT		FWD TRAIN
7	UT	BURMESTER	TRAIN	NP	SMALL INDUS.	COMMERCIAL	FLAT		
7	UT	CACHF JUNCTION	TRAIN	UP	SMALL INDUS.	COMMERCIAL	FLAT		
7	UT	CASTLE GATE	TRAIN	DRGW	SMALL INDUS.	UNDEVELOPED	FLAT		
7	UT	CEDAR CITY	TRAIN	UP	SMALL INDUS.	COMMERCIAL	FLAT		
7	UT	CLEARFIELD	TRAIN	UP	SMALL INDUS.	COMMERCIAL	FLAT		
7	UT	COLUMBIA	TRAIN	CBC	INDUSTRIAL	INDUSTRIAL	FLAT	1/C	
7	UT	CONSTOCK	TRAIN	UP	SMALL INDUS.	COMMERCIAL	FLAT		
7	UT	DELTA	TRAIN	UP	SMALL INDUS.	COMMERCIAL	FLAT		
7	UT	DESERT MOUND	TRAIN	UP	SMALL INDUS.	UNDEVELOPED	FLAT		
7	UT	ECHO	TRAIN	UP	SMALL INDUS.	COMMERCIAL	FLAT		
7	UT	GARFIELD	TRAIN	UP	SMALL INDUS.	COMMERCIAL	FLAT	1/C	
7	UT	GENEVA	STIDING	UP	INDUSTRIAL	INDUSTRIAL	FLAT		
7	UT	GREEN RIVER	TRAIN	DRGW	SMALL INDUS.	RESIDENTIAL	FLAT		
7	UT	HELPER	TRAIN	DRGW	INDUSTRIAL	COMMERCIAL	FLAT		
7	UT	HIAMATHA	TRAIN	UTAH	SMALL INDUS.	COMMERCIAL	FLAT		
7	UT	HORSE CANYON	TRAIN	CBC	SMALL INDUS.	INDUSTRIAL	FLAT		
7	UT	INTERNATIONAL	SMALTER	TOV	SMALL INDUS.	INDUSTRIAL	FLAT		
7	UT	IRON MOUNTAIN	TRAIN	UP	SMALL INDUS.	INDUSTRIAL	FLAT		
7	UT	IRON SPRINGS	TRAIN	UP	SMALL INDUS.	COMMERCIAL	FLAT		
7	UT	LUND	TRAIN	UP	SMALL INDUS.	COMMERCIAL	FLAT		
7	UT	LYNNDELL	TRAIN	UP	SMALL INDUS.	COMMERCIAL	FLAT		
7	UT	MAGNA	TRAIN	DRGW	SMALL INDUS.	INDUSTRIAL	FLAT		
7	UT	MARTIN	TRAIN	UTAH	SMALL INDUS.	INDUSTRIAL	FLAT		
7	UT	MIDVALE	TRAIN	UP	SMALL INDUS.	COMMERCIAL	FLAT		
7	UT	MIDVALE	TRAIN	DRGW	SMALL INDUS.	COMMERCIAL	FLAT		
7	UT	MILFORD	TRAIN	UP	SMALL INDUS.	COMMERCIAL	FLAT		
7	UT	MURRAY	PALLAS	UP	SMALL INDUS.	COMMERCIAL	FLAT		
7	UT	OGDEN	TRAIN	DRGW	SMALL INDUS.	COMMERCIAL	FLAT	1/C	
7	UT	OGDEN	WEST	SP	CLASS./INDUS.	COMMERCIAL	FLAT	1/C	
7	UT	OGDEN	EAST/WEST	UP	CLASS./INDUS.	COMMERCIAL	FLAT	1/C	
7	UT	PARK CITY	TRAIN	UP	SMALL INDUS.	COMMERCIAL	FLAT		
7	UT	POTASH	TRAIN	DRGW	SMALL INDUS.	COMMERCIAL	FLAT		
7	UT	PROVO	TRAIN	DRGW	INDUSTRIAL	COMMERCIAL	FLAT		
7	UT	PROVO	TRAIN	UP	INDUSTRIAL	COMMERCIAL	FLAT	1/C	
7	UT	SALT LAKE CITY	FOURTH SOUTH	UTAH	SMALL INDUS.	COMMERCIAL	FLAT		ROPER
7	UT	SALT LAKE CITY	ROPER	DRGW	SMALL INDUS.	COMMERCIAL	FLAT	1/C	ROPER
7	UT	SALT LAKE CITY	TRAIN	JOINT	CLASS./INDUS.	INDUSTRIAL	FLAT	1/C	
7	UT	SALT LAKE CITY	TRAIN	SLGW	SMALL INDUS.	COMMERCIAL	FLAT		
7	UT	SALT LAKE CITY	NORTH/SOUTH	UP	CLASS./INDUS.	COMMERCIAL	FLAT		NORTH/SOUTH
7	UT	SALT LAKE CITY	N.S.-L. STOCKYARD	UP	SMALL INDUS.	INDUSTRIAL	FLAT		NORTH/SOUTH
7	UT	SALT LAKE CITY	OILFIELD	UP	SMALL INDUS.	INDUSTRIAL	FLAT		
7	UT	WARNER	TRAIN	UP	SMALL INDUS.	COMMERCIAL	FLAT	1/C	
7	UT	WANDOVER	TRAIN	NP	SMALL INDUS.	COMMERCIAL	FLAT		
7	UT	W. JORDAN	SUGAR FACTORY	DRGW	SMALL INDUS.	INDUSTRIAL	FLAT		
1	VT	BARRE	BARRE	MB	INDUSTRIAL	COMMERCIAL	FLAT		
1	VT	BRATTLEBORO	BRATTLEBORO	CV	UNDEVELOPED	COMMERCIAL	FLAT	1/C	
1	VT	BURLINGTON	BURLINGTON	CV	INDUSTRIAL	COMMERCIAL	FLAT	1/C	
1	VT	BURLINGTON	BURLINGTON	VTR	CLASS./INDUS.	COMMERCIAL	FLAT	1/C	
1	VT	MONTPELIER	MONTPELIER	WJ	SMALL INDUS.	COMMERCIAL	FLAT	1/C	

7/20/07/20.

REG.	ST.	CITY	YARD	RAIL-ROAD	YARD FUNCTION	LOCATION TYPE	YARD TYPE	I/C	MAJOR YARD IF MULTI-YARD COMPLEX
1	VT	MURRISVILLE	LAMOTHE COUNTY	LCRR	CLASSIFICATION	UNDEVELOPED	FLAT		
1	VT	NEWPORT	TRAIN NORTH BENNINGTON	CP	CLASS-//INDUS.	UNDEVELOPED	FLAT		
1	VT	PACIFIC	NORTH BENNINGTON	VTR	SMALL-//INDUS.	RESIDENTIAL	FLAT		
1	VT	RUTLAND	RUTLAND	CLP	INDUSTRIAL	INDUSTRIAL	FLAT	I/C	
1	VT	RUTLAND	RUTLAND	SMRR	INDUSTRIAL	COMMERCIAL	FLAT	I/C	
1	VT	ST. ALBANS	ITALY	CV	CLASS-//INDUS.	COMMERCIAL	FLAT	I/C	
1	VT	SPRINGFIELD	SPRINGFIELD	ST	SMALL-//INDUS.	INDUSTRIAL	FLAT	I/C	
1	VT	SHANTON	SHANTON	SJL	INDUSTRIAL	COMMERCIAL	FLAT	I/C	
1	VT	WHITE RIVER JCT	BM	CV	CLASS-//INDUS.	COMMERCIAL	FLAT	I/C	
1	VT	WHITE RIVER JCT	CV	CV	CLASS-//INDUS.	UNDEVELOPED	FLAT	I/C	
2	VA	ALEXANDRIA	POTOMAC NORTH	RFP	CLASS-//INDUS.	COMMERCIAL	HUMP	I/C	POTOMAC SOUTH
2	VA	ALEXANDRIA	POTOMAC SOUTH	RFP	CLASSIFICATION	COMMERCIAL	HUMP	I/C	POTOMAC SOUTH
2	VA	ALEXANDRIA	SOUTH	SOU	CLASSIFICATION	COMMERCIAL	FLAT		
2	VA	ALEXANDRIA	TTX	SOU	CLASSIFICATION	COMMERCIAL	FLAT		
2	VA	ALTAVISTA	HURT	SOU	INDUSTRIAL	AGRICULTURAL	FLAT	I/C	
2	VA	ANDOVER	ANDOVER	SOU	CLASSIFICATION	INDUSTRIAL	FLAT	I/C	
2	VA	BRISTOL	BRISTOL	NW	CLASSIFICATION	INDUSTRIAL	FLAT		
2	VA	CAME CHARLES	NORTH	PC	CLASS-//INDUS.	RESIDENTIAL	FLAT		
2	VA	CAROL	TRAIN	NW	CLASSIFICATION	UNDEVELOPED	FLAT		
2	VA	CHARLOTTESVILLE	TRAIN	CO	SMALL-//INDUS.	INDUSTRIAL	FLAT	I/C	
2	VA	CHARLOTTESVILLE	FREIGHT HOUSE	SOU	SMALL-//INDUS.	RESIDENTIAL	FLAT		
2	VA	CHESAPEAKE	WERKLEY	NPB	INDUSTRIAL	INDUSTRIAL	FLAT		
2	VA	CHESAPEAKE	MONEY PT.	NPB	SMALL-//INDUS.	INDUSTRIAL	FLAT		
2	VA	CHESAPEAKE	PORTLOCK	NS	CLASS-//INDUS.	RESIDENTIAL	FLAT	I/C	
2	VA	CHESAPEAKE	SELVA	NW	CLASS-//INDUS.	UNDEVELOPED	FLAT		
2	VA	CLIFTON FORGE	SMITH CREEK	CO	CLASS-//INDUS.	UNDEVELOPED	FLAT		
2	VA	CLIFTON FORGE	TRAIN	CO	CLASS-//INDUS.	UNDEVELOPED	FLAT		
2	VA	COVINGTON	TRAIN	CO	CLASSIFICATION	UNDEVELOPED	FLAT		
2	VA	COVINGTON	PLANT	CO	CLASSIFICATION	INDUSTRIAL	FLAT		
2	VA	CREWE	TRAIN	NW	CLASSIFICATION	RESIDENTIAL	FLAT	I/C	
2	VA	DANFOR	MILLER	CRR	INDUSTRIAL	UNDEVELOPED	FLAT		
2	VA	DANTE	DANTE	CRR	CLASSIFICATION	UNDEVELOPED	FLAT	I/C	
2	VA	DANVILLE	HOTTOM	NFD	CLASSIFICATION	INDUSTRIAL	FLAT	I/C	
2	VA	DANVILLE	DUNDEE	SOU	CLASS-//INDUS.	INDUSTRIAL	FLAT	I/C	
2	VA	ELKTON	WERK CO.	NW	SMALL-//INDUS.	INDUSTRIAL	FLAT	I/C	
2	VA	FRANKLIN	TRAIN	NFD	INDUSTRIAL	INDUSTRIAL	FLAT	I/C	
2	VA	FRANKLIN	TRAIN	SCL	INDUSTRIAL	INDUSTRIAL	FLAT	I/C	
2	VA	FREDERICKSBURG	TRAIN	RFP	SMALL-//INDUS.	INDUSTRIAL	FLAT		
2	VA	FRONT ROYAL	CHEMICAL CO.	CD	INDUSTRIAL	INDUSTRIAL	FLAT		
2	VA	GLADSTONE	EAST	NW	CLASS-//INDUS.	RESIDENTIAL	FLAT		
2	VA	GRUNDY	TRAIN	NW	CLASS-//INDUS.	RESIDENTIAL	FLAT	I/C	
2	VA	HARRISONBURG	FRT. HOUSE	CHW	SMALL-//INDUS.	RESIDENTIAL	FLAT	I/C	
2	VA	HARRISONBURG	FRT. HOUSE	SOU	SMALL-//INDUS.	RESIDENTIAL	FLAT	I/C	
2	VA	HOPWELL	TRAIN	NW	INDUSTRIAL	INDUSTRIAL	FLAT	I/C	
2	VA	HOPWELL	TRAIN	SCL	INDUSTRIAL	INDUSTRIAL	FLAT	I/C	
2	VA	LITTLE CREEK	BRIDGE	PC	CLASS-//INDUS.	INDUSTRIAL	FLAT	I/C	
2	VA	LITTLE CREEK	TRAIN	PC	CLASS-//INDUS.	INDUSTRIAL	FLAT	I/C	
2	VA	LYNCHBURG	SANDY HOOK	CO	SMALL-//INDUS.	INDUSTRIAL	FLAT	I/C	
2	VA	LYNCHBURG	CITY	JOINT	SMALL-//INDUS.	INDUSTRIAL	FLAT	I/C	
2	VA	LYNCHBURG	KINNEY	NW	CLASS-//INDUS.	INDUSTRIAL	FLAT	I/C	
2	VA	LYNCHBURG	MONTVIEW	SJU	CLASSIFICATION	AGRICULTURAL	FLAT	I/C	

76/07/59.

REG.	ST.	CITY	YARD	RAIL-ROAD	YARD FUNCTION	LOCATION TYPE	YARD TYPE	I/C	MAJOR YARD IF MULTI-YARD COMPLEX
2	VA	MUNDOE	TRAI ⁿ	SUU	CLASS./INDUS.	RESIDENTIAL	FLAT		
2	VA	NEWPORT NEWS	28TH STREET	CO	INDUSTRIAL	RESIDENTIAL	FLAT		NEWPORT NEWS
2	VA	NEWPORT NEWS	COAL PIER	CO	INDUSTRIAL	INDUSTRIAL	HUMP		NEWPORT NEWS
2	VA	NEWPORT NEWS	NEWPORT NEWS	CO	CLASS./INDUS.	INDUSTRIAL	HUMP		NEWPORT NEWS
2	VA	NORFOLK	GOVERNMENT	NW	INDUSTRIAL	INDUSTRIAL	FLAT		LAMBERTS PT.(LOAD)
2	VA	NORFOLK	LAMBERTS PT.(EMT)	NW	INDUSTRIAL	INDUSTRIAL	HUMP		LAMBERTS PT.(LOAD)
2	VA	NORFOLK	LAMBERTS PT.(ELD)	NW	CLASS./INDUS.	INDUSTRIAL	HUMP		LAMBERTS PT.(LOAD)
2	VA	NORFOLK	NORTON	NW	INDUSTRIAL	INDUSTRIAL	FLAT		
2	VA	NORFOLK	NORTON	NW	INDUSTRIAL	INDUSTRIAL	FLAT		
2	VA	PETERSBURG	SEACOAST	JOINT	CLASSIFICATION	UNDEVELOPED	FLAT	I/C	
2	VA	PETERSBURG	BROADWAY	NW	SMALL INDUS.	INDUSTRIAL	FLAT		
2	VA	PETERSBURG	CITY	NW	SMALL INDUS.	INDUSTRIAL	FLAT	I/C	
2	VA	PETERSBURG	COLLIER	SCL	CLASS./INDUS.	AGRICULTURAL	FLAT	I/C	
2	VA	PORTSMOUTH	PORT NORFOLK	NPB	CLASS./INDUS.	RESIDENTIAL	FLAT	I/C	
2	VA	PORTSMOUTH	PINNERS PT.	SCL	SMALL INDUS.	INDUSTRIAL	FLAT	I/C	
2	VA	PORTSMOUTH	TRAIN	SCL	CLASS./INDUS.	RESIDENTIAL	FLAT	I/C	
2	VA	RADFORD	TRAIN	CO	INDUSTRIAL	INDUSTRIAL	FLAT		
2	VA	RICHMOND	FULTON	NP	CLASS./INDUS.	INDUSTRIAL	FLAT		
2	VA	RICHMOND	RIVER	CO	INDUSTRIAL	INDUSTRIAL	FLAT		
2	VA	RICHMOND	17Y ⁿ STREET	JOINT	INDUSTRIAL	RESIDENTIAL	FLAT	I/C	
2	VA	RICHMOND	ACCA	RPD	CLASS./INDUS.	RESIDENTIAL	FLAT	I/C	
2	VA	RICHMOND	BROWN STREET	SCL	INDUSTRIAL	RESIDENTIAL	FLAT	I/C	
2	VA	RICHMOND	SOUTH RICHMOND	SCL	SMALL INDUS.	INDUSTRIAL	FLAT	I/C	
2	VA	RICHMOND	BELLE ISLE	SOU	INDUSTRIAL	INDUSTRIAL	FLAT	I/C	
2	VA	RICHMOND	SHIP	SOU	INDUSTRIAL	INDUSTRIAL	FLAT	I/C	
2	VA	ROANOKE	ROANOKE	NP	CLASS./INDUS.	INDUSTRIAL	HUMP		
2	VA	ROANOKE	SOUTH	NP	INDUSTRIAL	INDUSTRIAL	FLAT		
2	VA	SALTVILLE	BODDY	NP	SMALL INDUS.	COMMERCIAL	FLAT	I/C	
2	VA	SALTVILLE	TRAIN	NP	SMALL INDUS.	INDUSTRIAL	FLAT		
2	VA	SHENANDOAH	TRAIN	NP	CLASS./INDUS.	INDUSTRIAL	FLAT		
2	VA	SHENANDOAH	TRAIN	NP	CLASS./INDUS.	COMMERCIAL	FLAT		
2	VA	STAUNTON	TRAIN	NP	SMALL INDUS.	INDUSTRIAL	FLAT	I/C	
2	VA	WAYNESBORO	FRY. HOUSE	NP	SMALL INDUS.	RESIDENTIAL	FLAT	I/C	
2	VA	WEST POINT	TRAIN	SOU	INDUSTRIAL	INDUSTRIAL	FLAT	I/C	
2	VA	WINCHESTER	TRAIN	RD	INDUSTRIAL	COMMERCIAL	FLAT	I/C	
2	VA	WINCHESTER	FRY. HOUSE	PC	INDUSTRIAL	COMMERCIAL	FLAT	I/C	
2	VA	WINCHESTER	FRY. HOUSE	NP	INDUSTRIAL	COMMERCIAL	FLAT	I/C	
6	WA	ABERDEEN	TRAIN	BN	CLASS./INDUS.	INDUSTRIAL	FLAT	I/C	
6	WA	ABERDEEN	TRAIN	UP	INDUSTRIAL	INDUSTRIAL	FLAT	I/C	
6	WA	ANACORTES	TRAIN	BN	CLASS./INDUS.	RESIDENTIAL	FLAT	I/C	
6	WA	ATTALIA	TRANSFER	BN	SMALL INDUS.	AGRICULTURAL	FLAT	I/C	
6	WA	AURUM	TRAIN	UP	SMALL INDUS.	AGRICULTURAL	FLAT	I/C	
6	WA	BANGOR	TRAIN	BN	CLASS./INDUS.	INDUSTRIAL	FLAT	I/C	
6	WA	HAY SHIRE	TRAIN	BN	CLASS./INDUS.	INDUSTRIAL	FLAT	I/C	
6	WA	HELLINGHAM	TRAIN	BN	CLASS./INDUS.	RESIDENTIAL	FLAT	I/C	
6	WA	HELLINGHAM	TRAIN	BN	CLASS./INDUS.	INDUSTRIAL	FLAT	I/C	
6	WA	HURLINGTON	TRAIN	HN	CLASSIFICATION	INDUSTRIAL	FLAT		
6	WA	CEDAR FALLS	TRAIN	C-4SPP	CLASSIFICATION	INDUSTRIAL	FLAT		
6	WA	CENTRALIA	TRAIN	BN	CLASS./INDUS.	INDUSTRIAL	FLAT	I/C	
6	WA	CENTRALIA	TRAIN	UP	CLASS./INDUS.	INDUSTRIAL	FLAT	I/C	
6	WA	CHEHALIS	TRAIN	JOINT	CLASS./INDUS.	INDUSTRIAL	FLAT	I/C	
6	WA	CHEHALIS	TRAIN	L-3WCO	CLASSIFICATION	AGRICULTURAL	FLAT	I/C	

76/07/08.

REG.	ST.	CITY	YARD	RAIL-ROAD	YARD FUNCTION	LOCATION TYPE	YARD TYPE	I/C	MAJPP YARD IF MULTI-YARD COMPLEX
6	WA	CHENEY	TRAIN	BN	SMALL INDUS.	RESIDENTIAL	FLAT	I/C	
6	WA	CLE ELUM	TRAIN	BN	CLASSIFICATION	AGRICULTURAL	FLAT	I/C	
6	WA	CLE ELUM	TRAIN	CMSP	CLASSIFICATION	AGRICULTURAL	FLAT	I/C	
6	WA	CONNELL	TRAIN	BN	SMALL INDUS.	AGRICULTURAL	FLAT	I/C	
6	WA	COSMOPOLIS	TRAIN	UP	SMALL INDUS.	AGRICULTURAL	FLAT	I/C	
6	WA	ELLENSBURG	TRAIN	UP	SMALL INDUS.	AGRICULTURAL	FLAT	I/C	
6	WA	ELMA	TRAIN	BN	INDUSTRIAL	INDUSTRIAL	FLAT	I/C	
6	WA	ENUNCLAW	TRAIN	BN	SMALL INDUS.	AGRICULTURAL	FLAT	I/C	
6	WA	ENUNCLAW	TRAIN	BN	INDUSTRIAL	RESIDENTIAL	FLAT	I/C	
6	WA	EUPHRATA	TRAIN	BN	INDUSTRIAL	RESIDENTIAL	FLAT	I/C	
6	WA	EVERETT	BAYSIDE	BN	SMALL INDUS.	RESIDENTIAL	FLAT	I/C	
6	WA	EVERETT	DELTA	BN	INDUSTRIAL	INDUSTRIAL	FLAT	I/C	DELTA
6	WA	EVERETT	BELT	BN	CLASSIFICATION	INDUSTRIAL	FLAT	I/C	DELTA
6	WA	FINDLEY	TANK	CMSP	SMALL INDUS.	AGRICULTURAL	FLAT	I/C	
6	WA	GOLD HAR	TRAIN	BN	SMALL INDUS.	AGRICULTURAL	FLAT	I/C	
6	WA	HOOQUIAM	TRAIN	BN	CLASSIFICATION	INDUSTRIAL	FLAT	I/C	
6	WA	KALAMA	JOINT	BN	INDUSTRIAL	AGRICULTURAL	FLAT	I/C	
6	WA	KENT	JOINT	BN	SMALL INDUS.	AGRICULTURAL	FLAT	I/C	
6	WA	KETTLE FALLS	AUTC	BN	SMALL INDUS.	AGRICULTURAL	FLAT	I/C	
6	WA	LONGVIEW	COL. JCT.	BN	SMALL INDUS.	AGRICULTURAL	FLAT	I/C	
6	WA	LONGVIEW	LONGVIEW PAPER	CLC	INDUSTRIAL	INDUSTRIAL	FLAT	I/C	
6	WA	MALDEN	TRAIN	LSWCO	INDUSTRIAL	INDUSTRIAL	FLAT	I/C	
6	WA	MARSHALL	TRAIN	CMSP	SMALL INDUS.	AGRICULTURAL	FLAT	I/C	
6	WA	MORTON	TRAIN	BN	SMALL INDUS.	AGRICULTURAL	FLAT	I/C	
6	WA	NEWPORT	TRAIN	CMSP	INDUSTRIAL	INDUSTRIAL	FLAT	I/C	
6	WA	NEWPORT	TRAIN	BN	SMALL INDUS.	RESIDENTIAL	FLAT	I/C	
6	WA	OLYMPIA	TRAIN	CMSP	SMALL INDUS.	RESIDENTIAL	FLAT	I/C	
6	WA	OLYMPIA	TRAIN	BN	CLASS-/INDUS.	INDUSTRIAL	FLAT	I/C	
6	WA	OMAK	TRAIN	BN	INDUSTRIAL	AGRICULTURAL	FLAT	I/C	
6	WA	OTHELLO	TRAIN	CMSP	CLASS-/INDUS.	AGRICULTURAL	FLAT	I/C	
6	WA	PASCO	TRAIN	BN	CLASS-/INDUS.	INDUSTRIAL	HUMP	I/C	
6	WA	PORT ANGELES	TRAIN	CMSP	INDUSTRIAL	RESIDENTIAL	FLAT	I/C	
6	WA	PORT TOWNSEND	TRAIN	CMSP	INDUSTRIAL	RESIDENTIAL	FLAT	I/C	
6	WA	QUINCY	TRAIN	CMSP	INDUSTRIAL	AGRICULTURAL	FLAT	I/C	
6	WA	RAYMOND	TRAIN	BN	INDUSTRIAL	INDUSTRIAL	FLAT	I/C	
6	WA	RAYMOND	TRAIN	BN	INDUSTRIAL	INDUSTRIAL	FLAT	I/C	
6	WA	PENTON	SCOPA	CMSP	INDUSTRIAL	INDUSTRIAL	FLAT	I/C	
6	WA	PENTON	TRAIN	BN	SMALL INDUS.	INDUSTRIAL	FLAT	I/C	
6	WA	SEATTLE	BALPER (INTERBAY)	BN	SMALL INDUS.	INDUSTRIAL	HUMP	I/C	
6	WA	SEATTLE	ELEVATOR	BN	INDUSTRIAL	INDUSTRIAL	FLAT	I/C	
6	WA	SEATTLE	HARBOR ISLAND	BN	CLASSIFICATION	INDUSTRIAL	FLAT	I/C	BN STACY STREET
6	WA	SEATTLE	SECOND AVE	BN	INDUSTRIAL	INDUSTRIAL	FLAT	I/C	
6	WA	SEATTLE	SOUTH SEATTLE	BN	INDUSTRIAL	INDUSTRIAL	FLAT	I/C	
6	WA	SEATTLE	STACY STREET	BN	CLASS-/INDUS.	INDUSTRIAL	FLAT	I/C	BN STACY STREET
6	WA	SEATTLE	WEST SEATTLE	UN	CLASS-/INDUS.	INDUSTRIAL	FLAT	I/C	
6	WA	SEATTLE	STACY STREET	BN	CLASS-/INDUS.	INDUSTRIAL	FLAT	I/C	MILW STACY ST.
6	WA	SEATTLE	VAN ASSELT	CMSP	INDUSTRIAL	INDUSTRIAL	FLAT	I/C	MILW STACY ST.
6	WA	SEATTLE	WATER FRONT	CMSP	INDUSTRIAL	INDUSTRIAL	FLAT	I/C	
6	WA	SEATTLE	ARGO	UP	CLASS-/INDUS.	INDUSTRIAL	FLAT	I/C	
6	WA	SEATTLE	HARBOR ISLAND	UP	CLASSIFICATION	INDUSTRIAL	FLAT	I/C	
6	WA	SEATTLE	HOUSE	UP	SMALL INDUS.	INDUSTRIAL	FLAT	I/C	
6	WA	SEATTLE	HOUSE	UP	SMALL INDUS.	INDUSTRIAL	FLAT	I/C	
6	WA	SHROD WOODLEY	TRAIN	BN	INDUSTRIAL	AGRICULTURAL	FLAT	I/C	
6	WA	SHELTON	TRAIN	BN	INDUSTRIAL	AGRICULTURAL	FLAT	I/C	
6	WA	SFOKAVE	CENTENNIAL	BN	SMALL INDUS.	INDUSTRIAL	FLAT	I/C	YARDLEY

76/07/03.

REG.	ST.	CITY	YARD	RAIL-ROAD	YARD FUNCTION	LOCATION TYPE	YARD TYPE	I/C	MAJOR YARD, IF MULTI-YARD COMPLEX
2	WV	DOLA	TRAIN	BO	INDUSTRIAL	COMMERCIAL	FLAT		
2	WV	FAIRMONT	TRAIN	BO	CLASS./INDUS.	COMMERCIAL	FLAT		
2	WV	FAIRMONT	TRAIN	WV	INDUSTRIAL	COMMERCIAL	FLAT	I/C	
2	WV	FOLLANSBETH	TRAIN	PC	SMALL INDUS.	INDUSTRIAL	FLAT		
2	WV	GRAFTON	EAST	BO	CLASS./INDUS.	COMMERCIAL	FLAT		
2	WV	HANDLICK	TRAIN	BO	INDUSTRIAL	AGRICULTURAL	FLAT		
2	WV	HANDLEY	TRAIN	CO	CLASS./INDUS.	COMMERCIAL	FLAT		
2	WV	HINTON	TRAIN	CO	CLASS./INDUS.	COMMERCIAL	FLAT		
2	WV	HUNTINGTON	16TH STREET	CO	CLASS./INDUS.	INDUSTRIAL	FLAT		
2	WV	HUNTINGTON	RIVEP	CO	CLASS./INDUS.	INDUSTRIAL	FLAT		
2	WV	IAEGER	AUVILLE	NW	INDUSTRIAL	UNDEVELOPED	FLAT		
2	WV	INSTITUTE	NEW	PC	INDUSTRIAL	INDUSTRIAL	FLAT		
2	WV	INSTITUTE	OLD	PC	INDUSTRIAL	INDUSTRIAL	FLAT		
2	WV	KENOVA	KENCOVA	CO	CLASS./INDUS.	COMMERCIAL	FLAT		
2	WV	KENOVA	TRAIN	NW	CLASS./INDUS.	COMMERCIAL	FLAT		
2	WV	KEYSER	TRAIN	NW	CLASS./INDUS.	RESIDENTIAL	FLAT		
2	WV	KINRALL	TRAIN	NW	SMALL INDUS.	UNDEVELOPED	FLAT		
2	WV	LOHSVILLE	TRAIN	WV	INDUSTRIAL	INDUSTRIAL	FLAT		
2	WV	LUKE	TRAIN	WV	SMALL INDUS.	INDUSTRIAL	FLAT		
2	WV	LUMBERTON	HAYWOOD	BO	SMALL INDUS.	INDUSTRIAL	FLAT		
2	WV	MADSOVILLE	TRAIN	WV	INDUSTRIAL	COMMERCIAL	FLAT	I/C	WEST CUMBO
2	WV	MARTINSBURG	FRT. HOUSE	BO	CLASSIFICATION	COMMERCIAL	FLAT		
2	WV	MARTINSBURG	G-M PLANT	BO	CLASSIFICATION	INDUSTRIAL	FLAT		
2	WV	MARTINSBURG	STANDARD LIME	BO	SMALL INDUS.	INDUSTRIAL	FLAT		
2	WV	MARTINSBURG	WEST CUMBO	BO	INDUSTRIAL	AGRICULTURAL	FLAT	I/C	WEST CUMBO
2	WV	MARTINSBURG	CUMBO	PC	CLASSIFICATION	AGRICULTURAL	FLAT	I/C	WEST CUMBO
2	WV	MARTINSBURG	MEDDOW CREEK	CO	SMALL INDUS.	UNDEVELOPED	FLAT		
2	WV	MORGANTOWN	TRAIN	HO	INDUSTRIAL	COMMERCIAL	FLAT		
2	WV	MOUNDSVILLE	TRAIN	BO	SMALL INDUS.	RESIDENTIAL	FLAT		
2	WV	MULLENS	WEST	NW	CLASS./INDUS.	UNDEVELOPED	FLAT		
2	WV	MULLENS	WEST	PC	CLASS./INDUS.	UNDEVELOPED	FLAT		
2	WV	NITRO	NITRO	NW	INDUSTRIAL	INDUSTRIAL	FLAT		
2	WV	PARKERSBURG	HIGH	BO	CLASS./INDUS.	COMMERCIAL	FLAT		
2	WV	PARKERSBURG	LOW	BO	CLASS./INDUS.	COMMERCIAL	FLAT		
2	WV	PEACH CREEK	EMPTY	CO	CLASS./INDUS.	UNDEVELOPED	FLAT		
2	WV	PEACH CREEK	LOAD	CO	CLASS./INDUS.	UNDEVELOPED	FLAT		
2	WV	PRINCETON	TRAIN	NW	INDUSTRIAL	COMMERCIAL	FLAT		
2	WV	QUINNIMONT	TRAIN	CO	SMALL INDUS.	UNDEVELOPED	FLAT		
2	WV	RAINFELL	TRAIN	NFG	SMALL INDUS.	COMMERCIAL	FLAT		
2	WV	RAINFELL	TRAIN	CO	SMALL INDUS.	COMMERCIAL	FLAT		
2	WV	RAVENSWOOD	RAVENSWOOD	BO	CLASS./INDUS.	COMMERCIAL	FLAT		
2	WV	RICHWOOD	TRAIN	BO	SMALL INDUS.	COMMERCIAL	FLAT		
2	WV	RIDGELY	TRAIN	WV	CLASS./INDUS.	COMMERCIAL	FLAT		
2	WV	ROWLESBURG	WPK JUNCTION	BO	INDUSTRIAL	RESIDENTIAL	FLAT	I/C	
2	WV	SAIN ALBANS	TRAIN	CO	CLASS./INDUS.	INDUSTRIAL	FLAT		
2	WV	SHENNSTON	ROBINSON MINE	BO	INDUSTRIAL	INDUSTRIAL	FLAT		
2	WV	THOMAS	TRAIN	WV	SMALL INDUS.	UNDEVELOPED	FLAT		
2	WV	THURMOND	TRAIN	CO	INDUSTRIAL	UNDEVELOPED	FLAT		
2	WV	WEIRTON	WEIRTON JCT.	PC	INDUSTRIAL	COMMERCIAL	FLAT		
2	WV	WELLSBURG	TRAIN	PC	SMALL INDUS.	RESIDENTIAL	FLAT		
2	WV	WHITTSVILLE	FLK RUN JCT.	CO	SMALL INDUS.	UNDEVELOPED	FLAT		
2	WV	WILCOX	TRAIN	NW	INDUSTRIAL	UNDEVELOPED	FLAT		
2	WV	WILLIAMSON	FAST	NW	CLASS./INDUS.	COMMERCIAL	FLAT		
2	WV	WILLIAMSON	MIDDLE	NW	CLASS./INDUS.	COMMERCIAL	FLAT		

76/3740R

REF.	ST.	CITY	YARD	RAIL-ROAD	YARD FUNCTION	LOCATION TYPE	YARD TYPE	I/C	MAJOR YARD IF MULTI-YARD COMPLEX
2	W	WILLIAMSON	NUPH	CNW	CLASS./INDUS.	COMMERCIAL	FLAT		
2	W	WILLIAMSON	POND CREEK	CNW	SMALL INDUS.	COMMERCIAL	FLAT		
2	W	WINEFIELD	TRAIN	CO	SMALL INDUS.	COMMERCIAL	FLAT		
2	W	WINEFIELD	TRAIN	WNF	SMALL INDUS.	COMMERCIAL	FLAT	I/C	
2	W	WORTHINGTON	CHIEFTON	WM	SMALL INDUS.	COMMERCIAL	FLAT		
4	WI	ADAMS	TRAIN	CNW	CLASSIFICATION	UNDEVELOPED	FLAT		
4	WI	ALTOONA	TRAIN	CNW	CLASSIFICATION	UNDEVELOPED	FLAT		
4	WI	ANTIGO	N TRAIN	CNW	CLASSIFICATION	AGRICULTURAL	FLAT		
4	WI	APPLETON	JUNCTION	CNW	CLASS./INDUS.	COMMERCIAL	FLAT	I/C	
4	WI	APPLETON	CITY	S00	CLASS./INDUS.	COMMERCIAL	FLAT	I/C	
4	WI	ASHLAND	DRE	CNW	CLASSIFICATION	COMMERCIAL	FLAT		
4	WI	ASHLAND	TRAIN	S00	CLASSIFICATION	COMMERCIAL	FLAT		
4	WI	GARRON	BARRON	S00	SMALL INDUS.	RESIDENTIAL	FLAT	I/C	
4	WI	BELLOIT	TRAIN	CMSPP	SMALL INDUS.	COMMERCIAL	FLAT	I/C	
4	WI	BELLOIT	TRAIN	CNW	INDUSTRIAL	COMMERCIAL	FLAT	I/C	
4	WI	BUTLER	BUTLER	CNW	INDUSTRIAL	INDUSTRIAL	FLAT	I/C	
4	WI	CHIPPEWA FALLS	CHIPPEWA FALLS	S00	CLASSIFICATION	RESIDENTIAL	FLAT	I/C	
4	WI	CUDAHY	TRAIN	CNW	INDUSTRIAL	INDUSTRIAL	FLAT	I/C	
4	WI	EAST TROY	EAST TROY	MUMET	SMALL./INDUS.	RESIDENTIAL	FLAT	I/C	
4	WI	EAU CLAIRE	CITY	CMSPP	CLASS./INDUS.	RESIDENTIAL	FLAT	I/C	
4	WI	EAU CLAIRE	CITY	CNW	INDUSTRIAL	RESIDENTIAL	FLAT	I/C	
4	WI	EAU CLAIRE	CITY	S00	SMALL INDUS.	RESIDENTIAL	FLAT	I/C	
4	WI	ELAND	TRAIN	CNW	SMALL./INDUS.	AGRICULTURAL	FLAT	I/C	
4	WI	FLROY	CITY	CNW	SMALL INDUS.	RESIDENTIAL	FLAT	I/C	
4	WI	GOODMAN	GOODMAN	GDCH	INDUSTRIAL	INDUSTRIAL	FLAT	I/C	
4	WI	GREEN BAY	TRAIN	CMSPP	CLASS./INDUS.	RESIDENTIAL	FLAT	I/C	
4	WI	GREEN BAY	NEW/OLD	CNW	CLASS./INDUS.	RESIDENTIAL	FLAT	I/C	
4	WI	GREEN BAY	MASON ST.	GM	CLASSIFICATION	RESIDENTIAL	FLAT	I/C	
4	WI	GREEN BAY	NORWOOD	GM	INDUSTRIAL	INDUSTRIAL	FLAT	I/C	
4	WI	HORICON	HORICON	MSPP	CLASS./INDUS.	RESIDENTIAL	FLAT		
4	WI	HURLEY	TRAIN	CNW	SMALL INDUS.	RESIDENTIAL	FLAT		
4	WI	JANESVILLE	WEST	CMSPP	CLASS./INDUS.	RESIDENTIAL	FLAT	I/C	
4	WI	JANESVILLE	SO. JAMESVILLE	CMSPP	CLASS./INDUS.	RESIDENTIAL	FLAT	I/C	
4	WI	JANESVILLE	TRAIN	CNW	INDUSTRIAL	UNDEVELOPED	FLAT	I/C	
4	WI	JEFFERSON JCT.	TRAIN	CNW	INDUSTRIAL	UNDEVELOPED	FLAT	I/C	
4	WI	KAUKAUNA	TRAIN	CNW	CLASS./INDUS.	RESIDENTIAL	FLAT		
4	WI	KENOSHA	BAIN	CNW	INDUSTRIAL	INDUSTRIAL	FLAT		
4	WI	KENOSHA	ELEVATION	CNW	CLASSIFICATION	RESIDENTIAL	FLAT		
4	WI	KENOSHA	FARM	CNW	CLASSIFICATION	RESIDENTIAL	FLAT		
4	WI	KENOSHA	FERRY	GM	SMALL INDUS.	AGRICULTURAL	FLAT	I/C	
4	WI	KENOSHA	TRAIN	CMSPP	CLASS./INDUS.	RESIDENTIAL	FLAT	I/C	
4	WI	KENOSHA	TRAIN	CMSPP	SMALL INDUS.	COMMERCIAL	FLAT	I/C	
4	WI	LA CROSSE	TRAIN	S00	INDUSTRIAL	RESIDENTIAL	FLAT	I/C	
4	WI	LADYSMITH	LAKE MILLS	CNW	SMALL INDUS.	AGRICULTURAL	FLAT	I/C	
4	WI	LADYSMITH	WEST	CMSPP	CLASS./INDUS.	RESIDENTIAL	FLAT	I/C	
4	WI	MADISON	MONGNA	CNW	SMALL INDUS.	RESIDENTIAL	FLAT	I/C	
4	WI	MADISON	TRAIN	ICG	SMALL INDUS.	RESIDENTIAL	FLAT	I/C	
4	WI	MADISON	CALUMENT	CNW	INDUSTRIAL	AGRICULTURAL	FLAT	I/C	
4	WI	MANITOWOC	CAR FERRY	CNW	INDUSTRIAL	INDUSTRIAL	FLAT	I/C	
4	WI	MANITOWOC	CAR FERRY	CNW	INDUSTRIAL	INDUSTRIAL	FLAT	I/C	
4	WI	MANITOWOC	CAR FERRY	S00	INDUSTRIAL	INDUSTRIAL	FLAT	I/C	
4	WI	MANITOWOC	CAR FERRY	CNW	INDUSTRIAL	INDUSTRIAL	FLAT	I/C	
4	WI	MARINETTE	CITY	CNW	CLASSIFICATION	COMMERCIAL	FLAT	I/C	
4	WI	MARINETTE	CITY	CNW	CLASS./INDUS.	COMMERCIAL	FLAT	I/C	
4	WI	MARSHFIELD	TRAIN	S00	CLASS./INDUS.	COMMERCIAL	FLAT	I/C	
4	WI	MARSHFIELD	TRAIN	S00	CLASS./INDUS.	COMMERCIAL	FLAT	I/C	

76/07/01.

REG.	ST.	CITY	YARD	RAIL-ROAD	YARD FUNCTION	LOCATION TYPE	YARD TYPE	I/C	MAJOR YARD IF MULTI-YARD COMPLEX
4	WI	MENASHA	MENASHA	CNSPP	INDUSTRIAL	INDUSTRIAL	FLAT		
4	WI	MERRILL	MERRILL	CNSPP	INDUSTRIAL	RESIDENTIAL	FLAT		
4	WI	MILWAUKEE	AIRLINE	CNSPP	CLASSIFICATION	INDUSTRIAL	HMO		AIRLINE
4	WI	MILWAUKEE	PLUE MOUND	CNSPP	CLASSIFICATION	INDUSTRIAL	FLAT		
4	WI	MILWAUKEE	URIDGE	CNSPP	SMALL INDUS.	INDUSTRIAL	FLAT		
4	WI	MILWAUKEE	CANAL	CNSPP	INDUSTRIAL	INDUSTRIAL	FLAT		AIRLINE
4	WI	MILWAUKEE	CHESTNUT STREET	CNSPP	INDUSTRIAL	COMMERCIAL	FLAT		CHESTNUT STREET
4	WI	MILWAUKEE	DAVIES	CNSPP	CLASS./INDUS.	INDUSTRIAL	FLAT		
4	WI	MILWAUKEE	FOWLER	CNSPP	SMALL INDUS.	RESIDENTIAL	FLAT		
4	WI	MILWAUKEE	STESON	CNSPP	INDUSTRIAL	INDUSTRIAL	FLAT		CHESTNUT STREET
4	WI	MILWAUKEE	GLENDALE	CNSPP	INDUSTRIAL	INDUSTRIAL	FLAT		
4	WI	MILWAUKEE	HARBOLT	CNSPP	INDUSTRIAL	COMMERCIAL	FLAT		
4	WI	MILWAUKEE	JONES ISLAND	CNSPP	INDUSTRIAL	INDUSTRIAL	FLAT		
4	WI	MILWAUKEE	LAKE	CNSPP	INDUSTRIAL	INDUSTRIAL	FLAT		
4	WI	MILWAUKEE	MENOMINEE BELT	CNSPP	SMALL INDUS.	COMMERCIAL	FLAT		
4	WI	MILWAUKEE	MILLER BREWERY	CNSPP	SMALL INDUS.	RESIDENTIAL	FLAT		
4	WI	MILWAUKEE	MILWAUKEE	CNSPP	CLASS./INDUS.	INDUSTRIAL	FLAT		
4	WI	MILWAUKEE	MUSKEGO	CNSPP	SMALL INDUS.	RESIDENTIAL	FLAT		AIRLINE
4	WI	MILWAUKEE	NO. AVENUE	CNSPP	SMALL INDUS.	COMMERCIAL	FLAT		GLENDALE
4	WI	MILWAUKEE	NO. MILWAUKEE	CNSPP	INDUSTRIAL	COMMERCIAL	FLAT		GLENDALF
4	WI	MILWAUKEE	PLANKINGTON	CNSPP	INDUSTRIAL	COMMERCIAL	FLAT		
4	WI	MILWAUKEE	PORT	CNSPP	INDUSTRIAL	INDUSTRIAL	FLAT		
4	WI	MILWAUKEE	REED ST.	CNSPP	SMALL INDUS.	INDUSTRIAL	FLAT		
4	WI	MILWAUKEE	RUCK JCT.	CNSPP	SMALL INDUS.	COMMERCIAL	FLAT		
4	WI	MILWAUKEE	STWELL	CNSPP	INDUSTRIAL	INDUSTRIAL	FLAT		
4	WI	MILWAUKEE	BUTLER	CNW	CLASS./INDUS.	COMMERCIAL	FLAT		
4	WI	MILWAUKEE	FIFTH WARD	CNW	CLASS./INDUS.	COMMERCIAL	FLAT		
4	WI	MILWAUKEE	JONES ISLAND	CNW	INDUSTRIAL	INDUSTRIAL	FLAT		JONES ISLAND
4	WI	MILWAUKEE	MITCHELL	CNW	CLASS./INDUS.	RESIDENTIAL	FLAT		MITCHELL
4	WI	MILWAUKEE	MITCHELL BELT	CNW	CLASS./INDUS.	RESIDENTIAL	FLAT		MITCHELL
4	WI	MILWAUKEE	NATIONAL AVE	CNW	CLASS./INDUS.	INDUSTRIAL	FLAT		
4	WI	MILWAUKEE	UPDIKE	CNW	SMALL INDUS.	INDUSTRIAL	FLAT		
4	WI	MILWAUKEE	CAR FERRY	GTW	INDUSTRIAL	INDUSTRIAL	FLAT		JONES ISLAND
4	WI	MILWAUKEE	CAR FERRY	CNW	INDUSTRIAL	INDUSTRIAL	FLAT		
4	WI	MILWAUKEE	CITY	CNSPP	INDUSTRIAL	COMMERCIAL	FLAT		
4	WI	NEENAH	CITY	CNSPP	SMALL INDUS.	RESIDENTIAL	FLAT		
4	WI	NEW LISDON	TRAIN	CNW	INDUSTRIAL	RESIDENTIAL	FLAT		
4	WI	NIAGRA	PAPER	CNW	INDUSTRIAL	COMMERCIAL	FLAT		
4	WI	NO. FOND DU LAC	NO. FOND DU LAC	CNW	CLASS./INDUS.	UNDEVELOPED	FLAT		
4	WI	NO. FOND DU LAC	SOUTH	CNW	INDUSTRIAL	RESIDENTIAL	FLAT		
4	WI	NO. FOND DU LAC	NO. FOND DU LAC	FO	CLASS./INDUS.	RESIDENTIAL	FLAT		
4	WI	NO. LA CROSSE	TRAIN	SN	CLASS./INDUS.	RESIDENTIAL	FLAT		
4	WI	OCONTO	OCONTO	CNW	SMALL INDUS.	RESIDENTIAL	FLAT		
4	WI	OSHKOSH	SO. OSHKOSH	CNW	INDUSTRIAL	COMMERCIAL	FLAT		
4	WI	OSHKOSH	OSHKOSH	SO	SMALL INDUS.	INDUSTRIAL	FLAT		
4	WI	PARK FALLS	TRAIN	SO	INDUSTRIAL	RESIDENTIAL	FLAT		
4	WI	PLYMOUTH	PLYMOUTH	CNSPP	INDUSTRIAL	RESIDENTIAL	FLAT		
4	WI	PORTAGE	TRAIN	CNSPP	CLASS./INDUS.	RESIDENTIAL	FLAT		
4	WI	PRAIRIE DU CHIEN	PRAIRIE DU CHIEN	CNSPP	SMALL INDUS.	RESIDENTIAL	FLAT		
4	WI	RACINE	CITY	CNSPP	INDUSTRIAL	RESIDENTIAL	FLAT		
4	WI	RACINE	JUNCTION	CNSPP	SMALL INDUS.	COMMERCIAL	FLAT		
4	WI	RACINE	RACINE	CNSPP	SMALL INDUS.	INDUSTRIAL	FLAT		
4	WI	RACINE	RACINE	CNSPP	CLASS./INDUS.	RESIDENTIAL	FLAT		
4	WI	RACINE	JUNCTION	CNW	INDUSTRIAL	COMMERCIAL	FLAT		

76/07/08.

REG.	ST.	CITY	YARD	RAIL-ROAD	YARD FUNCTION	LOCATION TYPE	YARD TYPE	I/C	MAJOR YARD IF MULTI-YARD COMPLEX
4	41	RHINELANDER	CITY	CNW	SMALL INDUS.	RESIDENTIAL	FLAT	I/C	
4	41	RHINELANDER	TRAIN	SDD	CLASSIFICATION	RESIDENTIAL	FLAT	I/C	
4	41	SHEBOYGAN	SHEBOYGAN	CNW	CLASS-/INDUS.	INDUSTRIAL	FLAT	I/C	
4	41	SPARTA	SPARTA	CNW	SMALL INDUS.	RESIDENTIAL	FLAT	I/C	
4	41	SPOONER	TRAIN	CNW	CLASSIFICATION	RESIDENTIAL	FLAT	I/C	
4	41	STEVENS POINT	TRAIN	CNW	CLASS-/INDUS.	RESIDENTIAL	FLAT	I/C	
4	41	STURTEVANT	STURTEVANT	CMSPP	CLASS-/INDUS.	UNDEVELOPED	FLAT	I/C	17TH STREET
4	41	SUPERIOR	17TH ST.	BN	CLASS-/INDUS.	COMMERCIAL	FLAT	I/C	17TH STREET
4	41	SUPERIOR	29TH ST.	BN	CLASSIFICATION	RESIDENTIAL	FLAT	I/C	
4	41	SUPERIOR	ALLCUEZ	BN	INDUSTRIAL	INDUSTRIAL	FLAT	I/C	
4	41	SUPERIOR	WELNAP ST.	BN	INDUSTRIAL	COMMERCIAL	FLAT	I/C	
4	41	SUPERIOR	EAST END	BN	CLASS-/INDUS.	UNDEVELOPED	FLAT	I/C	
4	41	SUPERIOR	SAUNDERS	BN	INDUSTRIAL	COMMERCIAL	FLAT	I/C	
4	41	SUPERIOR	CITY	CNW	INDUSTRIAL	COMMERCIAL	FLAT	I/C	
4	41	SUPERIOR	ITASCA	CNW	CLASS-/INDUS.	RESIDENTIAL	FLAT	I/C	
4	41	SUPERIOR	BEAVER ST.	LSTT	CLASS-/INDUS.	COMMERCIAL	FLAT	I/C	
4	41	SUPERIOR	21ST ST.	SDD	CLASS-/INDUS.	COMMERCIAL	FLAT	I/C	
4	41	SUPERIOR	STINSON	SDD	SMALL INDUS.	UNDEVELOPED	FLAT	I/C	STINSON
4	41	TOMAHAWK	CITY	CMSPP	SMALL INDUS.	RESIDENTIAL	FLAT	I/C	
4	41	WATERTOWN	TRAIN	CMSPP	CLASS-/INDUS.	RESIDENTIAL	FLAT	I/C	
4	41	WAUKESHA	TRAIN	CMSPP	SMALL INDUS.	COMMERCIAL	FLAT	I/C	
4	41	WAUKESHA	TRAIN	CNW	SMALL INDUS.	COMMERCIAL	FLAT	I/C	
4	41	WAUKESHA	TRAIN	SDD	SMALL INDUS.	COMMERCIAL	FLAT	I/C	
4	41	WAUSAU	CITY	CMSPP	CLASS-/INDUS.	RESIDENTIAL	FLAT	I/C	
4	41	WAUSAU	WAUSAU JCT	CNW	INDUSTRIAL	INDUSTRIAL	FLAT	I/C	
4	41	WEYERHAUSER	TRAIN	SDD	CLASSIFICATION	AGRICULTURAL	FLAT	I/C	
4	41	WISCONSIN RAPIDS	CITY	CMSPP	SMALL INDUS.	RESIDENTIAL	FLAT	I/C	
4	41	WISCONSIN RAPIDS	CITY	CNW	SMALL INDUS.	RESIDENTIAL	FLAT	I/C	
4	41	WISCONSIN RAPIDS	TRAIN	CNW	CLASSIFICATION	RESIDENTIAL	FLAT	I/C	
4	41	WISCONSIN RAPIDS	CITY	GBW	INDUSTRIAL	COMMERCIAL	FLAT	I/C	
6	41	BIG HORN MINE	MINE	BN	INDUSTRIAL	UNDEVELOPED	FLAT	I/C	
6	41	CASPER	TRAIN	BN	CLASS-/INDUS.	RESIDENTIAL	FLAT	I/C	
6	41	CASPER	TRAIN	CNW	CLASS-/INDUS.	RESIDENTIAL	FLAT	I/C	
6	41	CHEYENNE	TRAIN	CS	CLASS-/INDUS.	COMMERCIAL	FLAT	I/C	
6	41	CHEYENNE	TRAIN	UP	CLASS-/INDUS.	COMMERCIAL	FLAT	I/C	
6	41	CODY	TRAIN	BN	SMALL INDUS.	RESIDENTIAL	FLAT	I/C	
6	41	DURKEE	REFINERY	BN	SMALL INDUS.	AGRICULTURAL	FLAT	I/C	
6	41	FRANKIE	TRAIN	BN	SMALL INDUS.	AGRICULTURAL	FLAT	I/C	
6	41	GILLETTE	TRAIN	BN	SMALL INDUS.	RESIDENTIAL	FLAT	I/C	
6	41	GREEN RIVER	TRAIN	UP	CLASS-/INDUS.	COMMERCIAL	FLAT	I/C	
6	41	GRAYBULL	TRAIN	BN	SMALL INDUS.	RESIDENTIAL	FLAT	I/C	
6	41	GUERNSEY	TRAIN	BN	SMALL INDUS.	RESIDENTIAL	FLAT	I/C	
6	41	GUERNSEY	TRAIN	CS	SMALL INDUS.	AGRICULTURAL	FLAT	I/C	
6	41	LAPORTE	TRAIN	UP	INDUSTRIAL	AGRICULTURAL	FLAT	I/C	
6	41	LOWELL	TRAIN	BN	SMALL INDUS.	RESIDENTIAL	FLAT	I/C	
6	41	ORAVA	PLANT	BN	SMALL INDUS.	RESIDENTIAL	FLAT	I/C	
6	41	PULLMAN	TRAIN	BN	SMALL INDUS.	AGRICULTURAL	FLAT	I/C	
6	41	PULLMAN	TRAIN	UP	INDUSTRIAL	AGRICULTURAL	FLAT	I/C	
6	41	RAVLINS	TRAIN	UP	INDUSTRIAL	RESIDENTIAL	FLAT	I/C	
6	41	RIVERTON	TRAIN	CNW	SMALL INDUS.	RESIDENTIAL	FLAT	I/C	
6	41	ROCK SPRINGS	TRAIN	UP	INDUSTRIAL	INDUSTRIAL	FLAT	I/C	
6	41	SHEPHERD	TRAIN	BN	CLASS-/INDUS.	INDUSTRIAL	FLAT	I/C	
6	41	SHEPHERD	TRAIN	BN	SMALL INDUS.	RESIDENTIAL	FLAT	I/C	
6	41	SUNRISE	SUNRISE MINE	CW	INDUSTRIAL	INDUSTRIAL	FLAT	I/C	

76/07/09

REG.	ST.	CITY	YARD	RAIL-ROAD	YARD FUNCTION	LOCATION - YPR	YARD TYPE	I/C	MAJOR YARD IF MULTI-YARD COMPLEX
6	WV	VOCATION	STATION	GN	SMALL INDUS*	AGRICULTURAL	FLAT		
8	WV	WINDSOR	TRAIN STATION	C'S	SMALL INDUS*	AGRICULTURAL	FLAT		
6	WV	WINDLAND	STATION	HN	SMALL INDUS*	AGRICULTURAL	FLAT		
6	WV	WYODAK	MIKE	SN	SMALL INDUS*	UNDEVELOPED	FLAT		

APPENDIX D

REFERENCES

1. Yearbook of Railroad Facts, 1975 Edition, Association of American Railroads, Washington, D.C. (1975).
2. Rail Service in the Midwest and Northeast Region, a report by the Secretary of Transportation (1 February 1974).
3. H. Bartholomew, Land Uses in American Cities, Harvard University Press, Cambridge, MA. (1955).
4. S. J. Petracek, "Inventory of U.S. Railroad Yards, A Preliminary Summary," SRI Technical Note, TN-3983-75-1, (19 August 1975).
5. "Railroad Freight Car Classification Yard Installation: 1924-1976" Union Switch and Signal Division, Westinghouse Air Brake Company, Swissvale, Pennsylvania.
6. C. L. Woehlcke "Transportation Projections: 1970-1980", Jack Faucett Associates, Inc., NTIS Report #PB 221-738 (March 1973).
7. A. E. Moon et al., "Urban Railroad Relocation: Nature and Magnitude of the Problem", Report No. RP31, V.4. Stanford Research Institute, Menlo Park, California (1975).
8. National Intermodal Network Feasibility Study, Volume III, "A Nationwide Intermodal Network," Rieebie and Associates, Greenwich, Connecticut, (June 1975).
9. "Now, Weigh Your Car in about 20 Seconds," Railway Age, p. 50 (8 October 1973).
10. "Definition of a Standard Test of a Motion Weighing Railway Track Scale," Manual Recommendations, AREA Bulletin 640, pp. 150-152.
11. H. Stein, "In-Motion Truck Axle Weighing-Theoretical Considerations," Weighing and Measurement, pp. 10-13 (August 1975).
12. AAR Functionability Report, 16 Jan 1976 "Railroad Industry Review," pp. 47-50, Hayden, Stone Incorporated, New York, New York (1969).
13. "Shorter Labels?" Railway System Controls, p. 19 (February 1975).
14. "Software Techniques for Evaluating Kar Trak System Performance," Railway System Controls, pp. 14-20 (February 1975).

15. H. C. Ingrao, "Optical Automatic Car Identification--Field Test Program," Final Report, Transportation Systems Center, May 1976.
16. C. E. Taylor and W. J. Harris, Jr., "Automatic Car Identification--Report to the Operation-Transportation General Committee," Association of American Railroads. (15 October 1975).
17. R. Roberts, "ACI Requires Total Application," Modern Railroads, pp. 34-36 (August 1972).
18. "From GTW: A Strong Endorsement for ACI," Railway Age, pp. 50-51 (29 September 1975).
19. "Railroad Industry Review," pp. 47-50, Hayden, Stone Incorporated, New York, New York (1969).
20. "Rail Freight Automation Equipment," Frost and Sullivan, Inc., New York, New York (December 1974).
21. "Automatic Identification: What, When, and Where," Railway System Controls, p. 12 (March 1975).
22. "Automatic Systems of Wagon Identification," The Railway Gazette, pp. 489-497 (18 June 1965).
23. "Microwave Vehicle Identification System Developed for U.S. Army," Railway System Controls, p. 27 (March 1975).
24. "Microwave Used for Car Identification," Railway System Controls, pp. 24-25 (March 1975).
25. G. L. Leadley, "An Overview of Current Efforts To Detect and Prevent Steel Wheel Failures," paper presented at 22nd meeting of the Mechanical Failure Prevention Group, Anaheim, California (25 April 1975).
26. A. V. Dashburg, "The 50th Anniversary of the Car Retarder," AREA Bulletin 643, pp. 504-515 (1973).
27. F. Kirshner, "Control of Railroad Wheel Screech Noise," 6th International Congress on Acoustics, Tokyo, Japan, pp. F-61 to F-64 (21-28 August 1968).
28. H. C. Kendall, "Noise Studied in Retarder Yards," Railway System Controls, pp. 9-13 (July 1971).
29. E. E. Ungar, R. D. Strunk, and P. R. Nayak, "An Investigation of the Generation of Screech by Railway Car Retarders," Report No. 2067, Bolt, Beranek and Newman, Inc., Cambridge, Massachusetts (December 1970).

30. U. J. Kurze, E. E. Ungar, and R. D. Strunk, "An Investigation of Potential Measures of the Control of Car Retarder Screech Noise," Report No. 2143, Bolt, Beranek and Newman, Inc., Cambridge, Massachusetts (April 1971).
31. V. K. Southworth, "Noise Problems Involving Retarders," 12th Annual Meeting of the AAR Communication and Signal Section (25 September 1972).
32. F. Kirschner, "New Developments in the Control of Railroad Wheel Screech Noise," Proc. Inter-Noise 72, pp. 225-230 (4-6 October 1972).
33. R. L. Kiang, "Retarder Noise Study," SRI Final Report 1881, Stanford Research Institute, Menlo Park, California (20 January 1973).
34. "Retarder Noise, I & II," Railway System Controls, p. 26 (January 1974).
35. "Hump Yard Automation," The Railway Gazette, pp. 443-446 (5 June 1964).
36. "Dowty Control System for Marshalling Yards," The Railway Gazette, pp. 773-777 (1 October 1965).
37. K. Koehn, H. L. Holt, and A. Sabeti, "European Yard Retarder Systems," Railway Management Review--Quarterly, Vol. 72, No. 2, pp. A7-A19 (1972).
38. H. T. Landow, "Overseas Railroads Try New Yard Techniques," Modern Railroads, pp. 95-102 (September 1968).
39. T. Fukui, "Automation Systems at Takasaki Marshalling Yard," Japanese Railway Eng., Vol. 12, No. 1, p. 9 (1971).
40. I. Nisugi, "Modernization Plan for Koriyama Marshalling Yard," Japanese Railway Eng., Vol. 6, No. 2, p. 16 (1965).
41. M. Tsubai and E. Itakura, "Development of Electro Dynamic Car Retarder," Quarterly Reports of Railway Technical Research Institute, Japan, Vol. 13, No. 1, pp. 46-50 (1972).
42. Y. Usami, "Tests on Linear-Motorized Yard System in Toyama Marshalling Yard," Japanese Railway Eng., Vol. 11, No. 2, pp. 18-19 (1970).
43. Y. Usami et al., "Linear-Motorized Yard Automation System," Quarterly Reports of Railway Technical Research Institute, Japan, Vol. 14, No. 4, pp. 207-213 (1973).

44. "Procedures for Analyzing the Economic Costs of Railroad Roadway For Pricing Purposes," Final Report, prepared for Federal Railroad Administration by Stanford Research Institute (January 1976).
45. "Does the Concrete Tie Have a Future on U.S. Railroads," Railway Age, pp. 26-28 (10 April 1972).
46. "CN Tests Concrete Ties for More Durable Track," Railway Age, pp. 22-24 (12 March 1973).
47. M. Dick, "Concrete Ties: Despite Setbacks, Still Very Much in the Picture," Railway Age, pp. 46-48 (12 August 1974).
48. _____, "Concrete Tie Test on Santa Fe," Railway Age, pp. 32-33 (13 January 1975).
49. _____, "M/W Tools Promise Big Savings," Railway Age pp. 47-50 (11 September 1972).
50. P. J. DeIvernois, "The Evolution of Control Systems in Retarder Yards," AREA Bulletin 643, pp. 490-503 (1973).
51. T. Innami and K. Matsushima, "Automation of Koriyama Marshalling Yard," Proc. of the Second International Symposium on the Use of Cybernetics on the Railways, Montreal, pp. 188-193 (October 1967).
52. T. Taylor, Jr., "Fostering Terminal Management Innovations with ACI Quantum Jump Technology," 1973 Transportation Research Forum, Cleveland, Ohio (October 1973).
53. K. Troup, III (ed.), "Railroad Classification Yard Technology: An Introductory Analysis of Functions and Operations," Final Report, Transportation Systems Center, Cambridge, Mass. (1975).
54. D. J. Theis and L. C. Hobbs, "The Minicomputers Revisited," Datamation, pp. 24-34 (15 May 1971).
55. L. C. Hobbs and R. A. McLaughlin, "Minicomputer Survey," Datamation, pp. 50-61 (July 1974).
56. "Computer Applications to Classification Yards," AREA Bulletin 650, pp. 272-277 (1975).
57. W. V. Williamson, R. C. Nagel, and F. E. Young, "West Colton Yard," paper presented to AAR Communication and Signal Section and Data Systems Division, New York (October 1973).
58. J. J. Di Paola, "The Distributed Computer System in Classification Yards," AREA Bulletin 643, pp. 534-540 (1973).

59. General Railway Signal Company, "GRS Distributed Computer System," GRS Development Publication D21.0200.
60. J. R. Martin and G. C. Durand, "Implementation of a Distributed Computer Complex in Sheffield Yard," Proc. of the Fourth International Symposium on Railroad Cybernetics, Washington, D.C., pp. 3.041-3.043 (April 1974).
61. "Economics of Freight Cars with Characteristics Approaching the Limits of Acceptable Designs," AREA Bulletin 649, pp. 137-142.
62. A. E. Moon and D. A. Norman, "Economic Evaluation of the Sonicar," SRI Report, Stanford Research Institute, Menlo Park, California (November 1967).
63. S. R. Ditmeyer and A. S. Lang, "The Effects of New Freight Car Technology," Railway Management Review--Quarterly, Vol. 72, No. 2, pp. A59-A71 (1972).
64. "Track Train Dynamics To Improve Freight Train Performance," Government-Industry Program on Track Train Dynamics (1973).
65. T. W. Van Metre and R. G. Van Metre, Trains, Tracks, and Travel, Simmons-Boardman Publishing Corporation, New York, 1956.
66. "Transport Statistics of the United States," Interstate Commerce Commission, Bureau of Accounts, Washington, D. C. (for years 1967-1971).
67. Diesel and Diesel Electric Locomotives, Vernon Davy Macdonald and Co., Ltd., London, 1969.
68. "ATSF and Southern Test Hydraulic Diesel," Railway Locomotives and Cars, pp. 42-43 (August/September 1974).
69. R. McBrian, "New Motive Power Technology," in Technological Change and the Future of the Railways, R. S. Nelson and E. M. Johnson (eds.) pp. 206-220, Northwestern University Press, Evanston, Illinois (1960).
70. C.L. Combes, "Locomotive Design: Change by Evolution," Railway Age, pp. 68-74 (9-16 October 1967).
71. "EMD's 50th Anniversary," Railway Age, pp. 28-36 (28 August 1972).
72. "CN Develops Its Own Slip Control," Railway Locomotives and Cars, pp. 11-12 (January 1974).
73. "New Directions in Railroad Operations," Modern Railroads, pp. 44-50 (December 1972).

74. K. J. Pentinga, "Teaching Simultaneous Marshalling," The Railway Gazette, pp. 590-593 (22 May 1959).
75. H. Konig and P. Schaltegger, "Optimum Simultaneous Marshalling of Local Goods Trains in Marshalling Yards," Bulletin of the International Railway Congress Association, Vol. 4, No. 1, pp. 1-19, (January 1967).
76. M. W. Siddiquee, "Investigation of Sorting and Train Formation Schemes for a Railroad Hump Yard," 5th International Symposium on the Theory of Traffic Flow and Transportation, pp. 377-387 (1971).
77. H. T. Landow, "Yard Switching with Multiple Pass Logic," Railway Management Review--Quarterly, Vol. 72, No. 1, pp. 11-23 (1972).
78. H. R. Christianson, "Should Future Yards Classify in Two Stages," Railway Management Review--Quarterly, Vol. 72, No. 2, pp. A20-A32 (1972).
79. W. D. Middleton, "Santa Fe's Barstow: A New Yard with New Ideas," Railway Age, pp. 16-22 (24 February 1975).
80. "Pint-Sized Gravity Yards Keep the Traffic Rolling," Southern Pacific Magazine, pp. 10-11 (January/February 1975).
81. N. J. B. Alexander, "Hump Marshalling Yard Design," The Railway Gazette, pp. 997-1000 (17 December 1965).
82. I. R. Gobertshahn, "Methodology for Investigating the Possibilities of Forming Multi-Group Goods Trains during the First Sorting Phase at High-Capacity Marshalling Yards," Rail International, pp. 754-766 (December 1974).
83. "Koriyama Marshalling Yard," The Railway Gazette, pp. 54-56 (17 January 1969).
84. N. Miyakawa, "Automation of Koriyama Marshalling Yard and the Herringbone Track," Rail International, pp. 300-320 (May 1972).
85. "Manpower Aspects of Automation and Technical Change," European Conference of the Organization for Economic Cooperation and Development, Zurich, Switzerland (February 1966).
86. E. Mansfield, The Economics of Technological Change, W. W. Norton & Company, Inc., New York, New York (1968).
87. E. Mansfield, Industrial Research and Technological Innovation, W. W. Norton & Company, Inc., New York, New York (1968).
88. R. Ayres, "On the Sustenance of Technological Innovation," in Technological Forecasting and Social Changes, pp. 273-278, American Elsevier Publishing Co., New York, New York (1973).

89. K. Knight, "Organizational Factors that Influence Technological Innovation," AIAA Third Annual Meeting, Boston, Massachusetts (November 1966).
90. Moody's Transportation Manual, Moody's Investors Service, Inc., New York, New York (1973).
91. Railroad Quiz, 15th Edition, Association of American Railroads, Washington, D.C.
92. "Rail Service in the Midwest and Northeast Region," U.S. Department of Transportation (1 February 1974).
93. D. F. Pegrum, Transportation: Economics and Public Policy, Richard D. Irwin, Inc., Homewood, Illinois (1973).
94. A. J. Gellman, "Surface Freight Transportation," in Technological Change in Regulated Industries (W. M. Capron, ed.), pp. 166-196; Studies in the Regulation of Economic Activity, The Brookings Institution, Washington, D.C. (1971).
95. "Review 74," Railway Age, pp. 64-74 (27 January 1975).
96. Interstate Commerce Commission, 88th Annual Report to Congress, Washington, D.C. (30 June 1974).
97. "Apathy toward Rail Investment--A Warning," Railway Age, pp. 34-35 (10 November 1975).
98. P. R. Lawrence, "How To Deal with Resistance to Change," Harvard Business Review, reprint (January-February 1969).
99. R. E. Walton, "How To Counter Alienation in the Plant," Harvard Business Review, reprint (November-December 1972).
100. "Railroad Technology and Manpower in the 1970s," U.S. Department of Labor (1972).
101. "Improving Railroad Productivity," Final Report of the Task Force on Railroad Productivity, Washington, D.C. (November 1973).
102. "Where Does Railroad Technology Come From?" Railway Age, p. 60 (26 February 1968).
103. "Successful Industrial Innovations," National Science Foundation Report NSF 69-17 (1969).
104. J. E. Martin, et al., "Study of the Optimum Length, Speed and Weight of Freight Trains," Bulletin 639, American Railway Engineering Association.

105. Robert H. Leibich, "Economics of Short Trains, Peat, Marwick, Mitchell & Co. (June 1974).
106. Julian S. Eberhardt, "The Effects of Shorter, More Frequent Trains on Railroad Classification Yards: a computer simulation," Masters Theses, Northwestern University, Evanston, Illinois (December, 1964).

APPENDIX E

REPORT OF INVENTIONS

This report, a survey and assessment of existing conditions, practices, and technology, includes as Appendix C a listing and categorization of all U. S. railroad yards, and in Section 2 provides a more detailed quantitative description of different types of classification yards. The projection of future freight car switching needs found in Section 3 also represents a new contribution. The comprehensive listing and description of yard design considerations and technology which comprises Section 4 is also felt to represent a useful and previously unavailable information base.

300 copies

☆ U. S. GOVERNMENT PRINTING OFFICE: 1977--700-697--122

E-1/E-2

U. S. DEPARTMENT OF TRANSPORTATION
TRANSPORTATION SYSTEMS CENTER
KENDALL SQUARE, CAMBRIDGE, MA. 02142

OFFICIAL BUSINESS
PENALTY FOR PRIVATE USE, \$300



POSTAGE AND FEES PAID

U. S. DEPARTMENT OF TRANSPORTATION

518