

Report No. UMTA-MA-06-0100-80-1

**FIELD EVALUATION
OF ADVANCED METHODS
OF SUBSURFACE EXPLORATION
FOR TRANSIT TUNNELING**

D. E. THOMPSON
J. T. HUMPHREY
L. W. YOUNG, JR.
C. F. WALL



JUNE 1980

FINAL REPORT

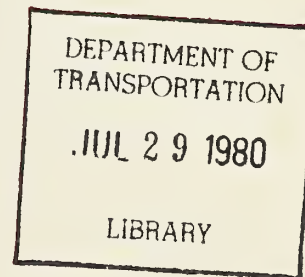

DOCUMENT IS AVAILABLE TO THE PUBLIC
THROUGH THE NATIONAL TECHNICAL
INFORMATION SERVICE, SPRINGFIELD,
VIRGINIA 22161

Prepared for

**U.S. DEPARTMENT OF TRANSPORTATION
URBAN MASS TRANSPORTATION ADMINISTRATION
Office of Technology Development and Deployment
Office of Rail and Construction Technology
Washington D C 20590**

NOTICE

This document is disseminated under the sponsorship of the Department of Transportation in the interest of information exchange. The United States Government assumes no liability for its contents or use thereof.

NOTICE

The United States Government does not endorse products or manufacturers. Trade or manufacturers' names appear herein solely because they are considered essential to the object of this report.

HE
18.5
A37
no.
DOT-
TSC-
MTA-
70-1

1. Report No. UMTA-MA-06-0100-80-1		2. Government Accession No.		3. Recipient's Catalog No.	
4. Title and Subtitle FIELD EVALUATION OF ADVANCED METHODS OF SUBSURFACE EXPLORATION FOR TRANSIT TUNNELING				5. Report Date June, 1980	
				6. Performing Organization Code	
7. Author(s) David Thompson**, John Humphrey**, Lloyd Young*, Fred Wall*				8. Performing Organization Report No. DOT-TSC-UMTA-80-1	
9. Performing Organization Name and Address *Bechtel Incorporated, 50 Beale Street San Francisco, California 94119 **Haley & Aldrich, Inc., 238 Main Street Cambridge, Massachusetts 02142				10. Work Unit No. (TRAIS) UM948/R9745	
				11. Contract or Grant No. DOT-TSC-1570	
12. Sponsoring Agency Name and Address U.S. Department of Transportation Urban Mass Transportation Administration Office of Technology Development and Deployment Office of Rail and Construction Technology Washington DC 20590				13. Type of Report and Period Covered FINAL REPORT September 1978 to December 1979	
				14. Sponsoring Agency Code UTD-30	
15. Supplementary Notes *Under contract to: U.S. Department of Transportation, Research and Special Programs Administration Transportation Systems Center, Cambridge, Massachusetts 02142					
16. Abstract This report presents the result of a field evaluation of advanced methods of subsurface explorations on an ongoing urban rapid transit tunneling project. Numerous methods of subsurface exploration, including hole advancement techniques, sampling procedures, and geophysical logging tools, were used to predict stratigraphy within a test section on an urban rapid transit project under construction. The performance of the exploration methods are evaluated in terms of adaptability to urban environment, technical performance in the test section conditions, and costs. Predictions of stratigraphy are presented, the accuracy of which will be evaluated in a later report.					
17. Key Words Tunnels, Exploration, Sampling, Geophysical, Site Investigation			18. Distribution Statement DOCUMENT IS AVAILABLE TO THE PUBLIC THROUGH THE NATIONAL TECHNICAL INFORMATION SERVICE, SPRINGFIELD, VIRGINIA 22161		
19. Security Classif. (of this report) Unclassified		20. Security Classif. (of this page) Unclassified		21. No. of Pages 412	22. Price

DEPARTMENT OF
TRANSPORTATION
JUN 29 1980
LIBRARY

U.S. DEPARTMENT OF TRANSPORTATION
FEDERAL HIGHWAY ADMINISTRATION
BUREAU OF MOTOR CARRIER SAFETY
WASHINGTON, D.C. 20591



PREFACE

This report documents a field evaluation of advanced methods of subsurface explorations for transit tunneling. It was conducted by Bechtel Incorporated, San Francisco, California, in association with Haley & Aldrich, Inc., Cambridge, Massachusetts.

The work was completed under Contract DOT-TSC 1570 for the Transportation Systems Center (TSC) on behalf of the Office of Rail and Construction Technology of the Urban Mass Transportation Administration (UMTA), Office of Technology Development and Deployment, U.S. Department of Transportation (DOT). The assistance and support throughout this study by Philip Mattson, Technical Monitor for TSC, is greatly appreciated.

This study was conducted with the concurrence and assistance of the Massachusetts Bay Transportation Authority (MBTA). The assistance of Francis Keville, Assistant Director of Construction-Northwest for the MBTA is acknowledged and appreciated.

The assistance of Jack Blanke of Bechtel for his contributions to the report, and Harry Sutcliffe, Manager of Bechtel's West Somerville, Massachusetts, office are greatly appreciated.

The authors would like to acknowledge with gratitude the organizations and personnel that contributed to the execution of the field investigations and evaluations:

Washington State University, College of Engineering,
Pullman, Washington; Nuclear Borehole Logging;

S.A. Alsup, Waban, Massachusetts; Seismic Borehole
Logging;

Guild Drilling Company, Inc., East Providence, Rhode
Island; Test Boring Contractor;

Geosystems, Inc., East Providence, Rhode Island; "ODEX"
Drilling Contractor;

Sprague & Henwood, Inc., Scranton, Pennsylvania; "ISM"
equipment supplier.

The final report could not have been produced without the very skillful efforts of graphic illustrator, Acey Welch, and senior typist, Marion Keegan, of Haley & Aldrich, Inc.

METRIC CONVERSION FACTORS

Approximate Conversions to Metric Measures				Approximate Conversions from Metric Measures			
Symbol	When You Know	Multiply by	To Find	Symbol	When You Know	Multiply by	To Find
LENGTH							
in	inches	2.5	centimeters	mm	millimeters	0.04	inches
ft	feet	30	centimeters	cm	centimeters	0.4	inches
yd	yards	0.9	meters	m	meters	3.3	feet
mi	miles	1.6	kilometers	km	kilometers	0.6	miles
AREA							
m ²	square inches	6.5	square centimeters	cm ²	square centimeters	0.16	square inches
ft ²	square feet	0.09	square meters	m ²	square meters	1.2	square yards
yd ²	square yards	0.8	square meters	km ²	square kilometers	0.4	square miles
mi ²	square miles	2.6	square kilometers	ha	hectares (10,000 m ²)	2.6	square miles
acres	acres	0.4	hectares				
MASS (weight)							
oz	ounces	28	grams	g	grams	0.035	ounces
lb	pounds	0.45	kilograms	kg	kilograms	2.2	pounds
	short tons (2000 lb)	0.9	tonnes	t	tonnes (1000 kg)	1.1	short tons
VOLUME							
teaspoons	teaspoons	5	milliliters	ml	milliliters	0.03	fluid ounces
tablespoons	tablespoons	15	milliliters	l	liters	2.1	pints
fl oz	fluid ounces	30	milliliters	l	liters	1.06	quarts
c	cups	0.24	liters	m ³	cubic meters	36	gallons
pt	pints	0.47	liters	m ³	cubic meters	1.3	cubic feet
qt	quarts	0.96	liters	m ³	cubic meters	1.3	cubic yards
gal	gallons	3.8	liters				
ft ³	cubic feet	0.03	cubic meters				
yd ³	cubic yards	0.76	cubic meters				
TEMPERATURE (exact)							
°F	Fahrenheit temperature	5/9 (after subtracting 32)	Celsius temperature	°C	Celsius temperature	9/5 (then add 32)	Fahrenheit temperature

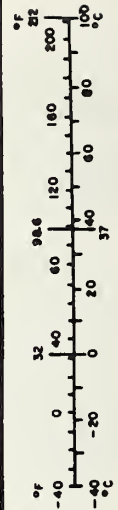
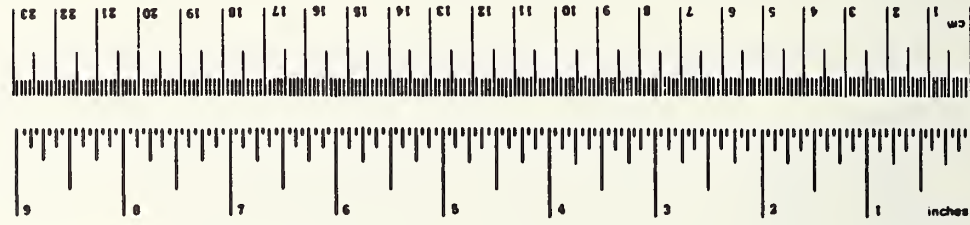

CONTENTS

<u>Section</u>		<u>Page</u>
1.	SUMMARY.....	1-1
	1.1 General	1-1
	1.2 Objectives.	1-1
	1.3 Results.....	1-3
	1.4 Conclusions.....	1-3
2.	INTRODUCTION	2-1
	2.1 General	2-1
	2.2 Purpose and Scope	2-3
3.	SOIL AND ROCK CHARACTERISTICS SIGNIFICANT IN TUNNELING	3-1
	3.1 Significant Soil and Rock Characteristics	3-1
	3.2 Timing for Maximum Benefit of Information	3-2
	3.3 Ranking of Significant Characteristics. .	3-2
4.	SITE CONDITIONS AND ALIGNMENT	4-1
	4.1 Horizontal Tunnel Alignment.	4-1
	4.2 Tunnel Cross Section	4-3
	4.3 Vertical Tunnel Alignment.	4-3
	4.4 Study Test Sections.	4-5
	4.4.1 Davis Square Site	4-5
	4.4.2 Holiday Inn Site.	4-7
5.	GEOLOGICAL ENVIRONMENT.	5-1
	5.1 Regional Geology	5-1
	5.1.1 General	5-1
	5.1.2 Bedrock	5-1
	5.1.3 Structure	5-3
	5.2 Site Geology	5-4
	5.2.1 Surficial Deposits.	5-4
	5.2.1.1 Miscellaneous Fill	5-4
	5.2.1.2 Outwash Sand and Gravel. .	5-5
	5.2.1.3 Marine Clay.	5-5
	5.2.1.4 Glacial Till	5-5

<u>Section</u>	<u>Page</u>
5.2.2 Bedrock and Structures	5-6
5.2.3 Groundwater	5-7
6. SUMMARY OF INVESTIGATIVE PROGRAMS	6-1
6.1 General.	6-1
6.2 Test Sections.	6-1
6.2.1 Holiday Inn Test Section.	6-1
6.2.2 Davis Square Test Section	6-5
6.3 Research and Literature Surveys.	6-5
6.4 Laboratory Soil and Rock Testing	6-7
7. FIELD EVALUATED EXPLORATORY PROCEDURES.	7-1
7.1 General.	7-1
7.2 Review of Test Boring Methods.	7-3
7.2.1 Borehole Advancement.	7-3
7.2.1.1 Displacement Boring.	7-4
7.2.1.2 Wash Boring.	7-4
7.2.1.3 Percussion Drilling.	7-4
7.2.1.4 Rotary Drilling.	7-5
7.2.1.5 Auger Borings.	7-5
7.2.1.6 Continuous Sampling.	7-5
7.2.2 Borehole Stabilization.	7-5
7.2.2.1 Water Stabilization.	7-6
7.2.2.2 Mud Stabilization.	7-6
7.2.2.3 Casing Stabilization	7-6
7.2.2.4 Grout Stabilization.	7-8
7.2.2.5 Freezing Stabilization	7-8
7.3 Project Test Boring Methods.	7-8
7.3.1 Standard Test Boring Methods.	7-9
7.3.2 ODEX TM Drilling	7-17

<u>Section</u>	<u>Page</u>
7.3.2.1	General 7-17
7.3.2.2	ODEX Systems 7-18
7.3.2.3	ODEX Application and Performance 7-22
7.4	Overburden Sampling 7-26
7.4.1	General 7-26
7.4.2	Drive Samples 7-27
7.4.3	Rotary Core Barrel Sampling 7-32
7.4.3.1	Denison TM Sampler 7-32
7.4.3.2	Pitcher TM Sampler 7-35
7.4.3.3	Diamond Bit Rotary Core Barrel Soil Sampling 7-38
7.5	Rock Core Sampling 7-42
7.5.1	NWD3 TM Double Tube Core Barrel 7-46
7.5.2	NWM3 TM Triple Tube Core Barrel 7-49
7.5.3	Integram Sampling Method (ISM) 7-51
7.5.3.1	The LNEC TM Integral Sampling Method 7-52
7.5.3.2	The CSIR TM Integral Sampling Method 7-55
7.5.3.3	Previous MBTA Red Line Extension Application. 7-57
7.5.3.4	Study Application. 7-58
7.5.3.5	Cost 7-67
7.6	Geophysical Borehole Logging 7-68
7.6.1	General 7-68
7.6.2	Nuclear Logging 7-70
7.6.2.1	Types of Nuclear Logs. 7-70
7.6.2.2	Field Procedures 7-72
7.6.2.3	Implementation Considera- tions. 7-75
7.6.2.4	Application in Tunneling 7-76
7.6.2.5	Cost 7-76
7.6.3	Electrical Logging. 7-77

<u>Section</u>	<u>Page</u>
7.6.3.1	Types of Electrical Logging 7-77
7.6.3.2	Field Procedures 7-79
7.6.3.3	Discussion of Results . . . 7-80
7.6.3.4	Implementation Considerations 7-82
7.6.3.5	Application in Tunneling . 7-83
7.6.3.6	Cost 7-83
7.6.4	Borehole Seismic Survey 7-83
7.6.4.1	General 7-83
7.6.4.2	Types of Surveys 7-84
7.6.4.3	Signal Enhancement 7-85
7.6.4.4	Equipment 7-86
7.6.4.5	Impulse Initiation 7-88
7.6.4.6	Field Procedure 7-89
7.6.4.7	Data Analysis 7-91
7.6.4.8	Implementation Considerations 7-95
7.6.4.9	Application to Tunneling . 7-97
7.6.4.10	Cost 7-99
7.7	In-Situ Testing 7-99
7.7.1	Borehole Permeability Testing . . . 7-101
7.7.2	Water Pressure Testing 7-101
7.7.3	Observation Wells and Piezometers . 7-104
7.8	Classification Systems and Laboratory Testing 7-107
7.8.1	Classification Systems 7-107
7.8.2	Classification Tests 7-109
7.8.2.1	Grain Size Analyses 7-109
7.8.2.2	Atterberg Limits 7-109
7.8.2.3	Moisture Content and Unit Weight 7-109
7.8.2.4	Petrographic Analysis . . . 7-110
7.8.3	Permeability Tests for Engineering Properties 7-110

<u>Section</u>	<u>Page</u>
8. RESEARCHED EXPLORATORY TECHNIQUES.	8-1
8.1 General	8-1
8.2 Horizontal Drilling	8-1
8.2.1 Horizontal Drilling Methods.	8-2
8.2.1.1 Diamond Wireline Drilling	8-2
8.2.1.2 Down-Hole Percussion Drilling.	8-3
8.2.1.3 Down-Hole Motor Drilling.	8-4
8.2.1.4 Rotary Drilling	8-5
8.2.2 Past Experience in Horizontal Drilling	8-5
8.2.2.1 U.S. Bureau of Mines.	8-6
8.2.2.2 Federal Highway Adminis- tration	8-7
8.2.3 Use and Limitations of the Horizontal Drilling System	8-7
8.2.4 Borehole Geophysical Methods	8-10
8.2.5 Conclusions.	8-11
8.3 Thermometric Surveys.	8-12
8.3.1 Survey Equipment and Procedures.	8-12
8.3.2 Illustrative Applications.	8-13
8.3.3 Implementation Considerations.	8-15
8.3.4 Possible Red Line Project Applications	8-15
8.3.5 Cost	8-16
8.4 Acoustic Explorations	8-16
8.4.1 Acoustic Borehole Logging.	8-16
8.4.1.1 Acoustic Velocity Logging Systems	8-17
8.4.1.2 Scanned Acoustic Holog- raphy	8-20
8.4.2 Acoustic Emission Monitoring	8-21
8.4.3 Acoustic Soundings	8-22

<u>Section</u>	<u>Page</u>
9. STRATIGRAPHIC EVALUATIONS.	9-1
9.1 General	9-1
9.2 Overburden Soils (Holiday Inn Site) . . .	9-3
9.2.1 Nuclear Correlations	9-4
9.2.2 Seismic Correlations	9-6
9.3 Bedrock (Holiday Inn Site).	9-7
9.3.1 Nuclear Correlations	9-10
9.3.2 Seismic Correlations	9-11
9.3.3 Structure.	9-12
9.3.3.1 Argillite	9-12
9.3.3.2 Diabase	9-15
9.4 Bedrock (Davis Square Site)	9-16
9.5 Groundwater	9-17
10. COST ANALYSIS.	10-1
10.1 General	10-1
10.2 Exploration Unit Prices	10-2
10.3 Test Boring Costs and Cost Distributions	10-2
10.4 ODEX TM Drilling	10-10
10.5 Integral Sampling Method (ISM) Drilling	10-11
10.6 Geophysical Surveys	10-11
10.6.1 Nuclear Logging	10-12
10.6.2 Seismic Survey.	10-13
10.6.3 Electrical Logging.	10-13
11. CONCLUSIONS.	11-1
11.1 General	11-1
11.2 Overburden Drilling	11-1
11.2.1 Conventional Drilling	11-1
11.2.2 ODEX TM Drilling	11-2
11.3 Overburden Sampling	11-3

<u>Section</u>	<u>Page</u>
11.3.1 Conventional Sampling	11-3
11.3.2 Denison TM Sampling	11-3
11.3.3 Pitcher TM Sampling	11-3
11.3.4 Diamond-Bit Rotary Core Barrel Sampling	11-4
11.4 Rock Sampling	11-4
11.4.1 Diamond Bit Rotary Core Barrel Sampling	11-4
11.4.1.1 Double Tube Solid Core Barrel	11-5
11.4.1.2 Double Tube Split Core Barrel	11-5
11.4.1.3 Triple Tube Core Barrel	11-5
11.4.2 Integral Sampling Method (ISM) . .	11-5
11.5 Geophysical Investigations	11-6
11.5.1 Nuclear Logging	11-6
11.5.2 Electric Logging	11-7
11.5.3 Signal Enhanced Seismic Velocity Surveys	11-7
11.6 Researched Exploratory Techniques	11-8
11.6.1 Horizontal Drilling	11-8
11.6.2 Thermometric Surveys	11-9
11.6.3 Acoustic Explorations	11-9
11.6.3.1 Acoustic Borehole Log- ging	11-10
11.6.3.2 Acoustic Emission Moni- toring	11-10
11.6.3.3 Acoustic Soundings . . .	11-10
11.7 Costs	11-10
APPENDIX A - GENERAL LEGEND AND NOTES	A-1
APPENDIX B - GEOLOGIC PROFILES	B-1
APPENDIX C - SUBSURFACE EXPLORATION SUMMARIES AND BOREHOLE NUCLEAR LOGGING SUMMARIES	C-1

<u>Section</u>	<u>Page</u>
APPENDIX D - ROCK CORE PHOTOGRAPHS.D-1
APPENDIX E - PETROGRAPHIC ANALYSIS.	E-1
APPENDIX F - SELECTED ELECTRIC LOGS	F-1
APPENDIX G - TYPICAL CROSSHOLE SEISMIC SIGNATURES	G-1
APPENDIX H - SEISMIC CROSSHOLE SECTIONS	H-1
APPENDIX I - LABORATORY PERMEABILITY TEST RESULTS	I-1
APPENDIX J - LABORATORY GRAIN SIZE DISTRIBUTION CURVES.	J-1
APPENDIX K - REPORT OF NEW TECHNOLOGY	K-1
APPENDIX L - BIBLIOGRAPHY	L-1

LIST OF ILLUSTRATIONS

<u>Figure</u>		<u>Page</u>
2-1	MBTA RED LINE EXTENSION NORTHWEST, PORTER SQUARE STATION PILOT TUNNEL.	2-4
4-1	MBTA RED LINE EXTENSION NORTHWEST AND STUDY TEST SECTIONS.	4-2
4-2	TYPICAL RED LINE TUNNEL SECTIONS	4-3
4-3	GENERALIZED SUBSURFACE PROFILE, HARVARD SQUARE TO DAVIS SQUARE.	4-4
4-4	DAVIS SQUARE SITE, SOMERVILLE, MASSACHUSETTS	4-6
4-5	HOLIDAY INN SITE, CAMBRIDGE, MASSACHUSETTS..	4-7
4-6	HOLIDAY INN SITE LOOKING SOUTH TOWARD HARVARD SQUARE	4-8
5-1	TECTONIC MAP OF BOSTON BASIN	5-2
5-2	ALTERED ARGILLITE WITH DIABASE INTRUSIONS .	5-6
6-1	SUBSURFACE EXPLORATION PLAN, HOLIDAY INN SITE, CAMBRIDGE, MASSACHUSETTS.	6-2
6-2	TYPICAL HIGH INTENSITY EXPLORATION INSTRUMENTATION PROFILE.	6-3
6-3	DOT/TSC FIELD EXPLORATION PROGRAM, MASSACHUSETTS AVENUE INBOUND LANE, HOLIDAY INN SITE. . . .	6-4
6-4	SUBSURFACE EXPLORATION PLAN, DAVIS SQUARE SITE, SOMERVILLE, MASSACHUSETTS.	6-6
7-1	GRENELLE DRILL RIG, 16TH CENTURY.	7-2
7-2	SERVCO TM MODEL 58WCB UNDERREAMER.	7-3
7-3	MIXING REVERT TM DRILLING FLUID ADDITIVE IN THE MUD RESERVOIR.	7-10

<u>Figure</u>	<u>Page</u>
7-4 CME-75 TM DRILL RIG	7-11
7-5 MOBILE B56 TM DRILL RIG.	7-11
7-6 STUDY DRILL BITS	7-14
7-7 INSTALLATION OF PVC GEOPHYSICAL/ INSTRUMENTATION CASING.	7-15
7-8 ODEX TM EQUIPPED "AIR TRACK" DRILL RIG ON BORING TSC 22	7-18
7-9 ODEX 76 TM BIT WITH EXTENDED REAMER.	7-19
7-10 ODEX BIT ADVANCING WITH ECCENTRIC REAMER EXTENDED AND CASING FOLLOWING.	7-20
7-11 ODEX BIT WITHDRAWN WITH ECCENTRIC REAMER RETRACTED.	7-20
7-12 CONVENTIONAL ROCK DRILLING IN ODEX BOREHOLE.	7-20
7-13 FOAM FLUSHING AGENT.	7-21
7-14 CHICAGO PNEUMATIC G900 TM EQUIPPED WITH ATLAS COPCO TM DOUBLE ACTING HAMMER.	7-23
7-15 ROTAIR 75 TM COMPRESSOR.	7-24
7-16 ODEX BIT PLUGGED BY THE MARINE CLAY.	7-25
7-17 "UNPLUGGING" THE ODEX BIT.	7-25
7-18 STATIONARY PISTON SAMPLER.	7-28
7-19 STANDARD SPLIT-SPOON SAMPLER.	7-29
7-20 AUTOMATIC FREE-FALLING TRIP WEIGHT.	7-30
7-21 DISASSEMBLED DENISON SAMPLER.	7-33
7-22 DENISON TM CORE BARREL.	7-34
7-23 DISASSEMBLED PITCHER TM SAMPLER.	7-35

<u>Figure</u>		<u>Page</u>
7-24	PITCHER TM SAMPLER WITH PROTRUDING SPRING- LOADED INNER SAMPLE TUBE	7-36
7-25	PITCHER TM SAMPLER OPERATION	7-37
7-26	PITCHER TM SAMPLER WITH CORED BOULDER JAMMED IN SAMPLE TUBE	7-38
7-27	SINGLE TUBE CORE BARREL.	7-40
7-28	DOUBLE TUBE CORE BARRELS.	7-40
7-29	GLACIAL TILL RECOVERED WITH NWD3 TM SPLIT INNER LINER CORE BARREL.	7-42
7-30	TYPICAL STUDY ROCK CORE SIZES.	7-46
7-31	NWD3 TM SPLIT INNER LINER CORE BARREL	7-47
7-32	FULL RECOVERY OF ARGILLITE IN NWD3 TM SPLIT LINER.	7-49
7-33	TRIPLE TUBE CORE BARREL WITH SOLID CLEAR PLASTIC LINER.	7-50
7-34	ISM PHASE I, RWT PILOT HOLE DRILLING AND STABILIZING ASSEMBLY.	7-53
7-35	ISM ORIENTING SIGHT ASSEMBLY.	7-54
7-36	ISM PHASE II, GRO TUBE AND STABILIZING ASSEMBLY.	7-54
7-37	ISM PHASE III, OVERCORING GROUT REINFORCED GRO TUBE.	7-55
7-38	CSIR RESIN CARTRIDGE AND REINFORCING PIPE ASSEMBLY.	7-56
7-39	HARVARD SQUARE ISM CORE.	7-57
7-40	SPRAGUE & HENWOOD HXWL TM TRIPLE TUBE SPLIT INNER LINER CORE BARREL.	7-59
7-41	HYDRAULIC REMOVAL OF SPLIT INNER LINER FROM HXWL CORE BARREL.	7-60

<u>Figure</u>	<u>Page</u>
7-42 ISM CORE BARRELS.	7-60
7-43 RWT CORE AND DESTROYED BIT.	7-61
7-44 DAVIS SQUARE ISM ROCK CORE.	7-62
7-45 ORIENTING THE ISM CORE.	7-63
7-46 DISASSEMBLED GRO TUBE SHOWING CONNECTION OF GRO TUBE TO ORIENTING RODS WITH SHEAR PIN.	7-63
7-47 ISM CORE RECOVERED WITH HXWL OVERCORE BARREL WITHOUT PROPER GROUT INJECTION.	7-64
7-48 ISM ROCK CORE.	7-65
7-49 GRO STABILIZING ASSEMBLY WITH SOLID GROUT/ REINFORCING TUBE	7-66
7-50 NUCLEAR LOGGING CONTROL PANEL, COMPUTER AND GRAPH RECORDER.	7-73
7-51 PREPARING FOR INSTALLATION OF NUCLEAR SONDES IN BOREHOLE.	7-73
7-52 DIGITAL RECORDING COMPUTER AND NUCLEAR LOGGING CONTROL PANEL.	7-74
7-53 ELECTRICAL LOGGING EFFECTS IN VARIABLE FORMATIONS.	7-78
7-54 SCHEMATIC DIAGRAM OF SINGLE POINT RESISTIVITY LOGGING TECHNIQUE.	7-79
7-55 MODEL 9245 "SUITCASE" ELECTRIC GEO-LOGGER TM UNIT.	7-80
7-56 SCHEMATIC OF ELECTRIC BOREHOLE LOGGER. . . .	7-81
7-57 ELECTRICAL BOREHOLE LOGGING.	7-81
7-58 SIGNAL ENHANCEMENT SEISMIC UNIT WITH BOREHOLE GEOPHONES.	7-87

<u>Figure</u>	<u>Page</u>
7-59 GEOMETRICS/NIMBUS INSTRUMENTS MODEL 1200 TM MULTIPLE CHANNEL SIGNAL ENHANCEMENT SEISMO- GRAPH.	7-88
7-60 PREPARING "SHOTHOLE" FOR CROSSHOLE SEISMIC SURVEY.	7-90
7-61 SEISMIC ARRAY PATTERNS, CROSSHOLE-UPHOLE SURVEY.	7-92
7-62 UTILIZING SIGNAL ENHANCEMENT TECHNIQUES FOR SURFACE SEISMIC REFRACTION SURVEY.	7-97
7-63 LIGHTWEIGHT AND PORTABLE SIGNAL ENHANCEMENT SEISMIC EQUIPMENT.	7-98
7-64 WATER PRESSURE TEST SURFACE EQUIPMENT.	7-102
7-65 SCHEMATIC DIAGRAM OF WATER PRESSURE TEST ASSEMBLY.	7-103
8-1 TYPICAL HORIZONTAL PENETRATION CAPABILITY...	8-9
8-2 SCHEMATICS OF TEMPERATURE LOGS.	8-13
8-3 TEMPERATURE LOGGING DURING ARTIFICIAL RECHARGE.	8-14
8-4 TYPICAL FIELD AND RECONSTRUCTED TEMPERATURE LOGS.	8-14
8-5 ACOUSTIC BOREHOLE LOGGER SHOWING COMPRESSION (P) AND SHEAR (S) WAVE PROPAGATION.	8-18
8-6 INTER-BOREHOLE ACOUSTIC VELOCITY LOGGING.	8-19
8-7 COMPONENTS USED FOR ACOUSTIC SOUNDING TECH- NIQUE.	8-23
9-1 SEISMIC UPHOLE DATA, BORING TSC 17, SERIES 4A.	9-7
9-2 BRECCIATED ARGILLITE WITH HIGH ANGLE JOINTS, DIABASE INTRUSIONS AND CALCITE VEINS.	9-8

<u>Figure</u>	<u>Page</u>
9-3 FRACTURED DIABASE WITH HEALED MACRO SHEARS AND SECONDARY MINERALIZATION.	9-9
9-4 STRUCTURAL DISCONTINUITIES, PORTER SQUARE PILOT TUNNEL.	9-13
9-5 ARGILLITE AND DIABASE WITH QUARTZ AND CALCITE MINERALIZATION.	9-14
10-1 COST DISTRIBUTION, TYPE A EXPLORATIONS. . .	10-6
10-2 COST DISTRIBUTION, TYPE B EXPLORATIONS. . .	10-7
10-3 COST DISTRIBUTION, TYPE C EXPLORATIONS. . .	10-8
10-4 COST DISTRIBUTION, TYPE D EXPLORATIONS. . .	10-9

LIST OF TABLES

<u>Table</u>		<u>Page</u>
1-1	COMPARATIVE SUMMARY OF STUDY EXPLORATORY METHODS	1-6
3-1	IMPORTANT SOIL AND ROCK CHARACTERISTICS.	3-4
7-1	CASING SIZES IN INCHES.	7-7
7-2	CORE BARREL AND BIT DIAMETERS.	7-44
7-3	GEOPHYSICAL BOREHOLE LOGGING TECHNIQUES AND CAPABILITIES.	7-69
7-4	PARAMETERS MEASURED BY VARIOUS DIRECT IN-SITU TESTING METHODS.	7-100
7-5	UNIFIED SOIL CLASSIFICATION SYSTEM.	7-108
9-1	SUMMARY OF GEOLOGICAL CONDITIONS.	9-2
9-2	SUMMARY OF WATER OBSERVATIONS IN FEET BELOW GROUND SURFACE.	9-18
10-1	SUMMARY OF EXPLORATION UNIT PRICES.	10-3
10-2	SUMMARY OF STUDY BOREHOLE COSTS.	10-5

LIST OF ABBREVIATIONS

ORGANIZATIONS

AAPG	- American Association of Petroleum Geologists
AASHTO	- American Association of State Highways and Transportation Officials
AEG	- Association of Engineering Geologists
AGS	- Australian Geomechanics Society
AICE	- American Institute of Chemical Engineers
AIME	- American Institute of Mining, Metallurgical and Petroleum Engineers
API	- American Petroleum Institute
ASCE	- American Society of Civil Engineers
ASTM	- American Society for Testing and Materials
BSCE	- Boston Society of Civil Engineers
CME	- Central Mine and Equipment Company
CSIR	- South African Council for Scientific and Industrial Research
DCDMA	- Diamond Core Drill Manufacturer's Association
ERDA	- Energy Research and Development Administration
FHWA	- Federal Highway Administration
GSC	- Geological Society of Canada
IAEA	- International Atomic Energy Agency
IAEG	- International Association of Engineering Geologists
IEEE	- Institute of Electrical and Electronics Engineering
IMM	- Institute of Mining and Metallurgy (London)
LNEC	- National Laboratory of Civil Engineering (Portugal)
MBTA	- Massachusetts Bay Transportation Authority
NARETC	- North American Rapid Excavation and Tunneling Conference
NSF	- National Science Foundation
SAICE	- South African Institute of Civil Engineers
S&H	- Sprague & Henwood, Inc.
SRI	- Southwest Research Institute
SME	- Society of Mining Engineers
TRB	- Transportation Research Board
TRRL	- Transportation and Road Research Laboratory (London)
TSC	- Transportation Systems Center
UMTA	- Urban Mass Transportation Administration
USAEC	- United States Atomic Energy Commission
USBM	- United States Bureau of Mines
USC&GS	- United States Coast and Geodetic Survey
USDOT	- United States Department of Transportation
USGS	- United States Geological Survey

EXPLORATION REFERENCES

DW	- Dewatering Well
I	- Inclinator
ISM	- Integral Sampling Method
N	- Number of Blows (Standard Penetration - Testing)
ODEX	- Pneumatic Percussive Casing Advancement Method
OW	- Observation Well
PZ	- Piezometer
RQD	- Rock Quality Designation
SPT	- Standard Penetration Test
SSPD	- Deep Settlement Point
SSPS	- Shallow Settlement Point
TSC8	- Study Exploration Numbers
TW	- Test Well

EXPLORATION EQUIPMENT

FC	- Flush Coupled Casing
FJ	- Flush Joint Casing
GRO	- Grout/Reinforcing/Orientating Tube
HXWL	- Sprague & Henwood Triple Tube Wire Line Core Barrel
NWD3	- Christensen Double Tube Core Barrel
NWM3	- Acker Triple Tube Core Barrel
PVC	- Polyvinyl Chloride Casing
RWT	- Sprague & Henwood Single Tube Core Barrel
XH	- Extra Heavy Duty Steel Casing

Tables 7-1 and 7-2 summarize DCDMA casing, core barrel and bit standard sizes and symbol designations.

GEOPHYSICAL SURVEYING

AM	- Americium
CM/SEC	- Centimeter Per Second
CVL	- Continuous Velocity Logger
FM	- Frequency Modulation
BE	- Beryllium
KHZ	- Kilohertz
GG	- Gamma-Gamma
NATG	- Natural Gamma
NG	- Neutron-Gamma
NN	- Neutron-Neutron

P	-	Compressional Wave
Pb	-	Lead
R	-	Resistivity
S	-	Shear Waves
SP	-	Spontaneous Potential

MISCELLANEOUS

BM	-	Bench Mark
CL	-	Center Line
ID	-	Inside Diameter
MSL	-	Mean Sea Level
ND	-	Not Determined
OD	-	Outside Diameter
RPM	-	Revolutions Per Minute
TM	-	Trademark or Brand Name

Refer to Appendix A, General Legend and Notes.

1. SUMMARY

1.1 GENERAL

The construction of new rail rapid transit systems and additions to existing systems has greatly increased the amount of tunneling performed in the United States. Since these transit systems are generally located in urban areas, tunneling is used to minimize the impact of the construction on the community.

Prior to construction, a thorough evaluation of the geotechnical parameters determined from the site investigation program must be accomplished during the selection of the tunnel alignment, to evaluate methods of construction, groundwater control, and temporary or permanent support structures. It is equally important that additional information be obtained on a continuing basis as the tunnel is constructed, so that knowledge of geotechnical parameters, ground performance and construction procedures may be continuously evaluated and refined.

A variety of advanced exploration techniques, geophysical procedures and instrumentation programs are available that can provide additional information from boreholes, as well as between the boreholes to effect more economical exploration programs. These procedures have the potential to reduce the uncertainties regarding the occurrence and physical properties of rock, soil and ground water between the boreholes. Although the opportunity for cost savings in the cycle of planning, design and construction has generally been applied to tunnel support and lining systems, and to a lesser extent to construction techniques, the optimization of the tunnel lining system and construction technique depends on the accuracy and the completeness of the subsurface exploration data. Therefore, increasing attention is being given to innovative exploration techniques.

1.2 OBJECTIVE

The objective of this study is to evaluate, through the use of a field demonstration project, the feasibility, applicability, reliability, and cost effectiveness of

selected advanced methods of subsurface exploration and instrumentation to produce data usable for rapid transit tunnel design and construction within the time, cost, and schedule constraints common to the industry.

The various exploration procedures selected for field evaluation may be grouped into two categories, "Direct" and "Indirect". "Direct" methods provide data relative to geotechnical parameters and stratigraphy from direct measurements made in the field. "Indirect" methods provide physical evidence of subsurface conditions but require correlations with known conditions through direct measurements. For example, most geophysical methods fall into the indirect category.

A test section on the Massachusetts Bay Transportation Authority (MBTA) Red Line Extension - Northwest, Cambridge, Massachusetts, was selected to evaluate direct and indirect methods of subsurface explorations used to investigate stratigraphy, ground water levels, bedrock structure, and other geotechnical parameters.

The majority of the exploration methods were employed at the location of mixed-face tunneling at a depth of approximately 100 feet below ground surface. Overburden soils consist primarily of a saturated, very dense, glacial till containing cobbles and boulders. The site represents a typical urban setting with the test section located under a major, four-lane divided street, with structures adjacent on both sides. The areas investigated will be excavated during construction of the tunnels to permit observation of actual stratigraphy and a comparison with predicted stratigraphy.

Because of the natural time lag between the investigation and construction, two stages of investigation are being pursued and reported. Stage I, (the subject of this report) entitled, "Field Evaluation of Advanced Methods of Subsurface Explorations for Transit Tunneling" includes an evaluation of various types of field explorations, geophysical measurements, in situ testing, and procedures necessary to predict probable subsurface conditions. Stage II, entitled, "Field Evaluation of Advanced Methods of Geotechnical Instrumentation and Monitoring for Transit Tunneling" will include an evaluation of geotechnical instrumentation procedures employed and geologic mapping necessary to evaluate the accuracy and applicability of predictions made during Stage I and to document the actual effects of tunneling on ground movements and ground water levels within the study area.

This study is being sponsored by the Transportation Systems Center (TSC) on behalf of the Office of Rail and Construction Technology of the Urban Mass Transportation Administration (UMTA), Office of Technology Development and Deployment, U.S. Department of Transportation (DOT).

1.3 RESULTS

Specific predictions of stratigraphy within the test section are summarized on the geological profiles in Appendix B and are discussed in Section 9 of this report. These predictions will be compared with actual stratigraphy encountered during tunnel driving.

Section 10 presents a summary and analysis of the exploration costs, and Section 11 presents conclusions with respect to the applicability and performance of various exploration methods.

Certain exploratory techniques, with merit but beyond the scope of this demonstration project, were researched and reviewed in detail, and a discussion is presented in Section 8 of the report. These methods include horizontal drilling, acoustical logging, and thermometric surveys.

1.4 CONCLUSIONS

A summary of the evaluation of various exploratory methods included in this study is provided in Table 1-1.

a. Standard Methods of Exploration:

Standard methods of exploration were used to obtain samples and identify stratigraphy for use as correlation to the advanced methods of exploration. Due to the difficulty in drilling and sampling of glacial till soils, an assessment was made of the effectiveness of the standard methods.

1. The selection of the most economical and satisfactory method of overburden drilling involves an evaluation of numerous boring advancement and stabilization techniques with consideration of the types of formations penetrated and the type of samples obtained. The selection of contractors to perform sophisticated exploratory methods should be based on contractor expertise, experience, and equipment capabilities.

2. The use of standard split-spoon drive samplers and the associated standard penetration test retained its position as the primary method of overburden sampling. Attempts at sampling glacial till soils with Denison and Pitcher samplers met with limited success due to the presence of cobbles and boulders in the till. However, the use of a diamond-bit rotary core barrel sampling of till soils was successful.
3. The use of double tube, swivel-type core barrels with split-inner liners and triple tube, swivel-type core barrels were considered most satisfactory for rock coring.

b. Advanced Methods of Exploration:

1. Nuclear geophysical logging was found to be rapidly and easily implemented in the urban environment. The nuclear logging information obtained supported the correlation explorations, in addition to further defining stratigraphy and local anomalies which were not detected by conventional exploration.
2. The signal enhanced seismic velocity logging successfully obtained clear unambiguous data. The use of a single electric blasting cap as an impulse source was found to be adequate for signal transmission up to 150 feet.
3. Electric borehole logging was difficult to accomplish due to the need to maintain a stable uncased borehole and the electrical interference present in an urban environment.
4. The Integral Sampling Method, a relatively expensive procedure, has demonstrated the ability to recover samples of oriented rock core in highly fractured formations. However, modifications are required for implementation in open-jointed rock.
5. The ODEXTM system has the capability to rapidly advance unsampled, cased boreholes in soils compatible with the equipment. The system was found to be incompatible with the fine-grained saturated soils in the test section. Noise levels were determined to be excessive for use in urban areas.

6. The researched advanced exploratory techniques of horizontal drilling, thermometric logging and acoustic exploration show positive potential for application as exploratory methods. The efforts and costs required to implement these methods are highest for horizontal drilling.
7. Until such time as equipment and procedures are developed to permit rapid and economic advancement of supplemental unsampled holes, all explorations in urban areas will continue to be advanced with appropriate sampling procedures. Under such circumstances, indirect borehole logging procedures such as many of the geophysical methods, must be justified based on their ability to detect minor anomalies between samples, or their ability to measure parameters which cannot be determined with other techniques.
8. The full potential and optimum use of many of the advanced geophysical logging techniques is intimately tied to the rapid and low cost advancement of unsampled holes between sampled holes. To permit more accurate extrapolation of stratigraphy based on indirect borehole geophysical methods, future emphasis must be placed on equipment capable of rapid, low cost, unsampled hole advancement.

TABLE 1-1. COMPARATIVE SUMMARY OF STUDY EXPLORATORY METHODS

	EXPLORATORY METHOD		URBAN APPLICABILITY	CURRENT USAGE ^(A)	AVAILABILITY OF METHOD ^(B)	VALUE ADDED IN EXPLORATION PROGRAM ^(C)	RELATIVE COSTS ^(D)
	DIRECT	INDIRECT					
<u>OVERBURDEN DRILLING</u>							
Cased Wash Boring	x		High	1	1	1	High
Uncased Mudded Boring	x		High	1	1	1	Medium
Continuous Sampled Boring	x		High	1	1	1	Medium
ODEX Drilling	x		Low	3	4	2	High
<u>OVERBURDEN SAMPLING</u>							
Split-Spoon Sampler	x		High	1	1	1	Low
Denison Sampler	x		High	1	1	3	High
Pitcher Sampler	x		High	1	1	3	High
Rotary Core Barrel	x		High	3	1	3,4	Medium
<u>ROCK SAMPLING</u>							
Single-Tube Barrel	x		High	3	1	7	Medium
Double-Tube Barrel	x		High	1	1	1	Medium
Double-Tube Split Barrel	x		High	1	1	3	Medium
Triple-Tube Split Barrel	x		High	2	1	3	Medium
Integral Sampling Method (ISM)	x		High	3	4	3	High
<u>IN-SITU TESTING</u>							
Permeability Tests	x		High	1	1	1	Low
Water Pressure Tests	x		High	1	1	1	Medium
Observation Wells	x		High	1	1	1	Low
Piezometers	x		High	1	1	1	High
<u>GEOPHYSICAL SURVEYS</u>							
Nuclear Logging		x	High to Medium	2	3	2,4,5,6	High
Electric Logging		x	Medium to Low	2	3	2,4,5,6	Medium
Signal/Enhanced Seismic Vel.- Downhole		x	High to Medium	2	3	2,4,5,6	High
Signal/Enhanced Seismic Vel.- Surface		x	Medium	2	3	2,4,5,6	Low
<u>RESEARCH EXPLORATORY TECHNIQUES</u>							
Horizontal Drilling	x		Medium	4	4	4,5	High
Thermometric Surveys		x	High	3	4	4,5,6	Medium
Acoustic Borehole Logging		x	Medium	3	4	4,5,6	High
Acoustic Emission Monitoring		x	Low	3	2	4,5,6	Low
Acoustic Sounding		x	Low	2	2	4,5,6	Medium

NOTES:

- (A) 1. High usage in exploration for transit tunneling.
2. Low usage in exploration for transit tunneling but medium to high usage in non-transit tunneling applications.
3. Low usage in exploration programs.
4. Low usage - underdevelopment.
- (B) 1. High availability.
2. High availability, requires specialized equipment.
3. Medium availability, requires specialty consultant and specialized equipment.
4. Low availability, requires specialty consultant and/or specialized equipment.
- (C) 1. Base method.
2. Improvement in rate of exploration.
3. Improvement in quality of samples obtained.
4. Provides increased continuity of data.
5. Provides confirmation of data obtained using other methods.
6. Provides new data.
7. Method of little value and generally should not be used.
- (D) Relative costs are compared within each category of exploration method, and also reflect necessary preparatory work prior to the implementation of the method. Any decision on exploration method should not be based solely on cost, but on obtaining the maximum information consistent with project objectives, subsurface conditions, and cost.

2. INTRODUCTION

2.1 GENERAL

The expansion of rapid rail transportation in urban areas throughout the United States has caused a careful examination of alternatives to surface transportation systems. Construction of rail systems in an urban environment, with surface space already limited due to existing development and the necessity to minimize impact on the community, has created increased demands on the use of underground space.

The use of underground space for rail transportation involves the below-grade construction of stations and interconnecting tunnels. The basis for the successful design and construction of these facilities is accurate information followed by sound decision making on alternatives such as alignment, construction methods, and physical design of tunnels, stations and appurtenant facilities. The acquisition of comprehensive subsurface information as early as possible in the planning and design process can do much to improve this decision making process.

With tunnel construction, the potential cost and schedule impact of variable subsurface conditions along the alignment are much greater than with surface construction. Therefore, improvements in data acquisition by using advanced and mutually supportive exploration techniques should result in cost effective improvements in planning, design and construction.

The construction costs associated with tunneling are largely dependent on the medium through which the tunnel is driven. The cost of the permanent structure itself may vary considerably, depending on the geological unit within which it is constructed. Most of the construction cost is incurred for shaft and tunnel excavation, temporary and permanent ground stabilization and support, utility relocation or support, and protection of existing structures.

Selection of ground support systems, optimization of excavation and construction processes, underpinning of structures, utility relocation, and other significant construction

cost items are influenced or dictated by data developed by the geotechnical exploration program.

It is of critical importance that the tunnel design engineer obtain as much detailed information as possible about the subsurface geological conditions prior to the actual tunnel construction. A thorough evaluation of the geotechnical parameters, determined from the site investigation program, must be accomplished during the selection of the tunnel alignment, to evaluate methods of construction, groundwater control, and temporary or permanent support structures. It is equally important that additional information be obtained on a continuing basis as the tunnel is constructed, so that knowledge of geotechnical parameters, ground performance and construction procedures may be continuously evaluated and refined.

The physical parameters which established the alignment of the tunnel in the first place, can also put severe limitations on the scope of a site investigation. It may be impossible to obtain subsurface information at certain locations due to topographical constraints or urban development.

Subsurface exploration methods and procedures may vary along the proposed alignment, depending on the geological conditions and environmental considerations which are encountered. Even with specialized equipment, there is a potential that representative in-situ samples cannot be obtained or are disturbed during the recovery process. The diameters of the exploratory boreholes are small, relative to the interborehole spacing; therefore, the subsurface conditions between the explorations are inferred and not specifically known. The interpretations of the geological conditions along the majority of the tunnel route are based on these limited explorations. Care must be exercised by the tunnel designer at this stage of design so that assumptions are not made which lead to additional expense and unwarranted hazards during the construction of the tunnel.

A variety of advanced exploration techniques, geophysical procedures and instrumentation techniques are available that can provide additional information from boreholes, and more economical exploration programs, as well as provide additional data between the boreholes. These procedures have the potential to reduce the uncertainties regarding the occurrence and physical properties of rock, soil and ground water between the boreholes. Many geophysical methods have been employed

successfully for a number of years in the oil and mineral exploration field, but have not gained wide acceptance on civil engineering projects.

A well-integrated subsurface exploration program, for an urban transit tunnel project (to minimize uncertainties and decrease potential liability) would include a detailed geological reconnaissance and a subsurface exploration program. The exploratory holes would be used for sampling, in-situ and laboratory testing, indirect geophysical surveys, and, finally, for the installation of monitoring instruments to record ground performance during tunnel construction. In addition, for areas of intense, complex or expensive construction activity, it might be necessary to employ more costly, site-specific investigations, such as horizontal alignment explorations, vertical inspection shafts, or pilot tunnels.

Thus, there are direct benefits in pre-tunneling subsurface investigations which maximize the use of state-of-the-art equipment, techniques and analysis.

2.2 PURPOSE AND SCOPE

The opportunity for cost savings in the design and construction of transit tunneling has generally been applied to tunnel support and lining systems, and, a lesser extent, to construction techniques. Optimization of the tunnel lining system and construction technique depends on the accuracy and completeness of subsurface exploration data. Therefore, increasing attention is being given to relatively new and advanced methods of exploration and monitoring techniques.

The United States Department of Transportation, through its modal elements, has sponsored several research studies on the subject of subsurface exploration and instrumentation methods applicable to tunneling projects. Although these studies provided excellent recommendations for new exploration methodologies and procedures, none had been thoroughly tested and evaluated under actual field conditions in association with a current transit tunneling project.

The Massachusetts Bay Transportation Authority (MBTA) is presently in the early stages of construction of an

extension of its Red Line subway system from Harvard Square Station to Alewife Brook Station in Cambridge, Massachusetts. This Northwest Extension project is a 3.1 mile addition to the MBTA's existing network of 120 miles of rapid transit lines which serve the greater metropolitan Boston area. The proposed tunnel construction presents an excellent opportunity to fully evaluate the more promising advanced techniques and equipment for subsurface exploration and instrumentation from inception to conclusion of transit tunnel construction (Figure 2-1).



FIGURE 2-1. MBTA RED LINE EXTENSION NORTHWEST,
PORTER SQUARE STATION PILOT TUNNEL

This field demonstration project was conceived and executed with the following objectives in mind:

a. To employ selected procedures for borings, soil and rock sampling, in-situ testing, geophysical methods, and construction monitoring on an on-going transit tunnel project.

b. To evaluate the feasibility, applicability, reliability and cost effectiveness of the selected exploration and instrumentation techniques.

c. To use the selected techniques to define the real and relevant geotechnical unknowns in a test section or at specific test points along the route of the MBTA Red Line Extension.

d. To evaluate the accuracy of the geotechnical predictions with appropriate field instrumentation and monitoring and geologic mapping during construction.

e. To evaluate the performance and reliability of selected items of geotechnical instrumentation installed for the project.

f. To demonstrate the effectiveness of instrumentation and monitoring during construction in documenting the effects of tunneling on adjacent structures.

g. To provide data during construction for use by designers and contractors which can be employed to evaluate tunneling procedures and their effects on ground deformations so that modifications could be employed in critical areas.

h. To provide, in report form, a document that assesses the feasibility, applicability, reliability, and cost effectiveness of the exploration and instrumentation methods applied to this tunnel beyond those methods and instruments traditionally employed in projects of this type, the report to serve as a reference for other tunnel designers and geotechnical consultants.

Certain worthwhile exploratory techniques beyond the scope of this demonstration project were researched and reviewed in detail, and a discussion presented in the text of the report. These methods include horizontal drilling, acoustical logging, and thermometric surveys.

Two stages of investigation are pursued and reported. Stage I, entitled, "Field Evaluation of Advanced Methods of Subsurface Explorations for Transit Tunneling" includes an evaluation of various types of field explorations, geophysical measurements, in-situ testing, and procedures necessary to predict probable subsurface conditions. This report documents Stage I investigations.

Stage II, entitled, "Field Evaluation of Advanced Methods of Geotechnical Instrumentation and Monitoring for Transit Tunneling" will include an evaluation of geotechnical instrumentation procedures employed and geologic mapping necessary to evaluate the accuracy and applicability of predictions made during Stage I and to document the actual effects of tunneling on ground movements and groundwater levels within the study area. Stage II investigations will be documented in a future report.

3. SOIL AND ROCK CHARACTERISTICS SIGNIFICANT IN TUNNELING

3.1 SIGNIFICANT SOIL AND ROCK CHARACTERISTICS

Identification of significant soil and rock characteristics is essential in order to safely and economically design and construct a tunnel. Design operations such as selecting horizontal and vertical alignment; temporary and final ground support systems; certain contract specified construction methods like use of compressed air and control of groundwater; and establishing the zone of influence due to tunneling and the corresponding criteria for determining building protection measures, all require knowledge of subsurface characteristics. In addition, the construction contractor must be provided with information on subsurface characteristics he can readily understand and use. This information is needed in order to plan his construction schedule, to select appropriate tunneling methods and equipment, and to establish procedures for control of the ground and protection of third-party property.

In order for any soil or rock characteristic to be significant in design or construction, it must first relate to a problem that must be solved for a particular tunneling project. For example, establishing the zone of influence of tunneling may not be required in unpopulated areas. Also, the soil and rock characteristics must be determined with sufficient accuracy, in consideration of material and spatial variations, to make the solution of the problem valid and realistic.

Heuer (14-22) describes some typical tunneling problems, all of which involve a knowledge of the subsurface conditions in their solution. As an illustration, and in no way implying that these are the only problems that must be considered, some of these problems are:

- a. Excavation:
 - 1. Standup time
 - 2. Face conditions
 - 3. Quantity of water

- b. Support of Excavation:
 - 1. Ground loads
 - 2. Design load on tunnel support

- c. Environmental Impact:
 - 1. Subsurface subsidence
 - 2. Building protection
 - 3. Health and safety
- d. Long-Term Tunnel Performance

3.2 TIMING FOR MAXIMUM BENEFIT OF INFORMATION

The solution to these problems involves making decisions. Schmidt (13-16) has described some of the typical decisions, and the time when these decisions need to be made in the sequence of design and construction. Decisions such as line and grade, tunnel versus cut-and-cover type construction, and policies on support systems, building and utility protection, and general construction techniques are made early in the project planning and feasibility stage. Subsurface information available at this stage may not be complete enough, due to a variety of reasons, to adequately represent ground conditions for use in sound decision making. Therefore, soil and rock characteristics, in addition to being important to the solution of a needed problem and being measurable, must also be determined with sufficient confidence at the time they are required for decision making. Too often, studies are made and decisions are finalized on alignment before a clear understanding is available to determine the impact on the community due to tunneling through the materials below the surface of the ground.

Soil and rock characteristics deemed significant to tunneling must be:

- a. Important to the solution of a problem;
- b. Measurable;
- c. Determined at a time needed for decision making.

3.3 RANKING OF SIGNIFICANT CHARACTERISTICS

Several authors, Underwood (13-20), Merritt (8-22), Schmidt (13-16), Peck (14-34) and others, have defined soil and rock characteristics important to tunneling and underground excavation. Schmidt, et al. (8-33) have subjectively ranked the characteristics for soft ground tunneling into a set of priorities. Adding important rock characteristics

to this ranking results in the listing of priorities shown in Table 3-1. This table does not imply that "Priority C" items are unimportant to design or construction, but only that concentration of resources should usually be made on higher ranking characteristics.

In establishing exploration programs, the guiding principle should be to maximize the amount of significant data. If careful attention to the objectives of the exploration program is made, the characteristics needed for decision making can be established and the exploration program tailored to help in providing them.

TABLE 3-1. IMPORTANT SOIL AND ROCK CHARACTERISTICS

PRIORITY A:**	
<u>SOIL</u>	<ul style="list-style-type: none">● Stratigraphy (including groundwater level)● Permeability● Rock surface● Obstructions, man-made or natural● Cohesion of granular soils
<u>ROCK</u>	<ul style="list-style-type: none">● General rock quality● Groundwater● Permeability
PRIORITY B:	
<u>SOIL</u>	<ul style="list-style-type: none">● Shear strength of cohesive soil (undrained)● Water pressure● Modulus, short term● Soil classification, in general
<u>ROCK</u>	<ul style="list-style-type: none">● Rock weathering● Orientation of major planes of weakness
PRIORITY C:	
<u>SOIL</u>	<ul style="list-style-type: none">● Modulus, long term (consolidation characteristics)● Water chemistry● Stress state (at rest pressure)● Gases
<u>ROCK</u>	<ul style="list-style-type: none">● Lithology and hardness● In-situ rock stress● Gases

**First Priority Characteristics

4. SITE CONDITIONS AND ALIGNMENT

4.1 HORIZONTAL TUNNEL ALIGNMENT

The Massachusetts Bay Transportation Authority (MBTA) Red Line Extension Northwest is a continuation of the original Boston Elevated Railroad, Cambridge Main Street Subway, which was completed in 1912, employing cut-and-cover construction techniques.

The Northwest Extension project, shown in Figure 4-1, will extend from the reconstructed Harvard Square Station to new stations at Porter Square, Cambridge and Davis Square, Somerville, and terminate at the new Alewife Brook Station in North Cambridge, Massachusetts, a distance of approximately 3.1 miles.

Much of the original topography along the alignment has been altered over the years and completely masked by heavy commercial and residential development.

Although ground surface varies from elevation 145 to 126 (MBTA Red Line Datum is 105.87 ft. below United States Coast and Geodetic Survey [USC&GS] Mean Sea Level 1929), the area along the alignment is relatively flat with abrupt topographic changes due to depressed railroad right-of-ways.

The portion of the tunnel alignment between Harvard and Porter Squares generally follows Massachusetts Avenue for its entire length of approximately 4,400 ft. Massachusetts Avenue is a heavily traveled, major artery which is bordered by academic, commercial, religious and residential structures varying from one to six stories in height. In addition, numerous surface and subsurface utility systems line the Avenue.

The alignment passes beneath a depressed section of the Boston & Maine Railroad in Porter Square and proceeds cross-country beneath numerous two and three-story wood frame residential dwellings into Davis Square, Somerville. The length of the alignment between Porter Square and Davis Square is approximately 2,900 ft.

Davis Square is a heavily developed and traveled shopping area with a major Boston & Maine Railroad line crossing above the proposed station area. The alignment leaves the

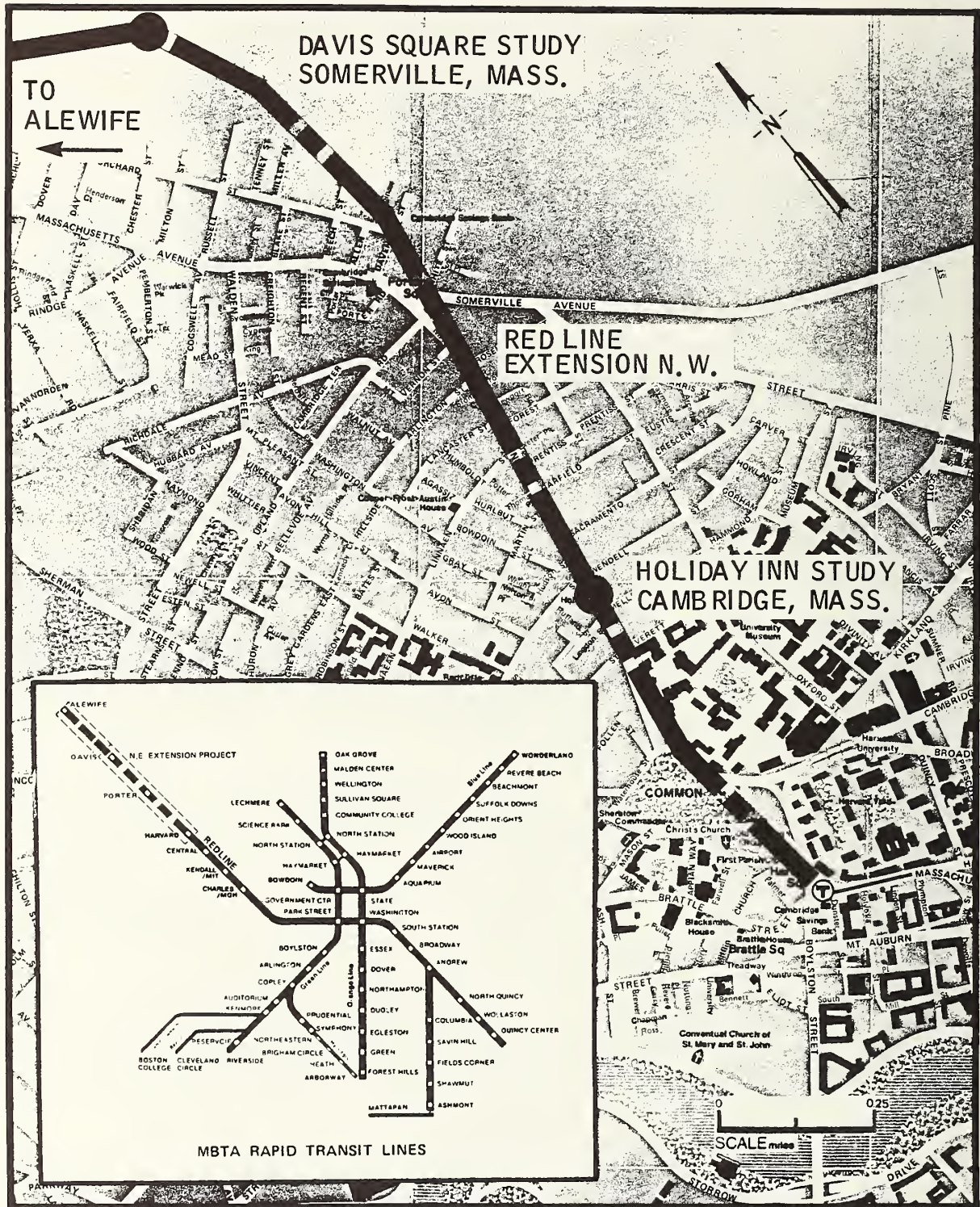

FIGURE 4-1. MBTA RED LINE EXTENSION NORTHWEST AND STUDY TEST SECTIONS

Davis Square Station through a cut-and-cover section towards Alewife Brook Station.

4.2 TUNNEL CROSS SECTION

The Northwest Extension project will consist of twin single-track tunnels which will connect cut-and-cover stations at Harvard and Davis Squares with a mined underground station at Porter Square.

The tunnel configuration for soil and rock conditions is shown in Figure 4-2, with the inside diameter of 19.2 feet selected for the minimum clearance envelope. Ventilation shafts are located periodically along the alignment, serving initially as construction access shafts and, later during operation, as ventilation and emergency exit shafts.

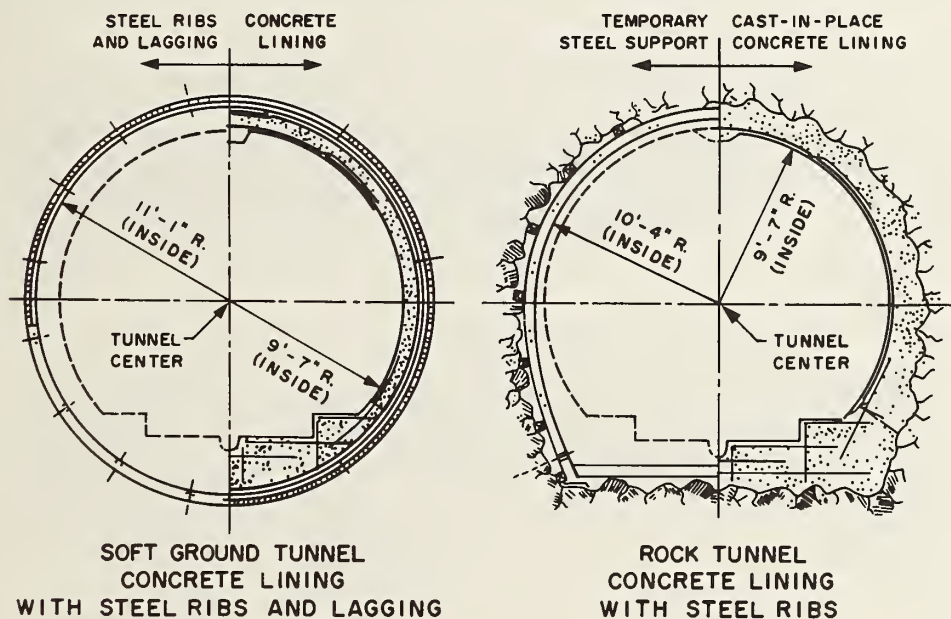

FIGURE 4-2. TYPICAL RED LINE TUNNEL SECTIONS

4.3 VERTICAL TUNNEL ALIGNMENT

The information obtained from widely spaced reconnaissance borings drilled in 1976 indicated that a major revision

in the vertical alignment would minimize potential surface impact and reduce construction costs. In some instances, the original tunnel crown came in close proximity to residential basements and water-bearing sands, and mixed-face conditions presented the potential for excessive ground surface settlement.

Additional subsurface explorations and geophysical surveys were conducted during 1977 and 1978. Based on this information, it was determined that a deeper vertical alignment would improve tunnel stability during construction and decrease potential hazards and overall costs. In addition, the lowering of the vertical alignment would also decrease the potential for disturbing existing utility systems and structures along the alignment.

The final design elevation of the vertical tunnel alignment between Harvard Square and Davis Square is shown on the generalized subsurface profile, Figure 4-3.

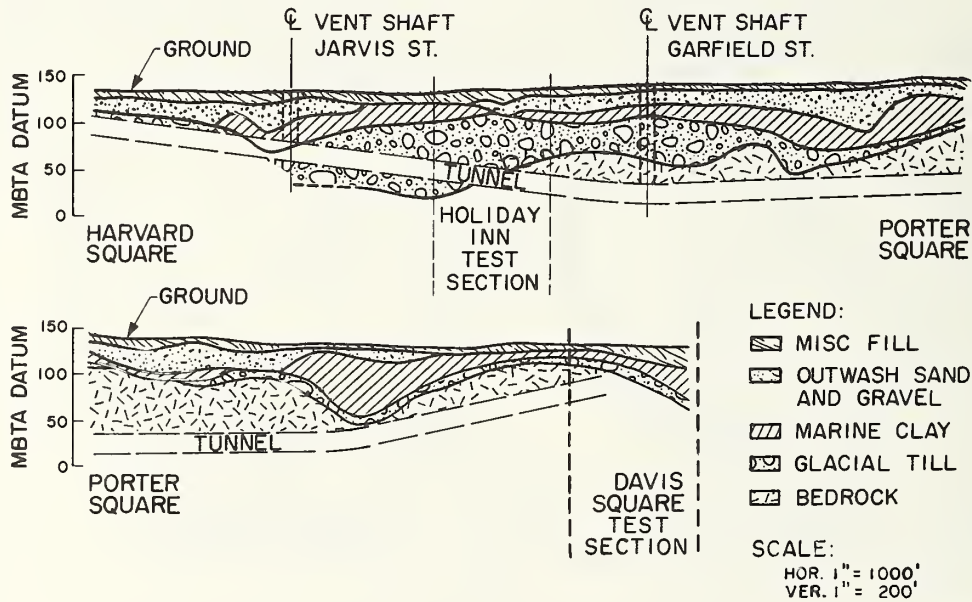

FIGURE 4-3. GENERALIZED SUBSURFACE PROFILE, HARVARD SQUARE TO DAVIS SQUARE

4.4 STUDY TEST SECTIONS

As in any subsurface investigation, the geotechnical parameters which will effect the design and construction of an underground opening must be thoroughly investigated and evaluated. The selection of a test section or sections to be used for this study began with an evaluation of existing data along the alignment.

The subsurface information obtained by Bechtel Incorporated, and submitted to the MBTA in various geotechnical reports for the Red Line Extension, was evaluated in order to determine the best locations for meeting the study objectives.

In order to satisfy the basic intent of this study, to evaluate advanced methods of subsurface explorations and geotechnical instrumentation for transit tunneling, areas with maximum geotechnical variability were sought. In addition, surface accessibility, pedestrian and vehicular traffic, and environmental considerations were also part of the selection process.

Based on the lowered vertical tunnel alignment adopted for construction, two potential test sites were considered. Two portions of the Harvard to Davis Square tunnels will be driven in "mixed-face" conditions; that is, partially in soil and partially in rock. In these sections, the definition of stratigraphy and other geotechnical parameters is of particular practical importance.

One of the mixed-face areas occurs near Davis Square, Somerville, referred to hereinafter as the "Davis Square Site". The second mixed-face area occurs beneath Massachusetts Avenue in Cambridge, opposite a Holiday Inn Motor Lodge, referred to hereinafter as the "Holiday Inn Site". Both sites offered similar geological conditions but varied considerably in their logistical and environmental considerations.

4.4.1 Davis Square Site

The Davis Square site is located in the vicinity of tunnel stations 260 to 264, just east of the proposed Davis Square Station, Somerville, where the deep bore tunnel alignment rises to meet the cut-and-cover station construction.

The site area occupies the majority of an 82.5 ft. wide, Boston & Maine Railroad right-of-way. Numerous two and three-story commercial and residential structures having shallow, soil bearing foundations abut and, in some instances, encroach onto railroad property (Figure 4-4).



FIGURE 4-4. DAVIS SQUARE SITE
SOMERVILLE, MASSACHUSETTS

As the test site would be divided by the active railroad tracks and protective fence, the conducting and future monitoring of the field work would be difficult, especially during the geophysical phases. In addition, several buildings within the test section prevented access to key areas of the mixed-face portion of the alignment. Other locations were designated as contractor staging areas for the proposed station construction. The longevity of any instrumentation installed in these areas would be questionable.

Due to these limitations, it was decided that the Davis Square Site would be eliminated as a potential test area. However, as a portion of the cut-and-cover Davis Square Station would require excavation and temporary support of a poor quality bedrock, it was decided to conduct the Integral Rock Sampling (ISM) phase of the study in the proposed station area. A public parking area provided the necessary access

to the selected ISM test site in the vicinity of Station 266+64 outbound.

4.4.2 Holiday Inn Site

The Holiday Inn Site is located in the vicinity of tunnel station 203 and 206, beneath Massachusetts Avenue in Cambridge, approximately 3/4 mile north of Harvard Square. The 300-ft. test section is occupied by a heavily traveled, major, four-lane artery. Commercial and residential structures varying from one to six stories in height, which are supported on shallow, soil bearing foundations, abut both sides of Massachusetts Avenue. A large in-ground concrete swimming pool at the Holiday Inn is approximately twelve feet from the edge of the proposed outbound tunnel. Numerous surface and subsurface utilities line the avenue, and pedestrian traffic in the area is exceptionally heavy. Although the site area imposed some surface access restrictions, it is considered to be representative of transit tunneling in an urban area and was, therefore, selected as the location of the primary test section (Figure 4-5).



FIGURE 4-5. HOLIDAY INN SITE, CAMBRIDGE, MASSACHUSETTS

The geological conditions, environmental considerations, engineering and construction parameters are considered to be comprehensive at the Holiday Inn site. The rapidly dipping bedrock surface would allow the detailed investigations of this study to be conducted within the 300-ft. long, mixed-face area. All three tunneling conditions (soil, mixed-face and bedrock) are anticipated to be encountered within the site area. In addition, a highly intruded bedrock complex, glacial till, and two water table conditions combine to require a high degree of engineering and construction expertise to construct the tunnels along this section of the alignment.

The Holiday Inn site was approved by the Transportation Systems Center as the prime study area, and field work commenced on 29 March 1979 (Figure 4-6).



FIGURE 4-6. HOLIDAY INN SITE LOOKING SOUTH TOWARD HARVARD SQUARE

5. GEOLOGICAL ENVIRONMENT

5.1 REGIONAL GEOLOGY

5.1.1 General

The project is within the New England Physiographic Province of the Appalachian Highlands. This province is characterized by hilly uplands, but is locally mountainous and exhibits an irregular, rocky coast. Topography is commonly structurally controlled. The majority of the province is underlain by metamorphosed rocks. Unmetamorphosed to slightly metamorphosed Paleozoic rocks constitute most of the Boston Basin, where the project is located. Ridges of Precambrian gneiss and granite are found to the southwest.

The entire province was subjected to glaciation during the Pleistocene Epoch. Thick deposits of till and outwash sand and gravel were deposited throughout the area. Glacial features such as drumlins are common.

The project is located in the northern portion of the Boston Basin, a structural, as well as topographic, depression which is filled with late Paleozoic rocks covered by Pleistocene glacial and post-glacial deposits. The northern and southern boundaries of the basin are marked by fault escarpments, but the western limit is not well defined topographically or geologically. The eastern boundary is submerged beneath the ocean (Figure 5-1).

5.1.2 Bedrock

The Boston Bay Group is the major stratigraphic sequence occurring in the portion of the basin where the project is located. This group has been divided into the Cambridge Argillite (upper unit) and the Roxbury Conglomerate (lower unit). The Cambridge Argillite is a shale that is locally weakly metamorphosed, with reworked tuffaceous material found throughout. The sediments that formed the Cambridge Argillite were fresh water deposits.

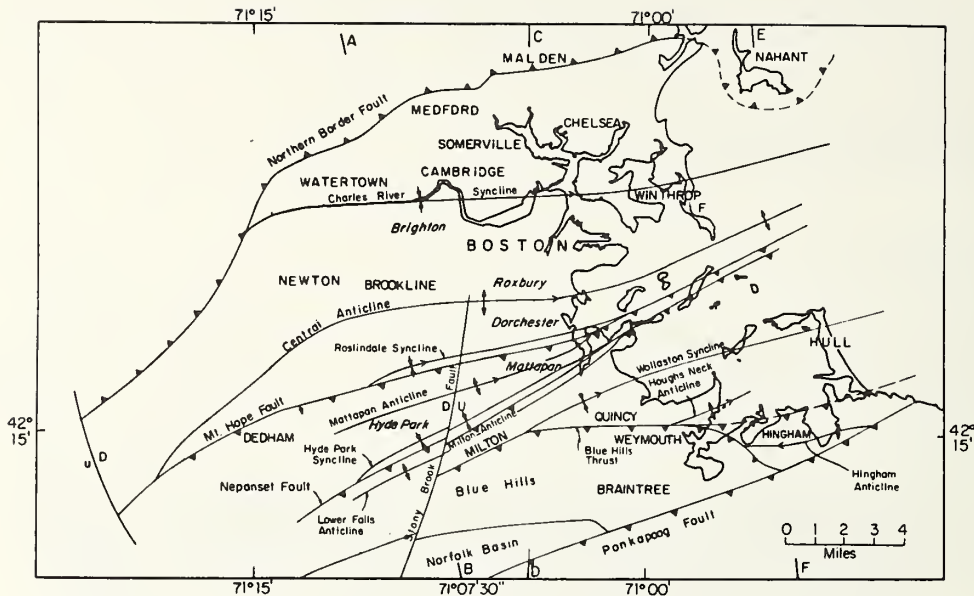

FIGURE 5-1. TECTONIC MAP OF BOSTON BASIN
BILLINGS (19-2)

The Cambridge Argillite is generally gray in color, fine grained and composed mainly of clay and silt-sized particles although sand-size particles are evident in the upper part. Light and dark banding, due to the effects of seasonal variation during deposition is also evident. The Cambridge Argillite reaches an estimated thickness of 17,000 feet in the northern part of the basin. Igneous dikes occur frequently throughout the formation.

The age of the Cambridge Argillite is not definitely known due to the lack of fossils; however, the formation is believed to be late Paleozoic. Alteration of minerals in the Cambridge Argillite to the soft clay mineral, kaolinite, is known to have occurred in the Boston Basin. Historically, kaolinized rock has posed a construction problem to engineered structures in the Boston Basin because of its low strength. It is not known whether the kaolinized rock has resulted from surface exposure during preglacial time, or from the hydrothermal alteration by hot solutions or gasses emitted during intrusion of the igneous rock. Regionally, the kaolinized rock has been encountered both at the bedrock surface and at depths well below the bedrock surface. Distribution of the kaolinite is unknown and occurrence of kaolinized rock cannot be predicted.

Light greenish-gray beds of volcanic tuff occur within the argillite. Although the material comprising these rocks is igneous in origin, the rocks are essentially sedimentary because the igneous materials were probably deposited directly into a body of water, or into streams which carried them to a quiet water environment. Where a small quantity of volcanic ash was deposited with the other sediments, the rocks are classified as "tuffaceous" to designate their mixed composition. The thickness of the tuff beds ranges from a few inches to tens of feet.

Dikes, composed of igneous rocks such as dacite, felsite, diabase, basalt, and alterations thereof, are found throughout the Boston Basin. Regionally, the dikes are known to vary in size, form, structure, and degree of weathering. They range in thickness from a few inches to more than 500 feet, and range in length from a few feet to several miles.

5.1.3 Structure

The project is located on the north limb of the Charles River Syncline, a regional bedrock structure which trends nearly east-west (Figure 5-1). The rock strata dips gently south with local variations in dip due to minor folding along the flank. Slaty cleavage, though known to be present in portions of the argillite, is not common and is distinctly limited in occurrence.

Faulting is one of the most common structural elements in the Boston Basin, and may be encountered anywhere within the basin. Known faults on the north limb of the Charles River Syncline show a broad range of orientation. The most common strikes of basin faults are north, northwest, and east. Numerous dikes penetrate the Cambridge Argillite. Most of the dikes and related intruded rocks dip steeply and have preferred strikes of north-northeast and east. Faulting of the dikes is common and many dikes were tilted and warped during deformation of the surrounding rocks.

Major faults have been postulated, based on an interpretation of the geologic structure, and are believed to be thrust faults sub-parallel to the main structure which trends east-west. The minor faults are generally younger, normal faults. These faults regionally occur parallel to joints and along dikes. Although the strike of the minor faults is quite variable, the most common strike is north-northwest. Regionally, the minor faults are narrow zones ranging from tight fractures to zones 3 feet wide and characterized in some cases by slickensides, gouge, and breccia. The dip is generally steep. Large regional faults are not known to cross the tunnel alignment, although minor faulting can be expected anywhere along the alignment.

5.2 SITE GEOLOGY

5.2.1 Surficial Deposits

Surficial deposits at the Holiday Inn study area consist of a thin layer of fill overlying a sequence of Pleistocene glacial and post-glacial deposits which rest upon the bedrock surface. Based on the geologic origin and the characteristics of the soils encountered, the surficial materials have been divided into four (4) principal strata overlying the bedrock. In order of increasing depth from ground surface, they are:

- a. Miscellaneous Fill
- b. Outwash Sand and Gravel
- c. Marine Clay
- d. Glacial Till

Figure 4-3 shows the general geology along Massachusetts Avenue between Harvard Square and Davis Square, which includes the Holiday Inn test section.

A general description of the characteristics and depths of the soil strata follows. A more detailed description of the soils and rock as determined from the study explorations is presented in Section 9. General bedrock characteristics are discussed in Section 5.2.2.

5.2.1.1 Miscellaneous Fill - Miscellaneous fill materials are present in varying thicknesses throughout the test section. The fill generally consists of silty fine to coarse sand with varying amounts of gravel, clay, organic materials and man-made materials such as bricks, concrete and asphalt. These materials are classified as one layer and are not subdivided, due to their highly variable nature.

The thickness of the fill stratum within the test section averages about 3 feet, varying to a maximum recorded thickness of about 6 feet. Fill material of varying composition and thickness is also present adjacent to buildings and retaining structures along the alignment, and in areas of underground utilities.

The density of the fill material within the test section ranges from medium-dense to dense. The corresponding range of penetration resistance is from 14 to 45 blows per foot, with the higher penetration resistances probably due to the presence of gravel and/or rubble materials.

Surfacing materials of asphalt and concrete, varying from 3 to 24 inches in thickness, exist throughout the test section.

5.2.1.2 Outwash Sand and Gravel - Underlying the miscellaneous fill is a stratum of medium to very dense brown sand, gravelly sand and silty sand. These deposits originated as glacial outwash deposited toward the end of the last glacial period (Lexington Substage). The thickness of the deposit is variable, averaging about 9 feet, with a maximum thickness of about 15 feet.

The density of the outwash sand and gravel varies widely with standard penetration resistance ranging from 14 to 55 blows per foot. The average standard penetration resistance in the stratum is in the range of 30 to 40 blows per foot.

5.2.1.3 Marine Clay - Underlying the outwash sand and gravel is a deposit of marine clay which contains varying proportions of silt and sand. The upper portion of the stratum consists of very stiff to hard interbedded gray clay, silt and fine sand. The lower portion of the stratum is a more homogeneous deposit of medium stiff to very stiff gray clay with occasional layers of fine sand and is moderately overconsolidated.

The thickness of the marine clay stratum ranges up to a maximum of 18 feet, with an average thickness of approximately 8 feet.

Standard penetration test results average about 20 to 30 blows per foot in the upper portion of the stratum, and 10 to 20 blows per foot in the less overconsolidated lower portion of the stratum.

5.2.1.4 Glacial Till - A relatively thick deposit of glacial till underlies the marine clay and constitutes the tunneling medium in areas of soft ground. The till generally consists of dense to very dense, silty, fine to coarse sand with varying amounts of clay, gravel, cobbles, boulders, and rock fragments of argillite and granite. The stratum was deposited directly over the bedrock surface in thicknesses varying from 51 to 83 feet within the test section.

The density of the glacial till ranges from dense to very dense with standard penetration resistance ranging from 45 to over 400 blows per foot. The average standard penetration resistance is over 150 blows per foot. Cobbles and boulders were encountered throughout the glacial till.

5.2.2 Bedrock and Structure

The principal rock type in the section is argillite. Argillite is defined as a rock formed from a claystone, siltstone, or shale, but has undergone a somewhat higher degree of induration. By definition, argillite does not exhibit the fossility or cleavage characteristics of shale or slate. However, localized occurrences of fossility are known to exist in the Boston Basin. The rock is generally gray in color with alternating light and dark gray beds. The lighter colored beds are usually formed of silt or fine sand, and the darker beds are formed from clay or fine silt. Thick sequences of siltstone or sandstone may occur anywhere within the argillite.

Within the test section, the argillite is altered and is light grayish-green to greenish-gray. The alteration is apparently caused by the intrusion of large igneous dikes, consisting primarily of diabase. These dikes have also caused extensive local fracturing (Figure 5-2). A major diabase dike, estimated to be approximately 140 feet in the horizontal dimension, was encountered within the test area. Additional details regarding the bedrock type and structure are summarized in Section 9.

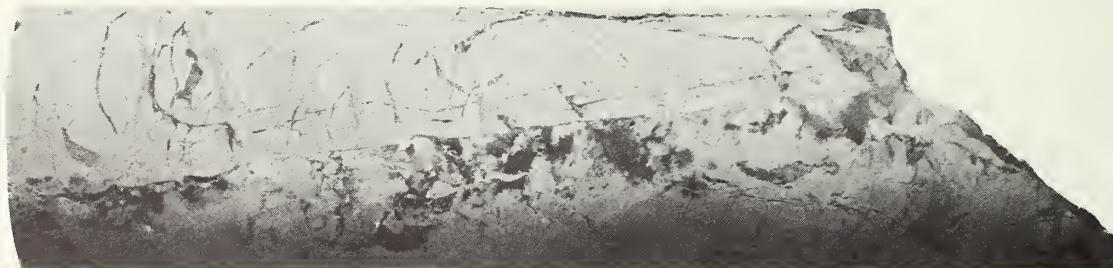

FIGURE 5-2. ALTERED ARGILLITE WITH DIABASE INTRUSIONS

The Red Line Extension tunnel alignment trends in a north-south direction approximately perpendicular to the axis of the Charles River Syncline. The project is located on the north flank of the syncline. The dip of the strata at this location is to the south.

An important feature to note is the presence of planes of weakness or separation along which the rock either has been broken by past geological forces or along which it is likely to break during tunnel excavation. These planes of weakness are controlled by relic bedding, jointing, faulting

and foliation. Structural characteristics, as well as other detailed properties revealed by the exploratory program, are described in the Subsurface Exploration Summaries in Appendix C.

5.2.3 Ground Water

The principal water bearing materials are the outwash sand and gravel and the zone along the bedrock/glacial till interface. The marine clay and glacial till together comprise an aquiclude between the overlying outwash sand and gravel and underlying bedrock/glacial till interface, resulting in two relatively independent water bearing zones.

The ground water in the outwash and gravel stratum is under water table conditions. However, it is probably not in direct hydraulic communication with the ground water at the bedrock/glacial till interface zone. The normal depth to the water table in the outwash sand and gravel ranges from about 9 to 14 feet below ground surface. Recharge to the ground water table in the outwash sand and gravel may be principally from infiltration of precipitation; however, there may be recharge due to leakage from water and sewer lines. The normal ground water gradient indicated by measurements in observation wells is from north to south.

Water levels in piezometers constructed in the bedrock indicate artesian conditions. Recharge to the bedrock/glacial till interface zone is probably via leakage from the overlying glacial till. Based on measurement of the elevation of the potentiometric surface, the general ground water gradient is from north to south.

6. SUMMARY OF INVESTIGATIVE PROGRAMS

6.1 GENERAL

One of the objectives of this study includes the field evaluation of advanced methods of subsurface explorations and geotechnical instrumentation and is conceived to be completed in two stages. Stage I, the subject of this report, directs itself toward the evaluation of advanced methods of subsurface explorations for use in the design and construction of urban rapid transit tunnel projects. Stage II, related to the evaluation of geotechnical instrumentation, will be reported in a separate, later report, prepared following completion of tunnel excavation in the test areas. The Stage II report will contain an evaluation of the performance of selected instrumentation and a comparison of the stratigraphy predicted during Stage I with that observed during tunnel excavation.

The Stage I report may be further separated into work completed in the field implementation and evaluation of certain exploratory techniques, and the results of research and literature surveys of other techniques. Additional definition of the investigative program follows.

6.2 TEST SECTIONS

Field application and evaluation of exploratory methods were performed in the two test sections previously described (Section 4.4) on the Massachusetts Bay Transit Authority's (MBTA) Red Line Extension. The areas were selected for their geologic complexity and the need for real and relevant geotechnical data.

6.2.1 Holiday Inn Test Section

As the principal test section, the exploration plan was developed to permit the implementation of a wide variety of exploratory methods and to facilitate the installation of geotechnical instrumentation to be evaluated during Stage II. The exploration program for the Holiday Inn site is summarized in Figure 6-1. The program consisted of six parallel rows of explorations spaced approximately 50 feet apart and oriented perpendicular to the tunnel alignment within the limits of anticipated mixed-face tunnel conditions.

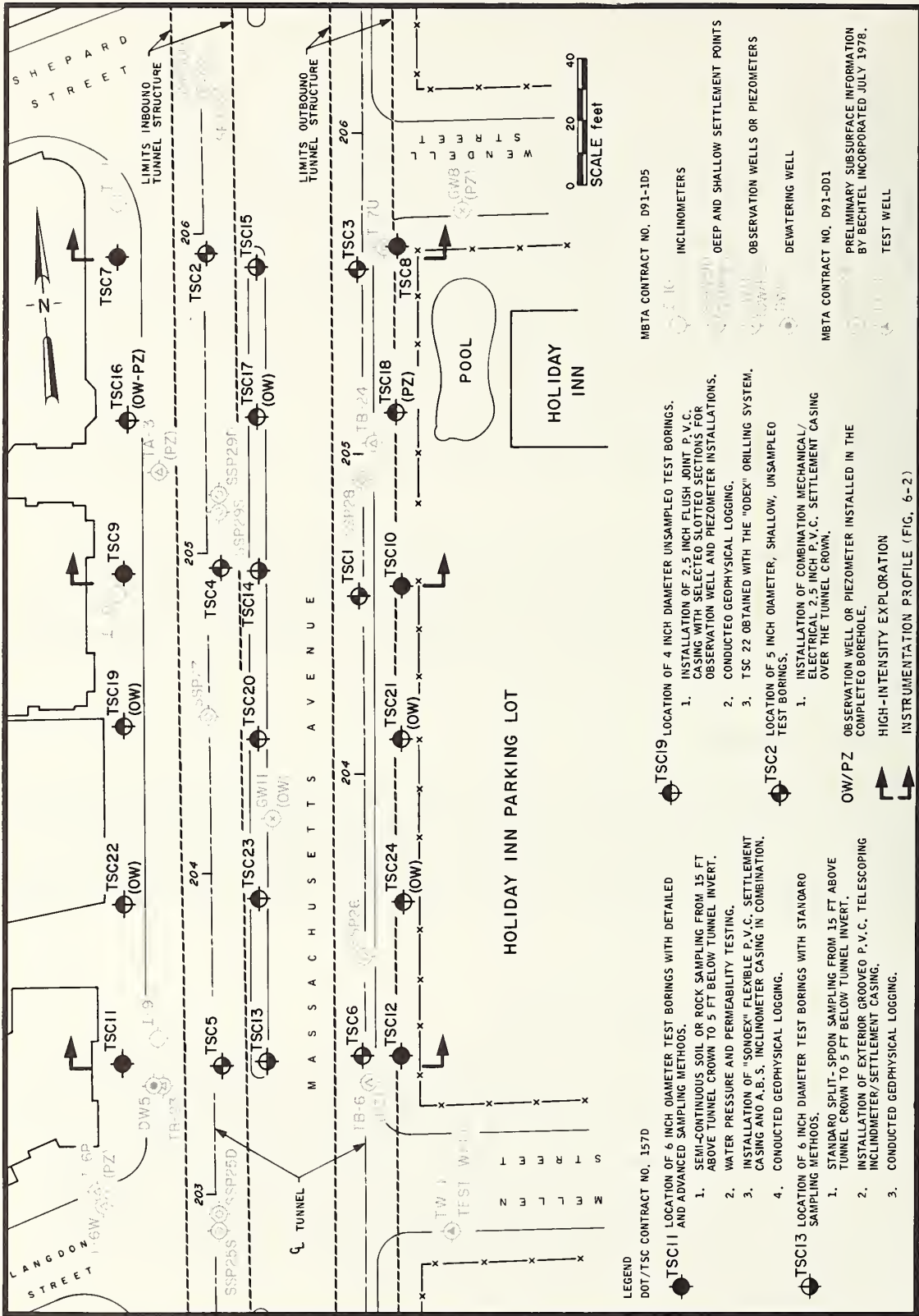

FIGURE 6-1. SUBSURFACE EXPLORATION PLAN, HOLIDAY INN SITE, CAMBRIDGE, MASSACHUSETTS

Three rows of explorations spaced approximately 100 to 150 feet apart (one at each end and one approximately in the middle of the test section) were designed as high-intensity exploration/instrumentation profiles (Figure 6-2). At the location of these profiles, sampling and field testing was intensive to provide an accurate basis from which to extrapolate the results of other investigative methods.

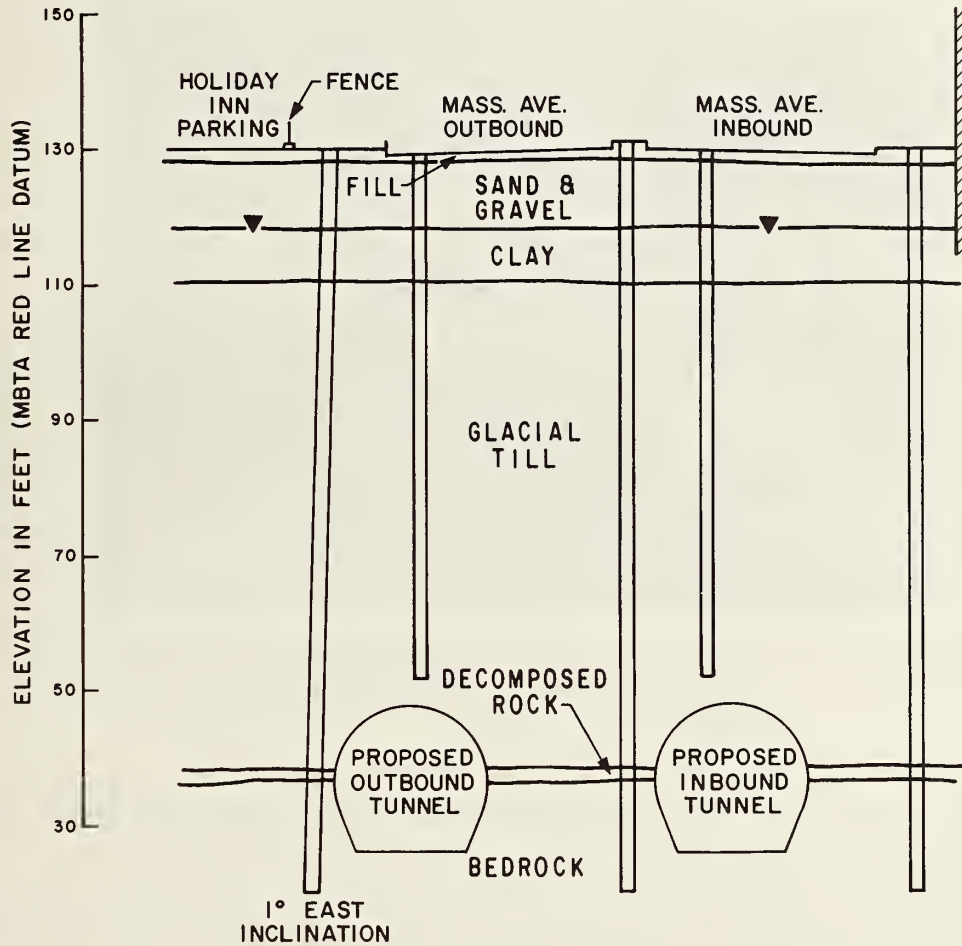

FIGURE 6-2. TYPICAL HIGH-INTENSITY EXPLORATION INSTRUMENTATION PROFILE

Intermediately between the high-intensity exploration/instrumentation holes, rows of unsampled holes were advanced to facilitate implementation of various geophysical methods and for the installation of instrumentation to be used during later stages of this study.

The exploratory holes were advanced using contract specified drilling equipment and sampling procedures (Figure 6-3). The completed holes were subsequently used for electrical and nuclear surveys and seismic studies, and, finally, for placement of geotechnical instrumentation. Borehole spacing was maintained close to 50 feet to facilitate cross-hole seismic velocity studies.



FIGURE 6-3. DOT/TSC FIELD EXPLORATION PROGRAM,
MASSACHUSETTS AVENUE INBOUND LANE,
HOLIDAY INN SITE

The following exploratory procedures were implemented at the Holiday Inn test section:

- a. Rotary Drilling
- b. Percussion Drilling (ODEX)
- c. Mud Stabilized Borehole
- d. Casing Stabilized Borehole
- e. Penetration Testing
- f. 2-inch and 3-inch Split Spoon Samples
- g. Denison Overburden Core Samples
- h. Pitcher Overburden Core Samples
- i. Double Tube Split Liner Overburden Core Samples
- j. Double Tube Solid and Split Liner Rock Core Samples
- Triple Tube Solid Liner Rock Core Samples

- l. Borehole Permeability Testing
- m. Borehole Water Pressure Testing
- n. Observation Wells
- o. Piezometers
- p. Instrumentation Casing Installation
- q. Nuclear Borehole Logging
 1. Natural Gamma
 2. Neutron Gamma
 3. Neutron-Epithermal-Neutron
 4. Gamma-Gamma
- r. Seismic Velocity Logging
 1. Uphole Survey
 2. Crosshole Survey
 3. Signal Enhancement Refraction Survey
- s. Electric Borehole Logging

6.2.2 Davis Square Test Section

The Davis Square test section was used only for implementation of the Integral Sampling Method (ISM) of rock coring. The bedrock of the site is approximately 50 feet below ground surface and will ultimately be excavated to accommodate construction of a new station using cut-and-cover procedures. Since the invert of the station is as much as 10 to 12 feet below the top of bedrock, the strength and structure of the rock are significant with respect to the design and construction of temporary excavation support systems.

The location selected for implementation of the ISM technique is shown in Figure 6-4.

6.3 RESEARCH AND LITERATURE SURVEYS

Certain exploratory procedures considered to be particularly useful in the field of transit tunneling are included in this study for research and literature survey only. Budget and time restrictions prohibited the inclusion of these procedures in the field evaluation aspects of the program. The following methods were researched and are described in detail in Section 8.

- a. Horizontal Drilling
- b. Thermometric Surveys
- c. Acoustic Explorations

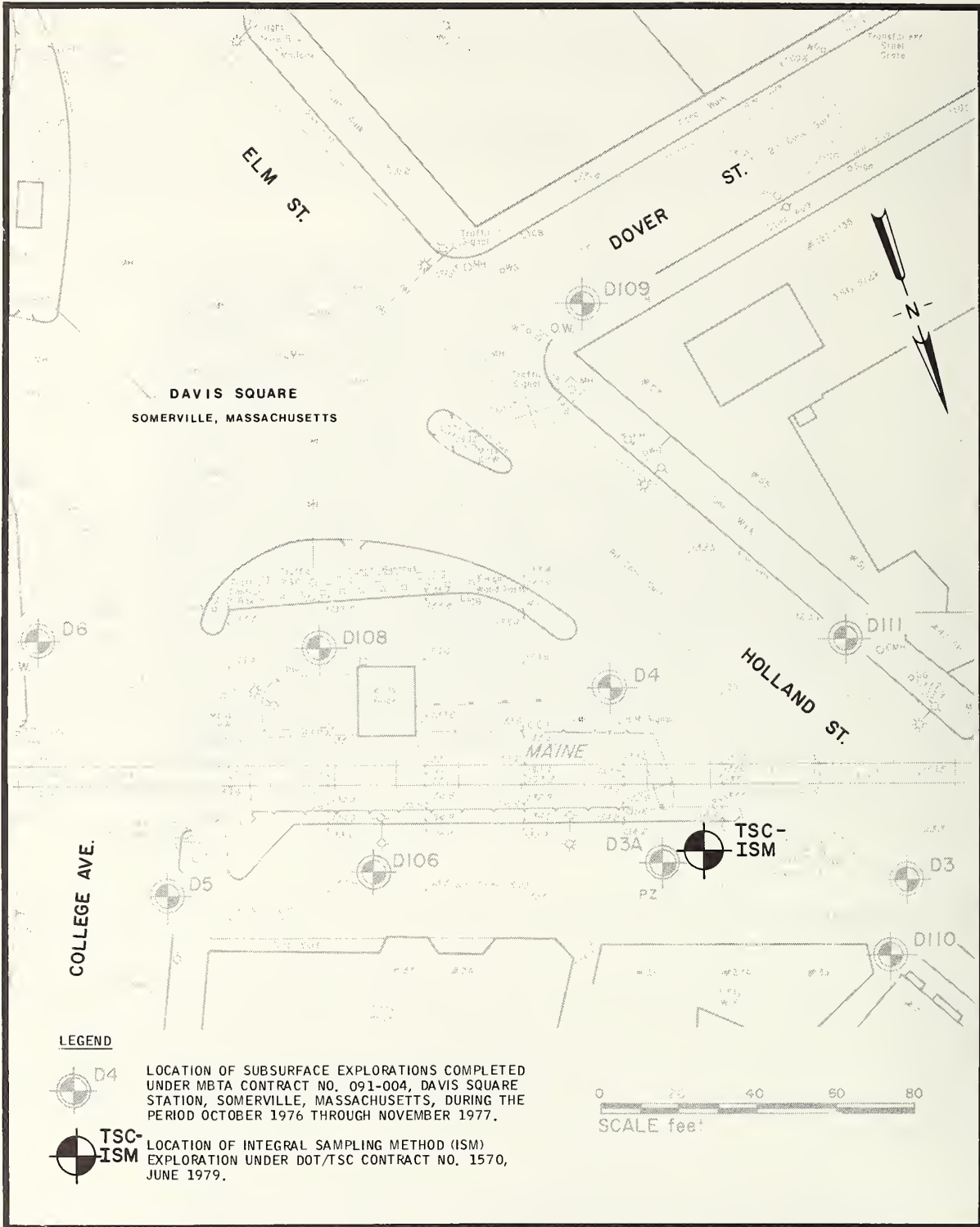

FIGURE 6-4. SUBSURFACE EXPLORATION PLAN, DAVIS SQUARE SITE, SOMERVILLE, MASSACHUSETTS

6.4 LABORATORY SOIL AND ROCK TESTING

Standard laboratory classification tests were conducted on representative samples recovered from explorations for the purpose of checking field classifications and for correlation with geophysical parameters which were measured. Detailed petrographic analysis of selected rock specimens were conducted to assist in the classification and determination of the structural characteristics of the bedrock. Rock cores were labeled and photographed for future reference purposes.

7. FIELD EVALUATED EXPLORATORY PROCEDURES

7.1 GENERAL

This report section will summarize and describe exploratory equipment and procedures implemented in the field for evaluation as opposed to those described, based only on literature research. Many of the procedures have been used in the industry for years and may be considered "standard"; others have never been used in the proposed application and are, indeed, "advanced". Still other methods are advanced, although their commercial availability and increasing application in the field of geotechnical explorations for other types of facilities is making them more standard.

The ultimate goal of a subsurface exploration program is to obtain the maximum amount of geotechnical information at a minimum of cost. This information will affect the feasibility, design and performance of the proposed engineering structure. Although the costs associated with conducting a conventional exploration program have been increasing at a rapid and uniform rate over the past 10 years, the level of recoverable information has increased at a slower rate.

Subsurface exploration technology has only recently approached the level of sophistication required for the design and construction of underground openings, considering some form of rotary core drilling was practiced by the Egyptians as early as 3000 B.C. Major improvements have been made in the design and construction of exploration equipment since the 16th century, when the Grenelle rig (Figure 7-1) required eight years to drill a 1,771-ft. well in France (Gass, 8-14).

The development of new methods and equipment by industry is continuously improving the level of geotechnical information recovered during subsurface exploration programs. A demonstration project program comprehensive enough in scope to include all of the promising methods would be impossible within any reasonable time and budget limitations. Therefore, those methods and equipment most relevant to this tunnel were selected for implementation and evaluation. Other methods, with equal potential but beyond the time and/or budget restrictions were defined and are treated in a research and literature survey (Section 8).

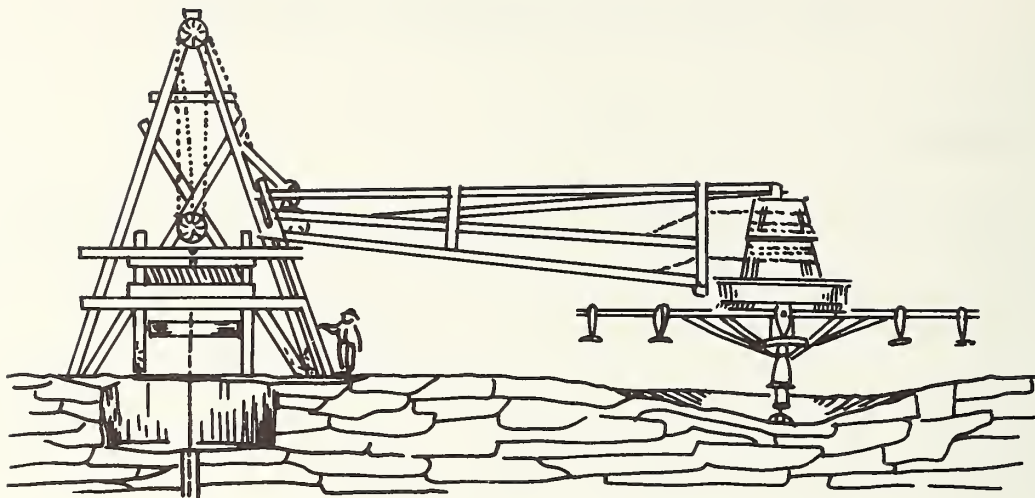

FIGURE 7-1. GRENELLE DRILL RIG, 16TH CENTURY
GASS (8-14)

Advanced data collection procedures, which may be utilized by the geotechnical engineer, range from those available, through equipment which is presently used in other engineering and construction fields, to very sophisticated experimental technology. The well driller's underreamer (Figure 7-2) which is used in penetrating boulders and obstructions, and a reported rocket drill developed by the Soviets, capable of penetrating 60 feet of overburden in 18 seconds, reflect the range and sophistication of "advanced" data collection procedures.

The various exploration procedures selected for field evaluation may be grouped into two categories. "Direct" methods provide data relative to geotechnical parameters and stratigraphy from direct measurements made in the field. "Indirect" methods provide physical evidence of subsurface conditions but require correlations with known conditions through direct measurements. Most geophysical methods fall into the indirect category.

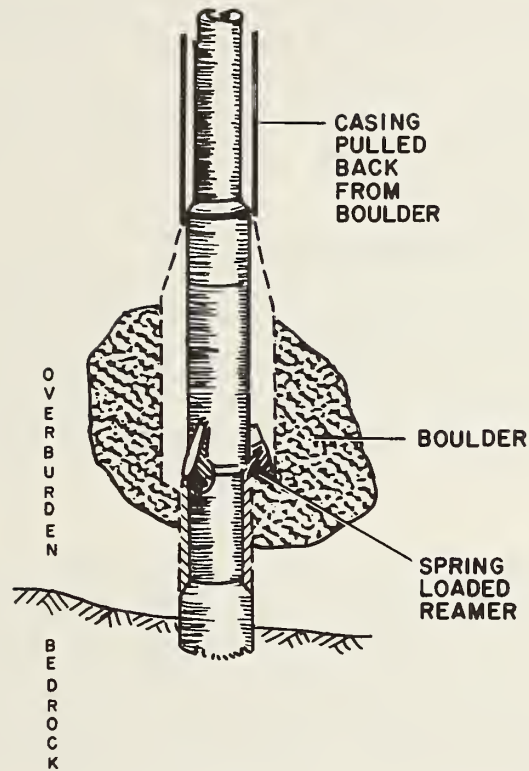

FIGURE 7-2. SERVOTM MODEL 58WCB UNDERREAMER

7.2 REVIEW OF TEST BORING METHODS

The term "subsurface exploration" used throughout this report refers to the numerous direct and indirect methods of determining the various subsurface geotechnical parameters which are required for tunnel design and construction. The term "test boring" refers only to a small diameter exploratory hole, generally vertical, and the methods of advancing such a hole. Various sampling methods and equipment are available which are used in conjunction with a single test boring to determine the depth to and approximate identity of the subsurface conditions. The project requirements, in addition to the economic and environmental considerations, also affect the selection of the specific drilling equipment to be employed on the project.

7.2.1 Borehole Advancement

The more commonly employed test boring techniques are classified in 6 groups, depending on the method used in

displacing or removing material during advancement of the borehole (Hvorslev, 8-17):

- a. Displacement Boring
- b. Wash Boring
- c. Percussion Drilling
- d. Rotary Drilling
- e. Auger Boring
- f. Continuous Sampling

The quality of information obtained from the various test boring methods varies with the character of the subsurface geologic conditions, so careful consideration must be given when selecting the desired method. It may be necessary to employ more than one method in advancing a particular borehole.

7.2.1.1 Displacement Boring - This method is the most simple and economical test boring procedure in non-caving ground. There is no attempt to stabilize the borehole and closed samplers such as the split tube, cup or piston sampler are forced in a closed position to the required sampling depth. This method is generally employed in preliminary reconnaissance work where only general subsurface data are required.

7.2.1.2 Wash Boring - This method involves advancing casing, as required, and washing out the material to the bottom of the casing with chopping bits to the desired sampling depth. The borehole may be stabilized with casing, water or drilling mud, and open samplers, such as the split or solid tube type, are driven into the undisturbed material at the bottom of the borehole. This method is the most commonly used in soils which do not contain obstructions such as large cobbles and boulders or cemented horizons.

7.2.1.3 Percussion Drilling (Churn Drilling) - This method involves advancing the boring by raising and dropping a heavy drill bit to form a slurry. Samples are obtained by bailing the slurry or replacing the bit with a conventional sampler after the slurry has been removed, and then driving the sampler with very heavy "down the hole" tools referred to as "jars". This is a primary method employed in the well drilling industry and is generally not as applicable for geotechnical investigations.

7.2.1.4 Rotary Drilling - This method is a variation of the Wash Boring technique, utilizing a rotary drill bit, rather than a chopping motion. It is employed primarily in advancing and cleaning the borehole to the required sampling depth and is used in conjunction with air, water or drilling mud to bring the cuttings to the surface.

7.2.1.5 Auger Borings - This method involves advancing helical augers, either solid flight or hollow stem, with large mobile equipment, to the required sampling depth. This is a rapid method for advancing the borehole, without the use of fluids, in partially saturated or unsaturated materials above the ground water table. Conventional sampling procedures are employed; however, some disturbance of the natural ground may be created by the advancing augers in the zone of sampling.

7.2.1.6 Continuous Sampling - This method of obtaining representative samples may be employed with any test boring procedure to provide more reliable and detailed information on subsurface conditions than any other method. In addition, it may be employed by itself to create an uncased borehole. A continuous column of soil or rock is obtained by conventional sampling procedures providing the most accurate picture of subsurface conditions.

7.2.2 Borehole Stabilization

A problem common to all test boring methods is the necessity of maintaining bore wall and bottom stability for the purpose of obtaining relatively undisturbed samples of the desired stratum. The subsurface conditions encountered in a specific area will generally dictate or influence the selection of the borehole stabilization method, which can be grouped into five general categories:

- a. Water Stabilization
- b. Mud Stabilization
- c. Casing Stabilization
- d. Grout Stabilization
- e. Freezing Stabilization

As with the various techniques which may be employed in advancing the boreholes, the selected stabilization method may also affect the quality of the sample recovered. Several different methods may be employed in a single borehole in any combination to insure that the most representative sample is obtained for analysis.

7.2.2.1 Water Stabilization - Stabilization of the borehole through a recycling or continuous water supply system is the most common and economical method of maintaining borehole stability. Water induced into the borehole will generally counteract soil and pore-water pressures in partially or fully saturated sediments for a sufficient length of time to allow sampling at the selected stratum. Water alone will generally not prevent the caving or sloughing of the borehole in soft or cohesionless sediments, especially above the water table. An uncased borehole, utilizing water for stabilization purposes, is typically used in rock or in relatively stiff, cohesive soils.

7.2.2.2 Mud Stabilization - Drilling mud may be a natural or artificially pre-mixed fluid which is recycled through the borehole system in order to stabilize the uncased portions of the borehole. It is also employed to improve sample recovery and minimize soil disturbance in cased boreholes.

Drilling mud may be prepared from any native clay or from several commercially available products, which are highly colloidal and thixotropic and contain various additives to control dispersion, viscosity, etc. The higher specific gravity of the mud will develop more positive down-the-hole pressures, in addition to forming a relatively impervious lining along the borehole walls. The mud will also tend to keep the cuttings in suspension longer, allowing more representative sampling at the bottom of the borehole. In addition, the mud will reduce abrasion and retard corrosion of the drilling and sampling tools.

7.2.2.3 Casing Stabilization - Driving heavy duty steel pipe or casing provides the most reliable, and most popular, although relatively expensive, method of advancing a borehole to its required depth. The Diamond Core Drill Manufacturer's Association (DCDMA) has established standards of nomenclature for the various casing diameters. These are summarized in Table 7-1.

The borehole is usually advanced by constant blows of a drive hammer (typically 300 lbs., falling 24 inches) upon a drive head which is attached to the casing. As the blows to drive the casing supply constant energy, supplementary information may be obtained on the soil resistance by counting blows and the resulting penetration.

TABLE 7-1. CASING SIZES IN INCHES

<u>TYPE</u>	<u>DESIGNATION</u>	<u>I.D.</u>	<u>O.D.</u>
Extra Heavy (XH)	2-1/2	2.50	2.88
	3	3.00	3.50
	3-1/2	3.50	4.00
	4	4.00	4.50
Flush Joint	RX or RW	1.19	1.44
	EX or EW	1.50	1.81
	AX or AW	1.91	2.25
	BX or BW	2.38	2.88
	NX or NW	3.00	3.50
	HX or HW	4.00	4.50
	PX or PW	5.00	5.50
	SX or SW	6.00	6.63
	UX or UW	7.00	7.63
ZX or ZW	8.00	8.63	
Flush Coupled	RX or RW	1.19	1.44
	EX or EW	1.63	1.81
	AX or AW	2.00	2.25
	BX or BW	2.56	2.88
	NX or NW	3.19	3.50
	HX or HW	4.13	4.50

The casing is usually driven in 5-ft. increments with representative samples being obtained at the completion of each 5-foot drive. The increments may be varied to meet specific sampling requirements. Various sizes of casing may be "telescoped" within each other to facilitate the coring of obstructions or to reduce the desired size of the borehole at depth.

The heavy duty steel casing may also be equipped with a diamond bit "shoe" and drilled, rather than driven, to the required sampling depth. This procedure will allow the penetration of obstructions without a decrease in borehole size.

After the casing is seated at the required depth, the hole must be thoroughly cleaned out before obtaining a sample. In soft or loose materials, stability of the borehole is in-

creased by keeping the casing filled with water or drilling fluids.

Using hydraulically operated drilling equipment, hollow stem helical augers with a removable center plug to allow passage of the sampling tools through the auger may also be employed as temporary casing.

7.2.2.4 Grout Stabilization - A borehole may encounter local zones of instability in the bedrock due to shear zones, faults, weathering or fractured rock which prevents deeper penetration of the drilling tools. This zone may be stabilized by pumping a cement grout into that portion of the hole and redrilling the borehole through the concrete plug. Although additional time will be required for setting of the grout, it may be preferable to advancing casing to this depth, which would also reduce the borehole size.

This method may also be applied in extremely unstable areas in the overburden sediments. However, depending on the depth of the zone, advancing casing may be a more practical solution.

7.2.2.5 Freezing Stabilization - A borehole may be stabilized by freezing the soil through which it passes by replacing the drilling fluid with kerosene, diesel fuel, or a brine solution which is chilled with "dry ice". This method is generally not applicable in unsaturated ground or where there is a strong groundwater flow.

A more costly method involves circulating the cooling liquid through a series of pipes which have been driven or drilled in a circle around the primary borehole. This procedure could facilitate the recovery of large diameter samples of unstable granular soil or fractured rock.

In some instances, it may be advantageous to use this procedure to recover "undisturbed" samples of naturally frozen granular soils to determine the presence of ice lensing or segregation.

7.3 PROJECT TEST BORING METHODS

Basic to the objectives of this study is the evaluation of the most efficient and economical method of making a small

diameter hole (test boring) in the subsurface strata, to facilitate the recovery of representative samples, and to provide access for in-situ testing and measurement of engineering properties. Toward this end, several of the standard procedures were employed and evaluated. In addition, a new method of rapidly advancing an unsampled hole for geophysical surveys, in-situ testing and instrumentation installation was evaluated. The ODEXTM system (Section 7.3.2) utilizes conventional air-operated, percussion drilling equipment in conjunction with a special bit to simultaneously advance the hole and drive casing at rapid rates in compatible soils.

7.3.1 Standard Test Boring Methods

Of the six primary methods summarized previously in this report, three techniques were employed either separately or in combination to accomplish the project goals, and three different methods of borehole stabilization were evaluated.

The primary test boring technique used on this project consisted of the rotary drilling method with mud stabilization of the borehole walls. Rotary drilling consists of advancing the borehole by very rapid rotation of a drilling bit which cuts and grinds the sediments at the bottom of the borehole into small particles or "cuttings". These cuttings are subsequently removed from the borehole by pumping water or a drilling fluid (mud) from a surface reservoir of varying capacity, through a closed recirculation system. The borehole cuttings are carried to the surface by the recirculating fluid and allowed to settle out into a separate section of the reservoir (Figure 7-3). A variety of drill bits are available for the various types of overburden and rock encountered and can be used by the driller as the situation demands.

Rotary drilling was originally developed by the petroleum industry for the drilling of deep oil wells. Rotary drills are manufactured in a variety of sizes and styles, ranging from small, hand-held portable drills to massive, off-shore mineral exploration equipment. The careful selection of the drilling equipment is a very important aspect of any subsurface exploration program. The equipment must be capable of meeting all, or as many of the various project requirements as possible, have sufficient mobility, and possess the ability to convert rapidly from one drilling technique to another. A hydraulic feed machine is always preferred, since it can maintain a constant advance pressure through varying formation

densities, thus minimizing erosion and disturbance of the in-situ materials.



FIGURE 7-3. MIXING REVERT™ DRILLING FLUID ADDITIVE IN THE MUD RESERVOIR

Two truck-mounted, hydraulically operated rotary drill rigs were used to obtain the majority of the subsurface explorations on the project. A CME-75™, manufactured by the Central Mine Equipment Company (Figure 7-4) and a Mobile B56™, manufactured by Mobile Drilling, Inc. (Figure 7-5), are completely self-contained units which have the capability and the mobility of meeting the multiplicity of project requirements.

Borehole stabilization by the use of drilling mud eliminates the costly and time consuming method of advancing heavy

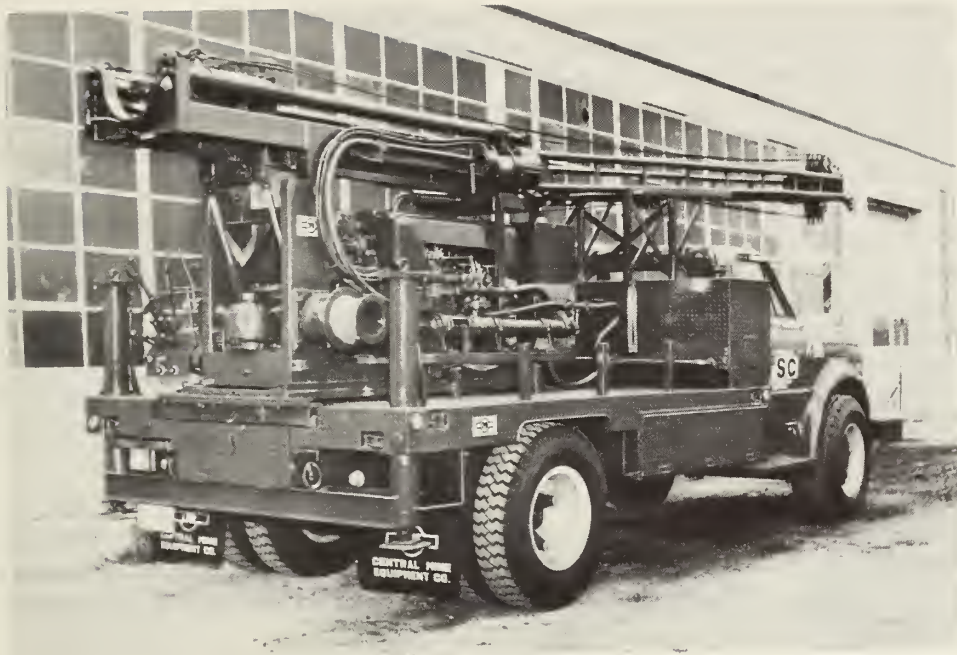

FIGURE 7-4. CME-75TM DRILL RIG



FIGURE 7-5. MOBILE B56TM DRILL RIG

steel casing. Drilling mud is simply a mixture of water and soil particles in suspension which has a specific gravity and viscosity greater than water. It is used to transport the borehole cuttings to the surface, maintain a state of equilibrium within the borehole and act as a coolant for the drill bit. Suitable muds may be created from in-situ clays or commercial products which will effectively stabilize the borehole wall and bottom for the purpose of the boring operation. The basic mud mixture which is used on many subsurface exploration programs is bentonite and fresh water (approximately 6 percent bentonite by weight). Attapulgite, a non-flocculating clay, will make a suitable mud when mixed with salt water. Weight additives, such as pulverized barite, hematite, galena, or other heavy mineral products, may be added to the mixture to further increase specific gravity in unstable soils or in the presence of artesian conditions. The drilling mud must be carefully mixed and monitored during the life of the test boring and driller expertise is required to maintain the correct mixture balance for optimum performance.

The study requirements dictated that two basic borehole sizes be obtained for the purpose of representative sampling and to facilitate the subsequent installation of instrumentation casing for future monitoring purposes. Typical site investigation explorations are usually in the 2 to 4-inch diameter range; however, in an effort to optimize borehole use and eliminate the future need of drilling additional costly test borings, the diameters were increased to accommodate the subsequent geophysical and instrumentation requirements of the study. Nine, 6-inch diameter, explorations were obtained, in which detailed overburden and rock sampling, in-situ testing, instrumentation casing installation and geophysical logging were accomplished. Although the actual diameters of the boreholes varied slightly depending on the drill bit size, these explorations are referred to as 6-inch diameter test borings for report purposes.

Fifteen, 4-inch diameter, unsampled test borings were obtained to facilitate the installation of plastic casing for geophysical logging purposes, and the subsequent installation of observation wells and piezometers. These exploration diameters also varied depending on the drill bit size, and the actual dimensions of all the explorations are indicated on the "Subsurface Exploration Summary" included as Appendix C.

Due to the presence of granular fills and near-surface granular outwash deposits, heavy duty steel casing was driven into a lower clay stratum to maintain the upper 10 to 15 feet

of the borehole. Six-inch inside diameter, flush joint, SW casing was employed in the large diameter holes, and 4-inch, flush joint HW casing was used in the small diameter holes. Standard wash boring techniques were employed to remove the borehole cuttings within the "cased" portions of the explorations. Before commencing any exploration, all boreholes were hand-augered to approximately 8 feet to determine the presence of underground utilities. Although the numerous underground utilities in the site area had been cleared by the various utility companies, the driller elected to confirm the absence of any utilities prior to advancing his casing. This augering of the upper exploration provided the additional advantage of closely observing the near surface fill and outwash deposits.

Once the borehole cuttings had been removed from the casing with recirculating water, a drilling mud was mixed for the purpose of maintaining borehole wall stability in the remaining uncased portion of the exploration.

To minimize environmental pollution and to facilitate the subsequent installation of observation wells and piezometers in the completed boreholes, a biodegradable organic polymer, manufactured by the Johnson Division, Universal Oil Products Company, under the patented trade name of "Revert"TM, was mixed with water and used as the drilling fluid for all the subsurface explorations. Revert has the important characteristic of automatically changing or reverting to a fluid as thin as water after a period of time.

A heavy mud mixture (approximately 10 to 20 lbs. per 250 gallons of water) was required to maintain borehole stability, but additional weight additives were not necessary. The drilling mud was pumped through a closed recirculation system by a Moyno 3L6TM progressive cavity pump. As the mud mixture would tend to lose its viscosity in approximately 24 hours, the mixture was either replaced or thickened on a daily basis.

Due to the design depth of the test borings and the anticipated subsurface conditions, extra heavy drill rods were used for advancing the explorations. The American Petroleum Institute's (API) 3-1/2 inch integral joint drill pipe was used on the majority of the larger diameter explorations. The increase in weight and stiffness of the drill rods gave additional stability to the bit, decreased whip and vibration and helped keep the borehole straight and uniform. In addition, explorations on the east or outbound side of Massachusetts Avenue and in close proximity to the proposed

tunnel wall, were drilled at approximately two degrees east inclination to provide additional clearance at depth. The heavier drill rods helped maintain this slight angle of the borehole. The smaller diameter boreholes were drilled with the more conventional, but still relatively heavy, Diamond Core Drill Manufacturer's Association's (DCDMA) 2-5/8 inch NW standard diamond core drill rods.

A variety of rotary drilling bits may be used, depending on the density and type of the material penetrated. Fish-tail bits and two-bladed bits are used in relatively soft or loose soils, and the heavier roller bits are used in the denser overburden and bedrock. Various sized tri-cone roller bits were the primary tool used in advancing the boreholes on the study (Figure 7-6).



FIGURE 7-6. STUDY DRILL BITS

In all cases, the overburden below the upper 10 to 15 feet of cased hole was penetrated and stabilized with the uncased, mudded borehole technique. In addition, the majority of the boreholes which penetrated into rock were obtained in the same manner with only a reduction in borehole size to 3 inches. In those explorations which required the recovery of continuous rock core samples, a 3.5-inch outside diameter NW, flush-joint, steel casing was lowered into the 6-inch diameter borehole to the top of the rock to provide a guide sleeve

and minimize vibrations during the rock coring phase. Fresh water was used during rock coring which also flushed the drilling mud from the borehole.

Prior to lowering the NW casing into the borehole, geophysical electric logging was conducted in the uncased portions of the borehole. This geophysical procedure can only be conducted in uncased holes and is discussed in detail later in Section 7.6.3 of this report.

Upon completion of all required sampling and testing in the borehole, various types of plastic instrumentation casing were installed in the completed boreholes for future monitoring (Figure 7-7). The installation procedures and materials employed for long-term ground movement monitoring will be discussed in a separate report to be prepared during Stage II of this study.



FIGURE 7-7. INSTALLATION OF PVC GEOPHYSICAL/
INSTRUMENTATION CASING

Installation of a 2.5-inch flush coupled polyvinyl-chloride (PVC) casing was required in all completed, non-instrumented boreholes to provide stability for borehole geophysical survey purposes. These casing installations were also modified for future ground water observation purposes and are discussed in additional detail in Section 7.7.3 of this report.

Upon completion of all the various sampling and testing procedures, all non-instrumented boreholes were tremie grouted with cement from the bottom of the exploration. Instrumentation and certain advanced rock sampling methods which required special types of grouts for installation or recovery purposes are discussed in more detail under the applicable report sections. The type and depth range of the borehole grout for each exploration is summarized on the Subsurface Exploration Summary (Appendix C).

The rotary drilling method used with borehole fluid (mud) stabilization was conducted with highly satisfactory results. On only two occasions did local wall sloughing require the redrilling of the borehole to accommodate the various sampling tools. It is believed that on these occasions the drilling fluid had commenced to break down and the borehole equilibrium was not maintained. The numerous cobbles and boulders in the glacial till stratum which would have required borehole size reduction if casing had been used, was not necessary. Drilling production rates averaged approximately 10 feet per hour in the 6-inch diameter test borings. This is considered to be an excellent advancement rate for the diameter of the exploration and the degree of difficulty in penetrating the dense glacial till.

Drilling fluids can be lost when lenses or pockets of highly permeable strata, such as clean gravel, are encountered, especially in the presence of a strong groundwater flow. However, these permeable zones can be sealed by the addition of cement, straw, or other commercial fibrous products to the drilling fluid which will be deposited in these zones and seal off the pervious strata.

Based on current New England prices, the study costs for rotary drilled, uncased, mud-stabilized overburden drilling of \$7.90 per foot is estimated to be less than one half the unit price of similar casing stabilized holes.

In compatible soils, exploration techniques employing rotary drilling methods with uncased, mud stabilization will provide cost-effective and timely data, without decreasing

the quality of the results. With the proper selection and use of drilling mud, it is possible to obtain more accurate subsurface information than could be obtained with the indiscriminate use of casing.

Additional data relative to unit prices and exploration costs are presented in Section 10.

7.3.2 ODEXTM Drilling

7.3.2.1 General - Many indirect subsurface exploration techniques, such as downhole geophysical logging, borehole seismic surveys, and numerous other exploratory procedures, require a small diameter hole or holes within which to work. In addition, instrumentation, such as inclinometers, extensometers, observation wells, piezometers, etc., require small diameter holes into which the instruments are installed. For many of these methods to be most cost effective, it is essential to develop a procedure for drilling small diameter, unsampled holes rapidly and at minimum cost. Through the use of such holes with indirect logging, and in combination with conventional sampled test borings, a thorough definition of subsurface conditions could be developed at minimal costs.

A drilling system currently used in the construction industry for installing earth anchors, tiebacks, etc., has the potential to advance unsampled, cased holes in overburden soils at remarkable rates in favorable conditions. The equipment utilizes conventional air-operated, percussion drilling equipment utilized in the industry for decades. The standard percussion drilling equipment has been modified by the Swedish firms of Atlas Copco and Sandvik Coromant to facilitate the installation of heavy duty, removable casing for borehole stabilization in conjunction with the drilling operation. The modified system is referred to as the ODEX system.

Conventional rotary percussion drilling, which has the capacity to rapidly penetrate obstructions and bedrock, does not have the capability of concurrent borehole casing stabilization. Without this stabilization, drill-bit plugging and jamming in overburden materials occur. Therefore, until relatively recently, rotary percussion drilling has been confined to rock drilling where borehole stabilization is not required. With the recent ODEX modifications, the equipment now has the capability of drilling rapid, unsampled, cased, small diameter holes in compatible overburden soils.

ODEX drilling equipment was mobilized and incorporated within the study for use in drilling unsampled test borings at the Holiday Inn Site to facilitate planned geophysical measurement and instrumentation installation.

7.3.2.2 ODEX Systems - The ODEX drilling equipment consists of a standard rotary percussion drill rig (Figure 7-8) equipped with a specially designed Sandvik drill bit. The bit consists of three parts (Figure 7-9):

- a. Pilot bit
- b. Reamer
- c. Guide

The eccentric reamer has the capability to drill a hole larger than the outer diameter of the steel borehole casing.



FIGURE 7-8. ODEXTM EQUIPPED "AIR TRACK" DRILL RIG ON BORING TSC 22

The pilot bit is machined in a single piece and carries 4 cemented carbide cutting inserts with the reamer equipped with 2 cemented carbide cutters. The ODEX bit system is available in three different sizes:

	<u>ODEX 76</u>	<u>ODEX 115</u>	<u>ODEX 127</u>
Pilot bit	2 3/4 in.	4 5/16 in.	4 5/16 in.
Reamer bit	3 25/32 in.	6 in.	6 3/8 in.

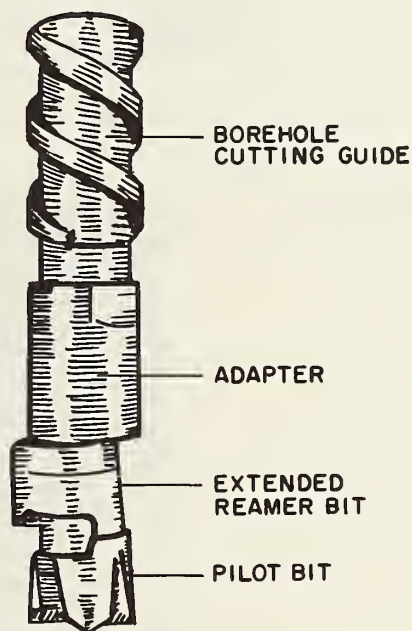
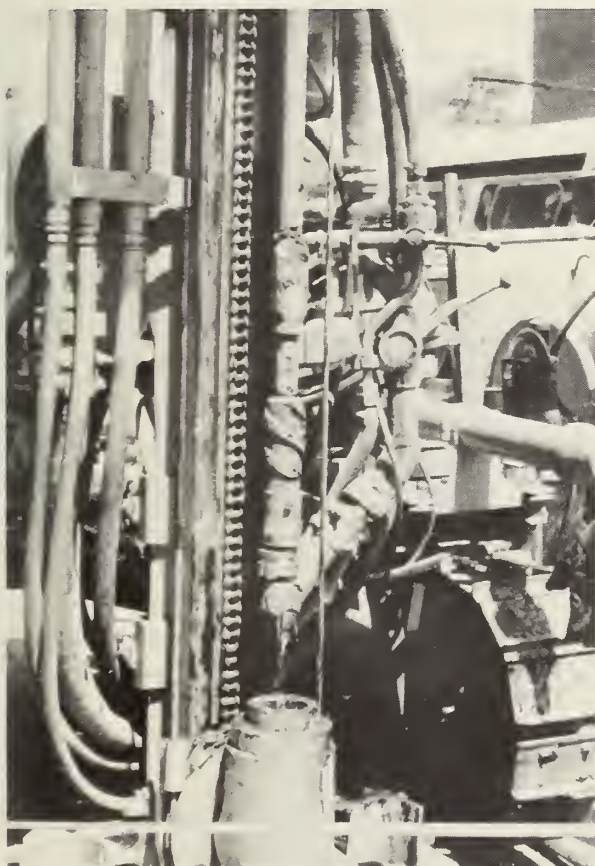

FIGURE 7-9. ODEX 76TM BIT WITH EXTENDED REAMER

As the pilot bit drills the overburden materials at the bottom of the hole, drill rod rotation automatically swings out the eccentric reamer which enlarges the hole so the casing can advance behind the ODEX bit (Figure 7-10). A portion of the impact energy is transferred from the rock drill by way of a shank adapter to a driving cap above the casing which is advanced without rotation.

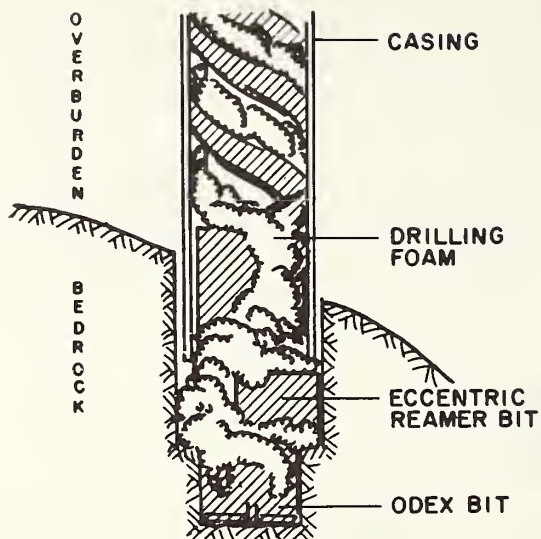

FIGURE 7-10.
ODEXTM BIT ADVANCING WITH
ECCENTRIC REAMER EXTENDED
AND CASING FOLLOWING

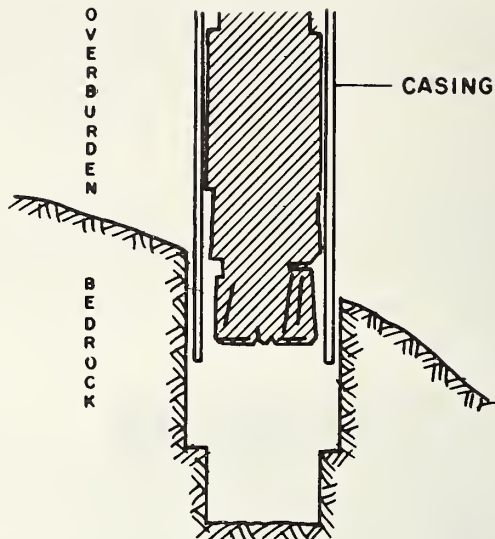

FIGURE 7-11.
ODEX BIT WITHDRAWN WITH
ECCENTRIC REAMER RETRACTED

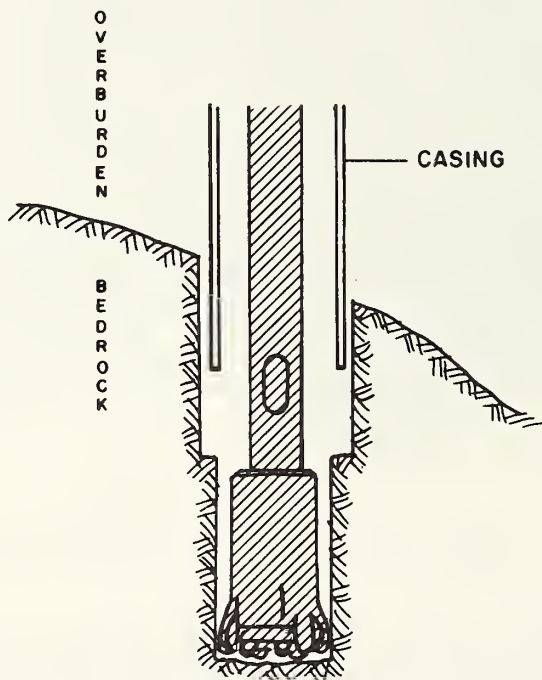

FIGURE 7-12. CONVENTIONAL ROCK
DRILLING IN ODEX BOREHOLE

When the drilling is completed, the drill bit is rotated in the opposite direction, aligning the eccentric reamer with the drill bit. This allows the drill tools to be withdrawn into the casing (Figure 7-11). If the ODEXTM hole has penetrated into solid rock, drilling can continue with conventional equipment through the casing tube (Figure 7-12). Inexpensive, smaller diameter plastic casing may be lowered through the temporary heavy duty steel casing, which is removed after completion of the drilling, for future monitoring and instrumentation installation purposes.

The ODEX bit is specially designed to screen the borehole cuttings and to allow only the smallest particles to pass up the casing. The oversize particles are forced back into the bottom of the hole and recrushed and then transmitted to the surface by a foam flushing agent. The foaming agent, which assists in disintegrating and lifting the cuttings up the casing, also lubricates and seals the borehole walls, allowing the casing to slide more easily into the borehole (Figure 7-13).

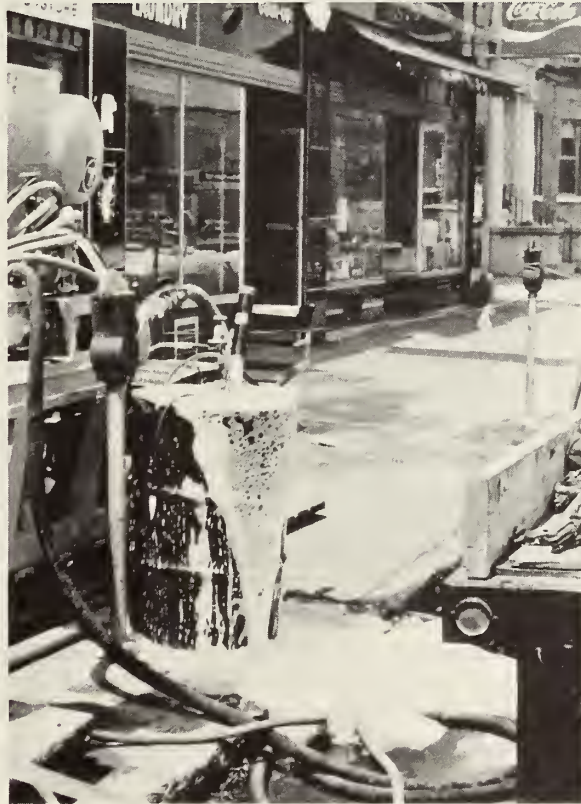

FIGURE 7-13. FOAM FLUSHING AGENT

DFA51TM, a special biodegradable, non-polluting foaming concentrate developed by Atlas Copco, is mixed at a ratio of 0.5 to 4 parts concentrate to 100 parts water.

The conventional rock drill is further modified by the addition of a specially designed Atlas Copco double-acting pneumatic drive hammer which operates in the traditional manner, with impact and rotation transmitted by means of the drill rods. This hammer is manufactured in either the top hammer or down-the-hole mode and may be combined with special casing lifters for grouting purposes. This specialized equipment may be adapted to standard truck-mounted drill rigs to supplement the more conventional subsurface exploration techniques.

7.3.2.3 ODEX Application and Performance - The ODEX equipment was utilized on a trial and demonstration basis to advance test boring TSC 22, an unsampled hole at the Holiday Inn Site planned for geophysical measurements. The equipment utilized was a Chicago Pneumatic G900TM "air track" equipped with an Atlas Copco BBE53TM double-acting hammer and an ODEX 76 drill bit (Figure 7-14).

A Rotair 75TM air compressor, manufactured by Holman Brothers Limited, Camborne, England, rated at 750 cubic ft/min at 160 psi, supplied the drill rig energy source. The air compressor required the presence of an operating engineer, thereby increasing the drilling crew from the 2 men used in conventional drilling to 3 men (Figure 7-15).

The mobility and size of the air track and the capability of being removed from the energy source allow access to areas which would be inaccessible for conventional drill rigs similar to those described in Section 7.3.1. Approximately 3 hours was required for initial unloading and setup on boring TSC 22.

During a contractor sponsored site demonstration conducted in an open storage yard, the ODEX equipment was monitored for noise level and was found to meet the requirements of the City of Cambridge. However, immediately after the initiation of drilling on TSC 22, it became apparent that the buildings within the test section tended to reflect the noise, causing concentrations and general levels well above ambient levels. The constant noise precipitated immediate complaints from merchants and residents in the area. No complaints of excessive noise had been received during conventional drilling.

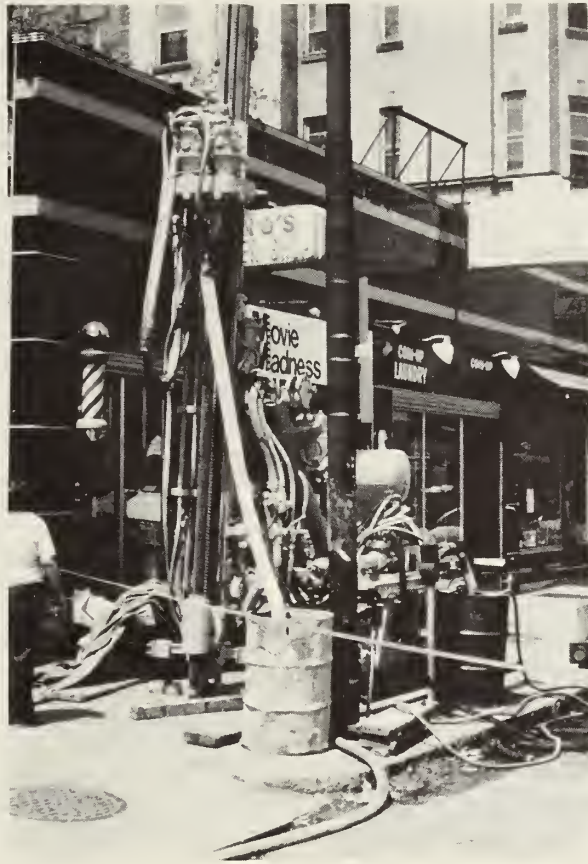

FIGURE 7-14. CHICAGO PNEUMATIC G900™
EQUIPPED WITH ATLAS COPCO™
DOUBLE ACTING HAMMER

Using the ODEX 76™ system, a borehole 2-3/4 inches in diameter was reamed to approximately 4 inches in diameter. Heavy-duty, flush-joint, steel NQ casing was installed in the borehole in conjunction with the drilling operations. The upper 16 feet of sand and gravel was penetrated at a rate of 2 feet per minute.

However, upon encountering the underlying clay stratum, the bit immediately plugged and removal of the drilling tools for cleaning was required several times before final penetration of the clay stratum was possible (Figure 7-16).



FIGURE 7-15. ROTAIR 75TM COMPRESSOR

Although the cobbles and boulders which were present in the glacial till did not present any penetration problems to the ODEXTM system, the silt and clay content within the glacial till plugged the bit with regularity. The driller attempted various methods to unplug the bit while it remained in the borehole. Basically, this involved pumping a surge of air down the drill rods, which had the immediate effect of blowing borehole cuttings and mud over a wide area at the ground surface (Figure 7-17). In an attempt to improve the drilling performance, various commercial foams were used, including Schramm Rota FoamTM and Baroid Quik FoamTM, at an approximate concentration of 1 gallon of foam concentrate to 50 gallons of water. Drilling without the use of foam was also attempted, but all methods failed to keep the drill bit from plugging on a regular basis. A maximum production rate of approximately 10 feet per hour was achieved. However, the overall borehole production rate averaged only about 4 feet per hour. It had been anticipated, based on previous contractor production rates, that an average drilling rate in excess of 10 feet per hour could be expected.

With continuing production problems, environmental concerns and a growing antipathy of the local residents, the ODEX system evaluation was terminated at 70 feet in TSC 22.

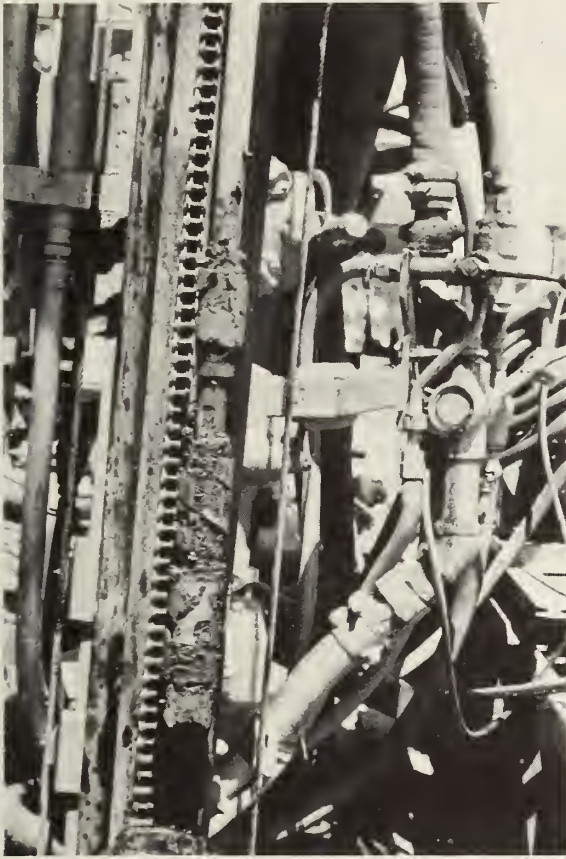

FIGURE 7-16.
ODEX™ BIT PLUGGED
BY THE MARINE CLAY



FIGURE 7-17.
"UNPLUGGING" THE ODEX BIT

Although the performance of the ODEX drilling system was disappointing in the test application, it, like other methodologies, has limitations which must be considered when applied to specific site conditions. The use of a down-the-hole hammer, which was not available for use in the test application, would have minimized the surface noise level. In addition, because of the environmental concerns, the driller was restricted and could not operate the drilling equipment at its optimum level.

The ODEX drilling system, which is a proven technology in other applications, does not appear to be a suitable subsurface exploration tool in residential urban areas, or where the subsurface conditions below the groundwater table contain

an excessive amount of fine material. As with any sophisticated exploration technique, driller expertise is absolutely essential.

The costs for the ODEXTM evaluation were computed based on a lump sum mobilization and dismantling fee of \$1100 plus \$125/hr. for time on the project. Based on the actual footage drilled and the time required to accomplish this production, a comparative unit price of \$44 per foot is associated with the ODEX drilling. Deducting the lump sum mobilization and dismantling costs and chargeable non-productive time, the actual drilling costs were \$20 per foot. However, application of the ODEX system in a more suitable environment would further decrease this average footage cost. For comparison, the unit price for overburden drilling with conventional hydraulic rotary drill rigs was \$7.90 per foot.

7.4 OVERBURDEN SAMPLING

7.4.1 General

Once the selection of the test boring methodology has been determined based on the anticipated subsurface geological conditions, the types of overburden samples required for engineering analysis and their method of recovery is selected.

The numerous sampling devices based on the type of sample they are capable of obtaining are divided into two broad categories:

- a. Disturbed samples
- b. Undisturbed samples

A disturbed sample is a representative sample of a selected geological unit which has undergone structural alteration or contamination by the sampling operation. These types of samples are used for classification purposes and are obtained primarily by "open drive" samplers. Borehole cuttings and other displacement type samples would also be classified as "disturbed".

Undisturbed samples are those which have been obtained by methods which minimize disturbance and are suitable for laboratory testing. A completely undisturbed sample cannot be obtained with present technology, and any undisturbed

sample may become "disturbed" during subsequent handling or transportation.

As with any subsurface exploration program, the specific subsurface geological conditions in the project area will dictate the most applicable method of recovering representative samples for engineering analysis.

The very compact glacial tills which are encountered within the test section on this project are similar in nature to glacially consolidated overburden soils throughout the northern United States and Canada. The equipment and procedures utilized during the field exploration evaluation phase reflect the density and composition of these sediments. Although many of the procedures and equipment are designed for use in glacial tills or hardpan, most have the capability to function in other geological deposits. The absence of soft, cohesive sediments, or loose, fine grained granular soils precludes the evaluation of such devices as the cone penetrometer and the various borehole shear devices.

7.4.2 Drive Samples

Drive sampling is the most common method of obtaining representative, disturbed samples of the overburden materials for engineering analysis. Drive samplers are divided into two basic groups, open samplers and piston samplers. The open sampler is, as its name suggests, always open at the lower end and soil materials enter into the sampler as it is forced into the ground. The piston sampler contains a movable plug or piston which is temporarily locked at the bottom of the sampler to prevent undesirable materials from entering the tube as it is pushed into the soil. As the major soil unit encountered in the test section is glacial till, the piston sampler was not used and is not discussed further in this report (Figure 7-18).

The drive sampler, of which there are many varieties, consists of a heavy-walled, open steel tube which is forced into the soil, usually by repeated blows of a standard weight falling a constant height.

Split-tube or split-spoon samplers are the most prevalent type of open drive samplers used in subsurface exploration programs today. The split-spoon, which is cut into two longitudinal sections, is driven into the soil at the bottom of the borehole, and the recovered sample is removed for classi-

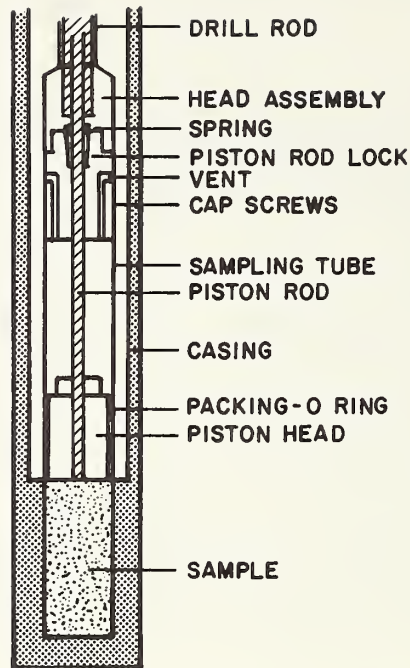

FIGURE 7-18. STATIONARY PISTON SAMPLER

fication and preservation in the event additional reference or laboratory testing is required. The split-spoon sampler is available in a variety of sizes and lengths. Various baskets, sleeves, or "trap doors" can be added to the sampler to assist in the retention of the sample during the recovery process. Figure 7-19 summarizes the more popular sizes of the basic split-spoon sampler.

The penetration or dynamic resistance of the split-spoon as it penetrates into the soil strata constitutes a type of in-situ testing which was first developed in the Boston area about 1927 (Mohr, 8-24).

A variety of methods and equipment for obtaining the measure of penetration resistance has been standardized by the American Society for Testing and Materials (ASTM D-1586-67) (AASHTO T-206-70). The Standard Penetration Test (SPT) consists of counting the number of blows required to drive a 2-in. O.D. x 1-3/8 in. I.D. open drive sampler a distance of 1 foot with a 140 lb. hammer free-falling 30 inches. The sampler is usually driven a total of 18 inches and the blows are recorded per 6 inches of penetration. The penetration

STANDARD SAMPLER*

SIZE	SHOE I.D.	CONNECTION	SPLIT SECTION LENGTH
2" O.D. x 1-1/2" I.D.	1-3/8"	AW	12", 18", 24"
2-1/2" O.D. x 2" I.D.	1-7/8"	AW	12", 18", 24"
3" O.D. x 2-1/2" I.D.	2-3/8"	NW	12", 18", 24"
3 1/2" O.D. x 3" I.D.	2-7/8"	NW	12", 18", 24"
4 1/2" O.D. x 4" I.D.	3-7/8"	NW	18", 24"

* ALSO AVAILABLE IN SOLID BARRELS UP TO 60 INCHES IN LENGTH AND HINGED TYPE SPLIT TUBES

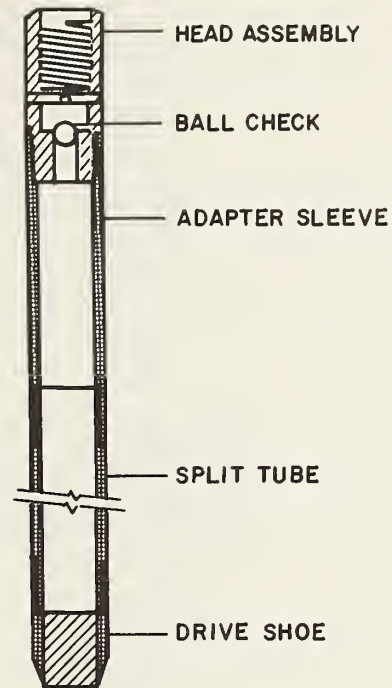

FIGURE 7-19. STANDARD SPLIT-SPOON SAMPLER

resistance (N) is determined by adding the second and third 6-inch penetration resistance blow counts. A penetration rate of 100 blows per foot is normally considered "refusal"; however, this criterion may be varied depending on the desired information. As in the drilling techniques discussed previously in this report, heavy duty 2-5/8 inch N size drill rods should be employed in obtaining drive samples in the deeper and larger diameter borings for stability during the driving operations.

When the relative density of the soil structure is critical (such as liquefaction studies), an automatic trip hammer is commercially available which ensures a 30-inch free-fall drop (Figure 7-20).

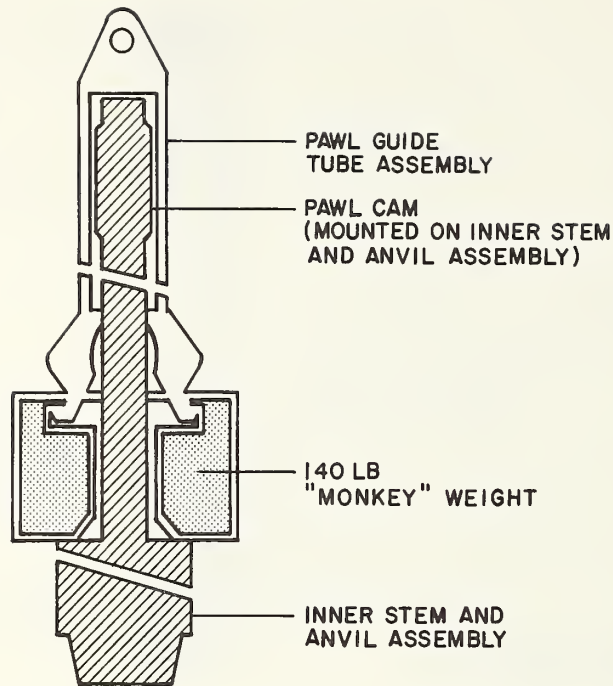

FIGURE 7-20. AUTOMATIC FREE-FALLING TRIP WEIGHT

The relationship between the consistency or relative density of the soils and the dynamic penetration resistance is summarized below:

<u>NON-COHESIVE SOILS</u>		<u>COHESIVE SOILS</u>	
<u>Relative Density</u>	<u>Number of blows per foot (N)</u>	<u>Consistency</u>	<u>Number of blows per foot (N)</u>
Very loose	≤ 5	Very soft	≤ 3
Loose	6 - 10	Soft	4 - 5
Medium dense	11 - 30	Medium stiff	6 - 10
Dense	31 - 50	Stiff	11 - 15
Very dense	≥ 51	Very stiff	16 - 30
		Hard	≥ 31

The majority of the project drive samples were obtained with the 2-in. O.D. split-spoon sampler. However, due to the high in-situ density of the glacial till and the presence of cobbles and boulders, all samples were obtained by driving the split-spoon with a 300-lb. hammer free-falling 24 inches. For sampling consistency, the heavier hammer was used in all dyna-

mic testing and with only a few exceptions, the penetration resistance varied from 100 to in excess of 400 blows per foot, well beyond the range of the standard penetration test application.

Continuous or semi-continuous samples were obtained in the range of the proposed tunnel construction in six of the explorations. This method permitted a more detailed evaluation of isolated and local lenses of cohesive and granular materials which are common within the glacial till unit. The standard sampling interval of 5 feet was maintained in the remaining sampled explorations.

In most instances, sample recovery was good to excellent; however, penetration of the sampler was usually terminated after 6 to 12 inches of penetration. Destruction or loss of the split-spoon is always a potential risk in exceedingly dense and granular materials.

The heavier and larger diameter 3-inch O.D. split-spoon sampler was also used to recover sufficient quantities of glacial till material for laboratory classification testing. The larger diameter split-spoon created excessive penetration resistance or encountered "refusal" on the coarser fractions of the till. The smaller, 2-inch diameter, open drive sampler was found to be more applicable for obtaining representative samples in the glacial till environment within the project area.

All samples were preserved in quart jars for classification purposes and additional laboratory testing.

Obtaining representative samples for engineering analysis with open-drive samplers is standard procedure in geotechnical engineering. The principal advantage of the open-drive samplers is their simplicity in construction and operation and their relative economy for evaluating in-situ soil parameters through widely accepted empirical correlations and recovering representative specimens for classification and laboratory testing. However, there are limitations in open-drive sampling, and reasonable and careful evaluation of the data must be exercised. Several studies have been conducted (deMello, 17-17), (Schmertmann, 9-26), (Ireland, 9-13) which summarize the advantages and disadvantages of the Standard Penetration Test. Some of the disadvantages associated with open drive sampling is that the sample may become highly disturbed or contaminated during penetration and may not be representative of the stratum sampled. Also, excessive hydrostatic pressures or penetration friction may indicate erroneous in-situ relative densities. These acknowledged inconsistencies do not

decrease the practical importance of the open-drive sampler. Precise geotechnical data from penetration resistance is not within the capability of the procedure. Its purpose is to obtain an approximate comparison of the various in-situ geological conditions and to provide samples for classification testing.

In the New England area, costs associated with open-drive sampling and standard penetration testing are usually assimilated into the overall cost of obtaining a drive sample boring in overburden. No additional payment is made for obtaining what is considered to be a normal function of the test boring operation. However, the contract arrangements for this study allowed separate payment for 2-inch and 3-inch split-spoon samples which allowed the drilling contractor to compute a lower uniform rate for overburden drilling exclusive of sampling interval, sample diameter, etc. This contractual procedure eliminates the unknown aspect of the number and type of samples which will be required during the conduct of the work. Contract specifications usually require a "sample at every strata change and not to exceed a 5-foot interval between sampling".

By utilizing this separate payment item for drive sampling, this study and other recent exploration programs indicate that an overall savings of 10 to 12 percent can be realized in the cost of obtaining a basic test boring.

7.4.3 Rotary Core Barrel Sampling

A variety of core barrels, which were originally developed for drilling and sampling of bedrock, have been modified or adapted by the drilling industry to obtain "undisturbed" overburden samples in very dense or partially cemented soils. These core barrels are used when the more conventional piston-type samples (Section 7.4.1) cannot penetrate the selected geological unit.

There are many local variations in the type and mechanics of these core barrels which are commercially available under a variety of trade names. Three of the more popular types of rotary core barrel samplers were used on the project and are discussed herein.

7.4.3.1 DenisonTM Sampler - The Denison core barrel was first developed in 1939 by the Denison District, U.S. Army Corps of

Engineers and is presently manufactured under exclusive patent rights held by the Acker Drill Company, Inc., Scranton, Pennsylvania.

The Denison TM Sampler is designed to recover undisturbed, thin-wall samples in glacial tills, hard clays, partially cemented soils, or soft and weathered rock. The sampler consists of a double-tube, swivel-type core barrel with a non-rotating inner thin-wall steel or brass liner designed to retain the sample during penetration and subsequent transportation to the laboratory (Figure 7-21).

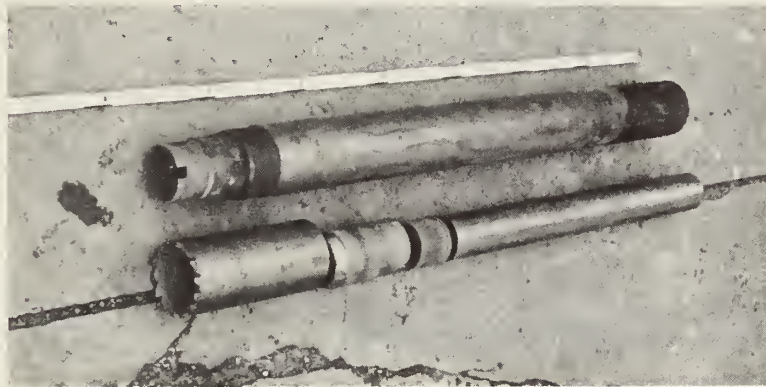

Figure 7-21. DISASSEMBLED DENISON SAMPLER

The inner liner tube of the Denison has a sharp cutting edge which can be extended from zero to about 3 inches beyond the outer rotating cutter bit. The amount of extension can be varied by means of interchangeable saw tooth cutter bits which are preselected, depending on the anticipated formation which is to be sampled. The maximum extension is used in relatively soft or loose soils and a cutting edge flush with the coring bit is used in hard or cemented formations. An important feature of the Denison is a system of check valves and release vents which bypass the hydrostatic pressure buildup within the inner sampling tube, improving sample recovery and minimizing pressure disturbance of the sample.

The Denison Sampler is rotated into the formation in the same manner as conventional rock coring procedures, in either a cased or mudded borehole. The Sampler is designed for use with water, mud or air and is available in five sizes, ranging from 2-15/16 inch O.D. to 7-3/4 inch O.D. A schematic

drawing of the Acker Denison Rotary Core Barrel Sampler is shown in Figure 7-22.

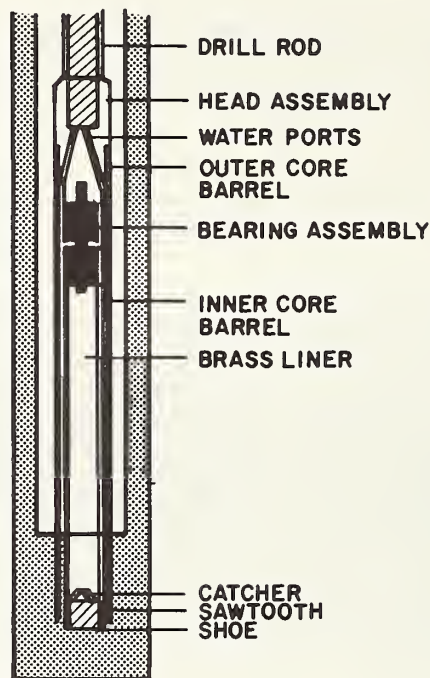

FIGURE 7-22. DENISONTM CORE BARREL

Due to the presence of the glacial till deposits and the anticipated density, the smaller diameter 2-15/16 inch sampler was used on the project. This sampler, which requires a minimal borehole size of 3-1/16 inches, would be more applicable for transit system subsurface exploration programs. The larger the diameter of any sample recovered, the more interior sample disturbance is minimized. This would provide additional laboratory testing operations and increased reliability of data.

Various saw-tooth cutter bit extensions were selected and tested, but all attempts to recover a satisfactory sample were unsuccessful. The lack of success of sample recovery was not due to a deficiency in the Denison Sampler, but due to the high density and the presence of cobbles and boulders in the glacial till. During sampling attempts, the inner sampler tube in the extended position would completely collapse during penetration, or else "refusal" would be encountered on cobbles and boulders which could not be penetrated

with the saw-tooth cutter bit.

Although the Denison TM Sampler was found not to be compatible with the subsurface conditions in the study area, it is considered to be a useful sampling device in dense formations which cannot be sampled by more conventional methods. As with all subsurface exploration procedures and equipment, there are inherent limitations and the most applicable sampling device must be carefully selected for the anticipated subsurface conditions. The unit price for Denison Rotary Core Barrel samples obtained during the course of the study was \$120 per sample.

7.4.3.2 Pitcher TM Sampler - The Pitcher Rotary Core Barrel Sampler is a modification of the Denison sampler which was developed by the Pitcher Drilling Company, Inc., Daly City, California in 1960 and is presently manufactured and distributed by Mobile Drilling Incorporated, Indianapolis, Indiana.

The Pitcher Sampler was also developed to recover undisturbed thinwall samples in formations which are too dense for conventional thinwall sampler penetration. The Pitcher Sampler consists of a single-tube, swivel-type core barrel with a self-adjusting, spring-loaded, inner thin-wall sample tube which telescopes in and out of the cutter bit as the hardness of the material varies. This telescoping aspect eliminates the need to pre-select a fixed inner barrel shoe length as with the Denison Sampler, which cannot be varied once drilling has commenced (Figure 7-23).

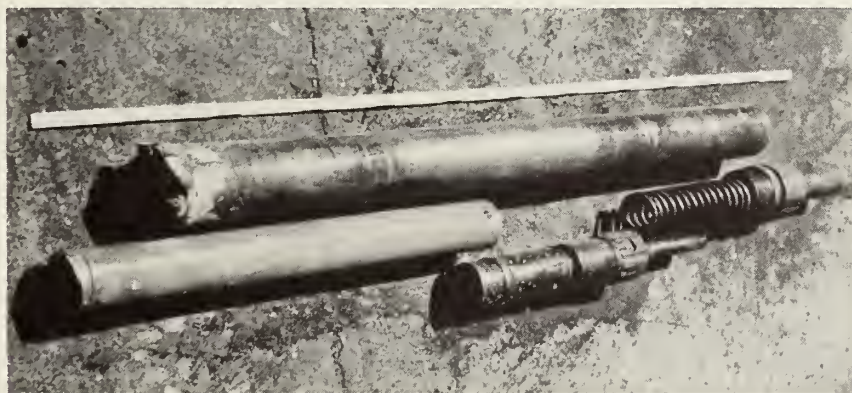

FIGURE 7-23. DISASSEMBLED PITCHERTM SAMPLER

The inner steel or brass thinwall liner tube has a sharp cutting edge which projects a maximum of 6 inches beyond the saw-tooth cutter bit in its normal assembled position (Figure 7-24). As the sampler enters the borehole, a sliding valve directs the drilling fluid through the thinwall sample tube for a thorough pre-flushing of the borehole. The instant the sample tube comes in contact with the bottom of the borehole, it telescopes into the cutter barrel and closes a sliding valve which diverts the drilling fluid to an annular space between the sample tube and the cutter barrel. This sliding valve arrangement allows the circulation of the drilling fluid to remove the borehole cuttings during sampling and prevents disturbance of the recovered sample by the drilling fluid.



FIGURE 7-24. PITCHERTM SAMPLER WITH PROTRUDING SPRING-LOADED INNER SAMPLE TUBE

The spring-loaded inner sample liner automatically adjusts to the density of the formation being penetrated. In very soft materials, the thinwall sample tube will extend as much as 6 inches beyond the cutter bit and as the formation density increases, the sample tube telescopes in the outer core barrel and compresses the control spring, which, in turn, exerts a greater force on the tube to insure adequate lead. In the presence of extremely dense formations or obstructions, the sample tube will retract completely into the outer core

barrel to allow the cutter bit to penetrate the obstruction.

The Pitcher Sampler is also rotated into the formation in the same manner as conventional rock coring procedures in either a cased or mudded borehole. The sampler is designed for use with either water or mud and is available in four sizes, ranging from 2-1/2 inch O.D. to 5-7/8 inch O.D. A schematic drawing of the Pitcher Sampler operation is shown in Figure 7-25.

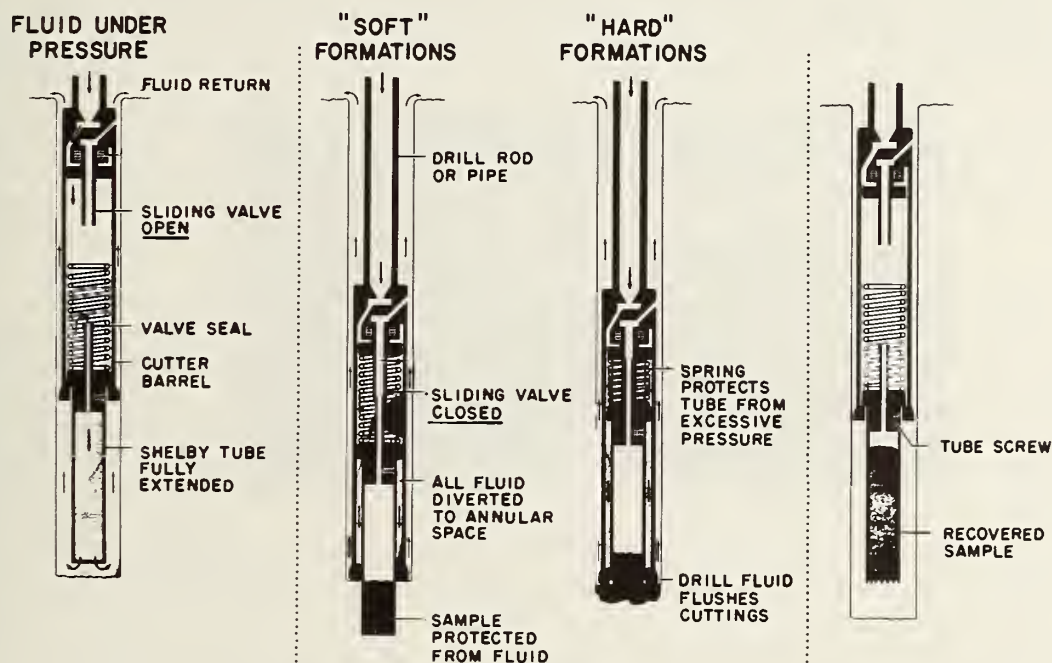

FIGURE 7-25. PITCHERTM SAMPER OPERATION

Due to the presence of the very dense glacial till deposits and the anticipated density at the test section, the more standard 3-inch O.D. sampler was used, requiring a minimum borehole size of 4-7/8 inches. As in any sampling procedure, a larger diameter recovered sample will minimize disturbance and provide additional laboratory testing options and reliability of data. The largest Pitcher sampler available requires a minimum borehole size of 7-3/4 inches.

Pitcher sampling was attempted several times with varying degrees of success and sample recovery. As with the Denison Sampler, the extreme density of the glacial till and the presence of cobbles and boulders prevented total penetra-

tion of the sampler. However, the telescoping aspect of the inner sample tube was a major advantage over the Denison Sampler. When encountering extremely dense material or refusal, the sample tube would retract into the core barrel, preventing collapse of the sample tube. However, as with the Denison, the saw-tooth cutter bit was unable to core completely through the granitic boulders, which effectively stopped the sampling attempt (Figure 7-26). The amount of penetration and recovery was a direct result of the presence and size of the cobbles and boulders within the glacial till unit; however, several satisfactory samples were recovered for subsequent laboratory testing.



FIGURE 7-26. PITCHERTM SAMPLER WITH CORED BOULDER JAMMED IN SAMPLE TUBE

The telescoping aspect of the Pitcher Sampler made it much more practical for sampling in the very coarse granular glacial till than the Denison Sampler; however, it too has its limitations in these very dense and coarse materials.

The unit price for Pitcher samples obtained during the course of the study was \$100 per sample.

7.4.3.3 Diamond Bit Rotary Core Barrel Soil Sampling - Conventional Diamond Bit Rotary Core Barrel sampling is usually associated with the recovery of competent rock core and not normally considered as an overburden soil sampling device. However, as has been discussed, various types of extremely dense or well-cemented overburden with numerous competent boulders can prevent the penetration and subsequent recovery of suitable large-diameter samples with the more typical

drive sample or rotary coring methods.

Rotary core barrels are manufactured in a variety of types and sizes and have reached a high level of sophistication for improving the quality and quantity of sample recovery. Also, by combining other types of modifications within the core barrel, the determination of formation structure and defects is accomplished.

The rotary core barrel is manufactured in three basic types: single tube, double tube, and triple tube. These three basic units all operate on the same principal of pumping drilling fluid through the drill rods and core barrel. This is done to cool the diamond bit during drilling and to carry the borehole cuttings to the surface. A variety of coring bits, core retainers and liners are utilized in various combinations to maximize the recovery and penetration rate of the selected core barrel.

The simplest type of rotary core barrel is the single tube, which consists of a case-hardened, hollow steel tube with a diamond drilling bit attached at the bottom. The diamond bit cuts an annular groove or kerf in the formation to allow upward passage of the drilling fluid and cuttings on the outside of the core barrel. However, the drilling fluid must pass over the recovered sample during drilling and the single tube core barrel cannot be employed in formations that are subject to erosion, slaking or excessive swelling. Although the single tube is a very rugged core barrel and easy to operate, its limitations during sampling of both soil and rock are contributing to its declining application on geotechnical engineering projects (Figure 7-27).

The most popular and widely used rotary core barrel is the double tube, which is basically a single tube barrel with a separate and additional inner liner and is available in either a rigid or swivel-type of inner liner construction (Figure 7-28). In the rigid types, the inner liner is rigidly attached to the outer core barrel so that it rotates with the outer tube. In contrast, the swivel-type of inner liner is supported on a ball bearing carrier which allows the inner tube to remain stationary, or nearly so, during rotation of the outer barrel, a major improvement over the rigid type for sampling of overburden materials. The sample or core is cut by rotation of the diamond bit and is in constant contact with the drilling fluid as it flushes out the borehole cuttings. The addition of bottom discharge bits and fluid control valves to the core barrel system minimizes the amount of

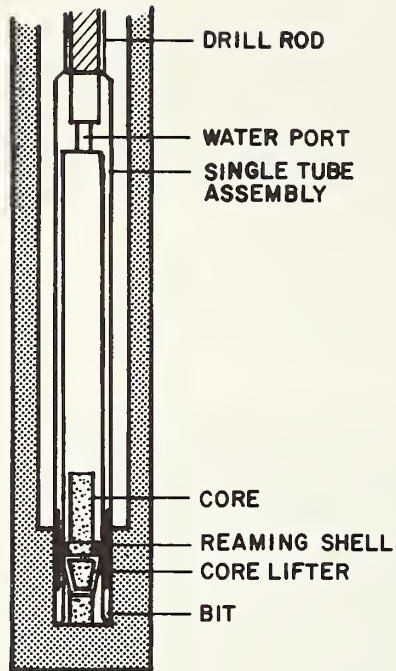

FIGURE 7-27. SINGLE TUBE CORE BARREL

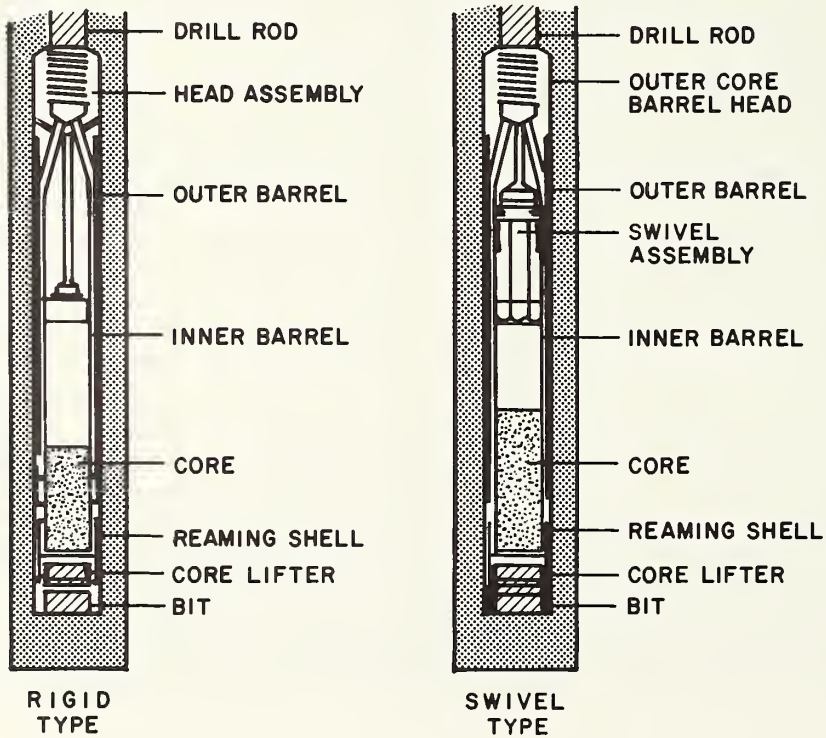

FIGURE 7-28. DOUBLE TUBE CORE BARRELS

drilling fluid and its contact with the sample which further decreases sample disturbance.

Additional modifications in the double tube core barrel such as the Sprague and Henwood Series MTM and Christensen Diamond Products Series DTM are examples of continuing developments by manufacturers to improve sample quality and recovery.

The third and most recent advancement in rotary core barrel design, is the triple tube core barrel which adds another separate, non-rotating liner to the double tube core barrel. This liner, which retains the sample, consists of a clear plastic solid tube or a split, thin metal liner. Each type of liner has its distinct advantages and disadvantages; however, they are both capable of obtaining increased sample recovery in poor quality rock or semi-cemented soils, with the additional advantage of minimizing sample handling and disturbance during removal from the core barrel.

These advanced rotary core barrel types are discussed in more detail in Section 7.5 of this report.

The variety of rotary core barrels which are available range in sizes from 1 to 10 inches in diameter, and the majority of these core barrels may be used with water, drilling mud, or air to recover overburden samples.

A conventional Christensen 2-1/8 inch I.D., NWD3, swivel-type, split-inner liner, rotary core barrel was used on this project and evaluated as an overburden sampling device. Although the difficulties in penetrating the cobbles and boulders within the glacial till unit were overcome by the use of the diamond bit core barrel, the finer portions of the glacial till tended to plug the drilling fluid ports in the bit, cutting off the recirculating fluid supply to the bottom of the borehole. As diamond bits are not designed for coring in soil or extremely weathered rock and are very susceptible to "burning up" under less than ideal conditions, this loss of drilling fluid would effectively terminate the sampling attempt. Although there was a tendency to plug the diamond bit during overburden drilling, there was a sufficient time lag to allow penetration and recovery before this occurred (Figure 7-29).

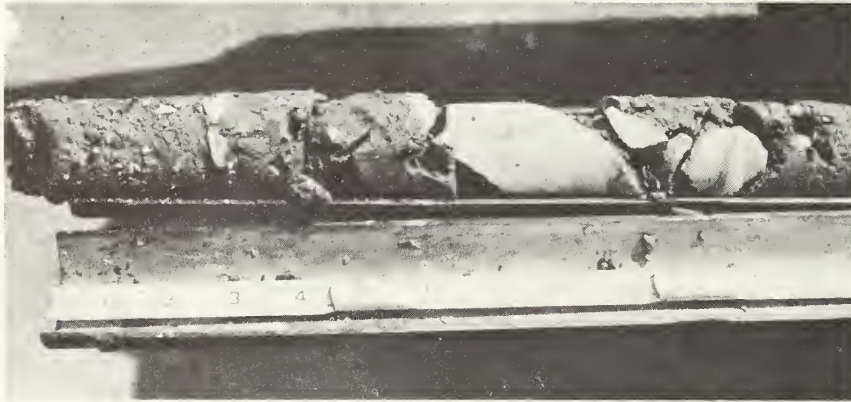

FIGURE 7-29. GLACIAL TILL RECOVERED WITH NWD3TM
SPLIT INNER LINER CORE BARREL

Rotary diamond core barrel sampling will obtain satisfactory representative samples in formations where all other types of sampling devices will not function. However, overburden diamond drilling will tend to destroy the diamond bits very rapidly, and this method is usually used as a last resort. Disposable or scrap diamond bits can be employed if the drilling contractor is made aware of the intentions to employ this procedure.

The project study did not have a separate unit price for overburden diamond drilling. The contractor agreed to a minimal amount of sampling employing this technique and was reimbursed at the rock coring unit price of \$23.00 per foot. This unit price per sample was compatible to the costs associated with open-drive sampling. Normally, overburden diamond drilling costs would be expected to be higher, especially if a substantial amount of this type of sampling was anticipated.

7.5 ROCK CORE SAMPLING

The primary objective of rock core sampling is to obtain continuous and undisturbed cores of the intact rock mass for careful and thorough evaluation of characteristics which may affect its performance during excavation or increased stress.

These characteristics include the following:

- a. Elevation
- b. Lithology
- c. Weathering
- d. Hardness
- e. Structure
- f. Discontinuities
- g. Bedding/Foliation
- h. Mineralogy
- i. Permeability

The rock core samples which are recovered can be further evaluated in the laboratory for such additional engineering properties as compressive strength, elastic modulus and abrasive properties. The completed rock core borehole may be tested and monitored to determine permeability, groundwater conditions, the presence of gas and the squeezing or expansive properties of the rock. The borehole may be further utilized for in-situ testing purposes, geophysical surveying and the installation of various types of monitoring equipment or instrumentation. Rock core sampling can provide substantial geotechnical information in the immediate vicinity of the borehole. However, rock core sampling usually only provides a small amount of information about the overall rock mass, and this information must be extrapolated into engineering decisions for the entire formation.

Careful observation and evaluation during drilling and logging of the recovered core is absolutely essential to any site investigation program.

The rock coring procedures and equipment which were first developed in 1863 by Leschot, a Swiss engineer, are still basically the same; a hollow steel tube equipped with a diamond bit is rotated into the rock surface. However, major improvements in the core barrels, diamond bits and associated equipment have created very sophisticated rock core sampling devices. Diamond rock drilling methods have been generally standardized by the American Society for Testing and Materials (ASTM D-2113-70). To facilitate standardization of equipment, the Diamond Core Drill Manufacturer's Association (DCDMA) have established standard sizes for bits, shells and casings. The various DCDMA size standards for core barrels and bits are summarized in Table 7-2.

The primary purpose of any type of core barrel is to recover the total amount of rock which is physically cored

TABLE 7-2. CORE BARREL AND BIT DIAMETERS

DESCRIPTION	RX	EX	AX	BX	NX	HX	PX	SX	UX	SX
	or RW	or EW	or AW	or BW	or NW	or HW	or PW	or SW	or UW	or ZW
Bit Set Normal I.D.	0.750	0.845	1.185	1.655	2.155	3.000	--	--	--	--
Bit Set Normal and Thinwall O.D.	1.160	1.470	1.875	2.345	2.965	3.890	--	--	--	--
Bit Set Thinwall I.D.	0.735	0.905	1.281	1.750	2.313	3.187	--	--	--	--
Shell Set Normal and Thinwall O.D.	1.175	1.485	1.890	2.360	2.980	3.907	--	--	--	--
Casing Bit Set I.D.	1.000	1.405	1.780	2.215	2.840	3.777	4.632	5.632	6.755	7.755
Casing Bit Set and Shoe O.D.	1.485	1.875	2.345	2.965	3.615	4.625	5.650	6.780	7.800	8.810

in a relatively undisturbed state. When drilling in competent rock, total recovery is rarely a problem; however, when the formation is highly weathered, fractured or soft, the amount of core recovery is problematic. The strength and behavior of the rock mass are primarily dependent upon the various inherent discontinuities and the material which is not recovered may have significant engineering implications.

Of the three basic types of core barrels which were discussed in the previous section of this report, the double tube core barrel is most frequently used in rock core sampling for geotechnical engineering applications. The triple tube core barrel is used in zones of highly variable hardness and consistency. The single tube, because of its sample recovery and disturbance problems, is rarely used.

The selection of the most practical core barrel for the anticipated bedrock conditions is important. The selection of the correct diamond bit is also essential to good recovery and drilling production. Although the final responsibility of bit selection is usually the drilling contractor's, there is a tendency in the trade to use "whatever happens to be at hand". The selection of the diamond size, bit crown contour and number of water ports is dependent upon the characteristics of the rock mass and the use of an incorrect bit can be detrimental to the overall core recovery. Generally, fewer and larger diamonds are used to core soft formations and more

numerous, smaller diamonds are used in hard formations which are mounted on the more commonly used, semi-round bit crown. Special impregnated diamond core bits have been recently developed for use in severely weathered and fractured formations where bit abrasion can be very high.

Typical rock core sampling involves the use of the open diamond bit. However, numerous types of coring and non-coring, non-diamond bits are available which may be used in conjunction with the rock core sampling operation. An excellent summary of drilling equipment and bits is presented by W.L. Acker III in Chapters 10 and 11, "Basic Procedures for Soil Sampling and Core Drilling", (Acker, 8-1).

There is a variety of diamond bit core barrels which have been developed for a variety of formation conditions by various manufacturers. The selection and evaluation of the rock core sampling equipment used on this project are not intended to imply that other equipment would not be equally suitable to the given circumstances.

Rock core sampling equipment from three different manufacturers are evaluated and discussed in detail below:

- a. Christensen NWD3 Double Tube Core Barrel,
- b. Acker NWM3 Triple Tube Core Barrel,
- c. Sprague & Henwood HXWL Triple Tube Core Barrel,
Sprague & Henwood RWT Single Tube Core Barrel.

The Sprague & Henwood core barrels were used in association with the advanced integral rock sampling method and are discussed in Section 7.5.3.

The core sizes recovered for this project range from RW to HX (Figure 7-30).



FIGURE 7-30. TYPICAL STUDY ROCK CORE SIZES

7.5.1 NWD3TM Double Tube Core Barrel

The Christensen Diamond Products NWD3, 2-1/2 inch I.D. swivel type, double tube core barrel equipped with a semi-round crown MR40TM (40 stones per carat) diamond bit was the primary rock core sampling device used for this project. In addition, a 17 stones per carat "scrap bit" was selectively used in the softer, fractured materials and a 60 stones per carat (HR60TM), step taper bit was used in the more competent zones of the bedrock. However, the MR40 bit, which was developed for medium hard, fractured rock drilling obtained excellent recovery results throughout all formation changes and was used as the project "all purpose" bit on the majority of the rock core sampling. Of a total of 59 separate rock core drilling runs, 94 percent of the rock which was drilled was recovered. Forty-five core runs obtained 100 percent recovery and 8 runs recovered 90 percent or better. The lower core recovery of the remaining 6 runs ranged from 18 to 75 percent, and in almost all instances was associated with the initial core run in the upper surface of the fractured rock.

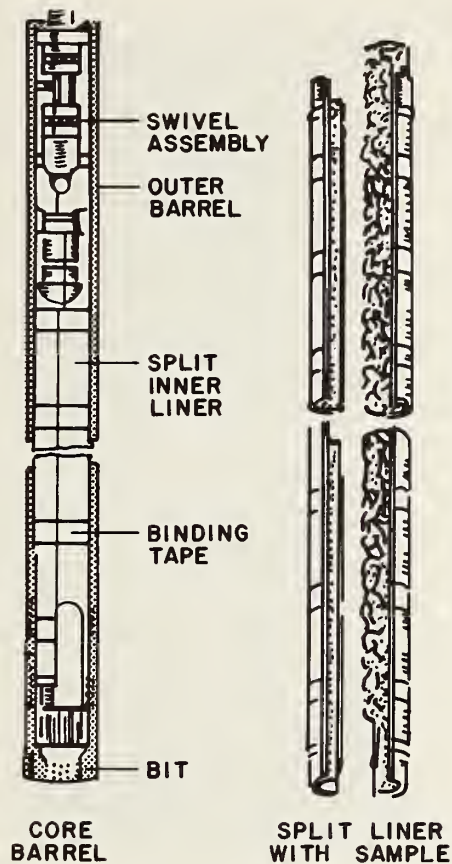

FIGURE 7-31. NWD3TM SPLIT-INNER LINER
CORE BARREL

The Christensen NWD3 double tube core barrel offers a non-rotating, adjustable, chrome-plated inner liner which is available in either solid or split tube versions (Figure 7-31).

There are several unusual but highly successful modifications in this barrel which include:

- a. Core barrel disassembly from the top or back of the tube prevents excessive wrench handling of the diamond bit and core lifter assembly.
- b. Adjustable inner liner annulus which controls the amount of fluid circulating through the core barrel. The amount of water which is required for drilling is a function of the quality of rock. This capability allows the core barrel to be adjusted to accommodate these changes, rather than to be entirely replaced.

- c. Rapid inner tube conversion from solid to split liner without special tools or replacement kits.

Depending on the quality of the rock being cored, the NWD3 was alternately used in the solid and split-inner liner modes. The solid liner was used primarily in the very sound and competent portions of the rock while the split liner was used in the weaker and more weathered portions. The design of the split-inner liner allows expansion of the two liner halves during the core recovery process. This feature allows swelling clays or highly fractured material, which could normally block a conventional solid liner, to move up into the liner, reducing blockage and grinding of the core and improving recovery in lower quality rock. An additional and major advantage of the split liner is observed during subsequent surface handling of the recovered core. The inner liner is easily removed from the core barrel and the filament tape which binds the liner halves together is cut and the two sections separated, exposing the recovered core in its near in-situ state (Figure 7-32). This design feature of the split liner eliminates the necessity of "banging out" the core (beating on the outside of a solid core barrel with a hammer in an attempt to loosen the sample), as is done with the conventional solid liner. This could severely disturb and alter the quality of the recovered core, leading to erroneous conclusions about the overall rock mass.

The split-inner liner is used in a variety of types and sizes of double tube core barrels. The capability of improving recovery in poor quality rock and the subsequent surface handling advantages, makes it a useful equipment addition for the purpose of rock core evaluation.

Approximately 200 feet of rock coring was obtained in the Holiday Inn Site area. The unit prices of \$19.00 per foot for double tube solid liner coring and \$23.00 per foot for double tube split liner coring are typical N core size unit prices in the New England area. Less core barrel jamming and blockage was experienced with the higher priced split liner. This had the overall effect of decreasing the drilling time per foot when compared to the production rates of the solid liner.



FIGURE 7-32. FULL RECOVERY OF ARGILLITE
IN NWD3TM SPLIT LINER

7.5.2 NWM3TM Triple Tube Core Barrel

The Acker Drill Company, Inc. NWM3, 2-1/8 inch I.D. swivel-type, triple tube core barrel equipped with a flat crown, series M, bottom-discharge bit was used in only limited application on the project study. The NWM3 is a modification of the Series M double tube core barrel, which includes an additional inner solid clear plastic liner which retains the sample recovery (Figure 7-33).

The purpose of the third, non-rotating inner liner is to further improve sample recovery in soft or highly fractured formations and to provide a temporary storage container for the recovered rock core during transportation and storage. The sample must subsequently be pressure extruded from the solid plastic liner.

The NWM3 offers an adjustable inner liner which can control the flow of water to the bit, an important design feature in variable formation conditions. The use of the bottom

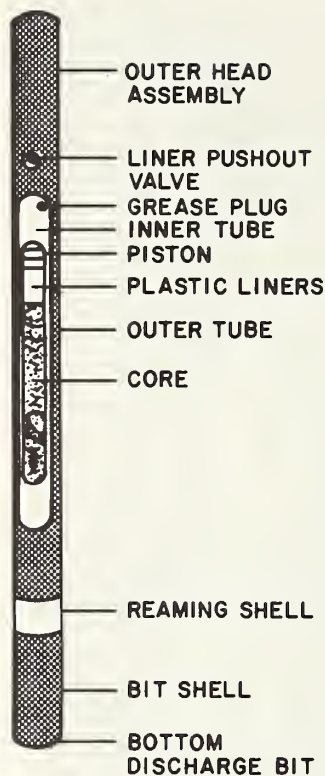

FIGURE 7-33. TRIPLE TUBE CORE BARREL WITH SOLID CLEAR PLASTIC LINER

discharge bit also minimizes the amount of drilling fluid contact with the recovered sample, decreasing the erosive action in highly decomposed rock.

The NWM3 triple tube core barrel is an important advancement in drilling technology that improves recovery in formations which are difficult to sample with conventional core barrels. On this project, the non-expanding aspect of the inner solid plastic liner caused some sample blockage during drilling. A special hydraulic or pneumatic jack is required for inner tube removal and subsequent sample extraction from the inner tube. Although the solid plastic sample liner tube has definite advantages during transportation and storage, it impeded field examination, photographing, and evaluation of the core immediately upon recovery.

The project unit price of \$23.00 per foot for triple tube rock coring is believed to be slightly lower than the regional average unit price when employing this sampling technique.

7.5.3 Integral Sampling Method (ISM)

The determination of the various bedrock discontinuity parameters, which affect the strength and stability of a rock mass, is of critical importance in the design and construction of underground openings in rock. The structural integrity of the rock mass is affected by the presence and orientation of such features as bedding, jointing and faulting, and also by the spacing, continuity, planarity and infilling of these discontinuities.

The primary method of evaluating the geotechnical parameters relies upon measurements and observations of exposed bedrock in the area of the proposed construction. These outcrops may or may not reflect the actual in-situ conditions of the bedrock unit at depth. In urban areas, such as the proposed Red Line Extension, bedrock outcrops are very limited and far removed from the actual area of construction. Typical subsurface exploration programs, which are initiated to obtain information about the structural defects of the bedrock, may lack the detail required for a reasonable assessment of these characteristics. Grinding of the rock core, poor recovery and washing out of the gouge and infillings during the drilling operation create erroneous conclusions regarding the quality of the in-situ rock mass. In addition, these conventional exploration methods are not capable of determining the orientation of the overall bedrock structure or the discontinuities.

Various geophysical methods have been developed which obtain selective information on the structural characteristics of the in-situ rock mass, but there is no "all purpose" geophysical method or combination of methods which will obtain all the necessary information for a thorough evaluation of the in-situ rock properties.

Several subsurface exploration methods recently developed are capable of obtaining the structural orientation of the planar features of the in-situ bedrock. (Rosengren, 8-29) (Rowley, 8-30) (Moelle, 8-23). However, these techniques are combined with conventional diamond core drilling and are not

capable of recovering totally intact, undisturbed, continuous samples of the bedrock.

A method that combines structural orientation with total intact rock sample recovery is the "Integral Sampling Method" (ISM), developed by Manuel Rocha in 1970 during his tenure as Director of the National Laboratory of Civil Engineering (LNEC) in Lisbon, Portugal.

This technique, which was developed in the laboratory and thoroughly field tested by LNEC, is capable of obtaining totally intact rock core which can be used in measuring the orientation and frequency of occurrence of discontinuities within the rock mass. It further allows the observation and measurement of the thickness and consistency of fault gouge and joint filling material and their relative positions (Rocha, 8-27).

In 1975, the Geomechanics Division of the National Mechanical Engineering Research Institute, South African Council for Scientific and Industrial Research (CSIR) developed another prototype method for obtaining integral rock samples (Orr, 8-26). Although the CSIR method has not been thoroughly field tested under actual site investigation conditions, it is also capable of obtaining the same in-situ rock formation as the LNEC method.

The details of the two integral sampling methods are summarized below:

7.5.3.1 The LNECTM Integral Sampling Method - A conventional cased borehole with the required inclination is drilled to the depth where structural information on the bedrock unit is desired. The ISM core can then be recovered in NX (3 in.) and HX (3-7/8 in.) sizes, depending on the anticipated quality of the bedrock. The recovery of the ISM core sample is achieved in three basic operational phases.

Phase I:

A stabilizing guide assembly, having an outside diameter slightly less than the diameter of the borehole, is installed at the bottom of the hole. A small diameter pilot hole, approximately 1-1/4 inch in diameter, is drilled into the intact rock below the stabilizing guide assembly with an RWT size coring or non-coring diamond bit. The stabilizing assembly maintains the pilot hole in coaxial alignment with the primary borehole (Figure 7-34). When the pilot hole is com-

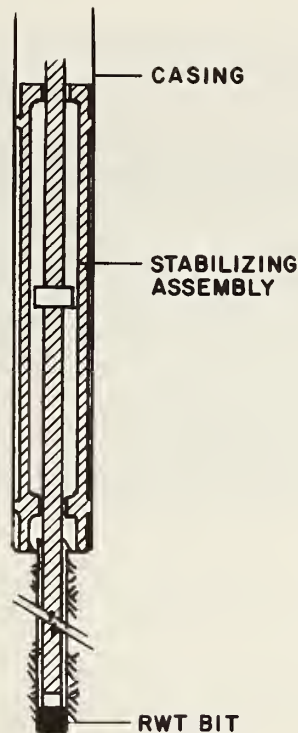

FIGURE 7-34. ISM PHASE I, RWT PILOT HOLE DRILLING AND STABILIZING ASSEMBLY

pleted, the pilot drill and stabilizing assembly is removed from the borehole.

PHASE II:

A second stabilizing guide assembly, which incorporates a detachable grout/reinforcing/orienting (GRO) perforated steel reinforcing tube, is lowered into the borehole so that the GRO tube extends into the pre-drilled RWT pilot hole. The GRO tube is connected to the surface with a string of interlocking, aligned, hollow orienting rods. A special orienting device is attached to the orienting rods and visually aligned with a permanent landmark whose directional bearing from the borehole may be determined at a later date (Figure 7-35).

A predetermined amount of cement or chemical grout is then injected through the orienting rods and GRO tube into the voids and fractures around the pilot hole. After the grout is allowed to solidify, the GRO assembly is sheared off above the grout rod and recovered from the borehole (Figure 7-36).

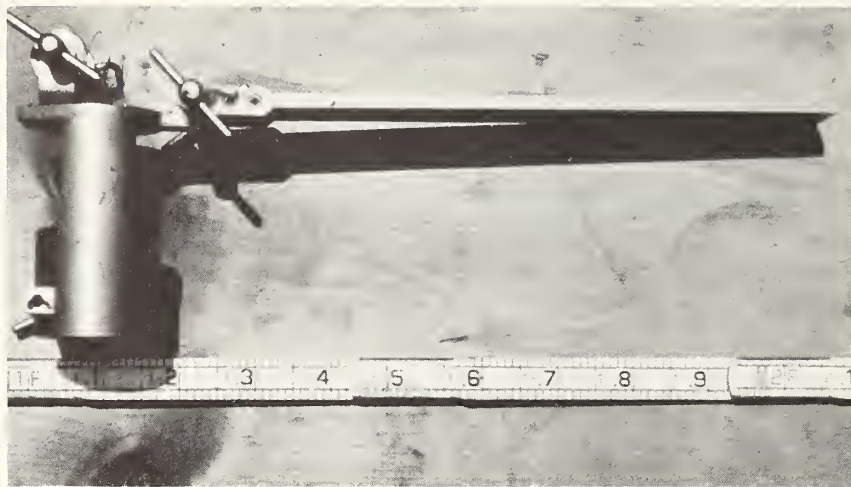

FIGURE 7-35. ISM ORIENTING SIGHT ASSEMBLY

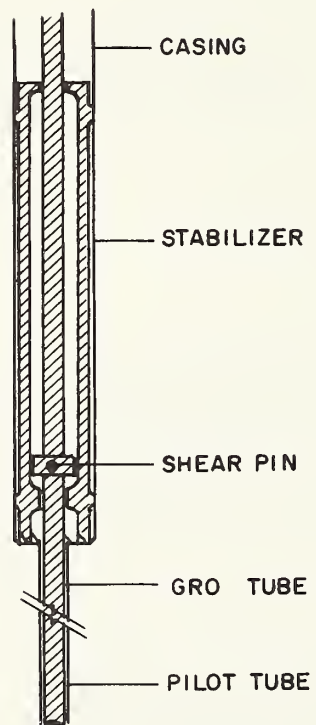

FIGURE 7-36. ISM PHASE II, GRO TUBE AND STABILIZING ASSEMBLY

PHASE III:

The solidified grout bonds the fractured rock to the oriented GRO reinforcing rod and the entire installation is overcored with a conventional core barrel, usually of the same diameter as the basic borehole (Figure 7-37). A variety of core barrels are suitable for the overcoring phase, although one equipped with a split-inner liner is preferred. The core barrel is retrieved in the normal manner and the intact integral rock sample is evaluated for structural defects,



FIGURE 7-37. ISM PHASE III, OVERCORING
GROUT REINFORCED GRO TUBE

7.5.3.2 The CSIRTM Integral Sampling Method - The Integral sampling technique developed at the CSIR follows the same basic procedures developed by LNEC and summarized above. However, there are several major differences in the equipment and specific methods relating to the insertion of the grout medium and the use of PVC grout/reinforcing/orienting rods.

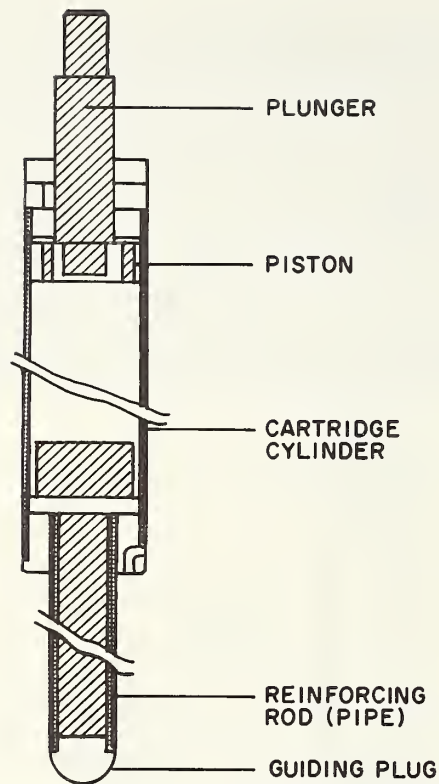

FIGURE 7-38. CSIR RESIN CARTRIDGE AND REINFORCING PIPE ASSEMBLY

A reinforcing rod manufactured from PVC is used in order to preclude damage to the drill bit in case any eccentricity occurs during the overcoring process. A resin-filled cartridge is attached to the reinforcing rod, eliminating the need for surface grout reservoirs and pumps (Figure 7-38).

The resin cartridge is manufactured from commercially available PVC tubing and a wooden plunger. The system is manually operated at ground surface and displaces the resin through randomly drilled holes in the PVC grout rod. A saw cut groove along the long axis of the PVC is used for orienting the core in the same manner as the LNEC method.

An NX size, double tube core barrel was used by CSIR in the overcoring process and excellent results have been obtained (Orr, 8-26).

7.5.3.3 Previous MBTA Red Line Extension Application - The integral rock sampling method was first applied in the New England area in June 1977 in the design explorations for the proposed new Harvard Square MBTA station. Several ISM explorations were obtained using equipment patented by Sprague & Henwood, Inc., Scranton, Pennsylvania, utilizing the LNEC system developed by Rocha. Subsequent to the "on-the-job" familiarization with the various equipment and operational procedures, several excellent integral rock core samples were recovered (Figure 7-39). However, the extremely weathered conditions at the top of bedrock prevented good recovery of the initial core run.



FIGURE 7-39. HARVARD SQUARE ISM CORE

Difficulty was experienced in selecting a grouting material which would have a high bonding strength and minimal setting time. Plaster-of-Paris™, because of insufficient strength and Portland™ cement, because of excessive setting time, were determined to be impractical and impeded production. Epoxy resins possessed excellent strength characteristics but required 6 to 8 hours setting time and special down-hole injection apparatus. U.S. Gypsum B-11 Hydrocal-C™ cement, which possessed sufficient bonding strength and a setting time of 2 to 4 hours, was eventually used with the majority of the integral rock core samples.

Overcoring was accomplished with an NX size, double tube core barrel which presented major difficulties during extraction of the rock core from the inner barrel.

The integral rock sampling conducted at Harvard Square showed that the rock mass was of a higher quality than would

be inferred from conventional NX size rock core.

7.5.3.4 Study Application - The proposed Davis Square MBTA Red Line Station in Somerville, Massachusetts was selected as the location for evaluating the integral sampling method. The ISM rock coring also supplemented existing design information for the proposed cut-and-cover excavation which will require up to 10 feet of rock core excavation.

A Mobile B56 truck mounted, hydraulically operated, rotary drill rig, using patented ISM equipment furnished by Sprague & Henwood, was used in obtaining one grout reinforced, oriented core hole during June 1979. A Sprague & Henwood representative familiar with the integral sampling method and equipment spent 2 days at the site briefing the investigators on its recommended use and application.

Several modifications to the equipment and materials were made prior to the start of the field work. These changes were made based on the experiences during the Harvard Square work in 1977. To further improve recovery and to facilitate the removal of the recovered core from the overcore barrel, a 3.75 O.X. x 2.40 I.D. HXWLTM triple tube, split-inner liner, wireline core barrel was used during the overcoring phase of the ISM sampling (Figure 7-40). Although this core barrel is referred to as a "wireline", it was not utilized in that capacity due to the relatively shallow depth to the bedrock. The removal of the split-inner liner of the HXWL core barrel requires a special hydraulic pump which gently removes the split tube from the inner liner, decreasing the post recovery disturbance of the core to a minimum (Figure 7-41).

In order to decrease the setting time of the reinforcing grout, and thereby increase the overall production time, several new grouts were evaluated. U.S. Gypsum B-11 Hydrocal-C, which was the primary grout used during the Harvard Square application, possessed a setting time of 2 to 4 hours. U.S. Gypsum White Hydrocal-BTM, used as a primary study grout, possessed a setting time of one-half to one hour. Although this rapid setting time improved the overall ISM production, there is a tendency for long-term breakdown of the grout during sample storage. Furthermore, if procedural difficulties should be encountered subsequent to the grout installation, the rapid setting time could impede corrective action and adequate sample recovery. Calcium Aluminate cement manufactured by Lone Star LaFarge, Inc., Norfolk, Virginia, was

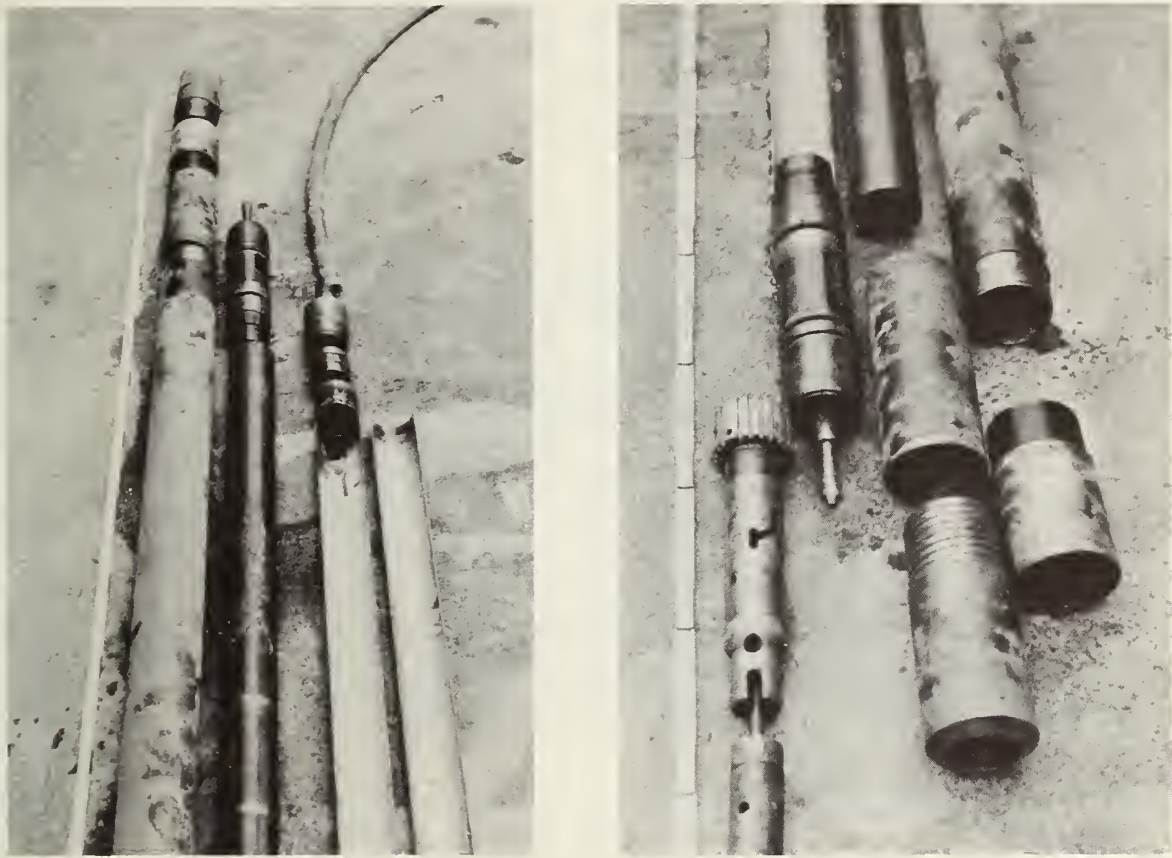

FIGURE 7-40. SPRAGUE & HENWOOD HXWLTM TRIPLE TUBE
SPLIT-INNER LINER CORE BARREL

also evaluated as a grout material. The setting time varied from 8 to 12 hours, and this grout was used at the end of the work day, when overnight setting did not affect the overall production. Calcium Aluminate grout possesses excellent long-term bonding characteristics. Several additional equipment modifications were made during the execution of the work and are discussed below.

Four-inch inside diameter HW flush joint casing was driven to the top of the bedrock, at a depth of about 50 feet, and the borehole cuttings were thoroughly washed out using conventional rotary wash boring methods. The stabilizing guide assembly was lowered into the borehole and the coaxial pilot hole was drilled with a 3/4-inch I.D. RWT diamond bit, single tube core barrel (Figure 7-42).

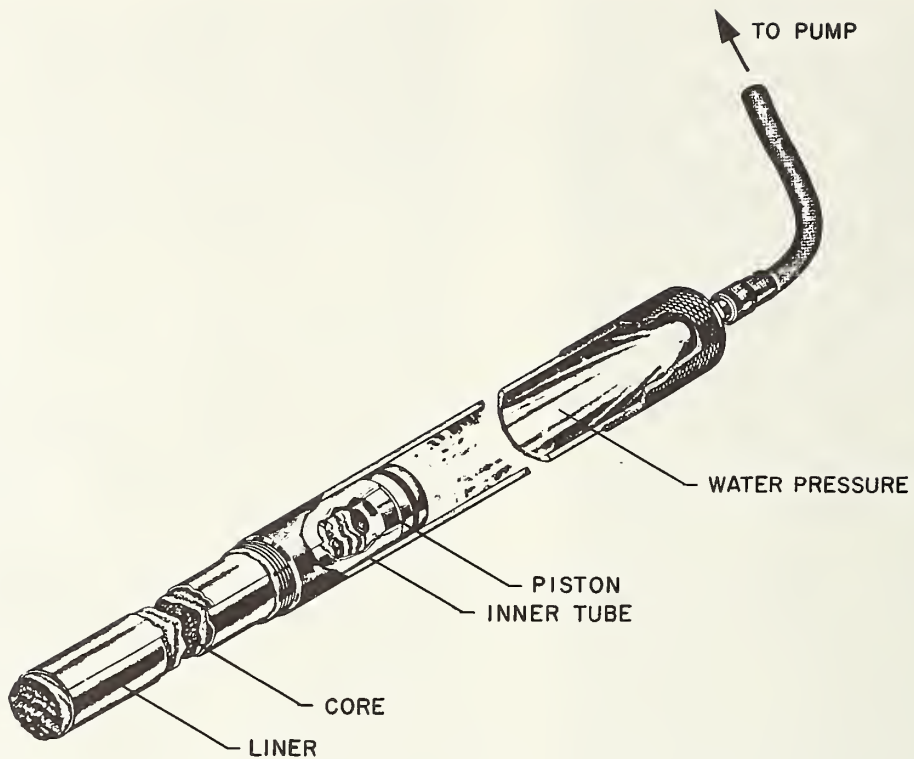

FIGURE 7-41. HYDRAULIC REMOVAL OF SPLIT-INNER LINER FROM HXWL CORE BARREL

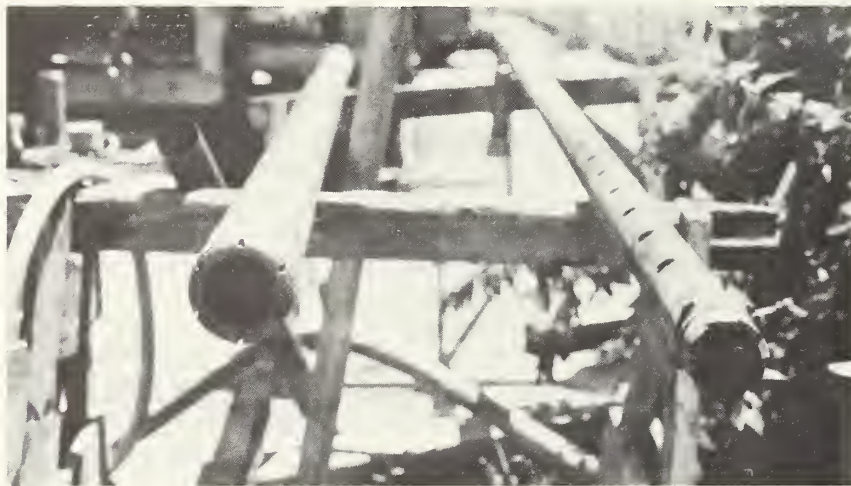

FIGURE 7-42. ISM CORE BARRELS: HXWL OVERCORE BARREL (LT.) AND RWT PILOT CORE BARREL WITH STABILIZING ASSEMBLY (RT.)

Extreme difficulty was experienced during this initial pilot hole coring with the core jamming the core barrel. This eventually plugged and totally destroyed the diamond bit (Figure 7-43). Various bit rotational speeds were evaluated and bit pressures were less than the total weight of the drill rods and core barrel.



FIGURE 7-43. RWT CORE AND DESTROYED BIT

The drilling spindle was rotated at its slowest speed of 75 rpm and the MoynoTM Progressive Cavity Pump was operated at its maximum capacity to assist in cooling the diamond bit and flushing the borehole cuttings to the surface. Diamond bit plugging continued, contributing to the complete destruction of two new RWT diamond bits in the upper 2 feet of the bedrock. The RWT bits, manufactured by the J.K. Smit Company, contained three, very small, water ports in the reaming assembly, which were enlarged by the investigators to increase water flow to the diamond bit. In addition, a positive displacement piston pump was added to the water recirculation system which gave improved pressure monitoring of the bit water flow during drilling. These equipment modifications greatly improved the pilot hole drilling; however, one additional RWT bit was "burned up" during the conduct of the work. It could not be determined if the bit design or the application was the contributing factor, as the RWT bits were the only ones available during the study evaluation.

Non-coring RWT size bits would minimize the problems

associated with the initial pilot hole coring in excessively fractured rock; however, no core would be recovered.

Upon removal of the stabilizing and pilot coring assembly, it was discovered that the highly fractured rock had collapsed into the pilot hole. This prevented insertion of the grout/reinforcing/orienting (GRO) rod into the small diameter coaxial pilot core hole. The upper portion of the rock was overcored in the normal manner to remove the disturbed and fractured rock from the borehole (Figure 7-44).

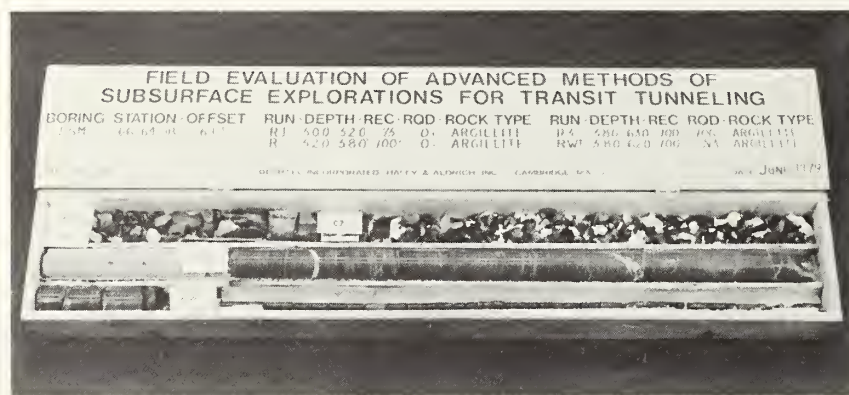

FIGURE 7-44. DAVIS SQUARE ISM ROCK CORE

The HW casing was redriven into the overcored portion of the rock to stabilize the upper portion of the highly fractured bedrock. It is estimated that 500 gallons of water per one-half hour were lost into the rock during the drilling operations in the upper 8 feet of bedrock.

A second RWT pilot hole was drilled from 52 to 57 feet with some core barrel jamming and the loss of an additional RWT diamond bit. The GRO assembly was successfully installed into the pilot hole and White Hydrocal cement grout was injected by gravity flow into the reinforcing tube.

The orienting rods were connected to the surface and the scribe marks were oriented to a permanent physical feature (Figure 7-45). Approximately 2 hours of setting time were allowed to insure adequate bonding of the grout, although a test sample indicated a total set time of less than one hour. The GRO tube was disconnected from the orienting rods by shearing the shear pin with a sharp hammer blow at the top of the orienting rods (Figure 7-46).



FIGURE 7-45. ORIENTING THE ISM CORE

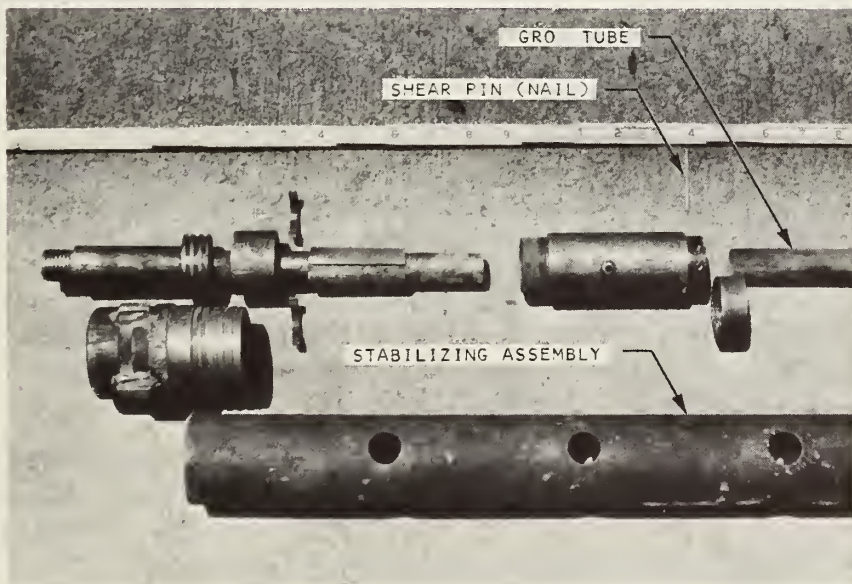

FIGURE 7-46. DISASSEMBLED GRO TUBE SHOWING CONNECTION OF GRO TUBE TO ORIENTING RODS WITH SHEAR PIN

The oriented and grouted section of the rock was over-cored with the HXWL triple tube, split-inner liner core barrel. Recovery of the highly fractured argillite was 100 percent. However, only traces of grout were observed at the bottom of the core run and it was assumed that the grout had flowed into the fractured rock beyond the limits of the over-coring operation (Figure 7-47).

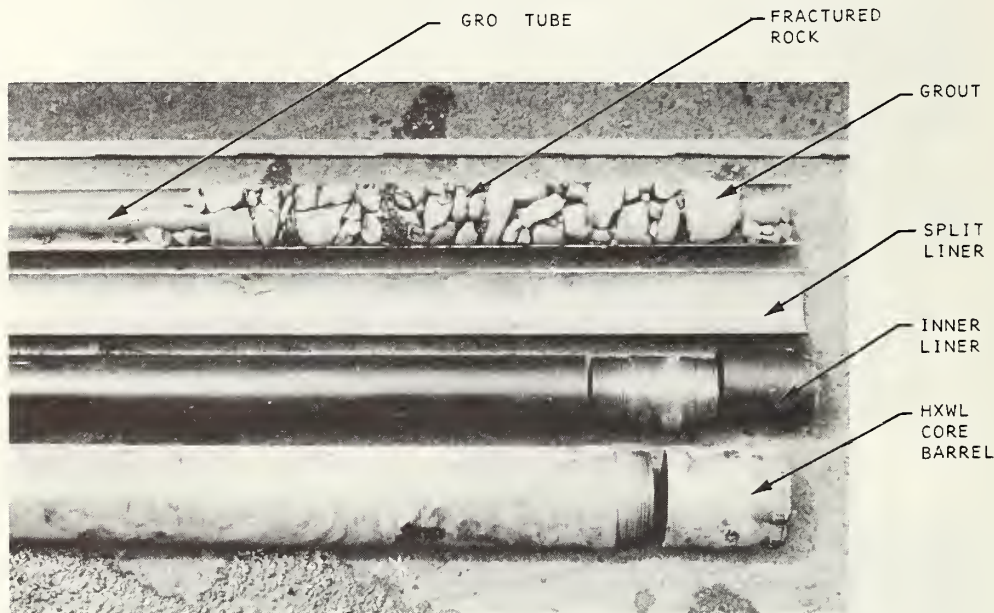

FIGURE 7-47. ISM CORE RECOVERED WITH HXWL OVERCORE BARREL WITHOUT PROPER GROUT INJECTION

To improve stability of the upper rock surface and to decrease the excessive water loss during drilling, the upper 8 feet of fractured rock were pressure grouted before commencing the third and final ISM core run.

With the various equipment modifications and improved drilling technique, the RWT pilot hole was drilled an additional 5 feet without experiencing difficulties. The GRO assembly was installed and oriented and Calcium Aluminate grout was injected by gravity flow and allowed to set overnight. The reinforced grouted section of rock was overcored. Recovery was 100 percent of a very sound, fresh argillite

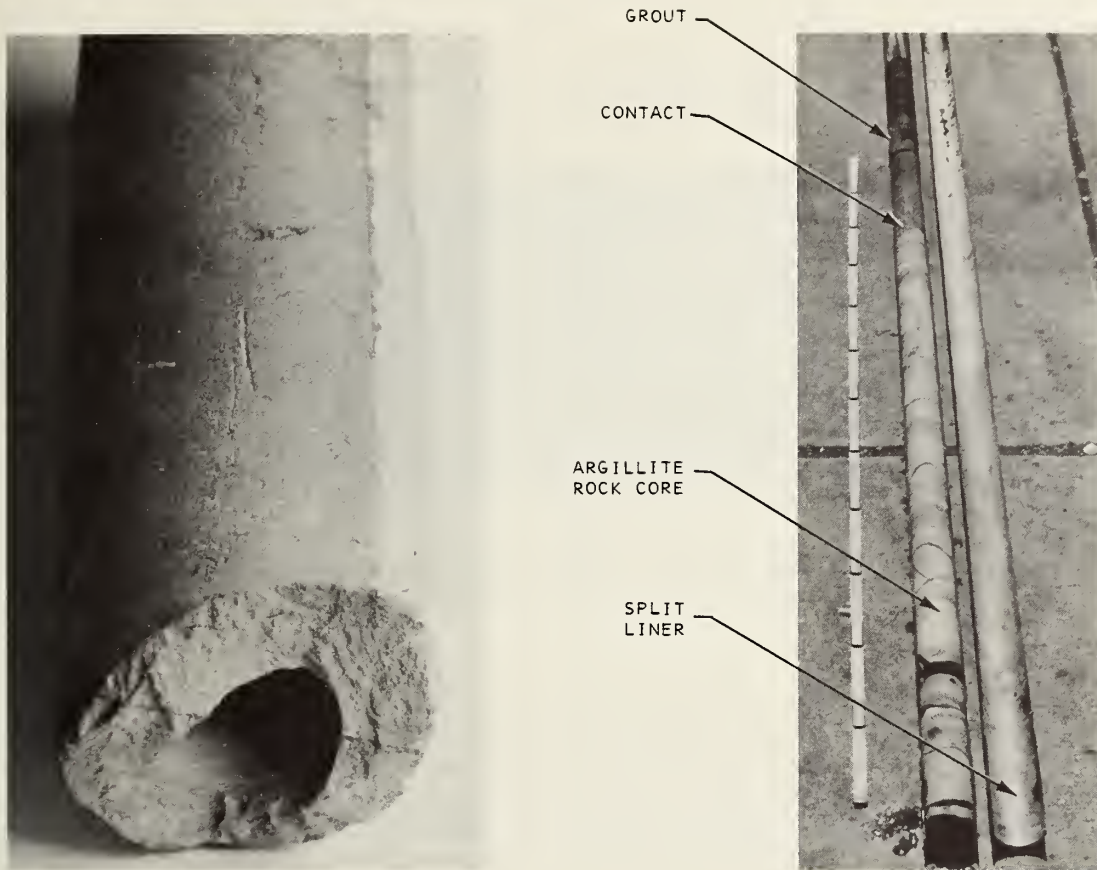

FIGURE 7-48. ISM ROCK CORE

(Figure 7-48). The absence of any open joints or fractures in the rock caused the grout to pass up the pilot hole to the top of the rock core where it solidified. The structural orientation of the few widely spaced tight joints and calcite veins were determined and are summarized on the ISM Subsurface Exploration Summary, Appendix page C-44.

The Integral Sampling Method for rock is a relatively new and sophisticated technique for obtaining total intact core recovery which accurately represents the in-situ rock mass conditions and its approximate structural orientation. A drilling crew thoroughly familiar with all phases of the procedure and equipment is essential. No rules appear to be available to help a newcomer cope with initial difficulties. Many of the initial problems which were encountered were probably due to driller unfamiliarity with the equipment.

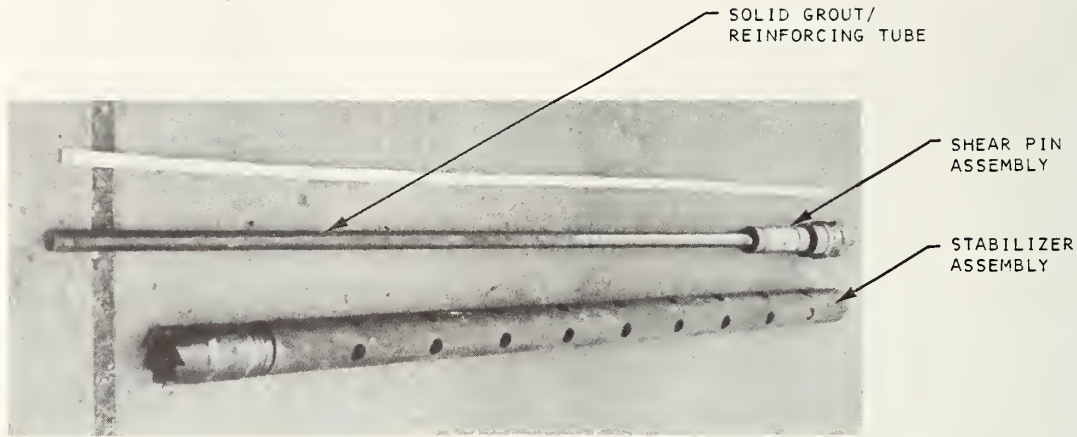

FIGURE 7-49. GRO STABILIZING ASSEMBLY WITH SOLID GROUT/REINFORCING TUBE

However, minor equipment modifications improved the technique and decreased the associated drilling problems. A wider selection of RWT size diamond coring and non-coring bits should be readily available to meet the varying bedrock types and conditions. The application of the double or triple tube, split-inner liner further improves recovery and eliminates excessive disturbance associated with core sample removal.

The grout reinforcing rods furnished by Sprague & Henwood (S&H) consisted of a five-foot, 3/4 inch I.D., heavy wall solid steel pipe (Figure 7-49). This unit was also used during the Harvard Square application in 1977 and some difficulty was experienced in bonding of the grout rod to the rock. The methods developed by LNEC and CSIR indicate that randomly drilled holes in the GRO tube were an integral part of the ISM equipment. If this feature was added to the S&H equipment, it would improve grout transmission into the adjacent rock and greatly improve the bonding characteristics between the rock and the GRO tube.

Although application of the integral sampling method was limited during the study, it appears that highly fractured, open-jointed rock may require intensive on-site testing and modification of grouting techniques, including multiple stage grout. There is no way to determine the extent of the movement of the premeasured grout into the rock mass. If additional grout is added to compensate for these types of struc-

tural discontinuities, there is a high risk that the grout may move up into the borehole and grout the entire installation in place.

As with any subsurface exploration technique, the limitations must be determined and understood. However, the ISM is presently the only technique which can recover totally intact, oriented core of moderately fractured rock for detailed structural and engineering analysis.

7.5.3.5 Cost - The study contract arrangements for conducting ISM were based on a lump sum, minimal monthly rental rate of \$4,400.00 for all equipment, materials and necessary supplies. The actual drilling time was compensated on an hourly basis of \$68.00 per crew hour. In addition, the Sprague & Henwood technical representative was reimbursed at \$370.00 per day.

The ISM coring was conducted during a 6-day period, which included mobilization and dismantling, overburden drilling and grouting of the completed borehole. Fifty feet of overburden was penetrated and 13 feet of ISM rock coring was obtained in three separate core runs. The technical representative, who brought the ISM equipment to the site, remained for 2 days to instruct the project personnel on the operation of the ISM equipment.

Converting the production and associated costs to a linear foot price, the ISM coring was approximately \$570.00 per foot of rock cored. This high unit price is due, in part, to the large fixed equipment rental rate of \$4,400.00 and the limited quantity of coring completed. Additional analysis of costs are contained in Section 10.

It is believed that with increasing driller familiarization with the ISM equipment, improvements and modification in the equipment, and the use of rapidly setting grouts, that this very expensive but highly important subsurface exploratory technique will provide an economical solution to a difficult area of subsurface exploration.

7.6 GEOPHYSICAL BOREHOLE LOGGING

7.6.1 General

There are numerous indirect methods, using geophysical principles, of exploring the medium surrounding a borehole. Table 7-3 enumerates these methods. These methods use various electrical, acoustic, seismic or radioactive techniques to discern the physical properties of the soil or rock encountered.

These geophysical methods are used for direct exploration, identification of geologic formations, identification of formation fluids, correlation between boreholes and identification of geologic discontinuities.

The geophysical methods are used in petroleum exploration, where the geology is usually simple. They are also used in metallic and non-metallic mineral exploration, where the geology is usually complex. The percent of total use of these geophysical methods in the above applications far exceeds its use in engineering exploration, where the geology has the broadest range of complexities.

Information on the geophysical methods can be obtained in general texts, such as, Telford, (1-26), Dobrin, (1-5), and Jakosky, (1-13). However, experience is needed to interpret the field data of the various methods.

The principal purpose of using borehole geophysics in an engineering exploration program is to predict the character of the rock or soil between sampled boreholes or ahead of a tunnel excavation program. A high degree of reliability in these techniques precludes the addition of expensive boreholes to the exploration program and may enable the contractor to ascertain the ground conditions ahead of the excavation. The techniques could provide a warning against such hazards as the presence of gas, high water volume, shear zones and other areas of poor quality rock that contribute to underground instability.

Each method will generate a quantity of data. In most cases this data is meaningless by itself, but when combined with correlation borings, the data are used to interpolate soil and rock information between borings. The various geophysical methods can also compliment each other by providing data

TABLE 7-3. GEOPHYSICAL BOREHOLE LOGGING TECHNIQUES AND CAPABILITIES ASH (8-4)

METHOD	Elastic Properties	Fractures	Lithology	Structure	Porosity	Permeability	Water Content	Fluid Movement	Borehole Diameter	Formation Damage	Mineral Identification	Rock Deformation	Material Deformation	Gas Detection
3-D Velocity (A)	x	x	x	x	x						x	x		
Acoustical Imaging (A)		x	x	x						x				
Seisviewer (A)	x	x	x	x						x				
Velocity (A)			x		x					x	x	x		
Wave Amplitude (A)	x		x								x	x		
Gamma Ray (N)			x	x							x			
Neutron (N)			x		x		x				x			
Density (gamma-gamma) (N)	x		x		x						x			
Nuclear Magnetism (N)					x	x								
Single Point Resistivity (E)			x			x								x
Induction (E)			x	x	x	x	x	x						x
Spontaneous Potential (E)			x					x					x	x
Borehole Gravimeter (M)	x				x									
Microlog (E)		x	x		x		x							x
SP Dipmeter (E)				x						x				
Guard and Laterologs (E)							x	x		x				x
Caliper (M)	x								x	x				
Borehole Television and Camera (E)		x		x						x				

(A) - Acoustical (N) - Nuclear (E) - Electrical (M) - Mechanical

which, when analyzed together, can provide a picture of the subsurface conditions. The geophysical information is then combined with the boring data and transferred to the geologic profiles.

Three geophysical methods were employed in the study to demonstrate this process. They are nuclear logging, electrical logging, and a borehole seismic survey. These methods are discussed in the following sections.

7.6.2 Nuclear Logging

Some atomic nuclei emit natural radiations and others can be induced to do so by bombardment. The nuclear radiations are in the form of alpha rays, beta rays, gamma rays or neutrons. Both gamma radiation and neutrons possess considerable penetrating power and are measured in radioactive logging.

Well logging instruments which measure the radioactivity of nearby formations may be considered under three headings: First, those which detect gamma radiation resulting from the natural radioactivity of the uranium, thorium and potassium in the rocks (natural gamma). Second, those which employ artificial gamma rays (gamma-gamma). Third, those which use neutron sources to induce nuclear processes (neutron neutron and neutron gamma) (Telford, 1-26).

7.6.2.1 Types of Nuclear Logs

a. Natural Gamma (NATG) Log. The NATG Log measures the natural gamma photon emission of the rocks through which the detecting device is trolled. The natural gamma response is principally related to the presence of potassium-40 but may also be influenced by minor amounts of uranium and thorium. Because of the high K-40 content and ion-absorption and exchange properties of most clays, the gamma log ordinarily gives a high gamma response in clay zones.

Clean quartz sands and carbonates give a low gamma response. The natural gamma log has its primary value as an indicator of lithology and is one of the most versatile tools for use in stratigraphic correlations. However, the natural gamma log does not have a unique response to lithology. The response is generally consistent within a unique geologic environment.

The radius of investigation of a gamma probe is a function of several factors, including the borehole fluid and diameter, casing size, rock density and photon energy. Depending on the bulk density of the rock, 90 percent of the gamma photons detected probably originate within 6 to 12 inches of the borehole wall. Thin beds (beds with a thickness less than twice the radius of investigation) will not be recorded at full amplitude because the volume of influence is never completely filled by the bed (Keys, 1-15).

b. Neutron Epithermal Neutron (NN) Log. The NN log records the epithermal neutrons produced when fast neutrons from a Pu-Be (or Am-Be) source are degraded in energy by interaction with materials surrounding the borehole. Because the neutrons are moderated most by collision with hydrogen atoms the log is indicative of the water content of the interrogated zone.

Below the water surface, the log responds primarily to soil and rock porosity, whereas above the water surface it responds to formation moisture. Because of variations in porosity associated with differing conditions of sedimentation, the neutron log can be of great value for correlation purposes.

In most soils and rocks, the hydrogen content is directly proportional to the interstitial water content. However, anomalous values are caused by the presence of hydrocarbons, by chemically or physically bound water, or by other hydrogenous materials such as gypsum. In the epithermal method the neutrons are above the thermal energies at which neutron capture or activation is possible. Therefore, the NN method provides the highest percentage of response to hydrogen and is the least affected by the chemistry of the surrounding rocks and the contained fluid.

The radius of investigation of the NN log is a function of the spacing between the source and the detector and of the type of material being logged. The radius is lower at high porosities or at higher percent moisture because of the reduced range of neutrons prior to capture. The normal range is 6 or 7 inches for a high porosity saturated medium and about 24 inches for a low porosity medium or dry rock.

c. Neutron Gamma (NG) Log. The NG log provides much the same information as the NN log although it is based upon a different physical principle. As a neutron from a Pu-Be source is slowed to thermal energies, it can be captured by

nuclei of atoms in the material through which it passes. At the instant of capture, the nucleus of the capturing atom will emit gamma rays which are characteristic of the element. Like the NN log, the NG log is most affected by the presence of water and it also is basically a porosity log below the water table. The neutron-gamma response is not well understood above the water table. Unlike the NN log, the NG log will be affected in some measure by formation chemistry. The log, on occasion, will provide stratigraphic diagnostics because of chemical anomalies of the rocks and their contained waters. The radius of investigation for the NG log is similar to the NN log (6 to 24 inches).

d. Gamma Gamma (GG) Log. The GG log is generated in response to backscattered and attenuated gamma radiation from a cobalt-60 source. Gamma photons are degraded in proportion to the number of electrons in the interrogated field.

Because electron density is generally equivalent to bulk density, the GG log is a measure of formation density when corrected for borehole conditions. Barring appropriate calibration, the GG log can be considered only as a qualitative measure for formation bulk density.

The radius of investigation is affected by the bulk density of the rock, by the borehole medium, by the presence of a casing, and by the borehole size and rugosity. Generally, 90 percent of the signal comes from within 6 inches of the sonde. However, experiments in high porosity sediments with a detector source spacing of 4 feet have been successful (Keys, 1-15).

7.6.2.2 Field Procedures - Eighteen holes were made available for geophysical logging (Borings TSC 7 to TSC 24 inclusive). The nuclear logging equipment consisted of a control panel, a computer tape punch, and a graph machine, all contained in a large van (Figure 7-50). A tripod was set up over the hole to be logged and the cable and sonde lowered to the bottom of the hole (Figure 7-51). The instruments were powered by the van's generator.

The vertical scale on the graph machine was set at 1 inch equals 20 feet. Two pens were available for recording the signature and so dual horizontal scales of 1 inch equals 50 and 1000 counts per second were used. The reading was a

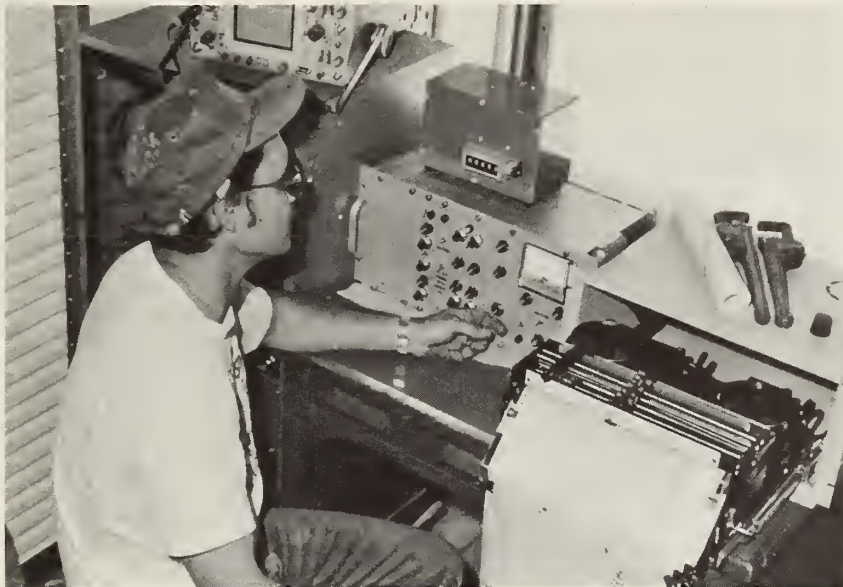

FIGURE 7-50. NUCLEAR LOGGING CONTROL PANEL, COMPUTER AND GRAPH RECORDER



FIGURE 7-51. PREPARING FOR INSTALLATION OF NUCLEAR SONDES IN BOREHOLE

continuous process; however, the computer was also capable of digitizing readings at 1 foot intervals and recording on a

tape for later reduction (Figure 7-52). The computer tape punch was triggered by a magnetic detector which sensed the magnets located at 1 foot intervals in the sonde cable.

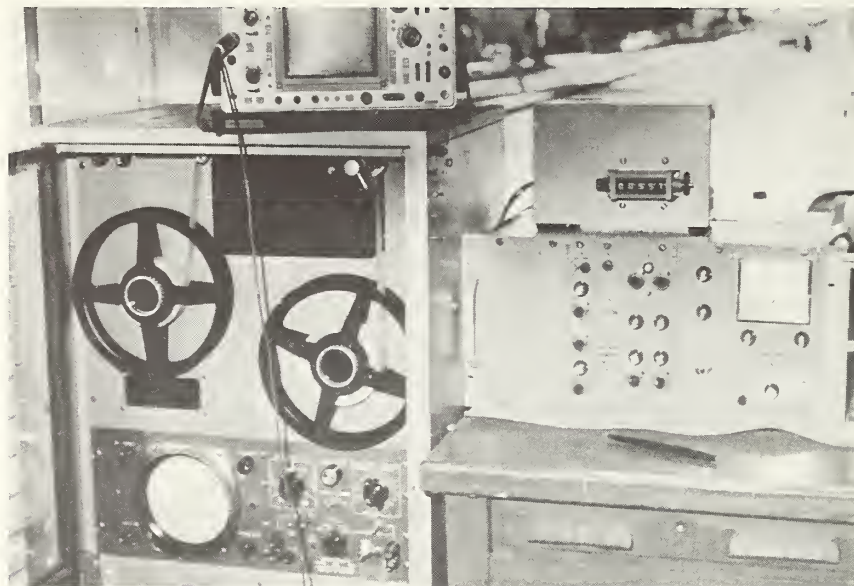

FIGURE 7-52. DIGITAL RECORDING COMPUTER AND NUCLEAR LOGGING CONTROL PANEL

The sonde was trolled up the hole at a constant rate of 20 feet per minute. The sonde was 1-1/4 inches in diameter and was 4 to 5 feet long. The sonde consists of a number of components which are interchangeably used for the various nuclear logs. The first component was a radiation detector (scintillometer), the second component was a spacer, and the third component was a radiation source. The source was cobalt-60 for gamma ray emission and americium-beryllium for neutron emission.

The sonde was trolled up the hole four times, once for each logging method. The detector and spacer only were used to obtain the natural gamma signature. The other three methods used the full compliment of detector, spacer and source.

The total time required for logging a hole was about one hour, including mobilization from hole to hole.

7.6.2.3 Implementation Considerations - There are certain intrinsic limitations to the nuclear logging method. The effective radius of investigation has been discussed previously in this report.

Borehole effects are the most important extraneous effects on a nuclear log. Above the water table, the signatures of the gamma gamma, neutron gamma and the neutron neutron logs are unreliable because of the unknown variations in moisture content of the materials penetrated by the bore.

These logs are also affected upon entering the water, and their responses cannot be used through an approximate five foot interval below the water table. Erroneous responses can also occur at the bottom of the boring, caused by a higher absorption rate of the source radiation.

Variable bore size and casing schedules cause slight interference in interpretation. This difficulty arose in the TSC program where 13 boreholes that penetrated rock exhibited six different borehole environments. This variability in borehole size is a consequence of the variety of exploration, testing and monitoring methods being used in the TSC program and normally would not occur in a non-research oriented exploration program.

The rugosity (roughness) of the borehole wall can interfere with the interpretation of the nuclear logs. This is especially true when the borehole is cased and the breakouts cannot be determined with a caliper log.

Nuclear logging instruments can be calibrated for a specific hole or casing size. However, the variety of hole sizes and casing schedules in the test section and the lack of a caliper log of the borehole wall necessitated a qualitative interpretation of the data.

Background experience and information in each geologic environment is essential because the nuclear log response is not the same for all geologic environments. Essentially, correlations are restricted to a single geologic environment.

It is important that experienced personnel interpret the nuclear logs. Considering the non-isotropic and heterogeneous nature of most natural deposits, the interpretation of the logs is an art as well as a science.

One problem particular to nuclear logging is that radioisotopes are used in the procedure. It is important that an operator be cognizant of the applicable federal or state regulations covering the use, transportation and storage of these materials. Training and experience in radiation monitoring and the safe handling of radioisotopes is a pre-requisite to obtaining a permit or license. On-the-job training must include the specific equipment and procedures to be used in well logging. Individual states usually require a permit to operate radioactive equipment within their borders. Some states (California) do not permit nuclear logging while others may have restrictions such as allowing logging only in fully cased holes (Idaho).

7.6.2.4 Application in Tunneling - Nuclear logging in boreholes can provide valuable information for use in tunnel design and construction. The method can correlate the stratigraphy within a geologic environment given a few logged boreholes for material identification purposes. This is demonstrated in the geologic profiles (Appendix B). The method can identify clay zones in the soil and fracture or shear zones in the rock which may cause stability problems during tunnel construction. Top of rock can also be identified.

In the tunneling construction phase, nuclear logging may be combined with horizontal drilling to identify problem areas ahead of the tunneling operation. Zones of clay or gouge or water inflow associated with fracture or shear zones may be identified.

The nuclear logging method can provide information by itself but, of more importance, it is a valuable correlation aid in an exploration program.

7.6.2.5 Cost - The total cost of the nuclear logging program was \$12,600. This cost included mobilization of the logging equipment and personnel from the State of Washington; logging 18 boreholes using four different nuclear logging techniques; reducing the data and inputting to a computer; analyzing the data and preparing a report. The cost also included hand digitizing the electric log field signatures and inputting to the computer.

7.6.3 Electrical Logging

The physical properties of rocks measured in electrical borehole logging are self-potential, electrical conductivity or the inverse, resistivity. Electrical borehole logging has become a standard procedure in petroleum exploration since the Schlumberger brothers initiated it in 1928. However, little experience is available in the application of electrical logging in the engineering field. Reasons for this lack of use include the complex geology at many engineering sites and the availability of core from diamond drill holes. The electric logging method can provide a means of correlation between boreholes and may identify formations.

7.6.3.1 Types of Electrical Logging - Many methods of electrical borehole logging have been developed in the past 40 years; these include resistivity, self-potential, spontaneous potential, induction and induced polarization. The electric logs can be conducted only in open (uncased) fluid-filled boreholes. The fluid must be conducting such as mud or water. Only the spontaneous potential and resistivity logs are discussed below since they were utilized on this project:

a. Spontaneous Potential (SP) Method. The spontaneous potential log provides a continuous record of the natural potentials developed between the trolling sonde and an electrode at ground surface.

Such potentials have been attributed in the past to electrofiltration and concentration potentials. However, some current thought relates them largely to oxidation-reduction potentials developed in the interrogated media. The spontaneous potential log is ordinarily analyzed in conjunction with the resistivity log and is useful in distinguishing sands from shales. It is used for evaluating lithology and in determining bed thickness.

The radius of investigation of the spontaneous potential method is highly variable. This is because the potential drop along the mud column in the borehole results from currents that originate away from the borehole along formation boundaries illustrated in Figure 7-53.

In the lithologic section shown, the currents flow into permeable beds until a sufficient cross-sectional area of the resistive bed is encountered to carry the current.

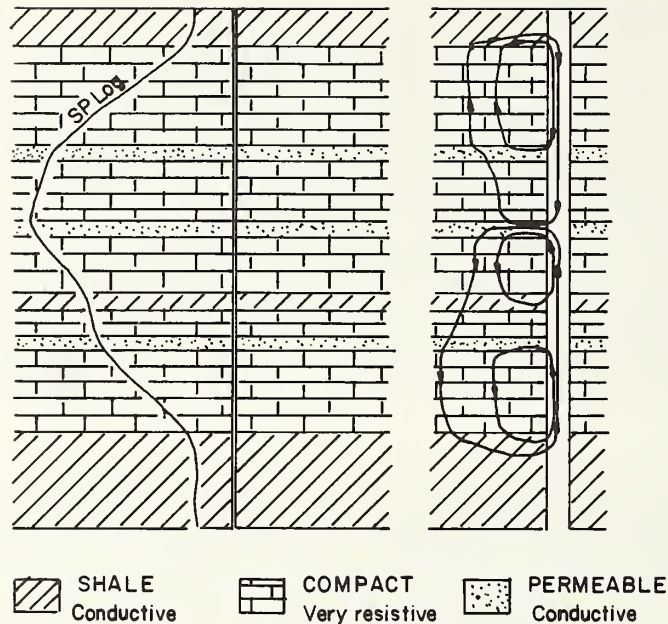

FIGURE 7-53. ELECTRICAL LOGGING EFFECTS IN VARIABLE FORMATIONS

The current then flows across the resistive bed until an impervious conductive bed is encountered. The current then returns to the borehole. Also, the SP may not relate directly to the permeable beds because the effect of these beds spreads the SP above and below the bed boundaries. This is illustrated in the left side of Figure 7-53 (Keys and MacCary, 1-15).

b. Resistivity (R) Method. The single point resistivity log provides a continuous record of apparent rock resistivity measured between a close-coupled lead plummet (A on Figure 7-54) and the shell (B on Figure 7-54) of the measuring sonde. Although the measured resistivity is less than true rock resistivity, the method has high resolving power and will accurately establish the boundary between strata of differing resistivity. The log can provide valuable data for lithologic correlation and bed thickness determination.

The radius of investigation for the single electrode resistivity system is very small and the method actually measures the resistance of the borehole fluid as it is affected by the resistance of the surrounding volume of rock (Keys, 1-15).

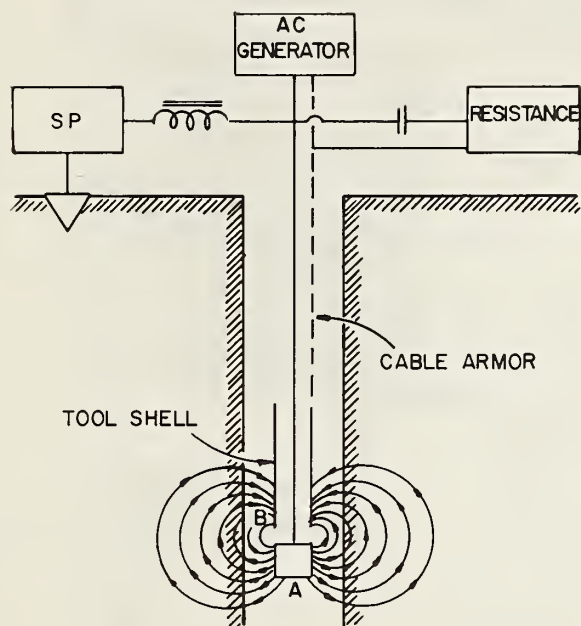

FIGURE 7-54. SCHEMATIC DIAGRAM OF SINGLE POINT RESISTIVITY LOGGING TECHNIQUE

7.6.3.2 Field Procedures - The instrument used to electrically log borings in the TSC test section was a modified Model 9245 Suitcase Geo-Logger, manufactured by Well Reconnaissance, Inc. (Figure 7-55). The logger is a completely self-contained, hand cranked hoist logger mounted in a light-weight aluminum suitcase. The approximate weight is 60 pounds. Figure 7-56 shows a schematic of the logging system.

Various tests are recommended to check electrical continuity and proper voltage levels in the instrument and the cable before operating. These tests can be accomplished with a small voltmeter. The recording pens are zeroed and the sensitivity and position controls adjusted for maximum use of the pressure-sensitive chart paper.

The tripod is positioned over the borehole and the sonde trolled down the hole with the hand crank. The footage counter indicates the depth of the sonde. The sonde is then trolled up the hole at a constant speed of about 25 feet per minute while the instrument records the logs. Three runs are made in each hole logged (Figure 7-57).

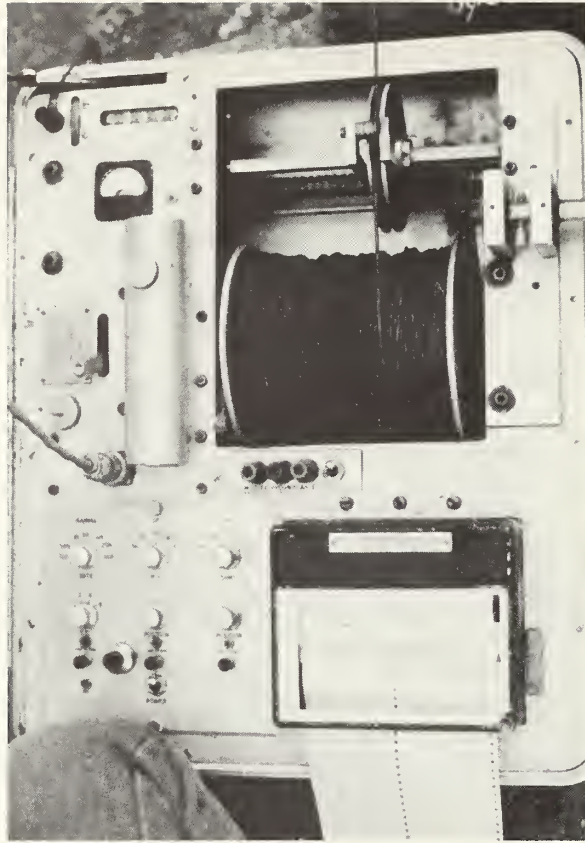

FIGURE 7-55. MODEL 9245 "SUITCASE"
ELECTRIC GEO-LOGGER™ UNIT

The electric logging method can be employed only in an open (uncased) fluid filled hole. Therefore, the logging is accomplished immediately after completion of the drilling. Because of the fractured nature of the rock at the TSC test section, the sonde jammed in some holes (causing some damage to the sonde wiring) and, in others, the sonde could not be trolled to the bottom. Therefore, the only holes where the electric logging was accomplished were TSC 7, 8, 9, 10, 11, 13, 14, 15, 16, 17, 18, 19, 20, 21 and 23.

7.6.3.3 Discussion of Results - The field electrical logs were transmitted to Dr. James Crosby of Washington State University for evaluation. They were hand digitized and input to a computer for reproduction as suites with the nuclear logs.

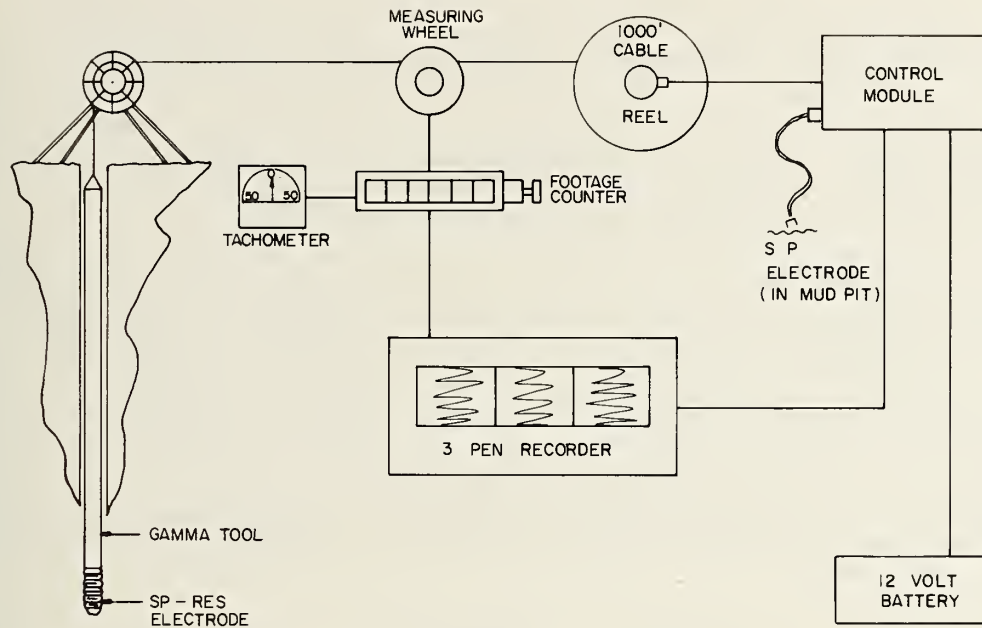

FIGURE 7-56. SCHEMATIC OF ELECTRIC BOREHOLE LOGGER



FIGURE 7-57. ELECTRICAL BOREHOLE LOGGING

For the boreholes where resistivity and spontaneous potential were determined, three runs of each log were made. In some cases, the response is off scale. In many cases the logs are not repeatable, and often the expected relationship between resistivity and spontaneous potential responses is not apparent. In the quality assurance programs at Washington State University, log repeatability is used as the basic criterion for validity of a log function.

Where repeat runs of a hole are made with the same tool, they must be identical within expected limits of variation. For these reasons, the electrical logs are not considered in defining and correlating units. The probable reasons for the failure of the electric logs to give a usable response are addressed in the next section.

Fourteen boreholes were electrically logged and four representative field logs are included in Appendix D for information purposes.

7.6.3.4 Implementation Considerations - The TSC test section site is on Massachusetts Avenue in the City of Cambridge. This thoroughfare is heavily traveled and includes electric buses powered by overhead electric lines. There are approximately 50 underground utilities between the building lines. These include metal ducts containing electric lines and telephone lines and steel water and sewer pipes. Also there are abandoned steel trolley tracks buried under the surface pavement.

These utility lines create excessive interference with the electric logging methods by introducing anomalous currents and potentials in the subsurface and effectively masking the true spontaneous potential and resistivity response.

Specific sources of anomalous readings include the magnetization of the armored sonde cable. Magnetic storms in the ionosphere, caused by solar flares, set up abnormal telluric currents in the earth which effect the response.

The flow of ground water through the borehole being logged will also affect the log response. Man-made effects include the following:

a. Circulating ground currents near electrical switch yards, transformers and power lines.

b. Electrochemical action (corrosion) along buried pipelines.

c. Cathodic protection devices on buried pipelines.

d. Potentials set up along large or long metallic objects, for example railroad or trolley tracks or pipes.

e. Local electrical operations (the electric buses).

f. Because truck tires are not perfect insulators, some finite resistance exists between the truck frame and the ground electrode. Standing mud and water add to this conduction which can be accentuated in a highly resistive formation, such as crystalline rock saturated with fresh water (Keys, 1-15).

7.6.3.5 Application in Tunneling - The ability of electrical logging methods to discern formation lithology and thickness and, to a lesser extent, to locate fractures is acknowledged. However, an urban environment introduces many complexities and sources of potential error into the acquisition of accurate, repeatable log responses. These problems have been enumerated in the preceding section. It may be possible to engineer an instrument to accommodate these problems. However, the results of this study indicate that electric logging may not be applicable in an urban environment, where the majority of transit tunneling is located.

7.6.3.6 Cost - The electric logging for this project was accomplished in-house, so a third party service contract was not required. It is estimated that the cost of logging 15 boreholes to a depth of 100 feet was approximately \$4,070, which includes the cost of a logging unit. The cost of the manpower alone to log the 15 holes is estimated at approximately \$560. A two-man crew is usually needed to log a borehole.

7.6.4 Borehole Seismic Survey

7.6.4.1 General - There are numerous types of seismic waves. These waves are propagated by impulses in the earth's crust. These impulses may be artificial, such as quarry blasts, nuclear detonations and petroleum or engineering explorations;

or they may be natural, such as earthquakes or void collapses in carbonate rocks.

The various types of seismic waves are placed into two broad classifications, surface waves and body waves. Surface waves travel along the medium at the surface. The two types of surface waves are Love waves and Rayleigh waves. These surface waves have large amplitude and long period and can usually be observed near machinery which produce continuous electrodynamic vibrations.

Body waves are of two types, compressional waves and shear waves. Compressional or P waves travel through the earth with a longitudinal motion. Shear or S waves travel through the earth with a translational motion. P waves always have higher velocities than S waves and consequently appear first in a seismic wave train. If the materials being investigated have relatively low bulk densities, the S waves may sometimes be obscured by surface wave arrivals. It is the P and S waves that are used in engineering investigations. Appendix E shows some typical seismic signatures obtained during the project study.

The purpose of most borehole seismic investigations is to obtain a measurement of the transit time of these P and S seismic waves between boreholes. These measurements are used in calculations to determine the engineering characteristics of materials that the waves pass through. P wave velocities are dependent on the bulk and shear moduli of materials in the propagation path, and the S wave velocities are dependent on the shear modulus. If the bulk density of the materials is known or can be estimated, the measured velocities are used in standard formulae with these densities to calculate parameters which may give an indication of how subsurface materials behave during excavation or construction activities. These parameters are Poisson's Ratio and Young's Modulus.

7.6.4.2 Types of Surveys - The principal types of borehole surveys are: (a) crosshole surveys and (b) downhole or up-hole surveys. The radius of investigation is limited only by the amount of energy available for impulse generation and the bulk densities of the investigated materials. In urban areas the maximum energy may be limited by the necessity to protect adjacent buildings and utilities.

a. Crosshole Survey - The crosshole investigation is conducted by introducing a shock impulse at a selected depth in one borehole and recording the resulting shock waves in an adjacent borehole (or series of boreholes). Accurate determination of the initiation time of the impulse and the arrival time of the waveforms reaching the recording positions, along with measurement of the distances between the point of impulse and recording positions, provide the information needed for determination of velocities. The recordings are usually, but not necessarily always, made at the same elevation as the impulse so that the most direct path of propagation influences the recorded information.

A single "sensing" borehole may be used, but it is more common to collect recordings from a linear series of boreholes or from an azimuthal array of boreholes so that the data represent several measurements of the shock waves arriving at different locations from the same initial impulse. Multiple recording positions permits a direct comparison of the wave forms and velocities along different paths from the same input, and no uncertainty about coupling effect or initiation time need be considered to perform a comparison.

b. Uphole or Downhole Survey - The uphole survey records the seismic wave transit time from the elevation of impulse initiation to the ground surface. Measurement of this time, as the survey progresses, provides repeated information on major changes in the velocity structure of the material penetrated by the borehole. In the downhole survey, the geophone and the impulse source are reversed with the geophone at depth and the energy source at the surface. The downhole survey was not used in this investigation.

7.6.4.3 Signal Enhancement - Signal enhancement is a recording technique that makes use of the frequency-amplitude randomness of ambient earth noise with time and the frequency-amplitude coherence of induced seismic signals. This coherence is assured when the instant of impulse initiation, impulse shape, and propagation path are controlled.

With the instrument used for this investigation, a set length of time after impulse initiation (detonation of a blasting cap), an individual recording representing ground motion is placed in the memory for each axis of sensitivity at each sensing position. The sequence of field operations can be repeated without changing the elevation or position

of the sensing equipment and impulse point, and another record taken that can be added, point by point throughout the time period selected, to the records in the memories.

The random character of ambient earth noise results in some random addition, subtraction, and nullification of levels as the new recording is added to the earlier one. However, the levels at each sample point representing the seismic signal will occur at the same level, with the same polarity, and at the same time follow the impulse initiation. Each repetition then systematically increases the signal level while the ambient noise level increases, on the average, at a lesser rate.

Theoretically, the signal level will increase above the noise level by a factor of \sqrt{n} , where n is the number of repetitions of the sequence of observations, provided that the signal is completely coherent in time, frequency, amplitude, and polarity and the noise completely random in time, frequency, amplitude, and polarity in the Gaussian sense.

In an urban environment, where random noise is usually at a maximum, the advantage of using an instrument with signal enhancement capability is obvious. Using this technique negates the necessity of using larger energy sources to overcome the ambient noise. Also, it may not be necessary to conduct the exploration program at night when the noise is at a minimum.

7.6.4.4 Equipment - The seismograph for multiple borehole uphole/crosshole surveys is discussed below along with some of the basic functions of the various components of the system.

The sensors used to detect motion within the boreholes are coil-magnet transducers that generate small voltages proportional to the rate of motion impressed upon the transducer package. For borehole work, three axes of sensitivity are usually recorded, an orthogonal set of one vertical motion detector output and outputs from two mutually perpendicular horizontal detectors. Transducers used on both the borehole and surface units for this investigation are Mark Products L-15TM geophones, with the borehole units encased in a tempered aluminum tube of 2.0-inch maximum O.D. and 15-inch length (Figure 7-58). The surface package containing 3 transducers is 6.0 inches O.D. and 2.5 inches high. The borehole sensor tube is hermetically sealed and weighted to assure a negative buoyancy when submerged in water or low-density

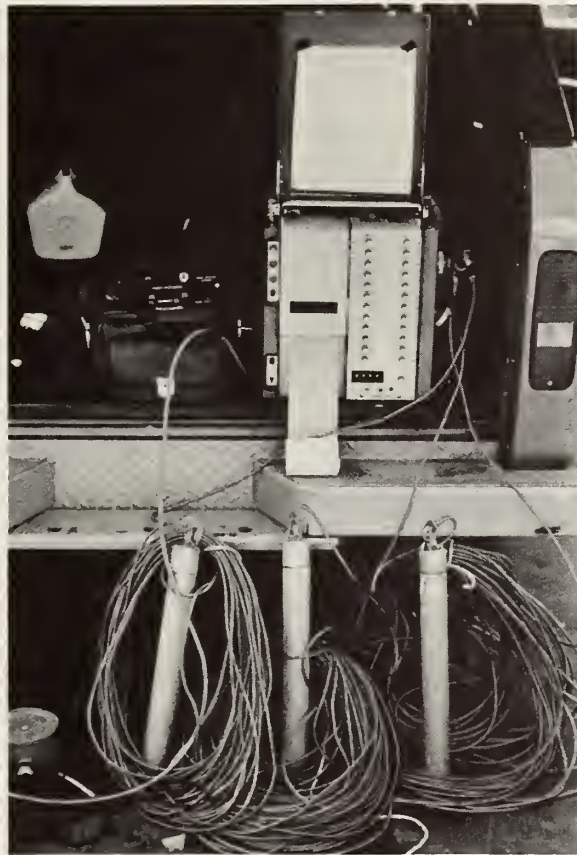

FIGURE 7-58. SIGNAL ENHANCEMENT SEISMIC UNIT WITH BOREHOLE GEOPHONES

drilling muds. Individual conductor pairs are attached to each of the 3 transducers within the package, with the exit point for conductors through a hermetically sealed conduit at the top of the borehole sensor package.

Ordinary Belden-type 8777TM 6-conductor cable was used to transmit the voltages generated from the sensing units to the recording part of the seismograph. This type of cable has the capacity to support 300 feet of its own weight in the borehole plus the sensing unit.

The recording unit used for the investigation was a Geometrics/Nimbus Instruments Model 1200TM Multiple Channel Signal Enhancement Seismograph. This unit has 12-channel recording capability with crystal controlled timing and individual memories for each data channel (Figure 7-59).

The only other equipment needed for the survey is a battery pack and a high voltage blaster to fire the blasting cap.

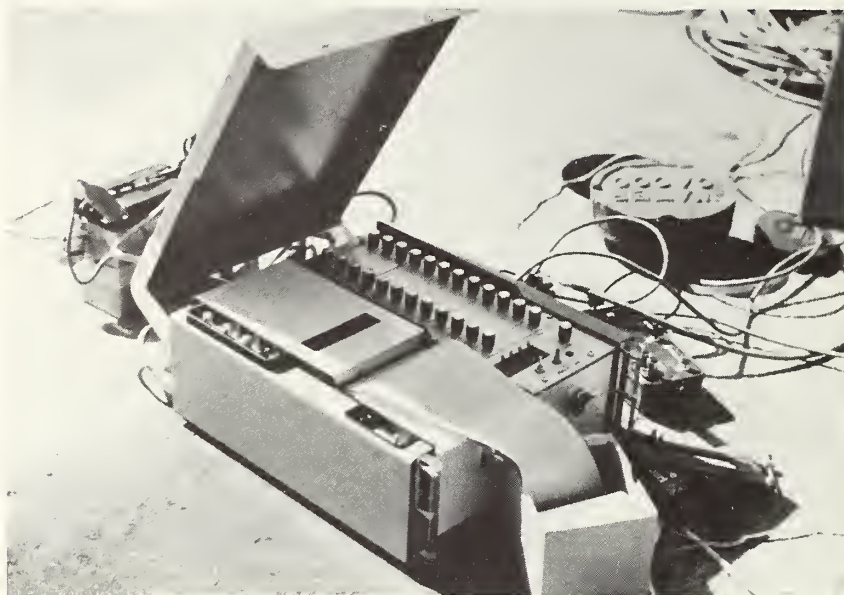

FIGURE 7-59. GEOMETRICS/NIMBUS INSTRUMENTS MODEL 1200™ MULTIPLE CHANNEL SIGNAL ENHANCEMENT SEISMOGRAPH

7.6.4.5 Impulse Initiation - Many methods of impulse initiation are available, depending on the subsurface materials present and the procedures used in preparing the boreholes. The boreholes used for sensing on this project were cased with PVC tubing to reduce the chances of losing instrumentation to cave-ins, to maintain open-hole conditions throughout the depths where investigations are needed, and to provide access for other investigations. PVC casing also has seismic velocities similar to that of water, and potential for distortion of the signals because of velocity differences is minimized below the water table.

The borehole used for initiating impulses may be cased, uncased, or partially cased with any number of materials. Both the impulses from driving casing for wash borings and

impulses from driving a split-spoon sampler below such casing have been used as an impulse source. Special instrument driving "feet" have been used below the bottom of casing. Inside-casing hammers and air-gun impulses have been used and explosives have been commonly used for impulse initiation. If explosives are used in PVC casing, the casing is usually destroyed. This is true, even with single blasting caps, if the shot points are below the water table (as was the case in this test section). Very small charges of dynamite are also sufficient to seriously distort or rupture steel borehole casings.

Where strong impulse devices are used (air-guns, explosives) it is necessary to begin the investigation at the bottom of the borehole and progress upward to minimize risk of losing access to lower elevations because of casing destruction. Other impulse generators mentioned above may require initiating the investigations at shallow depth (driven devices) or at any particular depth of interest (within-casing hammers).

7.6.4.6 Field Procedure - The initial steps of field operations for the test section included lowering the three-component geophone units into the boreholes to selected depths and assembling the various components of the recording system. Depth control for the downhole units is accomplished by attaching a steel tape to the unit and measuring depth to the sensor from top of casing at each borehole. Assembly of the recording unit components requires only that the battery power pack and cap initiator unit are attached to the seismograph, and that the recording paper, supply is adequate.

For this investigation, 3 boreholes were selected as observation boreholes for obtaining records of the waveforms from impulses generated in a fourth borehole ("shothole"). The surface geophone was installed next to the shothole to obtain the uphole waveforms (Figure 7-60). Since each geophone unit includes three axes of sensitivity, all twelve of the available recording channels were utilized each time a seismogram was obtained.

A single "Instadet"TM electric blasting cap, weighted with a sinker and connected to lamp cord, was used as an impulse generator throughout the investigations. The lamp cord was also connected to the cap initiator, with the initiator discharging a capacitor to the cap for initiation and sending



FIGURE 7-60. PREPARING "SHOT HOLE" FOR CROSSHOLE SEISMIC SURVEY

an impulse to start the recording interval at instant of cap initiation.

Surveys of each set of 4 boreholes started with the 3 geophone units and blasting cap at the bottom of the boreholes at the same elevation (some exceptions are noted below). This initial investigation was $5\pm$ feet below tunnel invert elevation. The final elevation investigated was 15 to 25 feet above tunnel crown elevation (about 60 feet in depth).

With all data channels active, the cap was detonated and a recording of the resulting waveforms was obtained. The recording was then examined for adequacy (i.e., ability to time the arrival of compressional and shear waves) and was adjusted for amplitude or playback speed if necessary. The borehole geophone units were then rotated to change the horizontal axes azimuth as an aid to analysis and for data

redundancy, and a second cap was detonated at the same elevation to provide a separate recording at the same depth.

When a satisfactory recording set was obtained, the entire borehole array of instruments and cap was systematically raised in 5-foot intervals throughout the investigated range, repeating the recording pattern at each 5-foot elevation.

Variations to this pattern were necessary because of borehole conditions, several boreholes had caved before casing could be placed. Also, certain boreholes could not be used as shotholes because subsequent investigations were planned that could not be conducted if the casing were destroyed.

Caving limited access to an 82.5 foot depth in borehole TSC 18 and to 65.0 feet in borehole TSC 22. In such cases, the borehole geophone unit was placed on the bottom at maximum depth until the other elements of the instrument-cap array reached that elevation. The geophone unit in the limited-depth borehole was then raised systematically with the others above the bottom elevation.

Figure 7-61 shows the 4-borehole sets that were surveyed during this investigation. Seven test series were surveyed, including 3 linear arrays (1, 2, 3), two azimuthal arrays (5, 7), one "T"-shaped array (4), and one "L"-shaped array (6). Redundant data over the range of depths investigated were collected in boreholes TSC 7, 8, 15, 16, and 18 from different shothole positions. Borehole TSC 17 was used both as an observation borehole and shothole. Data for test series 4-5 and 6-7 were collected by obtaining records at a given elevation with one array configuration (4 or 6), then removing 2 borehole units and reinstalling them at the same depth in the next array configuration (5 or 7). In effect, this procedure doubled the potential use of the shothole because 2 arrays could be obtained before casing loss prevented re-use of the shothole. Redundant data for bias correction was also maintained by keeping one borehole instrument in place at each elevation as the other two were moved.

7.6.4.7 Data Analysis - The primary interest in analysis of the uphole/crosshole data is determination of the transit times of compressional and shear waves traveling direct paths from the shot initiation point to the borehole geophones or to the surface geophone. Velocity is determined by dividing the distance from shot point to the closest geophone by the

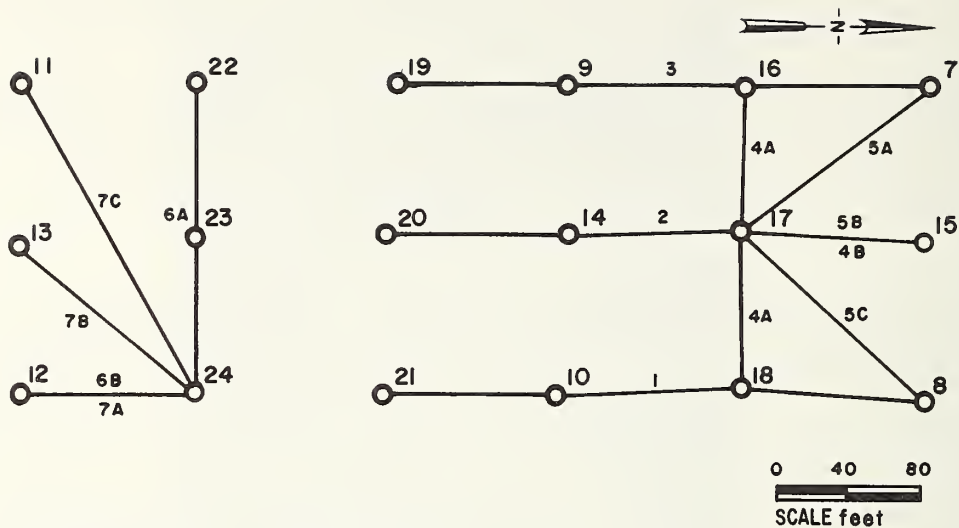

<u>CROSSHOLE TEST SERIES</u>	<u>BOREHOLE NUMBER</u>	<u>SHOTHOLE</u>
1	10-18-8	21
2	14-17-15	20
3	9-16-7	19
4A	18-17-16	17
4B	17-15	17
5A	17-7	17
5B	17-15	17
5C	17-8	17
6A	24-23-22	24
6B	24-12	24
7A	24-12	24
7B	24-13	24
7C	24-11	24

FIGURE 7-61. SEISMIC ARRAY PATTERNS, CROSSHOLE-UPHOLE SURVEY

transit time of the wave to that location, then dividing the distance between adjacent geophones by the transit time of the wave between those geophones for the balance of the linear array. For the non-linear arrays, the time between shot initiation and arrival time at the individual geophones is used.

Identification of the direct compressional wave is usually straightforward because it is the first arriving signal on the seismograms. Some interference with the direct wave may occur in crosshole investigations because of earlier or simultaneous arrival of refracted compressional waves from overlying or underlying higher velocity materials. These

typically occur when the shot to geophone spacing exceeds one-third to one-half of the depth difference between the refracting layer and the horizon of the shot and geophone. Such refractions can usually be identified by low amplitude, low frequency, and significant vertical component motion characteristics when compared to the direct compressional wave and are identified in Appendix G.

Shear wave arrivals are more difficult to identify because of interference from the various refractions, reflections, and reverberations that may accompany the passage of the compressional wave motions. Direct shear waves, however, typically show a phase relationship reversal between vertical and horizontal motions seen in the compressional wave, have a greater amplitude of motion, and always follow the arrival of the compressional wave.

Appendix G shows a selection of the seismograms analyzed for this study with the selection made on the basis of displaying signal characteristics and recording/display capabilities of the seismograph employed in the investigation:

Appendix page G-1. Refracted compressional waves from underlying high velocity materials.

Appendix page G-2. Compressional and shear waveforms at 75-foot depth without refraction interference. Note the strong effect of rotating the geophone in borehole TSC 7 on the horizontal waveform. Shotpoint was repeated at the same elevation for the 2 seismograms shown.

Appendix page G-3. Displays gain-ranging capability of recording system, with upper part of figure first playout of records stored in memory, then subsequent playout of the same memory record at different gain levels (note also some "clipping" or saturation of the storage levels).

Appendix page G-4. Expanded time-scale playout versus condensed scale for separate shots at the same depth after rotation of the borehole geophones.

Appendix page G-5. Typical waveforms.

Appendix page G-6. Typical waveforms, after rotation.

Appendix pages G-7 and G-8. Expanded playout scale showing ground roll on surface instrument from passing traffic (Borehole TSC 17).

Initiation time of the cap for energy impulse is at the left margin of each of the figures, marked by a downward deflection of the uppermost trace and an upward deflection of the lowest trace of each seismogram, and the beginning of vertical time intervals on the recording. Each time interval is of 1.0 millisecond length (0.001 second).

Some of the figures show one of the difficulties of analyzing uphole data (Appendix pages G-3 and G-5), where a late arriving wave propagating up the casing gives a false signal (Appendix page G-3) and traffic noise near surface interferes with clear signal arrival (Appendix page G-5).

Amplitude measurements from each of the data traces were also made for the compressional and shear waves to determine the effect of the various propagation paths on energy attenuation.

Measurements were taken near the initial part of the signal to avoid contamination by mode conversions or other interference. Each measurement was made at the same recorded instant of time for the vertical and two horizontal components so that a vector sum amplitude would be obtained of the form:

$$A = (X^2 + Y^2 + Z^2)^{\frac{1}{2}}$$

where

A is the vector sum amplitude.

X is the zero to peak amplitude in one horizontal direction.

Y is the zero to peak amplitude in the other horizontal direction.

Z is the zero to peak amplitude in a vertical direction.

All X, Y, and Z measurements were corrected for system gain settings before calculating the vector sum amplitude. The system was not amplitude calibrated prior to the survey, and the amplitudes are represented as relative comparisons, and not absolute measurements of ground disturbance levels.

Calculations were performed to determine Poisson's Ratio (σ) and Young's Modulus (E) according to the following relationships:

$$\sigma = \frac{(V_p/V_s)^2 - 2}{2 (V_p/V_s)^2 - 1}$$

$$E = \frac{\gamma V_s^2}{g \cdot 144}$$

Where V_p and V_s are the compressional and shear wave velocities in feet/second, respectively, γ is the bulk density in pounds/ft³, and g is the gravitational constant (32.2 feet/second²). The dividing factor of 144 is used to convert pounds/ft² to pounds/inch² so that Young's Modulus is expressed in conventional units of dimension.

Appendix H shows the measured compressional and shear wave velocities with calculated Poisson's Ratio and Young's Modulus for the seven test series of crosshole investigations.

7.6.4.8 Implementation Considerations - Because of the nature of this project (research) and because of the nature of the local environment (urban with high noise), several procedures were introduced which are not considered normal for an exploration program. These procedures were accomplished to test the technique under worst-case field conditions and are discussed here.

The borehole geophone units were not coupled to the casing, but simply allowed to rest against the side of the casing. Coupling the geophone unit to the casing can improve the quality of data recorded, if the casing is tightly coupled to the borehole wall. Considering that the wavelength of body waves propagating through glacial till and rock is very large in comparison to the dimensions of the borehole and that the range of depths investigated in this case is below the water table, significant improvement in signal quality would not be expected by this coupling.

A single electric blasting cap was used as an impulse source. This is completely adequate and convenient, if the subsurface conditions are suitable. This investigation was conducted where moderately dense to dense materials were examined below the water table. Coupling of the energy from detonation of the cap in water into the materials surrounding the shothole is very efficient under these conditions. This effect would not be available if the materials were dry (or in a dry casing), or if the materials were low density soils or deeply weathered rock above the water table.

Noise levels from the heavy street traffic above the elevations investigated had virtually no effect on data collection. The use of the signal enhancement features of the equipment was unnecessary under the existing subsurface conditions. This effect can be expected where a significant thickness of low density, discontinuous, and dry material lies between the street level and the zone being investigated, and the zone being investigated is in more dense materials below the water table. This upper zone significantly attenuated the street noise.

For the "non-linear" arrays, no effort was made to protect the geophone cables laid across concrete pavement of the traffic lanes of Massachusetts Avenue. This was a deliberate act to determine whether or not the cable could withstand such abuse without particular care, or if protection would be necessary. Only a single conductor was damaged during 2 days of field work under heavy traffic conditions.

A problem encountered at the shotpoint is the coupling effect, which occurs when more energy is coupled into less dense materials than into dense materials from the same level of impulse, resulting in strong attenuations of the seismic signal. Usually this problem can be accommodated by having redundant crosshole series and multiple shots in the test program.

Because of the nature of the local stratigraphy and the elevation of the water table, the signal enhancement capabilities of the instrument were not severely tested. In order to test this feature, a seismic refraction survey was attempted. The array of surface geophones was laid out parallel to Massachusetts Avenue, with the geophones placed between the concrete curb and the concrete sidewalk. A 10-pound hammer, with an inertial switch to initiate the time sequence, was used as an energy source. During this operation, the street traffic

was extremely heavy and a drilling rig was operating 20 feet from the geophone spread (Figure 7-62.)



FIGURE 7-62. UTILIZING SIGNAL ENHANCEMENT TECHNIQUES FOR SURFACE SEISMIC REFRACTION SURVEY

The enhancement technique enabled the operation to detect the P wave arrival on the seismic trace. However, the energy was not sufficient to detect the till-bedrock interface. A larger energy source, such as a mechanical thumper, would ensure the successful completion of a refraction survey in an urban environment when using the signal enhancement technique.

7.6.4.9 Application to Tunneling - Performance of seismic crosshole/uphole surveys in busy urban environments, where most transit tunneling is located, has often been viewed as having only limited potential for success. The limitation is that traffic and other sources of high level ground vibrations would cause ambient ground noise high enough to prevent accurate signal detection and signal timing. When such surveys were considered necessary in spite of the possible shortcomings, extraordinary measures were planned to overcome the noise problems (costly surveys taken at night when traffic would be at a minimum, large energy sources to provide very strong signals, etc.).



FIGURE 7-63. LIGHTWEIGHT AND PORTABLE
SIGNAL ENHANCEMENT SEISMIC
EQUIPMENT

Signal processing techniques offer alternatives to this problem, however, and these have recently become available in recording systems that are small, lightweight, and with low enough power requirements to provide the versatility needed for application in engineering surveys (Figure 7-63). Sufficient numbers of data channels are included with these systems so that multiple positions can be occupied for simultaneous recording. This makes the survey results more efficient to obtain and more reliable because of the ability to collect redundant readings.

The problem of using blasting agents in an urban environment is diminished when an instrument with enhancement capabilities is used. One blasting cap provided sufficient energy to complete a crosshole array with a source-detector distance of 150 feet.

The borehole seismic techniques, especially the cross-hole method, provide valuable data on the condition of subsurface formations. The ability to discern zones of poor quality rock is demonstrated and indicated on the geologic profiles. This information is invaluable in a tunnel operation. The seismic method may expand the existing borehole information and confirm the data at the borehole site.

7.6.4.10 Cost - The seismic borehole survey was executed with a third-party contract. The total cost of the contract was \$10,000.00. This cost included all equipment rental, the blasting service, personnel cost and report preparation.

The program was conducted in a series of 18 boreholes. The information confirmed borehole data and provided correlation between boreholes. Holes must be drilled to accommodate the seismic energy source and detectors. However, these holes can be rapidly drilled at a fraction of the cost of comprehensive exploration borings. Additional data on costs are contained in Section 10.

7.7 IN-SITU TESTING

Tests conducted on soil and rock formations in the field (in-situ testing) provide direct measures of engineering properties without the concern for sample disturbance that normally accompanies laboratory testing. Numerous in-situ tests applicable to the determination of parameters significant to tunneling have been developed and range in complexity from the standard penetration test to downhole shear tests and large scale pumping tests. Table 7-4 summarizes a number of the in-situ testing methods and the engineering parameters measured.

Of the procedures listed in Table 7-4, the study included application of standard penetration testing, piezometers, and borehole permeability testing. In addition, ground water observation wells were installed, and water pressure tests conducted in the rock. Large scale pumping tests were beyond the scope of this study; however, three such tests were completed during the design of this tunnel. Standard penetration testing and penetration testing as conducted for this study have been discussed earlier in this section.

TABLE 7-4. PARAMETERS MEASURED BY VARIOUS DIRECT IN-SITU TESTING METHODS SCHMIDT (8-33)

PARAMETER TYPE OF TEST	SHEAR STRENGTH	IN-SITU STATE OF STRESS	PIEZO- METRIC HEAD	MODULUS OF DEFORMA- TION	PERME- ABILITY	SOIL TYPE
Standard Penetration Test	x					x
Dynamic Cone Penetration Test	x					x
Static Cone Penetration Test	x					x
Vane Shear Test	x					
Dilatometer Test	x	x		x		
Borehole Jack Test	x			x		
Iowa Borehole Shear Test	x					
Piezometers			x		x	
Borehole Permeability Test					x	
Large Scale Pumping Test			x		x	

7.7.1 Borehole Permeability Testing

Two Falling Head Permeability tests were conducted in the fractured bedrock at the soil/rock interface in accordance with the U.S. Department of Navy design manual NAVFAC DM-7 and the permeability results were calculated using procedures established by Lambe and Whitman (Lambe, 13-8). The results are summarized in the Subsurface Exploration Summary for explorations TSC 8 and TSC 10. The following general procedures were used in conducting the Falling Head tests:

- a. A 4-inch diameter flush joint steel casing was advanced to the top of the bedrock and thoroughly washed out with clean water.
- b. The test section was created by advancing a 3-inch outside diameter rock core barrel to the required test depth which varied from 3 feet into the rock surface at TSC 8 and 8 feet at TSC 10.
- c. The casing was filled to the top with fresh water.
- d. The drop in the water level in the casing was measured and recorded at specific time intervals.

The tests were conducted as Falling Head infiltration tests as opposed to Constant Head tests (maintaining constant water level and recording flow rate) or drawdown tests (pumping out the casing and observing the rate of water level rise). As with many in-situ tests, the test is subject to a number of limitations and are generally considered to provide a crude estimate of permeability. The infiltration test is especially susceptible to filter skin effects caused by accumulation of suspended fines on the walls of the zone being tested.

7.7.2 Water Pressure Testing

Four Water Pressure Tests were conducted in the bedrock unit to determine the capacity of the in-situ rock mass to transmit water through voids or structural discontinuities. Testing and evaluation methods presented in the U.S. Bureau of Reclamation, "Earth Manual" were employed. The general testing procedures involved pumping water into a selected and isolated zone within the bedrock unit through a 1-inch Gamon-CalmetTM water meter under pressures which were controlled by an Ashcroft GD-1000TM pressure gauge. The borehole test zone

was isolated using a calibrated LynnesTM double pneumatic packer assembly. The volume of water which entered the rock unit in a given amount of time under a known pressure was measured using the water meter (Figure 7-64). A schematic diagram of the basic field equipment setup is shown in Figure 7-65.

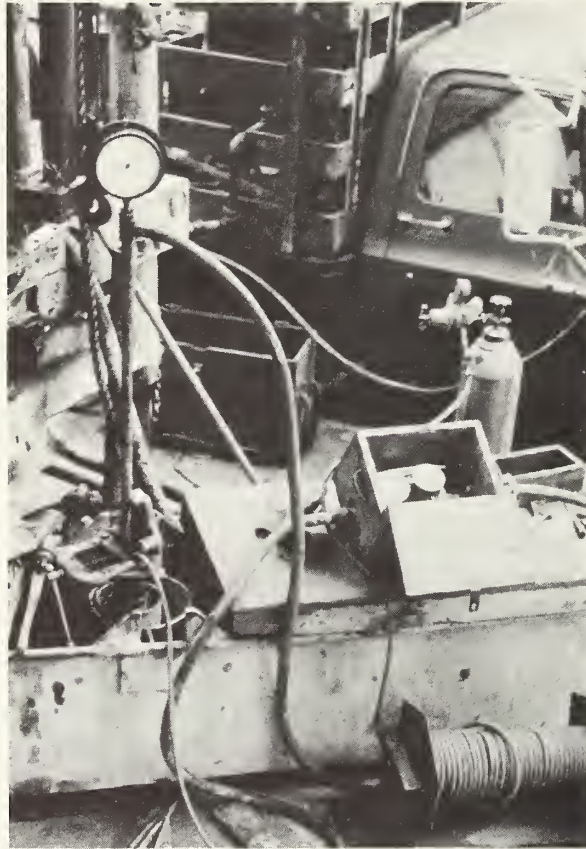

FIGURE 7-64. WATER PRESSURE TEST SURFACE EQUIPMENT

Various depths within two different boreholes (TSC 7 and TSC 8) were selected for testing, and a 10-foot packer spacing was selected with a variety of test pressures applied within a specific zone. The spacing of the pneumatic packers may be varied with the type and quality of the rock which, in turn, controls the selected zone of testing.

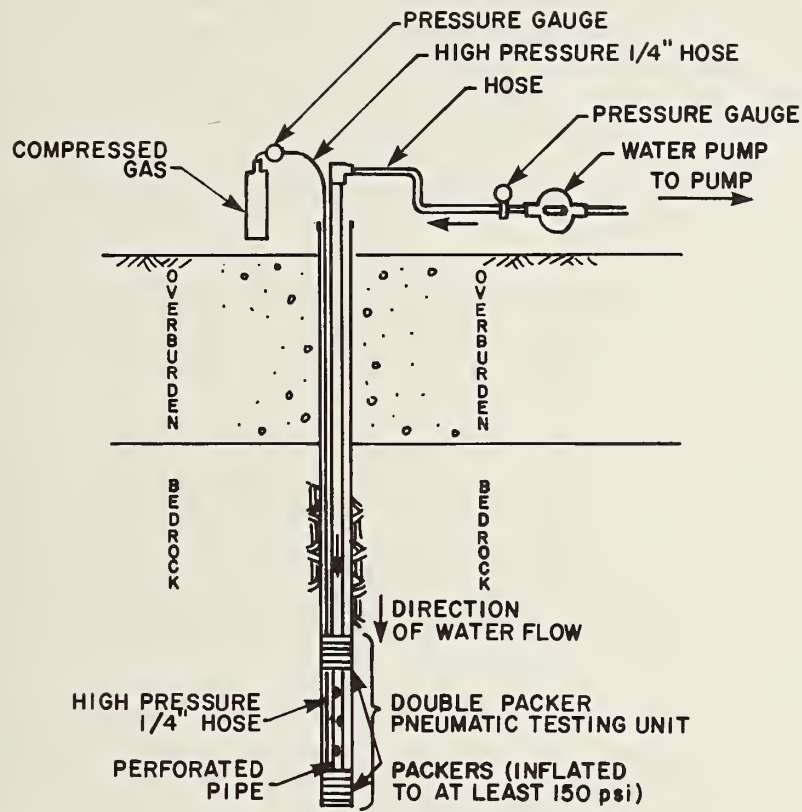

FIGURE 7-65. SCHEMATIC DIAGRAM OF WATER PRESSURE TEST ASSEMBLY

The following procedures were used in conducting the water pressure tests for this study:

- a. The double pneumatic packer assembly was installed in the 3-inch diameter rock core hole and an assembly friction test was conducted to determine the magnitude, if any, of pressure buildup through the testing apparatus.
- b. Nitrogen gas inflation of the packers from 200 to 300 psi, depending on the depth of the test and the quality of the rock.
- c. Pumping water through the water meter into the test zone at selected gauge pressures which were varied from 30 to 75 psi.

d. The time rate of water flow into the isolated test section at the selected gauge pressure was recorded from 5 to 10 minutes, depending on the volume of water which entered the rock. This step was usually repeated several times at varying pressures to obtain repeatable data.

e. Deflating the packers and moving the assembly to the next selected test section.

The calculated permeabilities expressed in centimeters per second is recorded on the applicable Subsurface Exploration Summary sheets (Appendix C).

The coefficient of permeability (K) calculated from the results of the various borehole permeability tests gives a gross indication of overall rock mass permeability. Although the test sections which were selected were in areas of joint and fracture concentrations and believed to represent the poorer quality rock, it was not possible to determine the percentage of joints which were "taking" the water or if only one major joint was the recipient.

The water pressure test results indicate an average $K = 10^{-5}$ cm/sec in the upper weathered and fractured bedrock zone decreasing to $K = 10^{-6}$ cm/sec in the lower, more competent portions of the rock at the locations tested. The Falling Head Permeability tests in the upper bedrock zone obtained consistent results of $K = 10^{-5}$ cm/sec. The permeability rate of the glacial till determined by laboratory testing was similar to the upper fractured bedrock with a calculated average $K = 10^{-5}$ cm/sec using both the Falling Head and Constant Head testing methods (see Section 7.8.3).

The Falling Head Permeability testing was conducted for this study on an hourly price basis which averaged approximately \$60.00 per test. The water pressure testing was conducted at a unit price basis of \$95.00 per test. (This included the various pressure modifications within each test zone).

7.7.3 Observation Wells and Piezometers

The determination of static groundwater levels, piezometric heads in confined aquifers and excess pore water pressures in various subsurface strata is important to the design and construction of any major underground opening.

The free ground water level, or table, is considered to be normal or static when the water surface is at equilibrium with the atmospheric pressure and the pore water pressure increases linearly with depth at a rate consistent with the unit weight of the pore fluid. Frequently, varying subsurface conditions may create temporary or secondary groundwater levels or hydrostatic pressures differing from static conditions. These non-static groundwater conditions require the installation of monitoring equipment at varying depths to facilitate long-term observation of the variations in the groundwater levels and pressures. In addition, observation wells and piezometers provide monitoring stations during in-situ pumping tests and construction dewatering operations for the determination of flow characteristics.

Two basic types of groundwater monitoring devices, observation wells and piezometers, were installed in the study area. They provide a total of 14 locations for observing the groundwater regime. No additional explorations were required for the installation of the observation wells and piezometers. The use of the biodegradable drilling mud "Revert" and the time factor allowed before installation, permitted installation of all groundwater monitoring units in the previously completed boreholes.

To insure borehole stability during subsequent geophysical surveying, each borehole was stabilized with Cresline™ 2.5-inch, Schedule 40, flush coupled PVC casing (ASTM D1786). In order to utilize existing plastic casing and to minimize project costs, 10-foot sections of pre-slotted "Hydrophilic"™ 2.5 inch, Schedule 40, PVC casing (ASTM D2120) with forty-six .015-inch wide slots per foot were selectively installed in the casing string for future groundwater observation purposes. At the completion of the borehole geophysical survey work, the boreholes were subsequently grouted to the base of the slotted wellpoint section, backfilled with a sand and sealed at the ground surface in a 3-inch diameter "Buffalo"™ roadway gate box for future monitoring purposes. Six observation wells were installed at varying depths within the Holiday Inn study area.

The costs associated with this installation method were minimal. The solid PVC (1.65/ft) was required for geophysical purposes and the conversion to an observation well installation required only the selective substitution of the slotted PVC (\$3.20/ft).

Two observation wells installed during the design phases of the Red Line Extension also provided additional ground water monitoring locations in the site area.

Open standpipe piezometers were installed in the site area to monitor the piezometric pressures in the relatively impermeable glacial tills and bedrock, and to determine the presence of excessive hydrostatic pressures and artesian conditions. In addition, 4 piezometers installed in the overburden and bedrock within the test area during the tunnel design stages have been incorporated into the ground water monitoring program of this study.

Two additional piezometers were installed in the bedrock to monitor joint water pressures in the rock units and to determine the hydraulic connection between the bedrock and overburden sediments. A flow type, open standpipe piezometer was constructed with a 1-3/8 inch O.D., porous tube, 1.0 foot in length, attached to a 3/4 inch, Schedule 80, rigid PVC riser pipe (ASTM D1785). The point was placed on, and encased in, a quartz silica sand filter material referred to as "Ottawa"TM sand which extended from 3 to 5 feet above the piezometer point.

An impervious seal of bentonite pellets was placed and compacted from 2 to 3 feet above the Ottawa sand filter material. The remaining portions of the bedrock and overburden were then sealed with a lean cement grout to ground surface or to the bottom section of the observation well. The installation details of the piezometers are summarized in the applicable Subsurface Exploration Summary (Appendix C).

The purpose of the ground water monitoring devices was to establish the existing ground water and hydrostatic pressure conditions in the study area. These monitoring devices will also furnish additional and valuable information during subsequent dewatering and construction activities associated with the actual Red Line tunnel construction.

Water depth determinations for each observation well or piezometer are summarized in Section 9, Table 1. Observations made in the wells and piezometers installed for this study have been affected by pumping of construction dewatering well No. DW5.

This pumping, which was associated with the dewatering operations for the Jarvis Street vent shaft, provided additional information on the hydraulic characteristics of the

site. Ground water levels and the definition of 2 hydraulically independent aquifers have been defined and are discussed further in Section 9.

The costs associated with the installation of a study piezometer to 100 feet, computed on a time and materials basis, is approximately \$350 for each completed installation.

7.8 CLASSIFICATION SYSTEMS AND LABORATORY TESTING

Although laboratory testing of soil and rock is not an exploration procedure, the test results, particularly the classification test results, are so closely interfaced with the explorations as to be an integral part of them. The accurate classification of soils and rock, using a well-defined and accepted classification system, is essential to any subsurface investigation. Laboratory data provides data used to classify and quantitatively assess the engineering properties of the subsurface geological formations.

Although laboratory testing is not within the scope of methods to be studied, for completeness, this section will briefly describe the systems adopted for classification of soil and rock, laboratory classification tests conducted, and tests for engineering properties.

7.8.1 Classification Systems

Overburden samples were classified using the Unified Soil Classification System (Table 7-5). A slightly modified version of the Burmeister Classification System was used in preparing the descriptive terminology of the various overburden units classified on the Subsurface Exploration Summaries (Appendix C).

A standard engineering classification system for rock has not been universally accepted by the geotechnical engineering industry. The Colorado School of Mines quarterly "Classification of Rocks" (Travis, 17-35) is the accepted standard for geological classifications. The American Society of Civil Engineers Manual No. 56 (ASCE, 17-30) which incorporates aspects of other commonly used classification systems (Deere, 17-15), provides the basis for the descriptions of the engineering properties of the rock. The details of the

TABLE 7-5. UNIFIED SOIL CLASSIFICATION SYSTEM

UNIFIED SOIL CLASSIFICATION SYSTEM									
Field identification procedures (Excluding particles larger than 3 in. and basing fractions on estimated weights)		Group symbols		Typical names		Information required for describing soils		Laboratory classification criteria	
<p>Gravels More than half of coarse fraction is larger than No. 4 sieve size</p> <p>Sands More than half of coarse fraction is smaller than No. 4 sieve size</p> <p>(For visual classification, the 4 in. sieve size may be used as equivalent to the No. 4 sieve size)</p> <p>Gravels with fines (appreciable amount of fines)</p> <p>Clean sands (little or no fines)</p> <p>Sands with fines (appreciable amount of fines)</p> <p>Clean gravels (little or no fines)</p> <p>Predominantly one size or a range of sizes with some intermediate sizes missing</p> <p>Wide range in grain size and substantial amounts of all intermediate particle sizes</p>		<p>GW</p> <p>GP</p> <p>GM</p> <p>GC</p> <p>SW</p> <p>SP</p> <p>SM</p> <p>SC</p>		<p>Well graded gravels, gravel-sand mixtures, little or no fines</p> <p>Poorly graded gravels, gravel-sand mixtures, little or no fines</p> <p>Silty gravels, poorly graded gravel-sand-silt mixtures</p> <p>Clayey gravels, poorly graded gravel-sand-clay mixtures</p> <p>Well graded sands, gravelly sands, little or no fines</p> <p>Poorly graded sands, gravelly sands, little or no fines</p> <p>Silty sands, poorly graded sand-silt mixtures</p> <p>Clayey sands, poorly graded sand-clay mixtures</p>		<p>Give typical name; indicate approximate percentages of sand and gravel; maximum size; angularity, surface condition, and hardness of the coarse grains; local or geologic name used; grain size distribution information; and symbol in parentheses</p> <p>For undisturbed soils add information on stratification, degree of compactness, cementation, root holes, and drainage characteristics</p> <p>Example: Silty sand, gravelly; about 20% hard, angular gravel particles 3-in. maximum size; rounded sand grains about 15% coarse to fines about 15% plastic lines with low dry strength; well compacted and moist in place; alluvial sand. (SM)</p>		<p>CU = $\frac{D_{60}}{D_{10}}$ Greater than 4</p> <p>CC = $\frac{D_{60}}{D_{10} \times D_{20}}$ Between 1 and 3</p> <p>Not meeting all gradation requirements for GW</p> <p>Above 'A' line with PI between 4 and 7 are borderline cases requiring use of dual symbols</p> <p>Atterberg limits below 'A' line, with PI greater than 7</p> <p>Atterberg limits above 'A' line, with PI greater than 7</p> <p>CU = $\frac{D_{60}}{D_{10}}$ Greater than 6</p> <p>CC = $\frac{D_{60}}{D_{10} \times D_{20}}$ Between 1 and 3</p> <p>Not meeting all gradation requirements for SW</p> <p>Atterberg limits below 'A' line or PI less than 4</p> <p>Atterberg limits above 'A' line with PI between 4 and 7 are borderline cases requiring use of dual symbols</p>	
<p>Identify the fractions as given under field identification</p> <p>Determine percentages of gravel and sand from grain size curve</p> <p>Depending on percentage of fines (fraction smaller than No. 200 sieve size) soils are classified as follows:</p> <p>Less than 5% GM, GP, SM, SP</p> <p>More than 5% to 12% GM, GP, SM, SP</p> <p>More than 12% to 17% GM, GP, SM, SP</p> <p>5% to 17% GM, GP, SM, SP</p> <p>Borderline cases requiring use of dual symbols</p>									
<p>Use grain size curve in identifying the fractions as given under field identification</p>									
<p>Field identification procedures on fraction smaller than No. 40 sieve size</p> <p>(The No. 200 sieve size is about the smallest particle visible to naked eye)</p> <p>More than half of material is smaller than No. 200 sieve size</p> <p>Fine grained soils</p>									
<p>Sils and clays greater than liquid limit</p> <p>Sils and clays less than 50</p> <p>Highly organic soils</p>		<p>ML</p> <p>CL</p> <p>OL</p> <p>MH</p> <p>CH</p> <p>OH</p> <p>PI</p>		<p>Inorganic silts and very fine clayey fine sands with slight plasticity</p> <p>Inorganic clays of low to medium plasticity, gravelly clays, sandy clays, silty clays, lean clays</p> <p>Organic silts and organic silts of low plasticity</p> <p>Inorganic silts, micaceous or silty silts, fine sandy or silty soils, elastic silts</p> <p>Inorganic clays of high plasticity, fat clays</p> <p>Organic clays of medium to high plasticity</p> <p>Peat and other highly organic soils</p>		<p>Give typical name; indicate degree of clayey or silty character, amount and maximum size of coarse grains; colour in wet condition, odour if any, local or geologic name, and other pertinent descriptive information, and symbol in parentheses</p> <p>For undisturbed soils add information on structure, stratification, consistency in undisturbed and remoulded states, moisture and drainage conditions</p> <p>Example: Clayey silt, brown; slightly plastic; small percentage of root holes; numerous vertical place; loess; (ML)</p>		<p>Plasticity index</p> <p>Plasticity chart</p> <p>for laboratory classification of fine grained soils</p>	

project classification systems are summarized in Appendix A, Legend and Notes.

Several similar engineering classification systems for rock recently developed by Europeans are becoming increasingly popular in the United States for application in the field of rock mechanics (Bieniawski, 17-5) (Barton, 17-3).

The laboratory testing program was implemented to assist in the classification of the soil and rock samples recovered from the test borings and to provide data on their significant engineering properties. In general, laboratory testing was performed in accordance with applicable ASTM standards or manufacturer's procedures. The various tests and procedures are summarized hereinafter.

7.8.2 Classification Tests

7.8.2.1 Grain Size Analyses - The grain size distribution of selected and representative soil samples were determined in accordance with ASTM Designation D422-63 (1972). Sixty-seven mechanical sieve analyses and 61 hydrometer analyses were conducted and subsequently used to modify the field visual classifications. Grain size distribution curves are shown graphically in Appendix J.

7.8.2.2 Atterberg Limits - The Atterberg limits of cohesive soils were determined in accordance with ASTM Designation D423-66 and D424-59 (1971). Eleven liquid and plastic limit tests were conducted on the selected finer portions of the glacial till materials. The Atterberg limits test results are summarized in the applicable Subsurface Exploration Summary sheet (Appendix C).

7.8.2.3 Moisture Content and Unit Weight - The determinations of the natural water content and total unit weight were made in accordance with ASTM Designation D2216-71. The total sample unit weight and two water content determinations were conducted on the glacial till recovered in a 3-inch diameter thinwall Pitcher tube. The results of this testing is summarized on the Subsurface Exploration Summary for test boring TSC-10 (Appendix C).

7.8.2.4 Petrographic Analysis - A petrographic analysis consists of viewing the transparent minerals of a thin section of rock (0.03 mm thick) under the polarized light of a specially designed microscope. Optical characteristics of the individual minerals making up a rock, and the microscopic view of texture and structure revealed by such an analysis, provide more accurate and detailed information about the internal structure and composition of the rock. The optical procedures used consisted of viewing a transparent thin section of rock on a Vickers M72CTM polarizing microscope with a rotating stage and a monocular viewing head.

Utilizing various petrographic techniques, the major mineral constituents were first identified. Further examination determined: a.) secondary minerals, b.) texture, c.) nature, degree and product of alteration, d.) cracks, e.) fractures and f.) any other feature of significance.

Four thin sections of various rock types from the test section were analyzed and microphotographed.

The petrographic analysis for each of these thin sections identifying rock type, composition, texture and other features of significance are included as Appendix E.

7.8.3 Permeability Tests for Engineering Properties

Laboratory permeability testing is a method of determining the rate of flow of water through a given soil unit. Depending on the range of permeability of the soil being tested, two different test procedures may be employed:

a. Constant Head Method - Employing ASTM Designation D2434-68 test procedures, a representative soil sample is compacted in a 1.4-inch diameter by 2.0-inch long cylindrical mold known as the Harvard MiniatureTM mold. The sample is then saturated by applying a head of water until the inlet and outlet flows are equalized. The flow of water through the sample is measured and the permeability K calculated.

b. Falling Head Method - This method of permeability testing is performed in accordance with procedures described in "Soil Testing for Engineers", by T.W. Lambe (1951). The soil sample is loosely placed in a 2.0-inch diameter lucite mold known as a permeameter. The sample is then saturated and all air removed by a vacuum process. A known column of

water is timed as it flows through the soil sample. The length of the soil is then measured and the permeability calculated. The soil sample is then densified by tapping the mold and the test procedure repeated for different void ratios (or lengths) of the soil. The relationship between the void ratio and permeability coefficient is plotted and is graphically shown in Appendix I.

Additional and more detailed laboratory testing conducted as a part of the various design stages of the Red Line Extension is incorporated into the analysis and predictive phases of this study.



8. RESEARCHED EXPLORATORY TECHNIQUES

8.1 GENERAL

Several new and rapidly developing methods of subsurface exploration offer potential to provide useful data for transit tunnel design and construction. Three of these methods of exploration have been designated for literature research and review and are discussed in this section.

The methods designated for literature review are:

- a. Horizontal Drilling
- b. Thermometric Surveys
- c. Acoustic Explorations

Due to practical limitations on the scope of field work included in this study and the compatibility of the procedures with the particular soil and rock conditions on the project, implementation of these methods on a trial basis was excluded from the program.

The following sections summarize the principles of these exploratory methods and their capabilities.

8.2 HORIZONTAL DRILLING

The lack of information at the elevation of an underground structure increases the risk and cost of the project. The risk is directly affected by this lack of information while the cost increases due to overdesign to accommodate the risk.

A method to reduce this risk is direct horizontal penetration along the alignment of the structure. This may be accomplished either by excavation of a pilot tunnel or by a program of horizontal drilling.

Pilot tunneling is not an advanced method of subsurface investigation. The high cost of pilot tunnels (\$225 to \$877 per foot) compared to horizontal drilling with a small diameter bore (\$48 to \$89 per foot) makes them unacceptable in all but rare circumstances. In addition, horizontal drilling

has other advantages over pilot tunneling, including a relatively high rate of advance, minimum rock disturbance, minimal safety and environmental problems, and providing discrete points where the investigation can be terminated at a lower cost.

Horizontal drilling is suitable as an exploration technique for most underground construction sites, especially those where structures will be deep underground and limited accessibility is available for a drilling set-up. Tunnels are a prime example of this type of project. The drilling can be accomplished during the final design stage and/or during construction when the location of gas pockets, water under pressure and "bad" rock zones is of paramount importance. Horizontal drilling is invaluable at a location where the geologic structure is primarily vertical, the structure is deep underground or the ground surface is covered by a thick section of overburden, or in heavily developed urban areas.

8.2.1 Horizontal Drilling Methods

Numerous investigators (Majtenyi 10-30), (Harding 10-18), (Ash 10-2), (Paone 10-34), have determined that there are presently only four techniques available to horizontal drilling that are feasible and that do not need extensive development work. These methods are:

- a. Diamond wireline core drilling
- b. Rotary drilling
- c. Down-hole motor drilling
- d. Down-hole percussion drilling

8.2.1.1 Diamond Wireline Drilling - Diamond wireline drilling is the only method available when a continuous core is desired. Core bits and core barrels are available in the size range AQ (1.89") to PQ (4.83"). However, the petroleum industry has developed diamond wireline bits up to a diameter of 12.25 inches with a 5.25-inch core that could be adapted for horizontal drilling. The large diameter hole would, if necessary, allow the hole to be cased through the drill string. Most surveying equipment and geophysical equipment will fit in the standard size holes; however, the Federal Highway Administration (FHWA) development goal is for a 6.75-inch hole to accommodate newly developed remote sensing equipment (Harding, 10-18). Presently, that

size horizontal hole can only be produced with a rotary drilling rig.

Because gyroscopic surveying tools have not been developed for use in horizontal holes, the state-of-the-art devices are magnetic and must be separated from the metal drill rods. The wireline feature enables the surveying or geophysical tools to be pumped through the drill string and into the open hole (provided a coring bit is used) without removing the rods from the hole. This is important because long horizontal holes must be surveyed every 20 or 30 feet.

The presently available surface drilling rigs are torque-limited rather than thrust-limited. Theoretically, the spin-up torque limitation (i.e., the limit where the rig will overcome the friction to turn the drill string) is about 10,000 feet for a wireline drill rig (Harding 10-18). This torque is sufficient to satisfy most needs. However, a major problem with long horizontal drilling is that the drill string is in compression because the thrust is supplied by a rig on the surface. This thrusting force causes the drill string to bend, with hole deviation as a result. In the oil drilling industry, the normal force on the drill bit is provided by heavy drill collars behind the bit so the drill string is actually in tension. This method cannot be used for horizontal drilling. Down-hole thruster drilling, which provides thrust by pushing bearing plates against the borehole wall, and down-hole percussion drilling, would eliminate this problem. Both of these methods are in the development stage for horizontal drilling and have had little use in practical application. Large diameter rods help to alleviate the bending problem because the stiffness of the drill rod increases as the fourth power of the diameter (Harding 10-18). However, rod diameter is limited by cost and by the size of the hole desired. In diamond wireline drilling, the rod and bit sizes are usually closely matched. The close match in size reduces the bending tendency because of the small annular space between the drill rod and the wall hole.

8.2.1.2 Down-Hole Percussion Drilling - Down-hole percussion drilling was not designed for horizontal drilling. Only one program is known (Jacobs Associates) for which this technique was used to accomplish horizontal drilling (Harding 10-18). Based on that program, the technique is suitable for horizontal penetrations up to 1,000 feet, with hole diameters of 4 to 6 inches. The presence of ground water severely limits the effectiveness of the percussion technique. The efficiency of

the method is also considerably reduced by the presence of soft material, such as clays or fault gouge. The Jacobs program used a modified diamond drilling rig which could be rapidly changed from percussion drilling to diamond coring for sampling. A unique rod handling and storage device was used in this program. One thousand feet of rod can be removed from the hole and stored at rates up to 200 feet per minute. The rod storage method cannot be used in a confined space. During the Jacobs program, no attempt was made to guide the drill string which apparently is a major problem with down-hole percussion drilling.

8.2.1.3 Down-Hole Motor Drilling - The down-hole motor is a positive displacement mud motor and is essentially a multi-stage MoynoTM pump used in a reverse application. When fluid is pumped under pressure into the motor, it is directed downward through the void areas between the rotor and the stator. In order for flow to occur, the rotor is displaced and turned within the stator by the pressure of the fluid column, thus powering the connecting rod, a hollow drive shaft, and finally a conventional bit sub at the end of the tool.

The paramount characteristic of this method is that the bit is driven without drill pipe rotation. This fact reduces pipe wear, increases penetration rates and controls deviation tendencies. The down-hole motor is the only device capable of surface-sensing what is happening at the bottom of the hole. This is possible because drilling torque is directly proportional to pressure differential in a positive displacement system. Since there is no drill pipe friction to distort readings, the mud pressure gauge can be used as an accurate weight and torque indicator. The instant the motor experiences a load change, the pressure gauge reflects a proportional change (Dyna-Drill 10-12).

The Dyna-DrillTM is the only down-hole motor that has a proven capability in horizontal drilling. The Dyna-Drill is a non-coring device; however, it may be possible to modify the machine to accommodate a short core barrel for sampling. The Dyna-Drill can be used to correct hole deviation but the drill string must be pulled to add the bent sub assembly and then pulled again before straight-line horizontal drilling could continue. Therefore, the Dyna-Drill system would not be a timesaving device compared to other horizontal drilling methods. Long distance horizontal drilling with a down-hole motor has been limited. More experience, in a variety of geological

environments, is needed before the technique can be considered a reliable alternative.

8.2.1.4 Rotary Drilling - Rotary drilling rigs using rolling cutter bits have been used more than any other method to drill longer horizontal holes. Horizontal rotary drilling in the United States has been limited to soft (coal) and very soft materials.

Small diameter rolling cutter bits are not capable of penetrating very hard "granitic" type rocks. The small bearings cannot survive the high thrust loads needed to overcome the rock's compressive strength. Therefore, the smallest size practical for drilling hard rock is probably 6.75 inches (Harding 10-18). Presently, heavy duty diamond drilling rigs or custom-built rotary rigs are used for most horizontal applications. As with diamond wireline core drilling, rotary drilling has the problem of the drill string being in compression rather than tension. The severity of this problem is increased for rotary drilling because the rotary drill bits require higher thrust for penetration rates equal to diamond wireline rigs and because there is usually a larger space between the hole wall and the drill rods. The larger annulus allows greater drill rod bending and increases the problem of hole deviation. Numerous devices have been developed to control the deviation with varying degrees of success. The devices include drill rod centralizers, square drill collars, and a newly-developed wireless telemetry system which gives "real time" survey data so adjustments in thrust and bit rotation speed can be made as required (Ash 10-2).

Maintaining hole stability and surveying the boring are problems with the rotary method. A wireline device was used to carry the surveying instrument on the Seikan Tunnel project. Grouting is used to maintain the hole integrity. One 2,600-foot hole on the Seikan Tunnel project was grouted 61 times with the number of grouting shifts being twice the number of drilling shifts (Harding 10-18).

8.2.2 Past Experience in Horizontal Drilling

The Koken FS400, a rotary rig especially designed for horizontal drilling, has penetrated to 4,300 feet in soft volcanic rocks on the Seikan Tunnel project in Japan. The Dyna-Drill™ down-hole motor was used on this project to control hole deviation at a distance of almost 4,000 feet. Other

work includes: (a) Two exploratory holes were done for a tunnel on the Pennsylvania Turnpike in 1955. These holes were drilled using the conventional diamond core method (not wireline) and were 1,700 feet and 1,800 feet long. Directional control was reported as fair to good. (b) Longyear Drilling and their subsidiaries in Canada and South Africa have drilled several horizontal exploratory holes almost 4,000 feet long using the diamond wireline method. A number of other horizontal holes have been drilled more than 1,000 feet including one of about 3,700 feet at the Mercury, Nevada test site. The Longyear 44TM drilling rig was used for several of these borings and the manufacturer believes that this unit has the capability to drill horizontally to as much as 5,000 feet in competent materials (Harding 10-18). (c) A 1,000 foot horizontal hole for the Straight Creek Tunnel project in Colorado used the wireline coring method. Directional control was considered fair to good (Dowding 10-11). (d) Jacobs Associates, in 1972, under contract to the Advanced Research Projects Agency, drilled a 4-inch diameter hole 862 feet long using a down-hole percussion drill. They used a new drill rod handling method that allowed them to pull 1,000 feet of rod at rates up to 200 feet per minute. There were no specific hole guidance requirements and directional control was apparently poor.

8.2.2.1 U.S. Bureau of Mines - The U.S. Bureau of Mines has extensive experience with drilling long horizontal holes. In 1942, they drilled two long horizontal holes in the oil-bearing sandstones of Pennsylvania. The holes were 2,334 feet long and 2,255 feet long and were drilled using conventional diamond coring (the wireline method had not yet been developed). Directional control was poor. In 1969-70, numerous horizontal holes were drilled in coal beds for methane relief. The longest was 503 feet. These holes were drilled using rotary drill rigs and drag bits. In 1972, several holes were drilled in coal beds; the longest was 850 feet, using a rotary drill rig. Directional control was good to very good. The Bureau of Mines, in 1972-73, with Fenix and Scisson, Inc., drilled two long horizontal holes. The first hole was drilled a length of 1,100 feet using a rotary drill rig and a roller bit. The latest techniques were used, including a cableless telemetry system for which the drill rod is the conductor to send the down-hole information to the surface. Directional control was excellent. The second hole was drilled to a distance of 1,730 feet using the Dyna-DrillTM, a positive displacement mud motor. The hole was started on the surface and drilled 1,320 feet on a curved trajectory to intersect a

7-foot thick coal bed. The hole was continued within the coal bed horizontally for another 410 feet. The directional control was good to excellent.

8.2.2.2 Federal Highway Administration - The Federal Highway Administration has authorized several studies (Harding 10-18), (Ash 10-2), to determine the state-of-the-art of horizontal drilling. Much of this report has been drawn from these sources. The reports were also used to help determine the potential for development in the areas of horizontal penetration capability, hole guidance and other factors that affect the economics of a long horizontal drilling program. The FHWA goal is to have the technology to drill a long, small-diameter, horizontal hole in a variety of different materials, including soft to hard rock and gouge, and with a hole size range of 2 to 24 inches. The technology should also be able to produce a hole 3 miles long that would remain open for at least a year without metallic casing and be a large enough diameter to accept the remote sensing sondes being contemplated (a minimum hole diameter of 6.75 inches would be needed to accept these sondes). The accuracy of hole location required is ± 30 feet in 3 miles or a target 60 feet in diameter, at that distance (Harding 10-18).

8.2.3 Use and Limitations of the Horizontal Drilling System

The diamond wireline core drilling technique is in a more advanced development stage than the other horizontal drilling methods considered. This system can be used to core any material, and using a triple tube core barrel, even samples of soft materials can be recovered. Holes as much as 4,000 feet long have been drilled. The wireline method has the best record of those considered for hole guidance. The diamond wireline core is the only method available to collect continuous core samples. The wireline method has the further advantage of permitting survey equipment or geophysical sondes to be pumped out into the hole through the core bit, thereby reducing the need for rod handling.

The rotary drilling method, using the proper rolling cutter or button bits, is capable of drilling any type formations encountered. However, the major advances in rotary drilling were made for the oil well drilling industry and are not directly applicable to horizontal drilling without engineering design changes. These changes would, generally, be custom orders, and thus expensive.

The Koken FS400TM drill rig used to drill the longest horizontal hole to date (5,300 feet on the Seikan Tunnel project) is just such a custom rig. Guidance of the drill bit is more difficult with a rotary rig. Also, the drill string must be pulled to take core samples or to use geophysical or surveying sondes outside the casing. Safety of the sonde entails a stabilized hole and for that, a grouting program may be needed which could be extensive and expensive.

The down-hole motor drill has proven itself for short, shallow holes, especially guided holes with a curved trajectory. There are few examples of the method being used to drill long horizontal holes. The two examples given are exceptional.

Many maintenance problems are associated with operation of the down-hole motor. Drilling cuttings may have a tendency to settle out of the drill mud in a horizontal hole because the drill rods are not rotating. There certainly is a potential, with proper development effort, for this type of device in horizontal drilling, especially if it could be combined with a down-hole thruster.

The down-hole percussion drill has limited use in horizontal drilling for long holes. No core is available with this method. The one example of a relatively long hole had no guidance control. The percussion drill operates best when drilling hard to very hard rock and its performance is poor in softer materials, including gouge. The presence of water in the borehole also limits the performance of the down-hole percussion drilling method.

Figure 8-1 shows the typical penetration capability of the various systems considered. It can be seen that hole diameter of the diamond wireline system is limited to the HQ size. Diamond bits are available in diameters up to the limit of the rotary drilling shown but they have not been modified nor has support equipment been developed for use in horizontal wireline applications.

The diamond wireline core drilling system and the rotary drilling system are the only methods that can be considered applicable for long distance horizontal drilling. Both systems must use the most rigid drill pipe available to control rod bending. The drilling equipment must be instrumented so that pump pressure, thrust pressure and the drill RPM are continuously monitored. Various stabilization techniques and tools are necessary to help control hole deviation. The hole

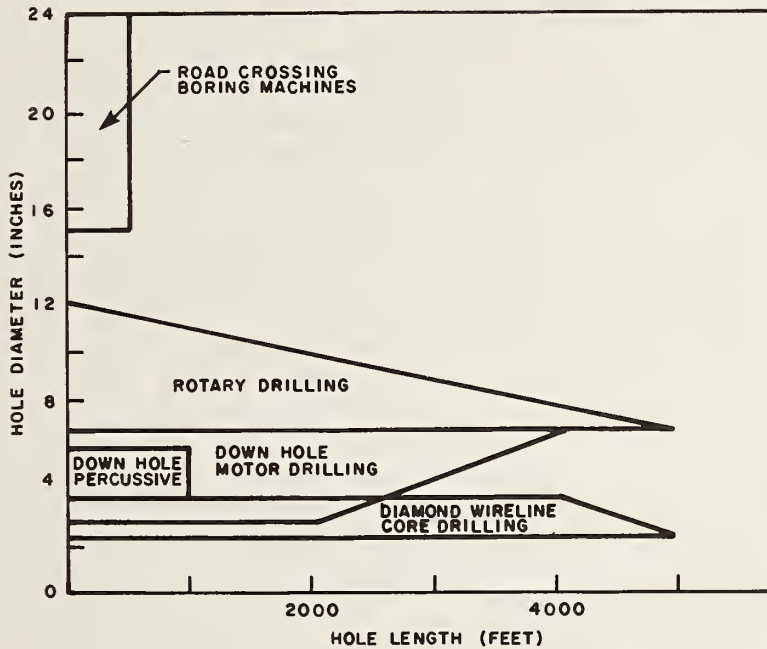

FIGURE 8-1. TYPICAL HORIZONTAL PENETRATION CAPABILITY HARDING (10-18)

initially must be surveyed every 20 or 30 feet. The interval between surveys can probably be extended to 50 or 100 feet with a return to shorter intervals, if needed. Because of the frequency of surveying, a multi-shot survey device is required. Magnetic devices are the least expensive. Gyroscopic devices, if developed and custom-built for horizontal drill holes, are likely to cost on the order of twenty times as much as the magnetic devices but will be an order of magnitude more accurate, (Harding, 10-18) an important consideration for very long drill holes. The wireless telemetry device, newly developed and field tested, (Ash, 10-2) is certainly the survey system of the future. In the continuous telemetry system, the exact location of the drill bit is transmitted through the drill rods to a printer at the surface.

An experienced, highly-skilled drilling crew is essential in a horizontal drilling operation. The problems associated with this method and the cost of the program can be multiplied by an inexperienced crew. Drill crew experience is a real concern because the low demand for horizontal drilling does not permit a crew to work exclusively or extensively in

the field. This lack of demand is the principal reason that horizontal drilling is so expensive. An increase in demand would encourage drilling equipment manufacturers to develop the equipment needed to overcome present problems and to make the technique economically comparable to vertical drilling.

The best use of the data obtained, using the horizontal drilling method, is to evaluate the geologic conditions along the proposed excavation corridor. The investigation is planned to locate zones of high water pressure, gas accumulations and "bad" rock zones such as swelling or squeezing ground, shear zones or faults with attendant gouge. When the conditions have been defined, design of the required support systems can be made. It is recognized that the diameter of a borehole is small relative to the tunnel diameter and variation in rock quality is likely to exist within the tunnel. The use of various borehole geophysical (remote sensing) methods to evaluate the rock properties outside the perimeter of the borehole, may extend the information limit throughout the entire zone of tunneling. Various geophysical methods available are described in the following paragraphs.

8.2.4 Borehole Geophysical Methods

This discussion is limited to those methods which can be accomplished using a self-contained borehole sonde which can be pumped or otherwise placed in the horizontal borehole and retrieved by a wireline. The sonde may require redesign for use in horizontal holes. Table 7-3 in Section 7 lists various logging techniques and the kinds of information they can produce. The broad classifications are described below. A detailed discussion of the geophysical methods can be found in Section 7.

The electrical logs yield information on the resistivity of the formation, relative porosity, identification of lithologic boundaries, salinity, water zones and sometimes the dip of the beds. These methods require a fluid-filled open hole.

The acoustical logs yield information on the porosity, permeability, Young's Modulus, Shear Modulus, Poisson's Ratio, lithology, geologic boundaries, rock mechanics and relationships to ultimate strength of the rock mass. These logs cannot be run inside steel casing.

The mechanical logs measure variations in borehole size, the locations and general geometry of caving zones, and the

alignment and location of the borehole path. These tools may be run in an open or uncased hole.

Other borehole logging or testing methods that do not fall into these general categories are available and are enumerated in the figure.

The logging techniques will give information to a limited distance outside the borehole. Techniques are being developed which are planned to extend the logging sensitivity to perhaps 50 feet, which would exceed most tunnel radii (SWRI 1-25).

8.2.5 Conclusions

The technique of using long, small-diameter horizontal borings to explore a tunnel alignment is available. Diamond wireline core boring is in a more advanced development stage than the other horizontal drilling methods considered. The rotary method, using rolling cutter bits, has been used to drill the longest, small-diameter horizontal hole to date. However, a specially built rig was used in that effort.

Some of the difficulties with drilling long horizontal holes are direction control, penetration rates, lack of experienced drillers, and lack of equipment designed for use in drilling, sampling or logging horizontal holes. On a per-foot basis, horizontal drilling is less expensive than other methods of direct horizontal penetration. However, the present state-of-the-art is not developed to the point where the equipment is economical and the procedures efficient enough to employ in ordinary transit tunneling.

A major conclusion from these studies is that long horizontal drilling is expensive because of the low demand for the method. The vertical and directional drilling demand which was at 30,000 holes and \$3.4 billion in 1974 may be compared to horizontal drilling for which demand was too low to document (Harding, 10-18). Clearly, the high demand led to the numerous technological developments in the vertical drilling industry. The same continuous, long-term demand will be necessary before manufacturers will spend development money in the horizontal drilling field.

8.3 THERMOMETRIC SURVEYS

Thermometric or geothermic surveying is a geophysical log that continuously records the depth versus temperature or temperature gradient in borehole fluids. The borehole fluid temperature is affected by natural ground temperatures. The rate that the natural heat is conducted to the fluid is influenced by the thermal conductivity of the subsurface materials. The thermal conductivity will vary with different soil and rock types, depending in part on composition and degree of consolidation. The borehole fluid temperature will also be influenced by fluid inflow. Inflow of relatively warm or relatively cold ground water through a fissured or water-bearing formation will cause a localized zone of anomalous temperature in the borehole fluid. In addition to locating zones of ground water flow and formation boundaries, temperature logs have reportedly been used for the following purposes: to locate abnormal radioactivity and oxidation regions (Telford, 7-15); detect cavities and locate gas flows (Hvorslev, 8-17); trace migration of ground water, evaluate adequacy of grouting and quality of water and corrosion potential (GWM, 11-10); help in the interpretation of resistivity and spontaneous potential logs (Davis, 11-16); indicate "uncomfortable" ground temperatures, and locate fresh cement behind casing (Ash, 10-2); and determine the extent of hydraulic fracturing, and detect high water pressure zones (LeRoy, 7-11).

8.3.1 Survey Equipment and Procedures

Temperatures in a borehole are determined with a resistor that is very sensitive to variation in temperature. The electrical circuit is calibrated to correlate variations in resistance with temperature variations. The calibrated resistance changes are recorded on a chart at the surface, typically at scales of 1, 2 or 5 degrees Fahrenheit per inch (Ash, 10-2). Controls are required for zero-positioning and for sensitivity or span (Keys, 1-15). Temperatures are measured to an absolute accuracy of 0.1°F (0.05°C) and to a precision of 0.01°F (0.005°C). Additionally, differential temperatures (or temperature gradients) may be measured by 2 sensors at close spacing or by 1 sensor and an electronic memory (Keys, 1-15), or by 1 sensor and magnetic tape (for later processing) (Ash, 10-2). When measuring differential temperatures, the recorder response is set at zero for some reference gradient. Deviations from the reference gradient indicate anomalous heating or cooling. Temperature logs are frequently

made at the same time as electrical logs (GWM, 11-10). The size of crew required is one or two, and the time required to log a 500-foot hole is about 45 minutes (Ash, 10-2).

8.3.2 Illustrative Applications

Figure 8-2 is a schematic diagram of temperature logs in boreholes with (a) a recently cemented zone, and (b) a gas leak. The cemented zone shows a high temperature anomaly caused by heat from hydration, while the zone of gas shows a low-temperature anomaly caused by expansion and cooling of the gas as it enters the well.

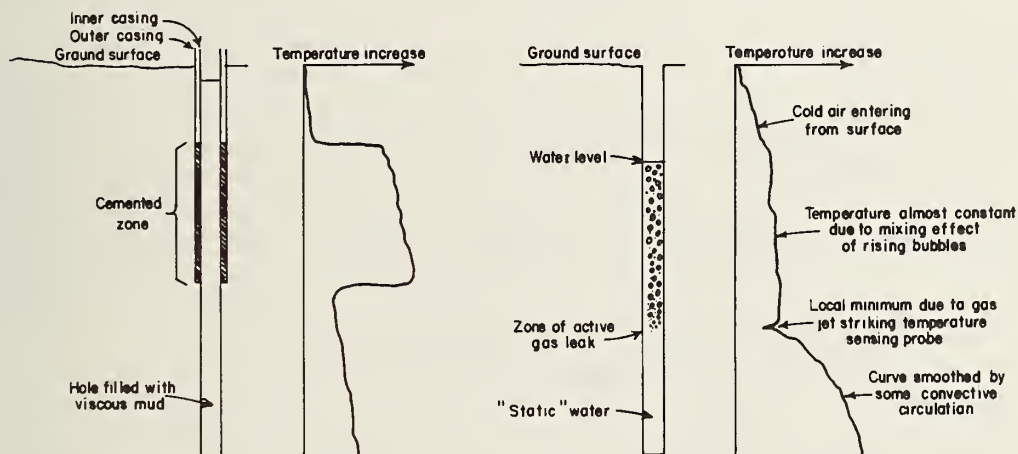

FIGURE 8-2. SCHEMATICS OF TEMPERATURE LOGS
DAVIS (11-6)

Figure 8-3 shows the effect on the temperature in an auger hole immediately adjacent to a well being artificially recharged with warm water. The zone of flow corresponds to the sand layer as indicated by the natural-gamma log.

Figure 8-4 shows logs of absolute temperature and differential temperature in a deep well. The differential temperature log shows higher sensitivity than the absolute temperature log.

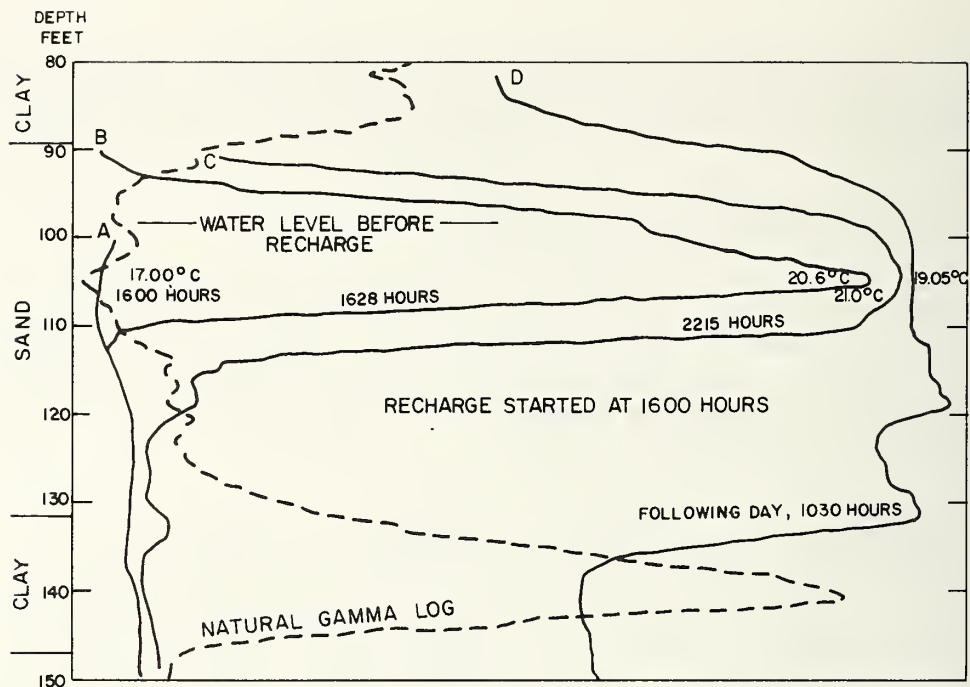

FIGURE 8-3. TEMPERATURE LOGGING DURING ARTIFICIAL RECHARGE KEYS (1-15)

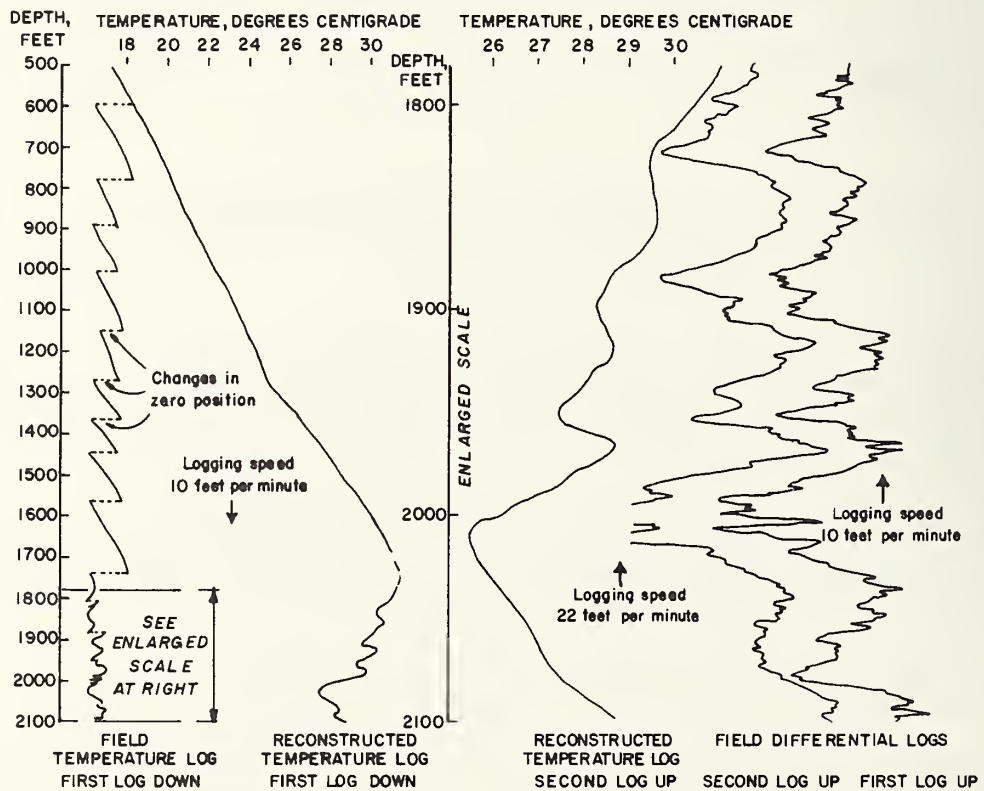

FIGURE 8-4. TYPICAL FIELD AND RECONSTRUCTED TEMPERATURE LOGS KEYS (1-15)

8.3.3 Implementation Considerations

Temperature measurements in recently completed borings are not indicative of the original temperatures at that location. During drilling, where the circulation of drilling fluids is through the drillpipe with return in the annulus, the bottom of the borehole is being cooled while the upper section is being heated (LeRoy, 7-11). After drilling is stopped, the formations will exchange heat with the borehole fluid at different rates according to their corresponding thermal conductivities. The resulting anomalies are generally most pronounced 24 to 36 hours after circulation ceases (Horslev, 8-17). To achieve equilibrium, however, up to several years may be required (Keys, 1-15).

Although Figure 8-4 shows a log with good repeatability, many times borehole fluids are significantly disturbed by logging instruments. In fact, the differential temperature log from a 2-sensor probe may be in error because the fluid has been disturbed at the location of the upper sensor. Temperature and resistivity probes should be run down the hole before other probes are used. Temperature and resistivity are preferably measured with a single probe that makes simultaneous logs (Keys, 1-15).

Each log should have field standardized values to minimize the effects of electronic drift caused by self-heating and environmental temperatures. Thermistors are normally supplied with calibration data showing resistance as a function of temperature. Field standardization can be accomplished by substituting the thermistor with a resistance-decade box to check the response of the entire system and to place standardized values on each log.

8.3.4 Possible Red Line Project Applications

Temperature logging was not used in the Red Line investigation program or the TSC field evaluation program. However, this logging method might have been used to determine possible zones of water inflow at tunnel elevations; that is, whether water inflow might occur in the glacial till, the upper zone of bedrock, the till/bedrock interface, or throughout the bedrock. In addition, temperature logs may have indicated the degree of (or lack of) hydraulic connection between the outwash sand aquifer and the till/bedrock aquifer at various locations along the alignment. Assuming the 2 aquifers have water at different temperatures, the logs could indicate the extent of mixing.

8.3.5 Cost

The "direct cost" of a temperature log is \$300 to \$400 for a 500-foot hole when conducted in association with other borehole logging methods (Ash, 10-2)

8.4 ACOUSTIC EXPLORATIONS

The application of acoustics for geotechnical engineering purposes is a relatively new but rapidly expanding technology. Acoustic methods currently available utilize various principles and techniques varying from active borehole scanning to passive acoustic emission monitoring. This section will briefly review the various techniques in the industry currently available or in the development stage.

Although there is some overlap and confusion between the terminology "acoustic" and "seismic", acoustics as used in this report is defined as the measurement of sound waves in, or above the audio range, while seismic waves are below the audio range (Kinsler, 5-21).

The numerous acoustical methods and techniques (which range from the operational through various developmental stages to experimental) have been grouped into three broad categories for this report:

- a. Acoustic Borehole Logging
- b. Acoustic Emission Monitoring
- c. Acoustic Soundings

More detailed information and evaluation in the field of acoustic monitoring, including the more experimental methods which have not been included, may be reviewed in the federally sponsored research projects by Gupta 1972 (5-17), Fitzpatrick 1972 (5-11), Rubin 1974 (5-35), Price 1976 (5-34), and Cully 1976 (5-7).

8.4.1 Acoustic Borehole Logging

Acoustic logging techniques were originally developed by the petroleum industry and provide a sophisticated array of

devices in various stages of development which could significantly reduce the number of boreholes in a site investigation program.

Acoustic logging consists of recording the time that is required for a compressional sound wave to traverse 1 foot of formation which is referred to as the "interval transit time" (Ash, 10-2). The various acoustical procedures, in addition to measuring the compressional and shear wave velocities in a given geological unit, are capable of providing extensive borehole and inter-borehole information about the lithology, structure, discontinuities and porosity of the formation when used separately or in combination with other geophysical logging methods.

A high-powered piezoelectric transducer, which converts electrical signals to acoustic or sound energy, is inserted in the borehole. This energy propagates through the formation and is reflected from the various anomalies. The reflected sound energy is then received by a second transducer, which converts it back to electrical energy, and the amplitude and elapsed time are recorded at ground surface (Figure 8-5). This information is then analyzed, usually by computer, and the various geotechnical parameters are evaluated.

Acoustic borehole logging includes Acoustic Velocity Logging Systems and Scanned Acoustic Holography, which are discussed hereinafter.

8.4.1.1 Acoustic Velocity Logging Systems - The Acoustic Velocity logging system was first developed by Mobil Oil Company in 1951, and was called the Continuous Velocity LoggerTM (CVL). This system consisted of 1 acoustic transmitter and receiver and was used primarily to determine porosity (Hamilton, 1-10). This system was subsequently modified to a dual receiver to improve record quality. However, these devices were subject to large errors due to borehole diameter variations and off-centering of the acoustical tool. This required that the geometry of the borehole be determined using a supplementary borehole caliper device.

The Borehole Compensated logging system (BHC) was developed to eliminate the problems encountered in the earlier systems by including a multiplicity of transducers positioned so they could cancel out instrument misalignment error (Myung, 5-29). The BHC system has been used to determine porosity, lithologic boundaries, fracture zones, log correlation to assist

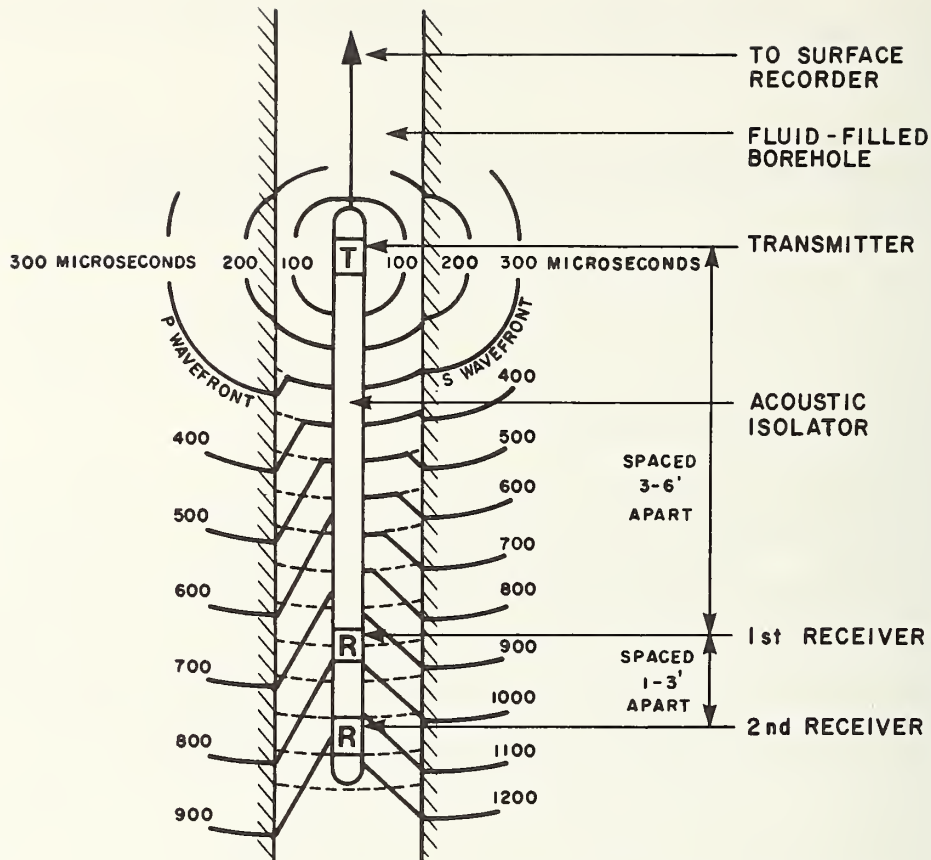

SIGNAL IS ELECTROMECHANICALLY CONVERTED TO A RECORD SHOWING THE DIFFERENCE IN ARRIVAL TIME BETWEEN THE FIRST AND SECOND RECEIVERS DIVIDED BY THE SPACING. THIS ELIMINATES THE EFFECT OF BOREHOLE FLUID TRAVEL TIME, AND THE RECIPROCAL OF FORMATION VELOCITY IS DIRECTLY RECORDED.

FIGURE 8-5. ACOUSTIC BOREHOLE LOGGER SHOWING COMPRESSION (P) AND SHEAR (S) WAVE PROPAGATION

in the interpretation of other geophysical procedures. The range of this system is limited to the immediate vicinity of the borehole wall, and it must be conducted in large diameter, uncased, fluid-filled holes.

A modified acoustic velocity logging system, called the Variable Density logging system (V3-D), combines a single-receiver CVLTM tool with a three-dimensional camera, which provides a continuous display, on film, of the complete wave train. The transmitter propagates elastic wave energy as a

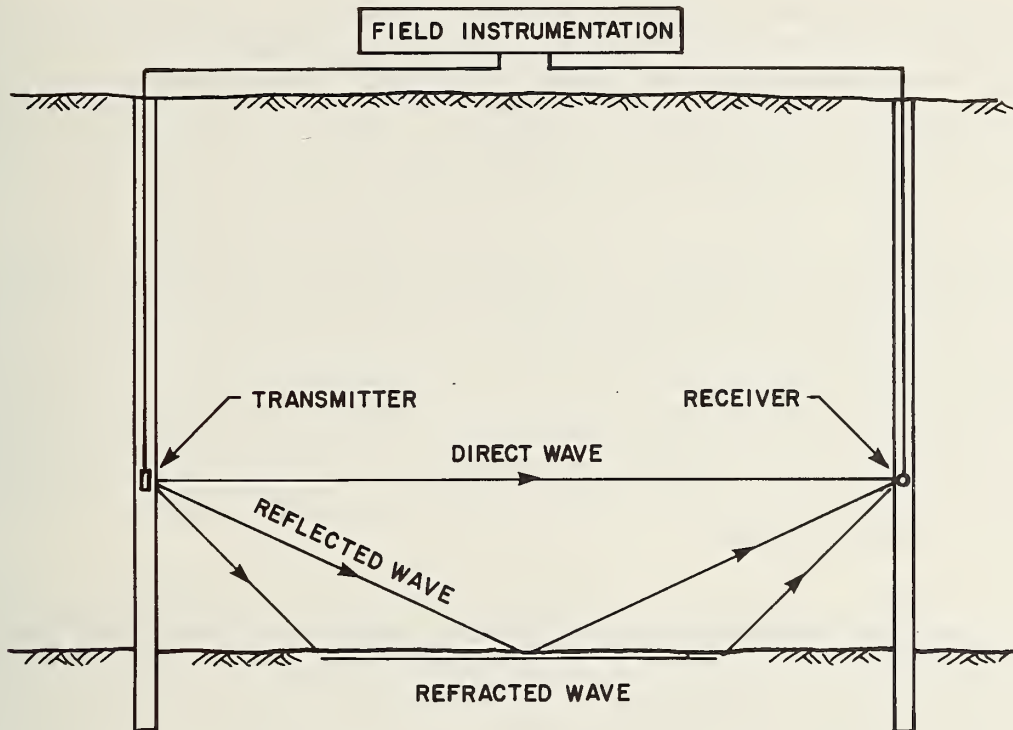

FIGURE 8-6. INTER-BOREHOLE ACOUSTIC VELOCITY LOGGING

compressional wave in the borehole fluid, which is reflected as pressure waves from the formation face. The receiver then converts these pressure waves to electrical signals, which are recorded on a specially designed 3-D surface camera (Myung, 5-28). The V3-D system is utilized in determining porosity, bedding, cement bond evaluation, locating gas zones, fractures studies and determining the elastic properties of rock. The system can also be applied between boreholes where the transmitter is in one hole and the receiver is moved up the other hole (Figure 8-6). The acoustical signal can be transmitted approximately 200 feet in competent rock (Hamilton, 1-10). The V3-D equipment may be utilized in either cased or uncased, fluid-filled boreholes.

A modified inter-borehole velocity logging technique has been recently developed (McCann, 5-25), (Grainger, 5-16). It consists of adapting an Edgerton, Germeshausen & Grier-type marine sparker with a very high energy (up to 1000 Joules) source. The energy is received by a radial resonance hydrophone and then amplified at the top of the borehole by a low-noise amplifier and projected onto an oscilloscope.

The sparker energy source extended the inter-borehole acoustic range up to 400 feet, although other researchers have questioned the safety of such high voltage sources in a borehole system (Rubin, 5-35). Smaller, 1 to 2 Joule sparkers have been used in shallow boreholes up to 20 feet apart in landslide investigations (Cratchley, 5-6).

Another variation of velocity logging which is still in the experimental stages is the Acoustic Pulse Echo system (APE) which can detect geological discontinuities up to 30 feet ahead of an excavation face (Gupta, 5-17). A moderately powered pulse-echo FM transmitter, operating in a range of 5 to 45 kHz, can process the return signal by a cross-correlation function and detect major structural interruptions in the bedrock unit. With additional development, this system appears to have potential for practical application during tunnel construction.

The basic costs of conducting acoustic velocity logging are dependent upon the type of equipment employed and location of the few contractors who specialize in this type of surveying. A minimum daily basic field rate in excess of \$1000 is to be anticipated and a fluid-filled borehole is required to conduct the work.

8.4.1.2 Scanned Acoustic Holography - Scanned Acoustic Holography is a very recent development in the field of acoustic imaging. A three-dimensional image of the interior structural features of an opaque object, called a hologram, can be reconstructed on photographic film without the use of a camera. The hologram is formed by projecting acoustic waves at the object of interest, which scatter and combine with a carrier wave. The interference pattern resulting from the intermixing of these 2 waves is converted to a photographic transparency. This transparency is illuminated by laser light which reconstructs an inverse image of the object. The laser illumination may be varied to provide different cross-sectional views of the opaque object (Ash, 10-2). The images are subsequently processed by computer to determine the strike and dip of the structure, presence of subsurface voids and highly fractured and faulted zones and other major structural features (Price, 5-32).

Although this system is still in the experimental stage and problems exist with the propagation of multipath wave media (Rubin, 5-35), initial test results indicate that scanned acoustic holography may be developed into a very useful subsurface exploration tool.

Although not a holographic technique, acoustic borehole photography, employing televiewer or seisviewer systems, is a method of obtaining a continuous acoustic photograph of the lithology and stratigraphic features exposed on the face of an uncased borehole. The downhole unit consists of a small piezoelectric transducer and a flux-gate magnetometer. A small motor rotates the unit at a fixed rate and the transducer emits a pulsed, narrow beam, acoustic signal which is reflected off the borehole walls and recorded. The amount of energy which is reflected is a function of the physical properties of that surface. A three-dimensional camera records an acoustical photograph of the entire borehole wall oriented to magnetic North. The system is presently used to determine fractures, voids, bedding and washouts in uncased holes and as a casing inspection tool (Myung, 5-27).

8.4.2 Acoustic Emission Monitoring

Acoustic emission monitoring is a technique of amplifying subaudible sound waves caused by the release of elastic strain energy which emanates from a stressed material. Such elastic energy, which is actually sound waves or noise, has been referred to as stress wave emissions, microseisms, microsonic noises and acoustic emissions (Koerner, 5-22). The latter term appears to be the more commonly used and is employed in this report.

Acoustic emissions are sounds generated by instabilities within a material which subsequently deforms. These sounds may occur in earthen dams; slopes; behind retaining walls; beneath footings; and in underground openings, mines and quarries.

These inherent sounds, which are very small in amplitude, can be monitored with highly sensitive piezoelectric transducers which will fit within very small diameter, shallow boreholes. The signal which is received is amplified, filtered and counted or recorded on a small, portable receiving unit which can be operated by 1 technician with minimal experience.

Surface environmental noises can be electronically filtered from the signal which makes its application suitable in urban areas. If the presence of acoustic emissions is not detected, the material is determined to be in equilibrium and stable.

The acoustic emission detector was first developed by the Liberty Mutual Insurance Company as a part of their loss prevention program in mine and tunnel safety (Beard, 5-3). Their patented unit, called the Seismitron™, is now marketed by several manufacturers under various models which can be purchased for approximately \$1,000 to \$3,000, depending on the sophistication of the recording unit.

8.4.3 Acoustic Soundings

A variation of acoustic emission monitoring, referred to as the Acoustic Sounding Technique, was developed to supplement the standard and costly methods of conventional test borings. It is used to determine the depth to sound bedrock (Lundstrom, 5-24), (Stimpson, 5-37).

This method combines the application of conventional, air-operated, percussion rock drilling equipment with an acoustical monitoring unit and is employed in areas of anticipated, relatively shallow and irregular bedrock surfaces.

An initial monitoring hole is drilled into the bedrock, and a waterproof geophone is installed in the bottom of the PVC cased hole and is attached to the acoustical monitoring unit (Figure 8-7).

The percussion drill rig commences the "soundings" at selected locations in any direction from the monitoring hole. As the drill bit advances through the overburden materials, a technician can monitor the differences in the intensity of the sound transmission through the various materials, and when it encounters bedrock. In addition, an experienced operator can usually identify boulders, weathered bedrock, voids and other supplementary information that may be of engineering importance. The depth and penetration rate of the drill bit is constantly monitored and correlated with the acoustical readings.

The type and quality of the bedrock will effect the magnitude of the sound waves and distance that they will be transmitted through the bedrock. Generally, the drill rig can be operated up to several hundred feet away from the monitoring hole.

This method could be employed when the project requirements demand detailed information about the location of an irregular bedrock surface overlain by rubble fill, boulder

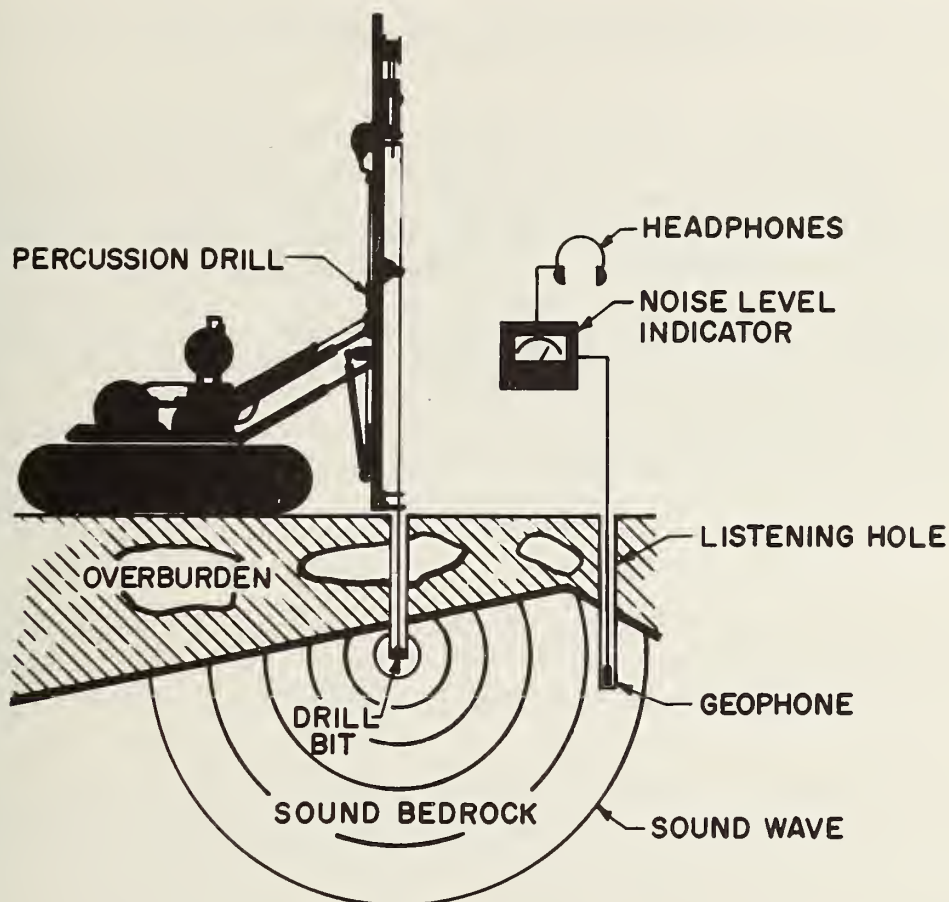

FIGURE 8-7. COMPONENTS USED FOR ACOUSTIC SOUNDING
TECHNIQUE LUNDSTROM (5-24)

tills, blasted bedrock debris, or any overburden material that would be difficult to penetrate for more conventional subsurface exploration methods.

Several limitations are inherent with this technique. Sound and competent rock is usually required for good acoustic transmission capabilities. Without supplementary correlation test borings, highly weathered or fractured rock may be interpreted as overburden. In addition, the pneumatic drill tends to plug in thicker overburden materials, especially in the presence of ground water. Bedrock depths up to 20 feet below ground surface can usually be determined very accurately. Good acoustical information has been obtained up to 50 feet in depth; however, reliable data obtained at these depths

will be a direct function of the overburden soils and groundwater level.

An additional limiting factor is the noise level of the pneumatic equipment and the tendency to discharge borehole cuttings within a large radius of the drill hole. These factors can both be reduced by using special "silent" equipment and employing casing which can control and direct the cuttings.

Excluding the initial purchase of the acoustical monitoring equipment, an "air-track" drill rig and compressor can be rented for approximately \$500-\$600 per day. Depending on the site access and subsurface conditions, a range of 15-25 acoustically monitored probes can be obtained in 1 day.

9. STRATIGRAPHIC EVALUATIONS

9.1 GENERAL

The principal objective of this study is to implement selected advanced methods of subsurface exploration on an on-going urban rapid transit tunneling project for the purpose of evaluating their performance, cost, and the accuracy and reliability of the data produced.

The performance of certain exploratory methods can be assessed through evaluation of difficulties met in implementation, adaptability of the techniques to the urban environment, examination of the quality of samples recovered, and other immediate measures.

The cost of all procedures, and the composition of costs, in terms of directly productive items and non-productive (support) items, are immediately determined during implementation.

However, the accuracy and reliability of most subsurface exploration techniques can only be assessed when the excavation is made for the structure being designed. Only at the time that the soils and rock are exposed to direct examination can predictions of stratigraphy, structure and properties be fully assessed and compared with actual existing conditions.

This section of the report will summarize stratigraphic evaluations and predictions for the two test sections investigated. These predictions will be used in conjunction with the field mapping of excavations (performed during Stage II of this study) to evaluate the accuracy of various exploratory methods.

The stratigraphic interpretations and predictions, based on an evaluation of all of the exploratory techniques, are summarized in the Geological Profiles in Appendix B.

Table 9-1 summarizes the major geological units and the elevations at which they are anticipated to be encountered, relative to tunnel crown and invert, within the Holiday Inn test section.

TABLE 9-1. SUMMARY OF GEOLOGICAL CONDITIONS

HOLIDAY INN SITE
CAMBRIDGE, MASSACHUSETTS

TUNNEL STATION	TUNNEL DIRECTION	TUNNEL CROWN ELEVATION	TUNNEL INVERT ELEVATION	APPROXIMATE ELEVATION OF			MAJOR ROCK TYPE	OVERALL AVERAGE ROCK QUALITY (RQD)
				TOP OF TILL	TOP OF DECOMPOSED ROCK	TOP OF NON-DECOMPOSED ROCK		
203+00	NORTHBOUND(1)	51.5 (4)	29.5	105.5	33.5	31	ARGILLITE	FAIR
203+50	"	50	28	108	N.O. (3)	38.5	ARGILLITE	N.O.
204+00	"	49	27	108	42	41	DIABASE	N.O.
204+50	"	47	25	113	42	40	DIABASE	POOR TO EXCELLENT
205+00	"	45.5	23.5	111	N.O.	50	DIABASE	VERY POOR TO FAIR
205+50	"	44	22	116	60	58.5	ARGILLITE/DIABASE	POOR TO EXCELLENT
203+50	SOUTHBOUND(2)	52	29.5	112	32.5	30	ARGILLITE	VERY POOR
204+00	"	50	28	107	N.O.	32	ARGILLITE	N.O.
204+50	"	48	26.5	114	N.D.	32 - 42	ARGILLITE	N.O.
205+00	"	47	25	118	42 - 49	41 - 46	ARGILLITE/DIABASE	POOR TO EXCELLENT
205+50	"	45.5	23.5	114	N.O.	49.5	DIABASE	POOR
206+00	"	44	22	111	57	55.5	ARGILLITE/DIABASE	POOR TO GOOD

NOTES: (1) NORTHBOUND = OUTBOUND
 (2) SOUTHBOUND = INBOUND
 (3) N.O. - SAMPLES NOT OBTAINED AND NO DETERMINATION MADE
 (4) MBTA RED LINE DATUM (105.87) FEET BELOW USC & GS, MSL 1929)

The subsurface conditions will be described in the following sequence:

- a. Overburden Soils (Holiday Inn Site)
- b. Bedrock (Holiday Inn Site)
- c. Bedrock (Davis Square Site)
- d. Ground Water (Holiday Inn Site)

9.2 OVERBURDEN SOILS (HOLIDAY INN SITE)

The overburden materials which were encountered at the Holiday Inn test section have been divided into four principal strata. In order of increasing depth below ground surface, they are:

- a. Miscellaneous Fill
- b. Outwash Sand and Gravel
- c. Marine Clay
- d. Glacial Till

The glacial till is the major soil unit investigated in detail in the site area, and the only overburden unit through which the tunnel will be constructed in the study area. As the overlying sediments have been discussed in Section 5, only the glacial till deposits will be evaluated in more detail.

The glacial till unit consists of a thick deposit of generally a very dense, glacially consolidated mass which directly overlies the bedrock. The glacial till, ranging in particle size from silt and clay to boulders, is generally neither stratified nor sorted according to size. However, several lenses and pockets of clay, silt or sand were encountered in the explorations. Boulders and cobbles, up to 3 feet in diameter, were encountered in the explorations. It is anticipated that boulders in excess of 3 feet occasionally exist within the glacial till unit.

The Geological Profiles (Appendix B) indicate two methods of interpretation for comparison purposes. The solid line interpretations are based on the physical data recovered from the test borings and the dotted line interpretations are based on the borehole nuclear logging surveys.

The test boring data indicate the presence of four major strata described above. Nuclear logging techniques confirm

the occurrence of these materials, although at slightly differing elevations. The nuclear surveys also indicate that the glacial till unit (Unit C) may be further divided into four subunits. The subunits (C₁, C₂, C₃ and C₄) are shown on the profiles with a general description of their inferred composition.

Subunit C₃ is indicated, based on nuclear logs, to be a semi-continuous clay layer with an average thickness of 5 feet within the glacial till stratum. The test borings conducted throughout the site area, including the design phase explorations, did not reveal the presence of this relatively uniform clay layer, but rather occasional and isolated pockets of clay. Although this clay layer, if present, will not be exposed in the tunnel within the Holiday Inn test section (Stations 203 to 206), it may be encountered, if it is continuous, during tunnel excavation south of the Holiday Inn site. This clay layer (Geological Profiles, Subunit C₃, Appendix B) is not a part of the overlying marine clay unit identified on the Geological Profiles (Unit B).

9.2.1 Nuclear Correlations

Geophysical logs investigate only a few inches beyond the borehole wall, and if there is a concentration of boulders near the bore, a particular zone may appear to be denser and less porous than the zone as a whole. Also, glacial till is prone to breaking out from the borehole wall and certain zones may appear less dense and more porous than they actually are. Rapid lateral changes in the type of material comprising the till make it difficult to correlate specific zones. However, in spite of these problems, four subunits are apparent in many of the holes. Division of the subunits is based on the combination of responses of the gamma gamma, neutron neutron, and natural gamma logs.

The units identified are based on the geophysical response only and do not necessarily correlate with test boring information.

Unit A is a miscellaneous granular surface material including fill and surficial outwash sand and gravel deposits. This includes the area where the geophysical logs are not reliable because of top hole effects, variable moisture content, and disturbance during drilling.

Unit B displays a high natural gamma activity characteristic of potassium-rich clay. It displays low density and high porosity, although these two characteristics are not discernible on many of the logs because of the interference by the water level. The boundaries of this unit are selected on the basis of high natural gamma count rate.

Unit C is glacial till, characterized by variable density, moderate porosity, and variable natural gamma activity. The variable nature of the till causes some difficulties in interpretation.

Subunit C₁ is characterized by moderate to high density, moderate porosity, and moderate natural gamma count rate. In some boreholes, the density relationship between C₁ and C₂ is reversed. That is, C₂ is denser in TSC 22, TSC 9, TSC 13, TSC 15, and TSC 8. Such variations can be expected in till. Where a density difference between C₁ and C₂ is not apparent, the two can sometimes be separated by a zone of high gamma gamma count at the top of C₂. This may be a very low density zone, or it may be a zone which is prone to breaking out. C₁ is probably a dense sandy unit.

Subunit C₂ is characteristically less dense and more porous than C₁, except in the cases mentioned above. It exhibits a moderate natural gamma activity. In most boreholes, the top of this unit displays apparent low density. It may be a clay lense, as it is often associated with high natural gamma activity, or it may be a zone that is prone to breaking out. The entire subunit generally corresponds to a zone of coarser grained material on the test boring logs.

Subunit C₃, a clay unit, is characterized by high natural gamma activity, lower density, and higher porosity. It is fairly continuous. A thin layer at this elevation was encountered in some of the test borings.

Subunit C₄ is characterized by a higher density, moderate porosity, and generally lower natural gamma activity. This unit corresponds to a dense sand encountered in some of the test borings. Typically, there appears to be a breakout at the base of this unit, just above the bedrock. This is a result of either a change in drilling procedure when rock was encountered (i.e., typically decreasing bit size) or it could be associated with a breakout of the loose weathered zone of bedrock which is probably mixed with the above unit.

9.2.2 Seismic Correlations

Seismic uphole and crosshole surveys were used to determine compressional and shear wave velocities in the glacial till and bedrock. Using these data, and parameters calculated from these data, such as Poisson's Ratio and Young's Modulus, an assessment of the elevation of the top of the rock was made. Seismic crosshole data are plotted versus elevation in Appendix H.

Measured compressional and shear wave velocities shown in Appendices G and H are as expected from the nature of materials encountered during other explorations. Seismic compressional velocities in the glacial till units range from 5875 feet/second to over 9000 feet/second, with an average velocity of 7500 to 8000 feet/second. This is a typical velocity range for moderately dense glacial till in New England. Some velocities measured with the bedrock surface close to the elevation of the cap-geophone arrays have obviously been contaminated by the refracted energy propagating through the bedrock (Appendix, page H-1, TSC 18 to TSC 8). The bedrock elevation on these figures is indicated by a line connecting the elevations where bedrock was observed in the test borings.

Shear wave velocities in the glacial till range from 2435 feet/second to more than 5000 feet/second, averaging between 3500 and 4000 feet/second. These velocity values are also typical of the New England glacial tills.

Variations of Poisson's Ratio computed from the velocities are an immediate result of the velocity variabilities. Glacial tills sometimes show a semi-systematic decrease in Poisson's Ratio values that cluster around a central value. However, only a few examples of decreasing Poisson's Ratio with depth in the glacial till units in this test section can be cited: Appendix H, page H-1, TSC 21 to TSC 10; page H-2, TSC 17 to TSC 15; page H-3, TSC 9 to TSC 16, and TSC 16 to TSC 7; and page H-8, TSC 24 to TSC 13. The remaining logs show either scattered values without obvious trend, or reversal of the typical trends. Glacial tills are highly variable deposits naturally, and such scattering should be expected.

The uphole velocity profiles are not as informative as the crosshole information because they represent an integration of the effects of materials between the shotpoint and ground surface, rather than direct effect of materials

between the boreholes. Figure 9-1 shows a deflection of curvature in a total transit time at the transition from glacial till to bedrock. However, in other cases, the total transit time plots are anomalous and are not considered useful in this investigation.

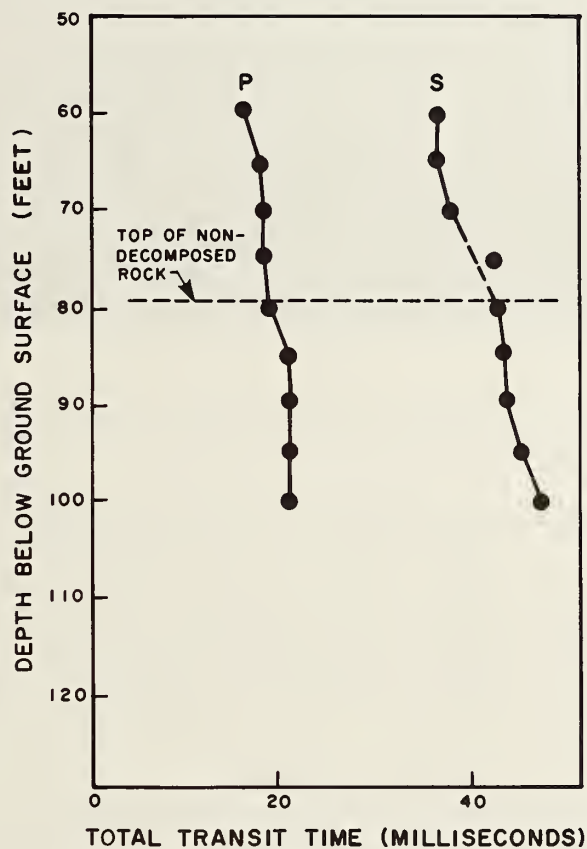

FIGURE 9-1. SEISMIC UPHOLE DATA, BORING TSC 17, SERIES 4A

9.3 BEDROCK (HOLIDAY INN SITE)

The host rock type in the study area, referred to as the Cambridge Argillite, is a slightly metamorphosed greenish-gray mudstone which varies from soft, severely fractured and weath-

ered near its surface (the quality generally improving with increasing depth) to very hard and fresh.

Secondary alteration, which probably accompanied later tectonic movements and intrusions of major igneous dikes, has further altered the argillite. Severe fracturing and brecciation, and, in many instances, subsequent healing to a competent rock, has created a highly intruded rock mass of varying composition (Figure 9-2).



FIGURE 9-2. BRECCIATED ARGILLITE WITH HIGH ANGLE JOINTS, DIABASE INTRUSIONS AND CALCITE VEINS

Numerous veins and stringers of secondary minerals, which include calcite, pyrite, epidote and quartz, are found in the argillite. Calcite, the most predominate mineral, is randomly encountered throughout the argillite, in addition to being the most prominent mineral observed along joints. The calcite has also cemented ancient joints and shears which are no longer considered as structural discontinuities in the rock mass.

Occasional transition zones to sandstone and volcanic tuff were also noted within the argillite unit. Typically, these zones vary from a few inches to a few feet in thickness.

An igneous rock consisting primarily of green, highly fractured diabase (Figure 9-3) intrudes the argillite in the vicinity of stations 204 to 205+50 NB and 204+50 to 206 SB. Although there are mineralogical and textural changes within the rock encountered in one exploration as compared to another, the diabase is believed to be one continuous dike. The greatest vertical thickness of the dike encountered in the explorations was 20.5 feet in TSC 10. However, previous design phase explorations in the same vicinity penetrated a vertical thickness of approximately 40 ft. of diabase intrusion.

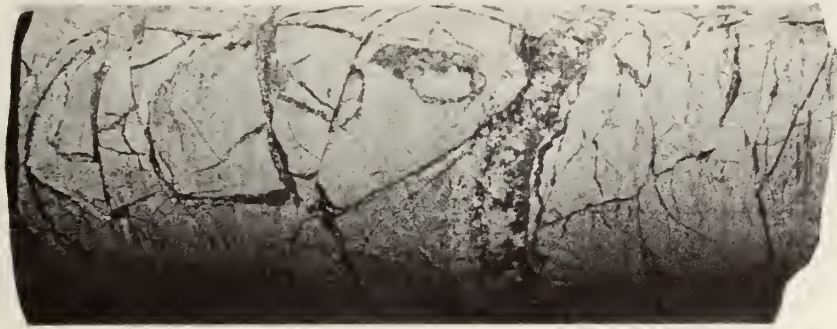

FIGURE 9-3. FRACTURED DIABASE WITH HEALED MACRO SHEARS AND SECONDARY MINERALIZATION

The thickness of the diabase dike, measured along the centerline of the proposed tunnels, is anticipated to vary from 80 feet in the southbound tunnel to 110 feet in the northbound tunnel occurring within the mixed-face limits (northbound) and almost completely outside the mixed-face limits (southbound). Several isolated and smaller igneous dikes are indicated immediately north of the major dike. There is also much inter-fingering of the diabase and argillite near their associated contact zones.

The dikes are anticipated to be steeply dipping. The estimated contacts between the argillite and diabase dikes are shown on the Geological Profiles, Appendix B. The diabase will comprise the majority of the rock in the mixed-face section of the northbound tunnel. Argillite is anticipated to be the principal rock type excavated in the mixed-face portion of the southbound tunnel with the diabase dike being encountered primarily in areas where some rock cover will exist.

Surficial weathering and hydrothermal alteration have further altered both bedrock types near their surface and along mineralized zones or contacts. In some instances, this severe alteration has created kaolinization and formed clay or clay seams within the rock mass.

A zone of "decomposed rock" has been identified on the subsurface exploration summaries and geological profiles. This zone has lost its structural integrity and more closely resembles a soil. The decomposed rock zone consists primarily

of a clayey sand with pieces and fragments of intermixed un-weathered rock.

The geological and structural classification of the rock mass was determined by visual analysis of the recovered rock core utilizing the classification systems and terminology summarized in Appendix A. All recovered rock core was photographed for future reference. Photographs of rock core are included in Appendix D. More detailed geological information regarding the petrographic characteristics of the rock is included in Appendix E.

9.3.1 Nuclear Correlations

As with the overburden soils, the geological profiles in Appendix B present two interpretations of the top of rock. The solid lines indicate interpretations based on extrapolation of the test borings and the dotted lines represent interpretation of the nuclear logs.

Bedrock Unit D is characterized by an increase in density, decrease in porosity, and normally an increase in natural gamma activity. Generally, the contact was selected on the basis of a decrease in gamma-gamma count rate. Within the bedrock, there are zones of high porosity accompanied by a drastic decrease of natural gamma activity which do not correspond to density decreases. The most likely explanation for such a relationship is that these are highly fractured zones, through which ground water is channeled. These zones do correspond to intervals where extensive jointing was noted in the test borings. The flow of ground water through the cracks may have dissolved the radioactive minerals and carried them away, hence the low natural gamma count. An alternate explanation for the low natural gamma count is the decrease of mass due to the fracturing. Drilling mud may have filled the fractures, preventing the gamma gamma sonde from responding to the decreased density.

An attempt was made to differentiate between the altered argillite and the diabase dike. However, no consistent relationship of the geophysical logs could be determined to separate them.

9.3.2 Seismic Correlations

Compressional wave velocities in the bedrock units range from 8,300 feet/second to more than 17,000 feet/second, with an increase in velocity for the crosshole data corresponding very closely with rock elevations encountered in the borings. The majority of the velocities shown are in the range of 11,000 feet/second to 13,000 feet/second (Appendix H), a range typical of the type of rock present. The lower values represent poor quality rock with a high degree of weathering or fracturing. Shear wave velocities in the bedrock units range from 3,758 feet/second to as much as 7,800 feet/second, indicating variable conditions are present in the bedrock.

The variations of Poisson's Ratio, calculated for the bedrock units, are not systematic in any obvious sense, but there is some correspondence between high values of Poisson's Ratio and poor quality rock. These areas are indicated on the geological profiles, Appendix B.

Young's Modulus values are strongly dependent upon the measurement of shear wave velocities. They typically show a close correspondence to the test boring logs, with a sharp, upward increase in the value of the modulus at and near the top of bedrock. In the glacial tills, there is a tendency for the modulus to increase with depth, but some lower values are evident near the bedrock. The modulus typically remains at higher values within the rock body, with only two zones showing values of less than 1.0×10^6 pounds/inch² for measurements clearly within the rock (Appendix H, page H-2, TSC 17 to TSC 15, 80-85 foot depth; and page H-3, TSC 19 to TSC 9, 90-100 foot depth). A variable condition is indicated in Appendix H, page H-1, TSC 21 to TSC 18, 86-100 foot depth, but this may be associated with the angular slant path from the shotpoints to the bottom of TSC 18 at 82.5 foot depth.

Amplitudes for the compressional and shear waves are summed vectorially in conjunction with the values of Poisson's Ratio and Young's Modulus, and are used to define zones of poor quality rock. These zones are delineated on the geological profiles, Appendix B.

9.3.3 Structure

9.3.3.1 Argillite - The Red Line tunnel alignment trends in the north-south direction approximately perpendicular to the axis of the Charles River syncline. The Holiday Inn site is located on the north flank of the syncline. The regional strike of the bedrock structure is about N70°W and the strata dips to the south at about 5 to 15 degrees.

An important feature to note is the presence of planes of weakness or separations along which the rock either has been broken by past geological forces, or along which it is likely to break during tunnel excavation. These planes of weakness or fractures are controlled by bedding planes and rock mass discontinuities such as joints, shears and faults (Figure 9-4).

Relic bedding is occasionally indicated by very thin banding which is caused by differential weathering of the ancient layers.

Foliation is very poorly developed in the weakly metamorphosed argillite at the test site.

Naturally occurring rock discontinuities lacking displacement are classified as joints. Joints make up the vast majority of the discontinuities observed and are in sufficient number to impart a blocky nature to the rock mass.

Jointing is ubiquitous in the rock core from the test section and usually occurs in sets. The joint surfaces range from smooth to rough, and the joint planes range from planar to curvilinear to very irregular. The joints are usually coated with calcite or other minerals from secondary mineralization. Some joints are open and not coated, while others are closed tight and cemented with secondary minerals. The joints generally dip between 20 and 80 degrees.

The joint spacing ranges from less than 1 inch to over 3 feet. Orientations of the joints could not be determined from the borings since no orienting techniques were used. The regional joints are known to dip steeply and to strike approximately north to northeast, while a second set strikes nearly east and dips south.



FIGURE 9-4. STRUCTURAL DISCONTINUITIES,
PORTER SQUARE PILOT TUNNEL

During glaciation, some near-surface open joints and bedding planes in the bedrock surface became filled with water. The water then froze and the joints became larger and wider due to the expansion of the ice ("ice jacking"). When the glacier melted, some of these joints filled with sediment. This condition was reported to have been observed in the excavations for the Pusey Library just south of Harvard Square. Some blocks of rock were entirely separated from the bedrock mass by a few inches of reworked till and the joints were filled with sediment. This condition, where identified in the test section, has been grouped in the "decomposed rock" zone previously described.

Naturally occurring rock discontinuities along which minor displacement has occurred are termed shears. Some shears may have been classified as joints, since evidence of displacement was not apparent. Clacite mineralization, or occasional clay gouge material, is usually associated with the shear fractures. The majority of the rock has been crushed and brecciated by former tectonic movements and subsequently healed by secondary mineralization (Figure 9-5).



FIGURE 9-5. ARGILLITE AND DIABASE WITH QUARTZ AND CALCITE MINERALIZATION

Major structural displacement, referred to as "faults", can only be inferred from the boring information. Various zones of extremely fractured rock which have been identified on the summary logs may be zones of severe jointing, or may

indicate fault zones. It is anticipated that faulting of the bedrock occurred in association with later tectonic movements when igneous dikes intruded the argillite.

The fracture zones and open joints are principal avenues for high volume water transport in the rock mass. The continuity of these fractures could not be determined, but the frequency of fracturing which was encountered would indicate water transmissibility. In-situ testing indicated an average permeability in the upper portions of the rock mass of about 10^{-5} cm/sec, decreasing to 10^{-6} cm/sec in the lower, more competent portions. It is expected that local fracture zones which display continuity may yield significant quantities of water during excavation.

In some instances, fractures are due to mechanical breaks created by the drilling operations and when identified, have been indicated on the summary logs.

The rock quality designation (RQD) and average length of core were measured in the borings to help define the spacing of the discontinuities in the bedrock. These parameters are generally lowest near the bedrock/glacial till interface. The RQD and average length of core generally increased from depths of 10 to 30 feet below the bedrock surface and were usually higher for the argillite than for the igneous rocks.

The various rock structural features determined from the recovered rock core are summarized on the Subsurface Exploration Summaries, Appendix B.

9.3.3.2 Diabase - Igneous intrusions in the form of dikes have intruded the argillite within the Holiday Inn test section. This is a common occurrence throughout the Cambridge Argillite formation. The igneous intrusions, consisting primarily of diabase in the test section, are steeply dipping to the southwest and generally strike in a northwest-southeast direction. They have been exposed to surficial weathering and hydrothermal alterations along open joints and shears. The diabase is a much harder, more brittle rock than the argillite. Due to its coarser texture and mineralogy, it contains much less clay and gouge material associated with its structural discontinuities. However, the diabase dikes display a higher percentage of discontinuities due to its tendency to more easily rupture during regional or local disturbances.

The massive nature of the igneous dikes and their total lack of bedding or laminations has created very rough and highly irregular fracture patterns. Although highly fractured, the discontinuities tend to be randomly oriented and are believed to lack continuity over long distances.

The terminology and definitions used in Section 9.3.3.1 are also applicable to the dike rocks. The various structural features determined from the recovered rock core are summarized in Appendix B.

9.4 BEDROCK (DAVIS SQUARE SITE)

One exploration was completed in Davis Square, Somerville, Massachusetts, for the purpose of evaluating the Integral Sampling Method (ISM) which has been described in detail under Section 7.5.3 of this report. The general subsurface geology determined from the ISM exploration is summarized below.

The Davis Square site is located approximately 1 mile north of the Holiday Inn site in the same geological environment and exhibits very similar subsurface conditions.

An overburden thickness of 49 feet, consisting of a sequence of outwash sands, marine clays and glacial till, was not sampled as a part of this study.

The bedrock, which is part of the Cambridge Argillite Formation, consists of a hard, slightly weathered to fresh, fine grained argillite. A 1-foot thick layer of decomposed rock was encountered at an elevation of 84.9 feet overlying an extremely fractured and jointed argillite from an elevation of 83.9 feet to an elevation of 75.9 feet. Major drilling fluid loss, estimated to be approximately 1000 gallons per hour, was experienced in this upper and highly fractured zone. However, over approximately 8 feet, the bedrock grades to a very sound, competent argillite with very few, widely spaced discontinuities for the remainder of the borehole.

Iron oxide staining was present in the upper fractured zone and random calcite veins were associated with healed, tight joints.

The ability to orient samples by the use of the ISM technique allowed the determination of the general structural characteristics of the rock. The accuracy of these structural determinations is not known, and subject to confirmation during the actual excavation of the Davis Square station.

The general orientation of the bedding (foliation) of the argillite at the ISM location strikes north 33 degrees west with a 12-degree dip to the southeast. Supplemental structural information relating to the prominent discontinuities within the sound argillite are summarized below:

<u>FEATURE</u>	<u>STRIKE</u>	<u>DIP</u>	<u>APPROXIMATE ELEVATION</u>
Joint	N86°E	55°W	71
Joint	N - S	15°W	71.5
Calcite vein	N30°W	30°SW	75
Calcite vein	N8°W	55°SW	72

The rock core recovered at the Davis Square site using the ISM technique was photographed for future reference, and the photograph is included in Appendix D, page D-5. The results of the ISM exploration are summarized in Appendix C, page C-44.

9.5 GROUND WATER

Measurements made in ground water observation wells and piezometers installed within the Holiday Inn test section indicate that there are two distinct potentiometric surfaces. The upper surface is associated with hydrostatic heads in the near surface outwash sand and gravel stratum. The lower surface reflects water levels in the somewhat permeable zone in the upper surface of the fractured bedrock.

The two potentiometric surfaces are essentially isolated from each other by the relatively impermeable marine clay and glacial till strata. Consequently, water levels measured in the shallow wells may not be the same as water levels measured in deep piezometers.

During the execution of the exploration program at the Holiday Inn site, the tunnel construction contractor initiated dewatering operations from a deep well installed in the fractured rock zone near the site. Measurements made in the test section piezometers and observation wells are summarized in Table 9-2 and demonstrate the isolation of the two water tables and the effects of dewatering the lower permeable zone.

TABLE 9-2. SUMMARY OF WATER OBSERVATIONS
IN FEET BELOW GROUND SURFACE

OBSERVATION DATE	TSC16 (OW)	TSC16 (PZ)	TSC17 (OW)	TSC18 (PZ)	TSC19 (OW)	TSC21 (OW)	TSC22 (OW)	TSC24 (OW)	TW1 (TW)	TA3 (PZ)	TB6 (PZ)	GW8 (PZ)	GW11 (OW)
May 1979 (1)	11.7	--	12.0	12.6	11.3	13.0	10.3	10.5	11.3	10.4	10.9	--	--
7/26/79 (2)	8.3	38.7	16.8	40.5	10.9	49.2	10.6	18.4	60.6	37.6	62.0	36.4	42 +
8/02/79 (2)	9.5	39.3	20.1	42 +	10.9	48.6	10.5	26.3	60.3	38.0	61.8	37.6	42 +
8/13/79 (2)	8.5	39.5	23.2	41.5	11.2	49.7	10.9	30.3	60.4	33.5	61.7	36.5	50.5
8/20/79 (2)	8.6	40.4	24.0	41.7	11.2	50.5	10.8	30.8	60.9	39.0	--	38.5	51.0
8/28/79 (2)	8.3	40.8	24.7	42.3	11.1	50.7	10.9	31.7	61.0	39.3	61.8	38.9	50.9
9/05/79 (2)	8.7	40.5	25.1	43.0	11.5	51.2	11.0	32.1	--	40.2	62.5	39.5	51.4
9/27/79 (3)	8.7	21.9	25.7	22.3	11.8	21.0	11.1	20.0	--	20.7	20.5	19.7	21.5
10/15/79 (2)	8.7	41.0	23.4	43.5	11.5	51.4	11.0	32.5	62.0	39.5	63.2	39.6	51.7
10/25/79 (2)	8.7	41.4	22.9	43.6	11.6	51.9	11.0	32.5	--	--	62.6	39.8	51.6

- NOTES: (1) Initial water reading obtained at completion of the test boring.
 (2) Red Line construction pumping from dewatering well DW5 significantly lowered water table in site area.
 (3) Pumping from DW5 terminated between 9/14/79 and 10/02/79.
 (4) Observation well TSC16 plugged and unreliable observations.
 (5) Subsurface Exploration Number TSC16
 Observation Well (OW)
 Piezometer (PZ)
 Pump Test Well (TW)

Initial readings taken in May 1979 indicate a relatively constant depth to ground water (10 to 13 feet) at all observation wells and piezometers. Subsequent to the start of pumping from dewatering well DW5, the water levels in the deep piezometers dropped to depths of 30 to 40 feet (TSC 16, 18, 24) while shallow observation wells remained at depths of 8

to 12 feet (TSC 16, 19, 22). When dewatering operations were terminated during the period 14 September to 2 October 1979, rapid recovery was evident in deep piezometers (TSC 16, 18, 24) while little or no response was evident in shallow observation wells (TSC 16, 19, 22).

The static potentiometric surface in both zones ranges from elevation 116 to 121 feet. The lower surface is currently depressed by pumping from the fractured rock, whereas, the upper surface remains relatively stable. This is clear evidence that the two potentiometric surfaces are isolated and do not necessarily respond together.

It is unlikely that all water levels at this test section will approach static conditions until after construction dewatering for the project is complete. Consequently, water level monitoring will reflect the intensity of dewatering activities from the upper rock surface, and the initiation of any dewatering activities from the upper sand and gravel stratum.



10. COST ANALYSIS

10.1 GENERAL

To provide data on the cost of exploratory procedures as implemented on this project, unit prices, execution time and materials consumption were monitored closely and are reported and analyzed in this section. As with the design of any permanent facility, the design of a subsurface exploration program involves the subjective evaluation of the cost of particular components versus the benefit that might be derived from the component.

The value of a particular piece of information gained with an exploratory technique is the true measure of the cost versus benefit of the technique. Value is a measure of the work attached to an object or service. Therefore, the value is subjective and depends on who is using the object or service and what confidence the user has in the product. The level of confidence may be defined as the quantity and quality of information (discerned through the use of the exploratory technique) relative to the information that is desired. Of course, as more information is obtained, the design is adjusted to accommodate it. This increase in information then causes a decrease in the probability of occurrence of a failure.

Each exploratory technique provides some quantity of information about subsurface conditions which may or may not be useful by itself. However, when combined with other exploration techniques, the increase in subsurface information will increase the confidence level of the user. The risk inherent in a project will also be decreased by this increase in information since the risk is equal to the product of the cost consequences and the probability of occurrence.

Mass transit tunneling usually occurs in an urban environment where failure to accommodate the subsurface conditions in design and construction may effect not only the tunnel but also the adjacent structures, utilities, streets, and other facilities above and adjacent to it. This potential risk supports the use of most exploration techniques capable of providing relevant items of information, particularly in areas of complex and expensive construction (cross passages, stations, mixed-face conditions, etc.).

The following sections define and analyze the cost of various exploratory techniques implemented on the MBTA Red Line project during 1979. The costs represent the value of the work for an urban transit tunneling project with tunnels approximately 100 feet below ground surface in a profile composed primarily of heavily overconsolidated glacial till and rock.

10.2 EXPLORATION UNIT PRICES

Subsurface exploration for this study was performed with equipment and labor provided under a negotiated contract with local drilling contractor selection based on expertise, familiarity with local conditions, equipment availability, and previous satisfactory performance on similar work. The drilling and sampling costs were compensated on a unit price basis while special testing and instrumentation installation were compensated on an hourly basis. The unit prices and hourly rates are summarized in Table 10-1 and are believed to represent the fair value of the work at the time and under the conditions it was completed.

Contractor selection based on expertise, experience and equipment capabilities, was found to be for this study and similar projects, essential to the proper execution of the work. This is particularly true with complex exploration programs involving numerous sophisticated exploratory procedures. Execution of sophisticated procedures by inexperienced personnel using equipment with minimal versatility can undermine reliability in the procedures. Similarly, the requirement to competitively bid exploration programs, and award to the lowest bidder, may cause designers to omit more sophisticated procedures from exploratory programs in favor of more standard procedures, capable of being performed by any driller, thereby affecting the confidence in advanced exploratory methods.

10.3 TEST BORING COSTS AND COST DISTRIBUTIONS

For the purpose of comparative cost studies and cost distribution studies, the test borings were divided into four

TABLE 10-1. SUMMARY OF EXPLORATION UNIT PRICES

ITEM NO.	DESCRIPTION	UNIT PRICE	QUANTITY
1	4" - 6" "UNSAMPLED" OVERBURDEN AND ROCK DRILLING PER FT.	7.90	1306.0
2	4" - 6" "SAMPLED" OVERBURDEN DRILLING PER FT.	12.50	778.3
3	NWD-3 DOUBLE TUBE ROCK CORE PER FT.	19.00	131.7
4	NWM-3 TRIPLE TUBE ROCK CORE PER FT.	23.00	67.1
5	2" SPLIT-SPOON SAMPLES PER EACH ATTEMPT	23.00	62
6	3" SPLIT-SPOON SAMPLES PER EACH ATTEMPT	26.00	3
7	3" O.D. PITCHER SAMPLES PER EACH ATTEMPT	100.00	2
8	3.5" O.D. DENISON SAMPLES PER EACH ATTEMPT	120.00	1
9	CREW AND DRILL RIG RATE FOR INSTALLING INSTRUMENTATION TESTING, ETC. PER RIG HOUR	60.00	265.75
10	WATER PRESSURE TEST, PER EACH	95.00	4
11A	ISM TESTING INCLUDING OVERBURDEN AND ROCK PER RIG HOUR	68.00	49.5
11B	ISM EQUIPMENT RENTAL, LUMP SUM, 30 DAYS	4400.00	LUMP SUM
11C	ISM TECHNICAL REPRESENTATIVE PER DAY	370.00	2
11D	ISM DIAMOND BIT WEAR PER FOOT	1.00	13
12A	BUFFALO ROADWAY BOXES, 5" DIAMETER PER BOX	90.00	9
12B	CEMENT PER 94 LB.	5.00	43
12C	2.5" I.D. SCHEDULE 40 P.V.C. FLUSH JOINT PIPE PER FT.	1.65	1330
12D	2.5" I.D. SCHEDULE 40 SLOTTED P.V.C. FLUSH JOINT PIPE PER FT.	3.20	80
12E	3/4" P.V.C. SCHEDULE 80 PIPE PER FT.	0.85	230
12F	BENTONITE PI PELLETS PER 50 LB. BOX	50.00	1
12G	OTTAWA SAND PER 50 LB. BAG	7.50	1
12H	FINE "PEA" GRAVEL PER CUBIC YARD	10.00	2
12I	CALCIUM CHLORIDE PER 50 LB. BAG	10.00	0
12J	COMMON SAND PER CUBIC YARD	10.00	3
12K	CALCIUM CARBONATE PER 50 LB. BAG	3.00	88
12L	BUFFALO ROADWAY BOXES, 2.5" DIAMETER PER BOX	15.00	14
13	MOBILIZATION AND DISMANTLING PER RIG	500.00	2
14	MOBILIZATION AND DISMANTLING FOR "ODEX" EQUIPMENT PER RIG	1100.00	1
15	"ODEX" EQUIPMENT RATE FOR OVERBURDEN AND ROCK DRILLING, PER RIG HOUR	125.00	15
16	UTILITY CLEARANCE, PERMITS, INSURANCE, BONDS LUMP SUM	1400.00	LUMP SUM

categories, depending on size and complexity of sampling procedures as follows:

<u>TEST BORING TYPE</u>	<u>DESCRIPTION</u>	<u>TEST BORINGS INCLUDED</u>
A	Six-inch diameter uncased, mud stabilized boring with detailed soil and rock sampling	TSC 7, 8, 9, 10, 11, 12
B	Six-inch diameter uncased, mud stabilized boring with standard soil and rock sampling	TSC 13, 14, 15
C	Four-inch diameter uncased, mud stabilized boring without sampling	TSC 16, 17, 18, 19, 20, 21, 22, 23, 24
D	Five-inch diameter uncased, mud stabilized boring without sampling	TSC 1, 2, 3, 4, 5, 6

Table 10-2 summarizes the depth range, total and "neat" costs for each type of exploration and the total and "neat" unit price per foot. "Neat" prices represent only the cost of the drilling and sampling aspects of the borehole costs and exclude instrumentation costs, permits, utility clearance, mobilization and dismantling, police protection and other items not directly associated with obtaining subsurface data. It is informative to note that total footage costs range from \$19.41/ft to \$32.86/ft, while "neat" costs range from \$7.90/ft to \$16.87/ft.

The distribution of costs for each type of exploration is summarized graphically on Figures 10-1, 10-2, 10-3 and 10-4 for exploration types A through D, respectively. All four types of explorations involved the expenditure of 11.9 percent (Type B Exploration) to 20.9 percent (Type D Exploration) of the costs toward technically non-productive items, such as utility clearances, permits, insurance, bonds, equipment mobilization and dismantling, and the services of police officers for traffic control. The supply and installation of instrumentation and/or geophysical casing accounts for 28.3 percent (Type C Explorations) to 42.7 percent (Type B Explorations) of the total borehole costs. Actual drilling costs account for 29.4 percent (Type D Explorations) to

TABLE 10-2. SUMMARY OF STUDY BOREHOLE COSTS

BORING TYPE	DESCRIPTION	DEPTH - FEET		COST PER BOREHOLE			COST PER FOOT		
		SOIL	ROCK	TOTAL	TOTAL (1)	AVERAGE (1)	NEAT (2)	AVERAGE (1)	NEAT (2)
A	6" DIAMETER BORING WITH DETAILED SOIL AND ROCK SAMPLING (INCLUDING INSTRUMENTATION CASING)	75	40	115	\$3659	\$3533	\$1814	\$32.86	\$16.87
B	6" DIAMETER BORING WITH STANDARD SOIL AND ROCK SAMPLING (INCLUDING INSTRUMENTATION CASING)	75	40	115	\$4307	\$3824 (3)	\$1633	\$34.76 (3)	\$14.84
C	4" DIAMETER DEEP BORING WITHOUT SAMPLING (INCLUDING P. V. C. GEOPHYSICAL CASING)	80	30	110	\$2511	\$2087	\$850	\$19.41	\$7.90
D	5" DIAMETER SHALLOW BORING WITHOUT SAMPLING (INCLUDING P. V. C. INSTRUMENTATION CASING)	75	0	75	\$2175	\$1900	\$572	\$26.20	\$7.90
E	ODEX DRILLING	70	0	70	\$3082	\$3082	\$1400	\$44.02	\$20.00
F	ISM DRILLING	50	13	63	\$8524	\$8524	\$8000	(4)	(4)

NOTES:

1. TOTAL AND AVERAGE BOREHOLE COSTS INCLUDE ALL DRILLING, SAMPLING, TESTING, CASING AND PRO-RATED MOBILIZATION AND DISMANTLING, UTILITY CLEARANCE, PERMITS, INSURANCE AND BONDS, POLICE PROTECTION AND INSTRUMENTATION CASING.
2. NEAT BOREHOLE COSTS INCLUDE ONLY ACTUAL DRILLING AND SAMPLING COSTS AND EXCLUDE MOBILIZATION AND DISMANTLING, UTILITY CLEARANCE, INSTRUMENTATION CASING, INSTALLATION OF INSTRUMENTATION CASING, INSURANCE AND BONDS, PERMITS, MISCELLANEOUS MATERIALS, POLICE PROTECTION.
3. TYPE "B" BORINGS WERE COMPLETED NEAR THE CENTER OF MASSACHUSETTS AVENUE AND INCLUDED MORE "STAND-BY" OR DELAY TIME ASSOCIATED WITH TRAFFIC RELOCATION AND INSTRUMENTATION INSTALLATION.
4. ISM DRILLING IS PRIMARILY FOR RECOVERY OF POOR QUALITY ROCK. FOOTAGE PRICES BASED ON TOTAL BOREHOLE LENGTH ARE MISLEADING. SEE REPORT TEXT FOR DISCUSSION OF COSTS.

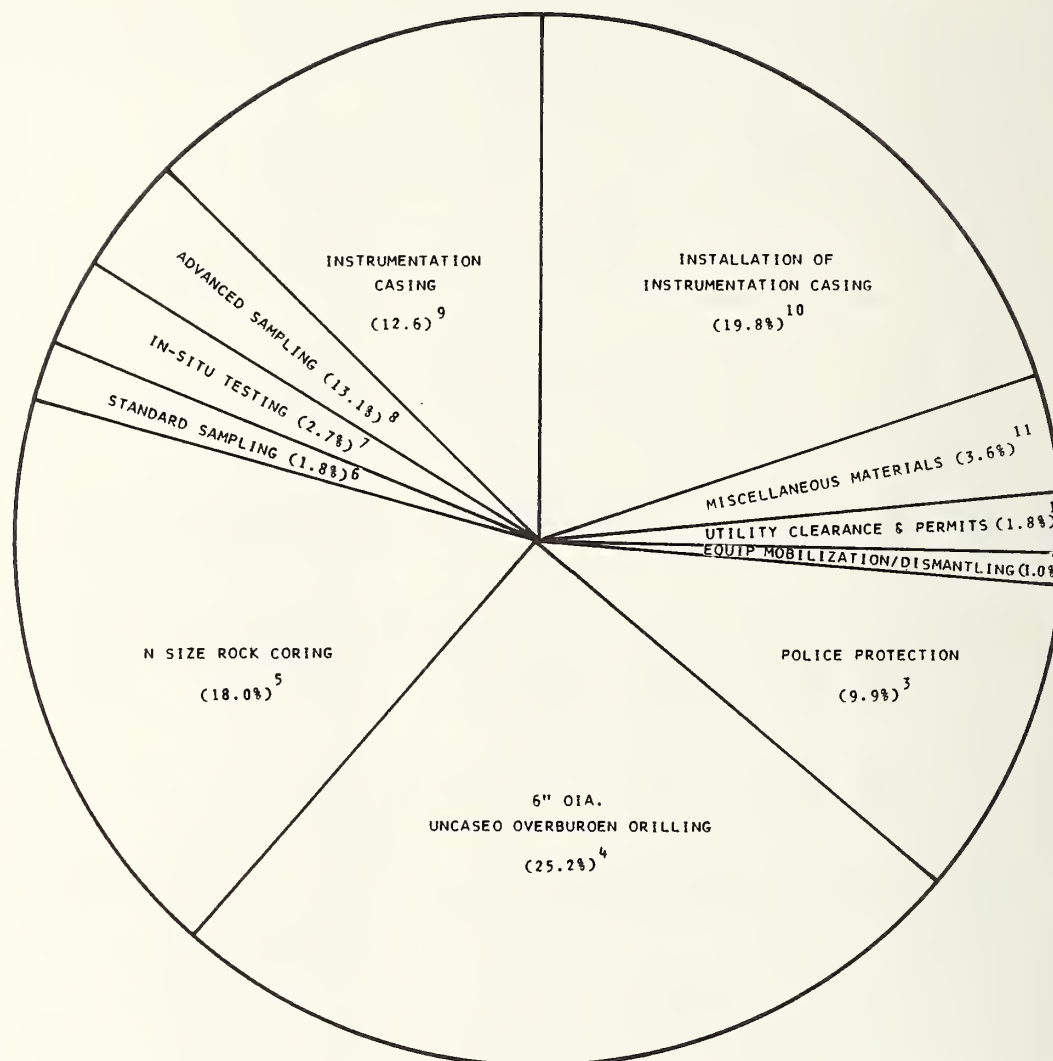

NOTES:

1. PRO-RATED UTILITY CLEARANCES, PERMIT COSTS, INSURANCE, BONDS, ETC.
2. PRO-RATED EQUIPMENT MOBILIZATION AND DISMANTLING.
3. SERVICES OF POLICE OFFICERS FOR TRAFFIC CONTROL.
4. SIX INCH DIAMETER, UNCASED, MUD STABILIZED OVERBURDEN DRILLING.
5. NWM AND NWD DOUBLE TUBE, SOLID AND SPLIT INNER LINER ROCK CORING.
6. SPLIT SPOON SAMPLING (TWO AND THREE INCH O.D.)
7. BOREHOLE PERMEABILITY TEST AND WATER PRESSURE TESTS.
8. DENISON SAMPLING, PITCHER SAMPLING AND NWM OVERBURDEN CORE SAMPLING.
9. SONDEX SETTLEMENT CASING IN COMBINATION WITH INCLINOMETER CASING AND ASSOCIATED MATERIALS.
10. EQUIPMENT AND CREW TIME ASSOCIATED WITH INSTALLATION OF INSTRUMENTATION CASING.
11. CEMENT, BENTONITE, OTTAWA SAND, COMMON SAND, GRAVEL, ROADWAY BOXES, WATERPROOF SEALANT, ETC.
12. SEE TABLE 10-2 FOR DEFINITION OF EXPLORATION TYPES.

FIGURE 10-1. COST DISTRIBUTION
TYPE A EXPLORATIONS

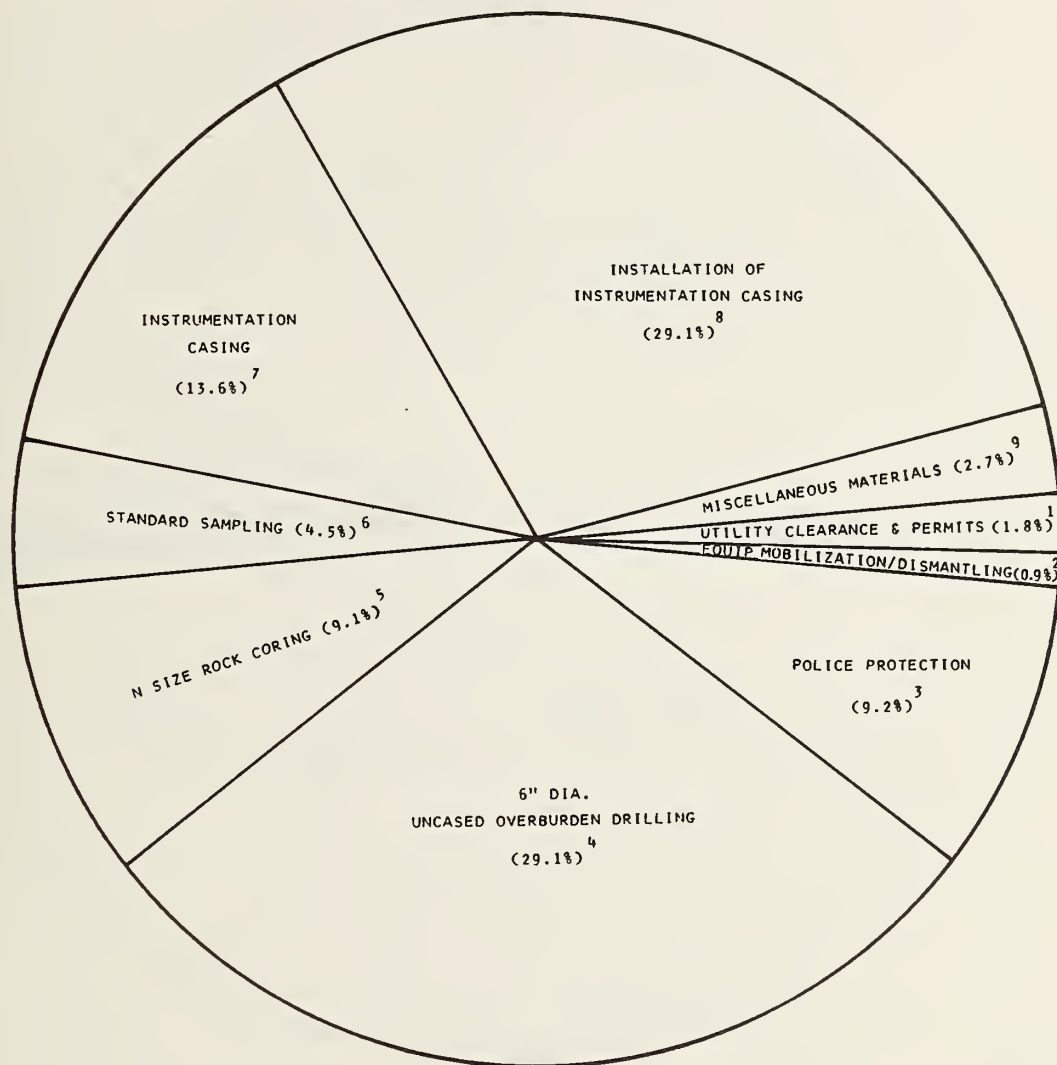

NOTES:

1. PRO-RATED UTILITY CLEARANCES, PERMIT COSTS, INSURANCE, BONDS, ETC.
2. PRO-RATED EQUIPMENT MOBILIZATION AND DISMANTLING.
3. SERVICES OF POLICE OFFICERS FOR TRAFFIC CONTROL.
4. SIX INCH DIAMETER, UNCASSED, MUD STABILIZED, OVERBURDEN DRILLING.
5. NWM AND NWD DOUBLE TUBE, SOLID AND SPLIT INNER LINER ROCK CORING.
6. SPLIT SPOON SAMPLING (TWO INCH O.D.)
7. TELESCOPING SETTLEMENT/INCLINOMETER CASING.
8. EQUIPMENT AND CREW TIME ASSOCIATED WITH INSTALLATION OF INSTRUMENTATION CASING.
9. CEMENT, BENTONITE, COMMON SAND, GRAVEL, ROADWAY BOXES, WATERPROOF SEALANT, ETC.
10. SEE TABLE 10-2 FOR DEFINITION OF EXPLORATION TYPES.

FIGURE 10-2. COST DISTRIBUTION
TYPE B EXPLORATIONS

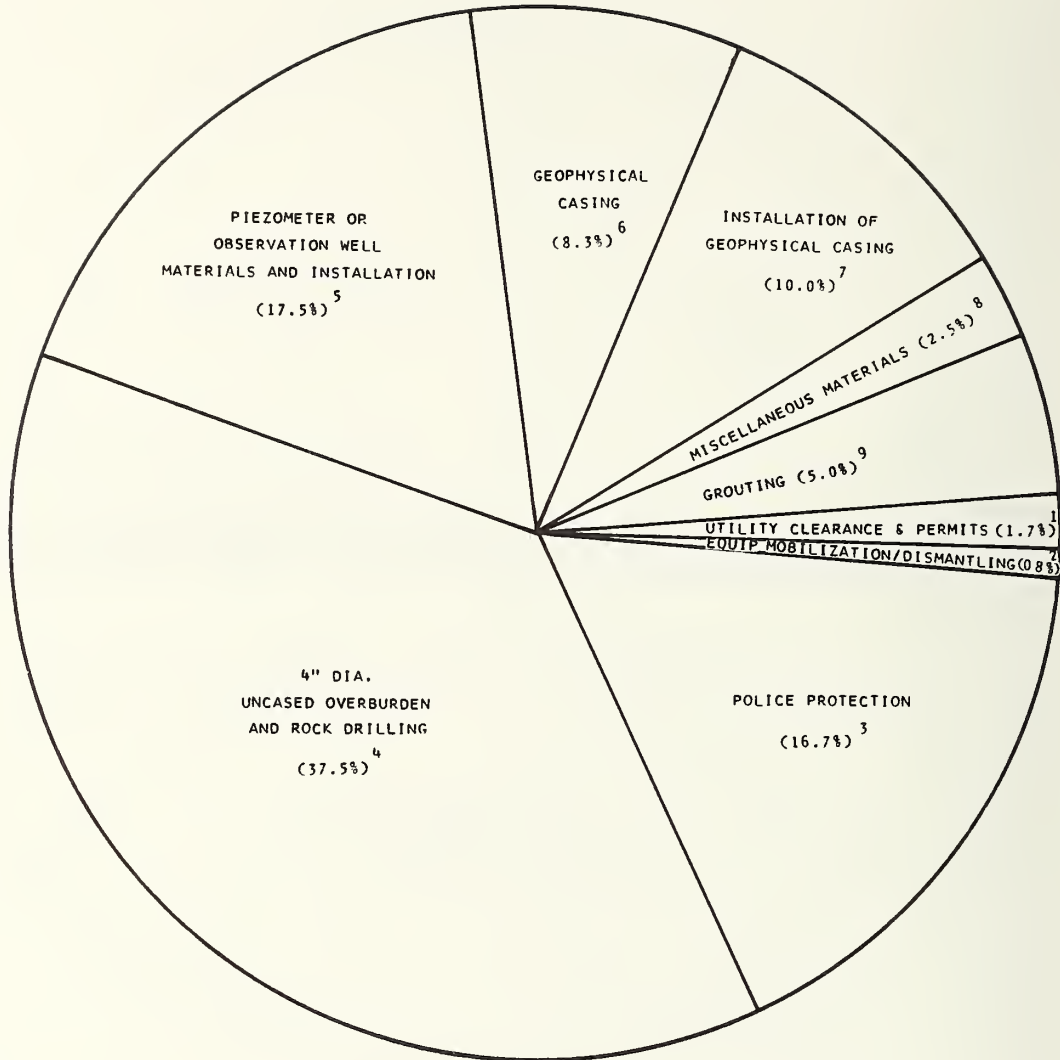

NOTES:

1. PRO-RATED UTILITY CLEARANCES, PERMIT COSTS, INSURANCE, BONDS, ETC.
2. PRO-RATED EQUIPMENT MOBILIZATION AND DISMANTLING.
3. SERVICES OF POLICE OFFICERS FOR TRAFFIC CONTROL.
4. FOUR INCH DIAMETER UNSAMPLED, UNCASED, MUD STABILIZED, OVERBURDEN AND ROCK DRILLING.
5. GROUNDWATER OBSERVATION WELL AND PIEZOMETER MATERIALS, ASSEMBLY AND INSTALLATION.
6. TEMPORARY P.V.C. CASING INSTALLED TO FACILITATE GEOPHYSICAL SURVEYS.
7. EQUIPMENT AND OVERTIME ASSOCIATED WITH INSTALLATION OF GEOPHYSICAL CASING.
8. CEMENT, BENTONITE, OTTAWA SAND, COMMON SAND, GRAVEL, ROADWAY BOXES, WATERPROOF SEALANT, ETC.
9. CEMENT GROUTING OF PIEZOMETERS, OBSERVATION WELLS AND ABANDONED GEOPHYSICAL HOLES.
10. SEE TABLE 10-2 FOR DEFINITION OF EXPLORATION TYPES.

FIGURE 10-3. COST DISTRIBUTION
TYPE C EXPLORATIONS

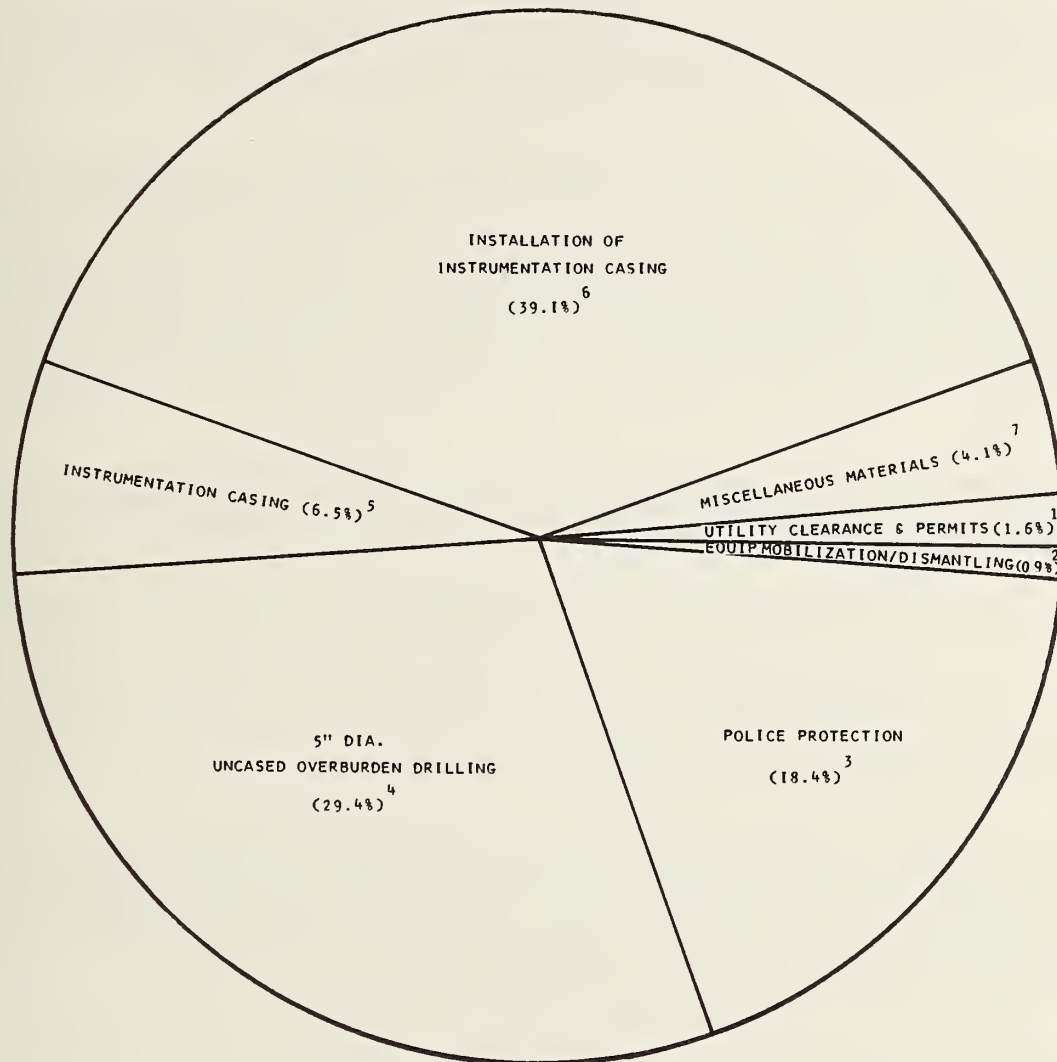

NOTES:

1. PRO-RATED UTILITY CLEARANCES, PERMIT COSTS, INSURANCE, BONDS, ETC.
2. PRO-RATED EQUIPMENT MOBILIZATION AND DISMANTLING.
3. SERVICES OF POLICE OFFICERS FOR TRAFFIC CONTROL.
4. FIVE INCH DIAMETER UNSAMPLED, UNCASED, MUD STABILIZED, OVERBURDEN DRILLING.
5. P.V.C. MECHANICAL/ELECTRICAL SETTLEMENT CASINGS AND ASSOCIATED MATERIALS.
6. EQUIPMENT AND CREW TIME ASSOCIATED WITH INSTALLATION OF INSTRUMENTATION CASING.
7. CEMENT, BENTONITE, COMMON SAND, GRAVEL, ROADWAY BOXES, WATERPROOF SEALANT, ETC.
8. SEE TABLE 10-2 FOR DEFINITION OF EXPLORATION TYPES.

FIGURE 10-4. COST DISTRIBUTION
TYPE D EXPLORATIONS

43.2 percent (Type A Explorations) of the total with sampling costs ranging from zero percent (Type C and D Explorations) to 14.9 percent (Type A Explorations).

By installing instrumentation casing in completed boreholes for use at a later date for construction monitoring, the costs of redrilling the borehole or drilling a new hole were eliminated. As may be noted from the cost distribution data, drilling costs and associated technically non-productive costs are a substantial portion of the total exploration costs. To incur these drilling costs twice would substantially increase the total cost of the program without increasing its value.

Based on the cost distribution data, it may be concluded that the principal elements of cost which comprise the exploration program are:

- a. Drilling (hole advancement)
- b. Instrumentation/geophysical casing supply and installation
- c. Technically non-productive work.

Sampling procedures, whether standard or advanced, account for a small percentage of the total costs. Therefore, if significant advances are to be made in reducing the cost of exploration programs, the principal efforts should be directed toward hole advancement methods.

10.4 ODEXTM DRILLING

Percussion drilling using an ODEX-type system has the potential to rapidly advance drill holes, thereby making available more observation points at low cost for use with indirect exploratory procedures. Although the system was found to be incompatible with the soil conditions and environmental restraints on this project, the investigators believe that the system (possibly with modifications) can provide cost-effective exploration in a compatible environment.

The average footage costs for the ODEX drilling on this study based on the total project billing associated with the work was \$44 per foot. Deducting the lump sum mobilization and dismantling costs (\$1,100) and non-productive time charges, the actual drilling costs were \$20 per foot. The cost is considerably greater than the unit price of \$7.90 per

foot for conventionally drilled holes (Table 10-1). However, application of the ODEX system in more compatible soils could drastically reduce this average footage cost.

10.5 INTEGRAL SAMPLING METHOD (ISM) DRILLING

The ISM procedure for rock coring is not intended to be cost competitive with conventional rock coring methods. The value of the procedure is in its capability to totally recover rock which could not be recovered using other more conventional methods.

The study costs for conducting ISM were calculated based on a lump sum minimal monthly rate of \$4,400 for all equipment, materials and supplies. The actual drilling time was compensated on an hourly basis of \$68.00 per crew hour. In addition, the Sprague and Henwood technical representative was reimbursed at \$370.00 per day.

During the 6-day working period at the Davis Square site, 50 feet of overburden was penetrated and 13 feet of ISM rock coring was completed in three separate core runs.

Converting the production and associated costs to a linear foot basis, the cost of ISM coring for this study, calculated as the total cost associated with drilling the rock, (including mobilization, permits, bonds, overburden drilling and technical representative services) divided by the length of rock cored, is approximately \$570 per foot. These high costs are due in part to the minimum 1-month equipment rental fee of \$4,400. Projecting these figures to a daily average production rate of 5 feet per day for 20 days, an average linear footage rate of about \$150 may be expected on a long-term project. If the technique and set time for the grouting phase could be refined to permit drilling two runs per day, the unit price per foot would be reduced to approximately \$75.00 per foot. The calculated linear footage rate for the Harvard Square ISM work conducted in June 1977 varied from \$75 to \$110 per foot.

10.6 GEOPHYSICAL SURVEYS

Geophysical techniques may provide information not directly available from a standard exploratory boring. This

information includes measures of porosity and permeability, shear and compressional seismic wave velocities, and subsequently, the elastic constants. The techniques may also confirm information initially observed in an exploratory boring, such as lithology, lithologic boundaries, and information on the size and lateral extent of faults, joints, fractures, and shear zones.

The geophysical investigation undertaken for this study consisted of three different borehole methodologies: seismic, electrical, and nuclear. The field work of two of the methods (seismic and nuclear) was accomplished with third-party contracts. The electric logging was accomplished by in-house personnel.

The principal reason for conducting geophysical logging is to gain information between boreholes (correlation) and to confirm existing information. A logical corollary is that fewer borings are needed in an investigation.

The resolution of the different geophysical methods is variable and, except for the seismic crosshole technique, limited in lateral extent. Because of this, a subjective decision is made, within a specific geologic environment as to the spacing of borings when using geophysical correlation techniques. However, in most cases, the spacing of the borings could be increased, thereby eliminating some of them.

Conducting geophysical logging in an urban environment (the locale of most mass-transit tunneling) has an impact on the cost. This is clearly seen with the nuclear logging. A total of 3 days was needed to complete the logging operation, although the total time spent logging, including on-site mobilization, was only 16 hours. Other costs, ancillary to any geophysical survey in an urban area, include traffic control, operating and material permits, and police protection.

10.6.1 Nuclear Logging

The cost of the nuclear logging, including the data digitization and computer time was \$12,600. The mobilization of the personnel and equipment was costly and above the norm because of the distance involved (Washington to Massachusetts). Adjusting the cost because of this anomaly indicates a more

realistic figure of \$10,200. This cost is about \$5.70 per foot of borehole logged.

10.6.2 Seismic Survey

The cost of the seismic crosshole/uphole investigation including data collection, interpretation, and the preparation of a report was \$10,000. Because the seismic methods produce information about the materials between the borings rather than at the borings, the method is not amenable to a cost-per-foot comparative price.

10.6.3 Electrical Logging

Although the electric logging was accomplished by in-house personnel and by using in-house equipment, a price can be calculated. For logging 15 borholes to a depth of 100+ feet, the cost is estimated at \$4,070. This price includes the cost of logging unit, a GISCO R-93TM Electric Logging System, similar to the unit actually used. The cost of the manpower to log fifteen 100+ foot boreholes is about \$560. This cost is for a 2-man crew consisting of a geologist and a laborer.

11. CONCLUSIONS

11.1 GENERAL

This section presents principal conclusions with respect to the application and performance of the methods of sub-surface explorations studied during this investigation. The conclusions are based on performance on an actual urban rapid transit tunnel project at the site of mixed-face tunneling conditions.

The site is considered to represent a typical urban area with the test section located under a major four-lane divided street, with masonry and wood frame structures abutting both sides of the street.

The majority of the methods were evaluated in relation to a mixed-face tunneling condition at a depth of approximately 100 feet below ground surface. Overburden soils consisted primarily of saturated, very dense, glacial till containing cobbles and boulders. The bedrock unit consisted of a partially metamorphosed shale (argillite) which has been intruded by major igneous dikes (diabase).

While several of the methods employed during this study were unsuccessful in the soil conditions at the Holiday Inn test section, similar applications in more compatible soil conditions would be expected to yield even more favorable results without equipment or procedural modifications. ISM rock sampling was conducted at the Davis Square test section which presented more variable rock conditions. Where the need for equipment modifications were evident during field evaluations, appropriate recommendations are presented.

11.2 OVERBURDEN DRILLING

11.2.1 Conventional Drilling

The selection of the most economical and satisfactory method of overburden drilling involves an evaluation of numerous hole advancement and stabilization techniques with consideration for the formations to be penetrated and the

samples to be obtained. No single method of drilling will prove satisfactory and economical for all formations and sampling requirements.

For the subsurface conditions investigated during this study, rotary drilled exploratory holes temporarily stabilized with biodegradable mud, (subsequently stabilized during geophysical surveys with PVC casing) was found most economical, with satisfactory performance.

11.2.2 ODEXTM Drilling

The ODEX system (Section 7.3.2) utilized air-operated, percussion rock drilling equipment with specialized eccentric drill bits to advance a hole and simultaneously advance heavy-duty steel casing. The percussion aspects of the system allow rapid penetration of dense soils, obstructions and boulders not possible with conventional rotary drilling methods.

The ODEX system, which is a proven technology in other applications, has the capability of remarkably rapid advancement of boreholes without sampling, in compatible soils. The system has the potential to provide economical, unsampled, casing stabilized boreholes suitable for use as supplemental geophysical holes, instrumentation installations, or other unsampled requirements.

The ODEX bit, reamer and flushing mechanism were found to be incompatible with the glacial tills in the test section. The silt and clay content of the soils below the groundwater table repeatedly plugged the bit, thereby significantly reducing the penetration rates. The system does not appear to be compatible with saturated soils containing significant clay and silt fractions.

The noise level of the equipment was found to be significantly greater as compared to standard test boring equipment, with the result that several complaints were received during drilling for this study. The use of a down-the-hole hammer, which was not available during this study, would reduce noise levels. In the manner the equipment was used during this study, the noise levels were found to be incompatible with an urban environment.

11.3 OVERBURDEN SAMPLING

11.3.1 Conventional Sampling

The open drive "split-spoon" sampler and the associated Standard Penetration Test retains its time-honored position as the primary method of obtaining representative soil samples for geotechnical engineering analysis. Acknowledged inconsistencies and limitations in the procedures do not decrease its practical importance for obtaining approximate comparisons of geological conditions.

For this study, the Standard Penetration test was modified to accommodate the high density of the overburden soils. The standard 2.0-inch O.D. sampler was driven with a 300-pound weight falling 24 inches versus the conventional 140-pound weight falling 30 inches. Satisfactory samples were recovered using this procedure although penetration resistances were consistently well above the range of any empirical correlations.

11.3.2 DenisonTM Sampling

The Denison Sampler (Section 7.4.3.1) is designed to recover undisturbed, thinwall samples in glacial tills, partially cemented soils, soft or weathered rock, hard clays or other very competent soils. The sampler consists of a double-tube, swivel-type core barrel with a non-rotating inner thinwall steel or brass liner designed to retain the sample during penetration and subsequent transportation.

The Denison Sampler met with limited success due to the presence of cobbles and boulders in the glacial till deposits. The core barrel was found to be incapable of coring the granitic boulders in the till. Therefore, on most attempts, penetration was obstructed and recovery was very poor, or non-existent.

11.3.3 PitcherTM Sampling

The Pitcher Sampler (Section 7.4.3.2) is a modification of the Denison sampler and was also developed to recover undisturbed thinwall samples in formations which are too dense for conventional thinwall sampler penetration. The

sampler consists of a single tube, swivel-type core barrel with a self-adjusting, spring-loaded, inner thinwall sample tube which telescopes in and out of the cutter bit as the hardness of the formation varies.

The telescoping liner aspect of the Pitcher sampler prevented damage of the sample tube, but it, like the Denison samplers, was incapable of coring the granitic boulders in the till when encountered.

11.3.4 Diamond-Bit Rotary Core Barrel Sampling

Diamond-bit rotary core barrel sampling is a sampling procedure normally associated with rock coring. Due to the density and cobble content of the glacial till in the test section, diamond-bit sampling was used with success in recovering samples of glacial till.

A diamond-bit equipped, split-inner liner, double-tube core barrel was used with success in penetrating all elements comprising the glacial till. There was a tendency of the bit to plug in the finer portions of the formation, thereby restricting flow of cooling water and increasing bit wear and damage. However, as a result of recent developments in core barrel design to minimize sample disturbance, relatively good quality samples were recovered with this tool.

Diamond-bit rotary core barrel sampling using double-tube, split-inner liner core barrels was found to be an effective overburden sampling device for obtaining samples in a formation which is excessively dense and contains a substantial percentage of cobbles and boulders.

11.4 ROCK SAMPLING

11.4.1 Diamond-Bit Rotary Core Barrel Sampling

Diamond-bit rotary rock core sampling continues to be the primary method of investigating the characteristics of rock masses. Recent developments in core barrel design have improved sample recovery and minimized disturbance associated with removal of the sample from the barrel.

11.4.1.1 Double-Tube Solid Core Barrel - Double-tube core barrels consist of a conventional rotary core barrel with a separate and additional inner liner which, with swivel-type construction, can remain stationary while the outer barrel rotates. Double-tube core barrels, NX size or larger, operated by experienced drillers, are capable of recovering representative samples of most formations. The method of removing the sample from the core barrel consists of shaking it out of the bottom of the barrel into the core box with resulting disturbance.

11.4.1.2 Double-Tube Split Core Barrel - Recent improvements in core barrel design have resulted in the availability of double-tube barrels with split-inner liners (Section 7.5.1). Sample disturbance is minimized since the inner liner, containing the sample, may be removed from the core barrel and opened by removing one half of the liner which is split longitudinally.

11.4.1.3 Triple-Tube Core Barrel - The third and most recent advancement in rotary core barrel design is the triple-tube core barrel (Section 7.5.2) which adds another separate, non-rotating liner to the double-tube core barrel. This liner, which retains the sample, consists of a clear plastic solid tube or a split, thin-metal liner. The inner liner, containing the sample, may be completely removed from the core barrel and transported to the laboratory for examination and testing.

Excellent quality samples were recovered with both the double-tube split, and triple-tube core barrels.

11.4.2 Integral Sampling Method (ISM)

The Integral Sampling Method (Section 7.5.3) is a procedure of rock coring which employs specialized drilling equipment to recover oriented and reinforced rock core samples using an overcoring technique. The method is applicable for investigation of fractured rock formations which cannot be recovered with more conventional techniques.

Although the application of the ISM was limited during this study, it appears that highly fractured, open-jointed rock may be beyond the present capabilities of the technique, or modifications to the current equipment and procedures may be required.

The following deficiencies are evident in the method as it currently exists:

a. In highly fractured, open-jointed formations, the rock has a tendency to collapse into the pilot hole, jamming or plugging the pilot bit. Water ports in the RWT bit were enlarged for this study, improving performance. The use of non-coring, solid, pilot bits may be advantageous in future similar applications.

b. The injection of the reinforcing grout is accomplished through the bottom of a solid grout tube. The grout must, therefore, flow up the outside of the tube to reach portions of the formation near the top of the core run. The addition of drilled holes in the grout tube throughout its length would improve grout distribution.

c. The grout-reinforcing tube, as supplied by the patent licensee, is a smooth steel pipe. Grout bond to the pipe was found to be poor. The addition of deformations, or grout holes described above, would improve bond characteristics.

d. Considerable field experience is required to determine the optimum grout mix, grouting methods, etc. to permit recovery of open-jointed formations.

With continued modifications and improvements in the equipment and increased familiarization with techniques, this exploration method will provide information concerning in-situ rock properties in poor quality formations which cannot be obtained by other methods.

11.5 GEOPHYSICAL INVESTIGATIONS

11.5.1 Nuclear Logging

Nuclear or radioactive logging (Section 7.6.2) measures and records the natural or artificially produced formation radiations in an open or cased, fluid-filled borehole. A variety of nuclear logging techniques can provide information on interborehole stratigraphy, formation anomalies and highly permeable zones. Nuclear logging not only requires special permits and licenses, but very sophisticated

electronic recording equipment and the expertise to conduct the work and to evaluate the information. At present, only a few organizations in the United States are capable of conducting nuclear borehole logging for geotechnical engineering purposes.

The nuclear logging information obtained as a part of this study closely substantiated the correlation explorations, in addition to further defining stratigraphy and local anomalies which were not detected by conventional explorations.

Nuclear logging was found to be rapidly and easily executed in the urban environment. However, as with any borehole logging technique, the method requires that a borehole be available. Considering the high fixed costs of mobilization, utility clearances, police protection, etc., as compared to the cost of borehole advancement and the minimal cost of sampling, it appears impractical to advance a hole without sampling. Therefore, nuclear logging must be justified based on its capability to detect anomalies between samples or to measure properties not otherwise determined, at least until a rapid and economical method is developed to advance an unsampled hole solely for use in geophysical borehole logging.

11.5.2 Electric Logging

Electrical borehole logging (Section 7.6.3) is used to monitor various inherent electrical properties of a geological formation in uncased, fluid-filled holes. The resistivity and spontaneous potential properties which are recorded can be useful in determining changes in formation composition and thickness and to provide interborehole correlations. Although electrical borehole logging is widely used in petroleum exploration, it has not met with wide acceptance in the engineering field. The uncased borehole requirement may be difficult to maintain on deep explorations and site electrical interference can prevent good log repeatability. Both of these problems were experienced during this study, which prevented the evaluation and correlation of the information with any degree of accuracy. Design modifications appear to be necessary in the equipment before electrical borehole logging is an applicable exploration tool in urban environments.

11.5.3 Signal Enhanced Seismic Velocity Surveys

Seismic borehole investigations (Section 7.6.4) are initiated to obtain a measurement of the transit time of

compressional and shear seismic waves between boreholes which are used in calculating the engineering properties (Poisson's Ratio and Young's Modulus) of the materials through which the waves pass. In addition, supplementary information is obtained for interborehole formation correlation purposes and the locating of major anomalies.

Conducting seismic crosshole/uphole surveys in heavily populated urban environments has generally obtained only limited success due to high level ground vibrations and ambient noise levels which prevent accurate signal detection. For this project, the application of recently developed, light weight and highly portable multiple channel, signal enhancement seismograph equipment, was successful in obtaining excellent data corroborated by conventional sampling and testing techniques. A sufficient number of data channels are included in the system so that multiple field positions can be occupied for simultaneous recording, making each survey result more efficient and reliable because of the ability to collect redundant readings.

The use of a single electric blasting cap as an impulse source was found to be completely adequate and convenient for signal transmission up to 150 feet in the soils examined.

The noise levels from heavy street traffic above the elevations investigated were minimized by the subsurface conditions. The stratum of fill and sand above the groundwater table tended to insulate the zone being investigated from a more difficult noise condition. In urban areas, where more difficult noise conditions exist, signal enhancement capabilities could be a pre-requisite for successful seismic surveys.

11.6 RESEARCHED EXPLORATORY TECHNIQUES

11.6.1 Horizontal Drilling

Horizontal borehole drilling techniques are in various stages of development as a potential alternative exploration method to vertical borings. Continuous horizontal sampling along the tunnel alignment will minimize geologic unknowns and can be accomplished during the final design stage and/or during the actual construction of a tunnel to assist in locating a variety of geological hazards beyond the tunnel

heading. Horizontal alignment drilling could provide invaluable information at locations where the geological structure is primarily vertical, the proposed structure is very deep underground, or in heavily developed urban areas where surface access and disruption would be a major consideration.

As with any newly developing technique, difficulties remain. Principal problem areas include direction control, penetration rates, lack of experienced drillers and equipment designed to perform the work. At present, the major disadvantage of horizontal drilling is the excessive costs, which are, in part, due to its low demand as a viable exploration tool. However, with continuing developments and improvements in the equipment and methodology and increasing driller familiarization with the techniques, it is believed that horizontal drilling will be a very valuable and economical exploration tool for transit tunneling projects.

11.6.2 Thermometric Surveys

Thermometric or temperature surveying is a geophysical logging method which records the borehole temperature versus depth and is used in locating zones of ground water flow, formation boundaries, cavities, gas, zones of hydraulic fracturing and other specialized applications.

Borehole thermometric surveying has been widely used in the ground water exploration industry for over 15 years, but has had little application in the field of geotechnical engineering. Thermometric logging can be conducted very rapidly with portable equipment for reasonable costs.

As with any geophysical method, successful interpretation requires experience and a thorough understanding of the geological conditions. When properly used and evaluated, thermometric logging can be a valuable technique in further defining a variety of geotechnical parameters.

11.6.3 Acoustic Explorations

Acoustic explorations may be grouped into three categories:

- a. Acoustic Borehole Logging
- b. Acoustic Emission Monitoring
- c. Acoustic Soundings

11.6.3.1 Acoustic Borehole Logging - Acoustic borehole logging consists of recording the transit time that is required for a compressional sound wave to pass through a formation. Data are interpreted by a computer to determine compressional and shear wave velocities, interborehole lithology, structure, discontinuities and porosity.

Several types of acoustic velocity systems are available and are commonly used in the petroleum industry; others are still in the experimental stages but show good potential for future use in geotechnical engineering.

All of the acoustic borehole logging techniques require very sophisticated field logging equipment, computer assisted interpretation, and highly trained personnel.

11.6.3.2 Acoustic Emission Monitoring - Acoustic Monitoring consists of amplifying subaudible sound waves referred to as acoustic emissions, which are generated by formation instabilities. The monitoring of acoustic emissions in shallow boreholes can give early warning to potential deformations and failures in underground openings, quarries, beneath dams, and behind retaining walls.

11.6.3.3 Acoustic Soundings - Acoustic soundings combine conventional air-operated percussion rock drilling equipment with an acoustic monitoring unit. A geophone attached to the monitoring unit is installed into known bedrock. As the percussion drill penetrates the overburden material, sound levels are monitored and the top of sound bedrock can be identified by the increased sound transmission. Although somewhat limited in depth in overburden materials, the drill rig can penetrate the most difficult materials very rapidly, eliminating the need for costly conventional rock core borings when they are only required to define the surface of the bedrock.

11.7 COSTS

Section 10 of this report deals with costs, both in terms of current unit prices for exploration techniques, and cost distribution for exploratory work. It is significant to observe from the cost data the following:

a. Total footage costs for exploratory holes drilled at the test section ranged from \$19.41/foot to \$32.86/foot. Only 41 to 51 percent of the total costs were associated with actual hole advancement and sampling. The balance of the costs are attributed to temporary or permanent PVC casing, utility clearance and permits, mobilization/dismantling, police protection, and miscellaneous materials.

b. All four types of explorations used in the test section involved the expenditure of 11.9 percent (Type B borings) to 20.9 percent (Type D borings) of the costs toward technically non-productive items such as utility clearances and permits, police protection, and equipment mobilization and dismantling.

c. Even the most intensive sampling procedures accounted for less than 15 percent of the total borehole costs.

In consideration of the high fixed costs associated with drilling an exploratory hole in an urban environment, it is essential that the maximum amount of relevant information be extracted from each hole. Therefore, all holes should be fully sampled with appropriate in-situ testing.

Until such time as equipment and procedures are developed to permit rapid and economic advancement of supplemental unsampled holes, all explorations in urban areas will continue to be advanced with appropriate sampling procedures. Under such circumstances, indirect borehole logging procedures, including many of the geophysical methods, must be justified based on their ability to detect minor anomalies between samples or their ability to measure parameters which cannot be determined with other techniques.

The full potential and optimum use of many of the advanced geophysical logging techniques are intimately tied to the rapid and low cost advancement of unsampled holes between sampled holes. To permit more accurate extrapolation of stratigraphy based on indirect borehole geophysical methods, future emphasis must be placed on the development of equipment capable of rapid, low cost, unsampled hole advancement.

APPENDIX A
GENERAL LEGEND AND NOTES

DESCRIPTION AND CLASSIFICATION OF SUBSURFACE MATERIALS

SOIL

SOIL DESCRIPTIONS NOTED ON THE SUBSURFACE EXPLORATION SUMMARY SHEETS ARE BASED ON VISUAL-MANUAL EXAMINATION AND SELECTED LABORATORY TESTS. THE CRITERIA, DESCRIPTIVE TERMS AND DEFINITIONS USED ARE PRESENTED BELOW:

TYPICAL DESCRIPTIONS
 BROWN MEDIUM DENSE COARSE TO FINE SAND, LITTLE GRAVEL, TRACE SILT WITH BRICK AND WOOD - FILL -
 BLUE-GRAY VERY STIFF SILTY CLAY, TRACE FINE SAND AND GRAVEL WITH THIN LENSES OF SILTY FINE SAND (CL) - MARINE CLAY -
 GRAY VERY DENSE SILTY FINE SAND, LITTLE COARSE TO FINE GRAVEL, TRACE COARSE SAND WITH COBBLES AND BOULDERS AND OCCASIONAL FINE SAND AND SILT LAYERS (SP)

CONSISTENCY OR COHESIONLESS SOILS	PENETRATION RESISTANCE (BLOMS PER FOOT)	CONSISTENCY OF COHESIVE SOILS	PENETRATION RESISTANCE (BLOMS PER FOOT)
VERY LOOSE	6 - 5	VERY SOFT	4 - 3
MEDIUM DENSE	11 - 30	MEDIUM STIFF	6 - 10
DENSE	31 - 50	VERY STIFF	11 - 15
VERY DENSE	≥ 51	HARD	16 - 30
			≥ 31

COLOR
 BROWN, YELLOW-BROWN, GRAY, BLUE-GRAY, ETC.

COMPONENTS
 MAJOR SOIL COMPONENT - FIRST SOIL COMPONENT USED
 SECONDARY COMPONENT - ADJECTIVE USED (IF 20-50% OF TOTAL)
 THIRD COMPONENT - "SOME" USED (IF THIRD COMPONENT COMPRISES 20-35% OF TOTAL)
 OTHER COMPONENTS - "LITTLE" USED (IF 10-20% OF TOTAL)
 "TRACE" USED (IF <10% OF TOTAL)

GEOLOGICAL DESCRIPTIVE TERMS
 FILL - MAN MADE DEPOSITS OF NATURAL EARTH MATERIALS OR WASTE MATERIALS
 OUTWASH - STRATIFIED DEPOSITS OF PRIMARILY SAND AND GRAVEL DEPOSITED IN RAPID MOVING GLACIAL MELT WATERS
 MARINE CLAY - FINELY INTERBEDDED SEDIMENTS OF SILT AND CLAY WHICH SETTLED OUT OF CALM POSTGLACIAL SEAS
 GLACIAL TILL - VERY DENSE HOMOGENEOUS SEDIMENTS RANGING IN PARTICLE SIZE FROM CLAY TO BOULDERS DEPOSITED DURING THE GLACIAL ADVANCE

MATERIAL	COMPONENT DEFINITIONS BY GRADATION		SIZE LIMITS (1)
	FRACTIONS	SIZE LIMITS (1)	
BOULDERS	MATERIAL TOO LARGE TO PASS THROUGH AN OPENING 8-INCHES SQUARE	UPPER	LOWER
CORBBLES	MATERIAL PASSING THROUGH AN 8-INCH SIEVE AND RETAINED ON THE 3-INCH SIEVE	-	3-IN.
	MATERIAL PASSING THROUGH THE 3-INCH SIEVE AND RETAINED ON THE NO. 4 SIEVE	COARSE FINE	3/4-IN. NO. 4
SAND	MATERIAL PASSING THROUGH THE NO. 4 SIEVE AND RETAINED ON THE NO. 200 SIEVE	COARSE MEDIUM FINE	NO. 4 NO. 10 NO. 40 NO. 200
	MATERIAL PASSING THROUGH THE NO. 200 SIEVE WHICH IS ALSO NON-PLASTIC IN CHARACTER AND WHICH HAS A LIQUID LIMIT OF 25 OR LESS WHEN DRIED	< NO. 200	
CLAY	MATERIAL PASSING THROUGH THE NO. 200 SIEVE WHICH IS ALSO PLASTIC IN CHARACTER AND WHICH WITHIN A CERTAIN RANGE OF MOISTURE CONTENTS AND WHICH EXHIBITS CONSIDERABLE STRENGTH WHEN AIR DRIED	< NO. 200	

(1) U.S. STANDARD SIEVE SIZE

ROCK

ROCK DESCRIPTIONS ARE BASED ON VISUAL-MANUAL EXAMINATION AND SELECTED LABORATORY TESTS. THE CRITERIA, DESCRIPTIVE TERMS AND DEFINITIONS USED ARE PRESENTED BELOW:

TYPICAL DESCRIPTION
 ALTERED ARGILLITE - LIGHT GREENISH GRAY, FRESH, HARD, BRECCIATED, REVEALED MACRO-SHEARS WITH FRACTURES AND JOINTS; OCCASIONAL CLAY FILLINGS, CALCITE VEINS AND DIABASE STRINGERS.
LITHOLOGY
 ALTERED ARGILLITE, OTABASE, ARGILLACEOUS SANDSTONE, ETC.
WEATHERING
 (THE ACTION OF THE ELEMENTS IN ALTERING THE COLOR, TEXTURE AND CHARACTER OF THE ROCK) DESCRIBED IN ACCORDANCE WITH THE FOLLOWING TERMINOLOGY:

FRESH - NO DISCOLORATION, SLIGHT STAINING IN JOINTS.
 SLIGHT - SLIGHT DISCOLORATION UP TO 1/4" INTO CORE FROM THE JOINT; JOINTS STAINED WITH CLAY INFILLING.
 MODERATE - SIGNIFICANT PORTION OF ROCK DISCOLORED OR STAINED.
 SEVERE - ALL ROCK DISCOLORED OR STAINED, SEVERE LOSS OF STRENGTH, CLAY SEAMS

FIELD HARDNESS
 DETERMINATION OF HARDNESS OF THE ROCK CORE WAS PERFORMED IN THE FIELD BY USING A STEEL KNIFE BLADE, AND THEN DESCRIBED IN ACCORDANCE WITH THE FOLLOWING CATEGORIES:
 VERY HARD - CANNOT BE SCRATCHED WITH A KNIFE BLADE
 HARD - CAN BE SCRATCHED BY A KNIFE BLADE BUT ONLY WITH GREAT DIFFICULTY
 MEDIUM-HARD - CAN BE SCRATCHED BY A KNIFE BLADE
 MEDIUM-SOFT - EASILY SCRATCHED BY A KNIFE BLADE
 SOFT - CAN BE GOUGED 1/8" INCH TO 1/4" INCH WITH A KNIFE BLADE
 VERY SOFT - CAN BE CUT IN HALF OR NEARLY SO WITH A KNIFE BLADE

DISCONTINUITIES
 SURFACES REPRESENTING BREAKS OR FRACTURES SEPARATING THE ROCK MASS INTO DISCRETE UNITS. DISCONTINUITIES ARE SUMMARIZED IN THE ROCK DESCRIPTIONS AND PRESENTED IN DETAIL ON THE GRAPHIC SUMMARY FOR EACH EXPLORATION. MAJOR FRACTURE ZONES ARE INDICATED BY CROSS HATCHING ON THE GRAPHIC LOG SUMMARIES.
 CRACK - A PARTIAL OR INCOMPLETE FRACTURE.
 JOINT - A SINGLE FRACTURE ALONG WHICH NO SHEAR DISPLACEMENT HAS OCCURRED. MAY FORM JOINT SETS.
 SHEAR - A FRACTURE ALONG WHICH DIFFERENTIAL MOVEMENT HAS TAKEN PLACE SUFFICIENT TO PRODUCE SLICKENSIDES, STRIATIONS OR POLISHING. MAY BE ACCOMPANIED BY A ZONE OF FRACTURED ROCK.
 FAULT - A MAJOR FRACTURE ALONG WHICH THERE HAS BEEN APPRECIABLE DISPLACEMENT. OFTEN ASSOCIATED WITH GOUGE AND/OR A SEVERELY FRACTURED ADJACENT ZONE OF ROCK.
 SHEAR OF FAULT ZONE - A BAND OR ZONE OF PARALLEL, CLOSELY SPACED SHEARS OR FAULTS.

DISCONTINUITY DESCRIPTION
 THE DESCRIPTION OF DISCONTINUITIES INCLUDES:
 A. INCLINATION OF THE ANGLE BETWEEN THE HORIZONTAL AND THE DISCONTINUITY SURFACE.
 B. SHAPE AND ROUGHNESS: A COMBINATION OF DESCRIPTIONS: SHAPE: PLANAR, CURVED, STEPPED, IRREGULAR ROUGHNESS: VERY ROUGH, ROUGH, SMOOTH.
 C. COATING: A MINERAL OR SUBSTANCE CONFINED TO THE JOINT SURFACE) EXP., STAIN, CALCITE, CLAY, QUARTZ.
 D. FILLING MATERIAL: SAME AS COATING, BUT OF GREATER THICKNESS.

UNIFIED SOIL CLASSIFICATION SYSTEM
 GROUP SYMBOL FINE-GRAINED SOILS
 ML INORGANIC SILTS AND VERY FINE SANDS, ROCK FLOUR, SILTY OR CLAYEY FINE SANDS, OR CLAYEY SILTS WITH SLIGHT PLASTICITY
 CL INORGANIC CLAYS OF LOW TO MEDIUM PLASTICITY, GRAVELLY CLAYS, SANDY CLAYS, SILTY CLAYS, LEAN CLAYS
 OL ORGANIC SILTS AND ORGANIC SILTY CLAYS OF LOW PLASTICITY
 MH INORGANIC SILTS, MICACEOUS OR OLIGOMACEOUS FINE SANDY OR SILTY SOILS, ELASTIC SILTS
 CH INORGANIC CLAYS OF HIGH PLASTICITY, FAT CLAYS
 OH ORGANIC CLAYS OF MEDIUM TO HIGH PLASTICITY, ORGANIC SILTS
 PT PEAT AND OTHER HIGHLY ORGANIC SOILS
 GROUP SYMBOL COARSE-GRAINED SOILS
 GW WELL-GRADED GRAVELS, GRAVEL-SAND MIXTURES, LITTLE OR NO FINES
 GP POORLY GRADED GRAVELS, GRAVEL-SAND MIXTURES, LITTLE OR NO FINES
 GM SILTY GRAVELS, GRAVEL-SAND-SILT MIXTURES
 GC CLAYEY GRAVELS, GRAVEL-SAND-CLAY MIXTURES
 SW WELL-GRADED SANDS, GRAVELLY SANDS, LITTLE OR NO FINES
 SP POORLY GRADED SANDS, GRAVELLY SANDS, LITTLE OR NO FINES
 SM SILTY SANDS, SAND-SILT MIXTURES
 SC CLAYEY SANDS, SAND-CLAY MIXTURES
SUPPLEMENTARY DESCRIPTIVE TERMS
 LAMINAE - 0 TO 1/16" INCH THICKNESS (COHESIVE SOIL)
 PARTING - 0 TO 1/16" INCH THICKNESS (GRANULAR SOIL)
 SEAM - 1/16" TO 1/2" INCH THICKNESS
 LAYER - 1/2" TO 12" INCH THICKNESS
 POCKET - SMALL, ERRATIC DEPOSIT USUALLY LESS THAN 12" INCHES
 STRATUM - GREATER THAN 12" INCH THICKNESS
 LENS - LENTICULAR DEPOSIT, LARGER THAN POCKET
 OCCASIONAL - ONE OR LESS PER FOOT OF THICKNESS
 FREQUENT - MORE THAN ONE PER FOOT OF THICKNESS
 INTERBEDDED - APPLIED TO STRATA OF SOIL LYING BETWEEN OR ALTERNATELY WITH OTHER STRATA OF A DIFFERENT NATURE
 ZONE - A REGULAR OR IRREGULAR BELT, LAYER, BAND OR STRIP
PENETRATION RESISTANCE:
 STUDY PENETRATION TEST: NUMBER OF BLOWS REQUIRED TO DRIVE A 2-INCH OUTSIDE DIAMETER SPLIT-SPOON PENETROMETER THROUGH THE SAMPLE TO A DEPTH OF 18 INCHES. TESTING WAS TERMINATED AT A MAXIMUM OF 400 BLOWS REGARDLESS OF THE SAMPLER PENETRATION.

LEGEND AND NOTES

GENERAL NOTES

1. LINES DRAWN BETWEEN EXPLORATIONS DIVIDING SUBSURFACE SOIL AND/OR ROCK FROM AVAILABLE INFORMATION AND MAY NOT AGREE WITH ACTUAL FIELD CONDITIONS.
2. ALL ELEVATIONS ARE IN FEET AND REFER TO MBSA RED LINE DATUM WHICH IS 105.87 FEET BELOW THE USC AND GS MEAN SEA LEVEL DATUM OF 1929.
3. REFER TO APPENDIX B FOR GEOLOGICAL PROFILES AND APPENDIX C FOR SUBSURFACE EXPLORATION SUMMARIES.
4. INITIAL WATER LEVEL OBSERVATIONS IN BOREHOLES WERE OBTAINED AT THE COMPLETION OF THE EXPLORATION AND MAY NOT REFLECT THE TRUE GROUND-WATER LEVEL AT BOREHOLE LOCATIONS.
5. OBSERVATION WELL AND PIEZOMETER READINGS ARE SUMMARIZED IN THE REPORT TEXT TABLE 8-1.
6. SEISMIC CROSSHOLE SURVEY DATA IS INCLUDED IN THE VARIOUS APPLICABLE TEXT FIGURES AND APPENDICES, BUT IS NOT INCLUDED ON THE GEOPHYSICAL SUMMARY SHEETS. GEOPHYSICAL SUMMARY SHEETS REPRESENT INTERPRETED CONDITIONS AT BOREHOLE LOCATIONS. SEISMIC CROSSHOLE SURVEYS REPRESENT INTERPRETED CONDITIONS BETWEEN BOREHOLES.
7. THE ELECTRICAL RESISTIVITY AND SPONTANEOUS POTENTIAL DATA IS OF QUESTIONABLE RELIABILITY DUE TO INTERFERENCE FROM TRANSIENT ELECTRICAL CURRENTS AND IS NOT INCLUDED ON THE GEOPHYSICAL SUMMARY SHEETS. GEOPHYSICAL SUMMARY SHEETS, BUT IS INCLUDED IN THE VARIOUS APPLICABLE TEXT FIGURES AND APPENDICES.
8. ALTHOUGH THE APPLICABLE TEST BOREHOLES WERE COMPLETELY LOGGED WITH CORES, THE LOGS WERE NOT AVAILABLE FOR THE ENTIRE LENGTH OF THE TESTS. SUMMARIZE ONLY THE DATA OBTAINED WITHIN THE ZONE OF THE PROPOSED TUNNEL CONSTRUCTION.
9. THE ROCK DISCONTINUITY SUMMARY INDICATED ON THE VARIOUS EXPLORATION SUMMARY SHEETS REFLECT THE AVERAGE CONCENTRATION OF DISCONTINUITIES ON A PER FOOT BASIS. ONE OR MORE DISCONTINUITIES MAY BE PRESENT IN ANY OF THE ONE FOOT ZONES.
10. THE GRAPHIC REPRESENTATION OF THE DISCONTINUITIES INDICATES ONLY THE APPROXIMATE LOCATION AND DIP ANGLE OF THE DISCONTINUITY. IT DOES NOT INDICATE ORIENTATION OR BEARING.

ROCK CONTINUED

CONTINUITY DESCRIPTION

- LONGEST CORE - THE LONGEST LENGTH OF CORE INCLUDING MECHANICAL BREAKS, IS MEASURED FOR EACH CORE RUN AND RECORDED.
- AVERAGE CORE - THE AVERAGE LENGTH OF CORE IS MEASURED FOR EACH CORE RUN AND RECORDED. THE AVERAGE CORE LENGTH IS PRESENTED ON THE GRAPHIC SUMMARY FOR EACH EXPLORATION.

STRUCTURAL DESCRIPTION

- FRACTURES - SPACING (*)
- VERY CLOSE - LESS THAN 2 INCHES
- CLOSE - 2 INCHES - 1 FOOT
- MODERATELY CLOSE - 1 FOOT - 3 FEET
- WIDE - 3 FEET - 10 FEET
- VERY WIDE - MORE THAN 10 FEET
- * SPACING REFERS TO PERPENDICULAR DISTANCE BETWEEN DISCONTINUITIES.

ATTITUDE DESCRIPTION

- ANGLE
- SHALLOW - 0 - 6
- MODERATELY SHALLOW - 6 - 35
- MODERATELY DIPPING - 35 - 55
- STEEP OR HIGH ANGLE - 55 - 90

MISCELLANEOUS FEATURES

ANY ADDITIONAL CHARACTERISTICS TO FURTHER IDENTIFY AND EVALUATE THE ROCK, SUCH AS SECONDARY MINERALIZATION, ALTERATION, SWELLING PROPERTIES, ETC.

LEGEND

MAJOR SUBSURFACE STRATA

- MISC FILL - BROWN, LOOSE TO DENSE COARSE TO FINE SAND, LITTLE COARSE TO FINE GRAVEL, LITTLE SILT WITH INTERMIXED LAMM, BRICK AND WOOD
- OUTWASH GRAVEL - BROWN, LOOSE TO MEDIUM DENSE COARSE TO FINE SAND, LITTLE MEDIUM TO FINE GRAVEL, TRACE TO LITTLE SILT
- MARINE CLAY - YELLOW-BROWN TO BLUE-GRAY VERY STIFF TO MEDIUM STIFF SILTY CLAY, TRACE COARSE TO FINE SAND AND GRAVEL WITH THIN LENSES OF SILTY FINE SAND AND FINE SANDY SILT
- GLACIAL TILL - BROWNISH GRAY MEDIUM TO VERY DENSE COARSE TO FINE SILTY SAND, LITTLE GRAVEL, TRACE CLAY WITH OCCASIONAL SAND, CLAY AND SILTY LAYERS WITH COBBLES AND BOULDERS
- DECOMPOSED BEDROCK - GRAY VERY DENSE CLAYEY SAND, TRACE TO LITTLE GRAVEL WITH ROCK FRAGMENTS AND BOULDERS
- ALTERED ARGILLITE - LIGHT GRAY TO GRAYISH GREEN, FRESH TO MODERATELY WEATHERED, HARD TO SOFT, BRECCIATED WITH REHEALED MACRO SHEARS. LOCAL FRACTURE ZONES, JOINTS AND SHEARS WITH OCCASIONAL CLAY AND GOUGE FILLINGS, QUARTZ, EPIDOTTE AND CALCITE VEINS, AND DIABASE STRINGERS.
- DIABASE - DARK GREEN TO OLIVE GRAY, FRESH TO SEVERELY WEATHERED, HARD TO SOFT, BRECCIATED WITH REHEALED MACRO SHEARS. LOCAL FRACTURE ZONES, JOINTS AND SHEARS WITH OCCASIONAL GOUGE FILLINGS, QUARTZ, EPIDOTTE AND CALCITE VEINS WITH IRON OXIDE STAINING AND ARGILLACEOUS INCLUSIONS.

ROCK QUALITY DESIGNATION (RQD)

RQD IS THE SUM IN INCHES OF ALL PIECES OF NX SIZE OR LARGER OF ROCK CORE, FOUR INCHES IN LENGTH AND LONGER, DIVIDED BY THE LENGTH IN INCHES OF THE CORE RUN, AND IS EXPRESSED AS A PERCENTAGE. IF THE CORE WAS CUT INTO TWO OR MORE SECTIONS, EACH SECTION IS CONSIDERED AS ONE PIECE TOGETHER AND CONSIDERED TO BE ONE PIECE. PROVIDING THEY CONSTITUTE THE REQUIRED FOUR INCH LENGTH. WHERE THE RECOVERY FOR A CORE RUN IS GREATER THAN 100 PERCENT, RQD VALUES WERE ADJUSTED TO ACCOUNT FOR THE PROPORTION OF THE CORE LEFT IN THE HOLE FROM THE PREVIOUS RUN. THE LENGTH DETERMINED WAS CALCULATED DOWN THE CENTERLINE OF THE CORE AND WAS CALCULATED FOR EACH CORE RUN.

SAMPLE TYPE

SAMPLE TYPE AND NUMBER (S2) IS INDICATED AT THE LOCATION IT WAS OBTAINED IN THE BOREHOLE.

- S - 2.0 INCH O.D. SPLIT SPOON SAMPLE
- S* - 3.0 INCH O.D. SPLIT SPOON SAMPLE
- D - 2-15/16 INCH O.D. DENISON SAMPLE
- P - 2-1/2 INCH O.D. PITCHER SAMPLE
- R - ROCK CORE RUN

* WHERE ONE SAMPLE CONTAINED TWO DIFFERENT SOIL TYPES, IT WAS SPLIT INTO TWO SEPARATE SAMPLES AND DESIGNATED WITH LETTERS A AND B (31A AND 31B).

TEST TYPE

TEST TYPE AND NUMBER (H3) IS INDICATED AT THE LOCATION IT WAS CONDUCTED OR OBTAINED FOR EITHER IN-SITU TESTS OR SELECTED LABORATORY TEST SAMPLES.

- G - GRAIN SIZE ANALYSIS
- H - HYDROMETER ANALYSIS
- A - ATTERBERG LIMITS
- PL - PLASTIC LIMIT
- PI - PLASTICITY INDEX
- LP - LABORATORY PERMEABILITY TEST
- WP - FIELD WATER PRESSURE TEST

ABBREVIATIONS

- TR - TRACE
- LI - LITTLE
- SEV - SEVERE
- SL - SLIGHT OR SLIGHTLY
- FLEX - FLEXIBLE
- OCC - OCCASIONAL OR OCCASIONALLY
- MOD - MODERATE OR MODERATELY
- MED - MEDIUM
- FRAC - FRACTURED
- SEV - SEVERE OR SEVERELY
- TR - TRACE
- W - WITH
- OBS - OBSERVATION
- RB - ROLLER BIT

SAMPLE RECOVERY

THE TOTAL LENGTH OF THE SOIL OR ROCK SAMPLE RECOVERED IS DIVIDED BY THE TOTAL LENGTH OF PENETRATION OR CORE RUN AND IS EXPRESSED IN PERCENT AND PRESENTED GRAPHICALLY ON THE SUMMARY SHEETS FOR EACH EXPLORATION.



APPENDIX B
GEOLOGIC PROFILES

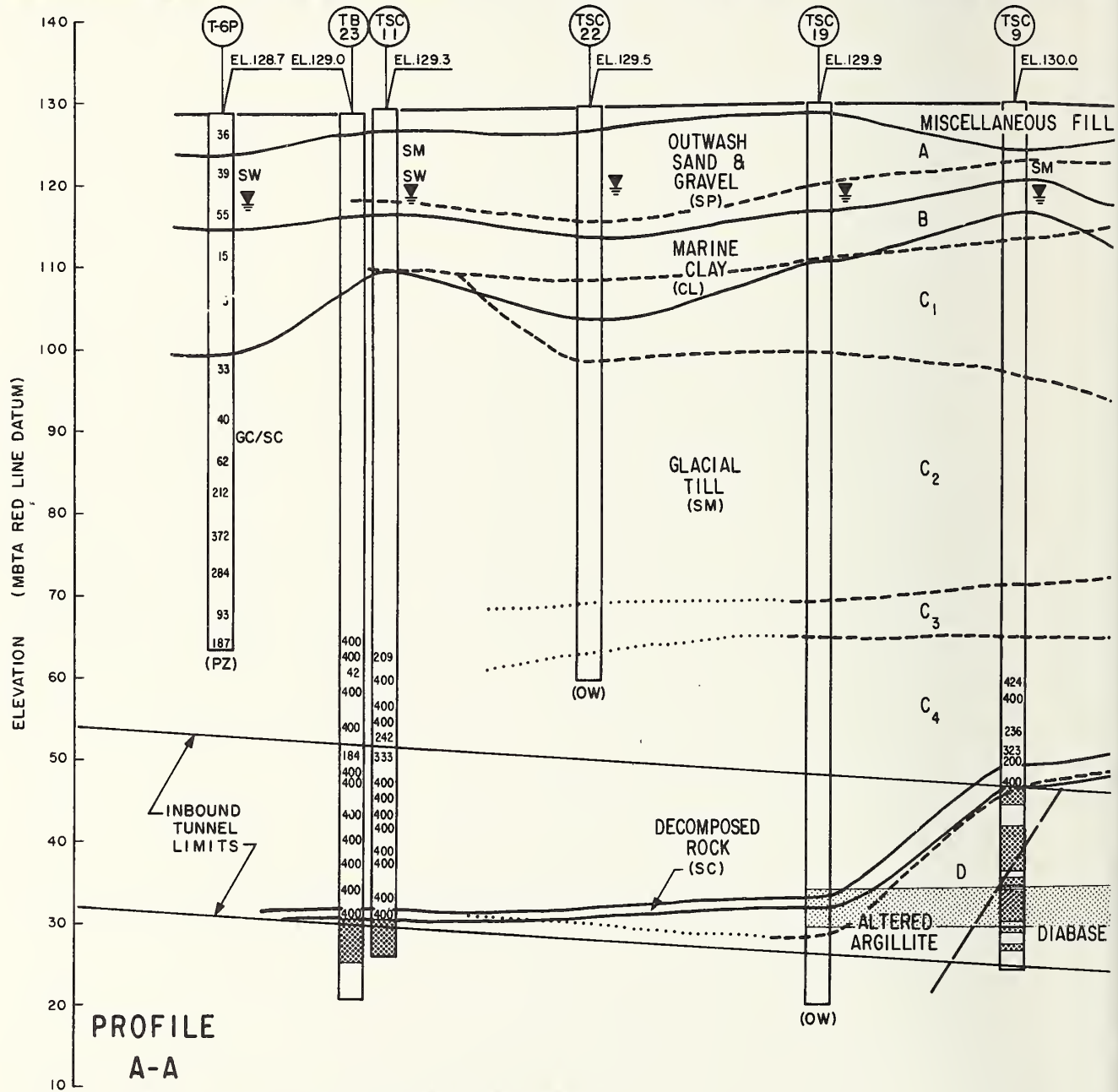

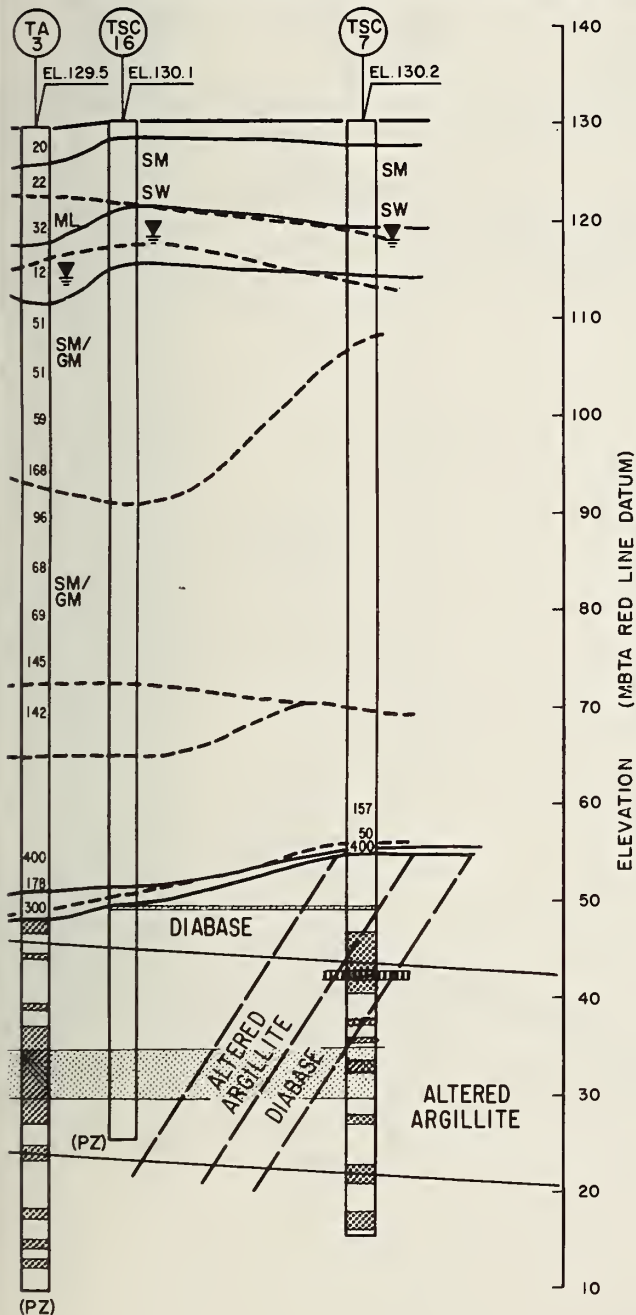

SCALE

HOR. 1" = 40'
 VER. 1" = 20'

LEGEND

- BORING NUMBER
- GROUND SURFACE ELEVATION
- UNIFIED SOIL CLASSIFICATION SYSTEM SYMBOLS
- PENETRATION TEST
 - 22 NUMBER OF BLOWS REQUIRED TO DRIVE A 2 INCH O.D. SPLIT SPOON SAMPLER ONE FOOT WITH A 300 LB. HAMMER FREE FALLING 24 INCHES
 - 400 NUMBER OF BLOWS REQUIRED TO DRIVE A 2 INCH O.D. SPLIT SPOON SAMPLER ONE FOOT WITH A 300 LB. HAMMER FREE FALLING 24 INCHES WAS IN EXCESS OF 400
- WATER LEVEL OBSERVED IN BOREHOLE UPON COMPLETION, MAY-JUNE 1979
- WATER LEVEL OBSERVED IN BOREHOLE DURING PUMPING OF DEWATERING WELL DW-5, JULY-AUGUST 1979
- INDICATES APPROXIMATE LOCATION OF STRATA CHANGE DETERMINED FROM TEST BORINGS
- INDICATES APPROXIMATE LOCATION OF STRATA CHANGE INFERRED FROM GEOPHYSICAL NUCLEAR LOGGING
- INDICATES APPROXIMATE LOCATION OF STRATA CHANGE INFERRED FROM INCOMPLETE GEOPHYSICAL DATA
- BOTTOM OF EXPLORATION
- OBSERVATION WELL OR PIEZOMETER INSTALLED IN COMPLETED BOREHOLE

BOREHOLE GEOPHYSICAL LOGGING

A	APPROXIMATE STRATA CHANGES INFERRED FROM NN AND NATG LOGGING	MISCELLANEOUS FILL AND SAND	
B		MARINE CLAY INFERRED FROM NATURAL GAMMA LOGGING	
C ₁		GLACIAL TILL INFERRED FROM NN AND NATG LOGGING	DENSE SANDY UNIT
C ₂			CLAY LENS OR ZONE OF GRAVEL, COBBLES AND BOULDERS
C ₃			CLAY UNIT
C ₄	DENSE SAND UNIT		
D	BEDROCK INFERRED FROM GAMMA-GAMMA LOGGING		
		ZONES OF POOR QUALITY ROCK INFERRED FROM SEISMIC CROSS-HOLE SURVEY	
		FRACTURE ZONES INFERRED FROM NUCLEAR BOREHOLE LOGGING	
		MAJOR FRACTURE ZONES DETERMINED FROM RECOVERED BEDROCK CORE	

GENERAL NOTES

1. REFER TO APPENDIX A FOR DETAILED LEGEND AND NOTES.
2. ALL ELEVATIONS ARE IN FEET AND REFER TO MBTA RED LINE DATUM WHICH IS 105.87 FEET BELOW U.S.C. & G.S. MEAN SEA LEVEL 1929.
3. REFER TO APPENDIX C FOR DETAILED SUBSURFACE EXPLORATION SUMMARIES.
4. SUBSURFACE STRATIFICATION LINES BETWEEN EXPLORATIONS ARE NECESSARY INTERPOLATIONS OF ALL AVAILABLE INFORMATION AND MAY NOT AGREE WITH ACTUAL FIELD CONDITIONS AT LOCATIONS OTHER THAN AT THE EXPLORATIONS.

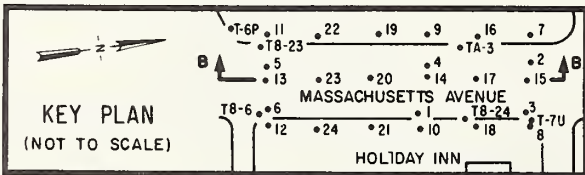
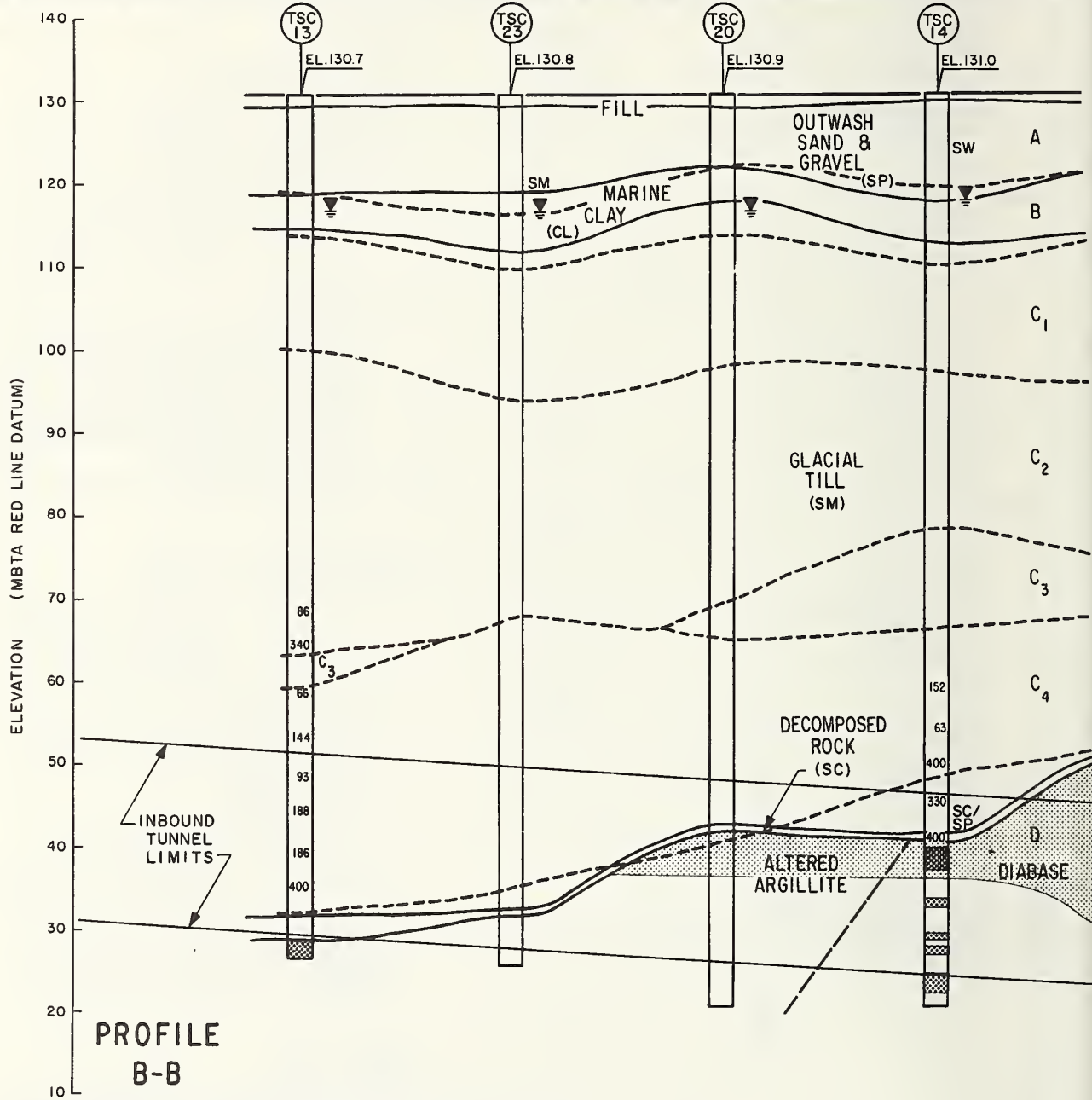

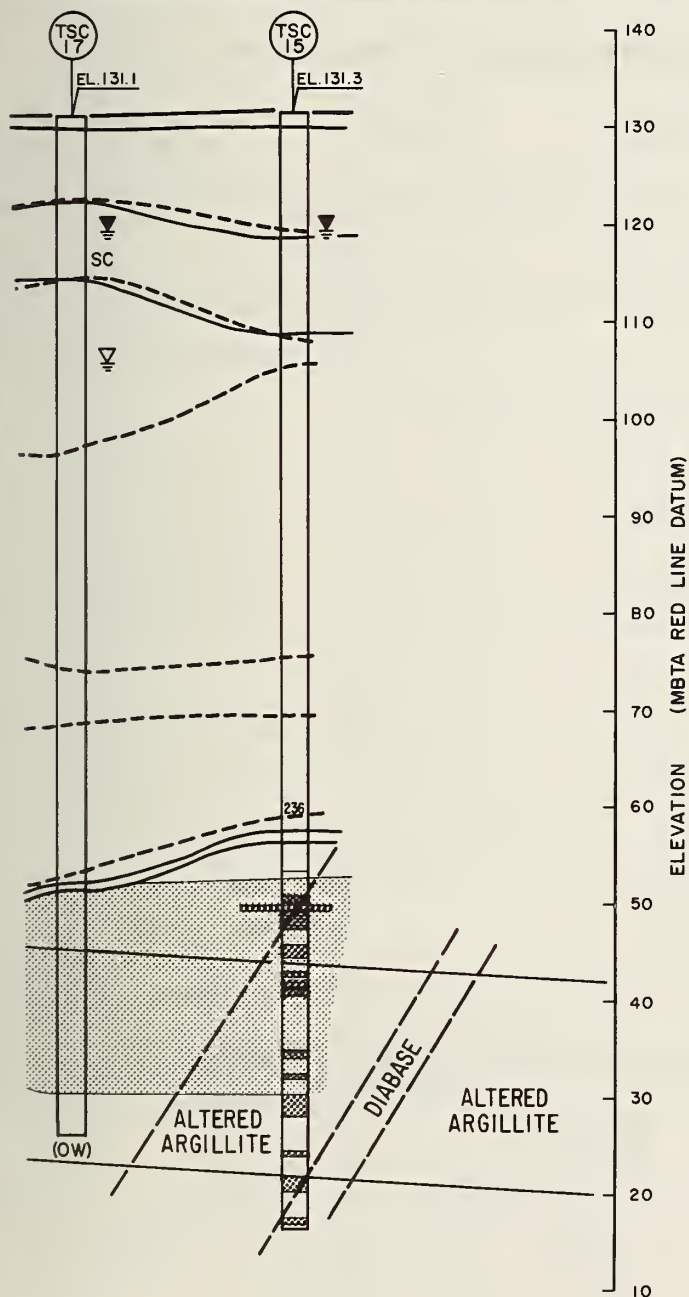

LEGEND

- TSC 1 BORING NUMBER
- EL. 129.1 GROUND SURFACE ELEVATION
- SM UNIFIED SOIL CLASSIFICATION SYSTEM SYMBOLS
- PENETRATION TEST
 - 22 NUMBER OF BLOWS REQUIRED TO DRIVE A 2 INCH O.D. SPLIT SPOON SAMPLER ONE FOOT WITH A 300 LB. HAMMER FREE FALLING 24 INCHES
 - 400 NUMBER OF BLOWS REQUIRED TO DRIVE A 2 INCH O.D. SPLIT SPOON SAMPLER ONE FOOT WITH A 300 LB. HAMMER FREE FALLING 24 INCHES WAS IN EXCESS OF 400
- ▽ WATER LEVEL OBSERVED IN BOREHOLE UPON COMPLETION, MAY-JUNE 1979
- ▽ WATER LEVEL OBSERVED IN BOREHOLE DURING PUMPING OF DEWATERING WELL DW-5, JULY-AUGUST 1979
- - - INDICATES APPROXIMATE LOCATION OF STRATA CHANGE DETERMINED FROM TEST BORINGS
- - - INDICATES APPROXIMATE LOCATION OF STRATA CHANGE INFERRED FROM GEOPHYSICAL NUCLEAR LOGGING
- ... INDICATES APPROXIMATE LOCATION OF STRATA CHANGE INFERRED FROM INCOMPLETE GEOPHYSICAL DATA
- BOTTOM OF EXPLORATION
- (OW) OBSERVATION WELL OR PIEZOMETER INSTALLED IN COMPLETED BOREHOLE
- (PZ)

BOREHOLE GEOPHYSICAL LOGGING

A	APPROXIMATE STRATA CHANGES INFERRED FROM NN AND NATG LOGGING	MISCELLANEOUS FILL AND SAND
B		MARINE CLAY INFERRED FROM NATURAL GAMMA LOGGING
C ₁	GLACIAL TILL INFERRED FROM GG, NN AND NATG LOGGING	DENSE SANDY UNIT
C ₂		CLAY LENS OR ZONE OF GRAVEL, COBBLES AND BOULDERS
C ₃		CLAY UNIT
C ₄		DENSE SAND UNIT
D		BEDROCK INFERRED FROM GAMMA-GAMMA LOGGING
		ZONES OF POOR QUALITY ROCK INFERRED FROM SEISMIC CROSS-HOLE SURVEY
		FRACTURE ZONES INFERRED FROM NUCLEAR BOREHOLE LOGGING
		MAJOR FRACTURE ZONES DETERMINED FROM RECOVERED BEDROCK CORE

GENERAL NOTES

1. REFER TO APPENDIX A FOR DETAILED LEGEND AND NOTES.
2. ALL ELEVATIONS ARE IN FEET AND REFER TO MBTA RED LINE DATUM WHICH IS 105.87 FEET BELOW U.S.C. & G.S. MEAN SEA LEVEL 1929.
3. REFER TO APPENDIX C FOR DETAILED SUBSURFACE EXPLORATION SUMMARIES.
4. SUBSURFACE STRATIFICATION LINES BETWEEN EXPLORATIONS ARE NECESSARY INTERPOLATIONS OF ALL AVAILABLE INFORMATION AND MAY NOT AGREE WITH ACTUAL FIELD CONDITIONS AT LOCATIONS OTHER THAN AT THE EXPLORATIONS.

SCALE

HOR. 1" = 40'
 VER. 1" = 20'

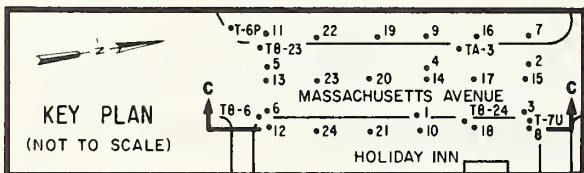
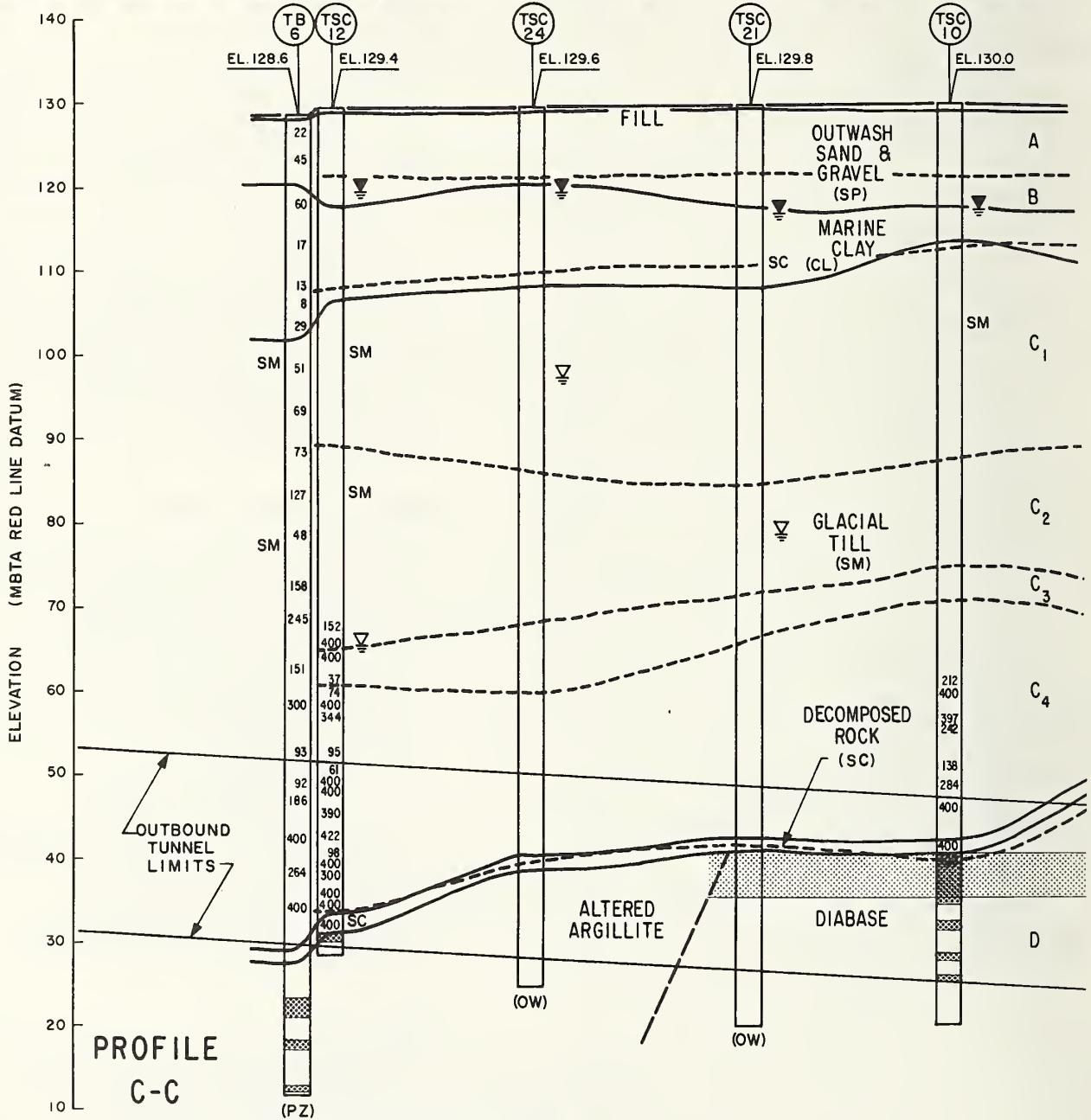

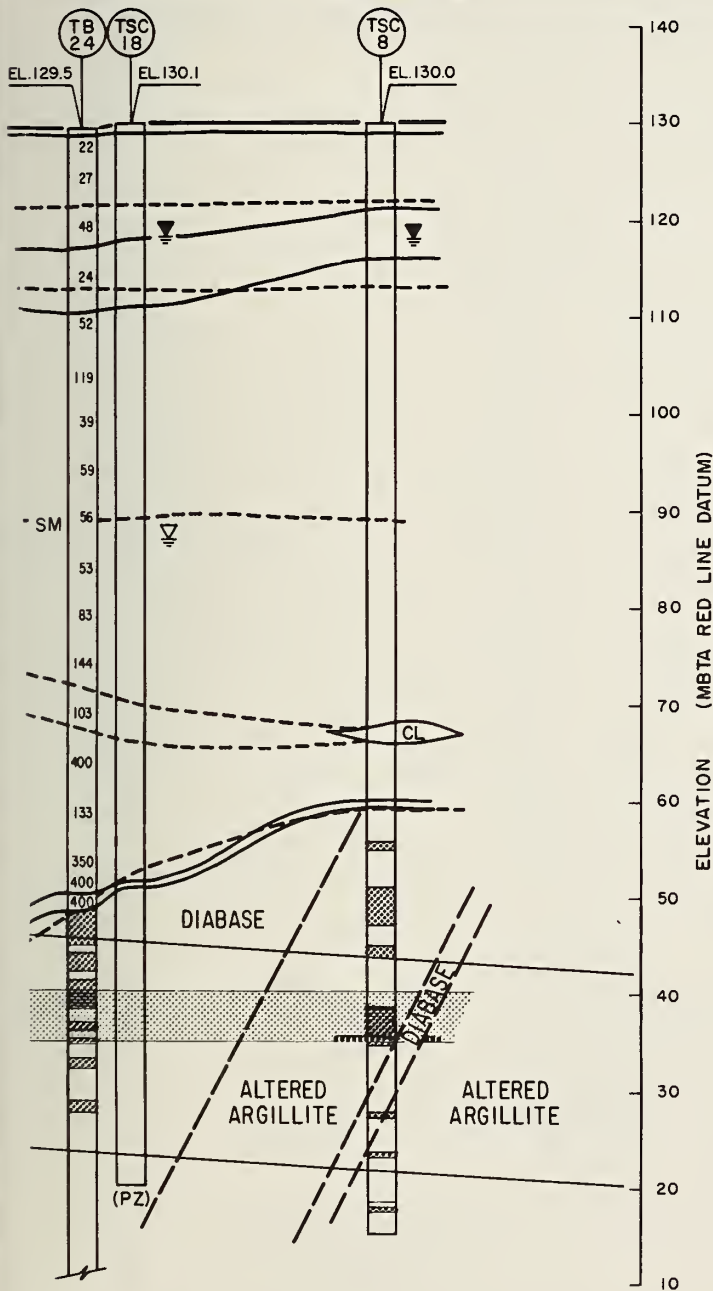

SCALE
 HOR. 1" = 40'
 VER. 1" = 20'

LEGEND

- BORING NUMBER
- GROUND SURFACE ELEVATION
- SM UNIFIED SOIL CLASSIFICATION SYSTEM SYMBOLS
- PENETRATION TEST
 - 22 NUMBER OF BLOWS REQUIRED TO DRIVE A 2 INCH O.D. SPLIT SPOON SAMPLER ONE FOOT WITH A 300 LB. HAMMER FREE FALLING 24 INCHES
 - 400 NUMBER OF BLOWS REQUIRED TO DRIVE A 2 INCH O.D. SPLIT SPOON SAMPLER ONE FOOT WITH A 300 LB. HAMMER FREE FALLING 24 INCHES WAS IN EXCESS OF 400
- WATER LEVEL OBSERVED IN BOREHOLE UPON COMPLETION, MAY-JUNE 1979
- WATER LEVEL OBSERVED IN BOREHOLE DURING PUMPING OF DEWATERING WELL DW-5, JULY-AUGUST 1979
- INDICATES APPROXIMATE LOCATION OF STRATA CHANGE DETERMINED FROM TEST BORINGS
- INDICATES APPROXIMATE LOCATION OF STRATA CHANGE INFERRED FROM GEOPHYSICAL NUCLEAR LOGGING
- INDICATES APPROXIMATE LOCATION OF STRATA CHANGE INFERRED FROM INCOMPLETE GEOPHYSICAL DATA
- BOTTOM OF EXPLORATION
- OBSERVATION WELL OR PIEZOMETER INSTALLED IN COMPLETED BOREHOLE

BOREHOLE GEOPHYSICAL LOGGING

A	APPROXIMATE STRATA CHANGES INFERRED FROM NN AND NATG LOGGING	MISCELLANEOUS FILL AND SAND	
B		MARINE CLAY INFERRED FROM NATURAL GAMMA LOGGING	
C ₁		GLACIAL TILL INFERRED FROM GG, NN AND NATG LOGGING	DENSE SANDY UNIT
C ₂			CLAY LENS OR ZONE OF GRAVEL, COBBLES AND BOULDERS
C ₃			CLAY UNIT
C ₄			DENSE SAND UNIT
D		BEDROCK INFERRED FROM GAMMA-GAMMA LOGGING	
		ZONES OF POOR QUALITY ROCK INFERRED FROM SEISMIC CROSS-HOLE SURVEY	
		FRACTURE ZONES INFERRED FROM NUCLEAR BOREHOLE LOGGING	
		MAJOR FRACTURE ZONES DETERMINED FROM RECOVERED BEDROCK CORE	

GENERAL NOTES

1. REFER TO APPENDIX A FOR DETAILED LEGEND AND NOTES.
2. ALL ELEVATIONS ARE IN FEET AND REFER TO MBTA RED LINE DATUM WHICH IS 105.87 FEET BELOW U.S.C. & G.S. MEAN SEA LEVEL 1929.
3. REFER TO APPENDIX C FOR DETAILED SUBSURFACE EXPLORATION SUMMARIES.
4. SUBSURFACE STRATIFICATION LINES BETWEEN EXPLORATIONS ARE NECESSARY INTERPOLATIONS OF ALL AVAILABLE INFORMATION AND MAY NOT AGREE WITH ACTUAL FIELD CONDITIONS AT LOCATIONS OTHER THAN AT THE EXPLORATIONS.

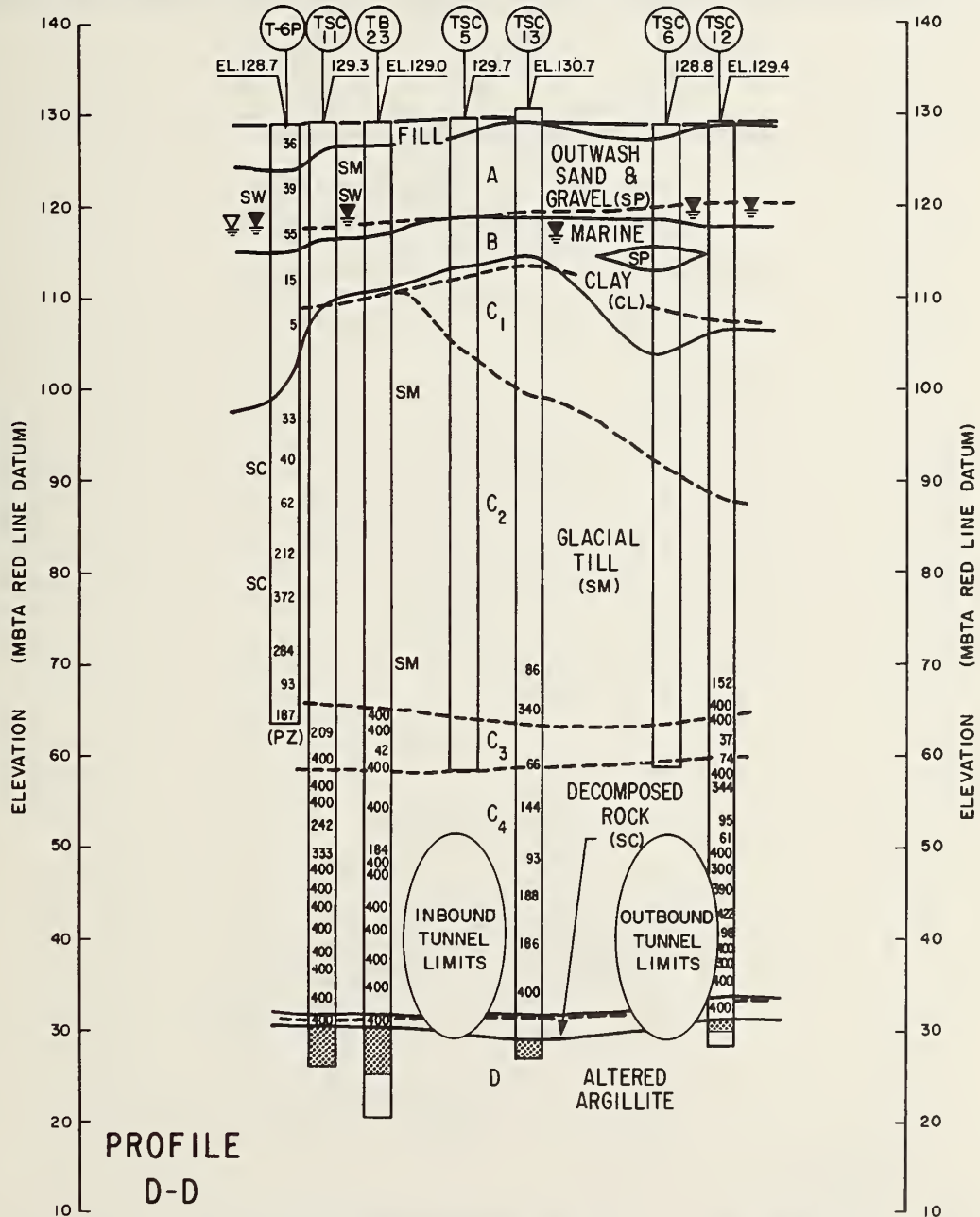

PROFILE
D-D

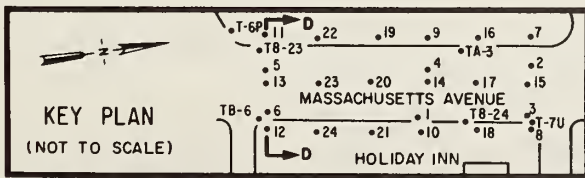

FOR LEGEND AND
NOTES SEE SHEET B-1

SCALE
HOR. 1" = 40'
VER. 1" = 20'

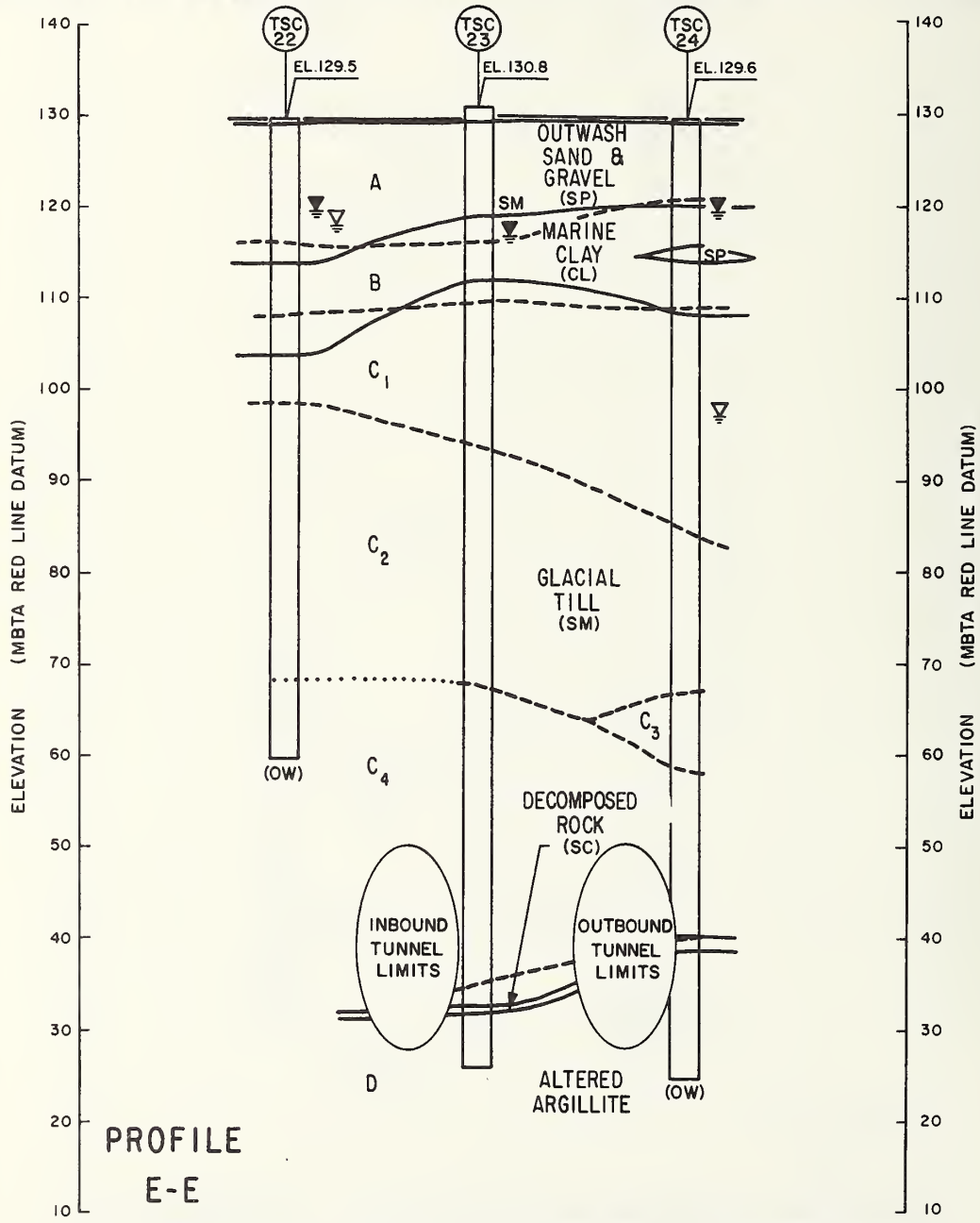

PROFILE E-E

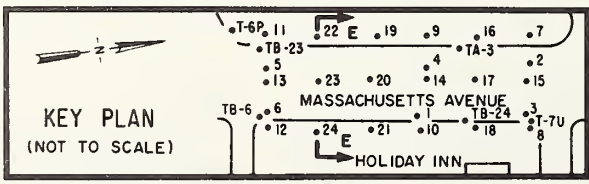

FOR LEGEND AND NOTES SEE SHEET B-1

SCALE
HOR. 1" = 40'
VER. 1" = 20'

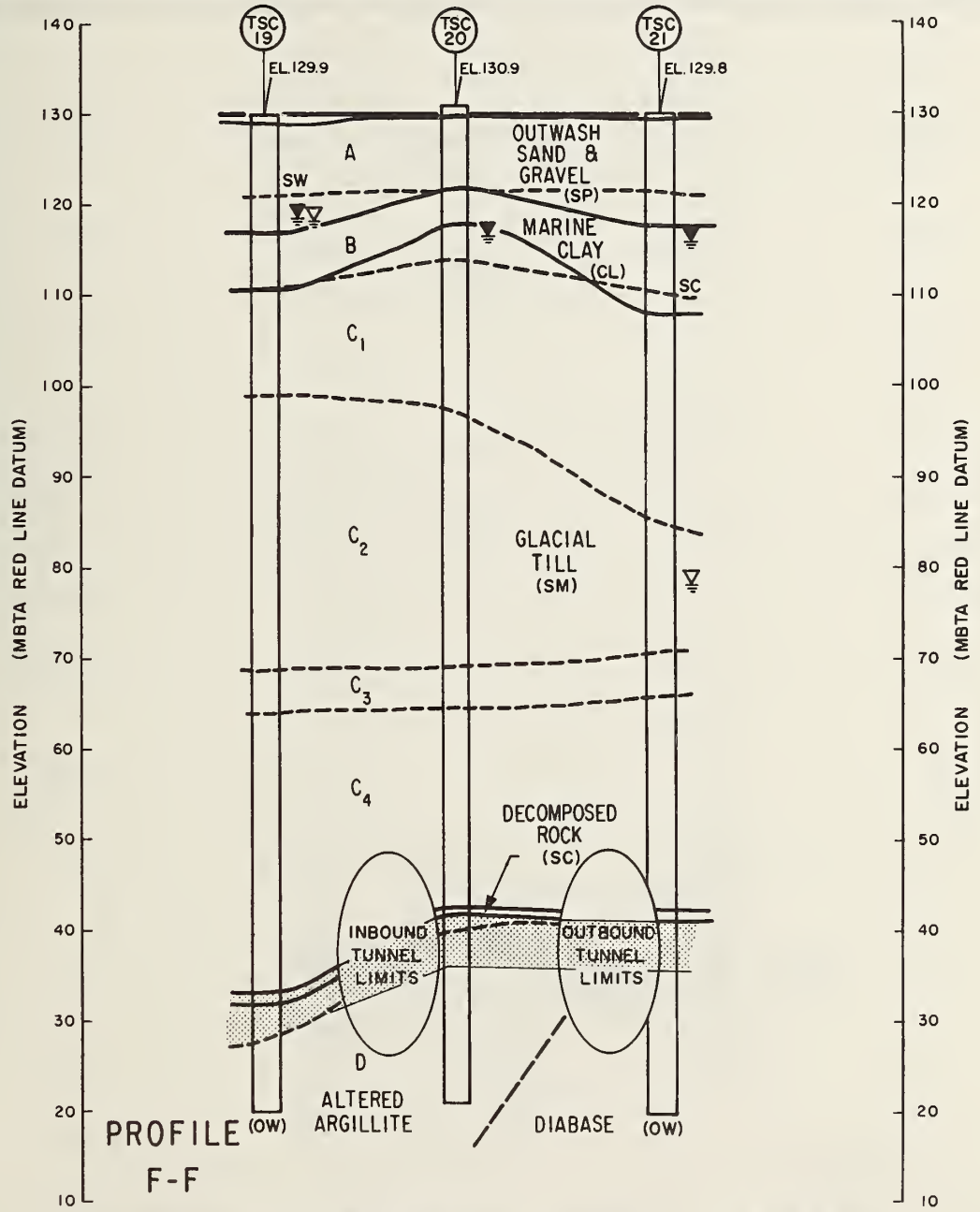

PROFILE F-F

FOR LEGEND AND NOTES SEE SHEET B-1

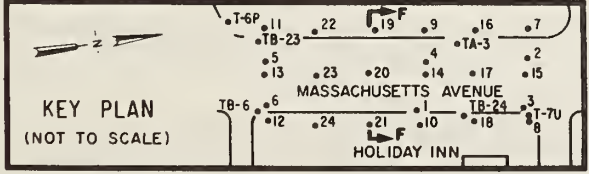

SCALE
 HOR. 1" = 40'
 VER. 1" = 20'

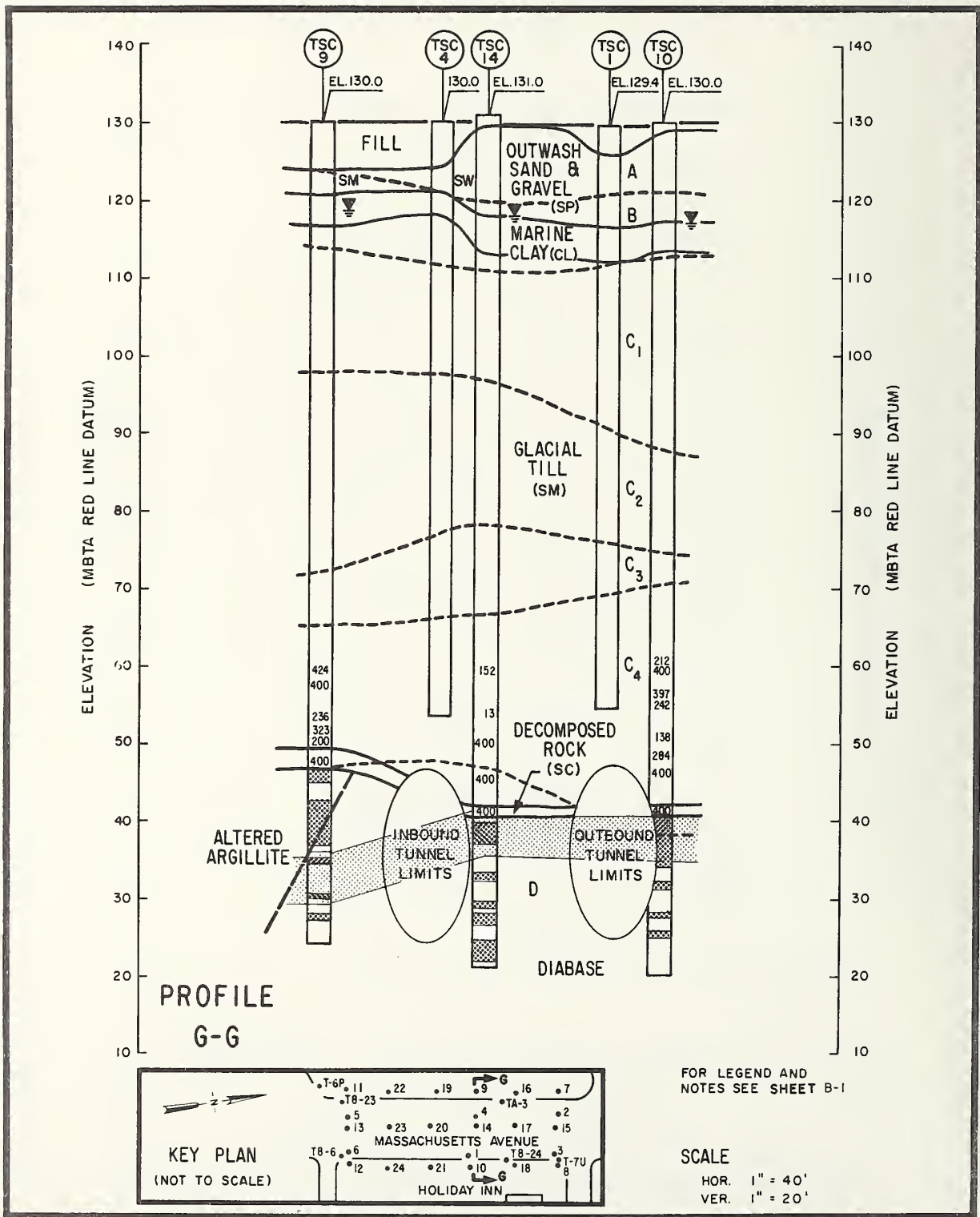

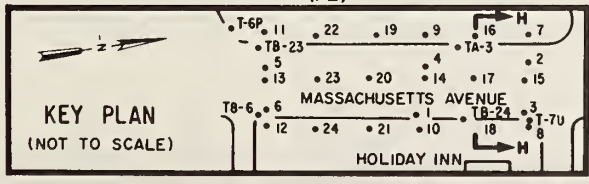
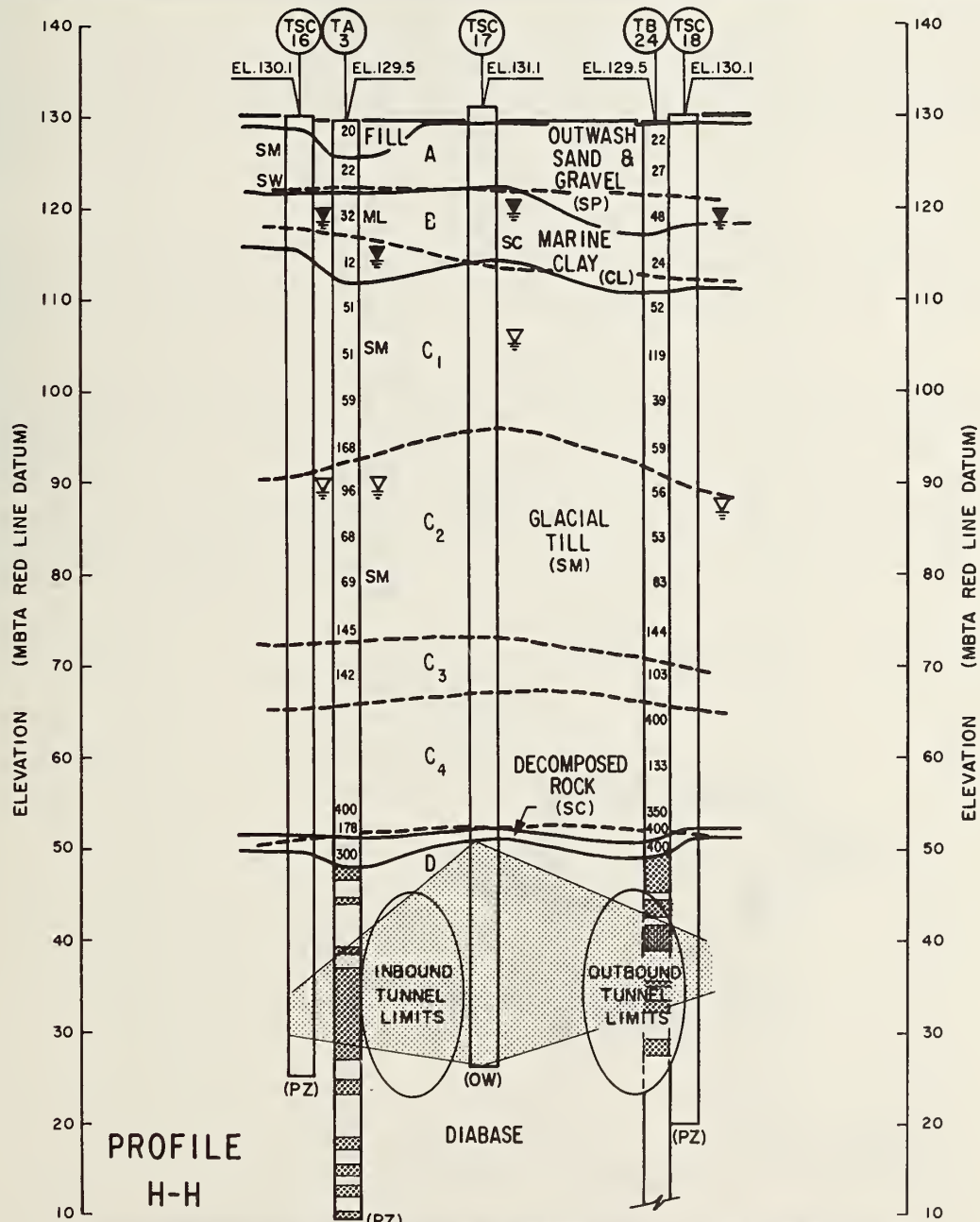

FOR LEGEND AND NOTES SEE SHEET B-1

SCALE
 HOR. 1" = 40'
 VER. 1" = 20'

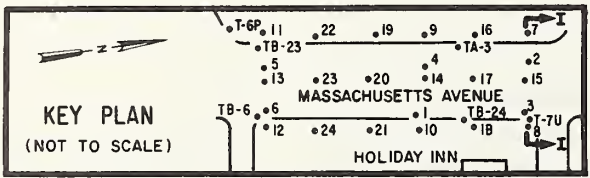
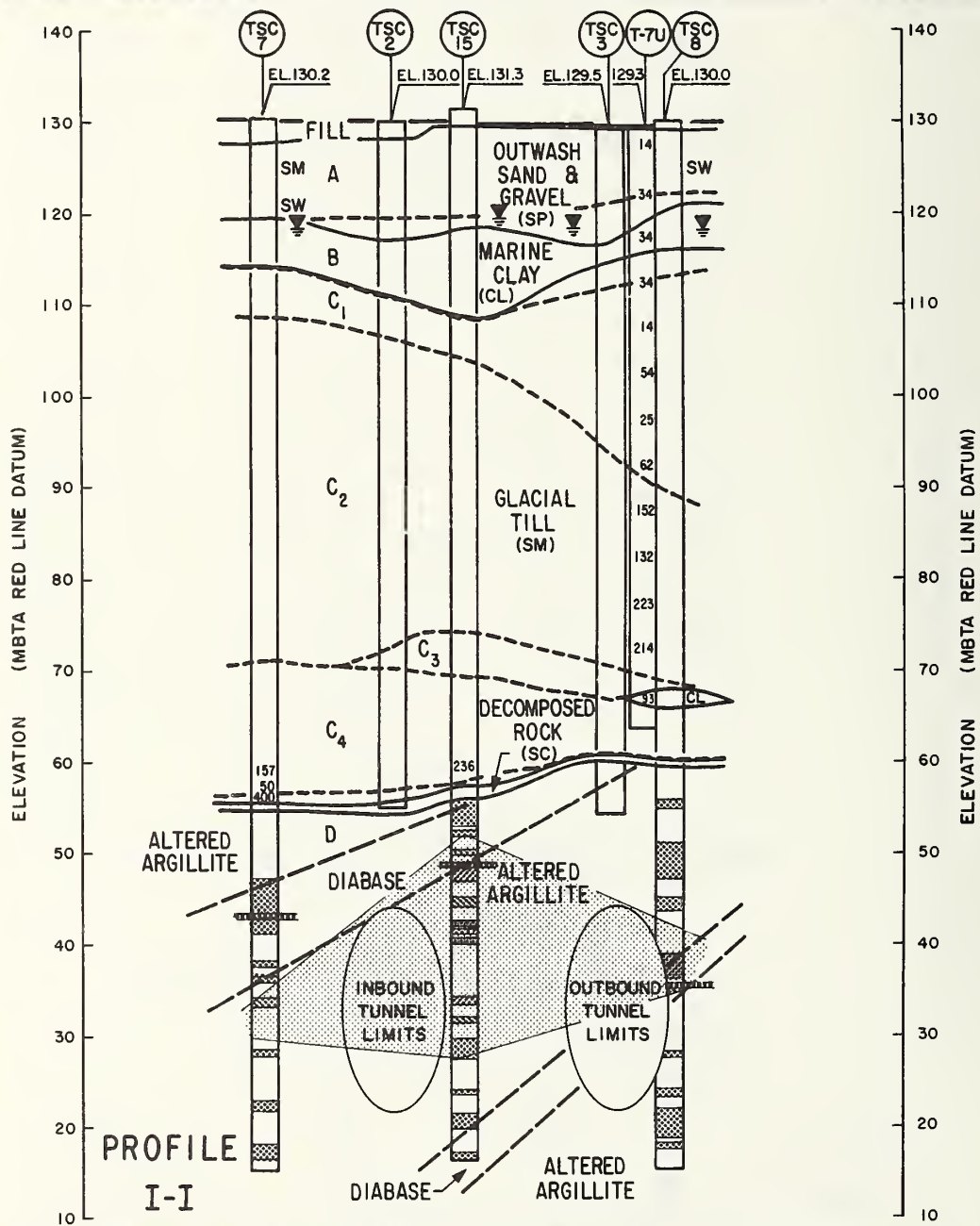

FOR LEGEND AND NOTES SEE SHEET B-1

SCALE
HOR. 1" = 40'
VER. 1" = 20'

APPENDIX C

SUBSURFACE EXPLORATION SUMMARIES AND BOREHOLE NUCLEAR LOGGING SUMMARIES

A subsurface exploration summary sheet has been prepared for each of the explorations, TSC1 through TSC24, conducted during the DOT/TSC project study. A summary sheet is also included for the ISM boring conducted at the Davis Square site.

The results of the nuclear borehole logging which was conducted in the majority of the explorations, is summarized on facing pages for comparison with the physical information recovered in the borehole.

Generally, the unsampled portions of the boreholes which are well above the proposed tunnel crown have not been included on the summary sheets due to space limitations.

Refer to Appendix A, Detailed Legend and Notes for explanation and definitions of the various terms and symbols used on the summary sheets.

SUBSURFACE EXPLORATION SUMMARY EXPLORATION NO. TSC 1

LOCATION HOLIDAY INN SITE, CAMBRIDGE, MA STATION 204 + 56.0 D.B. OFFSET 1.4' LT COMP. DATE 4-30-79
 HOLE SIZE (OVERBURDEN) 5-5/8" (ROCK) NONE GROUND SURFACE EL. 129.4' GROUNDWATER EL. NOT DETERMINED

CORE BARREL:
 TYPE NONE SIZE - DEPTH -
 TYPE NDNE SIZE - DEPTH -

PERMANENT INSTRUMENTATION CASING:
 TYPE MECHANICAL/ELECTRICAL SETTLEMENT
 SIZE 2.5" I.D. SCH 40 P.V.C.
 DEPTH 73.5'

BOREHOLE SEALING:
 GROUT TYPE LIME/CEMENT
 DEPTH RANGE 3-75'
 DATE SEALED 4-30-79

GROUNDWATER DETERMINATION
 NDNE

ELEV (FEET)	DESCRIPTION	INSTRUMENT CASING INSTALLATION SKETCH	USCS CLASS a SYM	SAMP TYPE a NO	TEST TYPE a NO	RECOVERY ANO RQO (PERCENT) 20 40 60 80 100	PENETRATION TEST (300 LB. WT./24" DROP) (BLOWS PER FOOT) 100 200 300 400	ROCK DISCONTINUITY SUMMARY										DEPTH (FEET)																											
								AVG LENGTH CORE (INCHES) 2 6 10	GRAPHIC LOG	TYPE					FILLING																														
										JOINT	SHEAR	MECH	PLANAR	IRREG	SMOOTH	ROUGH	GOUGE		CLAY	CALCITE	IRON OXIDE																								
99.4	GRAY SILTY SAND, LI GRAVEL W COBBLES & BOULDERS - GLACIAL TILL		B																				26																						
98.0	BDULDER																																											29	
																																													33
																																													37
																																													41
	GRAY SILTY SAND, LI GRAVEL W COBBLES & BOULDERS - GLACIAL TILL -																																												45
																																													49
76.4	BDULDER																																												53
73.7																																													57
	GRAY SILTY SAND, LI GRAVEL W COBBLES & BOULDERS - GLACIAL TILL -																																												61
																								65																					
																								69																					
																								73																					
54.4																								75																					

NOTES:

- TUNNEL CROWN SETTLEMENT INSTALLATION EXPLORATION NO SAMPLES REQUIRED FOR ENTIRE LENGTH OF HOLE. SAMPLE DESCRIPTIONS AND STRATA CHANGES OBSERVED FROM WASH WATER AND DRILLING CHARACTERISTICS AND ARE APPROXIMATE.
- INSTRUMENTATION CASING INACCESSIBLE AND IN-OPERATIVE. UPPER TEN FEET OF CASING SHEARED OFF DURING INSTALLATION AND GRANULAR FILL COLLAPSED OVER CASING. UNABLE TO SALVAGE.
- INSTRUMENTATION SKETCH INDICATES THE VARIOUS STEPS IN ASSEMBLING ALL "SONDEX" FLEXIBLE COUPLINGS.
- TUNNEL CROWN ELEVATION AT EL. 47.0'.

SUBSURFACE EXPLORATION SUMMARY EXPLORATION NO. TSC 2

LOCATDN HOLIOAY INN SITE, CAMBRIDGE, MA STATION 205 + 63.0 O.B. OFFSET 49.0' LT CDMR DATE 6-26-79

MDLE SIZE (OVERBURDEN) 5-5/8" (ROCK) NONE GRDNO SURFACE EL. 130.0' GROUNDWATER EL. NOT DETERMINED

CORE BARREL: TYPE <u>NONE</u> SIZE <u>-</u> DEPTH <u>-</u> TYPE <u>NONE</u> SIZE <u>-</u> DEPTH <u>-</u>	PERMANENT INSTRUMENTATION CASING: TYPE <u>MECHANICAL/ELECTRICAL SETTLEMENT</u> SIZE <u>2.5" I.O., SCH 40 P.V.C.</u> DEPTH <u>75.0'</u>	BDREHOLE SEALING: GRDUT TYPE <u>LIME/CEMENT</u> DEPTH RANGE <u>3-75'</u> DATE SEALED <u>6-26-79</u>	GROUNDWATER DETERMINATION NONE
---	--	---	--

ELEV (FEET)	DESCRIPTION	INSTRUMENT CASING INSTALLATION SKETCH	USCS CLASS & SYM	SAMP TYPE & NO.	TEST TYPE & NO.	RECOVERY AND ROD (PERCENT) 20 40 60 80 100	PENETRATION TEST (300 LB. WT./24" DRDP) (BLWS PER FDDT) 100 200 300 400	RDCK DISCONTINUITY SUMMARY										DEPTH (FEET)
								AVG LENGTH CORE (INCHES) 2 6 10	GRAPHIC LDG	TYPE		GEDM	COND	FILLING				
										JOINT	SHEAR			MECH	PLANAR	IRREG	SMOOTH	

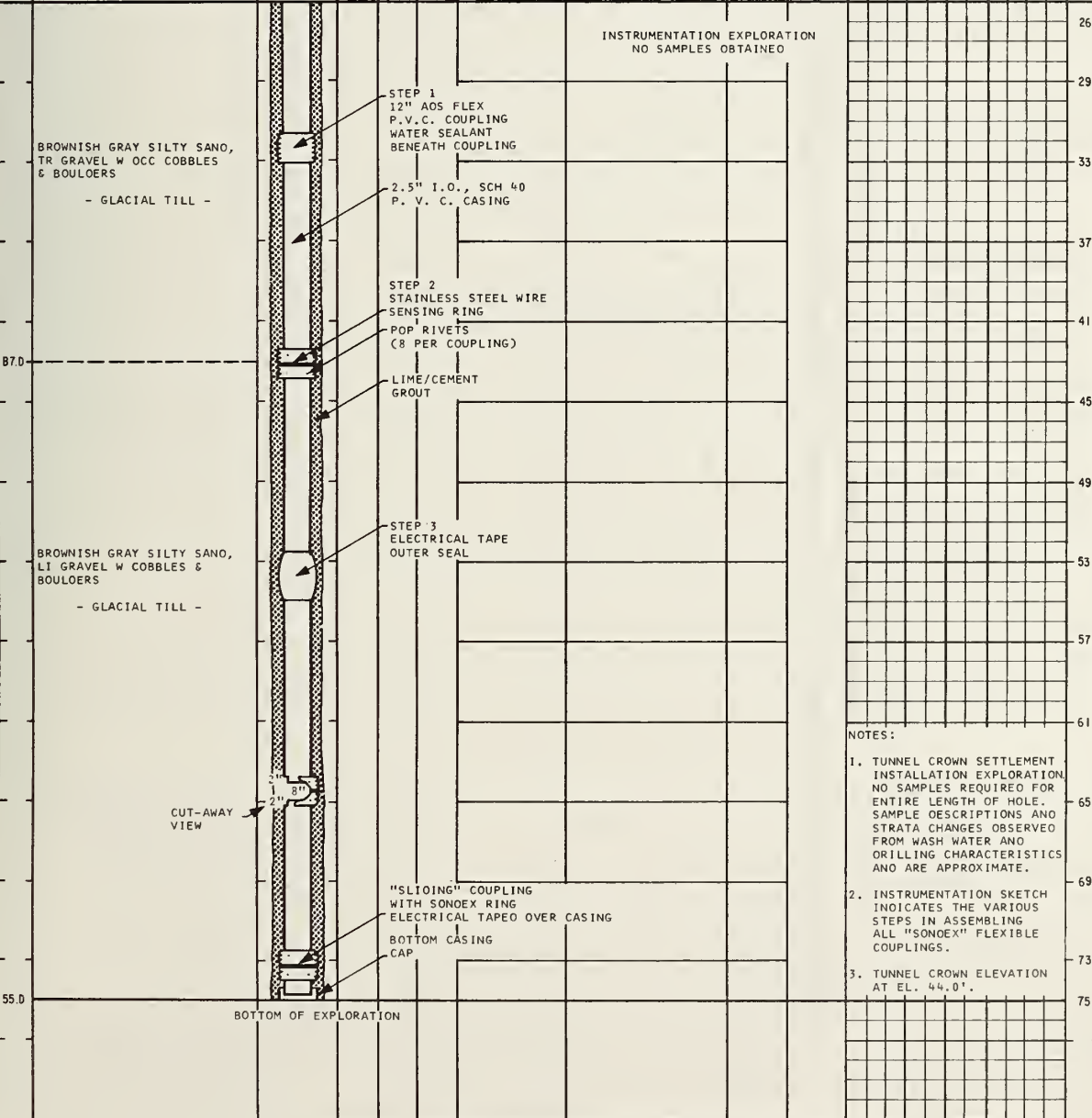

NOTES:

1. TUNNEL CROWN SETTLEMENT INSTALLATION EXPLORATION NO SAMPLES REQUIRED FOR ENTIRE LENGTH OF HOLE. SAMPLE DESCRIPTIONS AND STRATA CHANGES OBSERVED FROM WASH WATER AND DRILLING CHARACTERISTICS AND ARE APPROXIMATE.
2. INSTRUMENTATION SKETCH INDICATES THE VARIOUS STEPS IN ASSEMBLING ALL "SONDEX" FLEXIBLE COUPLINGS.
3. TUNNEL CROWN ELEVATION AT EL. 44.0'.

SUBSURFACE EXPLORATION SUMMARY

EXPLORATION NO. TSC 6

LOCATION HOLYOAK INN SITE, CAMBRIDGE, MA STATION 203 + 12.4 O.B. OFFSET 1.1' LT COMP. DATE 4-26-79
 HOLE SIZE (OVERBURDEN) 4" (ROCK) NONE GROUND SURFACE EL. 128.8' GROUNDWATER EL. 119.2'

CORE BARREL: TYPE NONE SIZE - DEPTH -
 TYPE NONF SIZE - DEPTH -
 PERMANENT INSTRUMENTATION CASING: TYPE MECHANICAL/ELECTRICAL SETTLEMENT BOREHOLE SEALING: GROUT TYPE LIME/CEMENT GROUNDWATER DETERMINATION INITIAL
 SIZE 2.5" I.O. SCH 40 P.V.C. DEPTH RANGE 3-70'
 DEPTH 70.0' DATE SEALED 4-26-79

ELEV (FEET)	DESCRIPTION	INSTRUMENT CASING INSTALLATION SKETCH	USCS CLASS & SYM	SAMP TYPE & NO.	TEST TYPE & NO.	RECOVERY AND ROD (PERCENT)	PENETRATION TEST (300 LB. WT./24" DROP) (BLOWS PER FOOT)	ROCK DISCONTINUITY SUMMARY						DEPTH (FEET)									
								AVG LENGTH CORE (INCHES)	GRAPHIC LOG	TYPE		CONO	FILLING										
										JOINT	SHEAR		MECH PLANNAR		IRREG	SMOOTH	ROUGH	BOUGE	CLAY	CALCITE	IRON		
						20 40 60 80 100	100 200 300 400	2	6	10													
21	GRAY SILTY CLAY																						
103.8																							
	BROWNISH GRAY SILTY SAND, LI GRAVEL W CLAY, COBBLES & BOULOERS - GLACIAL TILL -																						
97.8																							
58.8																							

NOTES:

- TUNNEL CROWN SETTLEMENT INSTALLATION EXPLORATION. NO SAMPLES REQUIRED FOR ENTIRE LENGTH OF HOLE. SAMPLE DESCRIPTIONS AND STRATA CHANGES OBSERVED FROM WASH WATER AND DRILLING CHARACTERISTICS AND ARE APPROXIMATE.
- INSTRUMENTATION CASING INACCESSIBLE AND IN-OPERATIVE FROM 36 TO 70 FEET BELOW GROUND SURFACE. GROUT ENTERED RUPTURED COUPLING AND SEALED INSIDE OF CASING.
- INSTRUMENTATION SKETCH INDICATES THE VARIOUS STEPS IN ASSEMBLING ALL "SONOEX" FLEXIBLE COUPLINGS.
- TUNNEL CROWN ELEVATION AT EL. 51.5'.

SUBSURFACE EXPLORATION SUMMARY EXPLORATION NO. TSC 7

LOCATION: HOLIDAY INN SITE, CAMBRIDGE MA. STATION: 205 + 62.5 D.B. OFFSET: 28.0 LT COMP. DATE: 5-22-79
 HOLE SIZE (OVERBURDEN): 5-5/8" (ROCK): 3" GROUND SURFACE EL.: 130.2' GROUNDWATER EL.: 118'

CORE BARREL: TYPE: NWD-3 SPLIT SIZE: 2-1/8" I.D. DEPTH: 74.9-84.0'
 TYPE: NWD-3 SIZE: 2-1/8" I.D. DEPTH: 84.0-115.0'

PERMANENT INSTRUMENTATION CASING: TYPE: INCLINOMETER/"SDNDEX" SETTLEMENT SIZE: 2.3" I.D. ABS/3.0" I.D. FLEX. ADS DEPTH: 114.0'/74.0'

BOREHOLE SEALING: GROUT TYPE: LIME/CEMENT DEPTH RANGE: 2.5-115' DATE SEALED: 5-22-79

GROUNDWATER DETERMINATION: INITIAL

ELEV (FEET)	DESCRIPTION	INSTRUMENT CASING INSTALLATION SKETCH	USCS CLASS & SYM.	SAMP TYPE & NO.	TEST TYPE & NO.	RECOVERY AND ROD (PERCENT)	PENETRATION TEST (300 LB. WT./24" DROP) (BLOWS PER FOOT)	AVG LENGTH CORE (INCHES)	GRAPHIC LOG	ROCK DISCONTINUITY SUMMARY							DEPTH (FEET)									
										JOINT	SHEAR	MECH	PLANAR	IRREG	SMOOTH	ROUGH		GOUGE	CLAY	CALCITE	IRON OXIDE					
										TYPE	GEOM	COND	FILLING													
		2.3" I.D. SCH 40 ABS PLASTIC INCLINOMETER CASING STAINLESS STEEL WIRE SENSING RING LIME/CEMENT GROUT 3.0" I.D. FLEX. UNSLDTED P.V.C. PLASTIC SETTLEMENT CASING								(AL) ATTERBERG LIMITS ND. LL% PL% PI% A3 16.8 14.7 2.1													61			
	GRAY SILTY SAND, LI GRAVEL W CBBLES & BULDERS - GLACIAL TILL -									(WP) WATER PRESSURE TEST WP1, K=2.7 X 10-6 CM/SEC. WP2, K=6.4 X 10-5 CM/SEC.														64		
59.0	GRAY V DENSE COARSE TO FINE SAND, LI SILT, TR GRAVEL			S1	G1																				72	
56.8	GRAY SANDY SILT, TR CLAY			S2A	G2																				74	
56.4	GRAY SILTY SAND, LI GRAVEL			S2B	G3																				76	
55.3	DECOMPOSED ARGILLITE			S3	A3																				76	
54.7	REDUCTION ADAPTER (SEE NOTE TSC 11)			S3	G4H4																				76	
	ALTERED ARGILLITE, GRAYISH GREEN, SL WEATHERED, HARD, BRECCIATED, REHEALED MACRO SHEARS W FRAC, JOINTS & DCC CLAY FILLING & SHEAR ZONES.			R1																					76	
				R2																					80	
46.7	DIABASE, GREEN, MDD WEATHERED, MED SDFT, FRAC & PITTED, W JDINTS & SHEAR ZONES			R3																					84	
42.2	DIABASE, SEV WEATHERED, FRAC W CLAY FILLINGS			R4																					88	
40.7	ALTERED ARGILLITE, SL WEATHERED, MED HARD, FRAC W CLAY FILLED JDINTS			R5																					92	
37.7	DIABASE, MED HARD, FRAC			R6																					96	
36.7	ALTERED ARGILLITE, GREEN SL WEATHERED, MED HARD, BRECCIATED			R7																					100	
33.0	DIABASE, FRAC W JDINTS			R8																					104	
32.6	ALTERED ARGILLITE, GREEN, SL WEATHERED, MED HARD, BRECCIATED W REHEALED MACRO SHEARS, JDINTS & FRAC			R9																					108	
27.9	DIABASE, FRAC W JDINTS																								112	
27.4																									115	
18.0	DIABASE FRAC W JDINTS																									
17.2	ALTERED ARGILLITE, GREEN, MED HARD, FRAC																									
15.2																										
BDDTDM OF EXPLORATION																										

BOREHOLE NUCLEAR LOGGING SUMMARY
EXPLORATION NO. TSC 7

LOCATION HOLIDAY INN SITE, CAMBRIDGE, MA STATION 205 + 62.5 O.B. OFFSET 28.0' LT DATE LOGGED 6-13-79

HOLE SIZE (OVERBURDEN) 5-5/8" (ROCK) 3" GROUND SURFACE EL 130.2' TOTAL DEPTH LOGGED 115.0'

DENSITY (GG-LOG) INCREASES →

WATER LEVEL ELEVATION FROM NUCLEAR LOG EL. 120.2±

POROSITY (NN-LOG) INCREASES ←

NUCLEAR LOG INTERPRETATION SUMMARIZED
ON GEOLOGICAL PROFILE SHEETS

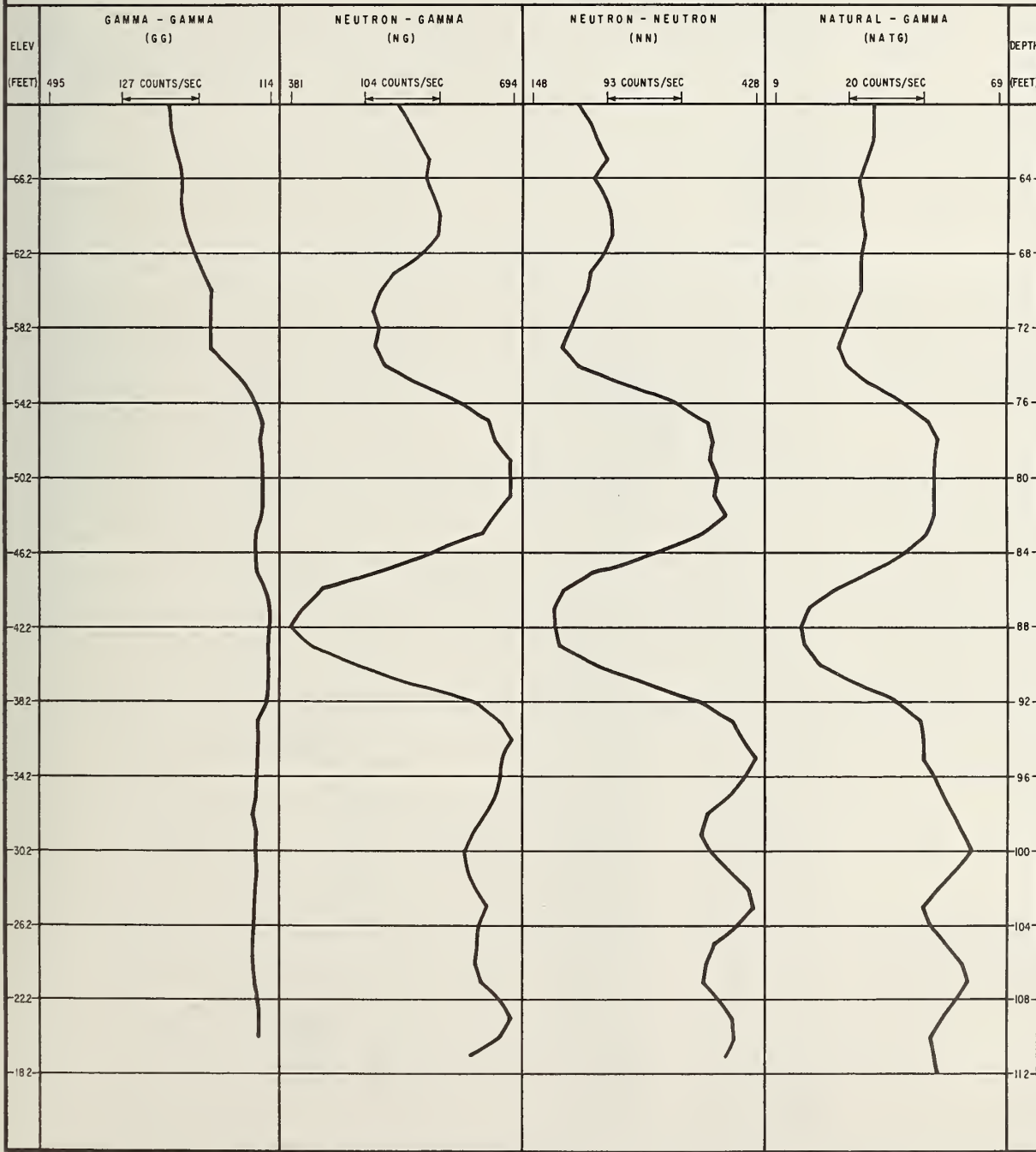

SUBSURFACE EXPLORATION SUMMARY EXPLORATION NO. TSC 8

LOCATION HOLIDAY INN SITE, CAMBRIDGE, MA STATION 205 + 65.0 O.B. OFFSET 10.0' RT. CDM.P. DATE 4-18-79
 HOLE SIZE (OVERBURDEN) 5-5/8" (ROCK) 3" GROUND SURFACE EL. 130.0' GROUNDWATER EL. 119.0'

CORE BARREL:
 TYPE NWD-3 SPLIT SIZE 2-1/8" I.D. DEPTH 71.5-72.9'
 TYPE NWD-3 SIZE 2-1/8" I.D. DEPTH 72.9-114.7'

PERMANENT INSTRUMENTATION CASING:
 TYPE INCLINOMETER/"SONDEX" SETTLEMENT
 SIZE 2.3" I.D. ABS/3.0" I.D. FLEX. ADS
 DEPTH 112.7'/70.5'

BOREHOLE SEALING:
 GROUT TYPE LIME/CEMENT
 DEPTH RANGE 3.0-114.7'
 DATE SEALED 4-18-79

GROUNDWATER DETERMINATION
 INITIAL

ELEV (FEET)	DESCRIPTION	INSTRUMENT CASING INSTALLATION SKETCH	USCS CLASS & SYM	SAMP TYPE & NO.	TEST TYPE & NO.	RECOVERY AND RDO (PERCENT) 20 40 60 80 100	PENETRATION TEST (300 LB WT./24" DROP) (BLDWS PER FOOT) 100 200 300 400	ROCK DISCONTINUITY SUMMARY										DEPTH (FEET)			
								AVG LENGTH CORE (INCHES) 2 6 10	GRAPHIC LOG	FILLING											
										JOINT	SHEAR	MECH	PLANAR	IRREG	SMOOTH	ROUGH	GOUGE		CLAY	CALCITE	IRON OXIDE
68.0	- GLACIAL TILL -																				61
66.0	GRAY SILTY CLAY																				64
	GRAY SILTY SAND W GRAVEL, CDBBLES & BOULGERS																				64
	- GLACIAL TILL -																				68
60.0	DECOMPOSED ARGILLITE																				68
58.6			SC	P1																	72
	ALTEREO ARGILLITE, LIGHT GREEN, SL WEATHERED, MED HARD, BRECCIATED, REHEALED MACRO SHEARS W FRAC & JOINTS, DCC CLAY FILLINGS, CALCITE VEINS & DIABASE STRINGERS			R1	FPI																72
				R2																	76
51.6	ALTERED ARGILLITE, LIGHT GREEN, FRESH, MED HARD, BRECCIATED, REHEALED MACRO SHEARS W FRAC & JOINTS, OCC CLAY FILLINGS, CALCITE VEINS & DIABASE STRINGERS			R3	WP3																80
				R4																	84
44.7	DIABASE, MED HARD, FRAC			R5																	88
43.8	ALTERED ARGILLITE, LIGHT GREEN, FRESH, HARD, RE- HEALED MACRO SHEARS W IRRE- GULAR DIABASE STRINGERS, WIDELY SPACED FRAC & CLAY FILLED JOINTS			R6																	88
				R7	WP4																92
-38.0	DIABASE, DARK GREEN, FRESH, HARD, HIGHLY FRAC W SECON- DARY MINERALIZATION			R8																	92
				R9																	96
-34.0				R10																	100
	ALTERED ARGILLITE, LIGHT GREEN, FRESH, HARD, BRECC- CIATED, REHEALED MACRO SHEARS W FRAC & JOINTS, DCC CLAY FILLINGS, CALCITE VEINS & DIABASE STRINGERS			R11																	104
				R12																	108
				R13																	112
				R14																	114.7
15.3																					114.7

NOTE:
 1. TSC8 DRILLED AT APPROXIMATELY
 1.5 DEGREES EAST INCLINATION.
 (FP) FALLING HEAD PERMEABILITY TEST
 FP1, $K=5.0 \times 10^{-5}$ CM/SEC.
 (WP) WATER PRESSURE TEST
 WP3, $K=5.2 \times 10^{-6}$ CM/SEC.
 WP4, $K=8.8 \times 10^{-6}$ CM/SEC.

TUNNEL
CROWN
ELEVATION

OUTBOUND TUNNEL LIMITS

INVERT
ELEVATION

LIME/CEMENT
GROUT

QUICK COUPLE
GROUT VALVE

BOTTOM OF EXPLORATION

BOREHOLE NUCLEAR LOGGING SUMMARY EXPLORATION NO. TSC 8

LOCATION HOLIDAY INN SITE, CAMBRIDGE, MA STATION 205 + 65.0 O.B. OFFSET 10.0' RT DATE LOGGED 6-14-79
 HOLE SIZE (OVERBURDEN) 5-5/8" (ROCK) 3" GROUND SURFACE EL. 130.0' TOTAL DEPTH LOGGED 115.0'

DENSITY (GG-LOG) INCREASES \longrightarrow WATER LEVEL ELEVATION FROM NUCLEAR LOG EL. 120±
 POROSITY (NN-LOG) INCREASES \longleftarrow NUCLEAR LOG INTERPRETATION SUMMARIZED
 ON GEOLOGICAL PROFILE SHEETS

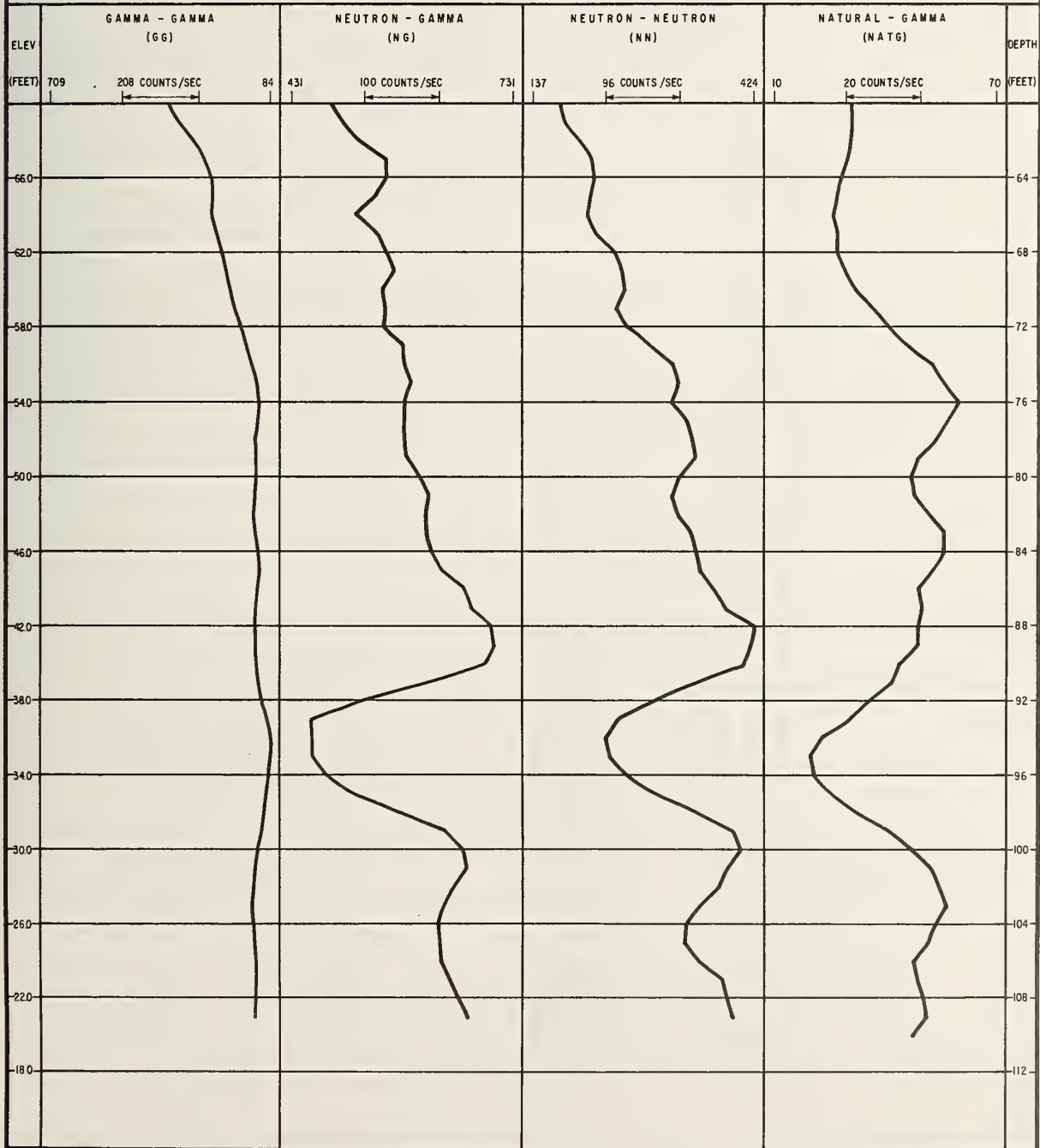

SUBSURFACE EXPLORATION SUMMARY

EXPLORATION NO. TSC 9

LOCATION HOLIQUAY INN SITE, CAMBRIDGE, MA STATION 204 + 63.0 O.B. OFFSET 75.5' LT COMP DATE 6-1-79
 HOLE SIZE (OVERBURDEN) 5-5/8" (ROCK) 3" GROUND SURFACE EL. 130.0' GROUNDWATER EL. 118.5'

CORE BARREL:
 TYPE NWM-3 SIZE 2-1/8" I.O. DEPTH 83.5-92.5'
 TYPE NWO-3 SIZE 2-1/8" I.O. DEPTH 92.5-106.0'

PERMANENT INSTRUMENTATION CASING:
 TYPE INCLINOMETER/"SONOEX" SETTLEMENT
 SIZE 2.3" I.O. ABS/3.0" I.O. FLEX. AOS
 DEPTH 105.0'/83.5'

BOREHOLE SEALING:
 GROUT TYPE LIME/CEMENT
 DEPTH RANGE 3-106'
 DATE SEALED 6-1-79

GROUNDWATER DETERMINATION
 INITIAL _____

ELEV (FEET)	DESCRIPTION	INSTRUMENT CASING INSTALLATION SKETCH	USCS CLASS & SYM.	SAMP TYPE & NO.	TEST TYPE & NO.	RECOVERY AND RQO (PERCENT) 20 40 60 80 100	PENETRATION TEST (300 LB. WT./24" DROP) (BLOWS PER FOOT)		AVG LENGTH CORE (INCHES) 2 6 10	GRAPHIC LOG	ROCK DISCONTINUITY SUMMARY											DEPTH (FEET)	
											JOINT	SHEAR	MECH	PLANAR	IRREG	SMOOTH	ROUGH	GOUGE	CLAY	CALCITE	IRON OXIDE		
56.0	BROWNISH GRAY SILTY SAND, LI GRAVEL W CLAY, COBBLES & BOULDERS - GLACIAL TILL -																					56	
59																							59
63																							63
67																							67
71	BROWNISH GRAY, V OENSE GRAVELLY COARSE TO FINE SAND, LI SILT W COBBLES & BOULDERS - GLACIAL TILL -			SM	S1	G5 H5																	71
75	BOULDER			SM-GM	S2	G6																	75
79	BROWNISH GRAY, V OENSE GRAVELLY COARSE TO FINE SAND, LI SILT, TR CLAY W COBBLES & BOULDERS - GLACIAL TILL -			SM-GM	S3	G7 H7																	79
83	GRAY CLAYEY GRAVEL - DECOMPOSED ARGILLITE -			SM-GM	S4*	G8																	83
87	ALTERED ARGILLITE, GRAYISH GREEN, SL WEATHERED, MED HARD, BRECCIATED, REVEALED MACRO SHEARS W FRAC, JOINTS & SHEARS			SM-GM	S5*	G9 H9																	87
91	DIABASE, HIGHLY FRAC ALTERED ARGILLITE, GRAYISH GREEN, MOO WEATHERED, MED SOFT, FRAC, BRECCIATED W CLAY FILLED JOINTS			GC	S6	G10 H10																	91
95	DIABASE, GREEN SL WEATHERED HARD, FRAC W REVEALED MACRO SHEARS, QUARTZ & EPIOTITE VEINS		R1																			95	
99			R2																			99	
103			R3																			103	
106			R4																			106	
			R5																				

* INDICATES 3-INCH SPLIT-SPOON SAMPLE

BOREHOLE NUCLEAR LOGGING SUMMARY

EXPLORATION NO. TSC 9

LOCATION HOLIDAY INN SITE, CAMBRIDGE, MA STATION 204 + 63.0 O.B. OFFSET 75.5' LT DATE LOGGED 6-13-79

HOLE SIZE (OVERBURDEN) 5-5/8" (ROCK) 3" GROUND SURFACE EL. 130.0' TOTAL DEPTH LOGGED 108.0'

DENSITY (GG-LOG) INCREASES →
 POROSITY (NN-LOG) INCREASES ←

WATER LEVEL ELEVATION FROM NUCLEAR LOG EL. 119±
 NUCLEAR LOG INTERPRETATION SUMMARIZED
 ON GEOLOGICAL PROFILE SHEETS

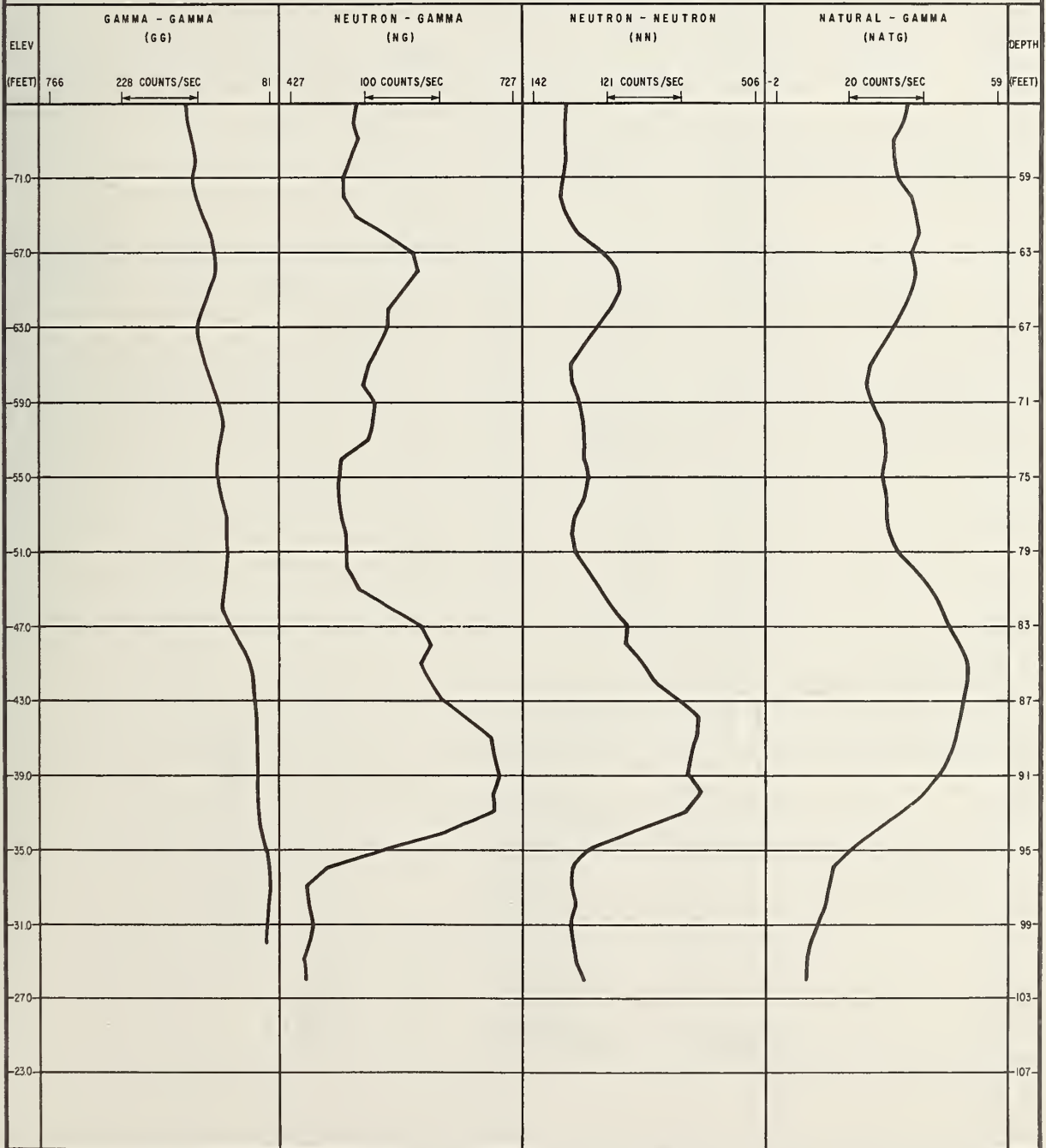

SUBSURFACE EXPLORATION SUMMARY
EXPLORATION NO. TSC 10

LOCATION HOLIOAY INN SITE, CAMBRIDGE, MA STATION 204 + 59.0 O.B. OFFSET 11.5' RT COMP. DATE 4-18-79
HOLE SIZE (OVERBURDEN) 5-5/8" (ROCK) 3" GROUND SURFACE EL. 130.0' GROUNDWATER EL. 117.4'

CORE BARREL:
TYPE NWO-3 SPLIT SIZE 2-1/8" I.O. DEPTH 86.0-89.5'
TYPE NWO-3 SPLIT SIZE 2-1/8" I.O. DEPTH 90.5-110.0'

PERMANENT INSTRUMENTATION CASING:
TYPE INCLINOMETER/"SONDEX" SETTLEMENT
SIZE 2.3" I.O. ABS/3.0" I.O. FLEX. AOS
DEPTH 109.0'/89.0'

BOREHOLE SEALING:
GROUT TYPE LIME/CEMENT
DEPTH RANGE 3-110'
DATE SEALED 4-18-79

GROUNDWATER DETERMINATION INITIAL

ELEV (FEET)	DESCRIPTION	INSTRUMENT CASING INSTALLATION SKETCH	USCS CLASS & SYM	SAMP TYPE & NO	TEST TYPE & NO	RECOVERY ANO RQO (PERCENT)	PENETRATION TEST (300 LB. WT./24" DROP) (BLOWS PER FOOT)	AVG LENGTH CORE (INCHES)	ROCK DISCONTINUITY SUMMARY							DEPTH (FEET)	
									GRAPHIC LOG	TYPE	GEOM	CONO	FILLING	JOINT	SHEAR		MECH
61	BROWNISH GRAY, V OENSE SILTY MED TO FINE SAND, TR GRAVEL & CLAY W COBBLES & BOULDOERS		SM	D1	G11 HI1				NOTE: 1. TSC10 DRILLED AT APPROXIMATELY 1.0 DEGREE EAST INCLINATION.							61	
64	- GLACIAL TILL -								(LP) PITCHER TUBE SAMPLE								
68	LIME/CEMENT GROUT STAINLESS STEEL WIRE SENSING RING GREASE BONO BREAKER BETWEEN CASINGS			SM	S1	G12 HI2				WATER CONTENT % TOTAL UNIT WEIGHT (LB/FT ³) NO. LP1 19.3 137.1 LP2 11.3							68
72	GRAY V OENSE, SILTY MED TO FINE SAND			SM	S2	G13 HI3				(AL) ATTERBERG LIMITS NO. LL% PL% PI% A21 32.0 18.1 13.9							72
76	GRAY V OENSE, SILTY SAND, LI GRAVEL			SM	S3	G14 HI4				(LP) LABORATORY PERMEABILITY TEST SEE APPENOX - I							76
80	GRAY V OENSE, FINE SANDY SILT			SM	S4	G15 HI5				(FP) FALLING HEAD PERMEABILITY TEST FP2, K = 2.0 X 10 ⁻⁵ CM./SEC.							80
84	GRAY GRAVELLY SAND, TR SILT			ML	PT1	G16 HI6											84
88	GRAY GRAVELLY SAND, TR SILT			SW-SM	S5	G17 HI7											88
92	GRAY V OENSE, SILTY COARSE TO FINE SAND, TR GRAVEL & CLAY W OCC COBBLE & BOULDER - GLACIAL TILL -			SM	S6	G18 HI8											92
96	GRAY V OENSE, SILTY COARSE TO FINE SAND, TR GRAVEL & CLAY W OCC COBBLE & BOULDER - GLACIAL TILL -			SM	S7	G19 HI9											96
100	GRAY GRAVELLY SILT, SME SAND, LI CLAY - DECOMPOSED DIABASE -			GM	R1	G20 H20											100
104	DIABASE, DARK GREEN, SEV WEATHERED, MED SOFT, FRAC & SME FITTING W CLAY FILLED JOINTS			GM-ML	S8	G21 H21 A21											104
108	DIABASE DARK GREEN, FRESH, MED HARD W REHEALED MACRO SHEARS, QUARTZ & EPIPOTITE VEINS, FRAC ZONES W CLAY FILLED JOINTS			R2	FP2												108
110	QUICK COUPLE GROUT VALVE			R3													110
				R4													
				R5													
				R6													

BOREHOLE NUCLEAR LOGGING SUMMARY EXPLORATION NO. TSC 10

LOCATION HOLIDAY INN SITE, CAMBRIDGE, MA STATION 204 + 59.0 O.B. OFFSET 11.5' RT DATE LOGGED 6-14-79
 HOLE SIZE (OVERBURDEN) 5-5/8" (ROCK) 3" GROUND SURFACE EL. 130.0' TOTAL DEPTH LOGGED 110.0'

DENSITY (GG-LOG) INCREASES \longrightarrow
 POROSITY (MN-LOG) INCREASES \longleftarrow

WATER LEVEL ELEVATION FROM NUCLEAR LOG EL. 121±
 NUCLEAR LOG INTERPRETATION SUMMARIZED
 ON GEOLOGICAL PROFILE SHEETS

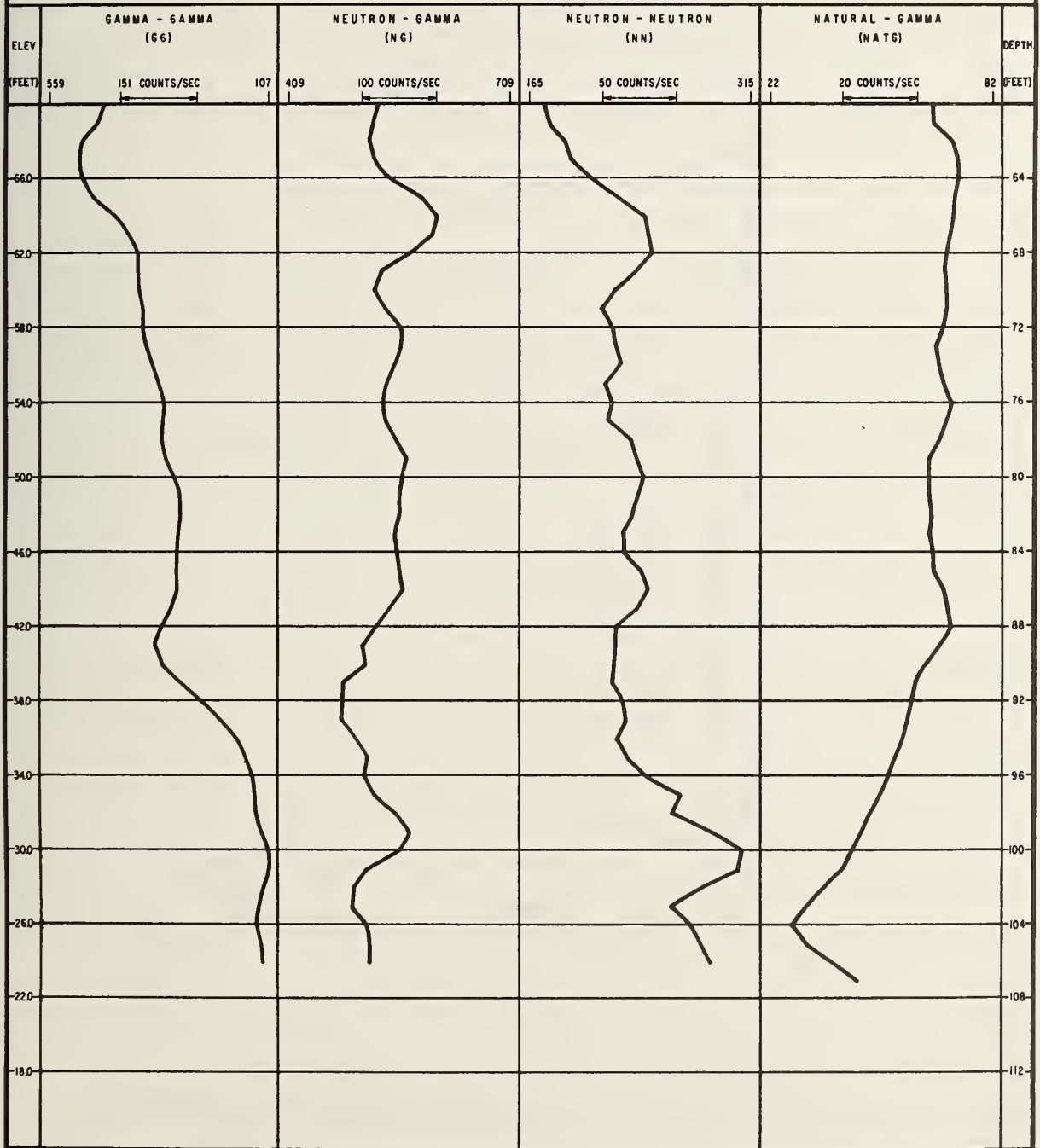

SUBSURFACE EXPLORATION SUMMARY EXPLORATION NO. TSC 11

LOCATION HOLIDAY INN SITE, CAMBRIDGE, MA STATION 203 + 10.5 O.B. OFFSET 76.5' LT CDMF DATE 5-31-79
HOLE SIZE (OVERBURDEN) 5-5/8" (ROCK) 3" GROUND SURFACE EL. 129.3' GROUNDWATER EL. 118.5'

CORE BARREL: TYPE NWO-3 SPLIT SIZE 2-1/8" I.D. DEPTH 99.0-103.5'
PERMANENT INSTRUMENTATION CASING: TYPE INCLINOMETER/"SONDEX" SETTLEMENT
SIZE 2.3" I.D. ABS/3.0" I.D. FLEX. ADS DEPTH 103.0'/99.0'
BOREHOLE SEALING: GROUT TYPE LIME/CEMENT DEPTH RANGE 3-103.5' DATE SEALED 5-31-79
GROUNDWATER DETERMINATION INITIAL

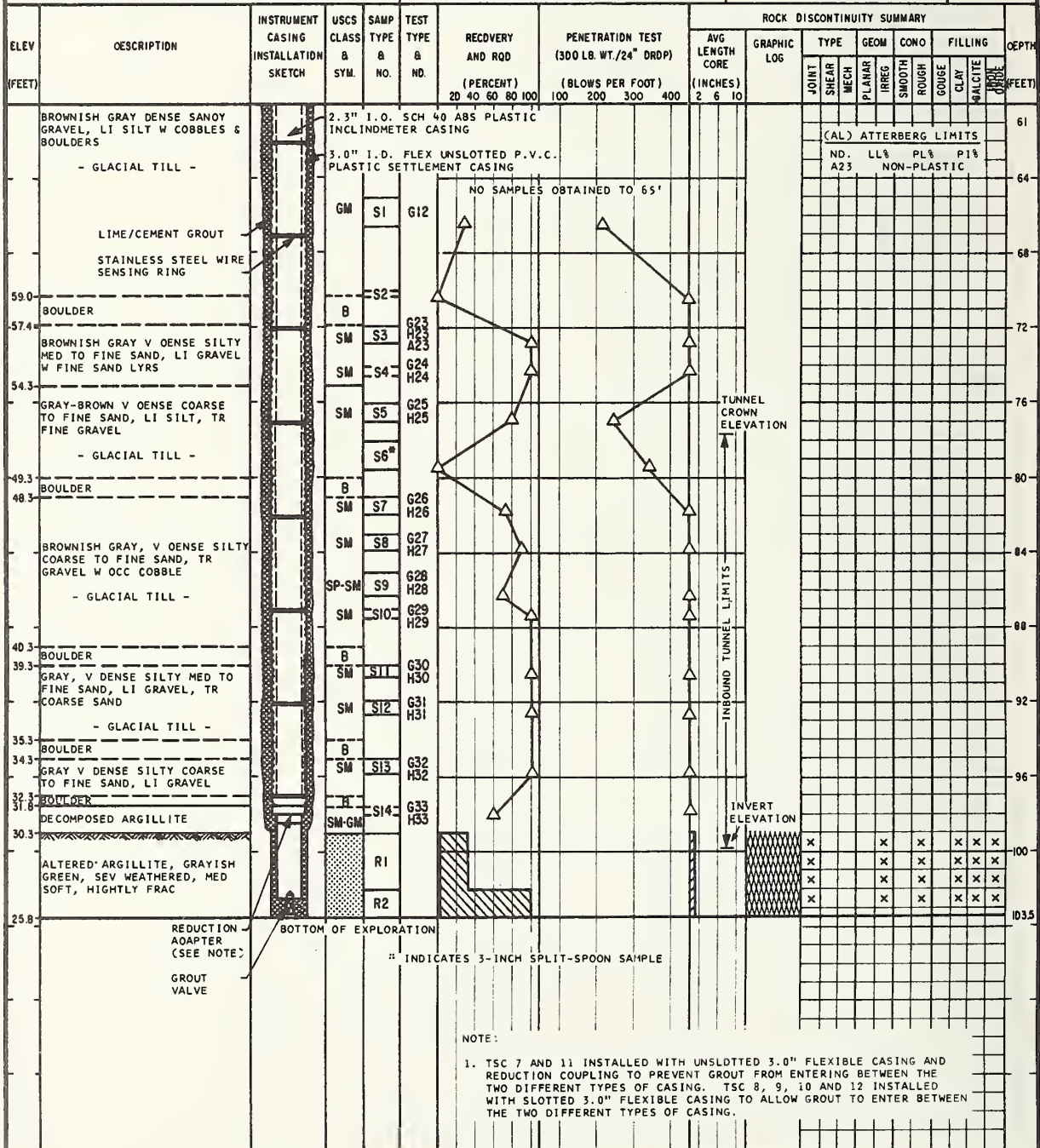

NOTE:
1. TSC 7 AND 11 INSTALLED WITH UNSLOTTED 3.0" FLEXIBLE CASING AND REDUCTION COUPLING TO PREVENT GROUT FROM ENTERING BETWEEN THE TWO DIFFERENT TYPES OF CASING. TSC 8, 9, 10 AND 12 INSTALLED WITH SLOTTED 3.0" FLEXIBLE CASING TO ALLOW GROUT TO ENTER BETWEEN THE TWO DIFFERENT TYPES OF CASING.

BOREHOLE NUCLEAR LOGGING SUMMARY

EXPLORATION NO. TSC 11

LOCATION HOLIDAY INN SITE, CAMBRIDGE, MA STATION 203 + 10.5 O.B. OFFSET 76.5' LT DATE LOGGED 6-13-79
 HOLE SIZE (OVERBURDEN) 5-5/8" (ROCK) 3" GROUND SURFACE EL. 129.3' TOTAL DEPTH LOGGED 102.0'

DENSITY (GG-LOG) INCREASES →
 POROSITY (NN-LOG) INCREASES ←

WATER LEVEL ELEVATION FROM NUCLEAR LOG EL. 119.3±
 NUCLEAR LOG INTERPRETATION SUMMARIZED
 ON GEOLOGICAL PROFILE SHEETS

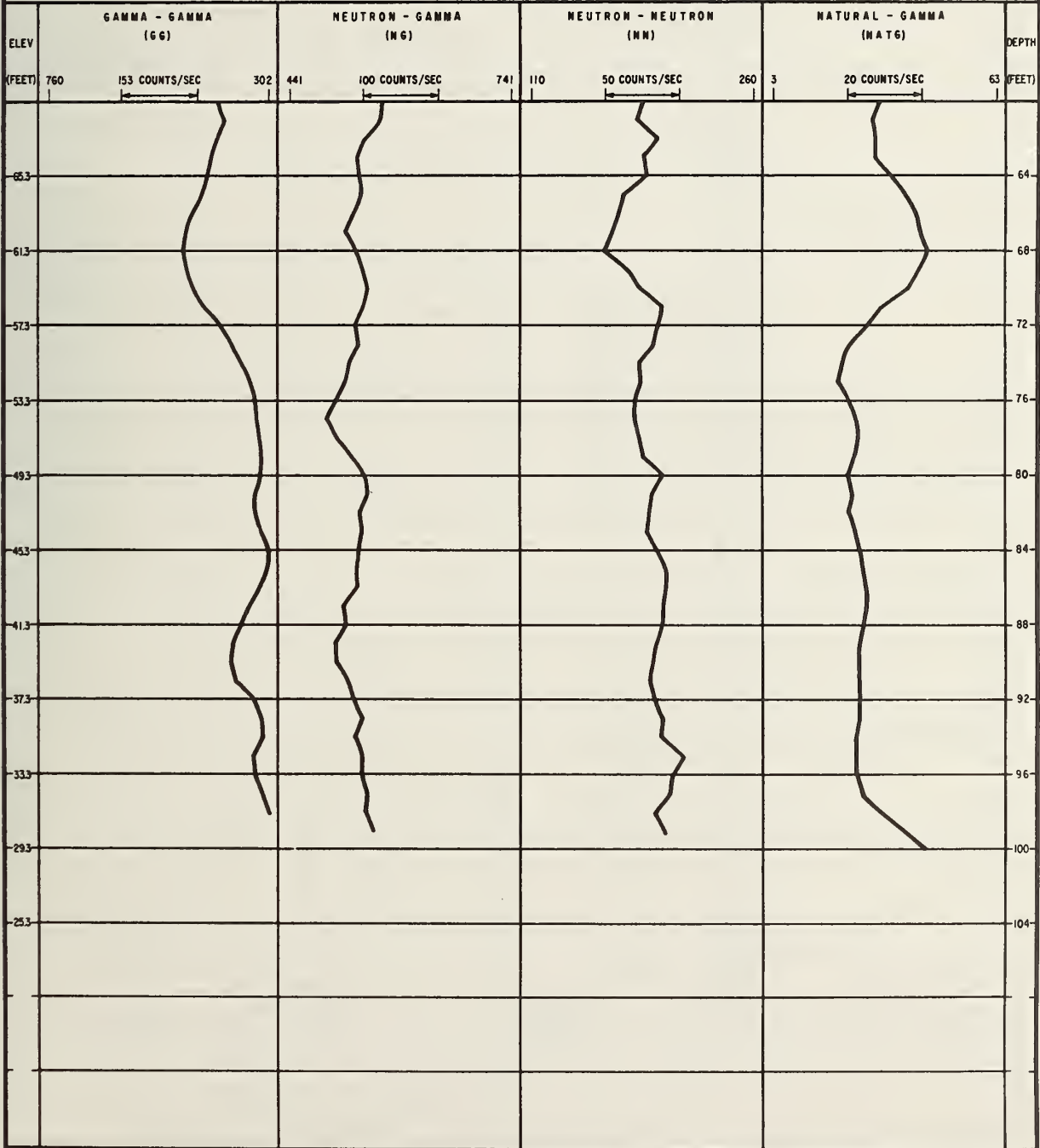

SUBSURFACE EXPLORATION SUMMARY

EXPLORATION NO. TSC 12

LOCATION: HOLIDAY INN SITE, CAMBRIDGE, MA STATION: 203 + 12.0 D.B. OFFSET: 10.5' RT COMP. DATE: 4-6-79

HOLE SIZE (OVERBUREN): 5-5/8" (ROCK): 3" GROUND SURFACE EL.: 129.4' GROUNDWATER EL.: 119.4'

CORE BARREL: TYPE: <u>NWD-3</u> SIZE: <u>2-1/8" I.D.</u> DEPTH: <u>98.3-101.0'</u> TYPE: <u>NDNE</u> SIZE: <u>-</u> DEPTH: <u>-</u>	PERMANENT INSTRUMENTATION CASING: TYPE: <u>INCLINOMETER/"SONDEX"</u> SETTLEMENT SIZE: <u>2.3" I.D. ABS/3.0" I.D. FLEX ADS</u> DEPTH: <u>94.5'/94.0'</u>	BOREHOLE SEALING: GROUT TYPE: <u>LIME/CEMENT</u> DEPTH RANGE: <u>3-101'</u> DATE SEALED: <u>4-6-79</u>	GROUNDWATER DETERMINATION INITIAL:
--	---	--	--

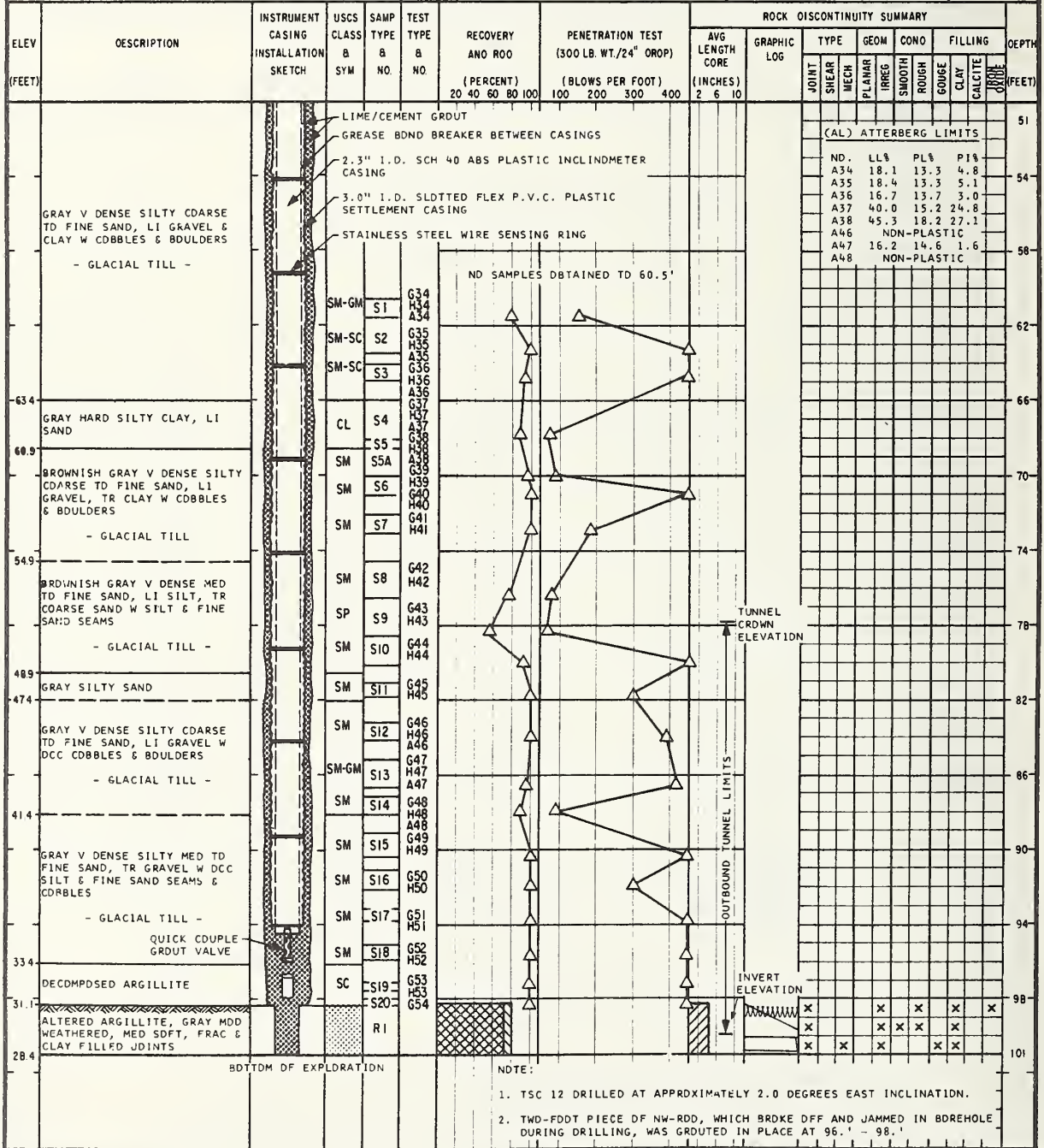

BOREHOLE NUCLEAR LOGGING SUMMARY EXPLORATION NO. TSC 12

LOCATION HOLIOAY INN SITE, CAMBRIDGE, MA STATION 203 + 12.0 O.B. OFFSET 10.5' RT DATE LOGGED 6-14-79
 HOLE SIZE (OVERBURDEN) 5-5/8" (ROCK) 3" GROUND SURFACE EL. 129.4' TOTAL DEPTH LOGGED 93.0'

DENSITY (GG-LOG) INCREASES →
 POROSITY (NN-LOG) INCREASES ←

WATER LEVEL ELEVATION FROM NUCLEAR LOG EL. 118.4±
 NUCLEAR LOG INTERPRETATION SUMMARIZED
 ON GEOLOGICAL PROFILE SHEETS

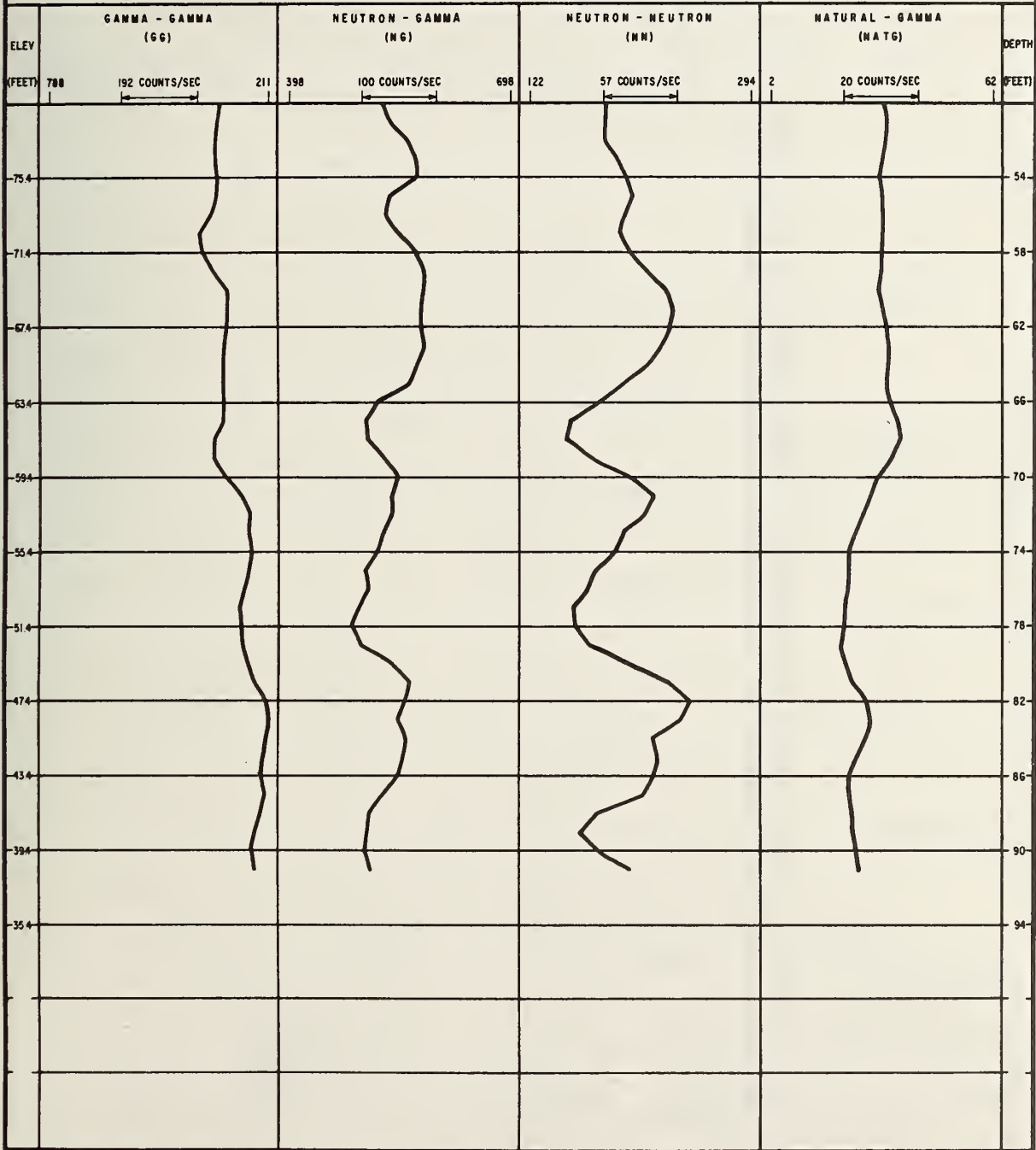

SUBSURFACE EXPLORATION SUMMARY EXPLORATION NO. TSC 13

LOCATION HOLIDAY INN SITE, CAMBRIDGE, MA STATION 203 + 11.0 O.B. OFFSET 31.0' LT COMP. DATE 5-7-79
 HOLE SIZE (OVERBURDEN) 5-5/8" (ROCK) 5-5/8" GROUND SURFACE EL. 130.7' GROUNDWATER EL. 116.7'

CORE BARREL: TYPE <u>NWO-3 SPLIT</u> SIZE <u>2-1/8" I.D.</u> DEPTH <u>99.0-104.0'</u> TYPE <u>NDNE</u> SIZE <u>-</u> DEPTH <u>-</u>	PERMANENT INSTRUMENTATION CASING: TYPE <u>TELESCOPING INCLINOMETER SETTLEMENT</u> SIZE <u>2.5" I.O. EXTRUDED P.V.C.</u> DEPTH <u>102.7'</u>	BOREHOLE SEALING: GROUT TYPE <u>LIME/CEMENT</u> DEPTH RANGE <u>2.5-104'</u> DATE SEALED <u>5-7-79</u>	GROUNDWATER DETERMINATION INITIAL
---	--	--	--------------------------------------

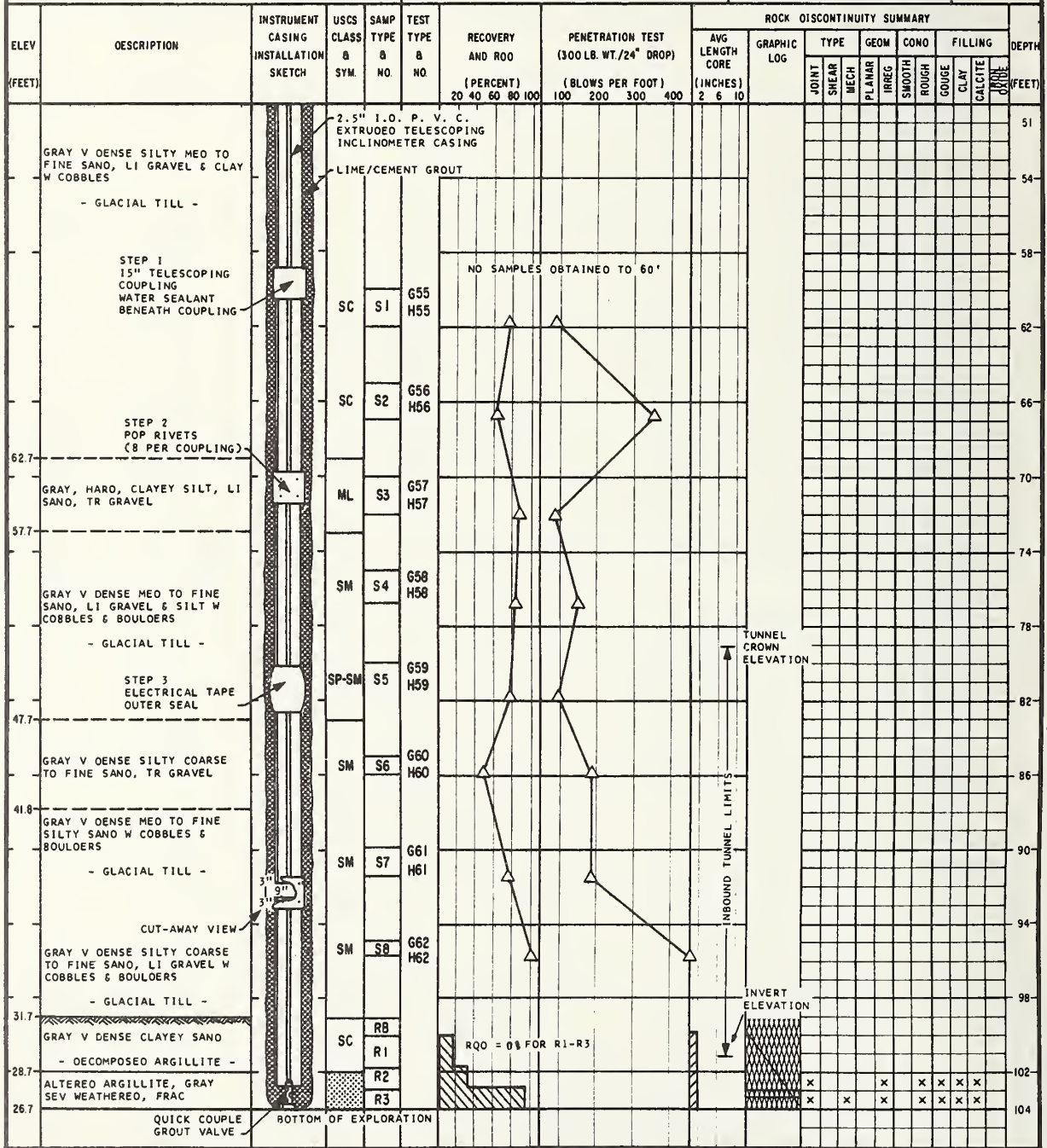

BOREHOLE NUCLEAR LOGGING SUMMARY EXPLORATION NO. TSC 13

LOCATION HOLIDAY INN SITE, CAMBRIDGE, MA STATION 203 + 11.0 O.B. OFFSET 31.0' LT DATE LOGGED 6-12-79
 HOLE SIZE (OVERBURDEN) 5-5/8" (ROCK) 5-5/8" GROUND SURFACE EL. 130.7' TOTAL DEPTH LOGGED 103.0'

DENSITY (GG-LOG) INCREASES \longrightarrow WATER LEVEL ELEVATION FROM NUCLEAR LOG EL. 118.7±
 POROSITY (NN-LOG) INCREASES \longleftarrow NUCLEAR LOG INTERPRETATION SUMMARIZED
 ON GEOLOGICAL PROFILE SHEETS

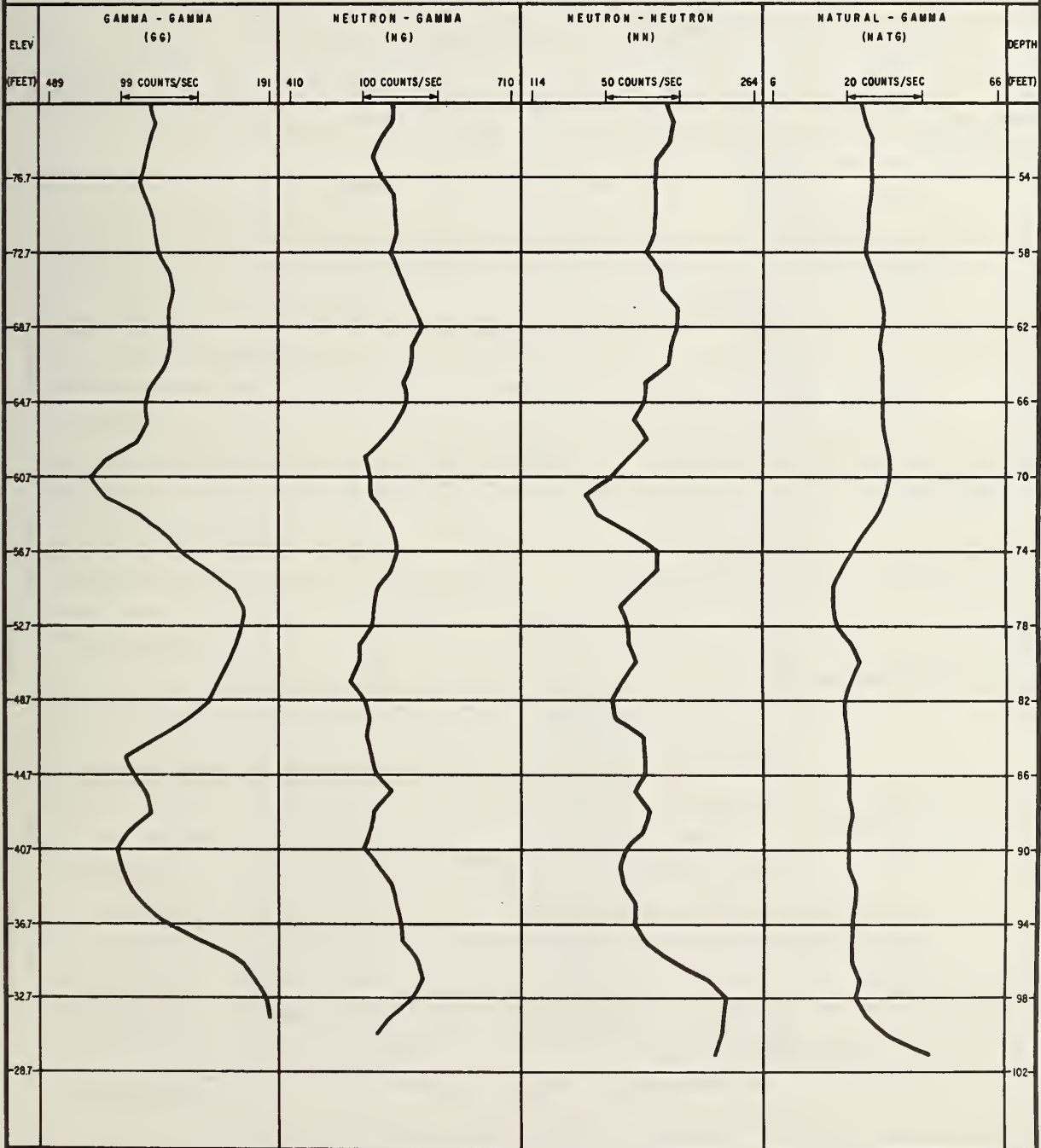

SUBSURFACE EXPLORATION SUMMARY
EXPLORATION NO. TSC 14

LOCATION HOLIDAY INN SITE, CAMBRIDGE, MA STATION 204 + 64.5 D.B. OFFSET 33.0' LT COMP. DATE 5-18-79
HOLE SIZE (OVERBURDEN) 5-5/8" (ROCK) 3" GROUND SURFACE EL. 131.0' GROUNDWATER EL. 118.0'

CORE BARREL: TYPE NWD-3 SPLIT SIZE 2-1/8" I.D. DEPTH 90.2-94.2'
PERMANENT INSTRUMENTATION CASING: TYPE INCLINOMETER/"SONOEX" SETTLEMENT
SIZE 2.3" I.D. ABS/3.0" I.O. FLEX ADS DEPTH 110.0'
BOREHOLE SEALING: GROUT TYPE LIME/CEMENT
DEPTH RANGE 3.0-110' DATE SEALED 5-18-79 INITIAL

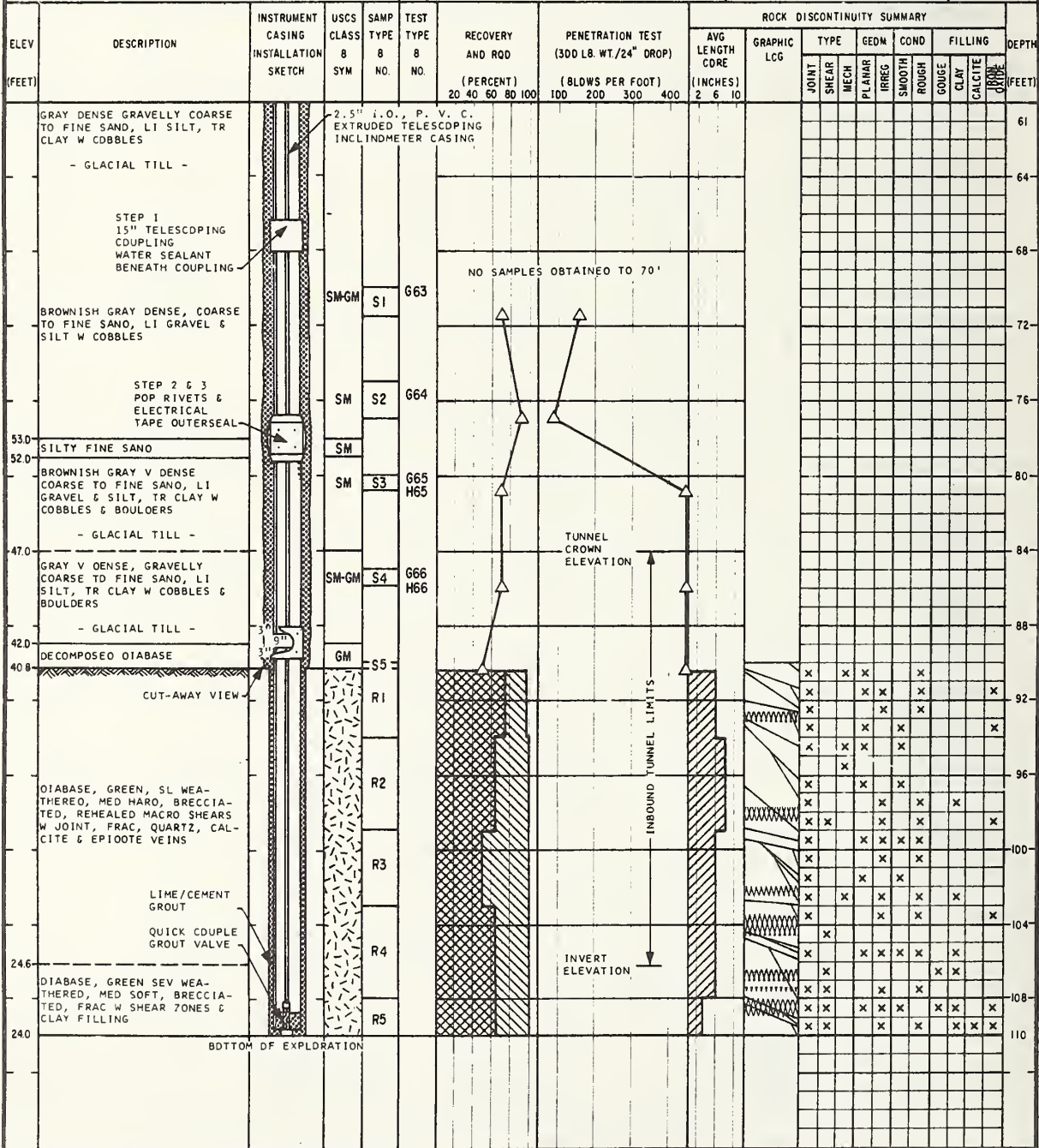

BOREHOLE NUCLEAR LOGGING SUMMARY EXPLORATION NO. TSC 14

LOCATION HOLIDAY INN SITE, CAMBRIDGE, MA STATION 204 + 64.5 O.B. OFFSET 33.0' LT DATE LOGGED 6-12-79
 HOLE SIZE (OVERBURDEN) 5-5/8" (ROCK) 3" GROUND SURFACE EL. 131.0' TOTAL DEPTH LOGGED 109.0'

DENSITY (GG-LOG) INCREASES \longrightarrow
 POROSITY (NN-LOG) INCREASES \longleftarrow

WATER LEVEL ELEVATION FROM NUCLEAR LOG EL. 121±
 NUCLEAR LOG INTERPRETATION SUMMARIZED
 ON GEOLOGICAL PROFILE SHEETS

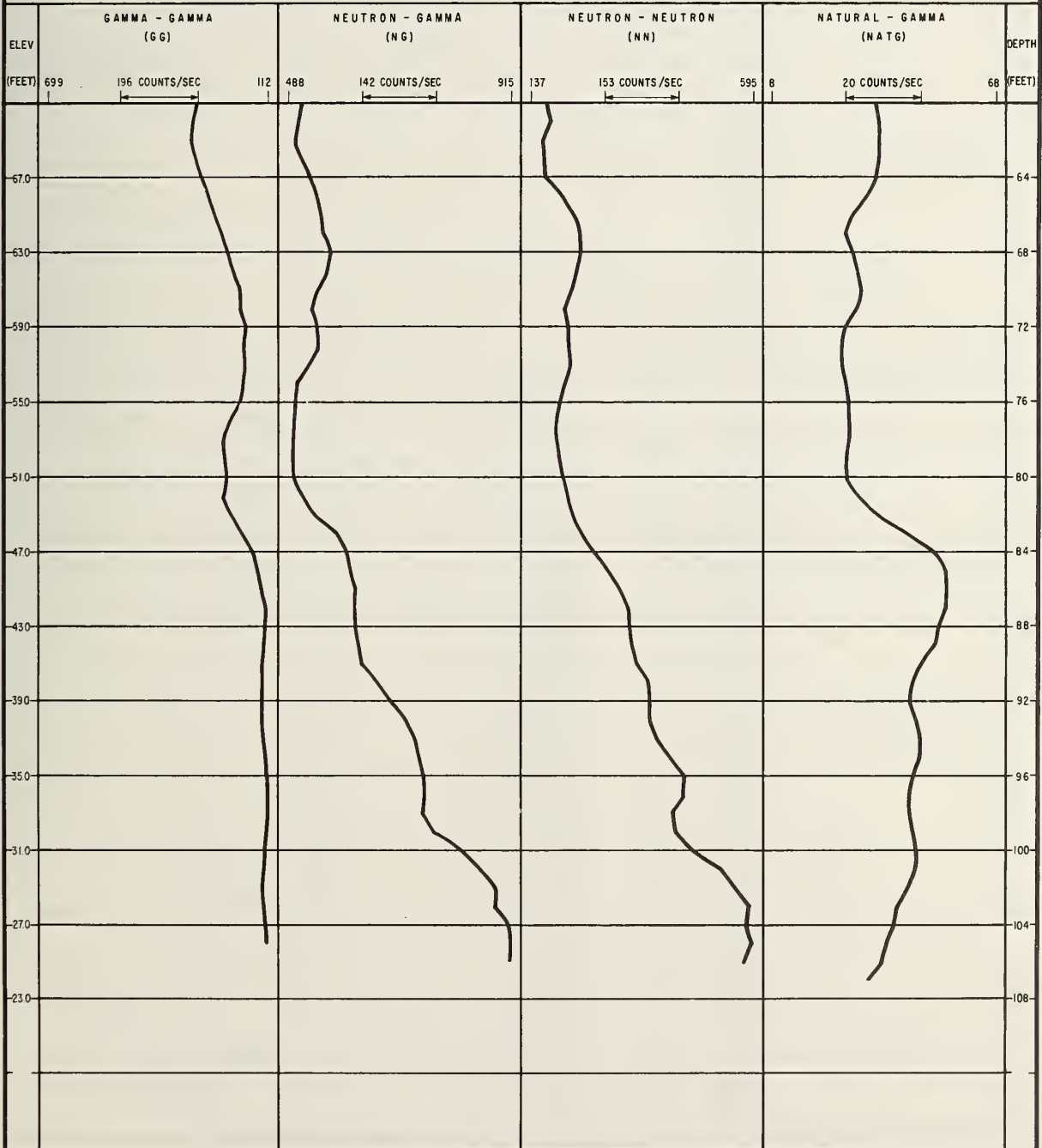

SUBSURFACE EXPLORATION SUMMARY EXPLORATION NO. TSC 15

LOCATION HOLIDAY INN SITE, CAMBRIDGE, MA STATION 205 + 58.5 O.B. OFFSET 34.0' LT CDMP DATE 5-14-79
 HOLE SIZE (OVERBURDEN) 5-5/8" (ROCK) 3" GROUND SURFACE EL. 131.3' GROUNDWATER EL. 119.3'

CORE BARREL:
 TYPE NWD-3 SPLIT SIZE 2-1/8" I.D. DEPTH 75.0-115.0'
 TYPE NONE SIZE - DEPTH -

PERMANENT INSTRUMENTATION CASING:
 TYPE INCLINOMETER/"SONOEX" SETTLEMENT
 SIZE 2.3" I.D. ABS/3.0" I.D. FLEX AOS
 DEPTH 102.0'

BOREHOLE SEALING:
 GROUT TYPE LIME/CEMENT
 DEPTH RANGE 3.0-115.0'
 DATE SEALED 5-14-79

GROUNDWATER DETERMINATION
 INITIAL

ELEV (FEET)	DESCRIPTION	INSTRUMENT CASING INSTALLATION SKETCH	USCS CLASS a SYM	SAMP TYPE a NO.	TEST TYPE b NO.	RECOVERY AND ROD				PENETRATION TEST (300 LB. WT./24" DROP)				AVG LENGTH CORE		GRAPHIC LOG	ROCK DISCONTINUITY SUMMARY							DEPTH (FEET)	
						(PERCENT)				(BLOWS PER FOOT)				(INCHES)			JOINT	TYPE	GEOM	COND	FILLING				
						20	40	60	80	100	200	300	400	2	6		10	SHEAR	MECH	PLANAR	IRREG	SMOOTH	ROUGH		GOUGE
61	BROWNISH GRAY V DENSE SILTY COARSE TO FINE SAND, TR COARSE TO FINE GRAVEL W COBBLES & BOULDERS																							61	
64	- GLACIAL TILL -																								64
68	STEP 1 15" TELESCOPING COUPLING WATER SEALANT BENEATH COUPLING		SM	SI	G67 H67																				68
72	BOULDER		B																					72	
57.3	ALTERED ARGILLITE		SC	R8																				76	
56.3	ALTERED ARGILLITE, GREENISH GRAY, MOO WEATHERED, MOO SOFT, BRECCIA TED & JDINTS		R1																					76	
54.9	DIABASE, GREEN, MOO WEA- THERED, MOO HARO, BRECCIA- TED, REHEALED MACRO SHEARS, FRAC, JOINTS & CLAY SEAMS		R2																					80	
48.9	ALTERED ARGILLITE, GREENISH GRAY, MOO WEATHERED, MOO SOFT, BRECCIA TED, REHEALED MACRO SHEARS, JOINTS, FRAC W CLAY FILLING		R3																					84	
43.3	CUT-AWAY VIEW		R4																					88	
29.3	ALTERED ARGILLITE, LIGHT GREENISH GRAY, SL WEATHERED MOO HARO, BRECCIA TED, RE- HEALED MACRO SHEARS W LOCAL OPEN & CLAY FILLED JOINTS & FRAC ZONES, MINOR TUFF & DIABASE INCLUSIONS		R5																					92	
	LIME/CEMENT GROUT		R6																					96	
	QUICK COUPLE GROUT VALVE		R7																					100	
	ARGILLACEOUS SANDSTONE, LIGHT GRAY, SEV WEATHERED, MOO SOFT, SEV FRAC & PITTED		R8																					104	
	DIABASE, GREEN SL WEATHERED MOO HARO, FRAC W DPEN & CLAY FILLED JOINTS & FRAC		R9																					108	
			R10																					112	
16.3																								115	

BOREHOLE NUCLEAR LOGGING SUMMARY EXPLORATION NO. TSC 15

LOCATION HOLIDAY INN SITE, CAMBRIDGE, MA STATION 205 + 58.5 O.B. OFFSET 34.0' LT DATE LOGGED 6-12-79
 HOLE SIZE (OVERBURDEN) 5-5/8" (ROCK) 3" GROUND SURFACE EL. 131.3' TOTAL DEPTH LOGGED 116.0'

DENSITY (GG-LOG) INCREASES \longrightarrow
 POROSITY (NN-LOG) INCREASES \longleftarrow

WATER LEVEL ELEVATION FROM NUCLEAR LOG EL. 120.3±
 NUCLEAR LOG INTERPRETATION SUMMARIZED
 ON GEOLOGICAL PROFILE SHEETS

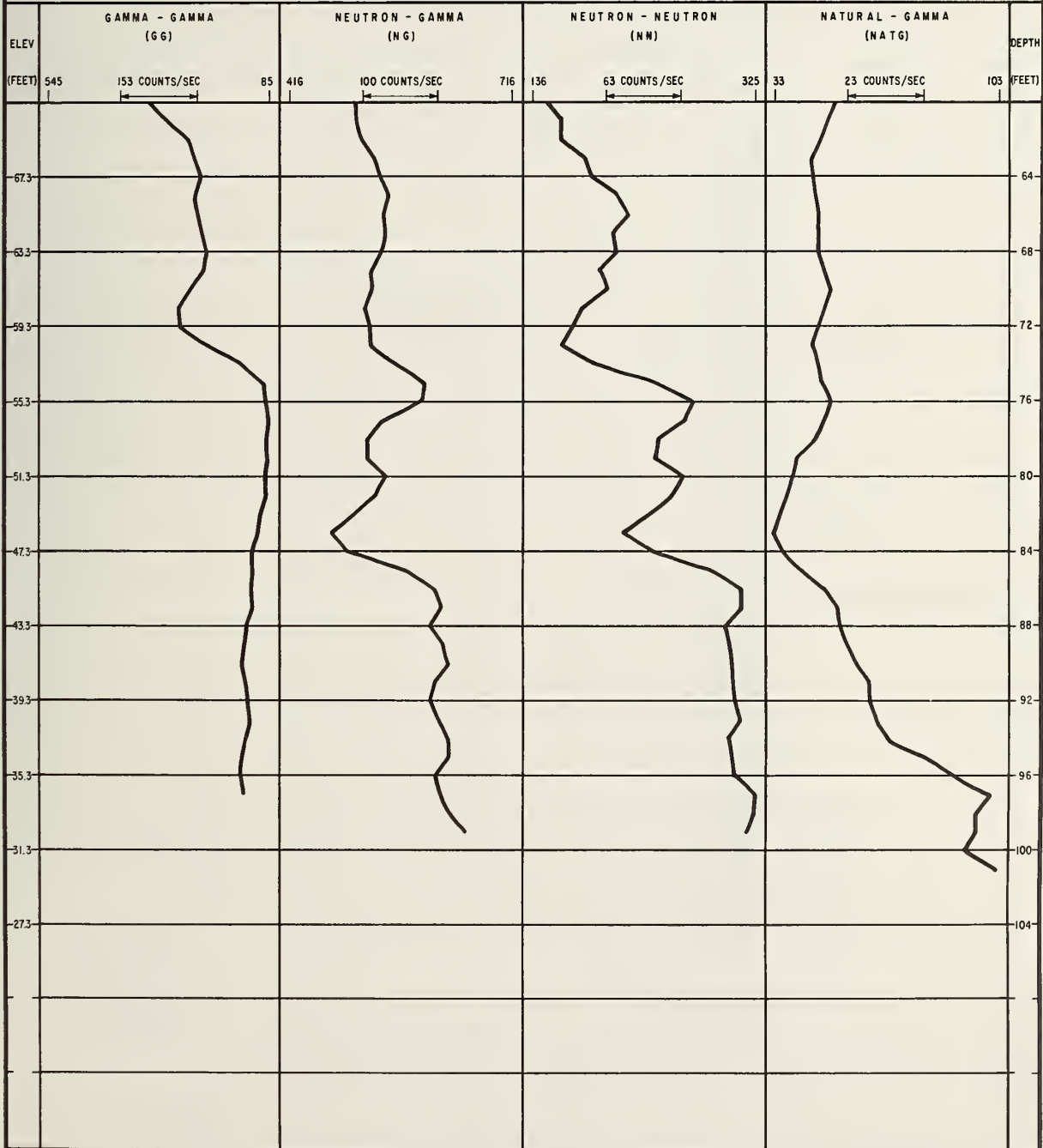

SUBSURFACE EXPLORATION SUMMARY EXPLORATION NO. TSC 16

LOCATION HOLIOAY INN SITE, CAMBRIDGE, MA STATION 205 + 11.0 O.B. OFFSET 24.5' LT COMP. DATE 5-24-79
 HOLE SIZE (OVERBURDEN) 5-5/8" (ROCK) 5-5/8" GROUND SURFACE EL. 130.1' GROUNDWATER EL. 118.4'

CORE BARREL:
 TYPE NONE SIZE - DEPTH -
 TYPE NONE SIZE - DEPTH -

PERMANENT INSTRUMENTATION CASING:
 TYPE GEOPHYSICAL/GROUNDWATER
 SIZE 2.5" I.O. SCH 40 P.V.C.
 DEPTH 100.0'

BOREHOLE SEALING:
 GROUT TYPE CEMENT
 DEPTH RANGE 3-96'
 DATE SEALED 5-28-79

GROUNDWATER DETERMINATION:
 OBS. WELL 10 - 20'
 PIEZOMETER 96-105'

ELEV (FEET)	DESCRIPTION	INSTRUMENT CASING INSTALLATION SKETCH	USCS CLASS & SYM	SAMP TYPE & NO.	TEST TYPE & NO.	RECOVERY AND RQO (PERCENT) 20 40 60 80 100	PENETRATION TEST (300 LB. WT./24" DROP) (BLOWS PER FOOT) 100 200 300 400	ROCK DISCONTINUITY SUMMARY						DEPTH (FEET)								
								AVG LENGTH CORE (INCHES) 2 6 10	GRAPHIC LOG	TYPE		CONO			FILLING							
										JOINT	SHEAR	MECH	PLANAR		IRREG	SMOOTH	ROUGH	GOUGE	CLAY	CALCITE	OTHER	
72.1	GRAY SILTY SAND, LI GRAVEL W COBBLES & BOULDOERS - GLACIAL TILL -		B																		56	
69.7	BOULOER																				59	
																					63	
	GRAY SILTY SAND, LI GRAVEL W COBBLES & BOULDOERS - GLACIAL TILL -																				67	
																					71	
																					75	
	2.5" I.O. SCH 40 P. V. C. FLUSH JOINT CASING																				79	
	FLUSH JOINT COUPLING																				83	
49.8	BEOROCK (DIABASE)																				87	
																					91	
		95																				
		99																				
		103																				
		105																				
25.1	BOTTOM OF EXPLORATION																					

NOTE:
 1. GEOPHYSICAL SURVEY AND INSTRUMENTATION INSTALLATION. NO SAMPLES REQUIRED FOR ENTIRE LENGTH OF HOLE. SAMPLE DESCRIPTIONS AND STRATA CHANGES OBSERVED FROM WASH WATER AND DRILLING CHARACTERISTICS AND ARE APPROXIMATE.

BOREHOLE NUCLEAR LOGGING SUMMARY EXPLORATION NO. TSC 16

LOCATION HOLIDAY INN SITE, CAMBRIDGE, MA STATION 205 + 11.0 O.B. OFFSET 24.5' LT DATE LOGGED 6-13-79
 HOLE SIZE (OVERBURDEN) 5-5/8" (ROCK) 5-5/8" GROUND SURFACE EL. 130.1' TOTAL DEPTH LOGGED 104.0'

DENSITY (GG-LOG) INCREASES →
 POROSITY (NN-LOG) INCREASES ←

WATER LEVEL ELEVATION FROM NUCLEAR LOG EL. 120.1±
 NUCLEAR LOG INTERPRETATION SUMMARIZED
 ON GEOLOGICAL PROFILE SHEETS

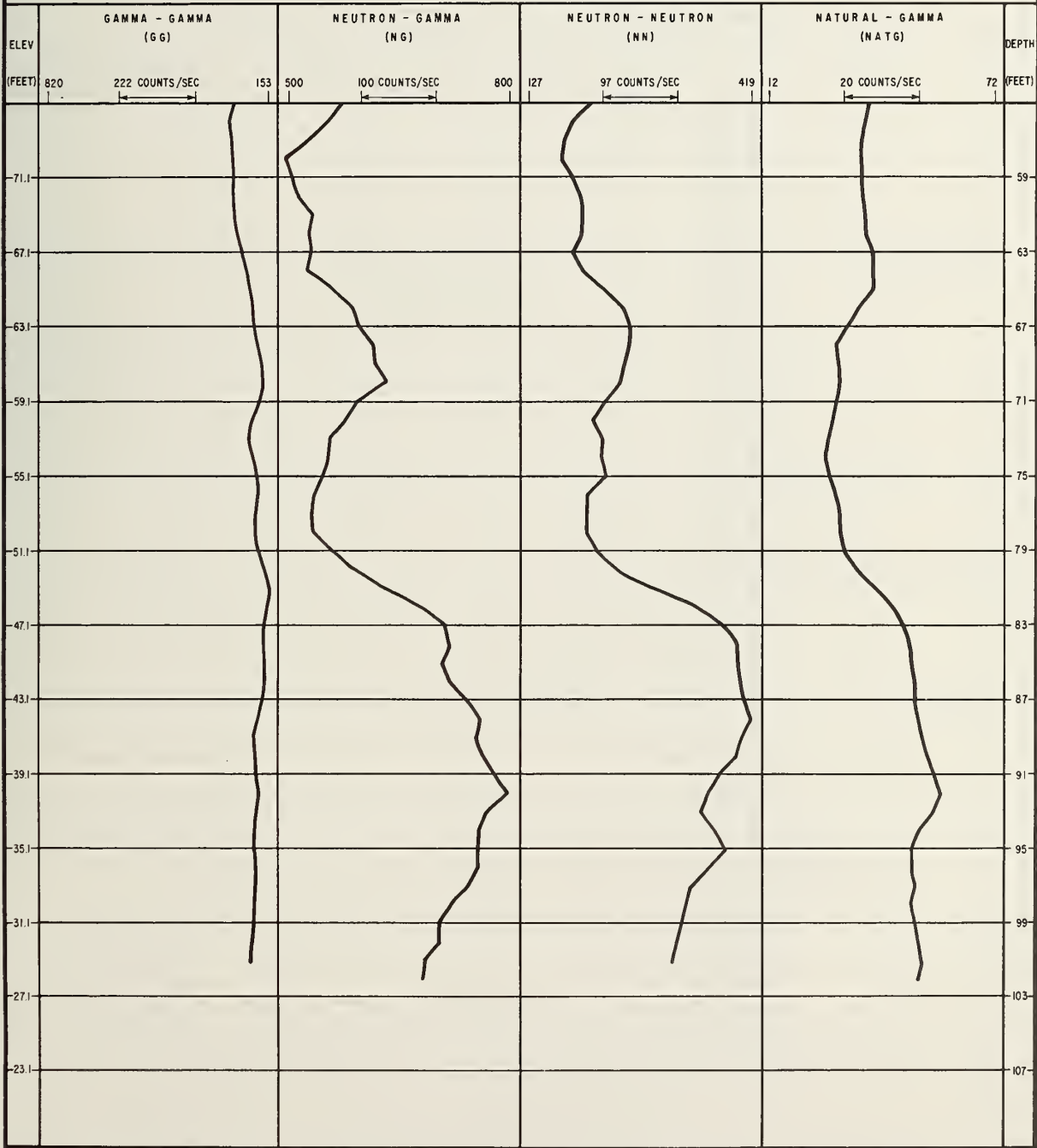

BOREHOLE NUCLEAR LOGGING SUMMARY EXPLORATION NO. TSC 17

LOCATION HOLIDAY INN SITE, CAMBRIDGE, MA STATION 205 + 11.5 O.B. OFFSET 52.5' DATE LOGGED 6-12-79
 HOLE SIZE (OVERBURDEN) 5-5/8" (ROCK) 3-3/4" GROUND SURFACE EL. 131.1' TOTAL DEPTH LOGGED 108.0'

DENSITY (GG-LOG) INCREASES →
 POROSITY (NN-LOG) INCREASES ←

WATER LEVEL ELEVATION FROM NUCLEAR LOG EL. 119.1±
 NUCLEAR LOG INTERPRETATION SUMMARIZED
 ON GEOLOGICAL PROFILE SHEETS

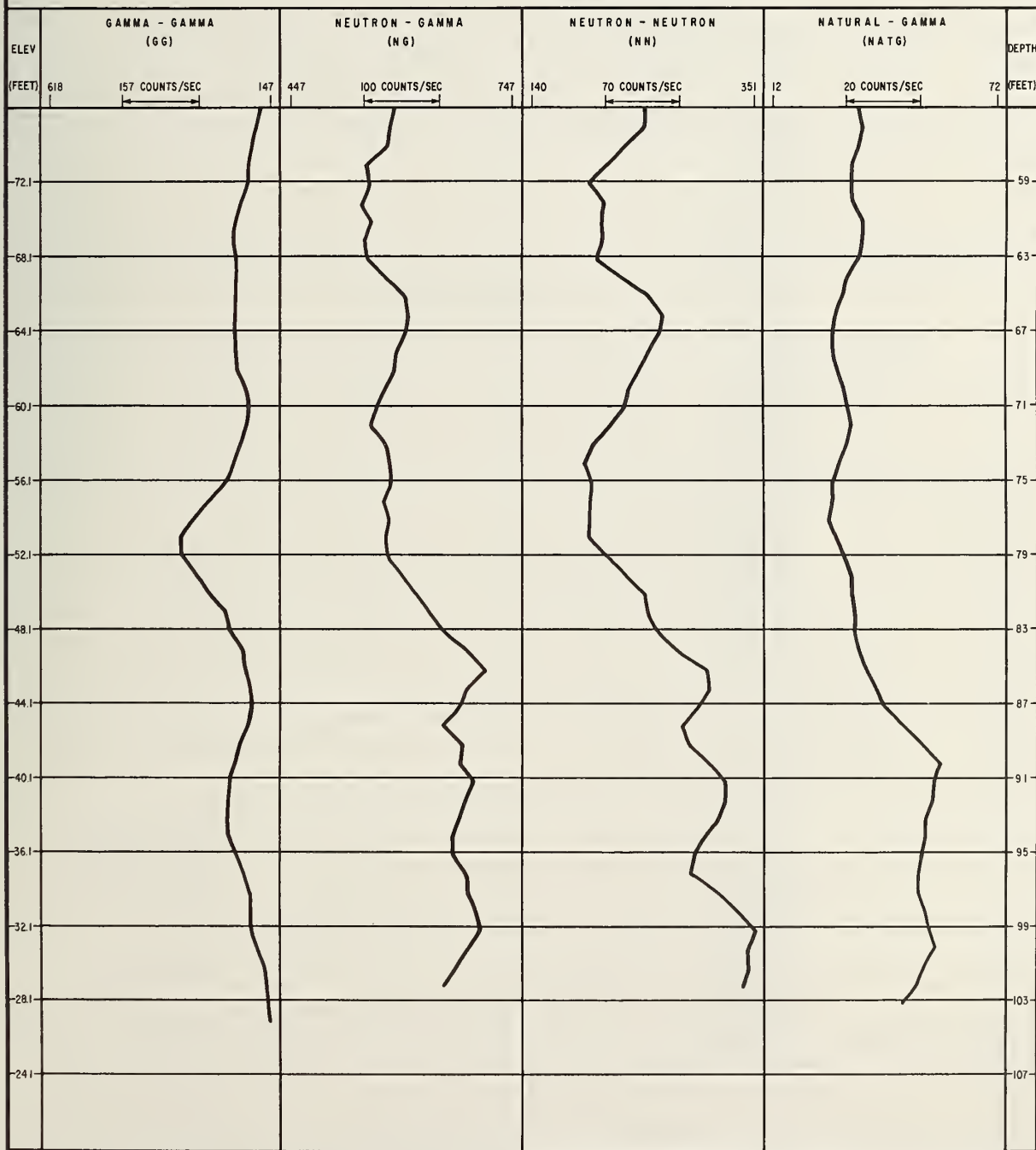

SUBSURFACE EXPLORATION SUMMARY

EXPLORATION NO. TSC 18

LOCATION HOLIDAY INN SITE, CAMBRIDGE, MA STATION 205 + 13.0 O.B. OFFSET 10.5' RT COMP. DATE 4-27-79

HOLE SIZE (OVERBURDEN) 4" (ROCK) 4" GROUND SURFACE EL. 130.1' GROUNDWATER EL. 118.2'

CORE BARREL: TYPE <u>NONE</u> SIZE <u>-</u> DEPTH <u>-</u> TYPE <u>NONE</u> SIZE <u>-</u> DEPTH <u>-</u>	PERMANENT INSTRUMENTATION CASING: TYPE <u>GEOPHYSICAL/GROUNDWATER</u> SIZE <u>2.5" I.O. SCH 40 P.V.C.</u> DEPTH <u>81.5'</u>	BOREHOLE SEALING: GROUT TYPE <u>CEMENT</u> DEPTH RANGE <u>5-90', 99-110'</u> DATE SEALED <u>6-22-79</u>	GROUNDWATER DETERMINATION: PIEZOMETER <u>93' TO 99'</u>
---	--	---	---

ELEV (FEET)	DESCRIPTION	INSTRUMENT CASING INSTALLATION SKETCH	USCS CLASS & SYM.	SAMP TYPE & NO.	TEST TYPE & NO.	RECOVERY		PENETRATION TEST (300 LB. WT./24" DROP)				AVG LENGTH CORE		ROCK DISCONTINUITY SUMMARY GRAPHIC LOG	DEPTH (FEET)
						(PERCENT)		(BLOWS PER FOOT)				(INCHES)			
						20	40	60	80	100	2	6	10		
61															
64															
68															
72															
76															
80															
84															
88															
92															
96															
100															
104															
108															
110															

FLUSH JOINT
COUPLING

GRAY SILTY SAND, LI GRAVEL
W CLAY, COBBLES & BOULDERS
(SAND SEAM AT 75 FT.)
- GLACIAL TILL -

2.5" I.O. SCH 40
P.V.C. FLUSH
JOINT CASING

SLOTS FOR
GROUTING
PURPOSES

51.1

BEOROCK
(OTABASE)

CEMENT
GROUT

3/4-INCH
RISER PIPE

BENTONITE
BALL SEAL

1.0" I. O.
PIEZOMETER

QUARTZ SILICA
SAND FILTER

CEMENT
GROUT

20.1

BOTTOM OF EXPLORATION

GEOPHYSICAL SURVEY
AND INSTRUMENTATION INSTALLATION
NO SAMPLES OBTAINED

TUNNEL
CROWN
ELEVATION

OUTBOUND TUNNEL LIMITS

INVERT
ELEVATION

NOTES:

- GEOPHYSICAL SURVEY AND INSTRUMENTATION INSTALLATION. NO SAMPLES REQUIRED FOR ENTIRE LENGTH OF HOLE. SAMPLE DESCRIPTIONS AND STRATA CHANGES OBSERVED FROM WASH WATER AND DRILLING CHARACTERISTICS AND ARE APPROXIMATE.
- BEOROCK CAVED AT 81.5 FEET. UNABLE TO ADVANCE INSTRUMENTATION CASING TO BOTTOM OF HOLE.
- TSC 18 DRILLED AT APPROXIMATELY ONE DEGREE EAST INCLINATION.

BOREHOLE NUCLEAR LOGGING SUMMARY EXPLORATION NO. TSC 18

LOCATION HOLIDAY INN SITE, CAMBRIDGE, MA STATION 205 + 13.0 O.B. OFFSET 10.5' RT DATE LOGGED 6-14-79
 HOLE SIZE (OVERBURDEN) 4" (ROCK) 4" GROUND SURFACE EL. 130.1' TOTAL DEPTH LOGGED 81.0'

DENSITY (GG-LOG) INCREASES →
 POROSITY (NN-LOG) INCREASES ←

WATER LEVEL ELEVATION FROM NUCLEAR LOG EL. 119.1±
 NUCLEAR LOG INTERPRETATION SUMMARIZED
 ON GEOLOGICAL PROFILE SHEETS

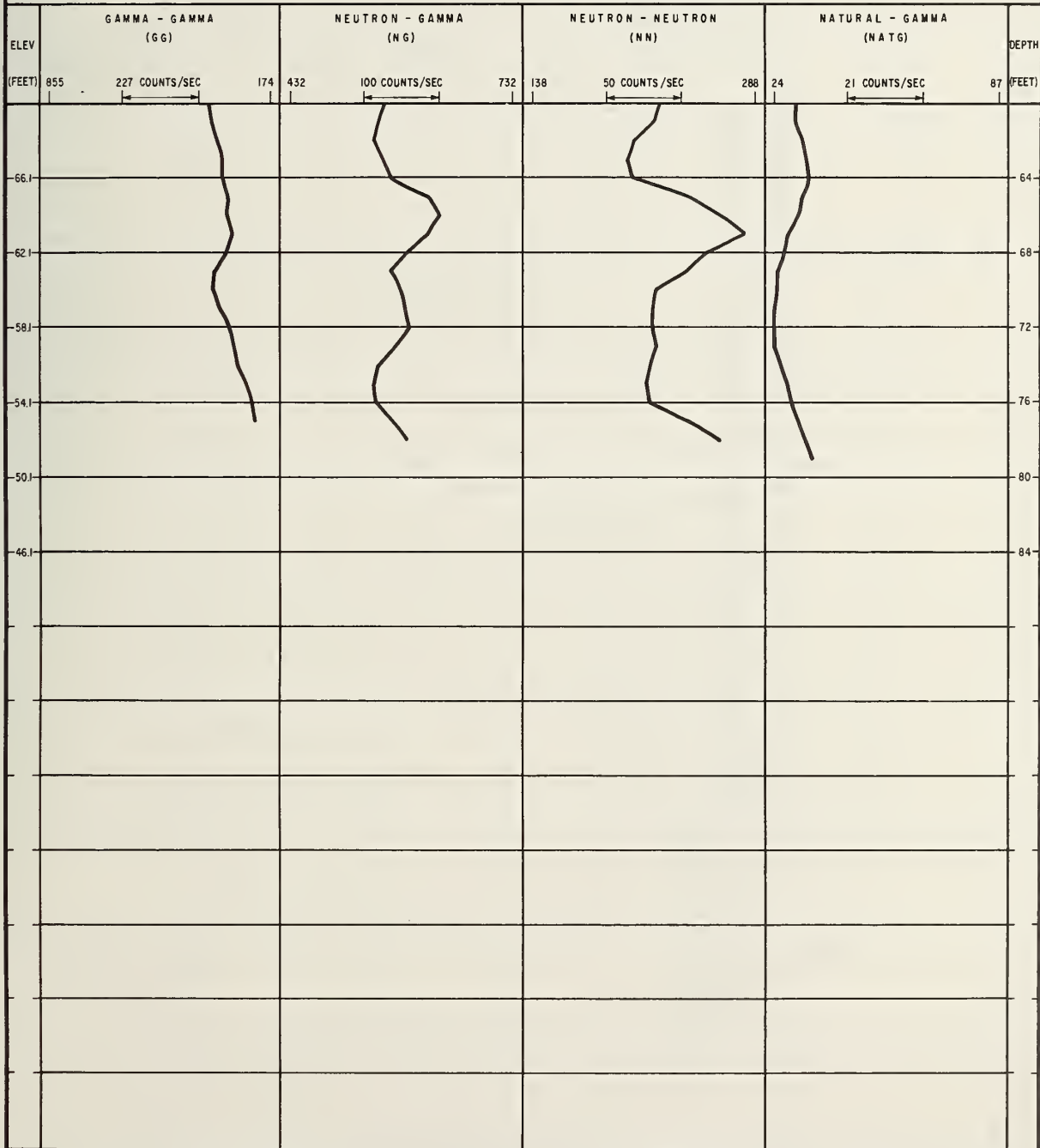

SUBSURFACE EXPLORATION SUMMARY EXPLORATION NO. TSC 19

LOCATION HOLIOAY INN SITE, CAMBRIDGE, MA STATION 204 + 16.0 O.B. OFFSET 76.0' LT COMP. DATE 6-5-79
 HOLE SIZE (OVERBURDEN) 5-5/8" (ROCK) 3-3/4" GROUND SURFACE EL. 129.9' GROUNDWATER EL. 118.6'

CORE BARREL:
 TYPE NONE SIZE - DEPTH -
 TYPE NONE SIZE - DEPTH -

PERMANENT INSTRUMENTATION CASING:
 TYPE GEDPHYSICAL/GROUNDWATER
 SIZE 2.5" I.O., SCH 40 P.V.C.
 DEPTH 110.0'

BOREHOLE SEALING:
 GROUT TYPE LIME/CEMENT
 DEPTH RANGE 3-110'
 DATE SEALED 6-29-79

GROUNDWATER DETERMINATION
 OBS. WELL
20 - 30'

ELEV (FEET)	DESCRIPTION	INSTRUMENT CASING INSTALLATION SKETCH	USCS CLASS & SYM.	SAMP TYPE & NO.	TEST TYPE & NO.	RECOVERY AND RQD (PERCENT) 20 40 60 80 100	PENETRATION TEST (300 LB. WT./24" DROP) (BLOWS PER FOOT) 100 200 300 400	ROCK DISCONTINUITY SUMMARY										DEPTH (FEET)					
								AVG LENGTH CORE (INCHES) 2 6 10	GRAPHIC LOG	TYPE		GEOM		COND		FILLING							
										JOINT	SHEAR	MECH	PLANAR	IRREG	SMOOTH	ROUGH	GOUGE		CLAY	CALCITE	OTHER		
61	GRAY SILTY SAND, LI GRAVEL W CLAY, CDBBLES & BOULDERS - GLACIAL TILL - 2.5" I.D., SCH 40 P. V. C. FLUSH JOINT CASING FLUSH JOINT COUPLING CEMENT GROUT SLOTS FOR GROUTING PURPOSES BEOROCK (ARGILLITE) BDTOM DF EXPLORATION																						
64																							
68																							
72																							
76																							
80																							
84																							
88																							
92																							
96																							
100																							
104																							
108																							
110																							

NOTE:
 1. GEDPHYSICAL SURVEY AND INSTRUMENTATION INSTALLATION. NO SAMPLES REQUIRED FOR ENTIRE LENGTH OF HOLE. SAMPLE DESCRIPTIONS AND STRATA CHANGES OBSERVED FROM WASH WATER AND DRILLING CHARACTERISTICS AND ARE APPROXIMATE.

BOREHOLE NUCLEAR LOGGING SUMMARY EXPLORATION NO. TSC 19

LOCATION HOLIDAY INN SITE, CAMBRIDGE, MA STATION 204 + 16.0 O.B. OFFSET 76.0' LT DATE LOGGED 6-13-79
 HOLE SIZE (OVERBURDEN) 5-5/8" (ROCK) 3-3/4" GROUND SURFACE EL. 129.9' TOTAL DEPTH LOGGED 110.0'

DENSITY (GG-LOG) INCREASES \longrightarrow
 POROSITY (NN-LOG) INCREASES \longleftarrow

WATER LEVEL ELEVATION FROM NUCLEAR LOG EL. 118.9±
 NUCLEAR LOG INTERPRETATION SUMMARIZED
 ON GEOLOGICAL PROFILE SHEETS

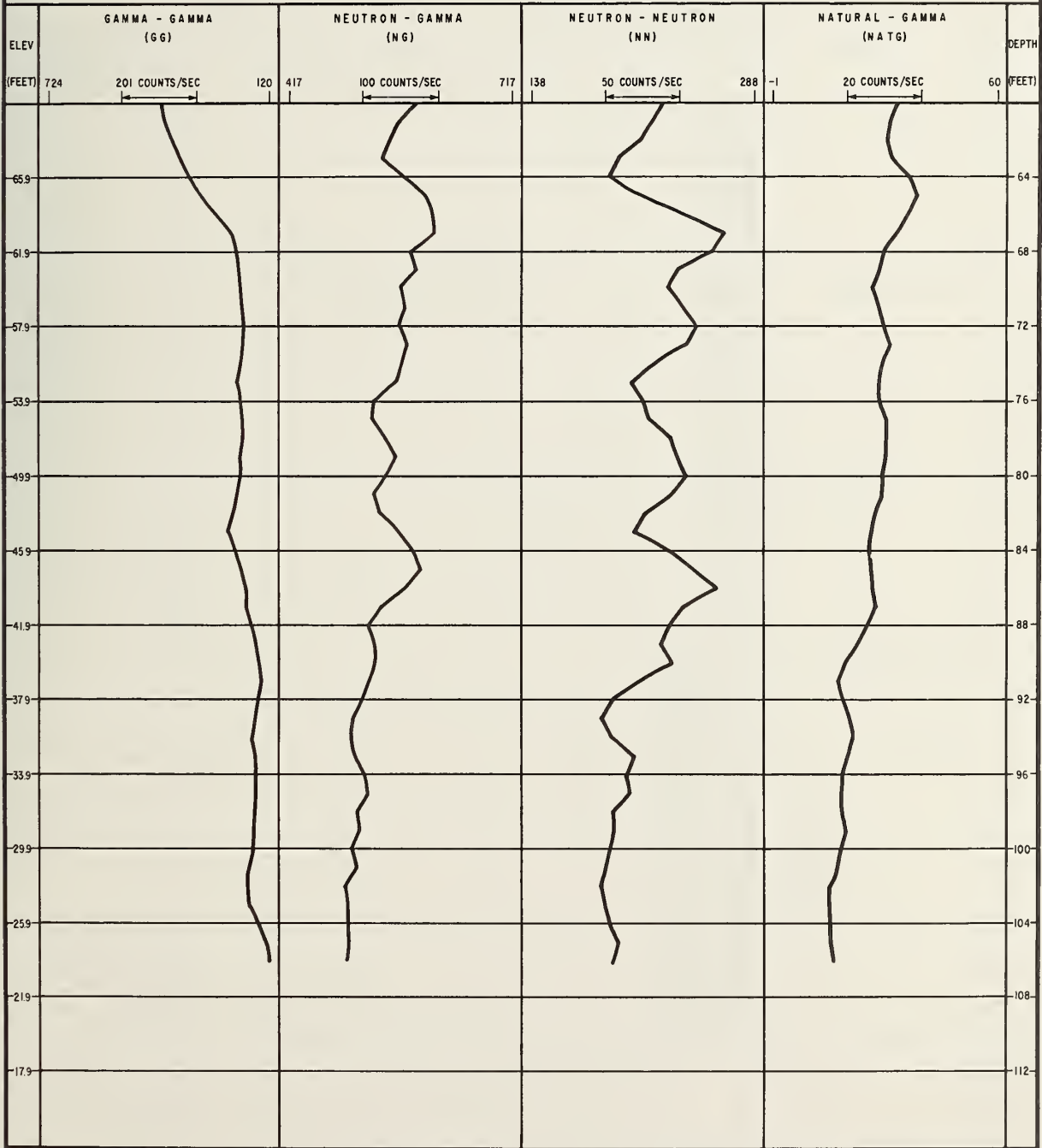

SUBSURFACE EXPLORATION SUMMARY EXPLORATION NO. TSC 20

LOCATION HOLIDAY INN SITE, CAMBRIDGE, MA STATION 204 + 12.0 O.B. OFFSET 33.4' LT COMP DATE 5-11-79
 HOLE SIZE (OVERBURDEN) 5-5/8" (ROCK) 5-5/8" GROUND SURFACE EL. 130.9' GROUNDWATER EL. 116.7'

CORE BARREL:
 TYPE NONE SIZE - DEPTH -
 TYPE NONE SIZE - DEPTH -

PERMANENT INSTRUMENTATION CASING:
 TYPE GEOPHYSICAL/GROUNDWATER
 SIZE 2.5" I.O. SCH 40 P.V.C.
 DEPTH 110.0'

BOREHOLE SEALING:
 GROUT TYPE LIME/CEMENT
 DEPTH RANGE 3-110'
 DATE SEALED 6-27-79

GROUNDWATER DETERMINATION
 INITIAL

ELEV (FEET)	DESCRIPTION	INSTRUMENT CASING INSTALLATION SKETCH	USCS CLASS & SYM.	SAMP TYPE & NO	TEST TYPE & NO	RECOVERY AND RQO (PERCENT)				PENETRATION TEST (300 LB. WT./24" DROP) (BLDS PER FOOT)				AVG LENGTH CORE (INCHES)	GRAPHIC LOG	ROCK DISCONTINUITY SUMMARY										DEPTH (FEET)
						20	40	60	80	100	100	200	300			400	JOINT	TYPE	GEOM	COND	FILLING					
						20	40	60	80	100	100	200	300			400	SHEAR	MECH	PLANAR	IRREG	SMOOTH	ROUGH	GOUGE	CLAY	CALCITE	
61	GRAY SILTY SAND, LI GRAVEL W COBBLES & BOULERS - GLACIAL TILL -													2 6 10												61
64						GEOPHYSICAL SURVEY AND INSTRUMENTATION INSTALLATION NO SAMPLES OBTAINED										64										
68																68										
72																72										
76																76										
80	BEOROCK (ARGILLITE)																									80
84																84										
88																88										
92																92										
96																96										
100																										100
104																										104
108																										108
110																										110

NOTES:
 1. GEOPHYSICAL SURVEY AND INSTRUMENTATION INSTALLATION. NO SAMPLES REQUIRED FOR ENTIRE LENGTH OF HOLE. SAMPLE DESCRIPTIONS AND STRATA CHANGES OBSERVED FROM WASH WATER AND DRILLING CHARACTERISTICS AND ARE APPROXIMATE.

BOREHOLE NUCLEAR LOGGING SUMMARY EXPLORATION NO. TSC 20

LOCATION HOLYOAK INN SITE, CAMBRIDGE, MA STATION 204 + 12.0 O.B. OFFSET 33.4' LT DATE LOGGED 6-12-79

HOLE SIZE (OVERBURDEN) 5-5/8" (ROCK) 5-5/8" GROUND SURFACE EL. 130.9' TOTAL DEPTH LOGGED 110.0'

DENSITY (GG-LOG) INCREASES →
POROSITY (NN-LOG) INCREASES ←

WATER LEVEL ELEVATION FROM NUCLEAR LOG EL. 120.9±
NUCLEAR LOG INTERPRETATION SUMMARIZED
ON GEOLOGICAL PROFILE SHEETS

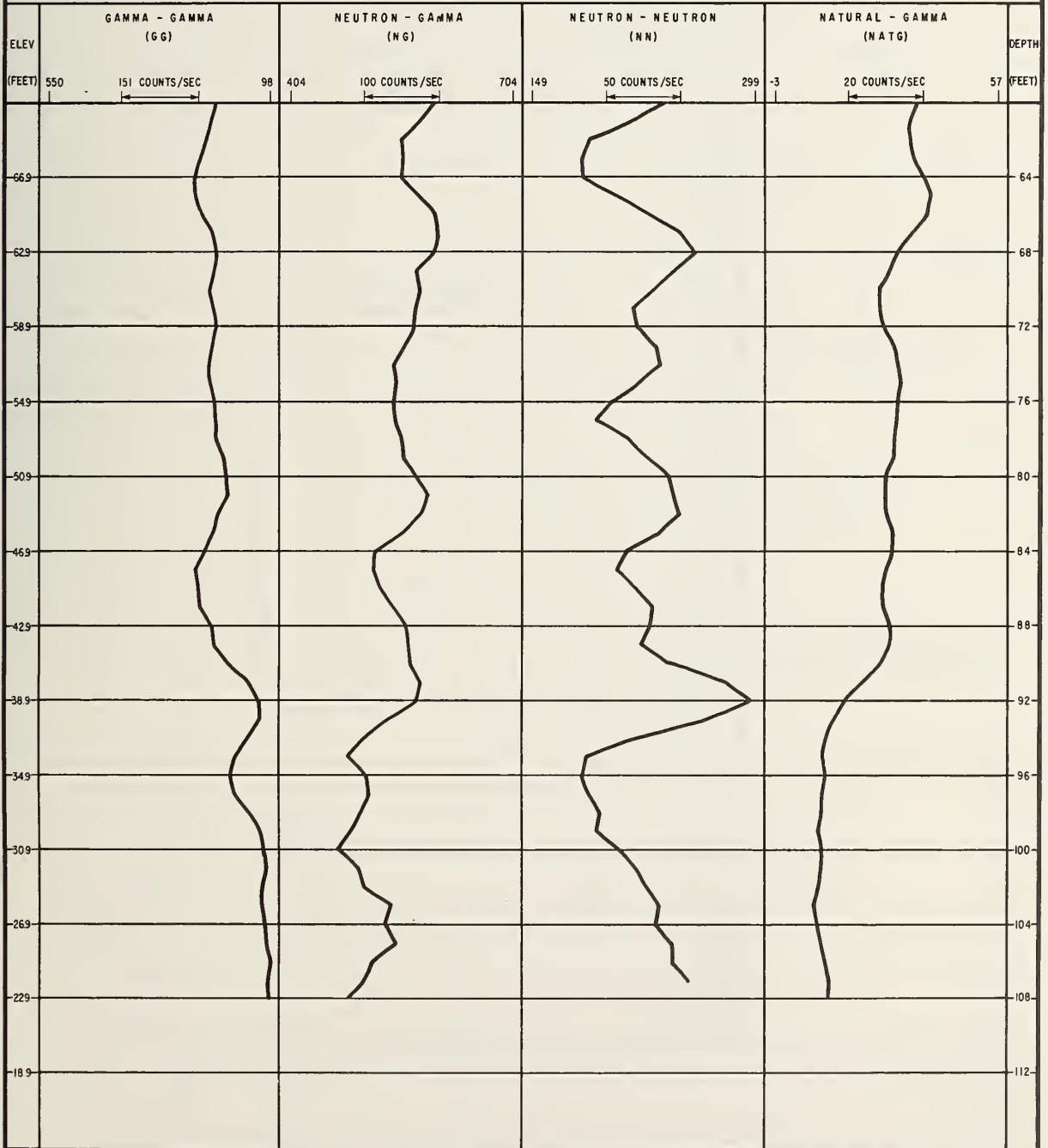

SUBSURFACE EXPLORATION SUMMARY EXPLORATION NO. TSC 21

LOCATION HOLIOAY INN SITE, CAMBRIDGE, MA STATION 204 + 11.0 O. B. OFFSET 11.0' RT COMP. DATE 4-20-79
 HOLE SIZE (OVERBURDEN) 4" (ROCK) 4" GROUND SURFACE EL. 129.8' GROUNDWATER EL. 116.8'

CORE BARREL: TYPE <u>NONE</u> SIZE <u>-</u> DEPTH <u>-</u> TYPE <u>NONE</u> SIZE <u>-</u> DEPTH <u>-</u>	PERMANENT INSTRUMENTATION CASING: TYPE <u>GEO PHYSICAL/GROUNDWATER</u> SIZE <u>2.5" I.O. SCH 40 P.V.C.</u> DEPTH <u>110.0'</u>	BOREHOLE SEALING: GROUT TYPE <u>LIME/CEMENT</u> DEPTH RANGE <u>3-110'</u> DATE SEALED <u>6-22-79</u>	GROUNDWATER DETERMINATION TEMPORARY OBS. WELL
--	---	---	--

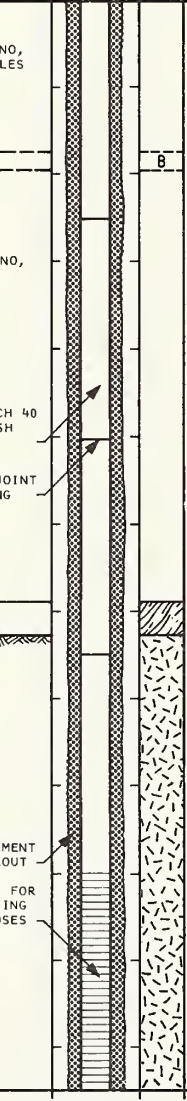
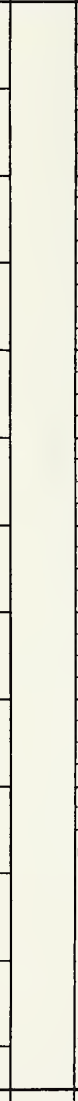
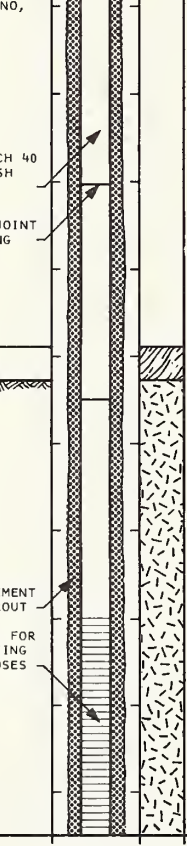
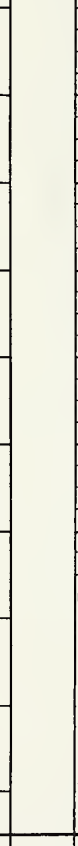
ELEV (FEET)	DESCRIPTION	INSTRUMENT CASING INSTALLATION SKETCH	USCS CLASS & SYM	SAMP TYPE & NO.	TEST TYPE & NO.	RECOVERY AND ROD (PERCENT) 20 40 60 80 100	PENETRATION TEST (300 LB. WT./24" DROP) (BLOWS PER FOOT) 100 200 300 400	AVG LENGTH CORE (INCHES) 2 6 10	GRAPHIC LOG	ROCK DISCONTINUITY SUMMARY										DEPTH (FEET)	
										TYPE		GEOM		COND		FILLING					
										JOINT	SHEAR	MECH	PLANAR	IRREG	SMOOTH	ROUGH	GOUGE	CLAY	CALCITE		OTHER
61	BROWNISH GRAY SILTY SAND, LI GRAVEL W CLAY, COBBLES & BOULDERS - GLACIAL TILL - BOULDER		B	-	-															61	
62.8 62.1																					64
68											GEO PHYSICAL SURVEY AND INSTRUMENTATION INSTALLATION NO SAMPLES OBTAINED										72
72	BROWNISH GRAY SILTY SAND, LI GRAVEL W COBBLES & BOULDERS - GLACIAL TILL - 2.5" I.O., SCH 40 P. V. C. FLUSH JOINT CASING FLUSH JOINT COUPLING 42.3 408 DECOMPOSED BEOROCK BEOROCK (OIBASE) CEMENT GROUT SLOTS FOR GROUTING PURPOSES 198 BOTTOM OF EXPLORATION		-	-	-															76	
80										TUNNEL CROWN ELEVATION										84	
84										OUTBOUND TUNNEL LIMITS										88	
88										INVERT ELEVATION										92	
92																				96	
96																				100	
100	NOTES:										104										
104	1. GEO PHYSICAL SURVEY AND INSTRUMENTATION INSTAL- LATION. NO SAMPLES REQUIRED FOR ENTIRE LENGTH OF HOLE. SAMPLE DESCRIPTIONS AND STRATA CHANGES OBSERVED FROM WASH WATER AND DRILLING CHARACTERISTICS AND ARE APPROXIMATE.										108										
108	2. TSC 21 DRILLED AT APPRO- XIMATELY ONE DEGREE EAST INCLINATION.										110										

BOREHOLE NUCLEAR LOGGING SUMMARY EXPLORATION NO. TSC 21

LOCATION HOLIDAY INN SITE, CAMBRIDGE, MA STATION 204 + 11.0 O.B. OFFSET 11.0' RT DATE LOGGED 6-14-79
 HOLE SIZE (OVERBURDEN) 4" (ROCK) 4" GROUND SURFACE EL. 129.8' TOTAL DEPTH LOGGED 110.0'

DENSITY (GG-LOG) INCREASES \longrightarrow
 POROSITY (NN-LOG) INCREASES \longleftarrow

WATER LEVEL ELEVATION FROM NUCLEAR LOG EL. 120.8±
 NUCLEAR LOG INTERPRETATION SUMMARIZED
 ON GEOLOGICAL PROFILE SHEETS

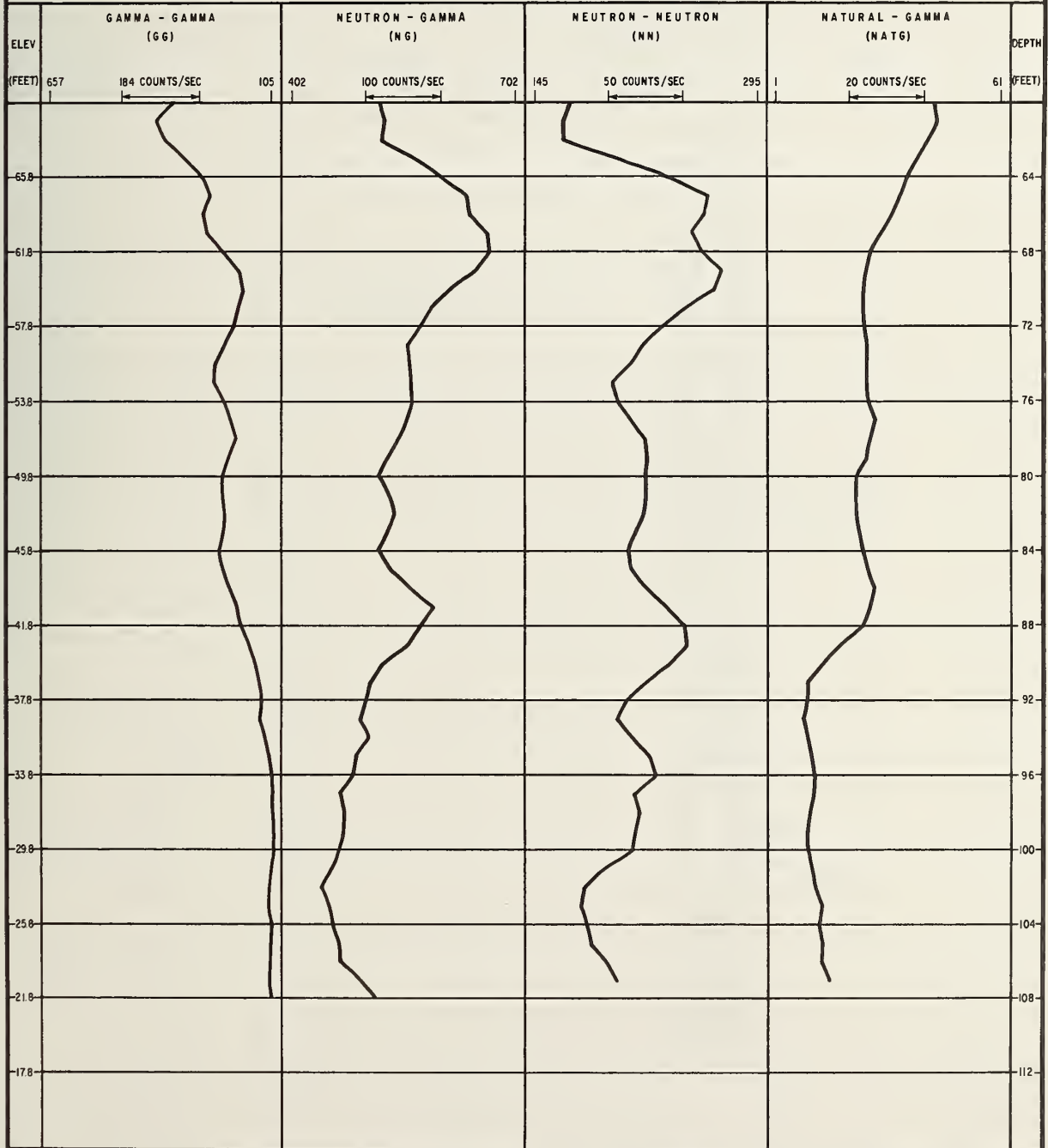

SUBSURFACE EXPLORATION SUMMARY
EXPLORATION NO. TSC 22

LOCATION HOLIDAY INN SITE, CAMBRIDGE, MA STATION 203 + 60.0 O. B. OFFSET 75.5' LT COMP. DATE 5-11-79
 HOLE SIZE (OVERBUROEN) 3.5" (ROCK) NONE GROUND SURFACE EL. 129.5' GROUNDWATER EL. 119.4'

CORE BARREL: TYPE NONE SIZE - DEPTH -
 PERMANENT INSTRUMENTATION CASING: TYPE GEOPHYSICAL/GROUNDWATER BOREHOLE SEALING: GROUT TYPE NONE
 SIZE 2.5" I.O. SCH 40 P.V.C. DEPTH RANGE NONE GROUNDWATER DETERMINATION: TEMPORARY OBS. WELL
 DEPTH 70.0' DATE SEALED NONE

ELEV (FEET)	DESCRIPTION	INSTRUMENT CASING INSTALLATION SKETCH	USCS CLASS & SYM	SAMP TYPE & NO.	TEST TYPE & NO.	RECOVERY AND ROD (PERCENT) 20 40 60 80 100	PENETRATION TEST (300 LB. WT./24" DROP) (BLOWS PER FOOT) 100 200 300 400	ROCK DISCONTINUITY SUMMARY										DEPTH (FEET)		
								AVG LENGTH CORE (INCHES) 2 6 10	GRAPHIC LOG	JOINT		SHEAR		MECH		GEOM			FILLING	
											PL	IR	SM	RO	BO	CL	CA	AR		
21	BROWN-GRAY SILTY CLAY																		24	
28																				32
32	GRAY SILTY SAND, LI GRAVEL W CLAY, COBBLES & BOULDERS - GLACIAL TILL -																			36
40																				44
48																				52
56																				60
64																				68
70																				70
59.5	BOTTOM OF EXPLORATION																			

NOTES:

1. GEOPHYSICAL SURVEY AND INSTRUMENTATION INSTALLATION. NO SAMPLES REQUIRED FOR ENTIRE LENGTH OF HOLE. SAMPLE DESCRIPTIONS AND STRATA CHANGES OBSERVED FROM WASH WATER AND DRILLING CHARACTERISTICS AND ARE APPROXIMATE.
2. EXPLORATION OBTAINED WITH THE "DOEX" DRILLING SYSTEM AND ADVANCED NO CASING TO 70 FEET. EXPLORATION TERMINATED DUE TO ENVIRONMENTAL POLLUTION FACTORS.
3. TUNNEL CROWN ELEVATION AT EL. 50.0'.

BOREHOLE NUCLEAR LOGGING SUMMARY EXPLORATION NO. TSC 22

LOCATION HOLIDAY INN SITE, CAMBRIDGE, MA STATION 203 + 60.0 O.B. OFFSET 75.5' LT DATE LOGGED 6-13-79
 HOLE SIZE (OVERBURDEN) 3.5" (ROCK) NONE GROUND SURFACE EL. 129.5' TOTAL DEPTH LOGGED 66.0'

DENSITY (GG-LOG) INCREASES \longrightarrow WATER LEVEL ELEVATION FROM NUCLEAR LOG EL. 120.5±
 POROSITY (NN-LOG) INCREASES \longleftarrow NUCLEAR LOG INTERPRETATION SUMMARIZED
 ON GEOLOGICAL PROFILE SHEETS

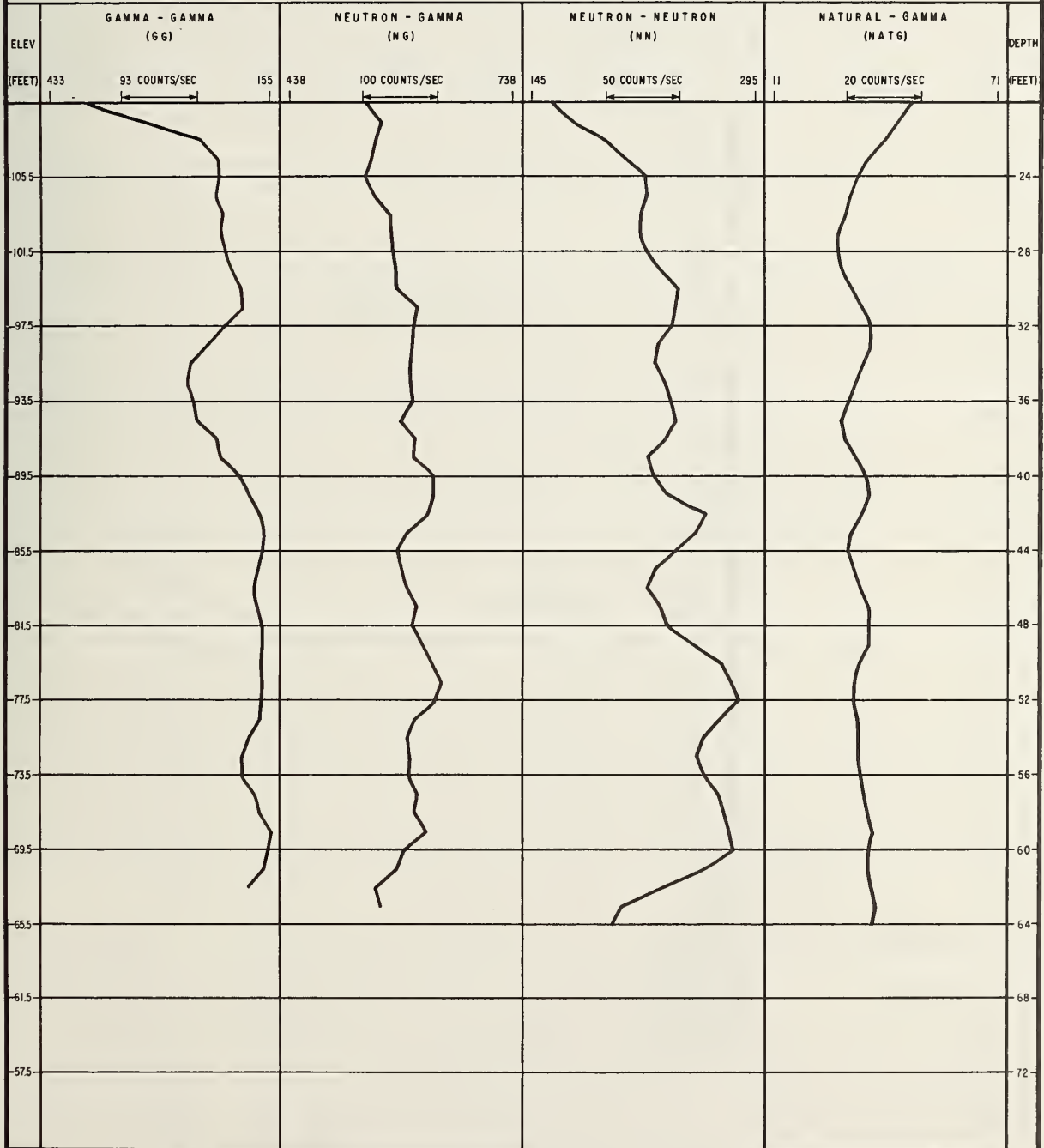

SUBSURFACE EXPLORATION SUMMARY EXPLORATION NO. TSC 23

LOCATION HOLIDAY INN SITE, CAMBRIDGE, MA STATION 203 + 62.0 O.B. OFFSET 33.5' LT COMP DATE 5-9-79
 HDLE SIZE (OVERBURDEN) 5" (ROCK) 5" GROUND SURFACE EL. 130.8' GROUNDWATER EL. 116.7'

CORE BARREL: TYPE <u>NONE</u> SIZE <u>-</u> DEPTH <u>-</u> TYPE <u>NONE</u> SIZE <u>-</u> DEPTH <u>-</u>	PERMANENT INSTRUMENTATION CASING: TYPE <u>GEO PHYSICAL/GROUNDWATER</u> SIZE <u>2.5" I.O., SCH 40 P.V.C.</u> DEPTH <u>105.0'</u>	BOREHOLE SEALING: GROUT TYPE <u>LIME/CEMENT</u> DEPTH RANGE <u>3-105'</u> DATE SEALED <u>6-27-79</u>	GROUNDWATER DETERMINATION INITIAL _____
--	--	---	--

ELEV (FEET)	DESCRIPTION	INSTRUMENT CASING INSTALLATION SKETCH	USCS CLASS SYM	SAMP TYPE NO.	TEST TYPE NO.	RECOVERY AND ROD (PERCENT) 20 40 60 80 100	PENETRATION TEST (300 LB. WT./24" DRP) (BLOWS PER FOOT) 100 200 300 400	ROCK DISCONTINUITY SUMMARY							DEPTH (FEET)							
								AVG LENGTH CORE (INCHES) 2 6 10	GRAPHIC LDG	TYPE			GEDM			COND		FILLING				
										JOINT	SHEAR	MECH	PLANAR	IRREG		SMOOTH	ROUGH	GOUGE	CLAY	CALCITE	OTHER	
56																						
59																						
63	BROWNISH GRAY SILTY SAND, LI GRAVEL W CLAY, COBBLES & BOULDERS - GLACIAL TILL -																					
67																						
71																						
75		2.5" I.O., SCH 40 P. V. C. FLUSH JOINT CASING																				
79		FLUSH JOINT COUPLING																				
83																						
87																						
91	BOULDERS																					
95		CEMENT GROUT																				
99		SLOTS FOR GROUTING PURPOSES																				
103	31.8 BEDROCK (ARGILLITE)																					
105	25.8 BDTOM OF EXPLORATION																					

NOTES:
 1. GEO PHYSICAL SURVEY AND INSTRUMENTATION INSTALLATION. NO SAMPLES REQUIRED FOR ENTIRE LENGTH OF HDLE. SAMPLE DESCRIPTIONS AND STRATA CHANGES OBSERVED FROM WASH WATER AND DRILLING CHARACTERISTICS AND ARE APPROXIMATE.

BOREHOLE NUCLEAR LOGGING SUMMARY EXPLORATION NO. TSC 23

LOCATION _____ STATION _____ OFFSET _____ DATE LOGGED _____
 HOLE SIZE (OVERBURDEN) _____ (ROCK) _____ GROUND SURFACE EL. _____ TOTAL DEPTH LOGGED _____

DENSITY (GG-LOG) INCREASES → WATER LEVEL ELEVATION FROM NUCLEAR LOG _____
 POROSITY (MN-LOG) INCREASES ← NUCLEAR LOG INTERPRETATION SUMMARIZED
 ON GEOLOGICAL PROFILE SHEETS

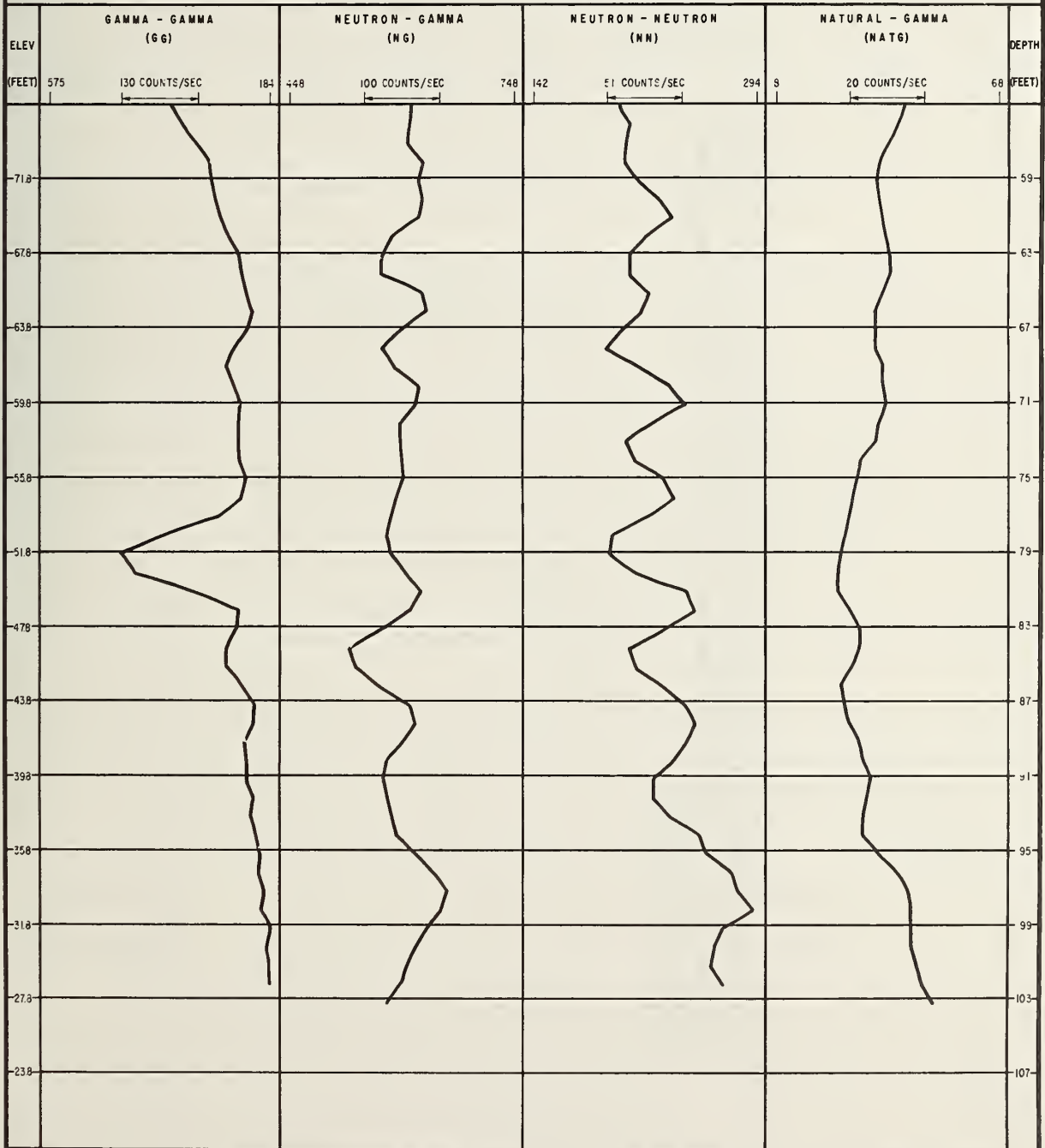

SUBSURFACE EXPLORATION SUMMARY EXPLORATION NO. TSC 24

LOCATION HOLIOAY INN SITE, CAMBRIDGE, MA STATION 203 + 60.4 O.B. OFFSET 12.0' RT COMP DATE 4-24-79
 HOLE SIZE (OVERBURDEN) 4" (ROCK) 4" GROUND SURFACE EL. 129.6' GROUNDWATER EL. 119.1'

CORE BARREL:
 TYPE NONE SIZE - DEPTH -
 TYPE NONE SIZE - DEPTH -

PERMANENT INSTRUMENTATION CASING:
 TYPE GEO PHYSICAL/GROUNDWATER
 SIZE 2.5" I.O., SCH 40 P.V.C.
 DEPTH 105.0'

BOREHOLE SEALING:
 GROUT TYPE LIME/CEMENT
 DEPTH RANGE 25-105'
 DATE SEALED 6-22-79

GROUNDWATER DETERMINATION
 OBS. WELL
16.6-26.6'

ELEV (FEET)	DESCRIPTION	INSTRUMENT CASING INSTALLATION SKETCH	USCS CLASS & SYM.	SAMP TYPE & NO.	TEST TYPE & NO.	RECOVERY AND ROD (PERCENT)			PENETRATION TEST (300 LB. WT./24" DROP) (BLOWS PER FOOT)				AVG LENGTH CORE (INCHES) 2 6 10	GRAPHIC LOG	ROCK DISCONTINUITY SUMMARY										DEPTH (FEET)
						20	40	60	80	100	100	200			300	400	JOINT	SHEAR	MECH	GEOM PLANAR	CONO IRREG	SMOOTH ROUGH	FILLING GROUT CLAY	CALCITE SILICE OTHER	
	GRAY SILTY SAND, LI GRAVEL W CLAY, COBBLES & BOULGERS - GLACIAL TILL -																							56	
																								59	
																								63	
																								67	
																								71	
																								75	
																								75	
																								79	
																								83	
																								87	
																								91	
38.6																								91	
	BEOROCK (ARGILLITE)																							95	
																								99	
																								103	
24.6																								105	

TUNNEL CROWN ELEVATION
 INVERT ELEVATION
 OUTBOUND TUNNEL LIMITS

NOTES:
 1. GEO PHYSICAL SURVEY AND INSTRUMENTATION INSTALLATION. NO SAMPLES REQUIRED FOR ENTIRE LENGTH OF HOLE. SAMPLE DESCRIPTIONS AND STRATA CHANGES OBSERVED FROM WASH WATER AND DRILLING CHARACTERISTICS ARE APPROXIMATE.
 2. TSC 24 DRILLED AT APPROXIMATELY ONE DEGREE EAST INCLINATION.

BOREHOLE NUCLEAR LOGGING SUMMARY EXPLORATION NO. TSC 24

LOCATION HOLIDAY INN SITE, CAMBRIDGE, MA STATION 203 + 60.4 O.B. OFFSET 12.0' RT DATE LOGGED 6-14-79
 HOLE SIZE (OVERBURDEN) 4 1/2" (ROCK) 4 1/2" GROUND SURFACE EL. 129.6' TOTAL DEPTH LOGGED 98.0'

DENSITY (GG-LOG) INCREASES →
 POROSITY (NN-LOG) INCREASES ←

WATER LEVEL ELEVATION FROM NUCLEAR LOG EL. 119.6±

NUCLEAR LOG INTERPRETATION SUMMARIZED
 ON GEOLOGICAL PROFILE SHEETS

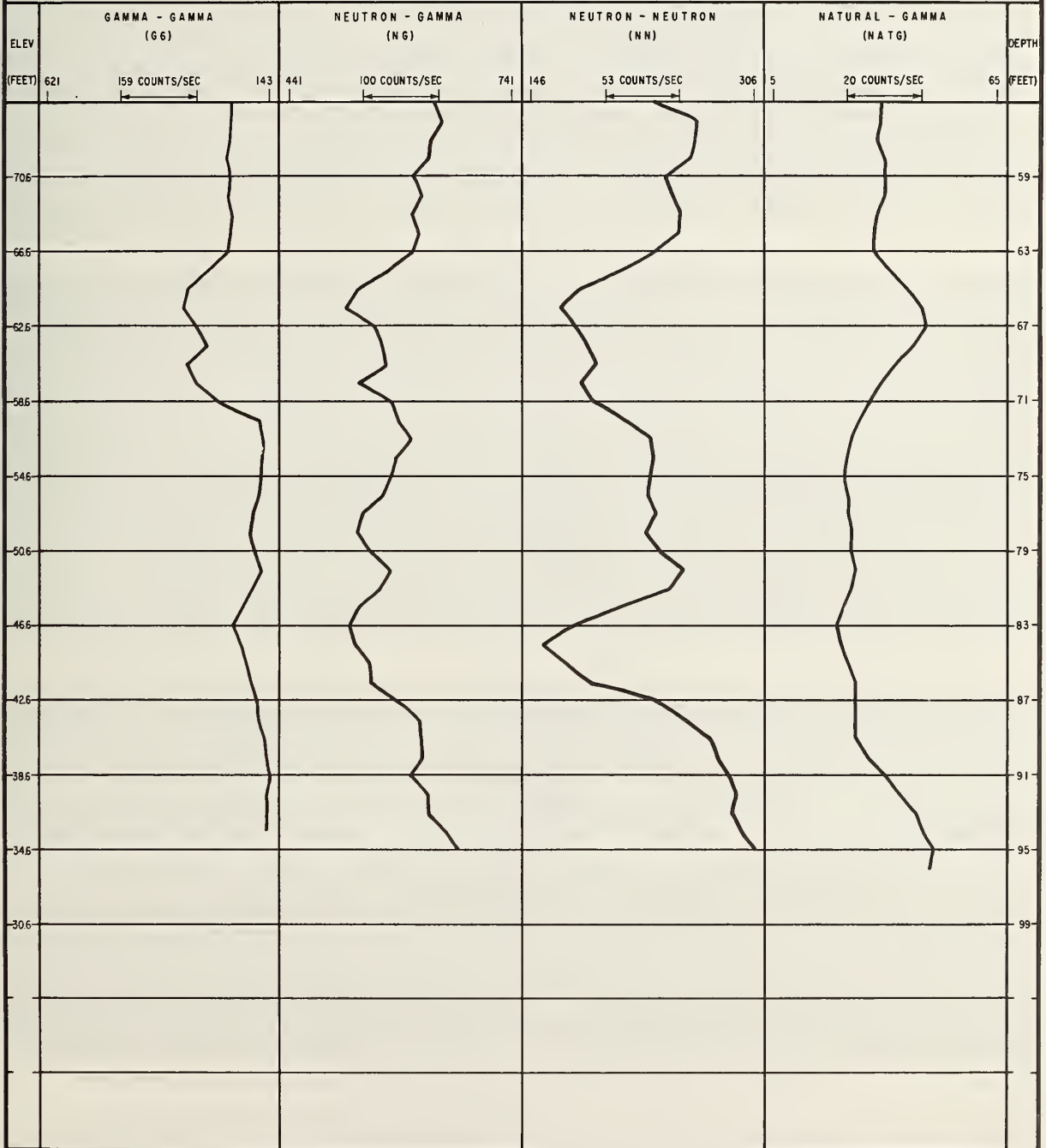

SUBSURFACE EXPLORATION SUMMARY

EXPLORATION NO. TSC-ISM

LOCATION OAVIS SQUARE, SOMERVILLE, MA STATION 266 + 64.0' O.B. OFFSET 6.0' LT COMP. DATE 6-20-79
 HOLE SIZE (OVERBURDEN) 5-5/8" (ROCK) 5-5/8" GROUND SURFACE EL. 133.9' GROUNDWATER EL. 12.0'

CORE BARREL:
 TYPE RWT-PILOT SIZE 1-3/16" DEPTH 50-63'
 HXL -
 TYPE SPLIT LINER SIZE 3-3/4" DEPTH 50-63'

PERMANENT INSTRUMENTATION CASING:
 TYPE NONE
 SIZE -
 DEPTH -

BOREHOLE SEALING:
 GROUT TYPE CEMENT
 DEPTH RANGE 3-63'
 DATE SEALED 6-20-79

GROUNDWATER DETERMINATION
 INITIAL

ELEV (FEET)	DESCRIPTION	INSTRUMENT CASING INSTALLATION SKETCH	USCS CLASS & SYM	SAMP TYPE & NO.	TEST TYPE & NO.	RECOVERY AND RQD				PENETRATION TEST (300 LB. WT./24" DROP)				AVG LENGTH CORE (INCHES)	GRAPHIC LOG	ROCK DISCONTINUITY SUMMARY							DEPTH (FEET)			
						(PERCENT)				(BLOWS PER FOOT)						JOINT	SHEAR	MECH	PLANAR	IRREG	SMOOTH	ROUGH		GOUGE	CLAY	CALCITE
						20	40	60	80	100	100	200	300													
	MEO OENSE, LIGHT BROWN, FINE SANDY SILT ⁴																						21			
108.9	MEO STIFF, GRAY SILTY CLAY																						24			
	STIFF, GRAY SILTY CLAY																						32			
93.9	OENSE, GRAY FINE SAND																						40			
88.4	V STIFF, GRAY, SILTY CLAY																						44			
84.9	HARD, GRAY SANDY CLAY, LI GRAVEL W COBBLES & BOULDEERS - GLACIAL TILL -																						48			
83.9	DECOMPOSED ARGILLITE		SC	SI	SPT																		52			
	HARD, SL WEATHERED, EXTREMELY TO MOD FRAC, GRAY, FINE-GRAINED ARGILLITE, V CLOSE, OPEN, SHALLOW DIPPING, SMOOTH TO WAVY JOINTS W IRON OXIDE STAINING, LOCAL BRECCIATED ZONES & REHEALED MACRO SHEARS			R1	ISM																		56			
75.9	HARD, FRESH, SOUND, GRAY, FINE-GRAINED ARGILLITE; V WIDE, TIGHT SHALLOW DIPPING SMOOTH TO WAVY JOINTS, LOCAL BRECCIATED ZONES, REHEALED MACRO SHEARS & CALCITE VEINS			R2	ISM																		60			
70.9	BOTTOM OF EXPLORATION			R3	ISM																		63			

NOTES:

1. INFERRED BEDROCK STRUCTURE DETERMINED FROM ONE INTEGRAL SAMPLING METHOD (ISM) EXPLORATION AND MAY NOT REFLECT THE OVERALL BEDROCK STRUCTURE AND SHOULD BE CONSIDERED APPROXIMATE.
2. UNABLE TO OBTAIN QUALITY ISM SAMPLE FOR ANALYSIS BETWEEN 50 AND 58 FEET DUE TO HIGHLY FRACTURED ROCK (SEE REPORT TEXT).
3. MAJOR WATER LOSS DURING CORING BETWEEN 50 AND 58 FEET. ESTIMATE 500 GALLONS PER HALF HOUR.
4. OVERBURDEN DESCRIPTIONS SUMMARIZED FROM ADJACENT EXPLORATION 03A OBTAINED IN NOVEMBER 1976.

APPENDIX D

ROCK CORE PHOTOGRAPHS

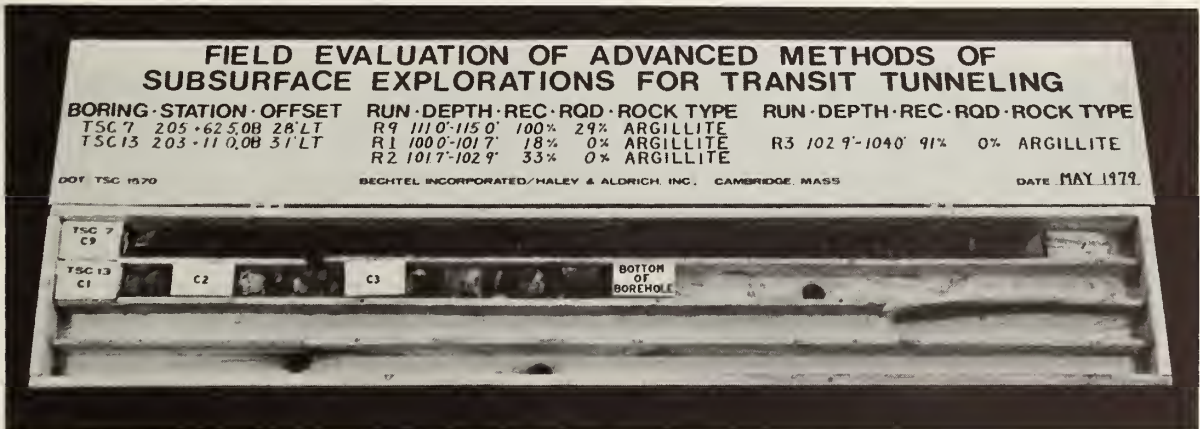
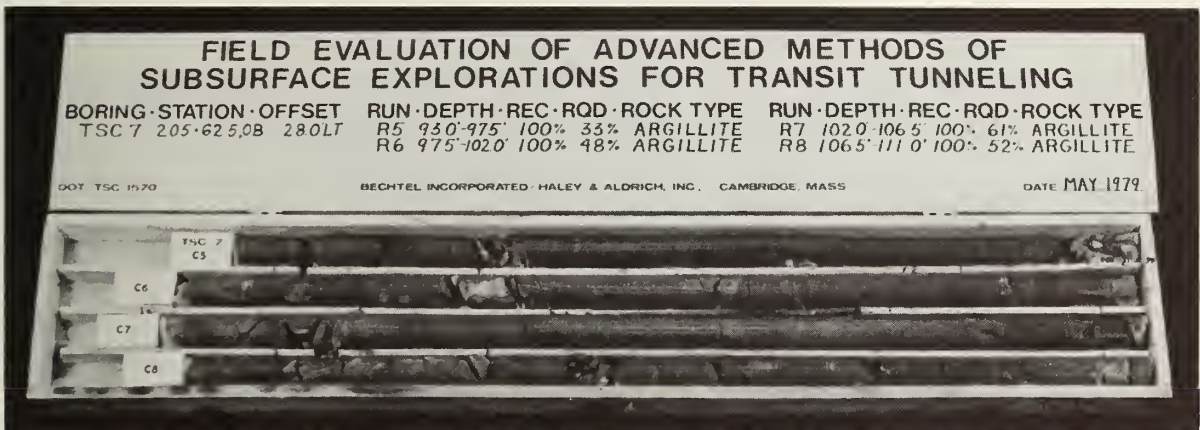



**FIELD EVALUATION OF ADVANCED METHODS OF
SUBSURFACE EXPLORATIONS FOR TRANSIT TUNNELING**

BORING · STATION · OFFSET	RUN · DEPTH · REC · RQD · ROCK TYPE	RUN · DEPTH · REC · RQD · ROCK TYPE
TSC 9 204-63.0B 75.5'LT	R1 83.5'-88.0' 96% 44% ARGILLITE	R2 88.0'-92.5' 100% 31% ARGILLITE
	R3 92.5'-97.0' 100% 42% DIABASE	

DOT/TSC 1570 BECHTEL INCORPORATED/HALEY & ALDRICH, INC., CAMBRIDGE, MASS. DATE JUNE 1979

**FIELD EVALUATION OF ADVANCED METHODS OF
SUBSURFACE EXPLORATIONS FOR TRANSIT TUNNELING**

BORING · STATION · OFFSET	RUN · DEPTH · REC · RQD · ROCK TYPE	RUN · DEPTH · REC · RQD · ROCK TYPE
TSC 9 204-63.0B 75.5'LT	R4 97.0'-101.5' 100% 51% DIABASE	R5 101.5'-106.0' 100% 87% DIABASE

DOT/TSC 1570 BECHTEL INCORPORATED/HALEY & ALDRICH, INC., CAMBRIDGE, MASS. DATE JUNE 1979

**FIELD EVALUATION OF ADVANCED METHODS OF
SUBSURFACE EXPLORATIONS FOR TRANSIT TUNNELING**

BORING · STATION · OFFSET	RUN · DEPTH · REC · RQD · ROCK TYPE	RUN · DEPTH · REC · RQD · ROCK TYPE
TSC 10 204-59.0B 11.5 RT	R1 86.0'-89.5' 43% NA GLACIAL TILL	R4 98.5'-102.0' 100% 94% DIABASE
	R2 90.5'-93.5' 73% 0% DIABASE	R5 102.0'-106.5' 98% 78% DIABASE
	R3 93.5'-98.5' 100% 57% DIABASE	

DOT/TSC 1570 BECHTEL INCORPORATED/HALEY & ALDRICH, INC., CAMBRIDGE, MASS. DATE APRIL 1979

**FIELD EVALUATION OF ADVANCED METHODS OF
SUBSURFACE EXPLORATIONS FOR TRANSIT TUNNELING**

BORING · STATION · OFFSET	RUN · DEPTH · REC · RQD · ROCK TYPE	RUN · DEPTH · REC · RQD · ROCK TYPE
TSC 15 205-5850B 340'LT	R1 750'-765' 100% 26% ARGILLITE	
	R2 765'-812' 100% 41% DIABASE	
TSC 10 204-5900B 115'RT	R6 1020'-1065' 100% 100% DIABASE	

DOT TSC 1570 BECHTEL INCORPORATED / HALEY & ALDRICH, INC., CAMBRIDGE, MASS. DATE MAY 1979

**FIELD EVALUATION OF ADVANCED METHODS OF
SUBSURFACE EXPLORATIONS FOR TRANSIT TUNNELING**

BORING · STATION · OFFSET	RUN · DEPTH · REC · RQD · ROCK TYPE	RUN · DEPTH · REC · RQD · ROCK TYPE
TSC 15 205-5850B 34'LT	R3 812'-845' 98% 16% DIABASE/ARG	R5 890'-935' 100% 65% ARGILLITE
	R4 845'-890' 100% 31% ARGILLITE	R6 935'-980' 100% 83% ARGILLITE

DOT TSC 1570 BECHTEL INCORPORATED / HALEY & ALDRICH, INC., CAMBRIDGE, MASS. DATE MAY 1979

**FIELD EVALUATION OF ADVANCED METHODS OF
SUBSURFACE EXPLORATIONS FOR TRANSIT TUNNELING**

BORING · STATION · OFFSET	RUN · DEPTH · REC · RQD · ROCK TYPE	RUN · DEPTH · REC · RQD · ROCK TYPE
TSC 15 205-5850B 34'LT	R7 980'-1025' 100% 52% ARGILLITE	R9 1070'-1115' 100% 66% ARGILLITE
	R8 1025'-1070' 100% 53% SANDSTONE	R10 1115'-1150' 100% 16% DIABASE

DOT TSC 1570 BECHTEL INCORPORATED / HALEY & ALDRICH, INC., CAMBRIDGE, MASS. DATE MAY 1979

**FIELD EVALUATION OF ADVANCED METHODS OF
SUBSURFACE EXPLORATIONS FOR TRANSIT TUNNELING**

BORING · STATION · OFFSET	RUN · DEPTH · REC · RQD · ROCK TYPE	RUN · DEPTH · REC · RQD · ROCK TYPE
TSC 14 204-645.0B 33'LT	R1 90'-940' 96% 75% DIABASE	R3 99'-1032' 100% 50% DIABASE
	R2 940'-990' 100% 63% DIABASE	R4 1032'-1080' 100% 63% DIABASE

DOT TSC 1570

BECHTEL INCORPORATED/HALEY & ALDRICH INC., CAMBRIDGE, MASS

DATE MAY 1979

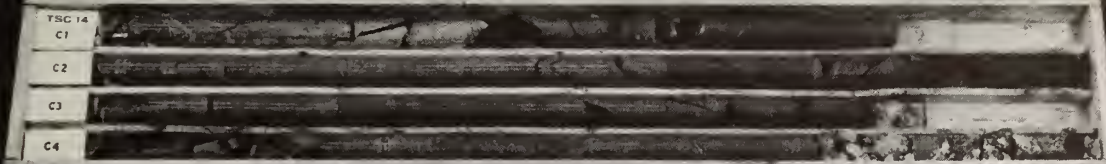

**FIELD EVALUATION OF ADVANCED METHODS OF
SUBSURFACE EXPLORATIONS FOR TRANSIT TUNNELING**

BORING · STATION · OFFSET	RUN · DEPTH · REC · RQD · ROCK TYPE	RUN · DEPTH · REC · RQD · ROCK TYPE
TSC 14 204-645.0B 33'LT	R5 1080'-1100' 100% 63% DIABASE	
TSC 11 203-105.0B 765'LT	R1 990'-1020' 33% 0% ARGILLITE	
	R2 1020'-1035' 100% 0% ARGILLITE	

DOT TSC 1570

BECHTEL INCORPORATED/HALEY & ALDRICH INC., CAMBRIDGE, MASS

DATE MAY 1979

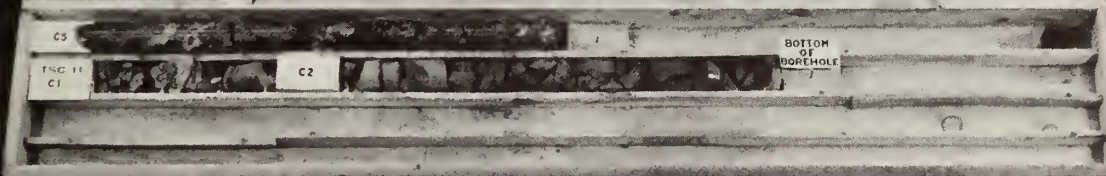

**FIELD EVALUATION OF ADVANCED METHODS OF
SUBSURFACE EXPLORATIONS FOR TRANSIT TUNNELING**

BORING · STATION · OFFSET	RUN · DEPTH · REC · RQD · ROCK TYPE	RUN · DEPTH · REC · RQD · ROCK TYPE
ISM 266-64.0B 6'LT	R1 500'-520' 75% 0% ARGILLITE	R3 580'-630' 100% 100% ARGILLITE
	R2 520'-580' 100% 0% ARGILLITE	RWT 580'-620' 100% NA ARGILLITE

DOT TSC 1570

BECHTEL INCORPORATED/HALEY & ALDRICH INC., CAMBRIDGE, MASS

DATE JUNE 1979

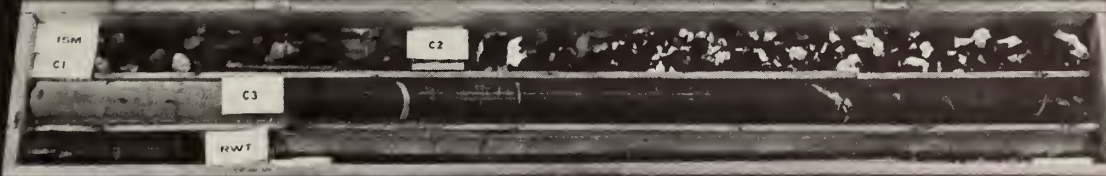

APPENDIX E

PETROGRAPHIC ANALYSIS

HALEY & ALDRICH, INC. CAMBRIDGE, MASSACHUSETTS		PETROGRAPHIC ANALYSIS		FILE NO. <u>4284</u>
PROJECT <u>DOT/TSC-1570, CAMBRIDGE, MA</u>		CLIENT <u>BECHTEL INCORPORATED</u>		SHEET NO. <u>1</u> OF <u>1</u>
LOCALE <u>HOLIDAY INN SITE, MASS. AVE., CAMBRIDGE, MA</u>		FORMATION <u>CAMBRIDGE ARGILLITE</u>		SAMPLE NO. <u>TSC10 R4</u>
				SAMPLE DEPTH <u>99.0 ft.</u>
				DATE ANALYZED <u>2 Oct. 79</u>
				ANALYZED BY <u>J. Hight</u>
				REVIEWED BY <u>A.W. Hatheway</u>
I. CLASSIFICATION		II. MICROSCOPIC VIEW		MAGNIFICATION <u>123x</u>
<p>1. CLASS Metamorphic (low grade)</p> <p>2. TEXTURE Granular</p> <p>3. ALTERATION Moderate to extensive</p> <p>4. NAME Diabase with epidote/ olivine vein</p>				
III. DESCRIPTION OF INDIVIDUAL MINERALS				
MINERAL	ESTIMATED PERCENTAGE	PHYSICAL AND OPTICAL CHARACTERISTICS		
plagioclase	30	labradorite		
sericite	10			
pyroxene	20			
calcite	10	intergrown with serpentine as a vein filling		
quartz	5	large intergrown crystals		
vein				
quartz epidote/ olivine	20	intergrown, some olivine altered to antigorite		
feldspar				
opaques	5	probably magnetite		
<p>IV. FEATURES OF ENGINEERING SIGNIFICANCE Although entire specimen shows evidence resorption alteration with badly pitted crystals, microfractures are very short and generally represent damage occurring at formation. Other larger microfractures are completely healed with products of secondary alteration. Rock appears to be relatively strong and isotropic</p>				

HALEY & ALDRICH, INC. CAMBRIDGE, MASSACHUSETTS		PETROGRAPHIC ANALYSIS		FILE NO. <u>4284</u>
PROJECT <u>DOT/TSC-1570, CAMBRIDGE, MA</u>		CLIENT <u>BECHTEL INCORPORATED</u>		SHEET NO. <u>1</u> OF <u>1</u>
LOCALE <u>HOLIDAY INN SITE, MASS. AVE., CAMBRIDGE, MA</u>		FORMATION <u>CAMBRIDGE ARGILLITE</u>		SAMPLE NO. <u>TSC14 R2</u>
				SAMPLE DEPTH <u>96.3 ft.</u>
				DATE ANALYZED <u>2 Oct. 79</u>
				ANALYZED BY <u>J. Hight</u>
				REVIEWED BY <u>A.W. Hatheway</u>
I. CLASSIFICATION		II. MICROSCOPIC VIEW	MAGNIFICATION 123x	
1. CLASS Metamorphic (low grade) 2. TEXTURE Xenoblastic 3. ALTERATION Extensive sericitization 4. NAME Metatuff				
III. DESCRIPTION OF INDIVIDUAL MINERALS				
MINERAL	ESTIMATED PERCENTAGE	PHYSICAL AND OPTICAL CHARACTERISTICS		
sericite	40	Little organic feldspar		
quartz epidote	15	Veins, again ferruginous remnants of epidote's parent remain; epidote intergrown with quartz		
pyrites	5	Opaque		
chlorite	40	Also occurring as secondary filling in veinlets		
IV. FEATURES OF ENGINEERING SIGNIFICANCE Numerous micro veinlets of quartz suggest this to be a microbreccia possibly formed in or near an ancient fault zone; longer fractures are quartz and chlorite filled; smaller fractures filled with chlorite only rock appears to be isotropic with regard to strength				

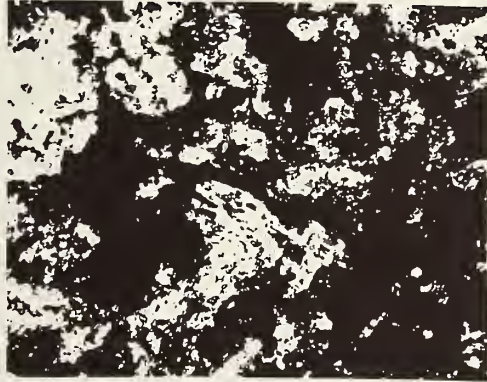
HALEY & ALDRICH, INC. CAMBRIDGE, MASSACHUSETTS		PETROGRAPHIC ANALYSIS		FILE NO. <u>4284</u>
PROJECT <u>DOT/TSC-1570, CAMBRIDGE, MA</u>		CLIENT <u>BECHTEL INCORPORATED</u>		SHEET NO. <u>1</u> OF <u>1</u>
LOCALITY <u>HOLIDAY INN SITE, MASS. AVE., CAMBRIDGE, MA</u>		FORMATION <u>CAMBRIDGE ARGILLITE</u>		SAMPLE NO. <u>TSC14 R5</u>
				SAMPLE DEPTH <u>109.5 ft.</u>
				DATE ANALYZED <u>2 Oct. 79</u>
				ANALYZED BY <u>J. Hight</u>
				REVIEWED BY <u>A.W. Hatheway</u>
I. CLASSIFICATION		II. MICROSCOPIC VIEW		MAGNIFICATION <u>123x</u>
<p>1. CLASS Metamorphic (low grade)</p> <p>2. TEXTURE clastic/breccia</p> <p>3. ALTERATION sericitization epidotization</p> <p>4. NAME Breccia in contact with diabase</p>				
III. DESCRIPTION OF INDIVIDUAL MINERALS				
MINERAL	ESTIMATED PERCENTAGE	PHYSICAL AND OPTICAL CHARACTERISTICS		
plagioclase	45	labradorite		
epidote	10	vein with serpentine		
sericite	5	slight		
quartz	5			
hornblende	5			
breccia				
epidote	5	both intergrown with serpentine/epidote and as		
quartz	15	large grains		
opaques	5	ferruginous remnant of epidote's parent		
quartz/feldspar	5	groundmass		
IV. FEATURES OF ENGINEERING SIGNIFICANCE A composite specimen taken along a possible shear zone, represented as nearly completely recemented breccia in contact with an intensely altered diabase. Fractures in diabase are serpentine filled but tight; fractures in breccia are discontinuously open and contain minor amounts of clay sized material				

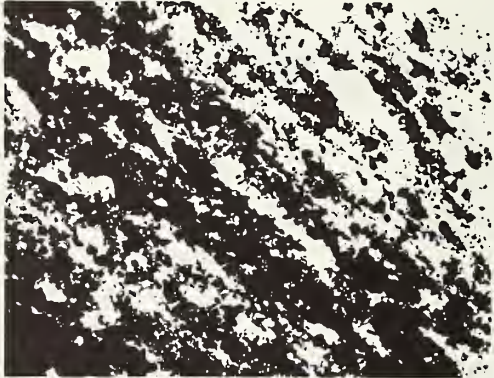
HALEY & ALDRICH, INC. CAMBRIDGE, MASSACHUSETTS		PETROGRAPHIC ANALYSIS		FILE NO <u>4284</u>
PROJECT <u>DOT/TSC-1570, CAMBRIDGE, MA</u>		CLIENT <u>BECHTEL INCORPORATED</u>		SHEET NO <u>1</u> OF <u>1</u>
LOCALE <u>HOLIDAY INN SITE, MASS. AVE., CAMBRIDGE, MA</u>		FORMATION <u>CAMBRIDGE ARGILLITE</u>		SAMPLE NO. <u>TSC15 R8</u>
				SAMPLE DEPTH <u>106.0 ft.</u>
				DATE ANALYZED <u>2 Oct. 79</u>
				ANALYZED BY <u>J. Hight</u>
				REVIEWED BY <u>A.W. Hatheway</u>
I. CLASSIFICATION		II. MICROSCOPIC VIEW		MAGNIFICATION <u>123x</u>
1. CLASS Metamorphic (low grade)				
2. TEXTURE Aphanitic with quartz veins				
3. ALTERATION Extensive sericitization				
4. NAME Altered argillite with metatuff inclusions				
III. DESCRIPTION OF INDIVIDUAL MINERALS				
MINERAL	ESTIMATED PERCENTAGE	PHYSICAL AND OPTICAL CHARACTERISTICS		
sericite epidote feldspar (alkali) quartz opaques	85 10 5	alteration product sodic plagioclase feldspar also the ferruginous remnant of epidote occasional grains to 400 u vein fillings		
IV. FEATURES OF ENGINEERING SIGNIFICANCE Numerous microfractures in semi-random orientation; some relict bedding, pronouncedly closely spaced microfractures; this rock probably does not possess as much strength as the other three rocks in this series analyses				

APPENDIX F
SELECTED ELECTRIC LOGS



TSC13

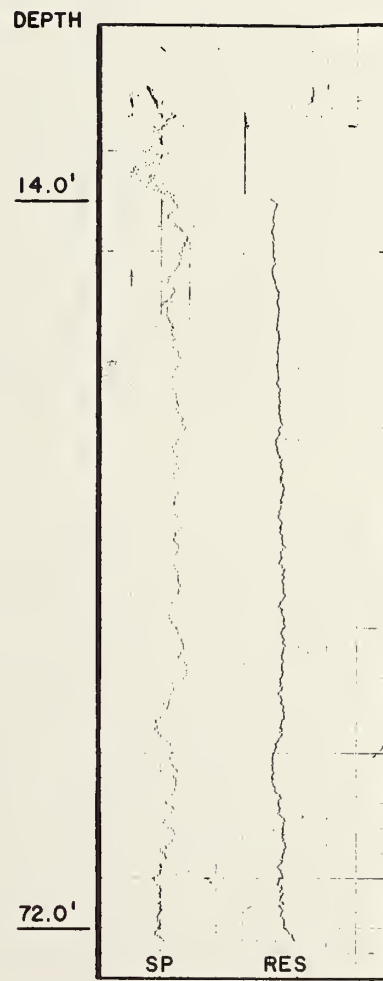

TSC15

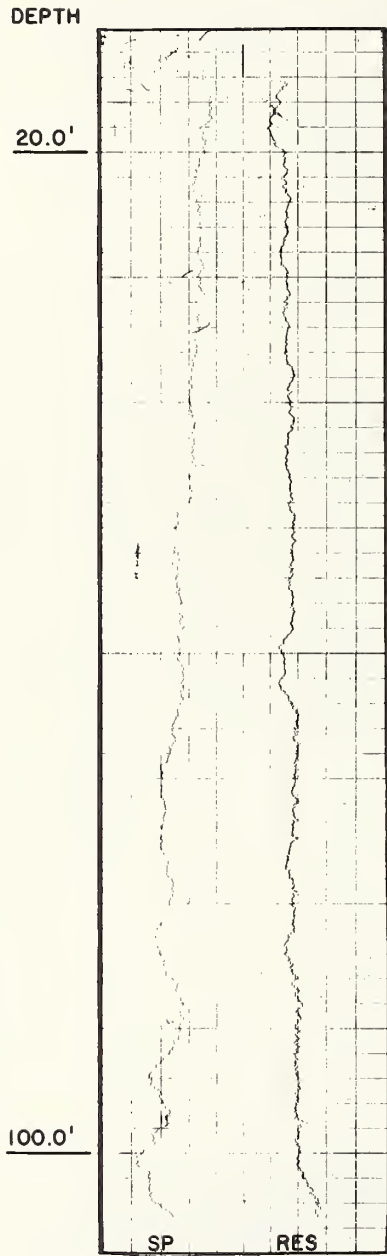

TSC17

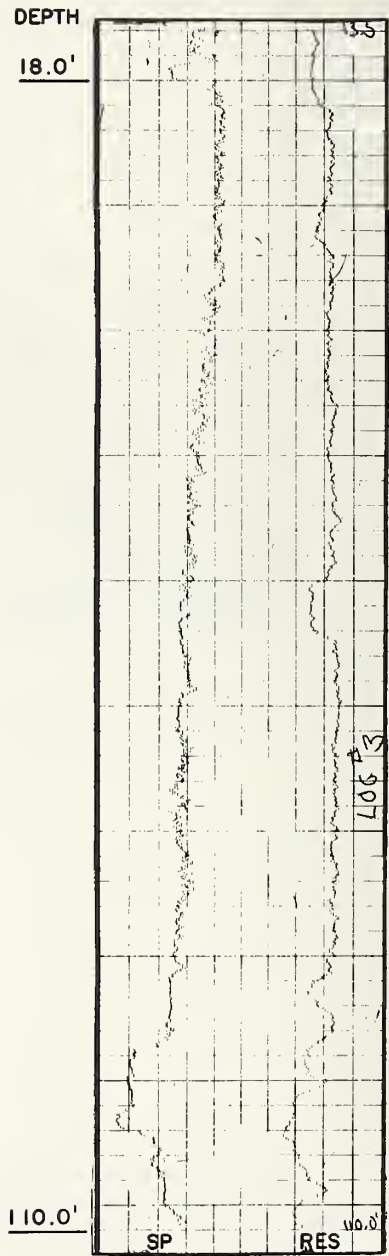

TSC21

APPENDIX G

TYPICAL CROSSHOLE SEISMIC SIGNATURES

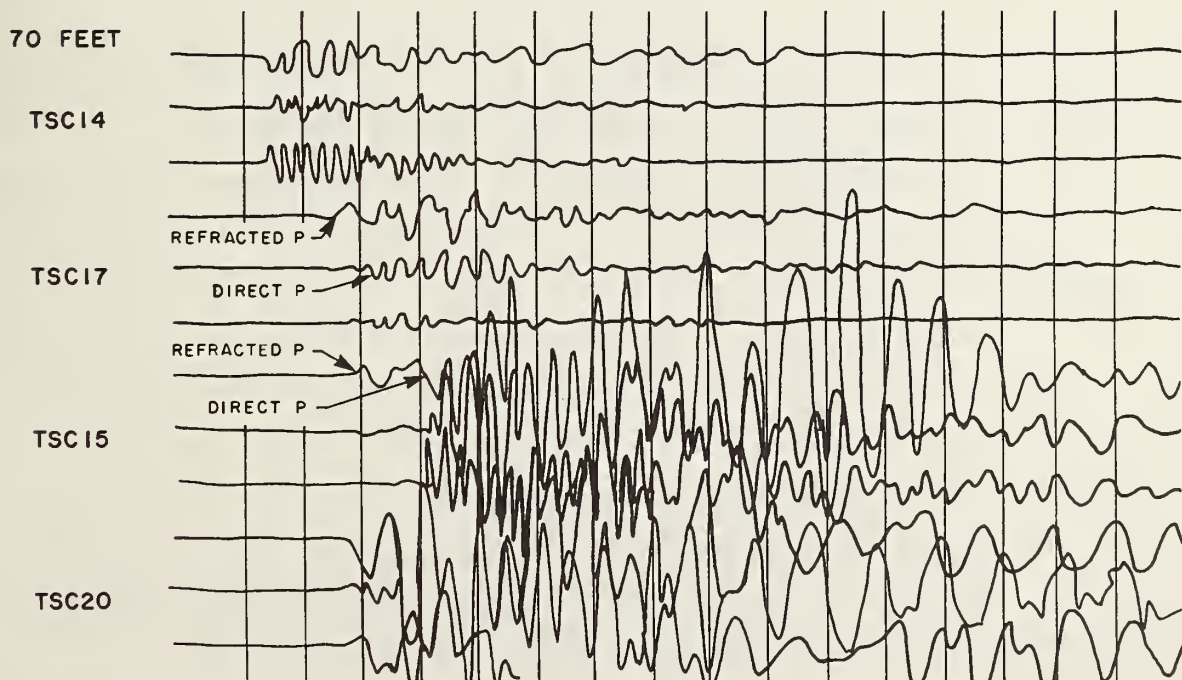
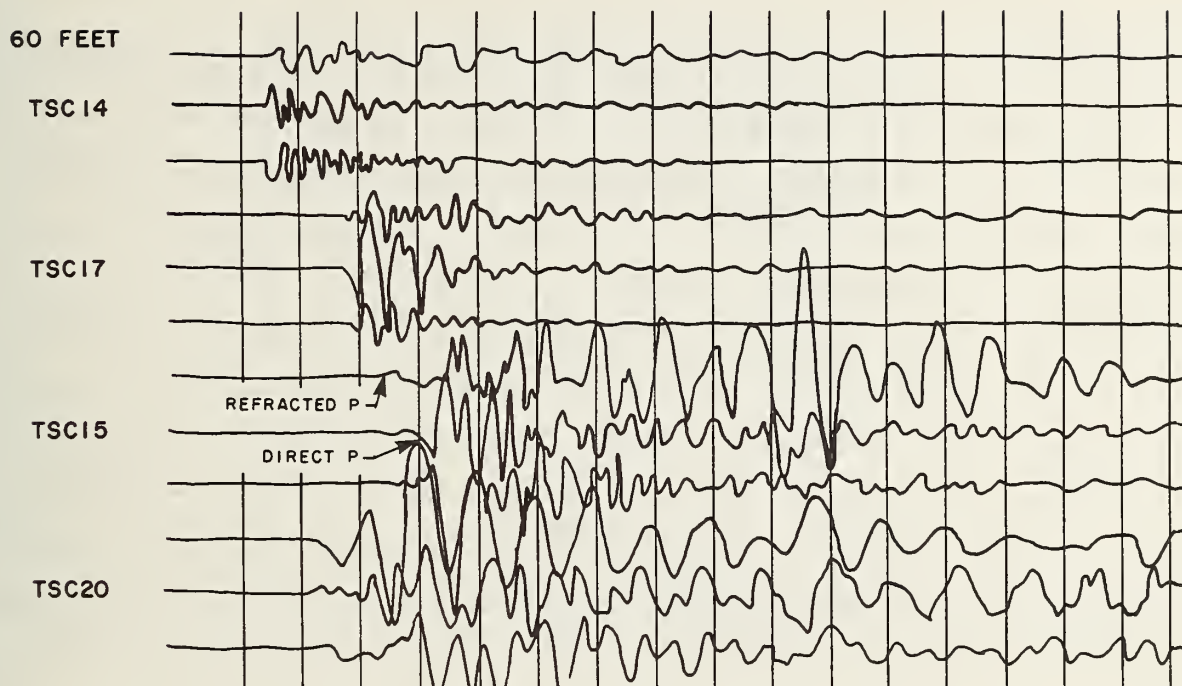

REFRACTED COMPRESSIONAL WAVES FROM UNDERLYING HIGH VELOCITY MATERIALS.

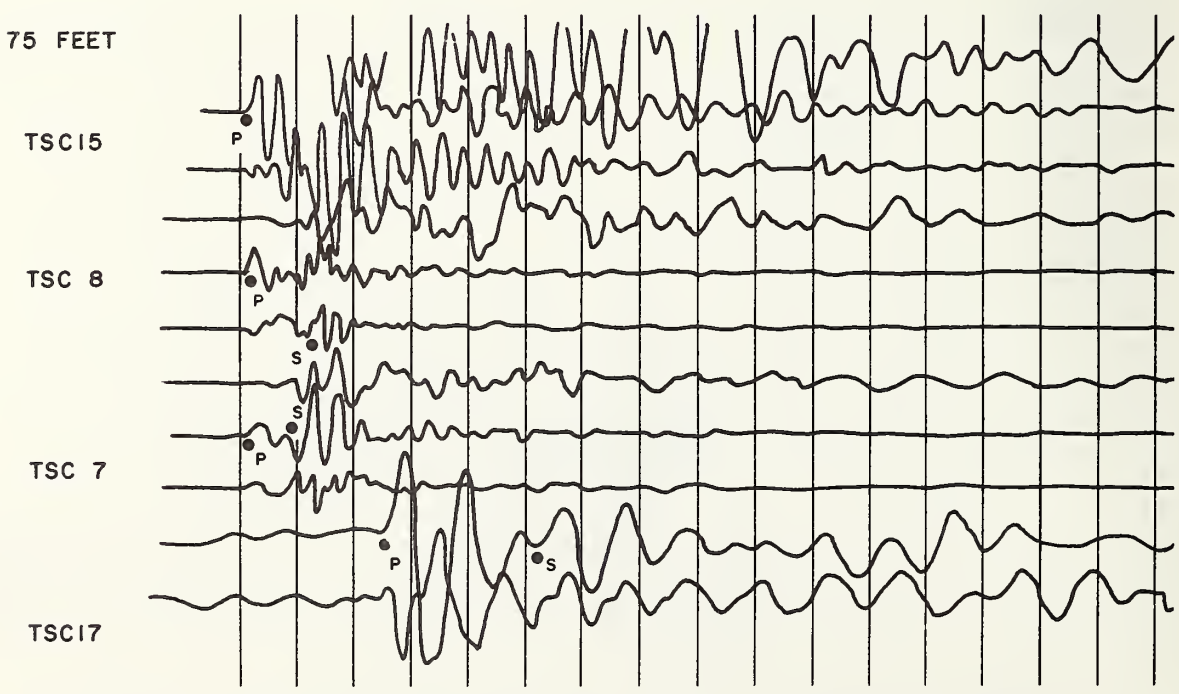
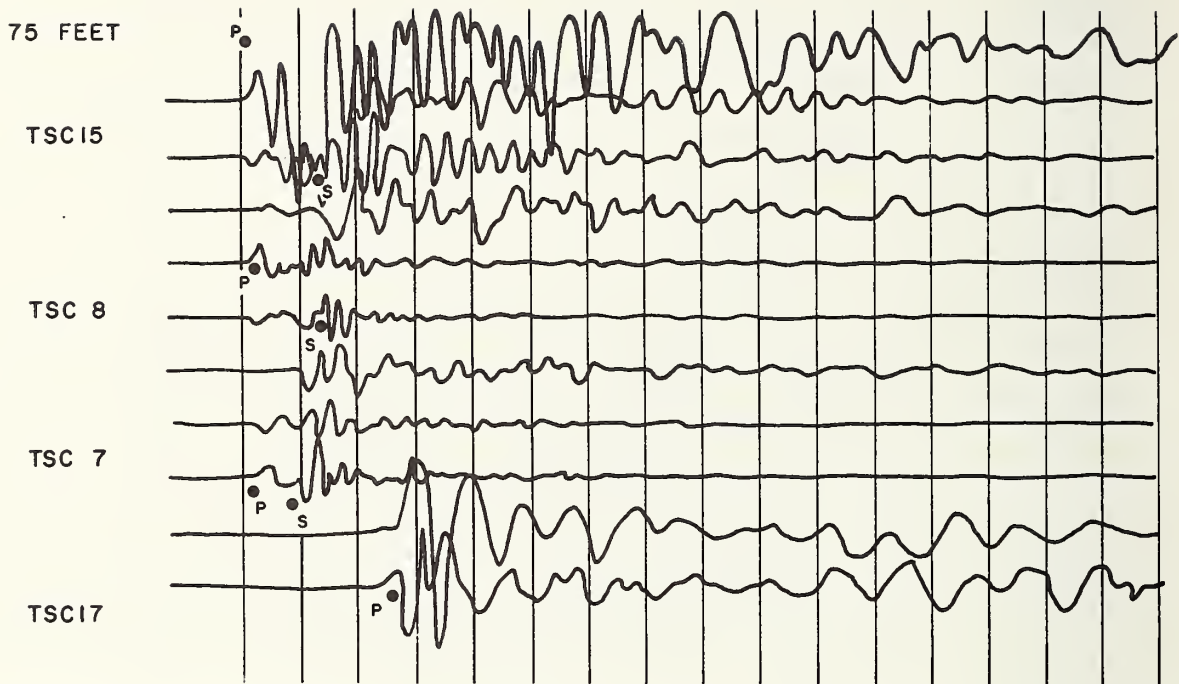

WAVE FORMS WITHOUT REFRACTION INTERFACE. GEOPHONES ROTATED IN LOWER TRACE.

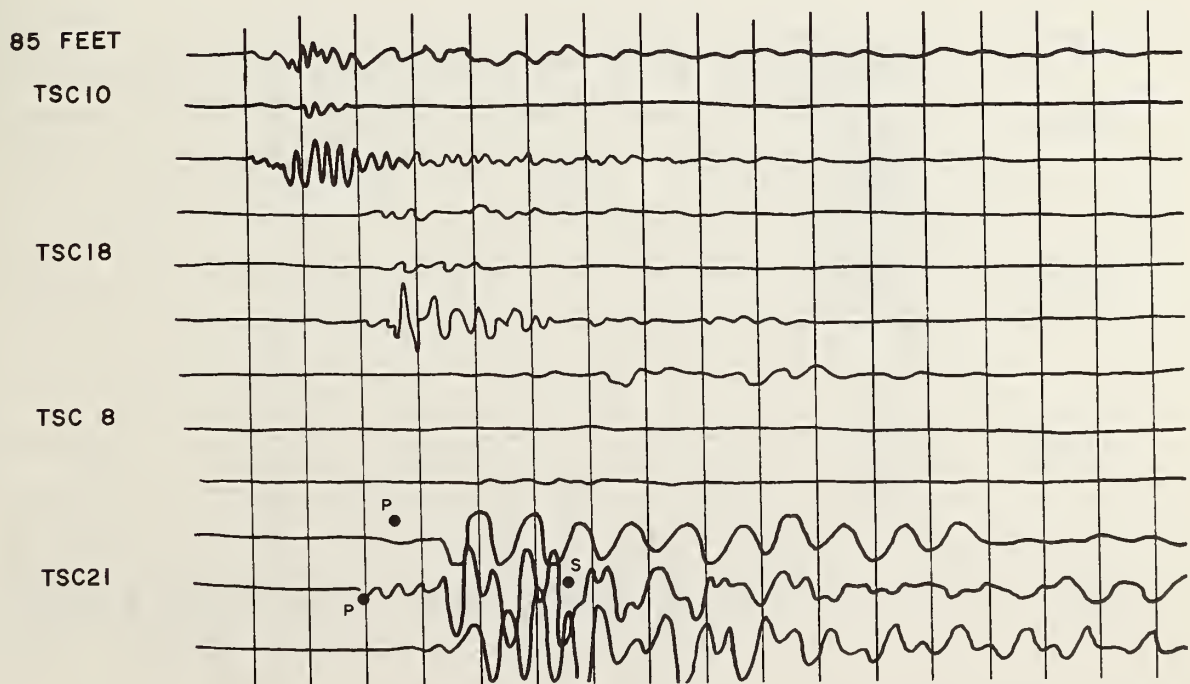
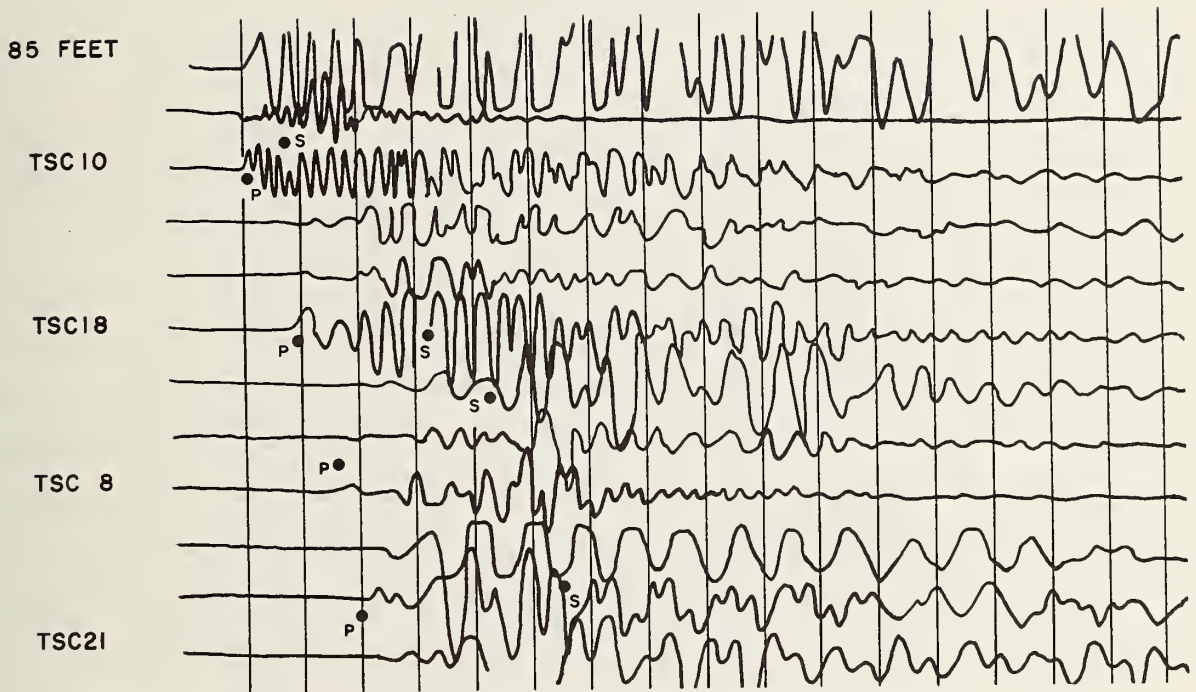

GAIN-RANGING CAPABILITY OF RECORDING SYSTEM SHOWN IN UPPER HALF OF EACH RECORD.

90 FEET

TSC15

TSC18

TSC16

TSC17

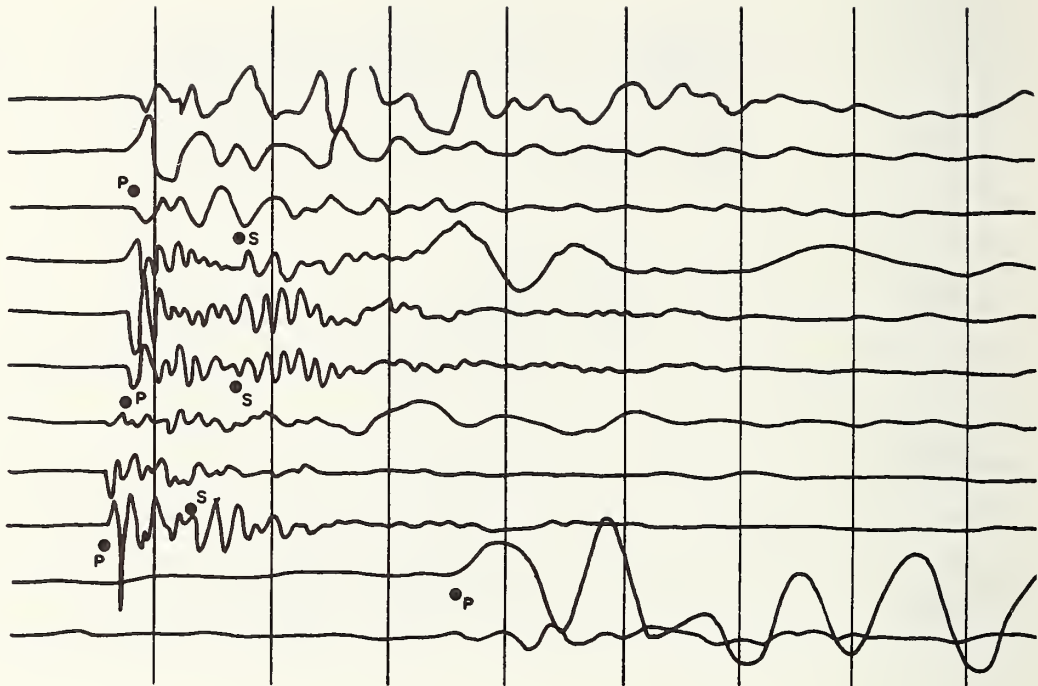

90 FEET

TSC15

TSC18

TSC16

TSC17

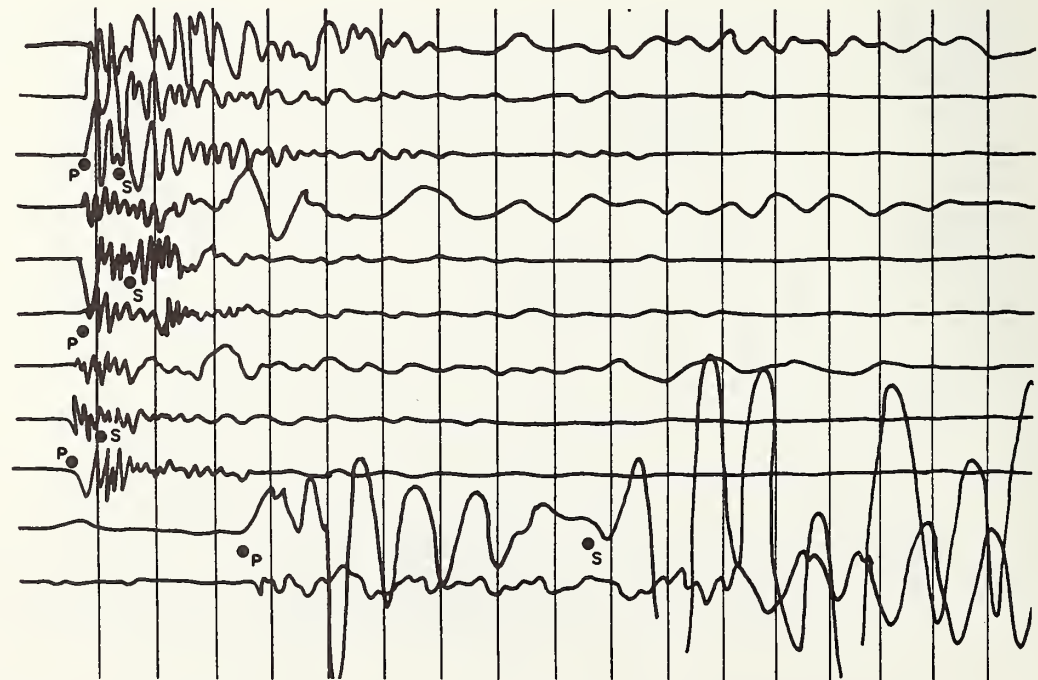

EXPANDED TIME SCALE PLAYOUT (UPPER) AND CONDENSED TIME SCALE PLAYOUT (LOWER).

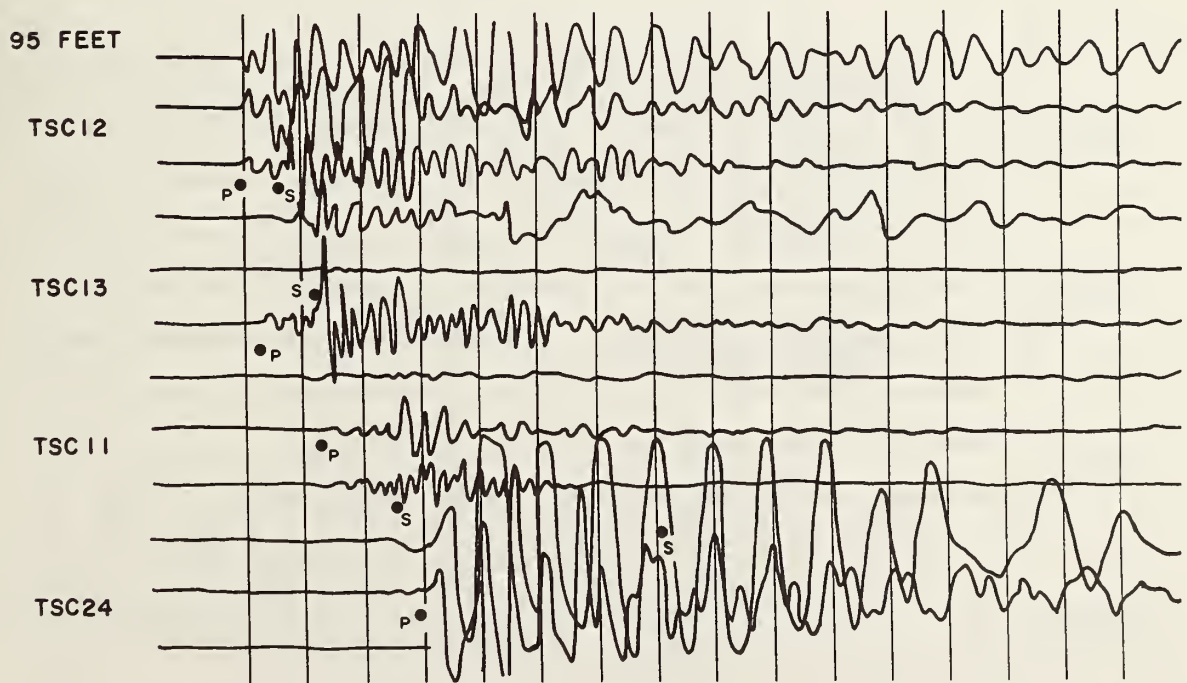
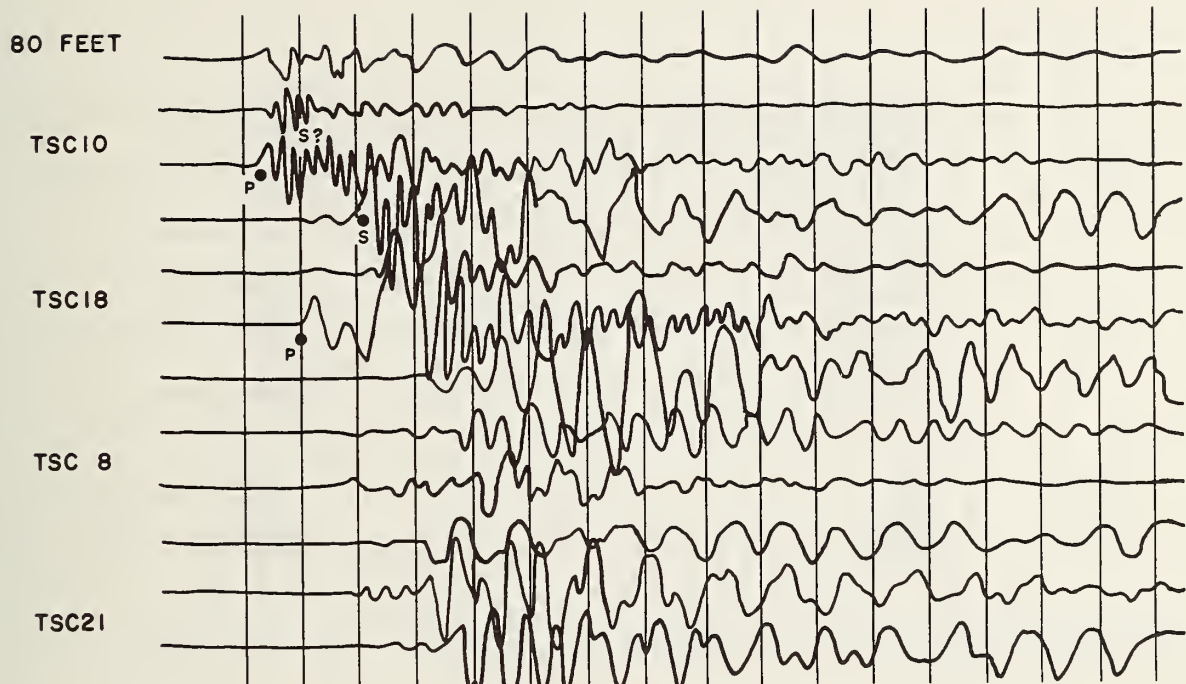

TYPICAL WAVEFORMS.

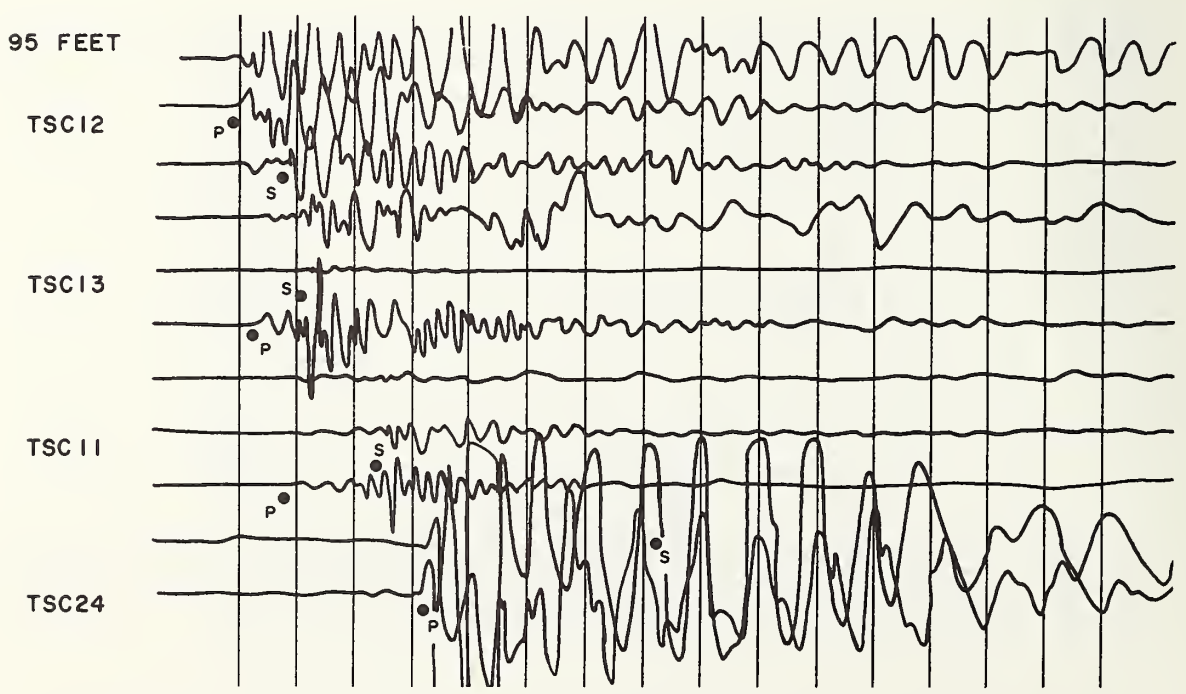
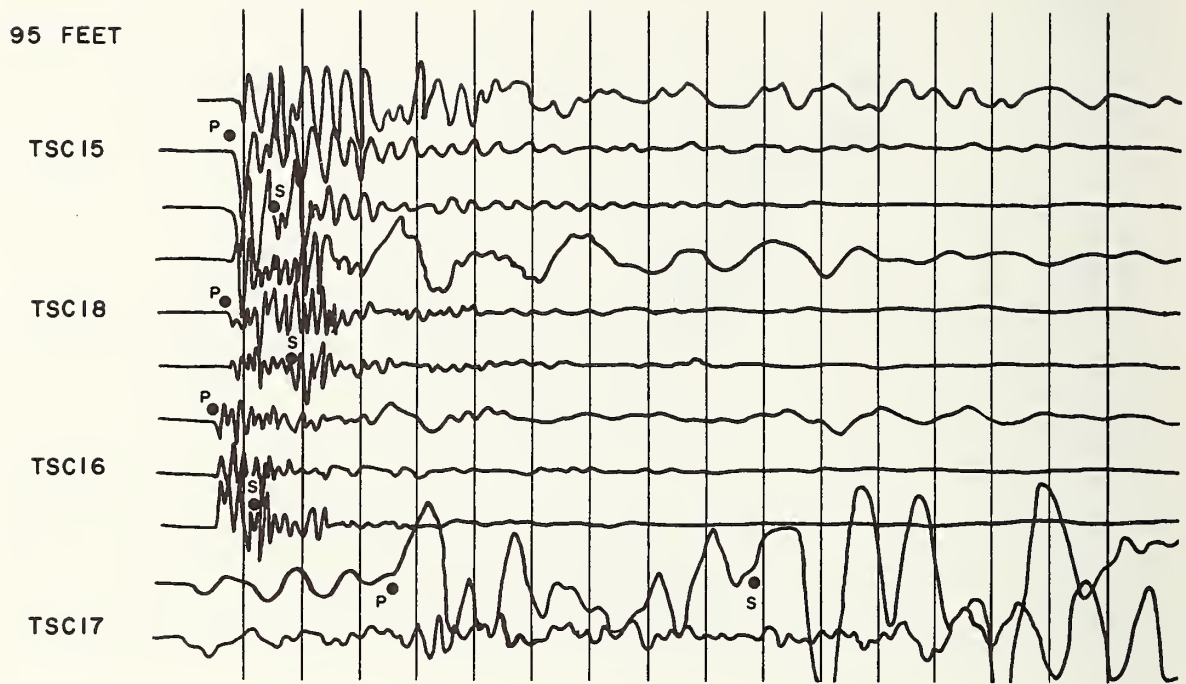

TYPICAL WAVEFORMS AFTER ROTATION.

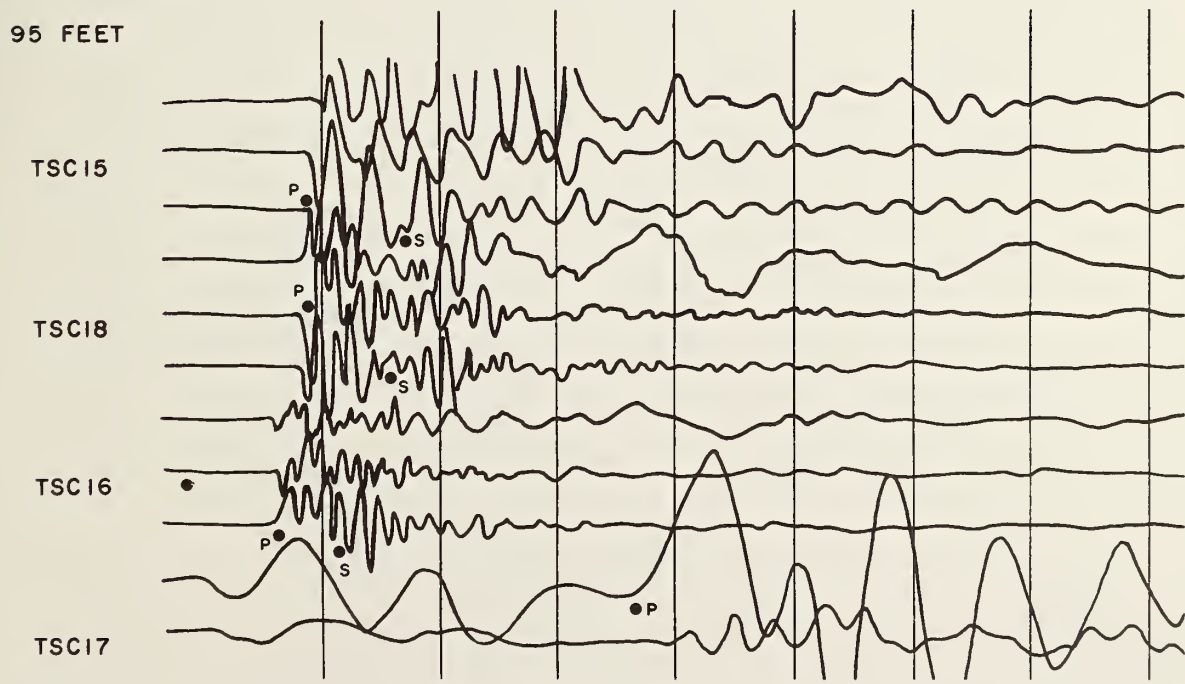
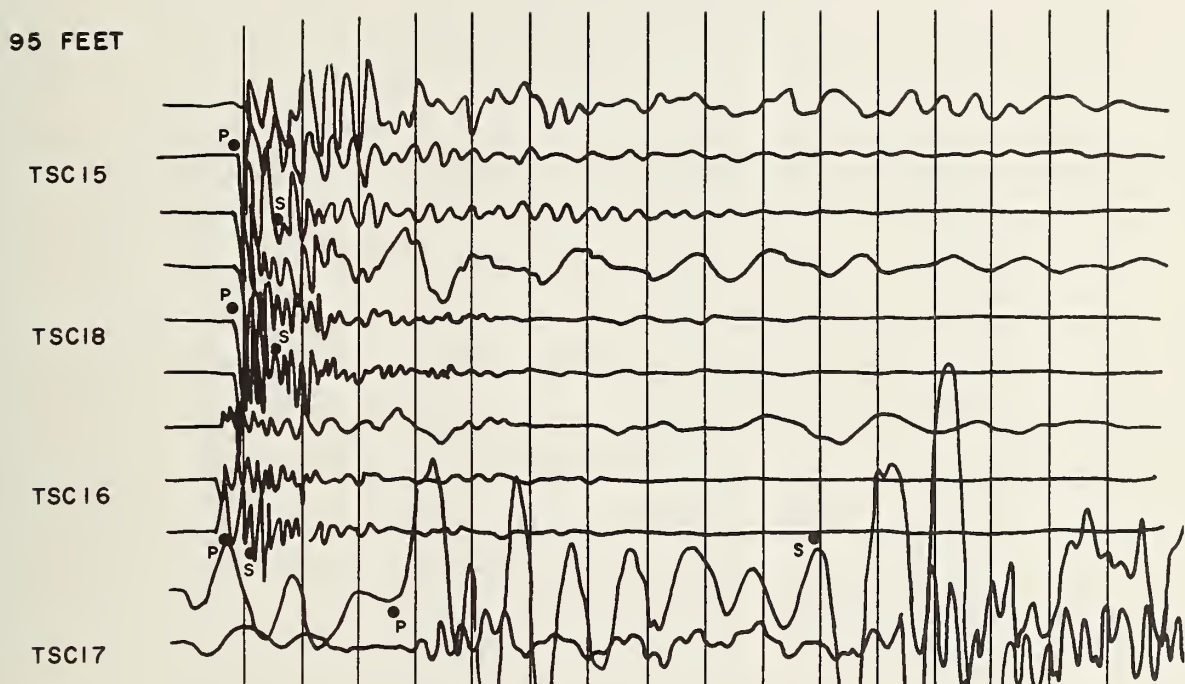

EXPANDED PLAYOUT IN LOWER HALF. NOTE GROUND ROLL AT TSC17 CAUSED BY PASSING VEHICLES.

APPENDIX H
SEISMIC CROSSHOLE SECTIONS

CROSSHOLE TEST SERIES

I

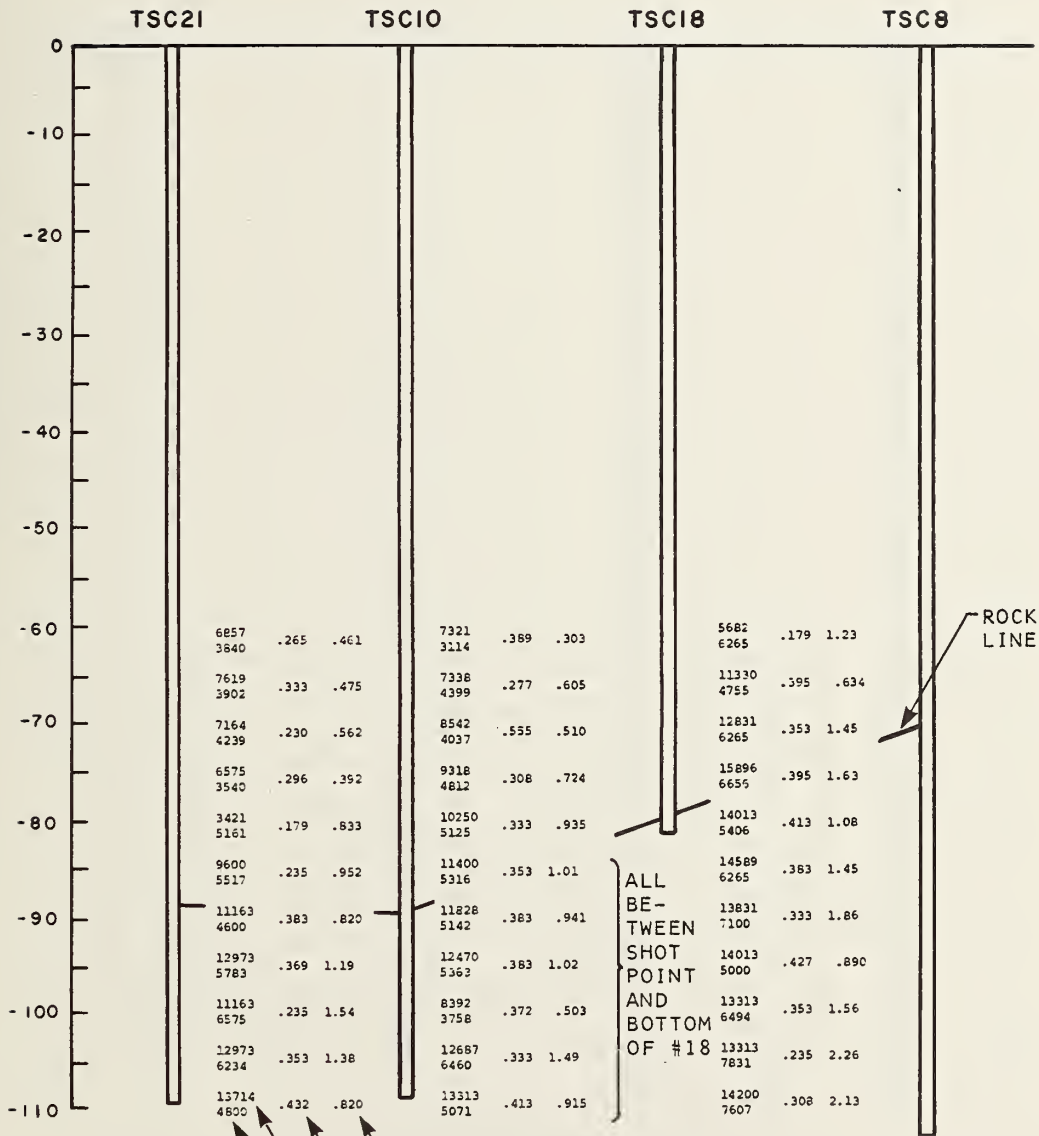

ALL
BE-
TWEEN
SHOT
POINT
AND
BOTTOM
OF #18

ROCK
LINE

YOUNG'S MODULUS ($\times 10^6$ PSI)
POISSON'S RATIO
P - WAVE VELOCITY (FT/SEC)
S - WAVE VELOCITY (FT/SEC)

SCALE
HOR. 1" = 40'
VER. 1" = 20'

CROSSHOLE TEST SERIES

2

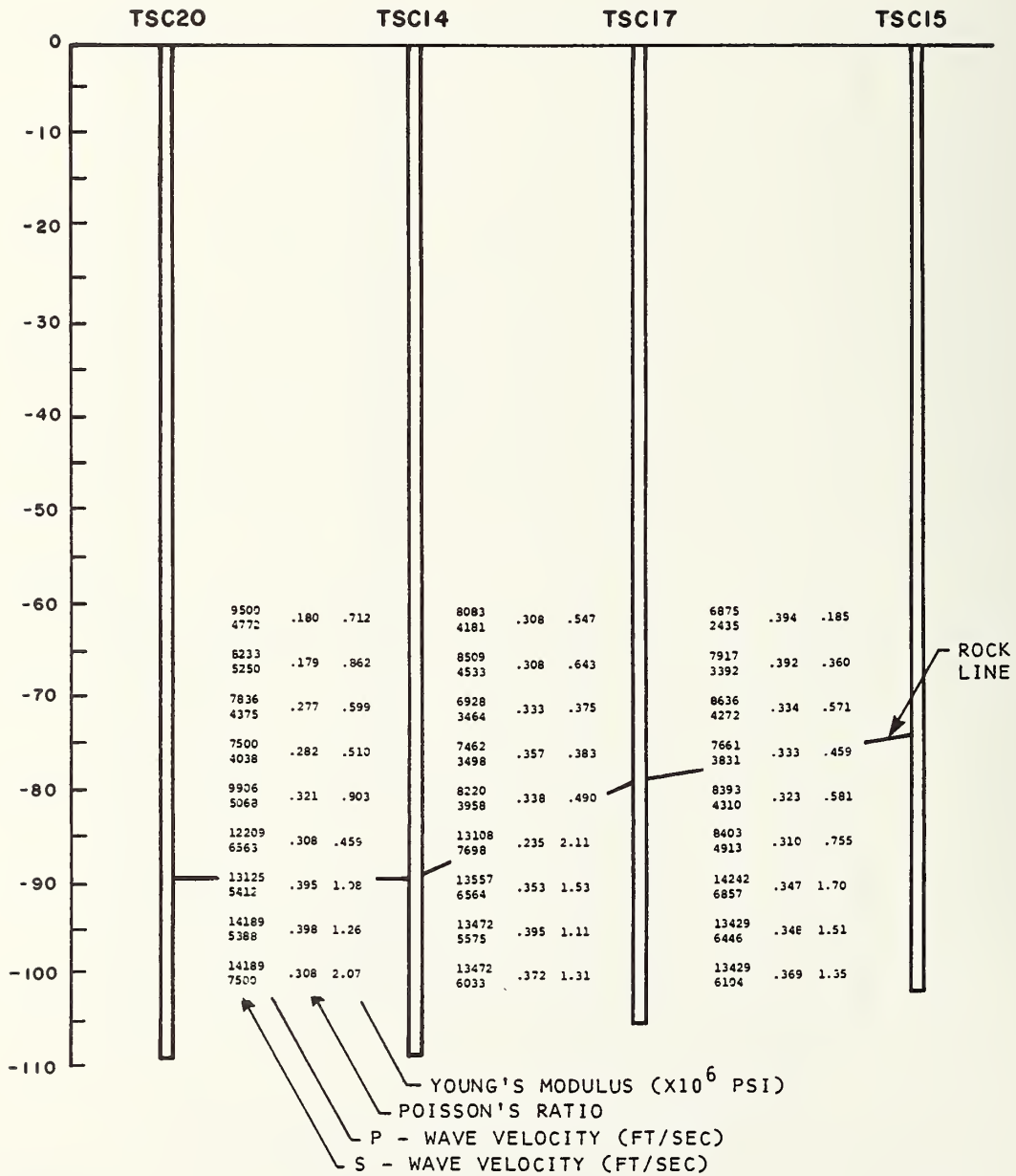

SCALE
 HOR. 1" = 40'
 VER. 1" = 20'

CROSSHOLE TEST SERIES

3

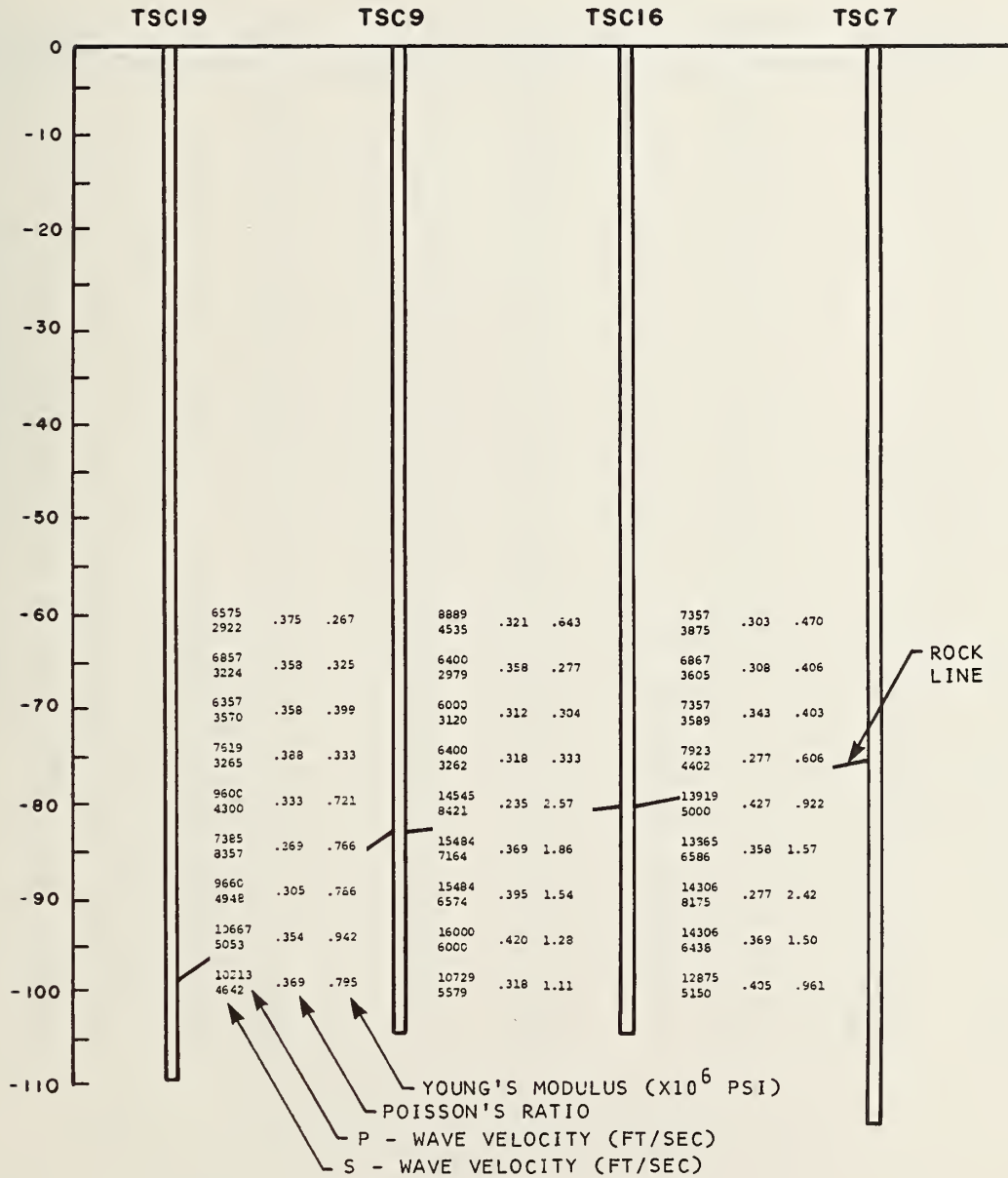

SCALE
 HOR. 1" = 40'
 VER. 1" = 20'

CROSSHOLE TEST SERIES

4A

4B

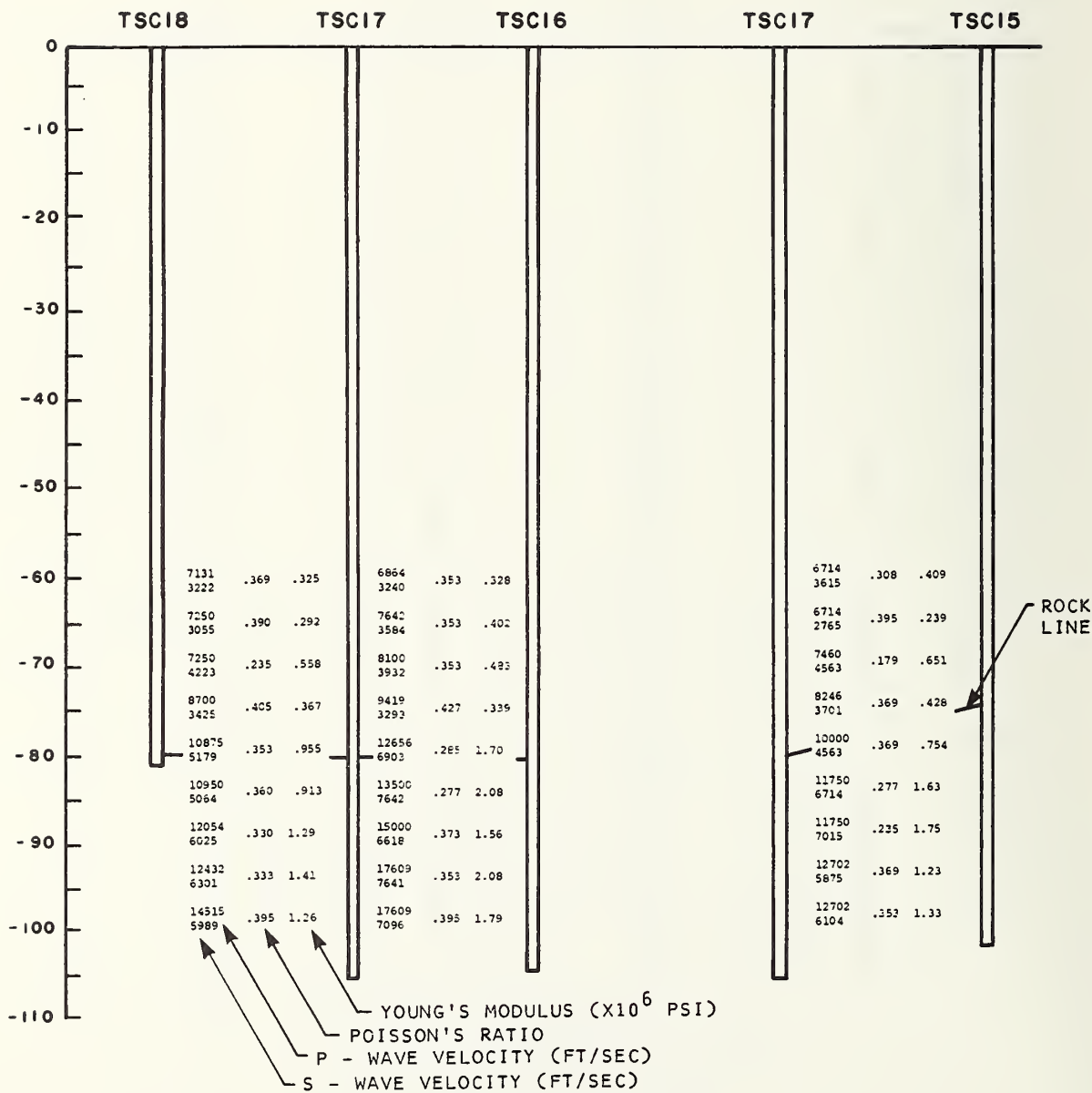

SCALE
 HOR. 1" = 40'
 VER. 1" = 20'

CROSSHOLE TEST SERIES

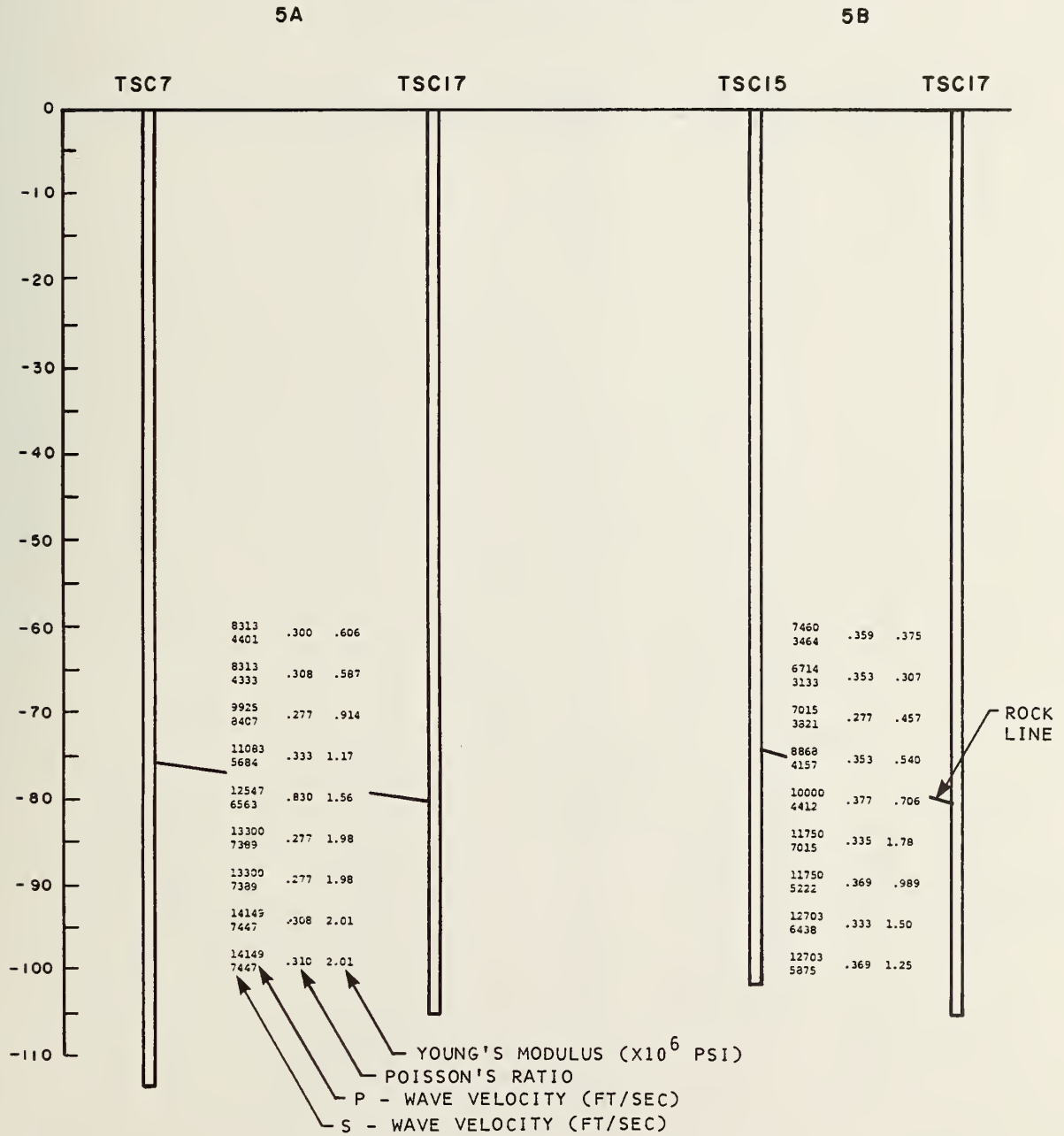

SCALE
 HOR. 1" = 40'
 VER. 1" = 20'

CROSSHOLE TEST SERIES

5C

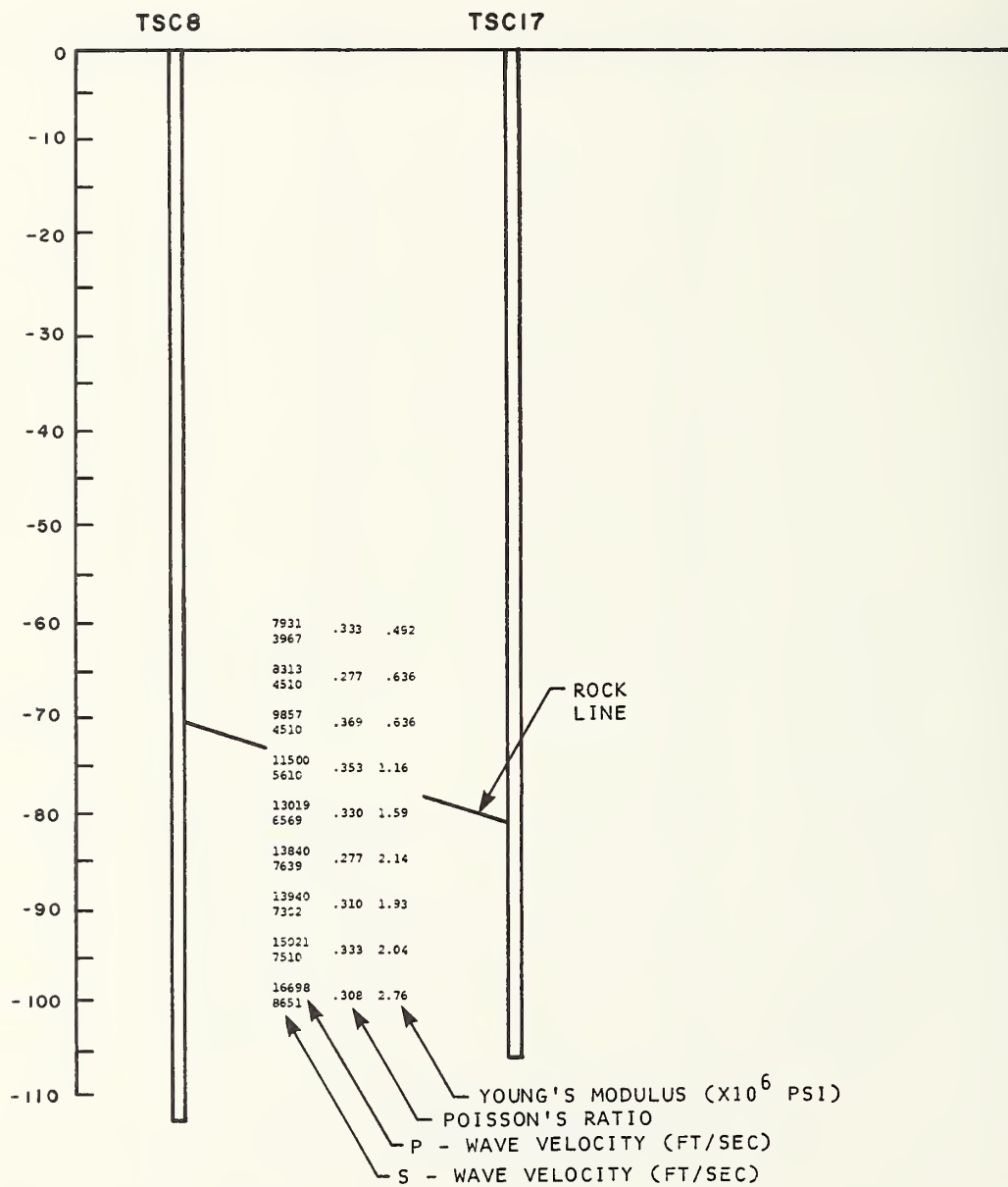

SCALE
 HOR. 1" = 40'
 VER. 1" = 20'

CROSSHOLE TEST SERIES

6A

6B

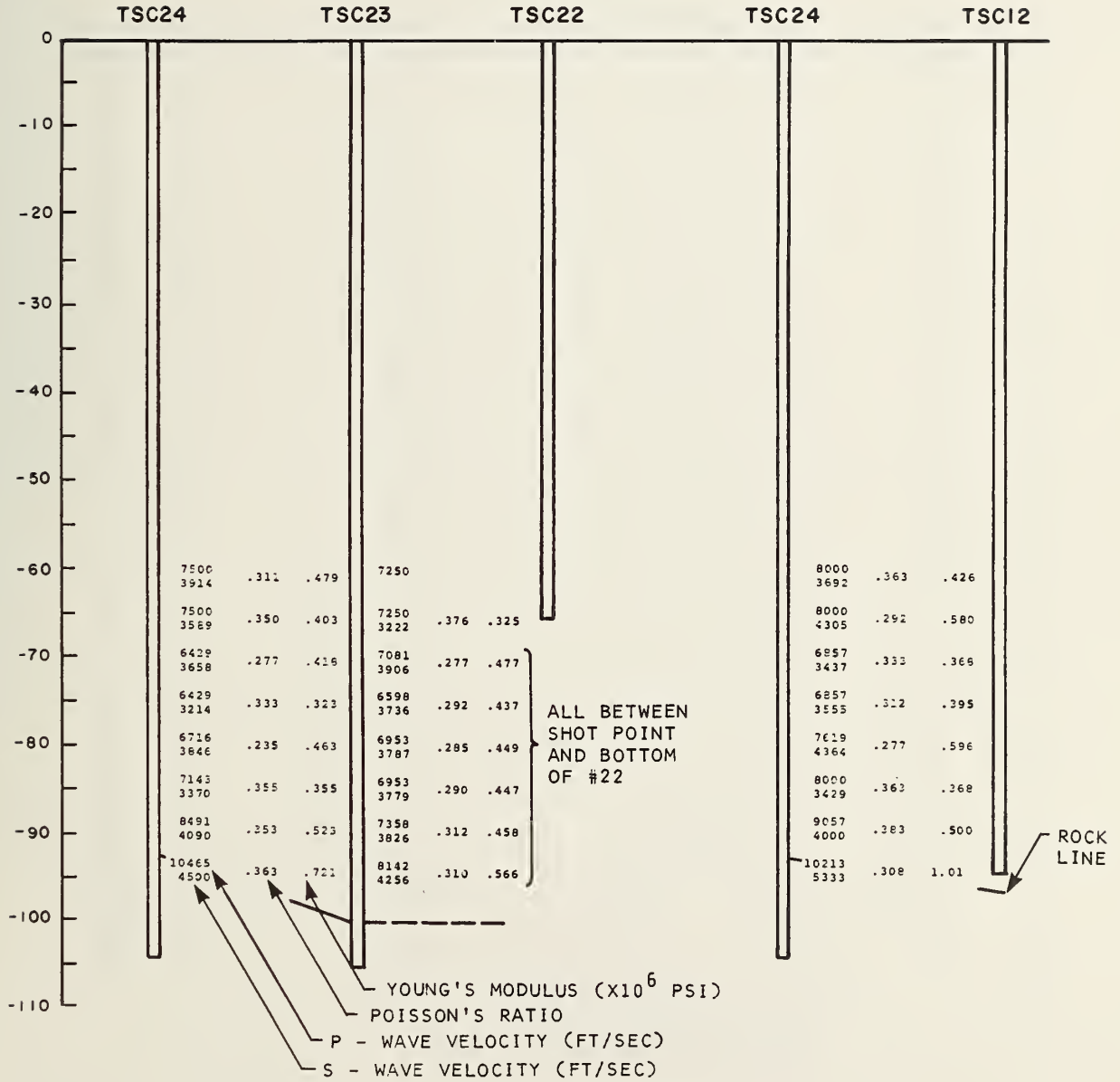

SCALE
 HOR. 1" = 40'
 VER. 1" = 20'

CROSSHOLE TEST SERIES

7A

7B

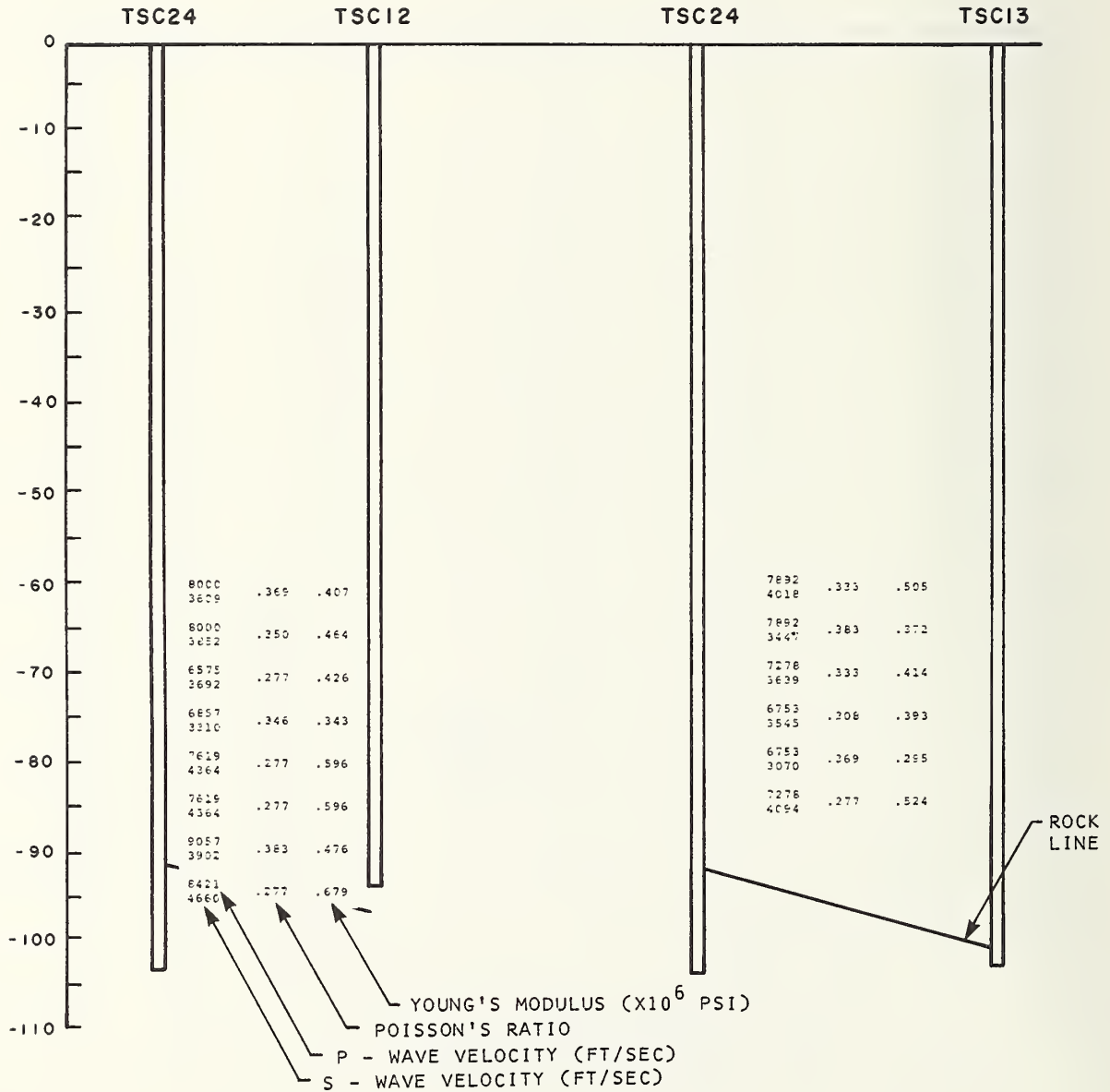

SCALE
 HOR. 1" = 40'
 VER. 1" = 20'

CROSSHOLE TEST SERIES

7C

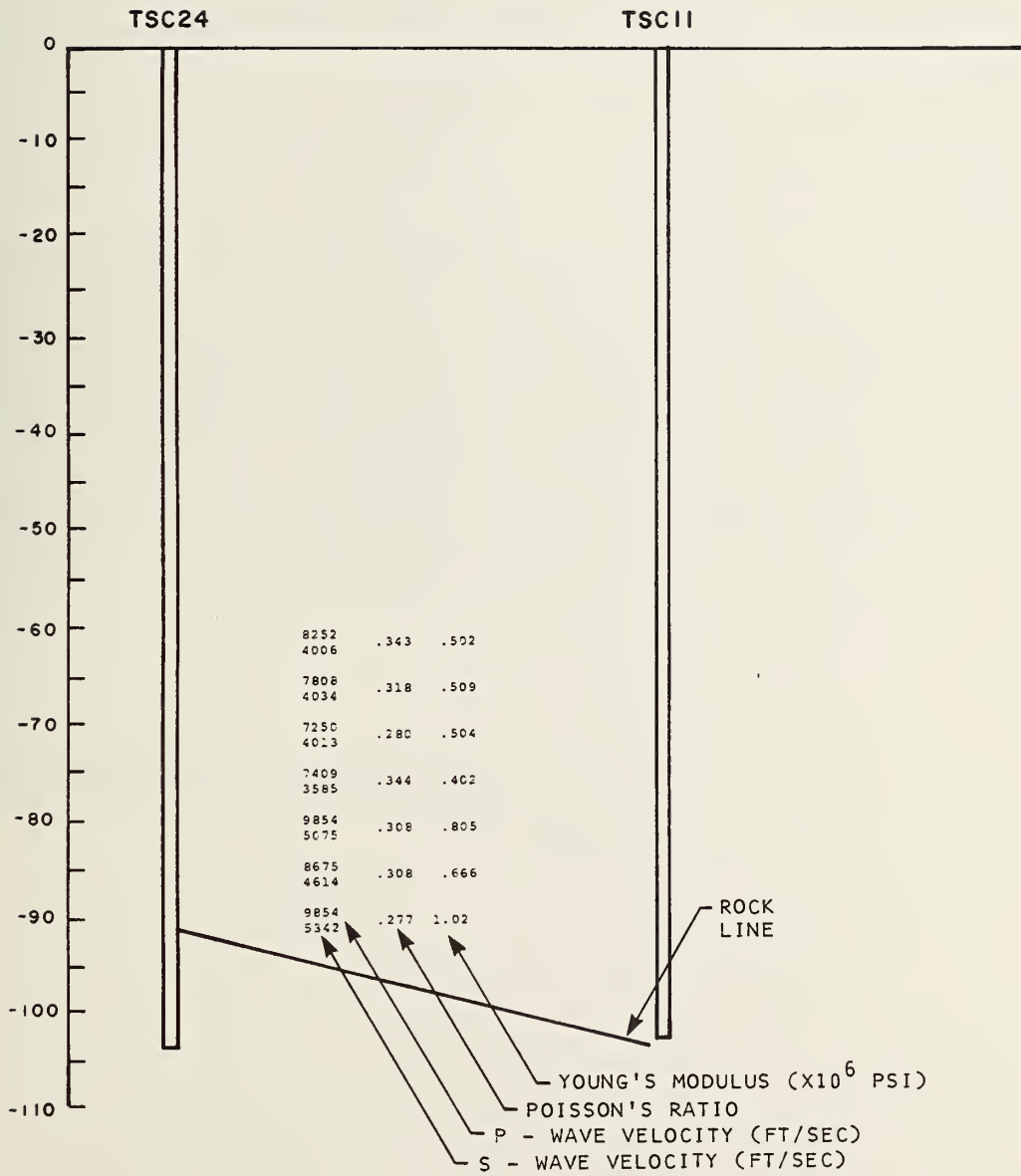

SCALE
 HOR. 1" = 40'
 VER. 1" = 20'

APPENDIX I

LABORATORY PERMEABILITY TEST RESULTS

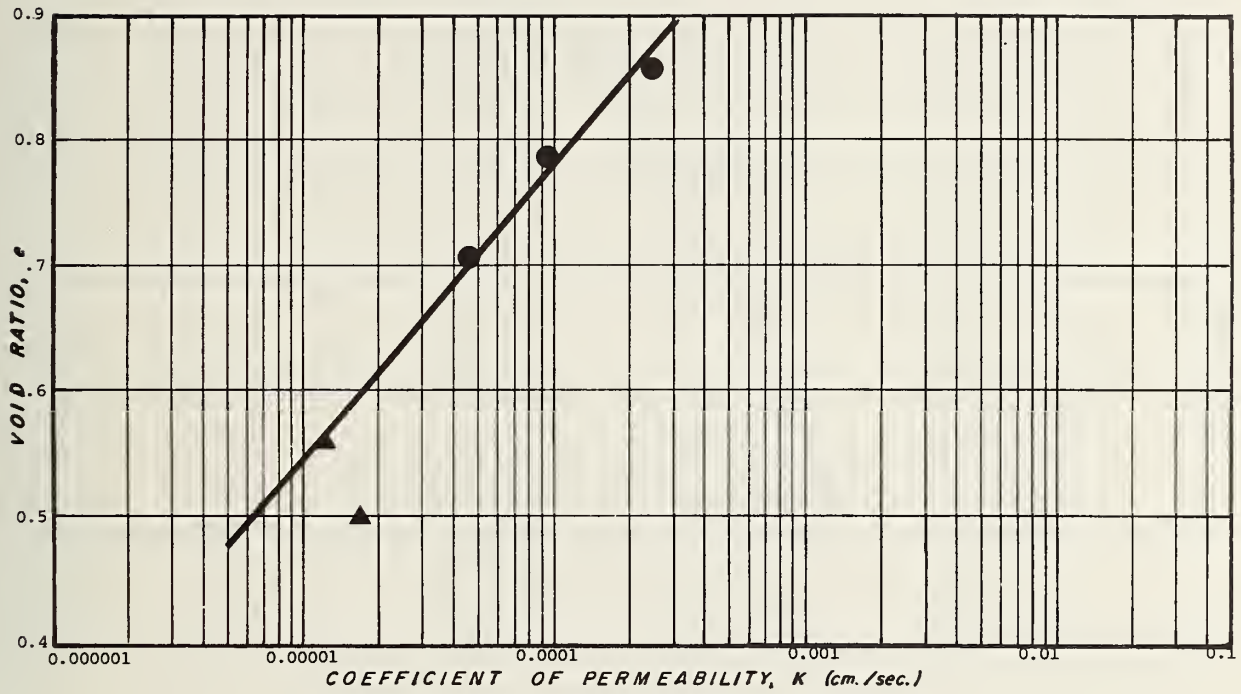

Boring	Sample	Depth(ft.)	Description	Symbol	Method
10	P1	76.5 - 77.1	Gray SILT	●	Falling head
				▲	Constant head

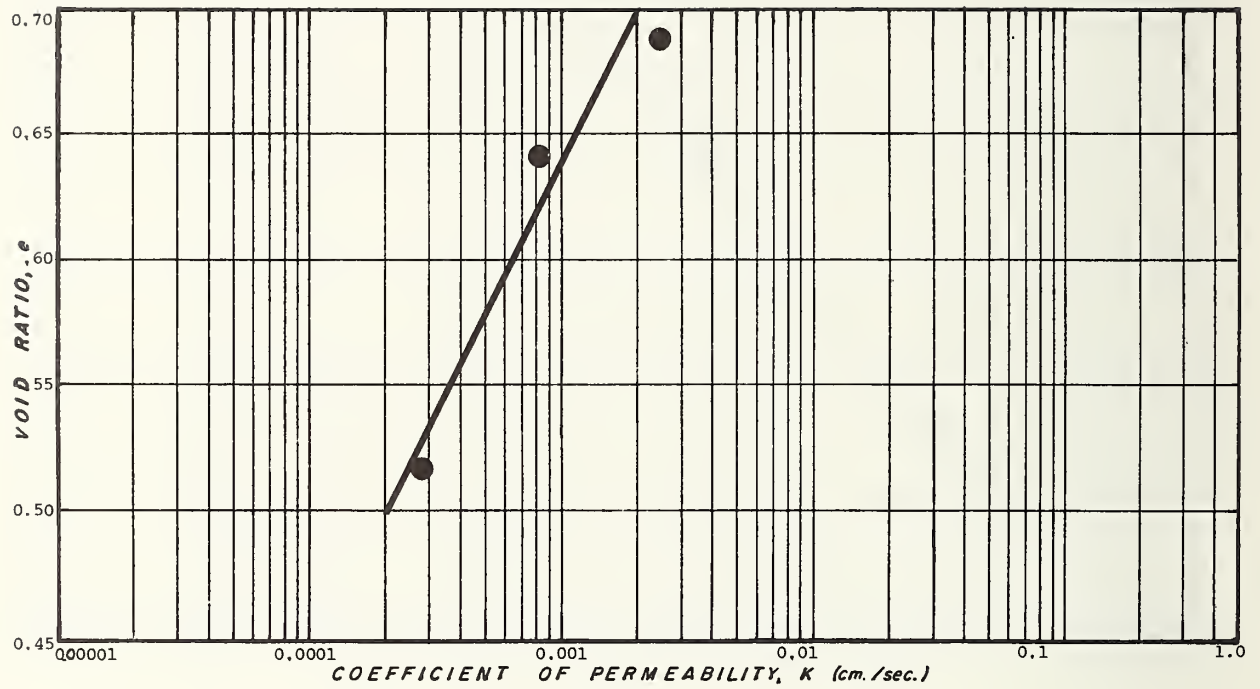

<u>Boring</u>	<u>Sample</u>	<u>Depth (ft.)</u>	<u>Description</u>
10	P1	77.1 - 78.0	Gray coarse to fine SAND, trace silt

APPENDIX J

LABORATORY GRAIN SIZE DISTRIBUTION CURVES

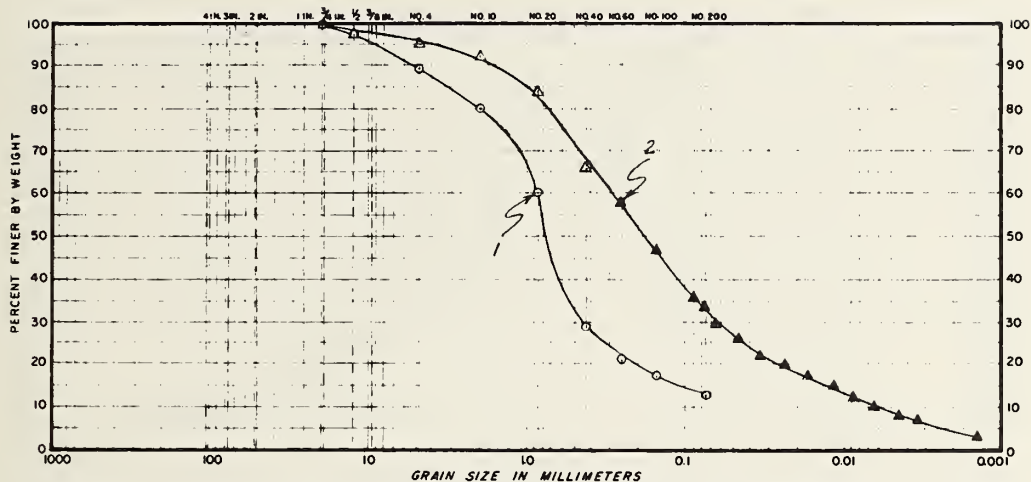

COBBLES	GRAVEL		SAND			SILT OR CLAY
	COARSE	FINE	COARSE	MEDIUM	FINE	

UNIFIED SOIL CLASSIFICATION SYSTEM, CORPS OF ENGINEERS, U.S. ARMY

Test No.	Boring	Sample	Depth(ft.)	Description
1	7	1	70-72	Gray coarse to fine SAND, little silt, little gravel
2	7	2a	72-73.4	Gray silty medium to fine SAND, trace gravel

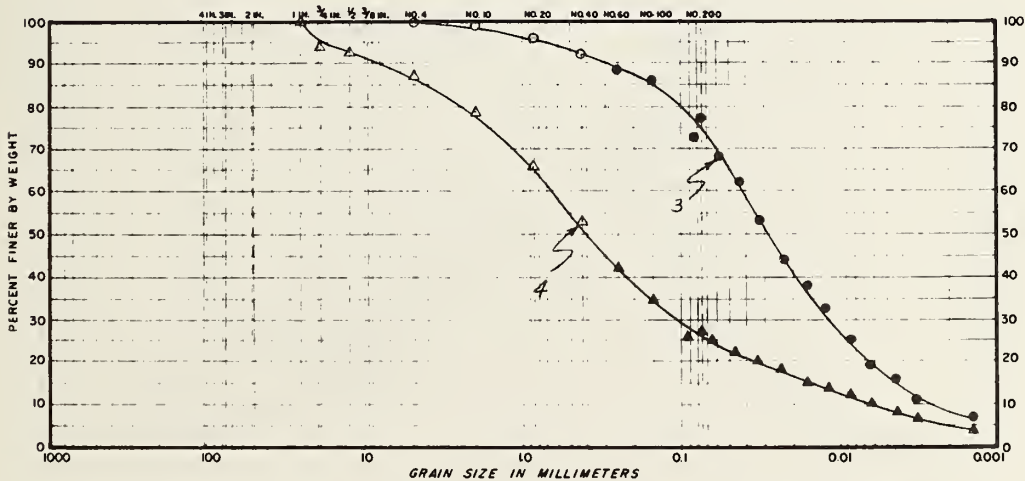

COBBLES	GRAVEL		SAND			SILT OR CLAY
	COARSE	FINE	COARSE	MEDIUM	FINE	

UNIFIED SOIL CLASSIFICATION SYSTEM, CORPS OF ENGINEERS, U.S. ARMY

Test No.	Boring	Sample	Depth(ft.)	LL%	PL%	PI%	Description
3	7	2b	73.4 - 73.8	16.8	14.7	2.1	Gray sandy SILT, trace clay
4	7	3	74-74.9	-	-	-	Gray silty coarse to fine SAND, little gravel

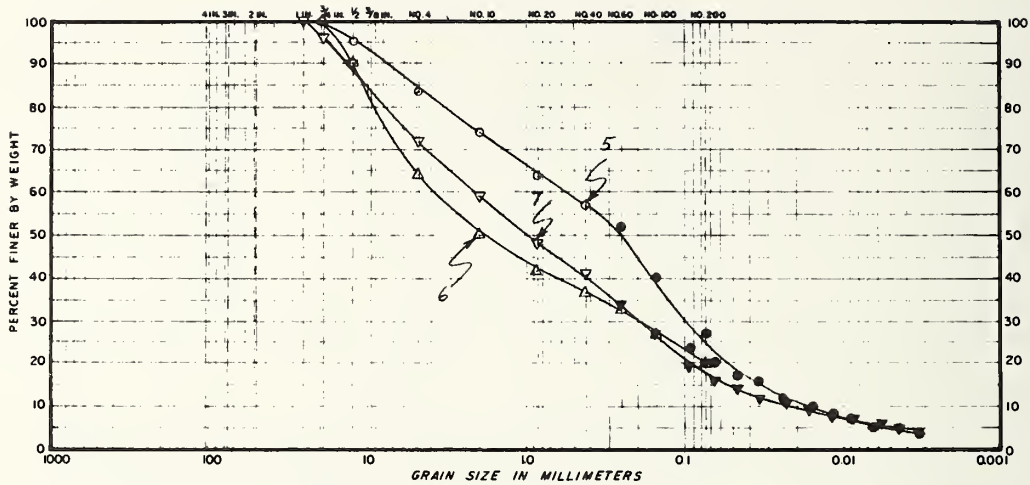

COBBLES	GRAVEL		SAND			SILT OR CLAY
	COARSE	FINE	COARSE	MEDIUM	FINE	

UNIFIED SOIL CLASSIFICATION SYSTEM, CORPS OF ENGINEERS, U.S. ARMY

Test No.	Boring	Sample	Depth (ft)	Description
5	9	1	70-71	Gray silty coarse to fine SAND, little gravel
6	9	2	72-72.5	Gray gravelly coarse to fine SAND, little silt
7	9	3	75-77	Gray gravelly coarse to fine SAND, little silt

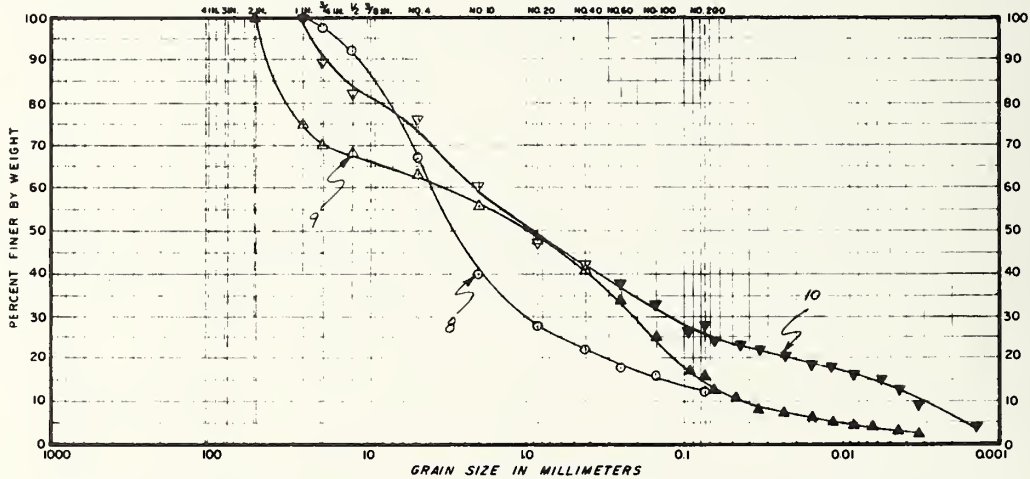

COBBLES	GRAVEL		SAND			SILT OR CLAY
	COARSE	FINE	COARSE	MEDIUM	FINE	

UNIFIED SOIL CLASSIFICATION SYSTEM, CORPS OF ENGINEERS, U.S. ARMY

Test No.	Boring	Sample	Depth (ft)	Description
8	9	4	77-78.5	Gray gravelly coarse to fine SAND, little silt
9	9	5	79-80.5	Gray gravelly coarse to fine SAND, little silt
10	9	6	83.0-83.2	Gray gravelly coarse to fine SAND, little silt, trace clay

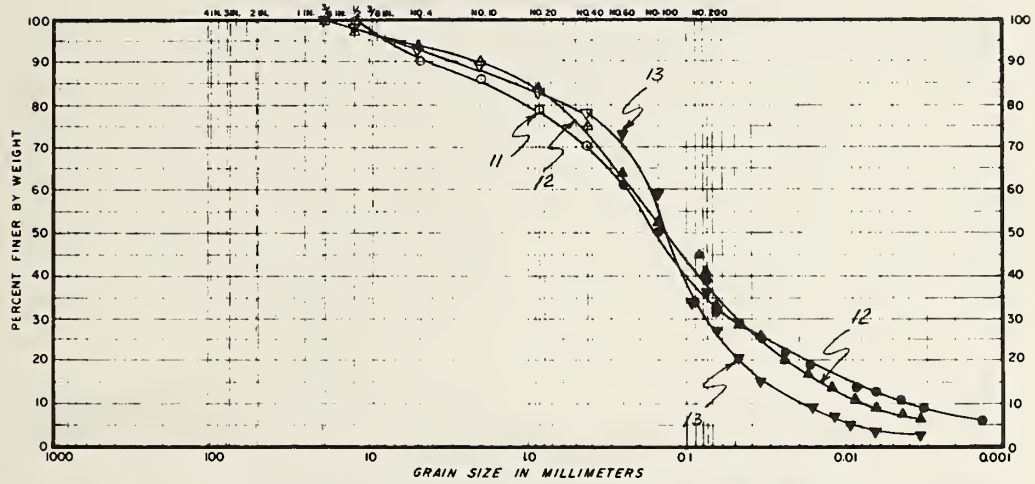

COBBLES	GRAVEL		SAND			SILT OR CLAY
	COARSE	FINE	COARSE	MEDIUM	FINE	

UNIFIED SOIL CLASSIFICATION SYSTEM, CORPS OF ENGINEERS, U.S. ARMY

Test No.	Boring	Sample	Depth (ft)	Description
11	10	D1	65-65.3	Gray silty medium to fine SAND, trace gravel, trace clay
12	10	1	67.7-69.7	Gray silty medium to fine SAND, trace gravel
13	10	2	70.0-70.8	Gray silty medium to fine SAND, trace gravel

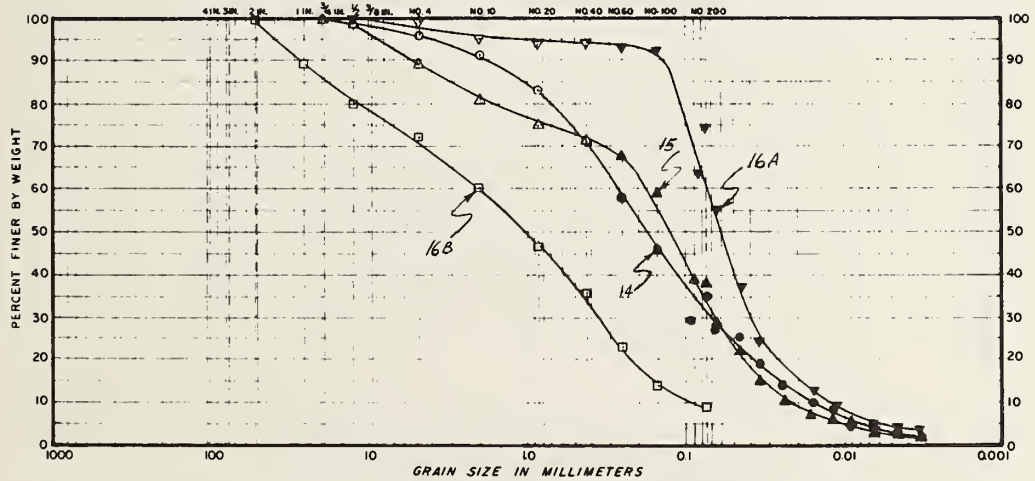

COBBLES	GRAVEL		SAND			SILT OR CLAY
	COARSE	FINE	COARSE	MEDIUM	FINE	

UNIFIED SOIL CLASSIFICATION SYSTEM, CORPS OF ENGINEERS, U.S. ARMY

Test No.	Boring	Sample	Depth (ft)	W_n (%)	γ_t (pcf)	Description
14	10	3	72-73.5	-	-	Gray silty medium to fine SAND
15	10	4	74-76	-	-	Gray silty coarse to fine SAND, little gravel
16A	10	P1	76.6-77.1	19.3	(137.1)	Gray sandy SILT
16B	10	P1	77.1-78	11.3		Gray gravelly coarse to fine SAND, trace silt

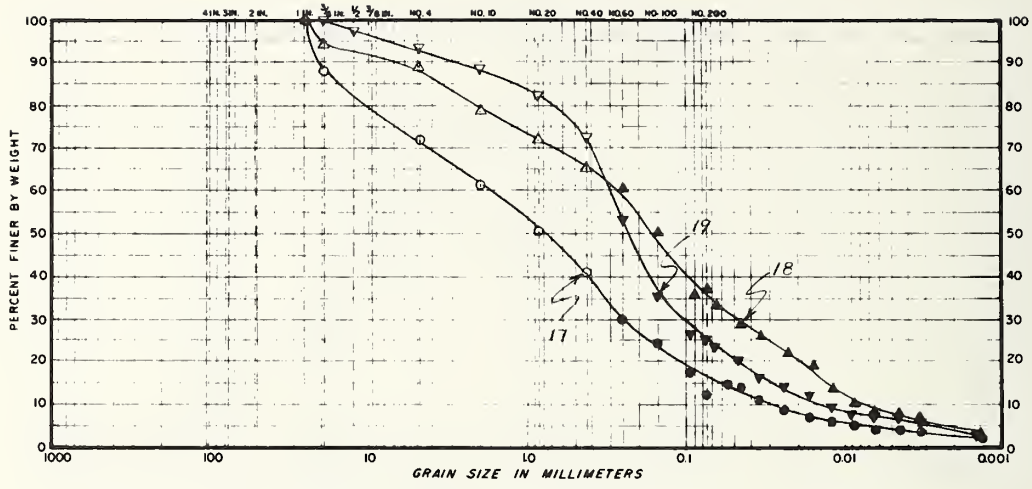

COBBLES	GRAVEL		SAND			SILT OR CLAY
	COARSE	FINE	COARSE	MEDIUM	FINE	

UNIFIED SOIL CLASSIFICATION SYSTEM, CORPS OF ENGINEERS, U.S. ARMY

Test No.	Boring	Sample	Depth(ft)	Description
17	10	5	78-80	Gray gravelly coarse to fine SAND, little silt
18	10	6	80.5-82.0	Gray silty coarse to fine SAND, trace gravel, trace clay
19	10	7	83-84.3	Gray silty medium to fine SAND, trace gravel

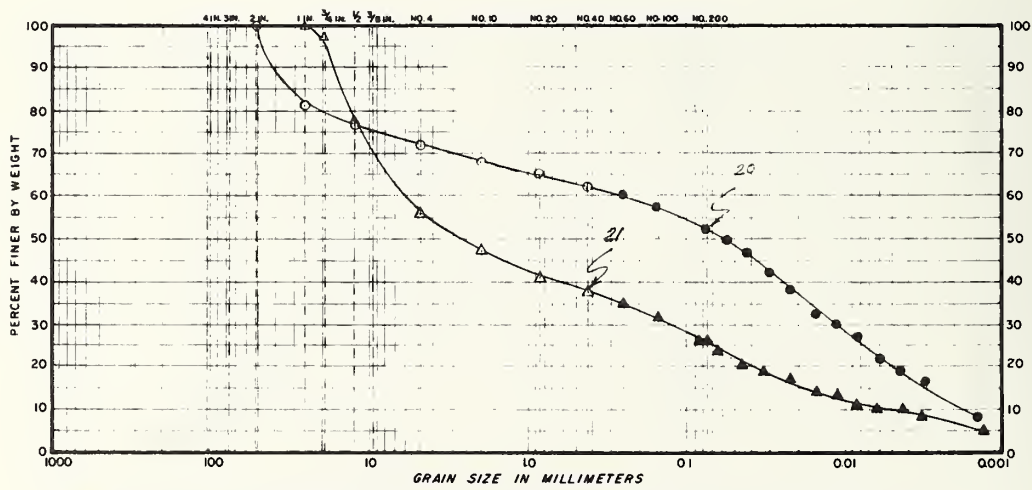

COBBLES	GRAVEL		SAND			SILT OR CLAY
	COARSE	FINE	COARSE	MEDIUM	FINE	

UNIFIED SOIL CLASSIFICATION SYSTEM, CORPS OF ENGINEERS, U.S. ARMY

Test No.	Boring	Sample	Depth(ft)	LL%	PL%	PI%	Description
20	10	C1	86-89.5	-	-	-	Gray gravelly SILT, some sand, little clay
21	10	8	89.5-90.3	32.0	18.1	13.9	Gray sandy GRAVEL, little silt, trace clay

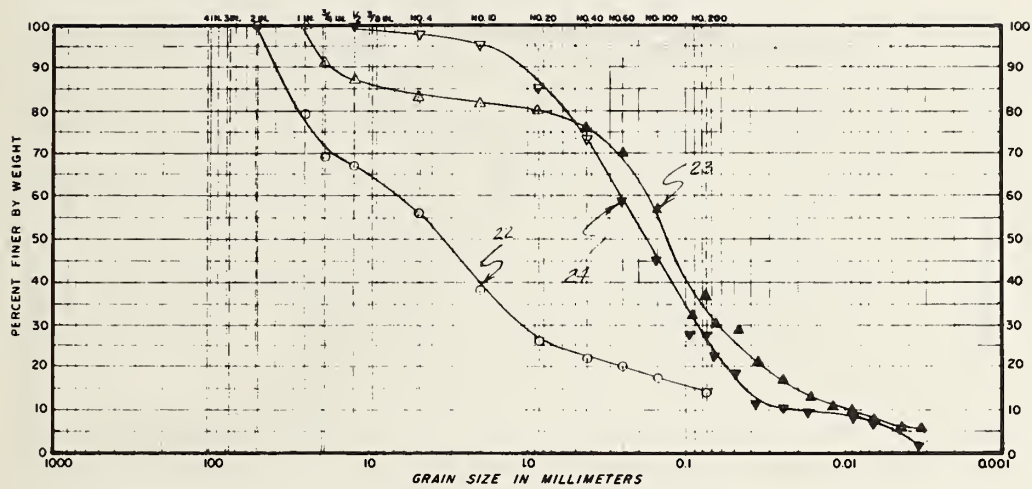

Test No.	Boring	Sample	Depth (ft)	GRAVEL			SAND			SILT OR CLAY
				COARSE	FINE	COARSE	MEDIUM	FINE		
UNIFIED SOIL CLASSIFICATION SYSTEM, CORPS OF ENGINEERS, U.S. ARMY										
22	11	1	65-66.4						Gray sandy GRAVEL, little silt	
23	11	3	72-72.8		non-plastic				Gray silty medium to fine SAND, little gravel	
24	11	4	74-74.5						Gray silty medium to fine SAND	

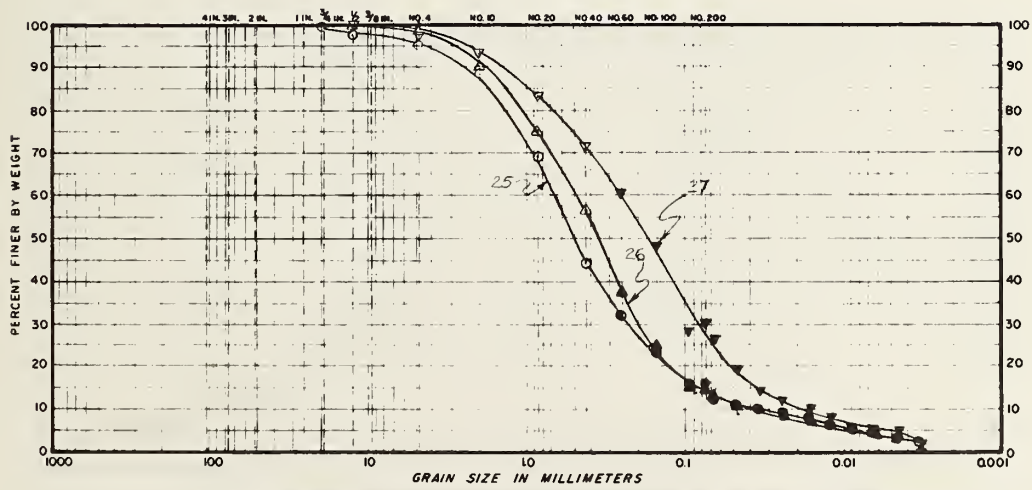

Test No.	Boring	Sample	Depth (ft)	GRAVEL			SAND			SILT OR CLAY
				COARSE	FINE	COARSE	MEDIUM	FINE		
UNIFIED SOIL CLASSIFICATION SYSTEM, CORPS OF ENGINEERS, U.S. ARMY										
25	11	5	76-77						Gray coarse to fine SAND, little silt	
26	11	7	81-81.9						Gray coarse to fine SAND, little silt	
27	11	8	83-83.8						Gray silty coarse to fine SAND	

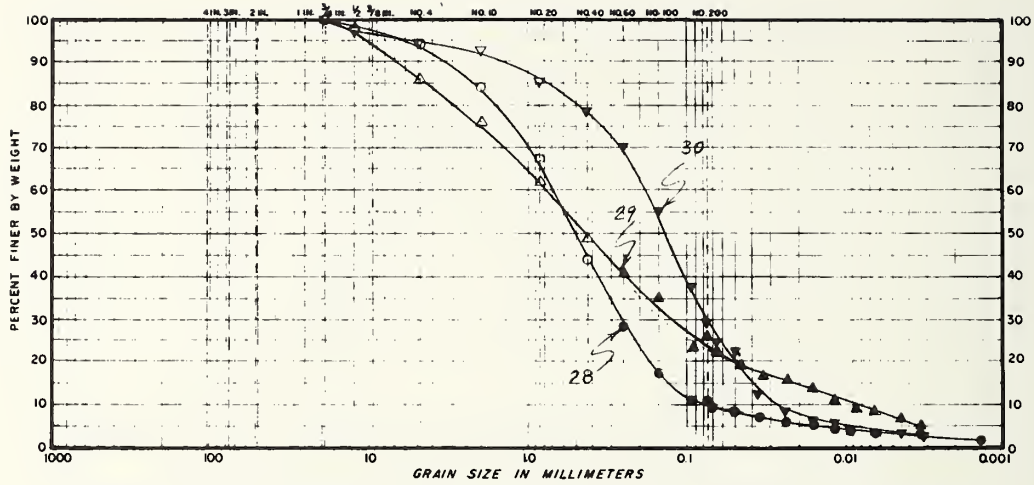

COBBLES	GRAVEL		SAND			SILT OR CLAY
	COARSE	FINE	COARSE	MEDIUM	FINE	

UNIFIED SOIL CLASSIFICATION SYSTEM, CORPS OF ENGINEERS, U.S. ARMY

Test No.	Boring	Sample	Depth(ft)	Description
28	11	9	85-86.2	Gray coarse to fine SAND, little silt, trace gravel
29	11	10	87-87.5	Gray silty coarse to fine SAND, little gravel
30	11	11	90-90.7	Gray silty medium to fine SAND, trace gravel

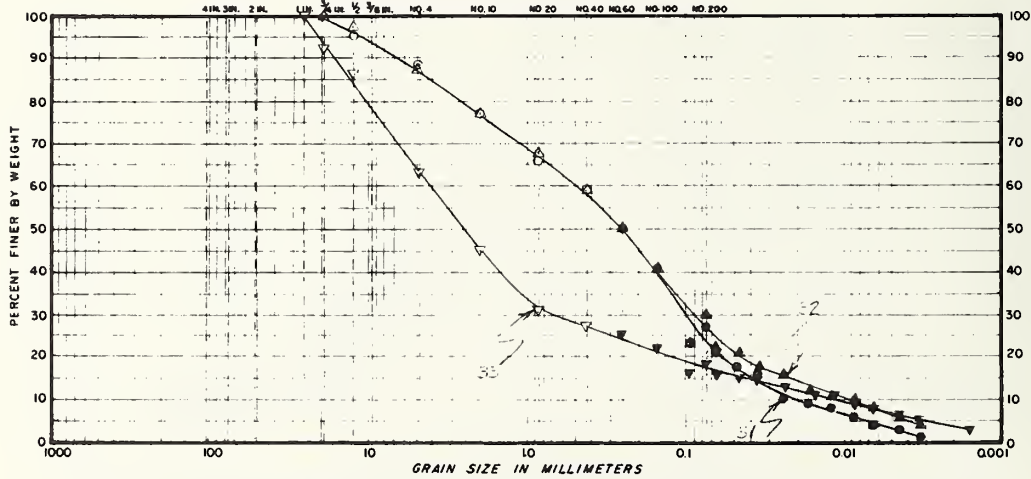

COBBLES	GRAVEL		SAND			SILT OR CLAY
	COARSE	FINE	COARSE	MEDIUM	FINE	

UNIFIED SOIL CLASSIFICATION SYSTEM, CORPS OF ENGINEERS, U.S. ARMY

Test No.	Boring	Sample	Depth(ft)	Description
31	11	12	92-92.7	Gray silty coarse to fine SAND, little gravel
32	11	13	95-95.8	Gray silty coarse to fine SAND, little gravel
33	11	14	97.5-98	Gray gravelly coarse to fine SAND, little silt

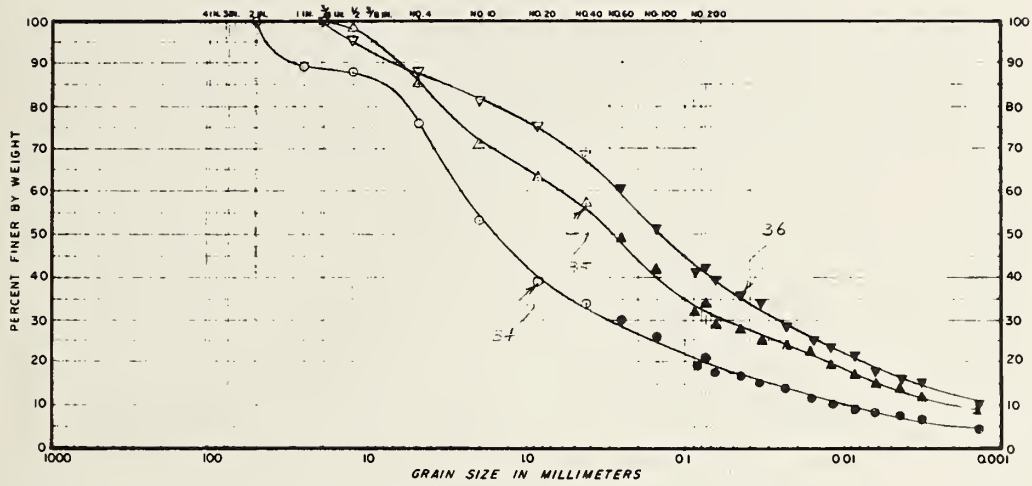

COBBLES	GRAVEL		SAND			SILT OR CLAY
	COARSE	FINE	COARSE	MEDIUM	FINE	

UNIFIED SOIL CLASSIFICATION SYSTEM, CORPS OF ENGINEERS, U.S. ARMY							
Test No.	Boring	Sample	Depth(ft)	LL%	PL%	PI%	Description
34	12	1	60-61.5	18.1	13.3	4.8	Gray gravelly coarse to fine SAND, little silt, trace clay
35	12	2	62-63.4	18.4	13.3	5.1	Gray silty coarse to fine SAND, little gravel, little clay
36	12	3	64-64.9	16.7	13.7	3.0	Gray silty coarse to fine SAND, little gravel, little clay

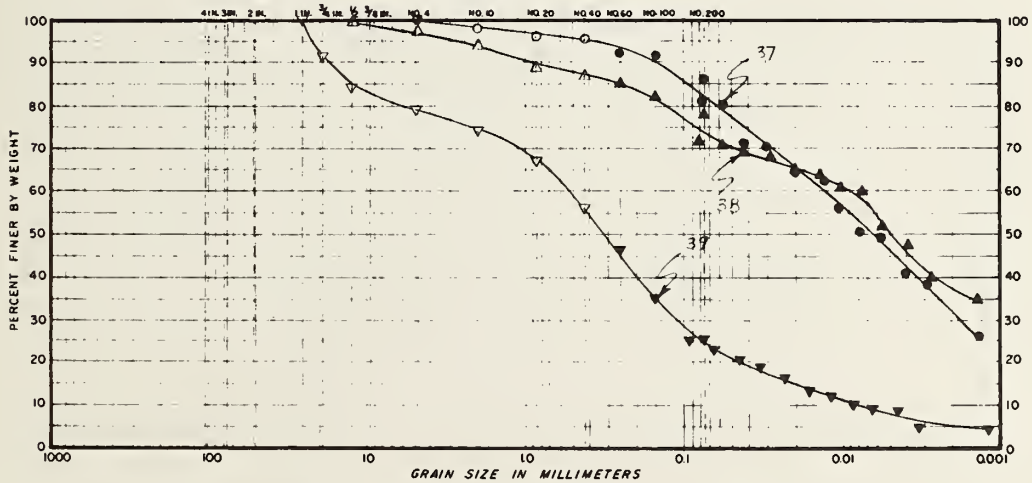

COBBLES	GRAVEL		SAND			SILT OR CLAY
	COARSE	FINE	COARSE	MEDIUM	FINE	

UNIFIED SOIL CLASSIFICATION SYSTEM, CORPS OF ENGINEERS, U.S. ARMY							
Test No.	Boring	Sample	Depth(ft)	LL%	PL%	PI%	Description
37	12	4	66-68	40.0	15.2	24.8	Gray silty CLAY, little fine sand
38	12	5	68-68.5	45.3	18.2	27.1	Gray silty CLAY, some sand
39	12	5A	69.9-70.9	-	-	-	Gray silty coarse to fine SAND, little gravel, trace clay

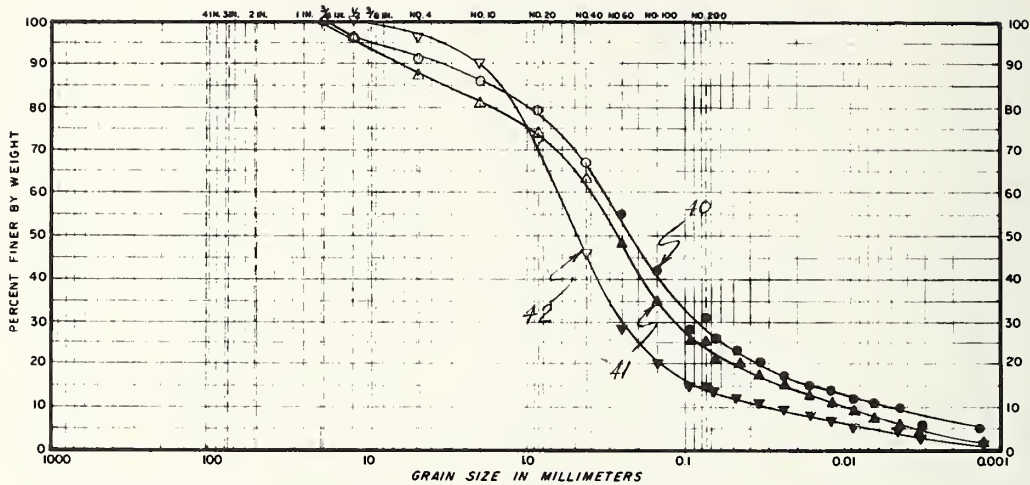

COBBLES	GRAVEL		SAND			SILT OR CLAY
	COARSE	FINE	COARSE	MEDIUM	FINE	

UNIFIED SOIL CLASSIFICATION SYSTEM, CORPS OF ENGINEERS, U.S. ARMY

Test No.	Boring	Sample	Depth(ft)	Description
40	12	6	69.9-70.9	Gray silty coarse to fine SAND, trace gravel
41	12	7	72-73	Gray silty coarse to fine SAND, little gravel
42	12	8	74.5-76.5	Gray coarse to fine SAND, little silt

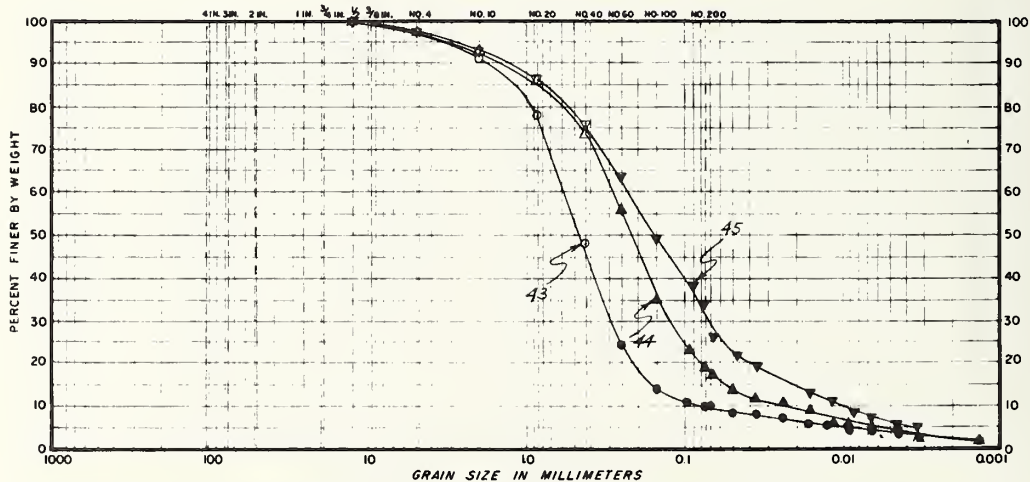

COBBLES	GRAVEL		SAND			SILT OR CLAY
	COARSE	FINE	COARSE	MEDIUM	FINE	

UNIFIED SOIL CLASSIFICATION SYSTEM, CORPS OF ENGINEERS, U.S. ARMY

Test No.	Boring	Sample	Depth(ft)	Description
43	12	9	76.5-78.5	Gray medium to fine SAND, trace silt
44	12	10	78.5-79.9	Gray medium to fine SAND, little silt
45	12	11	81-81.8	Gray silty medium to fine SAND

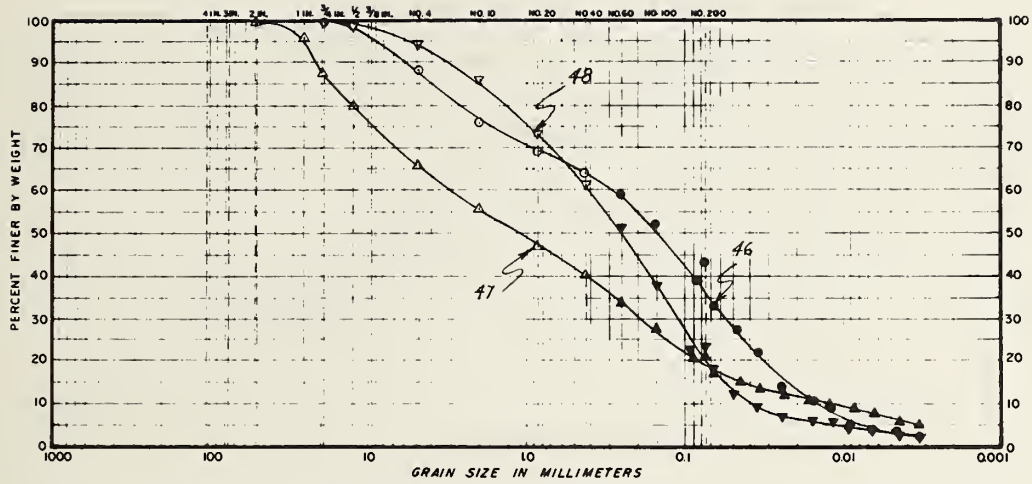

COBBLES	GRAVEL		SAND			SILT OR CLAY
	COARSE	FINE	COARSE	MEDIUM	FINE	

UNIFIED SOIL CLASSIFICATION SYSTEM, CORPS OF ENGINEERS, U.S. ARMY

Test No.	Boring	Sample	Depth(ft)	LL%	PL%	PI%	Description
46	12	12	83-84		non-plastic		Gray silty coarse to fine SAND, little gravel
47	12	13	85-86.5	16.2	14.6	1.6	Gray gravelly coarse to fine SAND, little silt
48	12	14	87-89		non-plastic		Gray silty coarse to fine SAND, trace gravel

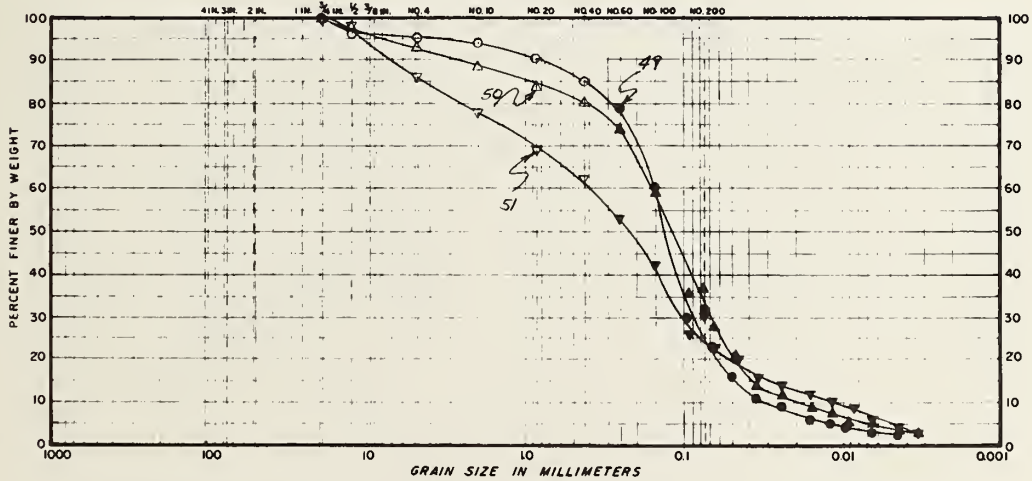

COBBLES	GRAVEL		SAND			SILT OR CLAY
	COARSE	FINE	COARSE	MEDIUM	FINE	

UNIFIED SOIL CLASSIFICATION SYSTEM, CORPS OF ENGINEERS, U.S. ARMY

Test No.	Boring	Sample	Depth(ft)	Description
49	12	15	89-90.3	Gray silty medium to fine SAND, trace gravel
50	12	16	91-92	Gray silty medium to fine SAND, trace gravel
51	12	17	93-93.6	Gray silty coarse to fine SAND, little gravel

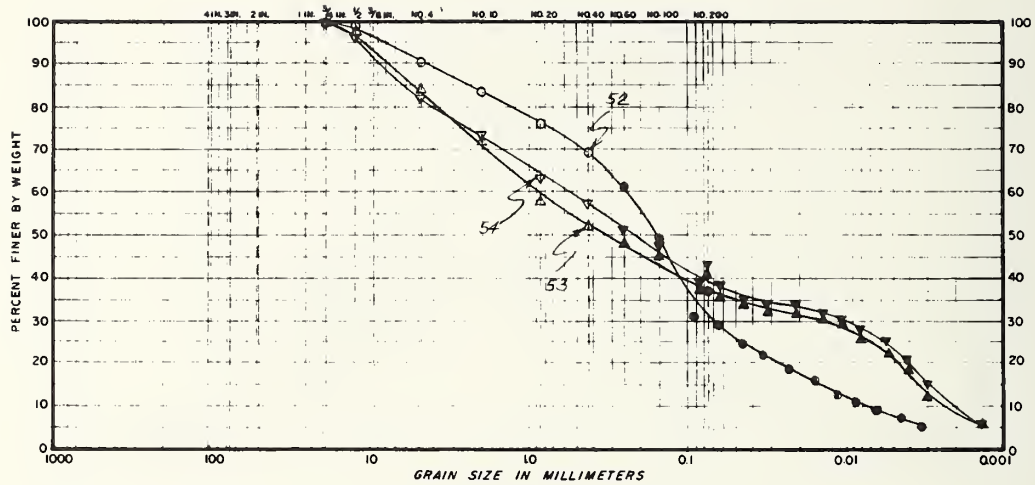

COBBLES	GRAVEL		SAND			SILT OR CLAY
	COARSE	FINE	COARSE	MEDIUM	FINE	

UNIFIED SOIL CLASSIFICATION SYSTEM, CORPS OF ENGINEERS, U.S. ARMY

Test No.	Boring	Sample	Depth(ft)	Description
52	12	18	95-95.8	Gray silty coarse to fine SAND, little gravel
53	12	19	97-97.3	Gray silty coarse to fine SAND, little gravel, trace clay
54	12	20	98-98.3	Gray silty coarse to fine SAND, little gravel, trace clay

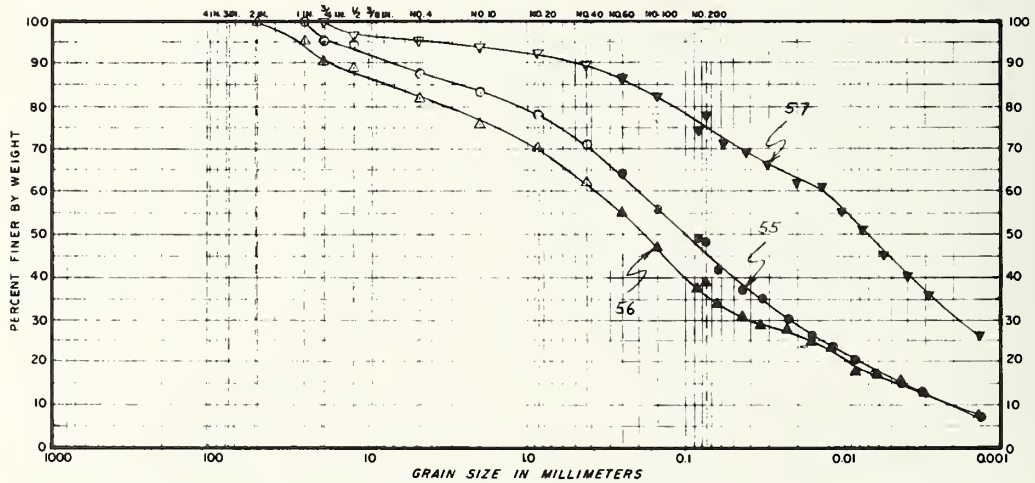

COBBLES	GRAVEL		SAND			SILT OR CLAY
	COARSE	FINE	COARSE	MEDIUM	FINE	

UNIFIED SOIL CLASSIFICATION SYSTEM, CORPS OF ENGINEERS, U.S. ARMY

Test No.	Boring	Sample	Depth(ft)	Description
55	13	1	60-62	Gray silty medium to fine SAND, little gravel, little clay
56	13	2	65-66.5	Gray silty medium to fine SAND, little gravel, little clay
57	13	3	70-72	Gray clayey SILT, little sand, trace gravel

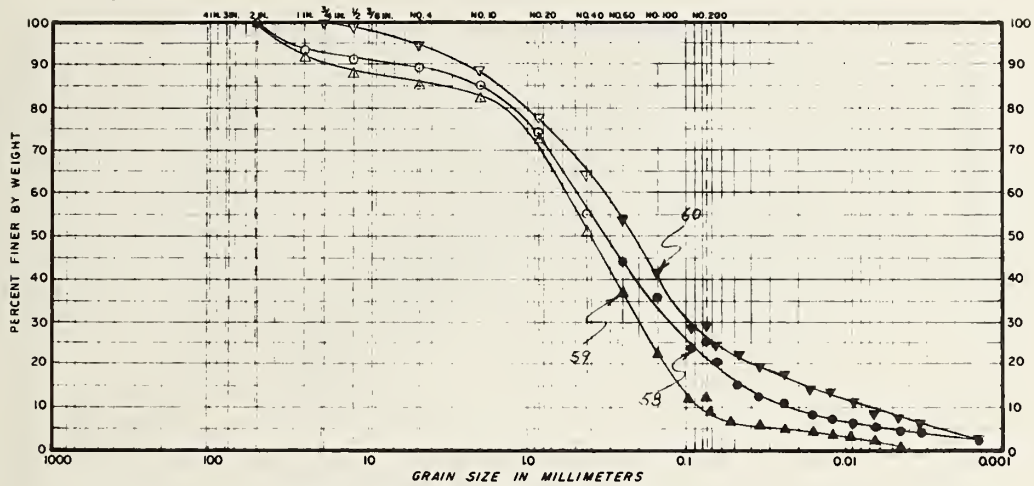

COBBLES	GRAVEL		SAND			SILT OR CLAY
	COARSE	FINE	COARSE	MEDIUM	FINE	

UNIFIED SOIL CLASSIFICATION SYSTEM, CORPS OF ENGINEERS, U.S. ARMY

Test No.	Boring	Sample	Depth (ft)	Description
58	13	4	75-76.8	Gray medium to fine SAND, little silt, little gravel
59	13	5	80-82	Gray medium to fine SAND, little gravel, trace silt
60	13	6	85-86	Gray silty coarse to fine SAND, trace gravel

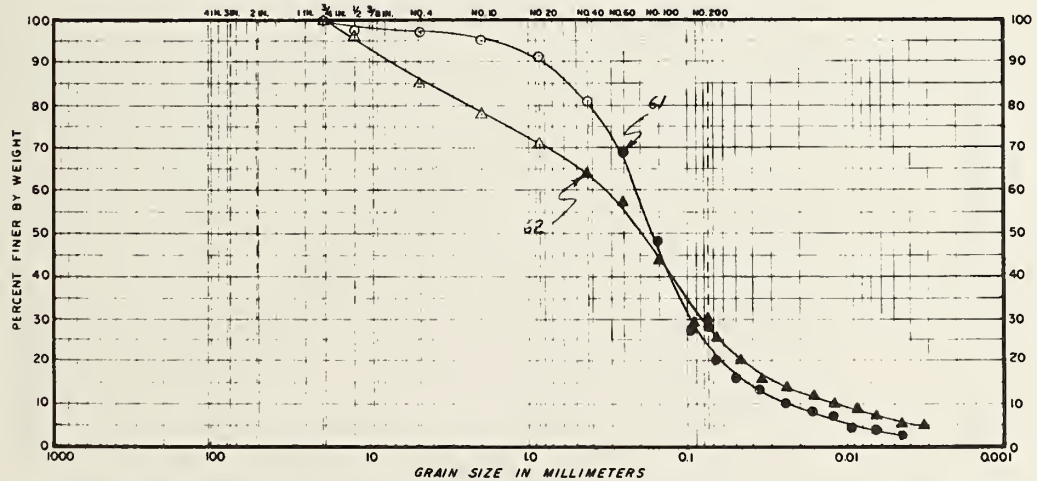

COBBLES	GRAVEL		SAND			SILT OR CLAY
	COARSE	FINE	COARSE	MEDIUM	FINE	

UNIFIED SOIL CLASSIFICATION SYSTEM, CORPS OF ENGINEERS, U.S. ARMY

Test No.	Boring	Sample	Depth (ft)	Description
61	13	7	90-91.5	Gray silty medium to fine SAND
62	13	8	95-95.8	Gray silty coarse to fine SAND, little gravel

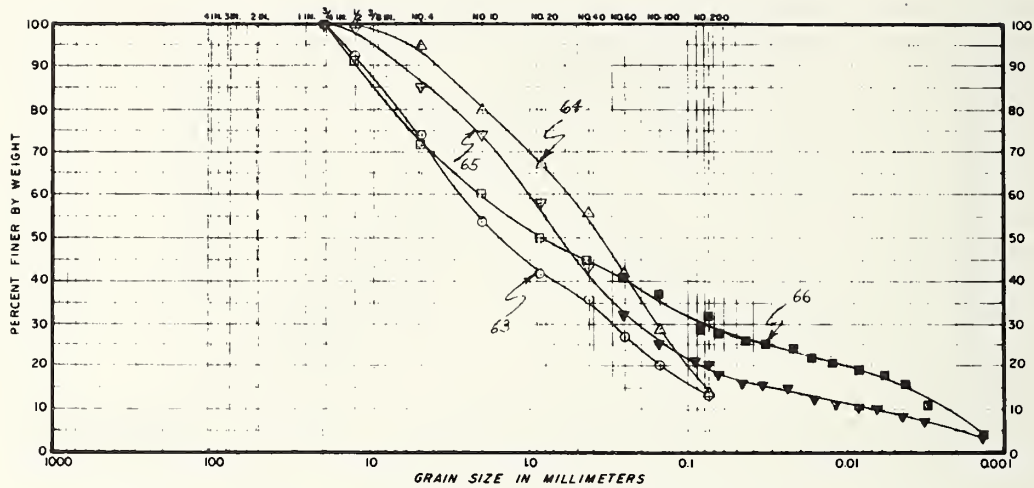

COBBLES	GRAVEL		SAND			SILT OR CLAY
	COARSE	FINE	COARSE	MEDIUM	FINE	

UNIFIED SOIL CLASSIFICATION SYSTEM, CORPS OF ENGINEERS, U.S. ARMY

Test No.	Boring	Sample	Depth(ft)	Description
63	14	1	70-71.5	Gray gravelly coarse to fine SAND, little silt
64	14	2	75-77	Gray coarse to fine SAND, little silt, trace gravel
65	14	3	80-80.7	Gray coarse to fine SAND, little gravel, little silt, trace clay
66	14	4	85-85.8	Gray gravelly coarse to fine SAND, little silt, trace clay

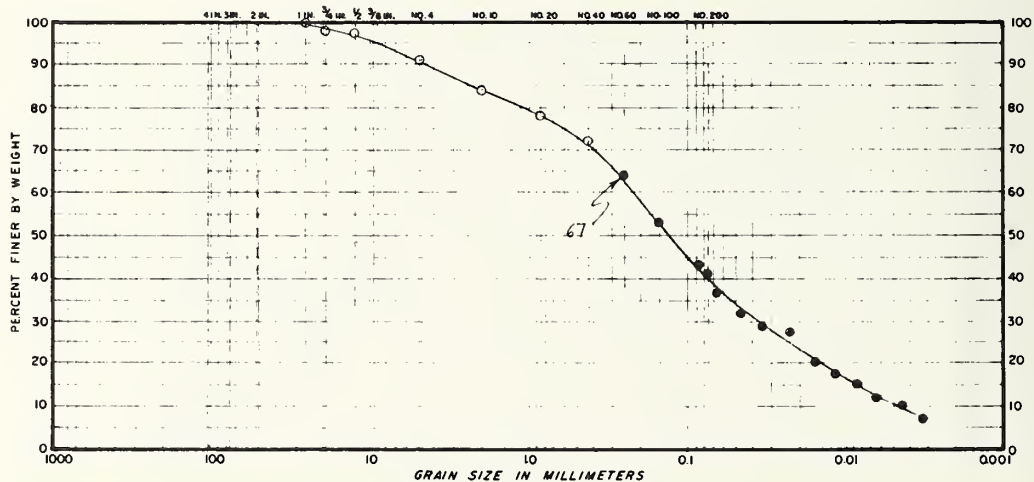

COBBLES	GRAVEL		SAND			SILT OR CLAY
	COARSE	FINE	COARSE	MEDIUM	FINE	

UNIFIED SOIL CLASSIFICATION SYSTEM, CORPS OF ENGINEERS, U.S. ARMY

Test No.	Boring	Sample	Depth(ft)	Description
67	15	S1	70-72	Gray silty coarse to fine SAND, trace gravel

APPENDIX K

REPORT OF NEW TECHNOLOGY

The work performed under this contract, while leading to no new technological inventions, has evaluated existing new and innovative methods of subsurface explorations for rapid transit tunneling. Conclusions and recommendations regarding the various types of equipment and procedures are intended to expand and improve the level of geotechnical information obtained from subsurface exploration programs.

APPENDIX L

BIBLIOGRAPHY SUMMARY

The bibliography is organized into four major subject categories with each related section arranged alphabetically by author. Report references are keyed to the bibliography using the author/number system (Doll, 2-4).

<u>INDIRECT EXPLORATION METHODS</u>	<u>SECTION</u>	<u>PAGE NO.</u>
General Geophysics	1	L-2
Electrical	2	L-5
Nuclear	3	L-7
Seismic	4	L-10
Acoustic	5	L-13
Electromagnetic	6	L-18
Thermometric	7	L-20

<u>DIRECT EXPLORATION METHODS</u>	<u>SECTION</u>	<u>PAGE NO.</u>
Subsurface Explorations	8	L-22
In-Situ Testing	9	L-27
Horizontal Drilling	10	L-30
Permeability and Piezometers	11	L-35
Grouting	12	L-37

<u>ENGINEERING AND DESIGN</u>	<u>SECTION</u>	<u>PAGE NO.</u>
Analysis and Prediction	13	L-39
Tunnel Design and Construction	14	L-42
Site Investigations	15	L-47
Engineering Geology	16	L-49
Classification Systems	17	L-51

<u>CASE HISTORIES</u>	<u>SECTION</u>	<u>PAGE NO.</u>
Red Line Geotechnical Reports	18	L-55
Boston and Area Geology	19	L-58
Case Histories	20	L-60

BIBLIOGRAPHY

INDIRECT EXPLORATION METHODS

Section 1. General Geophysics

- 1-1. Ballard, Robert F. and Frank K. Chang, "Rapid Subsurface Exploration Report 1. Review of Selected Geophysical Techniques," Army Engineer Waterways Experiment Station, Vicksburg, Mississippi (May 1973).
- 1-2. Bond, L.O., et al., "Well Log Applications in Coal Mining and Rock Mechanics," Transactions of SME, AIME, Vol 250 (December 1971).
- 1-3. Culley, R.W., "Innovations in Subsurface Exploration of Soils," Transportation Research Board, Washington DC (1976).
- 1-4. Dakhnov, V.M., "Geophysical Well Logging," Colorado School of Mines Quarterly, Vol 57, No. 2 (1962) p. 1-445.
- 1-5. Dobrin, M.B., Introduction to Geophysical Prospecting, McGraw-Hill, New York (1974).
- 1-6. "Essentials of Log Interpretation Practice," Schlumberger Limited (1972).
- 1-7. Golder, H.Q. and L.G. Soderman, "Merits and Mistakes of Geophysics in Civil Engineering," Proceedings, Second Pan American Conference on Soil Mechanics and Foundation Engineering, Vol 1 (1963) p. 513-531.
- 1-8. Griffiths, D.H. and R.F. King, Applied Geophysics for Engineers and Geologists, Pergamon Press, Oxford, England (1965).
- 1-9. Guyod, H., "Use of Geophysical Logs in Soil Engineering," American Society for Testing and Materials Symposium on Soil Exploration, Special Technical Publication 351 (1964) p. 74-85.
- 1-10. Hamilton, R.G. and J.I. Myung, "Summary of Geophysical Well Logging," Birdwell Division, Seismograph Service Corporation, Tulsa, Oklahoma.

- 1-11. Handbook of Engineering Geophysics, Bison Instruments, Inc., Minneapolis, Minnesota (1977).
- 1-12. Heiland, C.A., Geophysical Exploration, Prentice-Hall, Englewood Cliffs, New Jersey (1946).
- 1-13. Jakosky, J.J., Exploration Geophysics, Second Edition, Trija, Newport Beach (1960).
- 1-14. Jenkins, Jon C., "Practical Applications of Well Logging to Mine Design," SME Preprint No. 69-F-73, AIME, New York (1969).
- 1-15. Keys, Scott W. and L.M. MacCary, "Application of Borehole Geophysics to Water Resources Investigations," U.S. Geological Survey, Water Resources Investigations, Chapter E1 (1971).
- 1-16. LeRoy, L.W., D.O. LeRoy and J.W. Raese, Subsurface Geology, Colorado School of Mines (1977).
- 1-17. "Logging Capabilities and Services," Seismograph Service Corporation, Birdwell Division, Raytheon Company, Tulsa, Oklahoma (1977).
- 1-18. McDowell, P.W., "Research in Applied Geophysics," Portsmouth Polytech Department of Geology, Portsmouth, England (1978).
- 1-19. Moore, R.W., "Geophysics Efficient in Exploring the Subsurface," Proceedings, American Society of Civil Engineers, Journal of the Soil Mechanics and Foundations Division, Vol 87, No. SM3 (1961) p. 69-100.
- 1-20. Mossman, R.W., G.E. Heim and F.E. Dalton, "Seismic Exploration in the Urban Environment," International Geological Conference, Abstract No. 24 (1972) p. 397-398.
- 1-21. Pirson, S.J., Handbook of Well-Log Analysis, Prentice-Hall, Englewood Cliffs, New Jersey (1963).
- 1-22. Schwarz, S., "Geophysical Measurement Related to Tunneling," Proceedings, North American Rapid Excavation and Tunneling Conference, American Institute of Mining, Metallurgical and Petroleum Engineers, Vol 1 (1972) p. 195-208.

- 1-23. Scott, J.H., et al., "The Relationship of Geophysical Measurements to Engineering and Construction Parameters in the Straight Creek Tunnel Pilot Bore, Colorado," *International Journal of Rock Mechanics and Mining Science*, Vol 5, No. 1 (1968) p. 1-30.
- 1-24. Snodgrass, J.J., "Calibration Models for Geophysical Borehole Logging," *Report of Investigation, U.S. Bureau of Mines, Washington DC* (1976).
- 1-25. "Borehole Geophysical Probes for Indirect Sensing of Ground Conditions Relevant to Tunnel Design and Construction - A Technical Summary," *Southwest Research Institute, U.S. Department of Transportation, DOT-FH-11-9323* (1979).
- 1-26. Telford, W. M. et al., Applied Geophysics, Cambridge University Press (1976).
- 1-27. West, G. and M.J. Dumbleton, "An Assessment of Geophysics in Site Investigations for Roads in Britain," *Transportation and Road Research Laboratory, LR 680* (1975).
- 1-28. Widess, M.B., "How Thin is a Thin Bed?," *Geophysics*, Vol 38, No. 6 (December 1973) p. 1176-1180.

Section 2. Electrical

- 2-1. Anderson, L.A. and G.V. Keller, "A Study of Induced Polarization," *Geophysics* 29, No. 5 (1964).
- 2-2. Aspinall, A. and A.R. Walker, "The Earth Resistivity Instrument and Its Application to Shallow Earth Surveys," *Underground Services*, Vol 1, No. 3 (1975) p. 12-15.
- 2-3. Dakhnov, V.N., B.G. Latishova and V.A. Ryapolov, "Well Logging by Means of Induced Polarization (Electrolytic Logging)," *Promislavay Geofizika* (1952).
- 2-4. Doll, H.G., "The S.P. Log: Theoretical Analysis and Principles of Interpretation," *Transactions*, Vol 179, American Institute of Mining, Metallurgical and Petroleum Engineers, New York (1948).
- 2-5. Fountain, Lewis S., "Evaluation of High Resolution Earth Resistivity Measurement Techniques for Delt-ing Subsurface Cavities in a Granite Environment," Southwest Research Institute, San Antonio, Texas (1977).
- 2-6. Ghosh, M.K., "Geoprobe EMR-14: A New Multi-Spectral EM System for Determining Stratification of the Ground," Twenty-fifth International Geological Conference, Sydney (1976).
- 2-7. Keller, George V., "Engineering Applications of Electrical Geophysical Methods," *Proceedings of Sub-surface Exploration for Underground Excavation and Heavy Construction*, American Society of Civil Engineers (August 1974).
- 2-8. Keller, George V., and Frank C. Friscknecht, Electrical Methods in Geophysical Prospecting, Pergammon Press, New York (1970).
- 2-9. Lytle, R. Jeffrey, "Measurement of Earth Medium Electrical Characteristics: Techniques, Results and Applications," *IEEE Transactions on Geoscience Electronics*, Vol GE-12 (1974).
- 2-10. Moore, R.W., "Earth Resistivity Tests Applied to Sub-surface Reconnaissance Surveys," *Symposium on Surface and Subsurface Reconnaissance*, American Society for Testing and Materials Special Technical Publication No. 122 (1952) p. 89-103.

- 2-11. Olhoeft, G.R., The Physics and Chemistry of Rock and Minerals, Wiley, London, P. 261-270.
- 2-12. Platts, W.R., "Some Limitations of the Electrical Resistivity Apparatus," Highway Research Record No. 81 (1965) P. 16-19.
- 2-13. Schön, J., "Determination of Geotechnical Properties by Geophysical Measurements," Proceedings, First Congress International Association of Engineering Geology, Paris (1970) p. 301-310.
- 2-14. Van Zelst, R.W., "Suggested Method for Subsurface Testing by Electrical Resistivity Measurements," American Society for Testing and Materials, Special Technical Publication 479, Special Procedures for Testing Soil and Rock for Engineering Purposes (1970) p. 32-35.

Section 3. Nuclear

- 3-1. Alekseev, F.A., "The Present State and Prospects of Nuclear Geophysical Methods in Exploration, Prospecting and Exploitation of Mineral Resources," Proceedings, Vol IV, U.S. Atomic Energy Commission, Israel Program for Scientific Translations (1966) p. 1-14.
- 3-2. Alekseev, F.A., "Soviet Advances in Nuclear Geophysics," Iadernaia, Geofizika, Consultants Bureau, New York (1965).
- 3-3. Allen, L.S., R.L. Caldwell and W.R. Mills, "Borehole Models for Nuclear Logging," Society of Petroleum Engineers Journal, Vol 5, No. 2 (1965) p. 109-112.
- 3-4. Baicker, J., et al., "A Borehole Probe for In-Situ Neutron Activation Analysis: Phase I Report," Princeton Gamma-Tech, Inc., Bureau of Mines, Denver, Colorado (March 1978).
- 3-5. Belknap, W.B., et al., "API Calibration Facility for Nuclear Logs, Drilling and Production Practice," American Petroleum Institute (1959) p. 289-316.
- 3-6. Crosby, James W. III and J.V. Anderson, "Some Applications of Geophysical Well Logging to Basalt Hydrogeology," Ground Water, Vol 9, No. 5 (1971).
- 3-7. Crosby, James W. III, "Geophysical Logging Capabilities and Procedures: A Topical Report," Washington State University College of Engineering Research Report 73/15-84 (1973).
- 3-8. Czubek, J.A., et al., "Geostatistical Method of Interpretation of Nuclear Well Logs," Proceedings of the International Symposium Nuclear Techniques and Mineral Resources, International Atomic Energy Agency, Vienna, Austria (1977) p. 313-332.
- 3-9. Goldman, L., et al., "A Borehole for In-Situ Neutron Activation Analysis: Phase I Report," Princeton Gamma-Tech, Inc., U.S. Bureau of Mines, Contract No. H0262045 (March 1978) p. 29.
- 3-10. "Interpretation Manual," Birdwell Division, Seismograph Service Corporation, Tulsa, Oklahoma (1973).

- 3-11. Kokesh, F.P., "Gamma Ray Logging," Oil and Gas Journal, Vol 50 (1951) p. 284.
- 3-12. Korzhev, A.A., "Investigation of Boreholes by Methods Based on Radioactive Isotopes," Proceedings, Vol IV, U.S. Atomic Energy Commission, Israel Program for Scientific Translations (1966) p. 85-91.
- 3-13. Mero, J.L., "Uses of the Gamma Ray Spectrometer in Mineral Exploration," Geophysics, Vol 25 (1960) p. 1054-1076.
- 3-14. Norris, S.E., "The Use of Gamma Logs in Determining the Character of Unconsolidated Sediments and Well Construction Features," Journal of Ground Water, Vol 10, No. 6 (Nov-Dec 1972) p. 14-21.
- 3-15. "Nuclear Well Logging in Hydrolog," International Atomic Energy Agency, Technical Reports Series No. 126, Vienna (1971).
- 3-16. Pickell, J.J. and J.G. Heacock, "Density Logging," Geophysics, Vol 25 (1960) p. 891-904.
- 3-17. Poeter, E.J. and J.W. Crosby III, "Geophysical Borehole Investigations of Exploratory Holes for Mass Transit Tunneling, Cambridge, Massachusetts," Washington State University (1979).
- 3-18. Rhodes, John R., "Applications of Portable X-Ray Analyzers in Industry and Mining," Applications of Radioisotopes, Nuclear Engineering, Part XXII, Vol 66, American Institute of Chemical Engineers (1970) p. 48-57.
- 3-19. Terhune, R.W. and J.G. Shaw, "Calculation of Rock Fracturing from Multiple Nuclear Explosive Sources," Peaceful Nuclear Explosions III, Proceedings, International Atomic Energy Agency, Vienna (1974) p. 251-276.
- 3-20. Tittle, C.N., H. Faul and C. Goodman, "Neutron Logging of Drill Holes; The Neutron-Neutron Method," Geophysics, Vol 16 (1951) p. 626-658.

- 3-21. Zaporozhets, V.W. and B.I. Rogov, "Radiometric Equipment for Investigation of Boreholes," Proceedings, 1960, Vol IV, U.S. Atomic Energy Commission, Israel Program for Scientific Translations (1966) p. 1-14.

Section 4. Seismic

- 4-1. Albright, J.N., R.J. Hanold and B. Linville, "Seismic Mapping of Hydraulic Fractures Made in Basement Rocks," Proceedings of the Second ERDA Symposium on Enhanced Oil and Gas Recovery, Tulsa, Oklahoma (1976).
- 4-2. Alsup, S.A., K.R. Michael and M.E. Blackey, "Geophysical Investigations Seismic Crosshole/Uphole Velocity and Amplitude Measurements, Massachusetts Avenue, Cambridge, Mass.," S.A. Alsup & Associates, Inc. (1979).
- 4-3. Auld, B., "Cross-Hole and Down-Hole Velocity by Mechanical Impulse," Journal Geotechnical Engineering Division, Proceedings, American Society Civil Engineers, 103, No. GT12 (1977) p. 1381-1398.
- 4-4. Blake, Wilson, Fred Leighton and Wilbur Duvall, "Microseismic Techniques for Monitoring the Behavior of Rock Structures," Bureau of Mines, Denver, Colorado, Denver Mining Research Center (October 1974).
- 4-5. Brenden, B.B., V.I. Neeley and F.G. Garlick, "Borehole - Seismics Multiply Drill Data," Engineering and Mining Journal (February 1970).
- 4-6. Bullock, S.J., "The Case for Using Multi-Channel Seismic Refraction Equipment and Techniques in Site Investigations," Association Engineering Geologists, Vol XV, No. 1 (1978).
- 4-7. Carroll, R.D. and J.H. Scott, "Uphole Seismic Measurements as an Indication of Stress Relief in Granitic Rock Tunnels," U.S. Geological Survey Professional Paper 550-D (1966) p. D138-D143.
- 4-8. Evison, F.F., "The Seismic Determination of Young's Modulus and Poisson's Ratio for Rock In-Situ," Geotechnique, Vol VI, No. 3 (1956).
- 4-9. Fowler, Jack, "Vibroseismic Survey, High Reynolds Number Tunnel Site, Arnold Engineering Development Center, Arnold Air Force Station, Tennessee," Army Engineering Waterways Experiment Station, Vicksburg, Mississippi (February 1973).

- 4-10. Gilmer, T.H., "Seismic Reflections from Shallow Depths," Proceedings, Engineering Geology and Soils Engineering Symposium, No. 14 (1976) p. 71-83.
- 4-11. Greenhaigh, S.A. and R.J. Whitney, "Effective Application of the Seismic Refraction Method to Highway Engineering Projects," Journal, Australian Road Research, Vol 7, No. 1 (1977) p. 3-19.
- 4-12. Grigsby, J.K., "Vibrotrac Mark IV, A Unique Tracked Vibroseis Vehicle," Geophysics, Vol 41, No. 2 (1976) p. 354.
- 4-13. Hoar, R.J. and K.H. Stokoe, "Generation and Measurement of Shear Waves In-Situ," Dynamic Geotechnical Testing, ASTM STP654, American Society for Testing and Materials (1978) p. 3-29.
- 4-14. Johnson, Robert B., "Refraction Seismic and Electrical Resistivity Studies of Engineering Geologic Problems at Mountain Tunnel Sites," Eighth Annual Engineering Geology and Soils Engineering Symposium, Proceedings, Boise, Idaho (1970) p. 1-20.
- 4-15. Laine, E.F., et al., "Finding High Contrast Anomalies Using Cross Borehole High Frequency CW Probing," Geophysics, Vol 42, No. 7 (1977) p. 1518.
- 4-16. Leeds, D.J., "The Underground Seismic Environment," Proceedings, North American Rapid Excavation and Tunneling Conference, American Institute Mining, Metallurgical and Petroleum Engineers, Chicago (1972) p. 157-168.
- 4-17. Mooney, H.M., "Seismic Shear Waves in Engineering," Journal of the Geotechnical Division, American Society of Civil Engineers, Vol 100, No. GT8 (1974) p. 905-923.
- 4-18. Mossman, R.W. and G.E. Heims, "Seismic Exploration Applied to Underground Excavation," Proceedings, North American Rapid Excavation and Tunneling Conference, Chicago (1972) p. 169-192.
- 4-19. Mossman, R.W., G.E. Heim and F.E. Dalton, "Seismic Exploration in the Urban Environment," Engineering Geology, Section 13, Proceedings, International Geological Congress, No. 24 (1972) p. 183-190.

- 4-20. Mossman, W., G. Heim and F. Dalton, "Vibroiseis Applications to Engineering Work in an Urban Area," Geophysics, Vol 38, No. 3 (June 1973) p. 489-499.
- 4-21. Murphy, V.J., "Seismic Velocity Measurements for Moduli Determinations in Tunnels," Proceedings, North American Rapid Excavation and Tunneling Conference, Chicago (1972) p. 209-216.
- 4-22. Owen, T.E., S.A. Suhler and J.H. King, "Analysis of Borehole Seismic Velocity Tests - Nevada Test Center," Southwest Research Institute Project 14-4095-002 (May 1975).
- 4-23. Redpath, B.B., "Seismic Refraction Exploration for Engineering Site Investigations," Explosive Excavation Research Laboratory, NTIS-AD-768-710, Livermore, California (May 1973).
- 4-24. Sherwin, John R., "Special Data Collection Systems," Teledyne Geotechnical, Garland, Texas (December 1977).
- 4-25. Soland, Duane E., et al., "Excavation Seismology," First Annual Technical Report, Bureau of Mines Contract No. HO-211025, Honeywell, Inc., St. Paul, Minnesota (1972).
- 4-26. Stacy, T.R., "Seismic Assessment of Rock Masses," Proceedings, Symposium on Exploration for Rock Engineering, Johannesburg (November 1976).
- 4-27. Stokoe, I. and R. Woods, "In-Situ Shear Wave Velocity by the Crosshole Method," Journal of the Soil Mechanics and Foundations Division, American Society of Civil Engineers, Vol 98, No. SM5 (1972) p. 443-460.

Section 5. Acoustic

- 5-1. Arkadyev, E.A., et al., "New Versatile Nuclear and Acoustic Logger," Geofiz Kozl (Budapest), Vol 24 (1977) p. 83-90.
- 5-2. Ballard, Robert F. Jr., "Dynamic Techniques for Detecting and Tracing Tunnel Complexes," Army Engineer Waterways Experiment Station, Vicksburg, Mississippi (December 1977).
- 5-3. Beard, F.D., "Microseismic Forecasting of Excavation Failures," Civil Engineering, Vol 32, No. 5 (May 1962).
- 5-4. Carroll, Roderick D., "Rock Properties Interpreted from Sonic Velocity Logs," Proceedings, American Society of Civil Engineers, Vol 2, Journal Soil Mechanics and Foundation Division, No. SM2 (1966) p. 43-51.
- 5-5. Carroll, R.D. and J.E. Paul, "The Estimation of In-Situ Acoustic Properties of Volcanic Rocks from Compressional Velocity Measurements - Central Nevada," Central Nevada Report No. 39, USGS-474-69, U.S. Geological Survey, Denver, Colorado (1970).
- 5-6. Cratchley, C.R., et al., "Some Applications of Geophysical Techniques in Engineering Geology with Special Reference to the Foyers Hydroelectric Scheme," International Geological Congress, Abstracts, No. 24 (1972) p. 387-388.
- 5-7. Culley, R.W., "Innovations in Subsurface Exploration of Soils," Transportation Research Board, Washington DC (1976).
- 5-8. Dechman, G.H. and M.C. Sun, "Iterative Approximation Techniques for Microseismic Source Location," U.S. Department of the Interior, Bureau of Mines, Report No. R18254, Spokane Mining Research Center, Spokane (1977).
- 5-9. Dines, K.A. and R.J. Lytle, "Iterative Reconstruction of Underground Refractive Index Distributions from Cross-Borehole Transmission Data," California University, Lawrence Livermore Laboratory (November 1977).

- 5-10. Filipczynski, L., Ultrasonic Methods of Testing Materials, Butterworths, London (1966).
- 5-11. Fitzpatrick, G.L., H.R. Nicholls and R.D. Munson, "An Experiment in Seismic Holography," U.S. Bureau of Mines Report of Investigation 7607 (1972).
- 5-12. Freeme, C.R., "A New Ultrasonic Pulse Technique for Measuring the Elastic Properties of Road Materials," RP/6/64, National Institute for Road Research, Pretoria, South Africa (1964).
- 5-13. Freeme, C.R., "Application of Sonic and Ultrasonic Test Methods to the Measurement of Elastic Moduli of Pavement Materials," RB/2/71, National Institute for Road Research, Pretoria, South Africa (1971).
- 5-14. Gatfield, E.N., "An Apparatus for Determining the Velocity of an Ultrasonic Pulse in Engineering Materials," *Electronic Engineering*, Vol 24, No. 295 (1971) p. 390-395.
- 5-15. Geyer, R.L. and J.I. Myung, "The 3-D Velocity Log; A Tool for In-Situ Determination of the Elastic Moduli of Rocks," Birdwell Division, Seismograph Service Corporation, Tulsa, Oklahoma (1973).
- 5-16. Grainger, P. and D.M. McCann, "Interborehole Acoustic Measurements in Site Investigation," *Quarterly Journal Engineering Geology*, Vol 10, No. 3 (1977) p. 241-255.
- 5-17. Gupta, R.R., "Seismic Determination of Geological Discontinuities Ahead of Rapid Excavation," Final Technical Report, Bendix Research Laboratories, Southfield, Michigan (September 1972).
- 5-18. Guyod, H. and L.E. Shane, "Geophysical Well Logging, Introduction to Acoustical Logging," Vol 1, Houston (1969).
- 5-19. Hipkins, D.L. and L.A. Whitney, "Acoustic Techniques Suitable for Use in Soil," *Proceedings of Subsurface Exploration for Underground Excavation and Heavy Construction*, American Society of Civil Engineers (August 1974).

- 5-20. Huether, Theodor and Richard Bolt, Sonics, John Wiley & Sons, New York (1955).
- 5-21. Kinsler, Lawrence E. and Austin R. Frey, Fundamentals of Acoustics, John Wiley & Sons, New York (1950).
- 5-22. Koerner, R.M., A.E. Lord and W.M. McCabe, "Acoustic Emission Behavior of Cohesive Soils," Journal of Geotechnical Division, Proceedings, American Society of Civil Engineers, No. GT8 (1977) p. 837-850.
- 5-23. Kokesh, F.P., et al., "A New Approach to Sonic Logging and Other Acoustic Measurements," Journal of Petroleum Technology (March 1965).
- 5-24. Lundström, R. and R. Stenborg, "Soil-Rock Drilling and Rock Locating by Rock Indicator," Proceedings, Sixth International Conference on Soil Mechanics and Foundation Engineering (1965) p. 69-72.
- 5-25. McCann, D.M., P. Grainger, and C. McCann, "Interborehole Acoustic Measurements and Their Use in Engineering Geology," Geophysical Prospecting, Vol 23, No. 1 (March 1975) p. 50-69.
- 5-26. Morris, R.L., D.R. Grine and T.E. Arkfeld, "The Use of Compressional and Shear Acoustic Amplitudes for the Location of Fractures," Society of Petroleum Engineers of the American Institute of Mining, Metallurgical and Petroleum Engineers (October 1963).
- 5-27. Myung, J.I. and R.W. Baltosser, "Fracture Evaluation by the Borehole Logging Method," Birdwell Division, Seismograph Service Corporation, Tulsa, Oklahoma (August 1971).
- 5-28. Myung, J.I. and D.P. Helander, "Borehole Investigation of Rock Quality and Deformation Using the 3-D Velocity Log," Birdwell Division, Seismograph Service Corporation, Tulsa, Oklahoma (1973).
- 5-29. Myung, J. I. and W. M. Sturdevant, "Introduction to the Three Dimensional Velocity Log," Birdwell Division, Seismograph Service Corporation (July 1970).

- 5-30. Obert, Leonard and W.I. Duvall, "Microseismic Method of Determining the Stability of Underground Openings," Bulletin 573, U.S. Bureau of Mines.
- 5-31. Price, T.O., "Acoustic Holography as a Tool for Geological Prediction", Proceedings of Subsurface Exploration for Underground Excavation and Heavy Construction, American Society of Civil Engineers (August 1974).
- 5-32. Price, T.O., et al., "Scanned Acoustic Holography for Geological Prediction in Advance of Rapid Underground Excavation, Phase I," Holosonics, Inc., Richland, Washington. National Science Foundation, Washington DC (May 1975).
- 5-33. Price, T.O., "Demonstration of Acoustical Survey System. Washington Metro Area Transit Authority," Holosonics, Inc., Richland, Washington, National Science Foundation, Washington DC (June 1975).
- 5-34. Price, T.O., et al., "Scanned Acoustic Holography for Geological Prediction in Advance of Rapid Underground Excavation. Phase II," Holosonics, Inc., Richland, Washington. National Science Foundation, Washington DC (May 1976).
- 5-35. Rubin, L.A., D.L. Hipkins and L.A. Whitney, "Improved Subsurface Investigation for Highway Tunnel Design and Construction," Vol 2, Telcom, Inc., Federal Highway Administration, Washington DC (May 1974).
- 5-36. Silverman, Daniel, "Mapping the Earth With Elastic Wave Holography," IEEE Transactions on Geoscience Electronics, Vol GE-7, No. 4 (October 1969).
- 5-37. Stimpson, W.E., et al., "Determining Bedrock Elevation by Acoustic Sounding Technique," Rock Engineering for Foundations and Slopes, Vol 1, American Society of Civil Engineers (1976) p. 1-12.
- 5-39. Thill, R.E. and D.V. D'Andrea, "Acoustic Core Logging in Blast-Damaged Rock," Engineering Geology, Vol 10, No. 1, Amsterdam (1976) p. 13-36.
- 5-39. Tixier, M.P., et al., "Sonic Logging," Journal of Petroleum Technology (May 1959).

5-40. Winter, T.G., "A Survey of Sound Propagation in Soils,"
Acoustic Society of America, 84th Annual Meeting
(November 1972).

Section 6. Electromagnetic

- 6-1. Cook, J.C., "Borehole-Radar Exploration in A Coal Seam," Geophysics, Vol 42, No. 6 (1977) p. 1254-1257.
- 6-2. Cook, J.C., "Seeing Through Rock With Radar," Proceedings, North American Rapid Excavation and Tunneling Conference, Vol 1, American Institute of Mining, Metallurgical and Petroleum Engineers (1972) p. 89-101.
- 6-3. Cook, J.C., "Status of Ground-Probing Radar and Some Recent Experience," Proceedings, Subsurface Exploration for Underground Excavation and Heavy Construction, American Society of Civil Engineers (August 1974).
- 6-4. Dolphin, L.T., et al., "An Underground Electromagnetic Sounder Experiment," Geophysics, Vol 39, No. 1 (February 1974).
- 6-5. "Electromagnetic Pulso Sounding for Geologic Surveying With Application in Rock Mechanics and Rapid Excavation Program," Final Report No. 3190-2, Electro-Science Laboratory of the Ohio State University Electrical Engineering Department, U.S. Bureau of Mines, Denver (March 1972).
- 6-6. "Electromagnetic Subsurface Profiling," Geophysical Survey Systems, Inc., Technical Memo 004-72, North Billerica, Massachusetts (June 1972).
- 6-7. Holser, W.T., et al., "Radar Logging of a Salt Dome," Geophysics, Vol 37, No. 5 (October 1972).
- 6-8. Lytle, R.J., et al., "Using Cross-Borehole Electromagnetic Probing to Locate a Tunnel," Lawrence Livermore Lab., Energy Research and Development Administration (October 1976).
- 6-9. Moffatt, David L., "Subsurface Video Pulse Radars," Proceedings of Subsurface Exploration for Underground Excavation and Heavy Construction, American Society of Civil Engineers (August 1974) p. 195-203.

- 6-10. Morey, Rexford M., "Continuous Subsurface Profiling by Impulse Radar," Proceedings, Subsurface Exploration for Underground Excavation and Heavy Construction, American Society of Civil Engineers (August 1974).
- 6-11. Morey, Rexford M. and Walter S. Harrington, Jr., "Feasibility Study of Electromagnetic Subsurface Profiling," U.S. Environmental Protection Agency, EPA-R2-72-082, Office of Research and Monitoring, Washington DC (October 1972).
- 6-12. Rubin, L.A., J.N. Griffin and W.L. Still, "Subsurface Site Investigation by Electromagnetic Radar. Phase I, Feasibility," ENSCO Springfield, Virginia, Transportation and Instrumentation Sciences Division, National Science Foundation (March 1976).
- 6-13. Schroder, D., "The Terrascope, A New Mobile Geological Radar System," Geophysical Prospecting, Vol 24, No. 3 (1976) p. 596-597.

Section 7. Thermometric

- 7-1. Albright, James N., "A New and More Accurate Method For the Direct Measurement of Earth Temperature Gradients in Deep Boreholes," Proceedings, Vol 2, Second United Nations Symposium on the Development and Use of Geothermal Resources, Lawrence Berkeley Laboratory, San Francisco, California (1975) p. 847-852.
- 7-2. Ash, J.L., B.E. Russell and R.R. Rommel, "Improved Subsurface Investigation for Highway Tunnel Design and Construction: Volume 1, Subsurface Investigation System Planning," Federal Highway Administration, Washington DC (1974).
- 7-3. Benson, G.M., "Thermocorer for Rapid Drilling Tunneling and Excavating," Final Report, National Science Foundation Report NSF-RA-760483 (1976).
- 7-4. Birman, J.H., "Geothermal Exploration for Groundwater," Geological Society of American Bulletin, Vol 80 (August 1969) p. 617-630.
- 7-5. Birman, J.H., et al., "Thermal Monitoring of Leakage Through Dams," Geological Society of America Bulletin, Vol 82 (August 1971) p. 2261-2284.
- 7-6. Clark, C.B. and T.F. Lehnoff, "Thermal Mechanical Fragmentation of Hard Rock for Rapid Excavation," Annual Report, National Science Foundation Report No. NSF-RA-760017 (1975).
- 7-7. Collie, M.J. "Geothermal Energy, Recent Developments," Noyes Data Corporation, Park Ridge, New Jersey (1978).
- 7-8. "Direct Utilization of Geothermal Energy: A Symposium," Geothermal Resources Council, San Diego, California, U.S. Department of Energy, Washington DC (April 1978).
- 7-9. Goguel, Jean, Geothermics. McGraw-Hill, New York (1976).
- 7-10. Kappelmeyer, O. and R. Haenel, "Geothermics, with Special Reference to Application," Gebruder Borntraeger, Berlin (1974).

- 7-11. LeRoy, L.W., et al., "Subsurface Geology: Petroleum, Mining, Construction," Colorado School of Mines, Golden, Colorado (1977) p. 345-346.
- 7-12. Medav, Tsvi and F. Tonani, "A Critique of Geothermal Exploration Techniques," Proceedings, Vol 2, Second United Nations Symposium on the Development and Use of Geothermal Resources, Lawrence Berkeley Laboratory, San Francisco, California (1975) p. 1143-1154.
- 7-13. "Proceedings, Second United Nations Symposium on the Development and Use of Geothermal Resources," Lawrence Berkeley Laboratory, Volume 1, San Francisco, California (May 1975).
- 7-14. Schneider, R., "An Application of Thermometry to the Study of Groundwater," U.S. Geological Survey Water Supply Paper 1544B (1962).
- 7-15. Telford, W.M., et al., Applied Geophysics Cambridge University Press (1978).
- 7-16. Tratner, Alan A., "Geothermal World Directory, 1977/78 Edition," Geothermal World Publications, Reseda, California (1977).

DIRECT EXPLORATION METHODS

Section 8. Subsurface Explorations

- 8-1. Acker, W.L. III, "Basic Procedures for Soil Sampling and Core Drilling," Acker Drill Company, Scranton, Pennsylvania (1974).
- 8-2. "Advances in Rock Mechanics," Volume II, Part A, Reports of Current Research, Proc. Third Congress of the International Society for Rock Mechanics. National Academy of Sciences (1974).
- 8-3. Aggson, J.R., "Test Procedures for Non-Linear Elastic Stress-Relief Overcores," Investigation No. R18251, U.S. Department of the Interior, Bureau of Mines, Spokane Mining Research Center (1977).
- 8-4. Ash, J.L., G.E. Russell and R.R. Rommel, "Improved Subsurface Investigation for Highway Tunnel Design and Construction, Vol. 1, Subsurface System Investigation Planning," Report to the Federal Highway Administration, Fenix and Susson, Inc., Report No. FHWA-RD-74-29 (1974).
- 8-5. Barton, C.M., "Borehole Sampling of Saturated Uncemented Sands and Gravels," Groundwater, Vol 12, No. 3 (1974) p. 170-181.
- 8-6. Bieniawski, Z.T., ed., "Exploration for Rock Engineering," Proc. of the Sym. on Exploration for Rock Engineering, South African Institute of Civil Engineers, Geotechnical Division, Johannesburg, S.A. (1977).
- 8-7. Bozozuk, M., "Effect of Sampling, Size, and Storage on Test Results for Marine Clay," Sym. on Sampling of Soil and Rock, STP483, ASTM, Toronto, Canada (June 1970) p. 121-131.
- 8-8. Buchbinder, G., et al., "Measurement of Stress in Boreholes," Paper 66-13, Drilling for Scientific Purposes, Geological Survey of Canada.
- 8-9. Coates, D.J., et al., "Inclined Drilling for the Kielder Tunnels," Quarterly Journal Engineering Geology, Vol 10, No. 3, Great Britain (1977) p. 195-205.

- 8-10. Conway, J., "Suggestions for Improvement of the Over-core Method," Internal Report, U.S. Bureau of Mines, Spokane Mining Research Center.
- 8-11. De La Cruz, R.V. and R.E. Goodman, "Theoretical Basis of the Borehole Deepening Method of Absolute Stress Measurement," Eleventh Sym. on Rock Mechanics, AIME (1970) p. 353-374.
- 8-12. "Design Manual, Soil Mechanics, Foundations and Earth Structures," U.S. Department of the Navy, NAVFAC DM-7, U.S. Government Printing Office, Washington DC (1971).
- 8-13. Ellis, M.C., et al., "Borehole Television," Subsurface Geology; Petroleum, Mining, Construction, Colorado School of Mines, Golden, Colorado (1977) p. 516-523.
- 8-14. Gass, Tyler E., "Primitive Well Drilling Techniques: Part II," Water Well Journal (October 1979) p. 34-35.
- 8-15. Goughnour, Roger D. and Robert M. Mattox, "Subsurface Exploration State of the Art," Proc. Annual Highway Geology Symposium, No. 25, Raleigh, North Carolina (1974) p. 187-199.
- 8-16. Hooker, V.E. and D.L. Bickel, "Overcoring Equipment and Techniques Used in Rock Stress Determination," U.S. Department of the Interior, Bureau of Mines, Information Circular 8618.
- 8-17. Hvorslev, M.J., Subsurface Exploration and Sampling of Soils for Civil Engineering Purposes, Corps of Engineers Waterways Experiment Station, Vicksburg, Mississippi (1949).
- 8-18. "Innovations in Subsurface Exploration of Soils," Fifty-fourth Meeting of the Transportation Research Board, National Research Council, Washington DC (1976).
- 8-19. "ISM Coring System," Sprague and Henwood, Inc., Undated Marketing Brochure, Scranton, Pennsylvania.
- 8-20. Jennings, J.E., et al., "The Nkana Spoon as a Method for Subsurface Exploration," Proc. of the European Sym. on Penetration Testing, Vol 2, Pt. 2 (1975).

- 8-21. Kennedy, J.L., "Government Research Related to Possible New Drilling Methods," Oil and Gas Journal, Vol 68, No. 18 (May 1970) p. 142-145.
- 8-22. Merritt, Andrew H., "Underground Excavation: Geologic Problems and Exploration Methods," Proc. of Conference on Subsurface Exploration for Underground Excavation and Heavy Construction, ASCE (August 1974).
- 8-23. Moelle, K.H.R. and J.D. Young, "On Geological and Technological Aspects of Oriented N-size Core Diamond Drilling," Engineering Geology (1970).
- 8-24. Mohr, H.A., "Exploration of Soil Conditions and Sampling Operations," Bulletin No. 376, Soil Mechanics Series No. 21, Graduate School of Engineering, Harvard University, Cambridge, Massachusetts (1962).
- 8-25. Muhs, H., "State-of-the-Art Review on Soil Sampling," Specialty Session I, Seventh International Conference on Soil Mechanics and Foundation Engineering, Mexico (1969).
- 8-26. Orr, C.M., "The Integral Sampling Technique of Jointed Rock Masses Incorporating CSIR Apparatus," Geomechanics Internal Rep., ME/1363/4, South African Council Sci. Ind. Res., Pretoria, South Africa (November 1975).
- 8-27. Rocha, M., "Integral Rock Samples," Bull. Association Engineering Geologists, Vol X, No. 1 (1973).
- 8-28. Rocha, M., "Method of Integral Sampling of Rock Masses," Rock Mechanics, Felsmech, Vol 3, No. 1 (May 1971) p. 1-12.
- 8-29. Rosengren, K., "Diamond Drilling for Structural Purposes of Mt. Isa," Industrial Diamond Review (October 1970) p. 338-395.
- 8-30. Rowley, D.S., et al., "Oriented Cores," Christian Diamond Products, Salt Lake City (1971).
- 8-31. "Sampling of Soil and Rock," Special Publication 483, Seventy-third Meeting of the ASTM Symposium, Philadelphia PA (1970).

- 8-32. Schmidt, B., "Exploration in Soft Ground Tunnels - A New Approach," Proc. of Conference on Subsurface Exploration for Underground Excavation and Heavy Construction, ASCE (1974).
- 8-33. Schmidt, B., et al., "Subsurface Exploration Methods for Soft Ground Rapid Transit Tunnels," Volume I, Sections 1-6 and References, Parsons, Brinckerhoff, Quade and Douglas, New York, U.S. DOT/UMTA, Washington DC (1976).
- 8-34. Schmidt, B., et al., "Subsurface Exploration Methods for Soft Ground Rapid Transit Tunnels, Volume 2: Appendixes A-F," Parsons, Brinckerhoff, Quade and Douglas, Inc., DOT/UMTA, Washington DC (April 1976).
- 8-35. Seegmiller, Ben L., "Site Characterization Using Oriented Borehole Core," Seegmiller Associates, Salt Lake City, Utah. Monograph 1 on Rock Mechanics, Seventeenth Sym. on Rock Mechanics, AIME (1977) p. 74-78.
- 8-36. Sims, Darell L. and T.J. Wiley, Jr., "Drill String, Drill Pipe, Bumper Subs, Drill Collars, Coring Equipment," Prepared for National Science Foundation, Contract NSF C-482, NTIS No. PB 212-133 (April 1972).
- 8-37. Swiger, William F., et al., "Subsurface Investigation for Design and Construction of Foundations of Buildings, Appendixes A and B," ASCE, Journal of Soil Mechanics and Foundations Division, Vol 98, No. SM8 (1972) p. 771-785.
- 8-38. "Soil Sampling," U.S. Dept. of the Army, Engineer Manual EM1110-2-1907, U.S. Government Printing Office, Washington DC (1972).
- 8-39. "Soils Exploration and Testing," U.S. DOT, Demonstration Project No. 12, Federal Highway Administration, Arlington, Virginia.
- 8-40. "Standard Method for Field Vane Shear Tests in Cohesive Soil," Annual Book of ASTM Standards, Philadelphia, Pennsylvania (1972) p. 809-812.
- 8-41. "Standard Method for Penetration Test and Split-Barrel Sampling of Soils," ASTM: D1586-67, Philadelphia, Pennsylvania (1974).

- 8-42. "Subsurface Investigation for Design and Construction of Foundations of Buildings: Part II," Proc. ASCE Journal of Soil Mechanics and Foundations Division, Vol 98, No. SM6 (1972).
- 8-43. Trantina, J.A. and L.S. Cluff, "'NX' Borehole Camera," Sym. on Soil Exploration, Atlantic City, New Jersey, ASTM Special Technical Publication 351 (1964) p. 108-120.
- 8-44. Voloshin, V., D.D. Nixon and L.L. Timberlake, "Oriented Core - A New Technique in Engineering Geology," Bull. of Assoc. Engineering Geologists, Vol V, No. 1 (1968).
- 8-45. Walker, L.K., W.A. Peck and N.D. Bain, "Application of Pressuremeter Testing to Weathered Rock Profiles," Golder Associates, Melbourne, Australia, Proceedings Australia-New Zealand Conference on Geomechanics, No. 2 (1975) p. 287-291.
- 8-46. Westwood, A., N. MacMillan and R. Kalyoncu, "Chemo-mechanical Effects in Hard Rock Drilling," Martin Marietta Labs, Baltimore, Maryland, National Science Foundation, Washington DC (June 1973).
- 8-47. Williamson, T.N. and R.L. Schmidt, "Probe Drilling for Rapid Tunneling," Proc. NARETC, AIME Vol 1 (1972) p. 65-88.

Section 9. In-Situ Testing

- 9-1. Alexander, L.G., "Field and Laboratory Tests in Rock Mechanics," Proc. Third Conference on Soil Mechanics and Foundation Engineering, Australia-New Zealand (1960) p. 161-168.
- 9-2. Burland, J.B., "Field Measurements. Some Examples of Their Influence on Foundation Design and Construction," Ground Engineering, Vol 10, No. 7 (1977) p. 15-22.
- 9-3. deMello, Victor, F.B., "The Standard Penetration Test," Proc. of the Fourth Pan American Conference on Soil Mechanics and Foundation Engineering, ASCE, San Juan, Puerto Rico, Vol I (June 1971) p. 1-87.
- 9-4. Dixon, S.J., "Pressure Meter Testing of Soft Bedrock," ASTM Sym. on Determination of the In-Situ Modulus of Deformation of Rock, ASTM Special Technical Publication 477 (1969), p. 126-136.
- 9-5. Fairhurst, C., "Methods of Determining In-Situ Rock Stresses at Great Depths," Technical Report No. 1-68, Univ. of Minnesota, School of Mineral and Metallurgical Engineering, Minneapolis, Minnesota (1968).
- 9-6. Fairhurst, C., "Borehole Methods of Stress Determination," Madrid International Symposium on Rock Mechanics (October 1968).
- 9-7. Gibson, R.E. and W.F. Anderson, "In-Situ Measurement Of Soil Properties With The Pressuremeter," Civil Engineering and Public Works Review (May 1961) p. 3-6.
- 9-8. Goodman, R.E., T.K. Van and F.E. Heuze, "The Measurement of Rock Deformability in Boreholes," Tenth Sym. on Rock Mechanics, Univ. of Texas, Austin (1968).
- 9-9. Gorman, C.T., T.C. Hopkins and V.P. Drenevick, "In-Situ Shear Strength Parameters by Dutch Cone Penetration Tests," Proc. Third Ohio River Valley Soils Seminar, Lexington, Kentucky (1973).

- 9-10. Haimson, Bezalel C., "Preexcavation Deep-Hole Stress Measurements for Design of Underground Chambers," Proc. Third NARETC, AIME Engineers (June 1976).
- 9-11. Hendron, A.J., et al., "Compressibility Characteristics of Shales Measured by Laboratory and In-Situ Tests," ASTM Sym. on Determination of the In-Situ Modulus of Deformation of Rock, ASTM Special Technical Publication 477 (1969) p. 137-153.
- 9-12. Hughes, J.M.O., C.P. Wroth and D. Windle, "Pressure-meter Tests in Sands," Geotechnique, Vol 27, No. 4 (1977) p. 455-477.
- 9-13. Ireland, H.O., O. Moretto and M. Vargas, "The Dynamic Penetration Test, A Standard That is not Standardized," Geotechnique, Vol 20, No. 2 (1970) p. 185-192.
- 9-14. Kovacs, W.D., et al., "A Compactive Investigation of the Mobile Drilling Company's Safe-T-Driver With the Standard Cathead With Manna Rope for the Performance of the Standard Penetration Test," School of Civil Engineering, Purdue University, West Lafayette, Indiana (July 1975).
- 9-15. Marcuson, W.F. and W.A. Bieganousky, "SPT and Relative Density in Coarse Sands," ASCE Journal Geotechnical Engineering Division Proc. Vol 103, No. GT11 (1977) p. 1295-1309.
- 9-16. Mayer A., "Recent Work in Rock Mechanics," Milestones in Soil Mechanics - the First Ten Rankine Lectures 1961-1970, Thomas Telford Ltd. for Institution of Civil Engineers, London (1975) p. 57-80.
- 9-17. Morgenstern, N.R. and S. Thomson, "Comparative Observations on the Use of the Pitcher Sampler in Stiff Clay," ASTM Symposium on Sampling of Soil and Rock, ASTM Special Technical Publication 483, Toronto, Canada (June 1970) p. 180-191.
- 9-18. Muir Wood, A.M. and G. Caste, "In-Situ Testing for the Channel Tunnel," Sir William Halcrow and Partners, Proc. of the Conference on In-Situ Investigations in Soils and Rocks, British Geotechnical Society, London, (1970) p. 109-116.

- 9-19. Nataraja, M., "In-Situ Stress Measurements, Park River Project, Hartford, Connecticut," Dames and Moore, Cranford, New Jersey (1977).
- 9-20. Pandian, N.S. and A.A. Raju, "In-Situ Testing of Soft Rocks with Pressuremeter," Indian Geotechnical Journal, Vol 7, No. 4 (1977) p. 305-314.
- 9-21. Pearson, R. and S. Money, "Improvements in the Lugeon or Packer Permeability Test," Quarterly Journal Engineering Geology, Vol 10, No. 3 (1977) p. 221-239.
- 9-22. Rocha, M., "New Techniques in Deformability Testing of In-Situ Rock Masses," Determination of the In-Situ Modulus of Deformation of Rock, ASTM Special Technical Publication 477, Philadelphia (1970).
- 9-23. Ruiz, M.D. and F.P. Camargo, "A Large Scale Field Shear Test on Rock," Proc. First Congress of the International Society for Rock Mechanics, Lisbon, Vol 1 (1966) p. 257-262.
- 9-24. Schmertmann, J.H., "Suggested Method for Deep Static-Cone Penetration Tests," ASTM Special Technical Publication 479 (1970) p. 71-77.
- 9-25. Schmertmann, J.H., "The Importance of Side Friction and Lateral Stress on the S.P.T. N-Value," Proc. Fourth Pan American Conference on Soil Mechanics and Foundation Engineering, Vol III (1971) p. 90-99.
- 9-26. Schmertmann, J.H. and P. Alejandro, "The Dynamics of the Standard Penetration Test," ASCE, Geotechnical Engineering Division (October 1978).
- 9-27. Schmid, W.E., "Field Determination of Permeability by the Infiltration Test," ASTM Special Technical Publication 417 (1970) p. 142-159.
- 9-28. Van Schalkwyk, A., "Rock Engineering Testing in Exploratory Boreholes," Exploration for Rock Engineering, Proc. of the Sym., African Institute of Civil Engineers, Geotechnical Division, Vol 1, Johannesburg, South Africa (1977) p. 37-55.
- 9-29. Young, C. and O. Dubugon, "A Reflected Shear-Wave Technique for Determining Dynamic Rock Strength," International Journal of Rock Mechanics and Mining Science, Vol 14, No. 5/6 (1977) p. 247-259.

Section 10. Horizontal Drilling

- 10-1. Allen, R.H., "Square Drill Collar Controls Deviation," The Oil and Gas Journal (July 1963).
- 10-2. Ash, J.L., B.E. Russell and R.R. Rommel, "Improved Subsurface Investigation for Highway Tunnel Design and Construction, Volume I, Subsurface Investigation System Planning," Federal Highway Administration Report No. FHWA-RD-74-29 (1974).
- 10-3. Baguelin, F., J.F. Jézéquel and A. Lemehauté, "Lateral Self-Boring Penetrometer," Proc. International Conference Soil Mechanics and Foundation Engineering, Vol I, Tokyo, Japan (July 1977) p. 27-30.
- 10-4. Brantly, J.E., Rotary Drilling Handbook, Palmer Publications, New York (1961).
- 10-5. Bruner, T.E., "Horizontal, Small Diameter Road Borings in Rock," Proc. of the NARETC, AIME, San Francisco (1974).
- 10-6. Campbell, R.D., "Borehole Surveying and Directional Drilling," Eleventh Symposium on Exploration Drilling. Quart. of the Colorado School of Mines, Vol 58, No. 4 (October 1963).
- 10-7. Cervik, J., et al., "Rotary Drilling Holes in Coalbeds for Degasification," U.S. Bureau of Mines, No. R18097 (1975).
- 10-8. Cervik, J. and J.D. Haden, "Design and Development of Drill Equipment," U.S. Bureau of Mines, Methane Control Program Technical Progress Report 11 (1969).
- 10-9. Christenson, A.J. and R.R. Rommel, "Horizontal Drilling Control Techniques - Data Evaluation and Field Testing Program," Fenix and Scisson, Inc., Tulsa, Oklahoma, Report for U.S. Bureau of Mines, Contract H0111355 (1972).
- 10-10. Davis, Ira, Conference on Directional Drilling Presented at Massachusetts Institute of Technology, Cambridge, Massachusetts. Wilson Downhole Services, Houston, Texas (January 1975).

- 10-11. Dowding, Charles H., "Feasibility of Horizontal Boring for Site Investigation in Soil," Massachusetts Institute of Technology, School of Engineering, Report No. GHWA-RD-76-1, Cambridge, Massachusetts (February 1976).
- 10-12. Dyna-Drill Handbook, 2nd Ed., Dyna-Drill, Division of Smith International, Inc., Irvine, California.
- 10-13. Elder, C.W., Jr., "Horizontal Drilling for Oil in Pennsylvania," U.S. Bureau of Mines Report of Investigations 3779 (September 1944).
- 10-14. Folwell, W.T., "Raise Borers Applied Horizontally," Proc. NARETC, AIME (1972).
- 10-15. Foster, Eugene L., "A Preliminary Appraisal of the Relative Construction Costs of Pilot Tunnels vs. Long Horizontal Boreholes," Underground Technology Division, Foster-Miller Associates, Inc., Alexandria, Virginia (June 1975).
- 10-16. Garrison, E.P., "Directional Drilling and Down-Hole Motors," Workshop of the Ad Hoc Committee on Technology of Drilling for Energy Resources, National Research Council, National Assembly of Engineering, Park City, Utah (June 1975).
- 10-17. Garrison, E.P., "Down-Hole Motors," presented at the Workshop of the Ad Hoc Committee on Technology of Drilling for Energy Resources, National Research Council, National Assembly of Engineering, Park City, Utah (June 1975).
- 10-18. Harding, J.C., et al., "Drilling and Preparation of Reuseable, Long Range, Horizontal Bore Holes in Rock and in Gouge. Volume I. State-of-the-Art Assessment," Federal Highway Administration Report No. FHWA-RD-74-95, Washington DC (October 1975).
- 10-19. Harding, J.C., et al., "Drilling and Preparation of Reuseable, Long Range, Horizontal Bore Holes in Rock and in Gouge, Volume II, Estimating Manual for Time and Cost Requirements," Federal Highway Administration Report No. FHWA-RD-75-96 (1975).

- 10-20. Harding, J.C., et al., "Drilling and Preparation of Reuseable, Long Range, Horizontal Bore Holes in Rock and in Gouge, Volume III, A Development Plan to Extend Penetration Capability, Increase Accuracy and Reduce Costs," Federal Highway Administration Report No. FHWA-RD-75-97 (1975).
- 10-21. Heilhecker, Joe, "Telemetry, Drill-Stem Problems, and Hole Control," Workshop of the Ad Hoc Committee on Technology of Drilling for Energy Resources, National Research Council, National Assembly of Engineering, Park City, Utah (June 1975).
- 10-22. Henderson, Homer I., "The Continuous-Core Drilling Rig in the Exploration Program," Eleventh Symposium on Exploration Drilling. Quat. Colorado School of Mines. Volume 58, No. 4 (October 1963).
- 10-23. "High Frequency Impact Drilling," Mining Engineering, Volume 125, No. 1 (July 1971).
- 10-24. Knapp, S.R., "Bit Geometry as Related to Hole Deviation Mechanics," Drilling (May 1965).
- 10-25. Knapp, S.R., "Solutions to Crooked Hole Problems Possible," The Drilling Contractor (January-February 1967).
- 10-26. Larson, V.F., T.J. Wiley Jr., "Deep Sea Drilling Project, Technical Report No. 6, Core Bits," Prepared for National Science Foundation, Contract NSF C-482, NTIS No. PB-232-159 (April 1974).
- 10-27. Mack, W.J. Jr., et al., "Drilling and Preparation of Reuseable, Long Range, Horizontal Bore Holes in Rock and in Gouge. Volume II. Estimating Manual for Time and Cost Requirements," Foster-Miller Associates, Inc., Waltham, Massachusetts, Federal Highway Administration, Washington DC (October 1975).
- 10-29. Majtenyi, S.I. and L.A. Rubin, "Long Distance Horizontal Penetration and Sensing in Rock," International Symposium of Field Measurements in Rock Mechanics, Special Print, Zurich (1977).

- 10-30. Majtenyi, S.I., "Horizontal Site Investigation Systems," Proceedings Third NARETC (June 1976) p. 64-80.
- 10-31. Maurer, William C., Novel Drilling Techniques, Pergamon Press, London (1968).
- 10-32. Melaugh, John F., "Directional Drilling: A Survey of the Art and the Science," (May 1970).
- 10-33. Mochida, Yutaka, "Long Horizontal Boring," Permanent Way, Vol 14, No. 3, Japan (April 1973).
- 10-34. Paone, J., et al., "Horizontal Boring Technology: A State-of-the-Art Study," U.S. Bureau of Mines, Information Circular 8392 (1968) p. 41-86.
- 10-35. "Paper on Koken FS-400 Horizontal Boring Machine," Koken Boring Company, Ltd., Tokyo, Japan.
- 10-36. Rommell, Robert R. and Larry A. Rives, "Advanced Techniques for Drilling 1000-Ft. Small Diameter Horizontal Holes in a Coal Seam," U.S. Bureau of Mines Contract No. HO-111355, Volume 2, Telcom, Inc., McLean, Virginia (March 1973).
- 10-37. Rubin, L.A., et al., "A New Sensing System for Pre-Excavation Subsurface Investigation for Tunnels in Rock Masses. Volume I. Feasibility Study and System Design," ENSCO, Springfield, Virginia. Federal Highway Administration Contract No. FH-11-8602, Washington DC (August 1976).
- 10-38. Rubin, L.A., et al., "A New Sensing System for Pre-Excavation Subsurface Investigation for Tunnels in Rock Masses. Volume II. Appendices: Detailed Theoretical, Experimental and Economic Foundation," ENSCO, Springfield, Virginia. Federal Highway Administration, Washington DC (August 1976).
- 10-39. Shipman, F.H. and C.J.H. Brest Van Kempen, "Feasibility Study of Hydro-Mechanical Bore Hole Deviation Sensing, Final Report," Terratek, Inc., National Science Foundation (1978).
- 10-40. Weber, W., "Horizontal Tunneling in Urban Underground Working," Bauingenieur 52, No. 4 (1977) p. 145-150.

- 10-41. Williamson, T.N. "Research in Long Hole Exploratory Drilling for Rapid Excavation Underground," Report for U.S. Bureau of Mines, Jacobs Associates, Contract HO20020, San Francisco, California (October 1972).
- 10-42. Williamson, T.N. and R.L. Schmidt, "Probe Design for Rapid Tunneling," Proc. of NARETC, AIME, Vol 1 (1972) p. 65-87

Section 11. Permeability and Piezometers

- 11-1. Beard, D.C. and P.K. Weyl, "Influence of Texture on Porosity and Permeability of Unconsolidated Sand," AAPG Bull., Vol 57, No. 2 (February 1973) p. 349-369.
- 11-2. Bozozuk, M., "Description and Installation of Piezometers for Measuring Pore-Water Pressures in Clay Soils," Building Note No. 37, Division of Building Research, National Research Council, Ottawa, Canada.
- 11-3. Carmichael, Robert S., "Gravity Geophysics for Groundwater Exploration in Glaciated Areas," Michigan State University, East Lansing, Office of Water Research and Technology, Washington DC (July 1976).
- 11-4. Casagrande, A., "Non-Metallic Piezometer for Measuring Pore Pressures in Clay," Appendix to "Soil Mechanics in Design and Construction of Logan Airport," Jour. BSCE, Vol 36, No. 2 (1949) p. 214-221.
- 11-5. Casagrande, A., "Piezometers for Pore Pressure Measurements in Clay," Division of Engineering and Applied Physics, Harvard University, Cambridge, Massachusetts (1958).
- 11-6. Davis, Stanley N. and Roger J.M. DeWiest, Hydrogeology, John Wiley & Sons, Inc., New York (1970).
- 11-7. "Dewatering and Groundwater Control for Deep Excavations," U.S. Departments of the Army, Navy and Air Force, Technical Manual No. 5-818-5, Washington DC (April 1971).
- 11-8. Gould, J.P., "Analysis of Pore Pressure and Settlement Observations at Logan International Airport," Soil Mechanics Series No. 34, Publication 476, Department of Engineering, Harvard University, Cambridge, Massachusetts (December 1949).
- 11-9. "Ground Water and Wells," Universal Oil Products, Johnson Division, Universal Oil Products, St. Paul, Minnesota (1972).

- 11-10. Ground Water Manual, U.S. Dept. of Int., Bur. of Reclamation (1977).
- 11-11. Hvorslev, M.H., "Time Lag and Soil Permeability in Groundwater Observations," Bulletin No. 36, Waterways Experiment Station, U.S. Army Corps of Engineers, Vicksburg, Mississippi (1951).
- 11-12. "Instrumentation of Earth and Rockfill Dams, Part I, Groundwater and Pore Pressure Observations," Engineering Manual 1110-2-1908, Department of the Army, Office of the Chief of Engineers (1971).
- 11-13. Lang, S.M., "Pumping Test Methods for Determining Aquifer Characteristics," ASTM Special Technical Publication 417 (1967) p. 35-55.
- 11-14. Milligan, V., "Field Measurements of Permeability in Soil and Rock," Proc. In-Situ Measurement of Soil Properties, ASCE, Vol II (June 1975) p. 3-36.
- 11-15. "Permeability and Capillary of Soils," American Society for Testing and Materials, Special Technical Publication No. 417, Philadelphia, Pennsylvania (1967).
- 11-16. Powers, J.P., "Groundwater Control in Tunnel Construction," Proc. NARETC, AIME, Vol 1 (1972) p. 331-370.
- 11-17. Vaughn, P.R., Field Instrumentation in Geotechnical Engineering, Butterworth and Company, London (1973).
- 11-18. Warlam, A.A. and E.W. Thomas, "Measurement of Hydrostatic Uplift Pressure on Spillway Weir with Air Piezometers," ASTM Symposium on Instruments for Soil Mechanics, ASTM Special Technical Publication 392, p. 143-151.
- 11-19. Wilkes, P.F., "The Installation of Piezometers in Small Diameter Boreholes," Geotechnique, Vol 20, No. 3 (1970) p. 330-333.
- 11-20. Wissa, A.E.Z., et al., "The Piezometer Probe," Proc. ASCE, CISMSP, Vol 1 (1975) p. 536-545.

Section 12. Grouting

- 12-1. "Bibliography of Cement Grouting," American Society of Civil Engineers, Journal of Soil Mechanics and Foundations Division, SM4 (July 1963).
- 12-2. Cambefort, H., "The Principles and Application of Grouting," Quat. Journal of Engineering Geology, Vol 10, No. 2 (1977) p. 57-95.
- 12-3. Chemical Grout Field Manual, Cyanamid International, Wayne, New Jersey (April 1966).
- 12-4. Einstein, H.H. and M.H. Barvenik, "Grouting Applications in Civil Engineering. Volumes I and II," Massachusetts Institute of Technology, Cambridge, Massachusetts, Department of Civil Engineering (January 1975).
- 12-6. Erickson, H.B., "Chemical Grouting at NORAD," Sixth Symposium on Rock Mechanics, University of Missouri, Rolla (1964).
- 12-7. Erickson, H.B., "Strengthening Rock by Injection of Chemical Grout," Proc. American Association of Civil Engineers, Vol 94, No. SM1 (1966) p. 159-173.
- 12-8. Grant, L.F., "Application of the Unit Take Concept in Evaluating Grout Hole Drilling Method," Bull. Association of Engineering Geologists, Vol 1, No. 1 (1964).
- 12-9. "Grouting in Soils, Volume 1, A State-of-the-Art Report," US DOT, Federal Highway Administration, FHWA-RD-76-26 (June 1976).
- 12-10. "Grouting Methods and Equipment," U.S. Departments of the Army and Air Force, TM5-818-6 and AFM88-32 (February 1970).
- 12-11. "Grouting of Foundation Sands and Gravels," Technical Memorandum No. 3-408, U.S. Army Corps of Engineers, Vicksburg, Mississippi (June 1955).
- 12-12. Grouts and Muds in Engineering Practice, Butterworth and Company, London (1963).

- 12-13. Haffen, Marcel and Jean Janin, "Grouting Cohesionless Water Bearing Soils in City Tunnels," NARETC, AIME, Vol 2 (1972) p. 1539-1568.
- 12-14. Herndon, Joe and Tom Lenahan, "Grouting in Soils. Volume 2. Design and Operations Manual," Halliburton Services, Duncan, Oklahoma, Federal Highway Administration, Washington, DC (1976).
- 12-15. Janin, J.J. and G.F. LeSciellour, "Chemical Grouting for Paris Rapid Transit Tunnels," Proc. American Association of Civil Engineers, Vol 94, No. CO1, p. 61-74.
- 12-16. Karol, R.H. "Chemical Grouts and Field Grouting," Bull. Association of Engineering Geologists, Vol 1, No. 1 (1964).
- 12-17. Maser, Kenneth R., "Remote Sealing of Mine Passages," Department of the Interior, NTIS PC AOZ/MF A01, Washington, DC (April 1975).
- 12-18. Neelands, R.J. and A.N. James, "Formulation and Selection of Chemical Grouts With Typical Examples of Their Field Use," Sym., Grouts and Drilling Muds in Engineering Practice, Butterworths, London (1963) p. 150-155.
- 12-19. Pressure Grouting, U.S. Department of the Interior, Bureau of Reclamation, TM646 (June 1957).
- 12-20. Sinclair, B.J., "Estimation of Grout Absorption in Fractured Rock Foundation," PhD Thesis, University of Illinois, Urbana (1972).
- 12-21. Smith, D.K., et al., "Borehole Cementing," Subsurface Geology, Petroleum, Mining, Construction, Colorado School of Mines, Golden, Colorado (1977) p. 407-424.

ENGINEERING AND DESIGN

Section 13. Analysis and Prediction

- 13-1. Antonides, L.E., "How You Can Predict Rock Falls," Engineering and Mining Journal (December 1975).
- 13-2. Clark, G.B., et al., "Rock Properties Related to Rapid Excavation," Report for U.S. DOT, OHSGT, Contract 3-0143. Rock Mechanics and Explosives Research Center, University of Missouri, Rolla, (March 1969).
- 13-3. Coon, R.F. and A.H. Merritt, "Predicting In-Situ Modulus of Deformation Using Rock Quality Indexes," ASTM Special Technical Publication 477 (1969) p. 154-173.
- 13-4. Dolleri, A., "Geotechnical Problems and Their Structural Solutions During the Subway Construction in Vienna," Rock Mechanics, Supplement No. 5 (1976) p. 191-208.
- 13-5. Gentry, D.W., et al., "Tunnel Advance Rate Prediction Based on Geologic Engineering Observations," Int. Journal Rock Mechanics and Mining Science, Vol 8 (1971).
- 13-6. Handewith, H.J., "Predicting the Economic Success of Continuous Tunneling in Hard Rock," Lawrence Manufacturing Company, Seattle, Washington. Canadian Mining Metallurgical Bulletin, Vol 63, No. 697 (May 1970) p. 595-599.
- 13-7. Lambe, T.W., "Interpretation of Field Data," Proceedings Lecture Series on Observational Methods in Soil and Rock Engineering, Illinois Section ASCE, Chicago (1970) p. 116-148.
- 13-8. Lambe, T.W. and R.V. Whitman, Soil Mechanics, John Wiley & Sons, Inc., New York, New York (1969).
- 13-9. Merritt, A.H., "Geologic Predictions for Underground Excavations," Proc. First NARETC, AIME, Vol 1, Chicago (1972) p. 115-132.
- 13-10. "New York City Transit Authority Design Guidelines. Construction," Engineering Department, New York City Transit Authority. Urban Mass Transportation Administration, Washington DC (March 1975).

- 13-11. Ozdemir, Levent, "A Laboratory and Field Investigation of Tunnel Boreability," Colorado School of Mines, Golden. National Science Foundation, Washington DC (May 1975).
- 13-12. Peck, R.B., "Advantages and Limitations of the Observational Method in Applied Soil Mechanics," Geotechnique, Vol 19, No. 2 (1969) p. 171-187.
- 13-13. Pipkin, B.W., "Analysis of Wedge Failures in Layered Rocks," Bulletin of Association Engineering Geologists, Vol V, No. 1 (1968).
- 13-14. Ranken, R.E. and J. Chaboussi, "Tunnel Design Considerations: Analysis of Stresses and Deformations Around Advancing Tunnels," University of Illinois, Urbana. Department of Civil Engineering (August 1975).
- 13-15. Robinson, C.S., "Prediction of Geology for Tunnel Design and Construction," Proc. NARETC, AIME, Vol 1 (1972) p. 105-114.
- 13-16. Schmidt, B., "Prediction of Settlements Due to Tunneling in Soil, Three Case Histories," Proc. NARETC, AIME, Vol 2 (1974) p. 1179-1200.
- 13-17. Scott, James H., "Prediction of Geologic and Hydrologic Conditions Ahead of Rapid Excavation Operations by Inhole Geophysical Techniques," U.S. Bureau of Mines (June 1973).
- 13-18. Scott, James H., "Prediction of Rock Character by Geophysical Logging Ahead of Mining and Tunneling," Society Exploration Geophysics, No. 43 (1973).
- 13-19. Tarkoy, P.J., "A Study of Rock Properties and Tunnel Boring Machine Advance Rates in Two Mica Schist Formations," Fifteenth Sym. on Rock Mechanics, Custer State Park, South Dakota (September 1973).
- 13-20. Underwood, Lloyd B., "Exploration and Geologic Prediction for Underground Works," Proc. of Conference on Subsurface Exploration for Underground Excavation and Heavy Construction, ASCE (August 1974).

- 13-21. VanMarcke, E.H., "Probabilistic Modeling of Soil Profiles," ASCE Journal Geotechnical Engineering Division, Vol 103, No. GT11 (1977) p. 1227-1246.
- 13-22. Vick, Steven G., "A Probabilistic Approach to Geology in Hard Rock Tunneling," Massachusetts Institute of Technology, School of Engineering, Cambridge. National Science Foundation, Washington DC (June 1974).
- 13-23. Wahlstrom, E.E., "The Validity of Geologic Projections: A Case History," Economic Geology, Vol 59 (1964) p. 465-474.
- 13-24. Wang, Fun-Den, R. Miller and L. Ozdemir, "Improving Hard Rock Tunneling Through Comparison of Laboratory and Field Tunnel Boring Studies," Proc. Second NARETC, AIME, Vol 2, p. 1741-1757.
- 13-25. Weiss, E.H., "Engineering-Geological Prediction for the Expressway Tunnel through the Arlberg, Tyrol-Vorarlberg, Austria," Rock Mechanics Supplement No. 5 (1976) p. 133-156.
- 13-26. Wheby, Frank T. and Edward M. Cikanek, "A Computer Program for Estimating Costs of Hard Rock Tunneling (COHART)," U.S. DOT, OHSGT and UMTA, Contract 9-00003 (May 1970).
- 13-27. Wickham, G.E., et al., "Ground Support Prediction Model RSR Concept," Proc. NARETC, AIME (1974) p. 691-707.
- 13-28. Wickham, G.E., et al., "Support Determinations Based on Geologic Predictions," Proc. NARETC, AIME, Vol 1 (1972) p. 43-64.

Section 14. Tunnel Design and Construction

- 14-1. Abel, J.F., "Tunnel Mechanics," Quat. of the Colorado School of Mines, Vol 62, No. 2 (1967).
- 14-2. Anderson, E.R. and T.G. McCusker, "Chemical Consolidation in a Mixed Face Tunnel," Proc. NARETC, AIME, Vol 1 (1972) p. 315-330.
- 14-3. "A Systems Study of Soft Ground Tunnel," Report DOT-FRA-OHSGT-231, U.S. DOT, OHSGT and UMTA, Contract 9-0034, Tulsa, Oklahoma (May 1970).
- 14-4. Atkinson, J.H. and D.M. Potts, "Stability of a Shallow Circular Tunnel in Cohesionless Soil," Geotechnique, Vol 27, No. 2 (1977) p. 203-215.
- 14-5. Beth, D.B., "Tunnel Survey," Tunnels and Tunneling (November - January 1969).
- 14-6. "Better Contracting for Underground Construction," US DOT/UMTA MA-06-0025-74-24 (1974).
- 14-7. Black, D.L., et al., "Basic Understanding of Earth Tunneling by Melting. Volume I. Basic Physical Principles," Westinghouse Electric Corporation, Pittsburgh, Pennsylvania. Transportation Systems Center, Cambridge, Massachusetts (July 1974).
- 14-8. "Blasting Vibrations and Their Effects on Structures," U.S.B.M. Bulletin 656, U.S. Government Printing Office, Washington DC (1971).
- 14-9. Brekke, T.L., "Blocky and Seamy Rock in Tunneling," Bull. of Assoc. of Engineering Geologists, Vol V, No. 1 (1968).
- 14-10. Bruce, W.E. and R.J. Morrel, "Rapid Excavation in Hard Rock: A Start-of-the-Art Report," Proc. from Deep Tunnels in Hard Rock, The University of Wisconsin-Milwaukee (November 1970).
- 14-11. "Cut-and-Cover Tunneling Techniques," Sverdrup & Parcel Report to Federal Highway Administration, No. FHWA-RD-73-40 (1973).
- 14-12. Damsky, L.R. and G.T. Gin, "Development of Economic Factors in Tunnel Construction," Bechtel, Inc., San Francisco, California. Transportation Systems Center, Cambridge, Massachusetts. UMTA, Washington DC (December 1977).

- 14-13. Deere, D.U., A.H. Merritt and E.J. Cording, "Engineering Geology and Underground Construction," Second International Conference of the International Association of Engineering Geology, Sao Paulo, Brazil (1974).
- 14-14. Deere, D.U., et al., "Design of Surface and Near-Surface Construction in Rock," Eighth Sym. on Rock Mechanics, AIME, Minneapolis, Minnesota (1967).
- 14-15. Dowding, C.H. and A. Rozen, "Damage to Rock Tunnels from Earthquake Shaking," ASCE Journal of the Geotechnical Engineering Division, Vol 104, No. GT2 (February 1978) p. 175-191.
- 14-16. Fairhurst, Charles and Steven L. Crouch, ed., "Design Methods in Rock Mechanics," Proceedings, Sixteenth Sym. on Rock Mechanics, ASCE, University of Minnesota, Minneapolis (September 1975).
- 14-17. "Federal Excavation Technology Program, 1972-1973 Report," Interagency Committee on Excavation Technology, National Science Foundation, Washington DC (January 1975).
- 14-18. Grosvenor, N.E., "New Tunneling Techniques," Bull. Engineering Geology, Vol IV, No. 1 (January 1967).
- 14-19. Haffen, M., "Urban Underground Structures and Geotechnical Problems: Several Characteristic Examples," Bull. IAEG, No. 9 (1974) p. 43-49.
- 14-20. Hamada, M., et al., "Dynamic Stress of a Submerged Tunnel During Earthquakes," Proc. World Conference on Earthquake Engineering, No. 6 (1977) p. 1509-1515.
- 14-21. Hendron, A.J., "Engineering of Rock Blasting on Civil Projects," Rock Excavation Seminar, ASCE, Metropolitan Section, New York (1976).
- 14-22. Heuer, Ronald E., "Important Ground Parameters in Soft Ground Tunneling," Proc. of Conference on Subsurface Exploration for Underground Excavation and Heavy Construction, ASCE (August 1974).

- 14-23. Hoek, E. and J. Bray, " Rock Slope Engineering,"
Institution of Mining and Metallurgy, London
(1974).
- 14-24. Housel, W.S., "Earth Pressure on Tunnels," Proc. ASCE,
Vol 68, No. SM6, p. 929-950.
- 14-25. Judd, W.R., et al., "Underground Excavation. An
Annotated Bibliography," Purdue University,
Lafayette, Indiana, Center for Information and
Numerical Data Analysis and Synthesis, US DOT,
Washington DC (December 1976).
- 14-26. Liu, T.K., et al., "Muck Utilization in Urban Trans-
portation Tunneling Process, Haley & Aldrich, Inc.,
Cambridge, Massachusetts, Transportation Systems
Center, Cambridge, Massachusetts (December 1977).
- 14-27. Mayo, R.S., et al., "Tunneling - The State of the
Art," U.S. Department of Housing and Urban Develop-
ment, Contract H-766 (1968).
- 14-28. Obert, L. and W.I. Duvall, Rock Mechanics and the
Design of Structures in Rock, John Wiley & Sons
(1967).
- 14-29. O'Reilly, M.P., et al., "Programme of Laboratory,
Pilot and Full-Scale Experiments in Tunnel Boring,"
in Tunneling '76, Institute of Mining and Metal-
lurgy, London (1976) p. 287-299.
- 14-30. Oriard, L.L., "Urban Blasting: Problems and Tech-
niques," ASCE, Foundation and Soil Mechanics
Division Rock Excavation Seminar, New York (1976).
- 14-31. O'Rourke, T.D. and E.J. Cording, "Observed Loads and
Displacements for a Deep Subway Excavation," Proc.
NARETC, AIME, Vol 2 (1974) p. 1305-1326.
- 14-32. Parker, H.W., et al., "Innovations in Tunnel Support
Systems," Report for Office of High Speed Ground
Transportation, US DOT, Contract No. DOT-FR-00023
(1971).
- 14-33. Parker, H.W. and R.H. Semple "Development and Large-
Scale Testing of Innovative Tunnel Support
Systems," Proc. NARETC, AIME, Vol I (1972) p. 469-
498.

- 14-34. Peck, R.B., "Deep Excavations and Tunneling in Soft Ground," Proc. Seventh International Conference on Soil Mechanics and Foundation Engineering, Mexico City, State-of-the-Art Volume (1969) p. 225-290.
- 14-35. Peck, R.B., et al., "Some Design Considerations in the Selection of Underground Support Systems," US DOT, OHSGT and UMTA, Contract 3-0152 (November 1969).
- 14-36. Peck, R.B., et al., "State of the Art of Soft Ground Tunneling," Proc. NARETC, AIME, Vol 1 (1972) p. 259-286.
- 14-37. Peterson, Carl R., "The Development of a Continuous Drill and Blast Tunneling Concept, Phase II," Rapidex, Inc., Peabody, Massachusetts. US DOT, Washington DC (May 1974).
- 14-38. Ranken, R.E. and J. Ghaboussi, "Tunnel Design Considerations: Analysis of Stresses and Deformations Around Advancing Tunnels," Department of Civil Engineering, University of Illinois, Urbana-Champaign. Federal Railroad Administration, Washington DC (August 1975).
- 14-39. Rebul, P. M., "Earth Responses in Soft Ground Tunneling," Proc. Conference on Earth and Earth Supported Structures, ASCE, Vol 1, Part 2 (1972) p. 1517-1535.
- 14-40. Robbins, R.J., "Vehicular Tunnels in Rock - Direction for Development," Proceedings, ASCE Paper 9173 (1972) p. 235-250.
- 14-41. Ross, N.A. and W.A. Hustrulid, "Some Comments on the Design of Medium to Hard Rock Tunnel Boring Machines," AIME, Proc. Twelfth Symposium on Rock Mechanics, Rolla, Missouri (1971) p. 977-992.
- 14-42. "Sym. on Raise and Tunnel Boring," Australian Geomechanics Society, Melbourne, Australia (August 1970).
- 14-43. Terzaghi, K., "Rock Defects and Loads on Tunnel Supports," Section I, Rock Tunneling with Steel Supports, Commercial Shearing and Stamping Company, Youngstown, Ohio (1946).

- 14-44. "Transportation Tunneling Program Review. Annual Conference on DOT Research and Development in Tunneling Technology," Easton, Maryland, US DOT, Washington DC (November 1976).
- 14-45. "Tunneling Technology: An Appraisal of the State of the Art for Application to Transit Systems," Golder Associates and MacLaren, Ltd., Toronto, Ontario, Canada (1976).
- 14-46. Wahlstrom, Ernest E., Tunneling in Rock, Elsevier Scientific Publishing Company (1973).
- 14-47. Wickham, G.E. and H.R. Tiedemann, "Cut and Cover Tunneling. Volume 1: Construction Methods, Design and Activity Variations," Jacobs Associates, San Francisco, California. Federal Highway Administration (May 1976).

Section 15. Site Investigations

- 15-1. "Acquisition and Use of Geotechnical Information," National Cooperative Highway Research Program 33, Transportation Research Board, National Research Council, Washington DC (1976).
- 15-2. Buschbach, T.C. and G.F. Heim, "Preliminary Geologic Investigations of Rock Tunnel Sites for Flood and Pollution Control in the Greater Chicago Area," Illinois Geologic Survey, Environmental Geologic Notes No. 52 (1972).
- 15-3. Conwell, C.N. and D. Wantland, "Seismic and Geological Investigation, Relocation of Tunnel No. 3, Grand Valley Project, Colorado," US Dept. of Interior, Bureau of Reclamation, Engineering Geology, Report No. G-112 (1950).
- 15-4. Dumbleton, M.J., "Available Information for Route Planning and Site Investigation," Transportation and Road Research Laboratory, Crowthorne, England (1973).
- 15-5. Dumbleton, M.J. and G. West, "Guidance on Planning, Directed and Reporting Site Investigations," Department of the Environment, TRRL Report LR625, London (1974).
- 15-6. Gardner, N.I., "Tunnel Site Investigations - A Review," Rapid Excavation - Problems and Progress, Proc. Tunnel and Shaft Conference, University of Minnesota, AIME (1970) p. 13-23.
- 15-7. Hirschfield, R.C., "Report on Hard-Rock Tunneling Investigation," Report for US DOT, Contract C-85-65 (1965).
- 15-8. Juergens, R.E., "Subsoil Surveys Eliminate Pre-Bid Guesswork," Construction Methods and Equipment (September 1962) p. 123-130.
- 15-9. Majtrayi, Steven L., "Planning of Site Investigations for Transportation Tunnels by Systems Analysis," Tunneling Technology Newsletter, U.S. National Committee on Tunneling Technology (June 1974).

- 15-10. Oliveira, R., "Engineering Geological Investigations and In-Situ Testing," Proc. International Association of Engineering Geologists, International Congress No. 2, Vol 2 (1974).
- 15-11. Overbey, W.K., Jr., et al., "Geologic Investigations for Siting and Planning Underground Coal Gasification Project," Abstract, Appalachian Energy, AAPG Bull., Vol 48, No. 9 (1974) p. 1894.
- 15-12. "Probing Ahead for Tunnels: A Review of Present Methods and Recommendations for Research," Transport and Road Research Laboratory, Department of the Environment Supplementary Report 171UC, Crowthorne, Berkshire, England (1975).
- 15-13. "Recommendations on Site Investigation Techniques," International Society for Rock Mechanics (1975).
- 15-14. "Site Investigations," British Standards Institution, British Standard Code of Practice CP2001 (1957).

Section 16. Engineering Geology

- 16-1. Calembert, L., "Engineering Geology Applied to Recent Underground Constructions in Belgium and Italy," Proc. International Association Engineering Geologists, International Congress, Vol 2, No. 2 (1974).
- 16-2. Conwell, Cleland and Dart Wantland, "Seismic and Geological Investigation, Relocation of Tunnel No. 3, Grand Valley Project, Colorado," U.S. Dept. of Interior, Bureau of Reclamation, Engineering Geology Report No. G-112 (1950).
- 16-3. Deere, D.U., et al., "Engineering Geology and Underground Construction," Proc. Second International Conference of the International Association of Engineering Geology, Sao Paulo, Brazil (1974).
- 16-4. "Engineering Geology Manual, Technical Instructions, No. 1," U.S. Dept. of Interior, Bureau of Reclamation (September 1968).
- 16-5. Faillace, G.A. and M.L. Silver, "Effect of Sampling on the Dynamic Stress Strain Properties of Till," Proc. of the Conference on the Properties of Till, The Midland Soil Mechanics and Foundation Engineering Society, Birmingham, England (April 1975) p. 156-163.
- 16-6. Goodman, R.E., Methods of Geological Engineering, West Publishing Company, St. Paul, Minnesota (1976).
- 16-7. Kahl, R.W. and C.A. Kogbe, "The Role of Engineering Geology in the Development of Nigeria," in Geology of Nigeria, Elizabethan Publishing Company, Surulere, Nigeria (1976).
- 16-8. Kendorski, F.S. and J.A. Bischoff, "Engineering Inspection and Appraisal of Rock Tunnels," Proc., 1976 NARETC, Las Vegas, Nevada (June 1976).
- 16-9. Klohn, E.J., "The Elastic Properties of a Dense Glacial Till Deposit," Canadian Geotechnical Journal, Vol II, No. 2 (May 1965) p. 116-140.

- 16-10. Merritt, A.H., "Tunnel Boring Machines; Geologic Controls," Proc. International Association Engineering Geologists, International Congress No. 2, Vol 2 (1974).
- 16-11. Nichols, D. and C. Campbell, ed., "Environmental Planning and Geology," Proc. of Symposium on Engineering Geology in the Urban Environment, Association of Engineering Geologists, U.S. Geological Survey, Menlo Park, California (1969).
- 16-12. Smoltczyck, U. and P. Holzmann, "Earth Pressure Reduction in Front of a Tunnel Shield," Proc. 7th International Conference on Soil Mechanics and Foundation Engineering, Vol 2 (1969) p. 473-481.

Section 17. Classification Systems

- 17-1. "Annual Book of ASTM Standards," Part 19, Designation D2488-69 and D2487-69 (1975).
- 17-2. Aufmuth, Raymond E., "A Systematic Determination of Engineering Criteria for Rock," Bull. of Assoc. Engineering Geologists, Vol XI, No. 3 (1974).
- 17-3. Barton, N., et al., "Engineering Classification of Rock Masses for the Design of Tunnel Support," Rock Mechanics, Vol 6, No. 4 (1974) p. 189-236.
- 17-4. Bieniawski, Z.T., "Engineering Classification of Jointed Rock Masses," The Civil Engineer in South Africa, South African Institution of Civil Engineers, Transvaal, South Africa (December 1973).
- 17-5. Bieniawski, Z.T., "Rock Mass Classification in Rock Engineering," Proc. of the Sym. on Exploration for Rock Engineering, Johannesburg, South Africa, African Institute of Civil Engineers, Geotechnical Division (1977).
- 17-6. Brekke, Tor L. and T.R. Howard, "Functional Classification of Gouge Materials from Seams and Faults in Relation to Stability Problems in Underground Openings," Report for U.S. Bureau of Mines, ARPA, Contract HO220022, University of California, Berkeley, California (1973).
- 17-7. Burmeister, D.M., "Identification and Classification of Soils, An Appraisal and Statement of Principles," STP 112, ASTM, Philadelphia, Pennsylvania (1951).
- 17-8. Cecil, O.S., "An Abrasion Hardness Test for Rock," Unpublished Manuscript, Special Project Report, Rock Mechanics Laboratory, University of Illinois (June 1966).
- 17-9. Chapman, D.R., et al., "A Comparative Study of Shale Classification Tests and Systems," Bull. of the Association of Engineering Geologists, Vol 13, No. 4 (1976) p. 247-266.

- 17-10. "Code of Stratigraphic Nomenclature," American Commission on Stratigraphic Nomenclature, Bull. AAPG, Vol 45, No. 5 (1961) p. 645-665.
- 17-11. Coon, R.F., et al., "Engineering Classification of In-Situ Rock," Technical Report No. AFWL-TR-67-144, Kirtland Air Force Base, New Mexico (1969).
- 17-12. Cooper, K.R., "A Rapid, Accurate Method of Mapping Tunnels in Circular Cross Section," Bull. of Assoc. Engineering Geologists, Vol V, No. 2 (1968).
- 17-13. Deere, D.U., "Indexing Rock for Machine Tunneling," Proc. NARETC, AIME (1970) p. 32-38.
- 17-14. Deere, D.U., "Technical Description of Rock Cores for Engineering Purposes," Rock Mechanics and Engineering Geology, Vol 1, No. 1 (1964) p. 17-22.
- 17-15. Deere, D.U. and R.P. Miller, "Engineering Classification and Index Properties for Intact Rock," Technical Report No. AFWL-TR-65-116, Air Force Weapons Laboratory, Kirtland Air Force Base, New Mexico (1966).
- 17-16. Deere, D.U., et al., "Engineering Classification of In-Situ Rock," Technical Report No. AFWL-TR-67-144, U.S. Air Force Weapons Lab, Kirtland Air Force Base, New Mexico (1969).
- 17-17. deMello, V.G.B., "The Standard Penetration Test," Fourth Pan American Conference on Soil Mechanics and Foundation Engineering, Vol 1 (1971) p. 1-86.
- 17-18. Franklin, J.A., et al., "Logging the Mechanical Character of Rock," Imperial College, London, Transactions Institute Mining Metallurgists, Section A, Vol 80, No. 770 (January 1971) p. A1-9.
- 17-19. Gamble, J.C., "Durability-Plasticity Classification of Shales and Other Argillaceous Rocks," PhD Thesis, University of Illinois, Urbana (1971).
- 17-20. Hall, W.J., et al., "Classification, Engineering Properties, and Field Exploration of Soils, Intact Rock and In-Situ Rock Masses," U.S. Atomic Energy Commission, WASH-1301-UC-11, Washington DC (1974).

- 17-21. Hamrol, A., "A Quantitative Classification of the Weathering and Weathering Ability of Rocks," Fourth International Conference on Soil Mechanics and Foundations, Paris (1957) p. 771-774.
- 17-22. Jack, H. "Tunnel Mapping Methods," Bulletin of Assoc. Engineering Geologists, Vol VI, No. 2 (1969).
- 17-23. Liu, Thomas K., "A Review of Engineering Soil Classification Systems," Highway Research Record No. 156, Classification Safety Factor, Terrain and Bearing (1967).
- 17-24. McGowen, A. and E. Derbyshire, "Genetic Influences on the Properties of Tills," Quarterly Journal of Engineering Geology, Vol 10, No. 4 (1977) p. 389-410.
- 17-25. Myung, John I. and R.W. Baltosser, "Fracture Evaluation by the Borehole Logging Method," Thirteenth Annual Symposium on Rock Mechanics, University of Illinois, Urbana (August 1971).
- 17-26. Olivier, H.J., "Determination of RQD from Petroscope Observations," Keeve Steyn and Partners, Johannesburg, South Africa, Exploration for Rock Engineering Proceedings of the Symposium, Johannesburg, South African Institute of Civil Engineers, Geotechnical Division, Vol 1 (1977) p. 63-68.
- 17-27. Page, T.C., et al., "Borehole Log for Engineering Purposes," Exploration for Rock Engineering, Proceedings of the Symposium Johannesburg, South Africa, South African Institute of Civil Engineers, Geotechnical Division, Vol 1 (1977) p. 87-91.
- 17-28. Proctor, R.J., "Mapping Geological Conditions in Tunnels," Bulletin of Assoc. Engineering Geologists, Vol VIII, No. 1 (1971).
- 17-29. Rankilor, Peter R., "A Suggested Field System of Logging Rock Cores for Engineering Purposes," Bulletin of Assoc. Engineering Geologists, Vol XI, No. 3 (1974).
- 17-30. "Subsurface Investigation for Design and Construction of Foundation Buildings," ASCE Manual and Reports on Engineering Practice No. 56 (1976).

- 17-31. "Sym. on the Identification and Classification of Soils," Fifth-third Annual Meeting ASTM, ASTM Special Technical Publication 113 (1950).
- 17-32. Tarkoy, P.J. and A.J. Hendron, Jr., "Rock Hardness Index Properties and Geotechnical Parameters for Predicting Tunnel Boring Machine Performance," University of Illinois, Department of Civil Engineering, Urbana, National Science Foundation (September 1975).
- 17-33. "The Preparation of Maps and Plans in Terms of Engineering Geology," The Quarterly Journal of Engineering Geology, Vol 5, No. 4 (1972).
- 17-34. "The Unified Soil Classification System," U.S. Army Corps of Engineers, Waterways Experiment Station, Vicksburg, Mississippi, Technical Memorandum No. 3-357, Vol 1 (1953).
- 17-35. Travis, Russel B., "Classification of Rocks," Quarterly of the Colorado School of Mines, Volume 50, No. 1 (January 1955).
- 17-36. White, C.G., "A Rock Durability Index," Quarterly of the Colorado School of Mines, Volume 64, No. 2 (April 1969).

CASE HISTORIES

Section 18. Red Line Geotechnical Reports

- 18-1. "Compilation of Geotechnical Data, Subsurface Investigation for Tunnels, Phase 1, 1a, and 1b, Massachusetts Bay Transportation Authority, Red Line Extension Northwest - Harvard Square to Davis Square," Bechtel, Inc., West Somerville, Massachusetts (June 1978).
- 18-2. "Geotechnical Data Report, Massachusetts Bay Transportation Authority, Red Line Extension Northwest - Harvard to Davis, Porter Square Station Pilot Tunnel," Haley & Aldrich, Inc., Cambridge, Massachusetts (June 1979).
- 18-3. "Geotechnical Data Report, MBTA, Red Line Extension Northwest, Vertical Inspection Shaft, Porter Square Station," Haley & Aldrich, Inc., Cambridge, Massachusetts (July 1978).
- 18-4. "Geotechnical Data Report - Subsurface Investigation, Phase 1, Massachusetts Bay Transportation Authority, Red Line Extension Northwest, Proposed Tunnels - Harvard to Davis Square," C.E. Maguire, Inc., Waltham, Massachusetts (April 1977).
- 18-5. "Geotechnical Data Report - Subsurface Investigation, Phase 1a, Massachusetts Bay Transportation Authority, Red Line Extension Northwest - Tunnels, Harvard Square to Davis Square," Bechtel, Inc., West Somerville, Massachusetts (September 1977).
- 18-6. "Geotechnical Data Report - Subsurface Investigation, Phase 1b, Massachusetts Bay Transportation Authority, Red Line Extension Tunnels, Harvard Square to Davis Square," Bechtel, Inc., West Somerville, Massachusetts (February 1978).
- 18-7. "Geotechnical Engineering Report, MBTA Red Line Extension, Davis Square to Alewife," Goldberg, Zoino, Dunnicliff & Associates, Inc., Newton Upper Falls, Massachusetts (March 1978).

- 18-16. "Summary Geotechnical Data Report, Massachusetts Bay Transportation Authority, Red Line Extension Northwest - Harvard to Davis, Harvard Square Station," for Bechtel, Inc., Haley & Aldrich, Inc., Cambridge, Massachusetts (March 1978).
- 18-17. "Summary Geotechnical Data Report, Massachusetts Bay Transportation Authority, Red Line Extension Northwest - Harvard to Davis, Porter Square Station," for Bechtel, Inc., Haley & Aldrich, Inc., Cambridge, Massachusetts (March 1978).

- 19-12. Kaye, C.A., "Engineering Geologic Framework of the Boston Basin," Preprint 3602, ASCE National Convention, Boston, Massachusetts (April 1979).
- 19-13. Kaye, C.A., "Kaolinization of Bedrock of the Boston, Massachusetts Area," U.S. Geological Survey Professional Paper 575-C (1967) p. 165-172.
- 19-14. Kaye, C.A., "Pleistocene Stratigraphy of Boston, Massachusetts," U.S. Geological Survey Professional Paper 424-B (1961).
- 19-15. LaForge, Laurence, "Geology of the Boston Area Massachusetts," U.S. Geological Survey Bulletin 839 (1932) p. 1-103.
- 19-16. Raam, D.A., "Geology of the Main Drainage Tunnel, Boston, Massachusetts," Jour. BSCE, Vol 49 (1962) p. 310-368.
- 19-17. Richardson, C.A., "Constructing A Soft-Ground Tunnel Under Boston Harbor," Civil Engineers, Vol 31, No. 1 (January 1961) p. 42-45.
- 19-18. Richardson, S.M., "Geology of the Dorchester Tunnel, Greater Boston, Massachusetts," Jour. BSCE, Vol 63, (1977) p. 247-269.
- 19-19. Tierney, F.L., M.P. Billings and M.M. Cassidy, "Geology of the City Tunnel, Greater Boston, Massachusetts," Jour. BSCE, Vol 55 (1968) p. 60-96.
- 19-20. Upson, J.E. and C.W. Spencer, "Bedrock Valleys of the New England Coast as Related to Fluctuations of Sea Level," U.S. Geological Survey Professional Paper 454-M (1964).
- 19-21. Worchester, J.R., "Boston Foundations," Jour. BSCE, Vol 1 (1914) p. 1-30.

Section 20. Case Histories

- 20-1. "Acquisition and Use of Geotechnical Information," National Cooperative Highway Research Program Synthesis of Highway Practice 33, Transportation Research Board, National Research Council, Washington DC (1976).
- 20-2. Arthur, Harold G., "Stillwater Tunnel Project," Proc. NARETC, AIME, Vol 2 (1972) p. 965-981.
- 20-3. Bartlett, J.V., T.M. Noskiewicz and J.A. Ramsey, "Soft Ground Tunneling for the Toronto Subway," Proceedings International Conference Engineers, Vol 32 (1965) p. 53-75.
- 20-4. Beaulieu, A.C., "Tunneling Experiences, City of Edmonton, Alberta, Canada," Proc. NARETC, AIME, Vol 2 (1972) p. 933-963.
- 20-5. Bellport, B.P., "Five Case Histories of Tunnel Boring," Mining Engineer, Vol 23, No. 6 (June 1971) p. 49-52.
- 20-6. Bemis, C.G., et al., "Site Explorations in Iran: A Case History," Proc. Engineering Geology Soils Engineering Sym., No. 14 (1976) p. 206-219.
- 20-7. Bickel, John O., "The English Channel Tunnel, Geology and Construction," Parsons, Brinckerhoff, Quade and Douglas, New York, Bull. Association Engineering Geologists, Vol 3, No. 1-2 (1966) p. 65-79.
- 20-8. Burke, H.H., "Garrison Dam - Tunnel Test Section Investigation," Proc. ASCE, Vol 83, No. SM4, Paper 1438 (1957).
- 20-9. Cornwell, W.L. and R. High, "Investigations for a Submarine Tunnel Beneath the Waitemata Harbour, Auckland, New Zealand," Proc. of the Conference on Geomechanics, No. 2, New Zealand (1975) p. 218-222.
- 20-10. D'Appolonia, D.J., E. D'Appolonia and D. Namy, "Proc. of Workshop on Cut-and-Cover Tunneling: Precast and Cast-in-Place Diaphragm Walls Constructed Using Slurry Trench Techniques," ECI-Soletanche, Inc., Pittsburgh, Pennsylvania, Federal Highway Administration, Washington DC (January 1974).

- 20-11. Dolcetta, Morando, "Problems with Large Underground Stations in Italy," Sym. on Underground Rock Chambers, ASCE, New York (1973).
- 20-12. "Final Report, Rock Mechanics Instrumentation, Straight Creek Pilot Tunnel Bore," for Colorado Department of Highways, Terrametrics, Golden, Colorado (1965).
- 20-13. Hansmire, W.H. and E.J. Cording, "Performance of a Soft Ground Tunnel and the Washington Metro," Proc. NARETC, Vol 1 (1972) p. 371-389.
- 20-14. Hartmark, H., "Geotechnical Observations During Construction of a Tunnel Through Soft Clay in Trondheim, Norway," Rock Mechanics and Engineering Geology, Vol 2, No. 1 (1964) p. 9-21.
- 20-15. Keville, F.M., et al., "MBTA Red Line Extension Northwest: Impact of Geotechnical Programs," ASCE National Convention, Boston (April 1979).
- 20-16. Knapp, R.S., "Settlements Due to Subway Construction in Clay," Proc. Purdue Conference on Soil Mechanics and Its Application (1940) p. 312-320.
- 20-17. Knight, "Subway Tunnel Construction in New York City," ASCE Journal Construction Division, Vol 90, No. CO2 (September 1964) p. 15-36.
- 20-18. Kuesel, T.R., "Soft Ground Tunnels for the BART Project," Proc. NARETC, AIME, Vol 1 (1972) p. 287-314.
- 20-19. Lane, K.S., "Field Test Sections Save Cost in Tunnel Support," ASCE, New York (1975).
- 20-20. MacDonald, F., "The Thames Tunnel," Underground Services, Vol 2, No. 2 (1974).
- 20-21. Maevis, "Planning Design for 63rd Street East River Tunnel," ASCE Reprint No. 1229 (July 1970).
- 20-22. Mahar, J.W., et al., "Observations During Construction of Rock Tunnels for the Washington DC Subway," Proc. NARETC, Vol 1 (1972) p. 659-681.

- 20-23. Peraino, J., "Chesapeake Bay Bridge - Tunnel Project, Two Tunnels and Four Islands," Civil Engineering, Vol 33, No. 12 (December 1963).
- 20-24. "Report of Subsurface Investigation, Final Design, DN-11/ Tunneling Alternative, North Lane," Metropolitan Atlanta Rapid Transit Authority, Law Engineering Testing Company, Atlanta (1976).
- 20-25. Robinson, C.L. and L.T. Fitzhugh, "Engineering Geologic, Geophysical, Hydrologic and Rock-Mechanics Investigations of the Straight Creek Tunnel Site and Pilot Bore, Colorado," U.S.G.S. Prof. Paper 815 (1974).
- 20-26. Robinson, C.S. and F.T. Lee, "Geology of the Straight Creek Tunnel Site, Colorado, and Its Predicted Effect on Tunnel Construction," U.S.G.S., O.F.R. (1962).
- 20-27. Scott, J.H. and R.D. Carroll, "Surface and Underground Geophysical Studies at Straight Creek Tunnel Site, Colorado," Highway Research Record Number 185.
- 20-28. Scott, J.H., et al., "The Relationship of Geophysical Measurements to Engineering and Construction Parameters in the Straight Creek Tunnel Pilot Bore, Colorado," International Journal of Rock Mechanics and Mining Sciences, Vol 5 (1968) p. 1-30.
- 20-29. Skinner, Eugene H., "The Flathead Tunnel. A Geologic, Operations, and Ground-Support Study, Burlington Northern Railroad, Salish Mountains, Montana," Bureau of Mines, Spokane Mining Research Center, (February 1975).
- 20-30. Tattersall, F., et al., "Investigations Into the Design of Pressure Tunnels in London Clay," Proc. Institution of Civil Engineers, Part I, Vol 4 (1955) p. 400-471.
- 20-31. Terzaghi, K., "Liner-Plate Tunnels on the Chicago Subway," Trans. ASCE, Vol 108 (1943) p. 970-1007.
- 20-32. Terzaghi, K., "Shield Tunnels of the Chicago Subway," Journal BSCE, Vol 29 (1942) p. 163-210.

- 20-33. Underwood, L.B., "Machine Tunneling in Missouri River Dams," ASCE, Journal Construction Division, Vol 91, No. CO2 (May 1965).
- 20-34. Ward, W.H. and H.S.H. Thomas, "The Development of Earth Loading and Deformation in Tunnel Linings in London Clay," Proc. Sixth International Conference on Soil Mechanics and Foundation Engineering, Vol 2 (1965) p. 432-436.
- 20-35. "Washington DC Metro System - Subsurface Investigations and Engineering Geology Studies," Numerous Reports available; Meuser, Rutledge, Wentworth and Johnston, New York. Washington Metropolitan Area Transit Authority, Washington DC. DeLeuw, Cather and Company, Inc., Washington DC (1973-1975).
- 20-36. Whiteman, J.C., "Driving BART's Toughest Tunnel," Second Symposium NARETC, Sacramento, California (1969).

*U.S. GOVERNMENT PRINTING OFFICE: 1980 - 600-767/44

HE18.2 A37 no. DOT
MTA 80-1

Field evaluation
methods of sub

Form DOT F 1720.2
FORMERLY FORM DOT F

DOT LIBRARY



00009961