

**U.S. DEPARTMENT OF COMMERCE
National Technical Information Service**

PB--257 733

**DYNALIST II: A COMPUTER PROGRAM FOR STABILITY
AND DYNAMIC RESPONSE ANALYSIS OF RAIL VEHICLE
SYSTEMS. VOLUME II. USER'S MANUAL**

J. H. WIGGINS COMPANY

**PREPARED FOR
FEDERAL RAILROAD ADMINISTRATION**

FEBRUARY 1975

1. Report No. FRA-OR&D-75-22.II		2. Government Accession No.		PB257733	
4. Title and Subtitle DYNALIST II, A COMPUTER PROGRAM FOR STABILITY AND DYNAMIC RESPONSE ANALYSIS OF RAIL VEHICLE SYSTEMS, Volume II, User's Manual				5. Report Date February 1975	
7. Author(s) Allen Bronowicki, T. K. Hasselman				6. Performing Organization Code	
9. Performing Organization Name and Address J. H. Wiggins Company 1650 South Pacific Coast Highway Redondo Beach CA 90277				8. Performing Organization Report No. DOT-TSC-FRA-74-14.II	
12. Sponsoring Agency Name and Address U.S. Department of Transportation Federal Railroad Administration Office of Research and Development Washington DC 20590				10. Work Unit No. (TRAINS) RR415/R5301	
				11. Contractor or Grant No. DOT-TSC-760-2	
				13. Type of Report and Period Covered Final Report 26 Feb. 1974-3 Oct. 1974	
				14. Sponsoring Agency Code	
15. Supplementary Notes This work was performed under Contract No. DOT-TSC-760 for the U. S. Department of Transportation, Transportation Systems Center, Kendall Square, Cambridge MA 02142.					
16. Abstract A methodology and a computer program, DYNALIST II, have been developed for computing the response of rail vehicle systems to sinusoidal or stationary random rail irregularities. The computer program represents an extension of the earlier DYNALIST program. A modal synthesis procedure is used which permits the modeling of subsystems or components by partial modal representation using complex eigenvectors. Complex eigenvectors represent the amplitude and phase characteristics of rail vehicle systems which occur as a result of wheel-rail interaction, heavy damping in the suspension system and rotating machinery. Both vertical and lateral motion are handled by the program which allows up to twenty-five component and fifty system degrees of freedom.					
17. Key Words Rail Vehicle Dynamics, Rail Vehicle Stability, Rail Vehicle Response, Ride Quality, Computer Modeling, Modal Synthesis			18. Distribution Statement DOCUMENT IS AVAILABLE TO THE PUBLIC THROUGH THE NATIONAL TECHNICAL INFORMATION SERVICE, SPRINGFIELD, VIRGINIA 22161 PRICES SUBJECT TO CHANGE		
19. Security Classif. (of this report) Unclassified		20. Security Classif. (of this page) Unclassified		21. No. of Pages 22. Price 97 5.00-2.25	

TABLE OF CONTENTS

<u>Section</u>	<u>Page</u>
1. INTRODUCTION	1
2. PROGRAM DESCRIPTION	3
2.1 Segment 1: Component Modes	3
2.2 Segment 2: Truncation of Modes	4
2.3 Segment 3: Component Mode Synthesis	5
2.4 Segment 4: Frequency Response	6
2.5 Data Files	6
2.6 Program Limits	8
3. OPERATING INSTRUCTIONS	25
3.1 Creating and Storing an Overlay Structure	25
3.2 Using DYNALIST Permanent File	26
3.3 Namelist Strategy	27
4. DATA SET-UP	29
4.1 Namelist Directory	29
4.2 Input Parameters and Format	30
5. DYNALIST II OUTPUT	41
5.1 Program Card Input	41
5.2 Intermediate Results	41
5.3 Results	41
5.4 Tape Identification	42
6. SAMPLE PROBLEMS	44
6.1 Sample Problem 1	44
6.2 Sample Problem 2	44
6.3 Sample Problem 3	45
6.4 Sample Problem 4	46
APPENDIX A: SAMPLE PROBLEM PRINTOUT FOR LATERAL CAR MODEL	A-1 .
APPENDIX B: REPORT OF INVENTIONS	B-1

Preceding page blank

LIST OF ILLUSTRATIONS

<u>Figure</u>	<u>Page</u>
1a. DYNALIST II Flow Diagram	10
1b. Flow Diagram for Segment 1	11
1c. Flow Diagram for Segment 2	12
1d. Flow Diagram for Segment 3	13
1e. Flow Diagram for OVERLAY (2,1)	14
1f. Flow Diagram for OVERLAY (2,2)	15
1g. Flow Diagram for OVERLAY (2,3)	16
1h. Flow Diagram for OVERLAY (2,4)	17
1i. Flow Diagram for OVERLAY (2,5)	18
1j. Flow Diagram for OVERLAY (3,0)	19
1k. Flow Diagram for Response Matrix Calculation . .	20
1l. Flow Diagram for OVERLAY (4,1)	21
1m. Flow Diagram for OVERLAY (4,2)	22
2. Layout of Component Data File (C.D.F.)	23
3. A Three-Car Train Modeled with Two Unique Components	24

1. INTRODUCTION

This manual describes the use of the DYNALIST II computer program for linear dynamic analysis of rail vehicle systems. The program provides a general capability for stability analysis and for computing vehicle response to either sinusoidal or random guideway irregularities. The building block concept is used to achieve modeling flexibility. A variety of systems may be studied by assembling the user generated components in different ways.

DYNALIST II has been developed with three basic objectives in mind:

- Simplified input
- Modeling flexibility
- Computational efficiency

Briefly stated, simplified input is provided for by using a NAMELIST format, and by the ability to generate component data files which may be added to and accessed in future runs. Modeling flexibility is provided for by the generality of the mathematical formulation which utilizes a subsystems modeling approach. Computational efficiency is achieved through use of the QR algorithm to compute complex eigenvalues and eigenvectors which are used in both stability and response analysis. Modal synthesis provides a means of keeping the size of any single eigenproblem small by using a truncated set of complex component eigenvectors as a basis for the system equations of motion.

Subsequent sections in this manual describe the program in detail and specify operating instructions as well as preparation of input data. Both printed and plotted forms of program generated output are described and a sample problem is presented.

A separate section with some discussion of user experience to date was considered for inclusion in this manual. However, the transient nature of this material and the need for some means of disseminating current information regarding program updates, identification and elimination of computational bugs, as well as commentary on current experience and guidelines for future use, suggests an alternative format. Several User Bulletins are supplied with this manual. It is anticipated that as user experience accumulates, additional bulletins will be issued.

2. PROGRAM DESCRIPTION

DYNALIST II is constructed of four segments. A series of flow diagrams are shown in Figure 1 which follows Section 2. The functions of these four segments are as follows:

- Segment 1. Determine modes for a component and create, or add to, a component data file. A modal data bank and data file may also be created for use in calculating component response in program Segment 4.
- Segment 2. Edit (truncate modes from) the various components on a component data file.
- Segment 3. Synthesize component data (edited or un-edited) into a system and determine system modes. A modal data bank and data file may also be created for use in calculating system response in program Segment 4.
- Segment 4. Obtain frequency response at specified physical coordinates due to forces applied at specified physical coordinates. Response due to stationary random or sinusoidal frequency-dependent forces may also be found. Excitation and response characteristics may be plotted on a standard plotting device.

2.1 Segment 1: Component Modes

Segment 1 calculates eigenvalues and eigenvectors for dynamic systems which can be described in terms of matrix equations of motion of the form

$$[m] \{\ddot{p}\} + [c] \{\dot{p}\} + [k] \{p\} = \{0\}$$

m , c and k are real matrices input in the p -coordinate system, which is the same coordinate system in which the component

eigenvectors are printed out. A physical u-coordinate system is defined by the matrix ϕ in the manner

$$\{u\} = [\phi] \{p\}$$

It is the physical u-coordinate system to which constraints and forces will be applied in later segments.

The p-coordinate system must be input with constraint coordinates first, followed by the free coordinates. Eigenvectors will be computed only for the free coordinates. If NFREE = 0, no eigenproblem will be solved.

Segment 1 will automatically generate the matrices m, c, k and ϕ for the rail vehicle systems shown in Figures 2-2 and 3-3(a) of Volume I. The system shown in Figure 2-2 is a six degree-of-freedom truck. IGEN = 2 will generate a truck. The system shown in Figure 3-3(a) is a fourteen degree-of-freedom car. IGEN = 1 will generate a car.

DYNALIST II has the capability of computing response of a component directly, without first using modal synthesis techniques. In order to exercise this option IRESP must be non-zero (= 1 or 2). This sets up a modal data bank in core and, if IRESP = 2, a modal data file on TAPE 12. The program is also structured to permit use of the subsystems modeling approach without transformation to component modal coordinates. The use of this option is recommended whenever component mode truncation is not required.

2.2 Segment 2: Truncation of Modes

Segment 2 has the capability of removing modes from any or all of the components on the component data file. The number of modes to be retained for each component must be specified in the vector NMODE2. The modes to be retained are listed in MODES. Remember that Segment 1 produces two modes for each

degree-of-freedom in the eigenproblem it solves. These modes are in order, from highest to lowest, of the magnitude of the complex eigenvalue, $\lambda = \sigma + i\omega$.

2.3 Segment 3: Component Mode Synthesis

Segment 3 uses component data to create a new set of modal coordinates, solves an eigenproblem of the kind discussed in Section II-1 and then converts the eigenvectors back to the system u-coordinates. Response data, as in Segment 1, will be generated if IRESP \neq 0 and a modal data file will be created if IRESP = 2.

Segment 3 assembles components in order. The coupled system has a p-coordinate system and a u-coordinate system, the same as for a component. The coupled coordinates are the same as the component coordinates, ordered in the same way as the components are assembled. Components are assembled in the order in which the component names are listed in the vector PRENAM. The three-car train of Figure 3 is assembled using five components, NCOMP = 5, from two unique components, 1 and 2. These components are assembled using PRENAM = (1, 2, 1, 2, 1), which results in the coordinates being numbered as shown in Figure 3. Eight physical displacement constraints are applied to the components in the system to form them into a train. The constraints are applied in the u-coordinate system and have the form

$$\begin{aligned}
 [G] \{u\} = & \quad u_4 - u_7 & = 0 \\
 & \quad u_{13} - u_9 & = 0 \\
 & \quad (u_3 - u_4)/L - u_8 & = 0 \\
 & \quad (u_{13} - u_{14})/L - u_{10} & = 0 \\
 & \quad u_{14} - u_{17} & = 0 \\
 & \quad u_{23} - u_{19} & = 0 \\
 & \quad (u_{13} - u_{14})/L - u_{18} & = 0 \\
 & \quad (u_{23} - u_{24})/L - u_{20} & = 0
 \end{aligned}$$

Thus, NROWG will equal 8 and the third constraint, for example, would be input as $G(3, 3) = 1/L$, $G(3, 4) = -1/L$, $G(3, 8) = -1$.

One last piece of information is needed to complete the synthesis. This is the list of dependent constrained p-coordinates. There will be as many dependent constraint coordinates as there are physical constraints. It is necessary to look at the system being synthesized to see which constraint coordinates are completely independent of each other. These coordinates will then be made dependent upon the remaining coordinates. These dependent constraint coordinates are listed in KDEP. For the system of Figure 3, $KDEP = (7, 8, 9, 10, 17, 18, 19, 20)$. Never include a free coordinate in KDEP.

2.4 Segment 4: Frequency Response

Segment 4 calculates frequency response at specified physical coordinates given forces at specified physical coordinates. The form of the force vector $F_u(i \Omega)$ is in general

$$F_{u_j}(i \Omega) = \left[\text{FORC0}_j + (i \Omega) \text{FORC1}_j + (i \Omega)^2 \text{FORC2}_j \right] e^{i \Omega \text{PHASE}_j^*}$$

NAXLE specifies the number of u-coordinates having applied forces; the numbers of these coordinates is contained in LAXLE. NLOOK specifies the number of u-coordinates where frequency response is desired, LOOK specifies the coordinate numbers. Thus, for the train shown in Figure 3, if response is desired at coordinates u_4, u_{14}, u_{24} and u_{26} , $NAXLE = 12$, $LAXLE = (1, 2, 5, 6, 11, 12, 15, 16, 21, 22, 25, 26)$, $NLOOK = 4$, and $LOOK = (4, 14, 24, 26)$.

2.5 Data Files

DYNALIST II uses three working files, TAPE 10, TAPE 11 and TAPE 12, which may be tapes or disks. Any of these may be saved at the end of program execution using the CATALOG Statement

* See Section 2.5, and in particular, Equation (2-38) of Volume I.

(see section III). They may then be used to restart the program at a later time using the ATTACH Statement (see Section III).

TAPE 10 and TAPE 11 are used as component data files only. Component data files are created and added to in program Segment 1. They may be edited in program Segment 2. A component data file (C.D.F.) contains the information necessary to describe one or more unique components. Each component has a unique "name", COMNAM (an F6.2 number). Each time program Segment 1 is called, a new C.D.F. may be created (by specifying NEWTAP = 0) or the component data may be added to the existing C.D.F. (NEWTAP = 1). Each time component information is added, in Segment 1, the information on the C.D.F. previously used is transferred to the other C.D.F. along with the new information. When and if component information is edited, in Segment 2, information is taken from the C.D.F. previously used, then edited and then transferred to the other C.D.F.. Program Segment 3 finds information for the various components it wants to assemble by looking for their "names" on the previously used C.D.F.. Segment 3 does not alter the information on a C.D.F. but it does switch the tape numbers as shown in Figure 1 just as do Segments 1 and 3. Each time program Segments 1, 2 and 3 are completed the message "THE ABOVE DATA IS NOW ON TAPE XX," (XX = 10 or 11) is printed. This information informs the user which file was previously used. When a run is made using a previously generated C.D.F., that file should always be mounted on TAPE 10. Execution using this file may begin with any of program Segments 1, 2 or 3. Cases may be stacked. A stacked case may use a C.D.F. produced in the previous case or a new C.D.F. can be created from scratch. The layout of the C.D.F. is shown in Figure 2.

TAPE 12 is used both as a working file and as a modal data file (M.D.F.). Program Segment 3 uses TAPE 12 as a working

file, so each time Segment 3 is entered, any modal information on TAPE 12 will be destroyed. An M.D.F. can be created in either of program Segments 1 or 3 by specifying IRESP = 2. An M.D.F. contains all the information necessary to compute frequency response except for force and frequency range information. Program Segments 1 and 3 also store the necessary information to compute response in common blocks if IRESP = 1 or 2. However, this information is destroyed upon execution of any segment. The user does not need to create an M.D.F. to calculate response, but he must go directly to Segment 4 to do so. Segment 4 takes its information from common blocks unless IRESP = 2, in which case the information is taken from the M.D.F.

2.6 Program Limits

DYNALIST II was designed to require no more than $150,200_8$ of core for the compiled overlay structure and all storage. Using the techniques of generating and loading the overlay structure, as described in Section III, no more than 10_8K of core should be required to load the program. The program has been run using less than 160_8K of core. In order to limit the size of the program there are limits to the sizes of various matrices and vectors read into the program. These are listed below:

- m , c and k matrices are of maximum size = 25×25 .
- Maximum number of component p-coordinates, $NCON+NRIGS+NFREE = 25$
- Maximum number of component u-coordinates $NU = 50$.
- Maximum size of ϕ matrix = 50×25 .
- Maximum number of components on a C.D.F. = 10.
- Maximum number of assembled components, $NCOMP = 10$.
- Maximum number of constraints, $NROWG = 25$.
- Maximum number of system p-coordinates, $NCTOTS = 50$.
- Maximum number of system u-coordinates, $NUNCOT = 100$.

- Maximum number of applied forces, NAXLE = 100.
- Maximum number of response coordinates, NLOOK = 100.
- Maximum number of power spectral density data points, NPSD = 50.
- a. Maximum number of divisions in frequency spectrum, NSTEP = 500.
- b. Maximum number of frequency increments times system modes retained for response, NSTEP X MORE = 8,000.

The number of system modes referred to in (8), NCOLT, may be calculated in the following manner. Add the number of constraint and rigid body coordinates for all components assembled in the system. Subtract the number of constraints, NROWG, since each constraint eliminates an independent boundary coordinate. Multiply this total by two since the second order equations are converted to first order equations by doubling the number of variables. To this add the sum of the number of modes retained for all components.

This final sum will be the number of system eigenvalues found in Segment 3. The number of system coupled u-coordinates is equal to the sum of the physical coordinates, NU, for all components assembled.

$$NCOLT = \left[\sum_{I=1}^{NCOMP} (NRIGS(I) + NCON(I)) - NROWG \right] \times 2 + \sum_{I=1}^{NCOMP} NMODE2(I)$$

$$NUNCOT = \sum_{I=1}^{NCOMP} NU(I)$$

Main OVERLAY (TEMP,0,0)

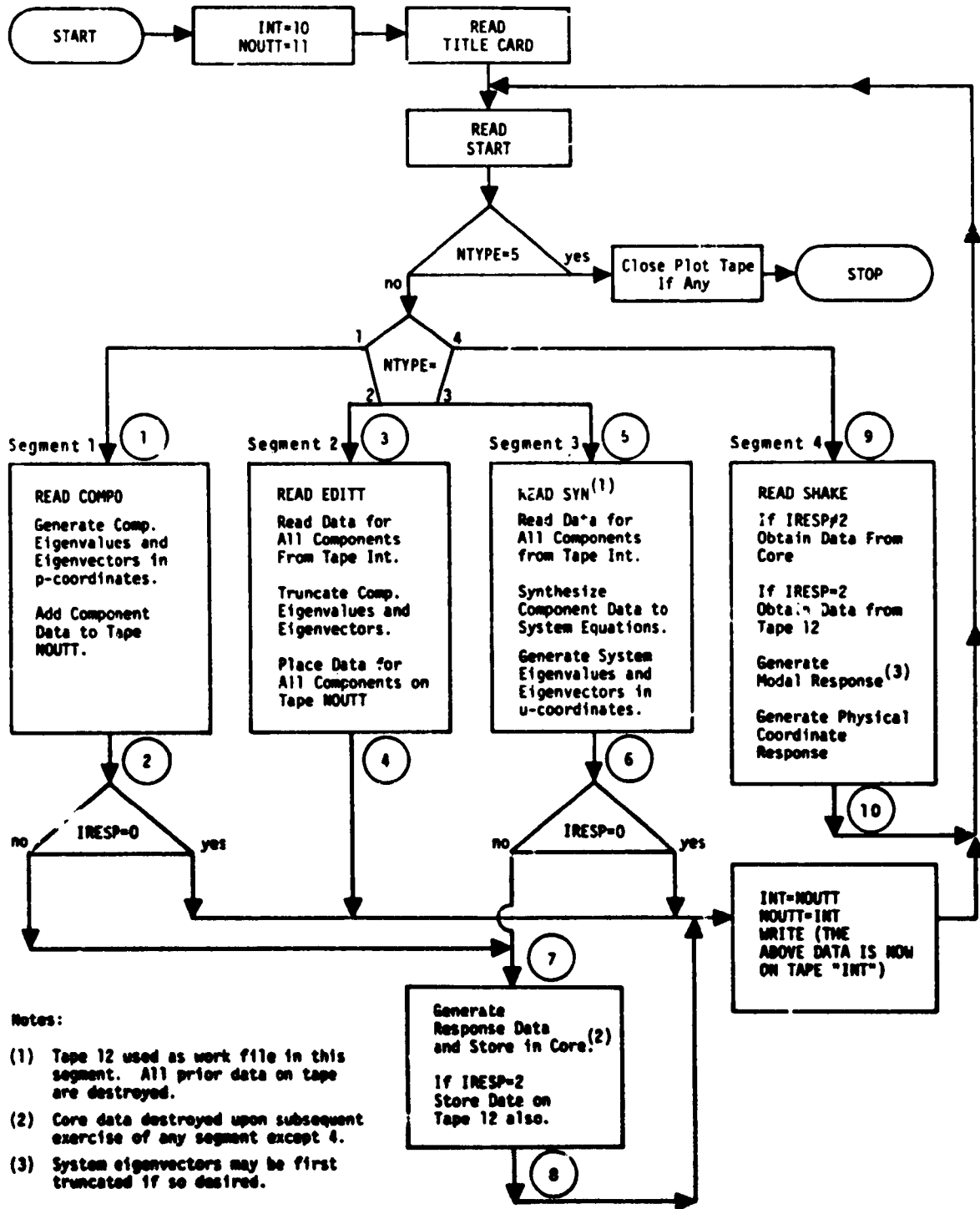

Figure 1a. DYNALIST II Flow Diagram

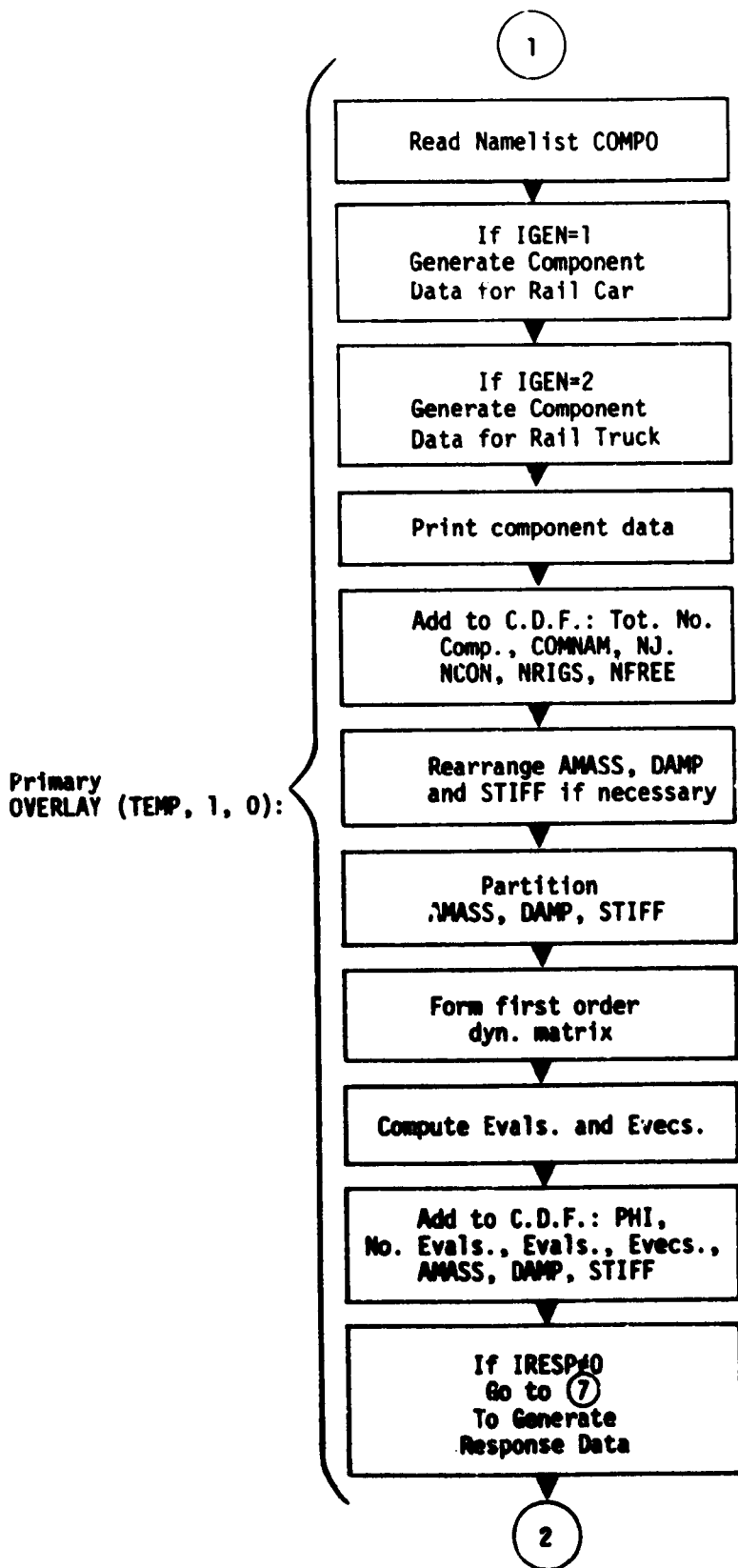

Figure 1b. Flow Diagram for Segment 1

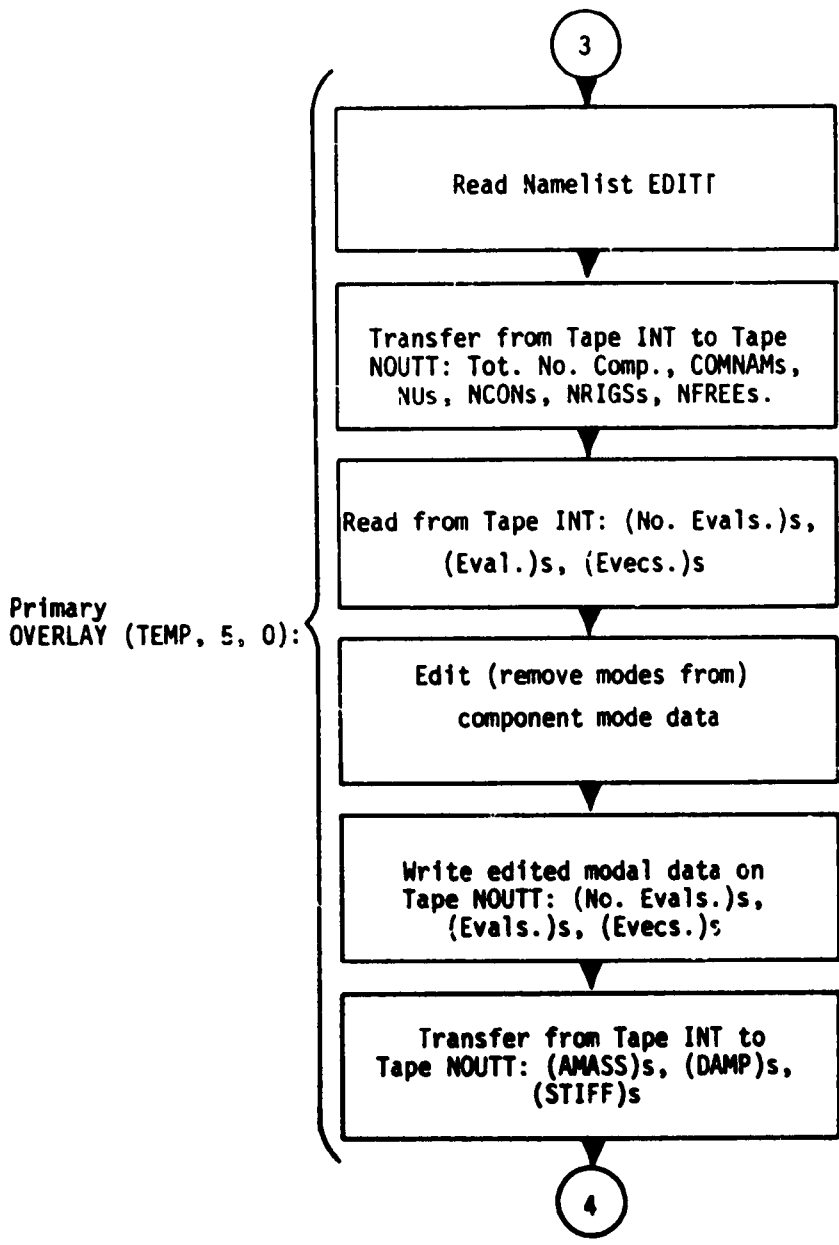

Figure 1c. Flow Diagram for Segment 2.

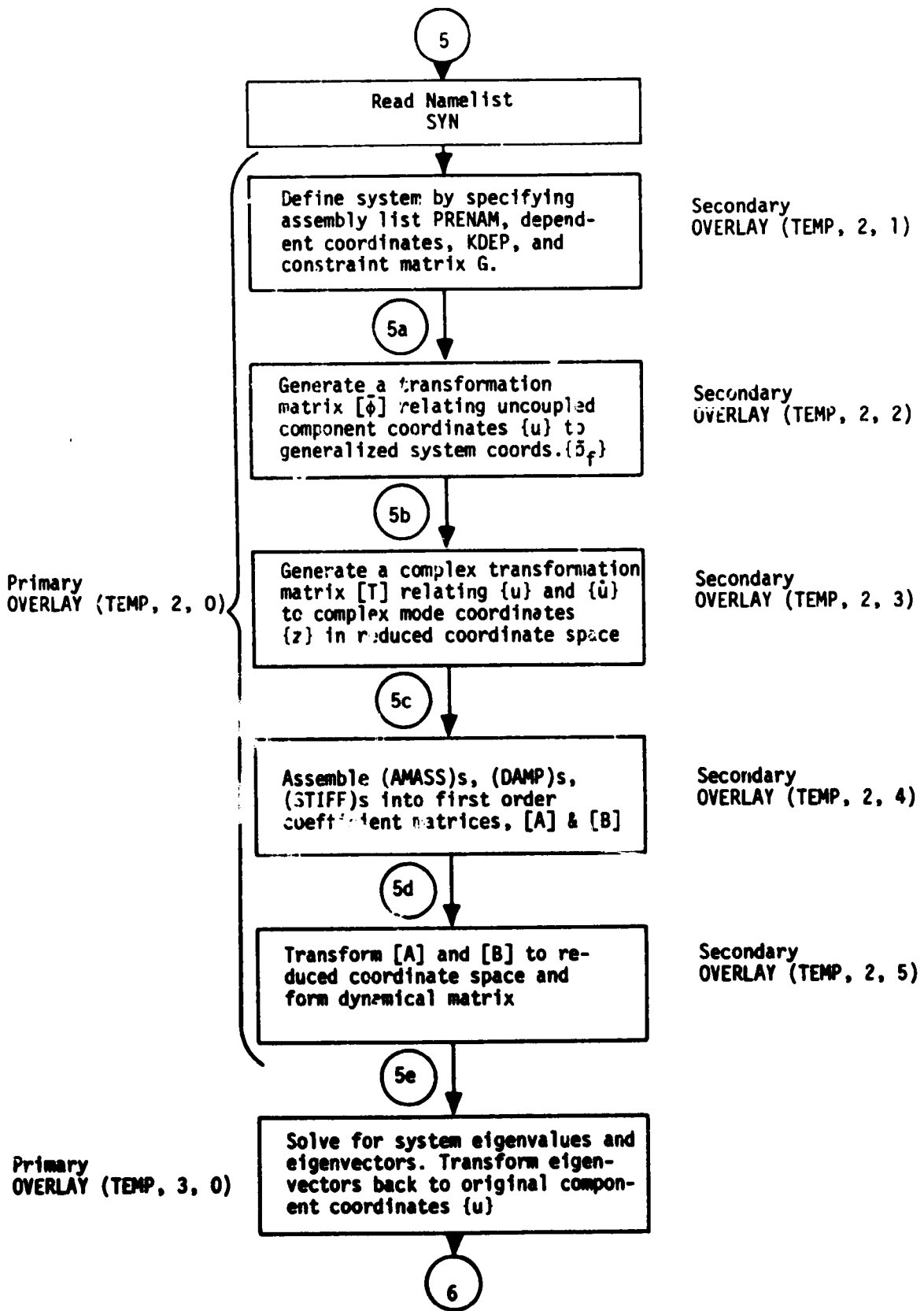

Figure 1d. Flow Diagram for Segment 3.

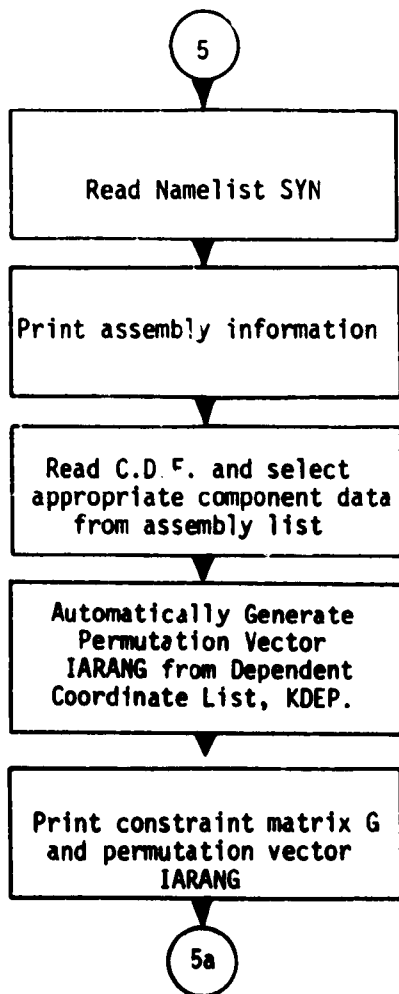

Figure 1e. Flow diagram for OVERLAY (2,1).

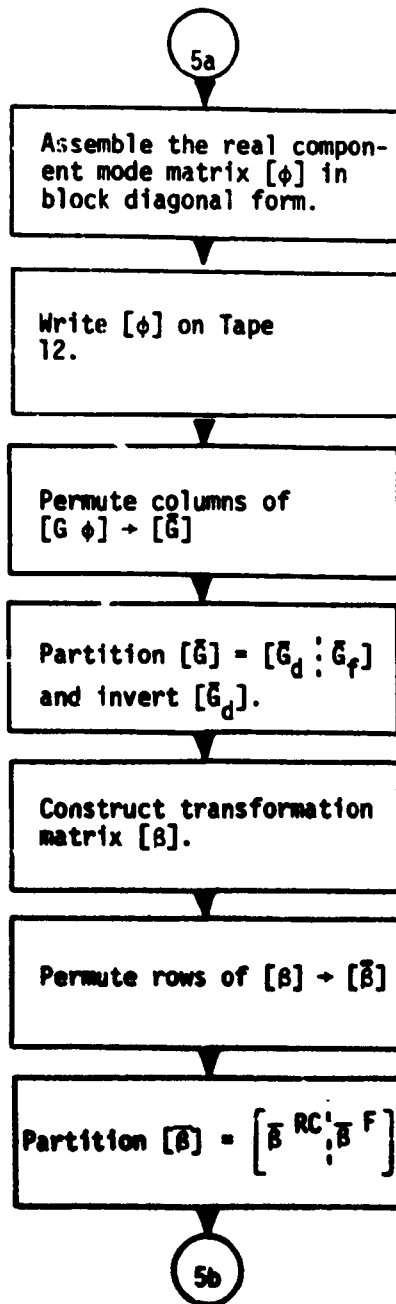

Figure 1f. Flow Diagram for OVERLAY (2.2).

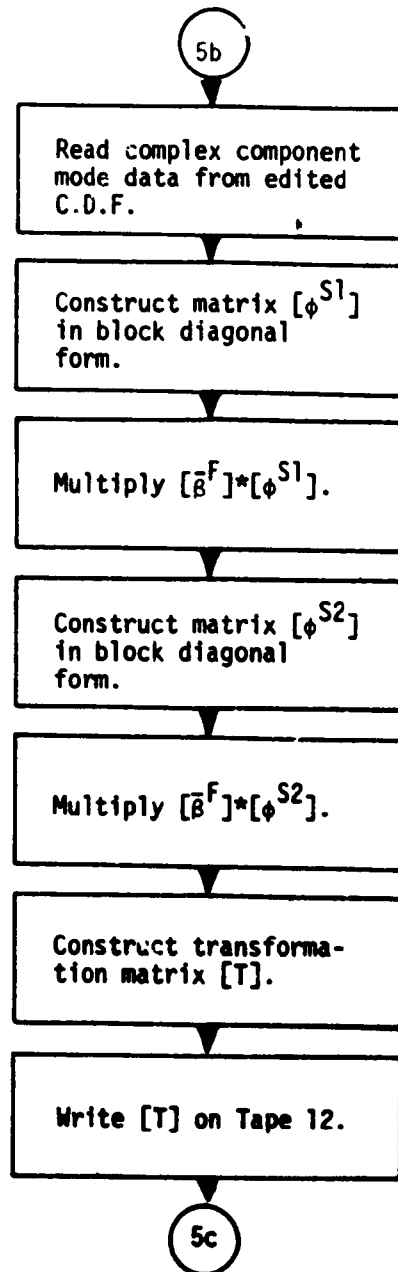

Figure 1g. Flow Diagram for OVERLAY (2,3).

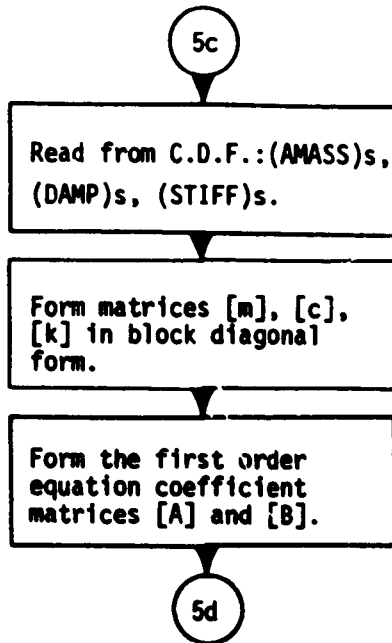

Figure 1b. Flow Diagram for OVERLAY (2,4).

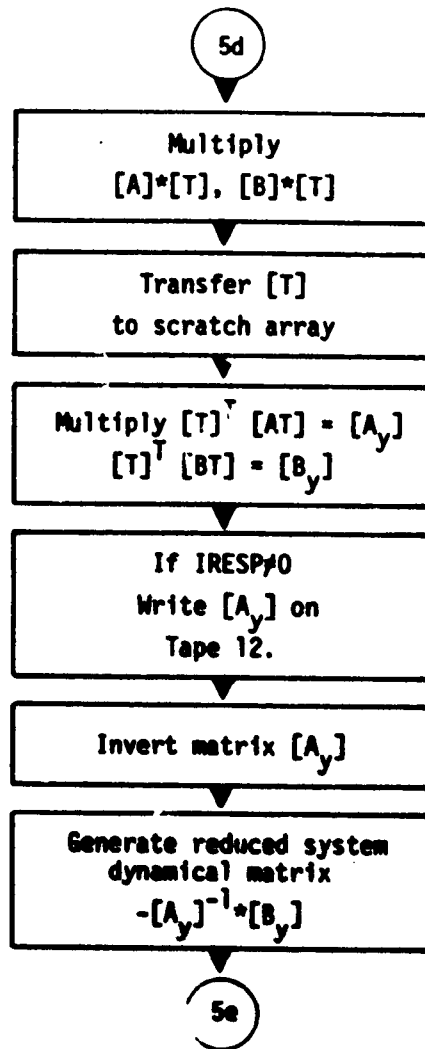

Figure 11. Flow Diagram for OVERLAY (2.5).

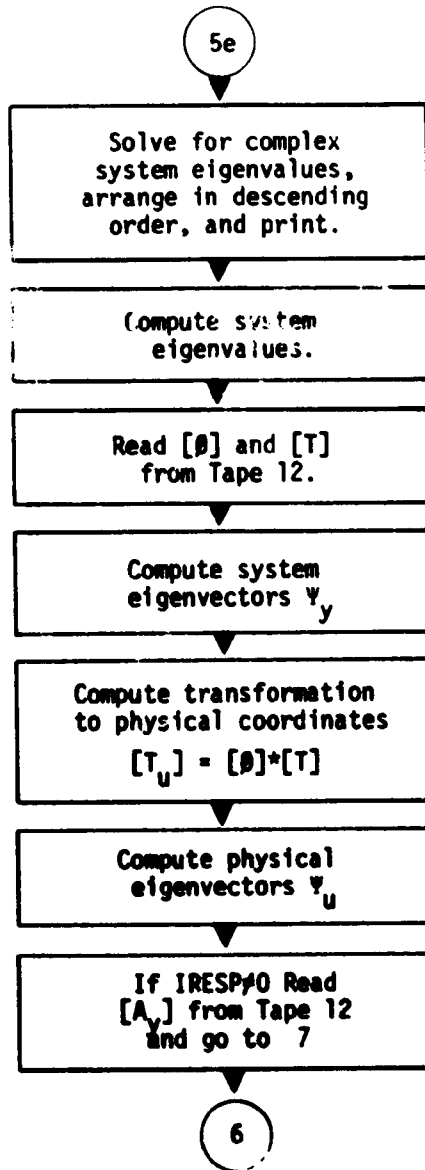

Figure 1j. Flow Diagram for OVERLAY (3,0).

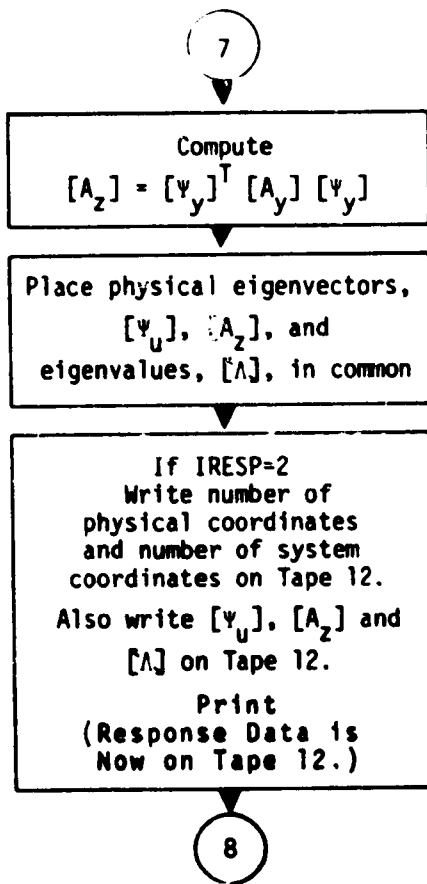

Figure 1k. Flow Diagram for Response Matrix Calculation

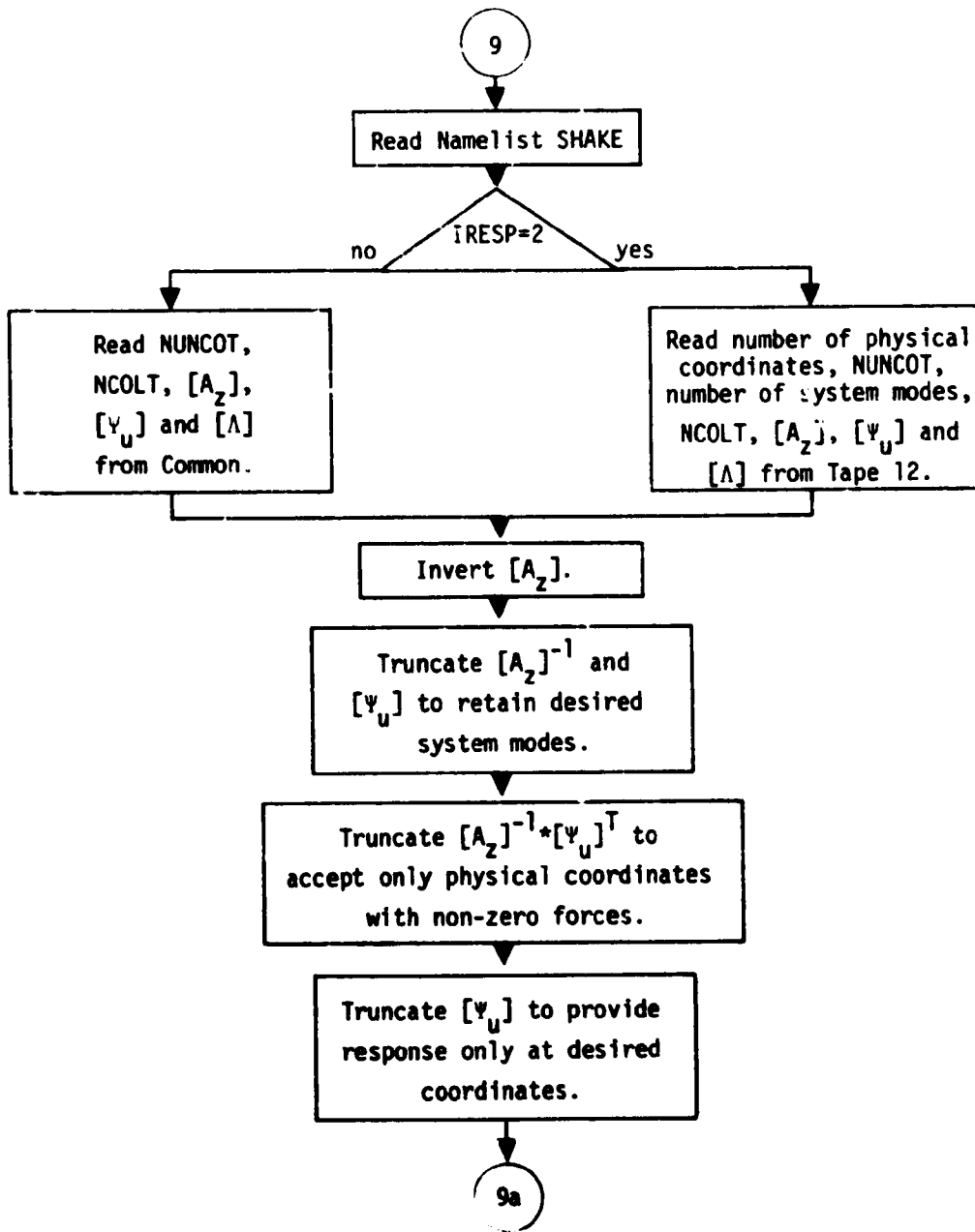

Figure 12. Flow Diagram for OVERLAY (4,1)

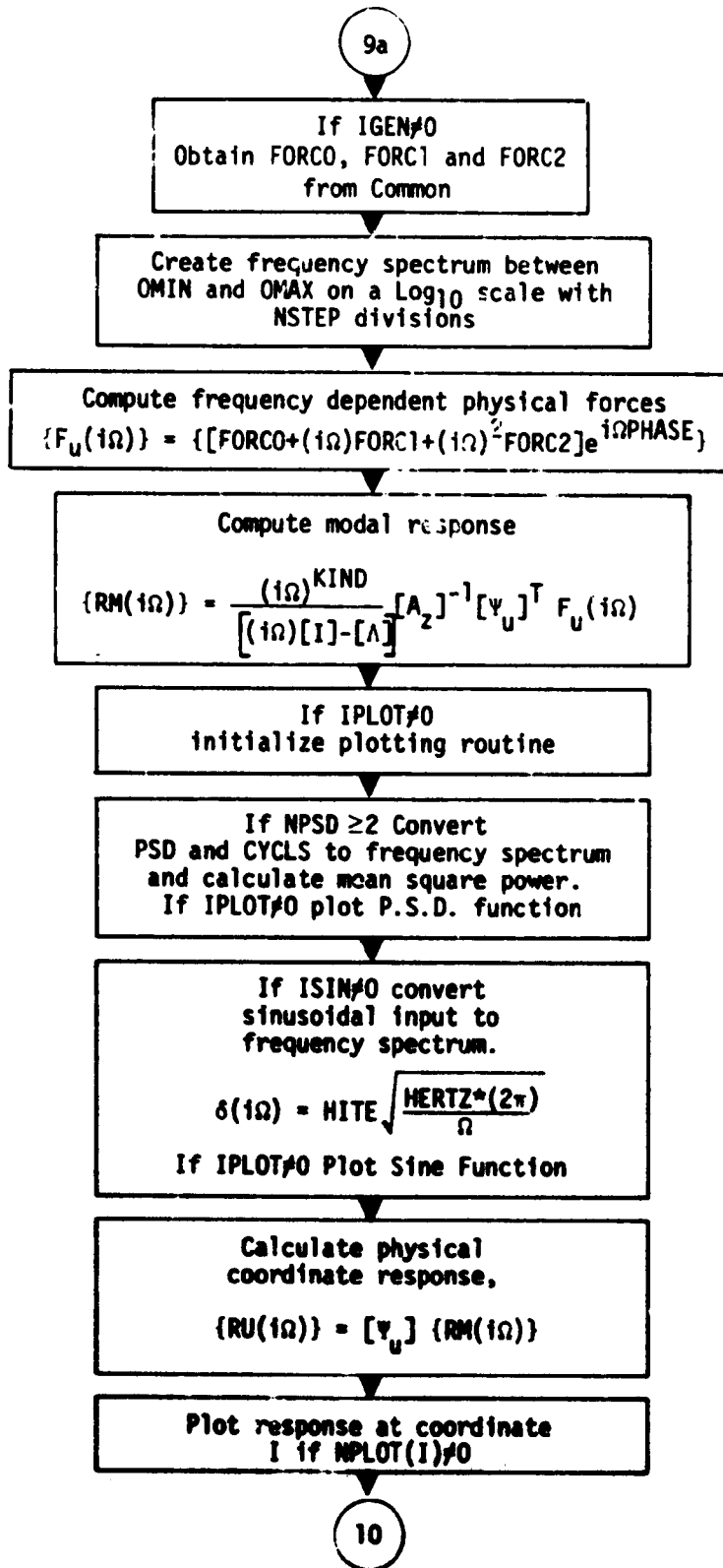

Figure 1m. Flow Diagram for OVERLAY (4.2)

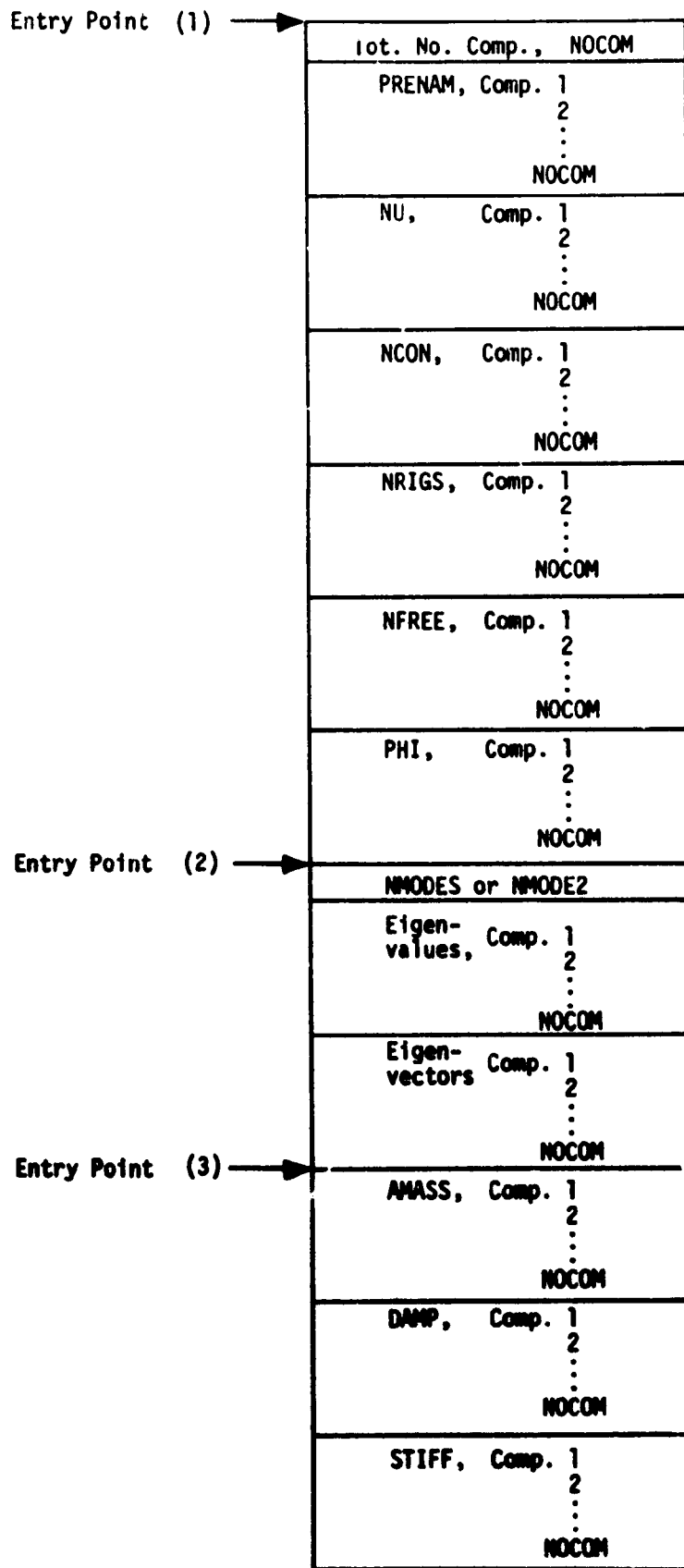

Figure 2. Layout of Component Data File (C.D.F.)

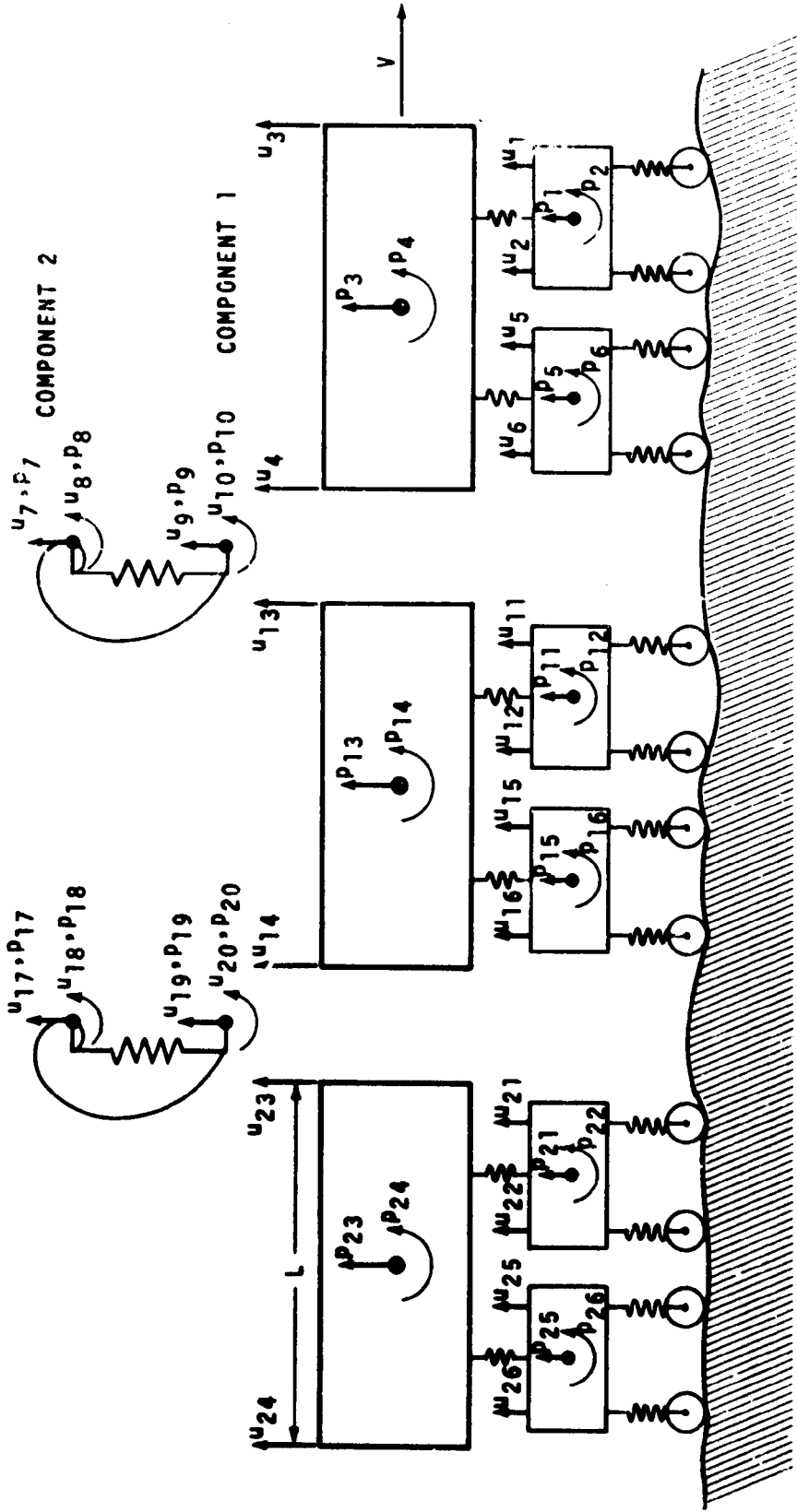

Figure 3. A Three-Car Train Modeled with Two Unique Components

3. OPERATING INSTRUCTIONS

3.1 Creating and Storing an Overlay Structure

The job control language, JCL, necessary to compile DYNALIST II, run a sample problem and store the Overlay structure on a permanent file is shown below. This JCL pertains to the CDC-6600 Scope operating system. Storing the program in this manner saves core capacity at run time and also decreases running time.

	Card
\$CHARGE,XXXXXXXX-YYY.	1
JOB,CM60000,CL200000,T200,I0500,P2.	2
COPYBR,INPUT,TAPE5.	3
REWIND,TAPE5.	4
COPYSBF,TAPE5,OUTPUT.	5
REWIND,TAPE5.	6
REQUEST,TEMP,*PF.	7
RUN(S,,,,,,30000) or FTN(OPT=2)	8
RFL,200000.	9
NOGO.	10
TEMP.	11
CATALOG,TEMP,DYNALIST.	12
EXIT(S)	13
7/8/9	14
DYNALIST II Sample Problem 1	
7/8/9	
DYNALIST II Source Deck	
6/7/8/9	

Card 1 gives the operator's charge number, for billing purposes. Card 2 gives time limits, run priority and core limits. CM is the core necessary to compile and CL is the core necessary

to load and run. Cards 3-6 place the data deck on the output file for easy reference. Card 7 sets aside a permanent file for DYNALIST which we will later catalog. Card 8 may take one of two forms; RUN and FTN. These are two different CDC Fortran compilers. DYNALIST is presently compatible with the RUN compiler. In order to use the FTN compiler, the Return Statements at the end of all primary and secondary overlays must be removed. RFL on Card 9 kicks up the size of the required core from 60_gK to 200_gK. NOGO on card 10 generates the overlay structure, and TEMP on card 11 loads and executes the overlay structure. The compiled program is then cataloged on permanent file DYNALIST. EXIT(S) and the 7/8/9 card terminate the JCL. A sample problem should be included to test the program followed by another 7/8/9 card and the DYNALIST II source deck and a 6/7/8/9 termination card.

3.2 Using DYNALIST Permanent File

Having placed the Overlay Structure of DYNALIST II on the permanent file, all that is required to execute the program is the ATTACH statement of Card 7 and the TEMP statement of Card 10 (following page). Any C.D.F. or M.D.F. on permanent file needed to execute the program should also be brought in to the program using the ATTACH statement of Card 8. Here TAPEYY will be TAPE10 if a C.D.F. is to be used, and TAPEYY will be TAPE12 if an M.D.F. is to be used. If a C.D.F. or an M.D.F. is to be saved after program execution, a permanent file must first be set up using the REQUEST statement of Card 9. If a C.D.F. is to be saved, TAPEXX will be TAPE10 or TAPE11. If an M.D.F. is to be saved, TAPEXX will be TAPE12. The data file is saved using the CATALOG statement of Card 11. TAPEXX is as described above. RP=10 means that the file will be saved for only ten days and will automatically purge itself after that period. Note that, using this method, only 160_gK of core is required to execute the program.

	Card
\$CHARGE,XXXXXXXX-YYY.	1
JOB,CM160000 T150,I0300,P2,TP1.	2
COPYBR,INPUT,TAPE5.	3
REWIND,TAPE5.	4
COPYSBF,TAPE5,OUTPUT.	5
REWIND,TAPE5.	6
ATTACH,TEMP,DYNALIST.	7
ATTACH,TAPEYY,OLDATA.	8
REQUEST,TAPEXX,*PF.	9
TEMP.	10
CATALOG,TAPEXX,NEWDATA,RP=10.	11
EXIT(S)	12
7/8/9	13
DYNALIST II Data Deck	
6/7/8/9	

3.3 Namelist Strategy

Namelist data input, once learned, gives the user an extremely flexible tool for controlling the execution of DYNALIST II and for supplying the program with the information it needs. DYNALIST II has five namelists; START, COMPO, EDITT, SYN and SHAKE. Namelist START contains program control information. It determines which of the four program segments will be executed next. The next four namelists, COMPO, EDITT, SYN and SHAKE supply information necessary to Segments 1,2,3 and 4 respectively. If START directs program control to Segment 2, then the next namelist in the data deck should be EDITT. Remember that the first column of each card must be blank. A namelist line begins with a dollar sign followed by the namelist name. The name is followed by one or more blanks and then the members of the namelist are given, always followed by a comma. The members of a namelist may be entered in any order or not entered at all. Having

specified the data to be given to the program, the namelist is terminated with another dollar sign and the word END. As a practical example suppose the user wishes to edit the C.D.F. for the system of Figure 3. This system has two unique components, Component 1 and Component 2. Component 1 has six free coordinates so it will have twelve modes on the C.D.F. The modes will be in order from highest eigenvalue modulus to the lowest. We will retain the six lowest modes for this component. Component 2 has no free coordinates and therefore no modes on the C.D.F. The data setup to transfer control to Segment 2, edit modes and then terminate program execution, is shown below.

```
$START NTYPE=2,IFOUT=0,  
$END  
$EDITT  
NMODE2(1)=6,0,  
MODES(1,1)=7,8,9,10,11,12,  
$END  
$START NTYPE=5,  
$END
```

Note that the elements of a vector may be entered sequentially without giving the position of each element within the vector. A matrix may also have its elements entered sequentially, column by column. If Component 2 had six modes to retain and we wished to retain the four lowest of them these modes could be entered as $\text{MODES}(1,2)=3,4,5,6,.$

4. DATA SET-UP

4.1 Namelist Directory

Overlay (0,0): Namelist START
NTYPE, IFOUT, NEWTAP, IRESP

Segment 1: Namelist COMPO
COMNAM, IGEN, NU, NCONS, NRIGS, NFREE
ISYMM, ISYMC, ISYMK, AMASS (25,25),
DAMP (25,25), STIFF (25,25), PHI, (50,
25), VELO, CREEP, RAD, CONE, GAGE, TWB,
CWB, MW, AIW, AMT, AIT, AMC, AIC, DLW,
DYW, DLT, DYT, SLW, SYW, SLT, SYT, ASYMM

Segment 2: Namelist EDITT
NMODE 2(10), MODES (50,10)

Segment 3: Namelist SYN
NCOMP, PRENAM (10), G(25,100), NROWG,
KDEP (100)

Segment 4: Namelist SHAKE
MORE, MODES (50), NAXLE, LAXLE (100),
NLOOK, LOOK (100), IGEN, FORC0 (100),
FORC1 (100), FORC2 (100), PHASE (100),
OMIN, OMAX, NSTEP, KIND, NPSD, PDS (50),
CYCLS (50), ISIN, HITE, HERTZ, IPLOT,
NPLOT (100), SIZE

4.2 Input Parameters and Format

All input to the program with the exception of Card 1 (the title card) is namelist input. There are five namelist blocks START, COMPO, EDITT, SYN and SHAKE. These namelist blocks are stacked in pairs with the first block of the pair always being START. The second block of a pair can be either COMPO, EDITT, SYN or SHAKE. COMPO is entered if the user wants to determine modes for a component and create or add to a component data file. EDITT is entered if the user wants to edit a component data file. SYN is entered if the user wants to complete the synthesis using data from a component data file. The user must specify whether he is entering COMPO, EDITT, SYN or SHAKE by setting the parameter NTYPE, which is contained in namelist block START. The values to which NTYPE must be set are defined below along with all other input parameters.

Card 1 of a run is a title card of up to 80 characters (FORMAT 8A10). The first character should be blank.

The following four parameters are input in namelist block START.

NTYPE: NTYPE specifies whether the data following is for determining the modes of a component (NTYPE=1), editing a component mode data file (NTYPE=2), synthesizing the component modes to obtain the system modes (NTYPE=3), or computing response at physical coordinates (NTYPE=4). Upon completion of all steps termination is achieved by specifying NTYPE=5.

IFOUT: IFOUT is a flag for printing results of intermediate calculations in the ensuing program segments. Once specified, IFOUT remains unchanged until re-specified. IFOUT=0 means print only the input and the final results. IFOUT \neq 0 means print the results of most intermediate calculations. This is useful for debugging and interpretation, but it is also somewhat expensive.

NEWTAP: NEWTAP only has to be specified when NTYPE=1 and is ignored when NTYPE=2, 3 or 4. If a new component data file is to be created NEWTAP=0. If the data for the component which is to be analyzed is to be added to an existing component data file, NEWTAP \neq 0.

IRESP: IRESP need only be specified when NTYPE=1, 3 or 4. IRESP defaults to zero. In program segments 1 and 3 (NTYPE=1 and 3) the A_z matrix and the physical eigenvectors must be generated in order to calculate response later. This information will be generated if IRESP \neq 0. If IRESP=2 this information will be used to make a modal data file on Tape 12. In program segment 4 (NTYPE=4) the modal data will be drawn from common unless IRESP=2, in which case it will read from the modal data file on Tape 12. IRESP defaults to zero.

The following parameters are input only when NTYPE=1. They are in namelist block COMPO.

COMNAM: A six digit "name" (F6.2) to be associated with the component data.

IGEN: A flag to indicate whether component data is to be given in matrix form or whether the matrices are to be automatically generated for the lateral car model. IGEN=1 means generate coefficient matrices for a car, Figure 3-3(a) of Volume I. IGEN=2 means generate component data for a truck, Figure 2-2 of Volume I. IGEN defaults to zero, in which case the following rail vehicle data are ignored:

Rail Vehicle Data for COMPO

VELO: Vehicle forward velocity.

CREEP: Rail creep coefficient.

RAD: Wheel radius.

CONE: Mean wheel cone angle.

GAGE: Track gauge.

TWB: Truck wheelbase, distance between wheelsets.

CWB: Car wheelbase, distance between truck attachment points.

AMW: Wheelset mass.

AIW: Wheelset moment of inertia.

AMT: Truck mass.

AIT: Truck moment of inertia.

ANC: Car mass.

AIC: Car moment of inertia.

DLN: Wheelset lateral damping.

DYV: Wheelset yaw damping.

DLT: Truck lateral damping.

DYT: Truck yaw damping.

SLW: Wheelset lateral stiffness.

SYW: Wheelset yaw stiffness.

SLT: Truck lateral stiffness.

SYT: Truck yaw stiffness.

ASYMM: A small number to perturb the wheelset and truck masses slightly in order to avoid repeated roots. Default is to .0025.

The following members of namelist COMPO must be input when IGEN=0. When IGEN \neq 0, they are computed automatically.

NU: The total number of physical coordinates of the component. NU is the number of rows in the PHI matrix. When IGEN=1, NU=14, when IGEN=2, NU=6.

NCON: The total number of constraint coordinates of the component. When IGEN \neq 0, NCON=0.

NRIGS: The total number of rigid body coordinates of the component. When IGEN \neq 0, NRIGS=0.

NFREE: The total number of free coordinates in the component p-coordinate system. When IGEN \neq 0, NFREE=NU.

PHI: A matrix relating the component p-coordinates (constrained, rigid body and free coordinates) to the physical u-coordinate system. PHI has NU rows and NCON+NRIGS+NFREE columns. Only the non-zero terms of PHI need be entered and when IGEN \neq 0, PHI is the identity matrix.

AMASS: The component mass matrix. AMASS is of order $NCON + NRIGS + NFREE$. Only the non-zero terms need be entered.

DAMP: The component damping matrix of the same order as AMASS. Only the non-zero terms need be entered.

STIFF: The component stiffness matrix. Only the non-zero terms need be entered.

ISYMM;
ISYMC;
ISYMK: Symmetry indicators for the mass, damping and stiffness matrices, respectively. If the matrix is a non-diagonal, symmetric matrix the appropriate flag should be set to 1 and only the non-zero upper-triangular terms need be entered. Default is to zero.

The following parameters are input only when $NTYPE=2$. They are input in namelist block EDITT.

NMODE2: NMODE2 is a vector which must contain one element for each component on the component data file. The elements of NMODE2 are the number of modes to be retained on the edited component data tape for the corresponding component. The first element of NMODE2 corresponds to the first component on the component data file, the second element corresponds to the second component, etc. The elements of NMODE2 must be less than or equal to the number of modes on the input component data file for the corresponding component. If no modes for a particular component are to be retained or the component had no normal modes to begin with, a zero must be entered for the corresponding element of NMODE2.

MODES: MODES is a matrix which specifies the modes to be retained for each component on the edited component mode data file. MODES (1,1) through MODES (NMODE2(1), 1) are the modes to be retained for the first component on the data file. MODES (1,2) through MODES (NMODE2(2),2) are the modes to be retained for the second component on the data file, etc. The values of MODES (1,I) through MODES (NMODE2(I),I) must be greater than or equal to one and less than or equal to the number of modes recorded for component I on the input component data file. If component I is to have no modes retained or if component I has no modes to begin with MODES (X,I) need have no entries.

The following parameters are input only when NTYPE=3. They are entered in namelist block SYN.

NCOMP: The number of components involved in the synthesis. Note that if data for a component on the component data file are used more than once, NCOMP is incremented each time it is used.

PRENAM: A vector of length NCOMP. The values of PRENAM are floating point names (numbers) of the format F6.2. The values of PRENAM correspond to the names given to the desired components on the input component data file. (The names on the input component data file were set by the parameter COMNAM which was input in common block COMPO). Note in particular that the values of PRENAM need not be unique (i.e., PRENAM(I) may equal PRENAM(I+P) for any P provided, of course, that $I+P \leq NCOMP$).

- NROWG: The number of rows of the constraint matrix (G) described below.
- G: The matrix defining the constraint relationships among the component coordinates. G has NROWG rows and a column for each unconnected coordinate of the complete system. NROWG is the number of constraint relationships. Only the non-zero terms of G need be entered.
- KDEF: A vector containing a list of all the dependent constraint and rigid body coordinates in the system uncoupled p-coordinate system. KDEF should have NROWG entries since each connection constraint equation is used to eliminate one degree-of-freedom. No free coordinate should be named in KDEF.

The following parameters are input in namelist block SHAKE.

- OMIN: The lower bound of the frequency spectrum over which frequency response will be computed. OMIN is given in Hertz and should not equal zero since the frequency spectrum is converted to a logarithmic scale.
- OMAX: The upper bound of the frequency spectrum over which frequency response will be computed. OMAX is given in Hertz and should not equal zero.
- NSTEP: The number of divisions into which the frequency spectrum will be divided. For plots, NSTEP should be a large number, such as 200 for a frequency spectrum having four cycles on a logarithmic scale. In order not to exceed available core space the product of NSTEP times the number of system modes retained to compute response should not exceed 8,000.

NAXLE: The number of physical coordinates where forces are applied.

LAXLE: The numbers of the physical coordinates, in the system coupled u-coordinate system, where the forces are applied.

FORC0: The displacement-dependent forces. FORC0 has entries for each of the coordinates named in LAXLE, in the same order in which they are named in LAXLE. Only the non-zero terms need be entered.

FORC1: The velocity-dependent forces. FORC1 has entries for each of the coordinates named in LAXLE. Only the non-zero terms need be entered.

FORC2: The acceleration-dependent forces. FORC2 has entries for each of the coordinates named in LAXLE. Only the non-zero terms need be entered.

PHASE: The relative phase lag at each force coordinate. For the train application, the lead wheel has a PHASE of zero. The trailing wheels have PHASE equal to the l/V ratio, where l is the distance behind the lead wheel and V is the vehicle forward velocity. Only the non-zero terms of PHASE need be entered.

NLOOK: The number of physical coordinates where frequency response is desired.

LOOK: The numbers of the physical coordinates, in the system uncoupled u-coordinate system, where response is desired.

KIND: KIND determines whether the frequency response calculated is for displacement response, velocity response or acceleration response. KIND=0 means

zero-order, or displacement response will be computed. KIND=1 gives first-order, or velocity, response. KIND=2 gives second-order, or acceleration, response. KIND defaults to 2.

MORE: If modal truncation is to be used for response after the system eigenvalues have been computed, then MORE should be given some value less than the number of system modes corresponding to the number of system modes which will be retained for response calculations. If MORE is not specified then no modal truncation will occur, and MORE will default to NCOLT, the number of system modes.

MODES: If modal truncation is used in response calculations then MODES will contain the numbers of the system modes to be retained. MODES should have MORE entries. When MORE is unspecified MODES should be unspecified.

IGEN: When the automatic rail-vehicle matrix generation option is used in program segment 1, wheel-rail interaction forces are stored in common. By specifying IGEN not equal to zero, these forces will be used to automatically generate the force vectors FORC0, FORC1 and FORC2. NAXLE, LAXLE and PHASE must still be input by hand. This force information is lost when the program is restarted using component or modal information stored on tape. IGEN defaults to zero.

NPSD: When NPSD is given some value greater than or equal to two, response to a stationary random track input will be computed in addition to frequency response. NPSD represents the number of points where power spectral density data will be input. DYNALIST II

interpolates a straight line on a log-log scale between these points, thus at least two points must be given to properly define the P.S.D. of the input over the frequency spectrum. NPSD may equal 50 at most. NPSD defaults to zero.

CYCLS: CYCLS is a vector containing the frequencies from lowest to highest, in Hz., at which the power spectral density of the forcing function is given in the vector P.S.D. CYCLS must contain NPSD entries. CYCLS must bound the frequency spectrum, thus CYCLS (1) must be ≤ 0 OMIN and CYCLS (NPSD) \geq OMAX.

PSD: PSD contains the power spectral density of the forcing function at the frequencies given in CYCLS. PSD will have NPSD entries.

ISIN: If response due to a frequency dependent sinusoidal input is desired in addition to frequency response, set ISIN=1. Never invoke the power spectral density option and the sinusoidal input option in the same call to program segment 4. The program is incapable of computing frequency response, power spectral density of response and response to a sinusoidal input all at the same time. ISIN defaults to zero.

HITE: HITE is the amplitude of the sinusoidal track irregularity at the frequency specified in HERTZ.

HERTZ: The frequency in HERTZ at which the frequency dependent sinusoidal input is given.

IPLOT: If frequency response plots are to be made IPLOT is set equal to one. IPLOT defaults to zero.

NPLOT: For each coordinate specified in LOOK, NPLOT should be non-zero if response at that coordinate is to be plotted, and NPLOT should be zero if response at that coordinate is not to be plotted. NPLOT defaults to zero.

SIZE: SIZE specifies the height from the bottom of the plot to the top of the plot, in inches. It scales all dimensions of the plots to the same proportions. SIZE defaults to 11 inches, which is the standard width of the CAL-COMP Plotter. SIZE=8.0 gives notebook size plots.

5. DYNALIST II OUTPUT

DYNALIST II produces both printed and plotted outputs. All program printed output is preceded by explanatory headers. There are four general categories of printed output. These are as follows:

5.1 Program Card Input

Card input to the program is printed under appropriate headings. In the case of matrices input in namelist statements, where only the non-zero elements need be entered, the entire matrix, including zero elements, is printed.

5.2 Intermediate Results

The results of many intermediate calculations are printed if the input flag IFOUT is set non-zero (see definitions of input parameters). This option will, hopefully, see very limited use. If it is used, however, the printed variables, or matrices, are preceded by headings including the name of the variable or matrix printed.

5.3 Results

Results of program Segment 1 are considered to be the eigenvalues and eigenvectors of the component. Each eigenvector is printed along with its associated eigenvalue and the eigenvalues are numbered sequentially. The order in which the eigenvalues and eigenvectors appear on the printed output (and the order in which they are numbered) is the same order as they are written on the output component data file. To edit the modes of the component (program Segment 2), the numbers appearing with the eigenvalues and

eigenvectors in the output of program Segment 1 can be used. Note that the eigenvectors of Segment 1 are in the p-coordinate system which is the same coordinate system in which the component mass, damping and stiffness matrices are input.

Printed results of Segment 2 consist of editing information.

Printed results of Segment 3 consist of the final system eigenvalues and eigenvectors. Each eigenvalue is printed along with its associated eigenvector. The eigenvectors have been transformed back to the system uncoupled u-coordinates.

Printed results of Segment 4 consist of the response and phase (in degrees) at each specified system u-coordinate at each frequency. The frequency response is that due to an input of unit amplitude. In addition, if a sinusoidal input was specified, the magnitude of the sinusoidal input and the response due to that input is given at each u-coordinate at each frequency. If a power spectral density input was specified, the magnitude of the p.s.d., along with the p.s.d. of the response, is also given for each u-coordinate, in addition to the mean square value of the input, when a p.s.d. input is given. The frequency spectrum is given in Hertz on a \log_{10} scale. Thus, all frequencies will have to be converted back to Hertz by the user.

5.4 Tape Identification

Upon completion of any of program Segments 1, 2 and 3, one of the following messages is printed: THE ABOVE DATA IS NOW ON TAPE 10, or THE ABOVE DATA IS NOW ON TAPE 11. The file referenced in this message is the latest update of the component data file, except that after completion of program

Segment 3 no data was added to the C.D.F. and it is the other tape which was last revised.

If modal data files were created in either of Segments 1 or 3, the following message is printed: RESPONSE DATA IS NOW ON TAPE 12.

Plotted output from Segment 4 consists of frequency response curves for each u-coordinate specified in LOOK. The number of the u-coordinate is written on the plot, along with a heading telling if acceleration, velocity or displacement response is given. If a power spectral density or sinusoidal input is given, the magnitude of the input over the frequency spectrum is also plotted. In addition to frequency response, a plot depicting response to the given input is also produced. Both scales on the plots are logarithmic in order to accurately present response over the full range of frequencies and amplitudes.

Sample output for Sample Problem 2 is included in Appendix A. Sample Problem 2 is described in Section 6.

6. SAMPLE PROBLEMS

There are four sample problems included with the DYNALIST II source deck which accompanies this USER'S MANUAL. These samples include the job control language necessary to execute the problems. The sample problems are intended to check out as many program options as possible as well as to acquaint the user with these options. Listings of the four sample problems are included at the end of this section.

6.1 Sample Problem 1

Sample problem 1 is to be run with the DYNALIST II source as shown in Section 3.1. The program computes eigenvalues and eigenvectors for a six-degree of freedom vertical car model. Three of these cars are combined with linking components having both vertical and pitch stiffness, as shown in Figure 3. Mode shapes for the three-car train are found using no component mode truncation. Response is then found at system u-coordinates 4, 14, 24 and 26, which are shown in Figure 3. Response to a sinusoidal input is also found. No plots are produced in order to check out the basic program without getting involved with plotter incompatibilities. If Sample Problem 1 runs properly, a permanent file containing the DYNALIST II Overlay structure will be produced. Sample Problems 2-4 May use this permanent file.

6.2 Sample Problem 2

Sample Problem 2 finds modes for a six degree-of-freedom truck model and then links two of these truck components together with no modal truncation to find the exact modes for a car. Response is then found at coordinates 11, 15 and

17. These response points are, respectively: the lateral displacement of the attachment point between the rear truck and the car, the lateral displacement of the center of the rear car, and the lateral displacement of the trailing wheelset. If the plotting capability of DYNALIST II is compatible with the plotter system on the user's computer, then plots will be produced. Attention is called to the PROGRAM card in OVERLAY (TEMP, 0, 0) where the PLOT entry is used to dimension a plot buffer instead of a CALL PLOTS statement in SUBROUTINE DPICT of OVERLAY (TEMP, 4, 2). This may need to be changed. The printed output which should be generated by this problem is given in Appendix A of this USER'S MANUAL.

6.3 Sample Problem 3

This problem uses the automatic matrix generation subroutine to generate coefficient matrices for the lateral vibration of a fourteen degree-of-freedom car. Six conjugate pairs of modes are retained for the car and modes are found for a three-car train. Coupling elements using both lateral and yaw springs are used. Segment 3 is entered with the response parameter IRESP = 2. A modal data file is thus produced, and this M.D.F. is to be cataloged for later use in Sample Problem 4. Response calculations are made in Segment 4 at four points; coordinates 15, 33, 43 and 45. These points are, respectively, lateral motion at the connection between the front and middle cars, lateral motion at the connection between the middle and rear cars, lateral motion at the center of the rear car, and lateral motion of the front wheelset on the rear truck of the rear car. Note that KIND = 0 so that displacement response will be computed. IRESP is not specified in Segment 4 so the data will be taken from core even though a M.D.F. was created. Force input was generated in the matrix routine and thus the force data need not be entered in the response Segment.

6.4 Sample Problem 4

This problem attaches the M.D.F. created in Sample Problem 3 for the three-car train. KIND is not specified in Segment 4 so acceleration response will be computed this time. The force information which was previously generated was lost at program termination and must now be entered by hand. Response points are system u-coordinates 15, 33, 43 and 45, the same response points defined in Sample Problem 3. Sample Problem 3 must be completed before Sample Problem 4 can be run.

The listings for JCL and namelist input for the four problems are found on the following pages.

```

*CHARGE..149730-436.
JOB,CMBU..,CL20,00,13.0,1051.,P2.
COPYR,INPUT,TAPES.
REWIND,TAPES.
COPYSBF,TAPES,OUTPUT.
REWIND,TAPES.
REQUEST,TEMP,*PF.
RUN(S,,,,,3000)
RFL,200000.
SET(J)
LOAD(ILGO)
NOGO.
TEMP.
CATALOG,TEMP,DYNALIST.
EXIT(S)
*
VERTICAL RESPONSE FOR A TRATN V=450 FT/SEC
SSTART NTYPE=1,NEWTAP=*,IFOUT=*,
SEND
SCOMPO
COMMAN=1,NU=6,NCON=0,NRIGS=1,NFREE=6,ESYMK=1,ISYMC=1.
AMASS(1,1)=250,AMASS(2,2)=290,AMASS(3,3)=170,AMASS(4,4)=1.45E6,
AMASS(5,5)=251,AMASS(6,6)=2411.
DAMP(1,1)=4.5E4,DAMP(2,2)=6.72E5,DAMP(6,6)=6.72E5,
DAMP(1,3)=-3E3,6E3,DAMP(1,4)=-1.245E5,0,0,9.8415E6,
DAMP(3,5)=-3E3,1.245E5,4.5E4,
STIFF(1,1)=5.185E5,STIFF(2,2)=1.175E7,STIFF(5,6)=1.175E7,
STIFF(1,3)=-1.85E4,0,3.72E4,STIFF(1,4)=-7.719E5,-6.5E5,0,6.49677E7,
STIFF(3,3)=-1.85E4,7.719E5,5.185E5,
STIFF(4,6)=-6.5E5,
PHI(1,1)=1,PHI(1,2)=4,-4,PHI(3,3)=1,PHI(3,4)=5,-50,
PHI(5,5)=1,PHI(5,6)=6,-4,
SEND
SSTART NTYPE=1,NEWTAP=1,
SEND
SCOMPO
COMMAN=2,NU=4,NCON=4,NRIGS=1,NFREE=4,
ESYMK=1,STIFF(1,1)=1.75E7,STIFF(2,2)=1.25E6,
STIFF(1,3)=-1.75E7,0,1.75E7,STIFF(2,4)=-1.25E6,0,1.25E6,
PHI(1,1)=1,PHI(2,2)=1,PHI(3,3)=1,PHI(4,4)=1,
SEND
SSTART NTYPE=3,IRES=1,
SEND
BSYN
NCON=9,NROWS=9,KOEP(1)=7,8,9,16,17,18,19,20, PREMAN(1)=1,2,1,2,1,
G(1,4)=1,G(1,7)=-1,
G(2,13)=1,G(2,9)=-1,
G(3,3)=1,G(3,6)=-1,G(3,9)=-1,
G(4,13)=1,G(4,14)=-1,G(4,15)=-1,
G(5,14)=1,G(5,17)=-1,
G(6,23)=1,G(6,19)=-1,
G(7,13)=1,G(7,14)=-1,G(7,18)=-1,
G(9,23)=1,G(9,24)=-1,G(8,21)=-1,
SEND
SSTART NTYPE=6,
SEND
*SMAKE
NAVE=12,LAYLE(1)=1,2,5,6,11,12,15,16,21,22,25,26,
NLOOK=4,LOOK(1)=4,14,24,26,
FOR2(1)=JES,JES,JES,JES,JES,JES,JES,JES,JES,JES,
FOR3(1)=2.1E4,2.1E4,2.1E4,2.1E4,2.1E4,2.1E4,2.1E4,2.1E4,2.1E4,2.1E4,
2.1E4,2.1E4,
PHASE(1)=1,17777,19444,21222,22222,23999,45666,48666,
48666,48222,62889,64666,
ONTN=C1,ONAT=1,*,STEP=2,*,KIND=2,
ISTN=1,NITE=.0416666,HERTZ=5.2941,
SEND
SSTART NTYPE=5,6

```

DYNALIST II Source Deck

**

* 7/8/9 card
6/7/8/9 card

```

*CHARGE,L14973U-406.
JOB,CM163,0,12,0,105,0,P6,TPI.
COPY3R,INPUT,TAPES.
REWINO,TAPES.
COPYSRF,TAPES,OUTPUT.
REWINO,TAPES.
ATTACH,TEMP,DYNALIST.
SET(1)
TEMP.
EXIT(S)
* RIGID CAR WITH TWO TRUCKS LATERAL RESPONSE V=450 FT/SEC
*START NTYPE=1,NEWTAPE=1,IFOUT=0.
*END
*COMP0
*COMNAM=1,NU=9.
*CON=2,NRIGS=1,NFREE=6,ISYND=1.
*MASS(3,3)=6, *MASS(4,4)=29,
*MASS(5,5)=25, *MASS(5,6)=29,
*MASS(7,7)=6, *MASS(8,8)=29,
*DAMP(1,1)=1.55E3, *DAMP(1,5)=-1.55E3, *DAMP(3,7)=1.333333333333E4,
*DAMP(4,4)=8.333333333333E4, *DAMP(5,5)=1.55E3, *DAMP(7,7)=1.333333333333E4,
*DAMP(8,8)=8.333333333333E4,
*STIFF(1,1)=1.75E4, *STIFF(1,2)=1.75E4,
*STIFF(1,2)=1.5F5, *STIFF(1,3)=-5E6,
*STIFF(1,3)=1.5E5, *STIFF(1,4)=1.25E5, *STIFF(1,5)=-2E6,
*STIFF(1,4)=1.5E6, *STIFF(1,5)=1.75E4, *STIFF(1,6)=-5E5,
*STIFF(1,6)=0, *STIFF(1,6)=-2E6, *STIFF(1,7)=1.5E7, *STIFF(1,8)=-3E7,
*STIFF(1,7)=1.5E5, *STIFF(1,8)=2.5E5, *STIFF(1,9)=2.5125E5,
*STIFF(1,9)=1.5E7, *STIFF(1,9)=1.5E7,
*PHI(1,1)=1, *PHI(2,2)=1, *PHI(3,3)=1, *PHI(4,4)=1,
*PHI(5,5)=1, *PHI(6,6)=1, *PHI(7,7)=1, *PHI(8,8)=1,
*END
*START NTYPE=1,NEWTAPE=1.
*END
*COMP0
*COMNAM=2,NU=2.
*CON=1,NRIGS=2,NFREE=0.
*MASS(1,1)=17, *MASS(2,2)=1.85E6,
*PHI(1,1)=1, *PHI(2,2)=1,
*END
*START NTYPE=3,RESP=1.
*END
*SYN
*NCORP=3,NROWS=4, *KOP(1)=1,2,11,12.
*PREM(1)=1,2,1.
*G(1,1)=1, *G(1,9)=-1, *G(1,11)=-41.5, *G(2,2)=1, *G(2,11)=-1,
*G(3,11)=1, *G(3,9)=-1, *G(3,11)=41.5, *G(4,12)=1, *G(4,11)=-1.
*END
*START NTYPE=4.
*END
*SHAKE
*MAXLE=4, *MLOOK=3, *LAXLE(1)=4,6,14,18, *LOOK(1)=11,15,17.
*FOPC(1)=2.8125E5, *FOPC(1)=2.5125E5, *FOPC(1)=2.8125E5, *FOPC(1)=2.8125E5,
*PHASE(1)=1, *PHASE(1)=1, *PHASE(1)=1, *PHASE(1)=1,
*OMIN=1, *OMAX=10, *NSTEP=2,
*NSD=3, *PSD(1)=9E-3, *9E-3, *9E-3, *CYCLS(1)=1, *1, *1, *100.
*PLOT=1, *MPLOT(1)=1, *1, *1, *SIZE=0.
*END
*START NTYPE=5,8
**

```

* 7/8/9 card
** 6/7/8/9 card

```

*CHARGE,L14973U-M16.
JOB,CM16,301,721,IOS,J,P6,TP1.
COPYR,INPUT,TAPES.
REWIND,TAPES.
COPYSBF,TAPES,OUTPUT.
REWIND,TAPES.
REQUEST,TAPE12,PDF.
ATTACH,TEMP,DYNALIST.
SET(3)
TEMP.
CATALOG,TAPE12,RESPDATA,RP=13.
EXIT(S)
* GENERATE RESPONSE FOR A 3-CAR TRAIN AT 45 FT/SEC
*START NTYPE=1,NEWTAPE=,IFOUT=C.
SEND
SCOMP0
COMMAM=1,IGEN=1,VELO=450,CREEP=3E6,RAD=1.33,CONE=.725,GAGE=5,TWB=8.
CWR=83,AMW=61,AIW=29,ANT=25,AIT=28,ANC=17,AIC=1.85E6.
DLW=,DYN=,DLT=1.55E3,DYT=1.
SLW=9E5,SYW=3E7,SLT=1.75E4,SYT=3E6,ASYMM=3.
SEND
*START NTYPE=1,NEWTAPE=1.
SEND
SCOMP0
COMMAM=2,NU=4,NCON=4,NRIGS=5,NFREE=,
ISYMK=1,STIFF(1,1)=1.75E7,STIFF(2,2)=1.25E6,
STIFF(1,3)=-1.75E7,1.75E7,STIFF(2,4)=-1.25E6,1.25E6,
PHI(1,1)=1,PHI(2,2)=1,PHI(3,3)=1,PHI(4,4)=1.
SEND
*START NTYPE=2.
SEND
REDIFF
NMODE2(1)=12,3,40DES(1,1)=9,11,11,12,21,22,23,24,25,26,27,28.
SEND
*START NTYPE=3,IRESP=2.
SEND
*SYN
NCOMP=5,NROWS=9,KDEP(1)=15,16,17,18,33,34,35,36,PRENAM(1)=1,2,1,2,1.
G(1,7)=1,G(1,9)=-5,G(1,19)=-1.
G(2,25)=1,G(2,25)=50,G(2,17)=-1.
G(3,8)=1,G(3,16)=-1.
G(4,25)=1,G(4,19)=-1.
G(5,25)=1,G(5,25)=-5,G(5,33)=-1.
G(6,43)=1,G(6,44)=50,G(6,35)=-1.
G(7,25)=1,G(7,36)=-1.
G(8,44)=1,G(8,35)=-1.
SEND
*START NTYPE=4.
SEND
*SWAKE
KIND=3.
IGEN=1,NAXLE=12,NLOOK=4.
LAXLE(1)=2,6,1,14,2,24,20,32,35,42,46,50.
LOOK(1)=15,33,43,45,04IN=.1,OMAX=1,1,NSTEP=210.
*HASE(1)=,17777,18444,22222,23999,40666,42444.
,44444,46222,62800,64666.
NPSD=3,PSD(1)=9E-3,9E-3,9E-3,CYCLS(1)=.81,1,1.0.
IPLOT=1,NPLOT(1)=1,1,1,1,SIZE=8.
SEND
*START NTYPE=5.8

```

* 7/8/9 card

** 6/7/8/9 card

```
$CHARGE,L14973U-M06.  
JOB,CM160000.,T200.,T0500.,P6.,TP1.  
COPYBR,INPUT,TAPES.  
REWIND,TAPES.  
COPYSBF,TAPES,OUTPUT.  
REWIND,TAPES.  
ATTACH,TAPE12,RESPDATA.  
ATTACH,TEMP,DYNALIST.  
SET(0)  
TEMP.  
EXIT(S  
* ACCELERATION RESPONSE FOR THREE-CAR TRAIN AT 450 FT/SEC  
$START NTYPE=4,IRESP=2,IFOLT=0.  
SEND  
$SHAKE  
NAXLE=12,LAXLE(1)=2,6,10,14,20,24,28,32,38,42,46,50.  
NLOOK=4,LLOOK(1)=15,33,43,45,OMIN=.01,OMAX=100,NSTEP=200.  
FORCO(1)=2.8125E5,2.8125E5,2.8125E5,2.8125E5,2.8125E5,2.8125E5,  
2.8125E5,2.8125E5,2.8125E5,2.8125E5,2.8125E5,2.8125E5,  
PHASE(1)=0.,.017777, .184444, .202222, .222222, .239999, .406666, .424444,  
.444444, .462222, .628888, .646666,  
IPLOT=1,NPLOT(1)=1,1,1,0,  
SEND  
$START NTYPE=5,$  
**
```

```
* 7/8/9 card  
** 6/7/8/9 card
```

- APPENDIX A -

SAMPLE PROBLEM PRINTOUT
FOR LATERAL CAR MODEL

RIGID CAR WITH TWO TRUCKS LATERAL RESPONSE V=450 FT/SEC
SSTART NTYPE=1,NEWTAP=0,IFOUT=0.

SCOMPO
CONNAM=1,NU=8,
NCON=2,NRIGS=0,NFREE=6,ISYMC=1,
AMASS(3,3)=60,AMASS(4,4)=290,
AMASS(5,5)=750,AMASS(6,6)=2800,
AMASS(7,7)=60,AMASS(8,8)=290,
DAMP(1,1)=1.55F3,DAMP(1,5)=-1.55E3,DAMP(3,3)=1.33333333333333E4,
DAMP(4,4)=8.33333333333333E4,DAMP(5,5)=1.55E3,DAMP(7,7)=1.33333333333333E4,
DAMP(8,8)=8.33333333333333E4,
STIFF(1,1)=1.75E4,0,0,0,-1.75E4,
STIFF(1,2)=0,5F6,0,0,0,-5E6,
STIFF(1,3)=0,0,5E5,2.8125E5,-5E5,-2E6,
STIFF(1,4)=0,0,0,-6E6,3E7,0,-3E7,
STIFF(1,5)=-1.75E4,0,-5E5,0,1.0175E6,0,-5E5,
STIFF(1,6)=0,-5E6,-2E6,-3E7,0,8.1E7,2E6,-3E7,
STIFF(1,7)=0,0,0,0,-5E5,2E6,5E5,2.8125E5,
STIFF(1,8)=0,0,0,0,-3E7,-6E6,3E7,
PHI(1,1)=1,PHI(2,2)=1,PHI(3,3)=1,PHI(4,4)=1,
PHI(5,5)=1,PHI(6,6)=1,PHI(7,7)=1,PHI(8,8)=1,
SEND
SSTART NTYPE=1,NEWTAP=1,
SEND

SCOMPO
CONNAM=2,NU=2,
NCON=0,NRIGS=2,NFREE=0,
AMASS(1,1)=1700,AMASS(2,2)=1.85E6,
PHI(1,1)=1,PHI(2,2)=1,
SEND
SSTART NTYPE=3,IRESP=1,
SEND

SSYN
NCOMP=3,NROW=4,KDEP(1)=1,2,11,12,
PRENAM(1)=1,2,1,
G(1,1)=1,G(1,9)=-1,G(1,10)=-41.5,G(2,2)=1,G(2,10)=-1,
G(3,11)=1,G(3,9)=-1,G(3,10)=41.5,G(4,12)=1,G(4,10)=-1,
SEND
SSTART NTYPE=4,
SEND

SSHAKE
MAXLE=4,NLOOK=3,LAXLE(1)=4,8,14,16,LOOK(1)=11,15,17,
FORCO(1)=2.8125F5,2.8125E5,2.8125E5,2.8125E5,
PHASE(1)=0,.01777777,.10444444,.20222222,
OMINS=.01,OMAX=100,NSTEP=200,
NPSD=3,PSD(1)=9E-3,9E-3,9E-9,CYCLS(1)=.01,.1,100,
IPLOT=1,MPLOT(1)=1,1,1,SIZE=8,
SEND
SSTART NTYPE=5,S

Preceding Page Blank

RIGID CAR WITH TWO TRUCKS LATERAL RESPONSE $V=450$ FT/SEC

THE DAMPING MATRIX (DAMP) LISTED BY ROWS.

ROW 1	1.55000E+03	0.	0.	-1.55000E+03	0.	0.	0.
ROW 2	0.	0.	0.	0.	0.	0.	0.
ROW 3	0.	1.33333E+04	0.	0.	0.	0.	0.
ROW 4	0.	0.	0.33333E+04	0.	0.	0.	0.
ROW 5	-1.55000E+03	0.	0.	1.55000E+03	0.	0.	0.
ROW 6	0.	0.	0.	0.	0.	0.	0.
ROW 7	0.	0.	0.	0.	0.	1.33333E+04	0.
ROW 8	0.	0.	0.	0.	0.	0.	0.33333E+04

21
6

THE STIFFNESS MATRIX (STIFF) LISTED BY ROWS.

ROW 1	1.75000E+04	0.	0.	-1.75000E+04	0.	0.	0.
ROW 2	0.	5.00000E+06	0.	0.	-5.00000E+06	0.	0.
ROW 3	0.	0.	5.00000E+05	-6.00000E+06	-5.00000E+05	-2.00000E+06	0.
ROW 4	0.	0.	2.01250E+05	3.00000E+07	0.	-3.00000E+07	0.
ROW 5	-1.75000E+04	0.	-5.00000E+05	0.	1.01750E+06	0.	-5.00000E+05
ROW 6	0.	-5.00000E+06	-2.00000E+06	-3.00000E+07	0.	0.10000E+07	2.00000E+06
ROW 7	0.	0.	0.	-5.00000E+05	2.00000E+06	5.00000E+05	-6.00000E+06
ROW 8	0.	0.	0.	0.	0.	-3.00000E+07	2.01250E+05

THE MATRIX RELATING THE RIGID BODY, CONSTRAINED, AND FREE COORDINATES
TO THE ORIGINAL COMPONENT COORDINATES (MATRIX PHI).

ROW 1	1.00000E+00	0.	0.	0.	0.	0.	0.	0.	0.
ROW 2	0.	1.00000E+00	0.	0.	0.	0.	0.	0.	0.
ROW 3	0.	0.	1.00000E+00	0.	0.	0.	0.	0.	0.
ROW 4	0.	0.	0.	1.00000E+00	0.	0.	0.	0.	0.
ROW 5	0.	0.	0.	0.	1.00000E+00	0.	0.	0.	0.
ROW 6	0.	0.	0.	0.	0.	1.00000E+00	0.	0.	0.
ROW 7	0.	0.	0.	0.	0.	0.	1.00000E+00	0.	0.
ROW 8	0.	0.	0.	0.	0.	0.	0.	1.00000E+00	0.

A-7

N= 12

TRACE OF MATRIX= -1.025357000122E+03 0.

EIGENVALUES

-1.129011E+02	-3.131278E+02
-1.129011E+02	3.131278E+02
-1.441037E+02	2.858354E+02
-1.441037E+02	-2.858354E+02
-1.723900E+02	-7.359159E+00
-1.723900E+02	7.359159E+00
-5.234277E+01	6.872300E+01
-5.234277E+01	-6.872300E+01
-2.542517E+01	7.870714E+01
-2.542517E+01	-7.870714E+01
-5.515824E+00	2.234654E+01
-5.515824E+00	-2.234654E+01

THE NUMBER OF ROOTS FOUND IS 12

EIGENVALUE NO. 1 REAL PART=-1.12901E+02 IMAG. PART=-3.13128E+02
EIGENVECTOR FOR EIGENVALUE NO. 1

REAL PART	IMAG. PART
9.05213E-01	-1.12694E-01
-9.72164E-01	7.01410E-02
-2.06414E-02	2.12070E-02
1.59911E-01	1.70302E-01
1.00000E+00	0.
-9.66224E-01	6.9776E-02

EIGENVALUE NO. 2 REAL PART=-1.12901E+02 IMAG. PART= 3.13128E+02
EIGENVECTOR FOR EIGENVALUE NO. 2

REAL PART	IMAG. PART
9.05213E-01	1.12694E-01
-9.72164E-01	-7.01410E-02
-2.06414E-02	2.12070E-02
1.59911E-01	-1.70302E-01
1.00000E+00	0.
-9.66224E-01	-6.9776E-02

2
10

EIGENVALUE NO. 3 REAL PART=-1.44104E+02 IMAG. PART= 2.85856E+02
EIGENVECTOR FOR EIGENVALUE NO. 3

REAL PART	IMAG. PART
1.00000E+00	0.
-0.46275E-01	-1.08042E-01
-1.16405E-03	2.64375E-03
5.05340E-07	-2.55369E-06
-0.59015E-01	-2.94471E-02
7.22267E-01	1.86802E-01

EIGENVALUE NO. 4 REAL PART=-1.44104E+02 IMAG. PART=-2.85856E+02
EIGENVECTOR FOR EIGENVALUE NO. 4

REAL PART	IMAG. PART
1.00000E+00	0.
-0.46275E-01	1.08042E-01
-1.16405E-03	-2.64375E-03
5.05340E-07	2.55369E-06
-0.59015E-01	2.94471E-02
7.22267E-01	-1.86802E-01

EIGENVALUE NO. 5 REAL PART=-1.72390E+02 IMAG. PART=-7.35916E+00

EIGENVECTOR FOR EIGENVALUE NO. 5

REAL PART IMAG. PART

1.00000E+00 0.
-1.17457E-02 0.70677E-03
1.04180E-01 -2.41952E-02
-1.49010E-04 6.90615E-03
7.31674E-01 -2.65301E-01
-0.61646E-03 1.17705E-02

EIGENVALUE NO. 6 REAL PART=-1.72390E+02 IMAG. PART= 7.35916E+00

EIGENVECTOR FOR EIGENVALUE NO. 6

REAL PART IMAG. PART

1.00000E+00 0.
-1.17457E-02 -0.70677E-03
1.04180E-01 2.41952E-02
-1.49010E-04 -6.90615E-03
7.31674E-01 2.65301E-01
-0.61646E-03 -1.17705E-02

7 9

EIGENVALUE NO. 7 REAL PART=-5.23428E+01 IMAG. PART= 6.87236E+01

EIGENVECTOR FOR EIGENVALUE NO. 7

REAL PART IMAG. PART

1.00000E+00 0.
-5.40273E-02 3.40714E-02
1.74511E-01 4.60543E-01
-3.99929E-02 2.25763E-02
7.12314E-01 -1.04762E-01
-5.05707E-02 3.64427E-02

EIGENVALUE NO. 8 REAL PART=-5.23428E+01 IMAG. PART=-6.87236E+01

EIGENVECTOR FOR EIGENVALUE NO. 8

REAL PART IMAG. PART

1.00000E+00 0.
-5.40273E-02 -3.40714E-02
1.74511E-01 -4.60543E-01
-3.99929E-02 -2.25763E-02
7.12314E-01 1.04762E-01
-5.05707E-02 -3.64427E-02

EIGENVALUE NO. 9 REAL PART=-2.54252E+01 IMAG. PART= 7.87071E+01
EIGENVECTOR FOR EIGENVALUE NO. 9

REAL PART	IMAG. PART
1.00000E+00	0.
4.26977E-03	5.12011E-02
-4.10593E-01	8.20500E-01
3.80658E-03	4.56772E-02
7.77610E-01	5.03001E-02
6.44791E-03	5.02951E-02

EIGENVALUE NO. 10 REAL PART=-2.54252E+01 IMAG. PART=-7.87071E+01
EIGENVECTOR FOR EIGENVALUE NO. 10

REAL PART	IMAG. PART
1.00000E+00	0.
4.26977E-03	-5.12011E-02
-4.10593E-01	-8.20500E-01
3.80658E-03	-4.56772E-02
7.77610E-01	-5.03001E-02
6.44791E-03	-5.02951E-02

0 1 2

EIGENVALUE NO. 11 REAL PART=-5.51582E+00 IMAG. PART= 2.23465E+01
EIGENVECTOR FOR EIGENVALUE NO. 11

REAL PART	IMAG. PART
9.13404E-01	1.25986E-01
-2.31571E-02	3.88462E-02
1.00000E+00	0.
-1.64529E-02	3.78739E-02
8.70025E-01	-1.79472E-01
-2.25661E-02	4.17367E-02

EIGENVALUE NO. 12 REAL PART=-5.51582E+00 IMAG. PART=-2.23465E+01
EIGENVECTOR FOR EIGENVALUE NO. 12

REAL PART	IMAG. PART
9.13404E-01	-1.25986E-01
-2.31571E-02	-3.88462E-02
1.00000E+00	0.
-1.64529E-02	-3.78739E-02
8.70025E-01	1.79472E-01
-2.25661E-02	-4.17367E-02

THE ABOVE DATA IS NOW ON TAPE 11

THE FOLLOWING INFORMATION IS FOR COMPONENT 2.00

THE TOTAL NUMBER OF PHYSICAL COORDINATES (NJ) = 2

THE NUMBER OF CONSTRAINED COORDINATES (NCON) = 0

THE NUMBER OF RIGID BODY COORDINATES (NRIGS) = 2

THE NUMBER OF FREE COORDINATES (NFR) = 0

THE TOTAL NUMBER OF DYNAMIC DEGREES OF FREEDOM (NDJ) = 2

THE MASS MATRIX (AMASS) LISTED BY ROWS.

ROW 1
1.70000E+03 0.

ROW 2
0. 1.05000E+04

THE DAMPING MATRIX (DAMP) LISTED BY ROWS.

ROW 1
0. 0.

ROW 2
0. 0.

THE STIFFNESS MATRIX (STIFF) LISTED BY ROWS.

ROW 1
0. 0.

ROW 2
0. 0.

THE MATRIX RELATING THE RIGID BODY, CONSTRAINED, AND FREE COORDINATES TO THE ORIGINAL COMPONENT COORDINATES (MATRIX PHI).

ROW 1
1.00000E+00 0.

ROW 2
0. 1.00000E+00

THE ABOVE DATA IS NOW ON TAPE 10

THE FOLLOWING INFORMATION IS FOR THE FINAL SYSTEM.

THE STRUCTURE IS TO BE CONSTRUCTED OF 3 COMPONENTS.
THE NAMES ASSOCIATED WITH EACH COMPONENT ARE AS FOLLOWS.

COMPONENT NUMBER	COMPONENT NAME
1	1.00
2	2.00
3	1.00

THE NUMBER OF ROWS OF G IS 4

THE TOTAL NUMBER OF UNCONNECTED COORDINATES IS 10

THE MATRIX OF CONSTRAINTS (MATRIX G).

COLUMN 1	1.00000E+00	0.	0.	0.
COLUMN 2	0.	1.00000E+00	0.	0.
COLUMN 3	0.	0.	0.	0.
COLUMN 4	0.	0.	0.	0.
COLUMN 5	0.	0.	0.	0.
COLUMN 6	0.	0.	0.	0.
COLUMN 7	0.	0.	0.	0.
COLUMN 8	0.	0.	0.	0.
COLUMN 9	-1.00000E+00	0.	-1.00000E+00	0.
COLUMN 10	-4.15000E+01	-1.00000E+00	4.15000E+01	-1.00000E+00
COLUMN 11	0.	0.	1.00000E+00	0.
COLUMN 12	0.	0.	0.	1.00000E+00

COLUMN 13 0. 0. 0. 0. 0. .

COLUMN 14 0. 0. 0. 0. 0. 0.

COLUMN 15 0. 0. 0. 0. 0. 0.

COLUMN 16 0. 0. 0. 0. 0. 0.

COLUMN 17 0. 0. 0. 0. 0. 0.

COLUMN 18 9. 0. 0. 0. 0. 0.

THE DEPENDENT SYNTHESIS COORDINATES ARE

1 2 11 12

THE COORDINATES ARE TO BE REARRANGED TO THE FOLLOWING ORDER.

1 2 7 8 9 10 11 12 5 6 3 4

13 14 15 16 17 18

N= 28

TRACE OF MATRIX= -2.85942303889E+03 -1.18234311238E-11

EIGENVALUES

-1.129011E+02 3.131270E+02
 -1.129011E+02 -3.131270E+02
 -1.129010E+02 -3.131270E+02
 -1.129010E+02 3.131270E+02
 -1.441837E+02 2.859556E+02
 -1.441837E+02 -2.859556E+02
 -1.441837E+02 2.859556E+02
 -1.441837E+02 -2.859556E+02
 -1.723923E+02 -7.359930E+00
 -1.723923E+02 7.359930E+00
 -1.723913E+02 -7.359950E+00
 -1.723913E+02 7.359950E+00
 -5.230166E+01 6.871717E+01
 -5.230166E+01 -6.871717E+01
 -5.230538E+01 6.869180E+01
 -5.230538E+01 -6.869180E+01
 -2.549597E+01 7.870218E+01
 -2.549597E+01 -7.870218E+01
 -2.546465E+01 7.869530E+01
 -2.546465E+01 -7.869530E+01
 -5.48358E+00 2.229307E+01
 -5.48358E+00 -2.229307E+01
 -5.595369E+00 2.228291E+01
 -5.595369E+00 -2.228291E+01
 -1.290562E+00 -5.918988E+00
 -1.290562E+00 5.918988E+00
 -8.53491E-01 4.48591E+00
 -8.53491E-01 -4.48591E+00

TRANSFORMED EIGENVECTOR FOR ROOT -1.1290107E+02 3.1312777E+02

REAL	IMAGINARY
0.8678334E-05	-1.1816649E-05
2.4021888E-08	-5.9824540E-08
-1.9322778E-01	-5.4009731E-01
7.3686699E-01	5.0562465E-01
2.3064711E-02	1.0845456E-02
-1.3582584E-01	-3.9247352E-02
-2.8334960E-01	-5.6137650E-01
2.3460770E-01	5.6218712E-01
0.7681424E-05	-9.3339305E-06
2.4021888E-08	-5.9824540E-08
8.6684517E-05	-6.0512122E-06
2.4021888E-08	-5.9824540E-08
9.0521320E-01	1.1269441E-01
-9.7214411E-01	-7.0140848E-02
-2.8642136E-02	2.128527E-02
1.5591135E-01	-1.7038189E-01
1.0000000E+00	0.
-9.6622413E-01	-4.9777488E-02

2-14

TRANSFORMED EIGENVECTOR FOR ROOT -1.1290107E+02 -3.1312777E+02

REAL	IMAGINARY
0.8678330E-05	1.1816662E-05
2.4021858E-08	5.9824806E-08
-1.9322781E-01	5.4009733E-01
2.3686692E-01	-5.0562466E-01
2.0064712E-02	-1.0845455E-02
-1.3982585E-01	3.9247348E-02
-2.8334963E-01	5.6137650E-01
2.3460781E-01	-5.6218713E-01
0.7681423E-05	9.3339328E-06
2.4021858E-08	5.9824806E-08
0.6684516E-05	6.0512034E-06
2.4021858E-08	5.9824806E-08
9.0521320E-01	-1.1269441E-01
-9.7216411E-01	7.0140848E-02
-2.8642136E-02	-2.128527E-02
1.5591135E-01	1.7038189E-01
1.0000000E+00	0.
-9.6622413E-01	6.9777488E-02

TRANSFORMED EIGENVECTOR FOR ROOT -1.1290104E+02 -3.1312775E+02

REAL	IMAGINARY
1.1248963E-04	-5.7030301E-04
-1.1247265E-06	-1.1202661E-05
0.7231970E-01	-1.5644430E-01
-9.3948935E-01	1.1068796E-01
-2.0085970E-02	-1.9153480E-02
1.6013234E-01	1.5717425E-01
9.7014724E-01	-5.2091474E-02
-9.3374562E-01	1.1002603E-01
1.5916578E-04	-1.0539338E-04
-1.1247265E-06	-1.1202661E-05
2.0584193E-04	3.5951705E-04
-1.1247265E-06	-1.1202661E-05
9.0521331E-01	-1.1269446E-01
-9.7216340E-01	7.0140717E-02
-2.0649237E-02	-2.1285944E-02
1.5591113E-01	1.7030197E-01
1.0000000E+00	0.
-9.6622350E-01	6.9777356E-02

A-15

TRANSFORMED EIGENVECTOR FOR ROOT -1.1290104E+02 3.1312775E+02

REAL	IMAGINARY
1.1248968E-04	5.7030379E-04
-1.1247256E-06	1.1202661E-05
0.7231971E-01	1.5648420E-01
-9.3948936E-01	-1.1068795E-01
-2.0085967E-02	1.9153491E-02
1.6013232E-01	-1.5717427E-01
9.7014725E-01	5.2091360E-02
-9.3374563E-01	-1.1002592E-01
1.5916579E-04	1.0539337E-04
-1.1247256E-06	1.1202661E-05
2.0584190E-04	-3.5951705E-04
-1.1247256E-06	1.1202661E-05
9.0521331E-01	1.1269446E-01
-9.7216340E-01	-7.0140717E-02
-2.0649237E-02	2.1285944E-02
1.5591113E-01	-1.7030197E-01
1.0000000E+00	0.
-9.6622350E-01	-6.9777356E-02

TRANSFORMED EIGENVECTOR FOR ROOT -1.4410370E+02 2.8585555E+02

REAL	IMAGINARY
1.9070010E-05	-2.6545645E-06
1.8725193E-07	-9.05335476E-08
1.0000000E+00	0.
-8.4627546E-01	-1.8884170E-01
-1.1642775E-03	2.6434466E-03
5.0561069E-07	-2.5534714E-06
-8.5981520E-01	-2.9447053E-02
7.2226651E-01	1.8688232E-01
1.1299059E-05	1.1026577E-06
1.8725193E-07	-9.05335476E-08
3.5281002E-06	4.8598400E-06
1.8725193E-07	-9.05335476E-08
3.7605690E-01	2.4530351E-01
-2.7192420E-01	-2.7860957E-01
-1.0842189E-03	7.0854760E-04
8.1644293E-07	-8.3626061E-07
-3.1611597E-01	-2.2198948E-01
2.2577044E-01	2.4745294E-01

914

TRANSFORMED EIGENVECTOR FOR ROOT -1.4410370E+02 -2.8585555E+02

REAL	IMAGINARY
1.9682243E-05	8.0148589E-07
2.2779140E-07	-3.0263420E-08
1.0000000E+00	0.
-8.4627547E-01	1.8884170E-01
-1.1642752E-03	-2.6434180E-03
5.0559322E-07	2.5534404E-06
-8.5981519E-01	2.9447027E-02
7.2226660E-01	-1.8688230E-01
1.0228900E-05	2.0576178E-06
2.2779140E-07	-3.0263420E-08
7.7555641E-07	3.3135498E-06
2.2779140E-07	-3.0263420E-08
2.7546885E-01	1.5298842E-01
-2.6201312E-01	-7.7450332E-02
8.3739483E-05	-9.0637525E-04
-2.5142510E-07	7.8080525E-07
-2.6135733E-01	-1.2343002E-01
2.2755275E-01	5.9018174E-02

TRANSFORMED EIGENVECTOR FOR ROOT -1.4410370E+02 2.8585555E+02

REAL	IMAGINARY
2.0022724E-05	-3.6928561E-06
2.4914402E-07	-1.5862137E-07
1.0000000E+00	2.6464700E-23
-8.4627546E-01	-1.6884170E-01
-1.1643045E-03	2.6434408E-03
5.0563577E-07	-2.553720E-06
-8.5911519E-01	-2.9447067E-02
7.2226660E-01	1.868233E-01
9.8872474E-04	2.8899306E-06
2.4914402E-07	-1.5862137E-07
-6.5622960E-07	9.4727173E-06
2.4914402E-07	-1.5862137E-07
1.6034592E-01	4.4893860E-01
-5.8918497E-02	-4.1020573E-01
-1.3733611E-03	-9.8751193E-05
1.2273434E+00	-1.8250398E-07
-1.2464794E-01	-3.9072601E-01
3.1913793E-02	3.5421922E-01

TRANSFORMED EIGENVECTOR FOR ROOT -1.4410370E+02 -2.8585555E+02

REAL	IMAGINARY
2.0452390E-05	1.0019322E-06
2.7801788E-07	-1.6953837E-08
1.0000000E+00	0.
-8.4627547E-01	1.8884170E-01
-1.1642631E-03	-2.6434407E-03
5.0560465E-07	2.5534327E-06
-8.5981518E-01	2.9447030E-02
7.2226660E-01	-1.8682330E-01
8.9146478E-06	1.7055164E-06
2.7801788E-07	-1.6953837E-08
-2.6230944E-04	2.4091007E-06
2.7801788E-07	-1.6953837E-08
1.1073724E-01	1.2256425E-01
-1.1685945E-01	-8.2811307E-02
1.9510950E-04	-4.3550107E-04
-2.5703013E-07	3.4479118E-07
-9.8822678E-02	-1.0212171E-01
1.0288686E-01	6.7829239E-02

TRANSFORMED EIGENVECTOR FOR ROOT -1.7239233E+02 -7.3599302E+00

REAL	IMAGINARY
5.5065951E-05	1.1040011E-03
1.6254726E-05	1.2489095E-05
4.1041531E-01	-7.5070412E-01
1.7176205E-03	1.2391447E-02
2.4587736E-02	-8.8170434E-02
5.1846676E-03	2.9804602E-03
1.0103145E-01	-6.5820011E-01
5.3021819E-03	1.1300279E-02
-6.1950529E-04	5.8578364E-04
1.6254726E-05	1.2489095E-05
-1.2940764E-03	6.7486184E-05
1.6254726E-05	1.2489095E-05
1.0000000E+00	4.3368087E-19
-1.1746164E-02	8.7001054E-03
1.0421966E-01	-2.4200073E-02
-1.5023013E-04	6.9872299E-03
7.3173065E-01	-2.6540139E-01
-8.6176039E-03	1.1772068E-02

TRANSFORMED EIGENVECTOR FOR ROOT -1.7239233E+02 7.3599302E+00

REAL	IMAGINARY
5.5065951E-05	-1.1040011E-03
1.6254726E-05	-1.2489095E-05
4.1041530E-01	7.5070413E-01
1.7176207E-03	-1.2391447E-02
2.4587735E-02	8.8170435E-02
5.1846676E-03	-2.9804602E-03
1.0103045E-01	6.5820011E-01
5.3021871E-03	-1.1300279E-02
-6.1950529E-04	-5.8578364E-04
1.6254726E-05	-1.2489095E-05
-1.2940764E-03	-6.7486182E-05
1.6254726E-05	-1.2489095E-05
1.0000000E+00	-4.3368087E-19
1.0421966E-01	2.4200073E-02
-1.5023013E-04	-6.9872299E-03
7.3173065E-01	2.6540139E-01
-8.6176039E-03	-1.1772068E-02

TRANSFORMED EIGENVECTOR FOR ROOT -1.7239135E+02 -7.3595500E+00

REAL	IMAGINARY
-1.0330682E-03	1.2215677E-04
-6.4967482E-08	-1.8903727E-06
9.6162524E-01	1.4942549E-01
-1.2594584E-02	6.6170077E-03
1.030015E-01	7.7024424E-03
-1.1887489E-03	6.6952433E-03
7.4314003E-01	-1.4565572E-01
-1.0044203E-02	1.0030629E-02
-1.0303721E-03	2.0060725E-04
-6.4967482E-08	-1.8903727E-06
-1.0276759E-03	2.7905771E-04
-6.4967482E-08	-1.8903727E-06
1.0000000E+00	0.
-1.1746482E-02	0.7081267E-03
1.0421074E-01	-2.4207712E-02
-1.5047602E-04	6.9872457E-03
7.3170391E-01	-2.6542906E-01
-8.6176090E-03	1.1772412E-02

TRANSFORMED EIGENVECTOR FOR ROOT -1.7239135E+02 7.3595500E+00

REAL	IMAGINARY
-1.0330682E-03	-1.2215677E-04
-6.4967484E-08	1.8903728E-06
9.6142523E-01	-1.4942541E-01
-1.2594584E-02	-6.6170076E-03
1.030015E-01	7.7024416E-03
-1.1887489E-03	-6.6952433E-03
7.4314002E-01	1.4565571E-01
-1.0044203E-02	-1.0030629E-02
-1.0303721E-03	-2.0060724E-04
-6.4967484E-08	1.8903728E-06
-1.0276759E-03	-2.7905771E-04
-6.4967484E-08	-1.8903728E-06
1.0000000E+00	-2.1694043E-19
-1.1746482E-02	-0.7081267E-03
1.0421074E-01	2.4207712E-02
-1.5047602E-04	-6.9872457E-03
7.3170391E-01	2.6542906E-01
-8.6176090E-03	-1.1772412E-02

TRANSFORMED EIGENVECTOR FOR ROOT -5.2361658E+01 6.8717175E+01

REAL	IMAGINARY
6.0364203E-03	-6.263810E-03
2.4042413E-05	2.5065617E-05
7.9827174E-01	2.5988847E-01
-5.2166523E-02	1.3758130E-02
1.9191465E-02	4.1318906E-01
-3.7765626E-02	7.6014254E-03
6.1679475E-01	3.7712490E-02
-4.9817445E-02	1.5910273E-02
5.0306602E-03	-7.3041041E-03
2.4042413E-05	2.5065617E-05
4.0409000E-03	-8.3443273E-03
2.4042413E-05	2.5065617E-05
1.0000000E-09	0.
-5.4014607E-02	3.4824135E-02
1.7415422E-01	4.6085659E-01
-3.9978561E-02	2.2539233E-02
7.1246925E-01	-1.0473806E-01
-5.0561926E-02	3.6395601E-02

7-20

TRANSFORMED EIGENVECTOR FOR ROOT -5.2361658E+01 -6.8717175E+01

REAL	IMAGINARY
6.0364203E-03	6.263810E-03
2.4042413E-05	-2.5065617E-05
7.9827174E-01	-2.5988847E-01
-5.2166523E-02	-1.3758130E-02
1.9191465E-02	-4.1318906E-01
-3.7765626E-02	-7.6014254E-03
6.1679475E-01	-3.7712497E-02
-4.9817445E-02	-1.5910273E-02
5.0306602E-03	7.3041041E-03
2.4042413E-05	-2.5065617E-05
4.0409000E-03	8.3443273E-03
2.4042413E-05	-2.5065617E-05
1.0000000E+00	0.
-5.4014607E-02	-3.4824135E-02
1.7415422E-01	-4.6085659E-01
-3.9978561E-02	-2.2539233E-02
7.1246925E-01	1.0473806E-01
-5.0561926E-02	-3.6395601E-02

TRANSFORMED EIGENVECTOR FOR ROOT -5.2365378E+01 6.8691084E+01

REAL	IMAGINARY
-1.700029E-03	-8.4704410E-03
-9.4072702E-05	-6.4266274E-06
7.0511731E-01	3.4039137E-01
-2.0250053E-02	4.2916103E-02
2.8001581E-01	2.6563801E-01
-8.0524034E-02	2.9479322E-02
4.3948024E-01	3.7296721E-01
-2.3270701E-02	4.2850430E-02
2.2031346E-03	-8.2037360E-03
-9.4072702E-05	-6.4266274E-06
6.1071517E-03	-7.9370310E-03
-9.4072702E-05	-6.4266274E-06
1.0000000E+00	6.9300939E-10
-5.4000162E-02	3.4802544E-02
1.7436023E-01	4.6073005E-01
-3.9944050E-02	2.2526194E-02
7.1249142E-01	-1.8483032E-01
-5.0551543E-02	3.6375293E-02

TRANSFORMED EIGENVECTOR FOR ROOT -5.2365378E+01 -6.8691084E+01

REAL	IMAGINARY
-1.700029E-03	8.4704410E-03
-9.4072702E-05	6.4266273E-06
7.0511731E-01	3.4039137E-01
-2.0250053E-02	-4.2916103E-02
2.8001581E-01	-2.6563801E-01
-8.0524034E-02	-2.9479322E-02
4.3948024E-01	3.7296721E-01
-2.3270701E-02	-4.2850430E-02
2.2031346E-03	8.2037360E-03
-9.4072702E-05	6.4266273E-06
6.1071517E-03	7.9370310E-03
-9.4072702E-05	6.4266273E-06
1.0000000E+00	0.
-5.4000162E-02	-3.4802544E-02
1.7436023E-01	-4.6073005E-01
-3.9944050E-02	-2.2526194E-02
7.1249142E-01	1.8483032E-01
-5.0551543E-02	-3.6375293E-02

TRANSFORMED EIGENVECTOR FOR ROOT -2.5495973E+01 7.8702181E+01

REAL	IMAGINARY
2.2012553E-02	-2.6437706E-03
1.6907895E-04	-1.7551732E-04
1.0000000E+00	0.
4.1657549E-03	5.1345495E-02
-4.1031778E-01	6.1817164E-01
3.7893694E-03	4.5706493E-02
7.7727580E-01	5.0089908E-02
6.3482861E-03	5.0360940E-02
1.4995777E-02	4.6401983E-03
1.6907895E-04	-1.7551732E-04
7.979005E-03	1.1924167E-02
1.6907895E-04	-1.7551732E-04
5.4042153E-01	4.1694999E-01
-1.9218901E-02	2.9488449E-02
-5.6192294E-01	2.7106836E-01
-1.7064053E-02	2.6272576E-02
3.9917438E-01	3.5088007E-01
-1.7628353E-02	2.9469209E-02

TRANSFORMED EIGENVECTOR FOR ROOT -2.5495973E+01 -7.8702181E+01

REAL	IMAGINARY
2.2012553E-02	2.6437706E-03
1.6907895E-04	1.7551732E-04
1.0000000E+00	0.
4.1657549E-03	-5.1345495E-02
-4.1031778E-01	-6.1817164E-01
3.7893694E-03	-4.5706493E-02
7.7727580E-01	-5.0089908E-02
6.3482861E-03	-5.0360940E-02
1.4995777E-02	-4.6401983E-03
1.6907895E-04	1.7551732E-04
7.979005E-03	-1.1924167E-02
1.6907895E-04	1.7551732E-04
5.4042153E-01	-4.1694999E-01
-1.9218901E-02	-2.9488449E-02
-5.6192294E-01	-2.7106836E-01
-1.7064053E-02	-2.6272576E-02
3.9917438E-01	-3.5088007E-01
-1.7628353E-02	-2.9469209E-02

TRANSFORMED EIGENVECTOR FOR ROOT -2.5464652E+01 7.8695305E+01

REAL	IMAGINARY
1.9429115E-02	7.9039844E-04
2.5175513E-05	4.4712379E-05
1.0000000E+00	-8.0817442E-16
4.2557452E-03	5.1337914E-02
-4.1093950E-01	8.1865729E-01
3.8682360E-03	4.5720386E-02
7.7728322E-01	5.0364476E-02
6.4373926E-03	5.0350144E-02
1.8384331E-02	-1.0651649E-03
2.5175513E-05	4.4712379E-05
1.7339547E-02	-2.9207286E-03
2.5175513E-05	4.4712379E-05
8.6104508E-01	-1.770113E-01
1.2756250E-02	4.3452374E-02
-2.0099460E-01	7.7761632E-01
1.1427415E-02	3.0684452E-02
6.7018333E-01	-9.4202181E-02
1.4460029E-02	4.2215872E-02

A-23

TRANSFORMED EIGENVECTOR FOR ROOT -2.5464652E+01 -7.8695305E+01

REAL	IMAGINARY
1.9429115E-02	-7.9039844E-04
2.5175513E-05	-4.4712379E-05
1.0000000E+00	-8.0817442E-16
4.2557452E-03	-5.1337914E-02
-4.1093950E-01	-8.1865729E-01
3.8682360E-03	-4.5720386E-02
7.7728322E-01	-5.0364476E-02
6.4373926E-03	-5.0350144E-02
1.8384331E-02	1.0651649E-03
2.5175513E-05	-4.4712379E-05
1.7339548E-02	2.9207286E-03
2.5175513E-05	-4.4712379E-05
8.6104508E-01	1.770113E-01
1.2756250E-02	-4.3452374E-02
-2.0099460E-01	-7.7761632E-01
1.1427415E-02	-3.0684452E-02
6.7018333E-01	9.4202181E-02
1.4460029E-02	-4.2215872E-02

TRANSFORMED EIGFVECTOR FOR ROOT -5.4835578E+00 2.2293875E+01

	REAL	IMAGINARY
1	-6.4524784E-02	-3.9716284E-02
2	-2.1104293E-04	2.3225411E-04
3	7.1893924E-01	-1.7877073E-01
4	-5.6445074E-03	3.6055278E-02
5	7.4605834E-01	-3.0228201E-01
6	-9.4059022E-04	3.3331148E-02
7	5.9477243E-01	-3.9512944E-01
8	-4.3360920E-03	3.8045000E-02
9	-5.5766503E-02	-4.9354830E-02
10	-2.1104293E-04	2.3225411E-04
11	-2.1104293E-04	2.3225411E-04
12	9.1183620E-01	1.2896411E-01
13	-7.3265542E-02	3.8874592E-02
14	1.0000000E+00	1.7763568E-15
15	-1.6573202E-02	3.7930229E-02
16	8.6946014E-01	-1.7779212E-01
17	-2.2684144E-02	4.1773034E-02

TRANSFORMED EIGENVECTOR FOR ROOT -5.4835578E+00 -2.2293875E+01

	REAL	IMAGINARY
1	-6.4524784E-02	3.9716284E-02
2	-2.1104293E-04	-2.3225411E-04
3	7.1893924E-01	1.7877073E-01
4	-5.6445074E-03	-3.6055278E-02
5	7.4605834E-01	3.0228201E-01
6	-9.4059022E-04	-3.3331148E-02
7	5.9477243E-01	3.9512944E-01
8	-4.3360920E-03	-3.8045000E-02
9	-5.5766503E-02	4.9354830E-02
10	-2.1104293E-04	-2.3225411E-04
11	-4.7008221E-02	5.8993375E-02
12	-2.1104293E-04	-2.3225411E-04
13	9.1183620E-01	-1.2896411E-01
14	-2.3265542E-02	-3.8874592E-02
15	1.0000000E+00	-1.7763568E-15
16	-1.6573202E-02	-3.7930229E-02
17	8.6946014E-01	1.7779212E-01
18	-2.2684144E-02	-4.1773034E-02

TRANSFORMED EIGENVECTOR FOR ROOT -5.5953686E+00 -2.2202913E+01

REAL	IMAGINARY
-8.3535406E-03	8.1057523E-02
6.9894854E-04	3.8362831E-04
6.5722370E-01	-3.5999355E-01
-2.8947623E-02	-2.2671972E-02
7.6191412E-01	-2.8829342E-01
-2.3550875E-02	-2.3877540E-02
7.1472366E-01	-1.1492852E-01
-2.9354406E-02	-2.5040961E-02
-3.7359905E-02	6.5136948E-02
6.9894854E-04	3.8362831E-04
-6.6366269E-02	4.9216373E-02
6.9894854E-04	3.8362831E-04
9.1303329E-01	-1.2834381E-01
-2.3304489E-02	-3.8703538E-02
1.0000000E+00	0.
-1.6572657E-02	-3.7751156E-02
8.7157462E-01	1.7831145E-01
-2.2732540E-02	-4.1602525E-02

A-25

TRANSFORMED EIGENVECTOR FOR ROOT -5.5953686E+00 2.2202913E+01

REAL	IMAGINARY
-8.3535406E-03	-8.1057523E-02
6.9894854E-04	-3.8362831E-04
6.5722370E-01	3.5999355E-01
-2.8947623E-02	2.2671972E-02
7.6191412E-01	2.8829342E-01
-2.3550875E-02	2.3877540E-02
7.1472366E-01	1.1492852E-01
-2.9354406E-02	2.5040961E-02
-3.7359905E-02	-6.5136948E-02
6.9894854E-04	-3.8362831E-04
-6.6366269E-02	-4.9216373E-02
6.9894854E-04	-3.8362831E-04
9.1303329E-01	1.2834381E-01
-2.3304489E-02	3.8703538E-02
1.0000000E+00	0.
-1.6572657E-02	3.7751156E-02
8.7157462E-01	-1.7831145E-01
-2.2732540E-02	4.1602525E-02

TRANSFORMED EIGENVECTOR FOR ROOT -1.2985625E+00 -5.9189084E+00

PFAL	IMAGINARY
-5.7165155E-01	-1.2661913E-02
-1.8935561E-02	-1.5255317E-04
-1.7347447E-01	-1.4649650E-02
9.4670340E-04	1.8721294E-03
-1.7780748E-01	-1.6336533E-02
-6.5283755E-04	1.7120080E-03
-1.6691856E-01	-2.6457942E-02
8.8319834E-04	1.9822305E-03
2.1417422E-01	-6.3309564E-03
-1.8935561E-02	-1.5255317E-04
1.0000000E+00	-8.8117842E-16
-1.8935561E-02	-1.5255317E-04
-1.6319283E-01	-3.3479101E-02
-1.3311304E-03	2.8268696E-03
-1.3489853E-01	-5.0745646E-02
-2.8097749E-03	2.5235828E-03
-1.4004893E-01	-8.8950921E-02
-1.5512835E-03	2.9688891E-03

A-26

TRANSFORMED EIGENVECTOR FOR ROOT -1.2985625E+00 5.9189084E+00

PFAL	IMAGINARY
-5.7165155E-01	1.2661913E-02
-1.8935561E-02	1.5255317E-04
-1.7347447E-01	1.4649650E-02
9.4670340E-04	-1.8721294E-03
-1.7780748E-01	1.6336533E-02
-6.5283755E-04	-1.7120080E-03
-1.6691856E-01	2.6457942E-02
8.8319834E-04	-1.9822305E-03
2.1417422E-01	6.3309564E-03
-1.8935561E-02	1.5255317E-04
1.0000000E+00	0.
-1.8935561E-02	1.5255317E-04
-1.6319283E-01	3.3479101E-02
-1.3311304E-03	-2.8268696E-03
-1.3489853E-01	5.0745646E-02
-2.8097749E-03	-2.5235828E-03
-1.4004893E-01	8.8950921E-02
-1.5512835E-03	-2.9688891E-03

TRANSFORMED EIGENVECTOR FOR ROOT -0.5349151E-01 4.4058915E+00

REAL	IMAGINARY
9.6301925E-01	-0.8317764E-04
-4.4555123E-04	-1.0640694E-05
3.9587157E-03	0.5664207E-03
-1.3463673E-03	-4.4785025E-04
2.4218890E-02	1.5719095E-02
-1.3003707E-03	-3.8277716E-04
1.3711050E-02	1.0748624E-02
-1.4382201E-03	-4.6348082E-04
9.9150962E-01	-4.4158882E-04
-4.4555123E-04	-1.0640694E-05
1.0000000E+00	1.7763598E-15
-4.4555123E-04	-1.0640694E-05
4.2507667E-03	0.8926049E-03
-1.1977414E-03	-4.6491100E-04
2.5275289E-02	1.6334240E-02
-1.3486682E-03	-3.9736141E-04
1.4365607E-02	1.0743674E-02
-1.4930086E-03	-4.8114718E-04

A-27

TRANSFORMED EIGENVECTOR FOR ROOT -0.5349151E-01 -4.4058915E+00

REAL	IMAGINARY
9.6301925E-01	0.8317764E-04
-4.4555123E-04	1.0640694E-05
3.9587157E-03	-0.5664207E-03
-1.3463673E-03	4.4785025E-04
2.4218890E-02	-1.5719095E-02
-1.3003707E-03	3.8277716E-04
1.3711050E-02	-1.0748624E-02
-1.4382201E-03	4.6348082E-04
9.9150962E-01	4.4158882E-04
-4.4555123E-04	1.0640694E-05
1.0000000E+00	0.
-4.4555123E-04	1.0640694E-05
4.2507667E-03	-0.8926049E-03
-1.1977414E-03	4.6491100E-04
2.5275289E-02	-1.6334240E-02
-1.3486682E-03	3.9736141E-04
1.4365607E-02	-1.0743674E-02
-1.4930086E-03	4.8114718E-04

THE ABOVE DATA IS NOW ON TAPE 11

THE TOTAL NUMBER OF PHYSICAL COORDINATES = 18
THE TOTAL NUMBER OF SYSTEM MODES = 28

THE NUMBER OF SYSTEM MODES RETAINED FOR RESPONSE = 28

A-28
THESE MODES ARE

1	2	3	4	5	6	7	8	9	10
11	12	13	14	15	16	17	18	19	20
21	22	23	24	25	26	27	28		

THE NUMBER OF PHYSICAL COORDINATES HAVING APPLIED FORCES= 4

COORDINATE	ZERO-ORDER FORCE	FIRST-ORDER FORCE	SECOND-ORDER FORCE	PHASE (1=360DEG)
4	2.813E+05	0.	0.	0.
8	2.813E+05	0.	0.	1.778E-02
14	2.813E+05	0.	0.	1.844E-01
16	2.813E+05	0.	0.	2.022E-01

THE EIGENVALUES RETAINED FOR RESPONSE.

-1.129011E+02	3.131278E+02
-1.129011E+02	-3.131278E+02
-1.129010E+02	-3.131278E+02
-1.129010E+02	3.131278E+02
-1.441037E+02	2.858556E+02
-1.441037E+02	-2.858556E+02
-1.441037E+02	2.858556E+02
-1.441037E+02	-2.858556E+02
-1.723923E+02	7.359930E+00
-1.723923E+02	-7.359930E+00
-1.723913E+02	7.359550E+00
-1.723913E+02	-7.359550E+00
-5.236166E+01	6.871717E+01
-5.236166E+01	-6.871717E+01
-5.236538E+01	6.869108E+01
-5.236538E+01	-6.869108E+01
-2.589597E+01	7.870218E+01
-2.589597E+01	-7.870218E+01
-2.584465E+01	7.869530E+01
-2.584465E+01	-7.869530E+01
-5.887558E+00	2.229387E+01
-5.887558E+00	-2.229387E+01
-5.595369E+00	2.220291E+01
-5.595369E+00	-2.220291E+01
-1.298562E+00	5.918908E+00
-1.298562E+00	-5.918908E+00
-8.514915E-01	4.405891E+00
-8.514915E-01	-4.405891E+00

WE ARE LOOKING FOR 2 -ORDER RESPONSE AT 3 COORDINATES.
THE FREQUENCY RANGES FROM 1.000E-02 HERTZ TO 1.000E+02 HERTZ CUT INTO 200 DIVISIONS.

THE COORDINATES BEING OBSERVED ARE

11 15 17

THE POWER SPECTRAL DENSITY OF THE FORCING FUNCTION IS GIVEN AT 3 POINTS.

THESE POINTS ARE. FREQUENCY(HZ) PSD

.010	9.000E-03
.100	9.000E-03
100.000	9.000E-09

THE INTEGRAL OF THE DRIVER OVER THE INPUT FREQUENCY RANGE = 1.709E-03

THE INTEGRAL OF THE DRIVER OVER THE INPUT FREQUENCY RANGE = 1.709E-03

FREQUENCY RESPONSE AND POWER SPECTRAL DENSITY AT COORDINATE 11

FREQ (LOGHZ)	AMPLITUDE	PHASE (DEG)	PSD RESPONSE	PSD DRIVING
-2.000	3.949E-03	-1.795E+02	1.403E-07	9.000F-03
-1.980	4.330E-03	-1.795E+02	1.687E-07	9.000F-03
-1.960	4.747E-03	-1.795E+02	2.028E-07	9.000F-03
-1.940	5.206E-03	-1.795E+02	2.439E-07	9.000F-03
-1.920	5.708E-03	-1.795E+02	2.932E-07	9.000F-03
-1.900	6.259E-03	-1.794E+02	3.526E-07	9.000F-03
-1.880	6.863E-03	-1.794E+02	4.239E-07	9.000F-03
-1.860	7.525E-03	-1.794E+02	5.097E-07	9.000F-03
-1.840	8.251E-03	-1.793E+02	6.128E-07	9.000F-03
-1.820	9.048E-03	-1.793E+02	7.368E-07	9.000F-03
-1.800	9.921E-03	-1.793E+02	8.859E-07	9.000F-03
-1.780	1.088E-02	-1.792E+02	1.065E-06	9.000F-03
-1.760	1.193E-02	-1.792E+02	1.281E-06	9.000F-03
-1.740	1.308E-02	-1.792E+02	1.540E-06	9.000F-03
-1.720	1.434E-02	-1.791E+02	1.852E-06	9.000F-03
-1.700	1.573E-02	-1.791E+02	2.226E-06	9.000F-03
-1.680	1.725E-02	-1.791E+02	2.677E-06	9.000F-03
-1.660	1.891E-02	-1.790E+02	3.219E-06	9.000F-03
-1.640	2.074E-02	-1.790E+02	3.871E-06	9.000F-03
-1.620	2.274E-02	-1.789E+02	4.655E-06	9.000F-03
-1.600	2.494E-02	-1.789E+02	5.598E-06	9.000F-03
-1.580	2.735E-02	-1.788E+02	6.731E-06	9.000F-03
-1.560	2.999E-02	-1.787E+02	8.095E-06	9.000F-03
-1.540	3.289E-02	-1.787E+02	9.735E-06	9.000F-03
-1.520	3.607E-02	-1.786E+02	1.171E-05	9.000F-03
-1.500	3.955E-02	-1.786E+02	1.408E-05	9.000F-03
-1.480	4.338E-02	-1.785E+02	1.693E-05	9.000F-03
-1.460	4.757E-02	-1.784E+02	2.037E-05	9.000F-03
-1.440	5.217E-02	-1.784E+02	2.450E-05	9.000F-03
-1.420	5.722E-02	-1.783E+02	2.947E-05	9.000F-03
-1.400	6.276E-02	-1.782E+02	3.545E-05	9.000F-03
-1.380	6.883E-02	-1.781E+02	4.264E-05	9.000F-03
-1.360	7.550E-02	-1.780E+02	5.130E-05	9.000F-03
-1.340	8.281E-02	-1.779E+02	6.171E-05	9.000F-03
-1.320	9.083E-02	-1.778E+02	7.425E-05	9.000F-03
-1.300	9.964E-02	-1.777E+02	8.935E-05	9.000F-03
-1.280	1.093E-01	-1.776E+02	1.075E-04	9.000F-03
-1.260	1.199E-01	-1.775E+02	1.294E-04	9.000F-03
-1.240	1.315E-01	-1.774E+02	1.557E-04	9.000F-03
-1.220	1.443E-01	-1.773E+02	1.875E-04	9.000F-03
-1.200	1.584E-01	-1.772E+02	2.257E-04	9.000F-03
-1.180	1.738E-01	-1.770E+02	2.717E-04	9.000F-03
-1.160	1.907E-01	-1.769E+02	3.272E-04	9.000F-03
-1.140	2.092E-01	-1.767E+02	3.941E-04	9.000F-03
-1.120	2.297E-01	-1.766E+02	4.747E-04	9.000F-03
-1.100	2.521E-01	-1.764E+02	5.719E-04	9.000F-03
-1.080	2.767E-01	-1.763E+02	6.892E-04	9.000F-03
-1.060	3.038E-01	-1.761E+02	8.307E-04	9.000F-03
-1.040	3.336E-01	-1.759E+02	1.001E-03	9.000F-03
-1.020	3.663E-01	-1.757E+02	1.208E-03	9.000F-03

-1.000	4.023E-01	-1.755E+02	1.457E-03	9.000F-03
-0.980	4.420E-01	-1.753E+02	1.603E-03	8.208F-03
-0.960	4.856E-01	-1.751E+02	1.765E-03	7.486F-03
-0.940	5.336E-01	-1.749E+02	1.944E-03	6.827E-03
-0.920	5.865E-01	-1.747E+02	2.142E-03	6.226F-03
-0.900	6.448E-01	-1.744E+02	2.361E-03	5.679F-03
-0.880	7.091E-01	-1.742E+02	2.604E-03	5.179F-03
-0.860	7.800E-01	-1.739E+02	2.874E-03	4.723F-03
-0.840	8.583E-01	-1.737E+02	3.173E-03	4.308F-03
-0.820	9.448E-01	-1.734E+02	3.507E-03	3.929F-03
-0.800	1.040E+00	-1.731E+02	3.878E-03	3.583E-03
-0.780	1.146E+00	-1.729E+02	4.292E-03	3.268F-03
-0.760	1.263E+00	-1.726E+02	4.755E-03	2.980F-03
-0.740	1.393E+00	-1.723E+02	5.274E-03	2.718F-03
-0.720	1.537E+00	-1.719E+02	5.855E-03	2.479F-03
-0.700	1.697E+00	-1.716E+02	6.509E-03	2.261F-03
-0.680	1.875E+00	-1.713E+02	7.246E-03	2.062F-03
-0.660	2.073E+00	-1.710E+02	8.078F-03	1.880F-03
-0.640	2.294E+00	-1.707E+02	9.022E-03	1.715F-03
-0.620	2.541E+00	-1.704E+02	1.009E-02	1.564F-03
-0.600	2.817E+00	-1.700E+02	1.132E-02	1.426F-03
-0.580	3.127E+00	-1.697E+02	1.272E-02	1.301F-03
-0.560	3.476E+00	-1.694E+02	1.433E-02	1.186F-03
-0.540	3.869E+00	-1.692E+02	1.619E-02	1.082F-03
-0.520	4.313E+00	-1.689E+02	1.836E-02	9.868F-04
-0.500	4.817E+00	-1.687E+02	2.088E-02	9.000F-04
-0.480	5.390E+00	-1.686E+02	2.384E-02	8.208F-04
-0.460	6.045E+00	-1.685E+02	2.735E-02	7.486F-04
-0.440	6.795E+00	-1.685E+02	3.153E-02	6.827F-04
-0.420	7.660E+00	-1.686E+02	3.654E-02	6.226F-04
-0.400	8.662E+00	-1.688E+02	4.261F-02	5.679F-04
-0.380	9.828E+00	-1.692E+02	5.002E-02	5.179F-04
-0.360	1.119E+01	-1.699E+02	5.917E-02	4.723F-04
-0.340	1.280E+01	-1.708E+02	7.057E-02	4.308F-04
-0.320	1.470E+01	-1.721E+02	8.492E-02	3.929F-04
-0.300	1.697E+01	-1.740E+02	1.031E-01	3.583F-04
-0.280	1.967E+01	-1.765E+02	1.264E-01	3.268F-04
-0.260	2.289E+01	-1.799E+02	1.561E-01	2.980F-04
-0.240	2.668E+01	1.755E+02	1.935E-01	2.718F-04
-0.220	3.102E+01	1.693E+02	2.385E-01	2.479F-04
-0.200	3.562E+01	1.611E+02	2.869E-01	2.261F-04
-0.180	3.978E+01	1.505E+02	3.262E-01	2.062F-04
-0.160	4.219E+01	1.377E+02	3.346E-01	1.880F-04
-0.140	4.143E+01	1.234E+02	2.944E-01	1.715F-04
-0.120	3.699E+01	1.092E+02	2.140E-01	1.564F-04
-0.100	2.949E+01	9.627E+01	1.241E-01	1.426F-04
-0.080	1.997E+01	8.603E+01	5.187F v2	1.301F-04
-0.060	9.335E+00	8.512E+01	1.034E-02	1.186F-04
-0.040	4.810E+00	-1.786E+02	2.503E-03	1.082F-04
-0.020	1.537E+01	-1.567E+02	2.331E-02	9.868F-05

.000	2.566E+01	-1.631E+02	5.925E-02	9.000F-05
.020	3.388E+01	-1.714E+02	9.419E-02	8.208F-05
.040	3.981E+01	-1.787E+02	1.186E-01	7.486F-05
.060	4.389E+01	1.758E+02	1.315E-01	6.827F-05
.080	4.673E+01	1.720E+02	1.360E-01	6.226F-05
.100	4.887E+01	1.696E+02	1.356E-01	5.679F-05
.120	5.068E+01	1.685E+02	1.330E-01	5.179F-05
.140	5.239E+01	1.684E+02	1.296E-01	4.723F-05
.160	5.417E+01	1.690E+02	1.264E-01	4.308F-05
.180	5.612E+01	1.703E+02	1.237E-01	3.929F-05
.200	5.832E+01	1.721E+02	1.219E-01	3.583F-05
.220	6.084E+01	1.742E+02	1.209E-01	3.268F-05
.240	6.372E+01	1.767E+02	1.210E-01	2.980F-05
.260	6.704E+01	1.795E+02	1.221E-01	2.718E-05
.280	7.083E+01	-1.776E+02	1.244E-01	2.479E-05
.300	7.510E+01	-1.745E+02	1.278E-01	2.261F-05
.320	8.016E+01	-1.714E+02	1.325E-01	2.062F-05
.340	8.584E+01	-1.683E+02	1.385E-01	1.880E-05
.360	9.231E+01	-1.652E+02	1.461E-01	1.715F-05
.380	9.968E+01	-1.622E+02	1.544E-01	1.564E-05
.400	1.080E+02	-1.595E+02	1.644E-01	1.426F-05
.420	1.174E+02	-1.571E+02	1.792E-01	1.301F-05
.440	1.277E+02	-1.553E+02	1.936E-01	1.186F-05
.460	1.389E+02	-1.540E+02	2.086E-01	1.072F-05
.480	1.502E+02	-1.535E+02	2.226E-01	9.868F-06
.500	1.606E+02	-1.540E+02	2.321E-01	9.000F-06
.520	1.703E+02	-1.554E+02	2.326E-01	8.208F-06
.540	1.711E+02	-1.576E+02	2.192E-01	7.486F-06
.560	1.873E+02	-1.598E+02	1.911E-01	6.827F-06
.580	1.567E+02	-1.598E+02	1.529E-01	6.226F-06
.600	1.412E+02	-1.613E+02	1.133E-01	5.679F-06
.620	1.234E+02	-1.593E+02	7.885E-02	5.179F-06
.640	1.054E+02	-1.549E+02	5.248E-02	4.723F-06
.660	8.869E+01	-1.480E+02	3.388E-02	4.308F-06
.680	7.396E+01	-1.383E+02	2.149F-02	3.929F-06
.700	6.165E+01	-1.256E+02	1.362E-02	3.583F-06
.720	5.206E+01	-1.096E+02	8.856E-03	3.268F-06
.740	4.547E+01	-9.032E+01	6.160E-03	2.980F-06
.760	4.196E+01	-6.886E+01	4.785E-03	2.718F-06
.780	4.120E+01	-4.695E+01	4.208E-03	2.479F-06
.800	4.241F+01	-2.619E+01	4.067E-03	2.261F-06
.820	4.465E+01	-7.197E+00	4.111E-03	2.062F-06
.840	4.710E+01	1.020E+01	4.172E-03	1.880F-06
.860	4.915E+01	2.447E+01	4.142E-03	1.715F-06
.880	5.034E+01	4.211E+01	3.964E-03	1.564F-06
.900	5.038E+01	5.756E+01	3.621E-03	1.426F-06
.920	4.907E+01	7.320E+01	3.132E-03	1.301F-06
.940	4.633E+01	8.947E+01	2.546E-03	1.186F-06
.960	4.222E+01	1.069E+02	1.929E-03	1.082F-06
.980	3.702E+01	1.263E+02	1.353E-03	9.868F-07

1.000	3.130E+01	1.489E+02	8.818F-04	9.000F-07
1.020	2.601E+01	1.760E+02	5.555E-04	8.208F-07
1.040	2.240E+01	-1.513E+02	3.756E-04	7.486F-07
1.060	2.117E+01	-1.163E+02	3.059E-04	6.827F-07
1.080	2.146E+01	-8.398E+01	2.866E-04	6.226F-07
1.100	2.152E+01	-5.566E+01	2.630E-04	5.679F-07
1.120	2.021E+01	-2.943E+01	2.116E-04	5.179F-07
1.140	1.741E+01	-2.675E+00	1.432E-04	4.723F-07
1.160	1.377E+01	2.702E+01	8.167E-05	4.308F-07
1.180	1.018E+01	6.169E+01	4.072E-05	3.929F-07
1.200	7.276E+00	1.024E+02	1.897E-05	3.583F-07
1.220	5.166E+00	1.487E+02	8.721E-06	3.268E-07
1.240	3.640E+00	-1.598E+02	3.949E-06	2.980F-07
1.260	2.577E+00	-1.012E+02	1.805E-06	2.718F-07
1.280	2.010E+00	-3.610E+01	1.001E-06	2.479F-07
1.300	1.739E+00	2.700E+01	6.836E-07	2.261F-07
1.320	1.401E+00	8.556E+01	4.049E-07	2.062F-07
1.340	9.187E-01	1.484E+02	1.587E-07	1.880F-07
1.360	5.483E-01	-1.260E+02	5.156E-08	1.715F-07
1.380	5.174E-01	-3.082E+01	4.186E-08	1.564F-07
1.400	4.764E-01	4.791E+01	3.237E-08	1.426F-07
1.420	3.701E-01	1.400E+02	1.782E-08	1.301F-07
1.440	4.173E-01	-1.266E+02	2.066E-08	1.186F-07
1.460	3.726E-01	-6.046E+01	1.502E-08	1.082F-07
1.480	6.561E-02	-8.441E+00	4.248E-10	9.868F-08
1.500	3.187E-01	-1.324E+02	9.143E-09	9.000F-08
1.520	4.435E-01	-8.649E+01	1.614E-08	8.208F-08
1.540	2.061E-01	-7.535E+01	3.141E-09	7.486F-08
1.560	4.220E-01	-1.186E+02	1.216E-08	6.827F-08
1.580	5.442E-01	-8.019E+01	1.844F-08	6.226F-08
1.600	1.928E-01	-8.266E+01	2.110E-09	5.679F-08
1.620	5.750E-01	-1.152E+02	1.712E-08	5.179F-08
1.640	5.533E-01	-6.705E+01	1.446E-08	4.723F-08
1.660	2.282E-01	-1.325E+02	2.243E-09	4.308F-08
1.680	6.677E-01	-9.678E+01	1.752F-08	3.929F-08
1.700	2.123E-01	-5.007E+01	1.616E-09	3.583F-08
1.720	5.101E-01	-1.207E+02	8.501E-09	3.268F-08
1.740	3.145E-01	-5.313E+01	2.948E-09	2.980F-08
1.760	3.242E-01	-1.320E+02	2.946E-09	2.718F-08
1.780	2.409E-01	-5.322E+01	1.438E-09	2.479F-08
1.800	2.221E-01	-1.268E+02	1.115E-09	2.261F-08
1.820	1.073E-01	-3.696E+01	2.375E-10	2.062F-08
1.840	1.452E-01	-1.007E+02	3.962E-10	1.880F-08
1.860	5.890E-03	-8.326E+01	5.949E-13	1.715F-08
1.880	5.602E-02	-4.953E+01	4.908E-11	1.564F-08
1.900	2.272E-02	-9.977E+01	7.362E-12	1.426F-08
1.920	7.713E-04	7.798E+01	7.739E-15	1.301F-08
1.940	9.312E-03	1.548E+02	1.029E-12	1.186F-08
1.960	2.119E-02	1.297E+02	4.860E-12	1.082F-08
1.980	1.797E-02	1.069E+02	3.185E-12	9.868F-08
2.000	5.095E-03	9.923E+01	2.336E-13	9.000F-08

FREQUENCY RESPONSE AND POWER SPECTRAL DENSITY AT COORDINATE 15

FREQ (LOGM)	AMPLITUDE	PHASE (DEG)	PSD RESPONSE	PSD DRIVING
-2.000	3.948E-03	-1.795E+02	1.403E-07	9.000F-03
-1.980	4.119E-03	-1.794E+02	1.686E-07	9.000F-03
-1.960	4.746E-03	-1.794E+02	2.028E-07	9.000F-03
-1.940	5.204E-03	-1.794E+02	2.438E-07	9.000F-03
-1.920	5.706E-03	-1.793E+02	2.931E-07	9.000F-03
-1.900	6.257E-03	-1.793E+02	3.523E-07	9.000F-03
-1.880	6.861E-03	-1.793E+02	4.236E-07	9.000F-03
-1.860	7.523E-03	-1.793E+02	5.093E-07	9.000F-03
-1.840	8.248E-03	-1.792E+02	6.123E-07	9.000F-03
-1.820	9.044E-03	-1.792E+02	7.362E-07	9.000F-03
-1.800	9.917E-03	-1.791E+02	8.851E-07	9.000F-03
-1.780	1.087E-02	-1.791E+02	1.064E-06	9.020F-03
-1.760	1.192E-02	-1.791E+02	1.279E-06	9.000F-03
-1.740	1.307E-02	-1.790E+02	1.538E-06	9.000F-03
-1.720	1.433E-02	-1.790E+02	1.849E-06	9.000F-03
-1.700	1.572E-02	-1.789E+02	2.223E-06	9.000F-03
-1.680	1.723E-02	-1.789E+02	2.673E-06	9.000F-03
-1.660	1.890E-02	-1.788E+02	3.214E-06	9.000F-03
-1.640	2.072E-02	-1.788E+02	3.864E-06	9.000F-03
-1.620	2.272E-02	-1.787E+02	4.645E-06	9.000F-03
-1.600	2.491E-02	-1.786E+02	5.585E-06	9.000F-03
-1.580	2.731E-02	-1.786E+02	6.715E-06	9.000F-03
-1.560	2.995E-02	-1.785E+02	8.073E-06	9.000F-03
-1.540	3.284E-02	-1.784E+02	9.706E-06	9.000F-03
-1.520	3.601E-02	-1.784E+02	1.167E-05	9.000F-03
-1.500	3.948E-02	-1.783E+02	1.403E-05	9.000F-03
-1.480	4.329E-02	-1.782E+02	1.687E-05	9.000F-03
-1.460	4.747E-02	-1.781E+02	2.028E-05	9.000F-03
-1.440	5.205E-02	-1.780E+02	2.438E-05	9.000F-03
-1.420	5.707E-02	-1.779E+02	2.931E-05	9.000E-03
-1.400	6.258E-02	-1.779E+02	3.524E-05	9.000F-03
-1.380	6.862E-02	-1.777E+02	4.237E-05	9.000F-03
-1.360	7.524E-02	-1.776E+02	5.095E-05	9.000F-03
-1.340	8.250E-02	-1.775E+02	6.125E-05	9.000F-03
-1.320	9.046E-02	-1.774E+02	7.364E-05	9.000F-03
-1.300	9.919E-02	-1.773E+02	8.854E-05	9.000F-03
-1.280	1.088E-01	-1.772E+02	1.065E-04	9.000F-03
-1.260	1.193E-01	-1.770E+02	1.280E-04	9.000F-03
-1.240	1.309E-01	-1.769E+02	1.539E-04	9.000F-03
-1.220	1.434E-01	-1.767E+02	1.850E-04	9.000F-03
-1.200	1.572E-01	-1.766E+02	2.225E-04	9.000F-03
-1.180	1.724E-01	-1.764E+02	2.675E-04	9.000F-03
-1.160	1.890E-01	-1.763E+02	3.216E-04	9.000F-03
-1.140	2.073E-01	-1.761E+02	3.867E-04	9.000F-03
-1.120	2.273E-01	-1.759E+02	4.649E-04	9.000F-03
-1.100	2.492E-01	-1.757E+02	5.570E-04	9.000F-03
-1.080	2.733E-01	-1.755E+02	6.722E-04	9.000F-03
-1.060	2.997E-01	-1.753E+02	8.082E-04	9.000F-03
-1.040	3.286E-01	-1.751E+02	9.716E-04	9.000F-03
-1.020	3.603E-01	-1.748E+02	1.169E-03	9.000F-03

-1.000	3.951E-01	-1.746E+02	1.05E-03	9.000F-03
-.980	4.331E-01	-1.743E+02	1.541E-03	8.208F-03
-.960	4.751E-01	-1.741E+02	1.690E-03	7.486F-03
-.940	5.210E-01	-1.738E+02	1.853E-03	6.827F-03
-.920	5.714E-01	-1.735E+02	2.033E-03	6.226F-03
-.900	6.266E-01	-1.732E+02	2.229E-03	5.679F-03
-.880	6.871E-01	-1.729E+02	2.445E-03	5.179F-03
-.860	7.535E-01	-1.726E+02	2.682E-03	4.723F-03
-.840	8.263E-01	-1.722E+02	2.941E-03	4.308F-03
-.820	9.062E-01	-1.718E+02	3.226E-03	3.929F-03
-.800	9.938E-01	-1.715E+02	3.539E-03	3.583F-03
-.780	1.090E+00	-1.711E+02	3.882E-03	3.268F-03
-.760	1.195E+00	-1.706E+02	4.259E-03	2.980F-03
-.740	1.311E+00	-1.702E+02	4.672E-03	2.718F-03
-.720	1.439E+00	-1.697E+02	5.126E-03	2.479F-03
-.700	1.577E+00	-1.693E+02	5.624E-03	2.261F-03
-.680	1.730E+00	-1.688E+02	6.170E-03	2.062F-03
-.660	1.898E+00	-1.682E+02	6.771E-03	1.880F-03
-.640	2.081E+00	-1.677E+02	7.430E-03	1.715F-03
-.620	2.283E+00	-1.671E+02	8.154E-03	1.564F-03
-.600	2.505E+00	-1.665E+02	8.950E-03	1.426F-03
-.580	2.748E+00	-1.659E+02	9.824E-03	1.301F-03
-.560	3.015E+00	-1.653E+02	1.079E-02	1.186F-03
-.540	3.308E+00	-1.646E+02	1.184E-02	1.082F-03
-.520	3.630E+00	-1.639E+02	1.305E-02	9.868F-04
-.500	3.983E+00	-1.631E+02	1.428E-02	9.000F-04
-.480	4.372E+00	-1.624E+02	1.569E-02	8.208F-04
-.460	4.798E+00	-1.616E+02	1.723E-02	7.486F-04
-.440	5.267E+00	-1.607E+02	1.894E-02	6.827F-04
-.420	5.782E+00	-1.599E+02	2.088E-02	6.226F-04
-.400	6.348E+00	-1.590E+02	2.288E-02	5.679F-04
-.380	6.971E+00	-1.581E+02	2.517E-02	5.179F-04
-.360	7.656E+00	-1.571E+02	2.768E-02	4.723F-04
-.340	8.410E+00	-1.561E+02	3.046E-02	4.308F-04
-.320	9.239E+00	-1.552E+02	3.353E-02	3.929F-04
-.300	1.015E+01	-1.542E+02	3.692E-02	3.583F-04
-.280	1.115E+01	-1.532E+02	4.065E-02	3.268F-04
-.260	1.225E+01	-1.521E+02	4.474E-02	2.980F-04
-.240	1.345E+01	-1.514E+02	4.917E-02	2.718F-04
-.220	1.474E+01	-1.506E+02	5.386E-02	2.479F-04
-.200	1.610E+01	-1.499E+02	5.857E-02	2.261F-04
-.180	1.746E+01	-1.494E+02	6.285E-02	2.062F-04
-.160	1.875E+01	-1.487E+02	6.614E-02	1.880F-04
-.140	1.994E+01	-1.476E+02	6.816E-02	1.715F-04
-.120	2.106E+01	-1.457E+02	6.934E-02	1.564F-04
-.100	2.221E+01	-1.430E+02	7.036F-02	1.426F-04
-.080	2.347E+01	-1.394E+02	7.166E-02	1.301F-04
-.060	2.494E+01	-1.349E+02	7.377E-02	1.186F-04
-.040	2.666E+01	-1.293E+02	7.805E-02	1.082F-04
-.020	2.967E+01	-1.231E+02	8.690E-02	9.868F-05

.030
.020
.040
.060
.080
.100
.120
.140
.160
.200
.220
.240
.260
.280
.300
.320
.340
.360
.380
.400
.420
.440
.460
.480
.500
.520
.540
.560
.580
.600
.620
.640
.660
.680
.700
.720
.740
.760
.780
.800
.840
.860
.880
.900
.920
.940
.960
.980

3.373E+01
3.097E+01
4.908E+01
5.179E+01
5.904E+01
6.688E+01
7.544E+01
8.488E+01
9.538E+01
1.072E+02
1.204E+02
1.355E+02
1.527E+02
1.724E+02
1.952E+02
2.215E+02
2.521E+02
2.879E+02
3.300E+02
3.797E+02
4.385E+02
5.090E+02
5.897E+02
6.845E+02
7.913E+02
9.053E+02
1.016E+03
1.109E+03
1.189E+03
1.192E+03
1.173E+03
1.155E+03
1.117E+03
1.078E+03
1.040E+03
1.004E+03
9.752E+02
9.486E+02
9.258E+02
9.066E+02
8.905E+02
8.775E+02
8.673E+02
8.595E+02
8.542E+02
8.511E+02
8.499E+02
8.503E+02
8.504E+02
8.495E+02

-1.173E+02
-1.126E+02
-1.091E+02
-1.062E+02
-1.036E+02
-1.010E+02
-9.837E+01
-9.554E+01
-9.255E+01
-8.938E+01
-8.605E+01
-8.255E+01
-7.891E+01
-7.514E+01
-7.126E+01
-6.729E+01
-6.327E+01
-5.923E+01
-5.522E+01
-5.131E+01
-4.760E+01
-4.419E+01
-4.121E+01
-3.884E+01
-3.724E+01
-3.651E+01
-3.662E+01
-3.723E+01
-3.772E+01
-3.731E+01
-3.539E+01
-3.172E+01
-2.631E+01
-1.930E+01
-1.084E+01
-1.070E+00
9.902E+00
2.199E+01
3.513E+01
4.928E+01
6.441E+01
8.050E+01
9.754E+01
1.155E+02
1.344E+02
1.541E+02
1.748E+02
1.630E+02
-1.416E+02
-1.107E+02

1.024E-01
1.246E-01
1.521E-01
1.831E-01
2.170E-01
2.540E-01
2.947E-01
3.403E-01
3.919E-01
4.511E-01
5.198E-01
6.002E-01
6.951E-01
8.082E-01
9.441E-01
1.109E+00
1.310E+00
1.559E+00
1.868E+00
2.255E+00
2.743E+00
3.357E+00
4.126E+00
5.070E+00
6.179E+00
7.376E+00
8.478E+00
9.209E+00
9.335E+00
8.843E+00
7.945E+00
6.903E+00
5.897E+00
5.007E+00
4.252E+00
3.625E+00
3.108E+00
2.682E+00
2.330E+00
2.037E+00
1.793E+00
1.588E+00
1.414E+00
1.267E+00
1.141E+00
1.033E+00
9.397E-01
8.572E-01
7.825E-01
7.122E-01

9.000F-05
8.208F-05
7.486F-05
6.827F-05
6.226F-05
5.679F-05
4.723F-05
4.308F-05
3.929F-05
3.583F-05
3.268F-05
2.980F-05
2.718F-05
2.479F-05
2.261F-05
2.062F-05
1.880F-05
1.715F-05
1.564F-05
1.426F-05
1.301F-05
1.186F-05
1.082F-05
9.868F-06
9.000F-06
8.208F-06
7.486F-06
6.827F-06
6.226F-06
5.679F-06
5.179F-06
4.723F-06
4.308F-06
3.929F-06
3.583F-06
3.268F-06
2.980F-06
2.718F-06
2.479F-06
2.261F-06
2.062F-06
1.880F-06
1.715F-06
1.564E-06
1.426F-06
1.301F-06
1.186F-06
1.082F-06
9.868E-07

1.000	0.452E+02	-9.521E+01	6.430E-01	9.000F-07
1.020	0.347E+02	-7.103E+01	5.719E-01	8.209F-07
1.040	0.147E+02	-4.619E+01	4.969E-01	7.486F-07
1.060	7.020E+02	-2.058E+01	4.175E-01	0.827F-07
1.080	7.343E+02	5.996E+00	3.357E-01	6.226F-07
1.100	6.711E+02	3.382E+01	2.557E-01	5.679F-07
1.120	5.944E+02	6.330E+01	1.830E-01	5.179F-07
1.140	5.091E+02	9.494E+01	1.224E-01	4.723F-07
1.160	4.215E+02	1.293E+02	7.652E-02	4.308F-07
1.180	3.380E+02	1.668E+02	4.489E-02	3.929F-07
1.200	2.636E+02	-1.520E+02	2.490E-02	3.583F-07
1.220	2.008E+02	-1.067E+02	1.317E-02	3.268F-07
1.240	1.501E+02	-5.702E+01	6.711E-03	2.980F-07
1.260	1.108E+02	-2.384E+00	3.334E-03	2.718F-07
1.280	6.157E+01	5.763E+01	1.650E-03	2.479F-07
1.300	6.100E+01	1.237E+02	8.413E-04	2.261F-07
1.320	4.735E+01	-1.659E+02	4.622E-04	2.062F-07
1.340	3.870E+01	-9.128E+01	2.816E-04	1.880F-07
1.360	3.308E+01	-1.458E+01	1.877E-04	1.715F-07
1.380	2.889E+01	6.311E+01	1.306E-04	1.564F-07
1.400	2.515E+01	1.415E+02	9.019E-05	1.426F-07
1.420	2.136E+01	-1.395E+02	5.936E-05	1.301F-07
1.440	1.743E+01	-6.014E+01	3.604E-05	1.186F-07
1.460	1.354E+01	1.797E+01	1.984E-05	1.082F-07
1.480	1.027E+01	9.117E+01	1.041E-05	9.868F-08
1.500	0.826E+00	1.563E+02	7.011E-06	9.000F-08
1.520	1.023E+01	-1.350E+02	8.594E-06	8.208F-08
1.540	1.361E+01	-5.029E+01	1.387E-05	7.486F-08
1.560	1.775E+01	4.774E+01	2.150E-05	6.827F-08
1.580	2.200E+01	1.549E+02	3.014E-05	6.226F-08
1.600	2.600E+01	-9.061E+01	3.838E-05	5.679F-08
1.620	2.952E+01	3.050E+01	4.513E-05	5.179F-08
1.640	3.237E+01	1.579E+02	4.949E-05	4.723F-08
1.660	3.427E+01	-6.844E+01	5.059F-05	4.308F-08
1.680	3.507E+01	7.180E+01	4.831E-05	3.929F-08
1.700	3.462E+01	-1.512E+02	4.293F-05	3.583F-08
1.720	3.287E+01	1.321E+01	3.531E-05	3.268F-08
1.740	3.002E+01	1.754E+02	2.686E-05	2.980F-08
1.760	2.631E+01	-1.390E+01	1.811F-05	2.718F-08
1.780	2.214E+01	1.658E+02	1.215F-05	2.479F-08
1.800	1.786E+01	-4.941E+00	7.207E-06	2.261F-08
1.820	1.377E+01	-1.656E+02	3.904E-06	2.062F-08
1.840	1.006E+01	4.415E+01	1.904E-06	1.880F-08
1.860	6.856E+00	-9.518E+01	8.060E-07	1.715F-08
1.880	4.184E+00	1.368E+02	2.738F-07	1.564F-08
1.900	2.045E+00	2.060E+01	5.968F-08	1.426F-08
1.920	4.041E-01	-8.320E+01	2.177E-09	1.301F-08
1.940	7.732E-01	5.000E+00	7.094E-09	1.186F-08
1.960	1.556E+00	-7.303E+01	2.621E-08	1.082F-08
1.980	2.000E+00	-1.373E+02	3.947E-08	9.868F-09
2.000	2.164E+00	1.727E+02	4.216E-08	9.000F-09

THE MEAN SQUARE RESPONSE OF COORDINATE 15 OVER THE RESPONSE SPECTRUM = 2.409F+01

FREQUENCY RESPONSE AND POWER SPECTRAL DENSITY AT COORDINATE 17

FREQ (LJGHZ)	AMPLITUDE	PHASE (DEG)	PSD RESPONSE	PSD DRIVING
-2.000	3.948E-03	-1.795E+02	1.403E-07	9.000F-03
-1.980	4.329E-03	-1.795E+02	1.686E-07	9.000F-03
-1.960	4.746E-03	-1.794E+02	2.028E-07	9.000F-03
-1.940	5.204E-03	-1.794E+02	2.438E-07	9.000F-03
-1.920	5.706E-03	-1.794E+02	2.931E-07	9.000F-03
-1.900	6.257E-03	-1.793E+02	3.523E-07	9.000F-03
-1.880	6.861E-03	-1.793E+02	4.236E-07	9.000F-03
-1.860	7.523E-03	-1.793E+02	5.093E-07	9.000F-03
-1.840	8.248E-03	-1.792E+02	6.123E-07	9.000F-03
-1.820	9.044E-03	-1.792E+02	7.362E-07	9.000F-03
-1.800	9.917E-03	-1.792E+02	8.851E-07	9.000F-03
-1.780	1.087E-02	-1.791E+02	1.064E-06	9.000F-03
-1.760	1.192E-02	-1.791E+02	1.279E-06	9.000F-03
-1.740	1.307E-02	-1.791E+02	1.539E-06	9.000F-03
-1.720	1.433E-02	-1.790E+02	1.849E-06	9.000F-03
-1.700	1.572E-02	-1.790E+02	2.223E-06	9.000F-03
-1.680	1.723E-02	-1.789E+02	2.673E-06	9.000F-03
-1.660	1.890E-02	-1.789E+02	3.214E-06	9.000F-03
-1.640	2.072E-02	-1.788E+02	3.864E-06	9.000F-03
-1.620	2.272E-02	-1.777E+02	4.645E-06	9.000F-03
-1.600	2.491E-02	-1.777E+02	5.585E-06	9.000F-03
-1.580	2.731E-02	-1.786E+02	6.714E-06	9.000F-03
-1.560	2.995E-02	-1.786E+02	8.072E-06	9.000F-03
-1.540	3.284E-02	-1.785E+02	9.705E-06	9.000F-03
-1.520	3.601E-02	-1.784E+02	1.167E-05	9.000F-03
-1.500	3.948E-02	-1.784E+02	1.403E-05	9.000F-03
-1.480	4.329E-02	-1.783E+02	1.687E-05	9.000F-03
-1.460	4.747E-02	-1.782E+02	2.028E-05	9.000F-03
-1.440	5.205E-02	-1.781E+02	2.438E-05	9.000F-03
-1.420	5.707E-02	-1.780E+02	2.931E-05	9.000F-03
-1.400	6.257E-02	-1.779E+02	3.524E-05	9.000F-03
-1.380	6.861E-02	-1.778E+02	4.237E-05	9.000F-03
-1.360	7.523E-02	-1.777E+02	5.094E-05	9.000F-03
-1.340	8.248E-02	-1.776E+02	6.124E-05	9.000F-03
-1.320	9.045E-02	-1.775E+02	7.363E-05	9.000F-03
-1.300	9.918E-02	-1.774E+02	8.853E-05	9.000F-03
-1.280	1.087E-01	-1.773E+02	1.064E-04	9.000F-03
-1.260	1.192E-01	-1.771E+02	1.280E-04	9.000F-03
-1.240	1.307E-01	-1.770E+02	1.539E-04	9.000F-03
-1.220	1.434E-01	-1.769E+02	1.850E-04	9.000F-03
-1.200	1.572E-01	-1.767E+02	2.224E-04	9.000F-03
-1.180	1.724E-01	-1.766E+02	2.674E-04	9.000F-03
-1.160	1.890E-01	-1.764E+02	3.215E-04	9.000F-03
-1.140	2.072E-01	-1.762E+02	3.865E-04	9.000F-03
-1.120	2.272E-01	-1.760E+02	4.647E-04	9.000F-03
-1.100	2.492E-01	-1.759E+02	5.588E-04	9.000F-03
-1.080	2.732E-01	-1.757E+02	6.718E-04	9.000F-03
-1.060	2.996E-01	-1.755E+02	8.078E-04	9.000F-03
-1.040	3.285E-01	-1.752E+02	9.712E-04	9.000F-03
-1.020	3.602E-01	-1.750E+02	1.168E-03	9.000F-03

-1.000	3.950E-01	-1.748E+02	1.604E-03	9.550F-03
-0.980	4.331E-01	-1.745E+02	1.600E-03	8.208F-03
-0.960	4.749E-01	-1.743E+02	1.598E-03	7.486F-03
-0.940	5.208E-01	-1.740E+02	1.592E-03	6.827F-03
-0.920	5.711E-01	-1.737E+02	2.030E-03	6.226F-03
-0.900	6.262E-01	-1.734E+02	2.227E-03	5.679F-03
-0.880	6.867E-01	-1.731E+02	2.442E-03	5.179F-03
-0.860	7.530E-01	-1.728E+02	2.678E-03	4.723F-03
-0.840	8.257E-01	-1.725E+02	2.937E-03	4.308F-03
-0.820	9.054E-01	-1.721E+02	3.221E-03	3.929F-03
-0.800	9.929E-01	-1.718E+02	3.532E-03	3.583F-03
-0.780	1.089E+00	-1.714E+02	3.874E-03	3.268F-03
-0.760	1.194E+00	-1.710E+02	4.249E-03	2.980F-03
-0.740	1.309E+00	-1.705E+02	4.660E-03	2.718F-03
-0.720	1.436E+00	-1.701E+02	5.111E-03	2.479F-03
-0.700	1.575E+00	-1.696E+02	5.606E-03	2.261F-03
-0.680	1.727E+00	-1.692E+02	6.150E-03	2.062F-03
-0.660	1.894E+00	-1.687E+02	6.746E-03	1.880F-03
-0.640	2.077E+00	-1.681E+02	7.400E-03	1.715F-03
-0.620	2.278E+00	-1.676E+02	8.118E-03	1.564F-03
-0.600	2.499E+00	-1.670E+02	8.906E-03	1.426F-03
-0.580	2.741E+00	-1.664E+02	9.771E-03	1.301F-03
-0.560	3.006E+00	-1.658E+02	1.072E-02	1.186F-03
-0.540	3.297E+00	-1.651E+02	1.176F-02	1.082F-03
-0.520	3.617E+00	-1.644E+02	1.291E-02	9.868F-04
-0.500	3.967E+00	-1.637E+02	1.416E-02	9.000F-04
-0.480	4.352E+00	-1.630E+02	1.554E-02	8.208F-04
-0.460	4.774E+00	-1.622E+02	1.706E-02	7.486F-04
-0.440	5.237E+00	-1.614E+02	1.873E-02	6.827F-04
-0.420	5.744E+00	-1.605E+02	2.056E-02	6.226F-04
-0.400	6.304E+00	-1.597E+02	2.257E-02	5.679F-04
-0.380	6.916F+01	-1.588E+02	2.477E-02	5.179F-04
-0.360	7.589E+00	-1.578E+02	2.720E-02	4.723F-04
-0.340	8.327E+00	-1.569E+02	2.987E-02	4.308F-04
-0.320	9.137E+00	-1.559E+02	3.280E-02	3.929F-04
-0.300	1.003E+01	-1.549E+02	3.601E-02	3.583F-04
-0.280	1.100E+01	-1.539E+02	3.953E-02	3.268F-04
-0.260	1.206E+01	-1.529E+02	4.337E-02	2.980F-04
-0.240	1.322E+01	-1.519E+02	4.752E-02	2.718F-04
-0.220	1.447E+01	-1.510E+02	5.193E-02	2.479F-04
-0.200	1.590E+01	-1.501E+02	5.646E-02	2.261F-04
-0.180	1.717E+01	-1.493E+02	6.081E-02	2.062F-04
-0.160	1.853E+01	-1.484E+02	6.459E-02	1.880F-04
-0.140	1.945E+01	-1.472E+02	6.754E-02	1.715F-04
-0.120	2.112E+01	-1.454E+02	6.979E-02	1.564F-04
-0.100	2.241E+01	-1.430E+02	7.164E-02	1.426F-04
-0.080	2.374E+01	-1.399E+02	7.334E-02	1.301F-04
-0.060	2.521E+01	-1.359E+02	7.538E-02	1.186F-04
-0.040	2.705E+01	-1.307E+02	7.910E-02	1.082F-04
-0.020	2.973E+01	-1.247E+02	8.724E-02	9.868F-05

3.363E+01	-1.190E+02	1.018E-01	9.000F-05
3.872E+01	-1.143E+02	1.231E-01	8.208F-05
4.469E+01	-1.109E+02	1.495E-01	7.486F-05
5.126E+01	-1.080E+02	1.794E-01	6.827F-05
5.844E+01	-1.055E+02	2.119E-01	6.226F-05
6.598E+01	-1.030E+02	2.472E-01	5.679F-05
7.429E+01	-1.004E+02	2.858E-01	5.179F-05
8.341E+01	-9.773E+01	3.286E-01	4.723F-05
9.351E+01	-9.446E+01	3.766E-01	4.308F-05
1.048E+02	-9.183E+01	4.312E-01	3.929F-05
1.174E+02	-8.863E+01	4.931E-01	3.583F-05
1.317E+02	-8.528E+01	5.655E-01	3.268F-05
1.478E+02	-8.180E+01	6.514E-01	2.980F-05
1.663E+02	-7.818E+01	7.513E-01	2.718F-05
1.873E+02	-7.447E+01	8.699E-01	2.479F-05
2.116E+02	-7.067E+01	1.012E+00	2.261E-05
2.395E+02	-6.683E+01	1.183E+00	2.062F-05
2.720E+02	-6.297E+01	1.391E+00	1.880F-05
3.097E+02	-5.916E+01	1.645E+00	1.715F-05
3.539E+02	-5.547E+01	1.958E+00	1.567E-05
4.055E+02	-5.197E+01	2.345E+00	1.426F-05
4.657E+02	-4.879E+01	2.822E+00	1.301F-05
5.356E+02	-4.606E+01	3.404E+00	1.186F-05
6.153E+02	-4.395E+01	4.096E+00	1.082F-05
7.072F+02	-4.263E+01	4.880E+00	9.868F-06
7.945E+02	-4.219E+01	5.881E+00	9.000F-06
8.796E+02	-4.261E+01	6.351E+00	8.208F-06
9.455E+02	-4.356E+01	6.692E+00	7.486F-06
9.802E+02	-4.441E+01	6.559E+00	6.827F-06
9.806E+02	-4.439E+01	5.988F+00	6.226F-06
9.536E+02	-4.290E+01	5.167E+00	5.679F-06
9.100E+02	-3.967E+01	4.289E+00	5.179F-06
8.590E+02	-3.480E+01	3.485E+00	4.723F-06
8.060E+02	-2.834E+01	2.799E+00	4.308F-06
7.541E+02	-2.054E+01	2.234E+00	3.929F-06
7.044E+02	-1.150E+01	1.778E+00	3.583F-06
6.572E+02	-1.354E+00	1.412E+00	3.268F-06
6.124E+02	9.780E+00	1.118E+00	2.980F-06
5.685E+02	2.181E+01	8.817E-01	2.718F-06
5.283F+02	3.465E+01	6.919E-01	2.479F-06
4.883E+02	4.822E+01	5.391E-01	2.261F-06
4.493E+02	6.240E+01	4.161E-01	2.062F-06
4.109E+02	7.709E+01	3.175E-01	1.880F-06
3.733E+02	9.210E+01	2.390E-01	1.715F-06
3.365E+02	1.072E+02	1.773E-01	1.564F-06
3.015E+02	1.220E+02	1.296E-01	1.426F-06
2.688E+02	1.360E+02	9.400E-02	1.301F-06
2.406E+02	1.486E+02	6.870E-02	1.186F-06
2.199E+02	1.594E+02	5.232E-02	1.082F-06
2.103E+02	1.687E+02	4.363E-02	9.868F-07

1.000	2.143E+02	1.780E+02	4.133E-02	9.000F-07
1.020	2.311E+02	-1.1705E+02	4.303F-02	8.208F-07
1.040	2.558E+02	-1.555E+02	4.898E-02	7.486F-07
1.060	2.815E+02	-1.1367E+02	5.411E-02	6.827F-07
1.080	3.010E+02	-1.142E+02	5.641E-02	6.226F-07
1.100	3.080E+02	-8.789E+01	5.387E-02	5.679F-07
1.120	2.990E+02	-5.744E+01	4.631E-02	5.179F-07
1.140	2.747E+02	-2.176E+01	3.565F-02	4.723F-07
1.160	2.414E+02	2.087E+01	2.511E-02	4.308F-07
1.180	2.115E+02	7.244E+01	1.758E-02	3.929F-07
1.200	2.014E+02	1.327E+02	1.454F-02	3.583F-07
1.220	2.207E+02	-1.637E+02	1.592E-02	3.268F-07
1.240	2.634E+02	-1.021E+02	2.070E-02	2.980F-07
1.260	3.184E+02	-4.233E+01	2.755F-02	2.718F-07
1.280	3.770E+02	1.724E+01	3.524E-02	2.479F-07
1.300	4.350E+02	7.810E+01	4.278E-02	2.261F-07
1.320	4.900E+02	1.412E+02	4.950E-02	2.062F-07
1.340	5.404E+02	-1.530E+02	5.499F-02	1.880F-07
1.360	5.866E+02	-8.411E+01	5.901E-02	1.715F-07
1.380	6.270E+02	-1.176E+01	6.149F-02	1.564F-07
1.400	6.617E+02	6.425E+01	6.246F-02	1.426F-07
1.420	6.902E+02	1.441E+02	6.198E-02	1.301F-07
1.440	7.122E+02	-1.319E+02	6.018E-02	1.186F-07
1.460	7.272E+02	-4.356E+01	5.723E-02	1.082F-07
1.480	7.349E+02	4.935E+01	5.329E-02	9.868F-08
1.500	7.349E+02	1.471E+02	4.861E-02	9.000F-08
1.520	7.275E+02	-1.098E+02	4.344E-02	8.208F-08
1.540	7.134E+02	-1.183E+00	3.810E-02	7.486F-08
1.560	6.944E+02	1.136E+02	3.295E-02	6.827F-08
1.580	6.758E+02	-1.136E+02	2.843E-02	6.226F-08
1.600	6.630E+02	3.365E+00	2.496E-02	5.679F-08
1.620	6.449F+02	1.387E+02	2.289E-02	5.179F-08
1.640	6.484E+02	-7.944E+01	2.239E-02	4.723F-08
1.660	7.347E+02	6.785E+01	2.325E-02	4.308F-08
1.680	7.947E+02	-1.399E+02	2.487E-02	3.929F-08
1.700	8.548E+02	1.737E+01	2.630E-02	3.583F-08
1.720	9.020E+02	-1.795E+02	2.659E-02	3.268F-08
1.740	9.197E+02	-9.421E+00	2.521E-02	2.980F-08
1.760	9.055E+02	1.687E+02	2.229E-02	2.718F-08
1.780	8.626E+02	-4.120E+00	1.844E-02	2.479F-08
1.800	7.990E+02	-1.669E+02	1.443E-02	2.261F-08
1.820	7.245E+02	4.100E+01	1.082E-02	2.062F-08
1.840	6.475E+02	-9.964E+01	7.884E-03	1.880F-08
1.860	5.745E+02	1.315E+02	5.659E-03	1.715F-08
1.880	5.090E+02	1.501E+01	4.052F-03	1.564F-08
1.900	4.527E+02	-8.884E+01	2.923E-03	1.426F-08
1.920	4.053E+02	-1.798E+02	2.137E-03	1.301F-08
1.940	3.657E+02	1.025E+02	1.586E-03	1.186F-08
1.960	3.320E+02	3.836E+01	1.193E-03	1.082F-08
1.980	3.027E+02	-1.170E+01	9.041E-04	9.868F-09
2.000	2.762E+02	-4.708E+01	6.866E-04	9.000F-09

THE MEAN SQUARE RESPONSE OF COORDINATE 17 OVER THE RESPONSE SPECTRUM = 1.411E+01

07/26/74 DS SCOPE 3.3 CYC N. 10/27/71

04.03.19.WCASMKM
04.03.19.IP 00003 INPUT UNITS USED.
04.03.19.SSEQUENCE.CAS.
04.03.19.
04.03.19.SCHARGE.S7910 -010.
04.03.19.
04.03.19.JOB.CH20000.T200.I0500.P2.TP1.
04.03.19.
04.03.19.COPYM.INPUT.TAPES.
04.03.20.FILE OPENED - TAPES
04.03.20.REVIND.TAPES.
04.03.21.COPYSOFTAPES.OUTPUT.
04.03.21.FILE OPENED - OUTPUT
04.03.22.REVIND.TAPES.
04.03.23.ATTACH.LGO.DYNA20.PM=0---0.
04.03.25.CYCLF ** DYNA2R
04.03.25.PFN FOUND IN SO 024
04.03.25.CYCLE 01. DYNA2B
04.03.25.FILE HAS BEEN ATTACHED
04.03.25.REQ:ST.TAPES. (PLOT.RING)
04.03.25.XPAUSE. PLOT 10/579100P-010/KHL/SCHWEIMH
04.03.25.ART
04.03.26.CH 20000 CM CELLS USED.
04.03.26.CP 00000.025 CP SEC. USED.
04.03.26.I0 00001.000 I0 SEC. USED.
04.03.26.SS 00000.925 SYSTEM SEC. USED.
04.04.23.GO.
04.04.23.XPAUSE. DELIVER TO DOT 10TH FLOOR
04.04.30.GO.
04.04.30.CH 000300 CM CELLS USED.
04.04.30.CP 00000.099 CP SEC. USED.
04.04.30.I0 00002.400 I0 SEC. USED.
04.04.30.SS 00000.999 SYSTEM SEC. USED.
04.04.38.SET.0.
04.04.38.LOAD.LGO.
04.04.46.FILE OPENED - TEMP
04.05.14.MOGO.
04.05.14.TEMP.
04.05.20.FILE OPENED - TAPE11
04.05.21.FILE OPENED - TAPE10
04.05.31.FILE OPENED - TAPE12
04.06.05.MT 42 ASSIGNED TO TAPES
04.06.49.VSNPLOT
04.06.54.MT 42 VISUAL REEL NUMBER IS 00PLOT
04.07.00.SMT 42 WRT RVD
04.07.00.SMT 42 PRU = 00000014
04.07.19.PP CALL ERROR
04.07.19.EXIT.
04.07.20.MT 42 BLOCKS WRITTEN--000091
04.07.21.IP 00003 STORAGE DATA BLOCKS ON FILE INPUT
04.07.21.OP 000134 STORAGE DATA BLOCKS ON FILE OUTPUT
04.07.21.CM 200000 CM CELLS USED.
04.07.21.CP 000026.720 CP SEC. USED.
04.07.21.I0 000071.556 I0 SEC. USED.
04.07.21.SS 000062.204 SYSTEM SEC. USED.
04.07.21.AC - FND OF JOB.

- APPENDIX B -
REPORT OF INVENTIONS

In accordance with the patent rights clause of the terms and conditions of this contract, and after a comprehensive review of the work performed, it was found that no new inventions, discoveries, or improvements of inventions were made.