

REPORT NO. FRA-OR&D-76-248

# PERFORMANCE ANALYSES OF INTERCITY GROUND PASSENGER TRANSPORTATION SYSTEMS

John S. Hitz

U.S. DEPARTMENT OF TRANSPORTATION  
Transportation Systems Center  
Kendall Square  
Cambridge MA 02142



APRIL 1976

FINAL REPORT

DOCUMENT IS AVAILABLE TO THE PUBLIC  
THROUGH THE NATIONAL TECHNICAL  
INFORMATION SERVICE, SPRINGFIELD,  
VIRGINIA 22161

Prepared for  
U.S. DEPARTMENT OF TRANSPORTATION  
FEDERAL RAILROAD ADMINISTRATION  
Research and Development  
Washington DC 20590

**NOTICE**

This document is disseminated under the sponsorship of the Department of Transportation in the interest of information exchange. The United States Government assumes no liability for its contents or use thereof.

1. Report No. FRA-OR&D-76-248		2. Government Accession No.		3. Recipient's Catalog No.	
4. Title and Subtitle PERFORMANCE ANALYSES OF INTERCITY GROUND PASSENGER TRANSPORTATION SYSTEMS				5. Report Date April 1976	
				6. Performing Organization Code	
7. Author(s) John S. Hitz				8. Performing Organization Report No. DOT-TSC-FRA-75-25	
9. Performing Organization Name and Address U.S. Department of Transportation Transportation Systems Center Kendall Square Cambridge MA 02142				10. Work Unit No. (TRAIS) RR518/R6349	
				11. Contract or Grant No.	
12. Sponsoring Agency Name and Address U.S. Department of Transportation Federal Railroad Administration Research and Development Washington DC 20590				13. Type of Report and Period Covered Final Report July 1974 - June 1975	
				14. Sponsoring Agency Code	
15. Supplementary Notes					
16. Abstract <p>This report documents the development of analytical techniques and their use for investigating the performance of intercity ground passenger transportation systems. The purpose of the study is twofold: (1) to provide a capability of evaluating new passenger train systems and (2) to provide information that assists in the formulation of development policies for new systems, thus, investigations evaluate the physical performance (average velocity, system capacity, mode split) of train systems with various design characteristics operating in a range of application conditions. Based on these analyses, conclusions are made regarding the potential performance effectiveness of train systems. The analyses cover design cruise speed, acceleration and braking rates, train length, seat density and lateral acceleration limits. Application characteristics considered include station spacing, dwell time, curve length, spacing and speed, switch concepts and train control strategies.</p>					
17. Key Words Intercity Ground Transportation Systems Transportation Performance Analyses Transportation Demand Analyses			18. Distribution Statement  DOCUMENT IS AVAILABLE TO THE PUBLIC THROUGH THE NATIONAL TECHNICAL INFORMATION SERVICE, SPRINGFIELD, VIRGINIA 22161		
19. Security Classif. (of this report) Unclassified		20. Security Classif. (of this page) Unclassified		21. No. of Pages 192	22. Price

625.4  
H63 p

## PREFACE

This study investigates the physical performance of intercity ground passenger transportation systems. The work was performed during fiscal year 1975 for the Federal Railroad Administration (FRA), Office of Research and Development, Advanced Systems Division. The study was performed for two primary purposes: (1) to provide a capability for evaluating new passenger train systems, and (2) to assist in the formulation of new systems development policy.

The project was divided into three task areas. These were the development of supply and demand analysis techniques (tasks 1 and 2) and their use in analyzing passenger train system performance (task 3). The supply model was developed within the Ground Systems Division at TSC for the computation of train system performance in terms of average velocity and system capacity, given input parameters describing train system design and the application in which it operates. The demand modeling techniques were developed to permit estimates of train system demand based on the system's level of service attributes, time, cost and frequency of service. The demand models were developed within the Research Division of TSC. This report summarizes the development of the analysis techniques (supply and demand models) and concentrates on describing their use in evaluating the performance of train systems (task 3). The analyses of system performance were conducted within the Ground Systems Division, at TSC.

The author expresses his appreciation to Mr. Steven E. Shladover and Mr. William F. Rooney of TSC for their efforts in developing the supply and demand models which provided the analytical foundation for this study.



# METRIC CONVERSION FACTORS

## Approximate Conversions to Metric Measures

Symbol	When You Know	Multiply by	To Find	Symbol
<b>LENGTH</b>				
in	inches	2.5	centimeters	cm
ft	feet	30	centimeters	cm
yd	yards	0.9	meters	m
mi	miles	1.6	kilometers	km
<b>AREA</b>				
in <sup>2</sup>	square inches	6.5	square centimeters	cm <sup>2</sup>
ft <sup>2</sup>	square feet	0.09	square meters	m <sup>2</sup>
yd <sup>2</sup>	square yards	0.8	square meters	m <sup>2</sup>
mi <sup>2</sup>	square miles	2.6	square kilometers	km <sup>2</sup>
	acres	0.4	hectares	ha
<b>MASS (weight)</b>				
oz	ounces	28	grams	g
lb	pounds	0.45	kilograms	kg
	short tons (2000 lb)	0.9	tonnes	t
<b>VOLUME</b>				
tsp	teaspoons	5	milliliters	ml
Tbsp	tablespoons	15	milliliters	ml
fl oz	fluid ounces	30	milliliters	ml
c	cups	0.24	liters	l
pt	pints	0.47	liters	l
qt	quarts	0.95	liters	l
gal	gallons	3.8	liters	l
ft <sup>3</sup>	cubic feet	0.03	cubic meters	m <sup>3</sup>
yd <sup>3</sup>	cubic yards	0.76	cubic meters	m <sup>3</sup>
<b>TEMPERATURE (exact)</b>				
°F	Fahrenheit temperature	5/9 (after subtracting 32)	Celsius temperature	°C

## Approximate Conversions from Metric Measures

Symbol	When You Know	Multiply by	To Find	Symbol
<b>LENGTH</b>				
mm	millimeters	0.04	inches	in
cm	centimeters	0.4	inches	in
m	meters	3.3	feet	ft
m	meters	1.1	yards	yd
km	kilometers	0.6	miles	mi
<b>AREA</b>				
cm <sup>2</sup>	square centimeters	0.16	square inches	in <sup>2</sup>
m <sup>2</sup>	square meters	1.2	square yards	yd <sup>2</sup>
km <sup>2</sup>	square kilometers	0.4	square miles	mi <sup>2</sup>
ha	hectares (10,000 m <sup>2</sup> )	2.5	acres	
<b>MASS (weight)</b>				
g	grams	0.035	ounces	oz
kg	kilograms	2.2	pounds	lb
t	tonnes (1000 kg)	1.1	short tons	
<b>VOLUME</b>				
ml	milliliters	0.03	fluid ounces	fl oz
l	liters	2.1	pints	pt
l	liters	1.06	quarts	qt
l	liters	0.26	gallons	gal
m <sup>3</sup>	cubic meters	35	cubic feet	ft <sup>3</sup>
m <sup>3</sup>	cubic meters	1.3	cubic yards	yd <sup>3</sup>
<b>TEMPERATURE (exact)</b>				
°C	Celsius temperature	9/5 (then add 32)	Fahrenheit temperature	°F

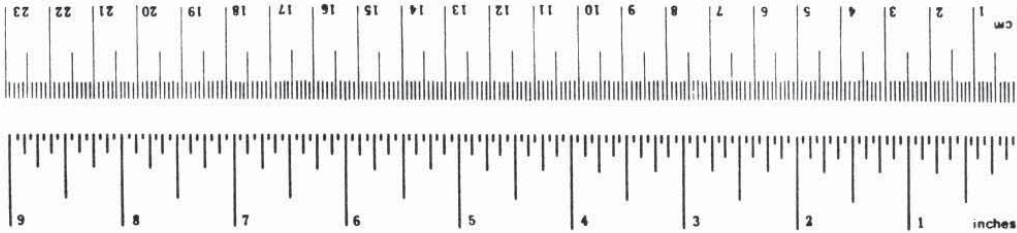

## TABLE OF CONTENTS

<u>Section</u>	<u>Page</u>
1. INTRODUCTION.....	1
1.1 Purpose and Background.....	1
1.2 General Description of Analyses.....	1
1.3 Content of Report.....	4
1.4 Study Conclusions and Recommendations.....	5
1.4.1 Conclusions.....	5
1.4.2 Recommendations.....	8
2. PARAMETRIC ANALYSES OF TRAIN PERFORMANCE.....	9
2.1 General Description of Train Supply Models.....	9
2.1.1 Assumptions and Limiting Features of the Supply Model.....	9
2.1.2 Velocity Model.....	15
2.1.3 Capacity Model.....	16
2.2 Analyses of Average Velocity Versus Train Design Cruise Speed.....	20
2.2.1 Station Operations, Station Spacing.....	23
2.2.2 Station Operations, Dwell Time.....	23
2.2.3 Station Operations, On/Off-Line Stations.....	26
2.2.4 Curve Operations, Curve Speed.....	27
2.2.5 Curve Operations, Curve Frequency.....	27
2.2.6 Curve Operations, Curve Length.....	30
2.2.7 Curve Operations, Combinations of Curves.....	32
2.2.8 Acceleration and Braking Rates, Factors Influencing Rate Limits.....	36
2.2.9 Acceleration and Braking Rate, Station Operations.....	37
2.2.10 Acceleration and Braking Rate, Curve Operations.....	39
2.3 Analyses of System Capacity Versus Train Design Cruise Speed.....	42
2.3.1 General.....	42

## TABLE OF CONTENTS (CONT.)

<u>Section</u>	<u>Page</u>
2.3.2 Station Operations, On-Line.....	48
2.3.3 Station Operations, Off-Line.....	55
2.3.4 Curve Operations.....	69
2.3.5 Acceleration and Braking Rates, Station and Curve Operations.....	74
2.4 Summary of Results, Parametric Sensitivity Analyses of Train Performance.....	77
2.5 Performance Evaluation Criteria for Train Systems.....	83
2.5.1 Development of Velocity Ratio Criterion for Average Velocity Performance.....	83
2.5.2 Application of Velocity Ratio Criterion.....	88
2.5.3 Limits of Capacity Performance.....	95
3. DEMAND ANALYSES.....	99
3.1 Background.....	99
3.2 General Description of Demand Analyses.....	99
3.2.1 Demand Models, Data Acquisition & Review of Corridors.....	99
3.2.2 Demand Analysis Methodology.....	102
3.3. Development and Use of Total Trip Model.....	105
3.3.1 Development of Model.....	105
3.3.2 Use of Total Trip Model.....	110
3.4 Selection, Characteristics and Use of the Mode Split Model.....	110
3.4.1 Selection of Mode Split Model, CN22... ..	110
3.4.2 Characteristics of Mode Split Model... ..	113
3.4.3 Use of the Mode Split Model.....	116
4. PRELIMINARY APPLICATIONS OF ANALYSIS TECHNIQUES.....	119
4.1 General Description of Approach.....	119
4.2 Supply Performance Analyses.....	120
4.2.1 Analysis of Route Alignments.....	120
4.2.2 Average Velocity Performance Versus Route Alignment.....	128

## TABLE OF CONTENTS (CONT.)

<u>Section</u>	<u>Page</u>
4.3 Applications of Demand Analysis Technique...	136
4.3.1 Modal Data.....	136
4.3.2 Results of Demand Analyses.....	139
4.4 Combined Demand-Performance Analyses.....	146
4.4.1 Results of Combined Analyses.....	146
4.4.2 Demand-Performance Evaluation Criteria - Economic Considerations...	154
4.4.3 System Capacity Limits for Actual Applications.....	157
5. CONCLUSIONS AND RECOMMENDATIONS.....	162
5.1 Conclusions.....	162
5.2 Parametric Analyses of Train Performance....	162
5.2.1 General Description of Train Supply Model.....	162
5.2.2 Analyses of Average Velocity Versus Train Design Cruise Speed.....	162
5.2.3 Analyses of System Capacity Versus Train Design Cruise Speed.....	163
5.2.4 Performance Evaluation Criteria for Train Systems.....	165
5.3 Demand Analyses - Characteristics of the Mode Split Model.....	166
5.4 Preliminary Applications of Analysis Techniques.....	166
5.4.1 Supply Performance.....	166
5.4.2 Applications of Demand Analysis Technique.....	168
5.4.3 Combined Demand-Performance Analyses.....	168
5.5 Recommendations.....	169
6. REFERENCES.....	171



## LIST OF ILLUSTRATIONS

<u>Figure</u>		<u>Page</u>
1-1.	Basic Analytical Approach.....	2
2-1.	Supply Model Structure.....	10
2-2.	Velocity Program Flowchart.....	17
2-3.	Capacity Program Flowchart.....	19
2-4.	Velocity-Distance Relationship.....	22
2-5.	Average Velocity Vs. Design Cruise Speed for Various Station Spacings.....	24
2-6.	Average Velocity Vs. Design Cruise Speed For Various Dwell Times and Station Spacing.....	25
2-7.	Average Velocity Vs. Design Cruise Speed for Various Curve Speeds.....	28
2-8.	Average Velocity Vs. Design Cruise Speed for Various Curve Frequencies and Speeds.....	29
2-9.	Average Velocity Vs. Design Cruise Speed for Various Curve Lengths and Speeds.....	31
2-10.	Average Velocity Vs. Design Cruise Speed for Various Combinations of Curve Speed, Length and Frequency...	33
2-11.	Average Velocity Vs. Design Cruise Speed for Various Combinations of Curve Frequency Speed.....	34
2-12.	Average Velocity Vs. Design Cruise Speed for Various Acceleration Rates, Station Spacings and Dwell Times.....	38
2-13.	Average Velocity Vs. Design Cruise Speed for Various Acceleration Rates, Curve Speeds and Frequencies.....	40
2-14.	Velocity-Distance Relationship for Various Acceleration Rates During Curve Operations.....	41
2-15.	Headway Requirements for Cruise Conditions as a Function of Emergency Stopping Distance and Train Length.....	47

## LIST OF ILLUSTRATIONS (CONT.)

<u>Section</u>	<u>Page</u>
2-16.	System Capacity Vs. Design Cruise Speed for Station Operations for Various Train Lengths, L..... 49
2-17.	System Capacity Vs. Design CRuise Speed for Station Operations for Various Train Lengths, L..... 50
2-18.	System Capacity Vs. Design Cruise Speed for Station Operations for Various Train Lengths, L, and Dwells..... 51
2-19.	System Capacity Vs. Design Cruise Speed for Station Operations for Various Dwell Times..... 52
2-20.	Effect of Station Operations on Minimum Headway, Hw..... 54
2-21.	Off-Line Station Concepts..... 56
2-22a.	Distance-Time Profile for Alternating Type Station..... 58
2-22b.	Distance-Time Profile for Stacking Type Station..... 58
2-23.	Effect of Switch Type on Minimum Headway, Hcrit, Between Tains #1 and 2..... 62
2-24.	System Capacity Vs. Design Cruise Speed for Various Types of Switches and Alternating Off-Line Stations..... 66
2-25.	System Capacity Vs. Design Cruise Speed for Various Type of Switches and Stacking Off-Line Stations..... 66
2-26.	Four Conditions for Minimum Headway During Curve Operations..... 70
2-27.	System Capacity Vs. Design Cruise Speed for Various Curve Speeds, Train Length = 500 ft..... 72
2-28.	System Capacity Vs. Design Cruise Speed for Various Curve Speeds, Train Length = 1000 ft..... 72
2-29.	System Capacity Vs. Design Cruise Speed for Various Acceleration Rates Station Operations..... 75

## LIST OF ILLUSTRATIONS (CONT.)

<u>Section</u>	<u>Page</u>
2-30.	System Capacity Vs. Design Cruise Speed for Various Acceleration Rates, Curve Operations..... 76
2-31.	Velocity Ratios for Actual Transportation Systems..... 85
2-32.	Cruise Speed Vs. Station Spacing for 62.5% Velocity Ratio..... 87
2-33.	Design Cruise Speed Vs. Station Spacing and Dwell Time..... 89
2-34.	Design Cruise Speed Vs. Station Spacing and Acceleration Rates..... 89
2-35.	Design Cruise Speed Vs. Curve Spacing and Curve Speed..... 91
2-36.	Design Cruise Speed Vs. Curve Spacing and Acceleration Rates..... 91
2-37.	Design Cruise Speed Vs. 60 MPH Curve Spacing for Various Station Spacings..... 92
2-38.	Design Cruise Speed Vs. 150 MPH Curve Spacing for Various Station Spacings..... 93
2-39.	Design Cruise Speed Vs. 240 MPH Curve Spacing for Various Station Spacings..... 94
2-40.	Design Cruise Speed Vs. Dwell Time for Upper and Lower Limits of Capacity-Cruise Speed Independence, On-Line Stations..... 98
3-1.	Combined Use of Supply and Demand Models..... 101
3-2.	Demand Analysis Process..... 104
3-3.	Mode Split Vs. Train Average Velocity, Northeast Corridor..... 106
3-4.	Mode Split Versus Train Average Velocity for Various Train Fare Levels, Northeast Corridor.... 107
3-5.	Methodology for Combining Outputs of Demand and Performance Analyses..... 108

## LIST OF ILLUSTRATIONS (CONT.)

<u>Figure</u>	<u>Page</u>
3-6.	Demand Model Elasticities Vs. Rail Model Share..... 115
4-1.	Distribution of Curves in the Boston- NY Section of the Northeast Corridor..... 125
4-2.	Distribution of Curves in the NY-Washington Section of the Northeast Corridor..... 125
4-3.	Average Velocity Vs. Design Cruise Speed for Two Sections of the Northeast Corridor, Upgraded to 10 <sup>0</sup> Superelevation..... 126
4-4.	Average Velocity Versus Design Cruise Speed for Various Alignments of the Boston-NY Section..... 130
4-5.	Average Velocity Versus Design Cruise Speed for Various Alignments of the NY-DC Section..... 130
4-6.	Mode Split Versus Design Cruise Speed for Various Route Alignments, Northeast Corridor..... 131
4-7.	Maximum Effective Design Cruise Speed Versus Number of Curves Removed from the Northeast Corridor..... 132
4-8.	Design Cruise Speed Versus Curve Density, Chicago-Detroit Corridor..... 134
4-9.	Design Cruise Speed Versus Curve Density, San Francisco-Sacramento Corridor..... 134
4-10.	Mode Split Versus Train Average Velocity, Chicago-Detroit..... 144
4-11.	Mode Split Versus Train Average Velocity, San Francisco-Sacramento..... 145
4-12.	Mode Split Versus Train Average Velocity for Various Train Fare Levels, Chicago-Detroit..... 147
4-13.	Mode Split Versus Train Average Velocity for Various Train Fare Levels, San Francisco-Sacramento..... 148
4-14.	Average Velocity Versus Design Cruise Speed for Various Alignments of the Northeast Corridor.... 150



LIST OF ILLUSTRATIONS (CONT.)

<u>Figure</u>		<u>Page</u>
4-15.	Mode Split Versus Design Cruise Speed for Various Hypothetical Route Alignment, Chicago-Detroit.....	151
4-16.	Mode Split Versus Design Cruise Speed for Various Hypothetical Route Alignment, San Francisco-Sacramento.....	151
4-17.	Average Velocity Versus Design Cruise Speed for Various 60 MPH Curve Densities, Chicago-Detroit.....	152
4-18.	Average Velocity Versus Design Cruise Speed for Various 60 MPH Curve Densities, San Francisco-Sacramento.....	152
4-19.	Performance Limits Based on Various Economic Considerations.....	156

## LIST OF TABLES

<u>Table</u>	<u>Page</u>
1-1.	AVERAGE VELOCITY SENSITIVITY TO CONSTRAINTS..... 5
1-2.	NUMBER OF 60 MPH CURVES PER 100 MILES WHICH CAN BE TOLERATED TO PERMIT EFFECTIVE APPLICATION OF DESIGN CRUISE SPEED..... 6
2-1.	PARAMETERS CONSIDERED BY THE SUPPLY MODEL..... 11
2-2.	RESULTS OF ACCELERATION PROFILE ANALYSIS ..... 15
2-3.	MAXIMUM ACCELERATION RATE FOR MINIMUM DESIGN THRUST..... 36
2-4.	MINIMUM HEADWAY, $H_{crit}$ , REQUIRED FOR DIFFERENT SWITCHES..... 64
2-5.	EVALUATION OF SWITCH TYPES FOR OFF-LINE STATIONS TO ACHIEVE IMPROVED SYSTEM CAPACITY..... 68
2-6.	SUMMARY OF CONDITIONS FOR MINIMUM DISTANCE BETWEEN TRAINS DURING CURVE OPERATIONS..... 71
2-7.	SUMMARY OF PARAMETRIC SENSITIVITY ANALYSIS RESULTS ON AVERAGE VELOCITY..... 78
2-8.	SUMMARY OF PARAMETRIC SENSITIVITY ANALYSIS RESULTS ON SYSTEM CAPACITY..... 79
2-9.	BASELINE VALUES FOR PARAMETRIC ANALYSES..... 82
2-10.	SUMMARY OF RESULTS MINIMUM CURVE SPACING TO PERMIT DESIGN CRUISE SPEEDS OF 100 200, 300 MPH FOR VARIOUS COMBINATIONS OF STATION SPACINGS AND CURVE SPEEDS, 62.5% VR..... 96
3-1.	CANDIDATE CORRIDORS FOR IMPROVED PASSENGER TRAIN SERVICE..... 103
3-2.	SUMMARY OF RESULTS USING TOTAL TRIP MODEL..... 111
3-3.	SUMMARY OF CALIBRATED VALUES FOR COEFFICIENT $a_o$ ..... 118
4-1.	CURVE CHARACTERISTICS FOR BOSTON TO NEW YORK SECTION OF NEC..... 123

LIST OF TABLES (CONT.)

<u>Table</u>		<u>Page</u>
4-2.	CURVE CHARACTERISTICS FOR NEW YORK TO WASHINGTON SECTION OF NEC.....	124
4-3.	EFFECTS OF CHANGES IN SUPERELEVATION.....	127
4-4.	NUMBER OF CURVES REMOVED TO PERMIT EFFECTIVE UTILIZATION OF DESIGN CRUISE SPEEDS.....	133
4-5.	SUMMARY OF CURVE-SPEED DISTRIBUTION CASES.....	133
4-6.	MAXIMUM NUMBER OF CURVES PERMISSIBLE VERSUS DESIGN CRUISE SPEED CHICAGO-TOLEDO-DETROIT.....	137
4-7.	MAXIMUM NUMBER OF CURVES PERMISSIBLE VERSUS DESIGN CRUISE SPEED SAN FRANCISCO-SACRAMENTO.....	138
4-8.	1974 ACCESS/EGRESS DATA.....	140
4-9.	1974 MODAL CHARACTERISTICS DATA, LINE HAUL AND TOTAL.....	141
4-10.	RESULTS OF SEAT DENSITY SURVEY.....	159
4-11.	RESULTS OF CAPACITY LIMITATION ANALYSIS.....	160

## EXECUTIVE SUMMARY

This report documents the development of analytical techniques and their use for investigating the performance effectiveness of intercity ground passenger transportation systems. The basic approach used in determining train performance effectiveness was to analyze the train-application system as a production process. This approach involved comparing system output indices of physical performance with input indices of train system design characteristics while considering the influence of various application constraints. System performance was measured by the three primary output indices of average velocity, system capacity and mode split. The analyses characterized train systems by design parameters which impact their physical performance; namely, design cruise speed, acceleration and braking capabilities, train length, seat density, and lateral acceleration limits on curves. The application is characterized in terms of the various constraints it presents to the train system; stations, curves, switches and controls. Stations are described by their spacing and dwell times; curves are described by their frequency of occurrence, length and speed.

The major study conclusions and recommendations are summarized below. Descriptions of analyses supporting the conclusions are contained within the main body of the report. The conclusions are arranged in three groups corresponding to the primary ways in which train performance was measured.

### CONCLUSIONS

#### Average Velocity Performance

1. The following general conclusions can be made regarding the performance effectiveness of various speed trains:
  - 100 mph trains will be effective in virtually all applications
  - 200 mph trains will be effective only in applications with relatively long stations spacings and good alignment



- 300 mph trains will generally be ineffective due to typically encountered geographical constraints, urban areas and required station stops.

2. Assuming the remaining curves are upgraded to 10° super-elevation, the following number of curve sections would have to be removed from the existing 400 curve sections in the Northeast Corridor to permit effective utilization of various train design cruise speeds:

<u>Train Design Cruise Speed, mph</u>	<u>Number of Curve Sections to be Removed</u>
100	0
200	150
300	315

3. The average velocity performance of trains with various design cruise speeds is sensitive to changes in typical applications constraints in the following order of severity:

Constraints	Train Design Cruise Speed		
	300 mph	200 mph	100 mph
Station Spacing	1	1	1
Curve Spacing	2	3	4
Curve Speed	3	2	3
Station Dwell	4	4	2
Acceleration Rates	5	5	5
Curve Length	6	6	6

#### System Capacity Performance

1. Based on analyses of actual train volumes, capacity will not be a limiting performance constraint for typical applications.

2. System capacity is independent of train design cruise speed between 30 mph and 300 mph.

3. Because on-line stations will generally limit theoretical system capacity, significant increases in capacity can be achieved by using off-line stations.

4. For off-line stations, low-speed-passive switches are preferred for trains with cruise speeds less than 150 mph. High speed switches are preferred for trains with cruise speeds greater than 150 mph.

### Mode Split Performance

1. The transformation of train design cruise speed into modal share is a function of rapidly diminishing returns, as it represents the accumulation of two negative functions: (a) the decreasing efficiency with which higher cruise speeds are converted to average velocity and (b) the decreasing elasticity of demand to trip time as mode split is increased.

2. An economic goal of maximizing system profits will result in the selection of a train design cruise speed which is less than optimal in terms of maximizing system demand.

3. For corridors with equivalent route alignments (same average velocity), the longer the route the greater the relative demand for train service.

4. The theoretical validity of using a demand model, calibrated for traditional train service, to estimate demand for the same generic mode but with widely different service characteristics is questionable.

### Recommendations for Additional Work

1. Detailed route alignment data for a number of potential applications of improved passenger train service should be obtained. The current study investigated, in practical terms, only the Northeast Corridor (NEC) for which existing alignment data was readily available. The results of applying the analytical techniques described here to a number of actual applications would indicate quite conclusively the maximum effective design characteristics (especially cruise speed) for new or improved systems.

2. A useful analytical complement to the present technique would be an economic model of train performance. The economic model should specifically relate train costs to system design cruise speed. With the results of such a model, economic criteria can be used as an additional means of establishing effective train system performance limits.



# 1. INTRODUCTION

## 1.1 PURPOSE AND BACKGROUND

The development of analysis techniques and investigations described by this report were initiated by FRA for two general purposes: (1) to provide a capability for evaluating new passenger train systems and (2) to provide information to assist in the formulation of policies regarding the development of new systems. The techniques developed can be utilized to evaluate new systems on the basis of their physical performance over a range of potential applications. For a specific application, the extent of route alignment upgrading required to effectively utilize a new train's design characteristics can be determined. Also, the benefits of various subsystem modifications to train systems, in terms of their impact on system performance, can be evaluated.

For the purpose of assisting in the development of new passenger systems, the analysis techniques developed are most useful in providing performance specification guidelines. This can be accomplished by evaluating the performance of proposed systems with alternative design characteristics over a range of anticipated application conditions. The maximum effective train system characteristics for the applications investigated can thus, be determined. Preliminary analyses of this nature have been performed and the results are documented in this report.

## 1.2 GENERAL DESCRIPTION OF ANALYSES

To address the general program objectives cited above, analytical techniques were developed and utilized to assess the performance effectiveness of trains operating in a variety of application conditions. The basic analytical approach used in determining performance effectiveness was to analyze the train-application system as a production function. This approach is generally described in Figure 1-1 and basically involves comparing system output indices of physical performance with input indices of train system design characteristics while considering the influence of various application constraints. The output indices are strictly physical



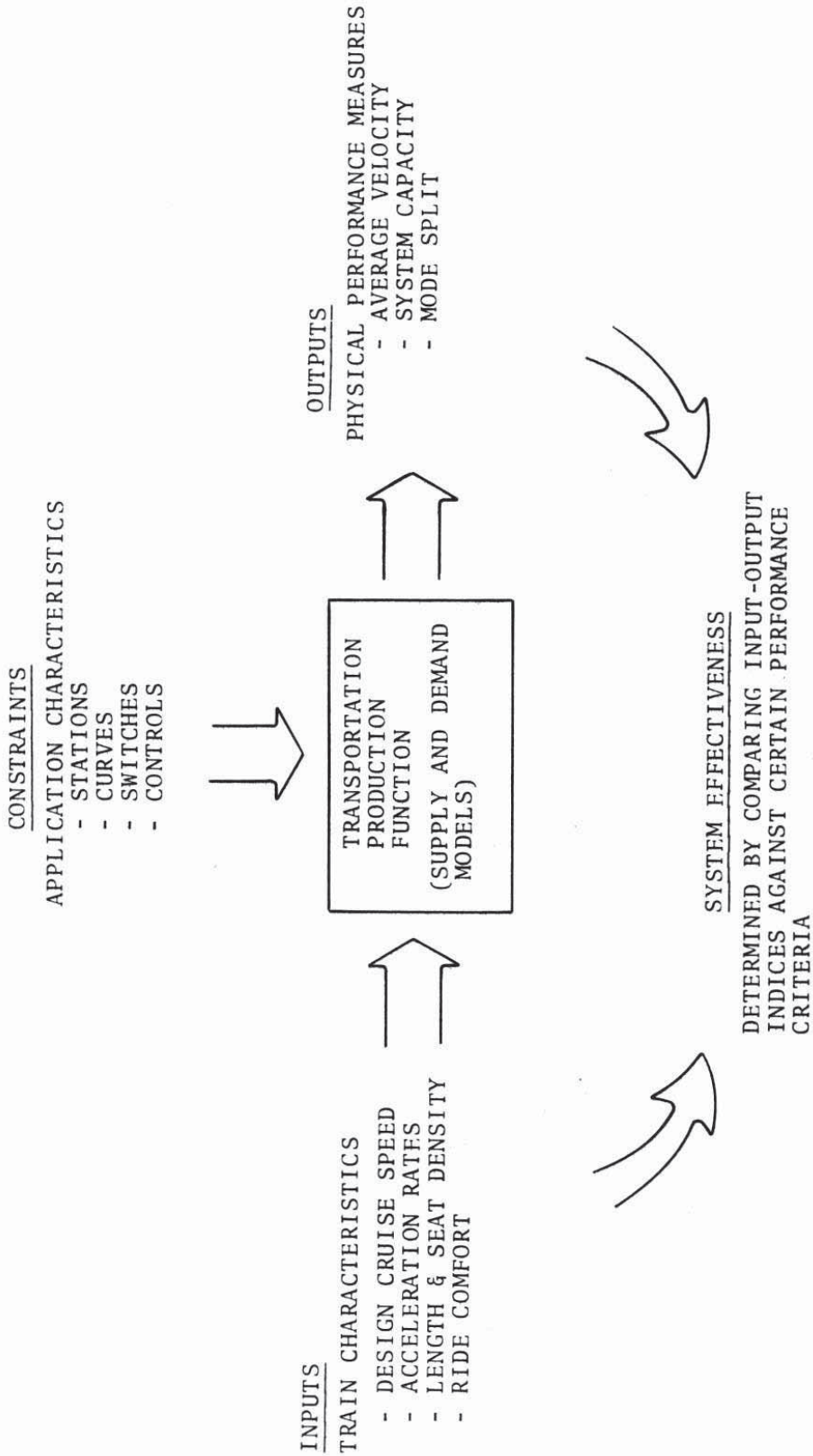

Figure 1-1. Basic Analytical Approach

performance measures (average velocity, system capacity, and mode split); hence, the analysis can be considered noneconomic; i.e., the costs of providing the transportation service investigated were not determined.

The analyses characterized train systems by design parameters which impact their physical performance. These are design cruise speed, acceleration and braking capabilities, train length and seat density, and lateral acceleration limits on curves. The variable of primary concern in the analyses is the train's design cruise speed, as this parameter basically determines alternative technology approaches to the same generic mode (traditional trains, improved trains, TACV, mag-lev, etc.) and thus has the most significant impacts on new system development policy. The application is characterized in terms of the various constraints it presents to the train system; stations, curves, switches and controls. Stations are described by their spacing and dwell times; curves by their frequency of occurrence, length and speed. The impact of various switch types (high and low-speed, active and passive) and control system concepts on system performance effectiveness are also considered.

The performance analyses described above, required the development or acquisition of certain analytical techniques referred to as supply and demand models. The supply models compute the performance of train systems in terms of output indices of average velocity and system capacity, given the input train characteristic parameters of design cruise speed, acceleration and braking rates, train length, and seat density. Based on a survey of existing transportation supply models, it was decided, for several reasons, to develop rather than acquire the necessary models. Existing supply models for analyzing intercity train performance tend to be extremely complex, require excessive computation costs, and concentrate on economic rather than physical measures of performance.<sup>1</sup> The most relevant work reviewed parallels the capacity analyses for stations performed in this study but with specific application to rapid transit systems.<sup>2</sup> Numerous performance models can be found with application to high-density network systems such

as PRT's and railroad freight systems.<sup>3</sup> None of these models had the computational simplicity incorporated into the model described here which enables analyses of train system physical performance to be performed by the manipulation of only a few input parameters. The development and characteristics of the supply models are summarized in Section 2 of this report. A detailed presentation of the model's development and underlying assumptions is presented in another report.<sup>4</sup>

The demand models compute mode split and mode volume on the basis of the train system's level of service characteristics, trip time, fare, and frequency of service. The mode split model used in these analyses, referred to as CN22, was chosen from among a series of models originally developed for use in the Northeast Corridor Study.<sup>5</sup> The characteristics of the demand models and the methodology for their use are summarized in Section 3 of this report.

### 1.3 CONTENT OF REPORT

Section 2 of this report discusses use of the supply models for performing parametric analyses of train system average velocity and capacity performance. The effects of application constraints and train system design on average velocity and capacity performance are analyzed. Criteria are developed and utilized to determine effective performance limits, in terms of design cruise speed, for various combinations of application constraints and train design characteristics. Effective limits of performance are also established on the basis of system capacity considerations.

Section 3 of the report presents a summary of the acquisition and development of the demand models and the various data requirements for their use. Mathematical characteristics of the demand models and their resulting implications on the ability of train systems to attract demand are discussed. Section 3 also describes the methodology developed for using the demand models, in combination with the supply models, in analyzing the performance effectiveness of train systems.

Section 4 of the report describes use of both the supply and demand models, applied to various specific applications, to determine actual train performance. The analyses are basically preliminary and were performed with the primary purpose of demonstrating use of the analysis techniques developed for evaluating actual train applications. The results, in Section 4 establish relationships between the mode split and mode volume generated by train systems as a function of their design characteristics, operating under various application conditions. Based upon these results, meaningful conclusions regarding the performance effectiveness of train systems can be made.

Section 5 of the report includes a summary of the important conclusions and recommendations for additional study resulting from the analyses conducted in the previous sections.

#### 1.4 STUDY CONCLUSIONS AND RECOMMENDATIONS

##### 1.4.1 Conclusions

A concise listing of the conclusions and recommendations basically summarized in Section 5, is presented below.

a) The average velocity performance of trains with various design cruise speeds is sensitive to changes in typical application constraints in the order of severity shown in Table 1-1.

TABLE 1-1. AVERAGE VELOCITY SENSITIVITY TO CONSTRAINTS

Constraints	Train Design Cruise Speed		
	300 mph	200 mph	100 mph
Station Spacing	1	1	1
Curve Spacing	2	3	4
Curve Speed	3	2	3
Station Dwell	4	4	2
Accel. Rates	5	5	5
Curve Length	6	6	6



b) The following general conclusions, based on the results presented in Table 1-2, can be made regarding the performance effectiveness of various speed trains:

- 100 mph trains will be effective in virtually all applications
- 200 mph trains will be effective only in applications with relatively long station spacings and good alignments
- 300 mph trains will be ineffective in most applications

TABLE 1-2. NUMBER OF 60 MPH CURVES PER 100 MILES WHICH CAN BE TOLERATED TO PERMIT EFFECTIVE APPLICATION OF DESIGN CRUISE SPEED

Design Cruise Speed, mph	Station Spacing, miles		
	25	50	100
100	67	100	>100
200	X	7	12
300	X	X	3

X - Ineffective for any curve spacing

- c) The Boston-New York and New York-DC corridors will permit effective train design cruise speeds of 120 mph and 172 mph, respectively, assuming the existing alignment up-graded to a constant 6°-5' superelevation of all curves.
- d) Assuming 10° superelevation for all curves (a significant improvement over the existing situation), the following number of curves would have to be removed from the existing 400 curves in the Northeast Corridor to permit effective design cruise speeds of 300, 200, and 100 mph respectively; 315, 150 and 0.
- e) Curves will generally not be a limiting constraint on system capacity.
- f) On-line stations, due to their dwell times, will generally be the limiting constraint on system capacity.

- g) Because of the large sensitivity of system capacity to on-line station operations, a significant increase in system capacity can be achieved by using off-line stations.
- h) Of the four generic switch types investigated for achieving off-line operations, the following are preferred: low-speed-passive for trains with design cruise speeds generally less than 150 mph, and high-speed-passive for trains with design cruise speeds generally in excess of 150 mph.
- i) Based solely on system capacity considerations, there is no limit to the performance effectiveness of trains with design cruise speeds between 30 mph and 300 mph assuming typical on-line station operations.
- j) Based on an analysis of actual volume for the Northeast Corridor, it does not appear that capacity will be a limiting performance constraint.
- k) The sensitivity of demand to trip time is approximately twice that of trip cost.
- l) The theoretical validity of using a demand model, calibrated for traditional train service, to estimate demand for the same generic mode but with widely different service characteristics is questionable.
- m) For corridors with equivalent route alignments (same average velocity), the longer the route the greater the relative demand for train service.
- n) The relationship between train modal share and train design cruise speed is a function of rapidly diminishing returns, as it represents the accumulation of two negative functions, the cruise speed to average velocity conversion efficiency and the time elasticity to modal share relationship.
- o) An economic goal of maximizing system profits, under the most likely conditions of transportation costs which increase with system design cruise speed, will generally

result in the selection of a train system with a design cruise speed less than that speed above which no additional demand can be generated.

#### 1.4.2 Recommendations

There are two primary study recommendations which constitute logical extensions of the work presented here. These recommendations are formulated to address in more detail the general study objective of developing analytical capabilities to evaluate new passenger train systems and assist in formulating new systems development policy.

- a) Detailed route alignment data for a number of potential applications of improved passenger train service should be obtained. The current study investigated, in practical terms, only the Northeast Corridor for which existing alignment data was readily available. Route alignment data for several other corridors, representative of a range of applications, would provide the basis for a more comprehensive analysis. The results of applying the analytical techniques described here to a number of actual applications would indicate quite conclusively the maximum effective design characteristics (especially cruise speed) for new or improved systems.
- b) A useful analytical complement to the present technique would be an economic model of train performance. The economic model should specifically relate train costs to system design cruise speed. The model should be preliminary, technology independent and capable of producing relative cost comparisons rather than absolute. The model will thus permit estimates to be made of the general shape of the transportation cost versus design cruise speed function described in Section 4.4.2. With the results of such a model, economic criteria can be used as an additional means of establishing effective train system performance limits.

## 2. PARAMETRIC ANALYSES OF TRAIN PERFORMANCE

### 2.1 GENERAL DESCRIPTION OF TRAIN SUPPLY MODELS

To provide the necessary analytical tools for evaluating the performance of train systems, a supply model was developed.<sup>6</sup> The model was designed with the capability to investigate the specific performance measures of system average velocity and system capacity for train systems with different design characteristics and operating under various application conditions. The model permits an evaluation of the impacts of a wide range of parameters on train performance and, together with a demand model, on user demand for system service.

A summary of the basic supply model structure is shown in Figure 2-1 with a detailed list of parameters which it will consider found in Table 2-1. A description of the supply model is given in the following sections together with a summary of results obtained in using the model to perform parametric analyses of train performance.

#### 2.1.1 Assumptions and Limiting Features of the Supply Model

The supply model was developed as two separate models (see Figure 2-1) to address the two basic measures of system performance, average velocity and system capacity. The velocity model considers those factors which affect average velocity; namely, acceleration rates and route obstacles such as stations and curves. The capacity model analyzes those parameters which affect system headway such as station operations, curves, train length, and control system design. The effect of each parameter on average velocity and capacity will be discussed in detail in the next section which covers the parametric analyses.

In developing the two supply models, certain assumptions were made which either limited the accuracy of the results under specific conditions or limited the range of potential conditions which could be investigated by the models. These assumptions and limitations are discussed below.



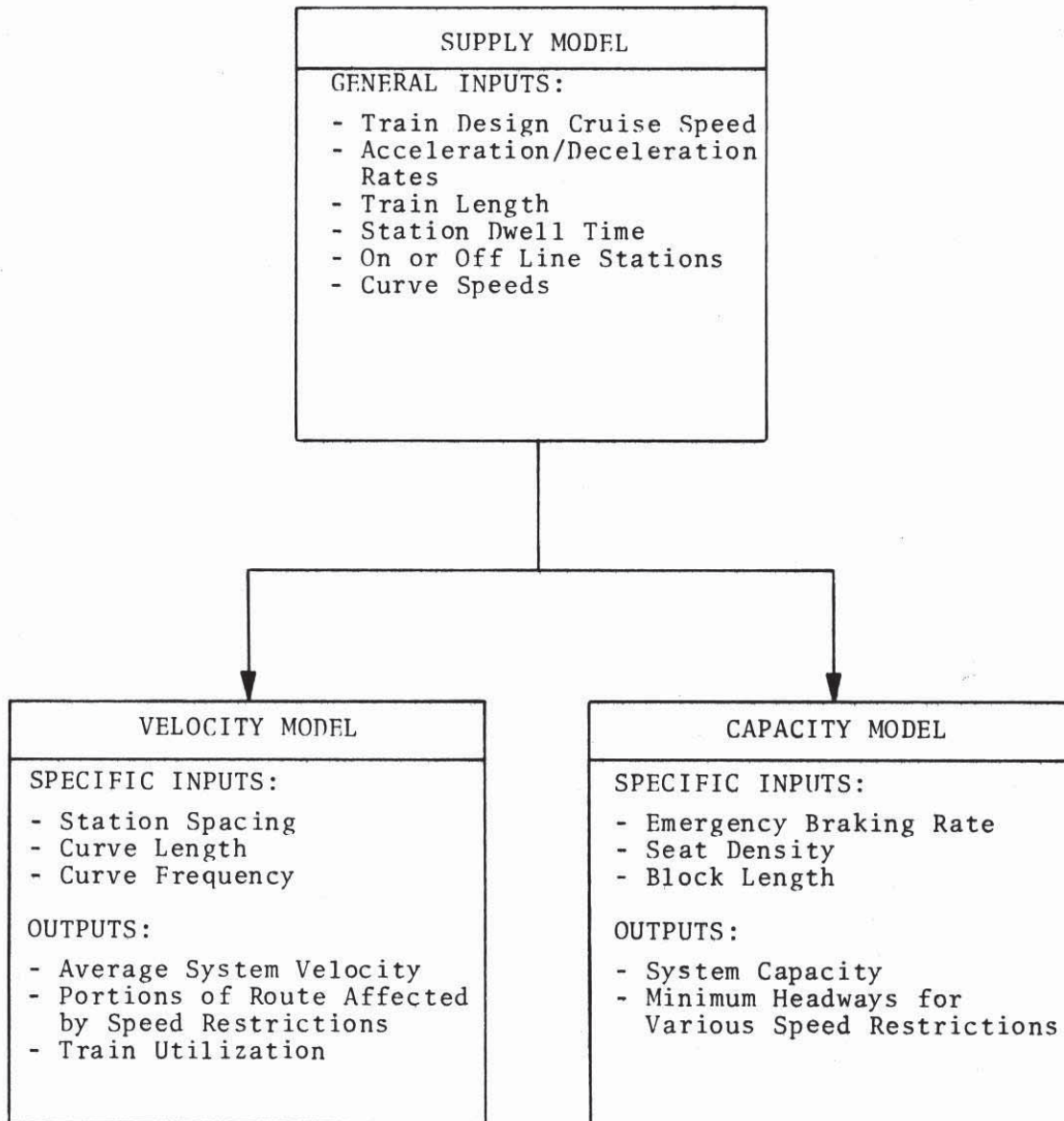

Figure 2-1. Supply Model Structure

TABLE 2-1. PARAMETERS CONSIDERED BY THE SUPPLY MODEL

<p>1. Measures of System Performance</p> <ul style="list-style-type: none"><li>- Average system velocity (alternately measured by trip time or train utilization)</li><li>- System capacity (alternately measured by minimum system headway)</li></ul>
<p>2. Train Characteristics</p> <ul style="list-style-type: none"><li>- Maximum design cruise speed</li><li>- Acceleration rate</li><li>- Braking rate</li><li>- Emergency braking rate</li><li>- Train seat density</li></ul>
<p>3. Application Characteristics</p> <ul style="list-style-type: none"><li>- Station spacing</li><li>- On/off-line stations</li><li>- Curve speed</li><li>- Curve length</li><li>- Curve frequency (distance between curves)</li><li>- Train control characteristics</li><li>- System length</li></ul>
<p>4. Operating Characteristics</p> <ul style="list-style-type: none"><li>- Station dwell time</li><li>- Train length</li></ul>

2.1.1.1 Real Time Versus Aggregate Modeling - Neither the velocity nor the capacity models produce real-time simulations of actual vehicle performance; i.e., the exact location and state of all vehicles in the system is not continuously monitored. To construct such a model, particularly for the capacity determinations, would have been beyond the scope of this project. The capacity program would have been difficult to simulate real-time because route obstacles such as curves, would cause transient interactions among trains down stream of the obstacle; i.e., "a ripple effect." Modeling such a condition would have been extremely difficult and, as will be explained below, would not have contributed greatly to the objectives of the study. An aggregate modeling approach was therefore used to simplify model development in spite of introducing some limitations to usage of the model.

2.1.1.2 Limitations of Aggregate Modeling, Capacity Model - As mentioned above, one of the limitations of the aggregate modeling approach used in the supply model is that it does not allow the continuous monitoring of interactions among individual trains on the guideway. This is not a severe limitation of the model in terms of obtaining practical results, however, because the tendency in a realistic operation would be to eliminate all interferences between trains to prevent degraded performance. For example, visualize a series of separate trains being dispatched from one end of a system at a specific cruise velocity and minimum headway. If the first train encounters a speed restriction on the route such as a station (a realistic necessity) and must slow down or stop, the second train, and the next, and so on, will also have to decelerate at ever increasing distances further back on the guideway to maintain safe critical following distances. The situation becomes worse if the first speed restriction on the guideway is followed by a second and so forth. It becomes apparent that, for the situation described, the system must practically be operated at a lower average velocity so that interactions between trains will not occur and a uniform flow of trains maintained. This does not mean that

the spacing between trains is at all times constant but that the average headway must be sufficiently large so that, for the worst obstacle on the guideway (an on-line station with a long dwell time), no interference will occur.

It should also be considered that it is to the economic advantage of the system operator to match the cruise speed capabilities of the trains with the maximum desired system capacity and speed permitted to avoid interference. If interference is allowed, the operator will be forced to either operate the trains below their cruise speed potential to maintain system capacity (constant headway), or reduce capacity (increase headways) to maintain maximum cruise speed. Assuming that any realistic system would be operated in a manner to eliminate interactions among trains, it does not appear that the aggregate modeling approach used for the capacity supply model is a practical limitation.

2.1.1.3 Limitations of Aggregate Modeling, Velocity Model - The aggregate modeling technique also creates limitations for the velocity model under certain specific conditions. As will be discussed in more detail later, guideway speed restrictions such as curves and stations are inputted to the model in terms of densities; i.e., numbers of curves or stations per mile. If the density of these restrictions and the train's maximum cruise velocity are high enough, the train will never attain maximum design speed between restrictions (before the train accelerates to cruise speed after coming out of one restriction in encounters another). The velocity model, however, is constructed on the assumption that cruise speed is achieved between restrictions. The reason for this feature (independence of restrictions) is to eliminate the complex real-time simulation which would be required to compute average velocities when speed restrictions are so close that cruise speed is never attained. When the velocity model encounters a situation where cruise speed is not achieved because of speed restrictions, the model indicates this fact and provides the necessary data so that a reasonably accurate estimate can be made of the actual average velocity under those conditions.



As is the case with the capacity model and the problem of interactions among trains, the inability of the model to accurately compute situations where speed restrictions impinge on one another is not a practical limitation. For any actual application where there are many speed restrictions, it would appear impractical to operate trains with a cruise capability far in excess of that which can be effectively utilized because of the restrictions; i.e., the system should be tailored so that the cruise speed capability of the train does not exceed the maximum speed permitted by the application. Any combination of speed restrictions which produces a situation where the train cruise speed capability is not attained is, therefore, an unrealistic application of that particular train.

2.1.1.4 Acceleration/Deceleration Profiles - For most practical applications the acceleration (and deceleration) rates will not be constant throughout the operational speed range. Such considerations as propulsion system efficiency, economy of operating costs, aerodynamic and propulsion system drag, and passenger comfort dictate non-linear acceleration profiles. To incorporate within the supply model the capability of simulating non-linear profiles presented several problems. First, the analyses were intended to be independent of detailed technology differences between train systems; however, steel wheel on rail, air cushion and magnetic levitation systems all have significantly different propulsion system and drag characteristics. Second, to consider non-linear acceleration profiles would have greatly increased the complexity of the model as it would have required numerical integration of the equations of motion for the vehicle for every change in velocity. It was, therefore, desirable to use linear profiles if the error in doing so was not significant. An analysis of linear and non-linear approximations to actual non-linear acceleration profiles was performed for various operating conditions to determine the extent of error for the approximate cases. The results of this analysis are summarized in Table 2-2 illustrating the insignificant error introduced when linear profiles are substituted for actual

TABLE 2-2. RESULTS OF ACCELERATION PROFILE ANALYSIS<sup>1</sup>

ACCELERATION PROFILE	AVERAGE SPEED, MPH
ACTUAL <sup>2</sup>	262.1
LINEAR <sup>3</sup>	262.5
EXPONENTIAL	225.9

Notes

1. Average velocity computed over a time period of  $4t$  where  $t$  equals the time to accelerate to speed for the linear profile case.
  - All profiles limited to .1g max acceleration
  - Acceleration was to 300 mph
2. Actual profile computations were based on the performance characteristics of a typical air cushion vehicle.
3. Profile used in supply models.

non-linear acceleration profiles. Based on these results a linear acceleration and braking profile was assumed in the construction of the model. It should be further noted that, although the actual acceleration profile for a real system is non-linear (for the reasons cited above) the deceleration profile (braking) should be nearly linear. This results because, in braking from high speeds (where the non-linearities are most severe during acceleration), the aerodynamic drag will augment the braking system and assist in providing a constant net braking force (during acceleration the propulsion system typically would not provide sufficient thrust to overcome aerodynamic drag and maintain a constant net force).

2.1.2 Velocity Model

The velocity model computes the maximum feasible average velocity which can be attained by a train of given maximum cruise velocity potential operating over a specified guideway system. The average velocity of a system will always be less than the vehicle

maximum cruise velocity because of the following general categories of speed restrictions typically encountered in train applications:

- a) Curves, lateral and vertical
- b) Switches
- c) Grades
- d) Stations

The first three-speed restrictions are all similar from an analytical standpoint because each type involves a slowing down of the train to some specific speed, traveling some distance at that reduced speed and then accelerating back to cruise speed. These three types of restrictions are, therefore, all analyzed as curves even though in reality they may actually be switches or grades. The stations are analyzed as a separate type of speed restriction as they involve not only braking to zero velocity but maintaining a dwell time in the station.

The logical flow of computations involved in the velocity program is described in Figure 2-2. The program computes the effect of stations first and then the effect of curves on average velocity. Station data inputted to the model includes station density (average distance between stops) and station dwell time. Curve data is introduced to the model in the form of two vectors which describe for each curve speed (nine possible curve speeds can be considered simultaneously) the number of times the curve repeats itself per mile of guideway and the average length, in miles, of each curve (the distance the train must maintain the curve speed). The velocity model, then, has the flexibility to evaluate and determine the sensitivity of wide range of application characteristics on average system velocity. With the average velocity of the system specified, travel times and train utilizations can easily be computed for an application of given length.

### 2.1.3 Capacity Model

The capacity model was designed with the objective of computing the maximum feasible system capacity for a given set of train,



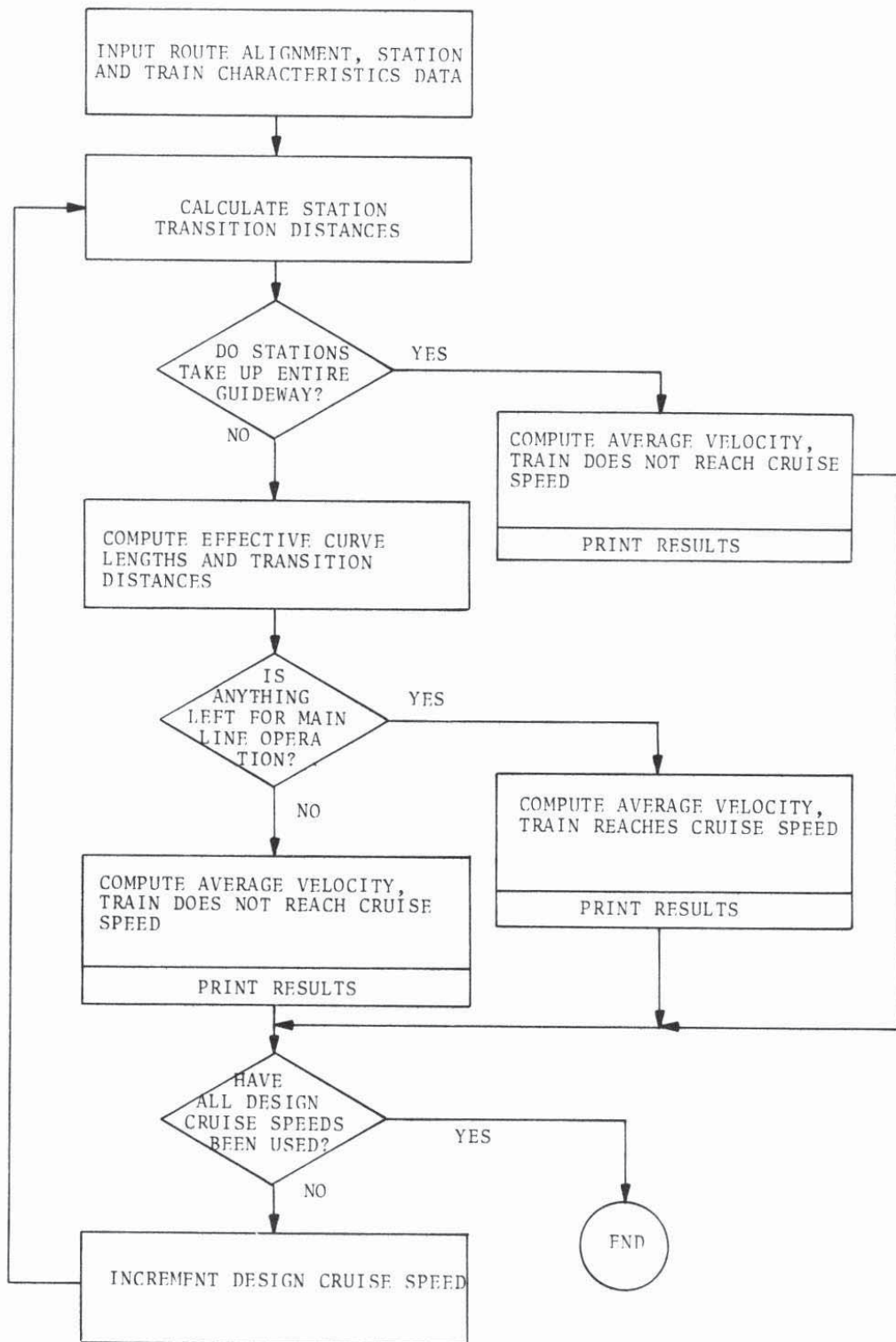

Figure 2-2. Velocity Program Flowchart



application and operating characteristics. The primary determinant of system capacity, assuming the principle of non-interference between trains, is the minimum safe headway as this defines the number of trains per hour which can pass a given point. System headway, in turn, is a complex function of such parameters as safe operating criteria, normal and emergency acceleration and braking rates, train speed and length, train control system design, and speed restrictions.

A computer flow diagram for the capacity model is shown in Figure 2-3 and describes, in summary form, the sequence of computations involved in determining headway and capacity. Given a set of inputs for train length, acceleration/braking rates, speed, and control system design the capacity model computes the minimum headway permissible for all speed restrictions (mainline operation, curves, and stations). The capacity model then compares all computed headways and chooses the largest as the system headway. Because on-line station operations include a dwell time they usually determine the system headway. When off-line stations are simulated by the model, the station effects on headway can be diminished to the point where minimum headway requirements imposed by curves or mainline operations may preside.

Because the lowest curve speed (independent of length or frequency) encountered on the guideway determines the minimum headway constraint (for curves) for only curve data necessary for the capacity model is the speed of the slowest curve. Similarly for station operations all that need be inputted is the longest dwell time encountered. The capacity program prints out the minimum headway computed for mainline, curve and station operations together with the maximum system capacity in terms of trains per hour and seats per hour.

Results of the parametric analysis are summarized in the tables in Section 2.4 listing the relative sensitivity of the various parameters investigated on average velocity or capacity as a function of vehicle speed. The sensitivity of a parameter is defined as the change in average velocity or capacity that results from varying the parameter in question over a complete

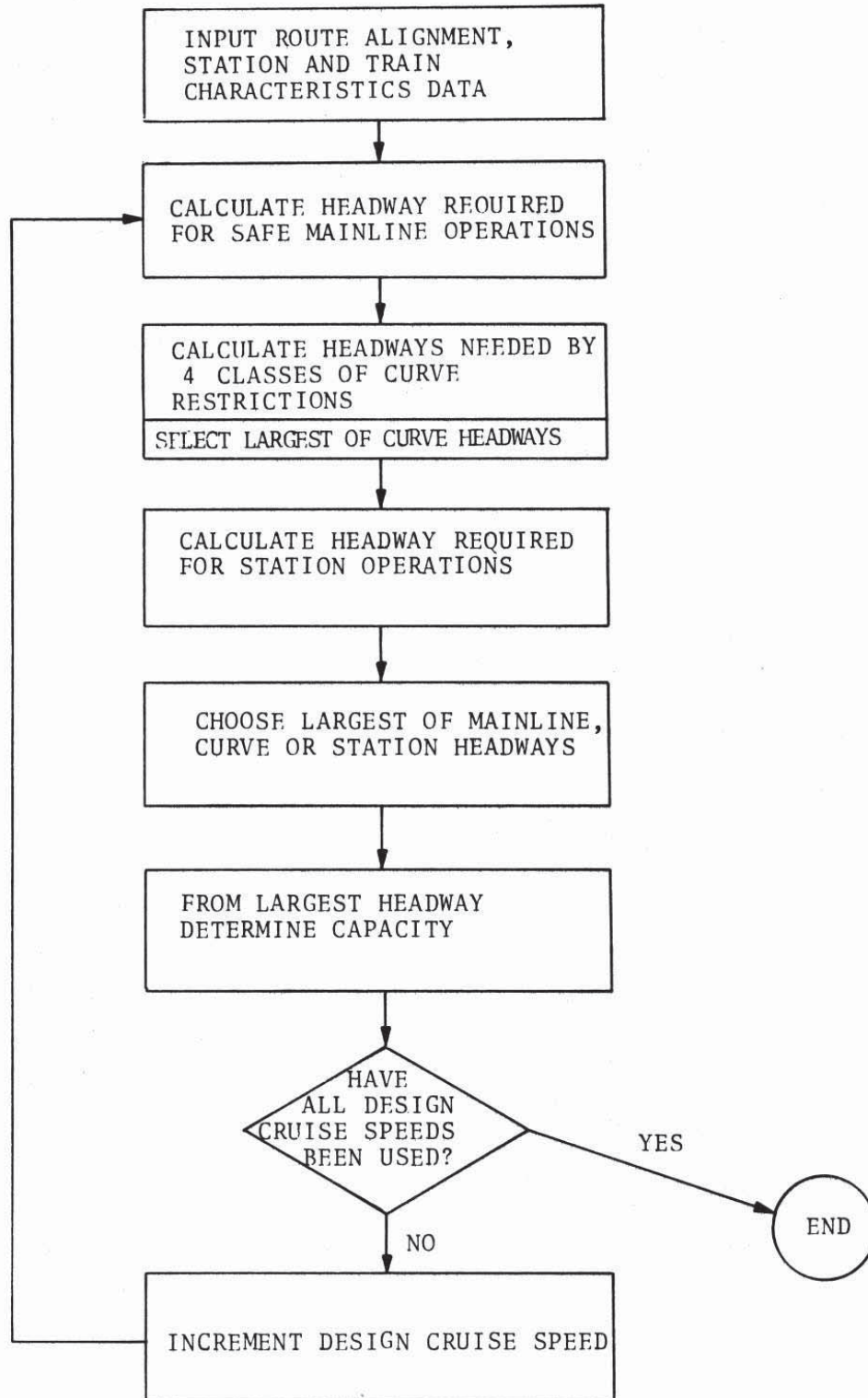

Figure 2-3. Capacity Program Flowchart

range of values typically encountered in most applications. The method of rating sensitivities is, therefore, somewhat subjective because it depends on the range of values selected for the parameters. It does, however, yield practical insight into the relative significance of and trade-offs involved in changing the system parameters investigated.

## 2.2 ANALYSES OF AVERAGE VELOCITY VERSUS TRAIN DESIGN CRUISE SPEED

Average system velocity as a function of train velocity is affected by three major groups of parameters. These are:

- a) Station Operations
  - station spacing
  - station dwell time
  - station on/off-line
- b) Curve Operations
  - curve speed
  - curve frequency
  - curve length
- c) Acceleration and Braking Rates

The approach used in the parametric analyses was to decouple each major group of parameters where possible so that the sensitivity of parameters in each group could be isolated from the effects of parameters in other groups. Thus, when investigating station operations, no curve restrictions were imposed and vice-versa. Acceleration and braking rates, being train characteristics, could not be decoupled; hence, when investigating station or curve operations, the acceleration and braking rates were set at a typical value of  $0.1g$ . Similarly, when investigating the sensitivity of acceleration and braking rates, typical values for station or curve operations were selected.

Throughout the parametric analyses, reference will be made to the velocity-distance relationship and transition-cruise ratio. These terms are basic to understanding the general effect of speed

restrictions, curves and stations, on system performance. The velocity-distance relationship is described in Figure 2-4, which is a simple plot of distance required to accelerate to speed for a constant acceleration rate. Because the distance required to accelerate to speed is a function of the velocity squared, it takes disproportionately longer distances to accelerate to higher speeds. Also, for a given velocity change, the distance covered is greater if the velocity change occurs at higher speeds. The transition-cruise ratio is defined as the ratio of distance spent in braking into, negotiating and accelerating out of speed restrictions (transition distance) to the distance spent at cruise speed for a given trip. Because the transition distance is always travelled at less than cruise velocity, the greater the transition-cruise ratio the lower will be the average velocity.

Several general observations can be made regarding system performance as measured by average velocity using the concepts of velocity-distance relationship and transition-cruise ratio:

- a) For a given trip involving speed restriction, the velocity-distance relationship dictates that the lower speed trains will always have an average velocity closer to cruise velocity than the higher speed train. Similarly, the lower speed train has a smaller transition-cruise ratio; i.e., it accelerates to cruise speed in less distance (smaller transition) and cruises a proportionately longer distance than the higher speed train for the same trip.
- b) When the transition-cruise ratio is high (relatively short distance between speed restrictions), any change to the system that impacts the transition distance (changing acceleration rates, curve lengths, dwell times, etc.) will have a larger impact on average velocity than when the ratio is small (long distances between speed restrictions).
- c) For a given trip involving speed restrictions, when neither the high speed or low speed train attains cruise speed (very close interval between restrictions) the



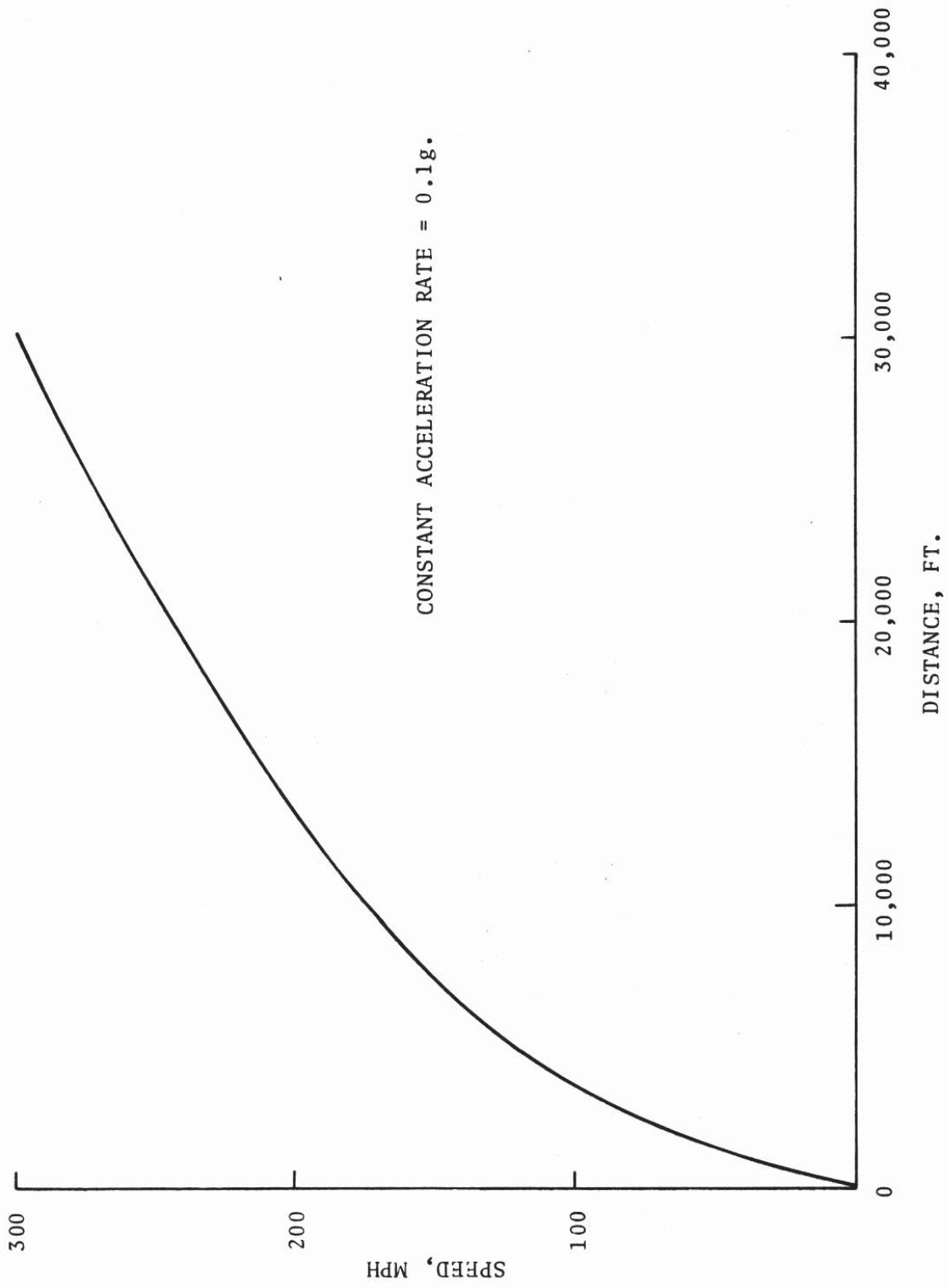

Figure 2-4. Velocity-Distance Relationship

transition-cruise ratio and average velocities will be the same for the two systems.

### 2.2.1 Station Operations, Station Spacing

Figure 2-5 is a typical illustration of the effects of station spacing on average velocity. The manner in which station spacing generally affects average velocity is by its impact on the transition-cruise ratio. Closer stations will result in more transition time relative to cruise time and, hence, lower average velocities. If stations are close enough, the trains will never achieve cruise velocity as the entire trip time is spent in transitions (see one-mile spacing for 100, 200 and 300 mph trains). Because of the velocity-distance relationship, the average velocity of higher speed trains is affected more by station spacing; i.e., for a given station spacing high velocity trains have a larger transition to cruise ratio.

Some general observations made on station spacing are:

- a) For a given train speed, average velocity increases with station spacing.
- b) High speed trains are impacted more severely by station spacing.
- c) If station spacing is sufficiently close, cruise speed will never be attained and average velocity will remain constant regardless of any increase in train cruise speed capability.

### 2.2.2 Station Operations, Dwell Time

The effect of station dwell time on average velocity for various station spacings is shown in Figure 2-6. Station dwell time affects average velocity by directly adding to the total transition time for a given trip distance. For this reason, as total trip time becomes less (either because of a shorter trip or a higher speed train) the dwell time will have a more significant impact on average velocity.

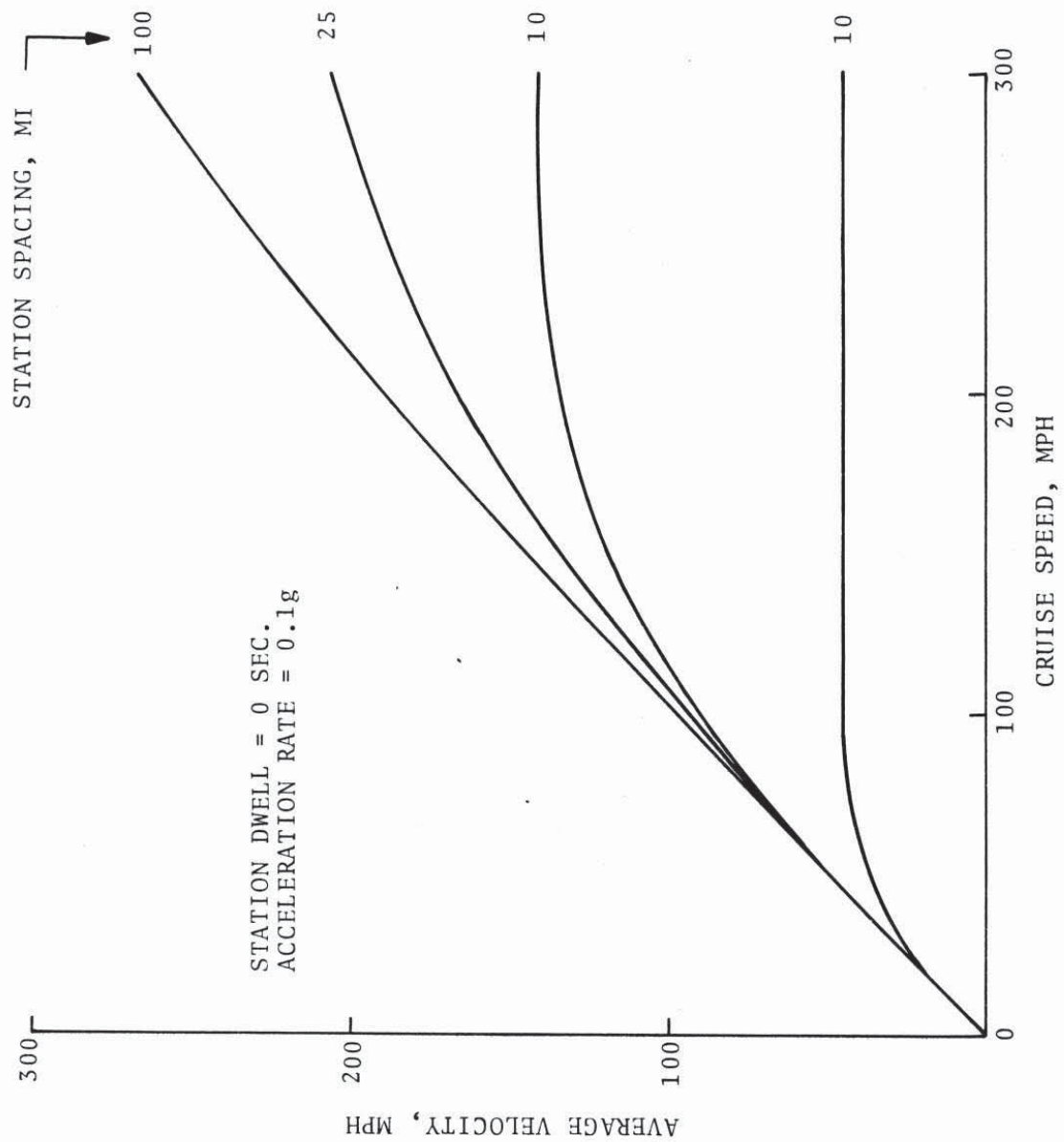

Figure 2-5. Average Velocity Vs. Design Cruise Speed for Various Station Spacings

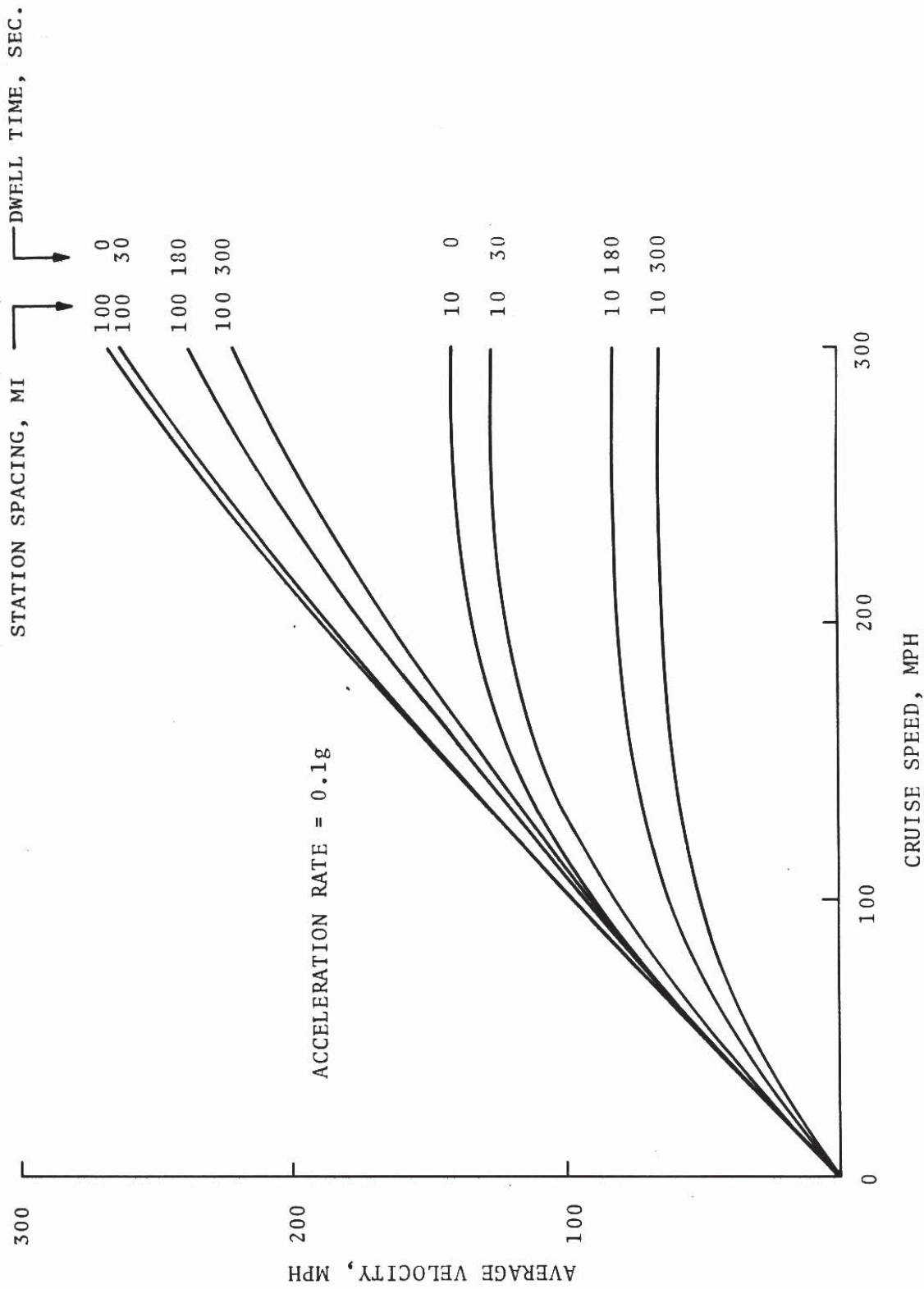

Figure 2-6. Average Velocity Vs. Design Cruise Speed For Various Dwell Times and Station Spacing



Some general observations made on station dwell time are:

- a) For a given trip distance (station spacing) and train cruise speed, an increase in dwell time decreases average velocity.
- b) For a given trip distance, dwell time will impact higher speed trains more severely. For example, from Figure 2-6, 100 mile station spacing, changing the dwell time from 0 to 300 seconds (5 minutes) produces percent changes in average velocity of 8 percent and 17 percent, for 100 mph and 300 mph trains respectively.
- c) For a given train speed, dwell time impacts average velocity more severely for short trips (less travel time) than long trips.

### 2.2.3 Station Operations, On/Off-Line Stations

On or off-line stations can affect average velocity with varying degree depending upon the off-line concept considered. Off-line stations which utilize high-speed switching will permit trains to skip certain stations on the route without any time spent in transition. The average velocity for such a system would be based on the average distance between actual stops for each train rather than the system station spacing. For example, if all trains skipped one station between stops the average velocity would be determined by twice the average station spacing. This is a good technique for increasing the average velocity of a system with high station densities. If the off-line stations utilize low speed switches or otherwise require all trains to slow down to negotiate the switch or pass through the station area, the benefit of off-line stations is greatly diminished. The only improvement in average velocity comes from elimination of the dwell time and switch-to-station transition time for the train not stopping. For example, if all trains were constrained to pass through station areas at a very low speed and trains stopped at alternate stations the improvement in system average velocity would be about equivalent to reducing station dwell time in half.

#### 2.2.4 Curve Operations, Curve Speed

Figure 2-7 illustrates the general effect of curves of various speed on average velocity. The curve analyses were performed without the influence of stations; i.e., station spacing was essentially infinite. Because of the velocity-distance relationship, the transition distance accelerating into and out of curves increases as a function of the difference between curve and cruise speed squared. For a given curve speed, therefore, the average velocity of higher speed trains will be affected more strongly. If the difference in curve and cruise speed is large enough for a given curve spacing, the train will never attain cruise speed (the entire non-curve travel time is spent in transition). Given this situation and no change in acceleration rates, the average velocity cannot be increased by increasing train velocity.

Some general observations made on curve speed are:

- a) For a given curve speed, its adverse affects on average velocity becomes greater as the difference between curve and cruise speed increases.
- b) Curves have no influence on average velocity if the cruise speed is less than curve speed.
- c) Average velocity is independent of cruise velocity when the difference between curve and cruise speed is such that cruise speed is not attained.

#### 2.2.5 Curve Operations, Curve Frequency

Curve frequency (or spacing between curves) can have a significant effect on average velocity even more dominant than curve speed. For example, increasing the spacing of a 60 mph curve from one to ten miles has a more pronounced effect than increasing the speed of the one-mile curves from 60 to 150 mph (see Figure 2-8). The frequency generally affects average velocity by controlling the amount of transition versus cruise time. Closer curves result in a greater transition-cruise ratio for trains of all speeds and hence a lower average velocity. Similarly, because of the velocity-distance relationship for a given curve spacing, higher speed trains

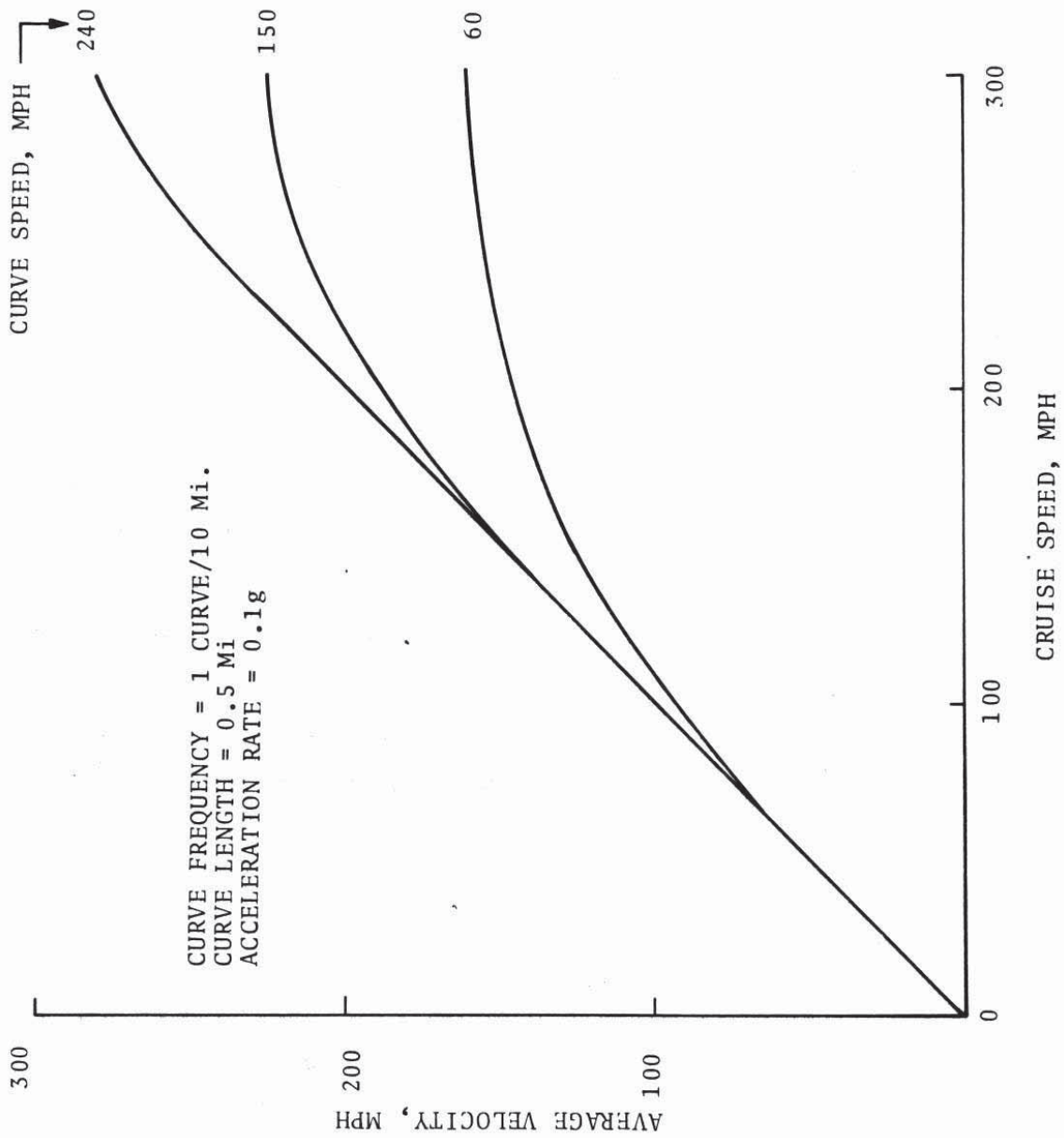

Figure 2-7. Average Velocity Vs. Design Cruise Speed for Various Curve Speeds

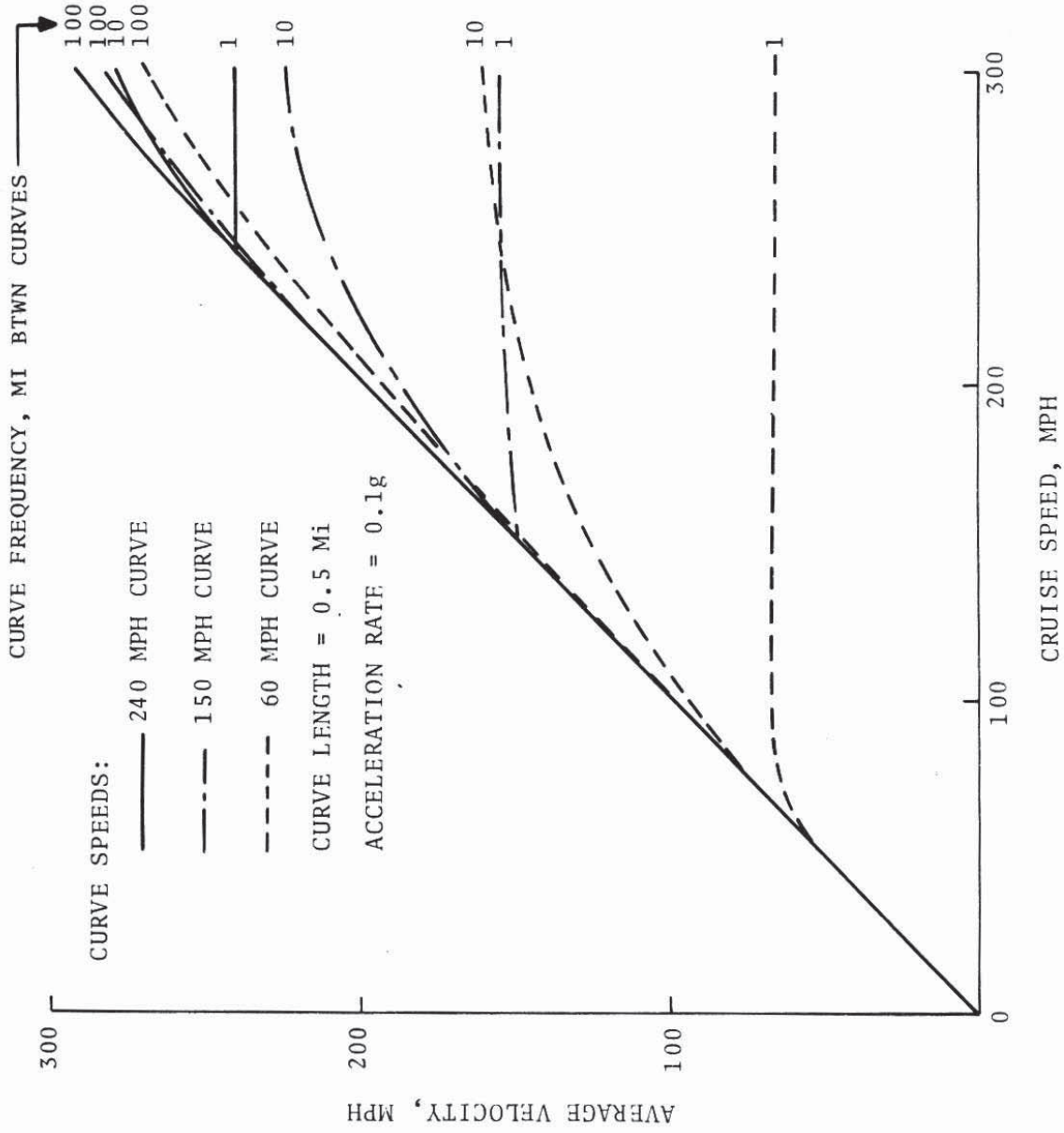

Figure 2-8. Average Velocity Vs. Design Cruise Speed for Various Curve Frequencies and Speeds



will be affected more strongly as they will have a larger transition-cruise ratio. If the curves are sufficiently close, as is the case with the one-mile spacing (Figure 2-8), the train spends its entire time in transition and never attains cruise speed. In this situation, the average velocity is independent of the train cruise speed capabilities. A train is unaffected by curve spacing if its cruise velocity is less than the minimum curve velocity.

Some general observations made on curve frequency are:

- a) Curve frequency generally has more impact on average velocity than curve speed.
- b) Average velocity increases with curve spacing.
- c) High speed trains are affected more by curve spacing.
- d) Average velocity is independent of cruise speed capabilities if curve spacing is sufficiently close that cruise speed is not attained.
- e) Average velocity is independent of curve spacing if the cruise speed is less than minimum curve speed.

#### 2.2.6 Curve Operations, Curve Length

Curve length is defined as that distance over which the train must maintain curve speed. As can be seen from Figure 2-9, a change in curve length has significantly less effect on average velocity than changing curve speed or frequency. The greatest influence of curve length on average velocity occurs when there is a large difference between curve and cruise speed; hence, for any curve speed, higher speed trains are impacted more by changes in curve length. This situation results because for higher speed trains, any change in curve length will provide a proportionately larger change in cruise distance (velocity-distance relationship) than for a slower train. If the curve length is sufficiently long for a given curve frequency, the train will never attain cruise velocity and average velocity will then be independent of the train cruise speed potential. If the train's cruise speed is less than the minimum curve speed then curve length will have no impact on average velocity.

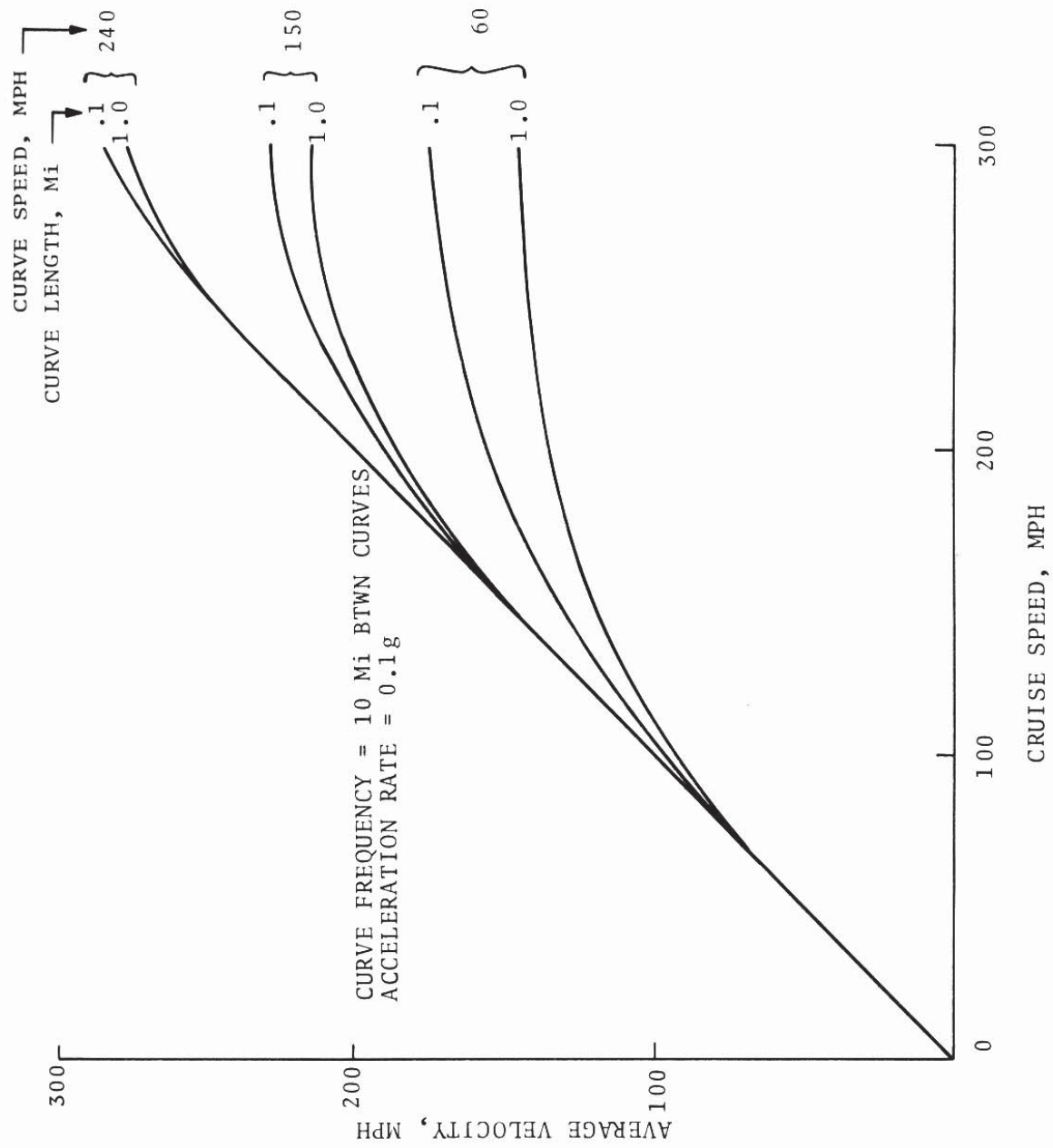

Figure 2-9. Average Velocity Vs. Design Cruise Speed for Various Curve Lengths and Speeds

Some general observations made on curve length are:

- a) Curve length is generally less significant than curve frequency or speed.
- b) The impact of curve length increases as curve spacing decreases.
- c) Curve length is more sensitive when the difference between curve and cruise speed is large; hence, for a given curve speed, higher speed trains are affected more by curve length.
- d) Average velocity is independent of cruise velocity if the curve length is sufficiently long that cruise speed is not achieved.
- e) Average velocity is independent of curve length if cruise speed is less than minimum curve speed.

#### 2.2.7 Curve Operations, Combinations of Curves

Previous discussions have investigated only single-speed curves. In practice, however, curves will be encountered with various speeds, lengths and frequencies. Several simplified combinations of curves have been analyzed, as presented in Figures 2-10 and 2-11, to determine significant relationships and trade-offs. The figures describe combinations of 60, 150, 240 mph curves (chosen to represent a uniform distribution between 0 and 300 mph) where either the curve length (Figure 2-10), or curve frequency, (Figure 2-11) was varied while the other parameters held constant.

The information contained within Figure 2-11 has particular relevance to the practical problem of determining strategies for upgrading route alignments. Given the hypothetical existing route alignment described by Case I (10 curves per 100 miles each, 60, 150 and 240 mph curves), all other cases represent various attempts to improve the route by removing 10 curves per 100 miles. The different strategies for removing these curves described by the cases in Figure 2-11 are summarized below in order of significance of impact on improving performance.

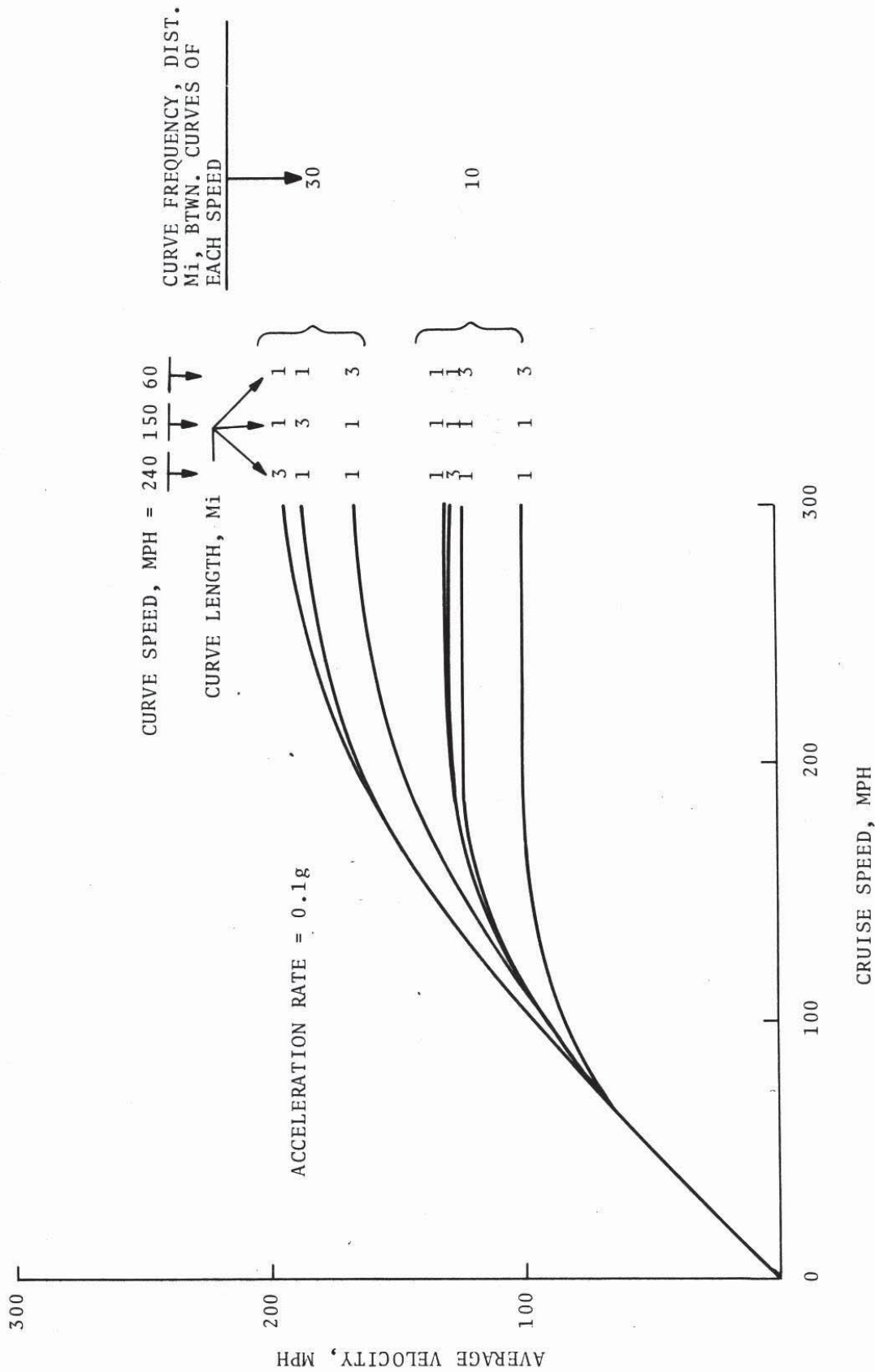

Figure 2-10. Average Velocity Vs. Design Cruise Speed for Various Combinations of Curve Speed, Length and Frequency



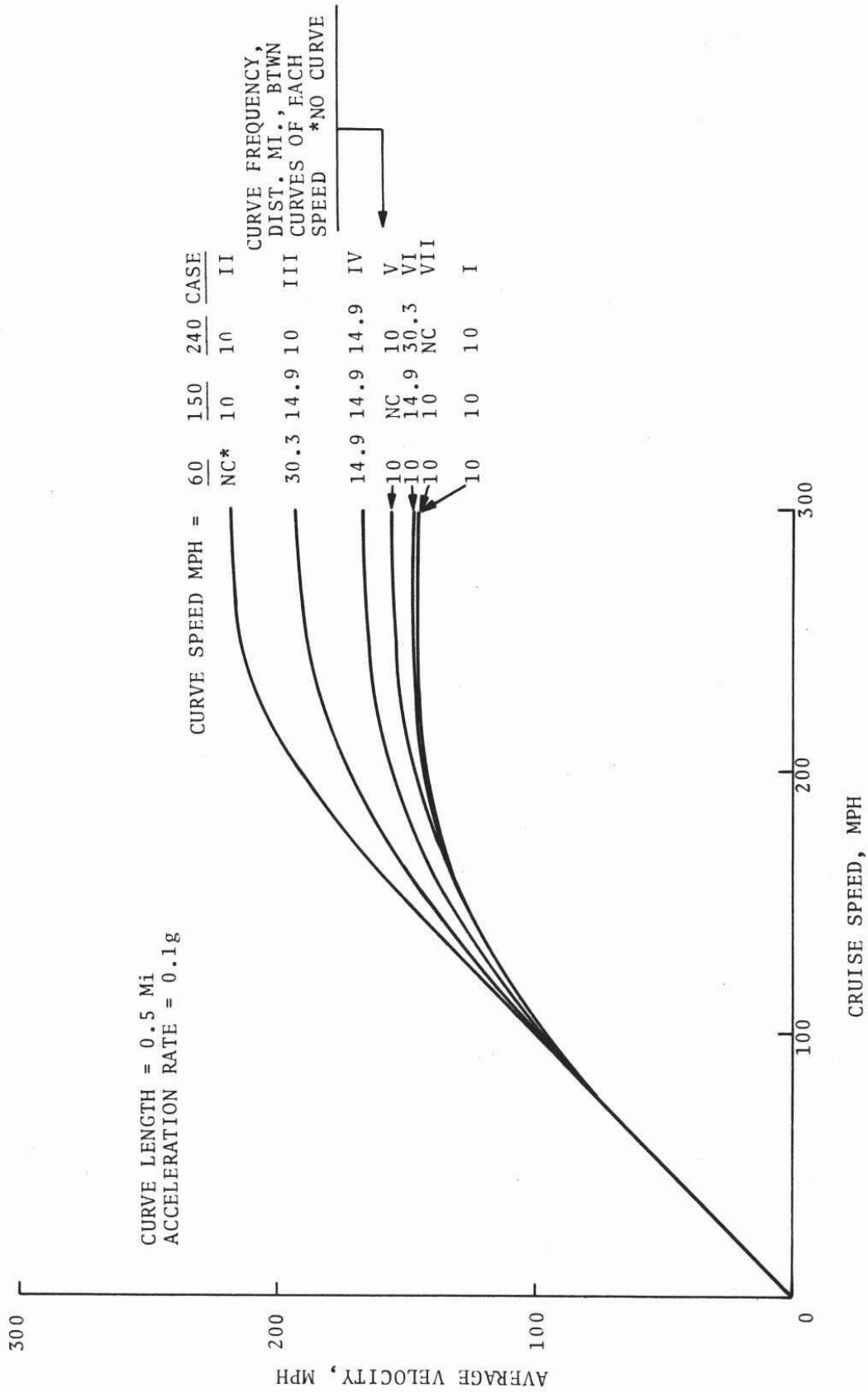

Figure 2-11. Average Velocity Vs. Design Cruise Speed for Various Combinations of Curve Frequency Speed

## SUMMARY OF UPGRADING STRATEGIES

<u>CASE</u>	<u>How 10 Curves Per 100 Miles Were Removed</u>
II	100% from 60 mph curves
III	67% from 60 mph curves, 33% from 150 mph curves
IV	33% from 60 mph, 150 mph and 240 mph curves
V	100% from 150 mph curves
VI	33% from 150 mph curves, 67% from 240 mph curves
VII	100% from 240 mph curves

It is obvious from Figure 2-11 that the most effective strategy for upgrading a given route is to remove the lowest speed curves first. No other combination of removing low and higher speed curves simultaneously yields the same effectiveness for the same number of curves removed.

The observation regarding the advantages of removing low speed curves first is predictable from the previous analysis of single-speed curves. Any length or frequency change to the lower speed curves produces more significant results than the same change to high speed curves. This results from the velocity-distance relationship which produces a proportionately greater improvement in the transition-cruise ratio for a given change in curve length or frequency when the difference between cruise and curve speed is large. A change in curve length produces a smaller change in average velocity than a change in curve frequency as changes in curve length diminish only the time the train must remain at curve velocity but otherwise requires that the train operate the same amount of time in transitions. A change in frequency, however, varies both time spend at curve speed and in transition.

Some general observations made on combinations of curves are:

- a) For a system containing a uniform mix of curve speeds, the lowest speed curves have the highest impact on system performance. The most effective improvements to route alignments can therefore be made by removing the lowest speed curves first.
- b) Curve frequency has more impact on system performance than curve length.

2.2.8 Acceleration and Braking Rates, Factors Influencing Rate Limits

Acceleration and braking rates encountered in high speed ground vehicles are primarily constrained by passenger comfort, safety and propulsion system design requirements. Passenger comfort and safety considerations dictate that normal acceleration and braking rates be less than .15g and emergency rates less than .4g. In addition, propulsion systems designed for efficiency require that acceleration and braking rates be minimized consistent with providing sufficient thrust to maintain cruise speed under typically encountered adverse conditions. A brief analysis was performed for high speed trains with design cruise speeds of 100, 200 and 300 mph to establish approximate values for the minimum thrust required to maintain cruise speed and the resulting maximum acceleration capabilities at start. Vehicle weight and drag characteristics were assumed to be similar to a TACV system and maximum adverse conditions to be overcome at cruise speed were valued at three percent grade and 30 mph headwind. The results of the analysis are summarized in Table 2-3 below.

TABLE 2-3. MAXIMUM ACCELERATION RATE FOR MINIMUM DESIGN THRUST

Maximum cruise speed to be maintained under adverse conditions, mph	Minimum thrust required to maintain cruise speed under adverse conditions, lbs	Maximum attainable acceleration rate at start, g's
100	4,633	.07
200	7,759	.12
300	12,342	.19

Several observations can be made from the preceding acceleration analysis:

- a) A range of .05g minimum to .15g maximum represents typical acceleration rates for all train systems.
- b) A reasonable normal value of acceleration to be used in analyzing passenger train systems is .1g.

- c) Because of the thrust required for cruise conditions, very high speed systems (200-300 mph) will have an excess acceleration capability at start. This will enable them to either start at high acceleration rates (.15g) or maintain constant rates of moderate acceleration (.1g) for longer periods of time than lower speed systems. As will be seen later, increased acceleration capabilities will improve both system average velocity and capacity.
- d) Lower speed ground systems (below 150 mph) must size the propulsion system to achieve a moderate starting acceleration (.1g) or sacrifice system performance (average velocity and capacity). In so doing, however, the propulsion system will then be over sized for cruise conditions.

#### 2.2.9 Acceleration and Braking Rate, Station Operations

Figure 2-12 illustrates the effect of changing the acceleration and braking rate through the range of typical values discussed above (.05g to .15g) for different conditions of dwell time and station spacing. For the zero dwell condition, the change in acceleration rates is most significant for close station spacings. This results because the train spends much of its time in transition, particularly high speed trains, and a change in acceleration rate will produce a significant shift in the transition-cruise ratio; whereas, for large station spacings, a change in acceleration rates affects only a small portion of the total operational cycle. When dwell times are added the effect of variations in acceleration rates are rapidly diminished, especially at close station spacings. For example, the total operational cycle time for ten-mile stations is so short (4.25 min. for 300 mph vehicle) that the addition of a modest three minute dwell more than negates the effect of increasing acceleration from .05g to .15g.

Some general observations made on acceleration rates, and station operations are:



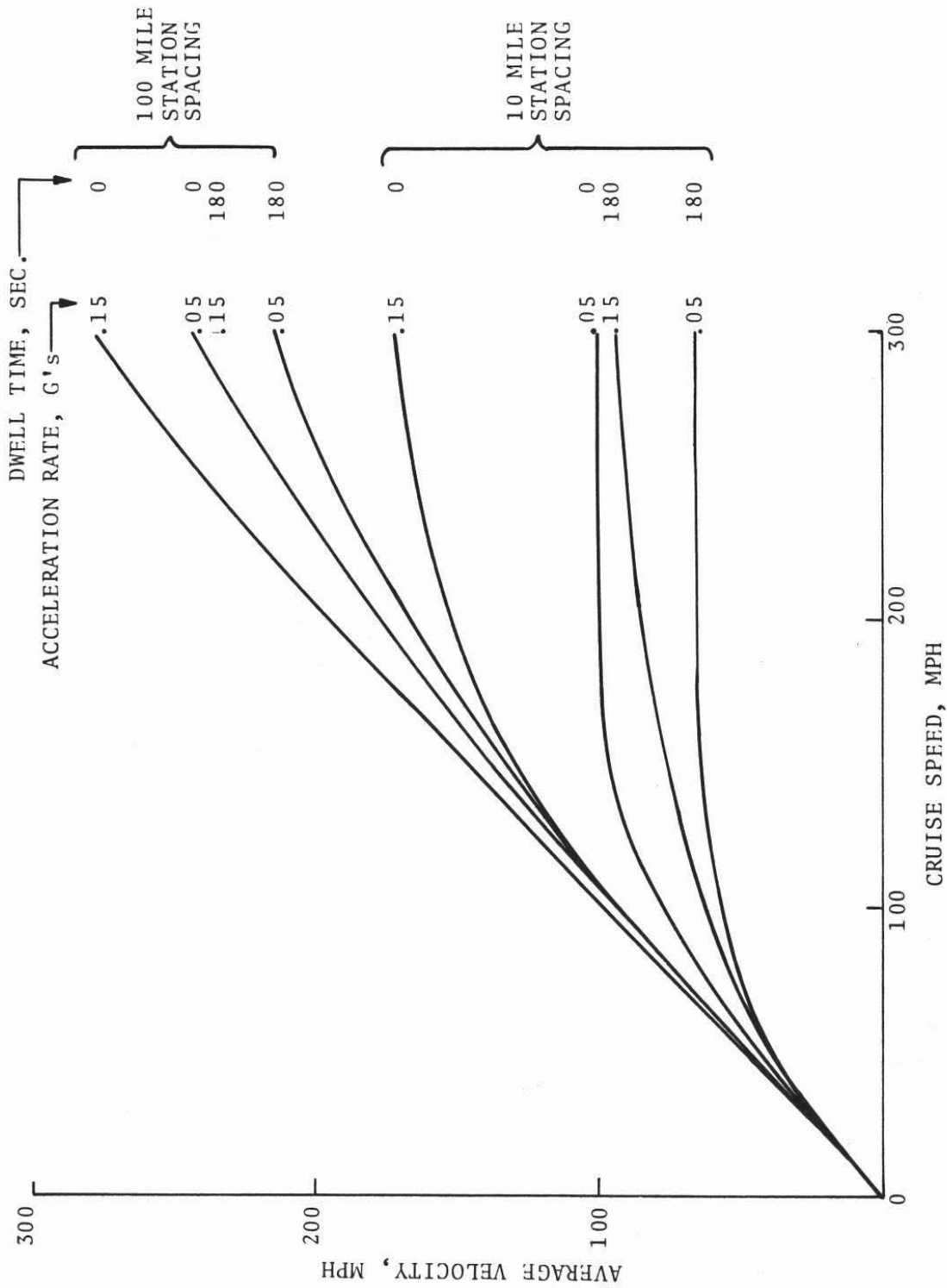

Figure 2-12. Average Velocity Vs. Design Cruise Speed for Various Acceleration Rates, Station Spacings and Dwell Times

- a) Acceleration rate has more impact at close station spacings.
- b) When dwell times are added the impact of acceleration rates is greatly diminished at close station spacings.

#### 2.2.10 Acceleration and Braking Rate, Curve Operations

As can be seen in Figure 2-13, the effect of acceleration and braking rate on curve operations is a function of curve speed and spacing. There are basically three categories of curve situations where a change in acceleration rate can produce negligible, moderate or significant changes in average velocity as described in Figure 2-14. In Case I, the curve spacing is so close that the increase in velocity incurred between curves is small, particularly for high speed curves due to the velocity-distance relationship, and, therefore, a change in acceleration rate produces only negligible changes in average velocity (see one-mile curve spacing, 60 and 240 mph curves, Figure 2-13). Very significant changes in average velocity occur as a function of acceleration rate when the curve spacing is increased sufficiently to permit cruise speed to be achieved between curves (Case II, Figure 2-14). In this case, a change in acceleration produces a proportionately large shift in the transition-cruise ratio and a correspondingly large change in average velocity. This effect is most pronounced when the difference between curve and cruise velocity is large because of the velocity-distance relationship (see ten-mile spacing, 60 mph curve, Figure 2-13). As station spacing is increased beyond that of Case II, the effect of acceleration rate on average velocity diminishes as a proportionately smaller amount of time is spent in transition (see Case III, Figure 2-14). The effect for a given change in acceleration rate on the Case III situation is greater when the cruise-curve velocity difference is large (see 100-mile spacing, 60 mph versus 240 mph curve, Figure 2-13).

Some general observations made on acceleration rates and curve operations are:

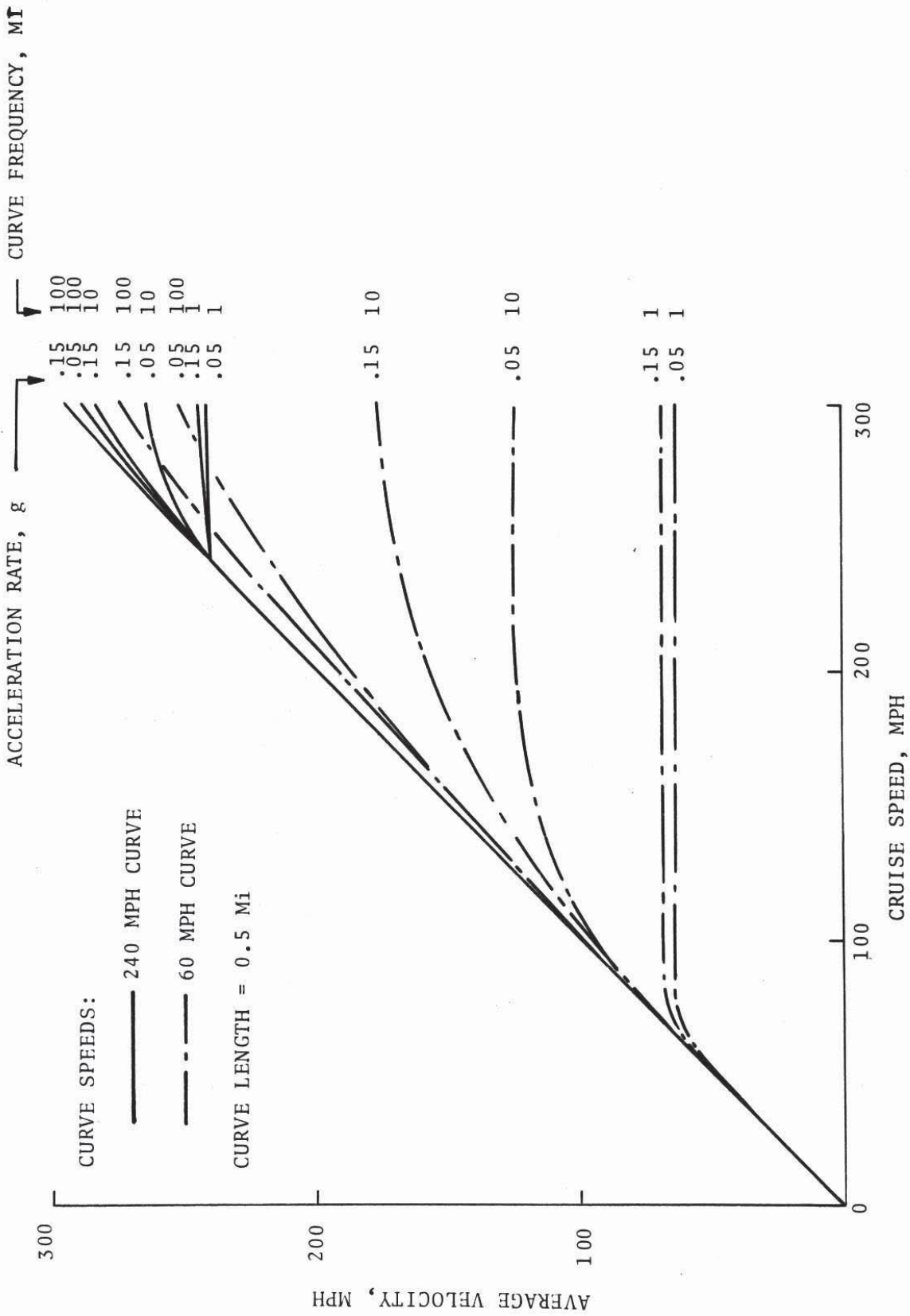

Figure 2-13. Average Velocity Vs. Design Cruise Speed for Various Acceleration Rates, Curve Speeds and Frequencies

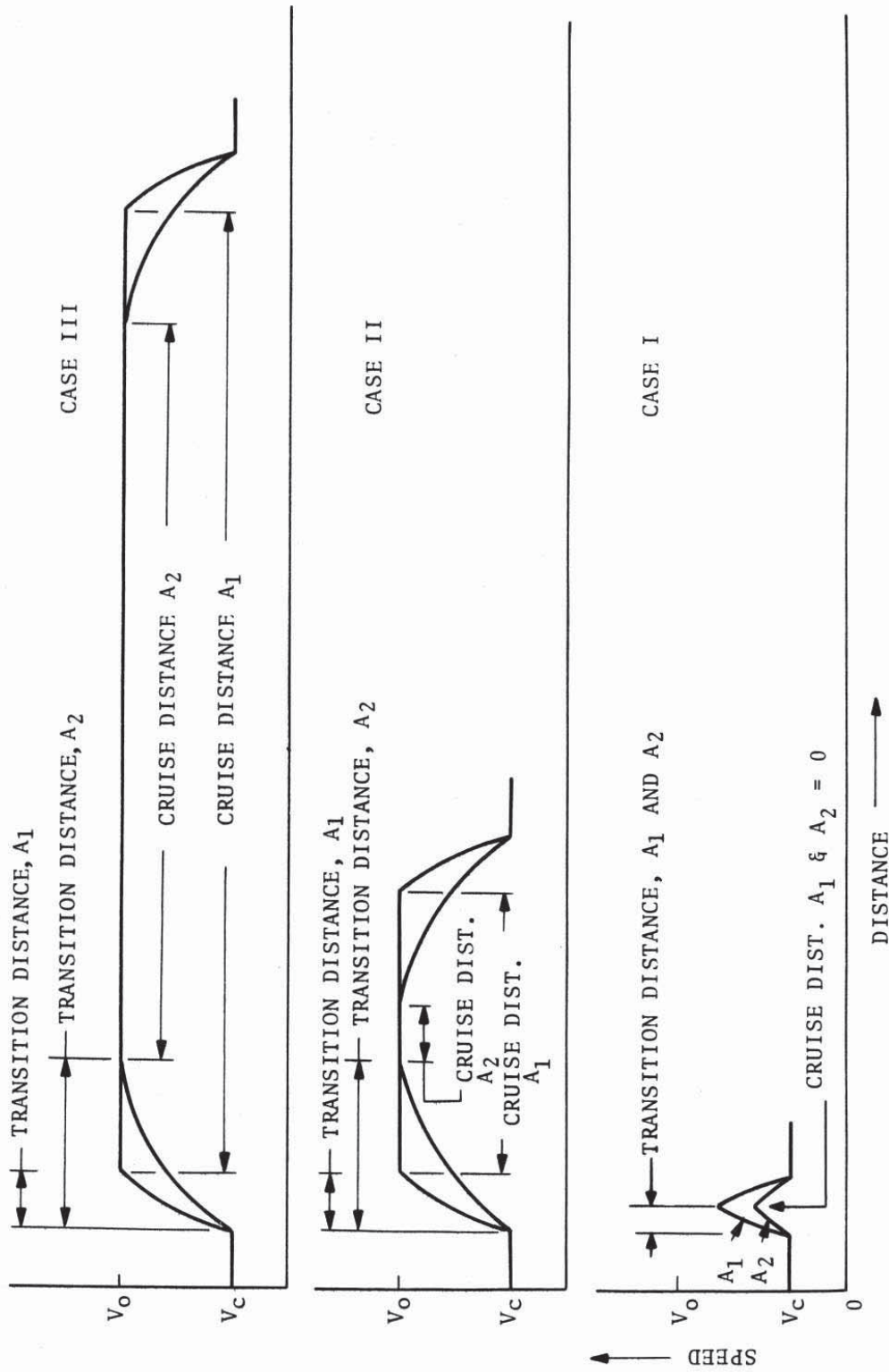

Figure 2-14. Velocity-Distance Relationship for Various Acceleration Rates During Curve Operations



- a) The impact of acceleration and braking rates on average velocity is greatest when station spacing is sufficient to permit attainment of cruise speed (about ten miles) and decreases with either very close or very large station spacings.
- b) The effect of changes in acceleration and braking rates increase with the difference between cruise and curve speed.

## 2.3 ANALYSES OF SYSTEM CAPACITY VERSUS TRAIN DESIGN CRUISE SPEED

### 2.3.1 General

System capacity, as measured by the number of trains per hour, is inversely related to the train headway or the time interval between trains passing a reference point on the route. As the headway decreases, system capacity will increase since more trains per hour can pass through a given station. The minimum permissible headway (maximum capacity) is determined by the minimum safe following distance between trains which is a complex function of the parameters listed below:

- a) Station Operations
  - Station dwell time
  - Stations on/off-line
- b) Curve Operations
  - Minimum curve speed
- c) Safety Criteria
- d) Train Related
  - Normal acceleration and braking rates
  - Emergency braking rates
  - Train control technique
  - Train length

As with the previous analysis of average velocity, the approach used in the capacity parametric analysis was to decouple, whenever possible, the major groups of parameters so their sensitivity on system capacity could be isolate. Hence, when station

operations were analyzed, no curves were assumed to be present in the system and vice-versa. Train-related parameters which could not be decoupled were specified at normal values. A detailed discussion of the effects of each parameter listed above on system capacity is provided in following sections; however, certain basic relationships affecting system headway and safe following distance are discussed first.

2.3.1.1 Safety Conditions - For high speed ground transportation systems, it is reasonable to assume that the minimum following distance between trains must always be sufficient to avoid collisions if one train in the system encounters trouble. (For low speed, high density systems such as PRT, it may be assumed that minor collisions or bumpings of vehicles is permissible if acceleration and jerk rates are not so high as to cause passenger injury or vehicle damage.) The most conservative assumption of possible hazards which could occur to a leading train is that it encounters a "brick wall" collision on the guideway. This worst case condition was assumed in the capacity analysis and requires the largest safe following distance between trains relative to other safety criteria which assume that the lead train "crashes" at some finite rate of acceleration.

If the conservative safety criterion is assumed, the minimum safe following distance between trains (measured from the nose of the lead train to the nose of the following train) must be composed of three spatial components: (1) the emergency stopping distance of the following train, (2) the length of the lead train, and (3) an additional space to account for margins of safety and automatic train control characteristics. It should be noted that the minimum following distance could have been defined as the distance between the tail of the leading train and the nose of the follower. System capacity and headway time, however, must be based on the nose-to-nose distance as this determines actual system throughput; i.e., the number of whole trains passed a fixed point on the route per unit time. For convenience and consistency, therefore, the minimum following distance was defined as including

the train length so that headway time and system capacity could be computed directly from the following distance.

2.3.1.2 Emergency Stopping Distance and Train Length - The emergency stopping distance of the following vehicle is inversely proportional to the emergency braking rate and directly proportional to the square of the velocity from which braking occurs. Assuming the same braking rates, higher speed vehicles will therefore require a disproportionately greater following distance for safe cruise operations (as will be discussed later, the minimum following distance of trains passing through speed restrictions such as curves and stations is not necessarily as simple a function of the train's cruise speed). The following distance for all speeds of operation can, however, be decreased uniformly by increasing the emergency braking rate (an emergency braking rate of about .4g appears to be maximum from considerations of passenger safety). As defined above, in addition to the emergency stopping distance, the train length is also included in the following distance and, therefore, always adds a fixed spatial quantity to the emergency stopping distance regardless of operations.

2.3.1.3 Automatic Train Control - Automatic train control techniques for high speed ground transportation can range from a train follower concept where the relative separation between trains is continuously monitored to block control concepts where the position of trains is known only to be within discrete "blocks" of guideway length. The type of automatic control assumed can significantly affect the required minimum following distance. The train follower concept, because it monitors the exact distance between trains, can theoretically permit the intertrain spacing to be equal to the train length plus the emergency stopping distance. In practice, the spacing would have to be increased somewhat to allow for margins of safety and control equipment response times. A simple go/no-go block control system, on the other hand, requires twice the intertrain spacing of the follower concept. The additional distance results because two blocks, each of a length equal the minimum following distance, are necessary between trains

to accommodate the situation where the leading train fails just after entering a new block leaving, in essence, only one block between trains before an emergency situation is detected. A more sophisticated block system containing block lengths less than the minimum following distance together with a phased speed control based on the number of blocks between trains will permit inter-train spacings less than the simple block concept. As the block lengths become smaller the permissible distance between trains approaches the limit required by the train follower concept. Depending on the train control concept assumed, therefore, the theoretical minimum distance between trains (also headway and capacity) can vary by a factor of two. Unless indicated otherwise, the capacity parametric analysis assumed an idealized control strategy (a train follower concept) as a detailed analysis of the effects of various control concepts on system capacity was beyond the scope of this project. The capacity model will, however, permit a determination of the approximate effects of various control concepts by the introduction of a pre-selected constant, FAC, which typically has a value between one and two, to represent the range of control strategies from the follower to the go/no-go block system respectively.

2.3.1.4 Relationship Between Following Distance and Headway - It is a commonly held notion that as the cruise velocity of a train is decreased closer headways can be maintained because slower trains can stop in shorter distances. This is basically a true proposition only for mainline operations and zero length trains, however. When train length and operations within speed restrictions and stations are considered, contra-intuitive changes in minimum headway as a function of cruise velocity can occur. For example, when trains are sufficiently long and certain classes of speed restrictions are encountered, the headway must increase as cruise velocity is decreased. A detailed discussion of the factors affecting headway is presented in the following parametric analysis; however, a general discussion of following distance and headway is presented here to provide a basic understanding of their relationship.



Considering mainline operations only, the minimum following distance between trains is equal to the emergency stopping distance plus the train length:

$$D_{\min} = D_e + L \quad (2.3-1)$$

where:  $D_{\min}$  = Minimum following distance

$D_e$  = Emergency stopping distance =  $.5V_o^2/A_e$

$V_o$  = Cruise velocity

$A_e$  = Emergency braking rate

$L$  = Train length

The resulting headway,  $H_m$ , for mainline conditions is the minimum following distance,  $D_{\min}$ , divided by the cruise velocity and can be described as containing two time elements,  $T_e$  and  $T_l$ , corresponding to the emergency stopping distance and the train length:

$$H_m = T_e + T_l \quad (2.3-2)$$

where:

$T_e = D_e/V_o = .5V_o/A_e$

$T_l = L/V_o$

The headway as a function of the emergency stopping distance and train length is described on the time-velocity plot in Figure 2-15. As can be seen, if train length is ignored, the headway is equal to  $T_e$  and decreases linearly with velocity as would be expected. When train length is considered, however, (which it must for any realistic application) the headway decreases to some velocity below which it increases again. Furthermore, for special cases of speed restrictions, as will be demonstrated later, the emergency stopping distance (and hence  $T_e$ ) and  $T_l$  are either non-linearly related to or entirely independent of train cruise velocity. In terms of Figure 2-15 speed restrictions will distort the  $T_e$  and  $T_l$  curves from the mainline case presented and result in further contra-intuitive changes in headway as a function of cruise velocity.

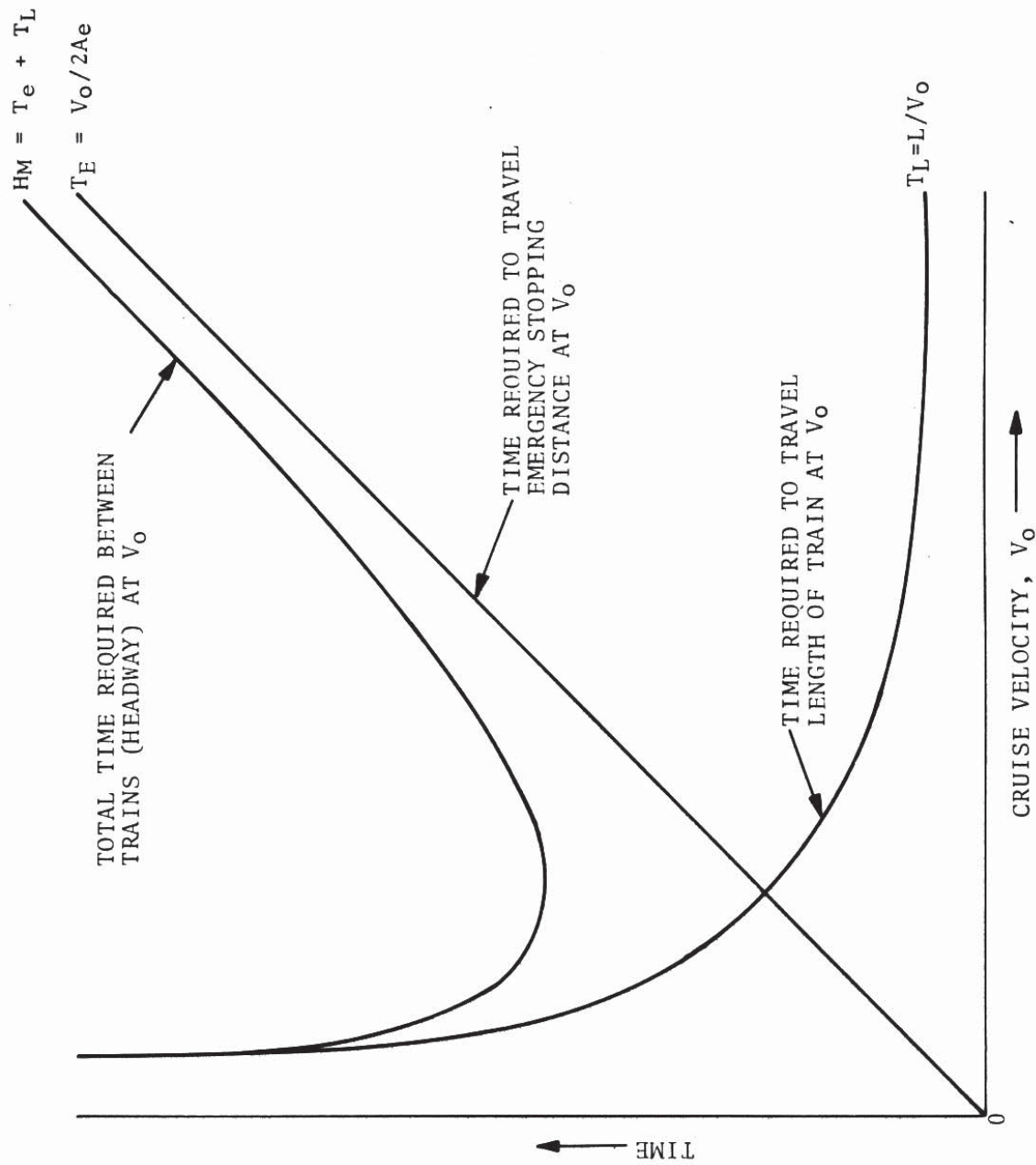

Figure 2-15. Headway Requirements for Cruise Conditions as a Function of Emergency Stopping Distance and Train Length

### 2.3.2 Station Operations, On-Line

Station operations can have a significant effect on the minimum headway. In fact, for most realistic applications, on-line station operations will dictate the operating headway regardless of what other speed restrictions exist in the system. The effect on system capacity of varying the primary station parameter, dwell time, for different train lengths is described in Figure 2-16, 2-17, 2-18 and 2-19. For zero train length and dwell time, it can be seen that capacity increases indefinitely, as expected, when cruise velocity is reduced. As train length is increased, however, system capacity peaks at some constant value and remains largely independent of cruise velocity particularly for train lengths above 200 feet (a length commonly exceeded in practice). Below some critical cruise speed, trains of any length will show a decrease in capacity. The decrease in capacity occurs at higher cruise speeds for longer trains.

As dwell times are increased, two effects can be noticed. First, system capacity is reduced except in special cases (short trains, small dwell times, large cruise velocities) where the capacity is unaffected by dwell. Secondly, the range of independence of system capacity and cruise velocity increases for shorter train lengths. When the dwell is increased beyond 30 seconds, system capacity is completely dominated by this factor and is essentially independent of cruise velocity or train length. For most practical applications, unless off-line station operations are implemented, system capacity will be restricted by station dwell times. If it is assumed that a high speed ground system requires a minimum of 1/2 to 3 minutes in a station to transfer baggage and patrons, it can be seen that the dwell time will constrain a systems capacity to well below the theoretical limits shown in Figure 2-19. A three-minute dwell time, however, (with a typical 500 ft train, one seat/ft) still permits a capacity of almost 9000 seats per hour. Longer trains and changes in station operations (off-line stations, shorter dwell) will permit increases in capacity.

An explanation for the influence of station operations on system headway and capacity can be provided with the aid of

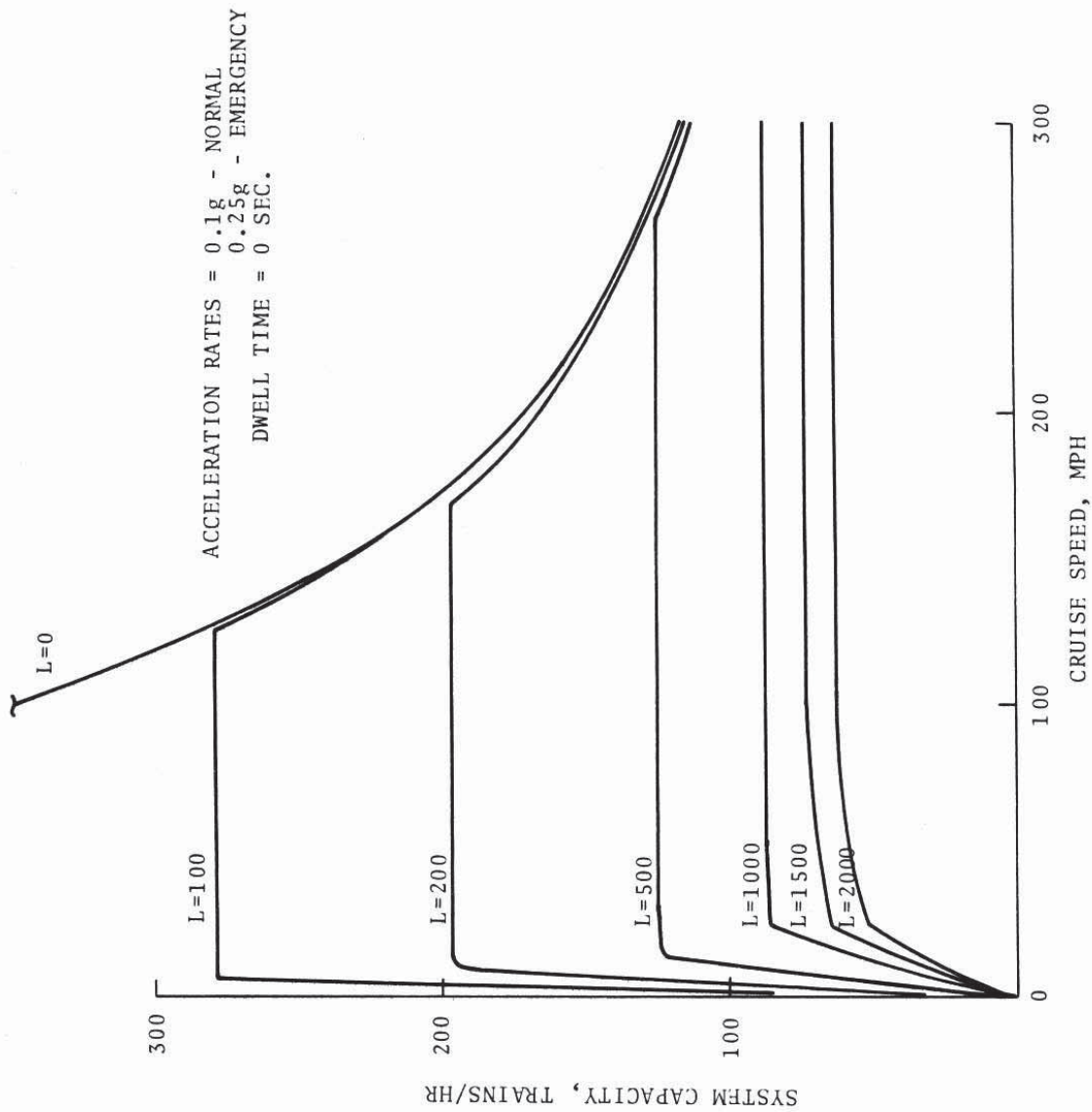

Figure 2-16. System Capacity Vs. Design Cruise Speed for Station Operations for Various Train Lengths, L

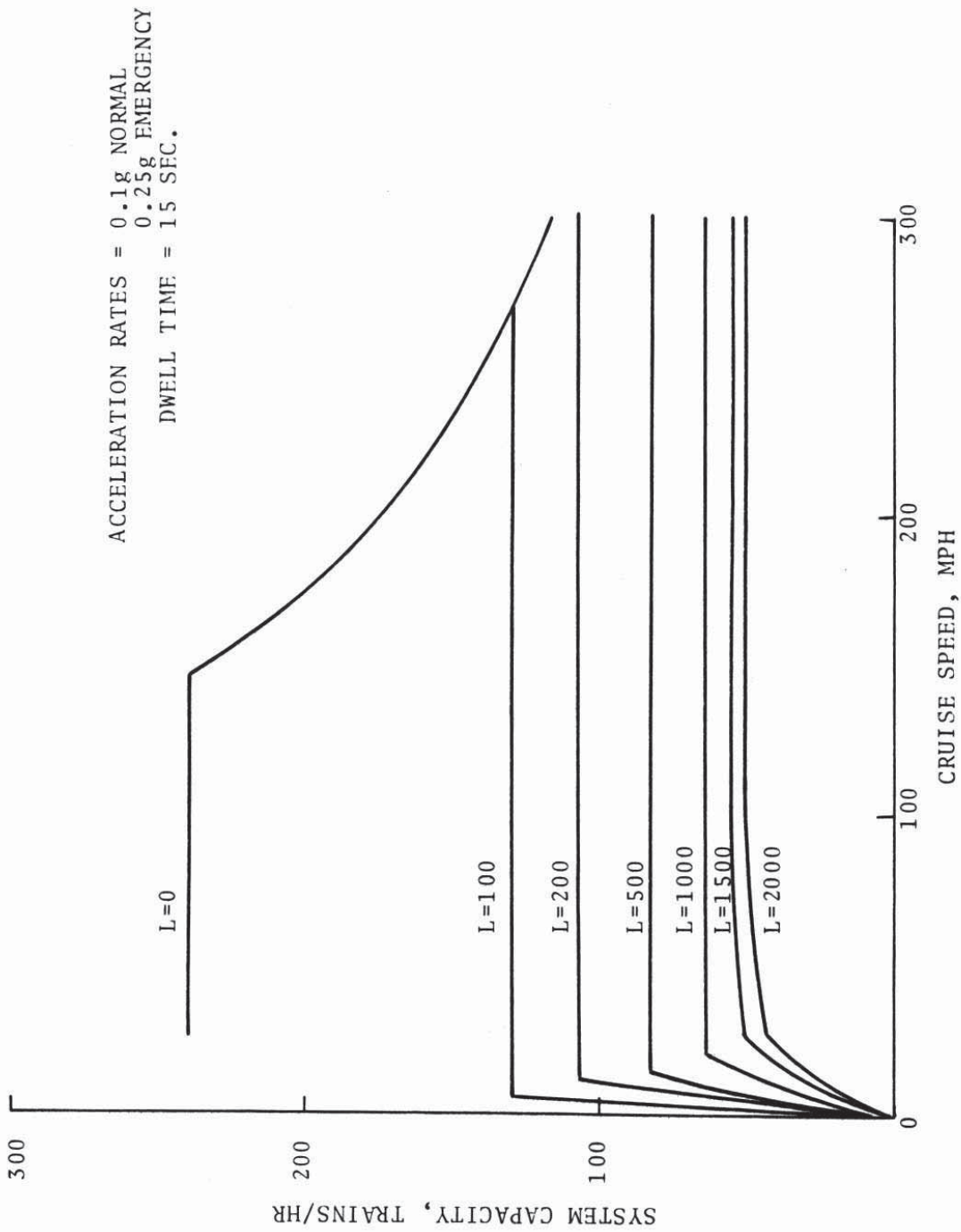

Figure 2-17. System Capacity Vs. Design Cruise Speed for Station Operations for Various Train Lengths, L



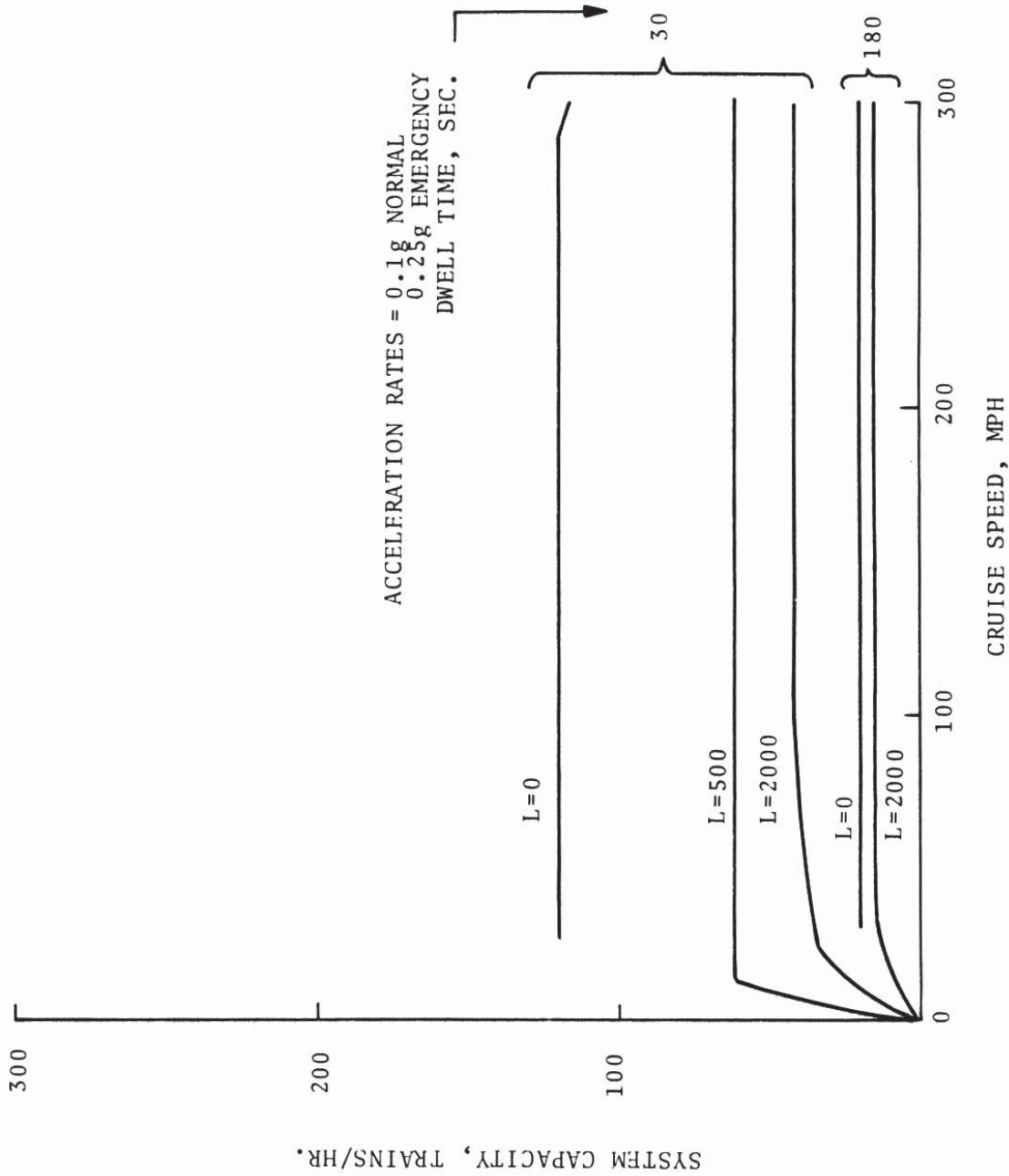

Figure 2-18. System Capacity Vs. Design Cruise Speed for Station Operations for Various Train Lengths, L, and Dwells

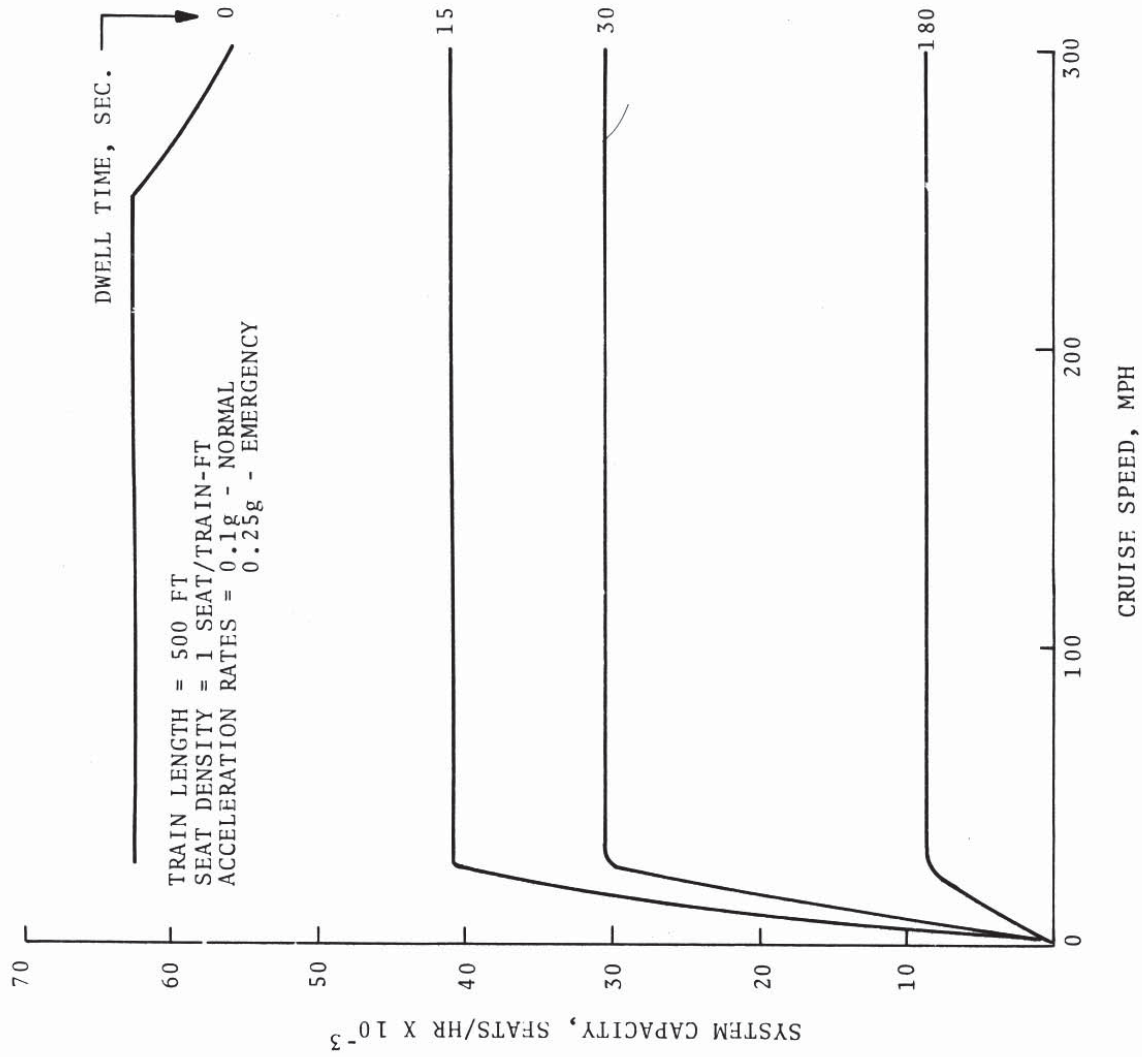

Figure 2-19. System Capacity Vs. Design Cruise Speed for Station Operations for Various Dwell Times

Figure 2-20 which consists of distance-time plots for two extreme station situations. As described previously, the minimum headway is determined by the minimum safe following distance between trains under the worst conditions encountered. Figure 2-20 describes the two potential worst conditions for station operations where the minimum distance between trains equals the train length plus the emergency stopping distance. When the train length is sufficiently long and/or there is a large dwell time, condition A will dominate occurring at a time when the leading train is leaving the station and the following train braking into the station. An interesting characteristic of the situation described by condition A is that, for a given train length, the headway between trains,  $H$ , remains constant regardless of cruise velocity above the value of  $V_{crit}$  defined in the figure. This characteristic is attributable to the occurrence of  $D_{min}$  at the same time  $T_m$ , on the distance-time curve regardless of cruise velocity above  $V_{crit}$ . This relationship results in the linear portion of the capacity curves, Figures 2-16 to 2-19, where capacity is independent of cruise velocity. If cruise velocities less than  $V_{crit}$  are encountered, the minimum safe following distance,  $D_{min}$ , occurs at rapidly increasing values of headway and produces the drop in capacity observed in Figures 2-16 to 2-18. As train length is increased, the minimum speed above which capacity is independent of speed increases: i.e.,  $V_{crit}$  increases with train length.

If the dwell time is particularly small and the train length short, as in condition B, Figure 2-20, the minimum required distance between trains,  $D_{min}$ , occurs prior to the station just as the following vehicle initiates braking. As can be seen from this figure, the dwell time for condition B can be varied between zero to  $T_a$  without having any effect on train spacing for a given train length and speed. This corresponds to the situation as described in Figures 2-16 and 2-17 where, for a given cruise velocity between 270 and 300 mph, there is no change in system capacity as the dwell time is increased from zero to 15 seconds. It can also be seen from condition B that the minimum distance between trains is a function of the cruise velocity. Condition B, therefore,

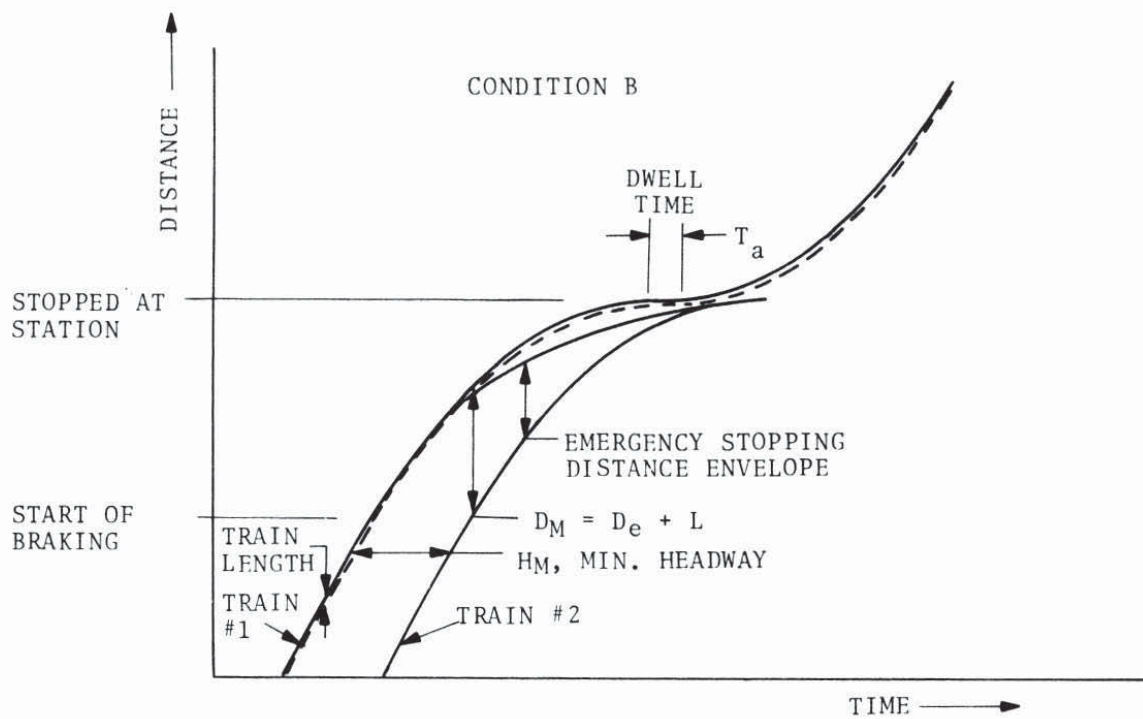
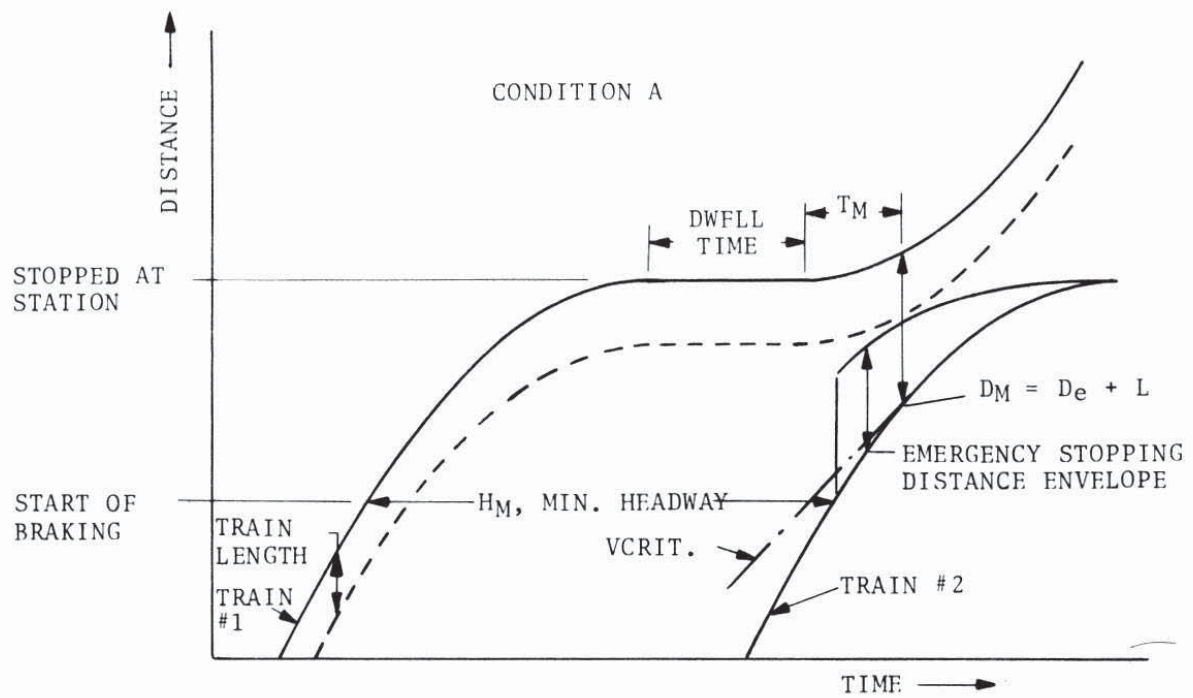

Figure 2-20. Effect of Station Operations on Minimum Headway,  $H_w$

produces those portions of the capacity curves, Figures 2-16 to 2-19, where capacity increases with decreasing cruise velocity.

Some general observations on on-line station operations are:

- a) System capacity is largely independent of cruise velocity except for the unusual cases of very short train lengths and dwell times.
- b) System capacity is determined almost completely by station dwell time for dwells greater than 15 seconds (a practical necessity).
- c) Normal values of dwell time and train length will restrict system capacity to well below its theoretical limit.

### 2.3.3 Station Operations, Off-Line

The use of off-line stations can significantly improve system capacity over that obtainable with on-line stations. Several types of off-line stations have been investigated as described in Figure 2-21. The type 1 station, referred to as the "stacking" type, causes all trains to pass through the station but each successive train arrives on a different track; thus, trains can be overlapped on stacks within the station and are simultaneously accessible by all passengers. The type 2 station, "alternating" type, enables alternate trains to stop in the station while others can proceed by the station at cruise speed without stopping. The alternating station, unlike the stacking station, would have only one train in the station at a time and, depending upon the number of trains bypassing the station, could have long intervals between trains stopping at intermediate station. A third type of off-line station, the "hybrid", could be implemented to provide the operational flexibility resulting from the combined features of the alternating and stacking stations. Because of the complexity involved in analyzing the characteristics of the hybrid station, only the alternating and stacking stations were investigated in detail.



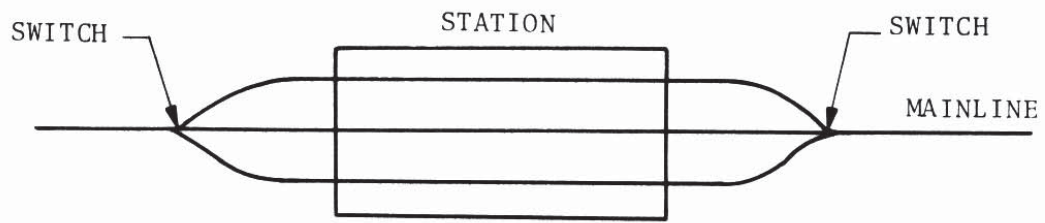

TYPE 1, STACKING STATION

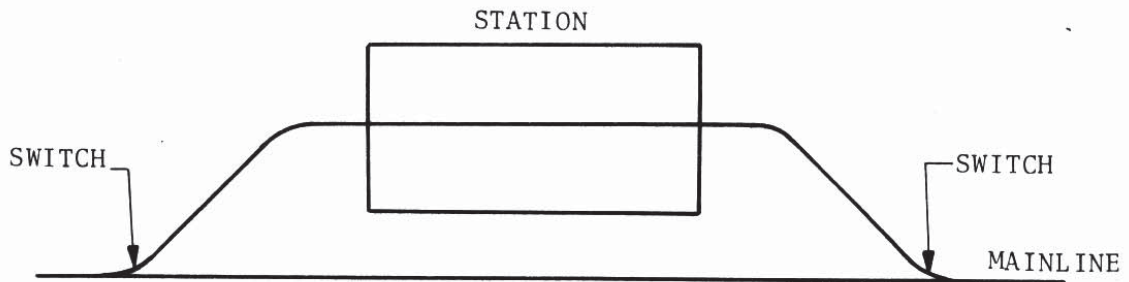

TYPE 2, ALTERNATING STATION

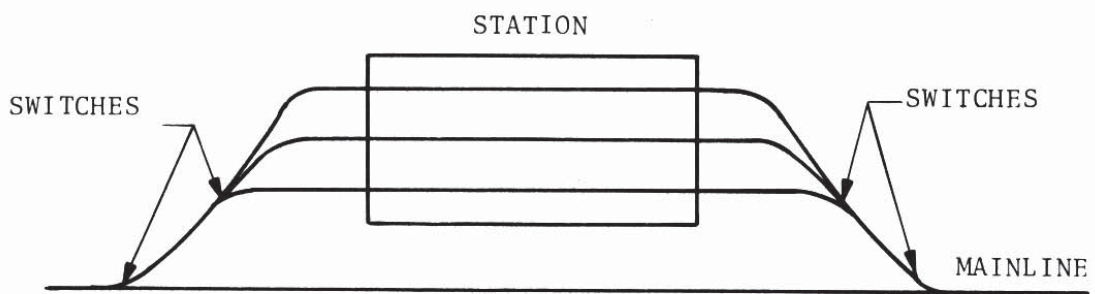

TYPE 3, HYBRID STATION

Figure 2-21. Off-Line Station Concepts

2.3.3.1 Alternating Station - The alternating off-line station would require a train distance-time profile similar to that described in Figure 2-22a. This figure shows the case of four consecutive trains operating at minimum headway (maximum capacity) with each train skipping one station between stops. Several features of this type of operation can be noted:

- a) The average velocity of the system will be increased because each train does not stop at all stations.
- b) By switching the lead train off the main line before entering the station, much of the transition time spent in the station can be eliminated from the headway between trains resulting, in most cases, in increased capacity over that of the on-line case.
- c) Alternating type station operations must be performed accordingly to a rigid schedule particularly when operating at maximum system capacity. Referring to Figure 2-22a, it can be seen that the distance-time profiles must contain a symmetrical pattern for continuous operations without interference among trains: (1) The linear portions of the distance-time trajectories of trains departing and arriving at stations (trains 1 and 3) must, when extended, be in line with each other; i.e., the arriving train must leave a slot on the guideway for the departing train to fill, (2) the headway between trains must be equal, and (3) each train must stop at its assigned station. If the system is not operating at peak capacity (excess headway between trains), some flexibility of operations in terms of unequal headways and stations stopped at may be possible.
- d) The average minimum headway between trains ( $H_{\text{off-line}}$ ) for the alternating type station must satisfy the following conditions:

$$H_{\text{off-line}} = (H_{\text{in}} - \text{out}) / (N+1) \geq H_{\text{crit}} \quad (2.3-3)$$

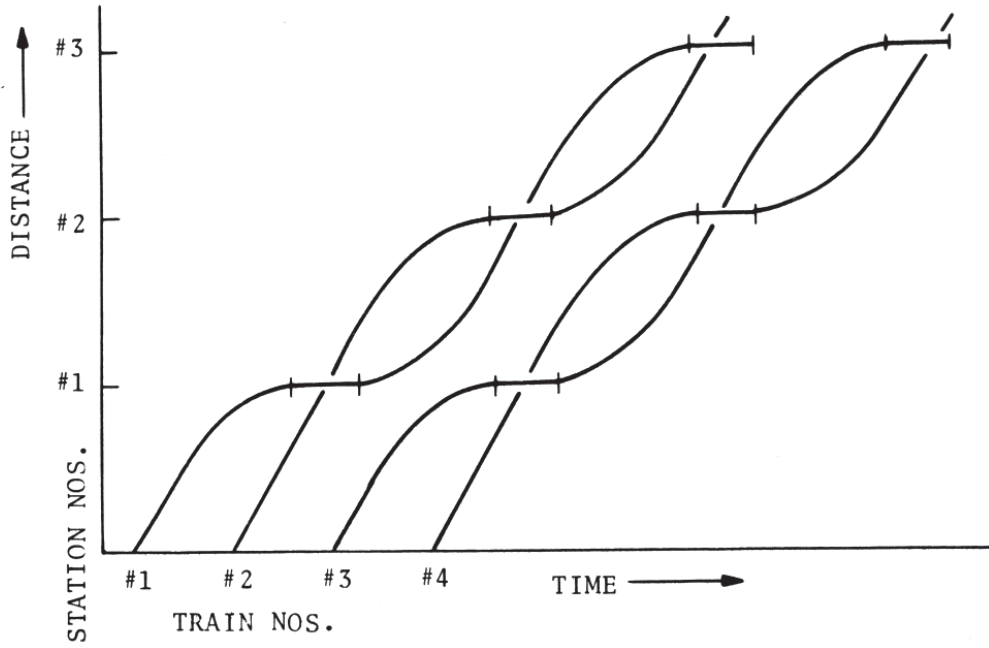

Figure 2-22a. Distance-Time Profile for Alternating Type Station

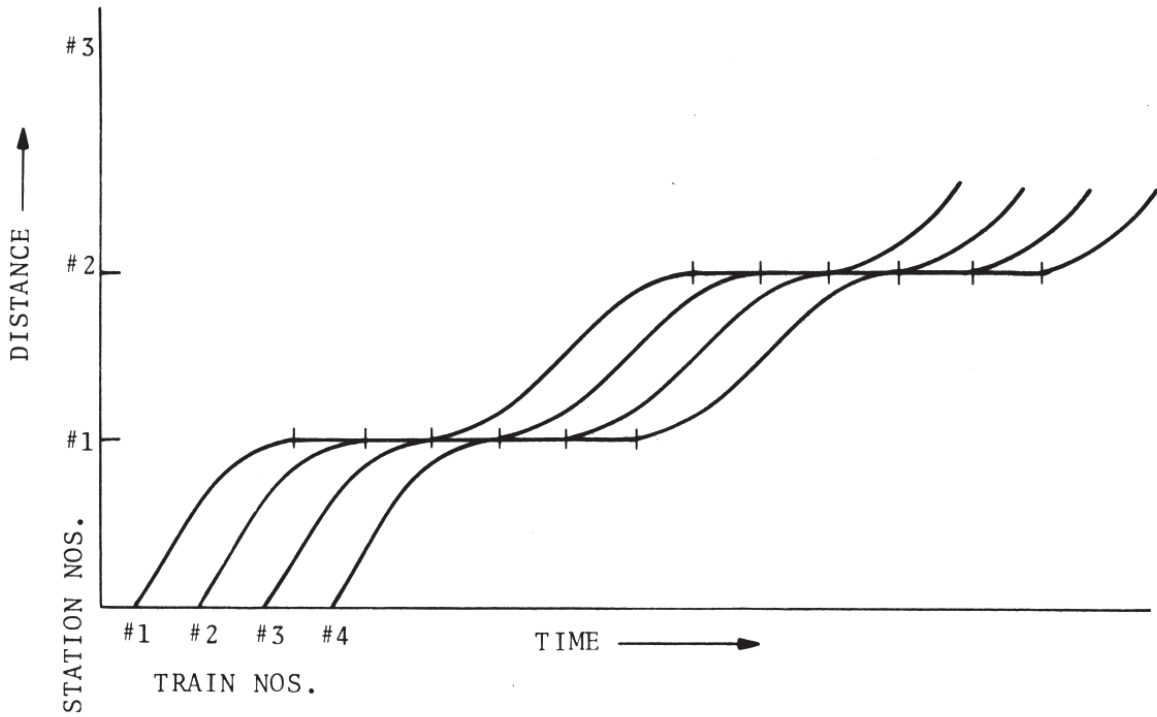

Figure 2-22b. Distance-Time Profile for Stacking Type Station

where  $H_{in-out}$  = the total transition time for the station (braking time plus dwell time plus acceleration time) represented by the time between trains 1 and 3, Figure 2-22a.

$N$  = a whole integer and equal to the number of stations skipped between stops.

$H_{crit}$  - the minimum safe headway between trains to be described later as a function of the type of switching used to achieve off-line operations.

2.3.3.2 Stacking Station - The distance-time profile for the stacking type of off-line station is described in Figure 2-22b. For the case shown it is also assumed that the system is operating at peak capacity. The following characteristics of operation utilizing the off-line stacking type of station should be noted:

- a) The average velocity of the system will not be increased as each train must stop at every station as with the on-line stations.
- b) The headway of the system can be less than that of the on-line system indicated by the headway between trains 1 and 4.
- c) The stacking type of off-line station imposes less constraints on the operations of trains than does the alternating station. In terms of the distance-time profiles described in Figure 2-22b the only condition which must be maintained is that the headways between trains be greater than a critical value (at maximum capacity the headways must also be equal). Provided the minimum is maintained, the stacking station will permit variations in the sequencing of incoming and outgoing trains by changing the dwell times. For example, train A could arrive at a station first followed, at a headway of 4.5 minutes, by train B. Train B could then leave the station first, reversing the sequence, by dwelling only one minute as opposed to a ten minute dwell for train A still leaving a 4.5 minute headway between trains.

- d) The average headway between trains using a stacking type station is constrained by the following conditions:

$$H_{\text{off-line}} = H_{\text{on-line}}/S \geq H_{\text{crit}} \quad (2.3-4)$$

where  $S = A$  whole integer and equal to the minimum number of stacks which must be available in the station.

$H_{\text{on-line}}$  = headway required for an on-line station with the same dwell time corresponding to the time between trains 1 and 4 in Figure 2-22b.

$H_{\text{crit}}$  = the minimum safe headway between trains for the type of switching used (defined below).

2.3.3.3 Switching for Off-Line Stations - The maximum system capacity which can be achieved with the use of off-line stations, as described by Equations 2.3-3 and 2.3-4 is a function of both the station and switching concept used. The various types of switches useful for off-line station operations can be generally classified according to switch speed (permissible speed of train through switch) and whether or not the switch is an active or passive element in the switching process. The type of switching assumed will establish the minimum possible headway,  $H_{\text{crit}}$ , for off-line station operations. A brief description of the four types of switches analyzed follows:

1. High Speed Switch - permits the train to be switched off the main line at cruise velocity. All deceleration from and acceleration to cruise speed occurs off the main line.
2. Low Speed Switch - requires that the train to be switched off the main line must decelerate to the switch speed before traversing the switch. For purposes of this analysis a switch speed of 50 mph was assumed for the low speed switch corresponding to the maximum speed at which a 1500 ft radius can be negotiated within passenger comfort limits. It is further assumed



that any train not being switched off the mainline will pass through the switch at cruise velocity.

3. Active Switch - can be either high speed or low speed and actively participates in the switching process. As defined here, it is assumed that the active switch must be completely cleared of the lead train before it can be recycled to receive the next train to be switched. The active switch, therefore, requires three times increments to be added to the headway between trains: (1) switch clearing time,  $T_{sc}$ ; (2) switch recycling or activation time,  $T_s$ ; and (3) switch verification time,  $T_v$  (time required to verify to an oncoming train that the switch has been recycled, assumed to be zero for this study).
4. Passive Switch - can also be either high speed or low speed but does not contribute actively to switching the train. The passive switch, therefore, does not add any time to the required headway between trains.

The effect of the various switching concepts on the minimum headway between trains can be explained with the aid of Figure 2-23 showing distance-time profiles for two consecutive trains traversing different type switches. The following conclusions can be summarized from analysis of the distance-time profiles:

1. High Speed Passive Switch - Because the train does not decelerate from cruise speed to negotiate the switch and the switch is passive: i.e., it does not require additional headway time, the minimum headway between trains for the high speed passive switch,  $H_{crit} (hp)$ , is the same as that required for mainline operations:

$$H_{crit} (hp) = H_m = T_1 + T_e \quad (2.3-5)$$

where  $T_1$  = Time required to travel the length of the train at cruise velocity.

$T_e$  = Time required to travel the emergency stopping distance at cruise velocity.

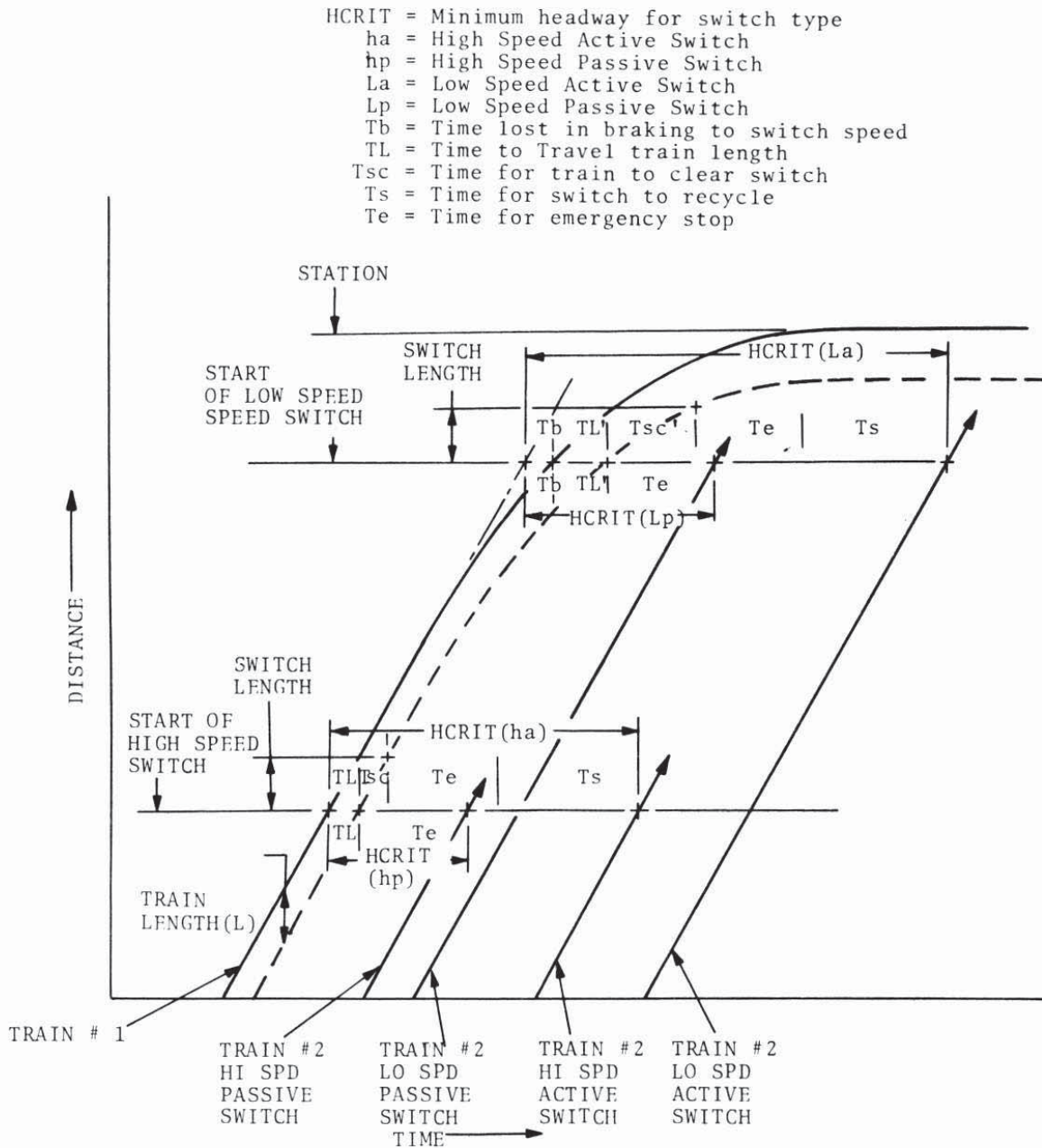

Figure 2-23. Effect of Switch Type on Minimum Headway, Hcrit, Between Trains #1 and 2

2. Low Speed Passive Switch - The low speed passive switch requires a larger headway than its high speed counterpart to avoid interference between trains. Because the lead train must decelerate on the mainline to switch speed, an additional time increment,  $T_b$  (equivalent to the time lost in approaching the switch because of braking), is required. The time required for the train length to clear the switch entrance,  $T_{l'}$ , must also be greater than for the high speed switch because the train is travelling at less than cruise speed. The emergency stopping time,  $T_e$ , for the low speed switch is the same as for the high speed case as it applies only to the following vehicle which remains at cruise velocity through the switch.

$$H_{crit} (lp) = T_{l'} + T_e + T_b \quad (2.3-6)$$

3. High and Low Speed Active Switches - Active switches will require switch clearing and switch activation times added to the minimum headway for the passive cases. For purposes of this analysis, the switch activation time,  $T_s$ , was assumed to be equal for both the high and low speed switches; however, in practice the high speed switch could require more time to recycle because it would be physically larger than the low speed switch. The low speed switch will have a longer clearing time,  $T_{sc'}$ , since the train will be moving slower through the switch.

$$H_{crit} (ha) = T_l + T_e + T_s + T_{sc} \quad (2.3-7)$$

$$H_{crit} (la) = T_{l'} + T_e + T_s + T_{sc'} + T_b \quad (2.3-8)$$

To provide an example of the effects of switching technique on minimum headway requirements,  $H_{crit}$ , typical switch parameters were assumed and resulting headways were calculated for several train cruise velocities. The results are shown in Table 2-4 and indicate, as expected, that the smallest and largest headways are required by the high speed passive and low speed active switches respectively.



TABLE 2-4. MINIMUM HEADWAY,  $H_{crit}$ , REQUIRED FOR DIFFERENT SWITCHES\*

Switch Type Cruise Speed	$H_{crit} =$	$T_1$	$+ T_e$	$+ T_s$	$+ T_{sc}$	$+ T_b$
High Speed Passive						
300	28.5	1.2	27.3	0	0	0
200	20.0	1.8	18.2	0	0	0
100	12.5	3.4	9.1	0	0	0
High Speed Active						
300	61.9	1.2	27.3	30	3.4	0
200	53.8	1.8	18.2	30	3.8	0
100	46.6	3.4	9.1	30	4.1	0
Low Speed Passive						
300	148.1	6.8	27.3	0	0	114
200	93.0	6.8	18.2	0	0	68
100	38.9	6.8	9.1	0	0	23
Low Speed Active						
300	183.1	6.8	27.3	30	5.0	114
200	128.0	6.8	18.2	30	5.0	68
100	73.9	6.8	9.1	30	5.0	23

\*Train length, 500 ft; braking rate, .1g normal .25g emergency

Switch Parameters:	<u>Speed</u>	<u>Length</u>	<u>Radius</u>	<u>Superelevation</u>
	300	1,500	25,000	10°
	200	1,100	12,718	7.5°
	100	600	4,017	5°
	50	370	1,500	5°

2.3.3.4 Capacity for Off-Line Stations - The improvement in system capacity which can be obtained by using off-line stations is described in Figures 2-24 and 2-25. These figures show system capacity as a function of train speed for the various switching concepts and off-line station types investigated. The results were based on a station dwell time of 180 seconds and the switch parameters listed in Table 2-4. An interesting feature of the figures is that changes in capacity as a function of speed occur in discontinuous steps. This is due to the constraints imposed by the headway Equations 2.3-3 and 2.3-4 requiring that the terms  $N$  and  $S$  must be whole integers. The step changes in capacity, therefore, occur when  $N$  and  $S$  change from one integer value to another. The numbers on the curves between step changes in Figures 2-24 and 2-25 correspond to the values of  $N$  and  $S$  for the alternating and stacking type stations respectively.

The capacity curves for the stacking type station show no change in capacity between changes in  $S$  while the curves for the alternating type station do indicate a change in capacity between values of  $N$ . Referring to Equations 2.3-3 and 2.3-4, this condition occurs because  $H_{in-out}$  (total station transition time) varies with train speed while  $H_{on-line}$  (on-line station headway) does not for the speed range, station and train conditions assumed (see also Figure 2-18, 180 second dwell).

The results of the analysis indicate that off-line stations can be utilized to increase system capacity over that obtainable with on-line stations although a greater improvement is achieved for lower speed systems other things being equal. One exception to this generalization can be seen in the case of the 300 mph train, alternating type station, low speed active switching, where the capacity is slightly less than the on-line system for the operating conditions assumed. While generally improving capacity, however, the off-line stations require a more complex operating schedule involving stacking trains within stations or skipping stations between stops. As can be seen from Figures 2-24 and 2-25 any increase in capacity is achieved at the expense of additional stacks or skipped stations. This would appear to be a severe



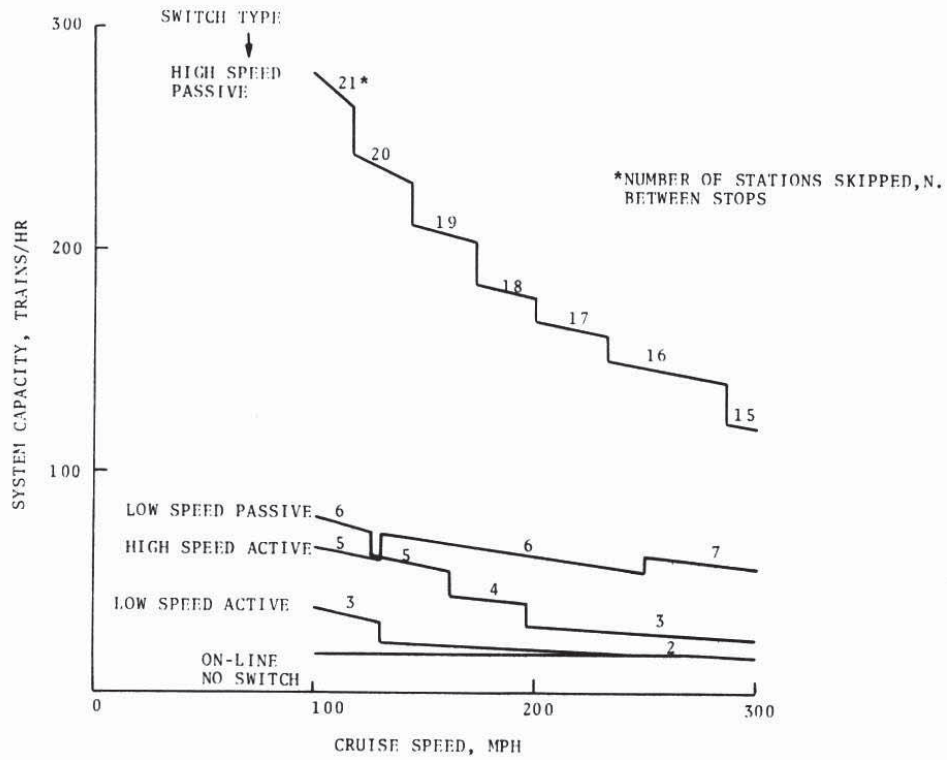

Figure 2-24. System Capacity Vs. Design Cruise Speed for Various Types of Switches and Alternating Off-Line Stations

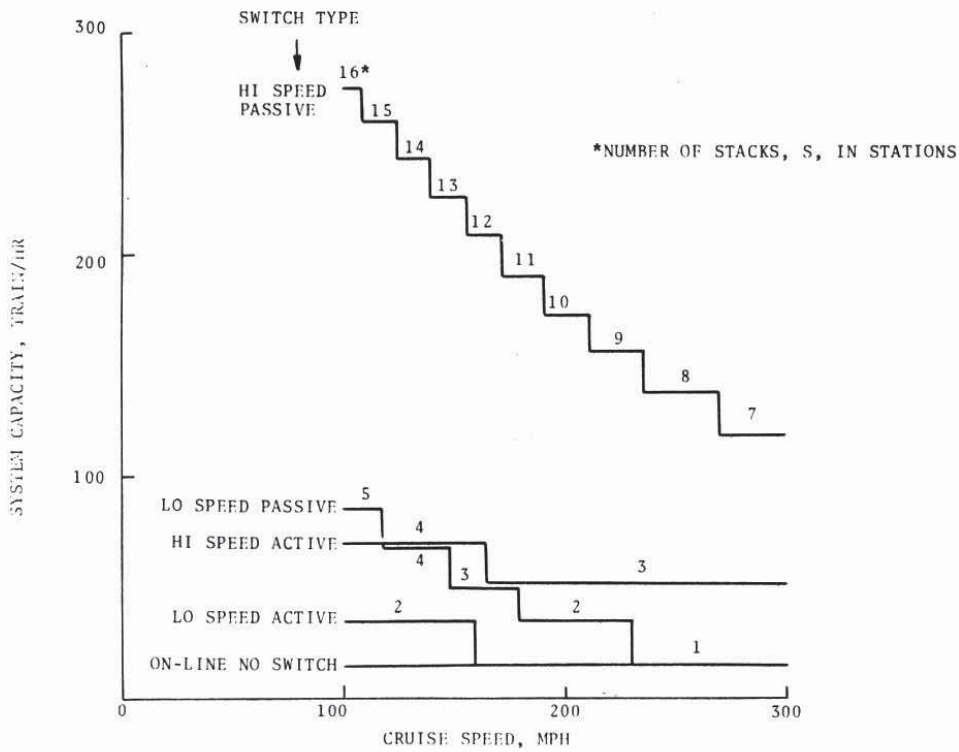

Figure 2-25. System Capacity Vs. Design Cruise Speed for Various Type of Switches and Stacking Off-Line Stations

operational restriction for the alternating type station as skipping any more than three or four stations between stops would appear impractical. Furthermore, the same capacity level can be achieved with fewer station stacks(S) than stations skipped (N) particularly for the higher speed systems (200 to 300 mph).

Figures 2-24 and 2-25 also show that the type of switching assumed can significantly affect system capacity. One means of assessing the relative merits of the various switch types is to compare the relative improvement in capacity achieved against switch complexity. In terms of switch complexity, the passive switch should be preferable over an active switch for a given switch speed, since it would be more reliable, less costly to operate and probably less costly to install. It should be noted, however, that a passive switch could lead to a more complex train technology hence, the effect on total system costs is not so easily assessed. If the same capacity improvement can be accomplished with a high or low speed passive switch, the low speed switch would probably be more desirable as it would cost less to install and require less right of way.

An evaluation of the various switch types in terms of their ability to achieve minor and major improvements in capacity, arbitrarily defined as a doubling and quadrupling of capacity respectively, for various train speeds is summarized in Table 2-5. As can be seen, in all cases, the passive switches are preferable over the active switches. In fact, the high and low speed active switches will not achieve a major improvement in capacity for any of the train speeds investigated. For the 100 mph system a low speed passive switch will achieve the minor and major capacity improvement objectives while the high speed passive switch is required for the 300 mph to meet both objectives and for the 200 mph to meet the major improvement objective. For very high speed systems (200-300 mph) it appears important, therefore, that a high speed passive switching capability exist if the full potential of their high speed is to be realized.

Some general observations on off-line stations are:

TABLE 2-5. EVALUATION OF SWITCH TYPES FOR OFF-LINE STATIONS TO ACHIEVE IMPROVED SYSTEM CAPACITY\*

Capacity Improvement Objective							
Switch Type	Switch Complexity	Minor (Double) Train Speed			Major (Quadruple) Train Speed		
		100	200	300	100	200	300
High Speed Passive	2	np	np	pref.	np	pref.	pref.
High Speed Active	4	np	np	np	no	no	no
Low Speed Passive	1	pref.	pref.	no	pref.	no	no
Low Speed Active	3	np	no	no	no	no	no

\*np - Can be achieved but "not preferrable" because the goal can be accomplished with a less complex switch

no - Switch will not achieve objective

pref. - Switch is "preferred" because it will accomplish objective with least complexity

Complexity - 1, least complex; 4, most complex

Switch and Train parameters - same as for Table 2-4.

- a) Off-line stations will generally permit an increase in capacity over that obtainable with on-line stations for the same station dwell time and train length.
- b) A given off-line station and switching concept will produce a greater gain in capacity for lower speed trains.
- c) The stacking type of off-line station will yield the highest capacity with least amount of added operational complexity.
- d) For low speed systems (less than 150 mph) the low speed passive switch is adequate to achieve a major improvement in capacity. High speed systems (greater than 150 mph) will require a high speed passive switching capability to significantly improve capacity over the on-line station case. The active switches (high and low speed) are not preferable for off-line station operations.

#### 2.3.4 Curve Operations

The analysis of the effects of curves on system capacity resulted in the identification of four situations during the negotiation of curves where the safe following distance between trains was at a minimum. The four conditions for minimum following distance are described by distance-time plots in Figure 2-26 and summarized in Table 2-6. The capacity model computes the minimum following distance for each condition for the lowest speed curve in the system and selects the largest distance to be used as the basis for calculating maximum system capacity. For all the curve analyses, it was assumed that the curves were sufficiently long that all four conditions were applicable. In practice, however, it is possible to encounter curves so short that the lead train does not remain at curve speed long enough for condition 3 to be applicable, for example. The capacity model, when considering curves, is therefore somewhat conservative.

Figures 2-27 and 2-28 describe the effect of curves on system capacity for various train lengths assuming no stations exist in the system. The figures are bounded by an outer envelop which



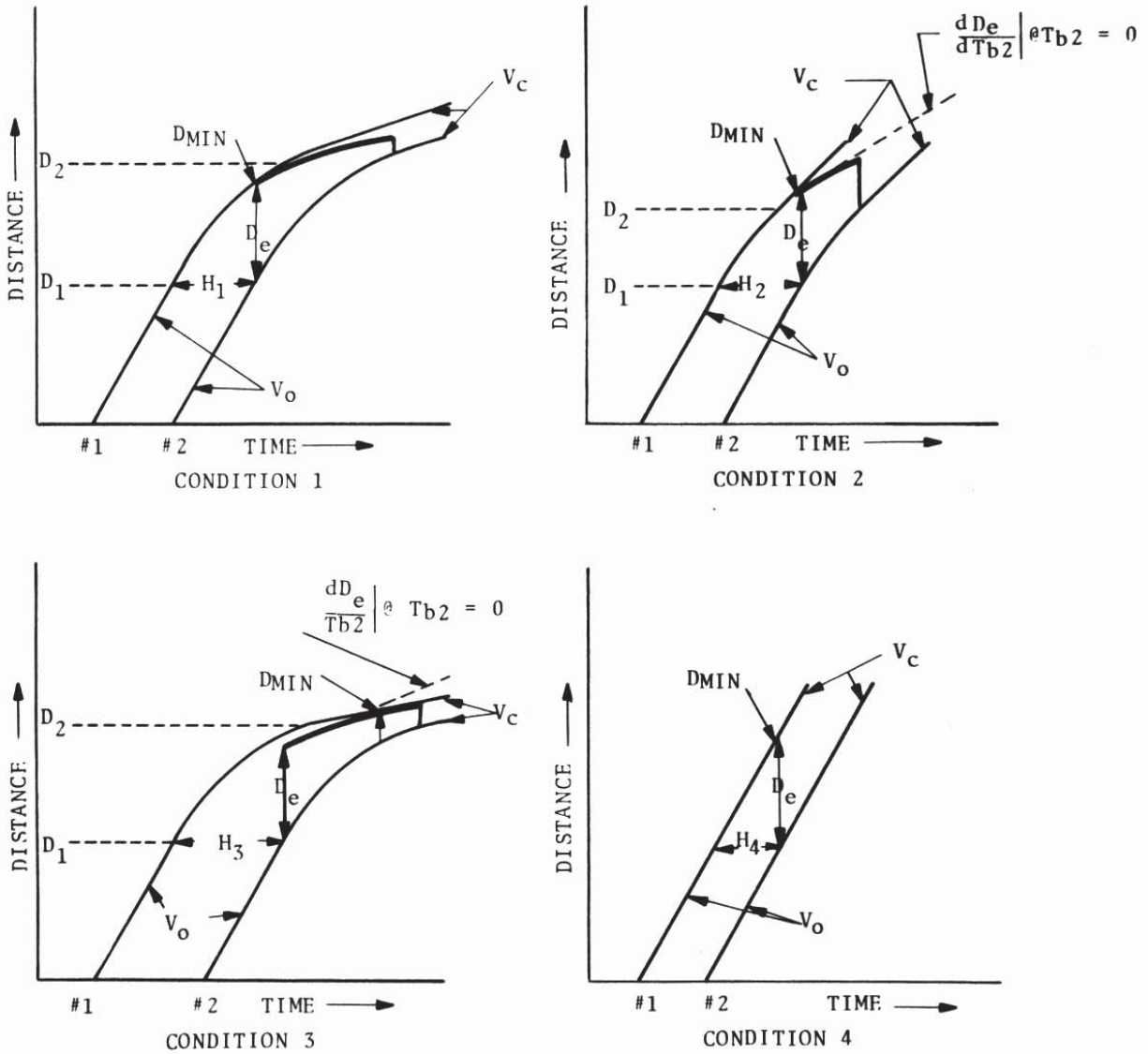

FOOT NOTES:

- $V_o$  = cruise speed before slowing for curve
- $V_c$  = curve speed
- $H$  = minimum headway
- $D_{MIN}$  = minimum following distance
- $D_1$  = point at which braking for curve starts
- $D_2$  = point at which braking for curve ends
- $D_e$  = emergency stopping distance. Maximum at  $D_1$ , minimum at  $D_2$  as described by heavy line
- $\frac{dD_e}{dT_{b2}} \Big|_{T_{b2} = 0}$  = Slope of emergency braking distance profile described by heavy line at the time when train #2 starts braking

Figure 2-26. Four Conditions for Minimum Headway During Curve Operations



TABLE 2-6. SUMMARY OF CONDITIONS FOR MINIMUM DISTANCE BETWEEN TRAINS DURING CURVE OPERATIONS (Figure 2-26)

Condition No.	State of Trains 1 & 2		Curve Characteristics for Condition to Dominate
	Train 1	Train 2	
1	Decelerating to curve speed	Just initiating braking	Generally occurs when curve speed is significantly less than cruise speed, $V_c \ll V_o$
2	At curve speed	Just initiating braking	<p>Curve speed must be greater than the speed corresponding to the slope of the emergency braking distance envelope for train 2 at the initiation of braking,</p> $V_c > \frac{d}{d} \frac{De}{Tb2} \Big  @ Tb2 = 0$ <p>Generally occurs when the curve speed is only slightly less than cruise speed</p>
3	At curve speed	Decelerating to curve speed	<p>Curve speed must be less than the slope of the emergency braking distance envelope at the initiation of braking for train 2,</p> $V_c < \frac{d}{d} \frac{De}{Tb2} \Big  @ Tb2 = 0$ <p>Generally occurs when curve and cruise speed are low.</p>
4.	At curve speed	At curve speed	Occurs only when curve speed equals cruise speed, $V_c = V_o$

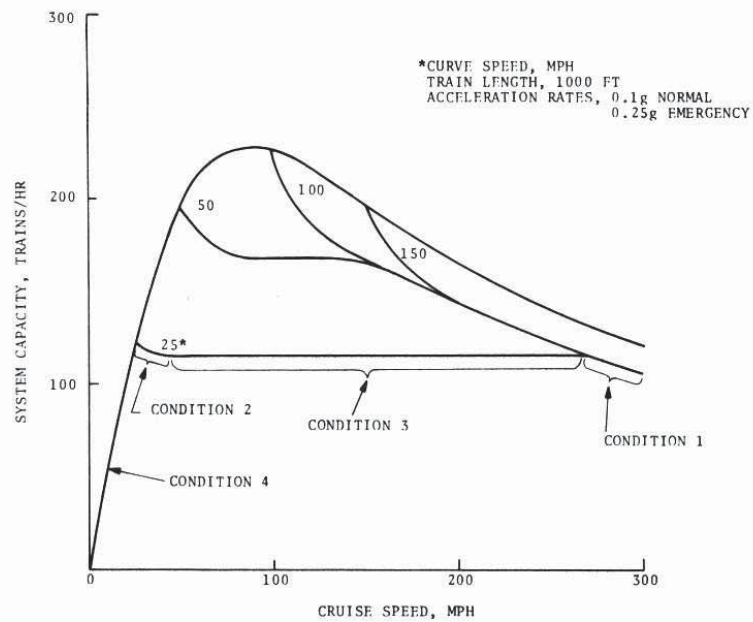

Figure 2-27. System Capacity Vs. Design Cruise Speed for Various Curve Speeds, Train Length = 500 ft.

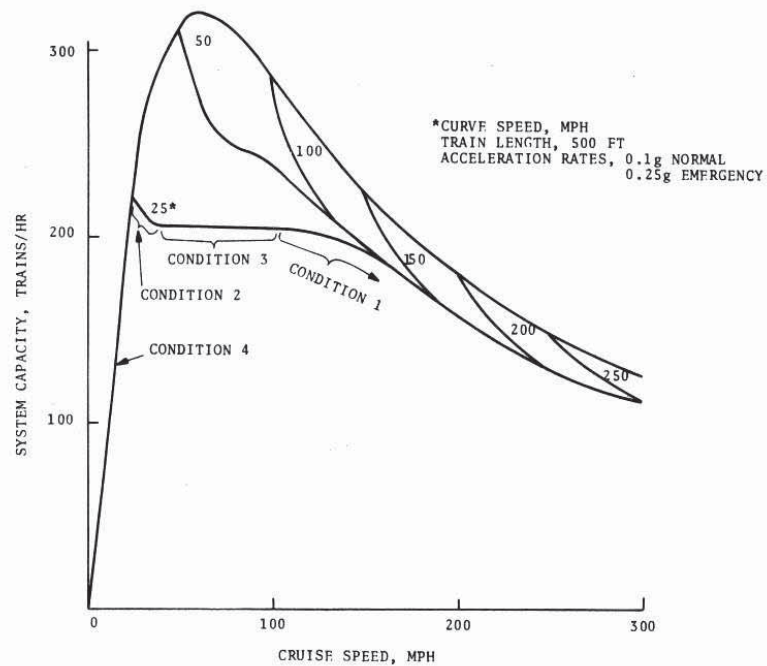

Figure 2-28. System Capacity Vs. Design Cruise Speed for Various Curve Speeds, Train Length = 1000 ft.

describes system capacity without the influence of any curves. As can be seen, the general effect of curves is to shift system capacity to below that described by the outer envelope for all train cruise speeds above the minimum curve speed. Several characteristics of the capacity plots (Figures 2-27 and 2-28) can be explained in terms of the minimum safe following distance conditions described in Table 2-6 and Figure 2-26:

- a) If the difference in cruise and curve speed is large ( $V_o = 300$  mph,  $V_c = 25$  mph) a change in curve speed does not affect capacity for the high speed train. This situation is described by condition 1 where it can be seen that the point of minimum safe distance between trains,  $D_{min}$ , remains at the same headway,  $H_1$ , for all curve speeds less than  $V_c'$ .  $V_c'$  is the curve speed corresponding to the slope of the emergency braking distance envelope (heavy line, Figure 2-26) of train 2 at the time of initial braking,  $T_{b2} = 0$ .
- b) If the cruise and curve speed are low, and the difference moderately large ( $V_o = 100$  mph,  $V_c = 25$  mph) condition 3 may dominate and results in those portions of the capacity curves where capacity is independent of cruise velocity for a given curve speed. Figure 2-26, condition 3 shows that the independence of capacity and cruise velocity is due to  $D_{min}$  occurring at the same headway,  $H_3$ , regardless of cruise velocity above  $V_o'$ .  $V_o'$  corresponds to the cruise velocity which produces an emergency braking distance envelope with a slope, at  $T_{b2} = 0$ , equal to the curve velocity.
- c) As the cruise velocity approaches the curve velocity, the effects of the curve on capacity diminish rapidly. This situation is described by condition 2 and produces those portions of the capacity curves where the capacity shifts abruptly from the inner envelope to the outer envelope.
- d) If the cruise velocity is less than the minimum curve speed the capacity is described by condition 4. This

situation is the same as for mainline operations (no curve present) and corresponds to the outer envelope of the capacity curve.

A comparison of Figures 2-27 and 2-28 with the capacity curves for on-line and off-line station operations (Figures 2-16 to 2-19 and 2-24 and 2-25 respectively) indicates that curves will be the dominant constraints on system capacity only under the conditions where low speed curves (25 mph) and off-line stations with high speed passive switching exist. Such a situation could arise in practice if, for example, natural geographical obstacles were present along the route which require very low speed tunnels, bridges or curves. In general, however, any on-line station present in the system will always determine system capacity.

Some general observations made on curve operations are:

- a) Curves generally will not be the dominant constraint on capacity for actual applications.
- b) The effect of curves on capacity becomes more severe with increasing train length.
- c) Curves have no effect on capacity if the maximum train cruise velocity is less than the minimum curve speed.

#### 2.3.5 Acceleration and Braking Rates, Station and Curve Operations

The effect of acceleration and braking rates, including emergency braking rates, on system capacity for typical on-line station and curve operations is described in Figures 2-29 and 2-30. As can be seen, the effect on system capacity of varying these parameters is not significant for either station or curve operations except for the case of varying the emergency braking rate on curve operations. For this situation, a change in the emergency braking rate from .15g to .4g (extreme range of typical values) more than doubles the system capacity for mainline and curve operations (curve speed 25 mph) for cruise speeds above 50 mph and 150 mph respectively. The change in capacity for station operations would also have a similar increase if the dwell time was zero. The

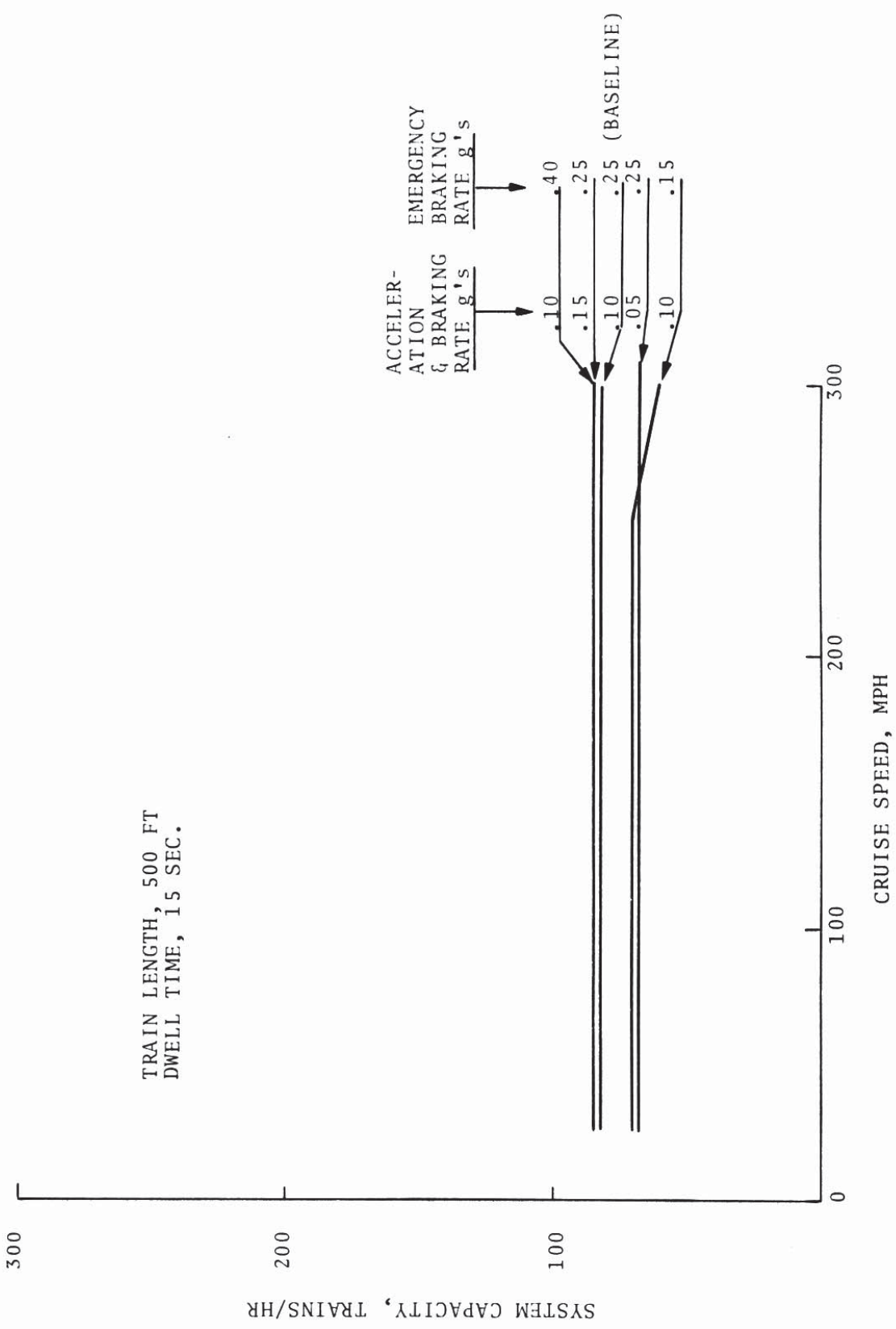

Figure 2-29. System Capacity Vs. Design Cruise Speed for Various Acceleration Rates, Station Operations



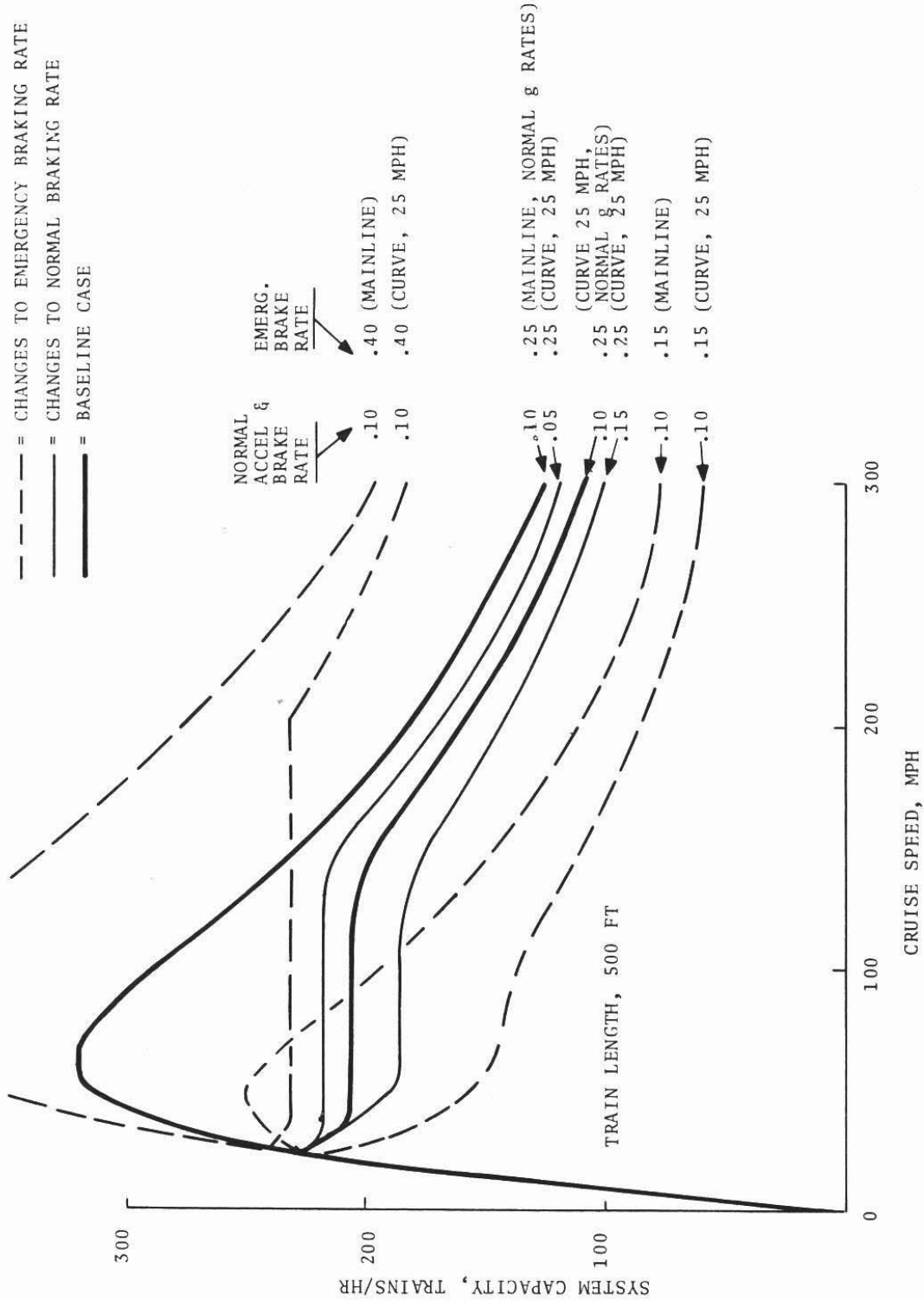

Figure 2-30. System Capacity Vs. Design Cruise Speed for Various Acceleration Rates, Curve Operations

dwell, however, has such a dominant effect on system capacity that it obliterates any improvement in acceleration rates. Similarly, in spite of the large variations in capacity for curve operations resulting from changes in acceleration rates, on-line station operations will always be the dominant constraint on system capacity for given acceleration rates because of dwell times.

An interesting contra-intuitive result which occurs when varying normal acceleration and braking rates can be seen in Figure 2-30 (25 mph curve, .25g emergency braking rates) where the system capacity increases when the normal braking rate is decreased from .15g to .05g. This situation occurs because the lead train is braking more slowly into the curve while the following vehicle maintains the same emergency braking rate potential. The result, as can be seen in Figure 2-26, (especially condition 1) is that less separation is required between trains (higher capacity) to avoid interference.

Some general observations, made on acceleration and braking are:

- a) Variation in the normal acceleration and braking rates does not produce significant changes in system capacity for curve or station operations.
- b) Variations in the emergency braking rate can produce large changes in system capacity but, if on-line stations are present, the change is completely dominated by the dwell time.
- c) For given acceleration rates, on-line stations will always determine system capacity. Curve operations may dominate only for some special cases of off-line station operations.

#### 2.4 SUMMARY OF RESULTS, PARAMETRIC SENSITIVITY ANALYSES OF TRAIN PERFORMANCE

A summary of the preceding performance analyses is presented in Tables 2-7 and 2-8 as sensitivities of average velocity and system capacity to the parameters investigated. For purposes of this study, sensitivity was defined as the change in system

TABLE 2-7. SUMMARY OF PARAMETRIC SENSITIVITY ANALYSIS RESULTS ON AVERAGE VELOCITY

Parameter	Typical Range of Values For Parameter Investigated	Other Conditions	Sensitivity of Parameters, mph		
			100 mph	200 mph	300 mph
Station Operations:	Min. Max.				
Station Spacing	10 mi 100 mi	180 sec. dwell	31	94	154
Dwell Time	15 sec 300 sec	25 mi spacing	21	48	73
On/Off-Line	On-line Off-line	180 sec dwell 25 mi spacing Alternate trains stop	9	24	51
Curve Operations:					
Curve Speed	60 mph 240 mph	1 curve/10 miles .5 mi long curves	6	55	120
Curve Frequency	1 curve/ 1 mi 100 mi	150 mph curve .5 mi long curve	0	48	130
Curve Length	.1 mi 1 mi	150 mph curve 1 curve/10 miles	0	5	14
Acceleration and Braking Rates:					
Station Operations	.05g .15g	25 mi spacing 180 sec dwell	4	20	38
Curve Operations	.05g .15g	1 curve/10 mi 150 mph curve .5 mi long curves	0	9	46



TABLE 2-8. SUMMARY OF PARAMETRIC SENSITIVITY ANALYSIS RESULTS ON SYSTEM CAPACITY

Parameter	Typical Range of Values For Parameter Investigated		Other Conditions	Sensitivity of Parameter, Seats/hr		
	Min.	Max.		100 mph	200 mph	300 mph
Station Operations:						
Station Dwell	15 sec	300 sec	500 ft. train length	35500	25500	35500
On/Off Line	on-line	Off-line (stack) Switching:	500 ft. train length 180 sec dwell	128500	72000	55000
		<ul style="list-style-type: none"> <li>• High Speed Passive</li> <li>• High Speed Active</li> <li>• Low Speed Passive</li> <li>• Low Speed Active</li> </ul>		26000	16000	16000
				35000	10000	0
				10000	0	0
Curve Operations:						
Curve Speed	60 mph	240 mph	500 ft. train length	23500	11500	0
Normal Acceleration and Braking Rates:						
Station Operations	.05g	.15g	500 ft. train length 180 sec dwell .25g emerg. brake	350	350	350
Curve Operations	.05g	.15g	500 ft. train length 150 mph curve .25g emerg. brake	0	2000	9000

TABLE 2-8. SUMMARY OF PARAMETRIC SENSITIVITY ANALYSIS RESULTS ON SYSTEM CAPACITY (Cont'd)

Parameter	Typical Range of Values For Parameter Investigated		Other Conditions	Sensitivity of Parameter,		
	Min.	Max.		100 mph	200 mph	300 mph
Emergency Braking Rate:						
Station Operations	.15g	.40g	500 ft. train length 180 sec dwell .10g accel and brake	300	300	650
Curve Operations	.15g	.40g	500 ft. train length 150 mph curve .10g accel and brake	101000	73500	57000
Train Length:						
Station Operations	100 ft	1000 ft	180 sec dwell	14444	14444	14444
Curve Operations	100 ft	1000 ft	150 mph curve	189252	126370	95005
Control System:						
Station Operations	Binary Block	Follower	180 sec dwell 500 ft. train length	1045	1045	1045
Curve Operations	Binary Block	Follower	150 mph curve 500 ft. train length	143500	79000	53000



performance, measured by average velocity (mph) and system capacity (seats/hr), resulting from a variation of the parameter over a range of values it could be expected to possess in a typical high-speed ground application. As such, the resulting sensitivity is somewhat subjective as it is dependent upon the range of values considered for the parameter. The computation of exact sensitivities, however, in terms of the percent change in performance for a one percent change in the parameter, would not have been any more meaningful. Since most of the functions are nonlinearly related, establishing single valued sensitivities to be used for comparison would have required arbitrarily choosing a typical value of the parameter about which a point sensitivity could be calculated. The sensitivities presented in Table 2-7 and 2-8, while not being exact, do provide a general appreciation of the relative significance of various controllable parameters on the performance of high-speed ground transportation systems.

Unless otherwise indicated, when each parameter was being investigated all other independent parameters were set a baseline values indicated in Table 2-9. It should be noted that station and curve operations parameters were decoupled during establishment of sensitivities; hence, the sensitivities listed for curve parameters are based on the assumption that no stations exist and vice-versa. When interpreting the sensitivities for actual applications, where both curves and stations necessarily exist, several considerations should be noted. The sensitivities listed, as measured by average velocity, are generally valid whether or not curves and stations are both present. This results because the effects of curves and stations on average velocity are basically cumulative. The effects of stations and curves on capacity, however, are not cumulative since only the speed restriction with the largest headway requirement dominates while the others have no effect. As was discussed in the capacity analysis, Section 2.3, except for certain special cases of off-line stations, station operations will always dominate over curve operations in determining capacity limits. It should be assumed, therefore, that the

sensitivities of curve parameters on capacity will be essentially zero whenever stations are also present.

TABLE 2-9. BASELINE VALUES FOR PARAMETRIC ANALYSES

Parameter	Baseline Value
Station operations	
● Spacing	25 miles
● Dwell time	180 seconds
● On/off-line	ON-line station
Curve operations	
● Curve speed	150 mph
● Curve frequency	1 curve every 10 miles
● Curve length	0.5 miles
Normal Acceleration Rate	0.1g
Normal Braking Rate	0.1g
Emergency Braking Rate	0.25g
Train Length	500 feet
Seat Density	1 seat/ft. of train length
Control System	Follower concept, FAC = 1.0

The average velocity sensitivity analysis indicates, as would be expected, that station spacing, curve frequency and curve speed all have significant impact on performance. The relatively large influence of curve operations indicates problems for very high speed systems operating in applications where topography and urbanization make straight routes impossible. The use of off-line stations, alternating type, can alleviate partially the deleterious effects of station spacing and dwell time on average velocity. For typical station and curve operations, acceleration rates do not have a particularly large impact on average velocity.

The sensitivity results on capacity indicate that, in the absence of any stations, curve operations as affected by train



length, control system and emergency braking rate have a large influence on system capacity. When stations are present, however, the sensitivity of curve operations will not be significant. The most sensitive station parameter on capacity (which will dominate for realistic applications where stations and curves are present) is the ability to perform high-speed passive switching to off-line stations. This observation is particularly important regarding the implementation of new high-speed ground systems if consideration is given to achieving maximum utilization of the investment. For on-line stations only, dwell time has a sufficiently large impact on capacity to overshadow the effects of varying other parameters such as train length, acceleration rates and control system design. The primary reason why off-line stations have such a large impact on capacity is that the adverse effects of dwell time are partially negated.

## 2.5 PERFORMANCE EVALUATION CRITERIA FOR TRAIN SYSTEMS

The purpose of this section is to describe the development and use of criteria for establishing minimum acceptable performance limits for train systems operating in various conditions.

### 2.5.1 Development of Velocity Ratio Criterion for Average Velocity Performance

2.5.1.1 Concept of Average Velocity Conversion Efficiency - A practical approach to gaging the effectiveness of a given train application is to measure how well the system converts its design cruise speed into average velocity. A simple measure of this conversion efficiency is the Velocity Ratio (VR) defined as the ratio of average velocity to design cruise speed for a given application. If this is to be a useful measure for judging the effectiveness of train applications, however, limits to acceptable levels of VR must be established.

2.5.1.2 Limits to Velocity Ratio - Several clearly defined limits to acceptable levels of VR can be easily established. Obviously, a VR of 100 percent (entire trip at cruise speed) cannot be

exceeded, and in fact, for realistic applications, station operations alone (assuming no curves on the route) will dictate an upperbound limit of something less than 100 percent. On the other hand, a VR of less than 50 percent is clearly unacceptable as this represents an application where, in essence, the train system never attains cruise speed. The same average velocity obtained by a system operating with a VR of less than 50 percent can be achieved by a system with a lower design cruise speed.

Based on the above considerations, it is apparent that acceptable values of VR must be greater than 50 percent and practically less than 100 percent. It remains only to establish how much greater than a VR = 50 percent is a minimum acceptable level of performance. For purposes of this study (and without the benefit of a detailed evaluation of the economic aspects of VR levels) a minimum level of 62.5 percent was chosen. This means, for a given application, a train system must operate at least 25 percent of the time at its design cruise speed.

2.5.1.3 Velocity Ratios for Actual Transportation Systems - The choice of 62.5 percent VR as a minimum acceptable level can be seen as quite reasonable when compared with VR's for current systems. Figure 2-31 summarizes the results of a review of VR's for several aircraft and rail modes over trips of varying length. Several conclusions can be drawn from an assessment of the results:

- a) Aircraft efficiency tends to peak at about VR = 75 percent for trips greater than 1200 miles.
- b) For trips less than 1200 miles, the VR of aircraft steadily decreases to less than 35 percent for trips under 200 miles.
- c) In the range of 200 to 500 mile trips, where standard jet aircraft are particularly inefficient, their VR's are less than 50 percent.
- d) The successful Japanese Tokaido train has a VR of about 77 percent.

- TOKAIDO
- x FLIGHT
- Δ<sub>1</sub> TURBOTRAIN TEST 160 MPH VERSION
- Δ<sub>2</sub> TURBOTRAIN CURRENT 125 MPH VERSION
- \*<sub>1</sub> METROLINER 160 MPH TEST VERSION
- \*<sub>2</sub> METROLINER 130 MPH CURRENT VERSION

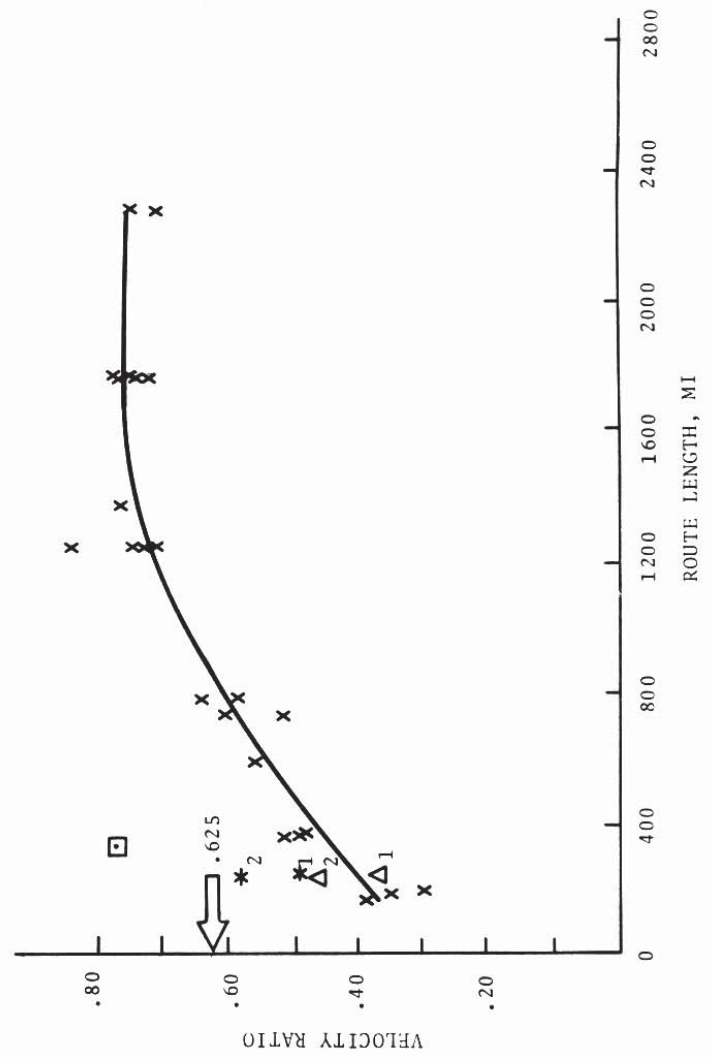

Figure 2-31. Velocity Ratios for Actual Transportation Systems



- e) The most efficient configuration of the Metroliner (between N.Y. and Washington), which is the most successful Amtrak train, has a VR of about 58 percent.
- f) The Turbotrain operating over poor track conditions between Boston and New York has a VR of only 47 percent.

As can be seen from Figure 2-31, the chosen minimum value of VR = 62.5 percent appears to be justifiable. It requires an efficiency greater than current aircraft and trains over trip conditions not well suited for their design characteristics. On the other hand a VR of 62.5 percent is less than that achieved by long-haul aircraft and the Tokaido train which operates over an exclusive right-of-way specifically designed for its speed characteristics.

2.5.1.4 Interpretation of 62.5 Percent VR - Figure 2-32 shows an example of how the 62.5 percent VR criterion can be applied to determine the maximum allowable train design cruise speed as a function of station spacing (no curves are assumed). According to this criterion, for example, a 300 mph train system cannot be effectively employed if station spacing (no curves or dwell time assumed) is less than 17.5 miles. The figure also illustrates dramatically the significance the VR criterion in establishing appropriate train system performance limits for certain application constraints. As can be seen from the figure, the maintenance of constant levels of average velocity performance becomes a function of rapidly diminishing returns in the face of increasing application constraints (in this case station spacing). The 62.5 percent VR actually represents a limit just short of where the constant average velocity performance lines become vertically asymptotic or requiring an infinite increase in design cruise speed to maintain the same average velocity.

Although the VR criterion is an appropriate means of establishing performance limits based on technical considerations, it must be recognized that actual decisions regarding selection of train design cruise speed characteristics will also be based on economic

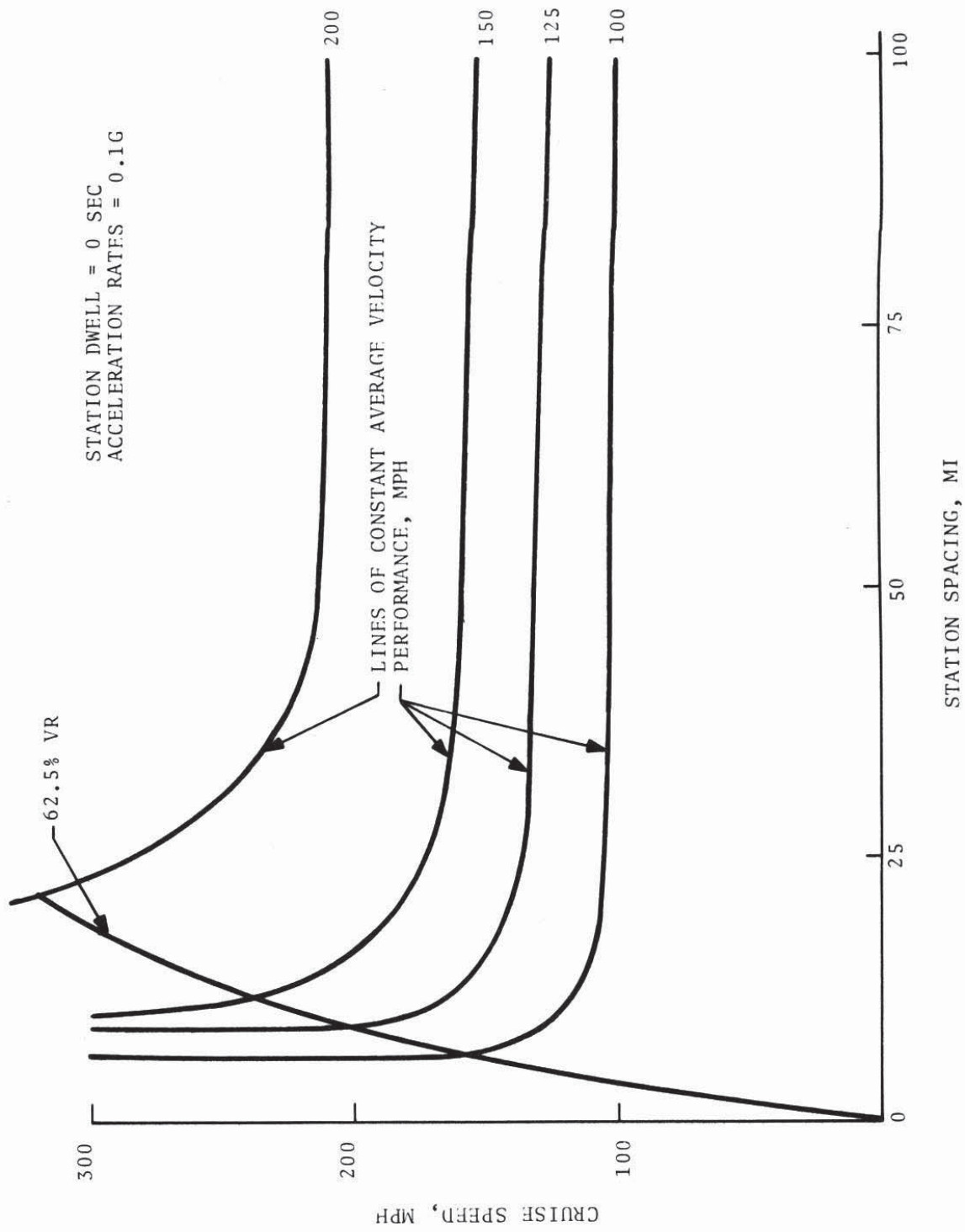

Figure 2-32. Cruise Speed Vs. Station Spacing for 62.5% Velocity Ratio

considerations. It must be realistically assumed that development costs will dictate the design of fewer types of train systems than potential applications and, hence, some systems will not be optimally suited, as measured by performance, in their specific applications. The few train systems that are developed, however, should have performance characteristics that realistically reflect the range of application constraints most likely to be encountered. It is neither cost or performance effective to develop train systems with performance characteristics that exceed the requirements of all potential applications. The value of these performance analyses, therefore, lies in the establishment of minimum constraints most likely to be encountered in potential train applications and of the impact these constraints have on desired performance characteristics. The performance analyses then constitute a vital input to the development of policies for guiding R&D investment decisions.

#### 2.5.2 Application of Velocity Ratio Criterion

The VR criterion discussed in the previous section will be applied to several typical application constraints to establish their impact on desired train design cruise speed characteristics.

2.5.2.1 Station Operations: Spacing, Dwell and Acceleration Rates - The relationships between maximum design cruise speed and station spacing for various dwell times and acceleration rates as determined by the 62.5 percent VR criterion are described in Figures 2-33 and 2-34. For a typical dwell time of 180 seconds and acceleration rates of 0.1g (no curves assumed), the minimum station spacing tolerable in permitting effective use of design cruise speeds of 300, 200 and 100 mph are 33, 16, 7 miles respectively.

From the two figures it can be seen that attempting to utilize higher design cruise speeds for a given application is a function of diminishing returns; i.e., effective use of higher cruise speeds requires disproportionately greater station spacings. Similarly, increasing acceleration rates yields diminishing benefits. The



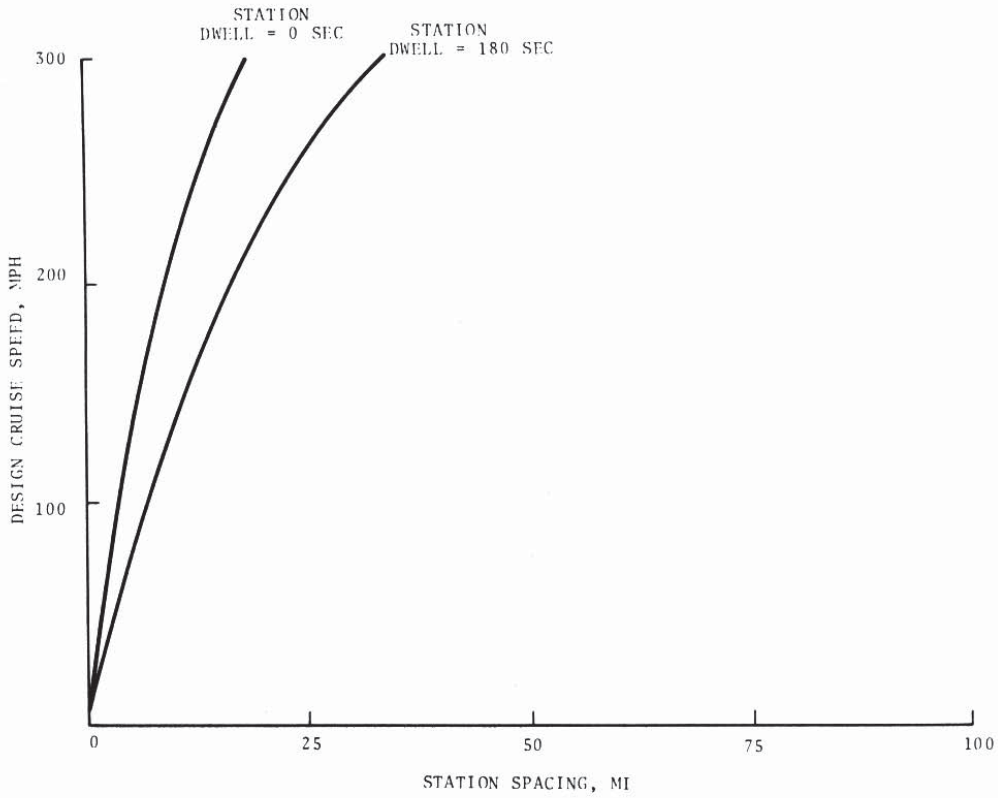

Figure 2-33. Design Cruise Speed Vs. Station Spacing and Dwell Time

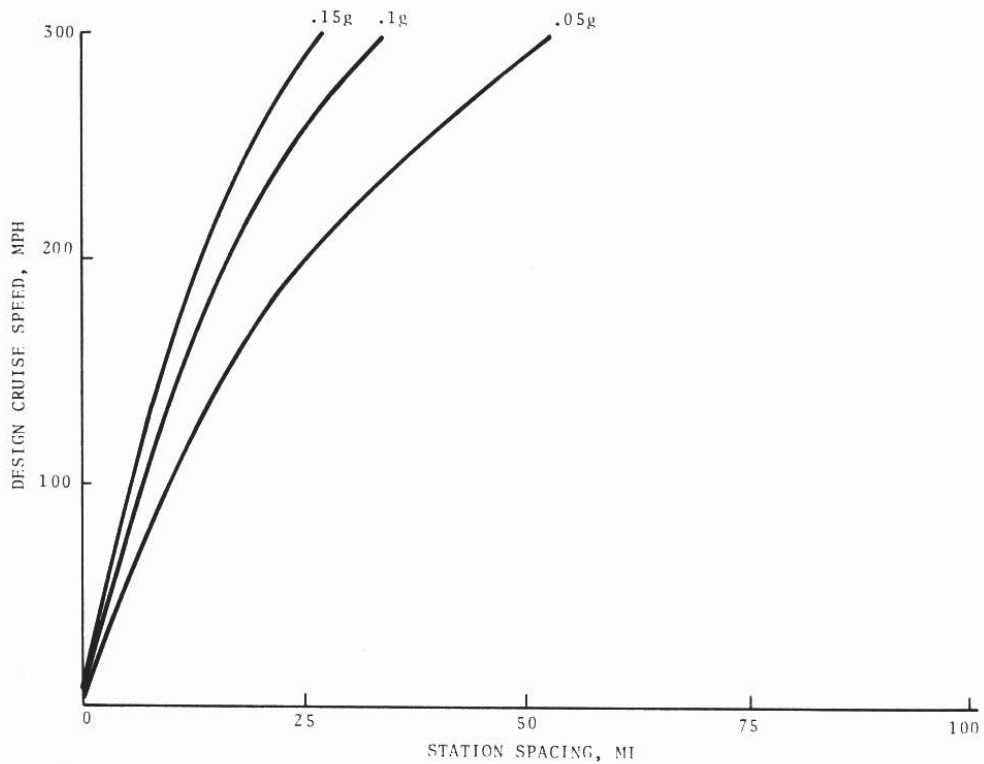

Figure 2-34. Design Cruise Speed Vs. Station Spacing and Acceleration Rates



improvement in effective design cruise speed for a given station spacing resulting from an increase in acceleration rate from 0.5g to .1g is greater than the increase from .1g to .15g. Nevertheless, changes in station dwell time and acceleration rate can produce relatively significant impacts on cruise speed performance particularly for higher speed systems. An increase in dwell time from 0 to 180 seconds decreases the permissible design cruise speed from 300 to 220 mph for a 17-mile station spacing. A decrease in acceleration rate from .15g to .05g decreases the permissible design cruise speed 300 to 210 mph at a station spacing of 27 miles.

2.5.2.2 Curve Operations: Spacings, Speed and Acceleration Rates - The impact of curve operations on train design cruise speed are shown in Figures 2-35 and 2-36 in a manner similar to that for station operations in the previous section. It can be noted from the figures, that for the same spacing, the impact of curves (curve speed and acceleration rates) on design cruise speed is less than for stations. This results because curves do not require trains to perform a complete stop as with stations. Similarly, the effect of curves on performance becomes less as the curve speed is increased. As will become evident, however, in the applications section of this report (Section 4), curve operations for actual applications represent more severe constraints on performance than stations because their spacing is typically much less.

2.5.2.3 Station and Curve Combinations - In the previous two sections, the effect of stations and curves acting individually on train design cruise speed were discussed. In actual applications, these two constraints will act together to produce cumulative effects on performance. Figures 2-37 and 2-38, and 2-39 show the relationships between design cruise speed and various combinations of station spacings (25, 50 and 100 miles) and curve operations (curve spacing and speed). The combined effect of these two constraints on performance is much greater than either acting individually. For example, stations (180 second dwell) and 60 mph

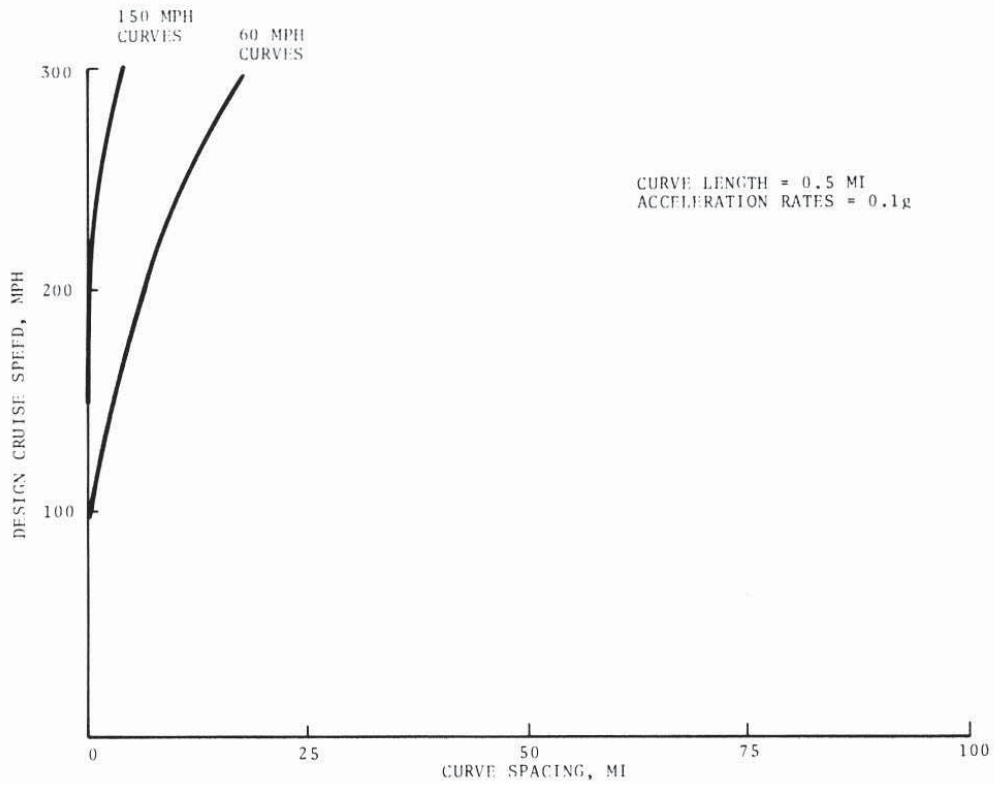

Figure 2-35. Design Cruise Speed Vs. Curve Spacing and Curve Speed

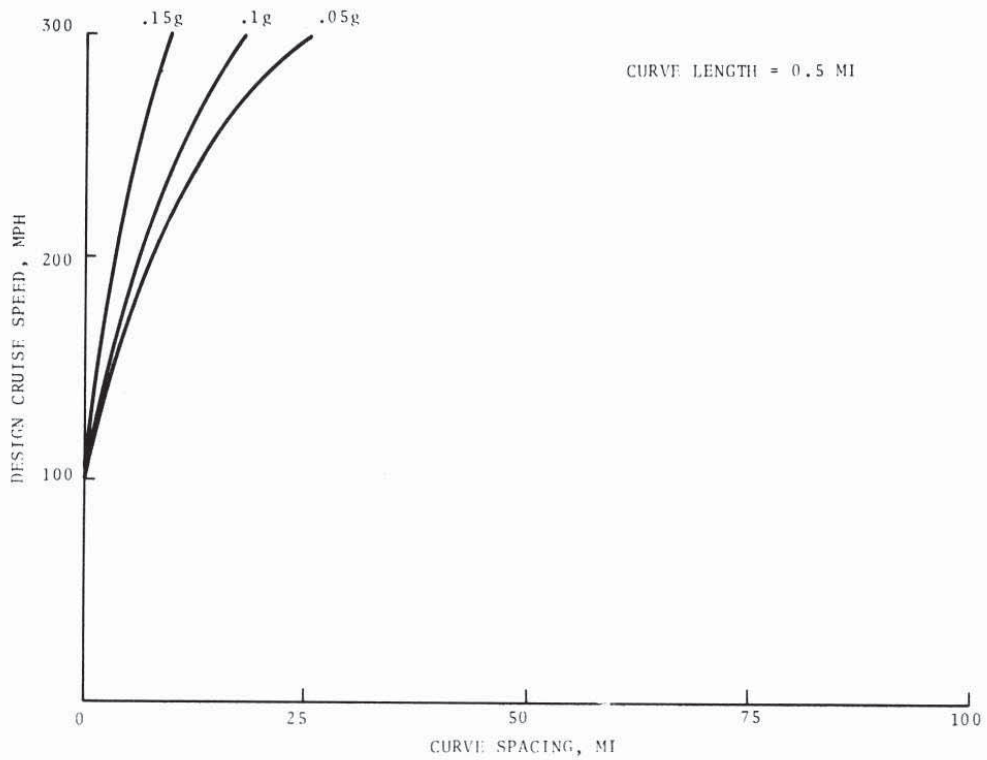

Figure 2-36. Design Cruise Speed Vs. Curve Spacing and Acceleration Rates

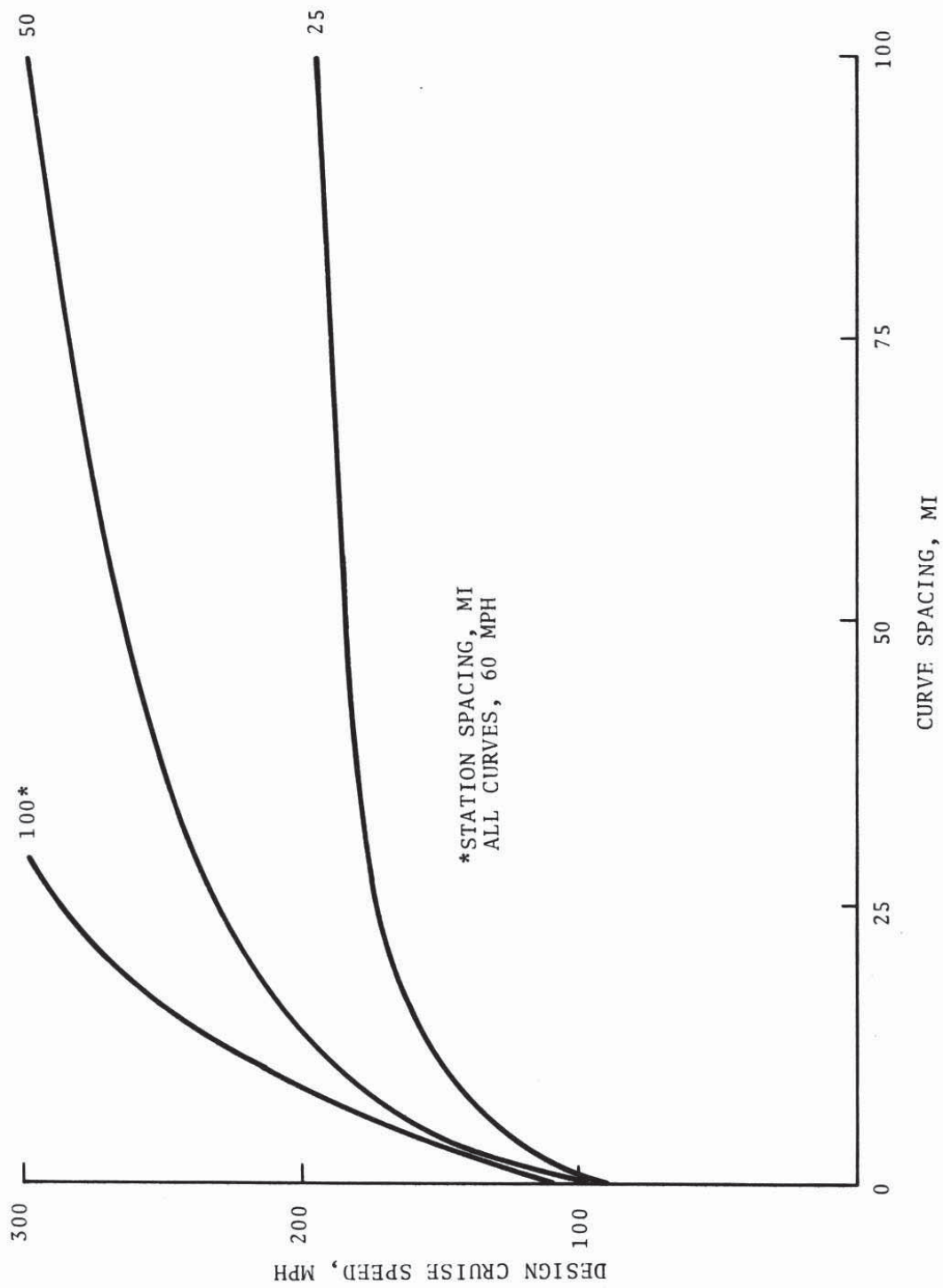

Figure 2-37. Design Cruise Speed Vs. 60 MPH Curve Spacing for Various Station Spacings

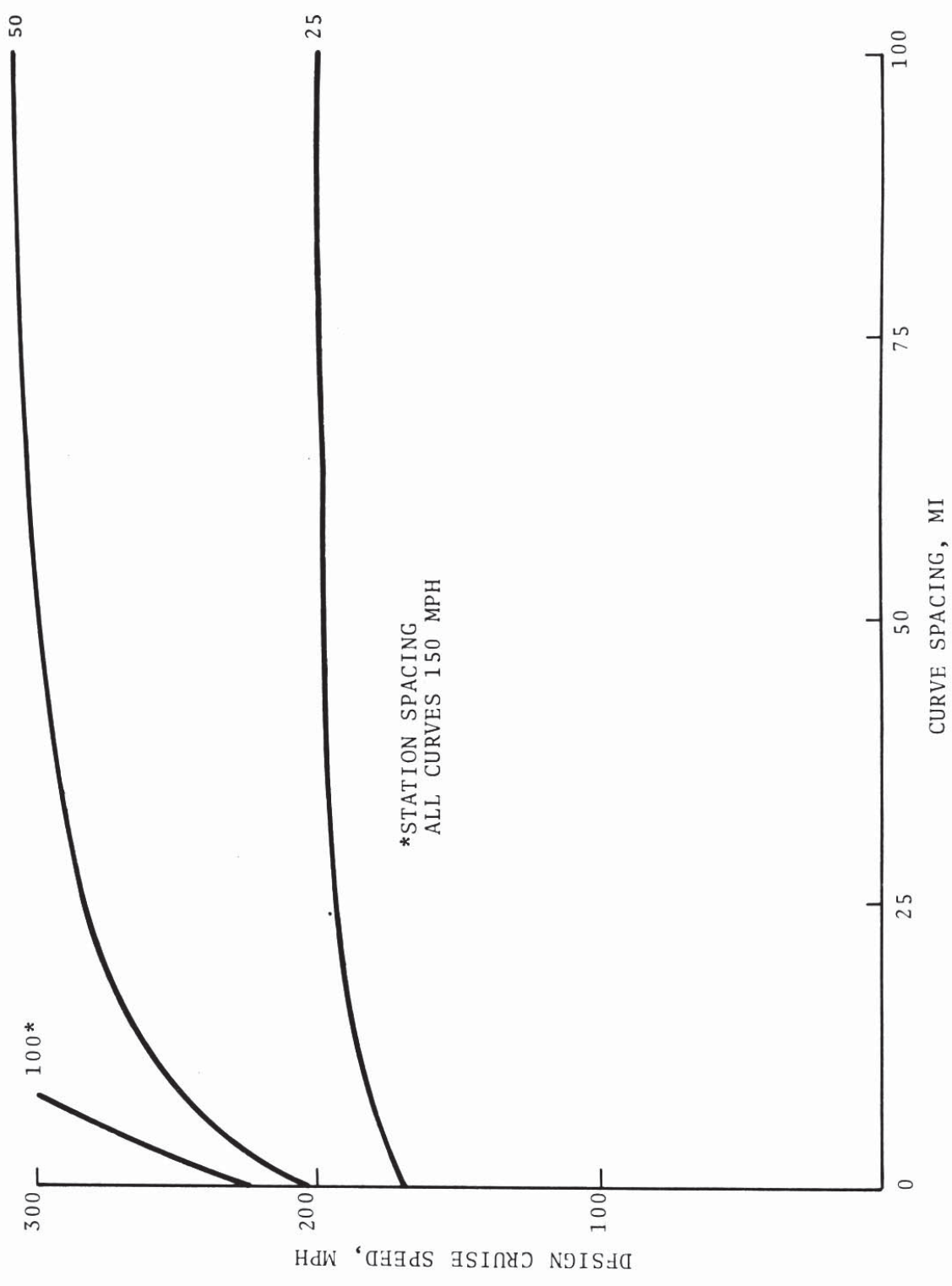

Figure 2-38. Design Cruise Speed Vs. 150 MPH Curve Spacing for Various Station Spacings



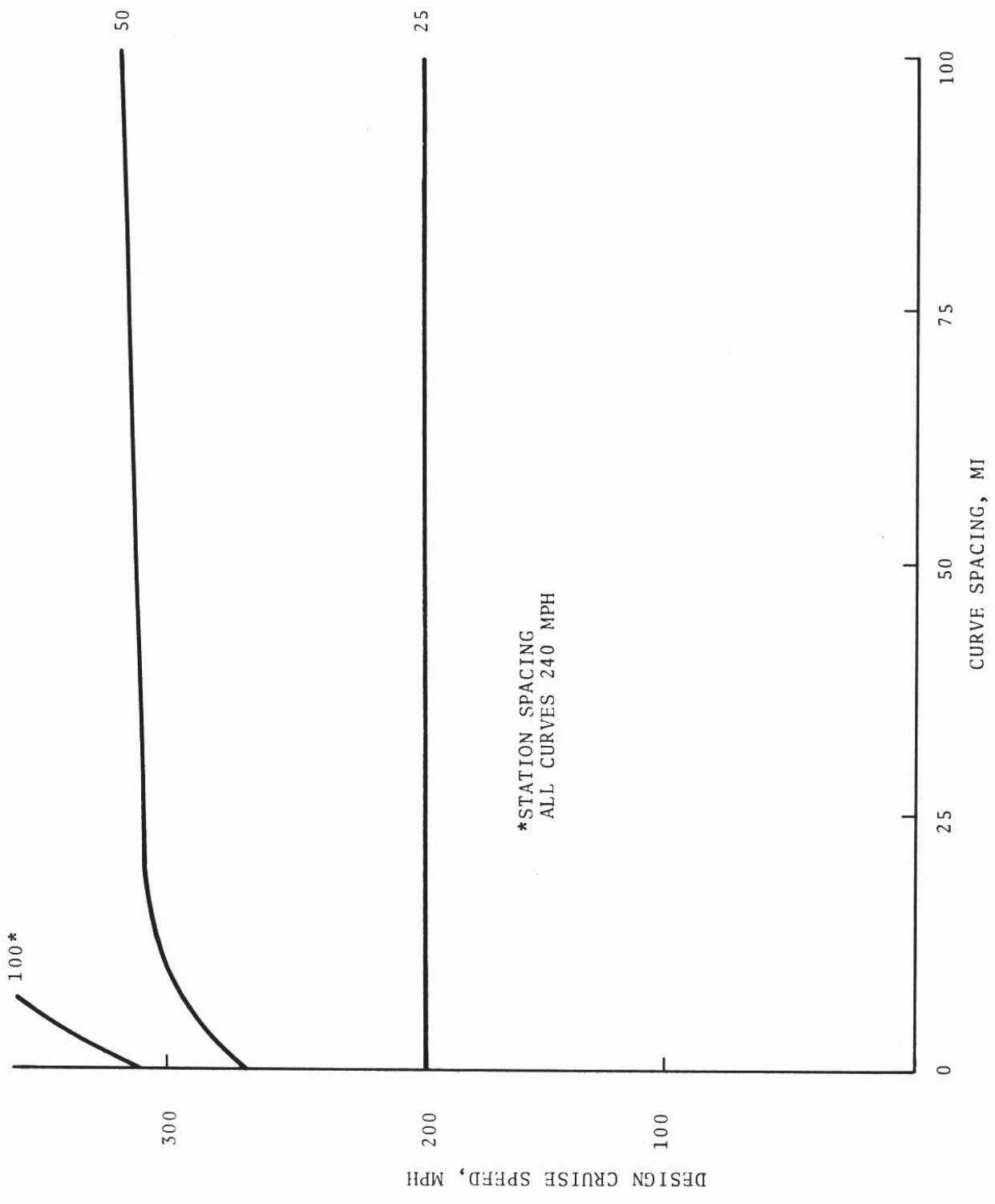

Figure 2-39. Design Cruise Speed Vs. 240 MPH Curve Spacing for Various Station Spacings

curve at a spacing of 25 miles, permit effective cruise speeds of 260 mph and 330 mph respectively when encountered individually. When these two constraints are encountered together under the same conditions, this permits an effective design cruise speed of only 175 mph.

The results of determining maximum effective cruise speeds for various combinations of station and curve conditions are summarized in Table 2-10. For several cases of high cruise speeds and close spacings of constraints, it can be seen that the applications are ineffective. Based upon these results for idealized site independent conditions, it is possible to draw general conclusions regarding the application effectiveness of trains with various design cruise speeds. For trains with cruise speeds under 100 mph, applications are virtually unlimited. Trains with 200 mph cruise speeds will be ineffective only in applications where the station spacing will be less than 50 miles. This does not appear to be too severe a restriction for intercity applications. For trains with cruise speeds in the 300 mph range, however, effective applications will be extremely difficult to find. Even if station spacings are 100 miles (maximum realistic spacing for intercity applications) a 300 mph system can tolerate only 3.4 curves of 60 mph between stations. The occurrence of natural geographical obstacles and urban areas along a given route necessitating curves and slow orders will greatly reduce (if not complete exclude) the number of effective 300 mph train applications.

### 2.5.3 Limits of Capacity Performance

The analyses of average velocity performance above indicated a strong relationship between train design cruise speed and the effectiveness of train applications as measured by average velocity and the velocity ratio criterion. Analyses of system capacity, however, show that over large ranges of speed there is essentially no relationship between capacity and design cruise speed (see Figures 2-16, 2-17, 2-18, and 2-19). Establishing optimum, best or effective limits to design cruise speed as measured by system capacity is therefore a relatively simple task.

TABLE 2-10. SUMMARY OF RESULTS

MINIMUM CURVE SPACING TO PERMIT DESIGN CRUISE SPEEDS OF 100, 200, 300 MPH FOR VARIOUS COMBINATIONS OF STATION SPACINGS AND CURVE SPEEDS, 62.5% VR

DESIGN CRUISE SPEED	STATION SPACING, MI								
	25			50			100		
	CURVE SPEED			CURVE SPEED			CURVE SPEED		
	60	150	240	60	150	240	60	150	240
300	X	X	0	X	45	10	29	11	0
200	X	62.5	0	14	0	0	8.5	0	0
100	1.5	0	0	1	0	0	0	0	0

X - Station and curve spacing are too close to permit effective application.

As can be seen from Figures 2-16 to 2-19, for a given train length and dwell time, system capacity remains constant at a maximum value between upper and lower cruise speed limits. Particularly for typical values of dwell time (greater than 30 seconds), the range of cruise speeds over which capacity is maximum and constant covers almost all values of interest (20 mph to over 300 mph). Furthermore, as discussed previously in Section 2.3.4, stations will virtually always dictate system capacity vis-a-vis curves. It can be concluded, therefore, that due to the effect of station operations there is no effective limit to design cruise speed within the range of 30 mph to 300 mph for train lengths less than 1000 ft and dwell times greater than 15 seconds. This conclusion is somewhat contrary to that which would be arrived at by only a cursory analysis of capacity limits based on the safe stopping distance for mainline operating conditions. Such conditions are represented by the outer envelopes of the capacity curves in Figures 2-27 and 2-28 and suggest the conclusion that a distinct maximum capacity does occur as a function of cruise speed in the vicinity of 100 mph. Such a conclusion is too simplistic, however, in that it ignores the effects of station operations which tend to make the issue of capacity versus cruise speed a moot point.

The range of conditions (cruise speed, dwell time and train length) over which system capacity is independent of cruise speed is summarized in Figure 2-40. For a given train length and station dwell time, capacity is constant (and at a maximum) for all cruise speeds between the lower and upper limits specified in the figure. Any cruise speed above or below the upper or lower limits respectively will require a reduction in system capacity.

A cruise speed below the lower limit corresponds to a speed less than  $V_{crit}$  discussed in Section 2.3.2 and described in Figure 2-20a. Under such conditions, the train cruise speed is so low relative to its length that an excessively long time is required for the train to clear the station. Alternately expressed, the train length component of the safe headway time ( $T_L$  in Figure 2-15) becomes the dominant factor. Exceeding the upper cruise speed limit in Figure 2-40 corresponds to the situation described in Figure 2-20b where for small dwell times and high cruise speeds, the minimum safe following distance is controlled by the emergency stopping distance. Again this condition can be described in terms of Figure 2-15 as representative of the situation where the emergency stopping time ( $T_e$ ) becomes the dominant component of the minimum safe headway ( $H_m$ ).



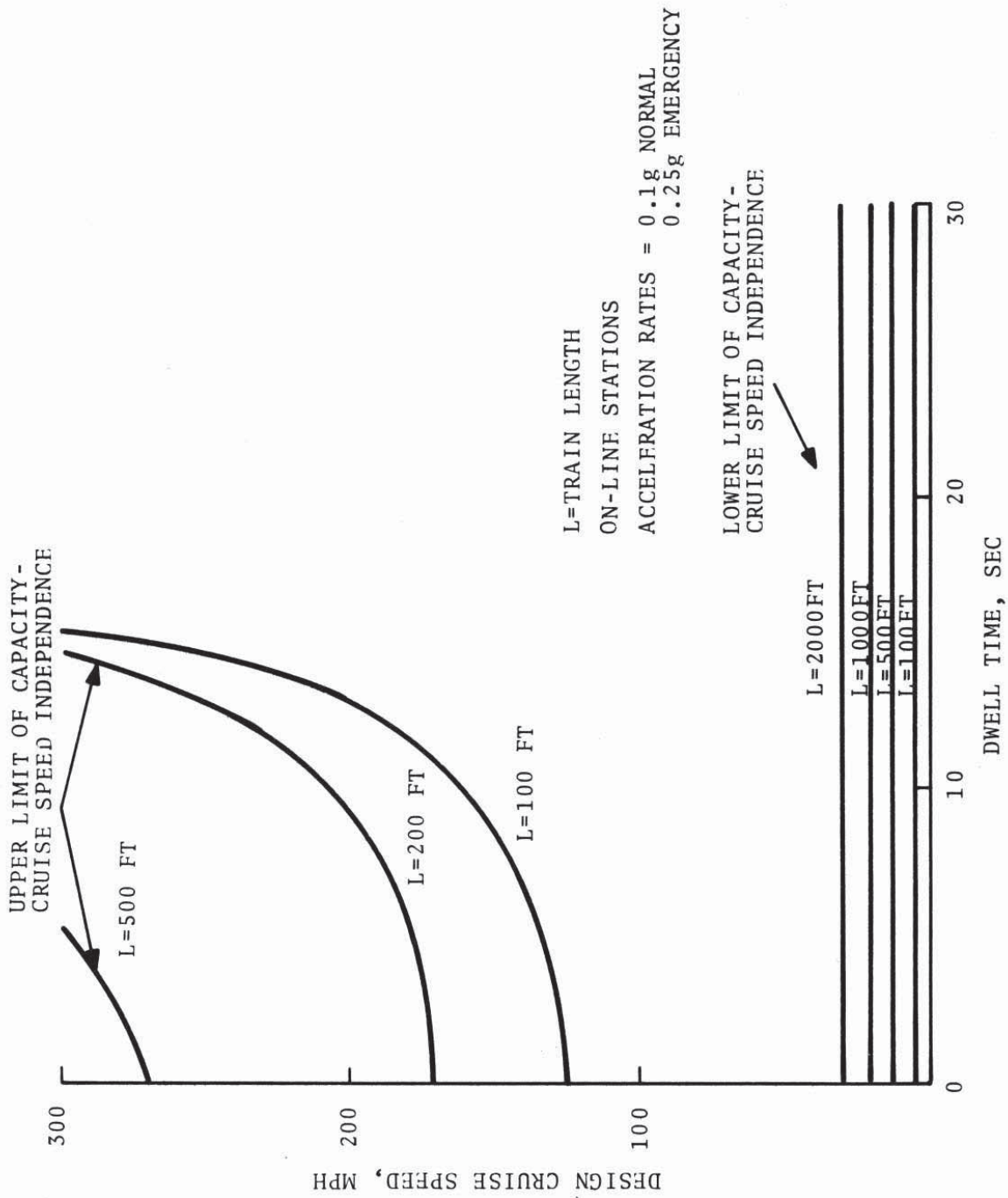

Figure 2-40. Design Cruise Speed Vs. Dwell Time for Upper and Lower Limits of Capacity-Cruise Speed Independence, On-Line Stations



### 3. DEMAND ANALYSES

#### 3.1 BACKGROUND

In the previous section, the physical performances of intercity ground passenger systems were analyzed on the basis of average velocity and capacity. This section describes an additional means of evaluating the physical performance of train systems; namely, determining the demand for service that results, in part, from the systems average velocity and capacity characteristics. Because the demand for service, in absolute terms and relative to competing modes, more nearly reflects the systems viability in realistic terms, this is perhaps the best measure of its physical performance.

This section of the report will describe, in general terms, development of the techniques and methods used for performing the demand analyses. The demand analysis basically involved the development of a total trip model (for determining total intercity trips), the survey and selection of a mode split model (for determining modal shares), the acquisition of socio-economic data (for calibration and use of the models) and use of the models for determining demand as a function of the level of service offered. Results obtained from using the techniques described in this section for specific train applications are presented in Section 4.

#### 3.2 GENERAL DESCRIPTION OF DEMAND ANALYSES

##### 3.2.1 Demand Models, Data Acquisition & Review of Corridors

The purpose of this study phase was to develop techniques and acquire data for analyzing the effects of changes in train and application characteristics on demand as measured by mode split (percent share of market) and mode volume (total riders per mode). To determine mode split as a function of train and application characteristics, a demand model was selected which quantified the relationship between percent ridership on competing modes and their level of service as measured by cost, frequency (trips per day) and trip time. Mode volume is determined by multiplying the total

intercity travel for all modes, computed by a total trip model, times the mode splits. The total trip model computes total travel on the basis of socio-economic attractions between city pairs and their distance apart.

The use of these two models (mode split and total trip) by themselves can produce results on travel behavior for improved train service between city pairs by assuming values for the train's performance (cost, frequency and trip time). This information is not too meaningful, however, unless it is coupled with the actual performance which can be achieved by trains operating between the city pairs. For this reason, the demand models are used in conjunction with the supply models, which compute actual performance, as described in Figure 3-1. The demand models receive actual performance data of trip time, design capacity and design frequency from the supply models for a given train application. This performance data, when combined with demand models, produces results in terms of modal splits and volume, load factor and feasibility of assumed frequency. The load factor is the ratio of actual capacity to design capacity and permits an assessment of whether the actual system's capacity is sufficient to carry the anticipated demand; i.e., a load factor greater than 1.0 is unfeasible (assuming no standees). Similarly, the feasibility of frequency assumed for the demand model can be determined by comparing it with the design frequency limit (minimum headway) output of the supply model. As can be seen from Figure 3-1, the level of service variable, cost, must be chosen as an exogenous policy input to the demand model since the supply model does not consider economic performance.

The development, calibration and use of the demand models required the acquisition of socio-economic data. The total trip model was derived and calibrated on the basis of the 1972 National Travel Survey data.<sup>7</sup> This survey provided travel volume data for auto, air, rail and bus modes between most major city pairs in the United States. Other 1972 population and employment data was also used to calibrate the total trip model. Similarly, the mode split model was calibrated against the same 1972 transportation survey

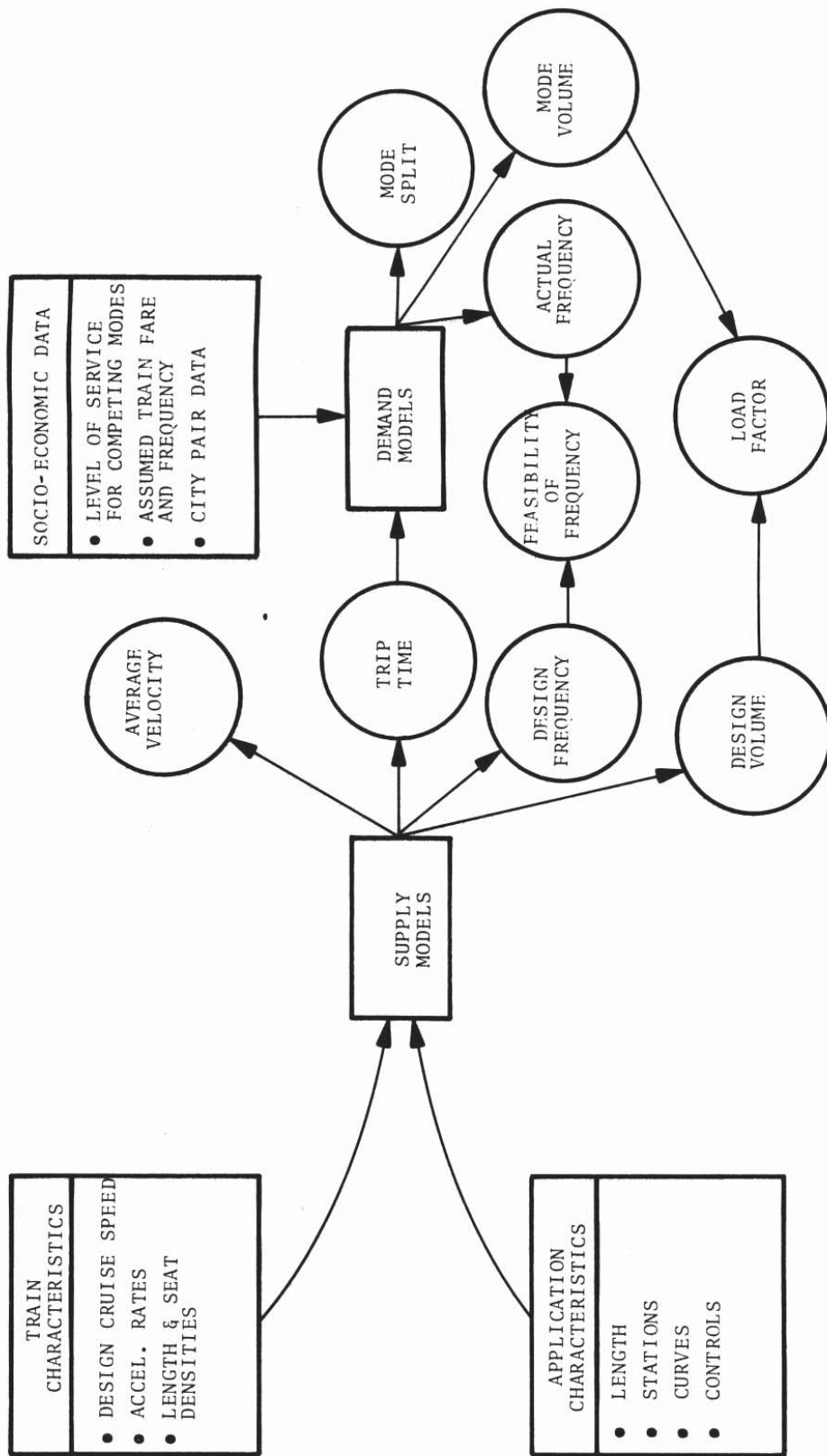

Figure 3-1-1. Combined Use of Supply and Demand Models

data together with specific information on modal characteristics for the same year taken from a variety of sources. With the demand models calibrated against known travel behavior in 1972, they were then used to predict total and modal travel characteristics for the year 1974 for various train and application conditions. The year 1974 was chosen as the baseline year as this was the last year for which accurate socio-economic and modal characteristic data was available. Although the demand modeling method developed has the capability to predict future travel behavior, such analyses were not performed as they were beyond the scope of the project. The primary objective of the study was to analyze travel behavior as a function of changes in train and application characteristics under present conditions.

In conjunction with the development of demand models, a review of potential intercity corridors for improved train passenger service was performed to determine their general characteristics and to select certain corridors for more detailed analysis. The results of this review are presented in Table 3-1 which lists all corridors generally recognized as candidates for improved service. (For example, see High Speed Ground Alternatives Study, Reference 1.) For purposes of demonstrating use of the demand and performance analysis techniques for specific corridors, three corridors were selected from the list; Northeast Corridor, Chicago-Toledo-Detroit Corridor and the San Francisco-Sacramento Corridor, which are representative of the range of values found across the spectrum of applications in Table 3-1.

### 3.2.2 Demand Analysis Methodology

A general description of the demand analysis process encompassing the development, calibration and use of the two demand models and the introduction of major data sources is provided in Figure 3-2. For a given city pair being investigated, the total trip model, together with socio-economic data for the cities, provides the total intercity person trips. The mode split model with data on rail and competing mode characteristics produces the



TABLE 3-1. CANDIDATE CORRIDORS FOR IMPROVED PASSENGER TRAIN SERVICE

	1972 NON-FARM SMSA EMPLOYMENT (MILLIONS)	1974 ESTIMATED SMSA POPULATION (MILLIONS)	% WHITE COLLAR EMPLOYMENT (SERVICES & GOVERNMENT & FINANCIAL, INSURANCE, REAL ESTATE)	DISTANCE FROM PREVIOUS CITY (AIR LINE MILES)	TOTAL CORRIDOR LENGTH (AIR LINE MILES)
1. NEW YORK CITY PHILADELPHIA BALTIMORE WASHINGTON D.C.	4.684 1.797 .818 1.239	11.570 4.834 2.131 3.070	48.6 39.8 43.6 65.8	95 91 30	216
2. BOSTON PROVIDENCE NEW HAVEN NEW YORK CITY	1.281 .369 .160 4.684	3.421 .875 .758 11.570	46.6 34.3 41.3 48.6	44 82 62	188
3. NEW YORK CITY ALBANY SYRACUSE ROCHESTER BUFFALO	4.684 .287 .232 .348 .484	11.570 .794 .644 .970 1.332	48.6 47.8 41.4 34.4 37.5	136 119 79 55	389
4. LOS ANGELES SANTA ANA SAN DIEGO	2.907 .419	6.944 1.587 1.501	40.6 51.8	35 76	111
5. CHICAGO MILWAUKEE MADISON	2.935 .575 .126	7.089 1.439 .307	36.6 35.4 56.9	82 74	156
6. PITTSBURGH AKRON CLEVELAND TOLEDO DETROIT	.861 .249 .839 .249 1.477	2.380 .686 2.032 .788 4.469	36.6 33.4 85.9 34.6 34.6	70 40 87 47	244
7. DETROIT TOLEDO CHICAGO	1.477 .249 2.935	4.469 .788 7.089	34.6 34.6 36.6	47 214	261
8. WASHINGTON D.C. RICHMOND NORFOLK	1.239 .250 .210	3.070 .559 .736	65.8 43.9 51.0	100 75	175
9. S.F. - OAKLAND SAN JOSE FRESNO LOS ANGELES	1.258 .403 .129 2.907	3.155 1.150 .438 6.944	48.5 40.6 47.9 40.6	30 129 209	368
10. HARTFORD NEW YORK CITY	.318 4.684	.943 11.570	45.3 48.6	106	106
11. LOS ANGELES LAS VEGAS	2.907 .120	6.944 .310	40.6 51.4	236	236
12. CHICAGO SPRINGFIELD ST. LOUIS	2.935 .071 .881	7.089 .171 2.382	36.6 54.9 37.8	174 84	258
13. CLEVELAND COLUMBUS DAYTON CINCINNATI	.839 .403 .324 .511	2.032 1.070 .863 1.400	35.9 45.5 37.7 36.3	112 71 63	246
14. SAN FRANCISCO SACRAMENTO	1.258 2.830	3.155 .865	48.5 59.2	86	86
15. RALEIGH-DURHAM GREENBURG CHARLOTTE ATLANTA	.100 .275 .190 .655	.455 .757 .589 1.732	54.2 29.5 34.0 39.0	55 65 300	420
16. JACKSONVILLE ORLANDO WEST PALM BEACH MIAMI	.203 .185 .125 .556	.671 .572 .406 1.418	43.9 43.4 43.9 41.6	144 142 62	348
17. PHILADELPHIA HARRISBURG PITTSBURGH	1.797 .190 .861	4.834 .423 2.380	39.8 46.9 36.6	84 185	269
18. SEATTLE TACOMA PORTLAND	.502 .107 .406	1.394 .404 1.070	44.2 49.4 41.2	28 129	157



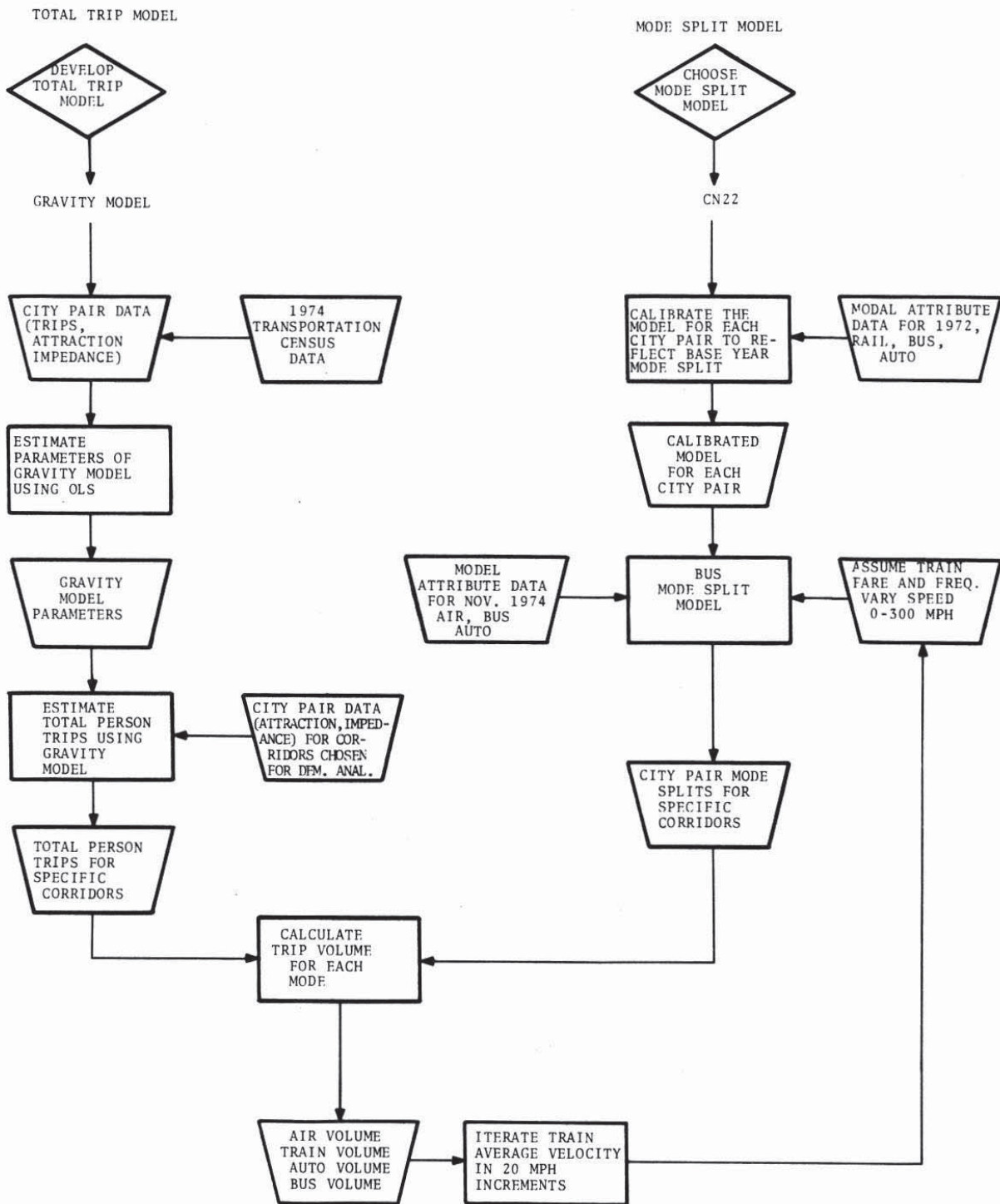

Figure 3-2. Demand Analysis Process

percent share of the travel market for each mode. The total trip and mode split results are then combined to produce total volume per mode.

For purposes of analyzing improved train service, the mode split model calibration for the rail mode was used. A frequency of service (typically 14 trips per day) and fare level (typically 0.75, 1.0 and 1.25 times the air fare for the same trip) were then assumed. Trip time for the train mode was considered a variable and iterated by assuming average train velocities in increments of 20 mph for each run of the model from 0 to 300 mph. Thus, for assumed values of train frequency and fare, plots of mode split (and volume) versus train average velocity were produced as the typical output of the demand analysis. Examples of such outputs are provided in Figures 3-3 and 3-4 for the Northeast Corridor. Figure 3-3 describes the train mode split relative to competing modes while Figure 3-4 indicates how the train mode split varies for different fare levels.

To provide more meaningful results the demand analysis outputs were combined with the performance analysis outputs (described in Section 2) to yield results relating train modal volume (demand) to changes in train characteristics (usually design cruise speed) for a given set of application conditions (station operations, route alignment, etc.). The process of combining the demand and performance analyses is described in Figure 3-5 and simply involves a transformation of mode split versus average velocity to mode split versus design cruise speed through the performance measure, average velocity, common to the outputs of both models. Results in this form permit an evaluation of the most effective combination of train and application characteristics based on the demand for service which results from the train's performance. Preliminary analyses of train effectiveness for specific applications, as measured by demand, are presented in Section 4 of this report.

### 3.3 DEVELOPMENT AND USE OF TOTAL TRIP MODEL

#### 3.3.1 Development of Model

As discussed above, the total trip model was used to determine the total number of person trips between a given city pair. The

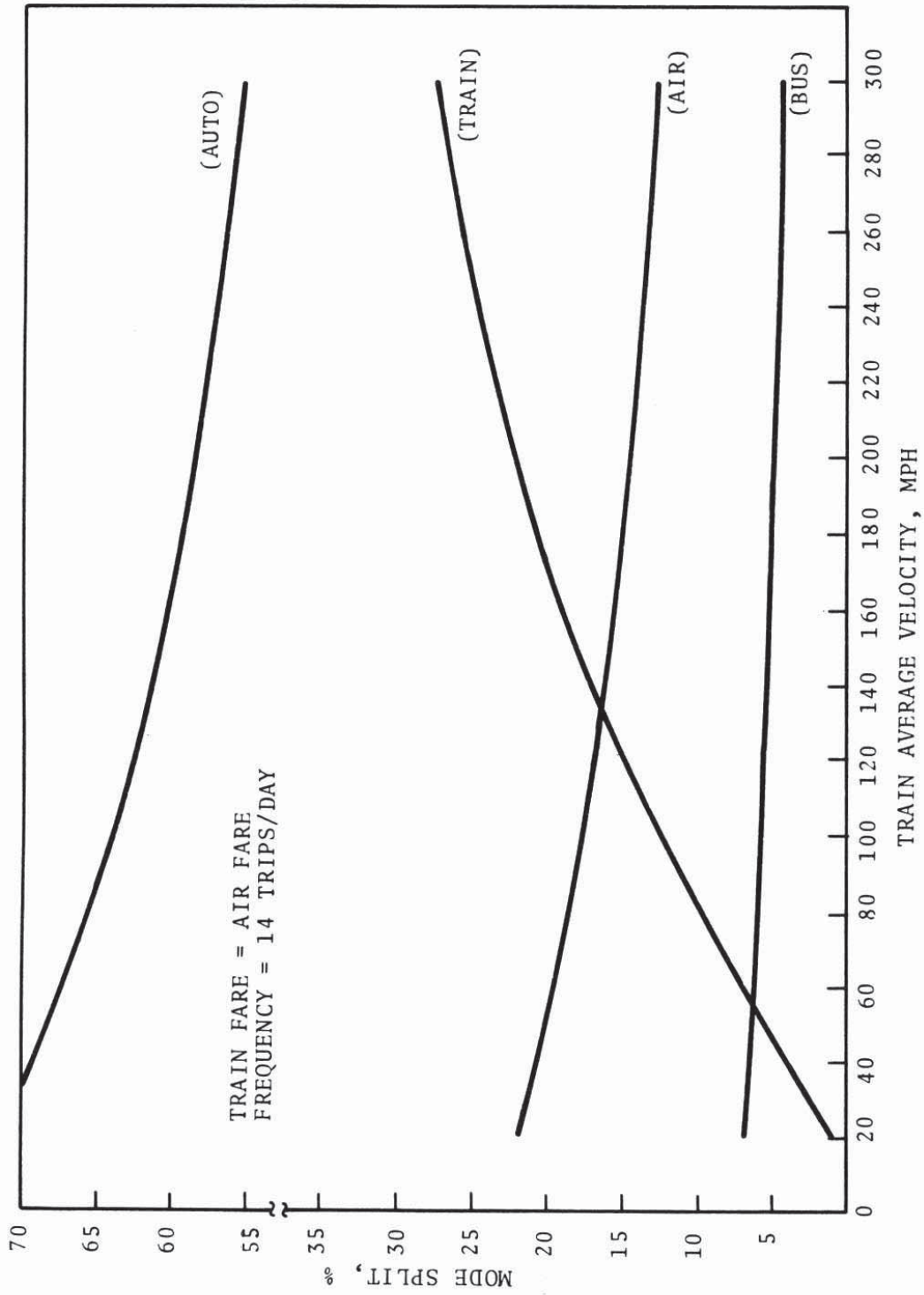

Figure 3-3. Mode Split Vs. Train Average Velocity, Northeast Corridor

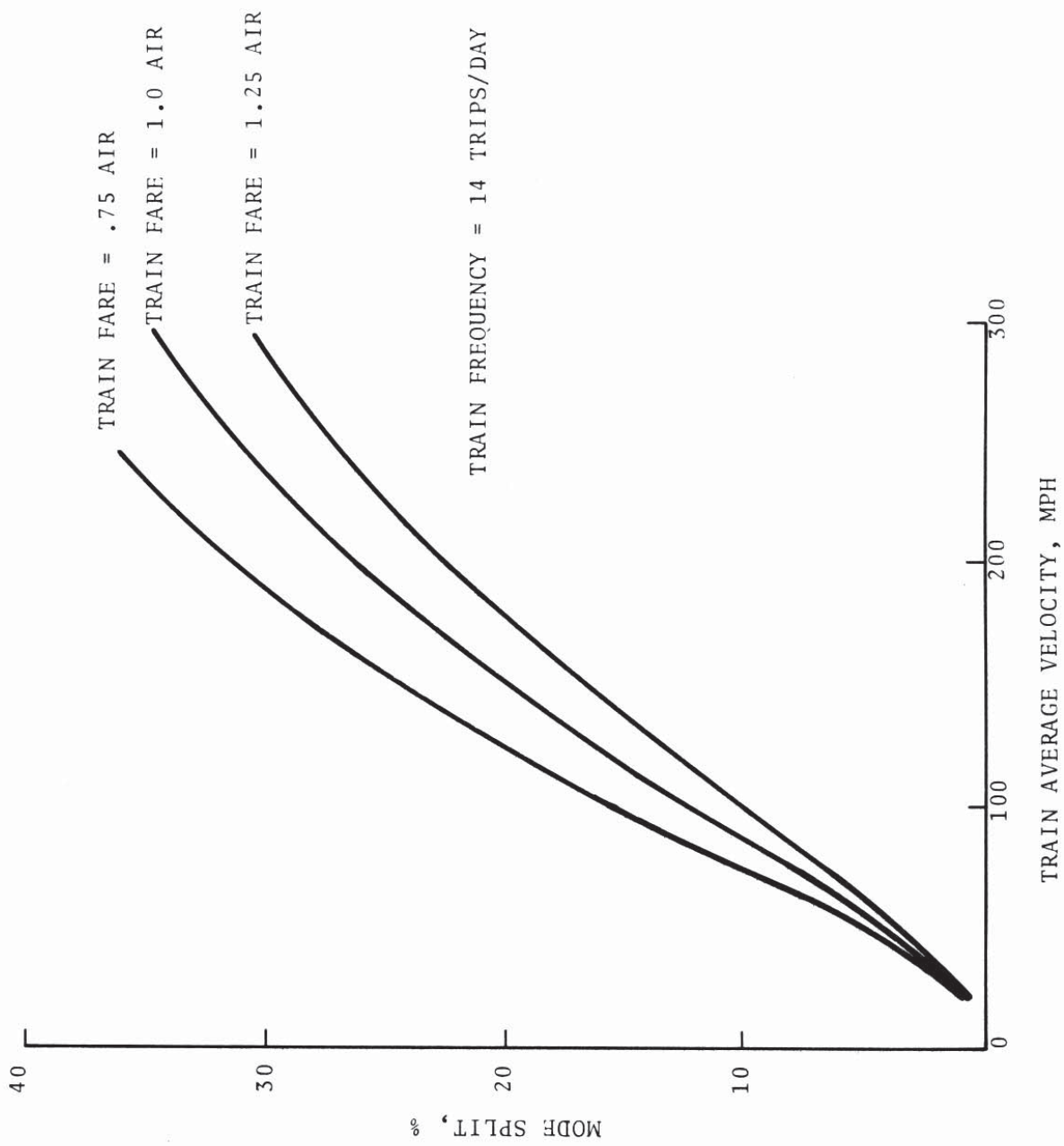

Figure 3-4. Mode Split Versus Train Average Velocity for Various Train Fare Levels, Northeast Corridor



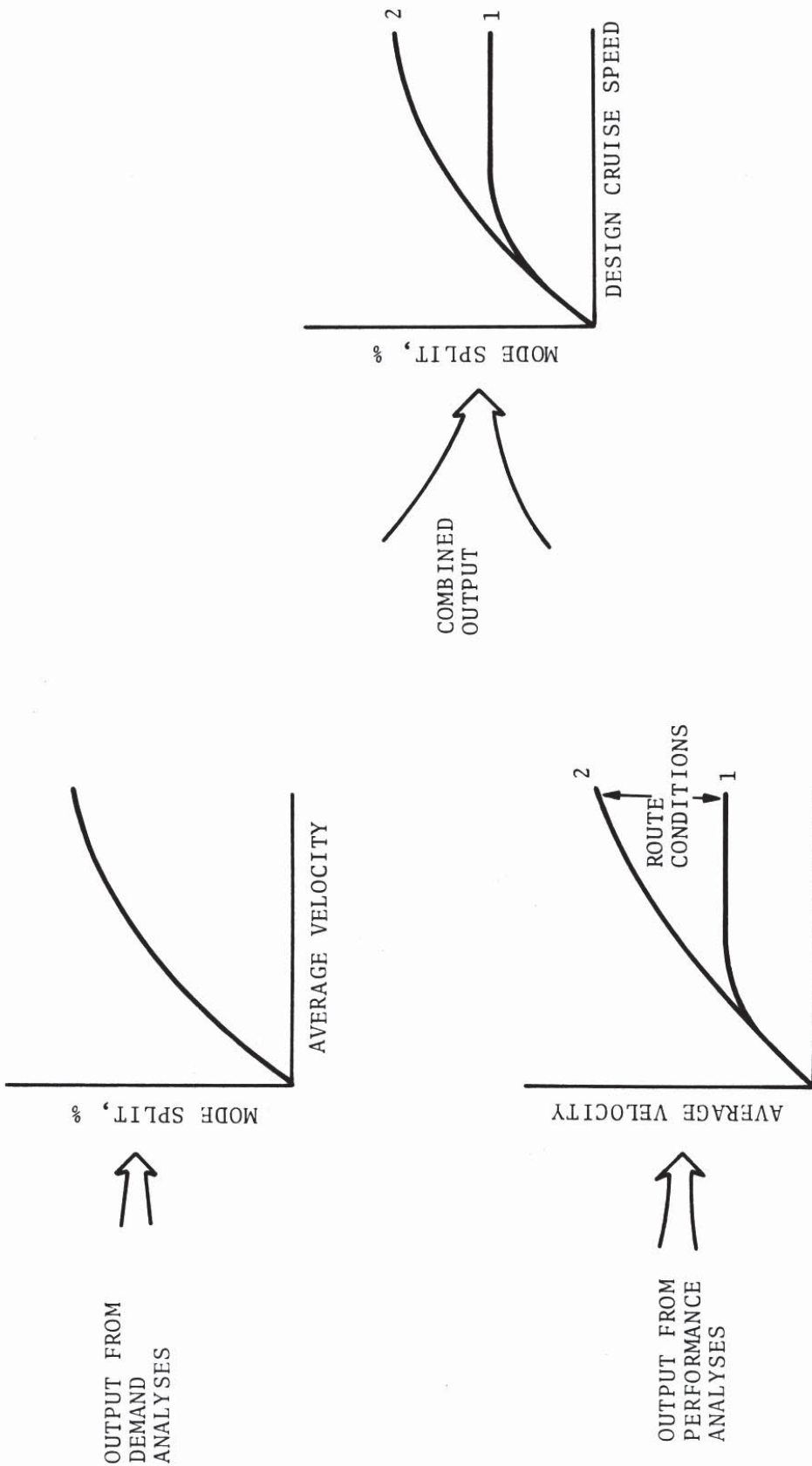

Figure 3-5. Methodology for Combining Outputs of Demand and Performance Analyses

output of this model was combined with the demand model to produce modal volumes and the supply model to produce load factors for a given train application. The total trip model was derived by regression analysis of the 1972 transportation survey data for 109 city pairs located less than 500 miles apart (the assumed maximum distance for improved train service applications).

The general form assumed for the total trip model was that of a gravity model:

$$T_{ij} = a (A_i A_j)^b (e)^{-cD_{ij}} \quad (3.3-1)$$

where

$T_{ij}$  = total number of person trips between cities i and j

$A_i$  and  $A_j$  = attractive forces of cities i and j

$D_{ij}$  = travel impedance between cities i and j.

Several attraction variables were investigated (population and income) before finally selecting total SMSA non-farm employment and percent SMSA white collar employment as the best variables. The impedance variable chosen was airline distance between the city pairs. The logarithmic form of the total trip model used for the regression analysis (ordinary least squares) is expressed as:

$$\log T_{ij} = B_1 + B_2 \log (A_{ij1}) + B_3 \log (A_{ij2}) + B_4 (D_{ij}) \quad (3.3-2)$$

where

$A_{ij1}$  = product of city pair's non-farm employment

$A_{ij2}$  = product of city pair's % white collar employment

$D_{ij}$  = airline distance between city pairs.

The values of the coefficients and other statistical results of the regression are listed below.

Coefficient	Value	Standard Error	T-Statistic
B <sub>1</sub>	3.41	2.032	1.68
B <sub>2</sub>	.35	.064	5.43
B <sub>3</sub>	1.35	.269	5.03
B <sub>4</sub>	-.0058	.0005	-10.87

$$R^2 = 0.625, \text{ corrected } R^2 = 0.614$$

### 3.3.2 Use of Total Trip Model

The total trip model was designed with the intent that it would be used to predict total travel for city pairs where existing information was not applicable; i.e., predictions of future travel or present travel for which data was not available. The results of using the model for test cases against known travel patterns (1972 transportation census), summarized in Table 3-2, caused a revision in the planned use of the model. As can be seen by the results, the model did not predict travel very accurately, particularly for non-NEC cities. Since the demand analyses for this study were going to be based on the year 1974, it was decided that the actual observed total trips for 1972 would be a more accurate and consistent source of data than the travel model predictions. The total trip model was therefore not used in the demand analyses except for city pairs involving Baltimore and Toledo for which existing travel behavior data was not available.

## 3.4 SELECTION, CHARACTERISTICS AND USE OF THE MODE SPLIT MODEL

### 3.4.1 Selection of Mode Split Model, CN22

The mode split model determines the modal shares of the transportation market based on the level of service characteristics trip time, cost, and frequency of service. Because a number of intercity mode split models have been developed, particularly as a result of the Northeast Corridor Project, it was decided to select an existing model for this study. A survey and evaluation of mode split models was performed for DOT by Peat, Marwick, Mitchell &

TABLE 3-2. SUMMARY OF RESULTS USING TOTAL TRIP MODEL\*

City Pair	1 Employment Product	2 % White Collar Worker	3 Airline Distance Miles	4 1972 Model Results Person Trips	5 1972 Actual Person Trips	6 Col 4/Col 5
Boston-N.Y.C.	6.00	2265	188	644287	756908	.85
Boston-Phil.	2.30	1855	274	213608	165615	1.29
Boston-Balt.	1.05	2032	370	105209	-	-
Boston-D.C.	1.59	3066	406	163661	222056	.74
N.Y.C.-Phil.	8.42	1934	95	1005102	849887	1.18
N.Y.C.-Balt.	3.83	2119	179	530248	-	-
N.Y.C.-D.C.	5.80	3198	213	877384	705239	1.24
Phil-Balt.	1.47	1735	91	482338	-	-
Phil-D.C.	2.23	2619	133	762609	577818	1.32
Balt-D.C.	1.01	2869	30	1188021	-	-
SF.-SACR.	.36	2871	86	596599	1005878	.59
Chi-Tol.	.73	1266	214	120934	-	-
Chi-Det.	4.33	1266	235	199626	368565	.54
Tol.-Det.	.37	1197	47	232280	-	-

\*NOTES: Column No.

3. From "Book of Official C.A.B. Airline Route Maps and Airport to Airport Mileages" 23rd Edition.

5. From 1972 Census of Transportation - National Travel Survey (Reference 7). (-) indicates not Available.



Co.<sup>8</sup> It was primarily on the basis of this study that the selection of a model was made.

The mode split model selected for this study, labeled CN22, was originally developed for the NEC project. It is classified as an abstract mode, cross-elasticity ratio model as the mode split is determined by the ratio of a given mode's service characteristics to the sum of the service characteristics for all the other competing modes. The CN22 model is unstratified in that it does not differentiate between trip types such as work and non-work trips.

The general form of the model is given as:

$$S_i = \frac{w_i}{\sum_i w_i} \quad (3,4-1)$$

$$w_i = a_0 t^{a_1} c^{a_2} f^{a_3}$$

$$f' = (1 - e^{-kf})$$

where

$S_1$  = mode split of given mode

$c$  = total average one-way door-to-door travel price in dollars

$t$  = total average one-way door-to-door travel time

$f$  = average number of one-way trips in one direction

calibrated coefficients:

	$a_0$	$a_1$	$a_2$	$a_3$	$k$
air	1.01	-2.23	-1.11	0.53	0.12
rail	1.46	-2.23	-1.11	1.05	0.12
bus	0.83	-2.23	-1.11	0.05	0.12
automobile	1.0	-2.32	-1.16	0	0

The CN22 model was chosen from among eight models developed for the Northeast Corridor Project because of its relatively high rating based upon criteria established in the PMM Report. The

CN22, with calibrated coefficients listed above, proved to be the most consistent of the unstratified models. On the basis of the root mean square error of modal trip estimates for non-NEC city pairs it is the best overall model. With the model specifically calibrated for the Northeast Corridor, CN22 ranked second only to CN27 (not used because it required stratified data) based on the root mean square error of estimated trips for each mode. Since the CN22 was the most accurate unstratified model for general applications it was the obvious choice for this study.

### 3.4.2 Characteristics of Mode Split Model

The fundamental characteristics of a mode split model are measured by its self and cross-elasticities. Elasticities are defined as the percent change in mode split for a one percent change in a level of service characteristic. Self-elasticities measure changes in a mode's modal split as a function of it's own characteristics versus changes in other mode's characteristics measured by the cross-elasticity. Of immediate concern to this study are the self-elasticities of the rail mode to rail service characteristics, as these will indicate the relative impact on demand of changing rail trip time, cost and frequency. The rail self-elasticity formulas are expressed below as:

$$E_r - r_t = a_1 (1 - S_r) \quad (3.4-2)$$

$$E_r - r_c = a_2 (1 - S_r) \quad (3.4-3)$$

$$E_r - r_f = \frac{a_3 f k e^{-ks}}{1 - e^{-kf}} (1 - S_r) \quad (3.4-4)$$

where:  $E_r - r_t$ ,  $E_r - r_c$  and  $E_r - r_f$  = the rail elasticities to rail time, cost and frequency respectively.

$a_1$ ,  $a_2$ , and  $a_3$  = the service characteristic coefficients in the mode split equation (3.4-1)

$S_r$  = the rail mode split

$f$  = frequency of service, trips per day

$k$  = constant, 0.12 for rail

Two critical conclusions can be drawn by observation of the elasticity equations:

1. For a given market share,  $S_r$ , changes in trip time will have about twice (2.23/1.11) the impact on demand as cost. This implies that more emphasis should be placed on improving the physical performance of train systems (trip time) rather than the cost of service. Alternately stated, if a one percent decrease in trip time can be achieved within a cost increase of less than two percent it will produce a net gain in demand and revenues. The elasticities for frequency can be seen to vary as a function of frequency itself. When the frequencies are small the function is relatively elastic but as the frequencies increase the function becomes less sensitive to changes in frequency. This has intuitive appeal as increasing trips per day beyond some minimum satisfactory level can be seen to have little additional benefit. The elasticity functions for time, cost and frequency are all plotted as a function of mode split in Figure 3-6. All elasticities decrease linearly with mode split to a zero value when  $S_r$  is equal to 1.0. For typical values of frequency, between 5 and 15 trips per day, the order of significance of the elasticities is time, cost and frequency.

2. As can be seen from the elasticity equations and the elasticity plots (Figure 3-6) the elasticities vary inversely with the mode split. This also has intuitive appeal since it would seem reasonable that for a given change in a mode's service characteristics its impact on demand would be greater if it had a smaller share of the market. In another context, if a mode has a very large share of the market it is obvious that it can't keep attracting equal percentages of demand for a given gain in service simply because there is a dwindling market to win over; i.e., the elasticity must go to zero as the mode split approaches 100 percent.

The concept of a diminishing elasticity with mode split has a significant implication for this study as regards the benefits to be gained by increasing service, particularly speed. This concept means that increasing the average velocity becomes subject to

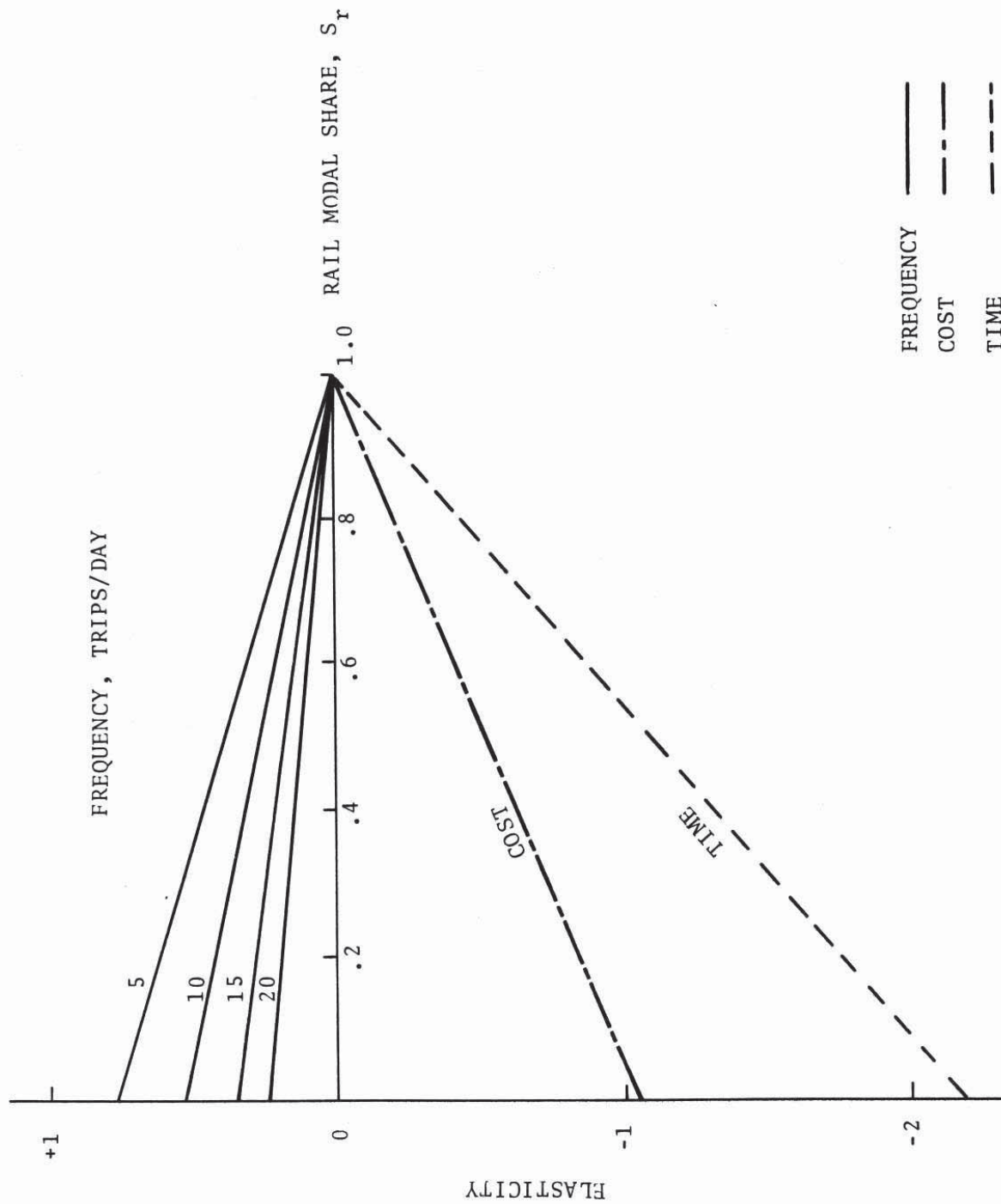

Figure 3-6. Demand Model Elasticities Vs. Rail Model Share



diminishing returns when measured by demand. It can be expected, therefore, that the mode split versus average velocity curves will have a decreasing slope (cost and frequency being constant) as is verified in Figure 3-6. It was demonstrated in Section 2 of this report that the conversion of design cruise speed into average velocity is also a function of decreasing benefits. Plots of mode split versus design cruise speed will therefore indicate the combined negative effects of two functions which diminish with speed; the conversion of design cruise speed to average velocity and average velocity to demand. This conclusion is verified by inspection of the mode split versus average velocity and design cruise speed curves in Section 4 which show the design cruise speed plots to always have smaller slopes.

#### 3.4.3 Use of the Mode Split Model

The CN22 mode split model (equation 3.4-1) has been calibrated for four different modes: rail, air, bus, and auto. The demand analyses in this study were based on use of the model calibration for the rail mode for all forms of improved train passenger service. Use of the model in this manner, however, raises the theoretical problem as to its validity for predicting ridership on a mode which has, in some cases, significantly different levels of service from the mode it was originally calibrated for. Surely, a train mode which has cruise speeds in the range of 200 to 300 mph is viewed as a distinctly different form of transportation than conventional train systems. Yet the demand model "sees" the new high speed system only in terms of its reduced travel time and predicts ridership accordingly. The issue is raised here only to suggest that it is a theoretical limitation of the demand strategy used in this study. Appropriate methods to compensate for the wide variation in service attributes for the same generic mode should be a subject for additional research.

Another problem encountered in the use of the mode split model is the calibration of the coefficient  $a_0$  in the model, equation 3.4-1. As can be seen from the model equation, the constant  $a_0$  does not actually affect the models characteristics in terms of

determining relative mode splits; i.e., it does not affect the model elasticities. The coefficient's primary function is to permit calibration of the model to reproduce base year conditions. Any deviation from base conditions such as changes in modal service characteristics are handled by the other coefficients.

This method of calibrating the model to fit base year conditions without affecting its elasticity characteristics is referred to as the "pivot point" technique and was generally used in this study where possible. As mentioned previously, however, actual modal volumes for city pairs involving Baltimore and Toledo were not known; hence, the pivot point technique could not be used. For Toledo, the calibrated  $a_0$  obtained for Chicago-Detroit was used. For Baltimore, the original calibrated values found in the PMM report were used, as these values were designed to be generally applicable. In the case of the San Francisco-Sacramento city pair, the existing travel data for rail indicated rather paradoxical patterns (relatively high volume but very poor service) and led to erroneous calibrations (unrealistically large  $a_0$ 's). For these city pairs the original PMM values were also used. A summary of the calibrated  $a_0$ 's for the various city pairs investigated is presented in Table 3-3. It should also be mentioned that the calibration of  $a_0$  did not have a particularly significant impact on the study results since the analysis was more concerned with relative changes in demand rather than absolute values.

TABLE 3-3. SUMMARY OF CALIBRATED VALUES FOR COEFFICIENT  $a_0$

Corridor	Air	Rail	Bus	Auto	Source
1. San Francisco-Sacramento	1.010	1.460	.830	1.00	Original PMM values
2.A Chicago-Detroit	1.238	.456	.109	.48	Calibrated
B Chicago-Toledo <sup>†</sup>	1.238	.456	.109	.48	Calibrated
C Toledo-Detroit*	1.010	1.460	.830	1.00	Original PMM values
3. Northeast Corridor					
3.A Boston-N.Y.C.	1.570	.770	.830	.64	Calibrated
B Boston-Phil.	1.565	2.120	.219	.71	Calibrated
C Boston-Balti.*	1.010	1.460	.830	1.00	Original PMM
D Boston-D.C.	.706	.360	.100	.80	Calibrated
E N.Y.C.-Phil.	.600	2.960	2.600	4.10	Calibrated
F N.Y.C.-Balt.*	1.010	1.460	.830	1.00	Original PMM
G N.Y.C.-D.C.	1.706	.781	.604	1.00	Calibrated
H Phil.-Balt.*	1.010	1.460	.830	1.00	Original PMM
I Phil.-D.C.	3.350	7.950	2.160	4.12	Calibrated
J Balt.-D.C.*	1.010	1.460	.830	1.00	Original PMM

\* Indicates that there was no mode split data with which to calibrate the model.

<sup>†</sup>The Chicago-Detroit calibrated parameters were used.

## 4. PRELIMINARY APPLICATIONS OF ANALYSIS TECHNIQUES

### 4.1 GENERAL DESCRIPTION OF APPROACH

The supply and demand analysis techniques developed in Sections 2 and 3 of this report were applied to several potential applications for improved train service. The specific corridors investigated were the Northeast (NEC), Chicago-Toledo-Detroit (C-D), and San Francisco-Sacramento (SF-S). These corridors represent a range of applications in terms of length (456, 300 and 89 miles respectively) and present travel behavior. The analyses of these corridors were preliminary for the following reasons:

- a) Existing or potential route alignment data were known for only the NEC application. For the C-D and SF-S corridors, various ideal alignments had to be assumed to permit parametric analyses.
- b) Present travel by rail in the Chicago-Detroit and SF-Sacramento corridors is so low that calibration of the demand model for improved train service was difficult and most likely inaccurate. (See discussion on calibration, Section 3).
- c) Detailed analyses of various operational strategies were not performed. All stations were assumed to be on-line with a 180-second dwell time. Independent operations of passenger and freight service were assumed.

Despite the preliminary nature of the analyses, the primary objective of this study phase was accomplished; the demonstration of the supply and demand analysis techniques for use in determining the best combination of train and application characteristics based on performance measures and criteria.

The following description of the analysis approach is arranged in order of supply, demand and combined studies. The supply and demand analyses utilize the techniques developed in Sections 2 and 3 of this report respectively applied to actual situations. The results of these two sections are based on considerations of supply



and demand performance criteria individually and not as an interactive process (the demand analysis ignores the effects of application characteristics on supply performance and vice versa). The combined analyses integrate the two techniques to indicate how demand varies as a function of supply performance for given set of application characteristics.

## 4.2 SUPPLY PERFORMANCE ANALYSES

The purpose of this analysis phase was to establish maximum effective train-performance characteristics (design cruise speed) permitted for specific application conditions based upon the average velocity and capacity measures and criteria described in Section 2 of this report.

### 4.2.1 Analysis of Route Alignments

4.2.1.1 Northeast Corridor - As a necessary prerequisite to the supply analyses, detailed information on the existing passenger rail route alignment for the Boston to Washington corridor was acquired from reports on the Northeast Corridor Project.<sup>9</sup> These reports identified every curve, its length and degree of curvature, on the Boston to Washington route. No information was provided on the superelevation of these curves however. The approach used in the supply analysis for the NEC was to take the existing route alignment and indicate how improvements to it would change the performance requirements of train systems operating over it. All improvements were made by either increasing the superelevation of curves or by removing curves. It was assumed that vertical curves and grades were not velocity impediments to passenger trains.

The velocity model (Section 2.1.2) requires curve data in form of two one-dimensional arrays which describe, for each curve speed, the number of times the curve repeats itself per route mile and its average length. Use of the velocity model for calculation of NEC average velocities as a function of route alignment required the conversion of the Klauder<sup>9</sup> data into curve speeds (stratified into nine speed ranges), the number of curves per speed range and their

average lengths. Since the Klauder<sup>9</sup> reports specified only the curve length and degree of curvature, the following assumptions were made regarding superelevations, transitions and lateral accelerations in order to convert the data into the required format:

- a) The existing route alignment was assumed to have a superelevation on all curves of 6°5'. This is the maximum superelevation generally permitted by current railroad standards and tends to represent a significant improvement over the existing alignment.
- b) All further improvements over the existing alignments were assumed to have an effective superelevation of 10°. This is well within the capabilities of improved train systems, particularly TLV's and cars with tilt bodies. The practical limit on superelevation for passenger service appears to be dictated more by human factors than technical considerations because of problems associated with stopping on curves. The DOT/FRA PTACV and TLRV test tracks at DOT/TTC have superelevations of 10° and 13° respectively.
- c) The curve transition sections (tangent to full radius and level to full superelevation) were assumed to be included within the curve lengths specified in the Klauder<sup>9</sup> data.
- d) The maximum permissible lateral accelerations for passengers on curves was assumed to be .08g's.

The lateral acceleration of a system negotiating a curve of specified radius and superelevation is described as:

$$A_l = \frac{V^2 \cos \theta}{32.2 R} - \sin \theta \quad (4.2-1)$$

Where

V = system velocity through the curve, fps.

R = curve radius, ft.

$\theta$  = superelevation (or superelevation plus tilt of body for tilting cars), degrees

The relationship between curve radius and degree curvature is defined as:

$$R = \frac{50}{\sin (1/2 D)} \quad (4.2-2)$$

where

D = degree of curvature, degrees

R = radius of curvature, ft.

Combining equations 4.2-1 and 2 yields the following expressions for curve speed as a function of superelevation and degree of curve:

$$v = \left[ \frac{1610 (A1 - \sin \theta)}{\cos \theta \sin (1/2 D)} \right]^{1/2} \quad (4.2-3)$$

This function was used in the reduction of the Klauder<sup>9</sup> data to determine the number of curves that fell within the ten 30 mph speed intervals between 0 and 300 mph. The data was reduced for three different superelevations (6°5', 10° and 15°). The results of the data reduction process are described in Tables 4-1 and 4-2.

The route alignments for the two sections of the NEC are quite different as described by the tables and Figures 4-1 and 4-2. The curve speed distribution plots of Figures 4-1 and 4-2 indicate that the Boston-NY section has a much greater density of low-speed curves (mean curve speed, 98 mph) than the NY-Washington section (mean curve speed, 162 mph) which is skewed more to the right. The overall curve densities for each section are similar however (1.0 curves/mile vs. 0.8 curves/mile, Boston-NY, NY-Washington respectively) As discussed in Section 2.2.7, it can generally be expected that the higher curve speed distribution of the NY-Washington section will permit a greater level system performance. This observation is verified in Figure 4-3 which indicates that the NY-Washington section permits a design cruise speed



TABLE 4-1. CURVE CHARACTERISTICS FOR BOSTON TO NEW YORK SECTION OF NEC

CURVE SPEED CATEGORY	NUMBER OF CURVES	TOTAL LENGTH OF CURVES	AVERAGE LENGTH OF CURVES	AVERAGE DISTANCE BETWEEN CURVES	PERCENT OF TOTAL LENGTH	MEAN VELOC.	
SUPERELEVATION, 6° 5'							
ABOVE 300 MPH	1	0.10	0.100	231.2	0.000	83	
270 TO 300	1	0.20	0.200	231.2	0.001		
240 TO 270	3	0.70	0.233	77.1	0.003		
210 TO 240	2	0.10	0.050	115.6	0.000		
180 TO 210	0	0.00	0.000	0.0	0.000		
150 TO 180	3	0.80	0.267	77.1	0.003		
120 TO 150	46	12.30	0.267	5.0	0.053		
90 TO 120	49	17.80	0.363	4.7	0.077		
60 TO 90	113	35.20	0.312	2.0	0.152		
30 TO 60	15	3.50	0.233	15.4	0.015		
0 TO 30	0	0.00	0.000	0.0	0.000		
SUPERELEVATION, 10°							
ABOVE 300 MPH	2	0.30	0.150	115.6	0.001		90
270 TO 300	3	0.70	0.233	77.1	0.003		
240 TO 270	2	0.10	0.050	115.6	0.000		
210 TO 240	2	0.50	0.250	115.6	0.002		
180 TO 210	1	0.30	0.300	231.2	0.001		
150 TO 180	10	2.20	0.220	23.1	0.010		
120 TO 150	61	18.20	0.298	3.8	0.079		
90 TO 120	87	30.70	0.353	2.7	0.133		
60 TO 90	58	16.40	0.283	3.9	0.071		
30 TO 60	7	1.30	0.186	33.0	0.006		
0 TO 30	0	0.00	0.000	0.0	0.000		
SUPERELEVATION, 15°							
ABOVE 300 MPH	5	1.00	0.200	46.2	0.004	118	
270 TO 300	2	0.10	0.050	115.6	0.000		
240 TO 270	2	0.50	0.250	115.6	0.002		
210 TO 240	1	0.30	0.300	231.2	0.001		
180 TO 210	4	0.70	0.175	57.8	0.003		
150 TO 180	52	14.50	0.279	4.4	0.063		
120 TO 150	73	26.20	0.359	3.2	0.113		
90 TO 120	65	19.30	0.297	3.6	0.083		
60 TO 90	24	7.30	0.304	9.7	0.032		
30 TO 60	5	0.80	0.160	46.2	0.003		
0 TO 30	0	0.80	0.000	0.0	0.000		



TABLE 4-2. CURVE CHARACTERISTICS FOR NEW YORK TO WASHINGTON SECTION OF NEC

CURVE SPEED CATEGORY	NUMBER OF CURVES	TOTAL LENGTH OF CURVES	AVERAGE LENGTH OF CURVES	AVERAGE DISTANCE BETWEEN CURVES	PERCENT OF TOTAL LENGTH	MEAN VEL	
SUPERELEVATION, 6°5'							
ABOVE 300 MPH	8	1.00	0.125	28.1	.004	138	
270 TO 300	3	0.30	0.100	75.0	.001		
240 TO 270	8	4.00	0.500	28.1	.018		
210 TO 240	11	5.10	0.464	20.4	.023		
180 TO 210	13	4.20	0.323	17.3	.019		
150 TO 180	28	12.10	0.432	8.0	.054		
120 TO 150	61	24.50	0.402	3.6	.011		
90 TO 120	27	9.10	0.337	8.3	.04		
60 TO 90	16	4.70	0.294	14.0	.021		
30 TO 60	5	1.20	0.240	45.0	.005		
0 TO 30	0	0.00	0.000	00.0	.000		
SUPERELEVATION, 10°							
ABOVE 300 MPH	12	2.50	0.208	18.7	.011		162
270 TO 300	8	5.10	0.637	28.1	.023		
240 TO 270	19	6.00	0.316	11.8	.027		
210 TO 240	20	6.30	0.315	11.2	.028		
180 TO 210	12	6.80	0.567	18.7	.03		
150 TO 180	22	9.90	0.450	10.2	.044		
120 TO 150	57	21.20	0.372	3.9	.094		
90 TO 120	18	4.80	0.267	12.5	.021		
60 TO 90	9	3.20	0.356	25.0	.014		
30 TO 60	3	0.40	0.133	75.0	.002		
0 TO 30	0	0.00	0.000	0.0	.000		
SUPERELEVATION, 15°							
ABOVE 300 MPH	23	8.10	0.352	9.7	.036	186	
270 TO 300	16	5.50	0.344	14.0	.024		
240 TO 270	20	6.30	0.315	11.2	.028		
210 TO 240	12	6.80	0.567	18.7	.03		
180 TO 210	19	8.40	0.442	11.8	.037		
150 TO 180	50	18.70	0.374	4.5	.083		
120 TO 150	24	7.70	0.321	9.3	.034		
90 TO 120	6	1.60	0.267	37.5	.007		
60 TO 90	10	3.10	0.310	22.5	.014		
30 TO 60	0	0.00	0.000	0.0	.000		
0 TO 30	0	0.00	0.000	0.0	.000		

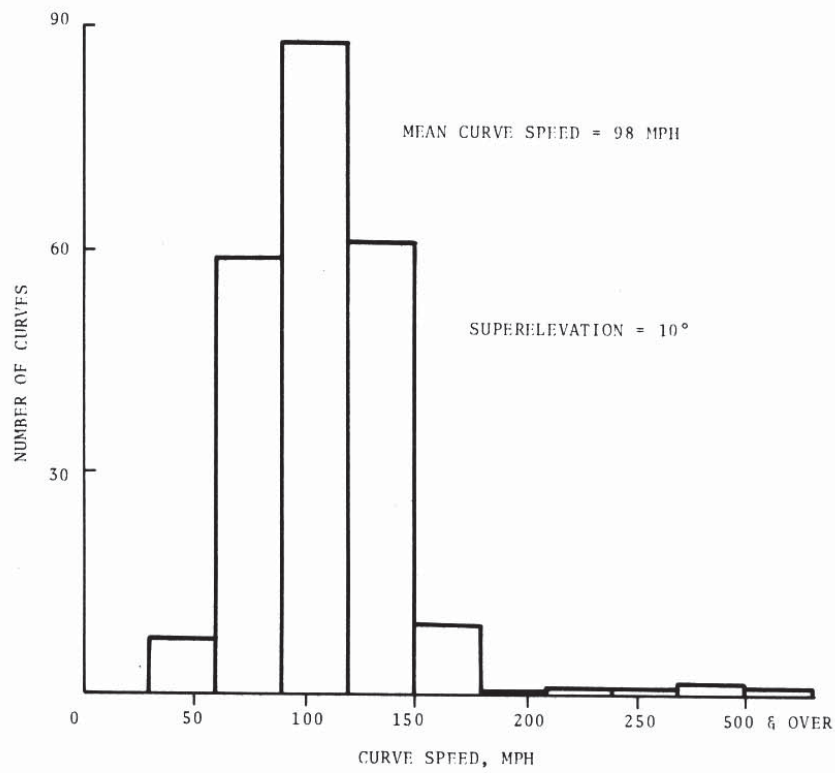

Figure 4-1. Distribution of Curves in the Boston-NY Section of the Northeast Corridor

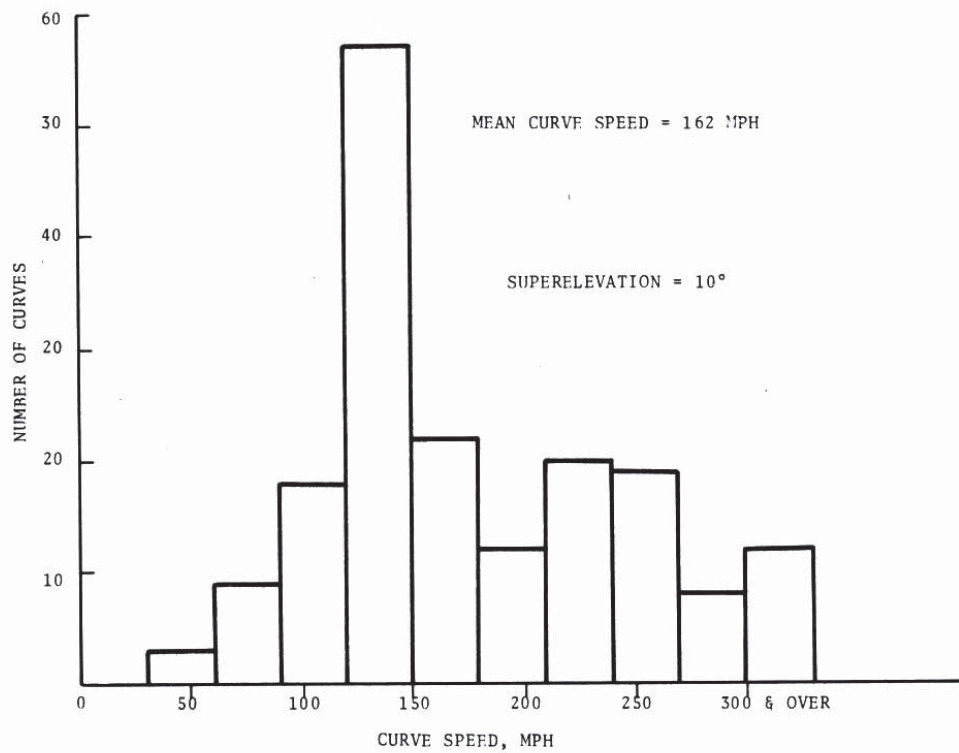

Figure 4-2. Distribution of Curves in the NY-Washington Section of the Northeast Corridor

STATIONS: BOS-PROV -NH-NY -PHIL -BALT -DC

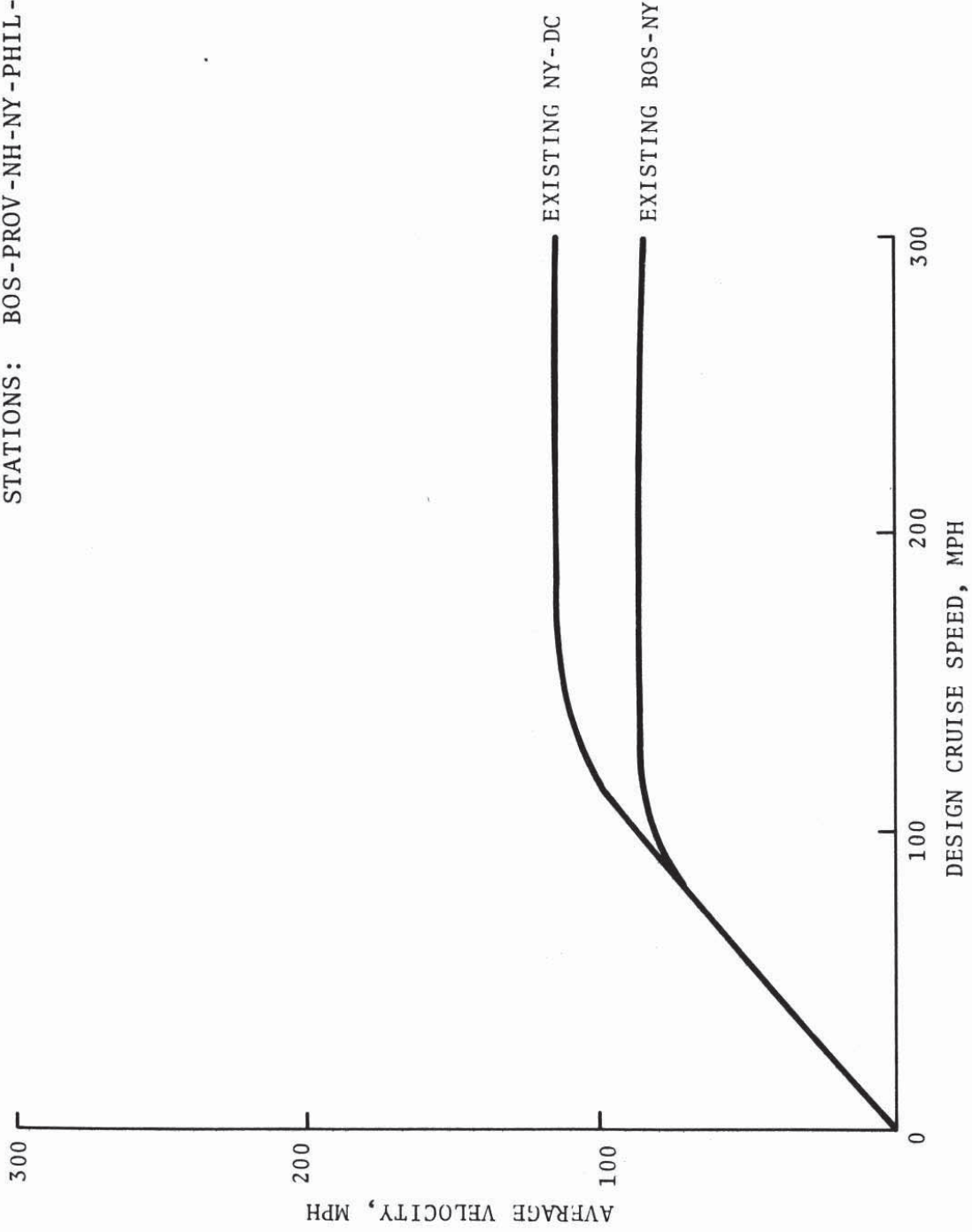

Figure 4-3. Average Velocity Vs. Design Cruise Speed for Two Sections of the Northeast Corridor, Upgraded to 10° Superelevation

of 183 mph versus 135 mph for the Boston-NY section using 62.5 percent velocity ratio performance criteria (10° superelevation on curves).

It is shown in Tables 4-1 and 4-2, that a change in superelevation will produce significant effects on the curve speed distribution and, thus, system performance. Increasing the superelevation from 6°5' to 15° decreases the number of curves in the 0-80 mph range from 128 to 20 (Boston-NY) and 21 to 10 (NY-Washington) and increases the mean curve speed from 83 to 118 mph and 138 to 186 mph for the Boston-NY and NY-Washington sections respectively. The impact of this change on system performance is shown on Table 4-3 where maximum effective design cruise speed (as determined by the 62.5 percent VR criteria) is listed for various superelevations. An increase in design cruise speed of 32 mph (Boston-NY) and 38 mph (NY-Washington) is permitted by upgrading the superelevation from 6°5' to 15°.

TABLE 4-3. EFFECTS OF CHANGES IN SUPERELEVATION\*

SUPERELEVATION, DEG.	BOSTON-NY		NY-WASHINGTON	
	MEAN CURVE SPEED, mph	DESIGN CRUISE SPEED, 62.5% VR	MEAN CURVE SPEED	DESIGN CRUISE SPEED, 62.5% VR
6°-5'	83	120	138	172
10°	98	140	162	183
15°	118	152	186	210

\* Stations - Bos-Prov-NH-NY-Phil-Balt-DC  
Dwell Time - 180 seconds  
Acceleration and Braking Rates - 0.1g

4.2.1.2 Chicago-Detroit and San Francisco-Sacramento Corridors - Because existing route alignment data for these two corridors was not available, an approach different from the NEC analysis was used to accomplish the same objective (to establish the route characteristics required for effective utilization of trains with various levels of performance). For these two corridors hypothetical route alignments were chosen and tested to establish train



performance levels. To simplify the analyses, aggregated curve speed distributions consisting of three representative speed ranges (60, 150 and 240 mph) were chosen. Various combinations of these curves were then studied to determine the maximum number of individual curves and combinations of curves which could be tolerated in achieving certain train performance levels.

#### 4.2.2 Average Velocity Performance Versus Route Alignment

4.2.2.1 Northeast Corridor - Because of the noticeable difference in route alignment characteristics between the Boston-NY and NY-Washington sections, they were analyzed separately and together as one route. It was assumed that each section had two intermediate stops (180-second dwell) creating two very similar corridors excluding route alignment. In actual practice, it is likely that more intermediate stops would be employed thus producing somewhat lower levels of performance than predicted in this study. To simplify the analysis and isolate the effects of curve alignment (degree of curvature) on train performance, it was assumed that the existing curves all had superelevations of 10°. Actually this represents an improvement over the existing situation (approximately 6° maximum on curves) as described in Table 4-3. The "existing" alignment was then upgraded in various stages by removing all curves below certain speeds and the improvement in train performance, resulting from the deletion of curves, measured. Although this approach provides a simplified means of demonstrating use of the supply model for determining the extent of alignment improvement necessary for achieving certain train performance levels, it is not necessarily representative of the improvement strategy that would be followed in actual practice. Rather than deleting entirely curves from a route as was done here, most curves would be upgraded to a higher speed. In addition, it is probably not realistic to assume that all curves would have the same superelevation. The net effect of these practical considerations is that, certain levels of improvement assumed in this study (particularly those requiring extensive upgrading) may be extremely difficult to achieve in reality.

Plots of the average speeds obtained for various stages of route improvement are shown in Figures 4-4, 4-5, and 4-6 for the Boston-NY, NY-Washington and Boston-Washington corridors respectively. For each corridor, the same improvements, in terms of removing all curves below certain speeds, were made. Because of the differences in curve speed distributions for the corridors (see Figures 4-1 and 4-2), however, the number of curves removed and the performance results obtained by deleting curves according to speed range varies considerably. For example, the existing alignment of the NY-Washington corridor has the highest average velocity because of its greater density of high speed curves. For the same improvement of removing all curves below 150 mph, however, the best level of performance is provided in the Boston-NY corridor because of its greater density of low speed curves and the resulting larger number of curves actually removed (213 versus 87 for Boston-NY and NY-Washington respectively).

Using the average velocity-cruise speed plots and the 62.5 percent velocity ratio criteria, it is possible to establish relationships between train design cruise speed and the number of curves which must be removed from the NEC to permit effective utilization of the train. This relationship is shown in Figure 4-7. In comparing the two subsections of the NEC, it can be seen that, for the same number of curves removed, the NY-Washington section permits a greater level of performance because of its high curve-speed distribution. When all curves are removed from the route, the same level of performance is achieved for all three routes because of their almost identical station densities. The figure also indicates that a design cruise speed of 150 mph can be effectively employed on the NEC without the removal of any curves. It should be reemphasized that this level of performance is theoretically possible only because of the assumed  $10^\circ$  superelevation for all curves and the few intermediate stops. The existing curves typically have a superelevation of less than  $6^\circ$  and existing trains stop at more intermediate stations. A summary of the number of curves which must be removed to permit effective

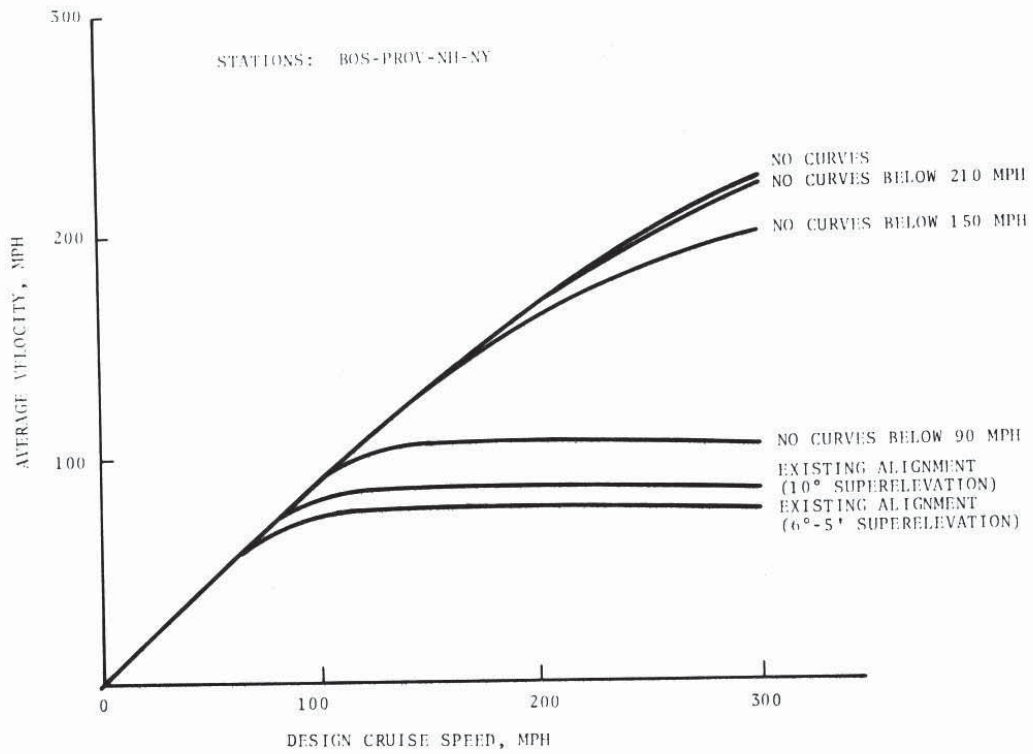

Figure 4-4. Average Velocity Versus Design Cruise Speed for Various Alignments of the Boston-NY Section

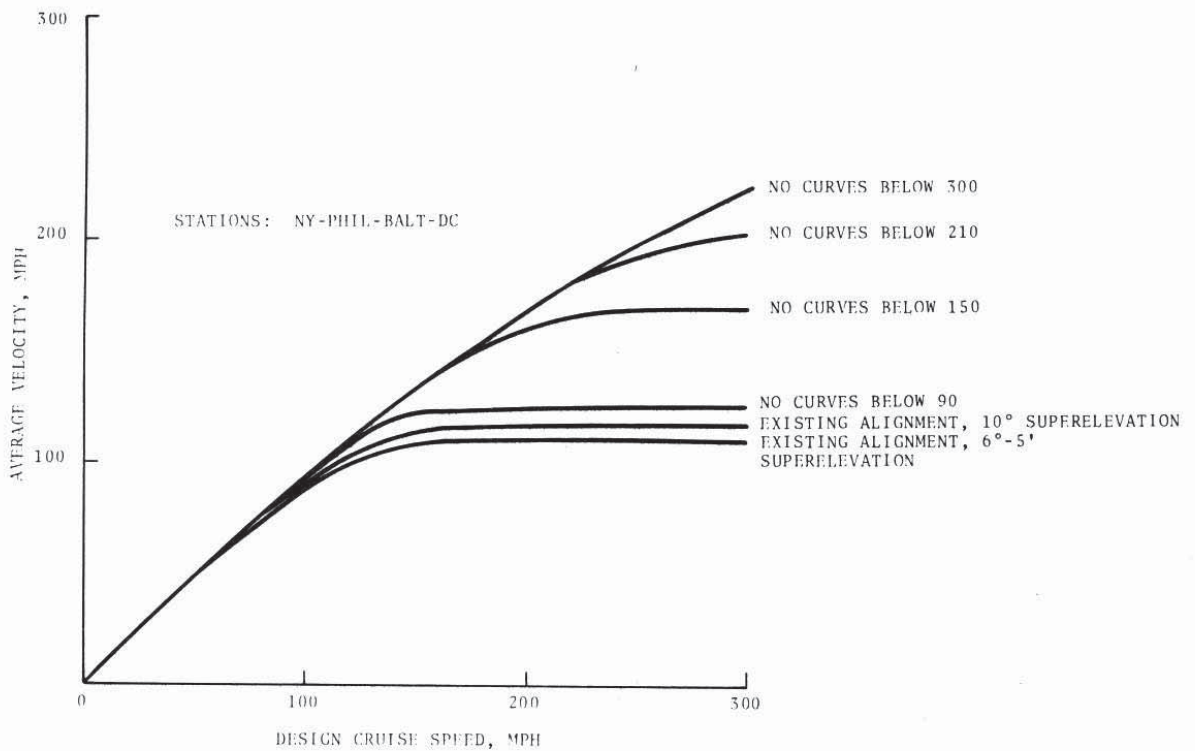

Figure 4-5. Average Velocity Versus Design Cruise Speed for Various Alignments of the NY-DC Section

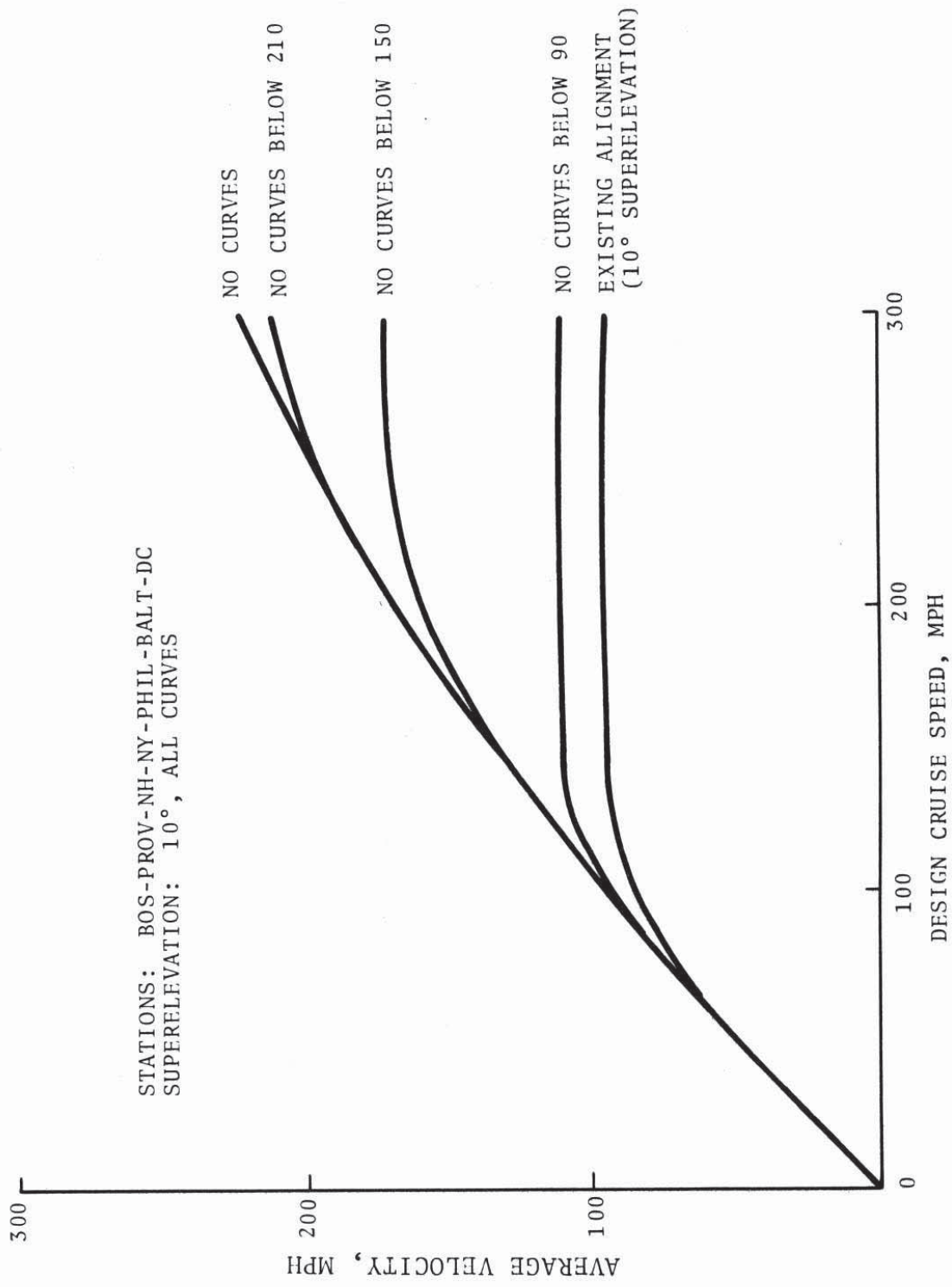

Figure 4-6. Mode Split Versus Design Cruise Speed for Various Route Alignments, Northeast Corridor



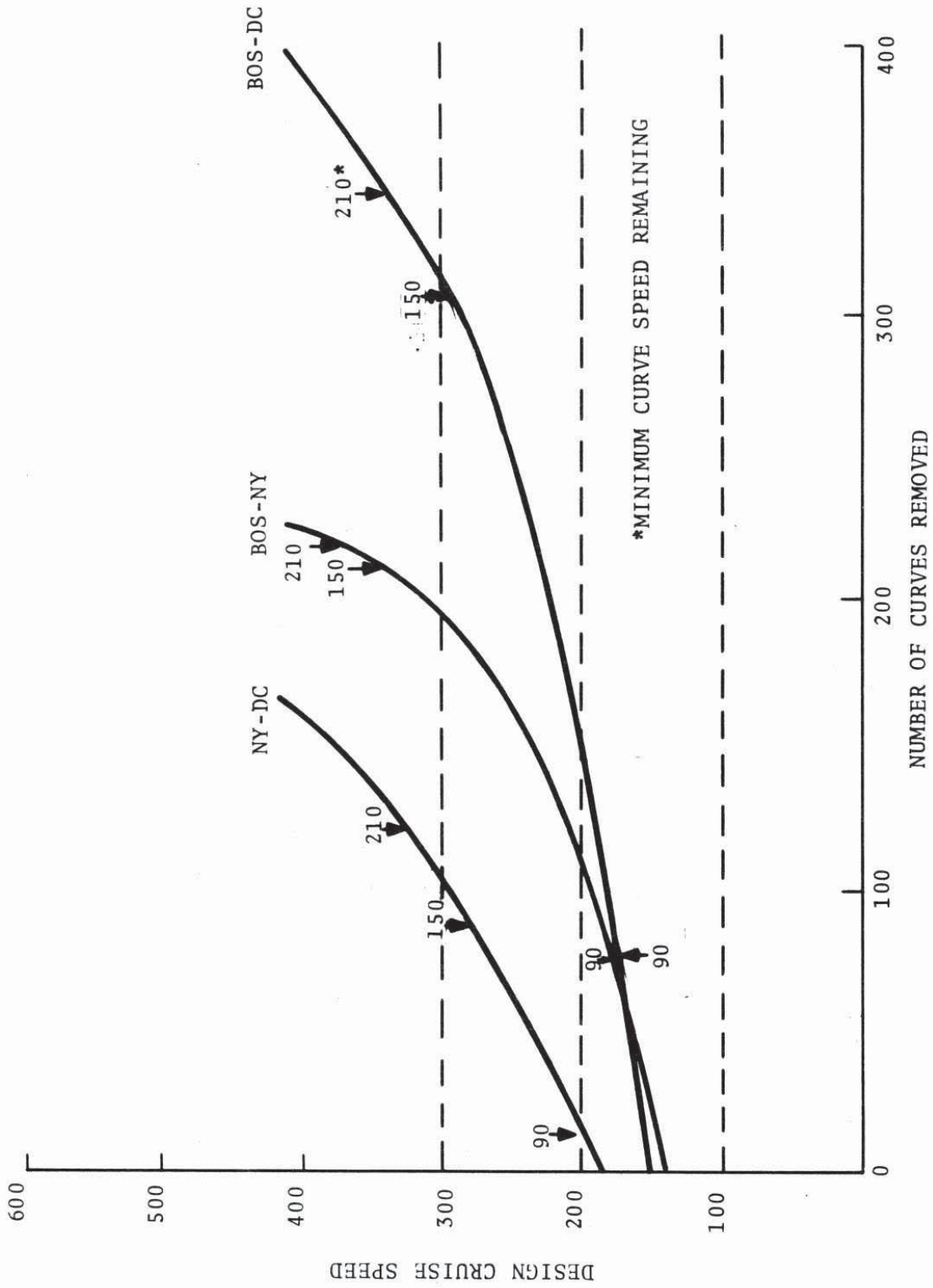

Figure 4-7. Maximum Effective Design Cruise Speed Versus Number of Curves Removed from the Northeast Corridor

use of train design cruise speeds of 100, 200 and 300 mph for the NEC sections is presented in Table 4-4.

TABLE 4-4. NUMBER OF CURVES REMOVED TO PERMIT EFFECTIVE UTILIZATION OF DESIGN CRUISE SPEEDS\*

DESIGN CRUISE SPEED	NUMBER OF CURVES REMOVED		
	BOS-NY	NY-DC	BOS-DC
300 MPH	195	105	315
200 MPH	110	15	150
100 MPH	0	0	0

\* 10° Superelevation

4.2.2.2 San Francisco-Sacramento and Chicago-Detroit Corridors - For these two corridors, hypothetical route alignments were assumed as actual data on potential train routes was not available. The analysis strategy used was to assume a series (six cases) of route alignments which represented a broad range of curve speed distributions from all low speed curves to all high speed curves. The six curve-speed distribution cases are summarized in Table 4-5.

TABLE 4-5. SUMMARY OF CURVE-SPEED DISTRIBUTION CASES

CASE	PERCENT OF CURVES IN EACH SPEED RANGE		
	60 mph	150 mph	240 mph
I	100%	0%	0%
II	50%	50%	0%
III	33%	33%	33%
IV	0%	100%	0%
V	0%	50%	50%
VI	0%	0%	100%

The analysis results are presented in Figures 4-8 and 4-9 in the form of plots of maximum effective train design cruise speed versus curve density (number of curves per 100 route miles) for

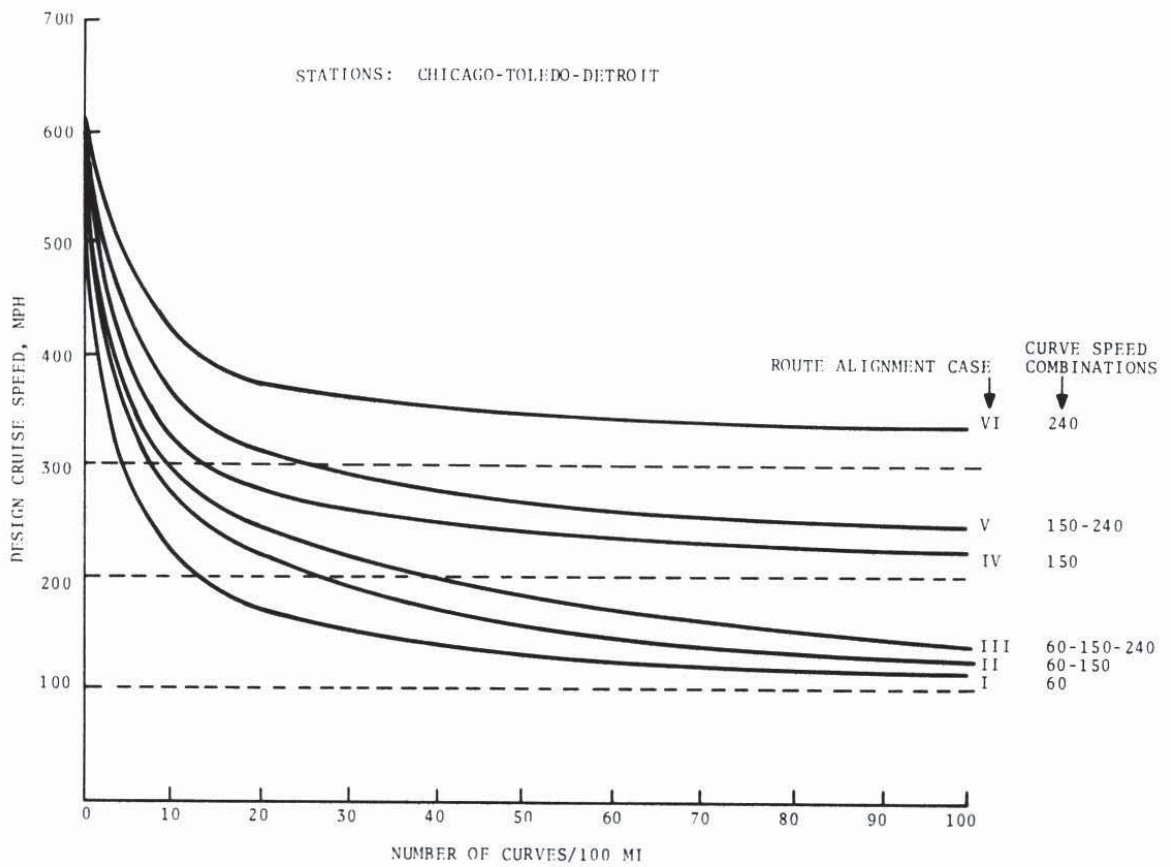

Figure 4-8. Design Cruise Speed Versus Curve Density, Chicago-Detroit Corridor

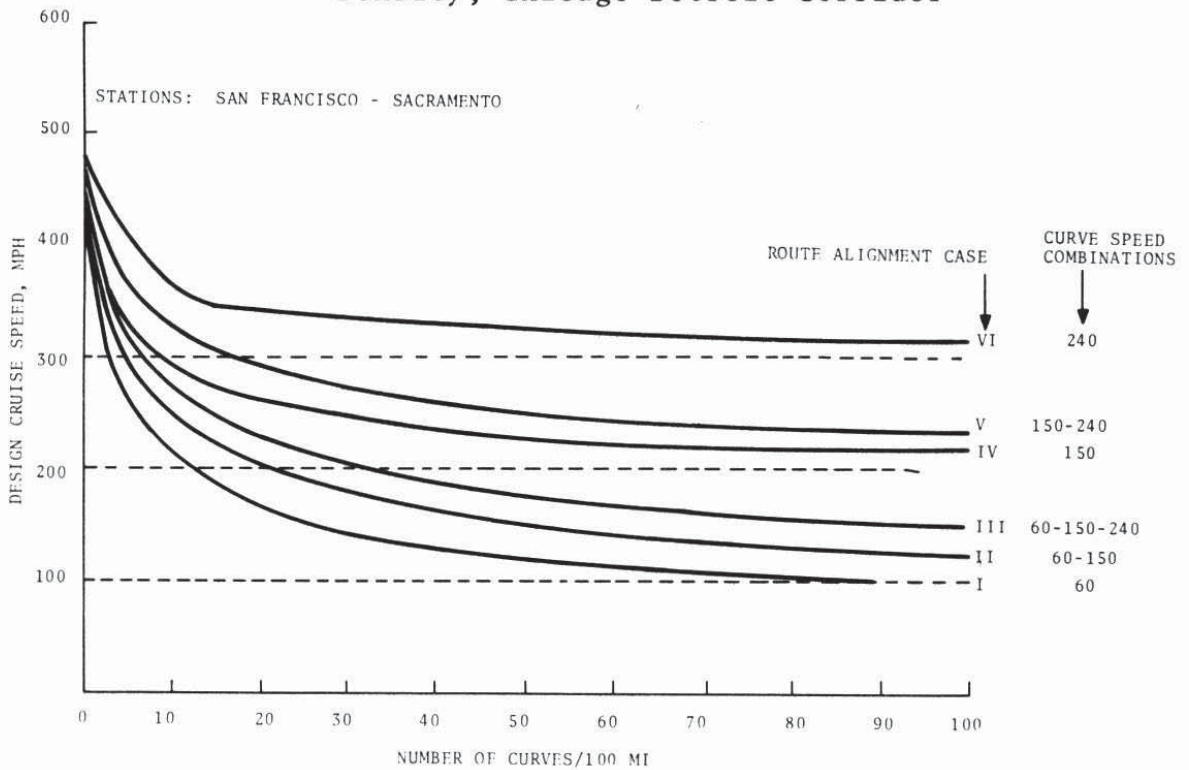

Figure 4-9. Design Cruise Speed Versus Curve Density, San Francisco-Sacramento Corridor

the six curve speed distributions investigated. For a given curve density, curve speed distribution Cases I through VI represent a logical sequence of route improvements. For example, the transition from Case I to Case III at the same curve density means that one-third of the 60 mph curves are upgraded to 150 mph and another third to 240 mph. A less realistic improvement sequence of completely removing curves from the system is represented by moving to a lower curve density along any one of the case plots; i.e., for Case IV a shift from 100 curve/100 miles to 50 curves/100 miles corresponds to removing half of the 150 mph curves from the system.

Both Figures 4-8 and 4-9 show the performance curves radiating from a common point on the vertical axis which corresponds to the effects of stations only (no curves are left in the system). The Chicago-Detroit corridor has a larger average station spacing than the San Francisco-Sacramento corridor (150 versus 89 miles) and a resulting higher design cruise speed limit (670 versus 480 mph) when all curves in the system are removed. For the same reason (larger station spacing), the performance limits for the Chicago-Detroit corridor are always greater than the San Francisco-Sacramento corridor for the same curve conditions. The difference in performance levels due to station spacing diminishes, however, as curve densities become greater.

Figures 4-8 and 4-9 permit a cursory comparison of the relative benefits derived by the two upgrading strategies of deleting curves versus increasing curve speed. Based upon the observations in Section 2.2.7, the strategy of removing curves would intuitively appear to yield greater performance gains than upgrading curves for the same number of curves affected. The two strategies produce very similar results, however, when the curve densities and extent of upgrading are large. For example, upgrading 50 percent of the 60 mph curves to 150 mph at a curve density of 50 curves/100 miles produces the same results as removing 50 percent of the 60 mph curves (50 curves/100 miles to 25 curves/100 miles). Only when curve densities are small (less than 10 curve/100 miles) does the strategy of removing versus upgrading produce significantly greater gains in performance. These observations can be explained in terms



of the pervasive detrimental effect that low speed curves have on train system performance. If an upgrade or removal of curves still leaves a significant number of low speed curves in the system (25/100 miles of 60 mph curves in the example) these remaining curves will still control system performance. The upgraded curves (150 mph in the example) are of sufficiently higher speed than the system average velocity achieved with 50 percent of the 60 mph curves removed (105 mph) that they have little or no effect on system performance. Generalizing, if the upgraded curve speed significantly exceeds the system average velocity permitted by the remaining low speed curves acting independently then the two improvement strategies of upgrading and removal yield approximately the same results.

A summary of the actual number of curves which can be tolerated in the Chicago-Detroit and San Francisco-Sacramento corridors in effectively utilizing design cruise speeds of 100, 200 and 300 mph for the six curve-speed distributions is shown in Tables 4-6 and 4-7. Virtually any number and combination of curves above 60 mph will permit effective employment of 100 mph trains. The number of curves which can be tolerated for 200 mph and, in particular, 300 mph systems appears to represent a severe limitation in the number of useful applications for these systems. An analysis of actual route alignments for each specific application, is necessary, however, before definitive conclusions can be made regarding the effectiveness of trains with high design cruise speeds.

#### 4.3 APPLICATIONS OF DEMAND ANALYSIS TECHNIQUE

##### 4.3.1 Modal Data

The demand analysis models and methods described in Section 3 are applied here to the Northeast, Chicago-Detroit and San Francisco-Sacramento corridors. The purpose of these applications is to demonstrate use of the demand models for determining the impact of changes in service attributes of the train mode on demand. To use the demand models for this purpose, the service characteristics of all competing modes (auto, bus and air) had to

TABLE 4-6. MAXIMUM NUMBER OF CURVES PERMISSIBLE VERSUS DESIGN CRUISE SPEED\*  
CHICAGO-TOLEDO-DETROIT

DESIGN CRUISE SPEED	I 60 CURVE DENSITY**	II 60-150 CURVE DENSITY	III 60-150-240 CURVE DENSITY	IV 150 CURVE DENSITY	V 150-240 CURVE DENSITY	VI 240 CURVE DENSITY
300 MPH	15	24	30	39	75	>300
200 MPH	39	81	114	>300	>300	>300
100 MPH	>300	>300	>300	>300	>300	>300

\*Route Length - 300 mi

Station Spacing - 150 mi

Station Dwell - 180

Acceleration and Braking Rates = .1g

Curve Length = .5 mi

\*\*Curve Density - Number of curves per 100 route miles

TABLE 4-7. MAXIMUM NUMBER OF CURVES PERMISSIBLE VERSUS DESIGN CRUISE SPEED\*  
SAN FRANCISCO-SACRAMENTO

DESIGN CRUISE SPEED	I 60 CURVE DENSITY**	II 60-150 CURVE DENSITY	III 60-150-240 CURVE DENSITY	IV 150 CURVE DENSITY	V 150-240 CURVE DENSITY	VI 240 CURVE DENSITY
300 MPH	3	5	6	8	16	>89
200 MPH	12	19	29	>89	>89	>89
100 MPH	81	>89	>89	>89	>89	>89

\* Route Length - 89 mi  
 Station Spacing - 89 mi  
 Station Dwell - 180 sec.  
 Acceleration and Braking Rates - .1g  
 Curve Length - .5 mi  
 \*\*Curve Density - Number of curves



be determined for the baseline year, 1974, in which the demand estimates were to be made. As discussed in Section 3, modal characteristics for 1972 also had to be acquired for purposes of calibrating the models. Information on the 1974 data is presented in summary form here.

The service characteristics quantified by the demand models are trip time, trip cost and frequency of service. Because the total trip must be considered in a comprehensive evaluation of modal performance, the access and egress times and costs are also included in the service characteristics as well as line haul information. The 1974 access and egress data acquired for the analysis by mode and city pair is summarized in Table 4-8. The line-haul and total (line haul plus access/egress) service characteristics are summarized in Table 4-9. The time and cost characteristics for the line haul portion of the train mode were not specified as these were the two primary variables to be investigated in the demand analyses.

#### 4.3.2 Results of Demand Analyses

The demand analyses were performed by providing the modal characteristics data summarized above to the demand model for each city pair. A train fare was chosen as a policy variable and was set at either 0.75, 1.0 or 1.25 times the air fare. The train fare was not considered a critical variable as the objective of the analysis was to investigate the impacts of physical performance (trip time) on demand, not costs. For a given city pair, train fare and frequency (set at 14 trips per day) the demand analyses were iterated for various train trip times resulting from increasing average velocity in 20 mph increments from 20 mph to 300 mph. The results of the demand analyses were presented in terms of mode split versus train average velocity plots.

Figures 3-3 (Section 3.2.2), and 4-10 and 4-11 show the mode splits for all competing modes versus train average velocity for train fare equal to air fare for the NEC, C-D and SF-SAC corridors. These plots show how demand for train service varies as a function of changes in the train's primary service attribute, speed, independent of application constraints (stations, curves, etc.) The



TABLE 4-8. 1974 ACCESS/EGRESS DATA

City	1 Air A/E Time hours	2 Air A/E Cost \$	3 Train A/E Time hours	4 Train A/E Cost \$	5 Bus A/E Time hours	6 Bus A/E Cost \$
Boston	.75	4.70	.55	3.04	.52	2.98
N.Y.C	1.22	5.74	.68	3.33	.80	3.59
Phil.	.98	5.21	.45	2.82	.47	2.87
Balt.	1.00	5.25	.45	2.82	.42	2.76
DC	1.07	5.41	.55	3.04	.57	3.09
SF	1.00*	5.25	.64*	3.24	.64*	3.24
SACR	.80*	3.59	.45*	1.60	.45*	1.60
Chi.	1.20*	5.69	.76*	3.50	.76*	3.50
Det.	1.40*	6.13	.69*	3.35	.69*	3.35
Tol.	1.10*	4.25	.44*	1.58	.44*	1.58

Column

- 1 From "NEC Highspeed Passenger Service Improvement Project" or Based on Formula from PMM's Analysis of intercity Modal Split Models (Reference 5) indicated by \*.
- 2 Based on Formula from PMM's Analysis of Intercity Modal Split Models (Reference 5) (Inflated to November 1974 by 22.2%.)
- 3 From "NEC Highspeed Passenger Service Improvement Project" or HSGT Alternatives Study" (Reference 1) indicated by \*.
- 4 Based on formula from PMM's "Analysis of intercity Modal Split Models" (Reference 5). (Inflated to November.)
- 5 From "NEC Highspeed Passenger Service Improvement Project" or based on formula from "HSGT Alternatives Study" (Reference 1) indicated by \*.
- 6 Based on Formula from PMM's "Analysis on intercity Modal Split Models" (Reference 5). (Inflated to November 1974 by 22.2%.)

TABLE 4-9. 1974 MODAL CHARACTERISTICS DATA,  
LINE HAUL AND TOTAL

	1	2	3	4	5	6
City Pair	Auto Distance miles	Auto Time hours	Auto Cost \$	Air Line-Haul Time hours	Air Fare \$	Air Frequency per day
Boston-NY	216	4.32	7.56	.75	25.00	47
Boston-Phil.	304	6.33*	10.64	1.00	37.00	26
Boston-Balt.	400	8.25*	14.00	1.15	43.00	10
Boston-DC	437	8.99*	15.29	1.13	45.00	30
NY-Phil.	93	1.86	3.25	.50	19.00	21
NY-Balt.	190	3.80	6.65	.80	28.00	14
NY-DC	229	4.58	8.01	.83	29.00	68
Phil.-Balt.	97	1.94	3.39	.51	19.00	11
Phil.-DC	136	2.72	4.76	.65	24.00	42
Balt.-DC	30	.78	1.36	.46	16.00	20
SF-SACR	89	1.78	5.78*	.33	12.08	30
Chi-Tol.	239	5.03*	8.36	.86	29.00	7
Chi-Det.	271	5.67*	9.48	.92	30.00	47
Tol.-Dot	61	1.22	2.13	.38	18.00	5

Column

- 1 Rand McNally Road Atlas.
- 2 At 50 mph (\* indicates 15 minute fuel stop).
- 3 Based on cost of 3.5¢/passenger mile (with tolls) or 2.42¢/passenger mile (without tolls - indicated by \*)  
From HSGT Alternative Study (Reference 1) plus 20.8% inflation.
- 4 From "Official Airline Guide", November 1974.
- 5 Jet Coach Fare (or intra-state for California) from  
"Official Airline Guide", November 1974.
- 6 From Official Airline Guide, November 1974.

TABLE 4-9. 1974 MODAL CHARACTERISTICS DATA,  
LINE HAUL AND TOTAL (Continued)

	7	8	9	10	11	12
City Pair	Train Line-haul Time hours	Train Frequ- ency per day	Train Fare \$	Bus Line-Haul Time hours	Bus Frequ- ency per day	Bus Fare \$
Boston-NY	Variable	14	Variable	4.25	66	13.45
Boston-Balt.		14		6.67	63	18.91
Boston-Phil.		14		8.25	42	24.67
Boston-DC		14		8.70	61	26.89
NYC-Phil.		14		1.72	105	6.35
NYC-Balt.		14		3.50	54	12.07
NYC-DC		14		3.95	85	14.50
Phil.-Balt.		14		2.17	51	6.60
Phil-DC		14		2.58	56	8.83
Balt.-DC		14		.92	125	2.95
SF-SACR		14		1.50	30	4.85
Chi-Tol.		14		5.00	20	13.95
Chi.-Det		14		5.33	20	16.40
Tol.-Det.		14		1.25	55	4.35

Column

- 8 From HSGT Alternatives Study (Reference 1) p. A-16.
- 10 From "Official Bus Guide", November 1974.
- 11 From "Official Bus Guide", November 1974.
- 12 From Continental Trailways Tariff.

TABLE 4-9. 1974 MODAL CHARACTERISTICS DATA,  
LINE HAUL AND TOTAL (Continued)

City Pair	13 Air Total Time hours	14 Air Total Cost \$	15 Train Total Time hours	16 Train Total Cost \$	17 Bus Total Time hours	18 Bus Total Cost \$
Boston-NY	2.72	35.44	Variable	Variable	5.57	20.02
Boston-Phil.	2.73	46.91			7.66	24.76
Boston-Balt.	2.90	52.95			9.19	30.41
Boston-DC	2.95	55.11			9.79	32.96
NY-Phil.	2.70	29.95			2.99	12.81
NY-Balt.	3.02	38.99			4.72	18.42
NY-DC	3.29	40.15			5.32	21.18
Phil.-Balt.	2.49	29.46			3.06	12.23
Phil.-DC	2.70	34.62			3.62	14.79
Balt.-DC	2.53	26.66			1.91	8.80
SF-SACR	2.26	20.92			2.59	9.69
Chi-Tol.	3.16	38.92			6.20	19.03
Chi-Det	3.52	41.82			6.78	23.25
Tol-Det	2.88	28.38			2.38	9.28

3

Column

- 13 Access + Line-Haul + Egress.
- 14 Access + Line-Haul + Egress.
- 17 Access + Line-Haul + Egress.
- 18 Access + Line-Haul + Egress.



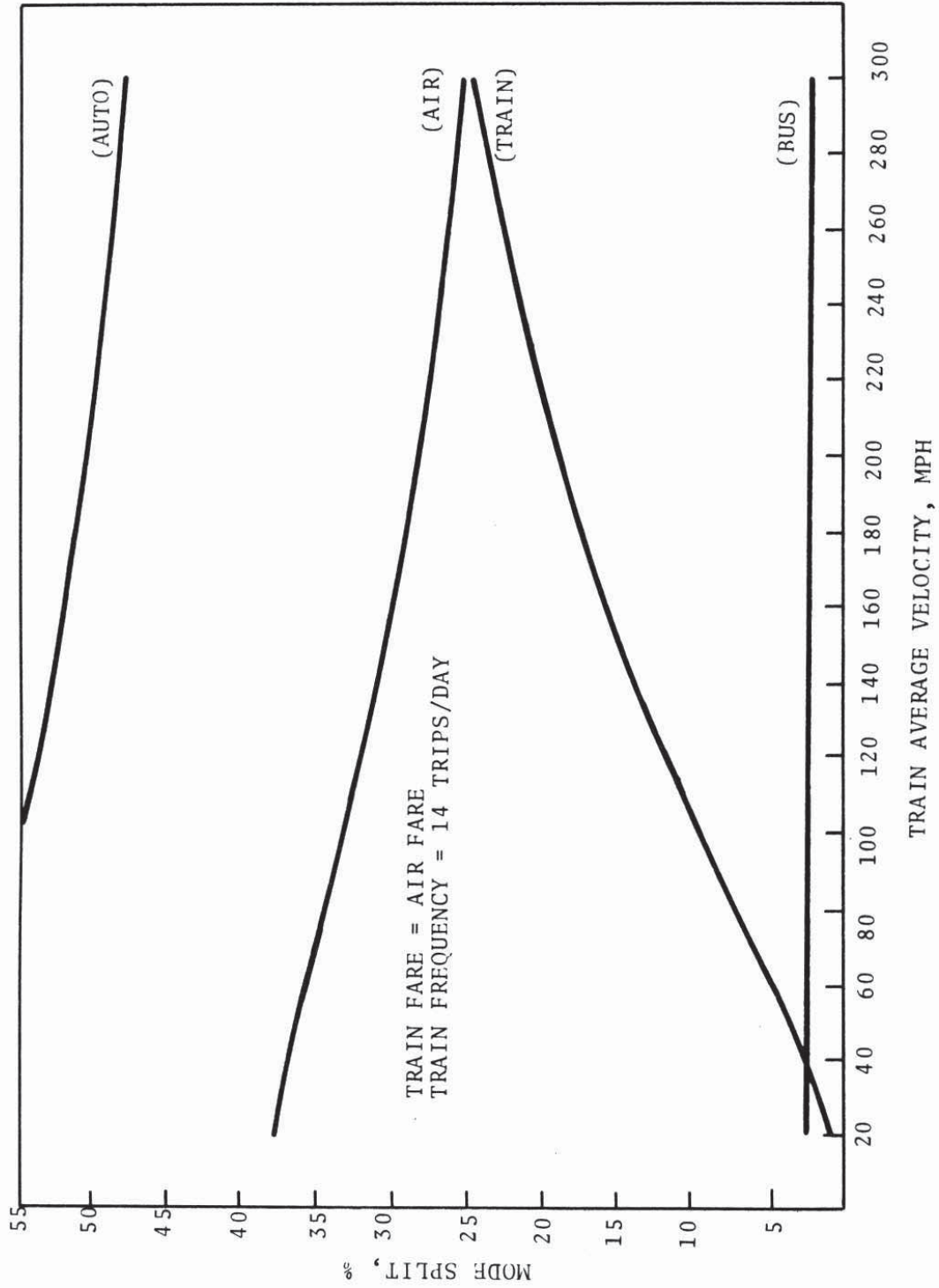

Figure 4-10. Mode Split Versus Train Average Velocity, Chicago-Detroit

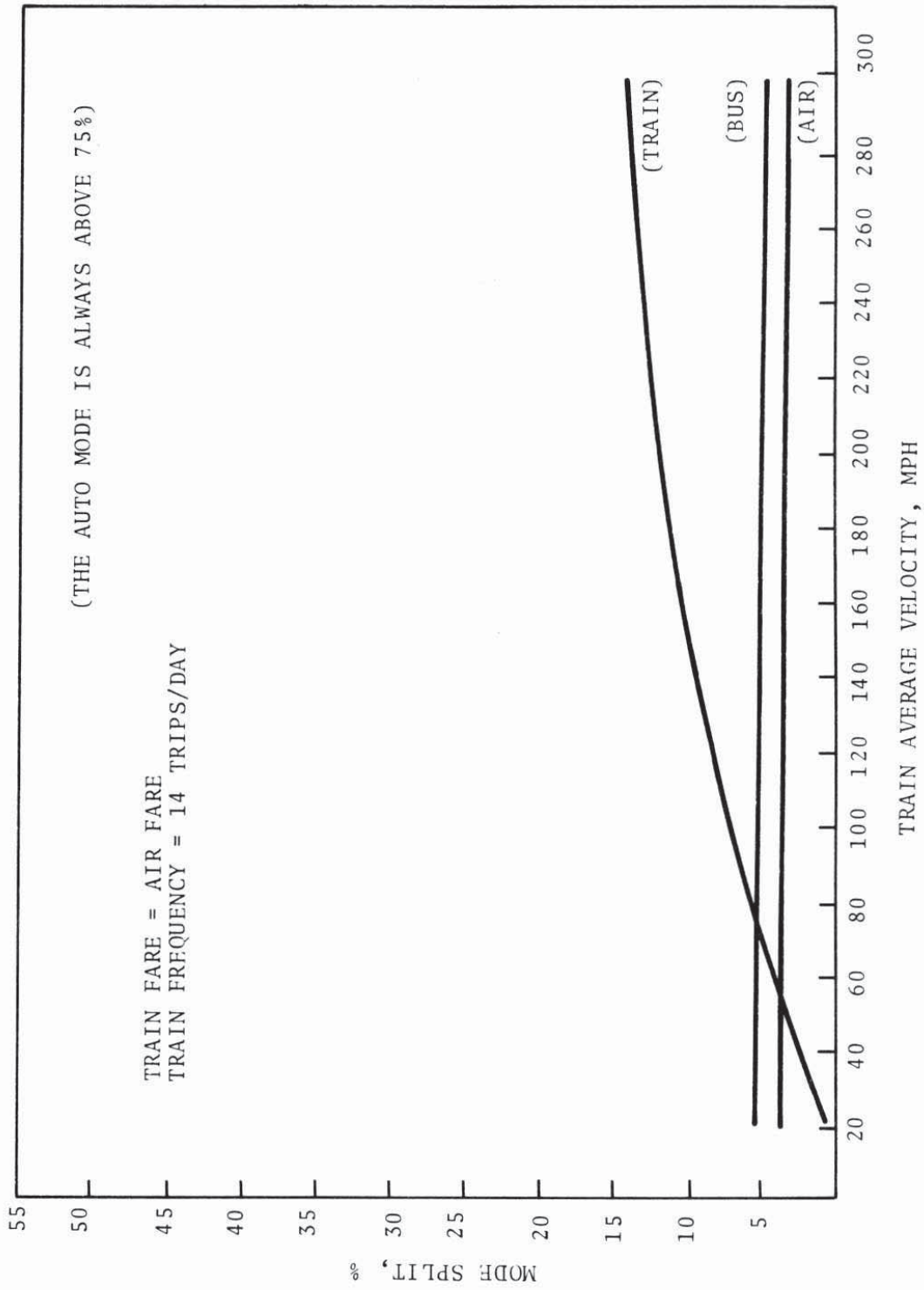

Figure 4-11. Mode Split Versus Train Average Velocity, San Francisco-Sacramento

effect of application constraints on demand will be demonstrated in the next section by means of combining the demand and performance analyses. The effect of changes in train fare level for the same applications can be seen in Figures 3-4 (Section 3.2.2) and 4-12 and 4-13.

Several general conclusions can be made from observation of Figures 3-3, 3-4, 4-10 to 4-13. Because of the dependency of the model elasticities to mode share (see Section 3.4.1 and Figure 3-6) increasing average velocity is a function of diminishing returns; i.e., equal increases in velocity will produce smaller gains in demand. Indeed, observation of all the figures confirms that the slope of the train demand curves decreases with increasing velocity.

Based on the investigation of only these corridors, it appears that the maximum demand achieved by the train mode is correlated with the length of the corridor; demand increases are correlated with corridor length. This is logical when viewed in terms of the relative competitiveness of the train mode to the auto mode. For short corridors, the auto is generally a very dominant mode because its service characteristics are good (time and cost) compared to even very high speed trains. This is usually the case because of access/egress times and costs which must be factored into the train service. For longer corridors, however, the train mode can compete quite favorably with auto, particularly at higher speeds. Other things being equal, therefore, trains should attract more demand as the corridor length increases. This conclusion will be somewhat modified for very long corridors where air service may produce a significantly better service than train and thus capture some of the train mode patrons.

#### 4.4 COMBINED DEMAND-PERFORMANCE ANALYSES

##### 4.4.1 Results of Combined Analyses

The purpose of this section is to demonstrate combined use of the demand and performance models for analyzing the effectiveness of train applications as measured by mode split. The basic technique used to combine the outputs of the demand and performance

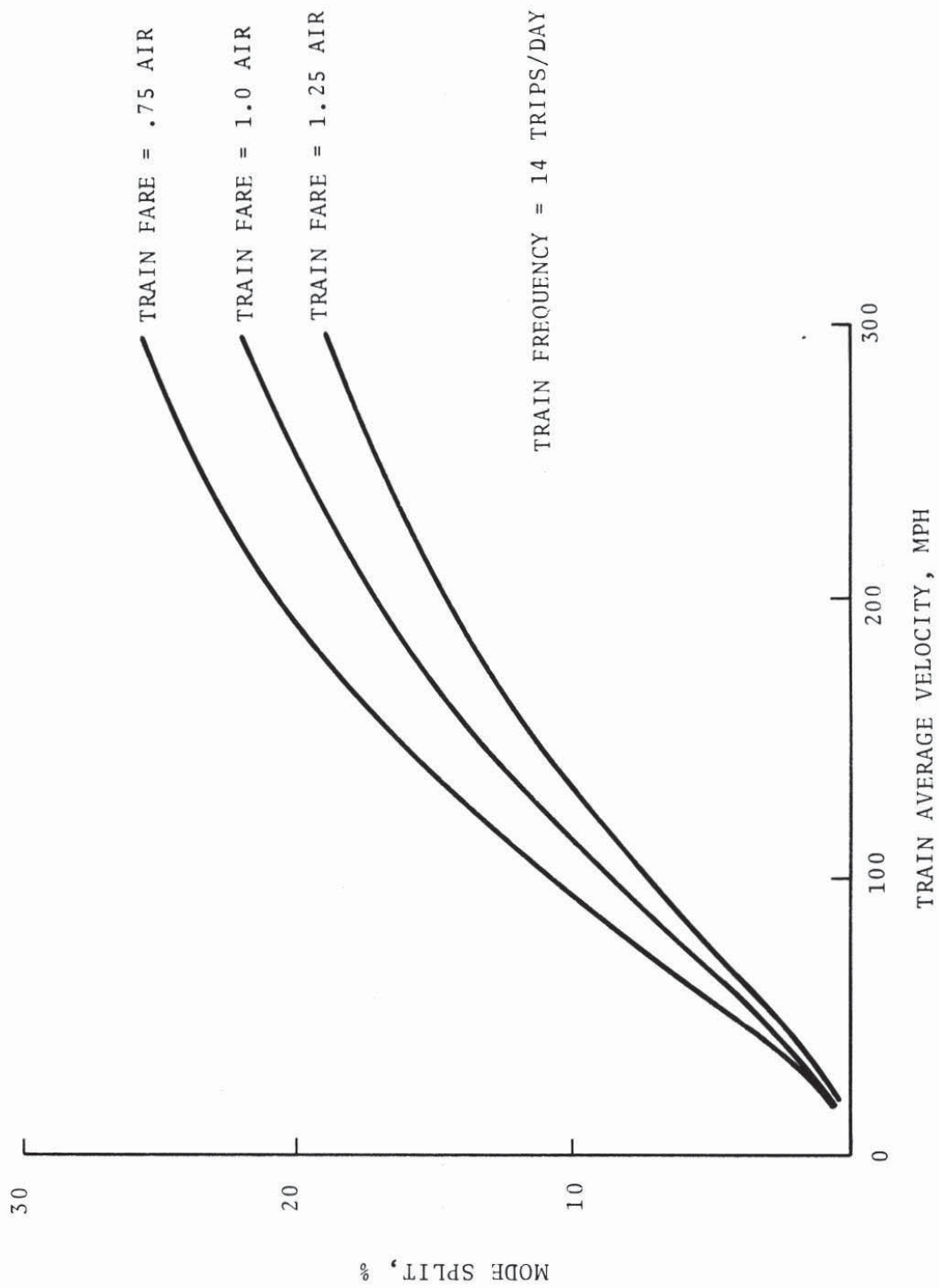

Figure 4-12. Mode Split Versus Train Average Velocity for Various Train Fare Levels, Chicago-Detroit



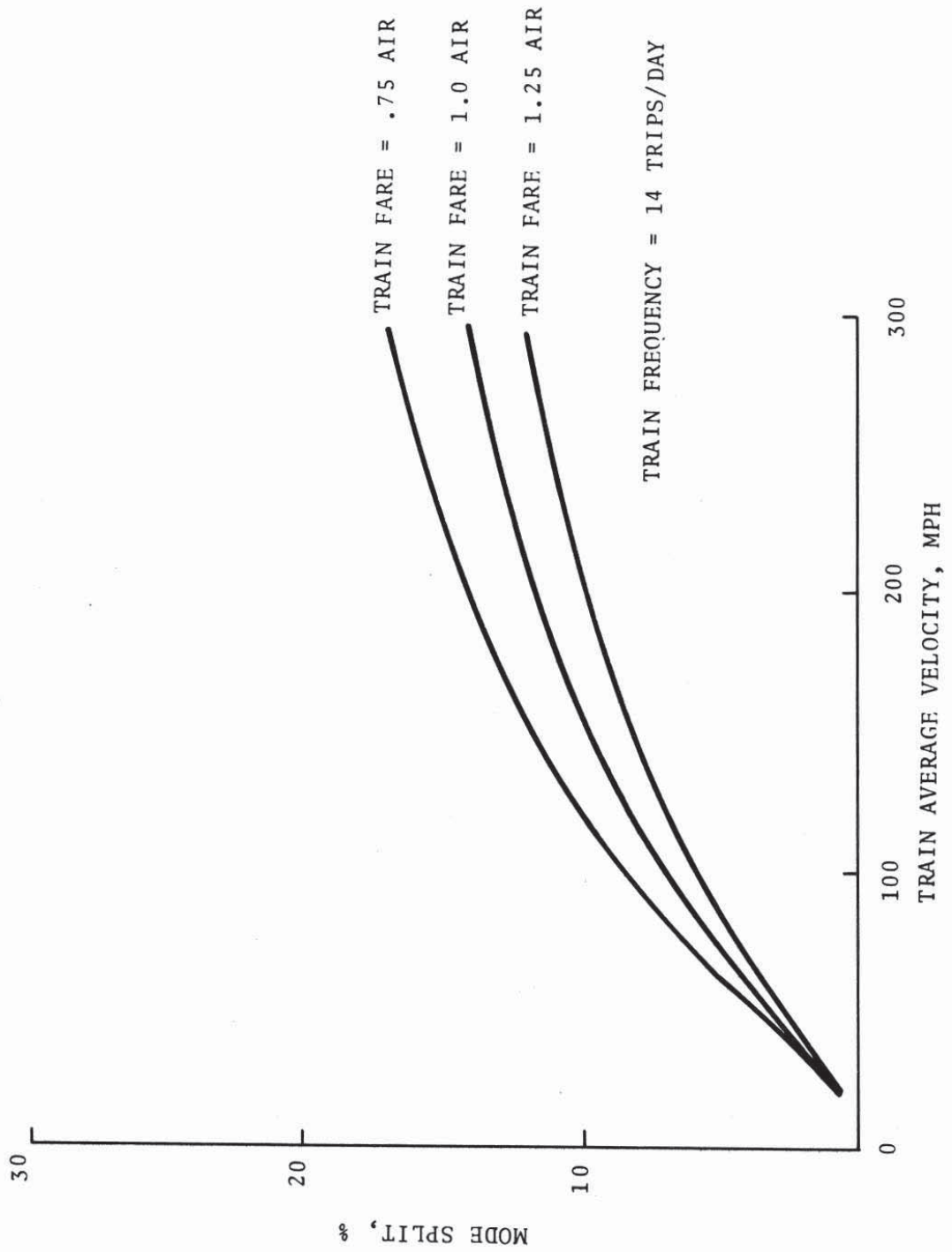

Figure 4-13. Mode Split Versus Train Average Velocity for Various Train Fare Levels, San Francisco-Sacramento

models is described in Section 3.2 (see also Figure 3-5) and involves a transformation of mode split versus average velocity plots to mode split versus design cruise speed plots through the measure, average velocity, common to both model outputs. The mode split versus design cruise speed plots can be constructed for various application conditions (route alignment and station operations) to indicate the impact of these constraints on demand. Similarly, the benefits to be gained in terms of increased demand by either upgrading route alignments or increasing train performance (design cruise speed capability) can be determined.

The results of the combined analyses are shown in Figures 4-14, 4-15 and 4-16 for the NEC, C-D and SF-SAC corridors respectively. The NEC results were based on the performance analyses of existing and improved route alignments described in Section 4.2.2.1 (Figure 4-6) and the demand results, Section 3.2.2 (Figure 3-3). In the case of the C-D and SF-SAC corridors, existing alignments were not known, hence, the results presented are based on several hypothetical alignments. The average velocity versus design cruise speed plots based on hypothetical alignments of the C-D and SF-SAC corridors and used for the combined analyses examples presented here are shown in Figures 4-17 and 4-18. The mode split versus average velocity plots for the three corridors which provided the demand inputs to the combined analyses are shown in Section 4.3.2, Figures 4-10 and 4-11 and Figure 3-3 (Section 3.2.2.). In all cases the train fares were assumed to be equal to the air fare.

A comparison of the mode split versus design cruise speed plots with the matching mode split versus average velocity plots reveals that in all cases the slope of the former plots are less than the later for the same speed. This of course is due to the "conversion efficiency" of design cruise speed to average velocity for a given application. When the application presents few constraints (few curves are long station spacings) the train's average velocity approaches it's design cruise speed (velocity ratio approaches 1.0) and the slope of the two plots are nearly the same. This case is represented by the NEC mode split versus design cruise

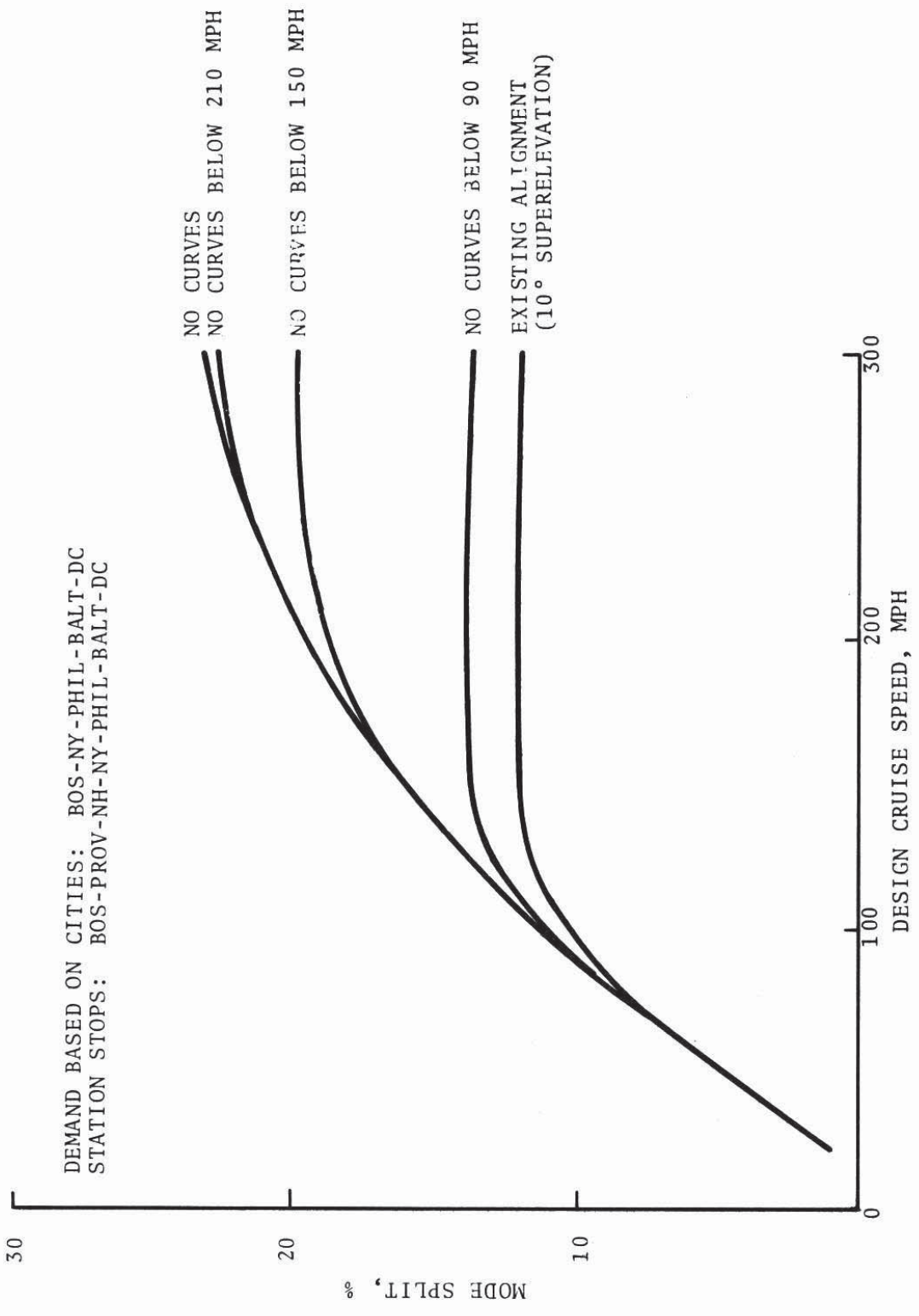

Figure 4-14. Average Velocity Versus Design Cruise Speed for Various Alignments of the Northeast Corridor

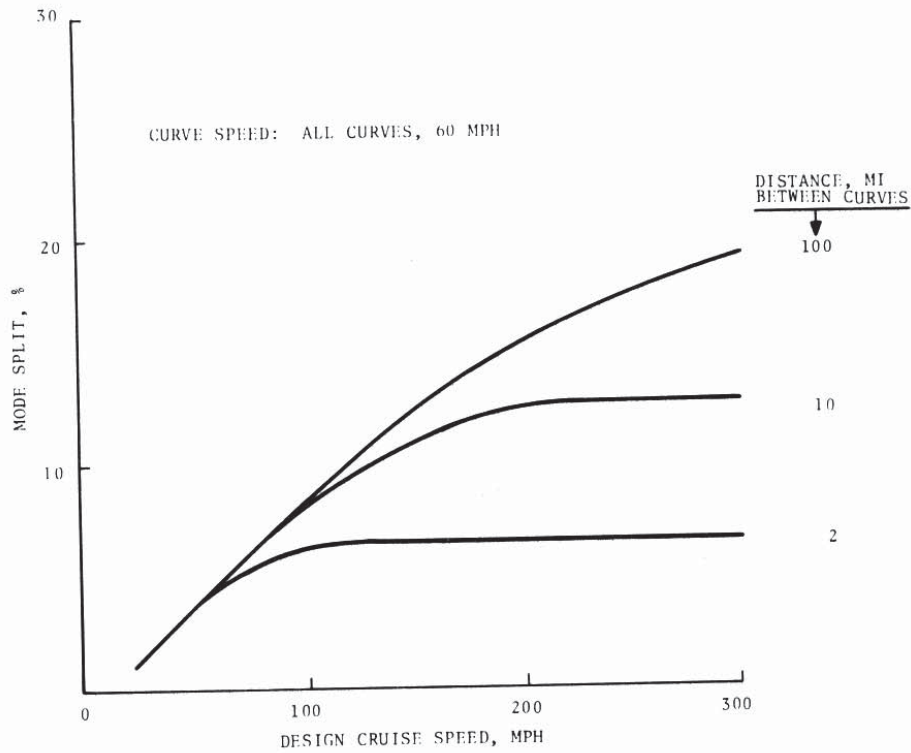

Figure 4-15. Mode Split Versus Design Cruise Speed for Various Hypothetical Route Alignment, Chicago-Detroit

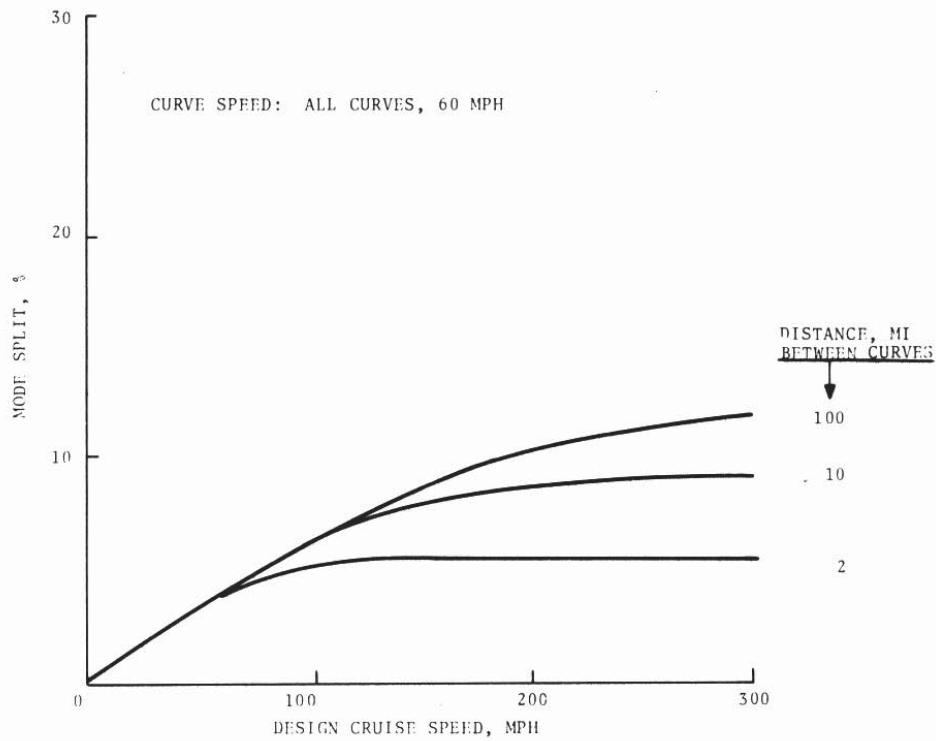

Figure 4-16. Mode Split Versus Design Cruise Speed for Various Hypothetical Route Alignment, San Francisco-Sacramento



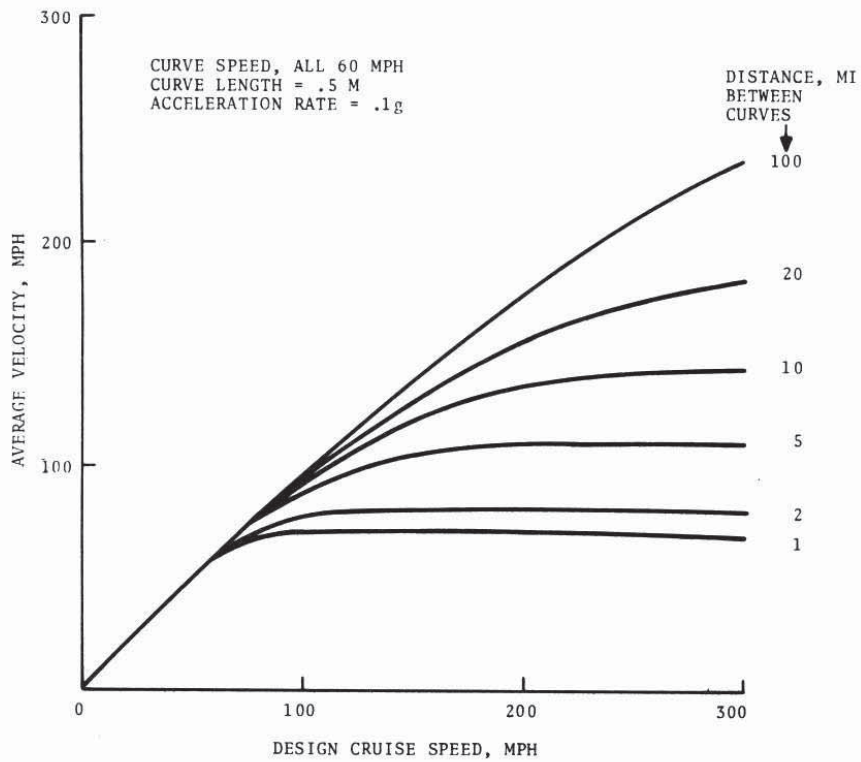

Figure 4-17. Average Velocity Versus Design Cruise Speed for Various 60 MPH Curve Densities, Chicago-Detroit

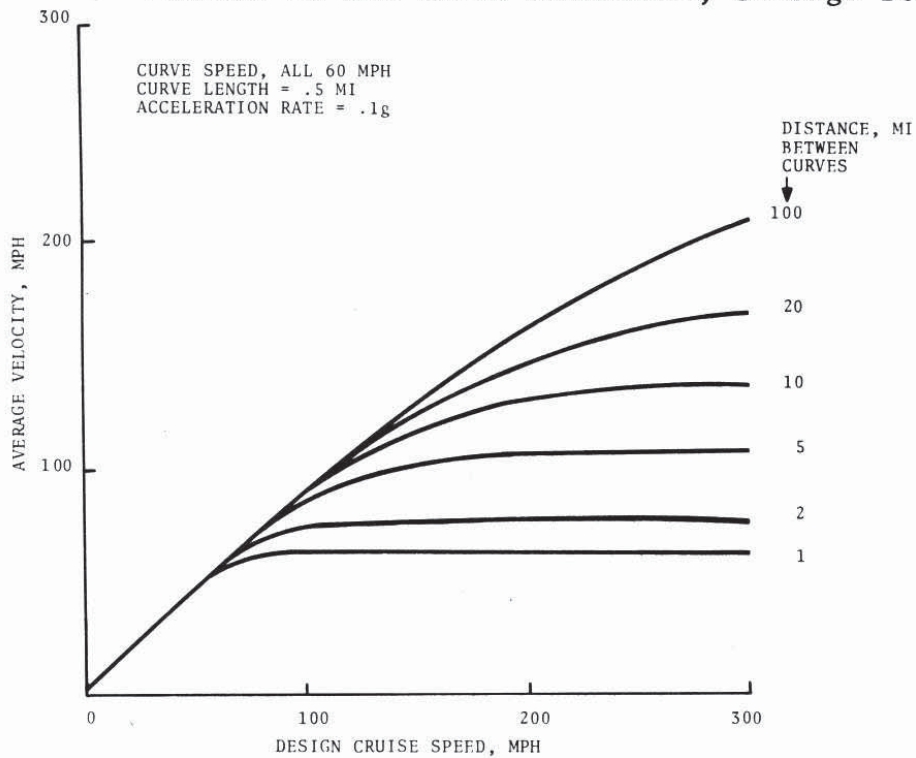

Figure 4-18. Average Velocity Versus Design Cruise Speed for Various 60 MPH Curve Densities, San Francisco-Sacramento

speed plot, Figure 4-14, where there are no curves in the system. This particular plot can be seen to approach the ideal situation represented in Figure 3-3 where mode split is plotted against average velocity. When the application constraints are severe, as in the case with the existing NEC alignment, Figure 4-14, the mode split versus design cruise speed plot diverges rapidly from the ideal case represented in Figure 3-3. In addition to the adverse effect of the trains' "velocity conversion efficiency" on the ability to attract demand there is also the negative effect of the dependency of time elasticity to mode share. This characteristic of the demand model, discussed in Section 3.4.2, results in smaller amounts of additional demand for equal increases in a train's average velocity. The relationship of time elasticity to mode split (see also Figure 3-6) causes the mode split versus average velocity plots, Figures 3-3, 4-10 and 4-11 to decrease in slope with average velocity. The results of the combined demand-performance analyses, Figures 4-14, 4-15 and 4-16, thus represent the accumulation of two negative factors (velocity conversion efficiency and the time elasticity-mode share relationship) which cause increases in demand versus design cruise speed to be a function of rapidly diminishing returns.

A direct comparison of the non-NEC and NEC mode split versus design cruise speed plots for maximum demand-system length relationships is not possible because equivalent route alignments were not investigated. The two non-NEC routes do have equivalent alignments, however, and have significantly different corridor lengths. For the same alignments (curve densities) and design cruise speeds, it can be seen (Figures 4-15 and 4-16) that the longer corridor, C-D produces a greater mode split. This is due primarily to the relative attractiveness of the train mode versus auto for longer routes, as discussed in Section 4.3.2. The C-D corridor also has a slight performance advantage over the SF-SAC corridor, because of its larger station spacing, which will tend to increase its mode split for the same design cruise speed. It should also be noted that the NEC, longest of the three corridors,

generates the highest mode split for the route alignment case of no curves. This is significant because the no curve case is about equivalent to the non-NEC corridor alignments of one 60 mph curve per 100 miles (see performance Figures 4-17 and 4-18 and 4-6). It can be generally concluded, therefore, that for a given design cruise speed longer corridors will generate higher train mode splits.

#### 4.4.2 Demand-Performance Evaluation Criteria - Economic Considerations

For reasons discussed in the previous section, the mode split versus design cruise speed plots reflect a function of diminishing returns. It is desirable, therefore, to establish criteria for determining where effective limits of performance exist in terms of mode split versus design cruise speed; i.e., where the costs of additional performance (higher cruise speed) outweigh the benefits (additional demand). The performance analyses of average velocity versus design cruise speed produced a relatively direct method of determining average velocity performance limits by the velocity ratio criterion. A similar technique for the demand performance analyses was not readily available, however, as this would have required detailed analyses of the economics of train operations which was beyond the scope of this study. Without an economic evaluation of the incremental costs involved in providing higher speed service, it can not be determined if the added patronage generated will produce positive net benefits. It was not possible, therefore, in the context of this study, to develop economic criteria for establishing limits of performance as measured by demand.

In spite of the inability to develop economic evaluation criteria, several general conclusions can be made concerning the limits of demand performance by assuming economic conditions which represent the range of expected situations. The first set of economic assumptions pertains to the financial goals of the



operating agency and the second set to the relationship between operating costs and the speed of service. Two financial goals representing extreme positions can be assumed:

1. Maximize system revenue
2. Maximize system profits (or minimize losses).

The first financial goal will result in an operating policy which attempts to maximize system patronage for a given fare structure regardless of system costs. This policy will probably not result in a financially viable operation as the cost incurred in attracting the last additional patron will most likely not be offset by the additional revenue. With this financial goal, however, a system should be operated at the highest design cruise speed which still attracts additional patronage; hence, the appropriate performance limit would occur when the slope of the demand versus design cruise speed curve is zero.

The second financial goal (maximize profits) produces several performance limits depending upon what cost versus design cruise speed relationship is assumed. Based on previous work, (10, 11) several generalized cost functions can be hypothesized as described in Figure 4-19a. A simplified (and somewhat unrealistic) assumption is that costs are constant with speed (case A., Figure 4-19a). In this case, maximum profits would occur at the speed corresponding to a zero slope on the demand revenue curve as shown in Figure 4-19b. A more realistic cost function is one that varies as a function of speed as described by curves B and C in Figure 4-19a. Whether the cost function decreases and then increases with speed as in curve B or increases steadily with speed as in curve C is dependent upon the relative magnitude of operating costs and capital financing costs both of which vary with speed. Operating costs tend to increase with speed particularly because of energy, and to a lesser extent, maintenance costs. Capital financing costs can either increase or decrease with speed depending upon the extent of increased train utilization achieved with higher speeds.



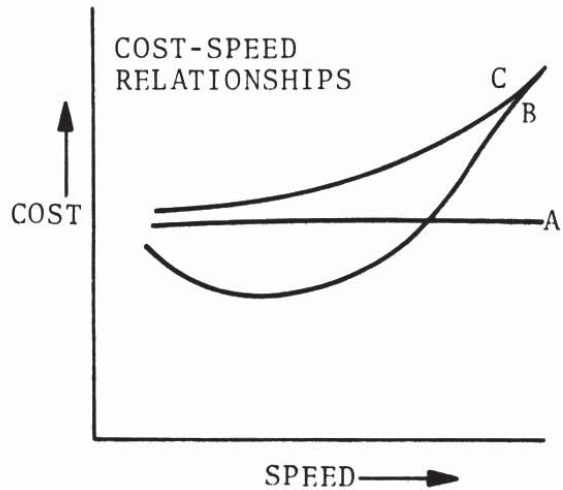

(a)

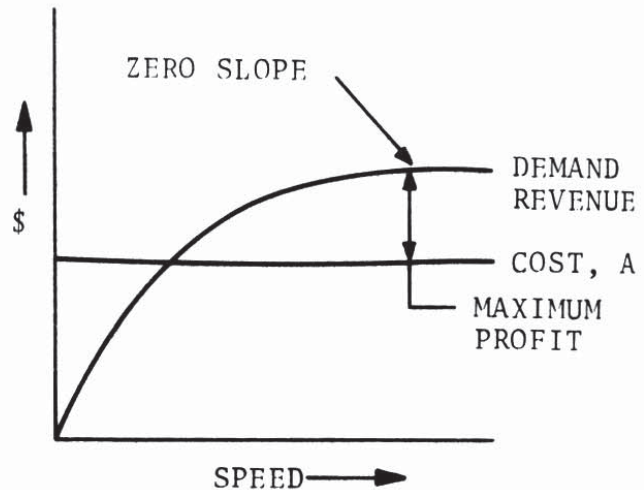

(b)

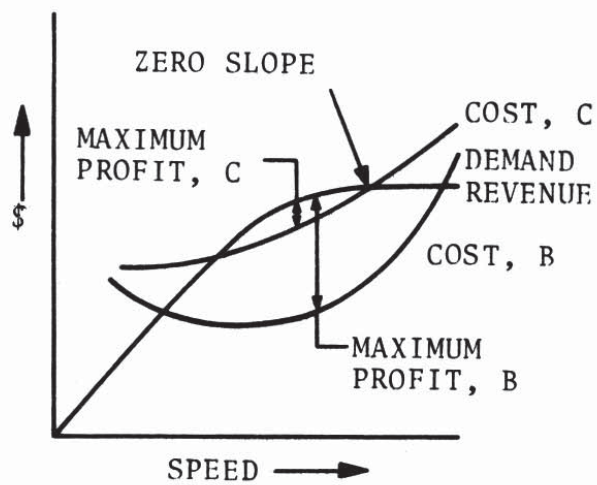

(c)

Figure 4-19. Performance Limits Based on Various Economic Considerations

Regardless of the mix between operating and capital financing costs, however, maximum profits will occur at a design cruise speed less than that corresponding to the zero slope point on the demand curve as illustrated in Figure 4-19c (except in the unlikely case where the cost curve B is still decreasing when the demand curve slope is zero, in which event maximum profits occur at the speed corresponding to the point of zero slope on the demand curve).

Based on the above discussion, it can be generally concluded that the limits of performance, as described by demand versus design cruise speed relationships, will occur at some speed corresponding to a positive slope on the demand curve. This conclusion assumes the most likely economic conditions of an operating policy which maximizes profits (or minimizes losses) and costs which rise with speed. For a given application, the exact limit can not be determined without detailed knowledge of the demand and costs relationships with speed. An important analytical complement to this study; therefore, is the capability to determine the economic performance of train systems. Such a capability would permit the development of both economic and physical criteria for evaluating the effectiveness of train applications.

#### 4.4.3 System Capacity Limits for Actual Applications

The capacity model described in Section 2 was combined with the demand models and applied to the Northeast Corridor to determine if system capacity limitations existed. Capacity limitations were established on the basis of comparing theoretical maximum capacities and minimum headways (determined by the capacity model) with expected volumes and assumed frequencies of service (determined by the demand model) respectively. If the theoretical capacity is greater than the actual volume (load factor less than 1.0) and the assumed frequency (14 trips per day) is less than the theoretical maximum frequency, then the system is feasible and has no capacity limitations. The Northeast Corridor was chosen for this analysis because it offers essentially the worst case situation; i.e., maximum actual volume.

The capacity analysis was performed for train lengths between 100 and 1000 feet (about 1 to 10 cars including engine) representing the range typically encountered. A train speed of 300 mph was chosen because it generated an actual volume as great as or greater than any speed less than 300 mph but produced the same theoretical capacity as other train speeds between 30mph and 300 mph (see Figure 2-18). A trip frequency of 14 trips per day and a fare or 0.75 air fare was assumed for the demand model. In view of the uncertainty of what actual fares would be, the assumed fare for 300 mph ground service appeared to be a reasonable minimum value. A potentially critical input to the capacity model was the seat density (seats per foot of train length). To ensure the selection of a reasonable value, a cursory survey of seat densities for actual passenger trains was performed. The results of that survey, justifying the use of a seat density of 1.0, are presented in Table 4-10.

The results of the capacity limitation analysis are presented in Table 4-11. This most important result is that capacity limitations do not exist for any of the assumed conditions. Even with a single car train making 14 trips per day, the load factor is still less than 1.0. The maximum theoretical frequencies and capacities appear to be far in excess of present requirements (actual volume based on 1974 data). The theoretical frequency and capacity limits will, however, be realistically scaled down due to less than ideal control systems (train follower assumed in analysis), longer station dwell times and practical train scheduling constraints (intermixing of freight and local traffic, etc.). Furthermore, future levels of actual demand will exceed those for the test year, 1974. These considerations will bring the theoretical and actual values much closer together. Nevertheless, because of the wide disparity between these values, it does not appear that capacity will be a limiting performance constraint for actual applications.

As a result of the findings for on-line stations, presented in Table 4-11, the discussions in Section 2 describing the advantages of off-line stations, in terms of their increasing system



TABLE 4-10. RESULTS OF SEAT DENSITY SURVEY

TYPE OF TRAIN	NUMBER OF SEATS	TRAIN LENGTH	NUMBER OF CARS	SEAT DENSITY
METROLINER	288	340	4	.847
	364	425	5	.856
	440	510	6	.862
ARROW	196	170	2	1.15
SILVERLINER	129	85	1	1.5
TURBOTRAIN	258	318	5	.811
	314	375	6	.837
	370	432	7	.987
	426	489	8	.871
	482	454	9	1.06
AVERAGE	326.7	359.8	5.3	.978



TABLE 4-11. RESULTS OF CAPACITY LIMITATION ANALYSIS

TRAIN LENGTH	MAXIMUM THEORETICAL FREQUENCY TRAINS/DAY	MAXIMUM THEORETICAL CAPACITY PASSENGERS/DAY	MAXIMUM THEORETICAL CAPACITY AT 14 TRAINS/DAY	ACTUAL VOLUME AT 14 TRAINS/DAY	LOAD FACTOR
100	448.08	44796.96	1400	1319.86	.9428
200	435.84	87184.32	2888	1319.86	.4714
500	413.76	206918.64	7000	1319.86	.1886
1000	391.44	391485.36	14000	1319.86	.0943

\* All Stations On-Line  
180 Sec. Dwell Time

capacity, are somewhat academic. It would appear that any major justification for off-line stations should be based on their increased operational flexibility over on-line stations, which can be significant. Similarly, the merits of one switch type versus another to achieve off-line capabilities should be approached from an operational (and cost) rather than capacity stand point.

## 5. CONCLUSIONS AND RECOMMENDATIONS

### 5.1 CONCLUSIONS

Based on the analyses of train system performance effectiveness described in Sections 2, 3 and 4, a number of conclusions were made. These conclusions are summarized below, by report section, to provide a concise listing of the study results. Detailed analyses and assumptions supporting the conclusions can be found in the appropriate sections of the report.

### 5.2 PARAMETRIC ANALYSES OF TRAIN PERFORMANCE

#### 5.2.1 General Description of Train Supply Model

- Real-time simulation of interactions among trains and the effects of speed restrictions that, on the average, are not independent is not a practical modeling requirement, as these are conditions to be avoided in real applications.
- For average acceleration rates of about  $0.1g$ , train performance can be computed on the assumption of linear acceleration profiles without introducing significant errors.

#### 5.2.2 Analyses of Average Velocity Versus Train Design Cruise Speed

- The "velocity-distance relationship" dictates that lower speed trains will always have a better velocity ratio (average to design cruise speed) than higher speed trains.
- Lower speed trains will always have a better "transition-cruise ratio" (acceleration and deceleration to cruise distance) than higher speed trains.
- The sensitivity of average velocity to factors impacting the transition distance is a direct function of the magnitude of the transition-cruise ratio.
- Based on analyses of the acceleration characteristics of

trains with various cruise speed capabilities:

- Average acceleration rates between .05 and .15g's represent the range typically encountered.
- High speed trains (above 200 mph) have an excess acceleration capability at start because the propulsion system must be designed to cruise under severe aerodynamic conditions.
- Low speed trains (below 100 mph) will have poor acceleration capabilities at start (~.05g's) if the propulsion system is designed for cruise speed conditions.
- Average velocity performance of trains with various design cruise speeds is sensitive to changes in typical application constraints in the following order of severity:

	<u>TRAIN DESIGN CRUISE SPEED</u>		
	300 MPH	200 MPH	100 MPH
Station Spacing	1	1	1
Curve Spacing	2	3	4
Curve Speed	3	2	3
Station Dwell	4	4	2
Acceleration Rates	5	5	5
Curve Length	6	6	6

- For an application containing a uniform mix of curve speeds, the most effective improvements to route alignment can be made by removing the lowest speed curves first.

### 5.2.3 Analyses of System Capacity Versus Train Design Cruise Speed

- The minimum safe following distance between trains is composed of three spatial components: (1) the emergency stopping distance, (2) the train length and (3) an additional space for safety margins and control response times.
- The minimum safe headway between trains for mainline conditions, excluding control response time, is composed of two elements: (1) the emergency stopping time (increases



with cruise speed) and (2) the time to travel the train's length (decreases with cruise speed).

- For an ideal train follower control concept, trains can be operated at the minimum safe following distance apart. For a go/no-go block control system, trains must be separated by two block lengths each equal to the minimum safe following distance.
- On-line stations, due to their dwell times, will always be the limiting constraint on system capacity, vis-a-vis curves or off-line stations.
- For typical on-line station dwell times, in excess of 30 seconds, maximum system capacity will be constant and independent of cruise speed between about 30 mph and 300 mph.
- "Alternating" type off-line stations have the following characteristics:
  - Permits increased average velocity and capacity over on-line stations.
  - Requires trains to skip certain stations.
  - Requires accurate scheduling, especially at high capacities.
- "Stacking" type off-line stations have the following characteristics:
  - Permits increased capacity over on-line stations but does not affect average velocity.
  - Permits increased flexibility of operations.
- Of the four generic switch types investigated for achieving off-line operations; high-speed-active, low-speed-active, high-speed-passive and low-speed-passive, the following are preferred:
  - Low-speed-passive for trains with design cruise speeds generally less than 150 mph.

- High-speed-passive for trains with design cruise speeds generally in excess of 150 mph.
- Off-line stations produce a greater increase in system capacity for lower speed trains.
- The "stacking" type of off-line station will yield the largest gain in capacity for the least amount of added scheduling complexity as compared with the "alternating" type station.
- Curves will generally not be the limiting constraint on system capacity.
- Normal and emergency braking rates have little influence on system capacity if on-line stations are present.
- Because of the almost exclusive sensitivity of system capacity to on-line station operations (especially dwell time) the most significant increase in system capacity can be achieved by using off-line stations.

#### 5.2.4 Performance Evaluation Criteria for Train Systems

- A 62.5 percent velocity ratio represents a reasonable minimum performance limit based on a review of the performance of various current transportation systems.
- The velocity ratio criterion permits an assessment of the impact of typically encountered applications constraints on train system performance effectiveness thus providing a useful input to the R&D policy decision process.
- Based upon site independent analyses of application constraints, the following general conclusion regarding the effectiveness of trains with various design cruise speeds can be made:
  - Trains with design cruise speeds under 100 mph will be performance effective in virtually all applications.
  - Trains with 200 mph design cruise speeds will generally be performance effective only in applications with station spacings in excess of 50 miles.

- Effective applications for 300 mph trains will be extremely difficult to find even with 100 mile station spacings.
- Based solely on system capacity considerations, there is no limit to the performance effectiveness of trains with design cruise speeds between 30 mph and 300 mph assuming typical on-line station operations.

### 5.3 DEMAND ANALYSES - CHARACTERISTICS OF THE MODE SPLIT MODEL, CN22 (Section 3.4.2)

- The sensitivity (elasticity) of demand to trip time is approximately twice the sensitivity to trip cost which is generally greater than the sensitivity to trip frequency.
- The elasticity of demand to trip time, cost and frequency decreases linearly as modal share increases; i.e., at 100 percent modal share the elasticities are zero.
- Because of the trip time elasticity - modal share relationship, incremental increases in demand for equal increases in average velocity is a function of diminishing returns.
- The theoretical validity of using a demand model calibrated for traditional train service to estimate demand for the same generic mode but with widely different service characteristics is questionable.

### 5.4 PRELIMINARY APPLICATIONS OF ANALYSIS TECHNIQUES

#### 5.4.1 Supply Performance (Section 4.2)

- The Boston-NY section of the NEC has a much lower curve speed distribution (mean curve speed, 98 mph) than the NY-DC section (mean curve speed, 162 mph) assuming 6°5's superelevation on all curves.
- The Boston-NY and NY-DC sections will permit effective train design cruise speeds of 120 mph and 172 mph respectively assuming the existing alignment, 6°5' superelevation on all curves, 62.5 percent velocity ratio criterion, and



the following stops: Bos-Prov-NH-NY-Phil- Balt-DC.

- Increasing the superelevation of all curves in the NEC from 6°5' to 15° increases the effective design cruise speed by 32 mph and 38 mph for the Boston-NY and NY-DC sections respectively.
- Assuming 10° superelevation for all curves (a significant improvement over the existing situation) the following number of curves would have to be removed, from the existing 400 curves in the NEC, to permit effective design cruise speeds of 300, 200 and 100 mph respectively: 315, 150 and 0.
- An analysis of hypothetical route alignments for the Chicago-Detroit and San Francisco-Sacramento corridors indicates the following general conclusions regarding the effectiveness of various speed trains:
  - 100 mph trains will be effective with virtually any number of curves above 60 mph.
  - 200 mph trains will be more effective in the Chicago-Detroit corridor because of the longer station spacing but will require very good alignments in both corridors; only 12-60 mph curves can be tolerated in the San Francisco-Sacramento corridor.
  - 300 mph trains will generally be ineffective in the San Francisco-Sacramento corridors (only 3-60 mph curves can be tolerated) and will be effective in the Chicago-Detroit corridor only with less than the equivalent of 15-60 mph curves.
- Regarding the relative effectiveness of either upgrading curves to a higher speed versus eliminating curves to achieve improved route alignments, the following generalization can be made: if the upgraded curve speed exceeds the system average velocity permitted by the remaining curves, then the two improvement strategies of upgrading and removal yield approximately the same results.



#### 5.4.2 Applications of Demand Analysis Technique (Section 4.3)

- Because of the relationship of the demand model elasticities to modal share, increasing a system's average velocity is a function of diminishing returns; i.e., equal increases in average velocity will produce decreasing gains in demand.
- Based upon a review of the demand model characteristics and three applications, it can be generally concluded that the relative demand for train service and corridor length are positively correlated; i.e., other things being equal, the longer the corridor the greater the train modal share.

#### 5.4.3 Combined Demand-Performance Analyses (Section 4.4)

- The relationship between modal share and train design cruise speed is a function of rapidly diminishing returns as it represents the accumulation of two negative functions, the cruise speed to average velocity conversion efficiency and the time elasticity-modal share relationship.
- For corridors with equivalent route alignments (same average velocity) the longer the route the greater the relative demand for train service.
- Economic evaluation criteria are required to establish exact limits to performance in terms of mode split versus train design cruise speed.
- Assuming the most likely economic conditions of: (1) an operating policy which maximizes profits (or minimizes losses) and (2) transportation costs which rise with system design cruise speed, it can be generally be concluded that the performance limit of demand versus design cruise speed will occur at a speed corresponding to a positive slope on the demand curve.
- The average seat density for typical passenger train systems is one seat per foot of train length.

- In spite of less than ideal control systems, train scheduling constraints and increased future demand which will tend to bring theoretical capacities and actual volumes closer together, it does not appear that capacity will be a limiting performance constraint.
- Because capacity will generally not be a limiting performance constraint even for on-line stations, any justification for off-line stations must be based primarily on their increased operational feasibility.

## 5.5 RECOMMENDATIONS (Section 5.2)

There are two primary study recommendations which constitute logical extensions of the work presented here. These recommendations are formulated to address in more detail the general study objectives of developing analytical capabilities to evaluate new passenger train systems and assist in formulating new systems development policy.

1. Detailed route alignment data for a number of potential applications of improved passenger train service should be obtained. The current study investigated, in practical terms, only the NEC for which existing alignment data was readily available. Route alignment data for several other corridors, representative of a range of applications, would provide the basis for a more comprehensive analysis. The results of applying the analytical techniques described here to a number of actual applications would indicate quite conclusively the maximum effective design characteristics (especially cruise speed) for new or improved systems.

2. A useful analytical complement to the present technique would be an economic model of train performance. The economic model should specifically relate train costs to system design cruise speed. The model should be preliminary, technology independent and capable of producing relative cost comparisons rather than absolute. The model will thus permit estimates to be made of the general shape of the transportation cost versus design

cruise speed function described in Section 4.4.2. With the results of such a model, economic criteria can be used as an additional means of establishing effective train system performance limits.



## REFERENCES

1. J.P. Vadeboncoeur, T.W. Smith and D.S. Adamson, Transop Model Methodology, TRW Systems Group, Washington, DC, December 1969, NECTP-216, PB-190936.  
  
U.S. Department of Transportation, High Speed Ground Transportation Alternatives Study, Office of Systems Analysis And Information, January 1973, PB-220-079.  
  
L.G. Chesler and B.F. Goeller, The Star Methodology for Short-Haul Transportation System Impact Assessment, Rand Corp., prepared for the U.S. Department of Transportation, Office of the Secretary, Washington DC, December 1973, V-1359-DOT, DOT-TSC-363.  
  
M.A. Crane, Simulation-Analysis of a High Speed Ground Transportation System, Massachusetts Institute of Technology, prepared for U.S. Department of Transportation, Office of the Secretary, Washington, DC, September 1968, PB-183-156, C-130-66.  
  
TRW Systems Group, System Simulation Studies, prepared for U.S. Department of Transportation, Federal Railroad Administration, Washington, DC, December 1969, PB-191411, FRA-RT-70-34.  
  
TRW Systems Group, Tracked Air Cushion Vehicle Systems, prepared for U.S. Department of Transportation, Federal Railroad Administration, Washington, DC, May 1970, PB-195030, FRA-RT-71-59.  
  
TRW Systems Group, High Speed Jetport Access, prepared for U.S. Department of Transportation, Federal Railroad Administration, Washington, DC, December 1969, PB-192842, FRA-RT-70-38.
2. Dietrich R. Bergmann, "Generalized Expressions for the Minimum Time Interval Between Consecutive Arrivals at an Idealized Railway Station", Transportation Research, Volume 6, #4, December 1972, pp. 327-341.



3. D.L. Kershner and W.J. Roesler, Network Model Studies for Personal Rapid Transit, John Hopkins University, APL, prepared for U.S. Department of Transportation, Urban Mass Transit Administration, Washington DC, June 1975, UMTA-MD-06-0018-75-1.  
 G. Kovatch and G. Zames, Personalized Rapid Transit Systems: A First Analysis, U.S. Department of Transportation, Transportation Systems Center, Cambridge, MA, August 1971, DOT-TSC-OST-71-11, PB204811.  
 W.K. Minger, "The AAR Network Simulation Model", Railway Management Review, No. 2, 1972, pp. A101-119.
4. Steven E. Shladover, Performance Model of Intercity Ground Passenger Transportation Systems, U.S. Department of Transportation, Transportation Systems Center, Cambridge, MA, August 1975, FRA-OR&D-76-08.
5. Models Reviewed in:  
 J.C. Bennet, J.C. Prokopy and R.H. Ellis, Analysis of Intercity Modal Split Models, prepared by Peat, Marwick, Michell & Co., U.S. Department of Transportation, Federal Railroad Administration and Office of the Secretary, Washington, DC, July 1973, DOT-FR-20005-5.
6. Shladover, S. op. cit.
7. U.S. Bureau of the Census, Census of Transportation, 1972 National Travel Survey, Washington, DC, 1974.
8. J.C. Bennet, J.C. Prokopy, and R.H. Ellis op. cit.
9. Louis T. Klauder and Associates, Preliminary Engineering Report on Possible Improvements to Railroad Passenger Service Between New York and Boston, Philadelphia, PA, prepared for Department of Commerce, November 15, 1965, PB-169-907.  
 Louis T. Klauder and Associates, Preliminary Engineering Improvements to Railroad Passenger Service Between New York and Washington, Philadelphia, PA, prepared for Department of Commerce, June 1, 1964, PB166-879.

Louis T. Klauder and Associates, Supplemental Reports on Improvements to Railroad Passenger Service Between New York and Washington, Philadelphia, PA, prepared for Department of Commerce, June 12, 1964, PB166-880.

10. TRW Systems Group, Tracked Air Cushion Vehicle Systems, op. cit.
11. J.D. Ward, "The Future Roles for TLV Systems," Journal of Dynamic Systems, Measurements, and Control, ASME, June 1974.