

Reference Copy

REPORT NO. UMTA-MA-06-0051-80-1

IDENTIFICATION OF THE FIRE THREAT  
IN URBAN TRANSIT VEHICLES

W.T. Hathaway  
A.L. Flores

U.S. DEPARTMENT OF TRANSPORTATION  
RESEARCH AND SPECIAL PROGRAMS ADMINISTRATION  
Transportation Systems Center  
Cambridge MA 02142



JUNE 1980  
FINAL REPORT

DOCUMENT IS AVAILABLE TO THE PUBLIC  
THROUGH THE NATIONAL TECHNICAL  
INFORMATION SERVICE, SPRINGFIELD,  
VIRGINIA 22161

Prepared for

U.S. DEPARTMENT OF TRANSPORTATION  
URBAN MASS TRANSPORTATION ADMINISTRATION  
Office of Technology Development and Deployment  
Office of Safety and Product Qualifications  
Washington DC 20590

**NOTICE**

This document is disseminated under the sponsorship of the Department of Transportation in the interest of information exchange. The United States Government assumes no liability for its contents or use thereof.

**NOTICE**

The United States Government does not endorse products or manufacturers. Trade or manufacturers' names appear herein solely because they are considered essential to the object of this report.

Technical Report Documentation Page

|  |  |   |           |
|--|--|---|-----------|
| 1. Report No.<br>UMTA-MA-06-0051-80-1  | 2. Government Accession No.                          | 3. Recipient's Catalog No.  |           |
| 4. Title and Subtitle<br>IDENTIFICATION OF THE FIRE THREAT IN URBAN TRANSIT VEHICLES   |  | 5. Report Date<br>June 1980   |           |
|  |  | 6. Performing Organization Code   |           |
| 7. Author(s)<br>W.T. Hathaway, A.L. Flores   |  | 8. Performing Organization Report No.<br>DOT-TSC-UMTA-80-8  |           |
| 9. Performing Organization Name and Address<br>U.S. Department of Transportation<br>Research and Special Programs Administration<br>Transportation Systems Center<br>Cambridge MA 02142  |  | 10. Work Unit No. (TRAIS)<br>UM021/R0735  |           |
|  |  | 11. Contract or Grant No.   |           |
| 12. Sponsoring Agency Name and Address<br>U.S. Department of Transportation<br>Urban Mass Transportation Administration<br>Office of Technology Development and Deployment<br>Office of Safety and Product Qualifications<br>Washington DC 20590   |  | 13. Type of Report and Period Covered<br>Final Report<br>Jan. 1979 - July 1979  |           |
|  |  | 14. Sponsoring Agency Code  |           |
| 15. Supplementary Notes  |  |   |           |
| 16. Abstract<br><br>The study presented includes on-site surveys of the 1978 calendar year experience of nine representative U.S. transit authorities. Analyses of the data collected and of the fault tree for bus and rail rapid transit vehicle fires allow for the identification of potential ignition sources and path of fire propagation. There is also a discussion of the approach to the selection of countermeasures to minimize and, where possible, to eliminate fire threats in transit vehicles. |  |   |           |
| 17. Key Words<br>Fire, Fire Safety, Fires, Vehicle Threat, Transit   |  | 18. Distribution Statement<br><br>DOCUMENT IS AVAILABLE TO THE PUBLIC THROUGH THE NATIONAL TECHNICAL INFORMATION SERVICE, SPRINGFIELD, VIRGINIA 22161 |           |
| 19. Security Classif. (of this report)<br>Unclassified   | 20. Security Classif. (of this page)<br>Unclassified | 21. No. of Pages<br>108   | 22. Price |



## PREFACE

The Urban Mass Transportation Administration (UMTA) in its mission of improving mass transportation is examining the present situation with respect to the fire threat in order to develop countermeasures and fire safety standards for transit vehicles. It is expected that ever larger numbers of people will be using mass transportation and that ever greater demands will be placed on mass transportation vehicles. It is important that fire safety not be overlooked by mass transit properties or by manufacturers of mass transit vehicles in their efforts to answer the growing demands.

This report is an attempt to identify potential sources of ignition and likely fire paths on transit vehicles together with probabilities of occurrence in order that priorities for countermeasures can be determined. It is hoped that this report will be a significant contribution in helping UMTA to achieve these important objectives.

The authors wish to thank William J. Rhine and Robert I. Haught of UMTA for their valuable guidance and comments over the course of this work. They also wish to acknowledge the important contributions of the following individuals: Herbert L. Bogen and Stephanie Markos, Raytheon Service Co., and Robert Anderson, formerly of Raytheon Service Co. and presently a member of the TSC staff, for their efforts in data collection and analysis; C.E. Bogner for his input to Section 4 and I. Litant and A.E. Barrington also of TSC. The authors wish especially to thank the chief executive officers of the transit properties surveyed and their staffs for their help and cooperation in the collection of the data of this report. The many helpful conversations with these individuals were of considerable help in the completion of this report.

# METRIC CONVERSION FACTORS

| Approximate Conversions to Metric Measures |                     |                                   | Approximate Conversions from Metric Measures |                     |                        |
|--|---------------------|-----------------------------------|--|---------------------|------------------------|
| When You Know                              | Multiply by         | To Find                           | When You Know                                | Multiply by         | To Find                |
| in   | LENGTH              | centimeters                       | mm   | LENGTH              | inches                 |
| ft   |                     | centimeters                       | cm   |                     | inches                 |
| yd   |                     | meters                            | m  |                     | feet                   |
| mi   |                     | kilometers                        | km   |                     | yards                  |
| sq in                                      | AREA                | square centimeters                | cm <sup>2</sup>                              | AREA                | square inches          |
| sq ft                                      |                     | square meters                     | m <sup>2</sup>                               |                     | square yards           |
| sq yd                                      |                     | square meters                     | m <sup>2</sup>                               |                     | square miles           |
| sq mi                                      |                     | hectares (10,000 m <sup>2</sup> ) | ha   |                     | acres                  |
| oz   | MASS (weight)       | grams                             | g  | MASS (weight)       | ounces                 |
| lb   |                     | kilograms                         | kg   |                     | pounds                 |
| (2000 lb)                                  |                     | tonnes                            | t  |                     | short tons             |
| tsp  | VOLUME              | milliliters                       | ml   | VOLUME              | fluid ounces           |
| Tbsp                                       |                     | milliliters                       | ml   |                     | pints                  |
| fl oz                                      |                     | liters                            | l  |                     | quarts                 |
| c  |                     | liters                            | l  |                     | gallons                |
| pt   |                     | cubic meters                      | m <sup>3</sup>                               |                     | cubic feet             |
| qt   |                     | cubic meters                      | m <sup>3</sup>                               |                     | cubic yards            |
| gal  | TEMPERATURE (exact) | Celsius temperature               | °C   | TEMPERATURE (exact) | Fahrenheit temperature |
| fl qt                                      |                     | Fahrenheit temperature            | °F   |                     | Fahrenheit temperature |

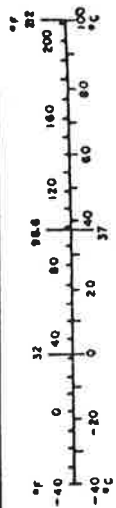
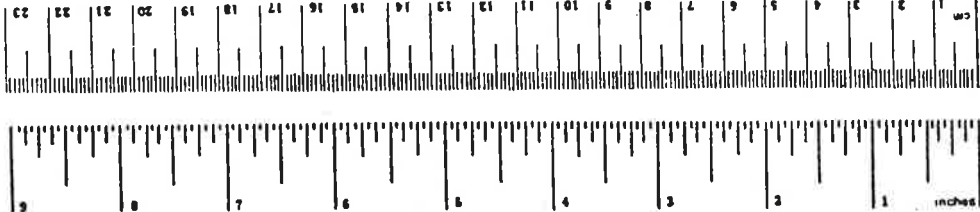

## TABLE OF CONTENTS

| <u>Section</u>  | <u>Page</u> |
|---|-------------|
| 1. INTRODUCTION.....  | 1           |
| 2. TRANSIT DATA ACQUISITION METHODOLOGY.....  | 2           |
| 3. DEFINITION OF THE FIRE THREAT.....   | 5           |
| 3.1 Data Analysis.....  | 5           |
| 3.2 Fault Trees and Scenarios.....  | 12          |
| 3.3 Relationship of Data, Scenarios,<br>and Fault Trees.....  | 25          |
| 4. METHODOLOGY FOR COUNTERMEASURE SELECTION.....  | 28          |
| 4.1 Approach to Countermeasure Development.....   | 28          |
| 4.2 Examples of Countermeasures.....  | 29          |
| 4.2.1 Bus Wheel Wells.....  | 36          |
| 4.2.2 Improved Vehicle Maintenance<br>and Cleanliness.....  | 36          |
| 4.2.3 Materials Technology.....   | 36          |
| 4.2.4 Flooring and Firewall<br>Construction.....  | 38          |
| 4.2.5 Smoke and Fire Detection<br>Devices.....  | 38          |
| 5. CONCLUSIONS.....   | 39          |
| REFERENCES.....   | 40          |
| APPENDIX A - FIRE AND SMOKE DATA FROM FRA/UMTA<br>REPORTING SYSTEM AND U.S. FIRE<br>ADMINISTRATION..... | A-1         |
| APPENDIX B - FIRE AND SMOKE SCENARIOS.....  | B-1         |

## LIST OF ILLUSTRATIONS

| <u>Figure</u>  | <u>Page</u> |
|--|-------------|
| 2.1 Sample Daily Log.....  | 4           |
| 3.1 Rapid Rail Transit Fire/Smoke Incident Rate<br>(1978 Data).....  | 6           |
| 3.2 Bus Fire/Smoke Incident Rate (1978 Data).....  | 7           |
| 3.3 Service Delay by Incident Type--RRT<br>(Data from 3 Properties) (1978 Data).....                           | 9           |
| 3.4 Service Delay by Incident Type--Bus<br>(Data from 4 Properties ) (1978 Data).....                          | 10          |
| 3.5 Cost of Repair Data from One Bus Property, Number of<br>Fire and Smoke Incidents Vs. Cost (1978 Data)..... | 11          |
| 3.6 Use of the "OR" Gate.....  | 13          |
| 3.7 Use of the "AND" Gate.....   | 14          |
| 3.8 Rail Rapid Transit Vehicle Fire Fault Trees.....   | 16          |
| 3.9 Bus Fire Fault Trees.....  | 20          |
| 4.1 Logic Diagram for Countermeasure Selection.....  | 30          |
| 4.2 Example of Application of Countermeasure at Bus<br>Wheel Well.....   | 37          |

## LIST OF TABLES

| <u>Table</u>                               | <u>Page</u> |
|--|-------------|
| 3.1 RAIL RAPID TRANSIT SCENARIO TYPES..... | 23          |
| 3.2 BUS SCENARIO TYPES.....                | 24          |
| 3.3 VEHICLE HEAT SOURCES.....              | 26          |



## 1. INTRODUCTION

The Transportation Systems Center (TSC) has been tasked by the Urban Mass Transportation Administration (UMTA) to assess the overall fire threat in transit systems and to identify and recommend suitable remedial actions. This report presents the identification of the fire threat in urban transit vehicles. The potential threat of fire in transit vehicles is well recognized. However, the quantification of actual occurrences, rates, losses, etc. is extremely limited. In addition, little formal analysis has been done on the conditions and events that result in the initiation and spread of fire and smoke in transit vehicles. The data that exist are generally internal operating information for individual transit properties; little additional data are generated for external use.

This report serves to fill some of the gaps in knowledge. It is based on site visits to nine representative transit properties during which data were obtained from daily logs, operator reports, accident reports, police reports, and maintenance reports. [Information from nine other properties was obtained by mailed-out questionnaires.] To the best of our knowledge, this is the most complete and accurate information currently available on fire and smoke incidents in urban mass transit vehicles.

These data are supplemented by fault tree diagrams and scenarios in identification of the fire threat. These are based on actual transportation fire and smoke incidents in TSC files, data analysis, interviews with transit personnel, and the use of maintenance manuals. Following a description of the TSC data acquisition methodology, the data are analyzed and discussed along with the relationship of the fault trees and scenarios to the identification of countermeasures.

## 2. TRANSIT DATA ACQUISITION METHODOLOGY

The initial TSC effort to establish the number and nature of fire and smoke incidents in transit vehicles consisted of a survey of several data sources. These included the data banks maintained by the U.S. Fire Administration's National Fire Incident Reporting System (NFIRS), the National Fire Protection Association's Fire Incident Data Organization (FIDO), the National Transportation Safety Board, the Federal Highway Administration's Bureau of Motor Carrier Safety and the Federal Railroad Administration's data reporting system (now maintained by UMTA as the "Rail Accident/Incident Report"). The information available from these sources was found to be limited in volume and detail and insufficient for this investigation. For a detailed review of all the available data banks containing fire and smoke data, the reader is referred to Reference 1. Most of the data sources contained either too few incidents or only the large or well known incidents. Examples of some of the data found are contained in Appendix A.

Because of these limitations, it was necessary to establish direct contact with the transit properties. Transportation Systems Center personnel visited nine representative properties to obtain data on frequency and type of fire/smoke incidents experienced. The site visits were made to the Massachusetts Bay Transportation Authority (MBTA), the New York City Transit Authority (NYCTA), the Bay Area Rapid Transit District (BART), the San Francisco Municipal Railway (MUNI), the Southern California Rapid Transit District (RTD-Los Angeles), the Denver Rapid Transit District (RTD-Denver), the Metropolitan Atlanta Rapid Transit Authority (MARTA), the Washington Metropolitan Area Transit Authority (WMATA), and the Chicago Transit Authority (CTA). Other properties responded with information through the

mail: the Port Authority of Allegheny County (Pittsburgh), the Greater Cleveland Regional Transit Authority (RTA), the City of Detroit--Department of Transportation, Transport of New Jersey (TNJ), the Mass Transit Administration (MTA-Baltimore), the Tri-County Metropolitan Transit District of Oregon (TRI-MET), the Southeastern Pennsylvania Transit Authority (SEPTA), the Transit Authority of River City (TARC-Louisville) and the Toronto Transit Commission. This information obtained by mail was not used in this report because it was felt that it did not reflect all the smoke and fire incidents for 1978.

It was found during the site visits that incidents are recorded in daily logs, similar to the one presented in Fig. 2.1, located at a central control center. Depending on the severity of the incident, follow-up reports may be filed. The amount of information recorded in the daily logs and the availability of follow-up reports varied among the transit properties. Usually the information recorded included:

- date and time of incident
- vehicle number and operator identification
- location of vehicle at time of incident
- delay in service and damage
- action taken.

The daily logs were handwritten, usually in tabular format. Typically, description of incidents lacked the degree of detail necessary for complete comprehension by personnel not familiar with day-to-day operational events at that property. It was often necessary to obtain clarification of accident descriptions from operating personnel, either because of local jargon used or because of brevity of remarks.

The data collected from the nine transit properties represented all bus and rail rapid transit (RRT) fire and smoke incidents which occurred at those transit properties during the calendar year 1978.

A B ROUTE TRANSPORTATION DEPARTMENT - RAIL

SUMMARY OF TRAIN OPERATION: DAY MONDAY DATE MAY 21, 1979 INITIAL           

| ITEM | CODL | DIR & LINE | LOCATION      | TIME  | MIN DELAY | TRAIN & TERMINAL | TRIPS ABD | TBL | CAR NUMBER(S) AND DETAILS                    |
|------|------|------------|---------------|-------|-----------|------------------|-----------|-----|--|
| A239 | CMD  | SB         | Silver Spring | 7:04  | 5/3       | SS 7:03a         | 1         | ATC | 111-1095 No speed readouts. ATP cut out      |
| A240 | CMD  | SB         | Un. Station   | 8:17  | 3         | SS 7:58a         | 0         | BKS | 111-1094 White light                         |
| A241 | CMD  | SB         | Takoma        | 8:20  | 15/27     | 5/14 SS 8        | 18a 6     | BKS | 104-1050 Hand brake w/11 not pump            |
| A242 | CMD  | NB         | Judiciary Sq  | 8:56  | 0         | DUP 8:42a        | 0         | SLT | 109-1129 MOL/P mode/reset                    |
| A243 | CMD  | NB         | Un. Station   | 8:59  | 10/20     | DUP 8:42a        | 2         | SMK | 109-1042 Air compressor-smoke from train     |
| A244 | CMD  | NB         | Un. Station   | 10:48 | 2         | DUP 10:37a       | 0         | BKS | 111-1094 Two blue lights. Trucks cut out     |
| A245 | CMD  | SB         | Takoma        | 12:12 | 0         | SS 12:08p        | 0         | ATC | 110-1061 Overshoot platform 2 cars. Lost PSS |
|      | MD   | NB         | Dupont Cir    | 2:38  | 0         | DUP 2:37p        | 0         | DRS | 110-1061 Door problem                        |
|      | MD   | NB         | Farragut N    | 2:41  | 12/12     | DUP 2:37p        | 2         | BKS | 110-1073 No brakes off indication            |
|      | MD   | NB         | Un. Station   | 4:32  | 0         | DUP 4:22p        | 0         | SLT | 108-1175 MOL/P mode/reset                    |
|      | MD   | NB         | Farragut N    | 5:17  | 0         | DUP 5:17p        | 0         | SLT | 108-1175 MOL/Pmode/reset                     |
|      | MD   | NB         | Dupont Cir    | 5:47  | 0         | DUP 5:47p        | 0         | SLT | 105-1170 MOL/P mode/reset                    |
| A251 | CMD  | NB         | Brookland     | 6:26  | 0         | DUP 6:12p        | 0         | SLT | 108-1175 MOL/P mode/no reset                 |
| A252 | CMD  | SB         | Ft Totten     | 9:15  | 0         | SS 9:10p         | 0         | MIS | 104-1125 Overshot platform, 2 cars. Kept PSS |
|      |      |            |               |       |           |                  |           |     | TOTAL TRIPS 266 TOTAL CAR MILES 15,956       |

FIGURE 2.1 SAMPLE DAILY LOG

### 3. DEFINITION OF THE FIRE THREAT

The purpose of this section is to define in quantitative and qualitative terms the fire threat in transit vehicles. Actual fire incident data gathered from the transit properties, as discussed in Section 2. and 3.1, are used to quantify the fire threat. Scenarios and fault trees are used as a supplement to the incident data and define the fire threat in a qualitative manner. Defining the fire threat in these terms will allow for the identification of all prospective countermeasures and will assist in determining the priorities for their implementation.

Section 3.1 is an analysis of the data collected from the transit properties and Sections 3.2 and 3.3 discuss the fault trees and scenarios and their relationships, respectively.

#### 3.1 DATA ANALYSIS

As discussed in Section 2., several sources of data were examined with the final result being a detailed survey of the records of nine transit properties. The data discussed in this section are limited to that from the nine transit properties. It should be recognized that uncertainties in interpretation of this type of data are inevitable as they are gathered from sources using to some extent, different procedures of collection and different methods and emphasis on records maintenance.

The data are aggregated, as shown in Figures 3.1 and 3.2, since the objective is to obtain the overall frequency distribution for all nine transit properties rather than to make comparisons between properties. Incidents are presented on the basis of occurrence per million vehicle miles. The nine transit properties for which the data of Figs. 3.1 and 3.2 apply reported a total of 417 million bus revenue miles and 331 million rail rapid transit revenue miles in 1978. During this

\*One property reporting

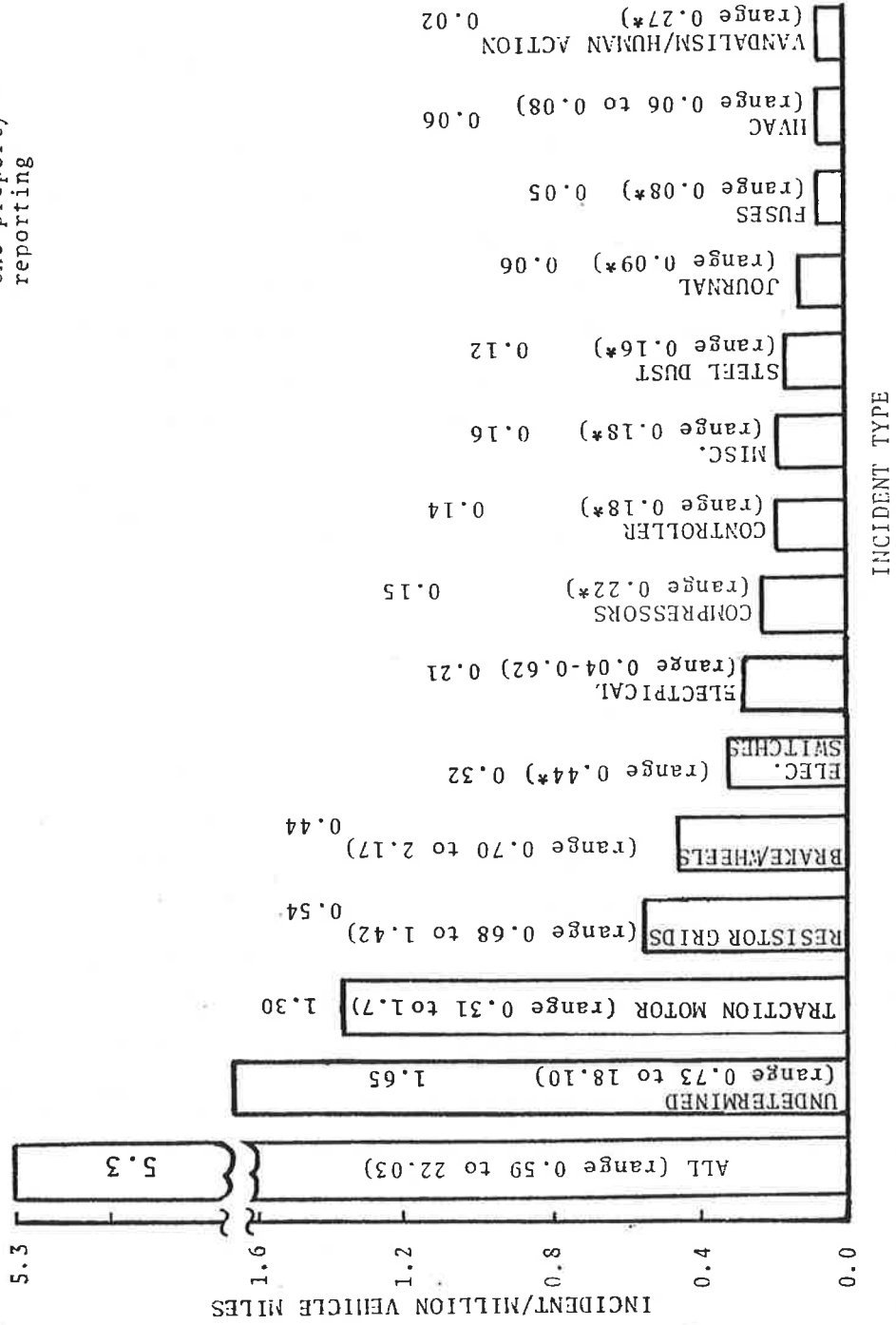

FIGURE 3.1 RAIL RAPID TRANSIT FIRE/SMOKE INCIDENT RATE (1978 DATA)

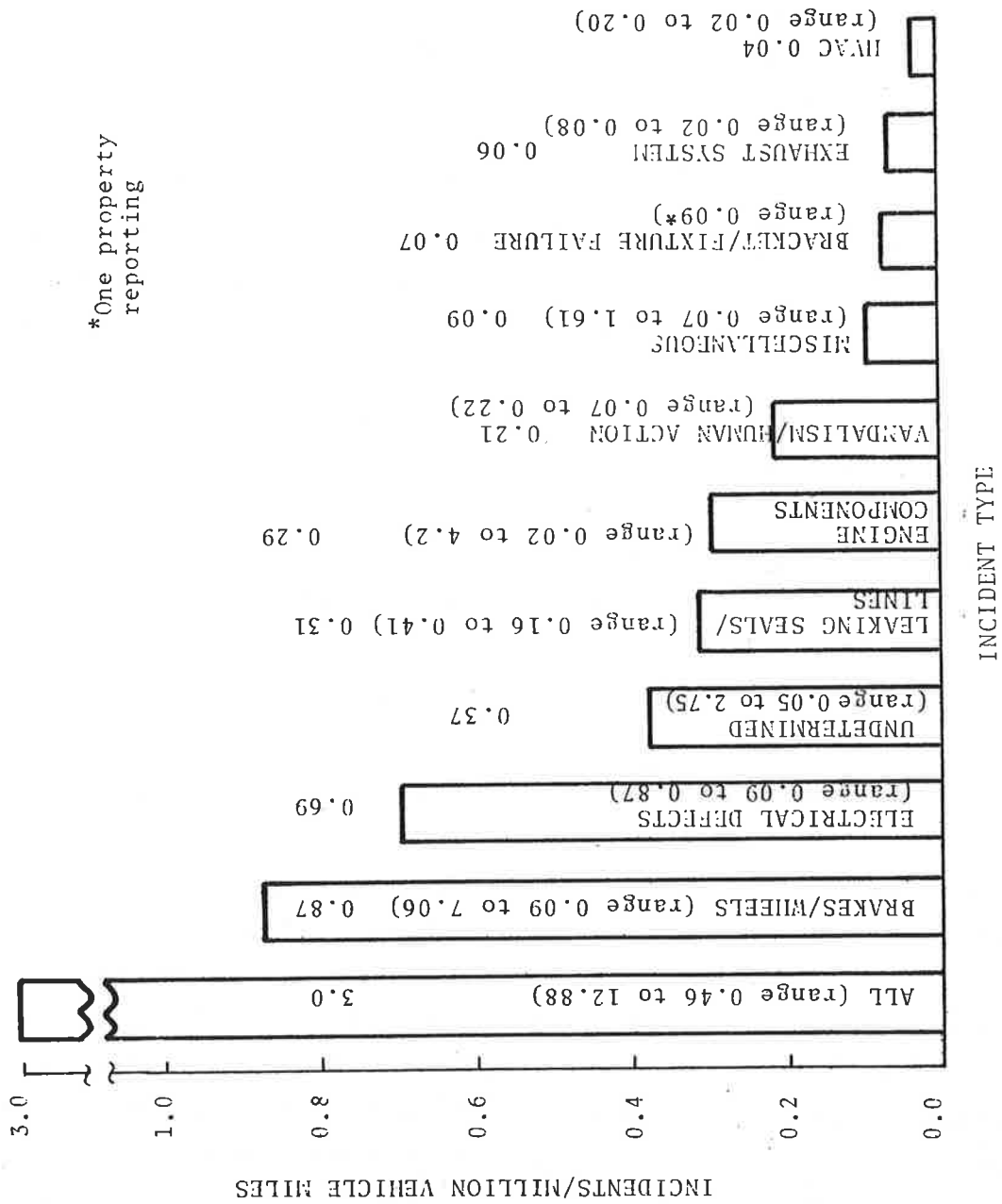

FIGURE 3.2 BUS FIRE/SMOKE INCIDENT RATE (1978 DATA)

period 1246 bus and 1742 rail rapid transit fire and smoke incidents were reported in the records of the nine transit properties. This yields 3.0 fire and smoke incidents per million bus-miles and 5.3 fire and smoke incidents per million rail rapid transit miles. As noted above, these incident rates are for the overall transit community and the range of incident rates for the individual properties varied considerably and are also shown in Figures 3.1 and 3.2. In many cases incident reports stated that fire or smoke had occurred but did not provide any further details; these incidents are tabulated under "undetermined." Several transit properties reported the service delay caused by the accident and these data are shown in Figures 3.3 and 3.4. The repair costs for fire and smoke damaged vehicles was reported by only one transit property and is plotted in Figure 3.5. As might be expected, the cost of repair of the vehicle varies with the frequency of occurrence; i.e., incidents which resulted in inexpensive damage had a high frequency of occurrence.

In the process of on-site examination of the transit property records, it was noted that the number of fire and smoke incidents were vastly outweighed by the total number of other types of on-board incidents. They included mechanical failures without fire or smoke, crashes, passenger injuries and fatalities, passengers falling or becoming sick in the vehicle, altercations of some type, vandalism, etc. As an example, at one bus property there were a total of 4000 incidents reported in 1978 of which, only 50 were fire and smoke incidents. Generally, it was found that fire and smoke incidents in buses represented approximately two percent of the total bus incidents. For rail rapid transit, the percentage of all incidents in which fire and smoke are involved is estimated by TSC to vary between one and five percent. These percentages represent the best estimates available and are limited by the difficulty in estimating the total number of incidents and also the variances in the



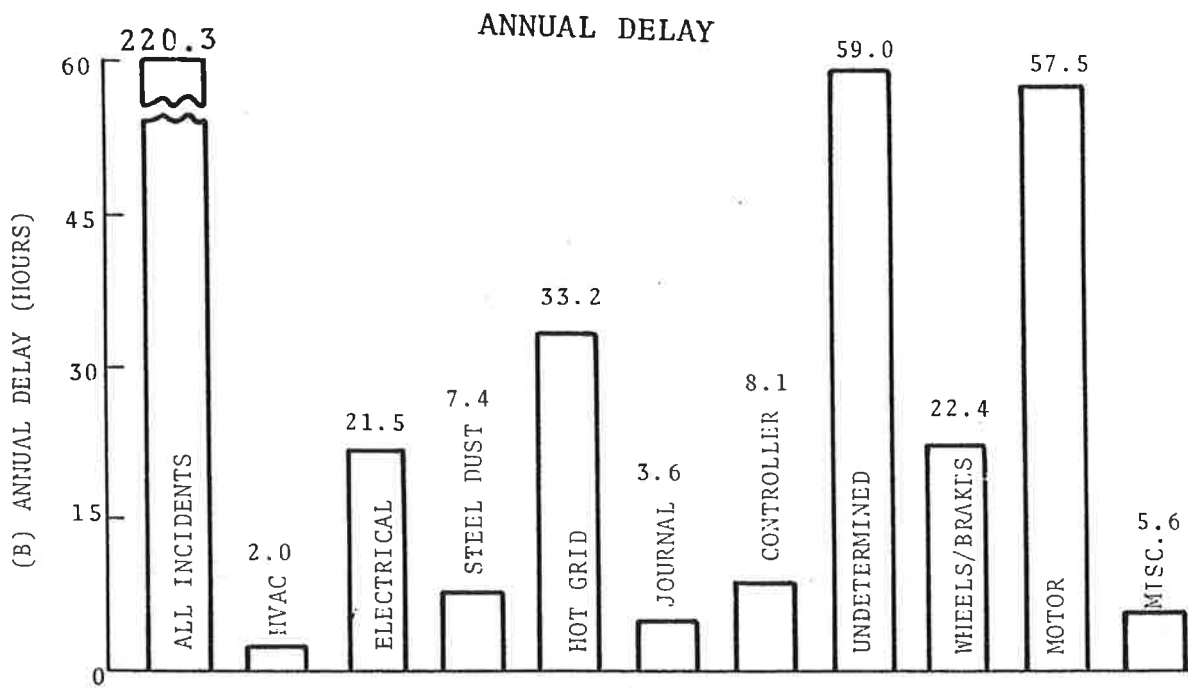
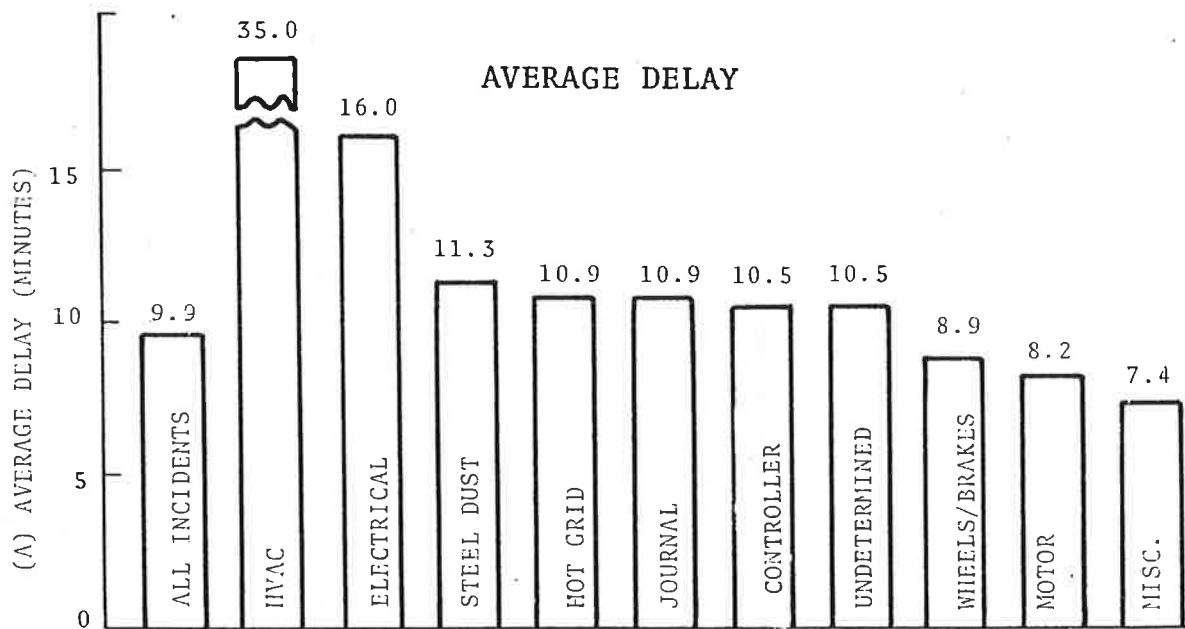

FIGURE 3.3 SERVICE DELAY BY INCIDENT TYPE--RRT  
(DATA FROM 3 PROPERTIES) (1978 DATA)

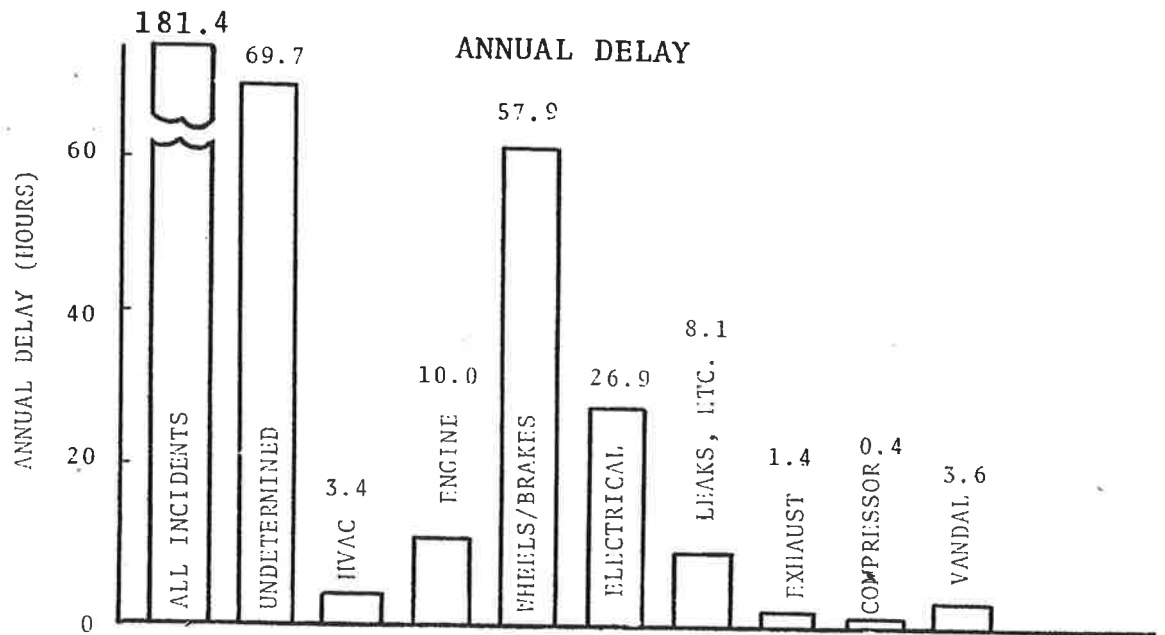
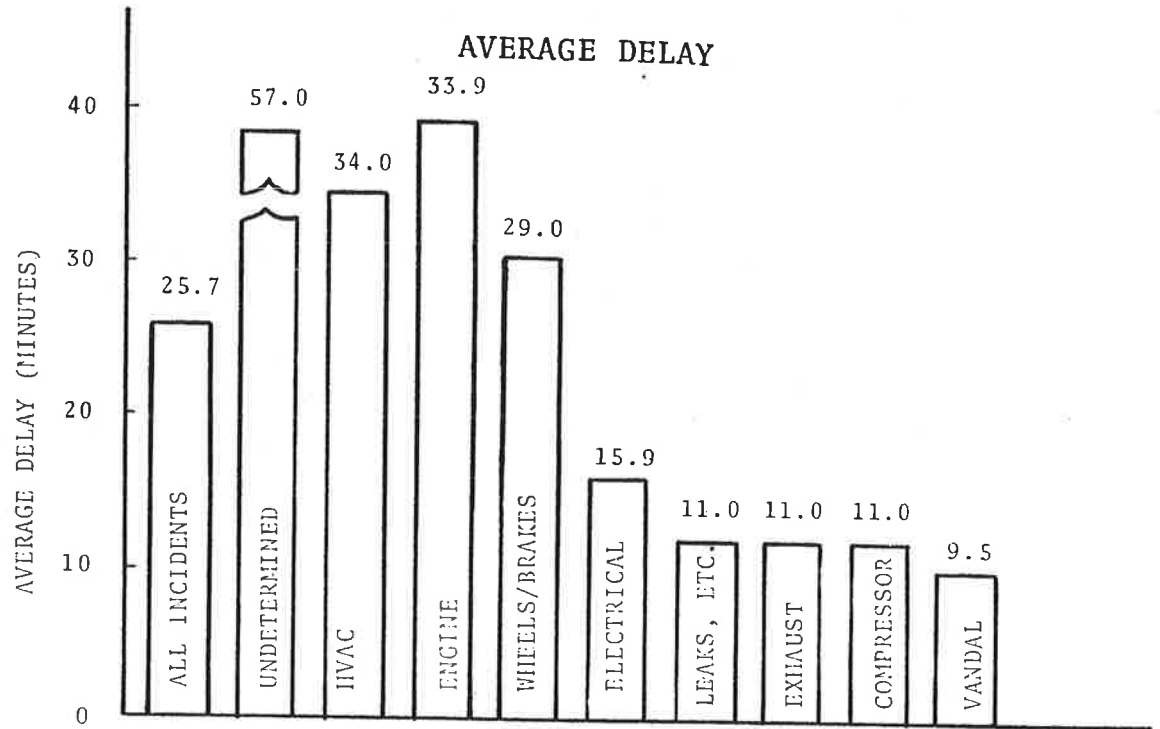

FIGURE 3.4 SERVICE DELAY BY INCIDENT TYPE--BUS  
(DATA FROM 4 PROPERTIES) (1978 DATA)

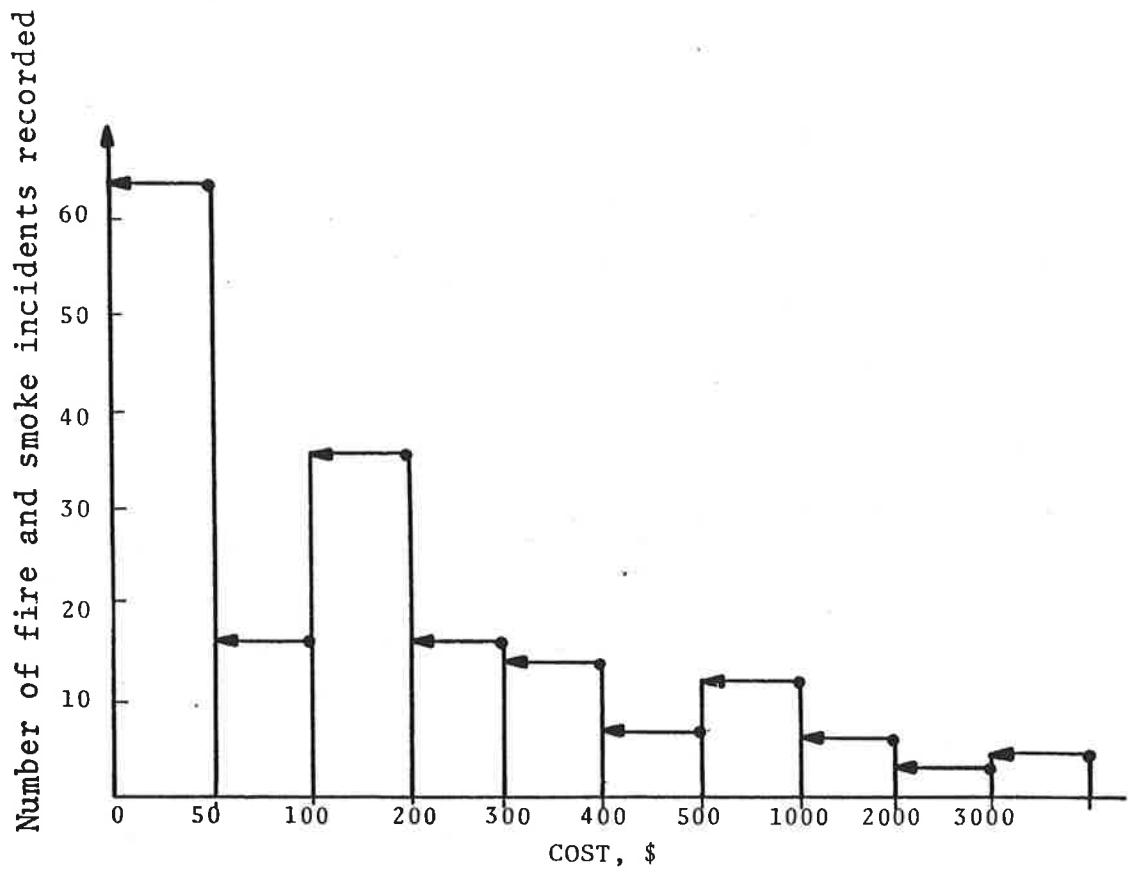

FIGURE 3.5 COST OF REPAIR DATA FROM ONE BUS PROPERTY, NUMBER OF FIRE AND SMOKE INCIDENTS VS. COST (1978 DATA)

reporting practices of the transit properties. The comparatively low rate of occurrence of fire and smoke incidents leads one to expect these represent a hazard fairly low on their list of problems to be dealt with. Although this may be true, it should be noted that each minor incident has the potential to become a major incident which may result in extensive loss of life and property.

### 3.2 FAULT TREES AND SCENARIOS

This section discusses the use of fault trees and scenarios as a means of qualitatively presenting how minor incidents occur and how they may become major incidents. Fault trees and scenarios will also allow for the identification of prospective countermeasures to eliminate the occurrence of an incident or to insure that a minor incident does not develop any further.

Fault tree analysis is a technique which provides a graphical representation of the relationship between certain specific events and the undesired or head event. As an example, Figure 3.6, shows a fault tree for a fire or smoke incident in a bus brake system. The "Fire/Smoke in Brake System" is the undesired or head event and the secondary events which may lead to the head event are "slack adjustor fails," "brake chamber push rod fails," or "other." The events are connected by "gates." An "OR" gate, as shown in Figure 3.6, requires that at least one of the secondary events occur in order for the head event to occur. An "AND" gate, as shown in Figure 3.7, requires that all secondary events must occur before the head event occurs. Reference 2 provides a more detailed discussion of fault tree analysis.

Simple trees, such as those of Figures 3.6 and 3.7, may be linked together to form larger trees. Fault trees may be qualitative, quantitative, or both, since, once the tree is fully developed in a qualitative manner, it is possible to determine the

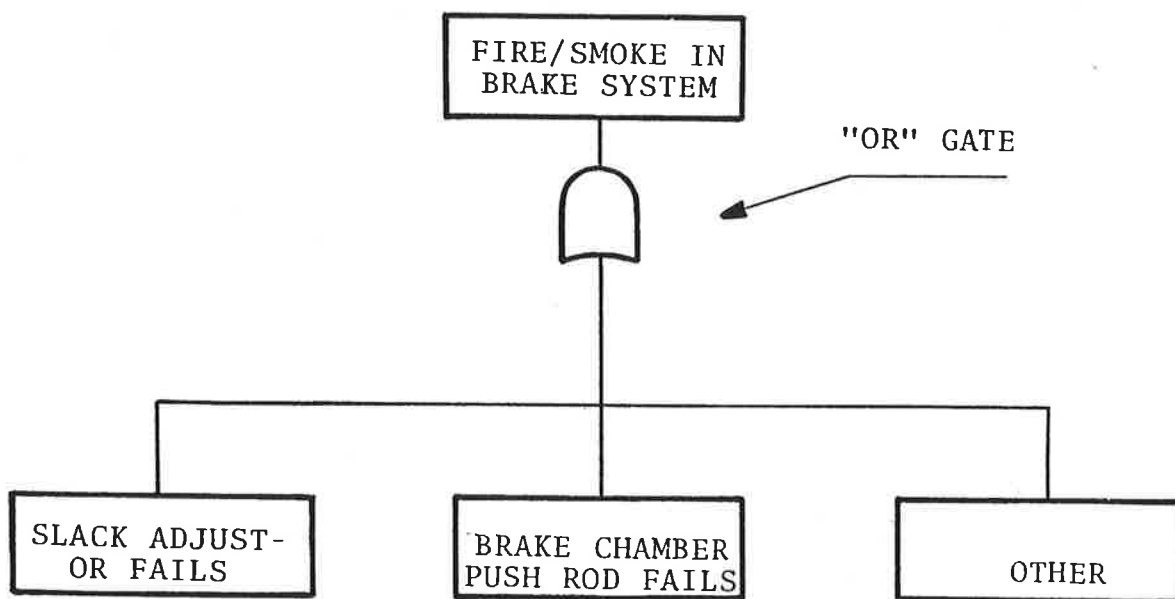

FIGURE 3.6 USE OF THE "OR" GATE

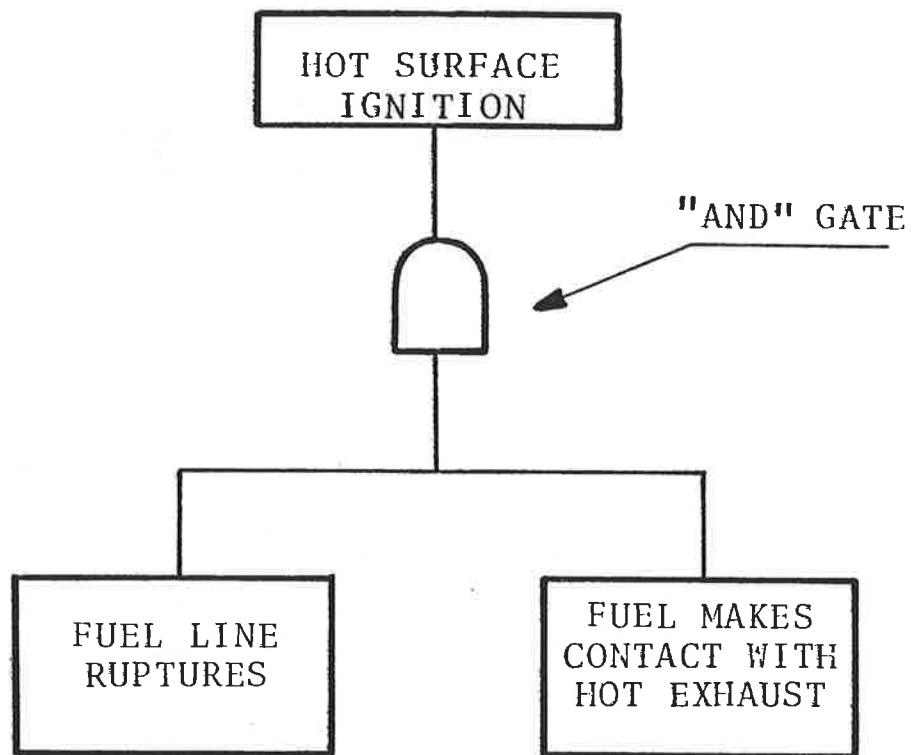

FIGURE 3.7 USE OF THE "AND" GATE

probability of occurrence of the head event. This is done by assigning values for the probability of occurrence or frequency of the secondary events and then calculating the probability of the head event occurring. These probabilities of occurrence then allow the ranking of various sequences by their probability of occurrence and provide the necessary base for decisions as to where countermeasures will result in the greatest return in saving of lives and property. The data of Section 3.1 are limited in type and detail of occurrence and, therefore, may represent only a small portion of the possible fire and smoke threats. Fault tree analysis will lead to the identification of other possible events and combinations of events which might not otherwise be recognized from the data, as potential causes of the head event. Furthermore, when working with historical data to predict the future occurrence of incidents, only those incidents which have occurred in the past and are in the historical data base may be projected to occur in the future. Incidents which have yet to occur may not be identified as possible future threats. The fault trees shown in Figures 3.8 and 3.9 represent smoke and fire incidents in rail rapid transit cars and buses, respectively. These fault trees, along with more detailed ones, will be used to identify the countermeasures necessary to minimize, and, where possible, to eliminate the fire threat in transit vehicles.

To supplement the fault trees, scenarios were developed to provide a detailed description of the fire and smoke initiation and propagation as well as the responses and actions of the vehicle occupants. Each of the scenarios corresponds to an event sequence in the fault trees.

A list of scenarios developed is given in Table 3.1 for RRT vehicles and in Table 3.2 for buses. The frequency of occurrence, obtained from Figures 3.1 and 3.2, of each scenario type is also listed as well as relative percentage of incidents.

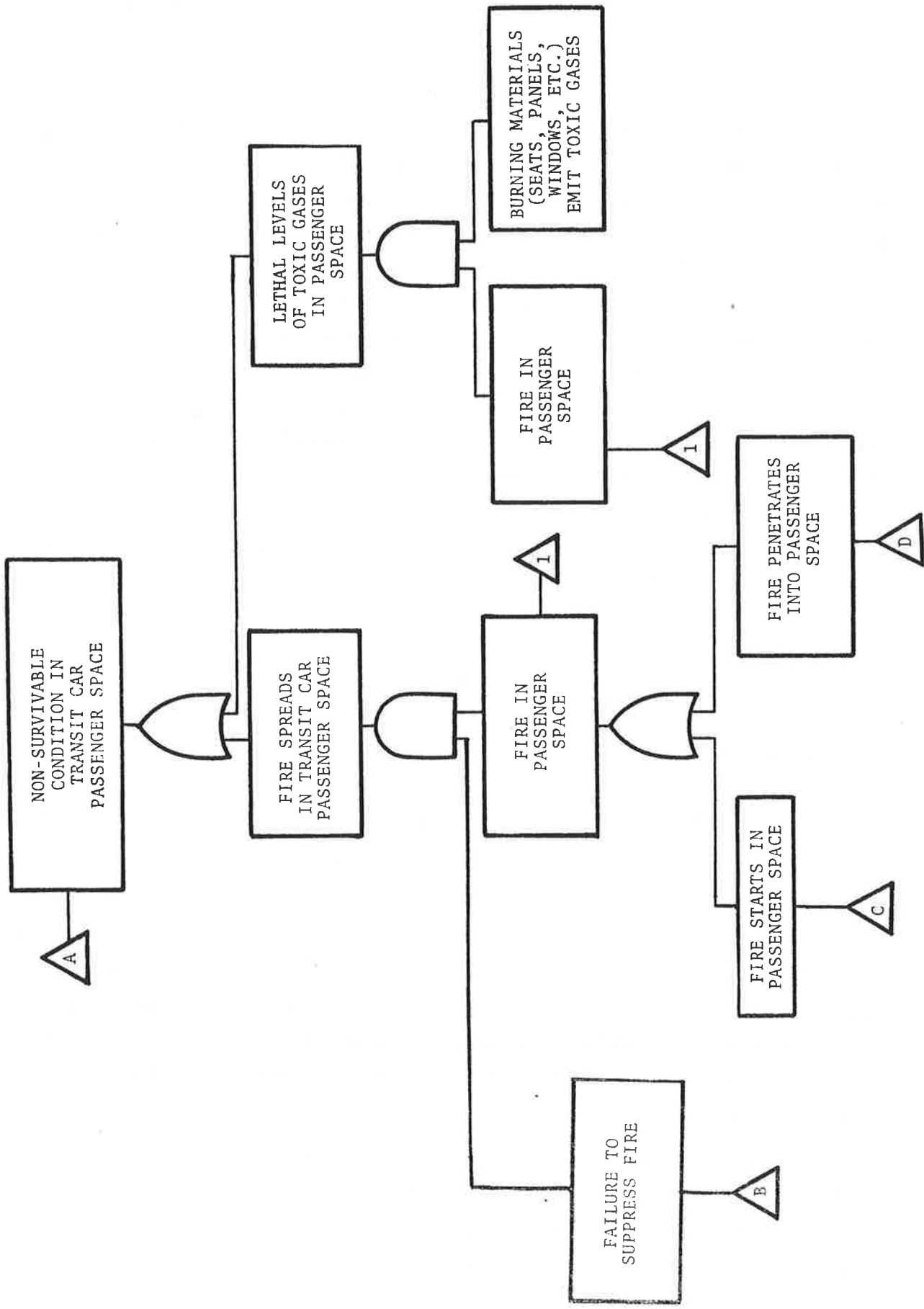

FIGURE 3.8.1 FAULT TREE A, RAIL RAPID TRANSIT VEHICLE FIRE



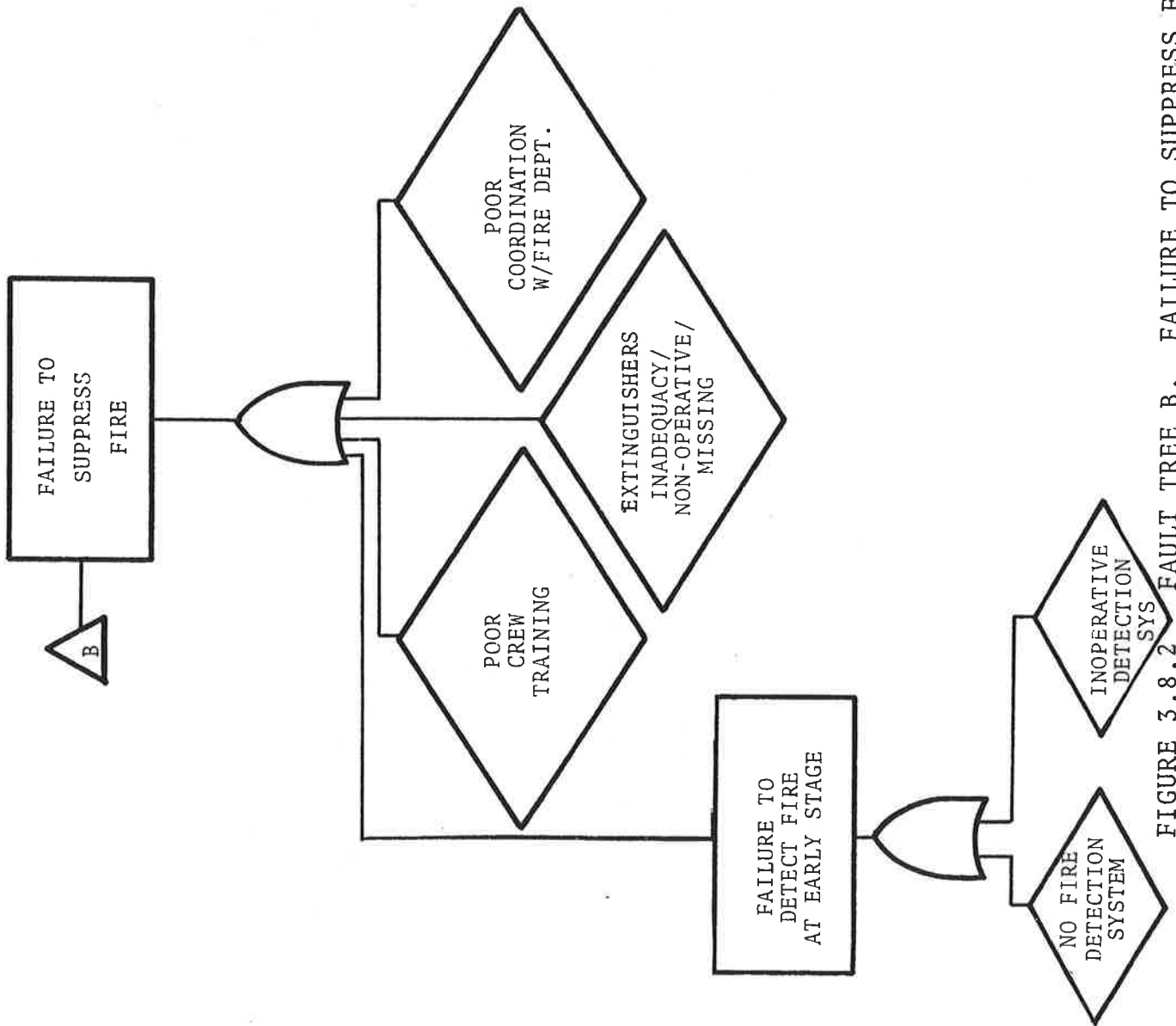

FIGURE 3.8.2 FAULT TREE B, FAILURE TO SUPPRESS FIRE

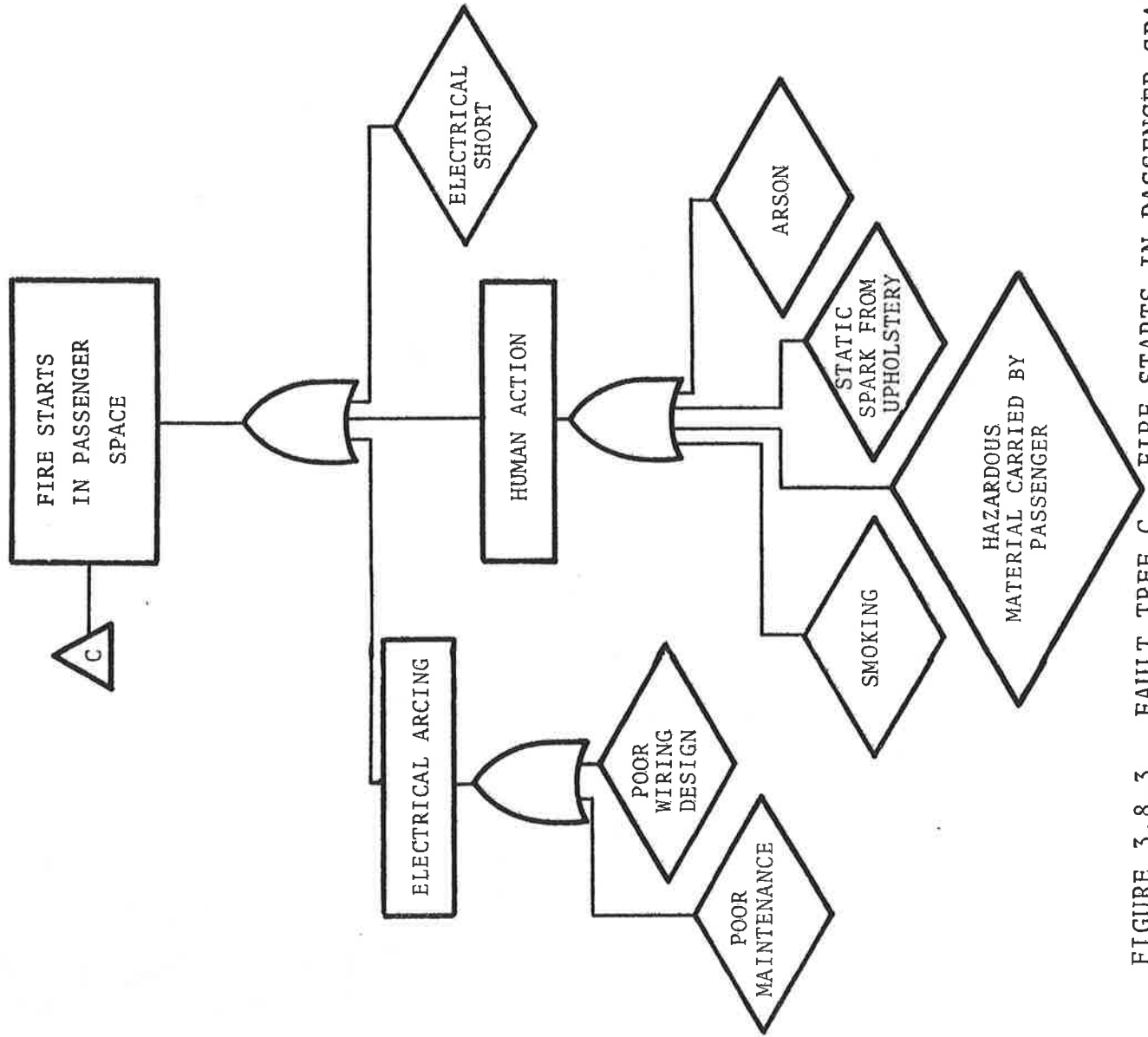

FIGURE 3.8.3 FAULT TREE C, FIRE STARTS IN PASSENGER SPACE

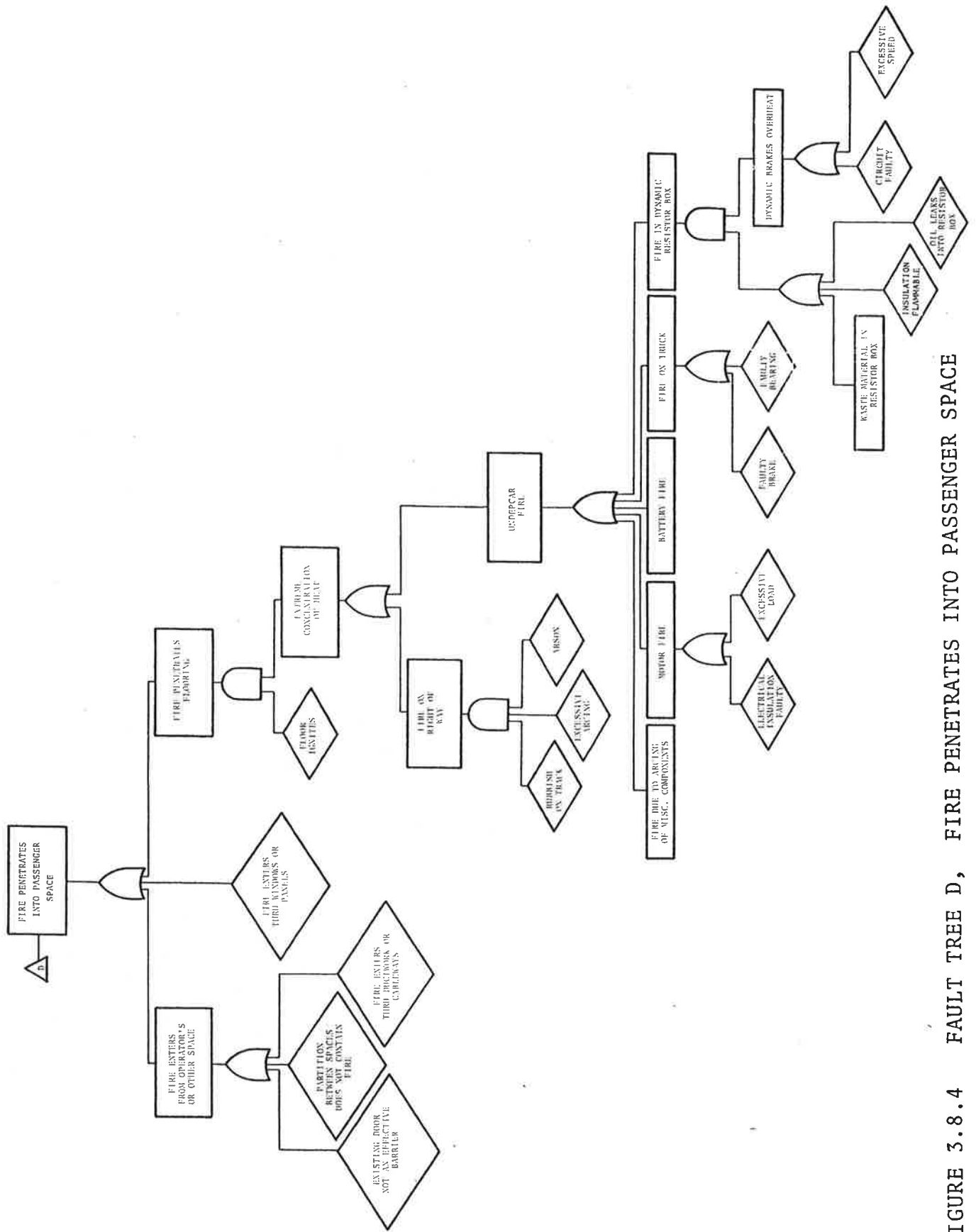
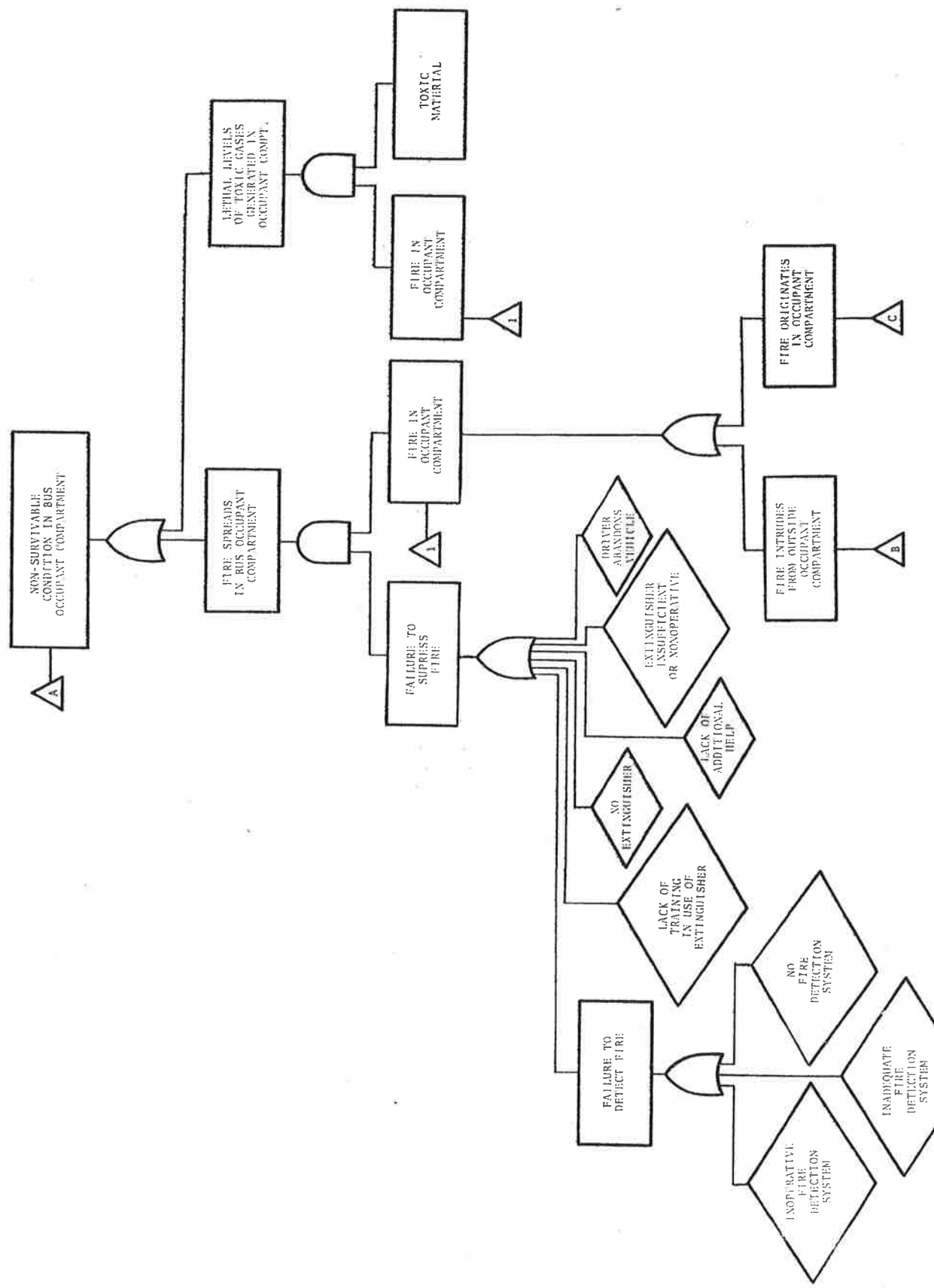

FIGURE 3.8.4 FAULT TREE D, FIRE PENETRATES INTO PASSENGER SPACE



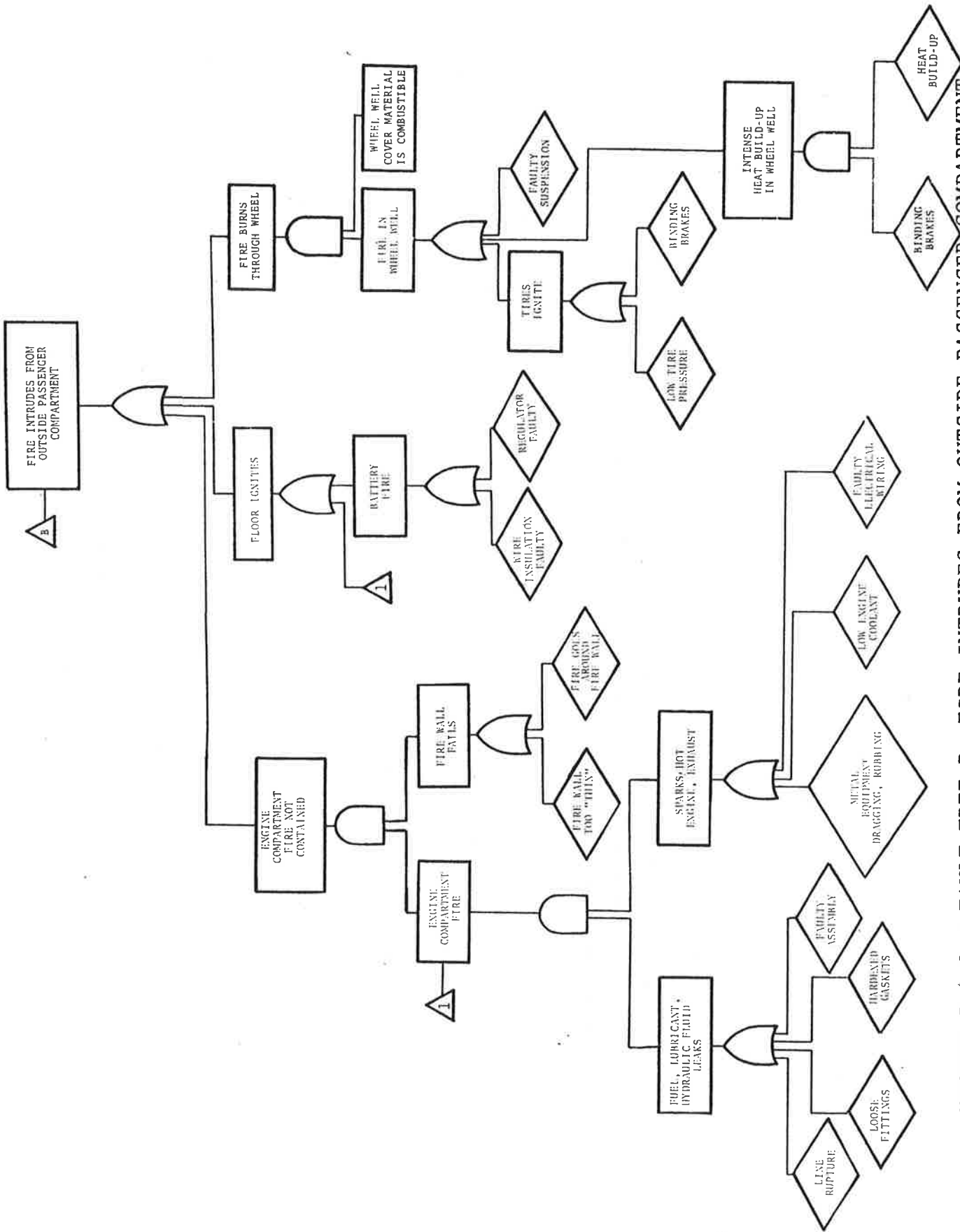

FIGURE 3.9.2 FAULT TREE B, FIRE INTRUDES FROM OUTSIDE PASSENGER COMPARTMENT

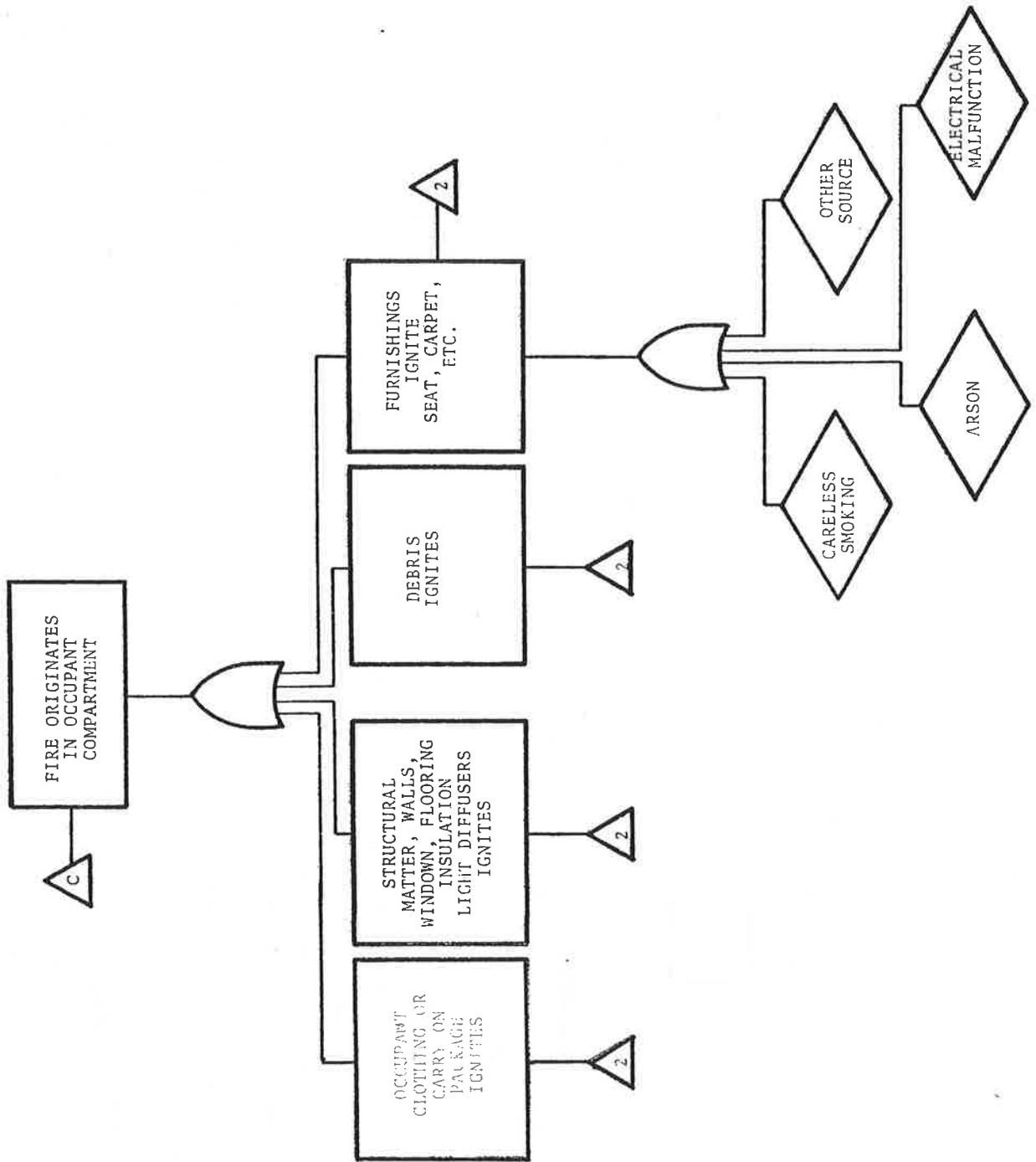

FIGURE 3.9.3 FAULT TREE C, FIRE ORIGINATES IN OCCUPANT COMPARTMENT

TABLE 3.1 RAIL RAPID TRANSIT SCENARIO TYPES

| Scenario Number | Ignition Source   | Incidents/Million Vehicle Miles | % of All Incident |
|-----------------|---|---------------------------------|-------------------|
|                 | (UNDERCAR FIRES)  |                                 |                   |
| 1               | traction motor  | 1.3                             | 24.5              |
| 2               | resistor grid   | 0.54                            | 10.2              |
| 3,4<br>5        | defective brake control<br>handbrake not fully released | 0.44                            | 8.3               |
| 6               | switch failure  | 0.32                            | 6.0               |
| 7<br>8          | battery cable short<br>metallic object lodged under car | 0.29*                           | 5.5               |
| 9               | compressor  | 0.15                            | 2.8               |
| 10              | controller  | 0.14                            | 2.6               |
| 11              | journal   | 0.06                            | 1.1               |
| 12              | fuse  | 0.05                            | 0.9               |
|                 | (OCCUPANT COMPARTMENT FIRES)                            |                                 |                   |
| 13<br>14<br>15  | arson<br>cigarette arson<br>HVAC                        | 0.02<br>0.06                    | 0.4<br>1.1        |
| 16              | defective lighting unit                                 | -                               | ..                |
|                 | (WAYSIDE IGNITION FIRES)                                |                                 |                   |
| 17              | steel dust  | 0.12                            | 4.3               |
|                 |   |                                 | 67.7              |
| 18, 19          | Undetermined and miscellaneous**                        |                                 | 32.3              |
|                 |   |                                 | 100.0             |

\* Includes Scenario 16

\*\*Vandals Drop Objects on Track, Equipment Cover on Track.

TABLE 3.2 BUS SCENARIO TYPES

| Scenario Number          | Ignition Source  | Incidents/Million Vehicle Miles | % of All Incidents |
|--------------------------|--|---------------------------------|--------------------|
|                          | (WHEEL WELL FIRES)   |                                 |                    |
| 20, 21, 22<br>23<br>24   | locked brake<br>underinflated tire<br>wheel bearing        | 0.87                            | 29.1               |
|                          | (ELECTRICAL WIRING FIRES)                                  |                                 |                    |
| 25, 26<br>27<br>28<br>29 | wiring short<br>instrument panel<br>lighting<br>side panel | 0.69                            | 22.9               |
|                          | (LEAKING FUEL AND OIL FIRES)                               |                                 |                    |
| 30<br>31, 32<br>33       | fuel line leak<br>oil leak<br>oily residues                | 0.31                            | 10.3               |
|                          | (ENGINE FIRES)   |                                 |                    |
| 34                       | engine   | 0.29                            | 9.7                |
|                          | (OCCUPANT COMPARTMENT FIRES)                               |                                 |                    |
| 35<br>36, 37, 38         | arson<br>cigarette, etc.                                   | 0.21                            | 7.0                |
|                          | (EXHAUST FIRES)  |                                 |                    |
| 39                       | exhaust system   | 0.06                            | 2.1                |
|                          |  |                                 | 81.1               |
| 40, 41                   | Undetermined and miscellaneous                             |                                 | 18.9               |
|                          |  |                                 | 100.0              |



All of the scenarios developed are contained in Appendix B. Here, the scenarios are grouped according to general location on the vehicle or category of ignition source. Additional scenarios were developed which do not belong in the categories given in Figures 3.1 and 3.2. These were developed either because similar events had actually happened (at least once) or the possibility of their occurrence seemed plausible. These scenarios are intended to indicate the range of incidents which can and do occur on the RRT cars and transit buses. They are not intended to be exhaustive with regard to the variety of detail which may underlie each incident type. A general idea of ignition source at a more fundamental level is indicated in Table 3.3.

These concepts can be used in devising appropriate countermeasures to reduce the frequency of occurrence of specific categories of fire incidents. This is discussed below.

### 3.3 RELATIONSHIP OF DATA, SCENARIOS, AND FAULT TREES

As discussed in Section 3.1 the data on transit vehicle fire and smoke incidents, presented in Figures 3.1 and 3.2, represent the most detailed data available and provide an indication of where transit vehicle fire and smoke incidents occur and of the components involved. With this information it is then possible to rank the scenarios by their probability of occurrence and the service delay associated with that occurrence. Also, using the data on component fire and smoke incidents, the fault trees will show how the path of the fire or smoke may progress in the vehicle and possibly result in occupant death or injury. Furthermore, the fault tree may be

TABLE 3.3 VEHICLE HEAT SOURCES

| Type                | Source  |
|---------------------|---|
| Mechanical Friction | brakes<br>bearings<br>underinflated tires   |
| Electrical          | wiring shorts<br>component shorts (starter,<br>generator, motor, lighting,<br>battery, switches, fuses,<br>etc.)<br>resistors |
| Engine Overheat     | cooling system failure  |
| Human Action        | arson<br>careless smoking, matches,<br>etc.   |

evaluated in a quantitative manner if data are available which will indicate the probability of occurrence of each path in the fault tree and the probability of occurrence of the head event. Scenarios and fault trees may also be used in evaluating countermeasures before they are implemented. This may be done by inserting the proposed countermeasure in a scenario or fault tree and then evaluating it to see whether it has a significant effect. Probabilities and measures of hazard for the countermeasure may be determined through expert judgment, through its relationships to the conditions and events in the fault tree, and through an estimate to the degree of percentage improvement over the existing conditions.

## 4. METHODOLOGY FOR COUNTERMEASURE SELECTION

This section contains a brief summary of the approach for the development of countermeasures. A more detailed discussion of countermeasure development will be provided in a future report.

As noted in Section 3, each fire and smoke incident may have the potential of becoming a major incident resulting in injuries, fatalities and property losses. The judicious application of appropriate countermeasures will serve to reduce the tendency of minor fire incidents from developing into major conflagration and may, in some instances prevent the occurrence of any fire incident, entirely. The historical data identify where the incidents occur, the fault trees provide a description of the path of development each incident may take, and the scenarios provide a detailed description of events and actions taken by the occupants.

### 4.1 APPROACH TO COUNTERMEASURE DEVELOPMENT

Modern vehicle design practices have been directed at providing a safe and reliable service for passengers and operators. This approach has resulted in the increased use of non-metallic materials in transit vehicles and perhaps an increase in the fire threat associated with these vehicles. Historically, improvements in the fire protection of transportation vehicles have been directed at improving the construction by utilizing less flammable and toxic materials. However, this effort addresses only a portion of the problem; a comprehensive approach is needed that will include all factors contributing to the fire threat.

The proposed fire protection countermeasures for transit vehicles will encompass five major categories which are

applicable to new vehicle construction and retrofit programs:

Fire hazard analysis will involve the identification of meaningful test methods and utilization of screening/large-scale tests, the establishment of realistic fire safety criteria, and fire characterization by means of scaling and modeling studies.

Materials technology will encompass the development of new materials and the selection and improvement of conventional materials for a variety of applications, including thermal barriers, extinguishants, and personnel and vulnerable equipment protection.

Fire engineering will explore new concepts in fire containment, detection, smoke control, and emergency egress.

Operations and maintenance will provide for a review and updating of operating procedures, operating manuals, maintenance procedures and emergency training.

Fire fighting will involve the evaluation of extinguishing and personal protection equipment concomitant with training functions.

As shown in the "Logic Diagram for Countermeasure Selection," Figure 4.1, several countermeasures within each category are available for application to the identified fire threats.

#### 4.2 EXAMPLES OF COUNTERMEASURES

Although the identification and selection of prospective countermeasures have just been initiated, several examples that appear worthy of further investigation are presented in this section.

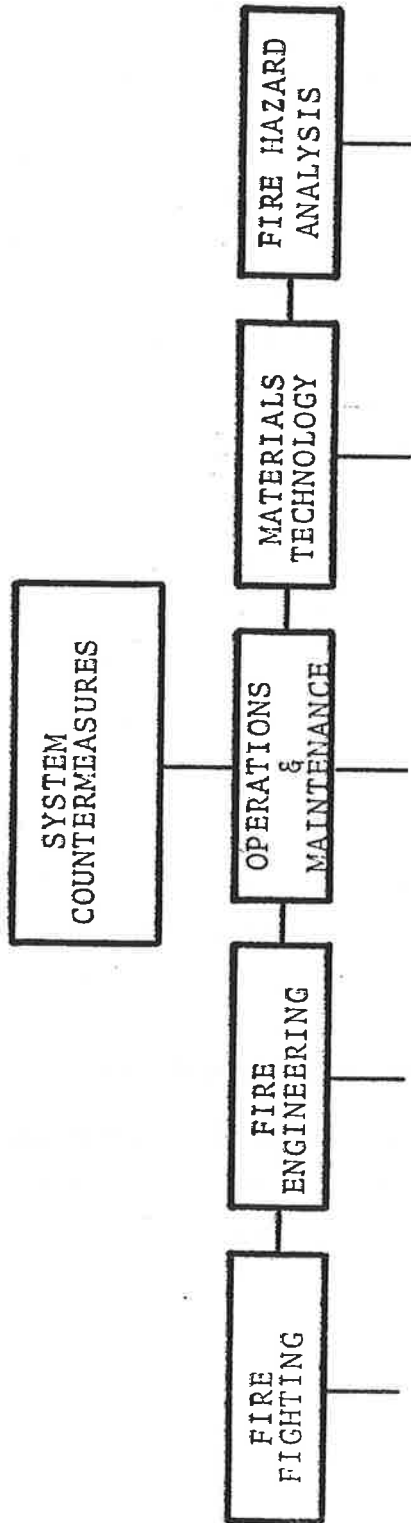

FIGURE 4.1 LOGIC DIAGRAM FOR COUNTERMEASURE SELECTION

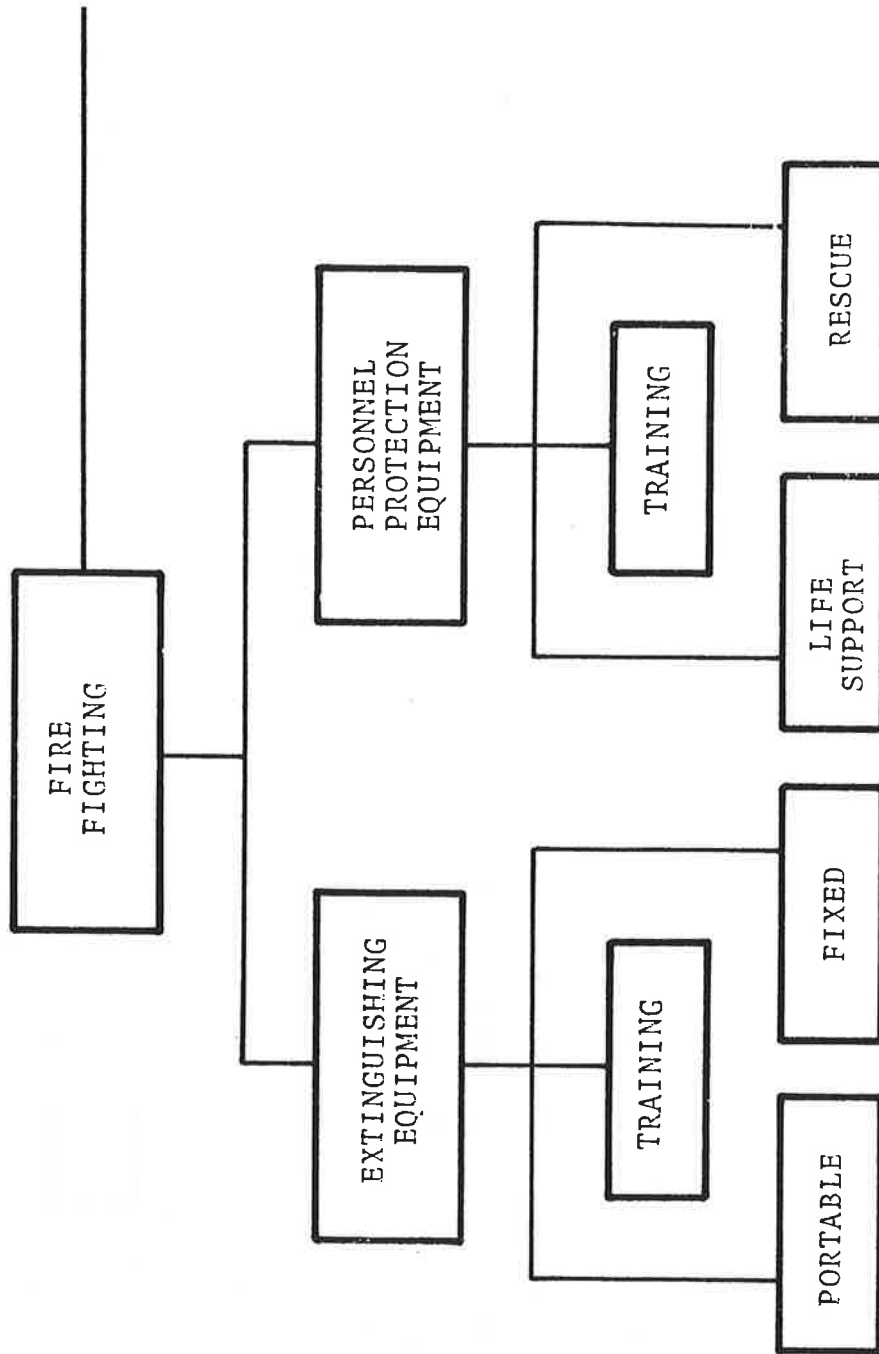

FIGURE 4.1 (CONTINUED)

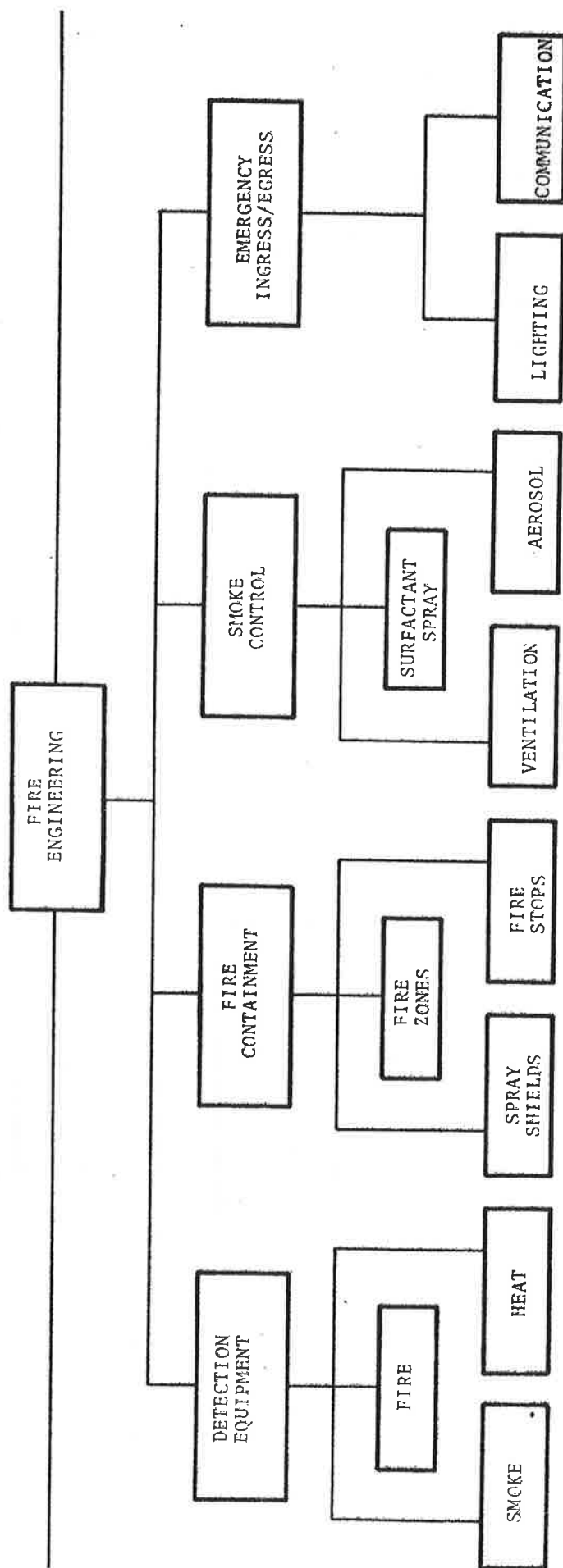

FIGURE 4.1 (CONTINUED)



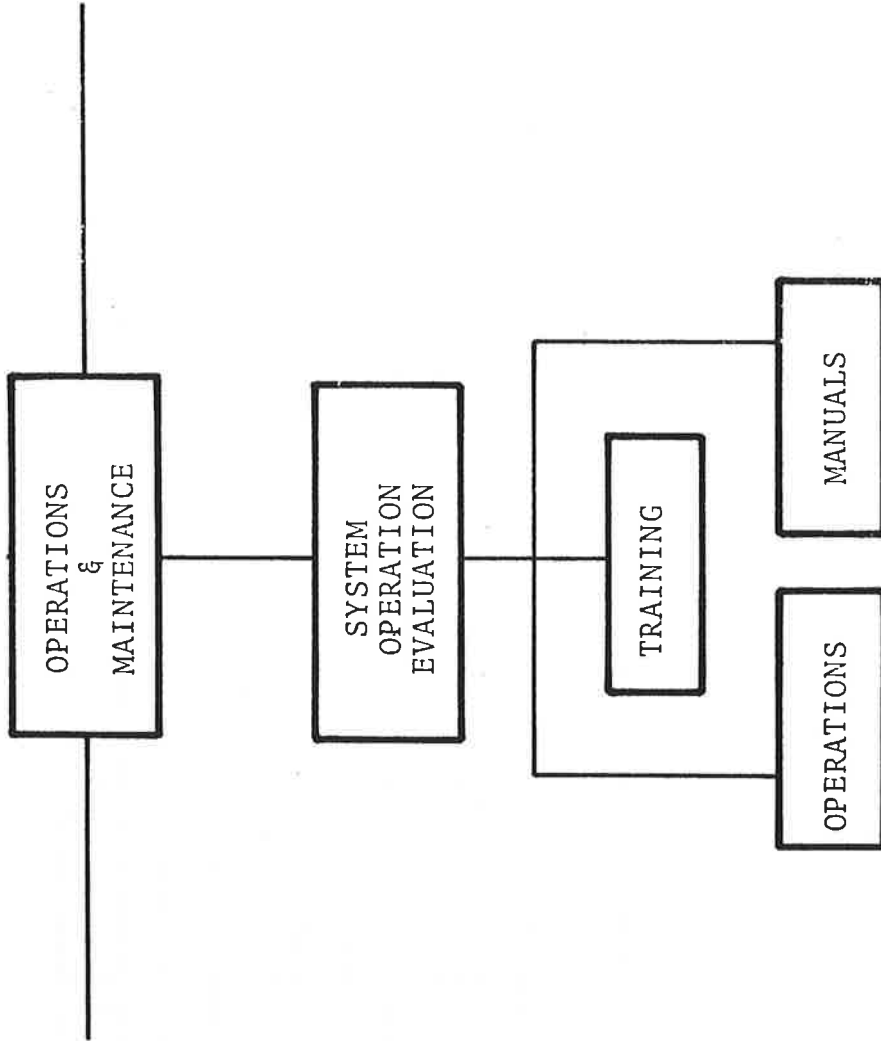

FIGURE 4.1 (CONTINUED)

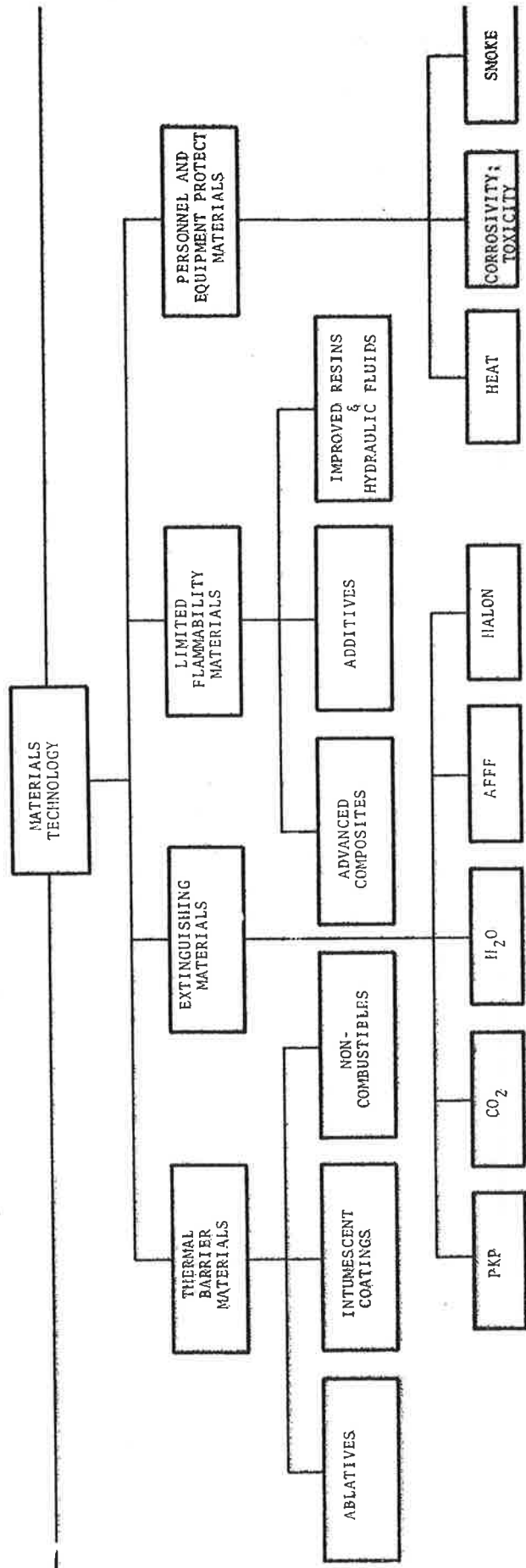

FIGURE 4.1 (CONTINUED)

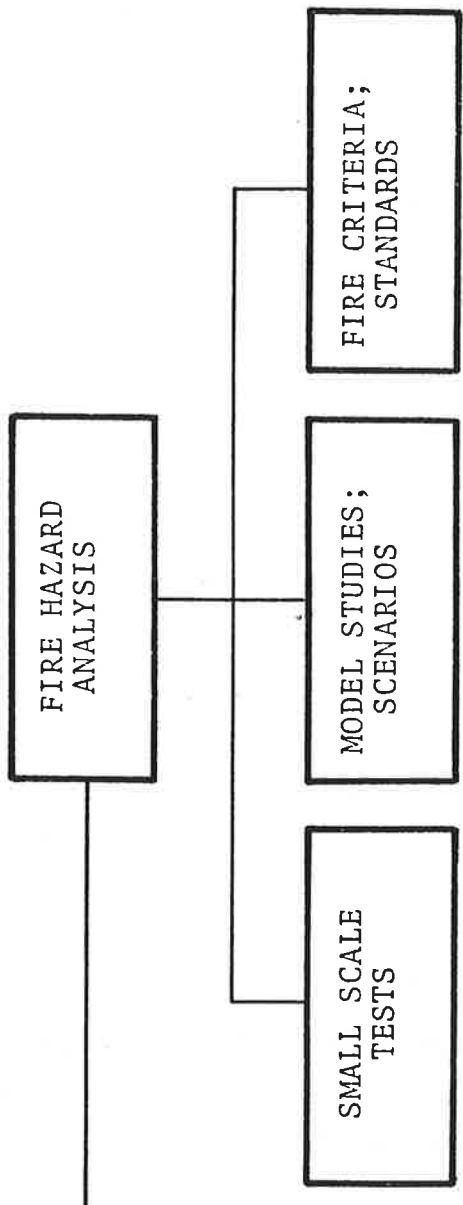

FIGURE 4.1 (CONTINUED)

#### 4.2.1 Bus Wheel Wells

As shown in Table 3.2 fires in bus wheel wells accounted for 29.1 percent of all bus fire and smoke incidents. Scenario numbers 20, 21, 22, 23 and 24 are actual cases where wheel well fires have resulted in minor injuries and property loss. An effective countermeasure to prevent this problem could be a change in the wheel well material from a combustible material to a non-combustible material or a fire stop as shown in Figure 4.2. Several other methods, such as improved vehicle maintenance and inspection, are prospective countermeasures to deal with this problem.

#### 4.2.2 Improved Vehicle Maintenance and Cleanliness

Deposits of grease, oil, metallic dust and other debris provide conditions where fires may be more easily ignited and propagated. Wires may become frayed and cause short circuits and arcing which results in fires and smoke. Improved maintenance and cleanliness are some of the principal countermeasures available. Lack of vehicle maintenance and cleanliness has been involved in the initiation of fire incidents.

#### 4.2.3 Materials Technology

The proper selection of transit vehicle materials will minimize the fire threat by resisting ignition and fire propagation as well as minimizing smoke generation and subsequent obscuration. As shown in Figures 3.8 and 3.9, and the data collected from transit properties, materials in themselves do not cause ignition but do contribute to fire propagation and smoke generation. The materials countermeasures to be developed will be discussed in a future report.

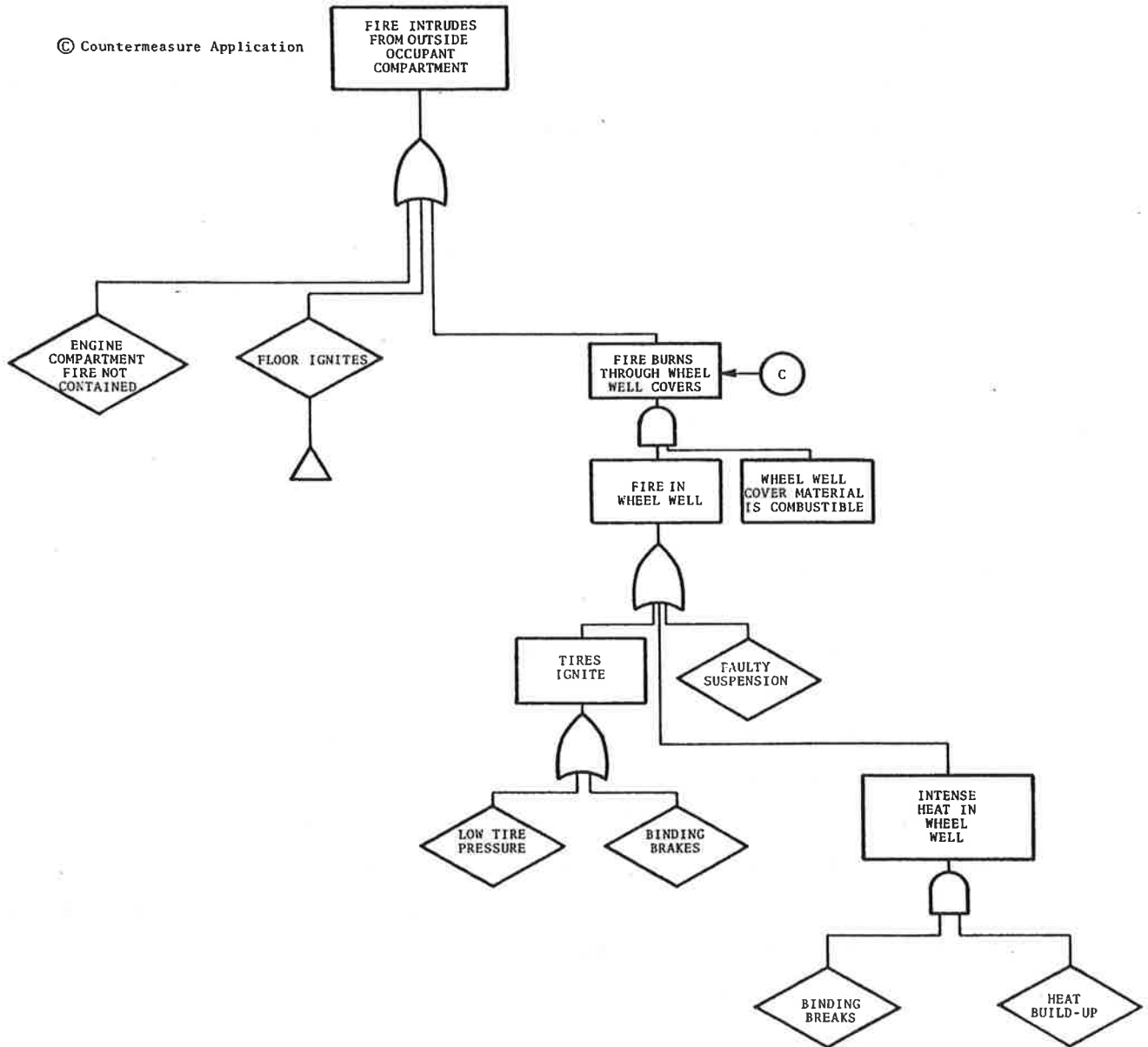

FIGURE 4.2 EXAMPLE OF APPLICATION OF COUNTERMEASURE AT BUS WHEEL WELL

#### 4.2.4 Flooring and Firewall Construction

Rapid rail vehicle floors are often of a sandwich type in which plywood or polyurethane sheet is laminated between two metal sheets. This laminated construction possesses a superior strength-to-weight ratio and also provides insulation against undercar noise. Areas of the floor which may be exposed to fires originating in electrical undercar equipment should be further protected with heat-and-fire shielding.

Air-conditioning ducting should be fire-stopped and protected to prevent the penetration of fire and smoke into the passenger compartment.

#### 4.2.5 Smoke and Fire Detection Devices

As noted in the rail rapid transit incident data, smoke and fire on the vehicle underside represent the majority of all incidents. In most instances the transit property operating personnel detect fire and smoke and take appropriate action before the incident develops any further. However, as noted in the scenarios, there have been cases where the initial incident has developed to major proportions and resulted in damage to the vehicle. Accordingly, consideration of the application of fire and smoke detectors under and in the vehicle may be appropriate.

## 5. CONCLUSIONS

Based on the data analyzed during visits to the transit properties and discussions with individuals in the transit community it is apparent that the rate of occurrence of fire and smoke incidents in transit vehicles is low relative to other types of incidents.

A major problem in studying urban mass transportation fires is availability of useful data. Records concerning fire and smoke incidents are not easily accessible. They are generally dispersed among records of transit property accidents, "unusual occurrences," or repairs. Descriptions of fire and smoke incidents usually are not explicit as to technical details or the extent of the damage, except in the case of special reports for major accidents. In most cases, it is not possible to follow an incident all the way to final disposition. Costs are not well documented; hence, cost/benefit estimation would be tenuous. Although it appears that most fire and smoke damage is of a minor or moderate nature and that incidents are relatively infrequent, better information on the severity of transit fires would be useful.

The foregoing is not intended to understate the potential that exists for severe hazards to life in those situations where fire fighting is difficult or where passenger escape is not straightforward; i.e., subsurface transit especially in underwater tubes.

## REFERENCES

1. W.T. Hathaway and I. Litant, Assessment of Current DOT Fire Safety Efforts, UMTA-MA-06-0051-79-1, U.S. Dept. of Transportation, July 1979.
2. Willie Hammer, Handbook of System and Product Safety, Prentice-Hall, Englewood Cliffs NJ, 1972, p. 238.



APPENDIX A

FIRE AND SMOKE DATA FROM FRA/UMTA

REPORTING SYSTEM AND U.S. FIRE ADMINISTRATION

Data obtained from FRA thru Dec. 1978.  
 Cut-off criteria for inclusion of incident:  
 \$2300 equipment or 1 man day injury.  
 Printout was searched for smoke-fire incidents;  
 the following incidents were found:

| <u>PROPERTY</u> | <u>DATE</u> | <u>CODE</u> | <u>PRIMARY CAUSE</u>            | <u>COST</u> |                      |
|-----------------|-------------|-------------|---------------------------------|-------------|----------------------|
| MBTA            | 8/1/75      | 474         | Elec. Fire                      | \$20,672    |                      |
| MBTA            | 11/30/75    | 706         | Object on Track<br>Causing Fire | \$19,881    |                      |
| BART            | 5/14/76     | 474         | Elec. Fire                      | \$5,250     |                      |
| BART            | 11/17/76    | 702         | Vandal Caused                   | \$100,000   |                      |
| CTA             | 1/8/76      | 474         | Elec. Fire                      | \$18,078    |                      |
| CTA             | 1/17/76     | 475         | Elec. Fire                      | \$20,351    |                      |
| CTA             | 8/25/76     | 474         | Elec. Fire                      | \$50,000    |                      |
| MBTA            | 5/8/76      | 474         | Elec. Fire                      | \$10,000    |                      |
| MBTA            | 5/24/76     | 499         | Unspec.                         | \$10,000    |                      |
| MBTA            | 6/15/76     | 474         | Elec. Fire                      | \$22,000    |                      |
| MBTA            | 6/24/76     | 499         | Unspec.                         | \$10,000    |                      |
| MBTA            | 10/5/76     | 499         | Unspec.                         | \$20,000    |                      |
| BART            | 8/5/77      | 474         | Elec. Fire                      | \$200,000   |                      |
| BART            | 9/7/77      | 474         | Elec. Fire                      | \$12,450    |                      |
| CTA             | 1/14/77     | 475         | Current Collector Syst.         | \$28,000    |                      |
| CTA             | 3/1/77      | 475         | Current Collector Syst.         | \$22,200    |                      |
| CTA             | 11/26/77    | 799         | Not Spec.                       | \$48,257    | } 3 cars<br>involved |
| CTA             | 11/26/77    | 799         | Not Spec.                       | \$4,831     |                      |
| CTA             | 11/26/77    | 799         | Not Spec.                       | \$191,875   |                      |
| MBTA            | 4/26/77     | 499         | Not Spec.                       | \$3,170     |                      |
| WMATA           | 5/12/77     | 474         | Elec. Fire                      | \$11,600    |                      |
| WMATA           | 7/6/77      | 474         | Elec. Fire                      | \$9,000     |                      |
| WMATA           | 7/11/77     | 474         | Elec. Fire                      | \$10,000    |                      |
| BART            | 1/5/78      | 474         | Elec. Fire                      | \$5,965     |                      |
| BART            | 5/30/78     | 702         | Vandalism                       | \$3,678     |                      |
| MBTA            | 5/18/78     | 449         | Cause Code not listed           | \$2,500     |                      |
| BART            | 12/18/78    | 702         | Vandalism                       | \$12,000    |                      |

1. RRT RAIL ACCIDENT/INCIDENT REPORT

| FORM OF HEAT IGNITION |  |                           |                  |                             |   |         |       |
|-----------------------|--|---------------------------|------------------|-----------------------------|---|---------|-------|
| UNKNOWN<br>OTHER      | HEAT<br>SPARK, FROM<br>LIQUID FUEL<br>EQUIP. | HEAT,<br>UNKNOWN,<br>FUEL | HEAT<br>ELEC ARC | HEAT<br>OPEN FLAME<br>SPARK | BACKFIRE,<br>INTERNAL<br>COMBUSTION<br>ENGINE | INVALID | BLANK |
| 2                     | 1  | 1                         | 7                | 1                           | 2   | -       | -     |
|                       | 4  | 4                         | 1                | 4                           | 2   |         |       |



KEY:

SOURCE: U.S. Fire Administration/NFIRS

States and Periods Covered:  
 ALASKA CY77 & 1st Qtr 78  
 MARYLAND CY77 & 2nd Qtr 78  
 MINNESOTA CY77  
 MISSOURI CY76, 1st Qtr 78  
 NEW YORK CY75, CY76 (3rd & 4th Qtr)  
 OHIO CY77, 1st Qtr 78  
 OREGON CY76, CY77 (Corrected)  
 1st Qtr 78  
 CY77

2. FIRE INCIDENTS INVOLVING SELF-POWERED RAIL

| TYPE OF MATERIAL IGNITED |                                    |           |               |        |             |         |       |
|--------------------------|------------------------------------|-----------|---------------|--------|-------------|---------|-------|
| GASOLINE                 | OTHER COMBUSTIBLE FLAMMABLE LIQUID | POLYVINYL | OTHER PLASTIC | RUBBER | WOOD, PAPER | INVALID | BLANK |
| 2                        | 1                                  | 1         | 1             | 4      | 3           | 1       | 1     |
| 3                        | 4                                  | 4         | 4             | 1      | 2           |         |       |

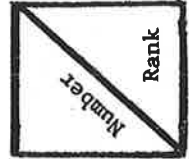

Key:

SOURCE: U.S. Fire Administration/NFIRS

States and Period Covered:  
 ALASKA CY77 & 1st Qtr 78  
 MARYLAND CY77 & 2nd Qtr 78  
 MINNESOTA CY77  
 MISSOURI CY76, CY77, 1st Qtr 78  
 NEW YORK CY75, CY76, (3rd & 4th Qtr)  
 OHIO CY77, 1st Qtr 78  
 OREGON CY76, CY77 (Corrected)  
 1st Qtr 78  
 CY77

3. FIRE INCIDENTS INVOLVING SELF-POWERED RAIL

| EQUIPMENT INVOLVED IN IGNITION |                      |                      |              |        |                   |         |                    |              |       |
|--------------------------------|----------------------|----------------------|--------------|--------|-------------------|---------|--------------------|--------------|-------|
| UNKNOWN                        | HEAT TRANSFER SYSTEM | ELEC. DISTRIB. UNCL. | FIXED WIRING | ENGINE | RECTIFIER CHARGER | VEHICLE | NO EQUIP. INVOLVED | INVALID CODE | BLANK |
| 1                              | 1                    | 1                    | 1            | 2      | 1                 | 3       | 1                  | -            | 2     |
| 3                              | 3                    | 3                    | 3            | 2      | 3                 | 1       | 3                  |              |       |

States and Periods Covered:  
 ALASKA CY77 & 1st Qtr 78  
 MARYLAND CY77 & 2nd Qtr 78  
 MINNESOTA CY77  
 MISSOURI CY76, CY77, 1Qtr 78  
 NEW YORK CY75, CY76 (3rd & 4th Qtr)  
 CY77, 1st Qtr 78  
 OHIO CY76, CY77 (Corrected)  
 1st Qtr 78  
 OREGON CY77

SOURCE: U.S. Fire Administration/NFIRS

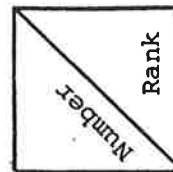

Key:

4. FIRE INCIDENTS INVOLVING SELF-POWERED RAIL



APPENDIX B

FIRE AND SMOKE SCENARIOS

NOTE: Scenarios based on incidents for which detailed reports were available are indicated by date of occurrence and property. The remaining scenarios are based on data indicating basic facts of incident but with few other details.

UNDER CAR FIRES











| FIRE INVOLVEMENT WITH OCCUPANT COMPARTMENT MAT'L   |  | FIRE PROPAGATION  |   |
|--|--|---|---|
| IGNITION   | FIRE DEVELOPMENT   | FIRE CONTROL  | FIRE INVOLVEMENT WITH OCCUPANT COMPARTMENT MAT'L  |
| <p>Train traveling through under-water tube during rush hour. Controller shorts to ground due to worn bushing. Heavy arcing ignites cable insulation. Heavy current draw blows main fuse. Train comes to stop.</p> | <p>Intense heat from burning cable insulation ignites greases and paint on nearby components.</p>  | <p>Operator calls Central for help. Fire department arrives 30 minutes after train stops to fight fire.</p> | <p>Fresh air from open doors increases intensity and rate of spread of fire within car. Flash-over does not occur.</p>  |
| <p>When train stops, tube begins to fill with smoke. Some passengers panic.</p>  | <p>Passengers get down off of cars on to the track bed, some with difficulty and apprehension. Many experience breathing problems due to heavy smoke. Train crew directs passengers "up wind" towards fresh air. Some older passengers collapse.</p> | <p>Many passengers suffer smoke inhalation.</p>   | <p>Many persons (passengers, crew, fire fighters) hospitalized for smoke inhalation and other fire related injuries - falls, burns, shock, etc. Car destroyed, tunnel damage severe, requiring 3 months shutdown to repair.</p> |
| OCCUPANT ATTENTION   |  | OCCUPANT ACTIONS  |   |
| OCCUPANT EVENTS  |  | TOXIC IMPACTS   |   |
| OCCUPANT ATTENTION   |  | FIRE IMPACTS  |   |



| IGNITION  | FIRE DEVELOPMENT  | FIRE CONTROL  | FIRE INVOLVEMENT WITH OCCUPANT COMPARTMENT MAT'L  | FIRE PROPAGATION   |
|---|---|---|---|--|
| <p><b>FIRE EVENTS</b></p> <p>Arsonist ignites crumpled newspaper on seat (last car) of Train.</p>   | <p>Burning newspaper burns through nylon seat cover and ignites polyurethane foam cushion.</p>            | <p>Central Communication calls fire dept. and next station to prepare them to deal with fire.</p> | <p>Fire spreads to reinforced fiberglass ceiling; heat nearby seats and burns carpeting and floor insulation.</p>       | <p>Flammable gases liberated from burning plastics (partial pyrolysis) flash over.</p> |
| <p><b>OCCUPANT EVENTS</b></p> <p>Train operator notified of fire by passengers on next car over intercom moments after leaving Station. Central Communication calls train operator to advise him of a report from a bystander that there is a fire in the last car.</p> | <p>Operator drives train to next above ground station to get passengers off train and deal with fire.</p> | <p>None</p>   | <p>Interior of car excluding attendants' compartment and last 8 seats destroyed. Exterior and undercar not damaged.</p> | <p><b>OCCUPANT ACTIONS</b></p>   |
|   |   |   |   |  |
|   |   |   |   |  |
|   |   |   |   |  |
|   |   |   |   |  |
|   |   |   |   |  |

13. RAPID RAIL FIRE - ARSON

| FIRE INVOLVEMENT WITH OCCUPANT COMPARTMENT MAT'L | FIRE PROPAGATION              | FIRE CONTROL   | FIRE DEVELOPMENT   | IGNITION  | FIRE INVOLVEMENT WITH OCCUPANT COMPARTMENT MAT'L                         | FIRE PROPAGATION                   |
|--|-------------------------------|--|--|---|--|------------------------------------|
| Heating duct ignited.                            | Heater wires to heating duct. | Train crew shuts off power and extinguishes fire with on-board extinguisher. | Heat from burning wires ignites plastic heating duct. Car begins to fill with smoke. | Vibration loosens electrical connection to heater in side panel of passenger compartment. Resistance heating at connection causes wiring to ignite. | All passengers in car (20) suffer smoke inhalation.                      | Heater and heating duct destroyed. |
|  |                               |  |  |   | Passengers get off car at station and run up to motorman in forward car. |                                    |
|  |                               |  |  |   |  |                                    |
|  |                               |  |  |   |  |                                    |
|  |                               |  |  |   |  |                                    |
|  |                               |  |  |   |  |                                    |
|  |                               |  |  |   |  |                                    |
|  |                               |  |  |   |  |                                    |
|  |                               |  |  |   |  |                                    |

OCCUPANT EVENTS

FIRE IMPACTS

TOXIC IMPACTS

OCCUPANT ACTIONS

OCCUPANT ATTENTION

15. RAPID RAIL FIRE - HEATER



WAYSIDE IGNITION FIRES

MISCELLANEOUS FIRES

**FIRE INVOLVEMENT WITH OCCUPANT COMPARTMENT MAT'L**

**FIRE PROPAGATION**

Because of delay in fighting fire, fire propagates to other cars. Smoke fills tunnel and pours over into escape gallery and opposite track tunnel.

**FIRE CONTROL**

Inadequate communication delays arrival of fire departments. Various other problems impede fire fighting, including determination of exact location of train in tunnel, and smoke obscuration.

**FIRE DEVELOPMENT**

Fire penetrates floor in second and third car from end of 7-car train, assisted by burning of plastic air ducts under car. Heavy smoke develops almost immediately, entering escape passages.

**IGNITION**

Short circuits and fire caused by impact of line switch, box cover causing misalignment of third rail and/or third rail protection board. Contact shoe assembly breaks on impact shorting to nearby metal. Train halted midway in 5-mile tunnel under large body of water.

**FIRE EVENTS**

|  |  |   |  |
|--|--|---|--|
| <p>As soon as fire was observed, the 40 passengers on train are moved to forward cars. A rescue train with 1000 - 2000 passengers is dispatched on opposite track.</p> | <p>Operating personnel wrong and firemen smoke enters escape gallery. Eventually, passengers are able to be evacuated to rescue train where passengers are already experiencing discomfort from smoke. Train carries passengers to safety.</p> | <p>One fireman died and 44 passengers and firemen hospitalized as result of smoke inhalation.</p> | <p>Five cars of seven car train destroyed. Tunnel service halted for 3 months until remedial practices instituted to assure passenger safety. Materials upgrading will be required, communications systems improvements will be instituted, as well as better training of personnel.</p> |
|--|--|---|--|

**OCCUPANT EVENTS**

**OCCUPANT ACTIONS**

**TOXIC IMPACTS**

**FIRE IMPACTS**

**OCCUPANT ATTENTION**

**19. RAPID RAIL FIRE - LOOSE EQUIPMENT**

WHEEL WELL FIRES

| FIRE EVENTS  | FIRE INVOLVEMENT WITH OCCUPANT COMPARTMENT MAT'L   |  |  |   | FIRE PRPGATION |
|--|--|--|--|---|----------------|
|  | IGNITION   | FIRE DEVELOPMENT   | FIRE CONTROL   | FIRE INVOLVEMENT WITH OCCUPANT COMPARTMENT MAT'L      |                |
| <p>Brake on rear right wheel locks; heat on drum builds to 1200°C. A load bang due to metal fracturing or tire exploding alerts driver and passengers. Tires begin to smolder. A few minutes later, tires are ignited.</p> | <p>Fire and heat ignites plastic wheel well.</p>   | <p>None. Plastic wheel well will not contain fire; fire extinguisher not on board.</p> | <p>Fire penetrates plastic wheel well and ignites seat above wheel well.</p> | <p>Wall, ceiling, and nearby seats begin to burn.</p> |                |
| <p>Driver stops bus to investigate loud bang. He gets off bus and examines wheel area and sees smoke coming from wheel well. He returns to bus to order passengers off. On returning back to wheel well, tires ignite.</p> | <p>Passengers leave bus; driver finds that fire extinguisher is not present. Driver calls fire department from nearby house.</p> | <p>N/A</p>   | <p>Repair cost: \$5,149.11</p>   | <p>Repair cost: \$5,149.11</p>                        |                |
| <p>OCCUPANT EVENTS</p> <p>Scenario Verified.<br/>Incident:<br/>Queen City Metro,<br/>11/12/75</p>  | <p>OCCUPANT ATTENTION</p>  | <p>OCCUPANT ACTIONS</p>  | <p>TUXIG IMPACTS</p>   | <p>FIRE IMPACTS</p>                                   |                |

| FIRE INVOLVEMENT WITH OCCUPANT  | COMPARTMENT MAT'L   | FIRE PROPAGATION  |
|---|---|---|
| IGNITION  | FIRE DEVELOPMENT  | FIRE CONTROL  |
| <p><b>FIRE EVENTS</b></p> <p>Outside rear wheel deflated by vandals placing too high a load on inner tire which over heats. Heavy load placed on brakes due to rapid deceleration of loaded bus on steep downgrade. Brakes overheat to ~1000°F. Inner tire begins to smoke, temperature within wheel well approaches ignition temperature of fiber-glass reinforced plastic wheel well and smoke particles. Wheel well ignites.</p> | <p>Ignited plastic wheel well gives off flammable vapors which remain in wheel well. Flammable vapors burn raising temperature of wheel well to point at which vigorous burning commences.</p>  | <p>No action by bus driver possible in time to prevent fire from spreading behind wheel well. Smoke caused by delay and flammable vapors from seat fire quickly fill overhead space of bus. By the time driver can investigate, fire is firmly established in occupant compartment.</p> |
| <p><b>OCCUPANT EVENTS</b></p> <p>All seats filled, standees crowd aisle of bus from front to rear. Woman sitting on seat, facing wheel well first notices high heat from wheel well. Flames break through wheel well in front of woman.</p>   | <p>Flames and bits of flaming plastic quickly ignite seat facing wheel well, then seat over wheel well. Smoke and flammable vapors from seat fire quickly fill overhead space of bus.</p>   | <p>Hot air pouring out of open doors replaced by fresh air pouring in through lower part of open doors. Fresh air feeds seat fire which in turn evolves more flammable vapors which burn at ceiling consuming melamine lining and melts aluminum exterior of bus.</p>                   |
| <p><b>OCCUPANT ACTIONS</b></p> <p>Woman screams as bits of flaming plastic fall on her legs. Passengers in wheel well area shouting "Fire!" and crowd away from wheel well area. Woman with scorched legs half dragged away as driver stops bus and opens doors.</p>  | <p>All passengers escape toxic vapors evolved from burning plastic seat covers, seat cushions, and plastic wheel well. Bus driver inhales smoke and toxic vapors when he goes to rear to investigate same. He escapes just in time.</p> | <p>One woman with painful burns on lower legs. One young boy injured by crush of people leaving bus through rear door. One woman suffers broken arm after fall from being pushed off bus steps by crowd. Bus driver suffers smoke inhalation.</p>                                       |
| <p><b>OCCUPANT ATTENTION</b></p>  | <p><b>OCCUPANT IMPACTS</b></p>  | <p><b>FIRE IMPACTS</b></p>  |

ELECTRICAL WIRING FIRES

| FIRE INVOLVEMENT WITH OCCUPANT COMPARTMENT MAT'L   | FIRE PROPAGATION                      | FIRE CONTROL  | FIRE DEVELOPMENT  | IGNITION   |
|--|---------------------------------------|---|---|--|
| Fire localized to under car area and burns through plywood floor.  | Fire burns hole through floor of bus. | By the time driver is aware of fire, it is beyond control. Fire department arrived to put out fire. | Burning insulation ignites plywood floor.   | Cable insulation becomes "skinned" off in shop. Arcing to chassis causes insulation to ignite. |
| Relatively minor damage. Electrical cables to transmission and several plywood floor panels need to be replaced. | N/A                                   | Passengers and driver leave bus without incident.   | Smoke emanating from under coach not seen by passengers or driver. Flames seen by pedestrian who reports it to fire department. Fire truck stops bus. |  |
|  |                                       |   |   |  |
|  |                                       |   |   |  |
|  |                                       |   |   |  |
|  |                                       |   |   |  |
|  |                                       |   |   |  |
|  |                                       |   |   |  |
|  |                                       |   |   |  |
|  |                                       |   |   |  |
|  |                                       |   |   |  |





LEAKING FUEL AND OIL FIRES

**FIRE INVOLVEMENT WITH OCCUPANT COMPARTMENT MAT'L**

**IGNITION**  
Oil leaking from faulty valve cover gasket vaporizes as it runs down towards exhaust manifold filling engine compartment with flammable vapor. Loose terminals on alternator allows cable connection to vibrate causing sparks. Spark ignites oily vapors. Time: 6:40 AM.

**FIRE DEVELOPMENT**  
Ignited vapors raise temperature in engine compartment. Oil which covers much of the engine ignites; rubber hoses and plastic insulators and parts begin to burn with intense heat.

**FIRE CONTROL**  
Bracket holding fire extinguisher had cut through fire extinguisher tank due to vibration several months after bus was first put into service. Fire extinguisher useless.

**FIRE PROPAGATION**  
Fire wall melts and rear seat, already very hot, bursts into violent flames due to added heat and air from engine compartment. Rear floor area and ceiling ignite. Radiation ignites remaining seats towards rear of bus.

**TEMPERATURE**  
Temperature in engine compartment rises to 1200°F. Aluminum fire wall near melting point. Heat transferred by radiation to rear seat (polyurethane with neoprene cover); rear seat begins to smolder, filling bus with dense smoke.

**TOXIC IMPACTS**  
Driver suffers smoke inhalation and eye irritation.

**FIRE IMPACTS**  
Bus total loss after fire department puts out fire.

**OCCUPANT ACTIONS**  
Driver looks for fire call box. Failing to see one, driver stops bus at small store which is open. Driver removes fire extinguisher but finds hole worn through side of cylinder due to rubbing against retaining bracket. Driver runs into store to call fire department.

**OCCUPANT ATTENTION**

**TOXIC IMPACTS**

**FIRE IMPACTS**

**OCCUPANT EVENTS**  
No passengers on bus. Driver is not aware of fire until interior filled with smoke from smoldering seats near fire wall. Operation of bus does not indicate presence of problems.

**OCCUPANT ATTENTION**

**TOXIC IMPACTS**

**FIRE IMPACTS**

Scenario Verified.  
Incident:  
MBTA, 2/14/78

| IGNITION   | FIRE DEVELOPMENT   | FIRE CONTROL  | FIRE INVOLVEMENT WITH OCCUPANT COMPARTMENT MAT'L                     | FIRE PROPAGATION                              |
|--|--|---|--|---|
| <p><b>FIRE EVENTS</b></p> <p>Presence of oil throughout engine compartment due to leaky gaskets and fittings leads to spontaneous ignition of "caked on" oil with a loud "bang".</p> | <p>Burning oil near exhaust manifold raises temperature of "caked on" oil nearby driving flammable vapors into the air in the engine compartment.</p> <p>A second explosion occurs. Fire becomes very intense.</p> | <p>Thin aluminum fire wall lined with 1/4" fiberglass.</p>  | <p>At second explosion, rear of passenger compartment in flames.</p> | <p>Entire bus quickly engulfed in flames.</p> |
| <p><b>OCCUPANT EVENTS</b></p> <p>Scenario Verified. Incident: Bi-State, 1/26/78</p>  | <p>At sound of first explosion, driver stops bus and orders passengers (15) off. A second explosion occurs.</p>  | <p>Passengers get off bus just in time before second explosion occurs, and rear of bus becomes engulfed. Driver forced to leave bus also.</p> | <p>N/A</p>   | <p>Bus total wreck. \$80,000</p>              |
|  |  |   |  |   |
|  |  |   |  |   |
|  |  |   |  |   |
|  |  |   |  |   |
|  |  |   |  |   |

33. BUS FIRE - OIL RESIDUES

| IGNITION   |  | FIRE DEVELOPMENT  |  | FIRE CONTROL  |  | FIRE INVOLVEMENT WITH OCCUPANT COMPARTMENT MAT'L  |  | FIRE PROPAGATION  |  |
|--|--|---|--|---|--|---|--|---|--|
| <p>Leak in engine cooling system causes engine to overheat which in turn evaporates oily deposits on engine. Temperature of exhaust manifold rises drastically because of added engine load due to steep grade bus is negotiating. Oily vapors ignite spontaneously at manifold.</p> |  | <p>Heat from burning vapors vaporize more oil to feed fire. Wiring insulation ignites. Temperature in engine compartment rises to 1200°F in places.</p>   |  | <p>On board fire extinguisher inadequate to deal with fire. Fire extinguished by Fire Department.</p> |  | <p>Aluminum fire wall melts; polyurethane seat cushion in front of fire wall ignites.</p> |  | <p>Heat and liberated flammables from burning seat cushions spread fire along ceiling and other rear seats.</p> |  |
| <p>Passenger at rear of bus notices heat and burning smell and alerts driver.</p>  |  | <p>Driver stops bus and orders passengers off. At that time, fire breaks through aluminum fire wall. He goes into store to call fire department and returns to bus and finds fire beyond his control.</p> |  | <p>N/A<br/>Bus emptied just before fire broke through fire wall.</p>                                  |  | <p>Bus a total wreck.</p>   |  |   |  |
| <p>OCCUPANT ATTENTION</p>  |  | <p>OCCUPANT ACTIONS</p>   |  | <p>TOXIC IMPACTS</p>  |  | <p>FIRE IMPACTS</p>   |  |   |  |

| IGNITION  | FIRE DEVELOPMENT   | FIRE CONTROL   | FIRE INVOLVEMENT WITH OCCUPANT COMPARTMENT MAT'L | FIRE PROPAGATION   |
|---|--|--|--|--|
| <p><b>FIRE EVENTS</b></p> <p>Fire set on a rear seat apparently by last passenger leaving bus at end of line.</p> | <p>Within one minute seat is blazing fiercely emitting dense smoke and flammable vapors.</p> | <p>None. Fire extinguisher not working.</p>  | <p>See ignition-development.</p>                 | <p>Fire spreads to side and ceiling melamine panels.</p> |
| <p><b>OCCUPANT EVENTS</b></p> <p>Scenario Verified. Incident: WMATA, 5/10/78</p>                                  | <p>Driver makes routine end-of-line inspection of bus and discovers burning seat.</p>        | <p>Driver attempts to put out fire with onboard extinguisher but finds it does not work. Driver calls fire department from phone booth nearby.</p> | <p>N/A</p>                                       | <p>Rear interior total loss. Repair cost \$20,000.</p>   |
| <p><b>OCCUPANT ATTENTION</b></p>  | <p></p>  | <p></p>  | <p></p>  | <p></p>  |
| <p><b>OCCUPANT ACTIONS</b></p>  | <p></p>  | <p></p>  | <p></p>  | <p></p>  |
| <p><b>FIRE IMPACTS</b></p>  | <p></p>  | <p></p>  | <p></p>  | <p></p>  |
| <p><b>TOXIC IMPACTS</b></p>   | <p></p>  | <p></p>  | <p></p>  | <p></p>  |

| FIRE INVOLVEMENT WITH OCCUPANT  |  | FIRE DEVELOPMENT  |  | FIRE CONTROL   |  | FIRE PROPAGATION  |  |
|---|--|---|--|--|--|---|--|
| IGNITION  |  | FIRE DEVELOPMENT  |  | FIRE CONTROL   |  | COMPARTMENT MAT'L   |  |
| <p><b>FIRE EVENTS</b></p> <p>Careless passenger drops lit cigarette on floor in front of his seat. Cigarette rolls forward against small paper bag containing a leaky can of lighter fluid which had been inadvertently dropped by passenger in forward seat. Lighter fluid soaked paper ignites and burns rapidly.</p> |  | <p>Rapidly burning bag ignites nylon seat cover. Heated can of lighter fluid ruptures causing fire to flare up and spread suddenly.</p> |  | <p>On board fire extinguisher inadequate to deal with burning polyurethane seats. Fire department arrives 8 minutes after being called by police car.</p>                                      |  | <p>Flames under seat ignite polyurethane seat cushion.</p> <p>Fire spreads rapidly from seat cushion to melamine wall panel, ceiling, and plastic lighting lenses.</p>  |  |
| <p><b>OCCUPANT EVENTS</b></p> <p>Bus fully loaded. Passengers near rapidly expanding fire panic, pushing away from fire.</p>  |  | <p>Passengers near rapidly expanding fire panic, pushing away from fire.</p>  |  | <p>Driver stops bus and opens doors, grabs fire extinguisher and tries to push his way towards fire. Large truck stops on right side and very close up to bus impeding exit of passengers.</p> |  | <p>Twenty-five passengers and bus driver suffer smoke inhalation.</p> <p>Interior of bus gutted. Eight passengers injured in crush to exit bus. One passenger suffers heart attack and dies later that day.</p> |  |
| <p><b>OCCUPANT ATTENTION</b></p>  |  | <p><b>OCCUPANT ACTIONS</b></p>  |  | <p><b>TOXIC IMPACTS</b></p>  |  | <p><b>FIRE IMPACTS</b></p>  |  |

EXHAUST FIRES



MISCELLANEOUS FIRES

| FIRE EVENTS   |  | FIRE DEVELOPMENT  |  | FIRE CONTROL   |  | FIRE INVOLVEMENT WITH OCCUPANT COMPARTMENT MAT'L                          |  | FIRE PROPAGATION                          |  |
|---|--|---|--|--|--|---|--|---|--|
| <p><b>IGNITION</b></p> <p>Bus stops at stop light on heavily traveled street. Speeding truck approaches bus from rear and is unable to stop before colliding with rear end of bus. Bus (gasoline engine) gasoline line is ruptured at the carburetor, carburetor bowl also ruptured. Spilled gasoline is ignited on hot exhaust manifold.</p> |  | <p><b>FIRE DEVELOPMENT</b></p> <p>Oil residues in engine compartment and electrical insulation begin to burn.</p> |  | <p><b>FIRE CONTROL</b></p> <p>Driver of truck and bus driver quickly extinguish engine fire with on-board fire extinguisher.</p>   |  | <p><b>FIRE INVOLVEMENT WITH OCCUPANT COMPARTMENT MAT'L</b></p> <p>N/A</p> |  | <p><b>FIRE PROPAGATION</b></p> <p>N/A</p> |  |
| <p><b>OCCUPANT EVENTS</b></p> <p>Shock of collision alerts driver and passengers.</p>   |  |   |  | <p>Passengers leave bus unhurt. Driver goes to look at damage and sees flames. He goes to get fire extinguisher. Together with truck driver, they put out fire which has not yet gotten out of hand.</p> |  | <p>N/A</p>  |  | <p>Minor fire damage to engine.</p>       |  |
| <p><b>OCCUPANT ATTENTION</b></p>  |  |   |  | <p><b>OCCUPANT ACTIONS</b></p>   |  | <p><b>TOXIC EFFECTS</b></p>   |  | <p><b>FIRE IMPACTS</b></p>                |  |







**U.S. DEPARTMENT OF TRANSPORTATION  
RESEARCH AND SPECIAL PROGRAMS ADMINISTRATION**

**TRANSPORTATION SYSTEMS CENTER**

**CAMBRIDGE, MA 02142**

**OFFICIAL BUSINESS  
PENALTY FOR PRIVATE USE, \$300**

**POSTAGE AND FEES PAID**

**U. S. DEPARTMENT OF TRANSPORTATION**

**513**

