

PB 297678

REPORT NO. FRA/ORD-78/72

**ON-BOARD FAILURE-PROTECTION  
REQUIREMENTS FOR  
RAILROAD-VEHICLE EQUIPMENT**

Richard L. Smith  
John L. Frarey

SHAKER : ARCH CORPORATION  
Northway Executive Park  
Ballston Lake NY 12019



MARCH 1979

FINAL REPORT

DOCUMENT IS AVAILABLE TO THE PUBLIC  
THROUGH THE NATIONAL TECHNICAL  
INFORMATION SERVICE, SPRINGFIELD,  
VIRGINIA 22161

REPRODUCED BY  
**NATIONAL TECHNICAL  
INFORMATION SERVICE**  
U. S. DEPARTMENT OF COMMERCE  
SPRINGFIELD, VA. 22161

Prepared for

**U. S. DEPARTMENT OF TRANSPORTATION  
FEDERAL RAILROAD ADMINISTRATION  
Office of Research and Development  
Washington DC 20590**

**NOTICE**

This document is disseminated under the sponsorship of the Department of Transportation in the interest of information exchange. The United States Government assumes no liability for its contents or use thereof.

**NOTICE**

The United States Government does not endorse products or manufacturers. Trade or manufacturers' names appear herein solely because they are considered essential to the object of this report.

1. Report No. FRA/ORD-78-72	2. Government Accession No.	3. Recipient's Catalog No. <b>PB297678</b>	
4. Title and Subtitle ON-BOARD FAILURE-PROTECTION REQUIREMENTS FOR RAILROAD-VEHICLE EQUIPMENT		5. Report Date March 1979	6. Performing Organization Code
7. Author(s) Richard L. Smith, John L. Frarey	8. Performing Organization Report No. DOT-TSC-FRA-79-6		10. Work Unit No. (TRAIS) RR831/R9326
9. Performing Organization Name and Address Shaker Research Corporation* Northway 10 Executive Park Ballston Lake NY 12019		11. Contractor Grant No. DOT-TSC-1029	13. Type of Report and Period Covered Final Report June 1976-June 1977
12. Sponsoring Agency Name and Address U.S. Department of Transportation Federal Railroad Administration Office of Research and Development Washington DC 20590		14. Sponsoring Agency Code	
15. Supplementary Notes U.S. Department of Transportation Research and Special Programs Administration *Under contract to: Transportation Systems Center Cambridge MA 02142			
16. Abstract An analysis of the 1975 railroad-equipment-caused accidents was made. Data reported to the FRA were the primary source of derailment information; however, data from other sources were also used. Individual cause codes were consolidated into groups which had a common characteristic that might be used to detect the presence of the defect. Fifteen cause codes were identified to account for two of every three accidents.  Existing on-board failure-detection systems were evaluated. A developmental on-board equipment failure-prevention system was identified.  Purchase costs are given in terms of yearly damage loss due to accidents, allowable system-payback period, and fraction of accidents the system is intended to prevent. A development effort in the area of on-board sensor technology is recommended. This effort is directed toward the production of a multi-sensor protection system which may provide a maximum reduction in equipment failures while also being cost-effective.			
17. Key Words Derailments, Railroad Equipment, Wayside Inspection, Hotbox Detector, Truck Dynamics, Wheels, Couplers, Brakes, Bearings, Detect, Warn, Sensors, Rail, Regression Analysis		18. Distribution Statement  DOCUMENT IS AVAILABLE TO THE PUBLIC THROUGH THE NATIONAL TECHNICAL INFORMATION SERVICE, SPRINGFIELD, VIRGINIA 22161	
19. Security Classif. (of this report) Unclassified	20. Security Classif. (of this page) Unclassified	21. No. of Pages 196	22. Price /HF PCA09/A01

PREFACE

This study has been conducted for the Federal Railroad Administration (FRA) through the Transportation Systems Center (TSC) in Cambridge, Massachusetts. Messrs. R. Ehrenbeck and W.I. Thompson, III, of TSC have been the technical monitors for the program.

METRIC CONVERSION FACTORS

Approximate Conversions to Metric Measures			Approximate Conversions from Metric Measures			
Symbol	When You Know	Multiply by	To Find	Symbol	When You Know	
<b>LENGTH</b>						
in	inches	2.5	centimeters	cm	centimeters	
ft	feet	30	centimeters	m	meters	
yd	yards	9	meters	km	kilometers	
mi	miles	1.6	kilometers			
<b>AREA</b>						
sq in	square inches	6.5	square centimeters	sq ft	square feet	
sq ft	square feet	0.09	square meters	sq yd	square yards	
sq yd	square yards	0.8	square meters	ac	acres	
ac	acres	2.5	hectares	ha	hectares (10,000 m <sup>2</sup> )	
		0.4	hectares			
<b>MASS (weight)</b>						
oz	ounces	28	grams	lb	pounds	
lb	pounds	4.5	kilograms	kg	kilograms	
	short tons	0.9	metric tons			
	2000 lb					
<b>VOLUME</b>						
fl oz	fluid ounces	30	milliliters	ml	milliliters	
pt	pints	473	milliliters	l	liters	
qt	quarts	946	milliliters	m <sup>3</sup>	cubic meters	
gal	gallons	3.8	liters	cu yd	cubic yards	
cu ft	cubic feet	0.03	cubic meters			
		0.76	cubic meters			
<b>TEMPERATURE (exact)</b>						
F	Fahrenheit temperature	$(F - 32) \times \frac{5}{9}$	C	Celsius temperature		
C	Celsius temperature	$C \times \frac{9}{5} + 32$	F	Fahrenheit temperature		

Approximate Conversions from Metric Measures			Approximate Conversions to Metric Measures			
Symbol	When You Know	Multiply by	To Find	Symbol	When You Know	
<b>LENGTH</b>						
in	inches	0.04	meters	cm	centimeters	
ft	feet	0.3	meters	m	meters	
yd	yards	0.9	meters	km	kilometers	
mi	miles	1.6	kilometers			
<b>AREA</b>						
sq in	square inches	0.16	square centimeters	sq ft	square feet	
sq ft	square feet	0.09	square meters	sq yd	square yards	
sq yd	square yards	1.2	square meters	ac	acres	
ac	acres	0.4	hectares	ha	hectares (10,000 m <sup>2</sup> )	
		2.5	hectares			
<b>MASS (weight)</b>						
oz	ounces	0.03	grams	lb	pounds	
lb	pounds	2.2	kilograms	kg	kilograms	
	short tons	1.1	metric tons			
<b>VOLUME</b>						
fl oz	fluid ounces	0.03	liters	ml	milliliters	
pt	pints	0.47	liters	l	liters	
qt	quarts	0.94	liters	m <sup>3</sup>	cubic meters	
gal	gallons	3.8	liters	cu yd	cubic yards	
cu ft	cubic feet	0.03	cubic meters			
		0.76	cubic meters			
<b>TEMPERATURE (exact)</b>						
F	Fahrenheit temperature	$(F - 32) \times \frac{5}{9}$	C	Celsius temperature		
C	Celsius temperature	$C \times \frac{9}{5} + 32$	F	Fahrenheit temperature		

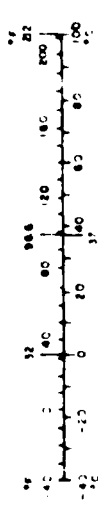

TABLE OF CONTENTS

<u>Section</u>	<u>Page</u>
1. INTRODUCTION _____	1
2. SUMMARY _____	4
3. LITERATURE REVIEW _____	6
4. REVIEW OF ACCIDENT INFORMATION _____	10
4.1 Scope of Available Accident Data Reviewed _____	12
4.2 Train Accident Data for 1975 _____	24
4.3 Analysis Results for 1975 Accident Data _____	27
5. ON-BOARD SYSTEM REQUIREMENTS _____	39
5.1 Systems Required by Data Reviewed _____	39
5.2 System Analysis/Benefit Cost _____	39
5.3 Safety Related Aspects _____	43
6. CANDIDATE PROTECTION SYSTEMS _____	44
6.1 Functional Design Requirements _____	44
6.2 Schematic Representation of Required Designs _____	49
7. CONCLUSIONS AND RECOMMENDATIONS _____	57
8. REFERENCES _____	58
APPENDIX I -- Cause Code Comparison List _____	I-1
APPENDIX II -- Computer Coded Data Fields Reviewed _____	II-1
APPENDIX III-- Tabulation of Equipment Caused Accidents _____	III-1
APPENDIX IV -- Histograms from Equipment Caused Accidents _____	IV-1
APPENDIX V -- Plots from Equipment Caused Accidents _____	V-1
APPENDIX VI -- Correlation Matrices from Data _____	VI-1
APPENDIX VII-- Regression Analysis Techniques _____	VII-1
APPENDIX VIII -- Report of Inventions _____	VIII-1

LIST OF ILLUSTRATIONS

	<u>Page</u>
1-1 What's an Equipment Caused Derailment? .....	3
3-1 Venn Diagram Showing Schematic of Key Words Used in Computer Search of more than 970,000 Catalogued Articles .....	9
4-1 1975 Equipment Caused Accidents .....	11
4-2 Equipment Accidents Ranked on How Many Occurred .....	14
4-3 Correlation Matrix for 262 Freight Accidents .....	18
4-4 Train Derailments by Year .....	20
4-5 Probability of Observing (Overheated Bearing) .....	23
4-6 Rail Equipment Accident/Incident Report .....	25
4-7 Most Costly Accidents/1975 .....	26
4-8 Equipment Accidents Ranked on Total Dollars Damage in 1975 .....	31
4-9 1974 Equipment Caused Accidents Distribution of Total \$ Damage .....	34
5-1 Schematic of Equipment Failure Protective System .....	41
6-1 Overheated Journal Sensor .....	50
6-2 Overheated Roller Bearing Sensor .....	51
6-3 Loose Wheel Detector .....	52
6-4 Thermal Overheat Sensor. Detector for Indicating Wheel Overheating .....	53
6-5 Coupler/Knuckle Overstress Cycle Sensor .....	54
6-6 Center Plate Wear/Integrity Sensor .....	55
6-7 Side Bearing Fail Detect Sensor .....	56

LIST OF TABLES

	<u>Page</u>
3-1 Literature Review Results Classified .....	7
3-2 On-Board Detection Schemes Identified from Literature Search .....	8
4-1 Train Derailment Trends .....	21
4-2 On-Board Protection System Cost Limits .....	30
4-3 All Equipment Related Accs. ....	32
4-4 Comment Summary of Histogram Data Appendix IV .....	35
4-5 Comment Summary of Graphic Plots Shown in Appendix V .....	37
4-6 Comment Summary of Correlation Coefficients in Appendix VI .....	38
5-1 Type Equipment Failure Protection Systems Needed .....	40
6-1 Applicable On-Board Sensing Methods .....	45
6-2 Recommended On-Board Protection System Sensors .....	46

APPENDIXES  
LIST OF ILLUSTRATIONS

	<u>Page</u>
II-1 Rail Equipment Accident/Incident Report .....	II-4
IV-1 Histogram of all Equipment-Caused Accidents Distributed over the Number of Cars in the Train at the Time of the Incident .....	IV-2
IV-2 Histogram of all Equipment-Caused Accidents Distributed over the Car Position that Caused the Incident in the Train .....	IV-3
IV-3 Histogram of Equipment-Caused Derailments Distributed over the Number of Cars in the Train at the Time of the Incident .....	IV-4
IV-4 Histogram of Equipment-Caused Freight Derailments Distri- buted over the Car Position that Caused the Incident in the Train .....	IV-5
IV-5 Histogram of Equipment-Caused Freight Derailments Distri- buted over the Number of Cars in the Train at the Time of the Incident. Data Sample from Trains with more than 87 Cars but Less than 109 .....	IV-6
IV-6 Histogram of Equipment-Caused Derailments Distributed over the Number of Loaded Cars at the Time of the Incident .....	IV-7
IV-7 Histogram of Equipment-Caused Derailments Distributed over the Number of Empty Cars in the Train at the Time of the Incident .....	IV-8
IV-8 Histogram of Equipment-Caused Derailments Distributed over the Number of Cars Derailed at the Time of the Incident .....	IV-9
IV-9 Histogram of All Equipment-Caused Accidents Distributed over the Track Density at the Site of the Incident .....	IV-10
IV-10 Histogram of Equipment-Caused Derailments Distributed over the Reported Speed at the Time of the Incident .....	IV-11
IV-11 Histogram of Equipment-Caused Derailments Distributed over the Trailing Tons in the Train at the Time of the Incident .....	IV-12
IV-12 Histogram of All Equipment-Caused Accidents Distributed over the Reported Time of Day (Minutes from Midnight) of the Incident .....	IV-13



IV-13	Histogram of All 1972 Equipment-Caused Accidents Distributed over the Logarithm of the Total Dollars Damage of the Reported Incident .....	IV-14
IV-14	Histogram of All Equipment-Caused Accidents Distributed over the Logarithm of the Total Dollar Damage of the Reported Incident .....	IV-15
IV-15	Histogram of All Equipment-Caused Accidents Distributed over the Logarithm of the Total Dollar Damages to Equipment Only .....	IV-16
IV-16	Histogram of All Equipment-Caused Accidents Distributed over the Logarithm of the Total Dollar Damages to Trace Only .....	IV-17
V-1	Dollars Damage Versus Speed at Time of Incident. Data from One Hundred Accidents Attributed to the Bearing Related Cause Codes Noted .....	V-1
V-2	Dollars Damage Versus Speed at Time of Incident. Data from One Hundred Accidents Attributed to the Railcar Body Cause Codes Noted .....	V-2
V-3	Number of Empty Derailed Cars Versus Speed at Time of Incident. Data from One Hundred Attributed to the Bearing Cause Codes Noted .....	V-3
V-4	Average Cost per Accident Versus Speed at Time of Accident. Data from Two Mile Per Hour Speed Increments in the Range from 0 to 70 MPH. (See Table III-E3 for Tabulated Numbers) ..	V-4
V-5	Number of Cars Derailed Versus Total Dollars Damage of Incident. Data from One Hundred Accidents Attributed to the Bearing Related Cause Codes Noted .....	V-5
V-6	Two Variable Distribution Plots of One Hundred Wheel and One Hundred Journal Bearing Associated Incidents. See Figure V-8 for Descriptive Display .....	V-6
V-7	Two Variable Distribution Plots of One Hundred Wheel and One Hundred Journal Bearing Associated Incidents. See Figure V-8 for Descriptive Display .....	V-7
V-8	Plot Indicating that Wheels Tend to Cause Incidents at Lower Temperatures and Higher Speeds than do Journal Bearings. Schematic Display of Data Density Clustering Shown in Figure V-6 and V-7 .....	V-8
VII-1	Data Arrangement .....	VII-11

VII-2	Schematic Plots Depicting Various Amounts of Scatter, as Well as Correlation Coefficients Between Variable X and Response Y _____	VII-12
VII-3	Correlation Matrix of (R) Values for Each of the Sixteen Accident Variables Listed _____	VII-13
VII-4	Matrix Format Showing 464 Unique Analytically Tested Associations between the Numbered Variables Listed _____	VII-14
VII-5	Schematic Data Plot Showing Observed Data Points $(X_i, Y_i)$ , Best Fit Points $(\hat{X}_i, \hat{Y}_i)$ , Averages $\bar{X} = \sum X_i/N$ , $\bar{Y} = \sum Y_i/N$ Error Values $(v_i - \hat{Y}_i)$ , and Residuals $(\hat{Y}_i - \bar{Y})$ _____	VII-15
VII-6	Three Criteria for Testing the Relative "Best Fit" of a Combination of Variables in a Hypotehtical Regression Model _____	VII-16
VII-7	Regression Example 1 (Response Y versus Variable X1) _____	VII-19
VII-8	Regression Example 1 (Response Y versus Variable X2) _____	VII-20
VII-9	Regression Example 1 (Response Y versus X1 + X2) _____	VII-21

APPENDIXES  
LIST OF TABLES

I-1	Comparison of 1975 Cause Codes with Previous Cause Codes for Year 1974 .....	I-1
II-1	Field Definition Table Data .....	II-1
II-2	First Set of Accident Data Variables Used in Review .....	II-5
II-3	Second Set of Accident Variables Used in Review .....	II-6
II-4	Third Set of Accident Data Variables Used in Review .....	II-7
II-5	State Code Name Cross Reference List .....	II-8
III-A1	All Equipment Related Accidents (Listed by Cause Code) ..	III-2
III-A2	All Equipment Related Accidents (Listed by Cause Code) ..	III-3
III-A3	All Equipment Related Accidents (Listed by Cause Code) ..	III-4
III-A4	All Equipment Related Accidents (Listed by Cause Code) ..	III-5
III-B1	Derailments by 75 Cause Code .....	III-6
III-B2	Derailments by 75 Cause Code .....	III-7
III-B3	Derailments by 75 Cause Code .....	III-8
III-B4	Derailments by 75 Cause Code .....	III-9
III-C1	Freight Train Equipment Accidents .....	III-10
III-C2	Freight Train Equipment Accidents .....	III-11
III-C3	Freight Train Equipment Accidents .....	III-12
III-C4	Freight Train Equipment Accidents .....	III-13
III-D1	Freight Train Equipment Derailments .....	III-14
III-D2	Freight Train Equipment Derailments .....	III-15
III-D3	Freight Train Equipment Derailments .....	III-16

III-D4	Freight Train Equipment Derailments .....	III-17
III-E1	Derailments by Speed, MPH .....	III-18
III-E2	Derailments by Speed, MPH .....	III-19
III-E3	Derailments by Speed, MPH .....	III-20
III-E4	Derailments by Speed, MPH .....	III-21
III-F1	Derailments by Fail Position .....	III-22
III-F2	Derailments by Fail Position .....	III-23
III-F3	Derailments by Fail Position .....	III-24
III-F4	Derailments by Fail Position .....	III-25
III-G1	Equipment Accidents by State .....	III-26
III-G2	Equipment Accidents by State .....	III-27
III-G3	Equipment Accidents by State .....	III-28
III-G4	Equipment Accidents by State .....	III-29
III-H1	75 Equipment Derailments by State .....	III-30
III-H2	75 Equipment Derailments by State .....	III-31
III-H3	75 Equipment Derailments by State .....	III-32
III-H4	75 Equipment Derailments by State .....	III-33
III-J1	Derailments by Month .....	III-34
III-J2	Derailments by Month .....	III-34
III-J3	Derailments by Month .....	III-35
III-J4	Derailments by Month .....	III-35
VI-1	Correlation Matrix for 262 Freight Accidents .....	VI-1

VI-2	Correlation Matrix for 100 Freight Accidents .....	VI-2
VI-3	Correlation Matrix for 100 Freight Accidents .....	VI-3
VI-4	Correlation Matrix for 100 Freight Accidents .....	VI-4
VI-5	Correlation Matrix for 100 Freight Accidents .....	VI-5
VI-6	Correlation Matrix for 100 Freight Accidents .....	VI-6
VI-7	Correlation Matrix for 100 Freight Accidents .....	VI-7
VI-8	Correlation Matrix for 61 Freight Accidents .....	VI-8
VI-9	Correlation Matrix for 96 Freight Accidents .....	VI-9
VI-10	Correlation Matrix for 42 Freight Accidents .....	VI-10
VII-1	Example of Regression Table Information .....	VII-17
VII-2	Regression Example 1 .....	VII-18
VII-3	Regression Table for Step 1 .....	VII-22
VII-4	Regression Table for Step 2 .....	VII-23
VII-5	Regression Example 2 .....	VII-24
VII-6	Regression Table for Step 2 .....	VII-25
VII-7	Example 3 Data - Yearbook of Railroad Facts 1977 Data .....	VII-26
VII-8	Example 3 - Correlation Matrix .....	VII-27
VII-9	Regression Table for Step 9 .....	VII-28
VII-10	Regression Table for Step 3 .....	VII-29
VII-11	Example 3 Train Derailment Trends .....	VII-30

LIST OF ABBREVIATIONS AND SYMBOLS

Acc	Accident
Accs	Accidents
AV CR MI/DY	Average Car Miles Per Day
AV FR CR LD	Average Freight Car Load
AV FR TR LD	Average Freight Train Load
AVG	Average
AV TR	Average Train
BK	Back
Brg	Bearing
$C_k$	Total Squared Error Coefficient
CORR	Correlation
CUM	Cumulative
Derail.	Derailment
Derailmts	Derailments
Equip.	Equipment
F	Statistical, F-Test Value
FRA	Federal Railroad Administration
FR Car	Freight Car
FR TR	Freight Train
k	Number of Parameters Entered into Regression
LOG	Logarithm to Base Ten
MAX	Maximum
Misc.	Miscellaneous
MPH	Miles Per Hour
$MSE_k$	Mean Sum of Squares of Errors
N	Number of Data Points
No.	Number
N.T.M./TR HR	Net Ton Miles Per Train Hour
NTM	Net Ton Miles
ORIG	Original
PRECIP	Precipitation (Rainfall, Inches of Rain)
$R_2$	Correlation Coefficient

$R_k^2$	Coefficient of Multiple Determination
REF.	Reference Literature Source
SQS	Squares
SS	Sum of Squares
STD DEV	Standard Deviation
TM	Ton Miles
T.M./FR CR DY	Ton Miles Per Freight Car Day
X	Independent Variable
$\bar{X}$	Average of All Independent Variable Data Values
$X_i$	$i^{\text{th}}$ Independent Variable Data Value
$\hat{X}_i$	Calculated $i^{\text{th}}$ Independent Variable Data Value
Y	Dependent Variable
$\bar{Y}$	Average of all Dependent Variable Data Values
$Y_i$	$i^{\text{th}}$ Dependent Variable Data Value
$\hat{Y}_i$	Calculated $i^{\text{th}}$ Dependent Variable Data Value
YR.	Year
$^{\circ}\text{F}$	Degrees Fahrenneit
\$DMG	Dollars Damage
\$TOT	Dollars Total for Year
\$/ACC	Average Dollars Per Accident
\$	Dollars
%	Percent
<	Less Than
>	Greater Than
#	Number
-.##	A Numeric 1 from Computer Output
$\sigma_x$	Standard Deviation of all Independent Variable Data Points
$\sigma_y$	Standard Deviation of all Dependent Variable Data Points

1. INTRODUCTION

The objective of this contract work was "to establish the impact and causes of railroad equipment derailments and derailment-related accidents, and to assess existing and possibly new on-board protective means for preventing or reducing the occurrence of these events." In order to accomplish this objective, three major areas of activity were undertaken: the collection and analysis of accident data, the collection of information about existing or proposed on-board protection systems and the analysis of the costs and the benefits in reduced derailments that could result from the deployment of new protective systems.

Justification for implementing on-board accident preventive systems was sought in reviewing the type of accidents that occur.

Accident data reviewed was limited to those caused by equipment failure. The failure detection equipment surveyed was directed toward but not limited to those devices that could detect and warn of equipment-related defects while operating on a moving railcar.

A major source of accident data is that collected by the Federal Railroad Administration (FRA) and published yearly in the FRA Accident Bulletin. The latest years' available data was 1975. These data are also available on magnetic tape since 1967 and automatic data processing of these tapes allows the extraction of additional information not normally published in the yearly accident bulletin. The cause codes specified for the year 1975 by the FRA have been used consistently through this report to categorize equipment failures and derailments. Appendix I addresses the changed codes after 1975. Since the cause codes for reporting accidents were changed starting in 1975, Appendix I was used for comparing previous code failure types to those in use during 1975.

The accident data were used to identify the major equipment failure types that occur. Of the most frequently occurring and most costly occurrences, those that had potential of being reduced through on-board sensor deploy-



ment were identified. It was found that six sensor types operating from a single power source on each car could be effectively used in reducing equipment caused accidents. The six types of accident preventive sensors described could play an important part in helping stop two out of every three accidents that occur. Figure 1-1 is a summary of data from equipment caused derailments.

# WHAT'S AN EQUIPMENT CAUSED DERAILMENT?

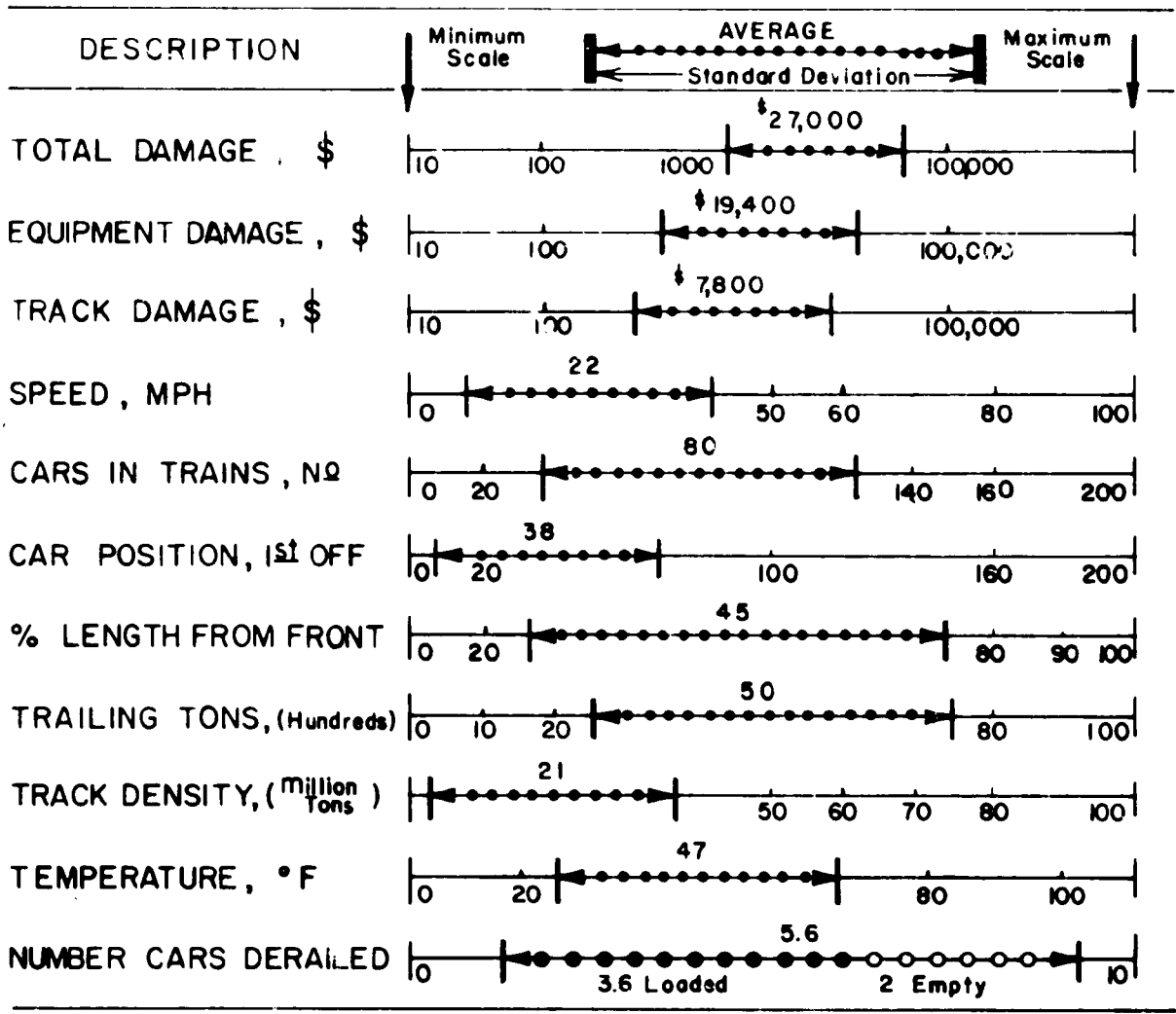

## DERAILMENTS

BY  
CAUSE CODE  
1975  
REPORTED  
INCIDENCES

87% OF ALL EQUIPMENT ACCIDENTS  
93% OF ALL EQUIPMENT DAMAGE

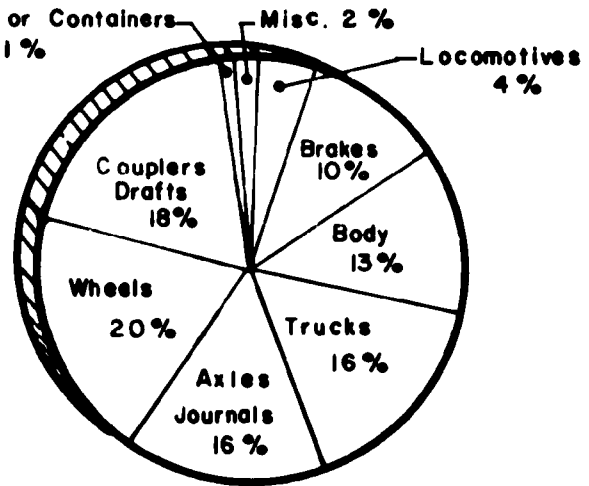

Fig. 1-1

## 2. SUMMARY

During this study existing on-board failure detection systems were reviewed. Systems found to be available for protecting freight cars were all in the development stage.

A developmental on-board equipment failure prevention system was identified. The system would consist of a central monitor-alarm box and several sensors. The sensors discussed were intended to detect and warn of six major impending failure modes. System purchase costs are given in terms of yearly damage loss due to accident, allowable system payback period, and fraction of accidents the system is intended to prevent.

An analysis of the 1975 railroad equipment caused accidents was made. Data reported to the FRA was the primary source of derailment information; however, data from other sources were also used. Individual cause codes were consolidated into groups that had a common characteristic that might be used to detect the presence of the defect. Fifteen cause codes were identified to account for two out of every three accidents. Several train operating conditions such as speed and weather were identified to be related to the rate of occurrence of certain accident types.

A development effort in the area of on-board sensor technology is recommended. The recommended effort is directed toward the production of a multi-sensor protection system which could provide a maximum reduction in equipment failures while also being cost effective.

63% of all equipment caused accidents were reported under 15 cause codes.

67% of all damages due to equipment caused accidents can be attributed to 15 cause codes.

87% of all equipment caused accidents result in some railcar derailments.

Costs associated with equipment derailments account for 93% of all costs associated with all equipment failures in 1975.

The average reported cost of an equipment caused accident is \$25,300.

The six most costly accident types in 1975 which are not protected by any wayside system costs on the average \$27,900 per accident.

The six most costly accident types in 1975 which are now protected by wayside systems costs on the average \$38,600 per accident.

The average cost of all equipment caused derailments for the nine years preceding 1976 is \$41,700,000.

The dollar damages incurred in equipment failure can be shown to be functionally related to the speed of operation and the number of cars that go off the track.

The rate of occurrence of some equipment caused derailments can be shown to be associated with such operating variables as temperature, speed, trailing load, track operating density, and weather conditions.

### 3. LITERATURE REVIEW

Table 3-1 is a summary classification of the applicable sources of literature examined during this study. A full compilation of 143 references were made during the study program. A schematic diagram showing the key words used in the computerized search of more than 970,000 articles which resulted in the tabulation of the 143 references is shown in Figure 3-1. Due to the extend of the tabulation the full biblicgraphy was not included in this report.

Table 3-2 is a compilation of the available on-board sensing schemes tabulated from the literature search performed. These failure detection techniques are listed against the FRA accident code corresponding to the equipment failure mode they purport to reduce. The accident codes listed are in decreasing order of importance based on the average yearly number of accidents which occur under that code number. This average was based on the ten years from 1964 - 1974.

There appears to be no "commercially" available on-board detection scheme which can detect the major moving equipment failures found to occur on freight. There are some potential on-board detection systems still in the development stages.

The majority of failure detection schemes which can be classified as on-board detectors are used mostly in track failure analysis. These schemes employ:

1. Ultrasonics
2. X-rays
3. Pulse propagation
4. Magnaflux
5. Eddy currents
6. Lights - mirrors
7. Audio - frequencies, and
8. Stress sensors.

TABLE 3-1

LITERATURE REVIEW RESULTS CLASSIFIED

PROTECTION SYSTEM TYPE	ARTICLE DESCRIPTION	NUMBER OF ARTICLES	TOTALS
Present day	Track Inspection Cars or Equipment	21	
On-board Systems	Obstacle or Car Presence Detectors	14	
	Rocking Car Detectors	3	
	Speed Detection	2	
	Hot Journal Sensors	1	
	Vibration Related Sensors	2	
	Locomotive Operation Check	1	44
Related	Acoustic Emission	6	
Off-board Systems	Ultrasonics	7	
	Hot Journal Sensors (new)	2	
	Wheel Defect Devices	5	
	Ice Detectors	2	
	Crossing Associated Protection	3	
	Hot Box Type Sensors	3	
	Wheel-to-Rail Resistance Sensing	1	
	Car Classification Scanner	1	30
Non-related	Communications Techniques	19	
Systems	Only Descriptors Related	46	65

GRAND TOTAL ..... 139

TABLE 3-2

ON-BOARD DETECTION SCHEMES IDENTIFIED  
FROM LITERATURE SEARCH

FRA Accident Code*	Applicable FRA 1975 Accident Codes	Description	Development Status
2319	451,452	Temperature Sensing Bolt (Ultrasonic Warning)	Prototype
		Phase Change Alloy	R&D Only
		Temperature Sensing Bolt (Radio Warning)	R&D Only
2314	464	Car Vibration Sensing (Wheel Flats)	R&D Only
4601	---	Hydraulic Pressure Det.	Patent
2207	442	None	
2315	466	None	
2609	432	None	
2701	421,422	None	
2201	443	None	
2312	461,462,463	None	
2318	453,454	None	
2221	---	None	
2212	440	None	
2210	423	None	
2510	405	None	
2615	---	None	
2611	434	None	
2213	441	None	
2612	433	None	
4501**	---	Ultrasonic/X-Ray/Pulse Propa- gation/Magnaflux/Eddy Current/ Lights-Mirrors/Audio Frequency/ Stress Detector	

\* Top 18 Equipment Failure Codes from Years 64-73

\*\* Track Failures Protected with Listed On-Board Sensing Schemes

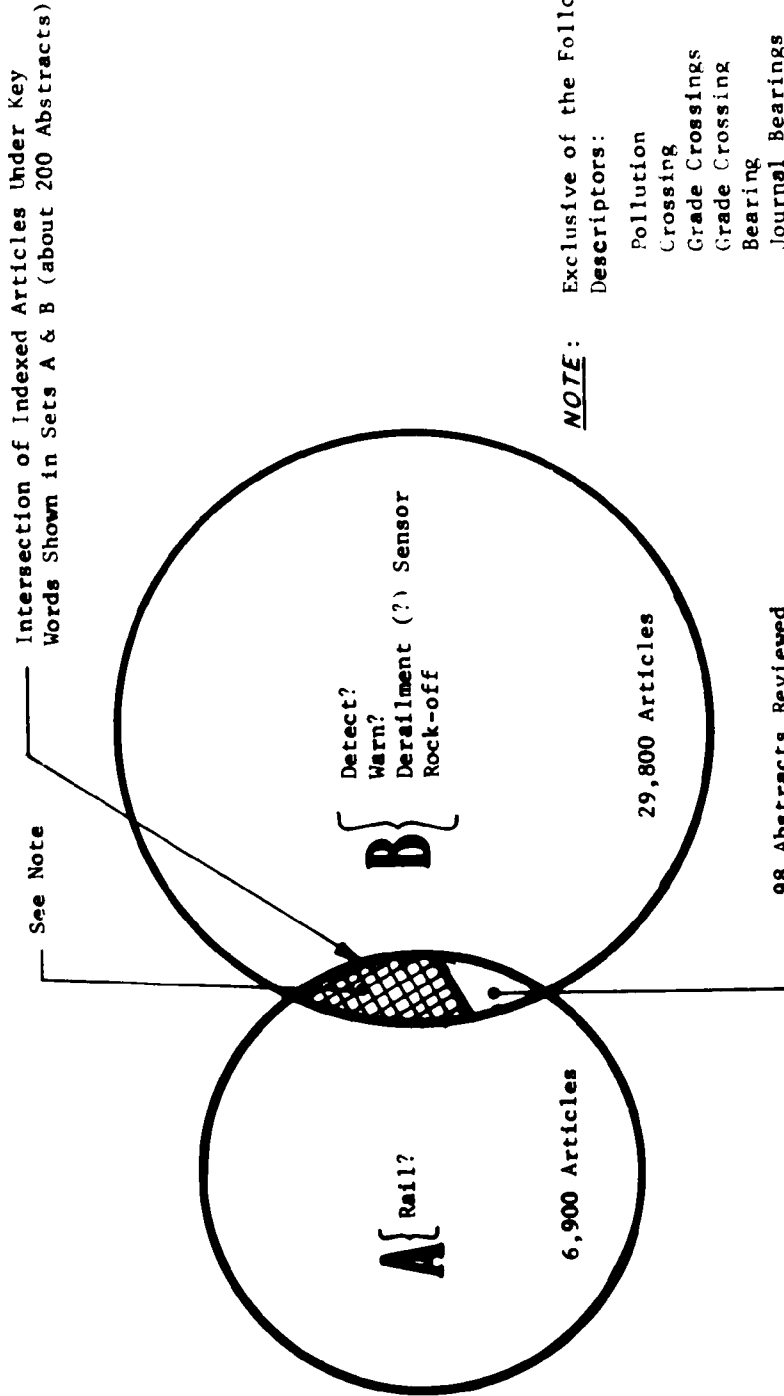

Fig. 3-1 Venn Diagram Showing Schematic of Key Words Used in Computer Search of more than 970,000 Catalogued Articles



#### 4. REVIEW OF ACCIDENT INFORMATION

The Federal Railroad Administration "Guide for Preparing Railroad Accident/ Incident Reports" reviews in detail the type of railroad accidents which must be reported. In general, these accidents fall into four classifications:

1. Impacts between trains and other obstacles\*,
2. Collisions/derailments involving more than \$1,750 worth of damages,
3. Death or injury type of incidents, and
4. Occupationally contracted illness.

The scope of such reporting results in over 10,000 reports to be filed by the railroads every year. Since the present study was concerned with effective sensor technology, the accident data review was reduced to 2,000 relevant reports.

The FRA accident data was obtained in coded form for the purpose of examining the types of accidents that occurred. The review was performed in light of how to implement an effective on-board sensor system which could reduce equipment caused rail accidents. The data was examined in a statistical and analytical manner. The intention being to get a good picture of what type of accident occurs most frequently, which type costs the most, and which type of incident would provide the most benefit if a detection scheme were used to reduce its occurrence. A distribution histogram of the 1975 accidents by damage costs is shown in Figure 4-1.

The FRA requirements for accident reporting were recently changed. Beginning in 1975, the required format of the data is significantly different than it had been for the previous 20 years. In terms of reviewing the time trends of some of the accident types, this created a

---

\* Exact definitions are found in Reference ( 1 ). The above descriptions have been shortened for convenience.

1975 EQUIPMENT CAUSED ACCIDENTS  
DISTRIBUTION OF TOTAL \$ DAMAGE  
 (1902 ACCS)

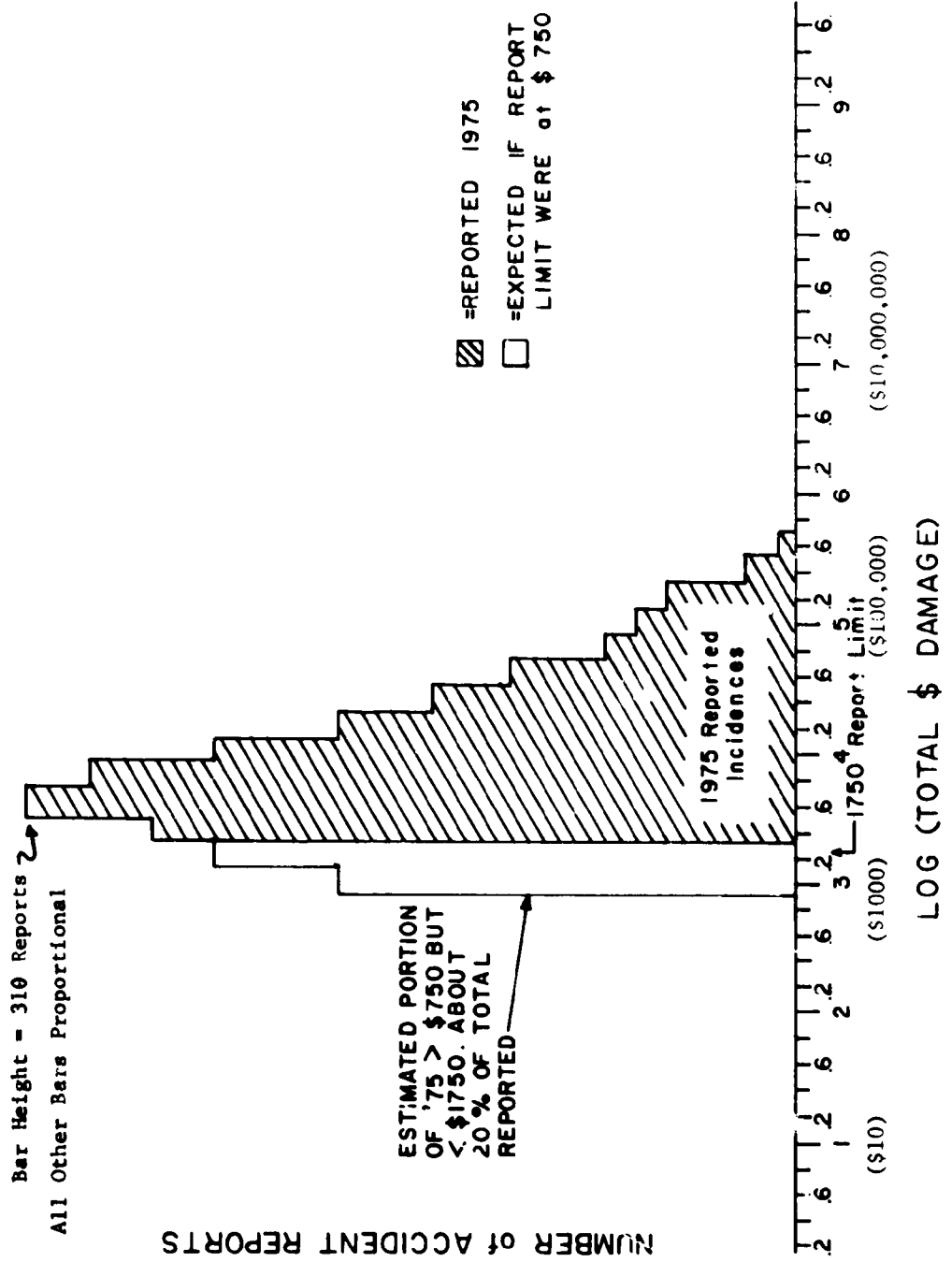

Fig. 4-1

difficult problem. Certain types of FRA accident codes were eliminated altogether in 1975. Since it is not likely that these accidents ceased to happen, it means that people recording the accident must have attributed those incidents to some presently allowable code. A major question arises as to how the distribution of recorded accidents by code might look had the old coding system been used. A partial answer to this question is contained in the comparison list of cause codes of Appendix I.

#### 4.1 Scope of Available Accident Data Reviewed

The present review of the FRA accident data was limited to those accidents attributed to mechanical and electrical equipment failures. These accidents account for roughly 20 percent of all recorded incidents. The intent was to review those incidences that were collectively a result of defective rolling stock equipment. No attempt was made to review those incidences recorded because they happened at a highway grade crossing or as a result of illness, death, or injury. Although it is realized that human factors are the initial cause of many reported incidences, the focus of attention in the present study was on those accidents which actually occurred from defective rail car components.

4.1.1. Why Review Accident Data? The accident data was reviewed in order to make the best possible judgment on which type of on-board sensor could be most effectively deployed. It has been established (Ref. 2) that certain subsystems of a railcar fail more frequently than others. In fact, sixty percent of all equipment-caused incidences before 1975 can be traced to no more than 18 equipment failure types out of the 54 types recorded. It appears the most effective way to reduce the number of accidents would be to concentrate on finding out why these 18 subsystems fail to operate properly. In reviewing the types of wayside detectors now available and in development (Ref. 2); it can be seen that in general, this is being done for some types of failures.

4.1.2 Definition of an Accident. For the present study, an accident was considered for review if it were filed with a Cause Code in the 400 series. In most instances only the first report filed with the FRA for a (Ref. 4) particular incidence was used. Accidents involving two or more railroads usually result in two or more records being filed. For the study at hand, no use was made of the duplicate copies of the accident.

A qualitative question related to "what is an accident?" is "which accidents should be considered as most important?." This question is directly related to the main point of the study. Of those accidents reviewed, which ones can and should be reduced with the aid of on-board sensors. Specific answers to these questions alter to a great extent the design, cost, and technique of deployment of any on-board detection system developed.

A definition of which accidents should be considered as most important was established as follows:

- (a) Those which occurred most frequently;
- (b) Those which caused the highest dollar damage;
- (c) Those which had the highest average cost per accident if more than one of that type occurred.

Other criteria for establishing the "severity" of an accident could be developed and some of these will be discussed; but in general, these three were used to define the most viable on-board sensor which could be developed.

4.1.3. How Accident Data was Used. The accident data reviewed was primarily examined in such a way as to establish the need for particular on-board sensor designs. Some types of accidents occur more frequently than others. Accidents ranked on how many occurred in 1975 are shown in Figure 4-2. Also indicated in that figure is whether the accident type shown

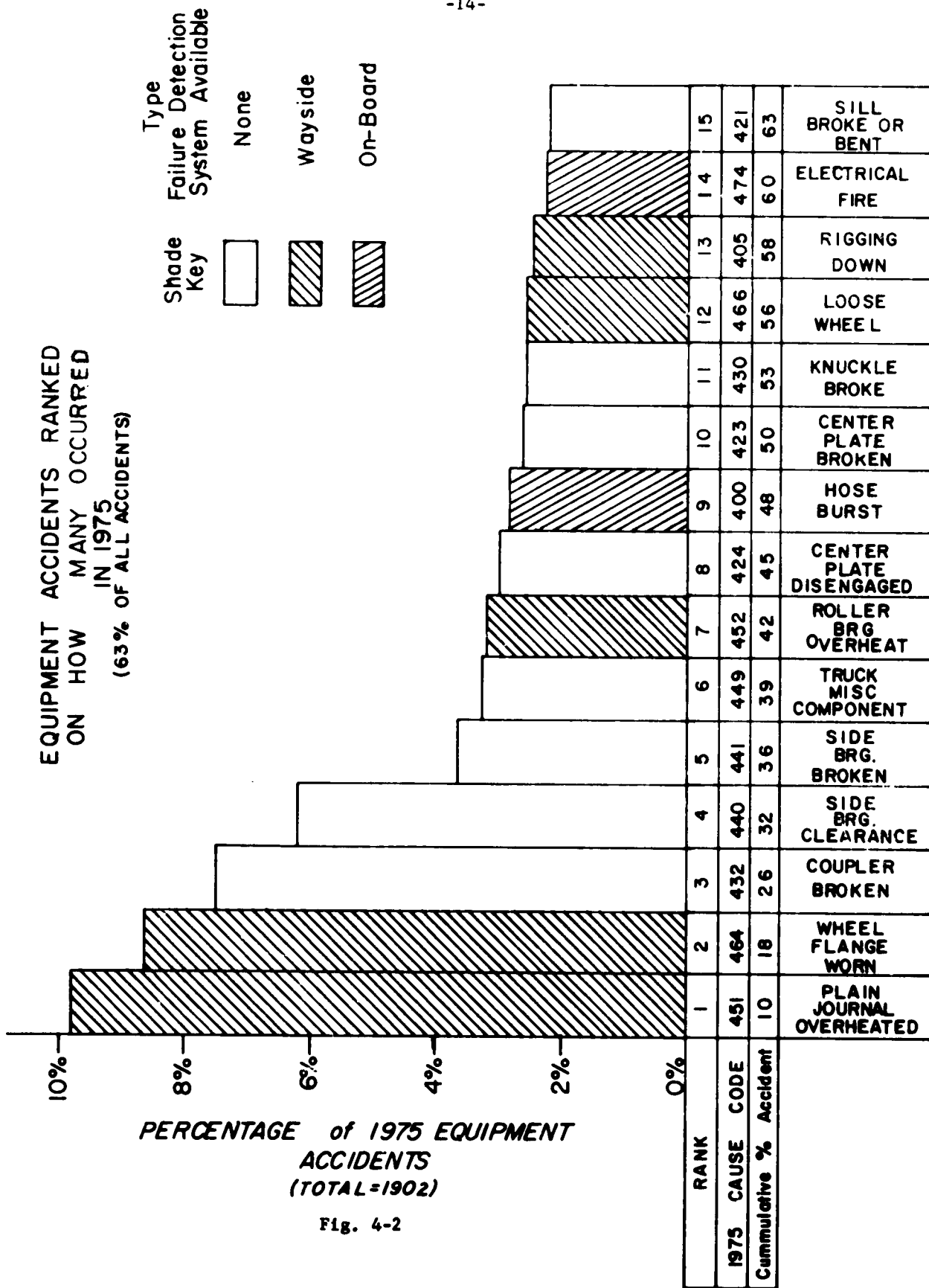

has some failure detection system in operation. The data shown in Figure 4-2 reveals that failure detection systems are most needed in reducing accidents which can be attributed to:

- (a) Coupler failures;
- (b) Improper side bearing operation;
- (c) Center plate malfunctions, and
- (d) Broken or bent sills.

4.1.4. Past and Present Data Forms. A complete review and comparison of the cause code changes that took effect in 1975 was made in Reference 2. In general, the number of codes used to classify equipment failures has been reduced. However, the number of attributable codes for some modes of failure have been expanded. Bearing failures, for example, can now be classified under roller or plain journal failures as needed; whereas, no differentiation was made in the past. Appendix I contains a list of cause codes for 1975 listed in their relationship to codes that existed before that time.

In addition to changing the cause code listings in 1975, the FRA also requires that certain additional information about the accident be submitted by the railroads. Added in 1975 for each incident were such variables as:

- (a) Temperature at time of incident
- (b) Trailing tonnage
- (c) Visibility (four possible types)
- (d) Weather (six possible types)
- (e) Track density
- (f) Number cars derailed (empty/loaded)
- (g) Car position in train at which failure occurred
- (h) Cars empty/cars loaded in train
- (i) Number of locomotives
- (j) Hours crew members had been on duty
- (k) Mile post
- (l) Direction of travel (north, south, east, west)
- (m) and others

This data was in addition to that required in years previous to 1975. The type of data recorded allows for a much more extensive review of accident causes than ever before.

4.1.5. Portion of Available Accident Data Reviewed. Much more data is available than could be thoroughly examined during the present study. Tables in Appendix II show subsets of available information that were used during the review process. In general, all variables (noted at the time of the equipment failure) which might have in some way revealed a common technique for reducing accidents were grouped together.

Both continuous and non-continuous variables were used. For example, the outdoor temperature recorded at the accident was a continuous variable which may in some way affect the type or severity of the accident. Non-continuous variables such as weather and visibility were also recorded and made use of in the data review. Each one of these variables had one digit number codes identifying the environmental situation at accident time. These codes were useful because they further identify those instances which occurred under certain fixed conditions. Different equipment failure rates under different "weather" conditions might imply that special modes of failure are operating under certain weather conditions.

4.1.6. Accident Data Evaluation Techniques. The 1975 accident data was reviewed with the aid of one or more of the following evaluation techniques:

- (a) Tabulated accident frequencies with ranking schemes;
- (b) Histogram displays of distributions;
- (c) Curve plotting techniques, and
- (d) Correlation and multiple regression methods.

The association between two variables is often examined by plotting one against the other. When a larger number of variables are available, plotting all associations for inspection becomes unwieldy. A standard computa-

tional screening technique which avoids large amounts of data plotting but still provides information on variable interdependence was used in the present study. The method used involved the calculation of correlation coefficients between all variables whose association was desired. The use of correlation coefficients and correlation matrix arrays is discussed separately in Appendix VII.

The 1975 accident data contained many variables which were recorded at the time of the accident. Potential relationships between many variables were sought by calculating a standard correlation coefficient matrix using the data variables. One set of variables chosen for evaluation was numbered as follows:

- 1 = Temperature ( $^{\circ}$ F)
- 2 = Visibility (codes 1-4)
- 3 = Weather (codes 1-6)
- 4 = Speed (mph)
- 5 = Trailing Tons
- 6 = Position 2 (equipment failure, car count from front)
- 7 = Number of Loaded Cars
- 8 = Number of Empty Cars
- 9 = Track Density (tons/year)
- 10 = Dollars Track Damage
- 11 = Dollars Equipment Damage
- 12 = Dollars Total Damage
- 13 = Frequency of Occurrence for 1975 (# by code)
- 14 = Number of Derailed Cars Loaded
- 15 = Number of Derailed Cars Empty
- 16 = Total Number of Cars Derailed

Figure 4-3 is a display of the correlation coefficients for each of the sixteen variables listed above (i.e., 112 unique numbers). The coefficients are displayed in matrix form for convenience. The row and column numbers correspond to those pairs of variables for which the correlation coefficient has been calculated. For instance,  $R = .80$  is the linear correlation coefficient between variables 5 and 7 (i.e., trailing tons and



CORRELATION MATRIX FOR 262 FREIGHT ACCIDENTS

0	1	2	3	4	5	6	7	8	9	10	11	12	13	14	15	16
1	.00	.18	-.09	-.07	.02	.03	-.01	.08	-.06	.03	-.10	-.05	-.07	-.09	-.11	-.13
2	.18	##	.00	-.02	.12	.03	.12	-.06	.01	.05	-.03	.00	.14	.03	.07	-.02
3	-.09	.00	##	.01	.04	-.06	.06	.06	.04	-.04	.00	-.02	.06	-.02	.01	-.00
4	-.07	-.02	.01	.99	-.07	.11	-.03	.04	.06	.15	.34	.31	-.10	.19	.22	.26
5	.02	.12	.04	-.07	##	.23	.80	-.00	-.05	-.02	.10	.05	.01	.18	.01	.12
6	.03	.03	.06	.11	.23	##	.23	.07	-.06	.02	.03	.03	.00	.09	.02	.07
7	-.01	.12	.06	-.03	.80	.23	##	-.27	-.10	-.01	.09	.06	.08	.24	-.19	.05
8	.08	-.06	.06	.04	-.00	.07	-.27	.99	.14	-.02	.00	-.01	-.01	-.18	.34	.07
9	-.06	.01	.04	.06	-.05	-.06	-.10	.14	##	.00	-.05	-.03	-.03	-.10	.01	-.06
10	.03	.05	-.04	.15	-.02	.02	-.01	-.02	.00	##	.41	.78	-.01	.26	.09	.23
11	-.10	-.03	.00	.34	.10	.03	.09	.00	-.05	.41	##	.88	-.02	.67	.46	.74
12	-.05	.00	-.02	.31	.05	.03	.06	-.01	-.03	.78	.88	##	-.02	.58	.36	.62
13	-.07	.14	.06	-.10	.01	.00	.08	-.01	-.09	-.01	-.02	-.02	##	.02	-.05	-.01
14	-.09	.03	-.02	.19	.18	.09	.24	-.18	-.10	.26	.67	.58	.02	##	.19	.81
15	-.11	-.07	.01	.22	-.01	.02	-.19	.34	.01	.09	.46	.36	-.05	.19	.99	.72
16	-.13	-.02	-.00	.26	.12	.07	.05	.07	-.06	.23	.74	.62	-.01	.81	.72	##

ALL ACC CODES - FREIGHT ONLY

- 1 = TEMPERATURE
- 2 = VISIBILITY
- 3 = WEATHER
- 4 = SPEED(MPH)
- 5 = TRAILING TONS
- 6 = POSITION 2
- 7 = NUMBER OF LOADED CARS
- 8 = NUMBER OF EMPTY CARS
- 9 = TRACK DENSITY
- 10 = DOLLARS TRACK DAMAGE
- 11 = DOLLARS EQUIPMENT DAMAGE
- 12 = DOLLARS TOTAL DAMAGE
- 13 = FREQUENCY OF OCCURANCE FOR 1975
- 14 = NUMBER OF DERAILED CARS LOADED
- 15 = NUMBER OF DERAILED CARS EMPTY
- 16 = TOTAL NUMBER OF CARS DERAILED

NOTE-- (-.##)      EQUALS 1.00  
 DUE TO FORMAT  
 OVER FLOW

Fig. 4-3

and number of loaded cars). The data shown is for 262 incidents where freight was being hauled. Correlation matrices for several other subsets of the 1975 accident data have been made and are shown in Appendix VI.

4.1.7 Data Trends and On-Board Sensor Implications. Data trends indicate that derailment accidents will increase in the future. Figure 4-4 shows the growth in the number of derailments over the past 20 years. Shown in the figure are the number of accidents from all derailment causes as well as those occurring from equipment failures. Estimates of the expected number of accidents are shown in the figure from 1977 to 1981 for which information is not yet available.

The calculated or estimated number of accidents shown were found from the time trends of two tabulated bits of data listed in the "Yearbook of Railroad Facts." The variables chosen were net ton miles per freight car day and average car miles per day. Each of the two data variables used has a stable relationship with time (see Table 4-1). Net ton miles per day and car miles per day were combined in a linear fashion to estimate the number of train derailments for the past 20 years. The curve fitting schemes used are reviewed separately in Appendix VII. As seen in Table 4-1, the two variables can be used with a high degree of reliability to compute an estimate of the number of accidents that occur in any one year. In fact, the mean deviation of the computer number of derailments is only 8 percent from what actually occurred. (See Example 2 of Appendix VII).

Since the two variables chosen to be correlated with the number of accidents are stable with time, it is not expected that they will deviate drastically from their historical time trend lines. For this reason, one would not expect that the computed number of accidents, as shown in Table 4-1, would deviate widely from the number of accidents that will occur between now and 1981. Thus, the number of derailments can be expected to increase within the near future for two reasons:

TRAIN  
DERAILMENTS by YEAR  
(20 YR. HISTORY)

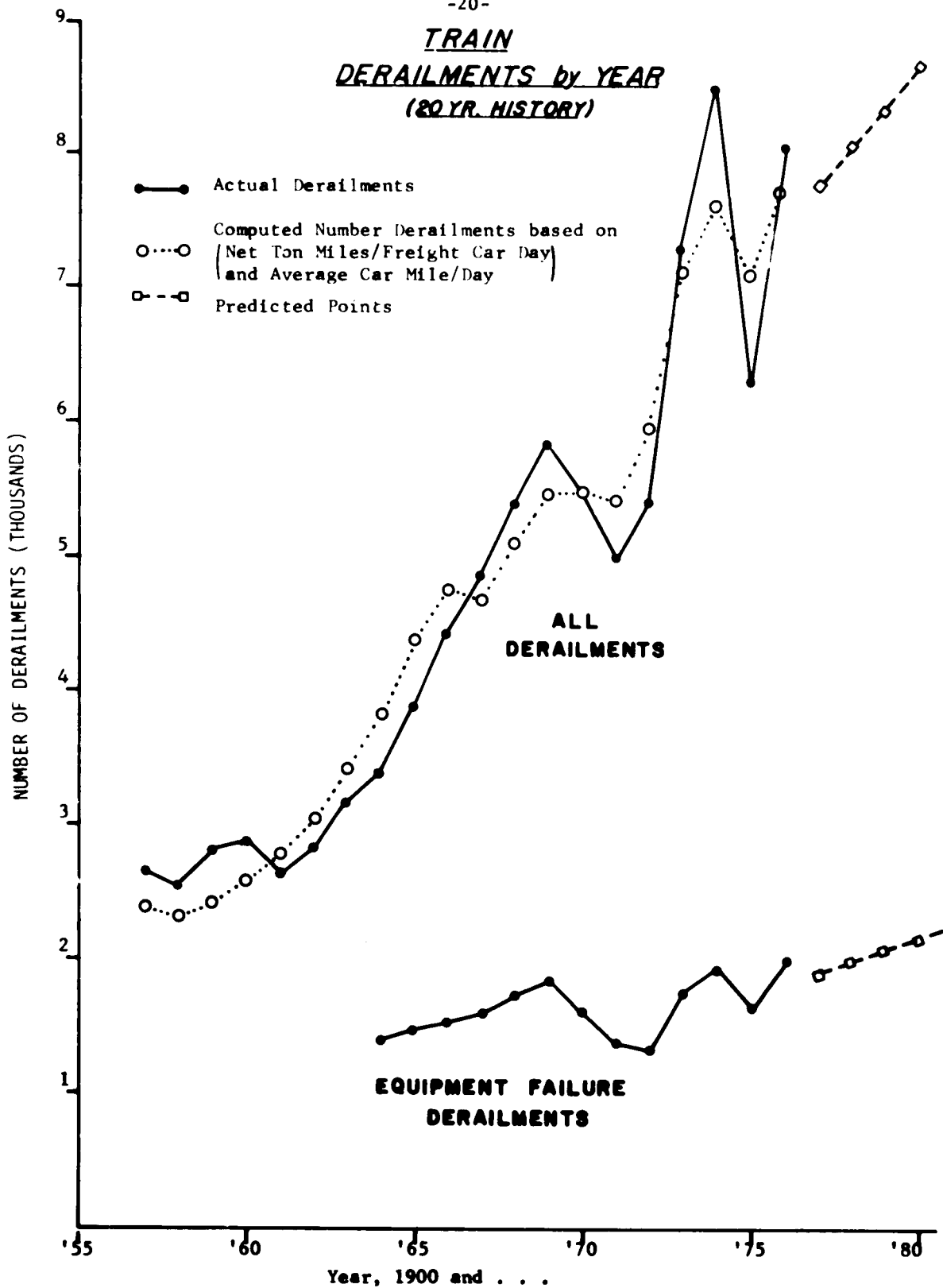

Fig. 4-4

TABLE 4-1  
TRAIN DERAILMENT TRENDS

* YEAR *	* TON MILES PER FIGHT CAR DAY *	* AVERAGE CAR MILES PER DAY *	* ACTUAL DERAILMENTS *	* COMPUTED DERAILMENTS *	* PERCENT DEVIATION *
* 1957 *	975	47.0	2684	2406	10.32
* 1958 *	882	43.6	2579	2321	9.98
* 1959 *	950	45.9	2850	2444	14.23
* 1960 *	954	45.7	2918	2560	12.25
* 1961 *	966	45.5	2671	2778	-4.04
* 1962 *	1041	47.6	2830	3056	-8.00
* 1963 *	1113	49.2	3170	3457	-9.08
* 1964 *	1160	50.0	3399	3799	-11.78
* 1965 *	1251	51.7	3869	4411	-14.02
* 1966 *	1310	53.0	4447	4744	-6.68
* 1967 *	1271	51.5	4960	4732	4.58
* 1968 *	1350	53.5	5487	5093	7.17
* 1969 *	1416	54.9	5960	5483	7.99
* 1970 *	1418	54.6	5602	5606	-0.07
* 1971 *	1373	53.3	5131	5452	-6.27
* 1972 *	1481	56.1	5509	5925	-7.55
* 1973 *	1621	57.7	7389	7196	2.60
* 1974 *	1646	57.4	8513	7613	10.56
* 1975 *	1510	53.5	6328	7140	-12.84
* 1976 *	1645	56.9	8061 Est.	7763	3.68
* TIME	TRENDS		TIME	TRENDS	
* 1977 *	1744	61.1	???	7659	
* 1978 *	1789	61.9	???	7953	
* 1979 *	1834	62.8	???	8246	
* 1980 *	1875	63.7	???	8539	
* 1981 *	1924	64.6	???	8832	

- (a) The projected number of accidents when correlated with such measures of rail usage as net ton miles per freight car day and average car miles per day indicates an increase in derailments, and
- (b) The trend of the number of accidents which have actually occurred for the past 20 years indicates an expected increase in accidents (see Figure 4-4).

In the case of equipment failures, it may be possible to reduce this trend with the aid of certain on-board and/or wayside detection systems. Reference is made to Figure 4-5.

The effectiveness of a wayside detection system depends upon its spacing. Mechanical failures which deteriorate rapidly (say within 20 miles) and cause the train to derail, may never be seen by a wayside system whose spacing is much greater than 20. In fact, in the case of overheated bearing failures, it can be shown from experimental data (Ref. 2) that the expected probability of observing a derailment before it occurs can be plotted as a function of detector spacing (solid line, Figure 4-5). The closer the detector spacing, the more likely that the failure will be observed before a derailment occurs. The average hotbox spacing (based on the number of detectors in use) is shown for convenience on the same figure.

For a perfect on-board failure detection system, the probability of observing the mechanical defect is simply proportional to the number of railcars protected (see dashed lines, Figure 4-5). Since the number of cars in the system is known, the cost to implement and the expected effectiveness of any on-board failure detection system can be estimated with greater ease than it can with wayside detectors. The reliability of a wayside system requires a knowledge of the characteristic failure time of the defects monitored.

**PROBABILITY OF OBSERVING  
(OVERHEATED BEARING)**

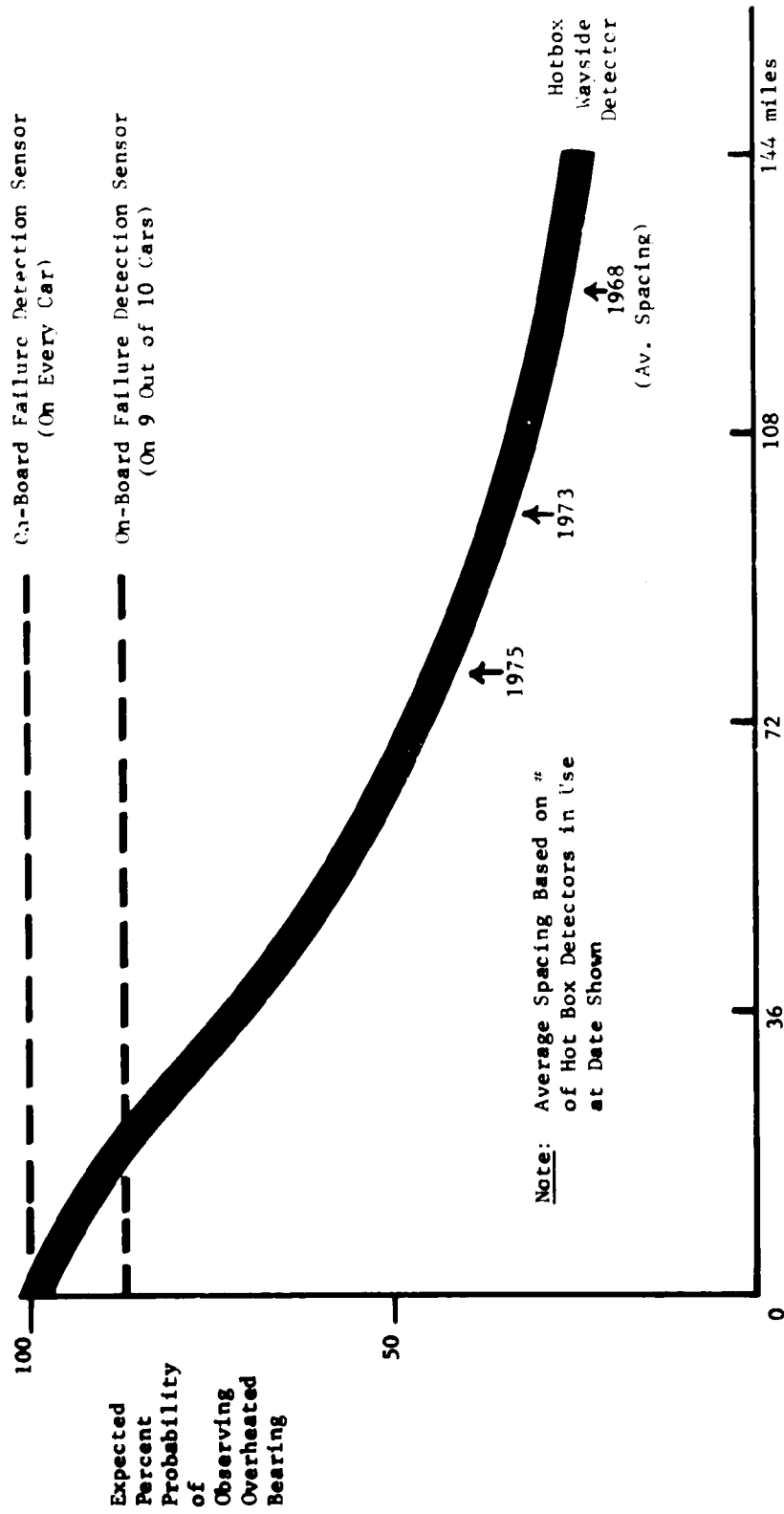

WAYSIDE DETECTOR SPACING

Fig. 4-5

#### 4.2 Train Accident Data for 1975

Approximately 20 percent of the reported rail accidents in 1975 involved some kind of equipment failure. The form of Figure 4-6 shows the type of information supplied to the FRA for each incident which has a total dollar damage loss in excess of \$1,750.

4.2.1 Specific Form of FRA Data. Table II-1 in Appendix II shows the computer coded fields of data as taken from the accident/incident report. A list of state code numbers as used in reporting are also included in the appendix. The acronyms used in coding the data are shown in Figure II-1 of the same appendix.

Figure 4-7 is a display of the first 256 field bits from eight of the most costly accident report sheets for 1975. Each of the incidents shown has a cause code in the 400 series. Four of the eight failures were caused by wheel defects. Two involved body defects. One was the result of a coupler defect and another a broken body bolster.

4.2.2 Description of Stored Codes Used in this Study. Appendix II also contains a list of cause codes regarded as relevant to the present study. Subsets of those accident conditions which might have provided a technological basis for reducing the number or cost of equipment failures were made. Only those data elements shown in Appendix II were reviewed. Reference 1 contains a complete description of data recorded at the time of the incident. The brief list of following definitions apply to those codes reviewed.

<u>DATA ACRONYM</u>	<u>DEFINITION OF MEANING</u>
CAUSE	Cause Code of Reported Incident
TEMP	Outdoor Temperature (°F) at Accident Site
VISIBLTY	Visibility Number, 1 = Dawn, 2 = Day, etc.
WEATHER	Weather Number, 1 = clear, 2 = cloudy, etc.
SPEED	Train Speed (MPH) at Time Accident Occurred

-continued-

DEPARTMENT OF TRANSPORTATION FEDERAL RAILROAD ADMINISTRATION				RAIL EQUIPMENT ACCIDENT/INCIDENT REPORT				FORM APPROVED OMB NO. 60460-006	
NAME OF RESPONSIBLE RAILROAD		Amtrak		Formal Name		Report Number		Date	
East West Railroad Company		EWRC		Adopted Code		67890			
North South Railroad Company		NSRC		Adopted Code		78901			
Intercity Transportation Corporation		ITC		Adopted Code		45678			
TYPE OF ACCIDENT/INCIDENT				DATE OF ACCIDENT/INCIDENT				TIME OF ACCIDENT/INCIDENT	
N/A				0 2   1 1 4   7 1 4				6:23	
HAZARDOUS MATERIALS (number of)									
Cars carrying		Cars damaged or destroyed		Cars involved in accident		Total weight of hazardous materials			
12		5		4		1,500			
LOCATION									
Division		Nearest station		Mile post or location		State			
Eastern		Gooberville		275.2		DC			
ENVIRONMENTAL CONDITIONS									
Temperature		Visibility		Wind		Sky			
-02°		1/4 mi		4 mph		6			
OPERATIONAL DATA									
Signal		Train order		Authority		Other			
20 mph		X		32		2			
EQUIPMENT									
Type of equipment		Description		Number		Other			
4 208		Single main track		4		2,3			
EWR 7220		N/A		N/A		N/A			
3		0		0		97		32	
3		0		0		16		2	
PROPERTY DAMAGE (estimated cost)									
Total		N/A							
ACCIDENT/INCIDENT CAUSE CODE									
523		N/A							
CASUALTIES									
Number of persons killed		Estimated total days disabled		Number of fatalities					
4		86		1					
CREW									
Engineer		Conductor		Brakeman		Other			
1		1		2		0			
SIGNATURE									
John H. Doe, Superintendent of Safety								03/15/74	
ITC Dispatcher failed to deliver a meet order to opposing train at Cross Junction, D. C.									

Fig. 4-6



### MOST COSTLY ACCIDENTS/1975

#7503UP 0375NE214	7503UP 0375NE214
7503291205PM1 0 0 0 0	365.3 0828 2150 E137 36100 12556.
3 1UP 15052917 YUP 15052917	Y40000000000038 0 4 0 1 36 0 1
0 0 401725 57045 460 0	0 111204350435 8NEBRAS
#7507BD AAC399	7507BD AAC399
7507310255PM1 0 0 0 0	230.101882 2255 R 46050 12324.
7 1	4 0 55 80 2 24 2
3 2 600000 18000 466	2 000306 4AKRON
#7508MP 8561	7508MP 8561
7508310150PM1 0 0 0 0	367.8 2080 2153 E703036259 1244.9
1MI 2655618 YMI 2655618	Y5000000000044 0 67 0 1 22 0 2
9 0 0 611750 20700 424 0	8KANSAS
#7508ATSF32085130	7508ATSF32085130
7508280115PM1 17 17 0 0	610 4886 2168 R991132707 12536
1ATSF29174917 YATSF29016620	Y40000000000042 0 0 0 1 25 0 0
0 0 502500 30000 466 0	5PLAINS
#7509LN 4120911795	7509LN 4120911795
7509230220PM1 0	C70 2158 2330 E623011003912316.
1 1PC 6230 1 PC 6230 1	1 2 11 1 180 0 1 28 0
0 418686 18100 442 0	3CINCIN
#7510UP 1075WY219	7510UP 1075WY219
7510250800PM1 0 0 0 0	789 5625 3169 E495 44985 12539.
4 180U 44997 23 YUP 25700224	N50000000000065 0 3 0 1 34 0 0
0 0 471500 39937 432 0	6WYOMIN
#7511SCL 1121100652	7511SCL 1121100652
7511020645PM1 1 1 1 0	A145 3750 4150 E156 11002012517.
3 1ACL 12129845 Y	30000000001150 42 0 1 44 0 1
0 0 0 756903 157000 465 0	3ROCKY
#7512RI SRWF28JTD	7512MKT AX191S
7512050650AM1 0 0 0 0	774 4866 2217 E83 2112631237.3
1TLDX7284 29 YTLDX7284 29	Y30000000000086 0 1 0 1 26 0 0
0 0 372300 423 799 0	15SOUTHE

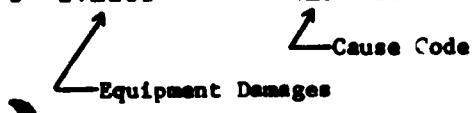

Fig. 4-7

<u>DATA ACRONYM</u>	<u>DEFINITION OF MEANING</u>
TONS	Gross Tonnage in Train, Excluding Power Units
POSITION 1	First Car by Count from Front that Derailed, exploded, etc.
POSITION 2	Car by Count from Front that Initiated Incident, if Applicable or Known
CARSEQ P1	
LOAD-F1	Number of Loaded Freight Cars in Train
EMPTY-F1	Number of Empty Freight Cars in Train
CARSDER 2	
LOAD-F1	Number of Freight Cars that were Loaded and Derailed
EMPTY-F1	Number of Freight Cars that were Empty and Derailed
EQP-DMG	Total Equipment Dollar Damage of Incident
TRK-DMG	Total Track Dollar Damage of Incident
CAUSE 2	Second Cause Code Attributed to Incident
ENGRS	Number of Engineers on Duty
CONDUCTR	Number of Conductors on Duty
BRAKEMEN	Number of Brakemen on Duty
ENGTIME	Length of Time Engineer was on Duty when Incident Occurred

#### 4.3 Analysis Results for 1975 Accident Data

In order to establish a baseline for the cost benefit and failure prevention potential of an on-board sensing system, the 1975 accident data was reviewed. The review was not made in depth but made use of previously unrecorded information as a result of the new regulations imposed on the incident reporting techniques. The data were used in order to establish, wherever possible, which accidents occur most frequently, which result in the most damage, and on which components of the railcar could potential on-board technology be most effectively deployed.

The tabulated and graphic review of relevant accident information for 1975 is contained in this section. One or more of the following computer techniques were used in processing the information results shown:

1. Tabulation and ranking of raw data,
2. Histogram distributions,
3. Graphic plots of functional data, and
4. Correlation/multiple regression analysis of pertinent information.

4.3.1 Dollar Damages Attributed to Accidents. In order to establish a baseline for potential savings that might be realized from deployment of an on-board sensing system, the dollar loss from accidents was reviewed. Dollar damages resulting from equipment caused accidents over the past nine years were found to be:

<u>Year</u>	<u>Equipment Caused Derailments Total Dollar Damages Reported (Track Plus Equipment Losses from Derailment)</u>
1975	44,853,000
1974	53,562,000
1973	43,580,000
1972	34,613,000
1971	36,867,000
1970	35,786,000
1969	47,778,000
1968	41,118,000
1967	37,320,000

An acceptable payback period for deploying any protection system is five years. Within that time, the full cost to deploy the system would have to be realized through a reduction in dollars lost due to equipment failures. The total maximum dollars that could reasonably be spent for an on-board protection system then appears to be (5 x 41.7 million) 208 million dollars. Actually, only a fraction of the derailments now occurring as a result of equipment failures could be prevented; and so the level of reasonable dollars that could be spent are a function of the relative fraction of derailments that would be prevented.

<u>Reasonable Total Cost to Deploy</u>	<u>Assumed Percentage of Yearly Derailments Prevented</u>
208 million	100%
109 million	50%
52 million	25%

If 50 percent of all equipment accidents were prevented, then approximately 100 million dollars could be spent in deploying the protection system. The expendable cost per sensor is calculated and shown in Table 4-2. The last column of the table lists the available dollars per subsystem for eight types of railcar subsystems which might be protected. It was found that an average of \$2.24 per component could be expended with the five year payback limit.

Failures in the eight subsystems shown account for 67 percent of all equipment damages that occurred in 1975. The eight subsystems shown are also those systems which account for the most costly failures which occurred in 1975 (see Figure 4-8).

Other cost analyses of the 1975 accident data which are pertinent to the design of an on-board accident prevention system were made. Contained in Table 4-3 is a summary of all equipment caused (400 cause code series) accidents listed by cause code. Similar tabulated tables are included in Appendix III. Column two of Table 4-3 is the 1975 cause code for which the number of accidents listed in column 3 were attributed. Roughly 1900 equipment incidents with more than \$1,750 damages were reported in 1975. As shown at the bottom of column 4, the average cost per accident was \$25,303. A total of 48 million dollars damage was incurred during the year. A total of which 44 million could be attributed to incidents involving derailments (see Appendix III data). Thus, any accident derailment prevented through some on-board/wayside detection scheme would on the average save the industry roughly \$25,000.

TABLE 4-2

ON-BOARD PROTECTION SYSTEM COST LIMITS

Railcar Subsystem Protected	Components Per Subsystem Assumed	Allowable Expense Per Subsystem if Available Dollars are Distributed Equally over 26 Components
Journal/Roller Bearings	8	\$ 17.89
Couplers	2	4.47
Wheels	8	17.89
Center Plates	2	4.47
Side Bearings	4	8.94
Truck Body/Bolsters	2	4.47
Total = 26		Dollars/Car \$ 58.14
		$\frac{26}{\text{Avg. Dollars Sensor}} = 2.24$

NOTE: # Cars = 1,720,000

Assume 50% of all equipment derailments prevented at 5 year payback.

**EQUIPMENT ACCIDENTS RANKED  
ON TOTAL DOLLARS DAMAGE  
IN 1975  
(67% OF ALL DAMAGE)**

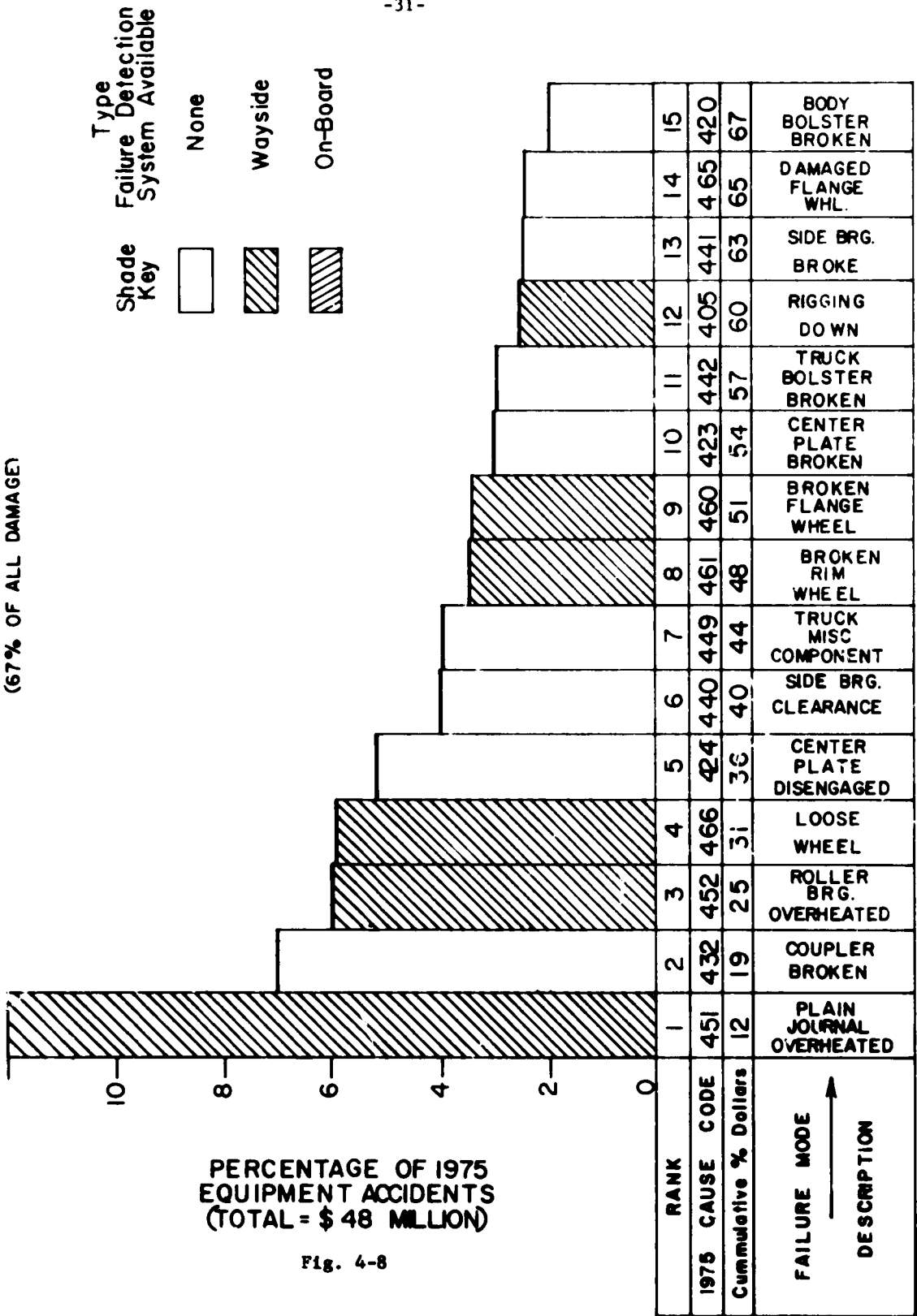

**PERCENTAGE OF 1975  
EQUIPMENT ACCIDENTS  
(TOTAL = \$ 48 MILLION)**

Fig. 4-8

ALL EQUIPMENT RELATED ACCS

RANK	CODE	ACCS	\$/ACC	RANK	\$ DMC	RANK
1	451	187	306.25	17	5727038	1
2	464	163	6387	50	1041126	16
3	432	141	25228	24	3557263	2
4	440	118	17832	29	2104224	6
5	441	69	17686	30	1220340	13
6	449	63	306.73	16	1932423	7
7	452	61	46760	5	2852396	3
8	424	56	43798	6	2452696	5
9	400	54	17642	31	952721	19
10	423	50	29039	20	1451991	10
11	430	49	13164	37	645056	28
12	466	48	58870	2	2825765	4
13	405	46	28262	21	1300079	12
14	474	45	17462	32	785807	25
15	421	43	12102	40	520391	29
16	461	41	42477	7	1741577	8
17	429	39	20472	26	798444	23
18	431	38	8523	46	323891	32
19	499	36	8885	45	319880	33
20	442	35	41269	9	1444431	11
21	469	34	26850	23	912932	20
22	462	34	29853	19	1015018	17
23	460	33	49196	4	1623470	9
24	439	33	27334	22	902031	21
25	420	31	34078	12	1056421	15
26	404	30	32514	13	975435	18
27	434	28	15491	34	433774	31
28	433	28	30392	18	850994	22
29	435	28	8465	47	237042	38
30	453	20	37504	10	750097	26
31	403	20	12088	41	241772	37
32	443	19	41965	8	797346	24
33	422	19	12810	38	243391	36
34	406	16	3878	53	62054	47
35	465	14	86832	1	1215657	14
36	459	14	50020	3	700282	27
37	409	14	6157	51	86204	44
38	463	13	35734	11	464548	30
39	425	12	19241	27	230893	39
40	407	11	8256	48	90821	42
41	450	10	31036	14	310366	34
42	472	8	17347	33	138778	41
43	479	8	30949	15	247592	35
44	401	7	23010	25	161075	40
45	473	7	10357	44	72500	46
46	471	6	14134	35	84806	45
47	410	5	5786	52	28932	50
48	454	5	17886	28	69434	43
49	475	5	6623	49	33115	49
50	470	3	11934	43	35803	48
51	412	2	11950	42	23900	52
52	402	2	13421	36	26843	51
53	419	1	12618	39	12618	53
54	411	1		89		89

TOTAL= 1903 25303=AVG 48153483=TOTAL  
1975 FEDERAL RAILROAD ADMINISTRATION ACCIDENT/INCIDENT DATA

Several histograms of available accident information were made during the study. Figure 4-9 is a display of accidents as a function of the total damage incurred. The data is from 1974 -- the last year for which a \$750 report limit was used. This figure should be compared with that of the 1975 data shown previously in Figure 4-1.

The 1974 data reveal a slightly higher number of incidents, as would be expected from the lower required report limit. The interesting detail is that roughly 20% of the accidents shown in the 1974 plot lie within the \$750-\$1750 cost band. A similar fact was found from 1973 and 1972 data (see Appendix IV). Thus, it can be concluded that approximately 20% more incidents occurred in 1975 than were reported.

Although there were about 475 unreported incidents due to the higher cutoff limit of reporting, it should be noted that these reports could only add up to something less than 2% of the total damages reported, i.e.:

$$\frac{475 \times \$1750 \text{ maximum} \times 100}{\$48,000,000} = 1.7\%$$

Several additional histograms are also shown in Appendix IV. Comments pertaining to the information contained in those displays are given in summary Table 4-4.

Of particular note are two histograms of the separate track and equipment costs associated with the 1975 incidents. These are shown in Figures IV-15 and IV-16 of Appendix IV. The average 1975 derailment resulted in \$18,269 in equipment damages and \$7,034 in track damages. Both equipment and track dollar damages appear to display a log normal type of histogram in c.s.t.



1974 EQUIPMENT CAUSED ACCIDENTS  
DISTRIBUTION OF TOTAL \$ DAMAGE

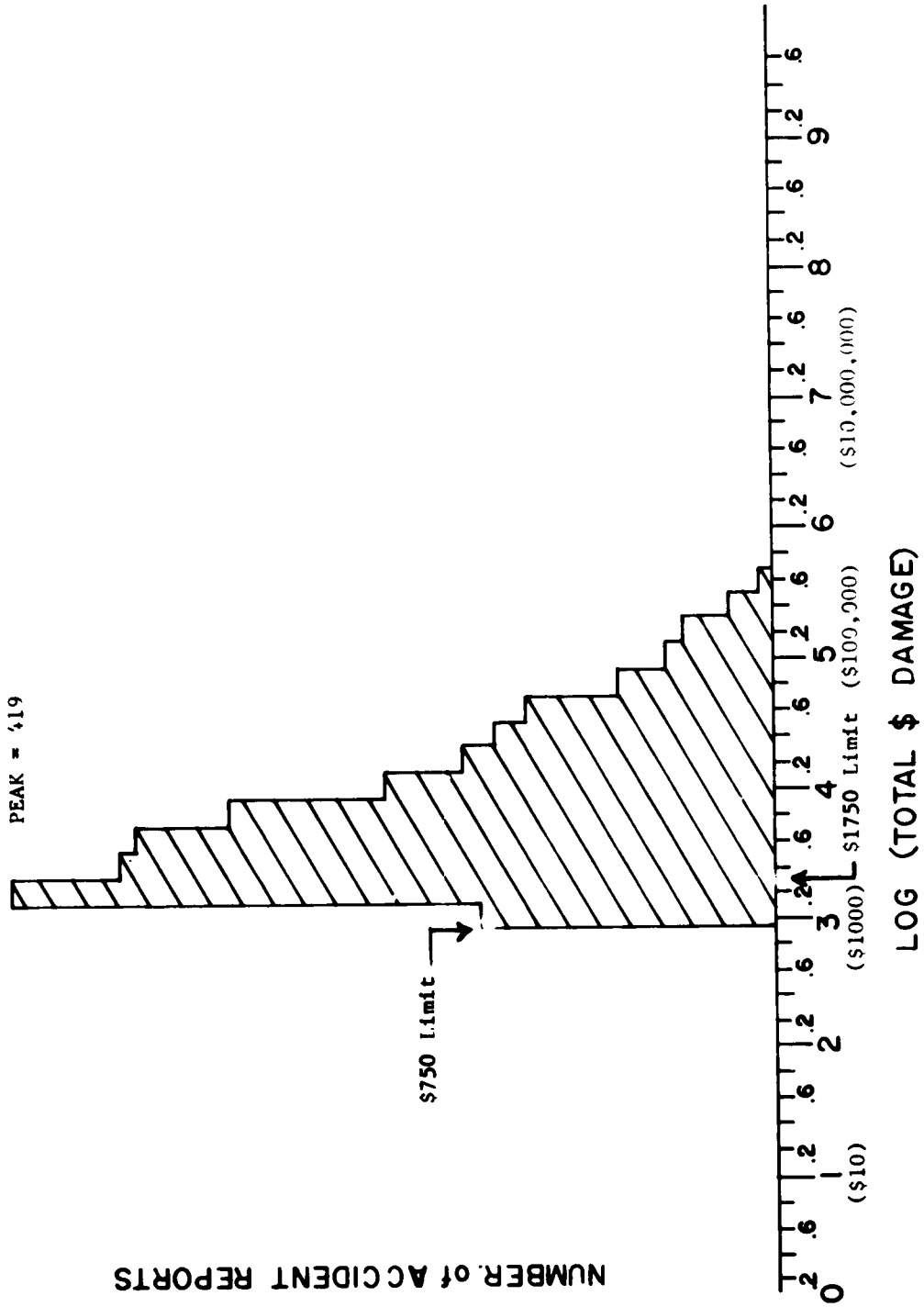

Fig. 4-9

TABLE 4-4

COMMENT SUMMARY OF HISTOGRAM DATA APPENDIX IV

Variable	Comments	Fig. #
Cars in Train	Average Train Length at Failure Time is 80 Cars	IV-1
Position 2	Most Accidents Occur at Random Points in the Train	IV-2
Cars in Train	Average Freight Train Length at Derailment Time is 90 cars	IV-3
Position 2	Most Accidents Occur at Random Points in the Train	IV-4
Position 2	Most Accidents Occur at Random Points in the Train	IV-5
# Cars Loaded	Average Number Loaded at Derailment Time is 52 Cars	IV-6
# Cars Empty	Average Number Empty at Derailment Time is 32 Cars	IV-7
# Cars Derailed	Average Derailment 6 cars: Most Frequent 2	IV-8
Track Density	Average Track Density at Accident Sites 20 Million Tons	IV-9
Derail Speed	Average Reported 21 mph. Most Frequent 6 mph	IV-10
Trailing Tons	Mean Trailing Tons at Accident Time, 5000 Tons	IV-11
Time	Most Accidents Occur at Random During the Day	IV-12
1974 \$ Damages	20% of Accidents Between \$750 and \$1750	IV-13
1973 \$ Damages	20% of Accidents Between \$750 and \$1750	IV-14
Equipment Damages	Average Dollar Loss = \$18,269	IV-15
Track Damages	Average Dollar Loss = \$7,034	IV-16

Several graphic plots from selected 1975 equipment-caused accident data are shown in Appendix V. Contained in tabular form in Table 4-5 are the important points to be noted from these displays.

Appendix VI is comprised of ten correlation matrices, each containing sixteen rows and columns. This appendix shows potential linear correlations for 1120 unique pairs of data variables. Only a few of the important conclusions to be drawn from these displays have been made. A summary of comments pertaining to the numeric data contained in this appendix is given in Table 4-6.

Each of the tables shown in Appendix VI is unique. The data tabulated comes from the subsets (cause codes) listed at the bottom of each of the correlation matrices printed. The tabulated correlation coefficients can be interpreted in two ways:

- a) On the magnitude of the value shown in each table, (numbers close to one represent high correlation between variables represented by the numbered rows and columns), or
- b) In comparison with the coefficients shown in the first table of the appendix, Table VI-1.

Since the first table of the appendix was calculated from all types of equipment failures, it represents a base line to which the other tables can be compared. A change in correlation coefficient between two pairs of variables from Table VI-1 and the same corresponding pairs in another table could mean that a different mode of failure is operating between those variables. For example, row-column element (4,12) in Table VI-1 is (.31). Row-column element (4,12) in Table VI-6 is (.51). Although the associations between the speed of the accident and the damage is positive, the loose wheel data (Table VI-6) shows a slightly higher strength of association than the average accident.

TABLE 4-5

COMMENT SUMMARY OF GRAPHIC PLOTS SHOWN IN APPENDIX V

Y-Variable	X-Variable	Comments	Fig. #
Total Damage	Speed, mph	Damages Increase with Speed	V-1
Equip. Damage	Speed, mph	Damages Increase with Speed	V-2
Derailed Cars	Speed, mph	Number of Derailed Cars Increases with Speed	V-3
Avg.&/Acc.	Speed	Average Damage/Accident Proportional to the Square of Speed	V-4
Cars Derailed	Damaged	Damage Proportional to Number Cars Derailed	V-5
Speed	Temp	Distribution Plot Comparing Bearing & Wheel Failures	V-6
Speed	Temp	Distribution Plot Comparing Bearing & Wheel Failures	V-7
Speed	Temp	Schematic of Information Shown in Previous Two Plots.	V-8

TABLE 4-6

COMMENT SUMMARY OF CORRELATION COEFFICIENTS APPENDIX VI

Type of Data	Comments	Fig. #
All Accident Codes	262 Freight Incidents	VI-1
Truck Body Defects	100 Freight Incidents	VI-2
Couplers	100 Freight Incidents	VI-3
Wheels Broke	100 Freight Incidents	VI-4
All Bearings	100 Freight Incidents (Position 2 as a %)	VI-5
All Bearings	100 Freight Incidents	VI-6
Journal Bearing Only	100 Freight Incidents	VI-7
Roller Bearing Only	61 Freight Incidents	VI-8
Wheel Flanges	96 Freight Incidents	VI-9
Wheels (Loose)	42 Freight Incidents	VI-10

## 5. ON-BOARD SYSTEM REQUIREMENTS

This section reviews the requirements of any system designed to protect freight cars from equipment failures. The requirements are discussed in terms of needs identified from the failure data reviewed, allowable costs, and the aspects of safety.

### 5.1 Systems Required by Data Reviewed

The review of equipment-caused accident data provided a definite basis for the types of protective elements most needed for today's freight carrying railcars. In order to provide a maximum reduction in the type of accidents that occur it would be necessary to develop devices which could protect those failures listed in Table 5-1. Listed in that table are the failures from a dollar loss and frequency standpoint.

Those railcar components which appear to require and be most suited for a protective system are:

1. Wheel bearings
2. Couplers/knuckles
3. Side bearings
4. Center plates, and
5. Wheels.

Schematically a potential protective system for the "worst" failures could be shown as in Figure 5-1. Shown in the figure is a single diagnostics control box which would provide power, signal monitoring, and alarm output in the case of a failure. Details of the operational characteristics of a feasible system design are discussed in Section 6.

### 5.2 System Analysis/Benefit Cost

Section 4.3 reviewed the dollar damages typically incurred from equipment-caused accidents. The average loss for the nine years cited was 41 million dollars per year. With a five-year payback and a 50% reduction in the top fifteen types of incidents, a reasonable cost for a protective system comes out to be \$58/railcar protected. A higher or lower allowable

TABLE 5-1

TYPE EQUIPMENT FAILURE PROTECTION SYSTEMS NEEDED

ACCIDENT FREQUENCY BASIS		
Description	Cause Code	Cum% Accs
Hot Journal Plain	451	10
Worn Flange	464	18
Coupler/Drawhead	432	26
Side Brg. Clearance	440	32
Side Brg. Broke	441	36
Truck Misc.	449	39
Hot Roller Brg.	452	42
Center Plate	424	45
Hose Burst	400	48
Center Plate Broke	423	50
Knuckle Broke	430	53
Loose Wheel	466	56
Rigging Down	405	58
Electrical Fire	474	60
Center S111 Broke	421	63

Total Accounted for 63%

COMPONENT OPERATIONAL FAILURE	ON-BOARD DETECTOR NEEDED
Hot Bearings	Thermal
Coupler Brake	Metal Fatigue
Side Bearing	Displacement
Center Plate	Wear
Wheel Loose	Displacement
Rigging Down	Displacement
Hose Burst	Fatigue
Bolster	Fatigue
Knuckles	Fatigue
Fire	Thermal
S111	Fatigue

TOTAL DAMAGE LOSS BASIS		
Cum% \$\$\$\$	Cause Code	Description
12	451	Hot Journal Plain
19	432	Coupler/Drawhead
25	452	Hot Roller Brg.
31	466	Loose Wheel
36	424	Center Plate
40	440	Side Brg. Clearance
44	449	Truck Misc.
48	461	Broken Rim
51	460	Broken Flange
54	423	Center Plate Broke
57	442	Truck Bolster
60	405	Rigging Down
63	441	Side Brg. Broke
65	465	Flange Therm/Flat
67	420	Body Bolster

67% Total Accounted for

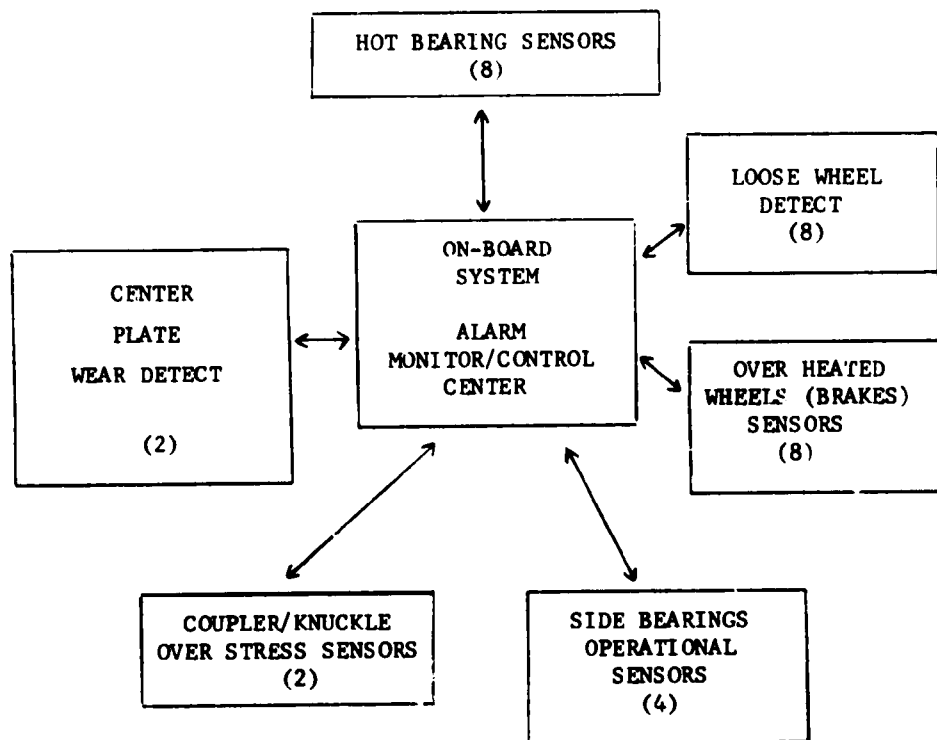

**Fig. 5-1 Schematic of Equipment Failure Protective System**



cost to deploy would result if different limits were assumed for the payback period or accident fraction reduced. In general, the allowable protective system costs can be fully bounded. Allowable system cost can be expressed as follows:

$$\left[ \begin{array}{l} \text{ALLOWABLE} \\ \text{COST TO} \\ \text{PROTECT} \\ \text{CAR} \end{array} \right] = \frac{\left( \begin{array}{l} \text{FRACTION} \\ \text{OF DAMAGE} \\ \text{PREVENTED} \end{array} \right) \left( \begin{array}{l} \text{COST} \\ \text{PER} \\ \text{ACCIDENT} \end{array} \right) \left( \begin{array}{l} \text{NUMBER} \\ \text{OF} \\ \text{ACCIDENTS} \\ \text{PER YEAR} \end{array} \right) \text{ YEARS} \\ \text{FOR SYSTEM} \\ \text{PAYBACK}}{\left( \begin{array}{l} \text{NUMBER OF CARS PROTECTED} \end{array} \right)}$$

If the following reasonable limits are assumed for each of the prescribed variables,

<u>DESCRIPTION</u>	<u>MINIMUM</u>	<u>MEAN</u>	<u>TYPICAL MAXIMUM</u>	<u>ABSOLUTE MAXIMUM</u>
Damage Fraction	.20	.50	.70	1.0
Cost/Acc	\$10,000	\$25,000	\$40,000	\$60,000
Number Accs/ Year	300	800	1,300	1,650
Payback Years	2	5	8	10
Cars Protected (millions)	.85	1.28	1.70	1.70
<u>[Allowable Car Protect Cost]</u>	<u>\$1.41</u>	<u>\$39.06</u>	<u>\$ 171</u>	<u>\$ 580</u>

it is seen that a wide range of allowable protection costs can be calculated. Unless one makes specific arguments in terms of safety factors, the available cost to deploy any protective car system is about \$200 or less per car.

The maximum dollar damage prevented, however, can be accomplished through judicious deployment of any system developed. From the cost/accident operational dependencies discussed in Section 4.3, it is apparent that some operating conditions result in a higher cost/accident than others. Those train cars expected to operate under high risk conditions should, obviously, be protected first. These would be cars expected to operate

1. at higher than average speeds
2. at higher loads
3. at low temperatures or in wet climates
4. within high density track systems

### 5.3 Safety Related Aspects

The development of a protective system for equipment-caused accidents is shown to be cost effective on the basis of the above discussion. Other aspects such as safety must also be considered. Protective systems are almost always implemented in an "after-the-fact" manner. The operation of any large piece of moving equipment requires continual care in order to decrease the chances of an accident happening. After a history of accidents has been established, people in general tend to favor systematic reduction of those accidents on the basis of safety or good judgment.

The main point of any implementation scheme on the basis of safety is:

"How much is the protective system worth in terms of the safety it provides?"

The answer to this question is extremely difficult and depends upon who is providing the response. No dollar value can be put on an accident which results in personal injury or death. This study has only provided answers to the cost benefits of the protective system in terms of the material losses.

## 6. CANDIDATE PROTECTION SYSTEMS

During the initial phases of this study a review of potential sensing techniques which could be applied to this work was reviewed. Table 6-1 is a correlation of sensing techniques that might be employed in on-board protective systems. Also shown in that figure are those techniques which are now used in either wayside or on-board protection systems. A review of the functional requirements imposed on the sensors and a schematic of six types of detectors follows.

### 6.1 Functional Design Requirements

6.1.1 Sensors. As discussed in Section 5.0, any system which could be employed in protecting freight cars from equipment failures must be cheap to produce. For this reason the six types of sensors proposed are intended to be as simple as possible. As summarized in Table 6-2, the main sensing scheme would be comprised of a set of continuity type (open or closed) switches. These switches (or sensors) would be activated in the event of a pending failure. The switch for each type of component protected would be normally closed. The normally closed position would insure a fail-safe signal and reflect any operational failure of the car component protected, if opened.

For example, an overheated bearing would be indicated by a thermally activated switch that would remain open after the bearing had exceeded some preselected temperature level. The activation level and specific thermal tripping method is at this point not important. Either an alloy which changes state or electronically activated element (thermistor) could be employed. The final selection would have to come from experimentation and reliability tests.

Wheels tend to fail operationally in two ways. Primarily wheels get loose or they become cracked from overheating. Two types of sensors are proposed for these failures. Loose wheels could be determined with a device which is attached to the inside of the wheel around the axle.

TABLE 6-1  
 APPLICABLE ON-BOARD SENSING METHODS

1975	Before 1975	On-board Method in Use Today	Continuity Check	Load Sending	Displace Sensor	Pressure Sensor	Wear Detection	Ultrasonic	Eddy Current	Capacitance	Vibration Detectors	Strain Sensor	Fiber Optics	Flow Sensors	Sonic Detectors	Reflectivity	Photoelectric	Phase Change Alloy	Piezoelectrics	Thermistors	Thermocouple
451,452	FRA ACCIDENT CODE*	●	0	0	0	0	0	0	0	0	0	0	0	0	0	0	0	●	0	0	0
464	2319	●	0	0	0	0	0	0	0	0	●	0	0	0	0	0	0	0	●	0	0
---	2314	●	0	0	0	0	0	0	0	0	0	0	0	0	0	0	0	0	0	●	0
442	4601	●	0	0	0	0	0	0	0	0	0	0	0	0	0	0	0	0	0	0	0
456	2207	●	0	0	0	0	0	0	0	0	0	0	0	0	0	0	0	0	0	0	0
432	2315	●	0	0	X	0	0	0	0	0	0	0	0	0	0	0	0	0	0	0	0
421,422	2609	●	0	0	0	0	0	0	0	0	0	0	0	0	0	0	0	0	0	0	0
443	2701	●	0	0	X	0	0	0	0	0	X	0	0	0	0	0	0	0	0	0	0
461,462,463	2201	●	0	0	X	0	0	0	0	0	X	0	0	0	0	0	0	0	0	0	0
453,454	2312	●	0	0	0	0	0	0	0	0	X	0	0	0	0	0	0	0	0	0	0
---	2318	●	0	0	0	0	0	0	0	0	0	0	0	0	0	0	0	0	0	0	0
440	2221	●	0	0	0	0	0	0	0	0	0	0	0	0	0	0	0	0	0	0	0
423	2212	●	0	0	0	0	0	0	0	0	0	0	0	0	0	0	0	0	0	0	0
405	2210	●	0	0	0	0	0	0	0	0	0	0	0	0	0	0	0	0	0	0	0
---	2510	●	0	0	0	0	0	0	0	0	0	0	0	0	0	0	0	0	0	0	0
434	2615	●	0	0	0	0	0	0	0	0	0	0	0	0	0	0	0	0	0	0	0
441	2611	●	0	0	0	0	0	0	0	0	0	0	0	0	0	0	0	0	0	0	0
433	2213	●	0	0	0	0	0	0	0	0	0	0	0	0	0	0	0	0	0	0	0
	2612	●	0	0	0	0	0	0	0	0	0	0	0	0	0	0	0	0	0	0	0

0 - Possible Scheme  
 ● - On-Board Technique Employed Today  
 X - Wayside Technique Available Today for Detection of Noted Failure Code  
 \* Top 18 Moving Equipment Failure Codes (60% of All Derailments 1974)  
 \*\* Top 20 Moving Equipment Failure Codes (67% of All Derailments 1975)

TABLE 6-2  
 RECOMMENDED  
 ON-BOARD PROTECTION  
 SYSTEM SENSORS

EQUIPMENT FAILURE TYPE	DESIGN APPROACH	ENGINEERING TECHNIQUE	SEE REPORT FAILURE #
BEARINGS Hot Journals Hot Roller Bearings	Thermal Overheat Sensor	Open-Close Switch Monitors	6-1 6-2
WHEELS (Loose) [ Thermal/Flat Cracked Rim Broken Rim ]	Wheel Position Sensor Wheel Position Sensor  Thermal Overheat Sensor (Brake System Location)	Open-Close Switch Monitors	6-3  6-4
COUPLER/KNUCKLE OVERSTRESS	Overstress/Impact Sensors	Integrate Impact Acceleration Time Signals. Chemi- cal, Time Integra- tors.	6-5
CENTER PLATE WEAR	Wear Detect Sensor	Open-Close Switch Monitors	6-6
SIDE BEARINGS MISSING	Presence Detector	Open-Close Switch Monitors	6-7

The purpose of the device would be to determine the presence of wheel motion relative to the axle. In its basic form the detector would remain inactive until the wheel slips on the axle. If any motion between the wheel and axle occurs, the detector (which could be spring loaded) would respond mechanically. The mechanical response would release a rod which would protrude perpendicularly from the axle. Since the axle is turning the protruding rod could be used to sever a loop in the sensing cable that is attached to the truck frame. The severed cable would provide an indication of the wheel being loose. Again use has been made of the open-closed switch to provide a measure of wheel integrity.

Thermally cracked wheels are a result of overheating from brakes. The presence of an overheated wheel could be established with the aid of a thermal detector placed on the brake shoe support head. In general, the same type of sensor used to indicate overheated bearings could be used here. A different level of thermal actuation may have to be established.

Couplers and knuckles are found to break and result in a reportable incident. If fatigue cracks occur resulting in a broken component, the failure is usually immediate. That is to say the time between the system being over stressed and the resultant accident is so small that no warning time is available.

Protection from this type of failure is extremely difficult. The following approach is recommended for helping overcome the "small time to failure" problem. It is recommended that overstress cycles be determined for the coupler/draw head unit. This would be established electronically with the aid of a small electrolytic integrator and a piezoelectric element such as an accelerometer. The passive piezoelectric unit would be designed to create a charge for every axial stress cycle in the coupler/knuckle assembly. The charge accumulated over each cycle would be bled off through a commercially available electrolytic integrator. These devices are commonly used as timers in the appliance industry and give an indication of the time it has been activated (usually through transfer of mercury through a small

capillary). An analog signal proportional to the number of overstress cycles could be read out at any time and evaluated for failure protection.

Center plates wear out. A protective collar of one loop of cable welded to the periphery of the truck center plate hole could be used to indicate excessive wear. A simple continuity check of the coaxial cable loop would provide the indicated integrity check on this failure point in the railcar. Again the normally closed switch technique would be used to indicate "good" operation.

Side bearings when missing cause accidents. Knowledge of their presence would be one indication of proper operation. It is recommended that a coaxial cable be attached to the upper body of the side bearing guide. Loss of the side bearing roller or insert would crush the cable causing an indication of improper operation (loss of electrical continuity).

6.1.2 Protection System Alarm, Monitor, and Control Center. Each car as discussed would be protected from the six basic failure modes with the aid of the sensors discussed above. These sensors would require a central power, diagnostics, and alarm center. It is expected that each car would require such a unit. The central monitor unit would consist of the following components.

- a) Sensor connecting points,
- b) Continuity and stress cycle monitoring,
- c) Radio signal alarming (frequency coded),
- d) Battery or power supply,
- e) Operational condition readout points, and
- f) Enclosure box.

Different levels of signal alarming could be used. Those sensing points deemed to be most critical (hot bearings or loose wheels) would provide a specific coded frequency signal that would represent a more urgent warning than say the side bearing sensors. The less critical failures might be monitored on a periodic basis. For instance, when the train is made up or when it arrived at a switching yard.

The periodic monitoring could be performed with either of two methods. For periodic monitoring, a specific signal readout mode would be activated electronically from a master alarm monitoring unit placed in the lead power car. Or periodic readout might be available to walk-around crews in certain switch yards. Readout in this mode would be made by plugging into the operational condition readout points of the sensor monitor box. The walk-around type of readout could also be used to check the performance of the monitoring box electronics, as well as the condition of the railcar components protected. Since the monitor placed on each car would require some kind of power, it is suggested that one of two types be used.

- a) Long life batteries, or
- b) Rectified piezoelectric power sources.

In either case, low power consumption would be most desired. If batteries were used, then two modes of signal sensing should be used. The monitor should only be activated while the railcar is under motion and last for only a short period after the railcar comes to a halt. In addition, the circuitry could be constructed so that only the sensors would be powered until a failure is noted. At this point the radio signal warning circuitry would be activated. On and off control of the sensing system could be derived from the acceleration (vibration) signal of the coupler protection sensor.

If monitoring power were derived from some piezoelectric source it would automatically shut down when car movement stopped. This type of power source would derive its energy from the vibrations inherent in the moving railcar.

## 6.2 Schematic Representation of Required Designs

Each of the six proposed sensors discussed in Section 6.1.1 are shown in Figures 6-1 through 6-7.



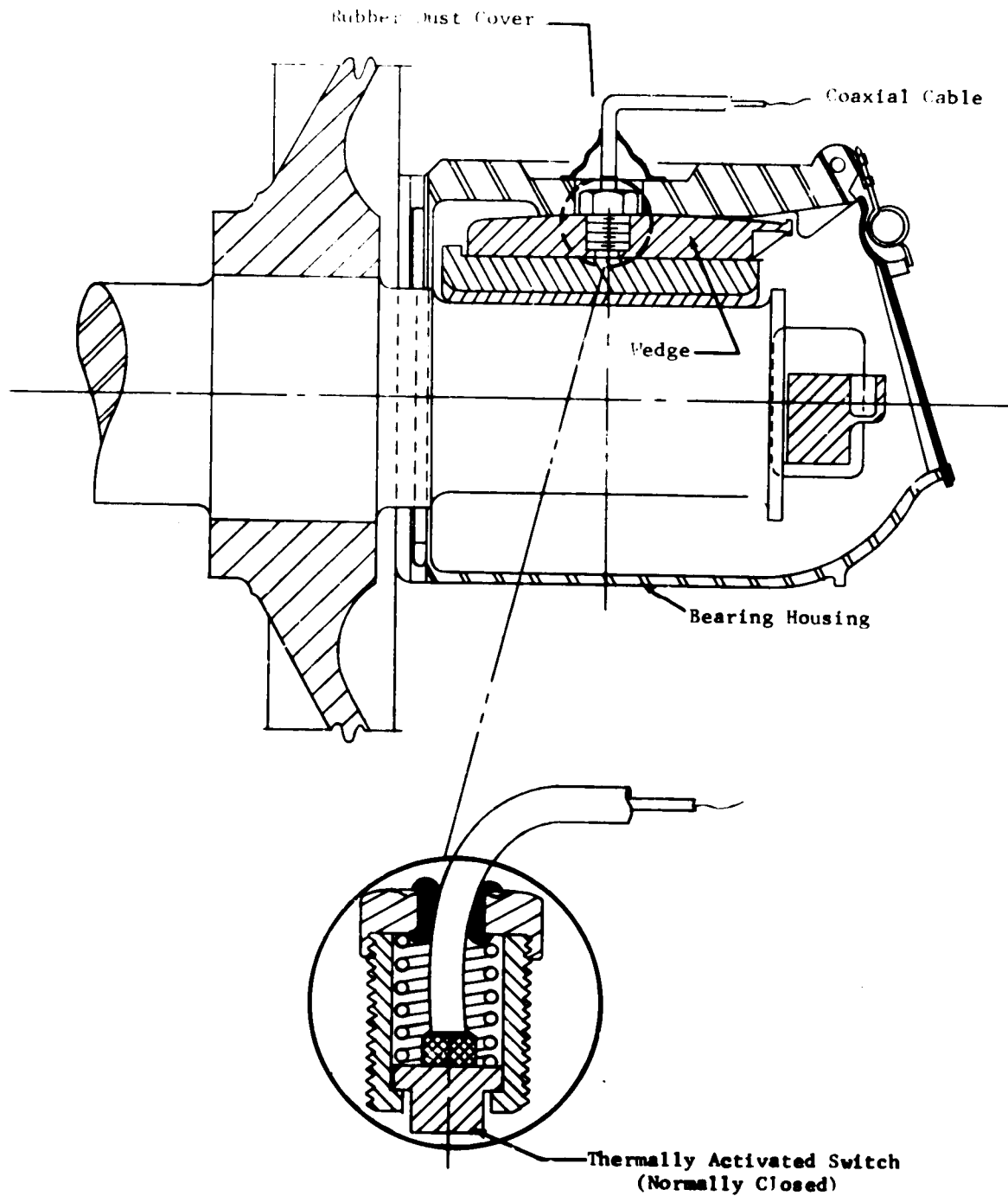

Fig. 6-1 Overheated Journal Sensor

This sensor installation scheme is an artist conception and is for illustration purposes only. This figure is not meant to represent actual or proposed railroad engineering design.

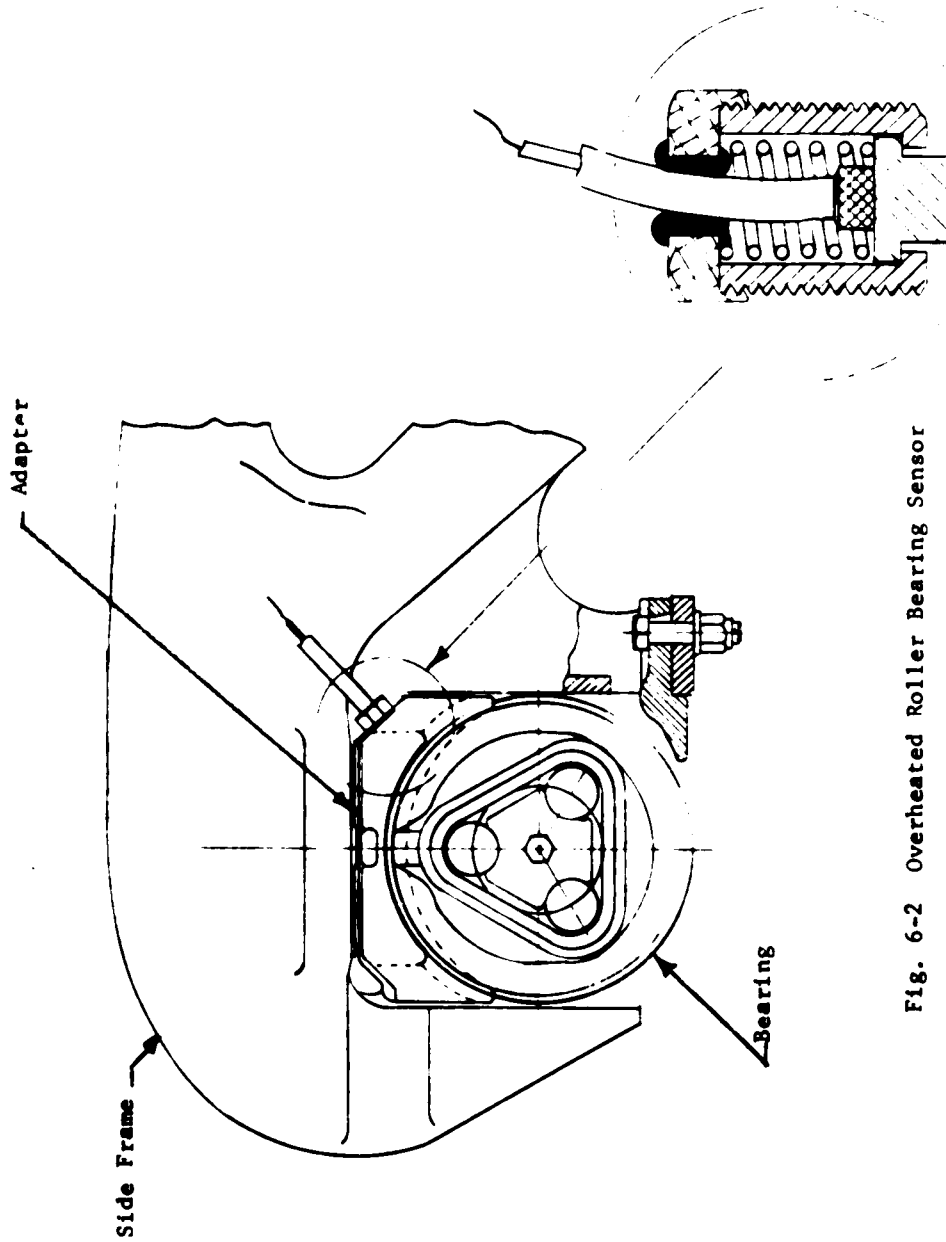

Fig. 6-2 Overheated Roller Bearing Sensor

This sensor installation scheme is an artist conception and is for illustration purposes only. This figure is not meant to represent actual or proposed railroad engineering design.

Sensor

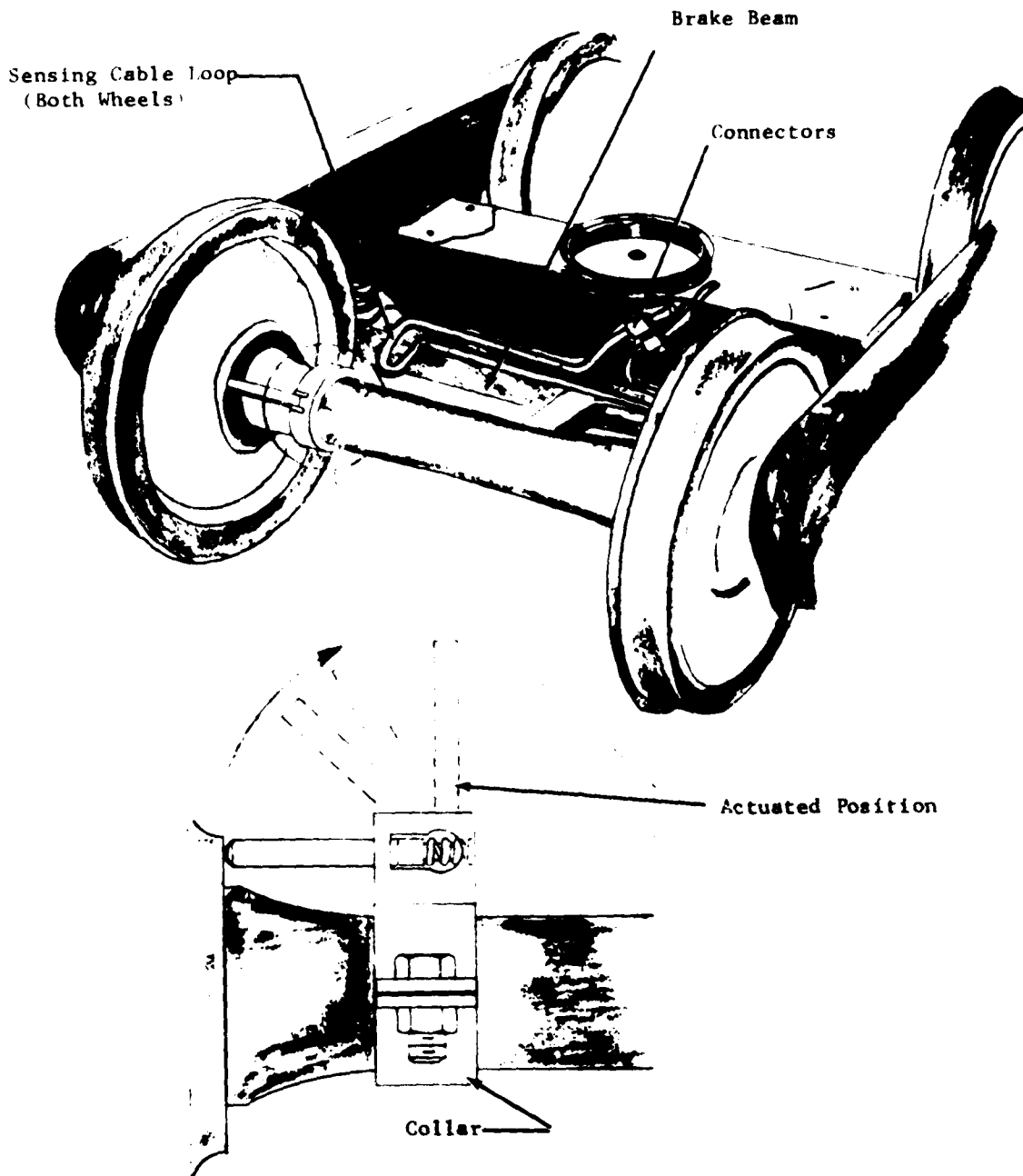

Fig. 6-3 Loose Wheel Detector

This sensor installation scheme is an artist conception and is for illustration purposes only.

This figure is not meant to represent actual proposed railroad engineering design.

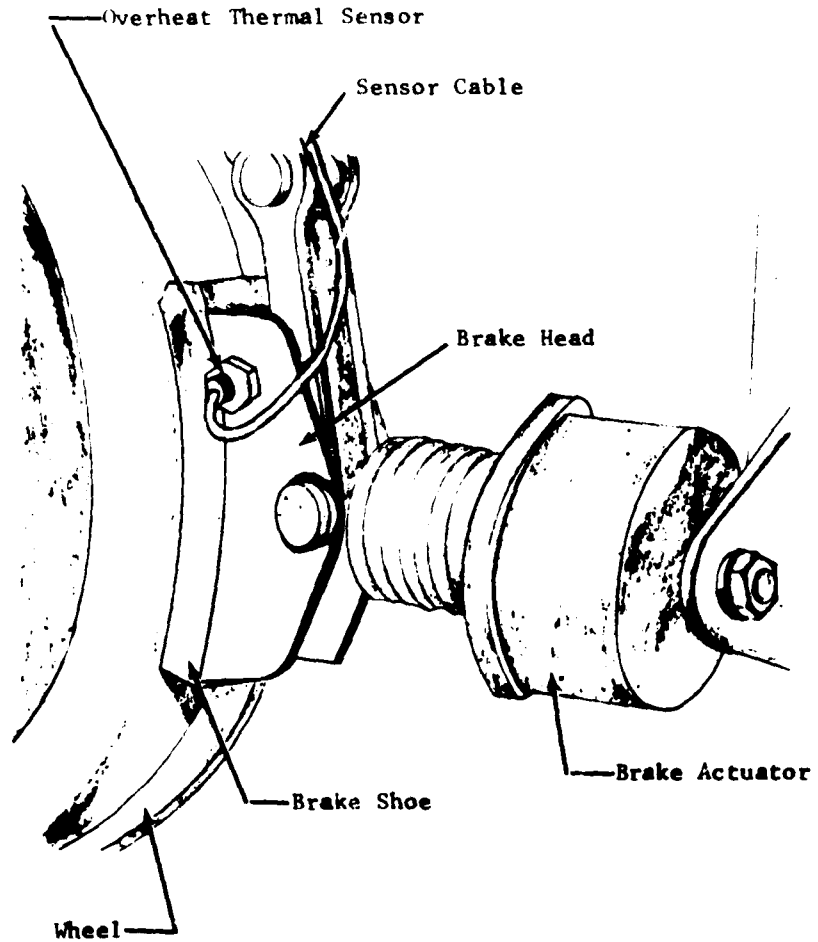

Fig. 6-4 Thermal Overheat Sensor. Detector for Indicating Wheel Overheating.

This sensor installation scheme is an artist conception and is for illustration purpose only. This figure is not meant to represent actual or proposed railroad engineering design.

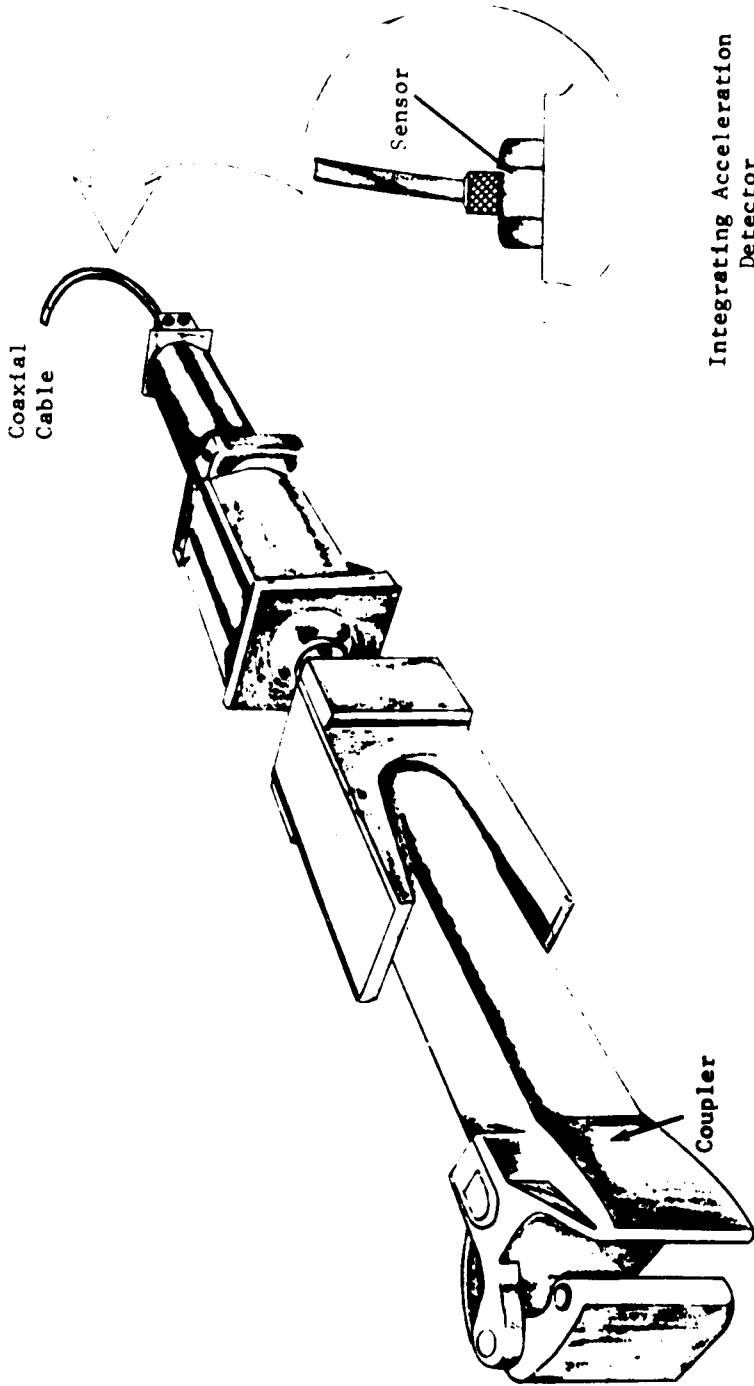

Fig. 6-5 Coupler/Knuckle Overstress Cycle Sensor

This sensor installation scheme is an artist conception and is for illustration purposes only. This figure is not meant to represent actual or proposed railroad engineering design.

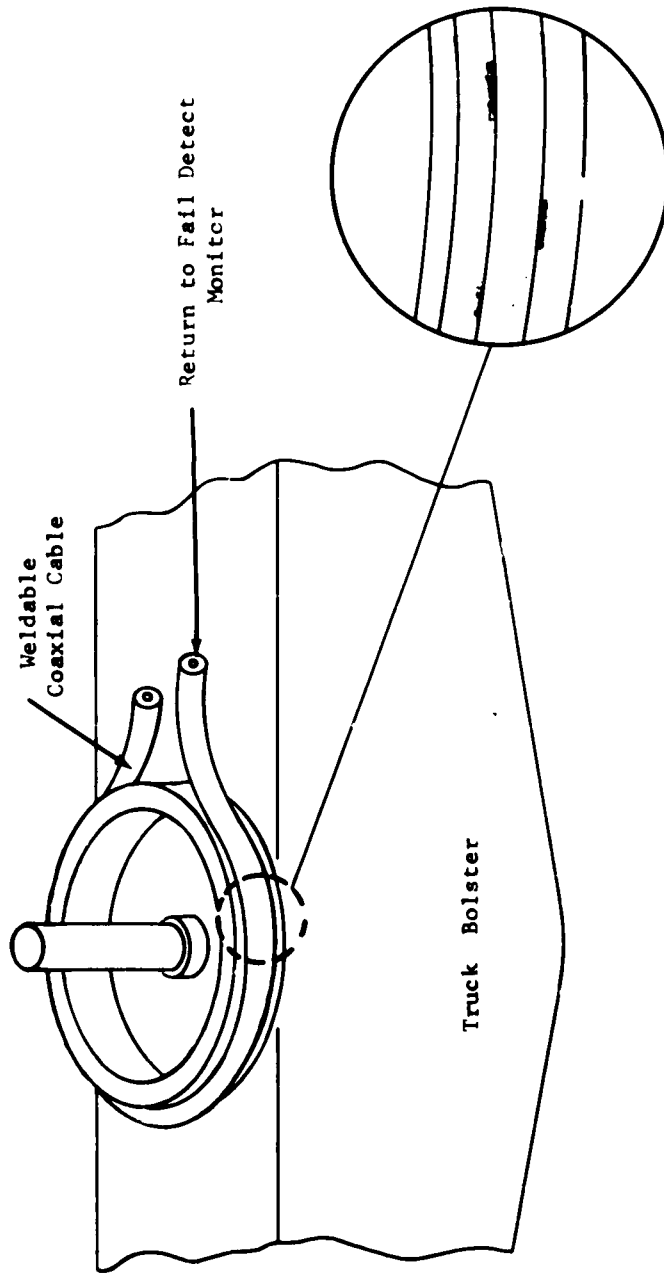

Fig. 6-6 Center Plate Wear/Integrity Sensor

This sensor installation scheme is an artist conception and is for illustration purposes only. This figure is not meant to represent actual or proposed railroad engineering design.

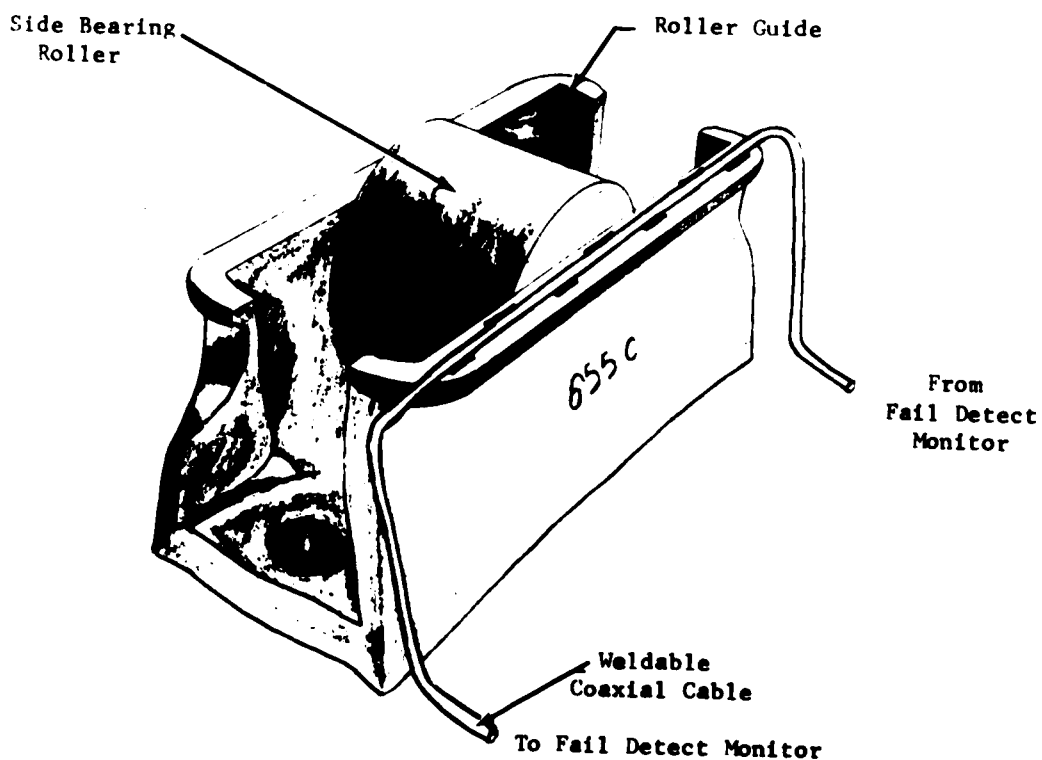

Fig. 6-7 Side Bearing Fail Detect Sensor

**Note:** Crushed Cable Indicates Failure of Side Bearing  
This sensor installation scheme is an artist conception and is for illustration purposes only. This figure is not meant to represent actual or proposed railroad engineering design.

7. CONCLUSIONS AND RECOMMENDATIONS

On-board protective systems built and deployed for less than \$58/railcar protected could be a cost effective way of reducing railway equipment caused accidents.

Equipment caused railroad accident types now protected by some wayside detection schemes could be further reduced in number if an on-board protective system were deployed.

A development effort in the area of on-board sensor technology is recommended. A recommended effort is directed toward the production of a multi-sensor protection system which could provide a maximum reduction in equipment failures while also being cost effective.

During this study existing on-board failure detection systems were reviewed. Systems found to be available for protecting freight cars were all in the development stage.

An on-board sensing protection system would need 20 or more sensors to effectively reduce the 15 most common and most costly equipment failures that occur.

Time trend data implies that derailments will tend to increase in the near future.



8. REFERENCES

1. FRA Guide for Preparing Accident/Incident Reports, DOT, FRA, 1975 Edition.
2. Wayside Derailment Inspection Requirements Study for Railroad Vehicle Equipment, J. L. Frarey, R. L. Smita, and A. I. Krauter, Report No. FRA/ORD-77/18, Prepared for DOT, FRA, May, 1977.
3. Yearbook of Railroad Facts, 1977.
4. FRA Accident/Incident Bulletin, 1975 Issue.

**APPENDIX I**

**CAUSE CODE COMPARISON LIST**

TABLE I-1

COMPARISON OF 1975 CAUSE CODES  
WITH PREVIOUS CAUSE CODES FOR YEAR 1974

Pre 1975		1975	
Cause Code	Description	1974 Derailments	Cause Code Description
2101	Crank case and air box explosions	0	472L Crank case or air box explosions
2102	Internal combustion engine	0	-----
2103	Generators and motor generator sets	0	-----
2104	Traction motor armature bearing fail.	8	471L Traction motor failure
2105	Other traction motor failures		
2106	Current collector systems	0	475L Current collector systems
2107	Electrical control and conversion	1	476L Remote control equipment
2108	Hyd., mech. power trans. to axle	0	-----
2110	Fires from short circuits	0	474L Electrically caused fire
2111	Fire from fuel or lube oil	0	473L Oil fire
2112	Other fires	0	-----
2113	Fumes from internal combustion engine	0	-----
-----	-----	0	-----
2188	Other defects	6	470L Running gear failure
			479L Cause code not listed
2201	Truck side frame, bent or broken	28	443 Side frame broken
2202	Equalizer bent or broken	7	-----
2203	Pedestal tire bar		
2204	Journal bearing nonintegral		
2205	Journal bearing assembly - inc. fires	56	442 Truck bolster broken
2206	Trancon, bent or broken		
2207	Truck bolster bent or broken	1	-----
2208	Truck bolster anchor	65	423 Center plate broken
2209	Subbing device		
2210	Center plate		
2211	Center pin broken or missing	45	425 Center pin broken or missing

TABLE I-1 (Continued)

Pre 1975		1975		
Cause Code	Description	1974 Derailments	Cause Code	Description
2212	Side bearing clearance	67	440	Side bearing clearance
2213	Side bearing broken or missing	112	441	Side bearing broken or missing
2214	Spring plank	}	---	-----
2215	Spring hanger			
2216	Spring hanger pin			
2217	Spring or snubber			
2218	Spring seat			
2219	Truck safety hanger	62	---	-----
2220	Inefficient weight on wheel	}	---	-----
2221	Truck stiff			
2288	Other truck defects			
2301-	Cast iron wheels	0	---	-----
2304	Cast steel wheel (CSW) flange broken	}	460	Broken flange
2305	Wrought steel wheel (WSW) flange bkn.			
2306	CSW tread or rim	}	465	Damaged tread or flange thermal/flat
2310	WSW tread or rim			
2307	CSW broken overheated	}	461	Broken rim
2308	CSW broken other causes			
2311	WSW broken overheated			
2312	WSW broken other causes	}	464	Worn flange or tread
2314	Flange worn			
2315	Loose wheel	49	466	Loose wheel
2316	Tire loose or broken	3	---	-----
2313	Wheel, other or unknown broken	}	469	Cause code not listed
2387	Other defects in wheels			
2317	Axle broken between journals	20	450	Axle broken or bent between wheels
2318	Journal broken cold	}	453	Journal fractured - new cold break

TABLE I-1 (Continued)

Cause Code	Description	1975		Cause Code	Description
		Pre J1975	1974 Derailments		
2319	Journal broken, overheated		323	{ 451	Journal (plain) overheated
				{ 452	Journal (roller) overheated
2388	Other defects in axles		11	459	Cause code not listed
2401	Air compressor				
2402	Air reservoir or fittings				
2406	Air brake parts falling off				
2407	Air brake sticking				
2408	Air brake defective - snow, ice				
2409	Air brake failure - excessive piston travel		46	403	Other brake components damaged, worn, broken, disconnected
2410	Triple valve lazy, etc.				
2501	Brake beam, broken, displaced				
2504	Brake hanger, broken, disconnected				
2507	Brake shoe, worn, broken, or missing				
2403	Air brake control valve		1	404	Brake valve malfunction
2404	Brake pipe or fittings		10	{ 401	Broken brake pipe
				{ 402	Obstructed brake pipe
2405	Air brake hose burst or broken		38	400	Air or hyd. hose burst or uncoupled
2502	Brake chains				
2503	Brake chains kinking		10	407	Hand brake linkage
2505	Brake rod				
2506	Brake shaft				
2508	Brake wheel loose		0	406	Hand brake defective
2509	Pawl or ratchet				
2510	Brake rigging coming down		45	405	Rigging down or dragging
2511	No brake on car				
2512	Insufficient braking power				
2488	Other air brake defects		19	409	Cause code not listed
2588	Other defects in fluid braker, etc.				

TABLE I-1 (Continued)

Cause Code	Description	1975		Cause Code	Description
		Pre 1975	1975		
		Derailments			
2601	Coupler broken - not out	}	146	{ 432	Coupler or drawhead broken
2609	Coupler				
2610	Coupler rivets	}	6	430	Knuckle broken or defective
2698	Other defects in couplers				
2605	Knuckle broken or defective	}	18	431	Coupler mismatch high, low
2606	Knuckle lock or lock lift				
2602	Coupler improper height	}	36	433	Coupler retainerpin/cross key missing
2612	Coupler key				
2613	Coupler key retainer	}	45	434	Draft gear mechanism
2608	Friction buffer of diaphragm				
2616-	Draft gear carrier	}	22	{ 435	Coupler carrier
2618	Other draft gear parts				
2611	Coupler yoke	}	25	-----	-----
2687	Other defects - draft gear				
2614	Striking casting or coupler carrier	}	4	-----	-----
2603	Jackknifing				
2604	Couplers passing	}	3	-----	-----
2607	Uncoupling device				
2615	Sills or draft lugs	}	90	-----	-----
2617	Cushion underframe				
2688	Other defects in cushion underframe		0	439	Cause code not listed
2701	Sills, bent or broken	}	44	{ 421	Center sill
2702	Body bolster				
2703	Other underframe parts	}	26	422	Draft sill
2704	Sides spreading, etc.				
2705	Drop end falling off	}	43	-----	-----
2706	Floor - material falling through				
2707	Side door falling off	}	-----	-----	-----
2708	Drop door open or defective				
2709	Hatch - dome, etc.	}	-----	-----	-----
2710	Stake pocket or hood retainer				

TABLE I-1 (Continued)

Pre 1975		1975	
Cause Code	Description	1974 Derailments	Cause Code Description
2788	Other defects in car structure	--	424 Center plate disengaged - off center
2801	Other parts of equipment	10	429 Cause code not listed
2888		28	---
4501	Worn flange and switch pt.	139	---
4502	Worn flange and switch & freq. too close		
4503	Worn flange improper surface of track		
4504	Worn flange tight gage of track		
4505	Worn flange improper leading of car		
4506	Truck stiff, switch pt. worn		
4507	Truck stiff, improper surface of track		
4508	Truck stiff, tight gage of track	134	---
4509	Truck stiff, improper leading		
4510	Truck stiff, wheel flange surface		
4511	Side brg. clearance & track surface		
4512	Side brg. clearance superelevation		
4513	Side brg. clearance loading of car		
4601	Rocking and swaying of car		
4588	Other combinations		

**APPENDIX II**

**COMPUTER CODED DATA FIELDS REVIEWED**



TABLE II-1

FIELD DEFINITION TABLE DATA

FIELD NAME	TYPE	MAXIMUM LENGTH	- POSITION -	
			START	END
AMTRAK	Fixed	1	1	1
INCIDENT	Fixed	18	2	19
1YR	Fixed	2	2	3
1MO	Fixed	2	4	5
RAILROAD	Fixed	4	6	9
INCDTNO	Fixed	10	10	19
INCDT2	Fixed	18	20	37
1YR2	Fixed	2	20	21
1MO2	Fixed	2	22	23
RR2	Fixed	4	24	27
INCDTNO2	Fixed	10	28	37
ICDT3	Fixed	18	38	55
1YR3	Fixed	2	38	39
1MO3	Fixed	2	40	41
RR3	Fixed	4	42	45
INCDTNO3	Fixed	10	46	55
GXID	Fixed	11	56	66
DATE	Fixed	6	67	72
YEAR	Fixed	2	67	68
MONTH	Fixed	2	69	70
DAY	Fixed	2	71	72
TIME	Fixed	6	73	78
HRMIN	Numeric	4	73	77
AMPM	Fixed	2	77	78
TYPE	Fixed	2	79	80
CARS	Numeric	3	81	83
CARS-DMG	Numeric	3	84	86
CARS-HZD	Numeric	3	87	89
EVACUATE	Numeric	6	90	95
DIVISION	Variable	20	251	270
STATION	Variable	20	271	290
MILEPOST	Fixed	6	96	101
STATE	Fixed	2	102	103
TEMP	Numeric	3	104	106
VISIBLTY	Fixed	1	107	107
WEATHER	Fixed	1	108	108
METHOD	Fixed	2	291	316
SPEED	Numeric	3	109	111
TYP-SPD	Fixed	1	112	112
TRN-NBR	Fixed	4	113	116
TRN-DIR	Fixed	1	117	117
TONS	Numeric	5	118	122
TYP-EQ	Fixed	1	123	123
EQ-ATT	Fixed	1	124	124
TRK-NAME	Variable	20	317	336

## FIELD DEFINITION TABLE DATA (continued)

FIELD NAME	TYPE	LENGTH	-POSITION-	
			START	END
TRK-CLAS	Fixed	1	125	125
TRKDNSTY	Fixed	6	126	131
TYP-TRK	Fixed	1	133	132
CARUNIT1	Fixed	14	133	146
RRCAR1	Fixed	4	133	136
CARNBR1	Fixed	6	137	142
POSITION1	Fixed	3	143	145
LOADED1	Fixed	1	146	146
CARUNIT2	Fixed	14	147	160
RRCAR2	Fixed	4	147	150
CARNBR2	Fixed	6	151	156
POSITION2	Fixed	3	157	159
LOADED2	Fixed	1	160	160
LOC1-TRN	Fixed	5	161	165
HEADEND1	Numeric	1	161	161
MID-MAN1	Numeric	1	162	162
MID-REM1	Numeric	1	163	163
R-MAN1	Numeric	1	164	164
R-REM1	Numeric	1	165	165
LOC2-DER	Fixed	5	166	170
HEADEND2	Numeric	1	166	166
MID-MAN2	Numeric	1	167	167
MID-REM2	Numeric	1	168	168
R-MAN2	Numeric	1	169	169
R-REM2	Numeric	1	170	179
CARSEQP1	Fixed	15	171	185
LOAD-F1	Numeric	3	171	173
LOAD-P1	Numeric	3	174	176
EMPTY-F1	Numeric	3	177	179
EMPTY-P1	Numeric	3	180	182
CABOOSE1	Numeric	3	183	185
CARSDER2	Fixed	15	186	200
LOAD-F2	Numeric	3	186	188
LOAD-P2	Numeric	3	189	191
EMPTY-F2	Numeric	3	192	194
EMPTY-P2	Numeric	3	195	197
CABOOSE2	Numeric	3	198	200
EQP-DMG	Numeric	7	201	207
TRK-DMG	Numeric	7	208	214
CAUSE	Fixed	4	215	218
CAUSE-1	Fixed	1	215	215
CAUSE-2	Fixed	2	215	216
CAUSE-3	Fixed	3	215	217

## FIELD DEFINITION TABLE DATA (continued)

FIELD NAME	TYPE	LENGTH	- POSITION -	
			START	END
CAUSE2	Fixed	4	219	222
CAUSE2-1	Fixed	2	219	219
CAUSE2-2	Fixed	2	219	220
CAUSE2-3	Fixed	3	219	221
CSE-DESC	Variable	40	337	376
TOTINJ	Numeric	4	223	226
DAYS-DIS	Numeric	6	227	232
TOTKLD	Numeric	4	233	236
ENGRS	Numeric	1	237	237
FIREMEN	Numeric	1	238	238
CONDUCTR	Numeric	1	239	239
BRAKEMEN	Numeric	1	240	240
ENGTIME	Numeric	4	241	244
CDTRTIME	Numeric	4	245	248
JOINT-CD	Fixed	1	249	249
REGION	Fixed	1	250	250

All fields are left justified.

DEPARTMENT OF TRANSPORTATION RAIL EQUIPMENT ACCIDENT/INCIDENT REPORT

FORM APPROVED  
DUE TO CHANGE

1. NAME OF RAILROAD OR EQUIPMENT OPERATOR		2. RAILROAD		3. RAILROAD EQUIPMENT NO.	
4. NAME OF RAILROAD EQUIPMENT		5. RAILROAD EQUIPMENT NO.		6. RAILROAD EQUIPMENT NO.	
7. NAME OF RAILROAD EQUIPMENT		8. RAILROAD EQUIPMENT NO.		9. RAILROAD EQUIPMENT NO.	
10. NAME OF RAILROAD EQUIPMENT		11. RAILROAD EQUIPMENT NO.		12. RAILROAD EQUIPMENT NO.	
13. NAME OF RAILROAD EQUIPMENT		14. RAILROAD EQUIPMENT NO.		15. RAILROAD EQUIPMENT NO.	
16. NAME OF RAILROAD EQUIPMENT		17. RAILROAD EQUIPMENT NO.		18. RAILROAD EQUIPMENT NO.	
19. NAME OF RAILROAD EQUIPMENT		20. RAILROAD EQUIPMENT NO.		21. RAILROAD EQUIPMENT NO.	
22. NAME OF RAILROAD EQUIPMENT		23. RAILROAD EQUIPMENT NO.		24. RAILROAD EQUIPMENT NO.	
25. NAME OF RAILROAD EQUIPMENT		26. RAILROAD EQUIPMENT NO.		27. RAILROAD EQUIPMENT NO.	
28. NAME OF RAILROAD EQUIPMENT		29. RAILROAD EQUIPMENT NO.		30. RAILROAD EQUIPMENT NO.	
31. NAME OF RAILROAD EQUIPMENT		32. RAILROAD EQUIPMENT NO.		33. RAILROAD EQUIPMENT NO.	
34. NAME OF RAILROAD EQUIPMENT		35. RAILROAD EQUIPMENT NO.		36. RAILROAD EQUIPMENT NO.	
37. NAME OF RAILROAD EQUIPMENT		38. RAILROAD EQUIPMENT NO.		39. RAILROAD EQUIPMENT NO.	
40. NAME OF RAILROAD EQUIPMENT		41. RAILROAD EQUIPMENT NO.		42. RAILROAD EQUIPMENT NO.	
43. NAME OF RAILROAD EQUIPMENT		44. RAILROAD EQUIPMENT NO.		45. RAILROAD EQUIPMENT NO.	
46. NAME OF RAILROAD EQUIPMENT		47. RAILROAD EQUIPMENT NO.		48. RAILROAD EQUIPMENT NO.	
49. NAME OF RAILROAD EQUIPMENT		50. RAILROAD EQUIPMENT NO.		51. RAILROAD EQUIPMENT NO.	
52. NAME OF RAILROAD EQUIPMENT		53. RAILROAD EQUIPMENT NO.		54. RAILROAD EQUIPMENT NO.	
55. NAME OF RAILROAD EQUIPMENT		56. RAILROAD EQUIPMENT NO.		57. RAILROAD EQUIPMENT NO.	
58. NAME OF RAILROAD EQUIPMENT		59. RAILROAD EQUIPMENT NO.		60. RAILROAD EQUIPMENT NO.	
61. NAME OF RAILROAD EQUIPMENT		62. RAILROAD EQUIPMENT NO.		63. RAILROAD EQUIPMENT NO.	
64. NAME OF RAILROAD EQUIPMENT		65. RAILROAD EQUIPMENT NO.		66. RAILROAD EQUIPMENT NO.	
67. NAME OF RAILROAD EQUIPMENT		68. RAILROAD EQUIPMENT NO.		69. RAILROAD EQUIPMENT NO.	
70. NAME OF RAILROAD EQUIPMENT		71. RAILROAD EQUIPMENT NO.		72. RAILROAD EQUIPMENT NO.	
73. NAME OF RAILROAD EQUIPMENT		74. RAILROAD EQUIPMENT NO.		75. RAILROAD EQUIPMENT NO.	
76. NAME OF RAILROAD EQUIPMENT		77. RAILROAD EQUIPMENT NO.		78. RAILROAD EQUIPMENT NO.	
79. NAME OF RAILROAD EQUIPMENT		80. RAILROAD EQUIPMENT NO.		81. RAILROAD EQUIPMENT NO.	
82. NAME OF RAILROAD EQUIPMENT		83. RAILROAD EQUIPMENT NO.		84. RAILROAD EQUIPMENT NO.	
85. NAME OF RAILROAD EQUIPMENT		86. RAILROAD EQUIPMENT NO.		87. RAILROAD EQUIPMENT NO.	
88. NAME OF RAILROAD EQUIPMENT		89. RAILROAD EQUIPMENT NO.		90. RAILROAD EQUIPMENT NO.	
89. NAME OF RAILROAD EQUIPMENT		90. RAILROAD EQUIPMENT NO.		91. RAILROAD EQUIPMENT NO.	
90. NAME OF RAILROAD EQUIPMENT		91. RAILROAD EQUIPMENT NO.		92. RAILROAD EQUIPMENT NO.	
91. NAME OF RAILROAD EQUIPMENT		92. RAILROAD EQUIPMENT NO.		93. RAILROAD EQUIPMENT NO.	
92. NAME OF RAILROAD EQUIPMENT		93. RAILROAD EQUIPMENT NO.		94. RAILROAD EQUIPMENT NO.	
93. NAME OF RAILROAD EQUIPMENT		94. RAILROAD EQUIPMENT NO.		95. RAILROAD EQUIPMENT NO.	
94. NAME OF RAILROAD EQUIPMENT		95. RAILROAD EQUIPMENT NO.		96. RAILROAD EQUIPMENT NO.	
95. NAME OF RAILROAD EQUIPMENT		96. RAILROAD EQUIPMENT NO.		97. RAILROAD EQUIPMENT NO.	
96. NAME OF RAILROAD EQUIPMENT		97. RAILROAD EQUIPMENT NO.		98. RAILROAD EQUIPMENT NO.	
97. NAME OF RAILROAD EQUIPMENT		98. RAILROAD EQUIPMENT NO.		99. RAILROAD EQUIPMENT NO.	
98. NAME OF RAILROAD EQUIPMENT		99. RAILROAD EQUIPMENT NO.		100. RAILROAD EQUIPMENT NO.	

TABLE II-2

## FIRST SET OF ACCIDENT DATA VARIABLES USED IN REVIEW

<u>Column Position</u>	<u>Maximum Numeric Length</u>	<u>Description of Stored Data</u>
1	4	Time of Day (converted to minutes from midnight)
5	3	Temperature (degrees F)
8	1	Visibility - one digit code
9	1	Weather - one digit code
10	3	Speed, miles per hour
13	5	Trailing Tons
18	3	Position 1
21	3	Position 2
24	3	Number of Cars Loaded
27	3	Number of Cars Empty
30	3	Numbers of Cars Loaded that Derailed
33	3	Number of Cars Empty that Derailed
36	7	Dollars Equipment Damage
43	7	Dollars Track Damage
50	4	Cause Code
54	1	Number of Engineers
55	1	Number of Conductors
56	1	Number of Brakemen
57	4	Time in Minutes Engineers on Duty

TABLE II-3

## SECOND SET OF ACCIDENT VARIABLES USED IN REVIEW

<u>Column Position</u>	<u>Maximum Numeric Length</u>	<u>Description of Stored Data</u>
1	4	Second Cause Code (if applicable)
5	3	Temperature
8	1	Visibility - one digit code
9	1	Weather - one digit code
10	3	Speed, miles per hour
13	5	Trailing Tons
18	3	Position 1, first car involved
21	3	Position 2, causing car unit
24	3	Number of Cars Loaded
27	3	Number of Cars Empty
30	3	Numbers of Cars Loaded that Derailed
33	3	Number of Cars Empty that Derailed
36	7	Dollars Equipment Damage
43	7	Dollars Track Damage
50	4	Primary Cause Code
54	1	Type Equipment Freight/Passenger, etc.
55	1	Type Accident Derail, Collision, etc.
56	1	Loaded at Position 1 Yes/No
57	1	Loaded at Position 2 Yes/No
58	1	Track Type; main, yard, etc.
59	6	Track Density, gross tons

TABLE II-4

## THIRD SET OF ACCIDENT DATA VARIABLES USED IN REVIEW

Column Position	Maximum Numeric Length	Description of Stored Data
1	2	State, 2 digit code
3	3	Number of Accidents in State
6	3	Temperature (degrees F)
9	1	Visibility - one digit code
10	1	Weather - one digit code
11	3	Speed, miles per hour
14	5	Trailing Tonnage
19	3	#Days in 1975 with 7.01 inches rain
22	3	Position 2, causing car unit
25	3	Number Cars in Train
28	3	Number Cars Derailed
31	3	Average Rainfall in that State (inches)
34	3	'75 Rainfall in that State (inches)
37	7	Total Dollars Damage
44	3	Cause Code of Accident
47	3	Number of '75 Accidents in Cause
50	1	Type Equipment, freight, etc.
51	1	Type Accident, derail, etc.
52	6	Track Density, Gross Tonnage
58	7	Blanks

TABLE II-5

## STATES BY CODED NUMBER

STATE	CODE	STATE	CODE
Alabama	01	Montana	30
Alaska	02	Nebraska	31
Arizona	04	Nevada	32
Arkansas	05	New Hampshire	33
California	06	New Jersey	34
Colorado	08	New Mexico	35
Connecticut	09	New York	36
Delaware	10	North Carolina	37
District of Columbia	11	North Dakota	38
Florida	12	Ohio	39
Georgia	13	Oklahoma	40
Idaho	16	Oregon	41
Illinois	17	Pennsylvania	42
Indiana	18	Rhode Island	44
Iowa	19	South Carolina	45
Kansas	20	South Dakota	46
Kentucky	21	Tennessee	47
Louisiana	22	Texas	48
Maine	23	Utah	49
Maryland	24	Vermont	50
Massachusetts	25	Virginia	51
Michigan	26	Washington	53
Minnesota	27	West Virginia	54
Mississippi	28	Wisconsin	55
Missouri	29	Wyoming	56



APPENDIX III

TABULATION OF EQUIPMENT CAUSED ACCIDENTS

Tables in Appendix III are arranged with a letter and a number code. Tables with the same letter designation contain the same information arranged row by row in a different sequence.

The number designations have the following meaning:

- 1 - Means the data has been assembled in sequential order of the column titled "Code", "Speed", "Position", "State", or "Month".
- 2 - Means the data has been assembled in rank order by the number of accidents which occurred under that code level (ACCS). See Columns 2 and 3.
- 3 - Means the data has been assembled by rank of the total dollar damage per accident of that code (\$ TOT/ACC). See Columns 4 and 5.
- 4 - Means the data has been assembled by rank of the total dollar damages for 1975 (\$ DMG). See Columns 6 and 7.

III-2  
TABLE III-A1

**ALL EQUIPMENT RELATED ACCS**  
(Listed by Cause Code)

CODE	ACCS	RANK	\$TOT/ACC	RANK	\$TOT DMG	RANK
400	54	9	17642	31	952721	19
401	7	44	23010	25	161075	40
402	2	52	13421	36	26843	51
403	20	31	12088	41	241772	37
404	30	26	32514	13	975435	18
405	46	13	28262	21	1300079	12
406	16	34	3878	53	62054	47
407	11	40	8256	48	90821	42
409	14	37	6157	51	86204	44
410	5	47	5786	52	28932	50
411	1	54		89		89
412	2	51	11950	42	23900	52
419	1	53	12618	39	12618	53
420	31	25	34078	12	1056421	15
421	43	15	12102	40	520391	29
422	19	33	12810	38	243391	36
423	50	10	29039	20	1451991	10
424	56	8	43798	6	2452696	5
425	12	39	19241	27	230893	39
429	39	17	20472	26	798444	23
430	49	11	13164	37	645056	28
431	38	18	8523	46	323891	32
432	141	3	25228	24	3557263	2
433	28	28	30392	18	850994	22
434	28	27	15491	34	433774	31
435	28	29	8465	47	237042	38
439	33	24	27334	22	902031	21
440	118	4	17832	29	2104224	6
441	69	5	17686	30	1220340	13
442	35	20	41269	9	1444431	11
443	19	32	41965	8	797346	24
449	63	6	30673	16	1932423	7
450	10	41	31036	14	310366	34
451	187	1	30625	17	5727038	1
452	61	7	46760	5	2852396	3
453	20	30	37504	10	750097	26
454	5	48	17886	28	89434	43
459	14	36	50020	3	700282	27
460	33	23	49196	4	1623470	9
461	41	16	42477	7	1741577	8
462	34	22	29853	19	1015018	17
463	13	38	35734	11	464548	30
464	163	2	6387	50	1041126	16
465	14	35	86832	1	1215657	14
466	48	12	58870	2	2025765	4
469	34	21	26850	23	912932	20
470	3	50	11934	43	35803	48
471	6	46	14134	35	84806	45
472	8	42	17347	33	138778	41
473	7	45	10357	44	72500	46
474	45	14	17462	32	785807	25
475	5	49	6623	49	33115	49
479	8	43	30949	15	247592	35
499	36	19	8885	45	319880	33

TOTAL= 1903      AVG= 25303      TOTAL= 48153483

1975 FEDERAL RAILROAD ADMINISTRATION ACCIDENT/INCIDENT DATA

TABLE III-A2  
(Listed by Cause Code)

**ALL EQUIPMENT RELATED ACCS**

RANK	CODE	ACCS	\$/ACC	RANK	\$ DMG	RANK
1	451	187	30625	17	5727038	1
2	464	163	6387	50	1041126	16
3	432	141	25228	24	3557263	2
4	440	118	17832	29	2104224	6
5	441	69	17686	30	1220340	13
6	449	63	30673	16	1932423	7
7	452	61	46760	5	2852396	3
8	424	56	43798	6	2452696	5
9	400	54	17642	31	952721	19
10	423	50	29039	20	1451991	10
11	430	49	13164	37	645056	28
12	466	48	58870	2	2825765	4
13	405	46	28262	21	1300079	12
14	474	45	17462	32	785807	25
15	421	43	12102	40	520391	29
16	461	41	42477	7	1741577	8
17	429	39	20472	26	798444	23
18	431	38	8523	46	323891	32
19	499	36	8885	45	319880	33
20	442	35	41269	9	1444431	11
21	469	34	26850	23	912932	20
22	462	34	29853	19	1015018	17
23	460	33	49196	4	1623470	9
24	439	33	27334	22	902031	21
25	420	31	34078	12	1056421	15
26	404	30	32514	13	975435	18
27	434	28	15491	34	433774	31
28	433	28	30392	18	850994	22
29	435	28	8465	47	237042	38
30	453	20	37504	10	750097	26
31	403	20	12088	41	241772	37
32	443	19	41965	8	797346	24
33	422	19	12810	38	243391	36
34	406	16	3878	53	62054	47
35	465	14	86832	1	1215657	14
36	459	14	50020	3	700282	27
37	409	14	6157	51	86204	44
38	463	13	35734	11	464548	30
39	425	12	19241	27	230893	39
40	407	11	8256	48	90821	42
41	450	10	31036	14	310366	34
42	472	8	17347	33	138778	41
43	479	8	30949	15	247592	35
44	401	7	23010	25	161075	40
45	473	7	10357	44	72500	46
46	471	6	14134	35	84806	45
47	410	5	5786	52	28932	50
48	454	5	17886	28	89434	43
49	475	5	6623	49	33115	49
50	470	3	11934	43	35803	48
51	412	2	11950	42	23900	52
52	402	2	13421	36	26843	51
53	419	1	12618	39	12618	53
54	411	1		89		89

TOTAL= 1903 25303=AVG 48153483=TOTAL

1975 FEDERAL RAILROAD ADMINISTRATION ACCIDENT/INCIDENT DATA

111-4  
TABLE III-A3

**ALL EQUIPMENT RELATED ACCS**

(Listed by Cause Code)

RANK	CODE	ACCS	\$/ACC	RANK	\$ DMG	RANK
35	465	14	86832	1	1215657	14
12	466	48	58870	2	2825765	4
36	459	14	50020	3	700282	27
23	460	33	49196	4	1623470	9
7	452	61	46760	5	2852396	3
8	424	56	43798	6	2452696	5
16	461	41	42477	7	1741577	8
22	443	19	41965	8	797346	24
20	442	35	41269	9	1444431	11
30	453	20	37504	10	750097	26
38	463	13	35734	11	464548	30
25	420	31	34078	12	1056421	15
26	404	30	32514	13	975435	18
41	450	10	31036	14	310366	34
43	479	8	30949	15	247592	35
6	449	63	30673	16	1932423	7
1	451	187	30625	17	5727038	1
28	433	28	30392	18	850994	22
22	462	34	29853	19	1015018	17
10	423	50	29039	20	1451991	10
13	405	46	28262	21	1300079	12
24	439	33	27334	22	902031	21
21	469	34	26850	23	912932	20
3	432	141	25228	24	3557263	2
44	401	7	23010	25	161075	40
17	429	39	20472	26	798444	23
39	425	12	19241	27	230893	39
48	454	5	17886	28	89434	43
4	440	118	17832	29	2104224	6
5	441	69	17686	30	1220340	13
9	400	54	17642	31	952721	19
14	474	45	17462	32	785807	25
42	472	8	17347	33	138778	41
27	434	28	15491	34	433774	31
46	471	6	14134	35	84806	45
52	402	2	13421	36	26843	51
11	430	49	13164	37	645056	28
33	422	19	12810	38	243391	36
53	419	1	12618	39	12618	53
15	421	43	12102	40	520391	29
31	403	20	12088	41	241772	37
51	412	2	11950	42	23900	52
50	470	3	11934	43	35803	48
45	473	7	10357	44	72500	46
19	499	36	8885	45	319880	33
18	431	38	8523	46	323891	32
29	435	28	8465	47	237042	38
40	407	11	8296	48	90821	42
49	475	5	6623	49	33115	49
2	464	163	6387	50	1041126	16
37	409	14	6157	51	86204	44
47	410	5	5786	52	28932	50
34	406	16	3878	53	62054	47
54	411	1		89		89

TOTAL= 1903 25303=AVG 48153483=TOTAL

1975 FEDERAL RAILROAD ADMINISTRATION ACCIDENT/INCIDENT DATA

TABLE III-A4

**ALL EQUIPMENT RELATED ACCS**

(Listed by Cause Code)

RANK	CODE	ACCS	\$/ACC	RANK	\$ DMG	RANK
1	451	187	30625	17	5727038	1
3	432	141	25228	24	3557263	2
7	452	61	46760	5	2852396	3
12	466	48	58870	2	2825765	4
8	424	56	43798	6	2452696	5
4	440	118	17832	29	2104224	6
6	449	63	30673	16	1932423	7
16	461	41	42477	7	1741577	8
23	460	33	49196	4	1623470	9
10	423	50	29039	20	1451991	10
20	442	35	41269	9	1444431	11
13	405	46	28262	21	1300079	12
5	441	69	17686	30	1220340	13
35	465	14	86832	1	1215657	14
25	420	31	34078	12	1056421	15
2	464	163	6387	50	1041126	16
22	462	34	29853	19	1015018	17
26	404	30	32514	13	975435	18
9	400	54	17642	31	952721	19
21	469	34	26850	23	912932	20
24	439	33	27334	22	902031	21
28	433	28	30392	18	850994	22
17	429	39	20472	26	798444	23
32	443	19	41965	8	797346	24
14	474	45	17462	32	785807	25
30	453	20	37504	10	750097	26
36	459	14	50020	3	700282	27
11	430	49	13164	37	645056	28
15	421	43	12102	40	520391	29
38	463	13	35734	11	464548	30
27	434	28	15491	34	433774	31
18	431	38	8523	46	323891	32
19	499	36	8885	45	319880	33
41	450	10	31036	14	310366	34
43	479	8	30949	15	247592	35
33	422	19	12810	38	243391	36
31	403	20	12088	41	241772	37
29	435	28	8465	47	237042	38
39	425	12	19241	27	230893	39
44	401	7	29010	25	161075	40
42	472	8	17347	33	138778	41
40	407	11	8256	48	90821	42
48	454	5	17886	28	89434	43
37	409	14	6157	51	86204	44
46	471	6	14134	35	84806	45
45	473	7	10357	44	72500	46
34	406	16	3878	53	62054	47
50	470	3	11934	43	35803	48
49	475	5	6623	49	33115	49
47	410	5	5786	52	28932	50
52	402	2	13421	36	26843	51
51	412	2	11950	42	23900	52
53	419	1	12618	39	12618	53
54	411	1		89		89

TOTAL= 1903 25303=AVG 48153483=TOTAL  
 1975 FEDERAL RAILROAD ADMINISTRATION ACCIDENT/INCIDENT DATA

TABLE III-B.

## DERAILMENTS BY 75 CAUSE CODE

CODE	ACCS	RANK	\$TOT/ACC	RANK	\$TOT DMG	RANK
400	50	9	18645	29	932271	12
401	6	41	25679	24	154075	39
402	1	42	5630	48	5630	49
403	16	30	14051	36	224820	35
404	18	29	48661	5	875912	20
405	46	12	28262	21	1300079	12
406	11	37	4504	49	49554	43
407	8	39	9284	45	74275	41
409	7	40	8619	46	80539	42
410	2	46	10053	41	20107	47
412	2	47	11950	39	23900	46
419	1	48	12618	38	12618	48
420	28	21	37443	12	1048413	15
421	27	22	15081	35	407206	30
422	13	32	16680	32	216844	36
423	50	10	29039	20	1451991	9
424	54	8	44939	8	2426746	5
425	12	35	19241	28	230893	33
429	34	15	23084	26	784859	22
430	39	13	12812	37	499678	26
431	31	19	9324	44	289067	32
432	126	3	26144	23	3294151	2
433	25	24	33611	13	840234	21
434	26	23	15789	33	410524	29
435	20	25	10015	42	200306	37
439	20	27	24614	25	492294	27
440	116	4	18035	30	2092124	6
441	69	5	17686	31	1220340	13
442	31	20	46267	7	1434281	10
443	18	28	40852	9	735346	24
449	62	6	30842	18	1912223	7
450	10	38	31036	17	310366	31
451	183	1	30060	19	5501129	1
452	61	7	46760	6	2852396	3
453	20	26	37504	11	750097	23
454	4	43	21788	27	87154	40
459	11	36	60516	2	665678	25
460	32	16	50530	4	1616970	8
461	38	14	37213	13	1414117	11
462	31	18	32256	16	999938	17
463	13	34	35734	14	464548	28
464	162	2	6391	47	1035476	16
465	14	31	86832	1	1215657	14
466	48	11	58370	3	2825765	4
469	32	17	28251	22	904032	19
470	3	45	11934	40	35803	44
471	3	44	9571	43	28715	45
479	6	42	37515	10	225092	34
499	13	33	15273	34	198555	38

TOTAL = 1653      AVG = 27134      TOTAL = 44852658

1975 FEDERAL RAILROAD ADMINISTRATION ACCIDENT/INCIDENT DATA

TABLE 111-B2

**DERAILMENTS BY 75 CAUSE CODE**

RANK	CODE	ACCS	\$/ACC	RANK	\$ DMG	RANK
1	451	183	30060	19	5501129	1
2	464	162	6391	47	1035476	16
3	432	126	26144	23	3294151	2
4	440	116	18035	30	2092124	6
5	441	69	17686	31	1220340	13
6	449	62	30842	18	1912223	7
7	452	61	46760	6	2852396	3
8	424	54	44939	8	2426746	5
9	400	50	18645	29	932271	18
10	423	50	29039	20	1451991	9
11	466	48	58870	3	2825765	4
12	405	46	28262	21	1300079	12
13	430	39	12812	37	499678	26
14	461	38	37213	13	1414117	11
15	429	34	23084	26	784859	22
16	460	32	50530	4	1616970	8
17	469	32	28251	22	904032	19
18	462	31	20256	16	999938	17
19	431	31	9324	44	289067	32
20	442	31	46267	7	1434281	10
21	420	28	37443	12	1048413	15
22	421	27	15081	35	407206	30
23	434	26	15789	33	410534	29
24	433	25	33611	15	840294	21
25	435	20	10015	42	200306	37
26	453	20	37504	11	750097	23
27	439	20	24614	25	492294	27
28	443	18	40852	9	735346	24
29	404	18	48661	5	875912	20
30	403	16	14051	36	224820	35
31	465	14	86832	1	1215657	14
32	422	13	16680	32	216844	36
33	499	13	15273	34	198555	38
34	463	13	35734	14	464548	28
35	425	12	19241	28	230893	33
36	459	11	60516	2	665678	25
37	406	11	4504	49	49554	43
38	450	10	31036	17	310366	31
39	407	8	9284	45	74275	41
40	409	7	8619	46	60339	42
41	401	6	25679	24	154075	39
42	479	6	37515	10	225092	34
43	454	4	21788	27	87154	40
44	471	3	9571	43	28715	45
45	470	3	11934	40	35803	44
46	410	2	10053	41	20107	47
47	412	2	11950	39	23900	46
48	419	1	12618	38	12618	48
49	402	1	5630	48	5630	49
TOTAL=		1653	27134=AVG	44852658=TOTAL		

1975 FEDERAL RAILROAD ADMINISTRATION ACCIDENT/INCIDENT DATA



TABLE III-B3

## DERAILMENTS BY 75 CAUSE CODE

RANK	CODE	ACCS	\$/ACC	RANK	\$ DMG	RANK
31	465	14	86832	1	1215657	14
36	459	11	60516	2	665678	25
11	466	48	58870	3	2825765	4
16	460	32	50530	4	1616970	8
29	404	18	48661	5	875912	20
7	452	61	46760	6	2852396	3
20	442	31	46267	7	1434281	10
8	424	54	44939	8	2426746	5
28	443	18	40852	9	735346	24
42	479	6	37515	10	225092	34
26	453	20	37504	11	750097	23
21	420	28	37443	12	1048413	15
14	461	38	37213	13	1414117	11
34	463	13	35734	14	464548	28
24	433	25	33611	15	840294	21
18	462	31	32256	16	999938	17
38	450	10	31036	17	310366	31
6	449	62	30842	18	1912223	7
1	451	183	30060	19	5501129	1
10	423	50	29039	20	1451991	9
12	405	46	28262	21	1300079	12
17	469	32	28251	22	904032	19
3	432	126	26144	23	3294151	2
41	401	6	25679	24	154075	39
27	439	20	24614	25	492294	27
15	429	34	23084	26	784859	22
43	454	4	21788	27	87154	40
35	425	12	19241	28	230893	33
9	400	50	18645	29	932271	18
4	440	116	18035	30	2092124	6
5	441	69	17686	31	1220340	13
32	422	13	16680	32	216844	36
23	434	26	15789	33	410534	29
33	499	13	15273	34	198555	38
22	421	27	15081	35	407206	30
30	403	16	14051	36	224820	35
13	430	39	12812	37	499678	26
48	419	1	12618	38	12618	48
47	412	2	11950	39	23900	46
45	470	3	11934	40	35803	44
46	410	2	10053	41	20107	47
25	435	20	10015	42	200306	37
44	471	3	9571	43	28715	45
19	431	31	9324	44	289067	32
39	407	8	9284	45	74275	41
40	409	7	8619	46	60339	42
2	464	162	6391	47	1035476	16
49	402	1	5630	48	5630	49
37	406	11	4504	49	49554	43

TOTAL= 1653 27134=AVG 44852658=TOTAL

1975 FEDERAL RAILROAD ADMINISTRATION ACCIDENT/INCIDENT DATA

TABLE III-B4

## DERAILMENTS BY 75 CAUSE CODE

RANK	CODE	ACCS	\$/ACC	RANK	\$ DMG	RANK
1	451	183	30060	19	5501129	1
3	432	126	26144	23	3294151	2
7	452	61	46760	6	2852396	3
11	466	48	58870	3	2825765	4
8	424	54	44939	8	2426746	5
4	440	116	18035	30	2092124	6
6	449	62	30842	18	1912223	7
16	460	32	50530	4	1616970	8
10	423	50	29039	20	1451991	9
20	442	31	46267	7	1434281	10
14	461	38	37213	13	1414117	11
12	405	46	28262	21	1300079	12
5	441	69	17686	31	1220340	13
31	465	14	86832	1	1215657	14
21	420	28	37443	12	1048413	15
2	464	162	6391	47	1035476	16
18	462	31	32256	16	999938	17
9	400	50	18645	29	932271	18
17	469	32	28251	22	904032	19
29	404	18	48661	5	875912	20
24	433	25	33611	15	840294	21
15	429	34	23084	26	784859	22
26	453	20	37504	11	750097	23
28	443	18	40852	9	735346	24
36	459	11	60516	2	665678	25
13	430	39	12812	37	499678	26
27	439	20	24614	25	492294	27
34	463	13	35734	14	464548	28
23	434	26	15789	33	410534	29
22	421	27	15081	35	407206	30
38	450	10	31036	17	310366	31
19	431	31	9324	44	289067	32
35	425	12	19241	28	230893	33
42	479	6	37515	10	225092	34
30	403	16	14051	36	224820	35
32	422	13	16680	32	216844	36
25	435	20	10015	42	200306	37
33	499	13	15273	34	198555	38
41	401	6	25679	24	154075	39
43	454	4	21788	27	87154	40
39	407	8	9284	45	74275	41
40	409	7	8619	46	60339	42
37	406	11	4504	49	49554	43
45	470	3	11934	40	35803	44
44	471	3	9571	43	28715	45
47	412	2	11950	39	23900	46
46	410	2	10053	41	20107	47
48	419	1	12618	38	12618	48
49	402	1	5630	48	5630	49

TOTAL= 1653 27134=AVG 44852658=TOTAL

1975 FEDERAL RAILROAD ADMINISTRATION ACCIDENT/INCIDENT DATA

III-10  
TABLE III-C1

FREIGHT TRAIN EQUIPMENT ACCS

CODE	ACCS	RANK	\$TOT/ACC	RANK	\$TOT DMG	RANK
400	50	8	17519	34	875962	18
401	4	46	37387	13	149550	40
402	2	49	13421	42	26843	49
403	13	35	16438	37	213697	37
404	28	21	33700	18	943612	16
405	33	15	37940	11	1252029	12
406	2	48	8037	49	16075	50
407	6	41	12645	44	75870	43
409	10	37	7014	51	70142	46
410	5	44	5786	52	28932	48
411	1	52		89		89
412	1	53	15900	38	15900	51
419	1	51	12618	45	12618	52
420	28	20	36754	14	1029136	15
421	36	14	13551	41	487866	27
422	17	29	13850	40	235456	34
423	43	10	31155	23	1339670	11
424	43	9	54676	5	2351085	5
425	7	40	30439	25	213075	38
429	29	18	25543	28	740773	24
430	37	13	12480	46	461789	29
431	17	30	12953	43	220208	36
432	114	2	29520	27	3365282	2
433	25	24	33645	19	841136	21
434	22	27	18806	32	413744	31
435	24	26	9241	48	221792	35
439	24	25	35838	15	860117	20
440	102	3	19942	29	2034172	6
441	62	5	18975	30	1176451	14
442	31	16	46040	8	1427248	10
443	16	31	49153	6	786459	22
449	51	7	34978	17	1783909	7
450	10	33	31036	24	310366	32
451	179	1	31633	21	5662477	1
452	61	6	46760	7	2852396	3
453	20	28	37504	12	750097	23
454	5	43	17886	33	89434	42
459	12	36	55962	4	671549	26
460	28	19	57082	3	1598296	9
461	40	12	43434	9	1737362	8
462	29	17	31889	20	924796	17
463	13	33	35734	16	464548	28
464	95	4	7263	50	690026	25
465	13	34	93238	1	1212103	13
466	42	11	66872	2	2808658	4
469	28	22	31276	22	875749	19
470	1	50	29803	26	29803	47
471	4	47	18928	31	75715	44
472	6	42	16796	35	100778	41
473	7	39	10357	47	72500	45
474	27	23	16483	36	445067	30
479	5	45	40178	10	200892	39
499	16	32	15033	39	240543	33

TOTAL= 1525      AVG= 29825      TOTAL= 45483753

1975 FEDERAL RAILROAD ADMINISTRATION ACCIDENT/INCIDENT DATA

TABLE III-C2

**FREIGHT TRAIN EQUIPMENT ACCS**

RANK	CODE	ACCS	\$/ACC	RANK	\$ DMG	RANK
1	451	179	31633	21	5662477	1
2	432	114	29520	27	3365282	2
3	440	102	19942	29	2034172	6
4	464	95	7263	50	690026	25
5	441	62	18975	30	1176451	14
6	452	51	46760	7	2852396	3
7	449	51	34978	17	1783909	7
8	400	50	17519	34	875962	18
9	424	43	54676	5	2351085	5
10	423	43	31155	23	1339670	11
11	466	42	66872	2	2808658	4
12	461	40	43434	9	1737362	8
13	430	37	12480	46	461789	29
14	421	36	13551	41	487866	27
15	405	33	37940	11	1252029	12
16	442	31	46040	8	1427248	10
17	462	29	31889	20	924796	17
18	429	29	25543	28	740773	24
19	460	28	57082	3	1598296	9
20	420	28	36754	14	1029136	15
21	404	28	33700	18	943612	16
22	469	28	31276	22	875749	19
23	474	27	16483	36	445067	30
24	433	25	33645	19	841136	21
25	439	24	35838	15	860117	20
26	435	24	9241	48	221792	35
27	434	22	18806	32	413744	31
28	453	20	37504	12	750097	23
29	422	17	13850	40	235456	34
30	431	17	12953	43	220208	36
31	443	16	49153	6	786459	22
32	499	16	15033	39	240543	33
33	463	13	35734	16	464548	28
34	465	13	93238	1	1212103	13
35	403	13	16438	37	213697	37
36	459	12	55962	4	671549	26
37	409	10	7014	51	70142	46
38	450	10	31036	24	310366	32
39	473	7	10357	47	72500	45
40	425	7	30439	25	213075	38
41	407	6	12645	44	75870	43
42	472	6	16796	35	100778	41
43	454	5	17886	33	89434	42
44	410	5	5786	52	28932	48
45	479	5	40178	10	200892	39
46	401	4	37387	13	149550	40
47	471	4	18928	31	75715	44
48	406	2	8037	49	16075	50
49	402	2	13421	42	26843	49
50	470	1	29803	26	29803	47
51	419	1	12618	45	12618	52
52	411	1		89		89
53	412	1	15900	38	15900	51

TOTAL= 1525 29825=AVG 45483753=TOTAL

TABLE 111-C3

## FREIGHT TRAIN EQUIPMENT ACCS

RANK	CODE	ACCS	\$/ACC	RANK	\$ DMG	RANK
34	465	13	33238	1	1212103	13
11	466	42	66872	2	2808658	4
19	460	28	57082	3	1598296	9
36	459	12	55962	4	671549	26
9	424	43	54676	5	2351085	5
31	443	16	49153	6	786459	22
6	452	61	46760	7	2852396	3
16	442	31	46040	8	1427248	10
12	461	40	43434	9	1737362	8
45	479	5	40178	10	200892	39
15	405	33	37940	11	1252029	12
28	453	20	37504	12	750097	23
46	401	4	37387	13	149550	40
20	420	28	36754	14	1029136	15
25	439	24	35838	15	860117	20
33	463	13	35734	16	464548	28
7	449	51	34978	17	1783909	7
21	404	28	33700	18	943612	16
24	433	25	33645	19	841136	21
17	462	29	31889	20	924796	17
1	451	179	31633	21	5662477	1
22	469	28	31276	22	875749	19
10	423	43	31155	23	1339670	11
38	450	10	31036	24	310366	32
40	425	7	30439	25	213075	38
50	470	1	29803	26	29803	47
2	432	114	29520	27	3365282	2
18	429	29	25543	28	740773	24
3	440	102	19942	29	2034172	6
5	441	62	18975	30	1176451	14
47	471	4	18928	31	75715	44
27	434	22	18806	32	413744	31
43	454	5	17886	33	89434	42
8	400	50	17519	34	875962	18
42	472	6	16796	35	100778	41
23	474	27	16483	36	445067	30
35	403	13	16438	37	213697	37
53	412	1	15900	38	15900	51
32	499	16	15033	39	240543	33
29	422	17	13850	40	235456	34
14	421	36	13551	41	487866	27
49	402	2	13421	42	26843	49
30	431	17	12953	43	220208	36
41	407	6	12645	44	75870	43
51	419	1	12618	45	12618	52
13	430	37	12480	46	461789	29
39	473	7	10357	47	72500	45
26	435	24	9241	48	221792	35
48	406	2	8037	49	16075	50
4	464	95	7263	50	690026	25
37	409	10	7014	51	70142	46
44	410	5	5786	52	28932	48
52	411	1		89		89

TOTAL= 1525 29825=AVG 45483753=TOTAL

1975 FEDERAL RAILROAD ADMINISTRATION ACCIDENT/INCIDENT DATA

TABLE 111-C4

## FREIGHT TRAIN EQUIPMENT ACCS

RANK	CODE	ACCS	\$/ACC	RANK	\$ DMG	RANK
1	451	179	31633	21	5662477	1
2	432	114	29520	27	3365282	2
6	452	61	46760	7	2852396	3
11	466	42	66872	2	2808658	4
9	424	43	54676	5	2351085	5
3	440	102	19942	29	2034172	6
7	449	51	34978	17	1783909	7
12	461	40	43434	9	1737362	8
19	460	28	57082	3	1598296	9
16	442	31	46040	8	1427248	10
10	423	43	31155	23	1339670	11
15	405	33	37940	11	1252029	12
34	465	13	93238	1	1212103	13
5	441	62	18975	30	1176451	14
20	420	28	36754	14	1029136	15
21	404	28	33700	18	943612	16
17	462	29	31889	20	924796	17
8	400	50	17519	34	875962	18
22	469	28	31276	22	875749	19
25	439	24	35838	15	860117	20
24	433	25	33645	19	841136	21
31	443	16	49153	6	786459	22
28	453	20	37504	12	750097	23
18	429	29	25543	28	740773	24
4	464	95	7263	50	690026	25
36	459	12	55962	4	671549	26
14	421	36	13551	41	487866	27
33	463	13	35734	16	464548	28
13	430	37	12480	46	461789	29
23	474	27	16483	36	445067	30
27	434	22	18806	32	413744	31
38	450	10	31036	24	310366	32
32	499	16	15033	39	240543	33
29	422	17	13850	40	235456	34
26	435	24	9241	48	221792	35
30	431	17	12953	43	220208	36
35	403	13	16438	37	213697	37
40	425	7	30439	25	213075	38
45	479	5	40178	10	200892	39
46	401	4	37387	13	149550	40
42	472	6	16796	35	100778	41
43	454	5	17886	33	89434	42
41	407	6	12645	44	75870	43
47	471	4	18928	31	75715	44
39	473	7	10357	47	72500	45
37	409	10	7014	51	70142	46
50	470	1	29803	26	29803	47
44	410	5	5786	52	28932	48
49	402	2	13421	42	26843	49
48	406	2	8037	49	16075	50
53	412	1	15900	38	15900	51
51	419	1	12618	45	12618	52
52	411	1		89		89

TOTAL = 1525 29825=AVG 45483753=TOTAL

1975 FEDERAL RAILROAD ADMINISTRATION ACCIDENT/INCIDENT DATA

TABLE III-D1

## FREIGHT TRAIN EQUIP. DERAIL.

CODE	ACCS	RANK	\$TOT/ACC	RANK	\$TOT DMG	RANK
400	46	8	18598	34	855512	19
401	4	41	37387	15	149550	39
402	1	48	5630	49	5630	49
403	13	32	16438	37	213697	32
404	17	26	51183	7	870112	17
405	33	14	37940	13	1252029	12
406	1	46	15750	39	15750	47
407	5	39	13025	41	65125	41
409	6	38	7982	47	47892	42
410	2	44	10053	45	20107	45
412	1	49	15900	38	15900	46
419	1	45	12618	43	12618	48
420	25	20	40845	11	1021128	15
421	23	22	16877	36	388181	30
422	12	33	17700	35	212409	34
423	43	9	31155	21	1339670	11
424	42	10	55435	5	2328285	5
425	7	37	30439	24	213075	33
429	26	19	28238	28	734188	22
430	36	13	12741	42	458696	28
431	15	28	14070	40	211064	35
432	106	2	29579	26	3135441	2
433	24	21	34911	18	837886	20
434	20	23	19525	32	390504	29
435	18	25	10430	44	187756	37
439	16	27	29432	27	470914	26
440	101	3	20058	31	2025872	6
441	62	5	18975	33	1176451	14
442	27	17	52485	6	1417098	9
443	15	29	48297	8	724459	23
449	50	7	35274	17	1763709	7
450	10	35	31036	23	310366	31
451	175	1	31066	22	5436568	1
452	61	6	46760	10	2852396	3
453	20	24	37504	14	750097	21
454	4	40	21788	29	87154	40
459	10	34	66319	3	663199	25
460	27	16	58955	4	1591796	8
461	37	12	38105	12	1409902	10
462	28	15	32921	19	921796	16
463	13	31	35734	16	464548	27
464	94	4	7280	48	684376	24
465	13	30	93238	1	1212103	13
466	42	11	66872	2	2808658	4
469	27	18	32175	20	868749	18
470	1	47	29803	25	29803	43
471	3	43	9571	46	28715	44
479	4	42	46973	9	187892	36
499	9	36	20292	30	182633	38

TOTAL = 1376      AVG = 31287      TOTAL = 43051459

1975 FEDERAL RAILROAD ADMINISTRATION ACCIDENT/INCIDENT DATA

TABLE 111-D2

**FREIGHT TRAIN EQUIP. DERAIL.**

RANK	CODE	ACCS	\$/ACC	RANK	\$ DMG	RANK
1	451	175	31066	22	5436568	1
2	432	106	29579	26	3135441	2
3	440	101	20058	31	2025872	6
4	464	94	7280	48	684376	24
5	441	62	18975	33	1176451	14
6	452	61	46760	10	2852396	3
7	449	50	35274	17	1763709	7
8	400	46	18598	34	855512	19
9	423	43	31155	21	1339670	11
10	424	42	55435	5	2328285	5
11	466	42	66872	2	2808658	4
12	461	37	38105	12	1409902	10
13	430	36	12741	42	458696	28
14	405	33	37940	13	1252029	12
15	462	28	32921	19	921796	16
16	460	27	58955	4	1591796	8
17	442	27	52485	6	1417098	9
18	469	27	32175	20	868749	18
19	429	26	28238	28	734188	22
20	420	25	40845	11	1021128	15
21	433	24	34911	18	837886	20
22	421	23	16877	36	388181	30
23	434	20	19525	32	390504	29
24	453	20	37504	14	750097	21
25	435	18	10430	44	187756	37
26	404	17	51183	7	870112	17
27	439	16	29432	27	470914	26
28	431	15	14070	40	211064	35
29	443	15	48297	8	724459	23
30	465	13	93238	1	1212103	13
31	463	13	35734	16	464548	27
32	403	13	16438	37	213697	32
33	422	12	17700	35	212409	34
34	459	10	66319	3	663199	25
35	450	10	31036	23	310366	31
36	499	9	20292	30	182633	38
37	425	7	30439	24	213075	33
38	409	6	7982	47	47892	42
39	407	5	13025	41	65125	41
40	454	4	21788	29	87154	40
41	401	4	37387	15	149550	39
42	479	4	46973	9	187892	36
43	471	3	9571	46	28715	44
44	410	2	10053	45	20107	45
45	419	1	12618	43	12618	48
46	406	1	15750	39	15750	47
47	470	1	29803	25	29803	43
48	402	1	5630	49	5630	49
49	412	1	15900	38	15900	46

TOTAL = 1376 31287=AVG 43051459=TOTAL

1975 FEDERAL RAILROAD ADMINISTRATION ACCIDENT/INCIDENT DATA



TABLE III-D3

## FREIGHT TRAIN EQUIP. DERAIL.

RANK	CODE	ACCS	\$/ACC	RANK	\$ DMG	RANK
30	465	13	93238	1	1212103	13
11	466	42	66872	2	2808658	4
34	459	10	66319	3	663199	25
16	460	27	58955	4	1591796	8
10	424	42	55435	5	2328285	5
17	442	27	52485	6	1417098	9
26	404	17	51183	7	870112	17
29	443	15	48297	8	724459	23
42	479	4	46973	9	187892	36
6	452	61	46760	10	2852396	3
20	420	25	40845	11	1021128	15
12	461	37	38105	12	1409902	10
14	405	33	37940	13	1252029	12
24	453	20	37504	14	750097	21
41	401	4	37387	15	149550	39
31	463	13	35734	16	464548	27
7	449	50	35274	17	1763709	7
21	433	24	34911	18	837886	20
15	462	28	32921	19	921796	16
18	469	27	32175	20	868749	18
9	423	43	31155	21	1339670	11
1	451	175	31066	22	5436568	1
35	450	10	31036	23	310366	31
37	425	7	30439	24	213075	33
47	470	1	29803	25	29803	43
2	432	106	29579	26	3135441	2
27	439	15	29432	27	470914	26
19	429	26	28238	28	734188	22
40	454	4	21788	29	87154	40
36	499	9	20292	30	182633	38
3	440	101	20058	31	2025872	6
23	434	20	19525	32	390504	29
5	441	62	18975	33	1176451	14
8	400	46	18598	34	855512	19
33	422	12	17700	35	212409	34
22	421	23	16877	36	388181	30
32	403	13	16438	37	213697	32
49	412	1	15900	38	15900	46
46	406	1	15750	39	15750	47
28	431	15	14070	40	211064	35
39	407	5	13025	41	65125	41
13	430	36	12741	42	458696	28
45	419	1	12618	43	12618	48
25	435	18	10430	44	187756	37
44	410	2	10053	45	20107	45
43	471	3	9571	46	28715	44
38	409	6	7982	47	47892	42
4	464	94	7280	48	684376	24
48	402	1	5630	49	5630	49

TOTAL = 1376      31287=AVG      43051459=TOTAL

1975 FEDERAL RAILROAD ADMINISTRATION ACCIDENT/INCIDENT DATA

## FREIGHT TRAIN EQUIP. DERAIL.

RANK	CODE	ACCS	\$/ACC	RANK	\$ DMG	RANK
1	451	175	31066	22	5436563	1
2	432	106	29579	26	3135441	2
6	452	61	46760	10	2850396	3
11	466	42	66872	2	2808658	4
10	424	42	55435	5	2328285	5
3	440	101	20058	31	2025872	6
7	449	50	35274	17	1763709	7
16	460	27	58955	4	1591796	8
17	442	27	52485	6	1417098	9
12	461	37	38105	12	1405902	10
9	423	43	31155	21	1339670	11
14	405	33	37940	13	1252029	12
30	465	13	93238	1	1212103	13
5	441	62	18975	33	1176451	14
20	420	25	40845	11	1021128	15
15	462	28	32921	19	921796	16
26	404	17	51183	7	870112	17
18	469	27	32175	20	868749	18
8	400	46	18598	34	855512	19
21	433	24	34911	18	837886	20
24	453	20	37504	14	750097	21
19	429	26	28238	28	734188	22
29	443	15	48297	8	724459	23
4	464	94	7280	48	684376	24
34	459	10	66319	3	663199	25
27	439	16	29432	27	470914	26
31	463	13	35734	16	464548	27
13	430	36	12741	42	458696	28
23	434	20	19525	32	390504	29
22	421	23	16877	36	388181	30
35	450	10	31036	23	310366	31
32	403	13	16438	37	213697	32
37	425	7	30439	24	213075	33
33	422	12	17700	35	212409	34
28	431	15	14070	40	211064	35
42	479	4	46973	9	187892	36
25	435	18	10430	44	187756	37
36	499	9	20292	30	182633	38
41	401	4	37387	15	149550	39
40	454	4	21788	29	87154	40
39	407	5	13025	41	65125	41
38	409	6	7982	47	47892	42
47	470	1	29803	25	29803	43
43	471	3	9571	46	28715	44
44	410	2	10053	45	20107	45
49	412	1	15900	38	15900	46
46	406	1	15750	39	15750	47
45	419	1	12618	43	12618	48
48	402	1	5630	49	5630	49

TOTAL= 1376 31287=AVG 43051459=TOTAL

1975 FEDERAL RAILROAD ADMINISTRATION ACCIDENT/INCIDENT DATA

TABLE III-E1

## DERAILMENTS BY SPEED, MPH

SPEED	ACCS	RANK	\$TOT/ACC	RANK	\$TOT DMG	RANK
2	103	5	5615	35	578386	22
4	212	1	5667	34	1201548	14
6	43	13	7709	33	331512	28
8	69	9	9170	31	632783	19
10	173	2	10301	30	1782126	9
12	43	14	14375	26	618166	20
14	107	4	12417	21	1328664	11
16	18	21	45789	12	824218	17
18	38	15	14940	25	567730	24
20	84	7	14067	27	1181676	15
22	26	19	29919	20	777915	18
24	139	3	29677	21	4125131	2
26	15	23	26424	22	396373	27
28	28	17	43750	14	1225002	13
30	86	6	35391	18	3043687	5
32	13	24	37315	17	485106	26
34	65	10	39721	15	2581884	6
36	8	30	20543	24	164346	32
38	27	18	57932	7	1564167	10
40	84	8	48394	10	4065140	3
42	16	22	38345	16	613525	21
44	46	12	66491	6	3058618	4
46	9	29	34254	19	308291	29
48	22	20	25240	23	555283	25
50	48	11	98130	3	4710264	1
52	11	26	119228	2	1311512	12
54	33	16	70711	5	2333470	7
56	5	32	57553	8	287766	30
58	5	31	44713	13	223568	31
60	12	25	47589	11	571071	23
62	2	34	11776	29	23553	35
64	9	27	97297	4	875675	16
66	2	35	54003	9	108006	33
68	9	28	217503	1	1957534	8
70	4	33	8710	32	34840	34
TOTAL=	1614	AVG=	27539	TOTAL=	44448536	

1975 FEDERAL RAILROAD ADMINISTRATION ACCIDENT/INCIDENT DATA

TABLE III-E2

DERAILMENTS BY SPEED, MPH

RANK	SPEED	ACCS	\$/ACC	RANK	\$ DMG	RANK
1	4	212	5667	34	1201548	14
2	10	173	10301	30	1782126	9
3	24	139	29677	21	4125131	2
4	14	107	12417	28	1328664	11
5	2	103	5615	35	578386	22
6	30	86	35391	18	3043687	5
7	20	84	14067	27	1181676	15
8	40	84	48394	10	4065140	3
9	8	69	9170	31	632783	19
10	34	65	39721	15	2581884	6
11	50	48	98130	3	4710264	1
12	44	46	66491	6	3058618	4
13	6	43	7709	33	331512	28
14	12	43	14375	26	618166	20
15	18	38	14940	25	567730	24
16	54	33	70711	5	2333470	7
17	28	28	43750	14	1225002	13
18	38	27	57932	7	1564167	10
19	22	26	29919	20	777915	18
20	48	22	25240	23	555283	25
21	16	18	45789	12	824218	17
22	42	16	38345	16	613525	21
23	26	15	26424	22	396373	27
24	32	13	37315	17	485106	26
25	60	12	47589	11	571071	23
26	52	11	119228	2	1311512	12
27	64	9	97297	4	875675	16
28	68	9	217503	1	1957534	8
29	46	9	34254	19	308291	29
30	36	8	20543	24	164346	32
31	58	5	44713	13	223568	31
32	56	5	57553	8	287766	30
33	70	4	8710	32	34840	34
34	62	2	11776	29	23553	35
35	66	2	54003	9	108006	33

TOTAL= 1614 27539=AVG 44448536=TOTAL

1975 FEDERAL RAILROAD ADMINISTRATION ACCIDENT/INCIDENT DATA

TABLE III-E3

(See Figure V-4 for Plot)

**DERAILMENTS BY SPEED, MPH**

RANK	SPEED	ACCS	\$/ACC	RANK	\$ DMG	RANK
28	68	9	217503	1	1957534	8
26	52	11	119228	2	1311512	12
11	50	48	98130	3	4710264	1
27	64	9	97297	4	875675	16
16	54	37	70711	5	2333470	7
12	44	46	66491	6	3058618	4
18	38	27	57932	7	1564167	10
32	56	5	57553	8	287766	30
35	66	2	54003	9	108006	33
8	40	84	48394	10	4065140	3
25	60	12	47589	11	571071	23
21	16	18	45789	12	824218	17
31	58	5	44713	13	223568	31
17	28	28	43750	14	1225002	13
10	34	65	39721	15	2581884	6
22	42	16	38345	16	613525	21
24	32	13	37315	17	485106	26
6	30	86	35391	18	3043687	5
29	46	9	34254	19	308291	29
19	22	26	29919	20	777915	18
3	24	139	29677	21	4125131	2
23	26	15	26424	22	396373	27
20	48	22	25240	23	555233	25
30	36	8	20543	24	164346	32
15	18	38	14940	25	567730	24
14	12	43	14375	26	618166	20
7	20	84	14067	27	1181676	15
4	14	107	12417	28	1328664	11
34	62	2	11776	29	23553	35
2	10	173	10301	30	1782126	9
9	8	69	9170	31	632783	19
33	70	4	8710	32	34840	34
13	6	43	7709	33	331512	28
1	4	212	5667	34	1201548	14
5	2	103	5615	35	578386	22

TOTAL= 1614 27539=AVG 44448536=TOTAL

1975 FEDERAL RAILROAD ADMINISTRATION ACCIDENT/INCIDENT DATA

TABLE III-E4

## DERAILMENTS BY SPEED, MPH

RANK	SPEED	ACCS	\$/ACC	RANK	\$ DMG	RANK
11	50	48	98130	3	4710264	1
3	24	139	29677	21	4125131	2
8	40	84	48394	10	4065140	3
12	44	46	66491	6	3058618	4
6	30	86	35391	18	3043687	5
10	34	65	39721	15	2581884	6
16	54	33	70711	5	2333470	7
28	68	9	217503	1	1957534	8
2	10	173	10301	30	1782126	9
18	38	27	57922	7	1564167	10
4	14	107	12417	28	1328664	11
26	52	11	119228	2	1311512	12
17	28	28	43750	14	1225002	13
1	4	212	5667	34	1201548	14
7	20	84	14067	27	1181676	15
27	64	9	97297	4	875675	16
21	16	18	45789	12	824218	17
19	22	26	29919	20	777915	18
9	8	69	9170	31	632783	19
14	12	43	14375	26	618166	20
22	42	16	38345	16	613525	21
5	2	103	5615	35	578386	22
25	60	12	47589	11	571071	23
15	18	38	14940	25	567730	24
20	48	22	25240	23	555283	25
24	32	13	37315	17	485106	26
23	26	15	26424	22	396373	27
13	6	43	7709	33	331512	28
29	46	9	34254	19	308291	29
32	56	5	57553	8	287766	30
31	58	5	44713	13	223568	31
30	36	8	20543	24	164346	32
35	66	2	54003	9	108006	33
33	70	4	8710	32	34840	34
34	62	2	11776	29	23553	35
TOTAL =		1614	27539=AVG		44448536=TOTAL	

1975 FEDERAL RAILROAD ADMINISTRATION ACCIDENT/INCIDENT DATA

TABLE III-F1

**DERAILMENTS BY FAIL POSITION**

POSITION	ACCS	RANK	\$TOT/ACC	RANK	\$TOT DMG	RANK
4	103	1	14176	27	1460155	4
8	80	2	17665	20	1413212	5
12	66	5	12724	28	839845	11
16	70	4	18735	18	1311471	6
20	75	3	23955	9	1796647	2
24	61	7	28070	5	1712292	3
28	65	6	30156	4	1960183	1
32	57	8	19627	16	1118754	8
36	44	11	18403	19	809775	12
40	52	9	20011	13	1040585	9
44	40	13	19950	14	798002	13
48	49	10	26092	6	1278550	7
52	34	14	19841	15	674601	14
56	44	12	21667	12	953355	10
60	22	17	14848	25	326673	19
64	20	19	21668	11	433363	17
68	22	16	15378	24	338317	18
72	27	15	17579	21	474648	15
76	20	20	22234	10	444680	16
80	14	21	14837	26	207730	21
84	21	18	15555	23	326656	20
88	12	24	11269	31	135232	28
92	13	22	7436	35	96668	31
96	12	23	10275	32	123309	30
100	12	25	11985	30	143821	24
104	6	29	25824	7	154946	22
108	7	28	8175	33	57229	32
112	8	26	16908	22	135270	27
116	8	27	19303	17	154429	23
120	3	30	44030	3	132091	29
124	2	32	24876	8	49753	33
128	3	31	3002	36	9007	35
132	1	33	141704	1	141704	25
144	1	34	7500	34	7500	36
152	1	36	12003	29	12003	34
160	1	35	135552	2	135552	26

TOTAL= 1076      AVG= 19710      TOTAL= 21208008

1975 FEDERAL RAILROAD ADMINISTRATION ACCIDENT/INCIDENT DATA

TABLE III-F2

**DERAILMENTS BY FAIL POSITION**

RANK	POSITION	ACCS	\$/ACC	RANK	\$ DMG	RANK
1	4	103	14176	27	1460155	4
2	8	80	17665	20	1413212	5
3	20	75	23955	9	1796647	2
4	16	70	18735	18	1311471	6
5	12	66	12724	28	839845	11
6	28	65	30156	4	1960183	1
7	24	61	28070	5	1717292	3
8	32	57	19627	16	1118754	8
9	40	52	20011	13	1040585	9
10	48	49	26092	6	1278550	7
11	36	44	18403	19	809775	12
12	56	44	21667	12	953355	10
13	44	40	19950	14	798002	13
14	52	34	19841	15	674601	14
15	72	27	17579	21	474648	15
16	68	22	15378	24	336317	18
17	60	22	14848	25	326673	19
18	84	21	15555	23	326656	20
19	64	20	21668	11	433363	17
20	76	20	22234	10	444680	16
21	80	14	14837	26	207730	21
22	92	13	7436	35	96668	31
23	96	12	10275	32	123309	30
24	88	12	11269	31	135232	28
25	100	12	11985	30	143821	24
26	112	8	16908	22	135270	27
27	116	8	19303	17	154429	23
28	108	7	8175	33	57229	32
29	104	6	25824	7	154946	22
30	120	3	44030	3	132091	29
31	128	3	3002	36	9007	35
32	124	2	24876	8	49753	33
33	132	1	141704	1	141704	25
34	144	1	7500	34	7500	36
35	160	1	135552	2	135552	26
36	152	1	12003	29	12003	34

TOTAL= 1076 19710=AVG 21208008=TOTAL

1975 FEDERAL RAILROAD ADMINISTRATION ACCIDENT/INCIDENT DATA



TABLE 111-F3

## DERAILMENTS BY FAIL POSITION

RANK	POSITION	ACCS	\$/ACC	RANK	\$ DMG	RANK
33	132	1	141704	1	141704	25
35	160	1	135552	2	135552	26
30	120	3	44030	3	132091	29
6	28	65	30156	4	1960183	1
7	24	61	28070	5	1712292	3
10	48	49	26092	6	1278550	7
29	104	6	25824	7	154946	22
32	124	2	24876	8	49753	33
3	20	75	23955	9	1796647	2
20	76	20	22234	10	444680	16
19	64	20	21668	11	433363	17
12	56	44	21667	12	953355	10
9	40	52	20011	13	1040585	9
13	44	40	19950	14	798002	13
14	52	34	19841	15	674601	14
8	32	57	19627	16	1118754	8
27	116	8	19303	17	154429	23
4	16	70	18735	18	1311471	6
11	36	44	18403	19	809775	12
2	8	80	17665	20	1413212	5
15	72	27	17579	21	474648	15
26	112	8	16908	22	135270	27
18	84	21	15555	23	326656	20
16	68	22	15378	24	338317	18
17	60	22	14848	25	326673	19
21	80	14	14837	26	207730	21
1	4	103	14176	27	1460155	4
5	12	66	12724	28	839845	11
36	152	1	12003	29	12003	34
25	100	12	11985	30	143821	24
24	88	12	11269	31	135232	28
23	96	12	10275	32	123309	30
28	108	7	8175	33	57229	32
34	144	1	7500	34	7500	36
22	92	13	7436	35	96668	31
31	128	3	3002	36	9007	35

TOTAL= 1076 19710=AVG 21208008=TOTAL

1975 FEDERAL RAILROAD ADMINISTRATION ACCIDENT/INCIDENT DATA

TABLE 111-F4

**DERAILMENTS BY FAIL POSITION**

RANK	POSITION	ACCS	\$/ACC	RANK	\$ DMG	RANK
6	28	65	30156	4	1960183	1
3	20	75	23955	9	1796647	2
7	24	61	28070	5	1712232	3
1	4	103	14176	27	1460155	4
2	8	80	17665	20	1413212	5
4	16	70	18735	18	1311471	6
10	48	49	26092	6	1278550	7
8	32	57	19627	16	1118754	8
9	40	52	20011	13	1040585	9
12	56	44	21667	12	953355	10
5	12	66	12724	28	839845	11
11	36	44	18403	19	809775	12
13	44	40	19950	14	798002	13
14	52	34	19841	15	674601	14
15	72	27	17579	21	474648	15
20	76	20	22234	10	444680	16
19	64	20	21668	11	433363	17
16	68	22	15378	24	338317	18
17	60	22	14848	25	326673	19
18	84	21	15555	23	326656	20
21	80	14	14837	26	207730	21
29	104	6	25824	7	154946	22
27	116	8	19303	17	154429	23
25	100	12	11985	30	143821	24
33	132	1	141704	1	141704	25
35	160	1	135552	2	135552	26
26	112	8	16908	22	135270	27
24	88	12	11269	31	135232	28
30	120	3	44030	3	132091	29
23	96	12	10275	32	123309	30
22	92	13	7436	35	96668	31
28	108	7	8175	33	57229	32
32	124	2	24876	8	49753	33
36	152	1	12003	29	12003	34
31	128	3	3002	36	9007	35
34	144	1	7500	34	7500	36

TOTAL = 1076      19710=AVG      21208008=TOTAL

1975 FEDERAL RAILROAD ADMINISTRATION ACCIDENT/INCIDENT DATA

TABLE 111-G1

(See Table II-5 for State Code Number/Name Identification)

**EQUIPMENT ACCIDENTS BY STATE**

CODE	ACCS	RANK	\$TOT/ACC	RANK	\$TOT DMG	RANK
1	54	12	14636	38	790350	25
2	1	49	137250	1	137250	40
4	16	33	14162	40	226599	38
5	32	24	25405	20	812963	24
6	60	9	27081	18	1624883	12
8	12	38	61347	4	736174	29
9	5	44	4496	46	22484	47
10	2	48	3412	48	6825	48
11	2	47	3250	49	6500	49
12	30	26	15108	37	453255	31
13	52	15	20092	27	1044820	19
16	21	29	21062	26	442318	32
17	136	2	16025	35	2179408	4
18	77	6	26880	19	2069760	7
19	92	5	23506	23	2162568	6
20	53	14	38214	12	2025381	8
21	63	8	29361	16	1849780	9
22	23	28	43607	9	1002973	21
23	5	43	4594	45	22974	46
24	21	30	5855	44	122963	41
25	15	34	17646	32	264702	37
26	50	16	11811	42	590587	30
27	50	17	18975	30	948784	22
28	19	31	49368	8	938008	23
29	54	11	29055	17	1568979	13
30	30	25	36675	13	1100274	15
31	41	21	60213	5	2468740	3
32	10	40	41639	10	416997	34
33	4	45	20002	28	80011	44
34	13	36	4321	47	56175	45
35	9	41	9433	43	84901	43
36	66	7	16486	33	1088121	16
37	33	23	39284	11	1296373	14
38	14	35	15384	36	215379	39
39	118	4	21498	25	2536785	2
40	30	27	54795	6	1643875	11
41	18	32	23626	22	425273	33
42	122	3	17804	31	2172187	5
45	12	37	33133	14	397602	35
46	7	42	13122	41	91856	42
47	47	18	22574	24	1060985	17
48	138	1	32173	15	4439949	1
49	12	39	65406	3	784883	27
50	3	46	110919	2	332759	36
51	46	19	16343	34	751804	28
53	42	20	25104	21	1054404	18
54	55	10	14360	39	789838	26
55	54	13	19314	29	1042966	20
56	33	22	53472	7	1764583	10

TOTAL= 1902      AVG= 25314      TOTAL= 48148008

1975 FEDERAL RAILROAD ADMINISTRATION ACCIDENT/INCIDENT DATA

TABLE 111-G2

(See Table II-5 for State Code Number/Name Identification)

**EQUIPMENT ACCIDENTS BY STATE**

RANK	CODE	ACCS	\$/ACC	RANK	\$ DMG	RANK
1	48	138	32173	15	4439949	1
2	17	136	16025	35	2179408	4
3	42	122	17804	31	2172187	5
4	39	118	21498	25	2536785	2
5	19	92	23506	23	2162568	6
6	18	77	26880	19	2069760	7
7	36	66	16486	33	1088121	16
8	21	63	29361	16	1849780	9
9	6	60	27081	18	1624883	12
10	54	55	14360	39	789838	26
11	29	54	29055	17	1568979	13
12	1	54	14636	38	790350	25
13	55	54	19314	29	1042966	20
14	20	53	38214	12	2025381	8
15	13	52	20092	27	1044820	19
16	26	50	11811	42	590587	30
17	27	50	18975	30	948784	22
18	47	47	22574	24	1060985	17
19	51	46	16343	34	751804	28
20	53	42	25104	21	1054404	18
21	31	41	60213	5	2468740	3
22	56	33	53472	7	1764583	10
23	37	33	39284	11	1296373	14
24	5	32	25405	20	812963	24
25	30	30	36675	13	1100274	15
26	12	30	15108	37	453255	31
27	40	30	54795	6	1643875	11
28	22	23	43607	9	1002973	21
29	16	21	21062	26	442318	32
30	24	21	5855	44	122963	41
31	28	19	49368	8	938008	23
32	41	18	23626	22	425273	33
33	4	16	14162	40	226599	38
34	25	15	17646	32	264702	37
35	38	14	15384	36	215379	39
36	34	13	4321	47	56175	45
37	45	12	33133	14	397602	35
38	8	12	61347	4	736174	29
39	49	12	65406	3	784883	27
40	32	10	41699	10	416997	34
41	35	9	9433	43	84901	43
42	46	7	13122	41	91856	42
43	23	5	4594	45	22974	46
44	9	5	4496	46	22484	47
45	33	4	20002	28	80011	44
46	50	3	110919	2	332759	36
47	11	2	3250	49	6500	49
48	10	2	3412	48	6825	48
49	2	1	137250	1	137250	40

TOTAL= 1902      25314=AVG      48148008=TOTAL

1975 FEDERAL RAILROAD ADMINISTRATION ACCIDENT/INCIDENT DATA

TABLE III-G3

(See Table II-5 for State Code Number/Name Identification)

**EQUIPMENT ACCIDENTS BY STATE**

RANK	CODE	ACCS	\$/ACC	RANK	\$ DMG	RANK
49	2	1	137250	1	137250	40
46	50	3	110919	2	332759	36
39	49	12	65406	3	784283	27
38	8	12	61347	4	736174	29
21	31	41	60213	5	2468740	3
27	40	30	54795	6	1643875	11
22	56	33	53472	7	1764583	10
31	28	19	49368	8	938008	23
28	22	23	43607	9	1002973	21
40	32	10	41699	10	416997	34
23	37	33	39284	11	1296373	14
14	20	53	38214	12	2025381	8
25	30	30	36675	13	1100274	15
37	45	12	33133	14	397602	35
1	48	138	32173	15	4439349	1
8	21	63	29361	16	1849780	9
11	29	54	29055	17	1568979	13
9	6	60	27081	18	1624883	12
6	18	77	26880	19	2069760	7
24	5	32	25405	20	812963	24
20	53	42	25104	21	1054404	18
32	41	18	23626	22	425273	33
5	19	92	23506	23	2162568	6
18	47	47	22574	24	1060985	17
4	39	118	21498	25	2536785	2
29	16	21	21062	26	442318	32
15	13	52	20092	27	1044820	19
45	33	4	20002	28	80011	44
13	55	54	19314	29	1042966	20
17	27	50	18975	30	948784	22
3	42	122	17804	31	2172187	5
34	25	15	17646	32	264702	37
7	36	66	16486	33	1088121	16
19	51	46	16343	34	751804	28
2	17	136	16025	35	2179408	4
35	38	14	15384	36	215379	39
26	12	30	15108	37	453255	31
12	1	54	14636	38	790350	25
10	54	55	14360	39	789838	26
33	4	16	14162	40	226599	38
42	46	7	13122	41	91856	42
16	26	50	11811	42	590587	30
41	35	9	9433	43	84901	43
30	24	21	5855	44	122963	41
43	23	5	4594	45	22974	46
44	9	5	4496	46	22484	47
36	34	13	4321	47	56175	45
48	10	2	3412	48	6825	48
47	11	2	3250	49	6500	49

TOTAL= 1902 25314=AVG 48148008=TOTAL

1975 FEDERAL RAILROAD ADMINISTRATION ACCIDENT/INCIDENT DATA

TABLE 111-64

(See Table II-5 for State Code Number/Name Identification)

**EQUIPMENT ACCIDENTS BY STATE**

RANK	CODE	ACCS	\$/ACC	RANK	\$ DMG	RANK
1	48	138	32173	15	4439949	1
4	39	118	21498	25	2536785	2
21	31	41	60213	5	2468740	3
2	17	136	16025	35	2179408	4
3	42	122	17804	31	2172187	5
5	19	92	23506	23	2162568	6
6	18	77	26880	19	2069760	7
14	20	53	38214	12	2025381	8
8	21	63	29361	16	1849780	9
22	56	33	53472	7	1764583	10
27	40	30	54795	6	1643875	11
9	6	60	27081	18	1624883	12
11	29	54	29055	17	1568979	13
23	37	33	39284	11	1296373	14
25	30	30	36675	13	1100274	15
7	36	66	16486	33	1088121	16
18	47	47	22574	24	1060985	17
20	53	42	25104	21	1054404	18
15	13	52	20092	27	1044820	19
13	55	54	19314	29	1042966	20
28	22	23	43607	9	1002973	21
17	27	50	18975	30	948784	22
31	28	19	49368	8	938008	23
24	5	32	25405	20	812963	24
12	1	54	14636	38	790350	25
10	54	55	14360	39	789838	26
39	49	12	65406	3	784883	27
19	51	46	16343	34	751804	28
38	8	12	61347	4	736174	29
16	26	50	11811	42	590587	30
26	12	30	15108	37	453255	31
29	16	21	21062	26	442318	32
32	41	18	23626	22	425273	33
40	32	10	41699	10	416997	34
37	45	12	33133	14	397602	35
46	50	3	110919	2	332759	36
34	25	15	17646	32	264702	37
33	4	16	14162	40	226599	38
35	38	14	15384	36	215379	39
49	2	1	137250	1	137250	40
30	24	21	5855	44	122963	41
42	46	7	13122	41	91856	42
41	35	9	9433	43	84901	43
45	33	4	20002	28	80011	44
36	34	13	4321	47	56175	45
43	23	5	4594	45	22974	46
44	9	5	4496	46	22484	47
48	10	2	3412	48	6825	48
47	11	2	3250	49	6500	49

TOTAL = 1902      25314=AVG      48148008=TOTAL  
 1975 FEDERAL RAILROAD ADMINISTRATION ACCIDENT/INCIDENT DATA

TABLE 111-H1

(See Table II-5 for State Code Number/Name Identification)

**75 EQUIP DERAILMTS BY STATE**

CODE	ACCS	RANK	\$TOT/ACC	RANK	\$TOT DMG	RANK
1	44	16	16757	35	737331	27
2	1	49	137250	1	137250	40
4	14	33	15149	38	212099	38
5	28	23	28318	20	792921	23
6	46	14	32262	17	1484096	13
8	11	34	66717	5	733890	28
9	1	48	2598	49	2598	49
10	2	46	3412	47	6825	47
11	2	47	3250	48	6500	48
12	25	27	15792	36	394804	34
13	48	11	19400	31	931241	19
16	19	29	20815	28	395495	33
17	117	2	17168	33	2008711	6
18	69	6	26148	22	1804275	8
19	83	5	25043	23	2078593	4
20	44	18	41900	13	1843641	7
21	53	7	33584	15	1779997	9
22	20	28	47323	11	946473	18
23	4	43	4993	45	19974	46
24	17	30	6918	44	117613	41
25	10	36	22173	26	221730	37
26	46	13	12562	41	577887	30
27	46	12	19532	30	898475	22
28	16	32	57160	7	914568	21
29	49	10	31536	18	1545278	12
30	26	25	40996	14	1065920	15
31	33	21	70534	4	2327640	3
32	8	41	51124	9	408997	32
33	4	44	20002	29	80011	43
34	8	39	4893	46	39150	45
35	8	40	9537	43	76301	44
36	53	8	12359	42	655079	29
37	26	26	48423	10	1259007	14
38	11	35	15736	37	173099	39
39	113	3	22187	25	2507150	2
40	27	24	59288	6	1600780	11
41	16	31	26313	21	421023	31
42	112	4	18157	32	2033611	5
45	9	38	42586	12	383277	35
46	7	42	13122	40	91856	42
47	38	19	24254	24	921685	20
48	120	1	32504	16	3900580	1
49	10	37	77271	3	772719	24
50	3	45	110919	2	332759	36
51	44	17	16913	34	744204	26
53	36	20	28405	19	1022596	16
54	50	9	14927	39	746393	25
55	46	15	21580	27	992711	17
56	30	22	56812	8	1704370	10

TOTAL= 1653      AVG= 27134      TOTAL= 44853183

1975 FEDERAL RAILROAD ADMINISTRATION ACCIDENT/INCIDENT DATA

TABLE 111-92

(See Table II-5 for State Code Number/Name Identification.)

**75 EQUIP DERAILMENTS BY STATE**

RANK	CODE	ACCS	\$/ACC	RANK	\$ DMG	RANK
1	48	120	32504	16	3900580	1
2	17	117	17168	33	2008711	6
3	39	113	22187	25	2507150	2
4	42	112	18157	32	2033611	5
5	19	83	25043	23	2078593	4
6	18	69	26148	22	1804275	8
7	21	53	33584	15	1779997	9
8	36	53	12359	42	655079	29
9	54	50	14927	39	746393	25
10	29	49	31536	18	1545278	12
11	13	48	19400	31	931241	19
12	27	46	19532	30	898475	22
13	26	46	12562	41	577887	30
14	6	46	32262	17	1484096	13
15	55	46	21580	27	992711	17
16	1	44	11757	35	737331	27
17	51	44	16913	34	744204	26
18	20	44	41900	13	1843641	7
19	47	38	24254	24	921685	20
20	53	36	28405	19	1022596	16
21	31	33	70534	4	2327640	3
22	56	30	56812	8	1704370	10
23	5	28	28318	20	792921	23
24	40	27	59288	6	1600780	11
25	30	26	40996	14	1065920	15
26	37	26	48423	10	1259007	14
27	12	25	15792	36	394804	34
28	22	20	47323	11	946473	18
29	16	19	20815	28	395495	33
30	24	17	6918	44	117613	41
31	41	16	26313	21	421023	31
32	28	16	57160	7	914568	21
33	4	14	15149	38	212099	38
34	8	11	66717	5	733890	28
35	38	11	15736	37	173099	39
36	25	10	22173	26	221730	37
37	49	10	77271	3	772719	24
38	45	9	42586	12	383277	35
39	34	8	4893	46	39150	45
40	35	8	9537	43	76301	44
41	32	8	51124	9	408997	32
42	46	7	13122	40	91856	42
43	23	4	4993	45	19974	46
44	33	4	20002	29	80011	43
45	50	3	110919	2	332759	36
46	10	2	3412	47	6825	47
47	11	2	3250	48	6500	48
48	9	1	2598	49	2598	49
49	2	1	137250	1	137250	40

TOTAL= 1653 27134=AVG 44853183=TOTAL

1975 FEDERAL RAILROAD ADMINISTRATION ACCIDENT/INCIDENT DATA



III-32  
TABLE III-H3

(See Table II-5 for State Code Number/Name Identification)

**75 EQUIP DERAILMTS BY STATE**

RANK	CODE	ACCS	\$/ACC	RANK	\$ DMG	RANK
49	2	1	137250	1	137250	40
45	50	3	110919	2	332759	36
37	49	10	77271	3	772719	24
21	31	33	70534	4	2327640	3
34	8	11	66717	5	733890	28
24	40	27	59238	6	1600780	11
32	28	16	57160	7	914568	21
22	56	30	56812	8	1704370	10
41	32	8	51124	9	408997	32
26	37	26	48423	10	1259007	14
28	22	20	47323	11	946473	18
38	45	9	42586	12	383277	35
18	20	44	41900	13	1843641	7
25	30	26	40996	14	1065920	15
7	21	53	33584	15	1779997	9
1	48	120	32504	16	3900580	1
14	6	46	32262	17	1484096	13
10	29	49	31536	18	1545278	12
20	53	36	28405	19	1022596	16
23	5	28	28318	20	792921	23
31	41	16	26313	21	421023	31
6	18	69	26148	22	1804275	8
5	19	83	25043	23	2078593	4
19	47	38	24254	24	921685	20
3	39	113	22187	25	2507150	2
36	25	10	22173	26	221730	37
15	55	46	21580	27	992711	17
29	16	19	20815	28	395495	33
44	33	4	20002	29	80011	43
12	27	46	19532	30	898475	22
11	13	48	19400	31	931241	19
4	42	112	18157	32	2033611	5
2	17	117	17168	33	2008711	6
17	51	44	16913	34	744204	26
16	1	44	16757	35	737331	27
27	12	25	15792	36	394804	34
35	38	11	15736	37	173099	39
33	4	14	15149	38	212099	38
9	54	50	14927	39	746393	25
42	46	7	13122	40	91856	42
13	26	46	12562	41	577887	30
8	36	53	12359	42	655079	29
40	35	8	9537	43	76301	44
30	24	17	6918	44	117613	41
43	23	4	4993	45	19974	46
39	34	8	4893	46	39150	45
46	10	2	3412	47	6825	47
47	11	2	3250	48	6500	48
48	9	1	2598	49	2598	49

TOTAL= 1653      27134=AVG      44853183=TOTAL

1975 FEDERAL RAILROAD ADMINISTRATION ACCIDENT/INCIDENT DATA

TABLE 111-H4

(See Table II-5 for State Code Number/Name Identification)

**75 EQUIP DERAILMNTS BY STATE**

RANK	CODE	ACCS	\$/ACC	RANK	\$ DMG	RANK
1	48	120	32504	16	3900580	1
3	39	113	22187	25	2507150	2
21	31	33	70534	4	2327640	3
5	19	83	25043	23	2078593	4
4	42	112	18157	32	2033611	5
2	17	117	17168	33	2008711	6
18	20	44	41900	13	1843641	7
6	18	69	26148	22	1804275	8
7	21	53	33584	15	1779997	9
22	56	30	56812	8	1704370	10
24	40	27	59288	6	1600780	11
10	29	49	31536	18	1545278	12
14	6	46	32262	17	1484096	13
26	37	26	48423	10	1259007	14
25	30	26	40936	14	1065920	15
20	53	36	28405	19	1022596	16
15	55	46	21580	27	992711	17
28	22	20	47323	11	946475	18
11	13	48	19400	31	931241	19
19	47	38	24254	24	921685	20
32	28	16	57160	7	914562	21
12	27	46	19532	30	898475	22
23	5	28	28318	20	792921	23
37	49	10	77271	3	772719	24
9	54	50	14927	39	746393	25
17	51	44	16913	34	744204	26
16	1	44	16757	35	737331	27
34	8	11	66717	5	733890	28
8	36	53	12359	42	655079	29
13	26	46	12562	41	577887	30
31	41	16	26313	21	421023	31
41	32	8	51124	9	408997	32
29	16	19	20815	28	395495	33
27	12	25	15792	36	394804	34
38	45	9	42586	12	383277	35
45	50	3	110919	2	332759	36
36	25	10	22173	26	221730	37
33	4	14	15149	38	212099	38
35	38	11	15736	37	173099	39
43	2	1	137250	1	137250	40
30	24	17	6918	44	117613	41
42	46	7	13122	40	91856	42
44	33	4	20002	29	80011	43
40	35	8	9537	43	76301	44
39	34	8	4893	46	39150	45
43	23	4	4993	45	19974	46
46	10	2	3412	47	6825	47
47	11	2	3250	48	6500	48
48	9	1	2598	49	2598	49

TOTAL= 1653 27134=AVG 44853183=TOTAL

1975 FEDERAL RAILROAD ADMINISTRATION ACCIDENT/INCIDENT DATA

TABLE III-J1

**DERAILMENTS BY MONTH**

MONTH	ACCS	RANK	\$TOT/ACC	RANK	\$TOT DMG	RANK
1	171	4	24137	8	4127431	5
2	154	7	38710	1	5961346	1
3	171	3	24034	9	4109858	7
4	142	11	26172	4	3716500	10
5	151	8	25033	6	3779988	9
6	156	6	14846	12	2316085	12
7	134	12	22779	10	3052466	11
8	142	10	29060	2	4126543	6
9	165	5	27121	3	4475031	2
10	148	9	26159	5	3871534	8
11	191	1	22132	11	4227258	4
12	177	2	24768	7	4383968	3
TOTAL=	1902	AVG=	25314	TOTAL=	48148008	

1975 FEDERAL RAILROAD ADMINISTRATION ACCIDENT/INCIDENT DATA

TABLE III-J2

**DERAILMENTS BY MONTH**

RANK	MONTH	ACCS	\$/ACC	RANK	\$ DMG	RANK
1	11	191	22132	11	4227258	4
2	12	177	24768	7	4383968	3
3	3	171	24034	9	4109858	7
4	1	171	24137	8	4127431	5
5	9	165	27121	3	4475031	2
6	6	156	14846	12	2316085	12
7	2	154	38710	1	5961346	1
8	5	151	25033	6	3779988	9
9	10	148	26159	5	3871534	8
10	8	142	29060	2	4126543	6
11	4	142	26172	4	3716500	10
12	7	134	22779	10	3052466	11
TOTAL=		1902	25314=AVG		48148008=TOTAL	

1975 FEDERAL RAILROAD ADMINISTRATION ACCIDENT/INCIDENT DATA

TABLE III-J3

**DERAILMENTS BY MONTH**

RANK	MONTH	ACCS	\$/ACC	RANK	\$ DMG	RANK
7	2	154	38710	1	5961346	1
10	8	142	29060	2	4126543	6
5	9	165	27121	3	4475031	2
11	4	142	26172	4	3716500	10
9	10	148	26159	5	3871534	8
8	5	151	25033	6	3779988	9
2	12	177	24768	7	4383968	3
4	1	171	24137	8	4127431	5
3	3	171	24034	9	4109858	7
12	7	134	22779	10	3052466	11
1	11	191	22132	11	4227258	4
6	6	156	14846	12	2316085	12
TOTAL=		1902	25314=AVG	48148008=TOTAL		

1975 FEDERAL RAILROAD ADMINISTRATION ACCIDENT/INCIDENT DATA

TABLE III-J4

**DERAILMENTS BY MONTH**

RANK	MONTH	ACCS	\$/ACC	RANK	\$ DMG	RANK
7	2	154	38710	1	5961346	1
5	9	165	27121	3	4475031	2
2	12	177	24768	7	4383968	3
1	11	191	22132	11	4227258	4
4	1	171	24137	8	4127431	5
10	8	142	29060	2	4126543	6
3	3	171	24034	9	4109858	7
9	10	148	26159	5	3871534	8
8	5	151	25033	6	3779988	9
11	4	142	26172	4	3716500	10
12	7	134	22779	10	3052466	11
6	6	156	14846	12	2316085	12
TOTAL=		1902	25314=AVG	48148008=TOTAL		

1975 FEDERAL RAILROAD ADMINISTRATION ACCIDENT/INCIDENT DATA

APPENDIX IV

HISTOGRAMS FROM EQUIPMENT CAUSED ACCIDENTS

The following meanings apply to information contained in this appendix.

- AREA = Number of observations used to make up histogram.
- MEAN =  $\frac{\text{Sum of observed values}}{\text{Area}}$
- STD DEV = Standard deviation of observed values.
- PEAK = Number of observations represented by the highest bar in the histogram.
- STEP = Cut-off value for that bar of the histogram.  
Bar represents all data with magnitudes between this value and that of the previous step.

NORMALIZED DATA HISTOGRAM

ALL EQUIPMENT CAUSED ACCIDENT TYPES

1975 FEDERAL RAILROAD ADMINISTRATION ACCIDENT/INCIDENT DATA

STEP

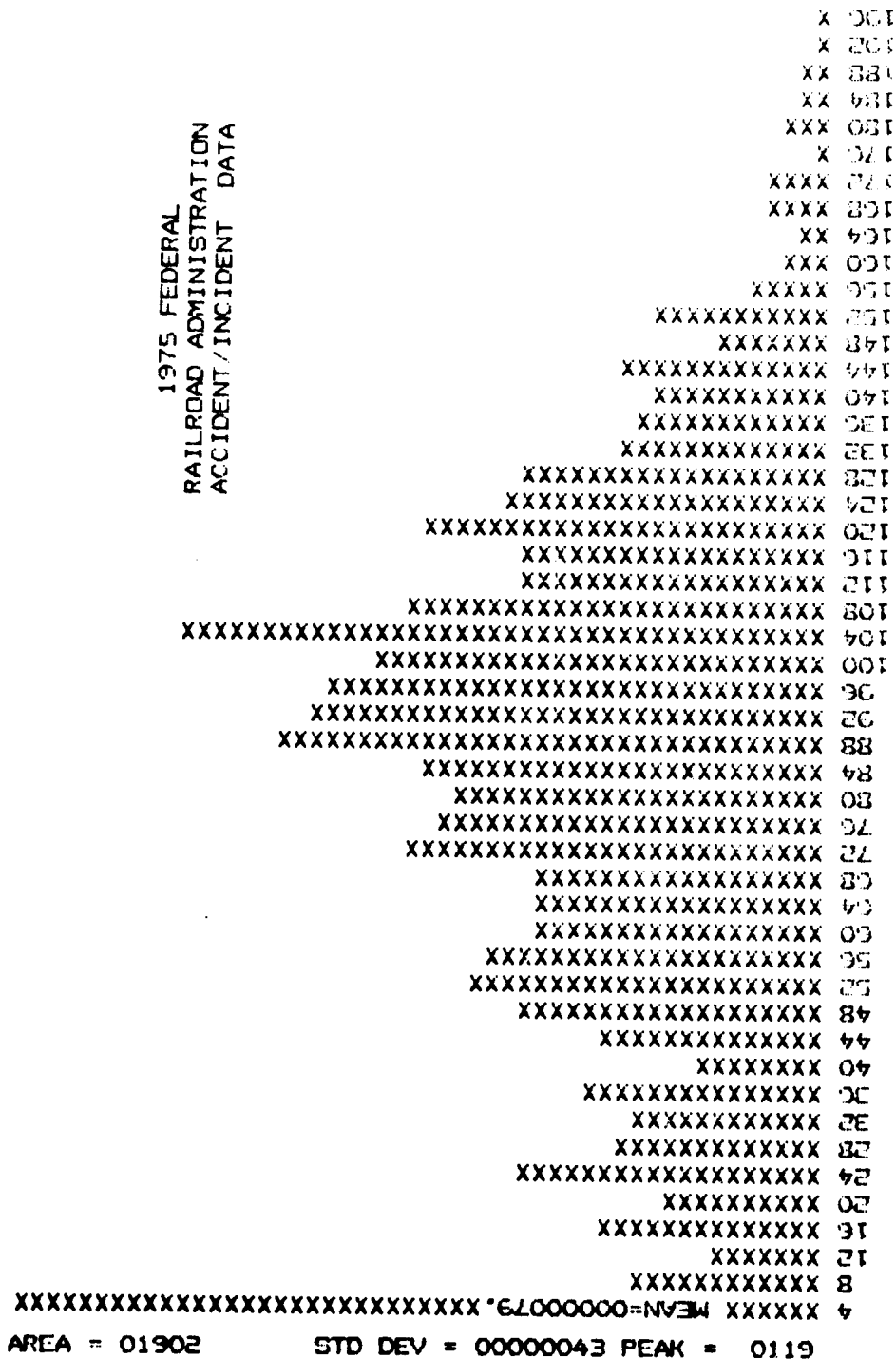

Fig. VI-1

Histogram of all Equipment-Caused Accidents Distributed over the Number of Cars in the Train at the Time of the Incident.

NORMALIZED DATA HISTOGRAM

ALL EQUIPMENT CAUSED ACCIDENT TYPES

1975 FEDERAL  
RAILROAD ADMINISTRATION  
ACCIDENT/INCIDENT DATA

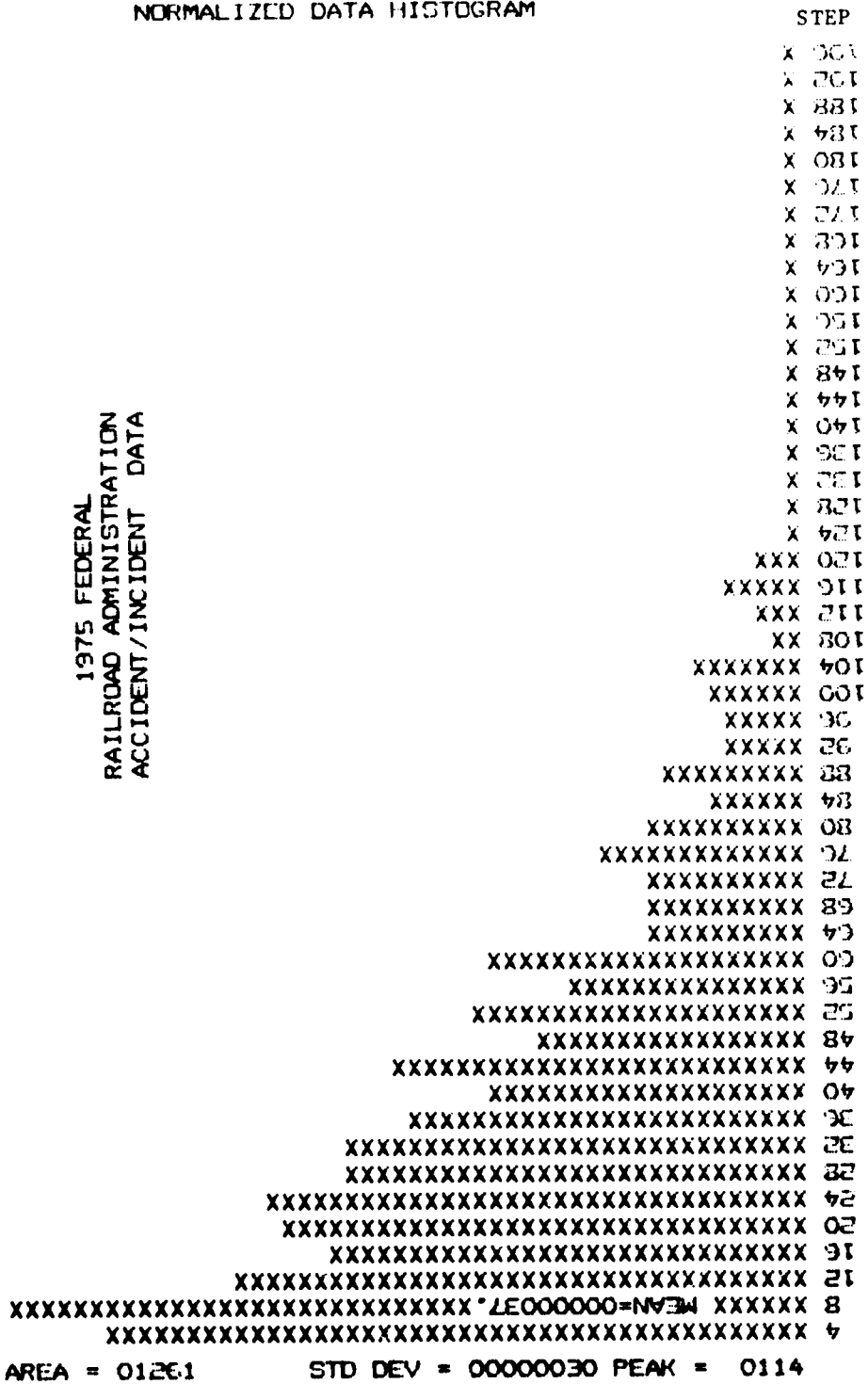

Fig. IV-2  
Histogram of all Equipment-Caused Accidents Distributed over the Car  
Position that Caused the Incident in the Train.



NORMALIZED DATA HISTOGRAM

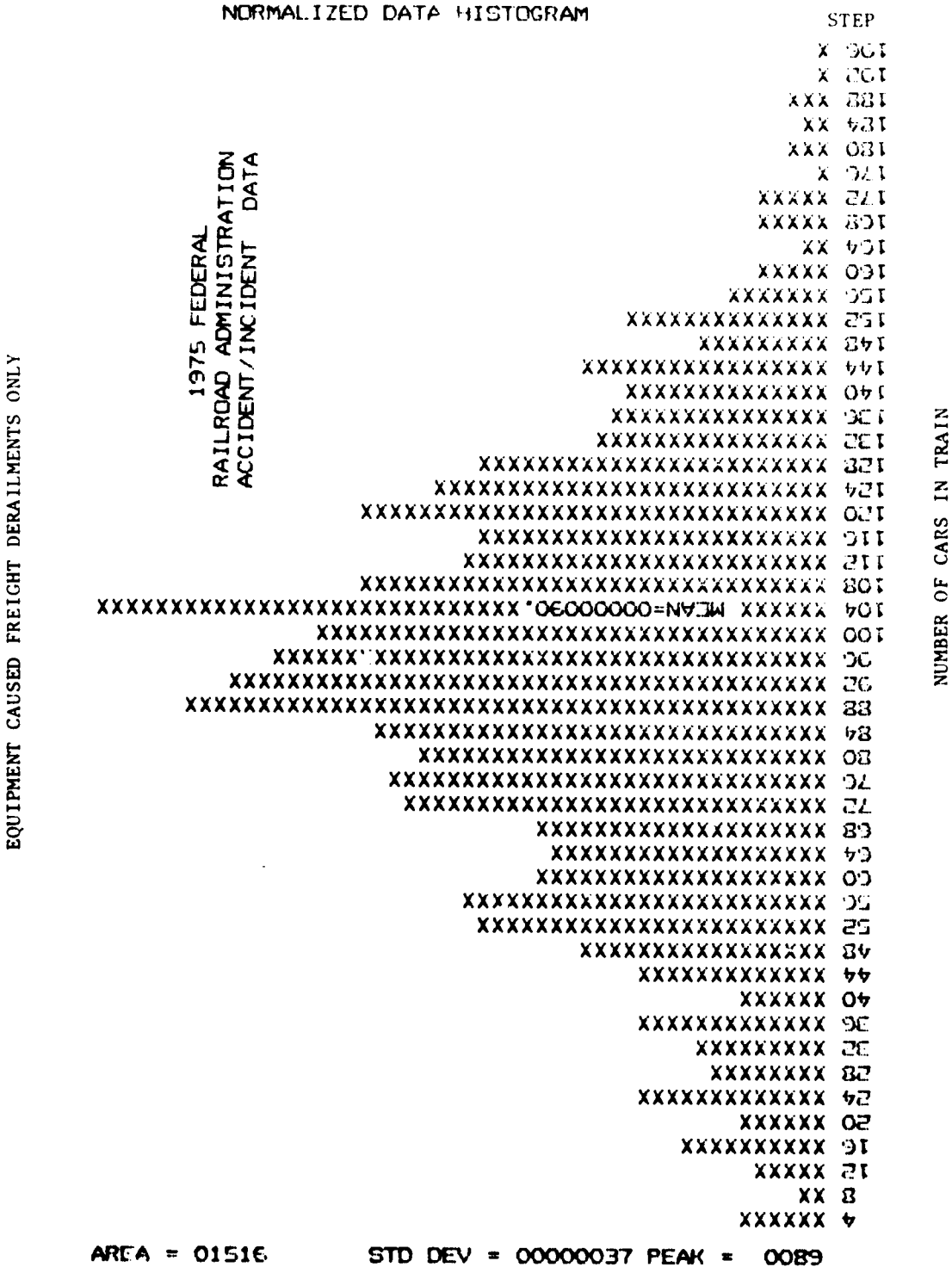

Fig. IV-3  
 Histogram of Equipment-Caused Freight Derailments Distributed over the  
 Number of Cars in the Train at the Time of the Incident.

IV-5  
 NORMALIZED DATA HISTOGRAM

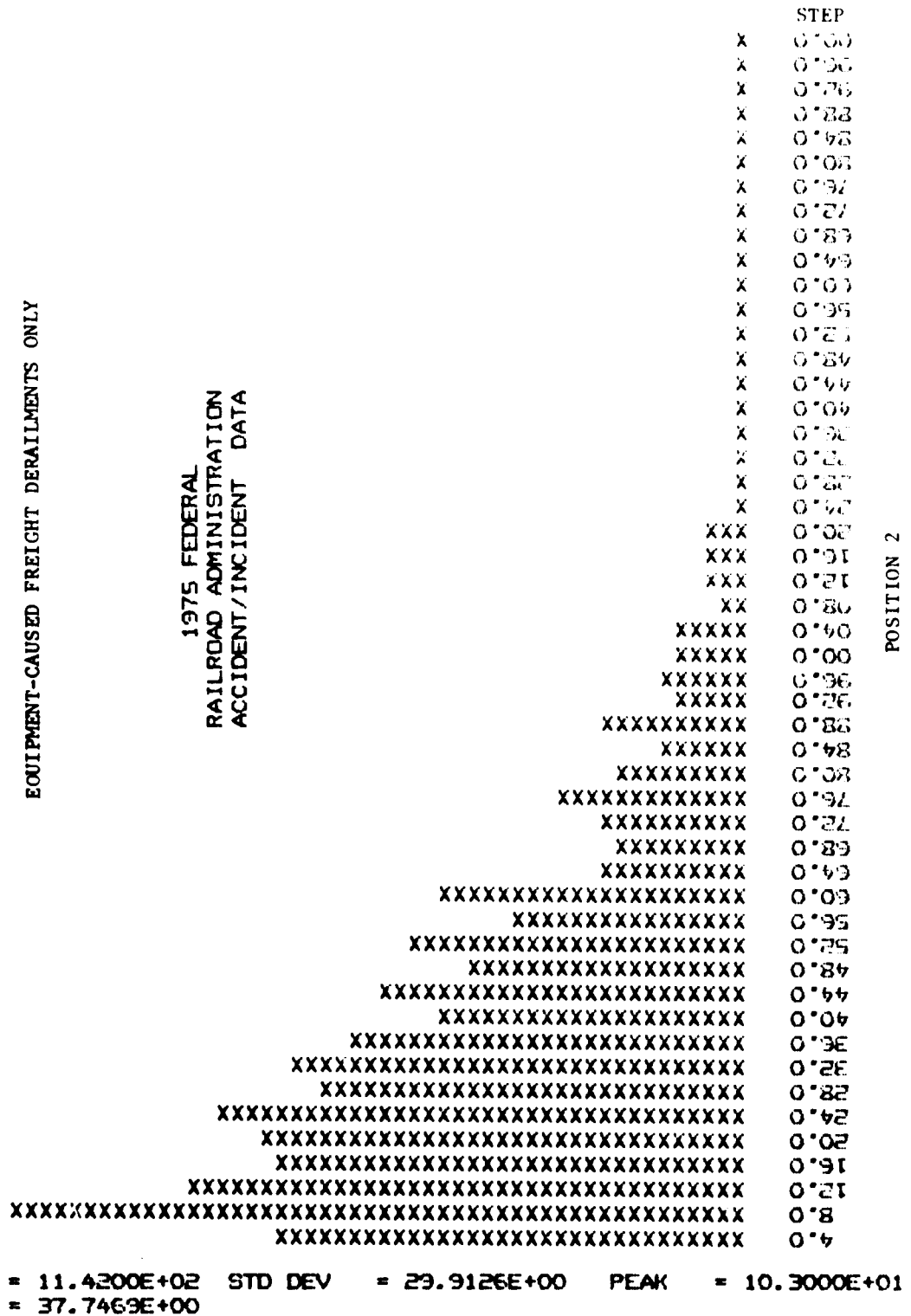
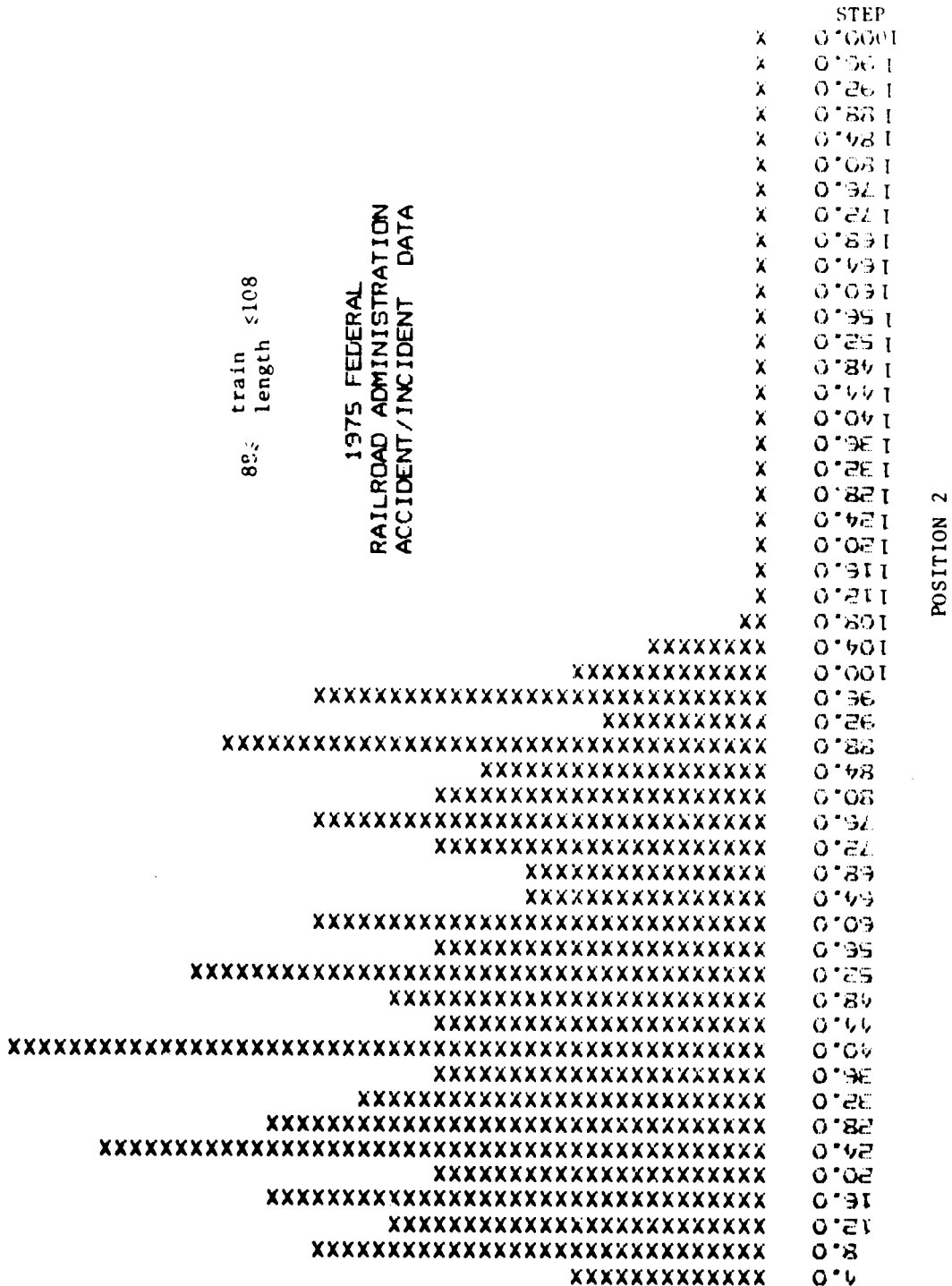

Fig.IV-4  
 Histogram of Equipment-Caused Freight Derailments Distributed over the Car  
 Position that Caused the Incident in the Train.

IV-6  
 NORMALIZED DATA HISTOGRAM

EQUIPMENT CAUSED FREIGHT ACCIDENTS



AREA = 24.2000E+01    STD DEV = 28.3336E+00    PEAK = 18.0000E+00  
 MEAN = 47.6611E+00

Fig. IV-5  
 Histogram of Equipment-Caused Freight Derailments Distributed over the Number of Cars in the Train at the Time of the Incident. Data Sample from Trains with more than 87 Cars but Less than 109.

NORMAL TALL IV TA HISTOGRAM

EQUIPMENT CAUSED DERAILMENTS ONLY

1975 FEDERAL RAILROAD ADMINISTRATION ACCIDENT/INCIDENT DATA

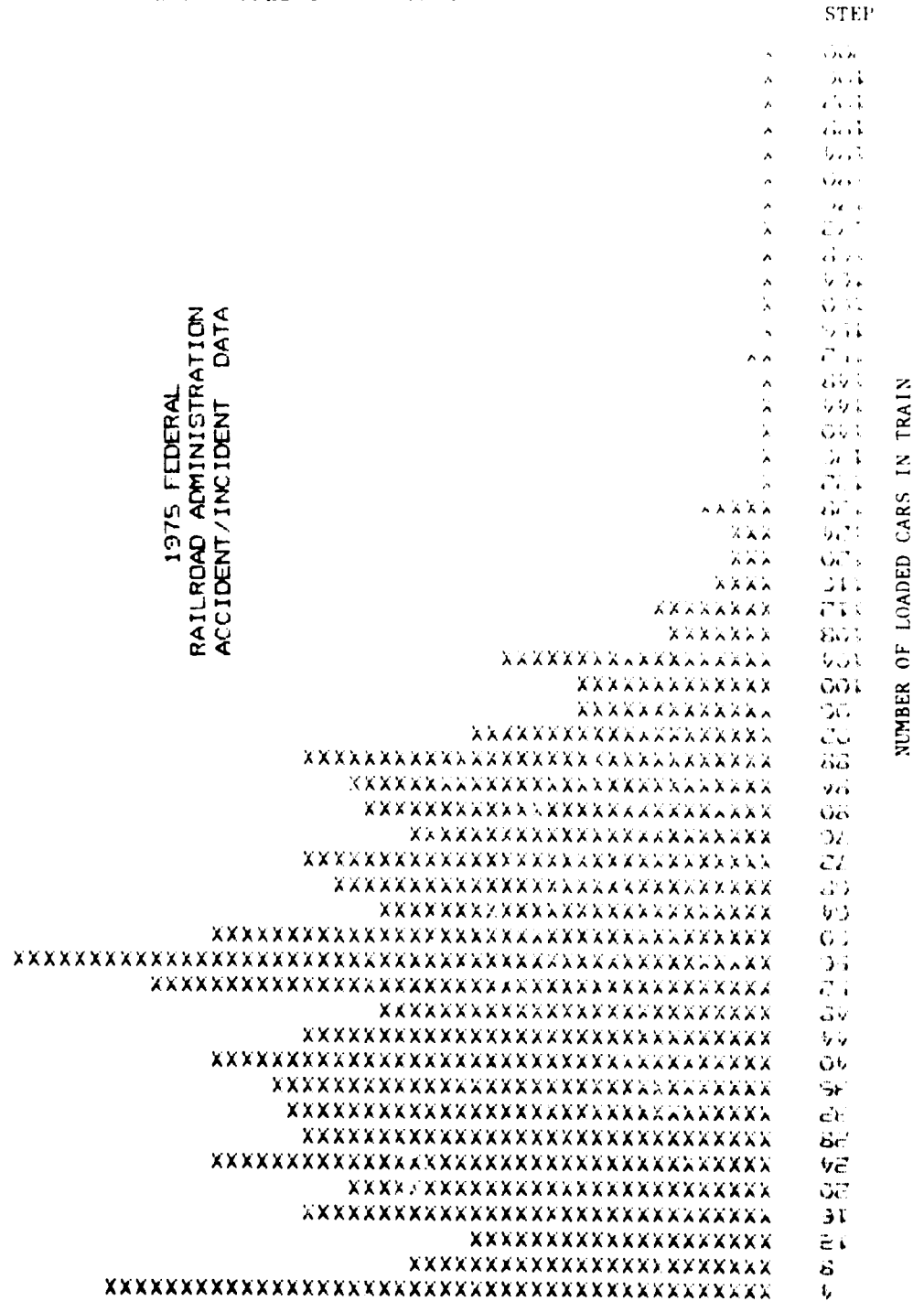

AREA = 1E.2400E+02    STD DEV = 33.4078E+00    PEAK = 99.0000E+00  
 MEAN = 52.0757E+00

Fig. IV-6  
 Histogram of Equipment-Caused Derailments Distributed over the Number of Loaded Cars at the Time of the Incident.

NORMALIZED DATA HISTOGRAM

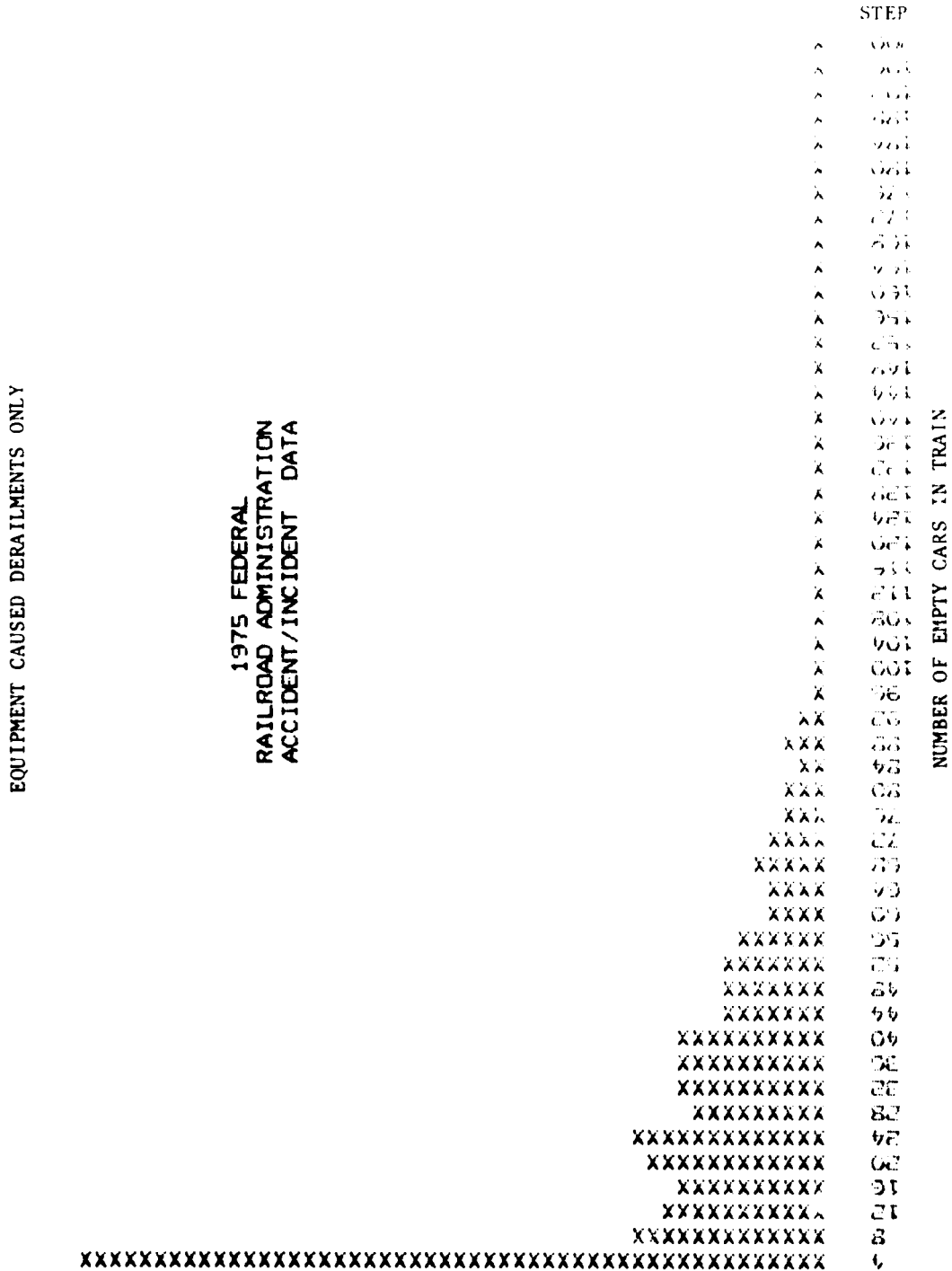

AREA = 16.0700E+02    STD DEV = 30.3154E+00    PEAK = 35.5000E+01  
 MEAN = 31.5973E+00

Fig. IV-7  
 Histogram of Equipment-Caused Derailments Distributed over the Number of Empty Cars in the Train at the Time of the Incident.

NORMALIZED DATA HISTOGRAM

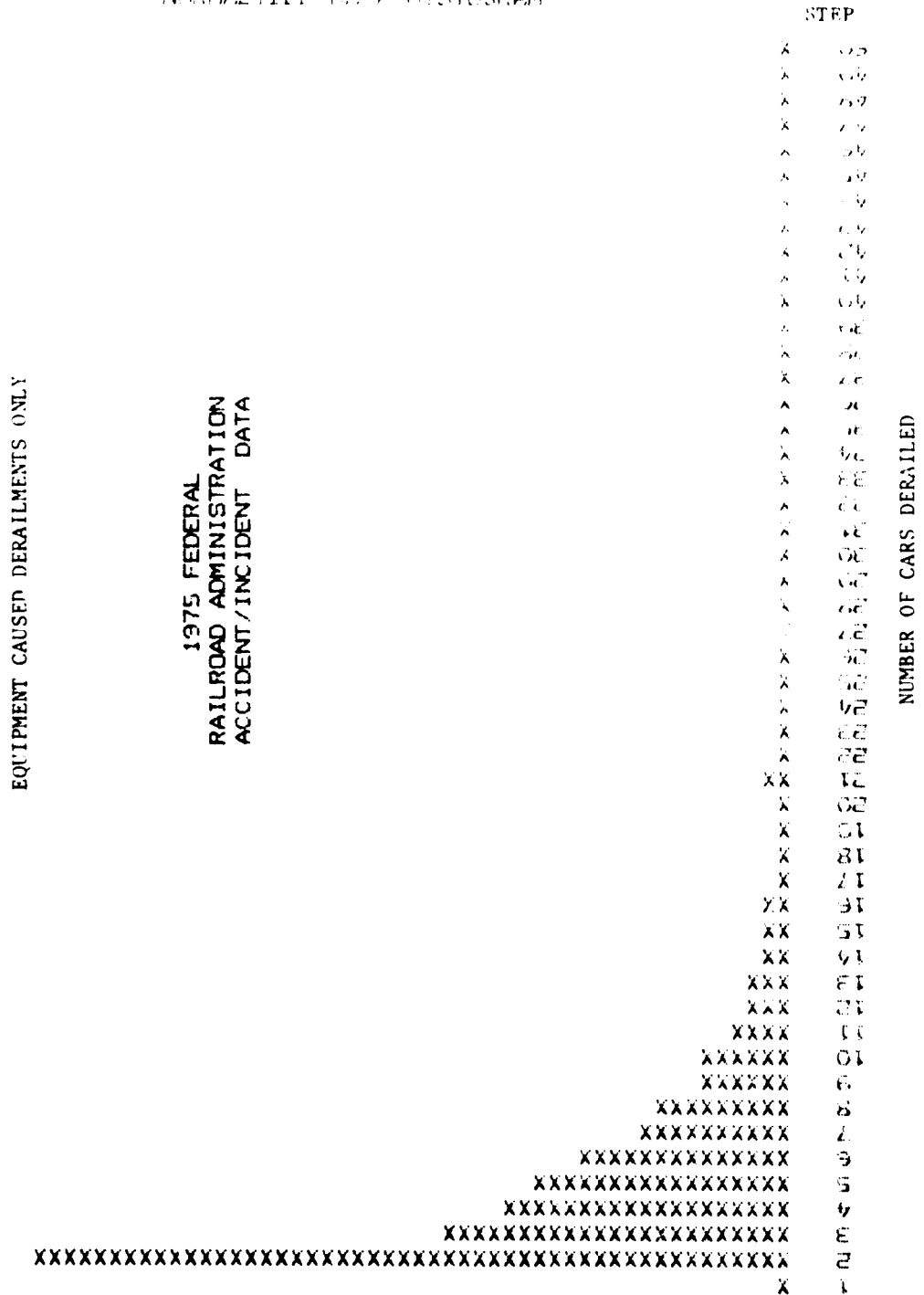

AREA = 16.0300E+02    STD DEV = 66.1571E-01    PEAK = 41.5000E+01  
 MEAN = 59.4884E-01

Fig. IV-8  
 Histogram of Equipment-Caused Derailments Distributed over the Number of Cars  
 Derailed at the Time of the Incident.

IV-10  
 NORMALIZED DATA HISTOGRAM

ALL EQUIPMENT CAUSED ACCIDENT TYPES

1975 FEDERAL  
 RAILROAD ADMINISTRATION  
 ACCIDENT/INCIDENT DATA

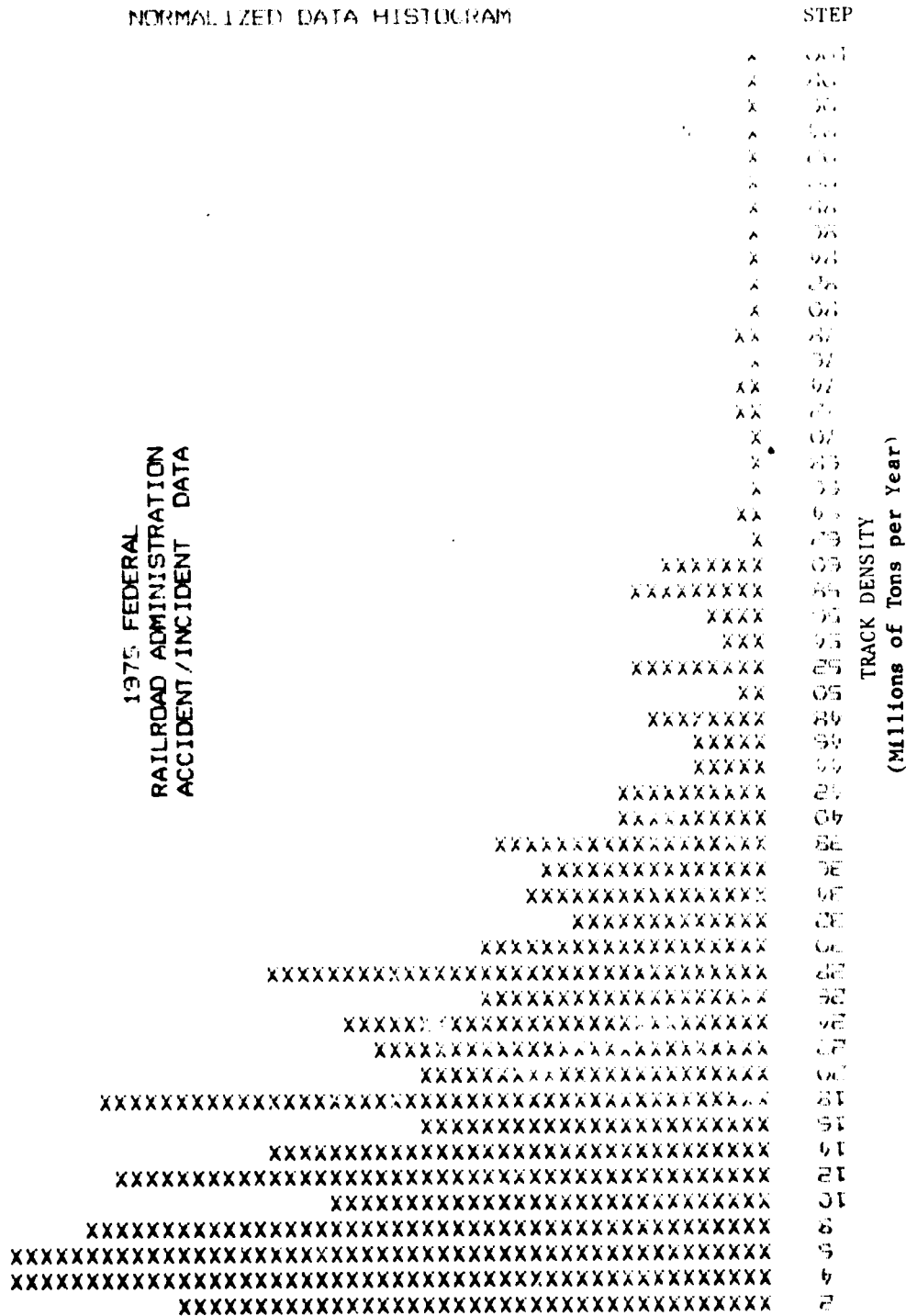

AREA = 12.4700E+02 STD DEV = 16.8778E+00 PEAK = 93.0000E+00  
 MEAN = 20.6578E+00

Fig. IV-9  
 Histogram of all Equipment-Caused Accidents Distributed over the Track Density at the Site of the Incident.

IV-11  
 NORMALIZED DATA HISTOGRAM

EQUIPMENT CAUSED DERAILMENTS ONLY

1975 FEDERAL  
 RAILROAD ADMINISTRATION  
 ACCIDENT/INCIDENT DATA

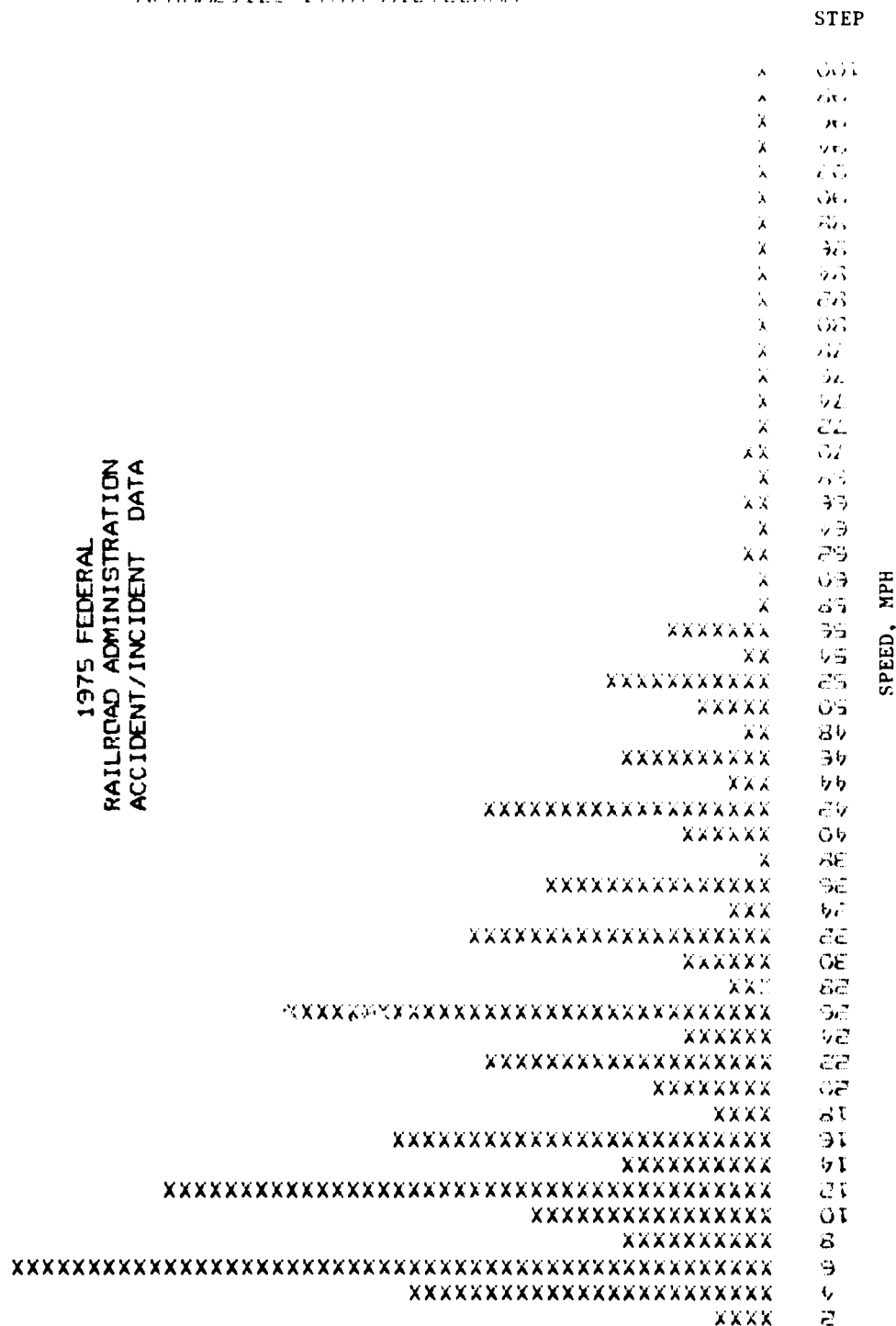

AREA = 16.3300E+02 STD DEV = 16.5019E+00 PEAK = 21.2000E+01  
 MEAN = 21.9571E+00

Fig. IV-10  
 Histogram of Equipment-Caused Derailments Distributed over the Reported Speed at the Time of the Incident.



IV-12  
 NORMALIZED DATA HISTOGRAM

EQUIPMENT CAUSED DERAILMENTS ONLY

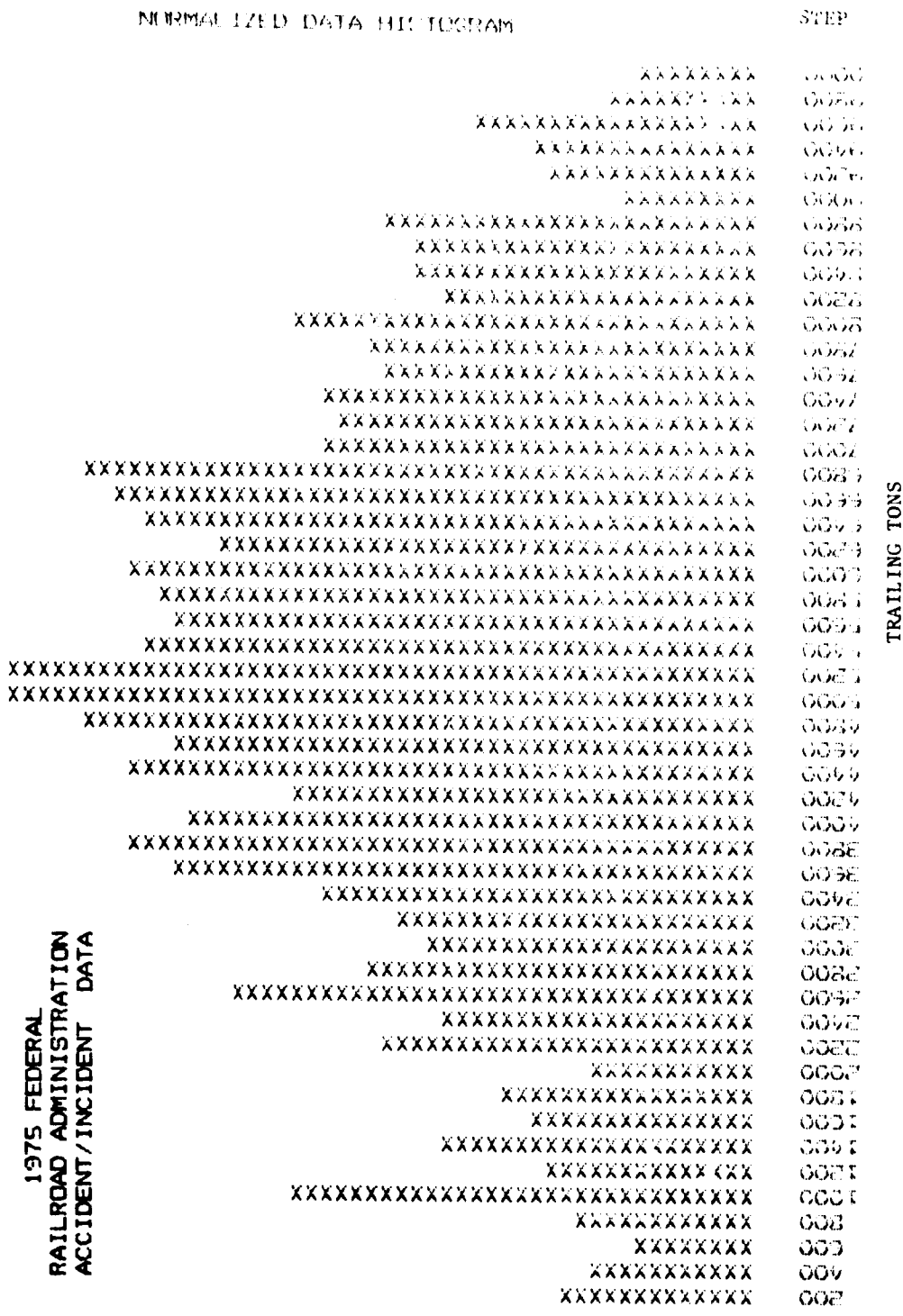

AREA = 13.1900E+02 STD DEV = 23.7969E+02 PEAK = 47.0000E+00  
 MEAN = 50.8312E+02

Fig. IV-11  
 Histogram of Equipment-Caused Derailments Distributed over the Trailing Tons in the Train at the Time of the Incident.



Mean = 736

Area = 1902

Std. Dev. = 428

Fig. IV-12  
Histogram of all Equipment-Caused Accidents Distributed over the Reported Time of Day (Minutes from Midnight) of the Incident.

1972 EQUIPMENT CAUSED ACCIDENTS  
DISTRIBUTION OF TOTAL \$ DAMAGE

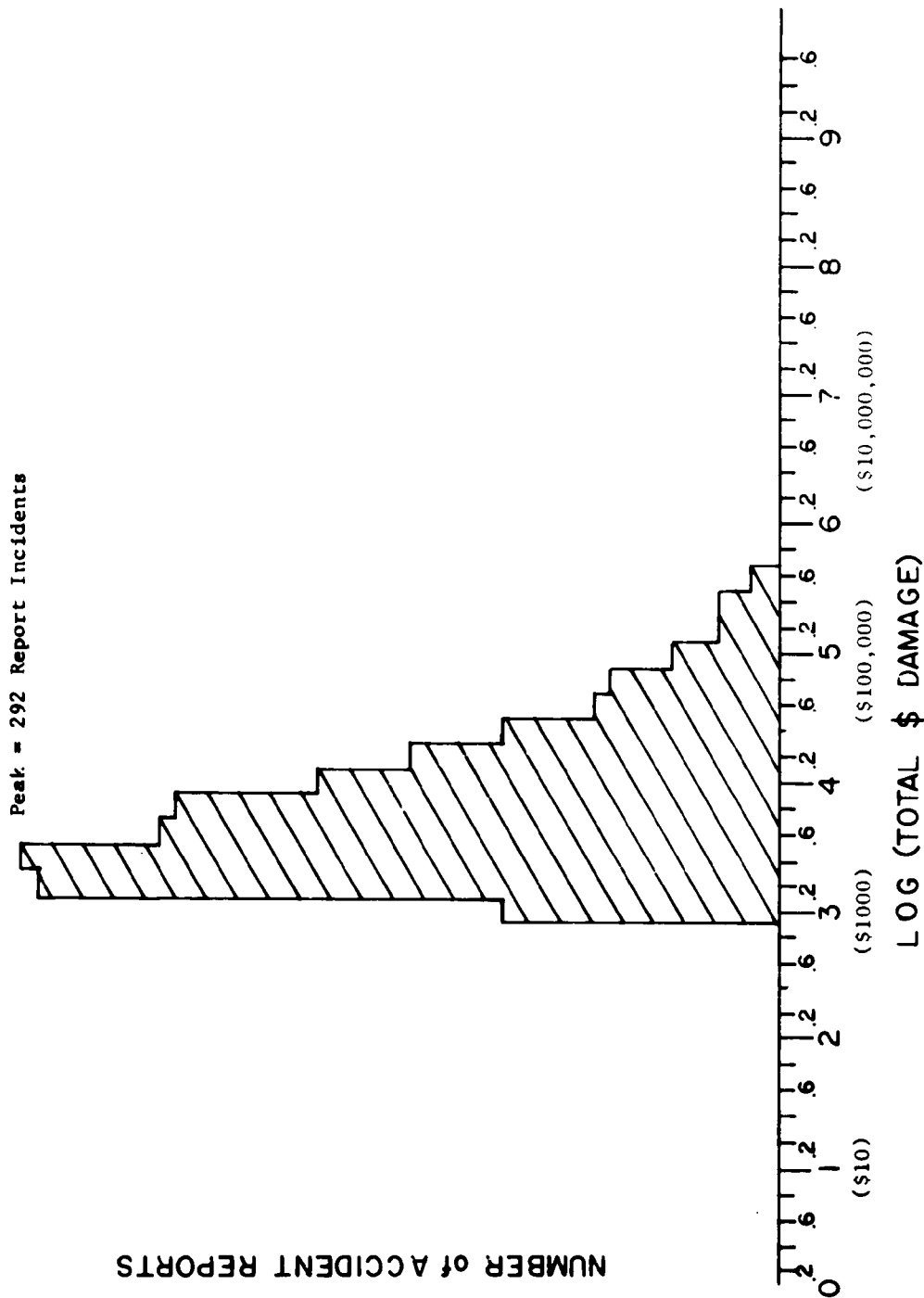

Fig. IV-13

Histogram of all 1972 Equipment-Caused Accidents Distributed over the Logarithm of the Total Dollars Damage of the Reported Incident.

1973 EQUIPMENT CAUSED ACCIDENTS  
DISTRIBUTION OF TOTAL \$ DAMAGE

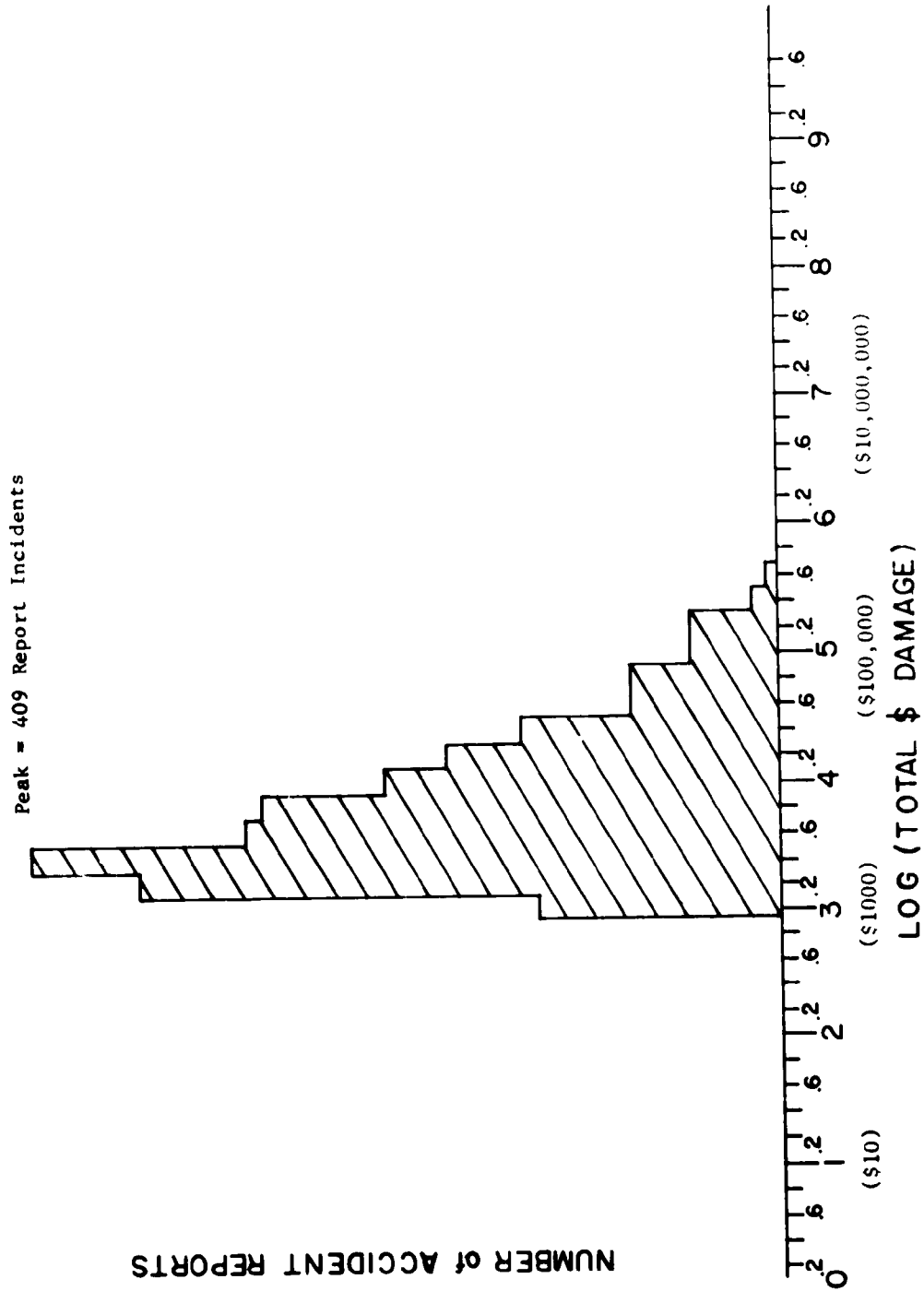

Fig. IV-14

Histogram of all 1973 Equipment-Caused Accidents Distributed over the Logarithm of the Total Dollars Damage of the Reported Incident.

NORMALIZED DATA HISTOGRAM

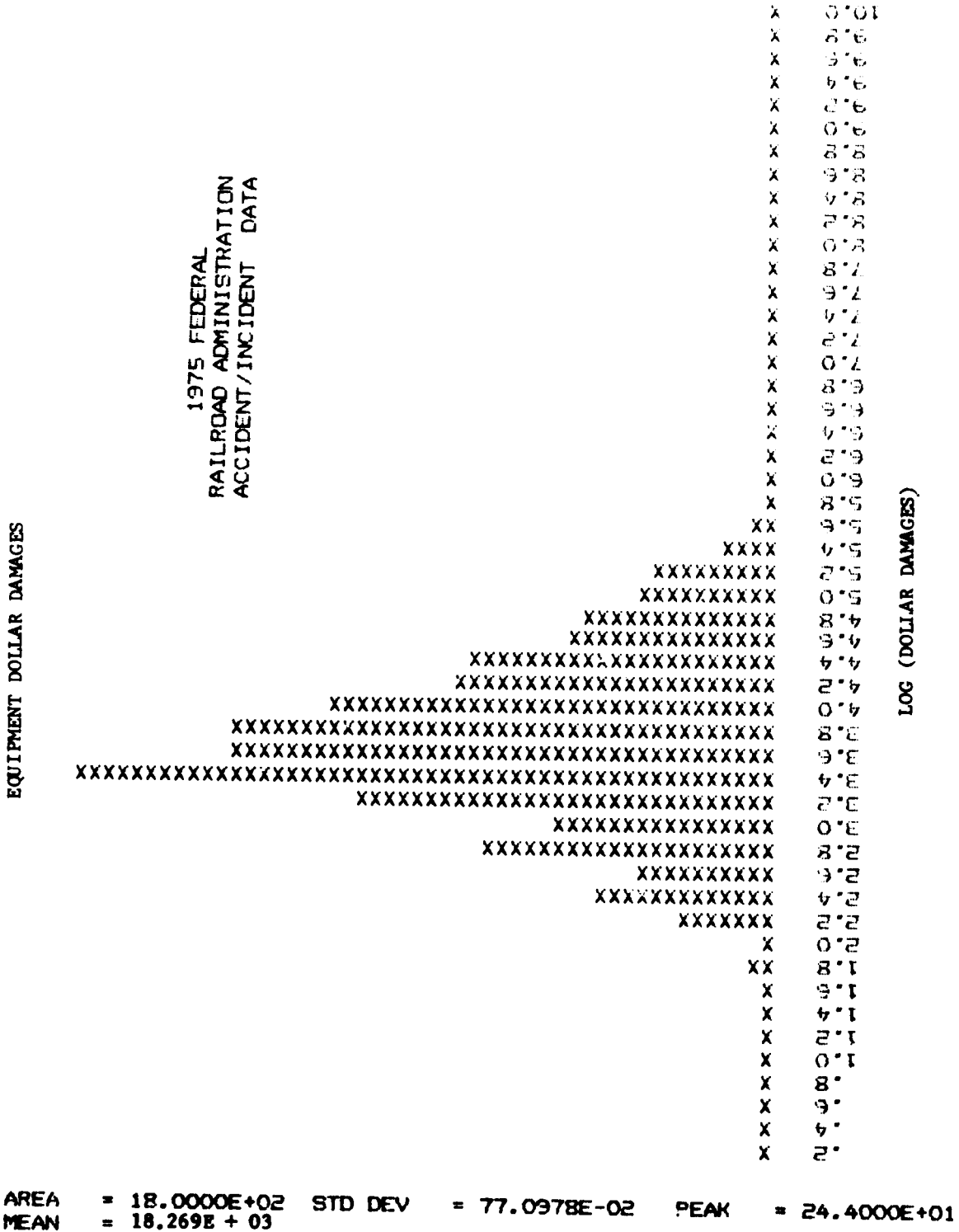
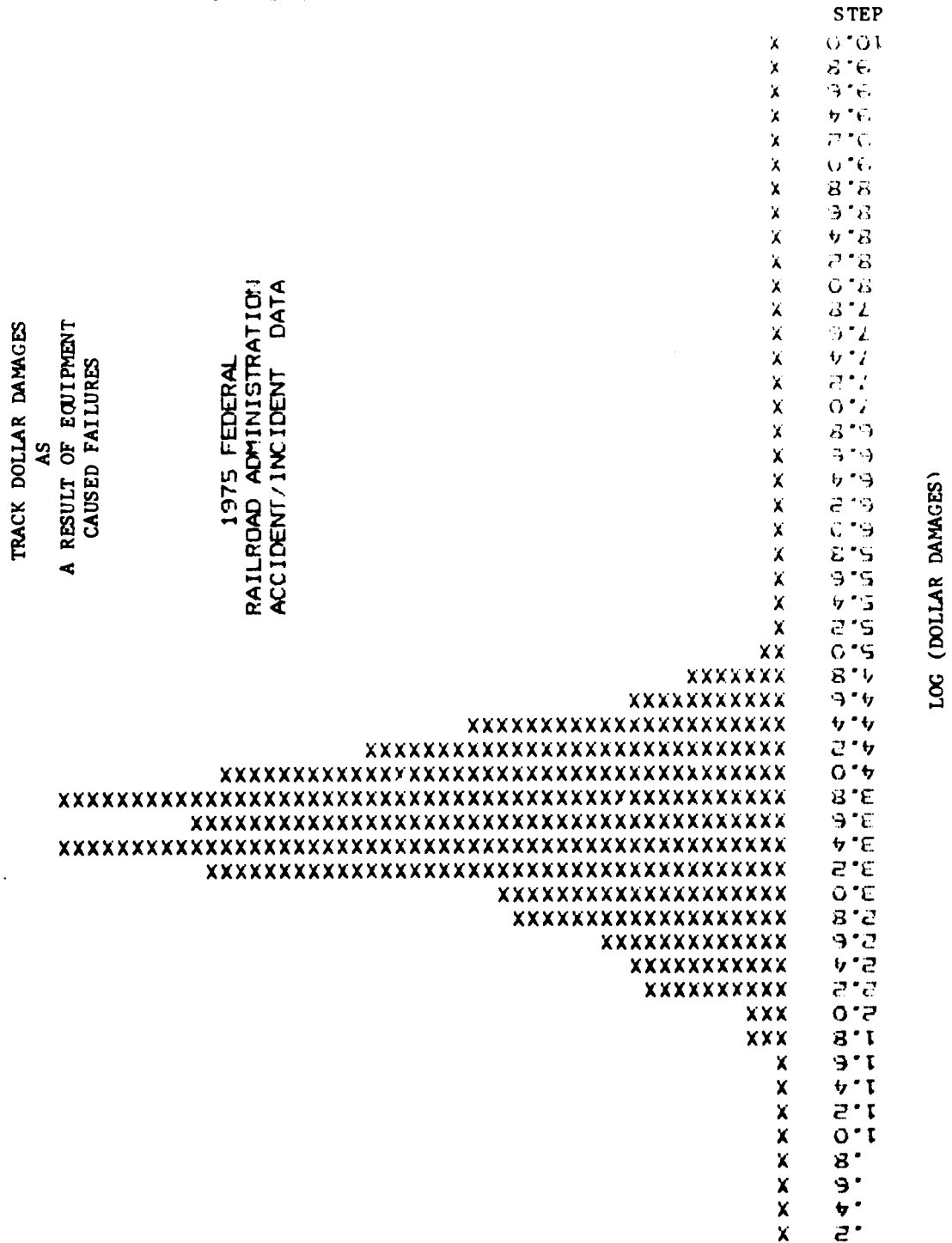

Fig. IV-15.  
 Histogram of all Equipment-Caused Accidents Distributed over the Logarithm of the Total Dollar Damages to Equipment Only.

IV-17/IV-18  
 NORMALIZED DATA HISTOGRAM



AREA = 15.8900E+02    STD DEV = 67.5295E-02    PEAK = 20.8000E+01  
 MEAN = 70,340E+02

Fig. IV-16  
 Histogram of all Equipment-Caused Accidents Distributed over Logarithm of the  
 Total Dollar Damages to Trace Only.

APPENDIX V

PLOTS FROM EQUIPMENT CAUSED ACCIDENTS

XXXXXXXX TOTAL DAMAGE VS SPEED XXXXXXXXXXXX

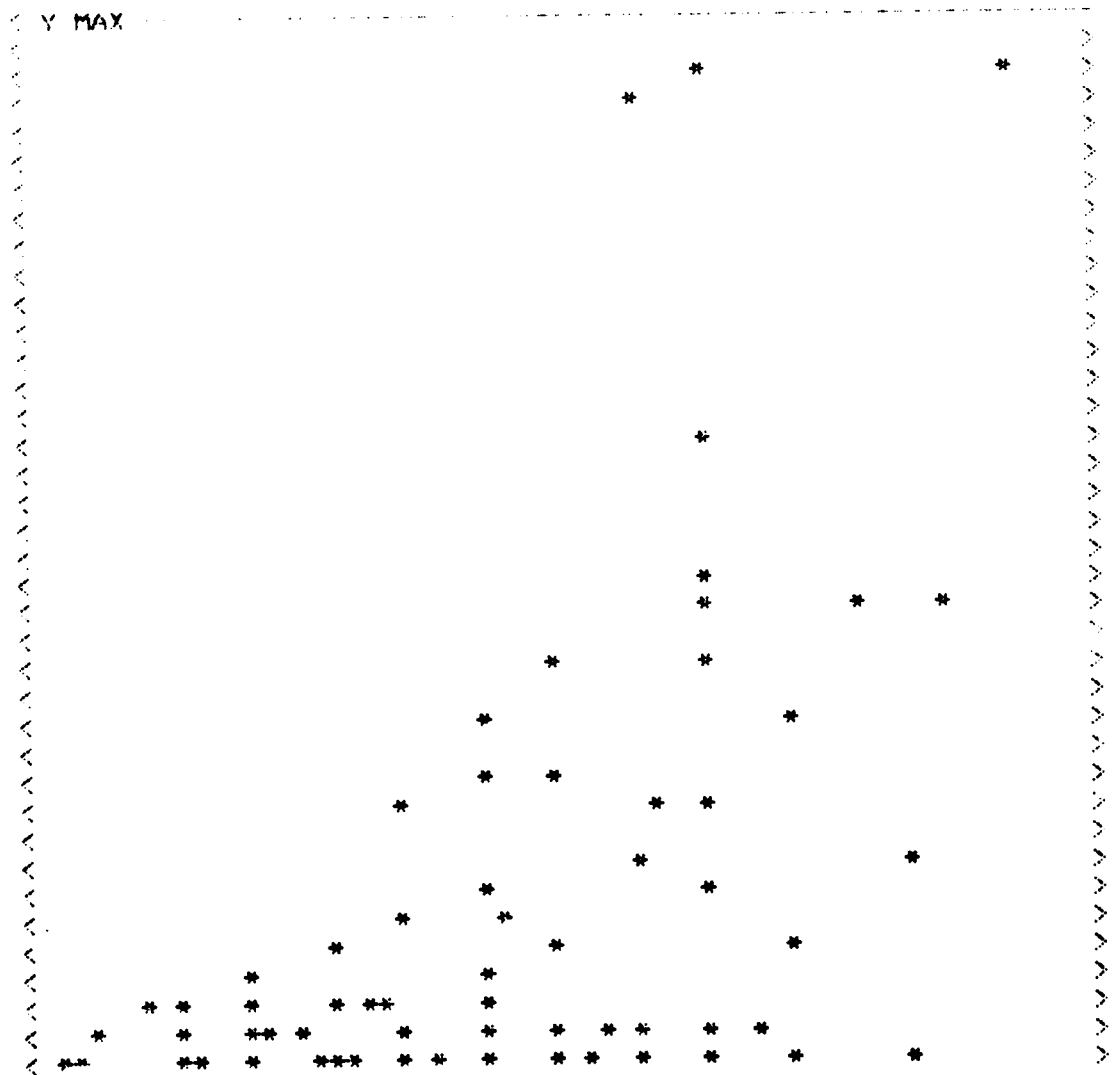

↑ X MIN = 0 70 = X MAX ↑

SCALE X = SPEED, (MPH)

SCALE Y = DOLLARS DAMAGE

Y MIN = 0 Y MAX = 335000

CODES 451 452 453 454 BEARINGS

Fig. V-1  
 Dollars Damage Versus Speed at Time of Incident.  
 Data from One Hundred Accidents Attributed to the Bearing  
 Related Cause Codes Noted.



XXXXX EQUIPMENT<sup>V-2</sup> DAMAGE VS SPEED XXXXXXXX

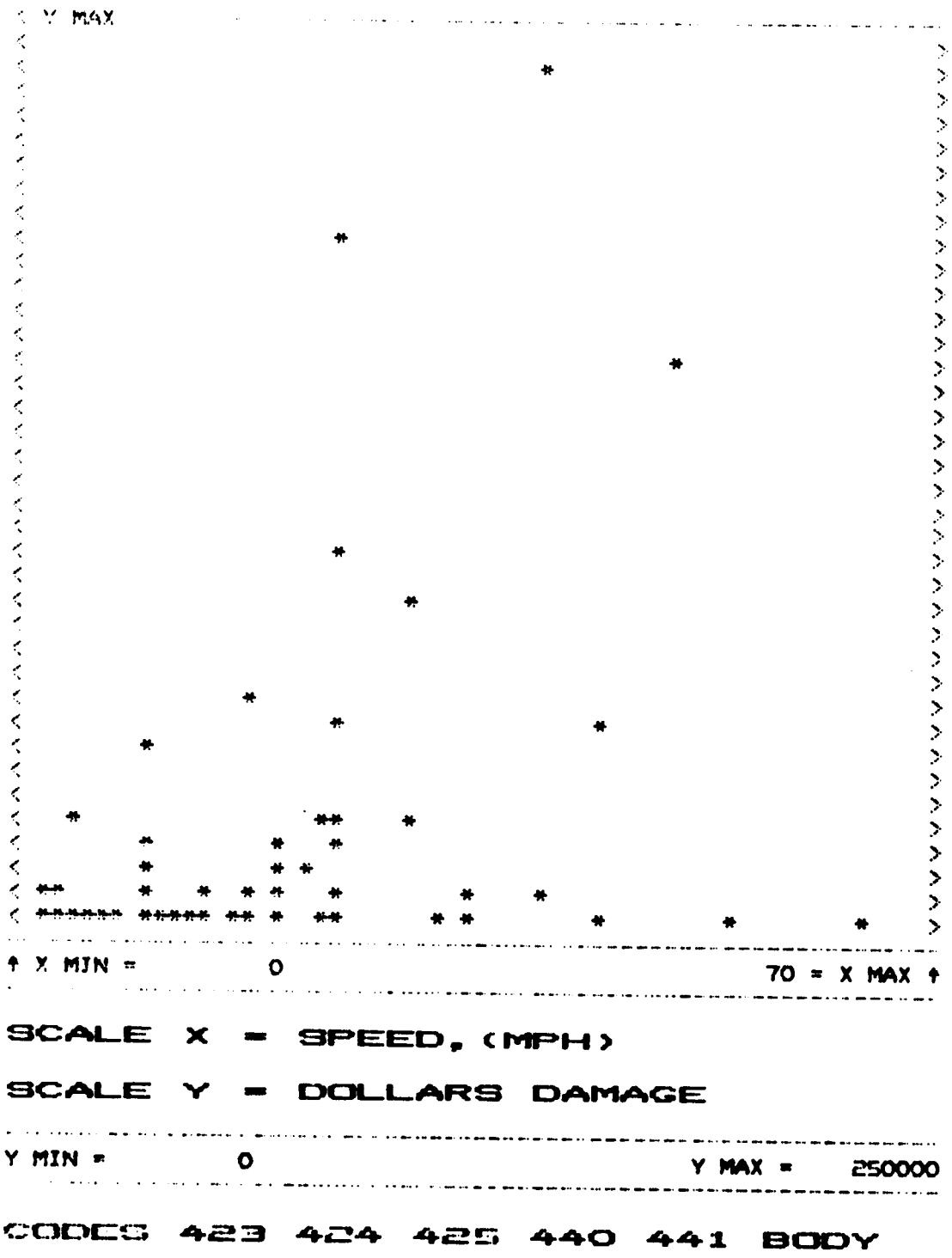
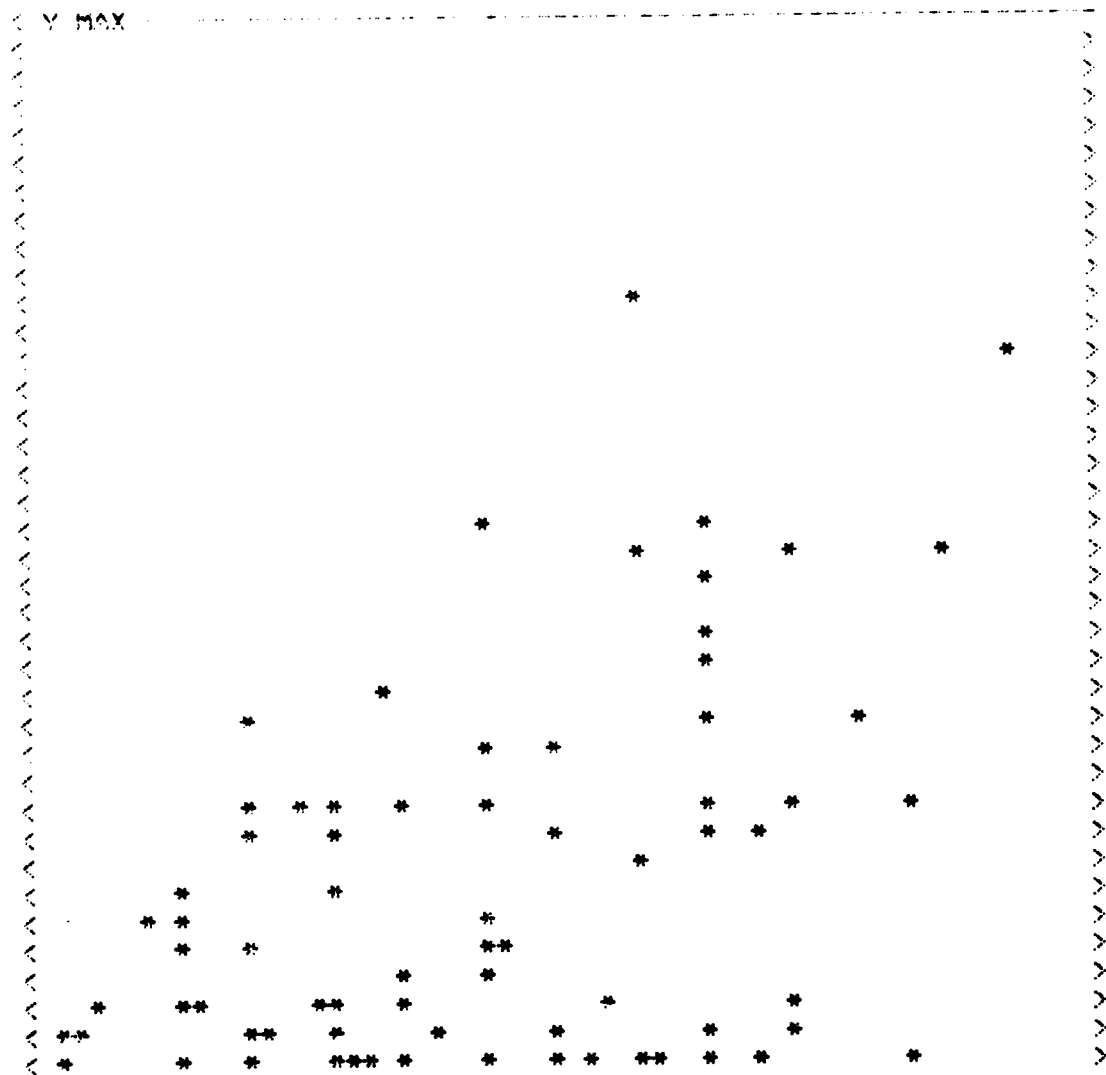

Fig. V-2  
 Dollars Damage Versus Speed at Time of Incident. Data from One Hundred Accidents  
 Attributed to the Railcar Body Cause Codes Noted.

XXXXXX DERAILED CARS VS SPEED XXXXXXXX



↑ X MIN = 0 70 = X MAX ↑

SCALE X = SPEED, (MPH)

SCALE Y = NUMBER OF EMPTY CARS

Y MIN = 0 Y MAX = 40

CODES 451 452 453 454 BEARINGS

Fig. V-3  
Number of Empty Derailed Cars Versus Speed at Time of Incident. Data from One Hundred Attributed to the Bearing Cause Codes Noted.

V-4  
 XXXXXXXXXXXX \$/ACC VS XXXXXXXXXXXXXXXXXXXX  
 SPEED

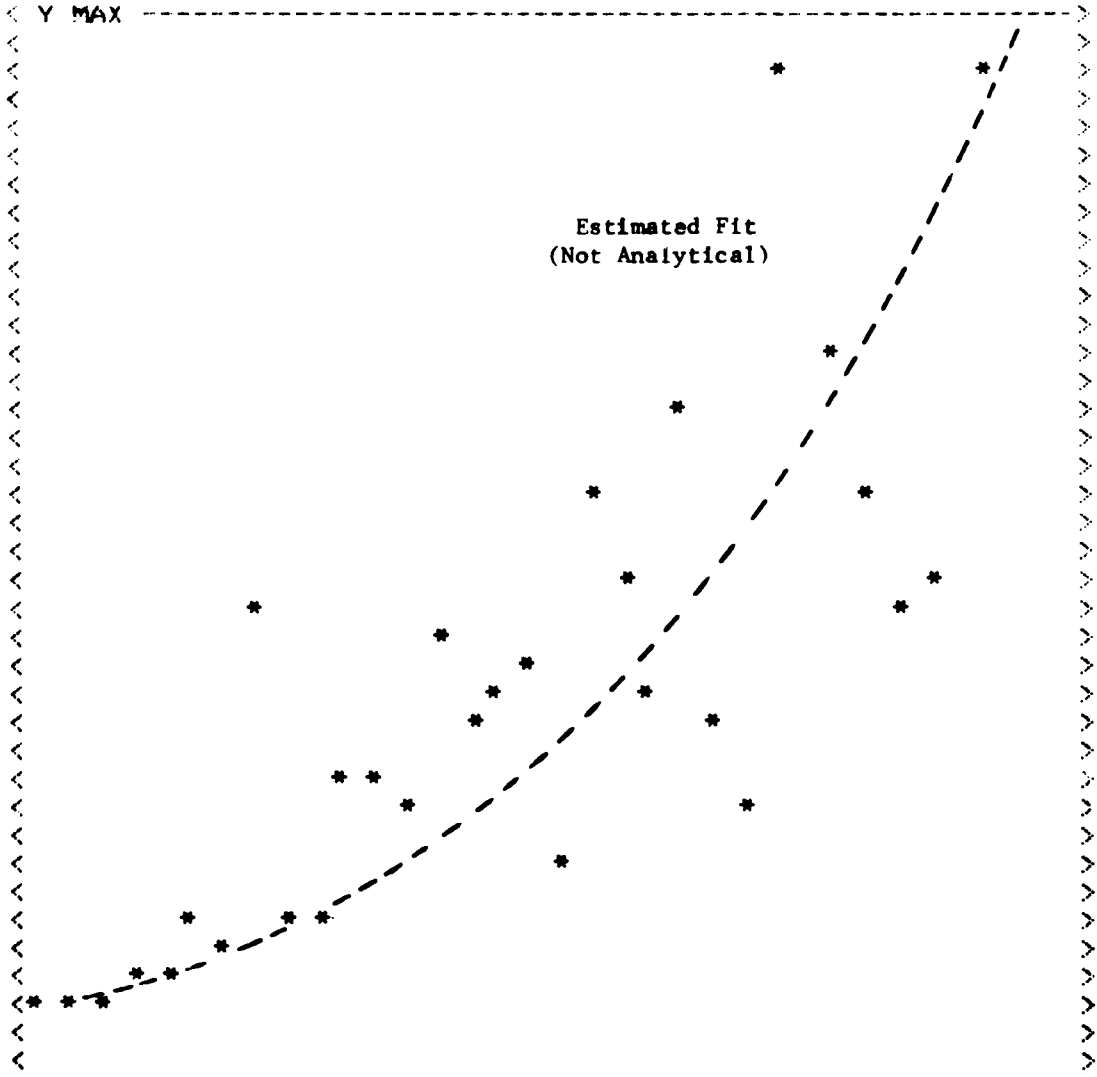

↑ X MIN = 0 70 = X MAX ↑

SCALE X = SPEED, (MPH)

SCALE Y = AVE. DOLLARS PER ACC.

↑ Y MIN = 0 100000 = Y MAX ↑

**1975 EQUIPMENT CAUSED ACCS**

Fig. V-4

Average Cost per Accident Versus Speed at Time of Accident. Data from Two Mile Per Hour Speed Increments in the Range from 0 to 70 MPH. (See Table III-E3 for Tabulated Numbers)

V-5  
 XXXXXX CARS DERAILED VS TOTAL DAMAGE XXXXXXXX

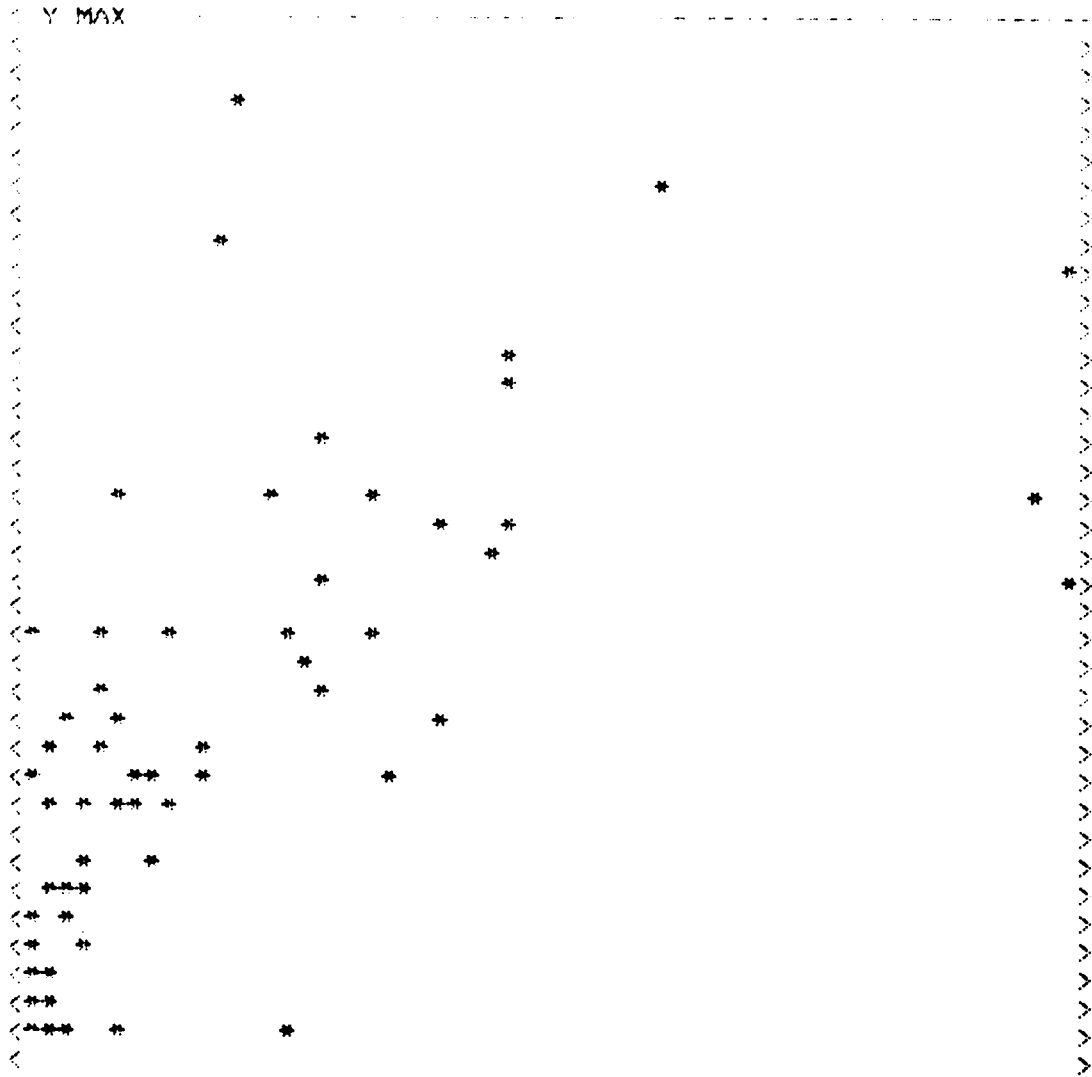

↑ X MIN = 0 335000 = X MAX ↑

SCALE X = DOLLARS DAMAGE

SCALE Y = NUMBER OF CARS

Y MIN = 0 Y MAX = 35

CODES 451 452 453 454 BEARINGS

Fig. V-5  
 Number of Cars Derailed Versus Total Dollars Damage of Incident. Data from One Hundred Accidents Attributed to the Bearing Related Cause Codes Noted.

XXXXXXXXXXXX SPEED VS TEMPERATURE XXXXXXXXXXXXXXXX

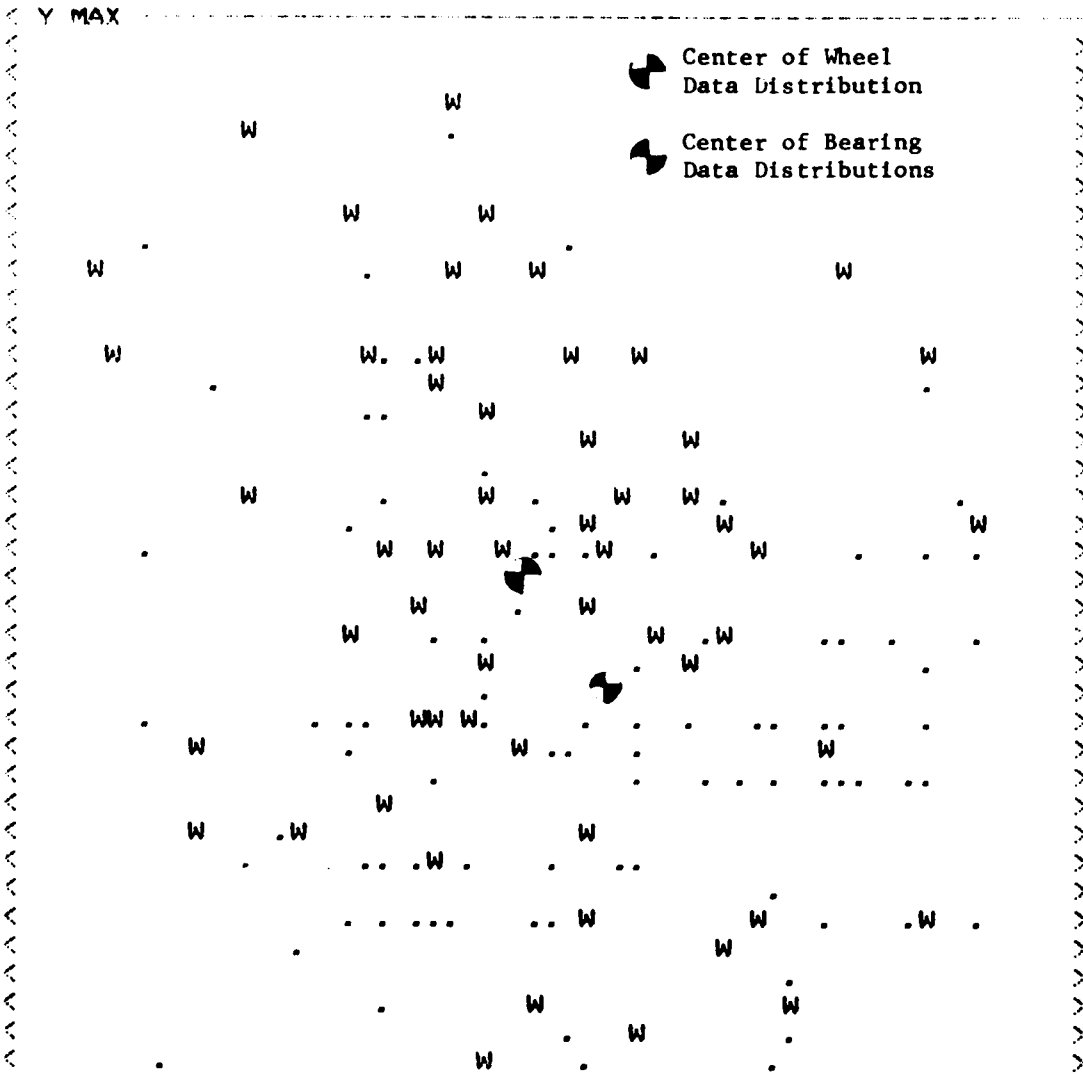

↑ X MIN = -10 100 = X MAX ↑

SCALE X = DEGREES F

SCALE Y = SPEED (MPH)

Y MIN = 0 Y MAX = 70

. = BRGS & W = WHEELS BROKEN

Fig. V-6 Two Variable Distribution Plots of One Hundred Wheel and One Hundred Journal Bearing Associated Incidents. See Figure V-8 for Descriptive Display.

XXXXXXXXXX SPEED VS TEMPERATURE XXXXXXXXXXXXXXX

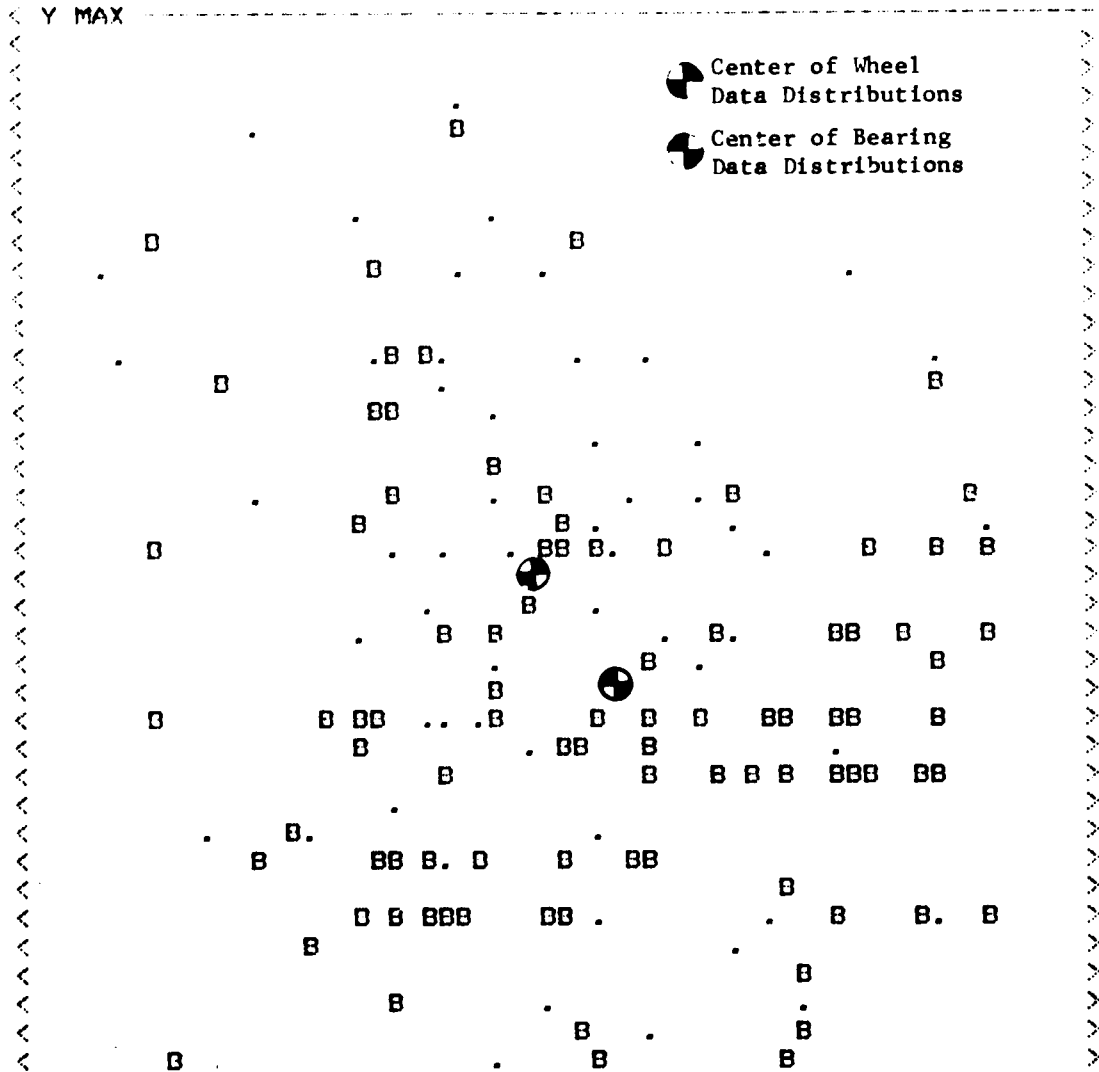

↑ X MIN = -10 100 = X MAX ↑

SCALE X = DEGREES F  
SCALE Y = SPEED (MPH)

Y MIN = 0 Y MAX = 70

B = BRGS & . = WHEELS BROKEN

Fig. V-7  
Two Variable Distribution Plots of One Hundred Wheel and One Hundred Journal Bearing Associated Incidents. See Figure V-8 for Descriptive Display.

SCHEMATIC REPRESENTATION OF DATA  
SHOWN IN TWO PREVIOUS FIGURES

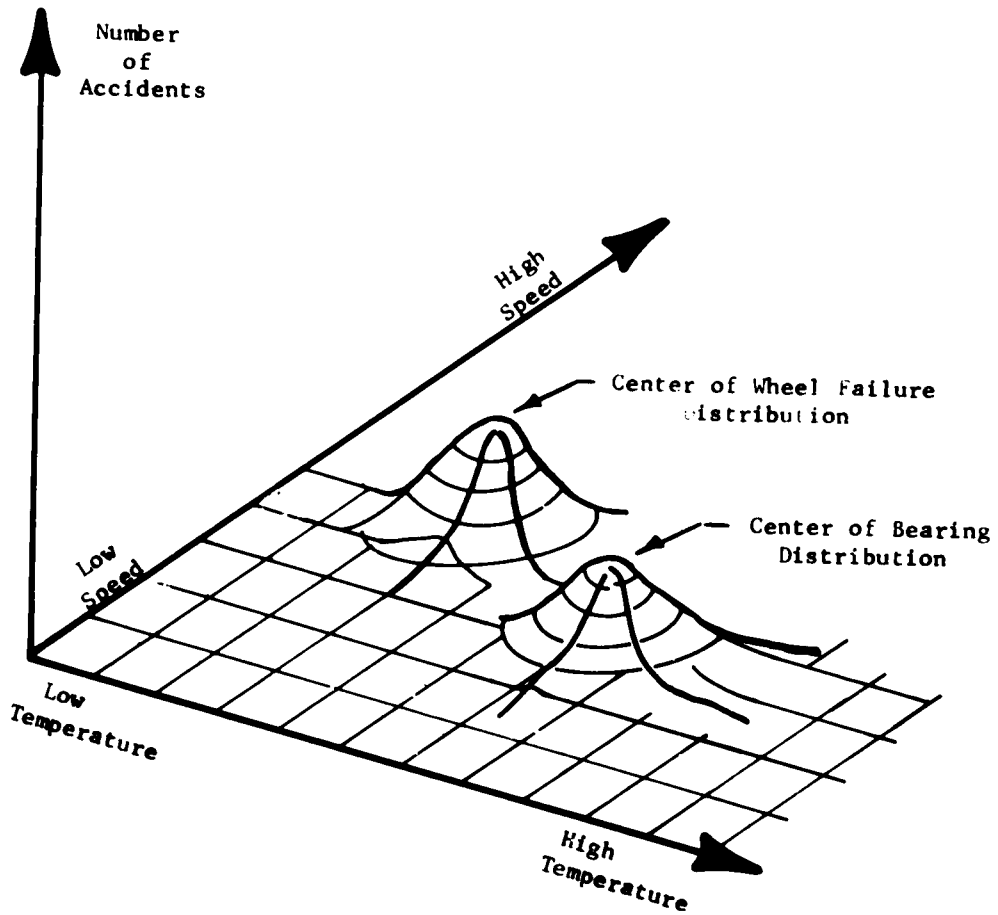

Fig. V-8

Plot Indicating that Wheels Tend to Cause Incidents at Lower Temperatures and Higher Speeds than do Journal Bearings.  
Schematic Display of Data Density Clustering Shown in Figure V-6 and V-7.

APPENDIX VI

CORRELATION MATRICES FROM DATA



VI-1

TABLE VI-1

CORRELATION MATRIX FOR 262 FREIGHT ACCIDENTS

0	1	2	3	4	5	6	7	8	9	10	11	12	13	14	15	16
1	.99	.18	-.09	-.07	.02	.03	-.01	.08	-.06	.03	-.10	-.05	-.07	-.09	-.11	-.13
2	.18	##	.00	-.02	.12	.03	.12	-.06	.01	.05	-.03	.00	.14	.03	-.07	-.02
3	-.03	.00	##	.01	.04	-.06	.06	.06	.04	-.04	.00	-.02	.06	-.02	.01	.00
4	-.07	-.02	.01	.99	-.07	.11	-.03	.04	.06	.15	.34	.31	-.10	.19	.22	.26
5	.02	.12	.04	-.07	##	.23	.80	-.00	-.05	-.02	.10	.05	.01	.18	-.01	.12
6	.03	.03	-.06	.11	.23	##	.23	.07	-.06	.02	.03	.03	.00	.09	.02	.07
7	-.01	.12	.06	-.03	.80	.23	##	-.27	-.10	-.01	.09	.06	.08	.24	.19	.05
8	.08	-.06	.06	.04	-.00	.07	-.27	.99	.14	-.02	.00	-.01	-.01	-.18	.34	.07
9	-.06	.01	.04	.06	-.05	-.06	-.10	.14	##	.00	-.05	-.03	-.09	-.10	.01	-.06
10	.03	.05	.04	.15	-.02	.02	-.01	-.02	.00	##	.41	.78	-.01	.26	.09	.23
11	-.10	-.03	.00	.34	.10	.03	.09	.00	-.05	.41	##	.88	-.02	.67	.46	.74
12	-.05	.00	-.02	.31	.05	.03	.06	-.01	-.03	.78	.88	##	-.02	.58	.36	.62
13	-.07	.14	.06	-.10	.01	.00	.08	-.01	-.09	-.01	-.02	-.02	##	.02	-.05	-.01
14	-.09	.03	-.02	.19	.18	.09	.24	-.18	-.10	.26	.67	.58	.02	##	.19	.81
15	-.11	-.07	.01	.22	-.01	.02	-.19	.34	.01	.09	.46	.36	-.05	.19	.99	.72
16	-.13	-.02	-.00	.26	.12	.07	.05	.07	-.06	.23	.74	.62	-.01	.81	.72	##

ALL ACC CODES -- FREIGHT ONLY

- 1 = TEMPERATURE
- 2 = VISIBILITY
- 3 = WEATHER
- 4 = SPEED(MPH)
- 5 = TRAILING TONS
- 6 = POSITION 2
- 7 = NUMBER OF LOADED CARS
- 8 = NUMBER OF EMPTY CARS
- 9 = TRACK DENSITY
- 10 = DOLLARS TRACK DAMAGE
- 11 = DOLLARS EQUIPMENT DAMAGE
- 12 = DOLLARS TOTAL DAMAGE
- 13 = FREQUENCY OF OCCURANCE FOR 1975
- 14 = NUMBER OF DERAILED CARS LOADED
- 15 = NUMBER OF DERAILED CARS EMPTY
- 16 = TOTAL NUMBER OF CARS DERAILED

NOTE-- (-.##) EQUALS 1.00  
DUE TO FORMAT  
OVER FLOW

TABLE VI-2

## CORRELATION MATRIX FOR 100 FREIGHT ACCIDENTS

0	1	2	3	4	5	6	7	8	9	10	11	12	13	14	15	16
1	##	.27	.18	.03	.02	.05	.02	.24	.09	.05	.04	.05	.03	.07	.12	.03
2	.27	##	.11	.09	.03	.01	.13	.04	.09	.10	.23	.17	.05	.07	.14	.14
3	.18	.11	##	.03	.03	.12	.05	.05	.07	.02	.15	.12	.00	.17	.00	.12
4	.03	.09	.02	##	.00	.09	.02	.11	.01	.20	.35	.29	.01	.14	.13	.19
5	.02	.03	.03	.09	##	.18	.51	.04	.05	.00	.01	.00	.06	.19	.04	.10
6	.05	.01	.12	.09	.18	##	.33	.16	.00	.02	.08	.05	.03	.12	.27	.26
7	.02	.12	.05	.02	.51	.33	##	.23	.07	.01	.03	.02	.11	.29	.18	.09
8	.24	.06	.05	.11	.04	.16	.23	##	.01	.01	.09	.03	.12	.14	.48	.21
9	.09	.09	.07	.01	.05	.00	.07	.01	.09	.00	.03	.01	.09	.07	.04	.08
10	.05	.10	.08	.20	.00	.02	.01	.01	.00	##	.60	.94	.08	.31	.06	.26
11	.04	.23	.15	.35	.01	.02	.03	.09	.03	.60	##	.84	.05	.56	.27	.57
12	.05	.17	.12	.29	.00	.05	.02	.03	.01	.94	.84	##	.07	.45	.16	.42
13	.03	.05	.09	.01	.06	.03	.11	.12	.09	.08	.05	.07	##	.04	.09	.09
14	.07	.07	.17	.14	.19	.12	.29	.14	.07	.31	.56	.45	.04	##	.07	.76
15	.12	.14	.00	.13	.04	.27	.18	.48	.04	.06	.27	.16	.09	.07	##	.70
16	.03	.14	.12	.19	.10	.26	.09	.21	.08	.26	.57	.42	.09	.76	.70	##

ACC CODE(S) 423 424 425 440 441 TRUCK BODY DEFECTS

- 1 = TEMPERATURE
- 2 = VISIBILITY
- 3 = WEATHER
- 4 = SPEED(MPH)
- 5 = TRAILING TONS
- 6 = POSITION 2
- 7 = NUMBER OF LOADED CARS
- 8 = NUMBER OF EMPTY CARS
- 9 = TRACK DENSITY
- 10 = DOLLARS TRACK DAMAGE
- 11 = DOLLARS EQUIPMENT DAMAGE
- 12 = DOLLARS TOTAL DAMAGE
- 13 = FREQUENCY OF OCCURANCE FOR 1975
- 14 = NUMBER OF DERAILED CARS LOADED
- 15 = NUMBER OF DERAILED CARS EMPTY
- 16 = TOTAL NUMBER OF CARS DERAILED

NOTE-- (-.##) EQUALS 1.00  
DUE TO FORMAT  
OVER FLOW

TABLE VI-3

## CORRELATION MATRIX FOR 100 FREIGHT ACCIDENTS

0	1	2	3	4	5	6	7	8	9	10	11	12	13	14	15	16
1	###	.21	.24	.14	.04	.13	.09	.08	.05	.17	.07	.09	.21	.11	.02	.06
2	.21	###	.08	.01	.13	.02	.16	.31	.12	.09	.04	.02	.07	.04	.11	.02
3	.24	.08	###	.03	.05	.05	.06	.05	.02	.04	.06	.06	.21	.08	.14	.02
4	.14	.01	.03	###	.09	.18	.07	.08	.07	.41	.30	.33	.11	.24	.10	.23
5	.04	.13	.05	.03	###	.13	.74	.17	.11	.07	.01	.02	.06	.11	.05	.05
6	.13	.02	.05	.18	.13	###	.09	.06	.10	.06	.10	.10	.09	.05	.15	.13
7	.09	.16	.06	.07	.74	.09	###	.46	.02	.08	.09	.09	.03	.19	.10	.07
8	.08	.31	.05	.08	.17	.06	.46	###	.10	.08	.00	.02	.08	.23	.38	.05
9	.05	.12	.02	.07	.11	.10	.02	.10	###	.05	.03	.04	.13	.06	.00	.05
10	.17	.09	.04	.41	.07	.06	.08	.08	.05	.99	.58	.69	.15	.50	.22	.49
11	.07	.04	.06	.30	.01	.10	.09	.00	.03	.58	###	.99	.01	.66	.56	.81
12	.09	.02	.06	.33	.02	.10	.09	.02	.04	.69	.99	###	.03	.67	.54	.81
13	.21	.02	.21	.11	.06	.09	.03	.08	.13	.15	.01	.03	###	.10	.17	.03
14	.11	.04	.08	.24	.11	.05	.19	.23	.06	.50	.66	.67	.10	###	.13	.80
15	.02	.11	.14	.10	.05	.15	.10	.38	.00	.22	.56	.54	.17	.13	###	.69
16	.06	.03	.02	.23	.05	.13	.07	.05	.05	.49	.81	.81	.03	.80	.69	###

ACC CODE(S) 430 432 433 434 435 COUPLER SYSTEM

- 1 = TEMPERATURE
- 2 = VISIBILITY
- 3 = WEATHER
- 4 = SPEED(MPH)
- 5 = TRAILING TONS
- 6 = POSITION 2'
- 7 = NUMBER OF LOADED CARS
- 8 = NUMBER OF EMPTY CARS
- 9 = TRACK DENSITY
- 10 = DOLLARS TRACK DAMAGE
- 11 = DOLLARS EQUIPMENT DAMAGE
- 12 = DOLLARS TOTAL DAMAGE
- 13 = FREQUENCY OF OCCURANCE FOR 1975
- 14 = NUMBER OF DERAILED CARS LOADED
- 15 = NUMBER OF DERAILED CARS EMPTY
- 16 = TOTAL NUMBER OF CARS DERAILED

NOTE-- (-.##) EQUALS 1.03  
DUE TO FORMAT  
OVER FLOW

TABLE VI-4

## CORRELATION MATRIX FOR 100 FREIGHT ACCIDENTS

0	1	2	3	4	5	6	7	8	9	10	11	12	13	14	15	16
1	##	.21	.05	.13	.22	.05	.29	.05	.07	.09	.19	.11	.01	.11	.18	.17
2	.21	##	.08	.06	.00	.07	.05	.04	.08	.03	.11	.11	.02	.14	.01	.10
3	.05	.08	##	.03	.12	.06	.12	.22	.13	.05	.02	.00	.06	.07	.02	.04
4	.13	.06	.03	##	.00	.00	.03	.22	.01	.06	.19	.12	.03	.03	.12	.02
5	.22	.00	.12	.00	##	.25	.87	.11	.09	.21	.04	.13	.06	.17	.16	.04
6	.05	.07	.06	.00	.25	##	.28	.02	.00	.02	.07	.06	.16	.06	.02	.06
7	.29	.05	.12	.03	.87	.28	##	.37	.07	.14	.02	.08	.07	.16	.23	.01
8	.05	.04	.22	.22	.11	.02	.37	##	.06	.07	.01	.02	.09	.18	.18	.05
9	.07	.03	.13	.01	.09	.00	.07	.06	##	.00	.10	.08	.08	.22	.06	.13
10	.09	.03	.05	.06	.21	.02	.14	.07	.00	.99	.20	.62	.10	.17	.15	.20
11	.19	.11	.02	.19	.04	.07	.02	.01	.10	.20	##	.89	.01	.76	.57	.84
12	.11	.11	.00	.12	.13	.06	.08	.02	.08	.62	.89	##	.03	.68	.52	.76
13	.01	.02	.06	.03	.06	.16	.07	.09	.08	.10	.01	.03	##	.04	.04	.01
14	.11	.14	.07	.03	.17	.06	.16	.18	.22	.17	.76	.68	.04	##	.30	.89
15	.18	.01	.02	.12	.16	.02	.23	.18	.06	.15	.57	.52	.04	.30	##	.70
16	.17	.10	.04	.02	.04	.06	.01	.05	.13	.20	.84	.76	.01	.89	.70	##

ACC CODE(S) 400 401 402 403 WHEELS BROKEN

- 1 = TEMPERATURE
- 2 = VISIBILITY
- 3 = WEATHER
- 4 = SPEED(MPH)
- 5 = TRAILING TONS
- 6 = POSITION 2
- 7 = NUMBER OF LOADED CARS
- 8 = NUMBER OF EMPTY CARS
- 9 = TRACK DENSITY
- 10 = DOLLARS TRACK DAMAGE
- 11 = DOLLARS EQUIPMENT DAMAGE
- 12 = DOLLARS TOTAL DAMAGE
- 13 = FREQUENCY OF OCCURANCE FOR 1975
- 14 = NUMBER OF DERAILED CARS LOADED
- 15 = NUMBER OF DERAILED CARS EMPTY
- 16 = TOTAL NUMBER OF CARS DERAILED

NOTE-- (-.##)

EQUALS 1.00  
DUE TO FORMAT  
OVER FLOW

TABLE VI-5

## CORRELATION MATRIX FOR 100 FREIGHT ACCIDENTS

0	1	2	3	4	5	6	7	8	9	10	11	12	13	14	15	16
1	##	-.06	-.25	-.13	.10	.13	-.17	-.93	.06	-.14	.00	-.07	.14	-.12	.16	-.03
2	.06	##	.03	.02	.02	.02	-.00	.04	.12	.02	-.00	.03	.01	.08	.01	.05
3	.25	.03	##	.25	-.07	.08	-.06	.27	-.09	.29	-.07	-.03	.11	.02	-.03	.04
4	.13	.02	.25	##	-.17	.17	-.21	.13	.01	.96	-.17	.50	.05	.45	.22	.44
5	.10	.02	.07	-.17	##	-.12	.50	-.08	.03	-.19	.96	.01	-.04	.00	.53	-.04
6	.13	.02	.08	.17	-.12	##	-.11	-.12	-.13	.16	-.15	.08	.24	.06	-.10	.09
7	.17	-.00	.06	.21	.50	-.11	##	-.17	.12	-.23	.45	-.05	.02	-.02	.96	-.06
8	.93	.04	.27	.13	-.08	-.12	-.17	##	.05	.14	-.04	.08	-.13	.13	-.16	.04
9	.06	.12	.09	.01	.03	.13	.12	.05	##	-.01	.02	.05	-.18	-.03	.10	-.05
10	.14	.02	.29	.96	-.19	.16	.23	.14	-.01	##	-.19	.53	-.03	.45	-.22	.46
11	.06	-.00	.07	.17	.96	.15	.45	-.04	.02	.19	##	.06	-.06	-.00	.45	-.04
12	.07	.03	.03	.50	.01	.08	-.05	.08	-.05	.53	.06	.99	-.06	.80	-.02	.72
13	.14	.01	.11	-.05	.04	.24	.02	-.13	.18	-.03	-.06	-.06	##	-.07	.05	-.07
14	-.12	.08	.02	.45	.00	.06	-.02	.13	-.03	.45	-.00	.80	-.07	##	-.01	.78
15	.16	.01	.03	.22	.53	-.10	.96	-.16	.10	.22	.45	-.02	.05	-.01	##	-.06
16	.03	.05	.04	.44	-.04	.09	-.06	.04	-.05	.46	-.04	.72	-.07	.78	-.06	##

## ACC CODE(S) 451 452 453 454 BEARING FAILURES

- 1 = TEMPERATURE
- 2 = VISIBILITY
- 3 = WEATHER
- 4 = SPEED(MPH)
- 5 = TRAILING TONS
- 6 = POSITION 2 AS A %
- 7 = NUMBER OF CARS IN TRAIN
- 8 = ABSOLUTE TEMP
- 9 = TRACK DENSITY
- 10 = SPEED+2
- 11 = TONS+2
- 12 = DOLLARS TOTAL DAMAGE
- 13 = FREQUENCY OF OCCURANCE FOR 1975
- 14 = LOG(TOT\$DAMAGE)
- 15 = LOG(TRAIN LENGTH)
- 16 = TOTAL NUMBER OF CARS DERAILED

NOTE-- (-.##) EQUALS 1.00  
DUE TO FORMAT  
OVER FLOW

TABLE VI-6

## CORRELATION MATRIX FOR 100 FREIGHT ACCIDENTS

0	1	2	3	4	5	6	7	8	9	10	11	12	13	14	15	16
1	1.00	.06	.25	.13	.10	.21	.11	.09	.06	.02	.08	.07	.14	.02	.12	.03
2	.06	1.00	.03	.02	.02	.00	.05	.04	.12	.13	.00	.03	.01	.04	.05	.05
3	.25	.03	1.00	.25	.07	.04	.09	.00	.09	.03	.03	.03	.11	.01	.12	.04
4	.13	.02	.25	1.00	.17	.09	.13	.12	.01	.40	.40	.50	.05	.42	.24	.44
5	.10	.02	.07	.17	1.00	.74	.09	.03	.02	.02	.01	.04	.03	.18	.04	
6	.21	.00	.04	.09	.00	1.00	.02	.19	.13	.07	.04	.05	.24	.09	.05	.10
7	.11	.05	.09	.13	.74	.02	1.00	.29	.05	.10	.08	.09	.03	.10	.28	.03
8	.09	.04	.00	.12	.09	.19	.29	1.00	.08	.10	.14	.14	.06	.16	.23	.04
9	.06	.12	.09	.01	.03	.13	.05	.08	1.00	.02	.06	.05	.18	.02	.07	.05
10	.02	.13	.03	.40	.02	.07	.10	.10	.02	1.00	.39	.56	.13	.38	.06	.33
11	.08	.00	.03	.46	.02	.04	.08	.14	.06	.39	1.00	.98	.03	.72	.31	.72
12	.07	.03	.03	.50	.01	.05	.09	.14	.05	.56	.98	1.00	.06	.73	.29	.72
13	.14	.01	.11	.05	.04	.24	.03	.06	.18	.13	.03	.06	1.00	.13	.08	.07
14	.02	.04	.01	.42	.03	.09	.10	.16	.02	.38	.72	.73	.13	1.00	.23	.91
15	.12	.05	.12	.24	.18	.05	.28	.23	.07	.06	.31	.29	.08	.23	1.00	.60
16	.03	.05	.04	.44	.04	.10	.03	.04	.05	.33	.72	.72	.07	.91	.60	1.00

## ACC CODE(S) 451 452 453 454 BEARING FAILURES

- 1 = TEMPERATURE
- 2 = VISIBILITY
- 3 = WEATHER
- 4 = SPEED(MPH)
- 5 = TRAILING TONS
- 6 = POSITION 2
- 7 = NUMBER OF LOADED CARS
- 8 = NUMBER OF EMPTY CARS
- 9 = TRACK DENSITY
- 10 = DOLLARS TRACK DAMAGE
- 11 = DOLLARS EQUIPMENT DAMAGE
- 12 = DOLLARS TOTAL DAMAGE
- 13 = FREQUENCY OF OCCURANCE FOR 1975
- 14 = NUMBER OF DERAILED CARS LOADED
- 15 = NUMBER OF DERAILED CARS EMPTY
- 16 = TOTAL NUMBER OF CARS DERAILED

NOTE-- (1.00) EQUALS 1.00  
DUE TO FORMAT  
OVER FLOW

TABLE VI-7

## CORRELATION MATRIX FOR 100 FREIGHT ACCIDENTS

0	1	2	3	4	5	6	7	8	9	10	11	12	13	14	15	16
1	##	.14	-.06	-.06	.10	.15	.23	.09	-.12	.04	-.12	-.11	-.12	-.00	.05	.03
2	-.14	##	.00	.04	.01	.09	-.14	-.03	.03	.02	.05	.05	.00	.03	.05	.04
3	.06	.00	##	.22	.04	.04	-.09	.01	-.01	-.00	.03	.02	.01	.04	.12	.09
4	.06	.04	.22	##	.09	.02	.10	.11	.04	.38	.48	.50	.01	.34	.34	.41
5	.10	.01	.04	-.09	.99	.03	.50	-.19	-.05	.01	-.11	-.09	-.15	-.09	-.09	.11
6	.15	.09	.04	.02	.03	##	.01	.27	-.12	.13	-.05	.01	.20	.09	-.05	.04
7	.23	.14	.09	.10	.50	.01	##	.41	.01	.10	-.10	.06	.00	.01	-.26	.10
8	.09	.03	.01	.11	.19	.27	.41	##	.10	.05	-.02	.03	-.13	-.02	.21	.08
9	.12	.03	.01	-.04	-.05	-.12	.01	.10	.99	.00	-.08	.07	.05	-.10	-.09	.12
10	.04	.02	.00	.38	.01	.13	.10	.05	.00	##	.46	.63	.13	.48	.10	.41
11	.12	.05	.03	.48	.11	-.05	.10	.02	.08	.46	##	.98	.13	.72	.48	.77
12	.11	.05	.02	.50	-.09	-.01	-.06	-.03	.07	.63	.98	##	.09	.74	.45	.77
13	.12	.00	.01	.01	.15	.20	.00	.13	.05	.13	.13	.09	.99	.09	.12	.12
14	-.00	.03	.04	.34	.09	.09	.01	-.02	.10	.48	.72	.74	.09	##	.31	.90
15	.05	.05	.12	.34	-.09	-.05	-.26	.21	.09	.10	.48	.45	.12	.31	##	.69
16	.03	.04	.09	.41	.11	.04	.10	.08	-.12	.41	.77	.77	.12	.90	.69	##

ACC CODE 451 ONLY

- 1 = TEMPERATURE
- 2 = VISIBILITY
- 3 = WEATHER
- 4 = SPEED(MPH)
- 5 = TRAILING TONS
- 6 = POSITION 2
- 7 = NUMBER OF LOADED CARS
- 8 = NUMBER OF EMPTY CARS
- 9 = TRACK DENSITY
- 10 = DOLLARS TRACK DAMAGE
- 11 = DOLLARS EQUIPMENT DAMAGE
- 12 = DOLLARS TOTAL DAMAGE
- 13 = FREQUENCY OF OCCURANCE FOR 1975
- 14 = NUMBER OF DERAILED CARS LOADED
- 15 = NUMBER OF DERAILED CARS EMPTY
- 16 = TOTAL NUMBER OF CARS DERAILED

NOTE-- (-.##) EQUALS 1.00  
DUE TO FORMAT  
OVER FLOW

TABLE VI-8

## CORRELATION MATRIX FOR C1 FREIGHT ACCIDENTS

0	1	2	3	4	5	6	7	8	9	10	11	12	13	14	15	16
1	##	.05	.10	.02	.10	.24	.20	.12	.05	.03	.03	.07	.07	.25	.18	.12
2	.05	.09	.18	.00	.03	.18	.04	.02	.08	.19	.18	.22	.22	.15	.17	.21
3	.10	.18	##	.19	.00	.07	.13	.12	.11	.04	.00	.07	.06	.03	.19	.06
4	.02	.00	.19	.99	.17	.21	.10	.00	.18	.18	.37	.33	.00	.24	.00	.23
5	.10	.09	.00	.17	##	.19	.81	.21	.03	.00	.18	.14	.03	.24	.10	.15
6	.24	.18	.07	.21	.19	##	.20	.10	.18	.20	.03	.08	.13	.05	.17	.03
7	.20	.04	.13	.10	.81	.20	##	.44	.08	.03	.15	.14	.05	.23	.27	.06
8	.12	.07	.12	.00	.21	.10	.44	##	.01	.15	.01	.05	.11	.20	.49	.06
9	.05	.08	.11	.18	.03	.18	.08	.01	##	.00	.07	.06	.12	.09	.07	.11
10	.03	.19	.04	.18	.00	.20	.03	.15	.00	##	.18	.45	.03	.04	.08	.08
11	.00	.18	.00	.37	.18	.03	.15	.01	.07	.18	##	.96	.03	.75	.27	.70
12	.07	.22	.07	.39	.14	.08	.14	.05	.06	.45	.96	##	.04	.69	.27	.71
13	.07	.22	.06	.00	.03	.13	.05	.11	.12	.03	.03	.04	##	.99	.15	.11
14	.25	.15	.03	.24	.24	.05	.23	.20	.09	.04	.75	.69	.15	##	.09	.07
15	.18	.17	.19	.00	.10	.17	.27	.49	.07	.08	.27	.27	.11	.07	##	.54
16	.12	.21	.06	.23	.15	.03	.00	.06	.11	.08	.76	.71	.07	.87	.54	##

## ACC CODE 452 ONLY

- 1 = TEMPERATURE
- 2 = VISIBILITY
- 3 = WEATHER
- 4 = SPEED(MPH)
- 5 = TRAILING TONS
- 6 = POSITION 2
- 7 = NUMBER OF LOADED CARS
- 8 = NUMBER OF EMPTY CARS
- 9 = TRACK DENSITY
- 10 = DOLLARS TRACK DAMAGE
- 11 = DOLLARS EQUIPMENT DAMAGE
- 12 = DOLLARS TOTAL DAMAGE
- 13 = FREQUENCY OF OCCURANCE FOR 1975
- 14 = NUMBER OF DERAILED CARS LOADED
- 15 = NUMBER OF DERAILED CARS EMPTY
- 16 = TOTAL NUMBER OF CARS DERAILED

NOTE-- (-.##)      EQUALS 1.00  
 DUE TO FORMAT  
 OVER FLOW



TABLE VI-9

CORRELATION MATRIX FOR 96 FREIGHT ACCIDENTS

0	1	2	3	4	5	6	7	8	9	10	11	12	13	14	15	16
1	###	.20	.25	.10	.01	.12	.04	.00	.01	.09	.04	.00	.13	.01	.08	.01
2	.20	###	.12	.02	.12	.09	.07	.05	.06	.09	.09	.10	.22	.01	.10	.05
3	.25	.12	###	.07	.15	.09	.12	.10	.04	.04	.11	.11	.01	.16	.02	.14
4	.10	.02	.07	###	.26	.13	.20	.08	.03	.47	.43	.51	.02	.38	.03	.38
5	.01	.12	.15	.26	###	.27	.78	.07	.05	.16	.26	.26	.12	.75	.21	.26
6	.12	.09	.09	.13	.27	###	.37	.13	.09	.02	.33	.26	.04	.07	.04	.05
7	.04	.07	.12	.20	.78	.37	###	.12	.06	.15	.25	.26	.22	.32	.24	.22
8	.09	.05	.10	.08	.07	.13	.12	###	.07	.08	.10	.06	.10	.14	.48	.04
9	.01	.06	.04	.03	.05	.09	.06	.07	###	.02	.03	.03	.02	.08	.02	.09
10	.09	.09	.04	.47	.16	.02	.15	.08	.02	###	.40	.66	.07	.45	.06	.41
11	.04	.09	.11	.43	.26	.33	.25	.10	.03	.40	.99	.95	.06	.38	.06	.35
12	.00	.10	.11	.51	.26	.26	.26	.06	.03	.66	.95	.99	.08	.46	.07	.42
13	.13	.22	.01	.02	.12	.04	.22	.10	.02	.07	.06	.08	.99	.03	.08	.00
14	.01	.01	.16	.38	.35	.07	.32	.14	.08	.45	.38	.46	.03	###	.11	.92
15	.08	.10	.02	.03	.21	.04	.24	.48	.02	.06	.06	.07	.08	.11	###	.26
16	.01	.05	.14	.38	.26	.05	.22	.04	.09	.41	.35	.42	.00	.92	.26	###

ACC CODE 464 ONLY

- 1 = TEMPERATURE
- 2 = VISIBILITY
- 3 = WEATHER
- 4 = SPEED(MPH)
- 5 = TRAILING TONS
- 6 = POSITION 2
- 7 = NUMBER OF LOADED CARS
- 8 = NUMBER OF EMPTY CARS
- 9 = TRACK DENSITY
- 10 = DOLLARS TRACK DAMAGE
- 11 = DOLLARS EQUIPMENT DAMAGE
- 12 = DOLLARS TOTAL DAMAGE
- 13 = FREQUENCY OF OCCURANCE FOR 1975
- 14 = NUMBER OF DERAILED CARS LOADED
- 15 = NUMBER OF DERAILED CARS EMPTY
- 16 = TOTAL NUMBER OF CARS DERAILED

NOTE-- (-.##) EQUALS 1.00  
DUE TO FORMAT  
OVER FLOW

TABLE VI-10

## CORRELATION MATRIX FOR 42 FREIGHT ACCIDENTS

0	1	2	3	4	5	6	7	8	9	10	11	12	13	14	15	16
1	##	.27	.07	.14	.13	.06	.16	.16	.13	.13	.25	.26	.16	.22	.00	.13
2	.27	##	.00	.05	.14	.11	.13	.01	.11	.12	.19	.13	.08	.17	.14	.01
3	.07	.06	##	.15	.23	.08	.08	.05	.09	.04	.07	.07	.14	.11	.12	.15
4	.14	.05	.15	.09	.12	.12	.15	.10	.10	.34	.50	.54	.03	.28	.39	.43
5	.13	.14	.23	.12	##	.58	.95	.26	.06	.05	.00	.01	.06	.35	.19	.10
6	.06	.11	.08	.18	.58	##	.52	.03	.09	.14	.18	.20	.17	.02	.19	.13
7	.16	.13	.08	.15	.95	.52	##	.39	.05	.08	.02	.04	.05	.40	.26	.08
8	.10	.01	.05	.10	.20	.03	.39	##	.13	.02	.13	.12	.27	.20	.40	.12
9	.13	.11	.09	.10	.06	.09	.05	.13	##	.04	.06	.07	.21	.10	.07	.11
10	.13	.12	.04	.34	.05	.14	.08	.02	.04	##	.27	.52	.17	.51	.21	.46
11	.25	.19	.07	.50	.00	.18	.02	.13	.06	.27	##	.96	.13	.72	.52	.79
12	.26	.13	.07	.54	.01	.20	.04	.12	.07	.52	.96	##	.07	.78	.52	.83
13	.16	.08	.14	.03	.06	.17	.05	.27	.21	.17	.13	.07	.99	.09	.09	.00
14	.22	.17	.11	.28	.35	.02	.40	.20	.10	.51	.72	.78	.09	##	.24	.78
15	.00	.14	.12	.39	.19	.19	.26	.40	.07	.21	.52	.52	.09	.24	##	.78
16	.13	.01	.15	.43	.10	.13	.08	.12	.11	.46	.79	.83	.00	.78	.78	.99

## ACC CODE 400 ONLY

- 1 = TEMPERATURE
- 2 = VISIBILITY
- 3 = WEATHER
- 4 = SPEED(MPH)
- 5 = TRAILING TONS
- 6 = POSITION 2
- 7 = NUMBER OF LOADED CARS
- 8 = NUMBER OF EMPTY CARS
- 9 = TRACK DENSITY
- 10 = DOLLARS TRACK DAMAGE
- 11 = DOLLARS EQUIPMENT DAMAGE
- 12 = DOLLARS TOTAL DAMAGE
- 13 = FREQUENCY OF OCCURANCE FOR 1975
- 14 = NUMBER OF DERAILED CARS LOADED
- 15 = NUMBER OF DERAILED CARS EMPTY
- 16 = TOTAL NUMBER OF CARS DERAILED

NOTE-- (-.##) EQUALS 1.00  
DUE TO FORMAT  
OVER FLOW

APPENDIX VII

REGRESSION ANALYSIS TECHNIQUES

INTRODUCTION

This appendix contains a general description of applied regression procedures. Application of these procedures is widely used today by management and scientific personnel. Successful use requires an understanding of the underlying theory as well as the practical data problems which can arise from everyday applications.

The following subjects are addressed:

- What is Regression Analysis?
- Why Use Regression Analysis?
- Data -- What Type?/How Much?
- Data Scatter.
- Correlation Coefficients and Matrix Arrays.
- Correlation Coefficients of Transformed Data.
- Selecting an "Optimum Set" of Explaining Parameters.
- A Large Number of Independent Variables.
- Regression Tables Explained.
- Example 1 -- Truly Independent Variables in Data.
- Example 2 -- Non-independent Variables in Data.
- Example 3 - Mixed Data Nine Variables.

What is Regression Analysis?

Regression Analysis is a technique which can be used to describe and establish relationships between two or more sets of data. It is particularly useful in cases where the data is statistical in nature and has scatter if plotted graphically. The relationships derived from this technique may not always provide a perfect description of associated data; nevertheless, it can be a powerful tool even when approximations to data variations are found. Problems that could only be handled by guesswork can be confidently handled once interrelationships are established with regression techniques.

Why Use Regression Analysis?

Regression procedures can be used to:

- a) describe;
- b) control, or
- c) predict.

In each case one must use a set of data which is numeric in form. In some instances the data can be separated into either dependent or independent groups. The dependent response variables are usually what is to be described, controlled, or predicted. In other cases, a knowledge of which variables are "independent" are not known before examining the data. Regression procedures can be employed to establish the interdependence of such sets of data.

In some fields, engineering concepts or models can be used to help select the independent variables to be employed in the regression relationship.

Once established, the functional form of the relationship can be used to predict or control the system response from a given set of independent variable values.

The power of regression analysis is best used whenever the response of the system to be described is affected by several operating parameters simultaneously. Often times system response to a single independent operating parameter is not available. Either single variable control tests on the systems are much too costly or cannot be implemented in practice. Given a collection of data, regression procedures can provide insight as to which variables, if any, are most useful in describing the system response.

#### Data -- What Kind?/How Much?

Data is usually considered as a set of observed values obtained from a system at some particular time, place, or condition. Data, like time, temperature, speed, or load, are often considered continuous in nature. That is to say they can have any numeric value over some range. Other non-continuous forms of data can also be used in practice. Such data conditions as wet-dry, day-night, or other types of operating condition can be assigned numeric values and used effectively in determining how the system responds to such conditions of operation.

Data variables are normally classified as either "dependent" or "independent." The expressions "independent variable" for X and "dependent variable" for Y in a regression model are simply conventional labels. There does not need to be nor is it implied that Y causally depends on X in a given case. No matter how strong the statistical relations, no cause-and-effect pattern is necessarily implied by the regression model. In some applications there does exist or it is learned through use of regression procedures that there is a one-to-one causal dependence between an observable variable and a response characteristic of a system. This condition is nice since it may provide one with a predictable, controllable, response to a given change in an operating parameter.

Data for regression analysis is most usually arranged in some matrix or array form where each element of the array is some observed data value or condition. Figure VII-1 represents a typical arrangement of a set of independent and dependent response variables.

The figure shows row after row of data arranged by sequential observation. Typically the rows of data are arranged

- a) on a sequential time basis;
- b) by different operating conditions;
- c) by location,
- d) by levels of response in the system being observed.

Data gathered on a time basis lends itself to time trend analysis. Examples are economic data, machinery failure data, or production data. Different operating conditions might be represented by such things as weather, load, speed, type of lubricant, or temperature. Data obtained at different locations of test points often times carries with it unique operating conditions which can later be used in data analysis. Examples are the location of a manufacturing plant, placement of a test probe within a test rig, or the place of an accident.

Level of response in a system can be effectively used in making or gathering test data. Preselected detection levels when exceeded can be used to trigger the data gathering process. Examples are frequently found in machinery diagnostics, nuclear physics experiments, and quality control systems. Data, in general, is not limited to these forms but is often times found to fall into one of these categories.

The amount of data required to describe a given system response depends upon many things. The desired number of independent observations can usually be given in terms of the number of variable types it takes to describe the system response.

In general, for every variable needed to satisfactorily describe the system in regression terms, ten or more separate measurements should be available. This is not a hard fast rule and obviously depends on the data gathering accuracy and the system under observation. One expensive machinery failure can often times provide enough data to establish why it did not work properly. Failing nine more units to get enough data would not make sense.

#### Data Scatter

Data normally used in regression studies oftentimes contains scatter. This is illustrated in Figure VII-2. The upper two plots contain relatively little scatter whereas the lower two represent data with large amounts of scatter. Scatter can result from a true lack of association between the variables plotted, or it can be that some unknown factors are acting on the response data which is not accounted for. Example 1 discussed below demonstrates how scatter in some cases can be greatly reduced through appropriate selection of plotting parameters. In many instances, an understanding of what makes the data scattered is critical to understanding what variables control the response of the system under investigation.

#### Correlation Coefficients

The association between two variables is often examined by plotting in graphic form one variable against the other. Whenever a large number of variables are involved this process is not always practical. The calculation of a correlation coefficient is one screening technique which avoids

data plotting but can still provide information on data interdependence. The "correlation coefficient" defined by (R) below is one measure of the degree of association between two variables.

$$R = \frac{\frac{1}{N} \sum_{i=1}^N (X_i - \bar{X})(Y_i - \bar{Y})}{\sigma_x \sigma_y}$$

The values represented by  $\bar{X}$  and  $\bar{Y}$  are the means of all the  $X_i$  and  $Y_i$  values whose association is being tested. The  $\sigma_x$ ,  $\sigma_y$  are the standard deviations of all  $X_i$  and  $Y_i$  values. A positive or negative (R) results whenever the slope of the association between variables is positive or negative, respectively.

It can be shown that the correlation coefficient (R) is always within the range:

$$-1 \leq R \leq 1$$

A sample set of correlation coefficients is shown in Figure VII-2 with a display of the graphic data used to obtain the coefficients. As shown, the closer the (R) value is to the extreme values of (+1) or (-1) the less scatter there is in the data. As (R) approaches zero the scatter approaches a random pattern for the variables being tested.

### Correlation Matrix

Correlation coefficients are often calculated for more than just one pair of variables. In fact for any number of (K) variables there can be

$$\frac{K(K-1)}{2}$$

unique pairs of linear associations which might be evaluated. Correlation coefficients are often displayed in array or matrix form for convenience. The elements of the array are the (R) values calculated from each pair of variables whose association is being tested. The row and column numbers of the matrix merely represent the variables for which the correlation coefficients have been calculated. A set of test values such as temperature can be assigned to a row-column number such as #1 in Figure VII-3. The first row of that figure is all (R) values for the interdependence between temperature and the fifteen other variables listed. The first row-column entry (.99) is a number very close to (1.00) and represents the high correlation of the temperature data with itself. All diagonal elements of a correlation matrix will be very near 1.00 if a linear association between variables is being tested. In Figure VII-3, the diagonal elements are all one or near one, but are shown as (-.##) due to an overflow in the format print condition of the computer printout.

The correlation matrix is a convenient way to display all tabulated associations, (R) values, whenever two or more sets of data variables are being evaluated.

#### Correlation Coefficients of Transformed Data

The correlation coefficient (or matrix array) is a numeric procedure whereby the potential relationship between two sets of data can be examined. Nonlinear as well as linear relationships can be tested for their relative degree of association if the data are first transformed. Data interdependence which can be linearized on log-log or semi-log plots can be inspected analytically by taking the appropriate logarithms of the data before computing the correlation coefficients. Systems governed by the laws of physics can often be explained by one of these functional relations. Testing for one of these relations at the onset of examining the data can provide quick review of the most obvious data dependencies.

Figure VII-4 is an array of correlation coefficients which displays a measure of all linear-linear, log-log, log-linear, and linear-log associations between the sixteen data variable types listed. The resulting (R) values are blocked off in convenient quadrants showing the results of the four types of associations tested. The upper left quadrant displays all linear-linear coefficients, whereas the lower right quadrant gives the log-log coefficients.

Note the circled data in Figure VII-4. It ranges from (.66) to (.82). The coefficients circled pertain to the association between the "number of cars" in the train and the "trailing tons" in the train at the time of the accident. The highest coefficient (.82) occurs from the data which has been converted through logarithms. Of the four associations tested, this implies that the log-log (power law other than first power) type of interrelationship is the best for these two variable parameters.

#### Selecting an "Optimum Set" of Explaining Parameters

The "best" regression equation is the one which can sufficiently describe the system under study with the smallest number of variable parameters. There is no unique statistical procedure that will provide the "best" descriptive equation in any given instance. Personal judgment is always required. Scientific insight and engineering principles should never be substituted by some automatic statistical screening method for obtaining the "best" model of representation of a given set of data. Some analytical procedures are more useful than others in helping find an "optimum set" of parameters that can sufficiently describe the system or data being studied. Two types of tests are common; parameter acceptability tests and optimization criteria for gathering the "best" set of parameters.

Single or multiple parameter acceptability can be established for a linear set of data through the use of the F-test

$$F = \frac{\text{Mean Square of the Regression Components}}{\text{Mean Square of the Error Components}}$$



Where a regression and error component are defined as follows:

$$\text{Regression components} = (\hat{Y}_i - \bar{Y})$$

$$\text{Error components} = (Y_i - \hat{Y}_i)$$

Each is shown graphically for a single parameter fit in Figure VII-5. This ratio can be calculated sequentially as parameters are being added to the model or collectively to all parameters in the model.

The (F) number for parameter acceptability can be established by using any of a number of prepared tables which show the level of significance for any number of data points and parameters in the model. In general, the higher the F-number the better chance there will be of the model successfully describing some additional set of data similar to that from which the model was developed.

Other analytical means are often used to establish an "optimum set" of parameters from those available. The methods commonly used involve the determination of all errors associated with the data and the explaining model. The errors being defined as the differences between the actual data and the corresponding predicted ones.

Three calculating procedures or criteria are helpful in determining whether one combination of parameters is better than another. Each is calculated as follows:

$$R_k^2 = 1 - \frac{\text{Sum of Squares of the Errors } (Y_i - \hat{Y}_i)^2}{\text{Total Sum of Squares } (Y_i - \bar{Y})^2}$$

$$MSE_k = \frac{\text{Sum of Squares of the Errors } (Y_i - \hat{Y}_i)^2}{(N-K-1)}$$

$$C_k = \frac{\text{Sum of Squares of the Errors}}{\left( \begin{array}{l} \text{Mean sum of Squares of} \\ \text{Errors for all Possible} \\ \text{Variables in Regression} \end{array} \right)} - (N-2(k+1))$$

where N is the number of data points and k is the number of parameters entered into the regression model. Note that when no parameters are in regression the sum of the squares of the errors is taken as the total sum of the squares.

The following comments are pertinent to the use of the three criteria:

Criterion	Comments	Value Approached as Number of Variables in Model Increases
$R_k^2$	Does not account for the number of variables in model.  Change in $R_k^2$ often very small as number of variables in model increases.	Rapidly approaches 1
$MSE_k$	May increase slightly upon adding model parameters.  Changes in $MSE_k$ often very small as number of variables increase.	Approaches a minimum (the variance of the errors)
$C_k$	Optimum test for finding models that give the smallest squared error.  Minimum $C_k$ occurs for models containing either bias or random errors.	Approaches $k + 1$ for "best" set of variables. (k = number of parameters in model.)

The computed values of  $R_k^2$ ,  $MSE_k$ , and  $C_k$  are shown graphically in Figure VII-6. In each case those combinations of variables providing a value of  $R_k^2$ ,  $MSE_k$ , or  $C_k$  that lies nearest the solid line (the left boundary of the shaded regions shown) will likely be the optimum combination of variables for modelling. The final selection, of course, being made from a scientific knowledge of the system being studied.

#### A Large Number of Independent Variables

The "optimum" selection process cannot always be used when a large number of independent parameters exist. Since each potential independent parameter can be included or excluded from the model there are  $(2^k - 1)$  possible linear regression equations that exist with k possible parameters. In addition, a few parameters may become a large collection of different parameters if cross products, logarithms, or other typical ways of modifying the data are to be examined. Even with the availability of large computers running all possible regression models for review becomes unwieldy. In the case of a large number of available parameters other procedures must be employed.

Among those used are the:

- a) Forward selection technique,
- b) Backward elimination procedure, and
- c) Stepwise procedure.

The objective of each procedure is to give the best description of the response data (dependent variable) with the fewest number of convenient parameters in the functional expression. Unfortunately the above procedures do not always lead to the same solution for a given set of data. In those instances where the data variables are not highly interrelated the above procedures will often achieve the same solution. In cases of highly interrelated parameters a unique description of the data is not always available. In these instances the "best" solution will require a value judgment or minimum errors criteria test to make the final selection.

The forward selection technique inserts variables into the regression model until a satisfactory equation is achieved. The order of insertion is usually based on a calculation of the fractional correlation coefficient between the existing model and the parameters not yet entered. The parameter with the highest coefficient is entered next.

The backward elimination method begins with all variables in regression. Parameters are then removed sequentially. The procedure stops when the explaining equation is sufficient to describe the data. Partial correlation coefficients and F-values are used to establish which, if any, of the parameters should be taken out of the regression equation at each step.

The stepwise procedure is an improved version of the forward selection process. The improvement involves a re-examination of each parameter in regression after one is entered. A variable previously entered may be found to be unnecessary after other parameters have been brought into the model. The partial F-test is applied to each variable after each parameter is entered into regression. If any variable is shown to be non-significant at any stage, it is immediately removed from the model. The entry-removal procedure continues until the model is found to be acceptable.

A further improvement of this standard technique can be made by running the  $C_k$  test (see previous discussion) on those parameters that are in the model when the stepwise procedure is ended. In doing so, a fewer number of parameters may be found which yield an equivalent solution. In any case, the search method does not require that all regressions be analyzed.

Regression Tables Explained

Every useful computerized regression program has a tabularized output. Most programs provide a similar set of output results convenient for many different applications. Table VII-1 is a sample analytical output sheet with annotated explanation of the pertinent elements. More of these tables will be presented below without annotation.

Example 1 - Truly Independent Variables in Data

It is assumed for this example that response data has been gathered from a set of observations. It is desired to predict these values from an equation using one or more of the independent variables  $X_1$  and  $X_2$  observed at the same time. The data for this example is tabulated in Table VII-2. The correlation matrix for this data shows a high correlation of each variable with respect to the response variable  $Y$ . It is also apparent that the interrelationship between  $X_1$  and  $X_2$  is very small (i.e.  $R = -.0346$ ). Graphic displays of the response variable ( $Y$ ) plotted against each of the two independent variables are made in Figures VII-7 and VII-8.

Since there were only two possible independent variable in this example, all regressions were run. The "best" equation for predicting the response values ( $Y$ ) is one of the following.

$$\begin{array}{ll} Y = .957 X_1 + 60.2 & \left\{ X_1 \quad \text{explains 51\% of variation} \right. \\ Y = .963 X_2 + 72.8 & \left\{ X_2 \quad \text{explains 44\% of variation} \right. \\ Y = X_1 + X_2 + 50 & \left\{ X_1 \ \& \ X_2 \quad \text{explains 99\% of variation} \right. \end{array}$$

The expression containing both variables (see the plot of  $Y$  against the sum of  $X_1$  &  $X_2$ , Figure VII-9), in this instance "fits" the data very well. However, either of the single variable equations might be used if a less accurate prediction of ( $Y$ ) were acceptable. This may be the case, if for instance, the measurement technique for finding the  $X_2$  values were very costly and the  $X_1$  data points were easy to obtain. One might be inclined to use the single expression which contains only  $X_1$ . Here again, an acceptable description of the response variable depends strongly on the criteria for an acceptable explaining expression.

Tables VII-3 and VII-4 provide a full set of computer calculations for this analysis along with the needed elements for writing the regression equations given.

Example 2 - Non-Independent Variables in Data

Table VII-5 is comprised of a set of data which is highly interrelated. The question arises as to which of the independent variables (or is it both?) can best be used to describe the noted responses ( $Y$ ). Each variable shows a high correlation with the response  $Y$ . Inspection of the correlation matrix does not reveal the answer. In fact, the extremely high ( $R = .983$ ) value between variables tends to add to the confusion.

Again since only two variables are available, all regressions were run. The regression table output of Table VII-6 reveals the important facts of this example. Note the partial F-values for each of the variables in regression. Each variable exceeds an expected F-value of 5.93 (2 variables, 19 degrees of freedom) at a 99.5% level of significance. In other words there is a smaller than .5% chance that the explaining variables 1 and 2 are not related to the response variable from the data presented.

### Example 3 - Mixed Data Nine Variables

Table VII-7 is comprised of selected observations from Reference (2). Each entry of the nine columns in the center is from the year of the corresponding value in column one. The last column of the table is the total number of derailments which occurred in the year noted. A question arises as to which of the columns (if any) might be suitable for predicting the number of derailments in a given year.

The correlation matrix for the tabulated data is displayed in Table VII-8. From the last column of this plot it would be surmised that two variables (TM/FR CR DY (R = .96) and (AV FR CAR LD (R = .94)) would be the most likely candidates for predicting derailments. Contrary to this initial observation due to high cross correlation in the data (AV FR CAR LD) is not among the "best set" of parameters which predict the response column data. In addition, (FR TR MI (R = .65)) will be shown to have a high degree of correlation after other parameters are entered into regression.

Although all possible regressions were not examined in this case (there would be 511 possible combinations of parameters) Table VII-9 shows the case where all nine variables have been entered into regression. Partial F-values for only two parameters at this stage show a significant level of fit (i.e. TM/FR CR DY (F = 4.38) and AV CR MI/DY (F = 5.21)).

Using the backward elimination process, one gets to the regression step shown in Table VII-10. Again the F-values reveal the most significant predictor of the response variable to be (TM/FR CR DY).

Two other variables shown to have a significant degree of correlation with the derailments are (AV CR MI/DY) and (FR TR MI). This three-variable fit has the C<sub>p</sub> value of 3.14 which is slightly lower than the value of 4 to be expected from an optimum solution. The computed derailments from this data are shown in Table VII-11 along with the percent deviations from the actual. Also shown are estimates of the number of derailments out to 1981. The computed derailments are derived from the three independent variables used in the regression equation, which is:

$$\text{NUMBER DERAILMENTS} = 14.847 \left( \frac{\text{TON MI}}{\text{FR CR DY}} \right) + 14.978 (\text{FR TR MI}) - 496.93 \left( \frac{\text{AV CR MI}}{\text{DAY}} \right) + 5103.8$$

DATA ARRANGEMENT

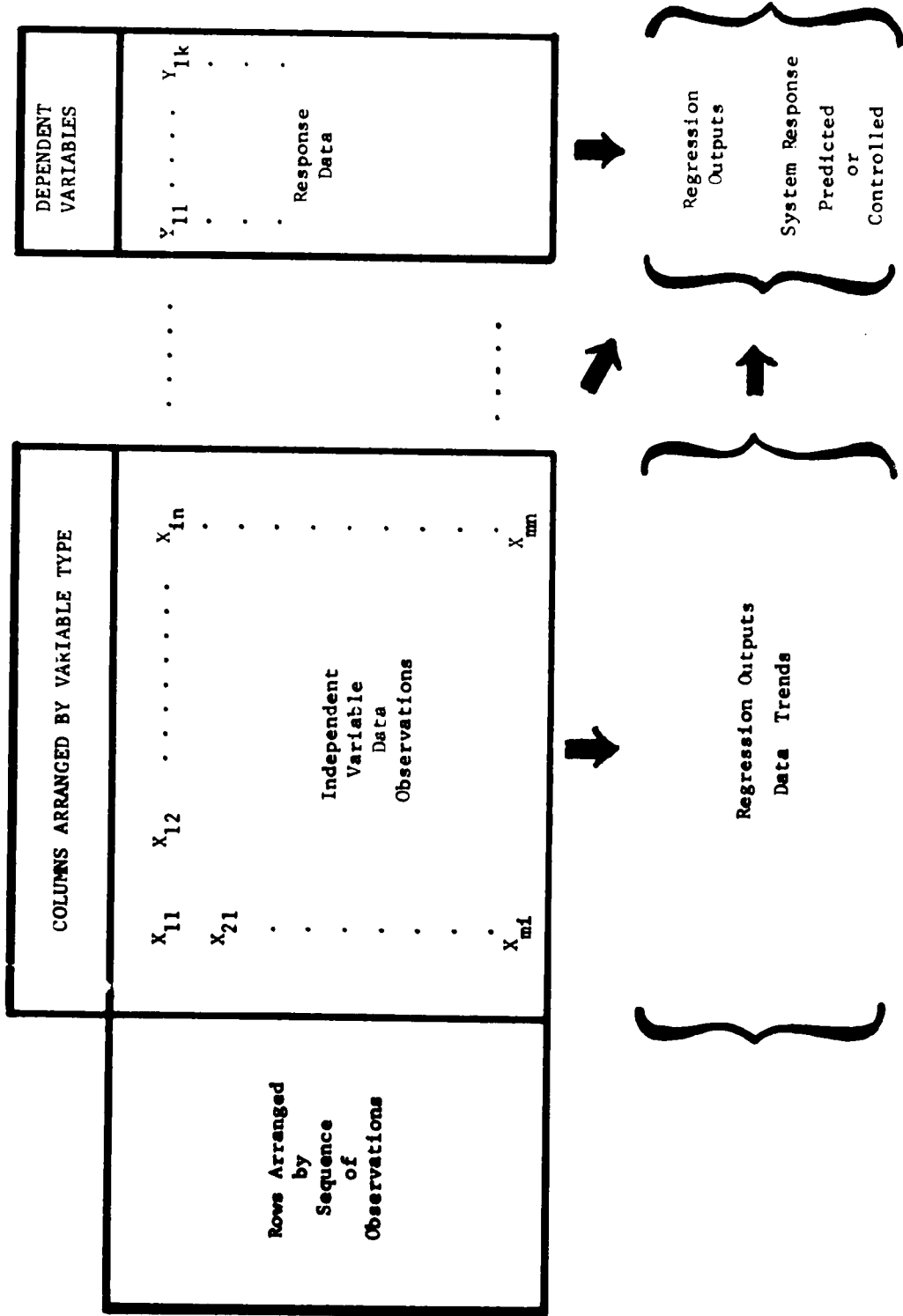

Fig. VII-1

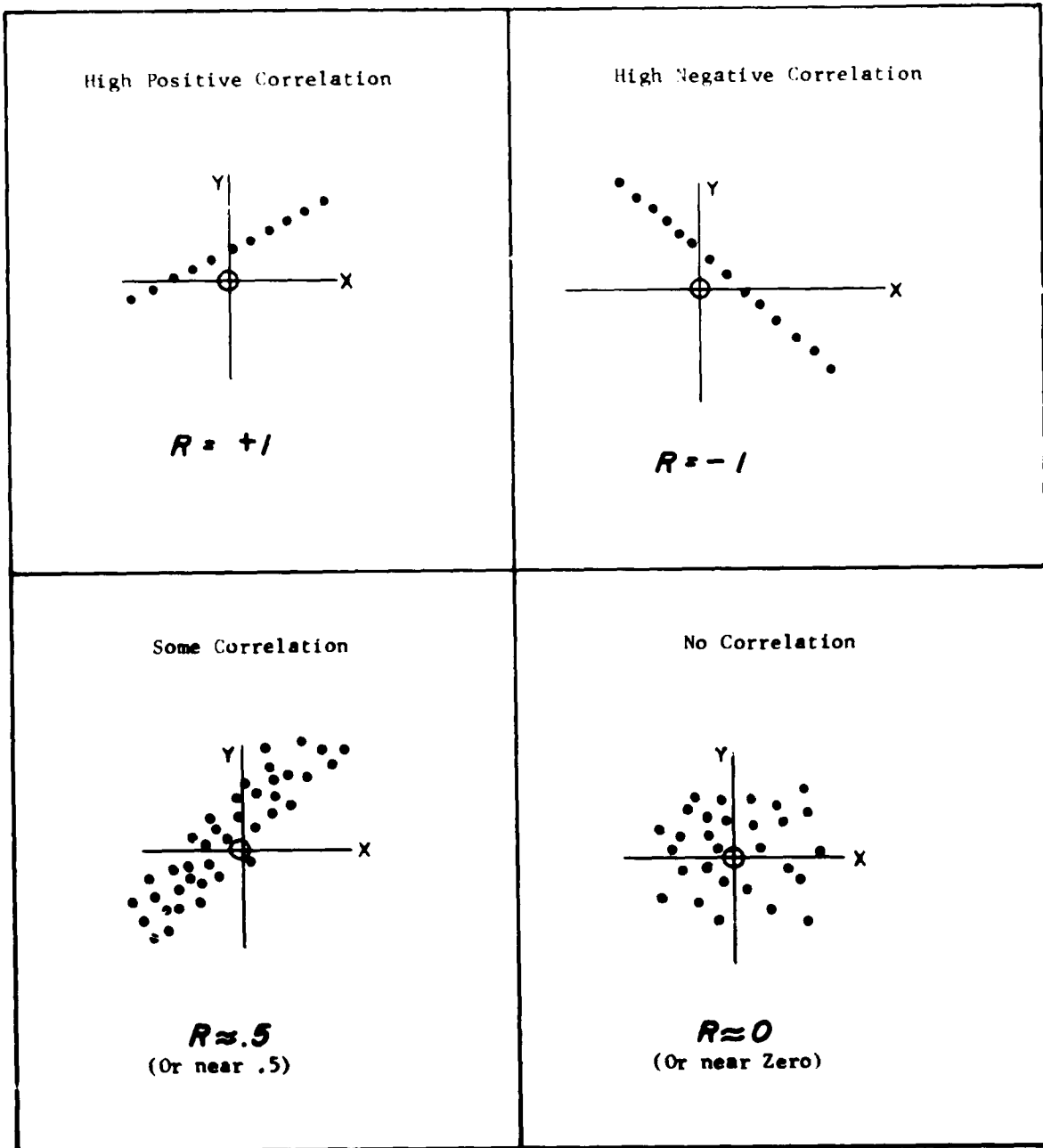

Fig. VII-2 Schematic Plots Depicting Various Amounts of Scatter, as Well as Correlation Coefficients between Variable X and Response Y.

CORRELATION MATRIX FOR 262 FREIGHT ACCIDENTS

0	1	2	3	4	5	6	7	8	9	10	11	12	13	14	15	16
1	.99	-.18	-.09	-.07	.02	.03	-.01	.08	-.06	.03	-.10	-.05	-.07	-.03	-.11	-.13
2	-.18	-.##	.00	-.02	.12	.03	.12	-.06	.01	.05	-.03	.00	.14	.03	.07	-.02
3	-.09	.00	-.##	.01	.04	-.06	.06	.06	.04	-.04	.00	-.02	.06	-.02	.01	-.00
4	-.07	-.02	.01	.99	-.07	.11	-.03	.04	.06	.15	.34	.31	-.10	.19	.22	.26
5	.02	.12	.04	-.07	-.##	.23	.80	-.00	-.05	-.02	.10	.05	.01	.18	-.01	.12
6	.03	.03	-.06	.11	.23	-.##	.23	.07	-.06	.02	.03	.03	.00	.03	.02	.07
7	-.01	.12	.06	-.03	.80	.23	-.##	-.27	-.10	-.01	.03	.06	.08	.24	-.19	.05
8	.08	-.06	.06	.04	-.00	.07	-.27	.99	.14	-.02	.00	-.01	-.01	-.18	.34	.07
9	-.06	.01	.04	.06	-.05	-.06	-.10	.14	-.##	.00	-.05	-.03	-.03	-.10	.01	-.06
10	.03	.05	-.04	.15	-.02	.02	-.01	-.02	.00	-.##	.41	.78	-.01	.26	.09	.23
11	-.10	-.03	.00	.34	.10	.03	.03	.00	-.05	.41	-.##	.88	-.02	.67	.10	.74
12	-.05	.00	-.02	.31	.05	.03	.06	-.01	-.03	.78	.88	-.##	-.02	.58	.36	.62
13	-.07	.14	.06	-.10	.01	.00	.08	-.01	-.09	-.01	-.02	-.02	-.##	.02	.01	.01
14	-.09	.03	-.02	.19	.18	.09	.24	-.18	-.10	.26	.67	.58	.02	-.##	.10	.81
15	-.11	-.07	.01	.22	-.01	.02	-.19	.34	.01	.09	.46	.36	-.05	.19	.99	.72
16	-.13	-.02	-.00	.26	.12	.07	.05	.07	-.06	.23	.74	.62	-.01	.81	.72	-.##

ALL ACC CODES - FREIGHT ONLY

- 1 = TEMPERATURE
- 2 = VISIBILITY
- 3 = WEATHER
- 4 = SPEED(MPH)
- 5 = TRAILING TONS
- 6 = POSITION 2
- 7 = NUMBER OF LOADED CARS
- 8 = NUMBER OF EMPTY CARS
- 9 = TRACK DENSITY
- 10 = DOLLARS TRACK DAMAGE
- 11 = DOLLARS EQUIPMENT DAMAGE
- 12 = DOLLARS TOTAL DAMAGE
- 13 = FREQUENCY OF OCCURANCE FOR 1975
- 14 = NUMBER OF DERAILED CARS LOADED
- 15 = NUMBER OF DERAILED CARS EMPTY
- 16 = TOTAL NUMBER OF CARS DERAILED

NOTE: (-.##) = 1.00





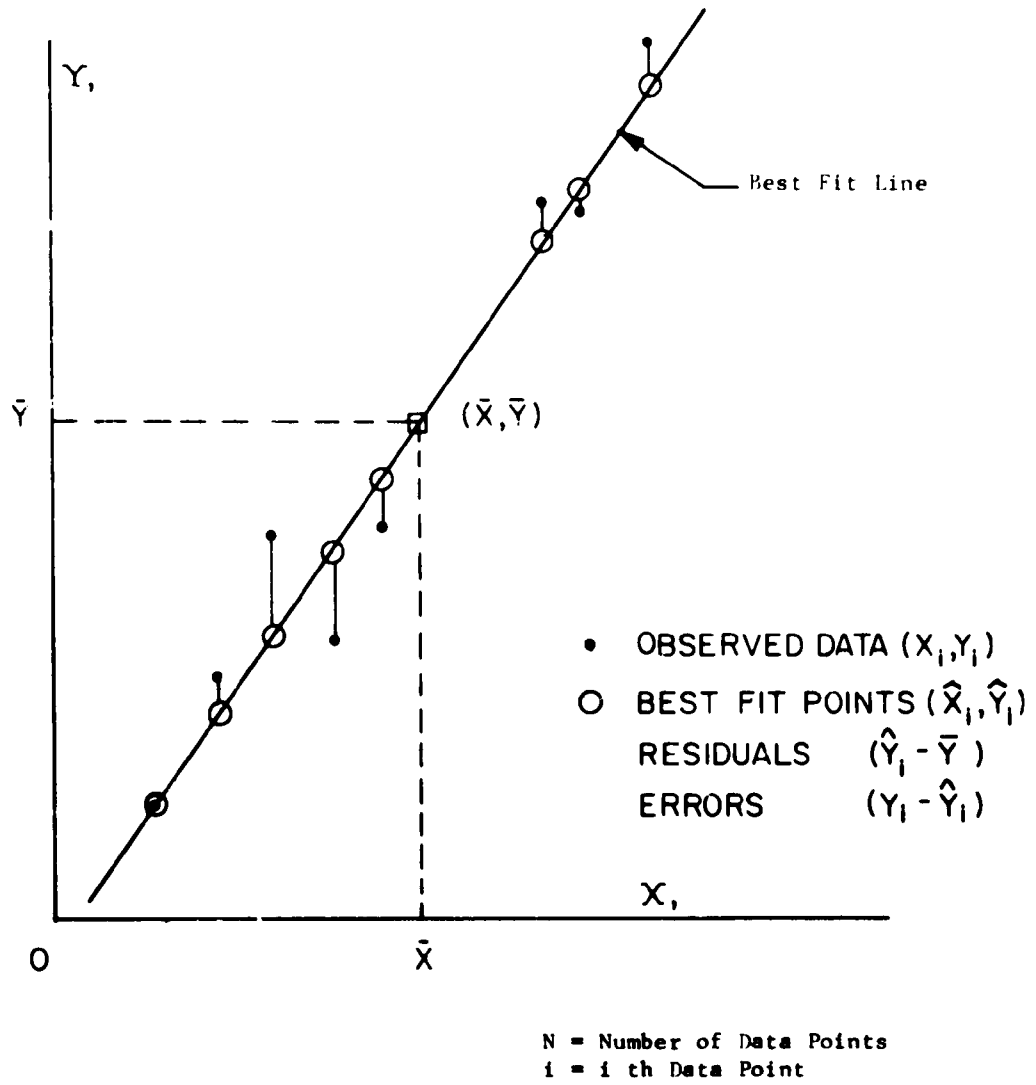

Fig. VII-5 Schematic Data Plot Showing Observed Data Points  $(X_i, Y_i)$ , Best Fit Points  $(\hat{X}_i, \hat{Y}_i)$ , Averages  $\bar{X} = \sum X_i / N$ ,  $\bar{Y} = \sum Y_i / N$  Error Values  $(Y_i - \hat{Y}_i)$ , and Residuals  $(\hat{Y}_i - \bar{Y})$ .

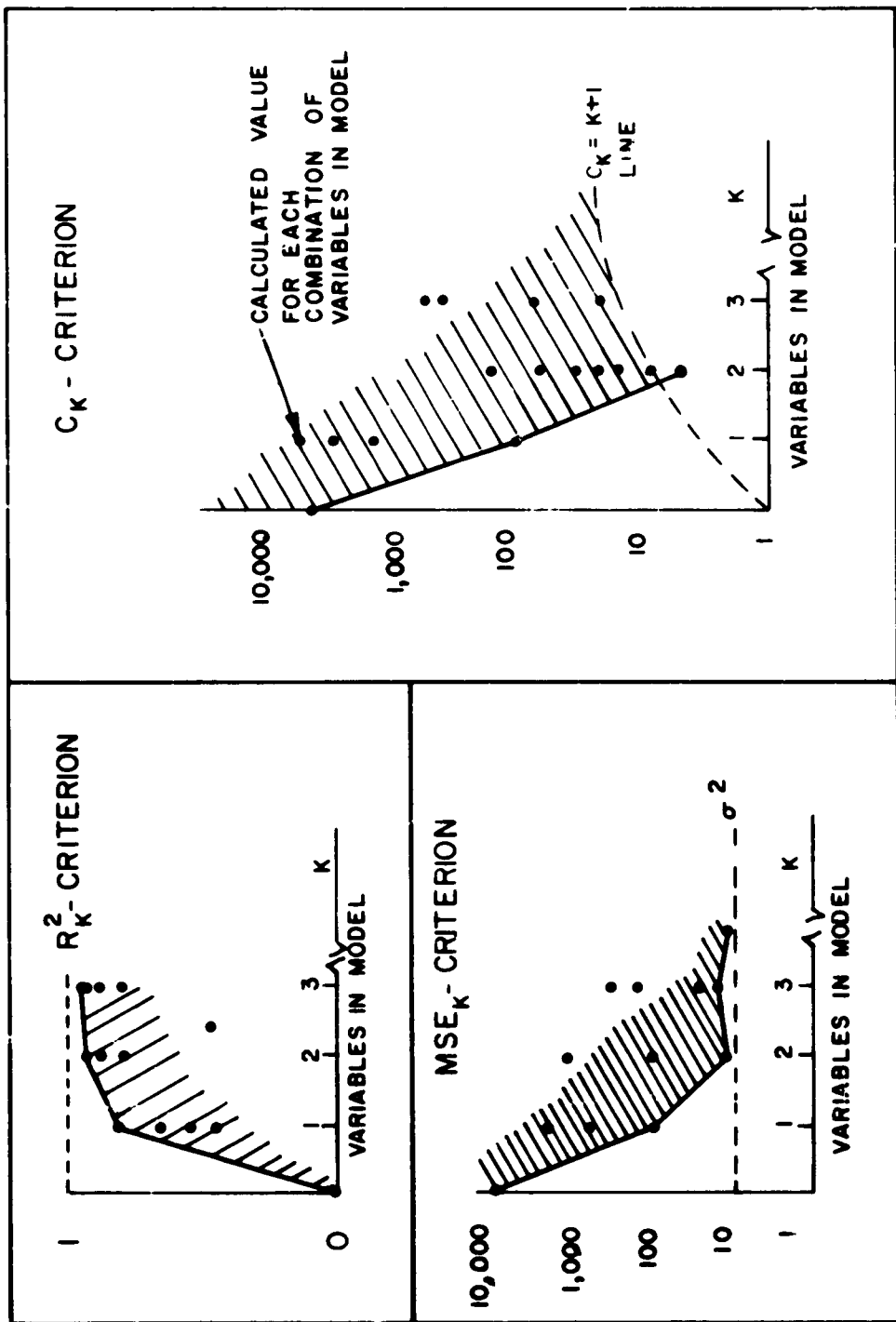

Figure VII-6 Three Criteria for Testing the Relative "Best Fit" of a Combination of Variables in a Hypothetical Regression Model.

TABLE VII-1

$\sum Y_1^2 - \frac{(\sum Y_1)^2}{N}$ <p>One Less than the Number of Data Points Degrees of Freedom (N-1)</p>	$\frac{\sum (Y_1 - \bar{Y})^2}{\sum (Y_1 - \bar{Y})^2}$ <p>Mean Squares of Regression Components</p>	$\frac{\sum (Y_1 - \bar{Y})^2}{\sum (Y_1 - \bar{Y})^2}$ <p>Sum of Squares of Errors</p>	$\frac{\sum (Y_1 - \bar{Y})^2}{\sum (Y_1 - \bar{Y})^2}$ <p>Mean Squares of Errors</p>	$\frac{\sum (Y_1 - \bar{Y})^2}{\sum (Y_1 - \bar{Y})^2}$ <p>F-Value for Regression to this Step</p>	$\frac{\sum (Y_1 - \bar{Y})^2}{\sum (Y_1 - \bar{Y})^2}$ <p>Corr. Coef. with Response, Given Variable 5 in Regression</p>	$\frac{\sum (Y_1 - \bar{Y})^2}{\sum (Y_1 - \bar{Y})^2}$ <p>% Scatter Accounted for by Equation</p>	$\frac{\sum (Y_1 - \bar{Y})^2}{\sum (Y_1 - \bar{Y})^2}$ <p>Standard Deviation of Residual Errors</p>
<p>Number of Variables in Regression (k)</p> <p>17</p>	<p>1</p>	<p>16</p>	<p>16</p>	<p>3.29</p>	<p>8.65107794E-02</p>	<p>60</p>	<p>4.5813345615</p>
<p>DESCRIPTION</p>	<p>REGRESSION</p>	<p>RESIDUALS</p>	<p>CUT OFF VALUES</p>	<p>R2 W/RESPONSE</p>	<p>CONSTANTS</p>	<p>CONSTANTS</p>	<p>TOTAL CONSTANT</p>
<p>OBSERVATIONS CORRELATED</p> <p>8.4358787055</p>	<p>ORIG UNITS</p> <p>5.07769848720</p>	<p>CORR MEAN SQS</p> <p>5.07769848720</p>	<p>ORIG UNITS</p> <p>24.1926193695</p>	<p>F-VALUES</p> <p>24.19261936955</p>	<p>F-VALUES</p> <p>4.164882008058</p>	<p>REGRESSION OF REGRESSION</p> <p>XXXXXX</p>	<p>STD DEVIATION</p> <p>1.4374105942</p>
<p>VARIABLES ENTERED</p> <p>5</p>	<p>VARIABLES OUT OF REGRESSION</p> <p>(NOT ENTERED)</p>	<p>VARIABLES ENTERED</p> <p>1</p>	<p>VARIABLES OUT OF REGRESSION</p> <p>(NOT ENTERED)</p>	<p>(NOT ENTERED)</p>	<p>(NOT ENTERED)</p>	<p>STD DEVIATION</p> <p>1.4374105942</p>	<p>RESPONSE VARIABLE</p> <p>7.365162745452</p>
<p>Partial F-Value for Variable if it were to be entered Next.</p>	<p>PERCENT VARIATION EXPLAINED</p> <p>XXXXXX</p>	<p>STD. DEV. OF RESIDUALS</p> <p>XXXXXX</p>	<p>VARIABLE SLOPE</p> <p>XXXXXX</p>	<p>(NOT ENTERED)</p>	<p>(NOT ENTERED)</p>	<p>REGRESSION</p> <p>XXXXXX</p>	<p>Y = 7.3X<sub>5</sub> + 3.6</p>
<p>Best Fit Equation at this Step of Analysis</p>	<p>XXXXXX</p>	<p>XXXXXX</p>	<p>XXXXXX</p>	<p>XXXXXX</p>	<p>XXXXXX</p>	<p>XXXXXX</p>	<p>XXXXXX</p>

EXAMPLE OF REGRESSION TABLE INFORMATION

TABLE VII-2

## REGRESSION EXAMPLE 1

VARIABLE X1	VARIABLE X2	RESPONSE Y
30.85	0.86	81.71
35.13	0.98	86.11
7.43	1.94	59.38
21.12	1.99	73.12
10.94	0.37	61.32
12.90	4.16	67.07
27.39	6.01	83.41
31.97	6.47	88.44
16.06	0.57	66.63
28.86	6.51	85.37
26.67	5.03	81.70
20.49	2.46	72.96
22.29	6.05	78.34
27.79	7.11	84.90
19.58	2.50	72.08
12.53	10.76	73.29
6.65	16.16	72.82
33.94	3.17	87.12
24.50	5.44	79.94
30.50	5.29	85.80
23.72	0.14	73.86
20.97	17.27	88.24
28.18	5.93	84.12
36.03	21.29	107.33
18.33	23.78	92.11
36.57	7.75	94.33
10.77	19.33	80.10
30.25	27.88	108.14
8.49	6.51	65.00
10.41	6.99	67.41
33.60	8.04	91.64
32.67	19.44	102.12
9.47	16.67	76.15
12.99	29.83	92.83
28.24	28.30	106.55

## CORRELATION MATRIX

R VALUES FOR DATA SHOWN ABOVE

1.0000	-0.0346	0.7187	VARIABLE X1 WITH RESPONSE Y
-0.0346	1.0000	0.6698	VARIABLE X2 WITH RESPONSE Y
0.7187	0.6698	1.0000	VARIABLE X1 WITH X2

VII-19  
 XXXXXXXXX RESPONSE Y XXXXXXXXXXXXX  
 VERSUS  
 VARIABLE X1

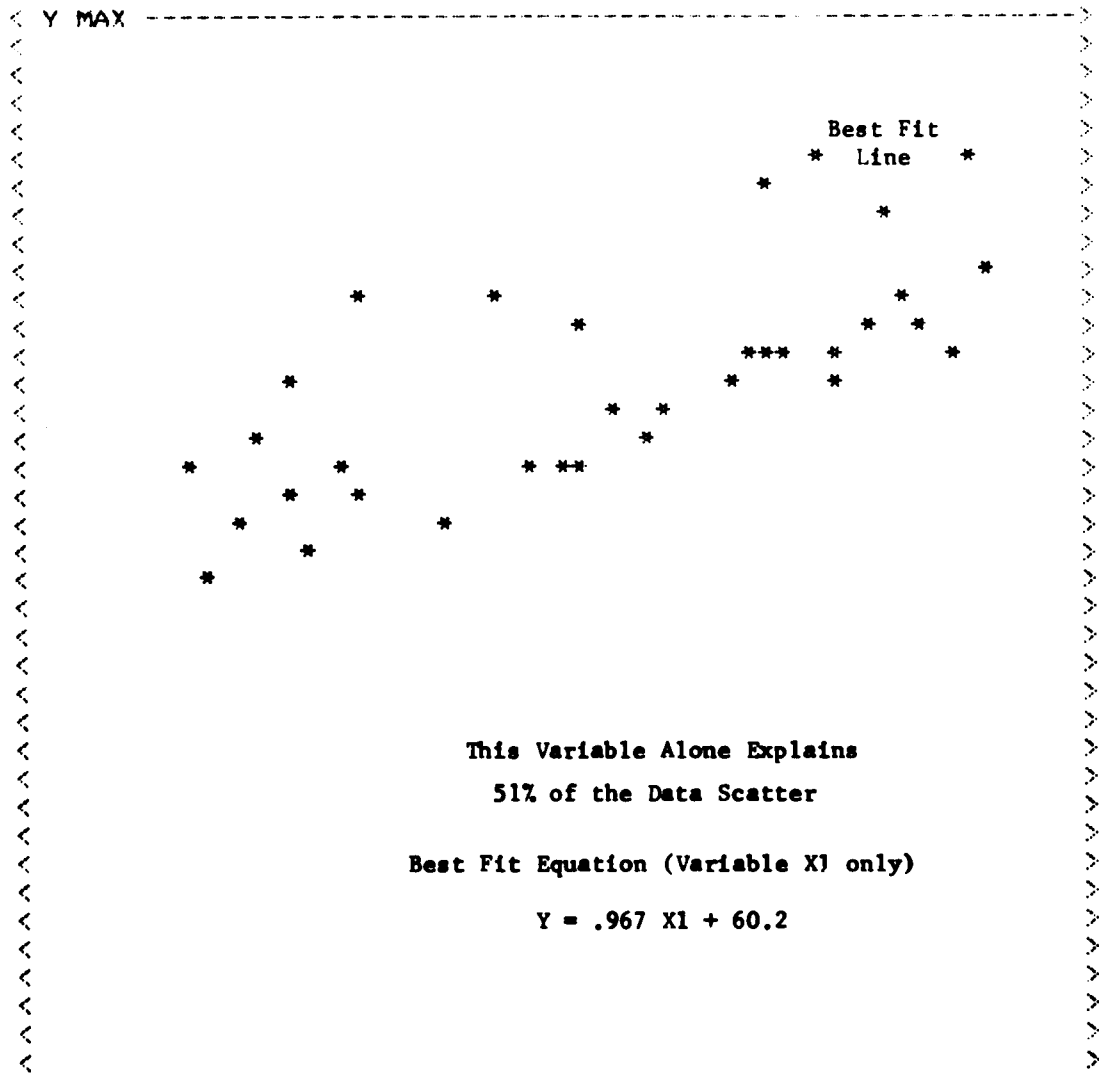

This Variable Alone Explains  
51% of the Data Scatter

Best Fit Equation (Variable X1 only)

$$Y = .967 X1 + 60.2$$

↑ X MIN = 0 40 = X MAX ↑

SCALE X = VARIABLE X1 DATA

SCALE Y = RESPONSE DATA

↑ Y MIN = 0 120 = Y MAX ↑

REGRESSION EXAMPLE 1

Fig. VII-7

VII-20  
 XXXXXXXXX RESPONSE Y XXXXXXXXXXXXX  
 VERSUS  
 VARIABLE X2

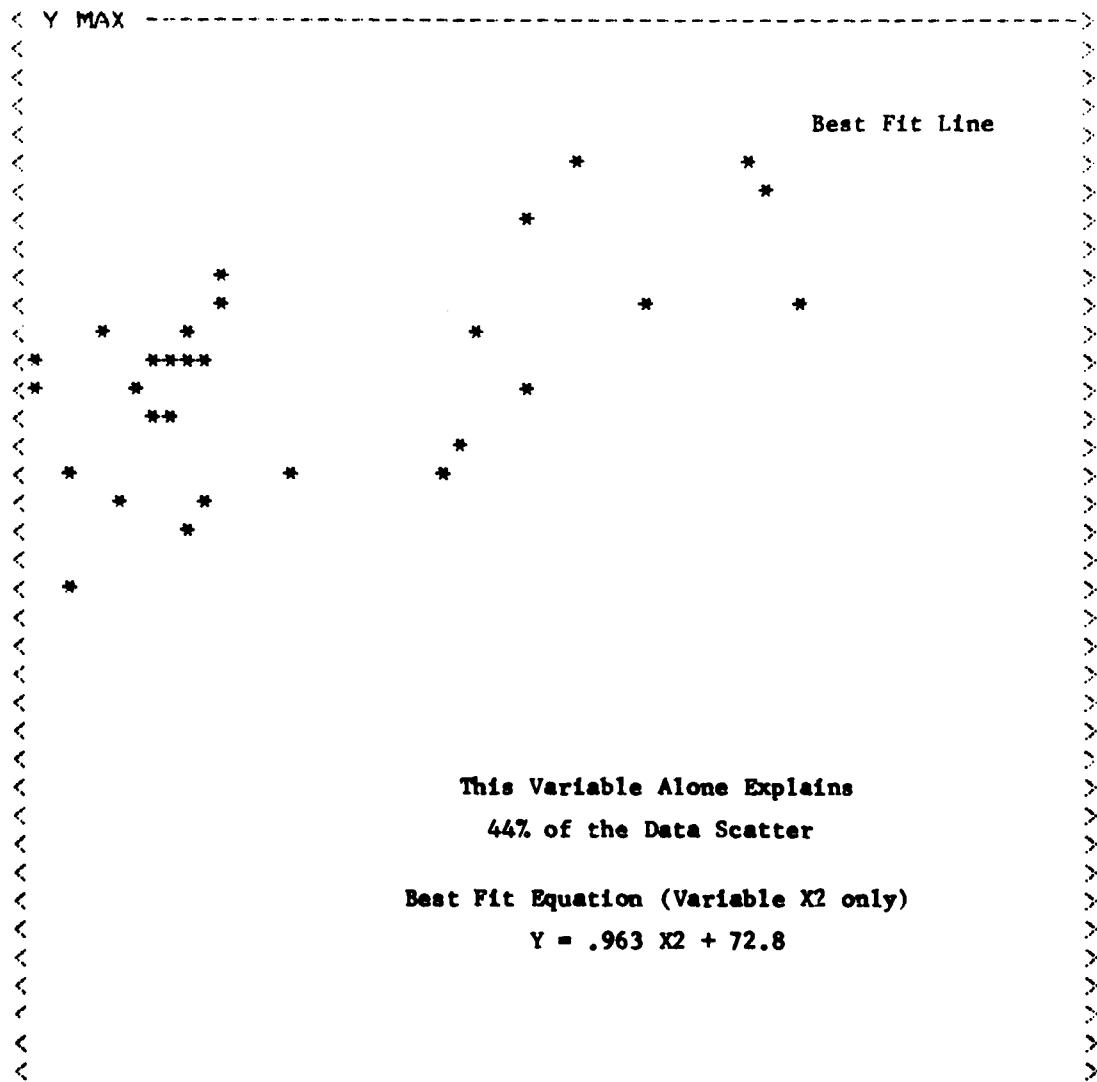

-----  
 † X MIN = 0 40 = X MAX †  
 -----

SCALE X= VARIABLE X2 DATA  
 SCALE Y= RESPONSE Y DATA

-----  
 † Y MIN = 0 120 = Y MAX †  
 -----

REGRESSION EXAMPLE 1

Fig. VII-8

XXXXXXXXXX RESPONSE Y XXXXXXXXXXXXX  
VERSUS  
X1 + X2

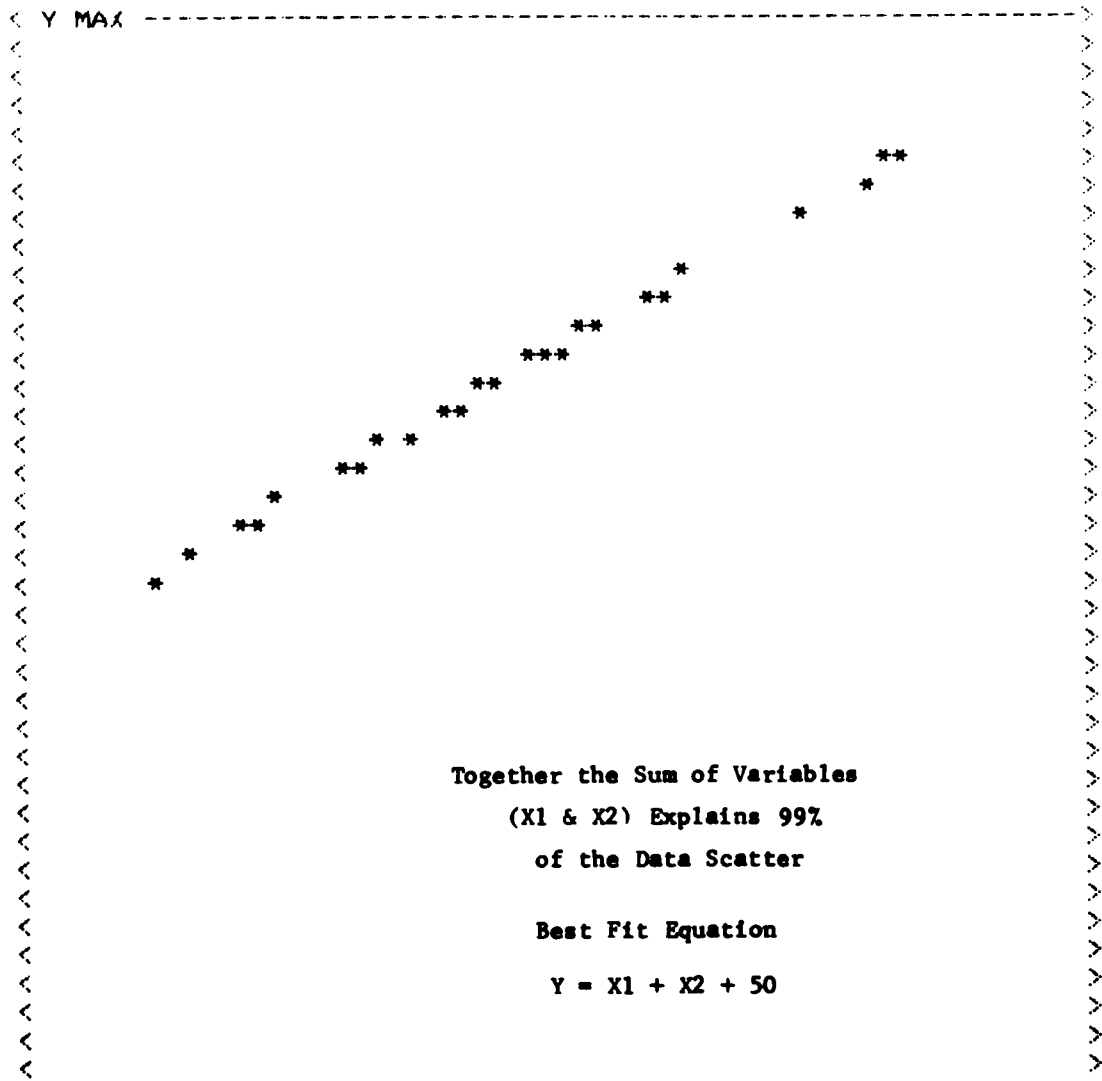

↑ X MIN = 0 70 = X MAX ↑

SCALE X = SUM OF X1 + X2

SCALE Y = RESPONSE Y DATA

↑ Y MIN = 0 120 = Y MAX ↑

REGRESSION EXAMPLE 1

Fig. VII-9



TABLE VII-3

```

XXXXXXXXXXXXXXXXXXXXXXXXXXXXXXXXXXXXXXXXXXXXXXXXXXXXXXXXXXXXXXXXXXXX
XXXXXXXXXXXXXXXXXX REGRESSION TABLE FOR STEP 1 XXXXXX TTEST  XX
XXXXXXXXXXXXXXXXXXXXXXXXXXXXXXXXXXXXXXXXXXXXXXXXXXXXXXXXXXXXXXXXXXXX
DESCRIPTION          TOTALS          REGRESSION          RESIDUALS

OBSERVATIONS              34              1              33
CORRLATE SS                1              .516643717978      .483356282022
  ORIG UNITS  5402.4355764  2791.134402328      2611.301174072
CORR MEAN SGS              .516643717978      1.46471600E-02
  ORIG UNITS              2791.134402328      79.13033860824
F TEST NUMBER              35.27262048183
XXXXXXXXXXXXXXXXXXXXXXXXXXXXXXXXXXXXXXXXXXXXXXXXXXXXXXXXXXXXXXXXXXXX
VARIABLES ENTERED          F-VALUES          CUT OFF VALUES
VARIABLE X1                35.27262048183      3.29
VARIABLES OUT OF REGRESSION  F-VALUES          R2 W/RESPONSE
VARIABLE X2 (NOT ENTERED)  218775120543.7      .4833562819513
XXXXXXXXXXXXXXXXXXXXXXXXXXXXXXXXXXXXXXXXXXXXXXXXXXXXXXXXXXXXXXXXXXXX
PERCENT VARIATION EXPLAINED  51
STD. DEV. OF RESIDUALS      8.8955235151
XXXXXXXXXXXXXXXXXXXXXXXXXX EQUATION OF REGRESSION XXXXXXXXXXXXXXXXXXXX
VARIABLE      SLOPE          STD DEVIATION      CONSTANTS

VARIABLE X1    .9675214529031      .1629077482        21.79622905226

RESPONSE VARIABLE              TOTAL CONSTANT
RESPONSE Y                     60.25005474328
  
```

```

XXXXXXXXXXXXXXXXXXXXXXXXXXXXXXXXXXXXXXXXXXXXXXXXXXXXXXXXXXXXXXXXXXXX
XXXXXXXXXXXXXXXXXX REGRESSION TABLE FOR STEP 1 XXXXXX TTEST  XX
XXXXXXXXXXXXXXXXXXXXXXXXXXXXXXXXXXXXXXXXXXXXXXXXXXXXXXXXXXXXXXXXXXXX
DESCRIPTION          TOTALS          REGRESSION          RESIDUALS

OBSERVATIONS              34              1              33
CORRLATE SS                1              .448751822465      .551248177535
  ORIG UNITS  5402.4355764  2424.352810659      2978.082765741
CORR MEAN SGS              .448751822465      1.67044902E-02
  ORIG UNITS              2424.352810659      90.24493229518
F TEST NUMBER              26.86414349263
XXXXXXXXXXXXXXXXXXXXXXXXXXXXXXXXXXXXXXXXXXXXXXXXXXXXXXXXXXXXXXXXXXXX
VARIABLES ENTERED          F-VALUES          CUT OFF VALUES
VARIABLE X2                26.86414349264      3.29
VARIABLES OUT OF REGRESSION  F-VALUES          R2 W/RESPONSE
VARIABLE X1 (NOT ENTERED)  248449882800.7      .551248177464
XXXXXXXXXXXXXXXXXXXXXXXXXXXXXXXXXXXXXXXXXXXXXXXXXXXXXXXXXXXXXXXXXXXX
PERCENT VARIATION EXPLAINED  44
STD. DEV. OF RESIDUALS      9.499733275
XXXXXXXXXXXXXXXXXXXXXXXXXX EQUATION OF REGRESSION XXXXXXXXXXXXXXXXXXXX
VARIABLE      SLOPE          STD DEVIATION      CONSTANTS

VARIABLE X2    .96295953P1549      .18578966          9.16581596248

RESPONSE VARIABLE              TOTAL CONSTANT
RESPONSE Y                     72.88046783306
  
```

TABLE VII-4

```

XXXXXXXXXXXXXXXXXXXXXXXXXXXXXXXXXXXXXXXXXXXXXXXXXXXXXXXXXXXXXXXXXXXX
XXXXXXXXXXXXXXXXXX REGRESSION TABLE FOR STEP 2 XXXXXX TTEST XX
XXXXXXXXXXXXXXXXXXXXXXXXXXXXXXXXXXXXXXXXXXXXXXXXXXXXXXXXXXXXXXXXXXXX
DESCRIPTION          TOTALS          REGRESSION          RESIDUALS

OBSERVATIONS             34             2             32
CORRLATE SS              1             .999999999993      7.07000000E-11
  ORIG UNITS      5402.4355764      5402.435576022      3.81952195E-07
CURR MEAN SQS           .499999999965      2.20937500E-12
  ORIG UNITS           2701.21778011      1.19360061E-08
F TEST NUMBER           226308345104.4
XXXXXXXXXXXXXXXXXXXXXXXXXXXXXXXXXXXXXXXXXXXXXXXXXXXXXXXXXXXXXXXXXXXX
VARIABLES ENTERED          F-VALUES          CUT OFF VALUES
VARIABLE X1                249504125585      3.29
VARIABLE X2                218775120543.7    3.29
VARIABLES OUT OF REGRESSION F-VALUES          R2 W/RESPONSE
XXXXXXXXXXXXXXXXXXXXXXXXXXXXXXXXXXXXXXXXXXXXXXXXXXXXXXXXXXXXXXXXXXXX
PERCENT VARIATION EXPLAINED          99
STD. DEV. OF RESIDUALS              1.09252030E-04
XXXXXXXXXXXXXXXXXXXXXXXXXX EQUATION OF REGRESSION XXXXXXXXXXXXXXXXXXXX
VARIABLE          SLOPE          STD DEVIATION          CONSTANTS

VARIABLE X1      1.000000000081      2.00198645E-06      22.5279025996
VARIABLE X2      1.000000000039      2.13796718E-06      9.518381198445

RESPONSE VARIABLE          TOTAL CONSTANT
RESPONSE Y                49.9999999975
    
```

TABLE VII-5

**REGRESSION EXAMPLE 2**

VARIABLE 1	VARIABLE 2	RESPONSE Y
975	47.0	2684
882	43.6	2579
950	45.9	2850
954	45.7	2918
966	45.5	2671
1041	47.6	2830
1113	49.2	3170
1160	50.0	3399
1251	51.7	3869
1310	53.0	4447
1271	51.5	4817
1350	53.5	5487
1416	54.9	5818
1418	54.6	5602
1373	53.3	5131
1481	56.1	5509
1621	57.7	7307
1646	57.4	8513
1510	53.5	6328
1645	56.9	8061

**CORRELATION MATRIX**

R VALUES FOR DATA SHOWN ABOVE

1.0000	0.9830 ←	0.9652 ←	VARIABLE 1 WITH RESPONSE Y
0.9830	1.0000	0.9233 ←	VARIABLE 2 WITH RESPONSE Y
0.9652	0.9233	1.0000	VARIABLE 1 WITH 2

TABLE VII-6

EXAMPLE 2

```

XXXXXXXXXXXXXXXXXXXXXXXXXXXXXXXXXXXXXXXXXXXXXXXXXXXXXXXXXXXXXXXXXXXXXXXXX
XXXXXXXXXXXXXXXXXX REGRESSION TABLE FOR STEP 2 XXXXXX TACCS XX
XXXXXXXXXXXXXXXXXXXXXXXXXXXXXXXXXXXXXXXXXXXXXXXXXXXXXXXXXXXXXXXXXXXXXXXXX
DESCRIPTION          TOTALS          REGRESSION          RESIDUALS
OBSERVATIONS         19              2                   17
CORRELATE SS         1              .951122926045      4.88770639E-02
ORIG UNITS  66291579  63137137.43008     3244541.569952
CURR MEAN SQE        .4755614680225    2.87512140E-03
ORIG UNITS          31568568.71504    190855.3864678
F TEST NUMBER                165.4056995681
XXXXXXXXXXXXXXXXXXXXXXXXXXXXXXXXXXXXXXXXXXXXXXXXXXXXXXXXXXXXXXXXXXXXXXXXX
VARIABLES ENTERED          F-VALUES          CUT OFF VALUES
VARIABLE 1                 34.25742007987    3.29
VARIABLE 2                 5.760216403996    3.29
VARIABLES OUT OF REGRESSION F-VALUES          R2 W/RESPONSE
XXXXXXXXXXXXXXXXXXXXXXXXXXXXXXXXXXXXXXXXXXXXXXXXXXXXXXXXXXXXXXXXXXXXXXXXX
PERCENT VARIATION EXPLAINED          95
STD. DEV. OF RESIDUALS                436.86998806
XXXXXXXXXXXXXXXXXXXXXXXXXX EQUATION OF REGRESSION XXXXXXXXXXXXXXXXXXXXX
VARIABLE      SLOPE          STD DEVIATION      CONSTANTS
VARIABLE 1    12.7944872366    2.1859768518       16206.13725571
VARIABLE 2    -324.8129266649    124.92601068       -16705.12367538
RESPONSE VARIABLE                                TOTAL CONSTANT
RESPONSE Y                                       5198.48641967
    
```

NOTE

→ 34.25742007987  
→ 5.760216403996

**Best Fit Equation  $Y = 12.7 X_1 - 325 X_2 + 5198$**

TABLE VII-7

EXAMPLE 3 DATA

YEARBOOK OF RAILROAD FACTS  
1977 DATA

YEAR	FR CAR MILES	PIGGY BK LOADINGS	T.M./ FR CR DY	N.T.M./ TR HR	AV FR CR LD	AV CR MI/DY	AV FR TR LD	FR TR MILES	CARS AV TR	NO. DERAIL YEAR
1957	30678	245.1	975	26833	43.8	47.0	1424	446.7	68.6	2684
1958	28077	278.1	882	27148	43.5	43.6	1417	400.4	70.1	2579
1959	28605	416.5	950	27870	43.5	45.9	1430	414.1	69.0	2850
1960	28170	554.1	954	28397	44.4	45.7	1453	404.5	69.6	2918
1961	27226	591.2	966	29671	44.9	45.5	1495	386.4	70.4	2671
1962	27772	706.4	1041	30896	45.4	47.6	1544	393.3	70.5	2830
1963	28153	797.4	1113	31960	46.7	49.2	1590	399.9	70.3	3170
1964	28912	890.7	1160	32640	47.8	50.0	1618	414.5	69.7	3399
1965	29336	1034.4	1251	33815	48.9	51.7	1685	420.9	69.6	3869
1966	30374	1162.7	1310	34750	50.1	53.0	1715	437.5	69.3	4447
1967	29661	1207.2	1271	35395	51.1	51.5	1740	420.4	70.5	4817
1968	30082	1337.1	1350	36091	51.8	53.5	1768	429.3	70.1	5487
1969	30349	1344.1	1416	36257	53.1	54.9	1804	433.4	70.0	5818
1970	29890	1257.5	1418	36578	54.9	54.6	1820	427.1	70.0	5602
1971	29181	1199.1	1373	35722	55.2	53.3	1751	429.5	67.9	5131
1972	30307	1330.9	1481	35436	56.5	56.1	1774	451.5	67.1	5509
1973	31248	1535.4	1621	36535	56.7	57.7	1844	469.1	66.6	7307
1974	30719	1511.7	1646	37258	58.4	57.4	1875	469.3	65.5	8513
1975	27656	1220.6	1510	38778	60.4	53.5	1932	402.6	68.6	6322
1976	28514	1403.6	1645	39124	61.0	56.9	1943	424.5	67.2	8061

TABLE VII-8

<p>EXPLANATION OF CORRELATION COEFFICIENTS</p>	<p>VARIABLE</p>
<p>1.00 0.53 0.53 0.25 0.35 0.52 0.83 0.92 0.47 0.48</p>	<p>FIELD MI</p>
<p>0.53 1.00 0.95 0.96 0.27 0.26 0.78 0.87 0.38 0.29</p>	<p>PIG FIELD</p>
<p>0.53 0.95 1.00 0.94 0.26 0.27 0.97 0.65 0.55 0.20</p>	<p>IMPROV BY</p>
<p>0.25 0.96 0.96 1.00 0.94 0.92 0.99 0.42 0.62 0.22</p>	<p>NUMBER IR</p>
<p>0.25 0.29 0.90 0.94 1.00 0.91 0.96 0.72 0.44 0.21</p>	<p>AV FIELD CAR LD</p>
<p>0.52 0.96 0.92 0.92 0.91 1.00 0.94 0.71 0.42 0.22</p>	<p>AV CR MLDY</p>
<p>0.22 0.95 0.97 0.29 0.95 0.94 1.00 0.42 0.49 0.22</p>	<p>AV FIELD LD</p>
<p>0.43 0.57 0.55 0.43 0.52 0.71 0.42 1.00 0.75 0.65</p>	<p>FR IR MI</p>
<p>0.47 0.42 0.56 0.42 0.66 0.62 0.69 0.75 1.00 0.71</p>	<p>CARE AV IR</p>
<p>0.42 0.29 0.26 0.28 0.94 0.92 0.91 0.65 0.71 1.00</p>	<p>NUMBER/ YR</p>

↑  
 This column shows all  
 partial correlation coefficients  
 with respect to the response  
 variable (number of derailments  
 per year).

Reproduced from  
 best available copy



TABLE VII-10

```

XXXXXXXXXXXXXXXXXXXXXXXXXXXXXXXXXXXXXXXXXXXXXXXXXXXXXXXXXXXXXXXXXXXXXXXXXXXX
XXXXXXXXXXXXXXXXXXXX REGRESSION TABLE FOR STEP 3 XXXXXX TACC3 XX
XXXXXXXXXXXXXXXXXXXXXXXXXXXXXXXXXXXXXXXXXXXXXXXXXXXXXXXXXXXXXXXXXXXXXXXXXXXX
DESCRIPTION          TOTALS          REGRESSION          RESIDUALS

OBSERVATIONS             19             3             16
CORRLATE SS              1             .965471738593     3.45282614E-02
  ORIG UNITS      66381679     64089635.03485     2292043.965187
CORR MEAN SQS           .3218239128643     2.15801633E-03
  ORIG UNITS           21363211.67828     143252.7478242
F TEST NUMBER           149.1295071317

XXXXXXXXXXXXXXXXXXXXXXXXXXXXXXXXXXXXXXXXXXXXXXXXXXXXXXXXXXXXXXXXXXXXXXXXXXXX
VARIABLES ENTERED          F-VALUES          CUT OFF VALUES
TM/FR CR DY              52.23219180421     3.29
AV CR MI/DY              15.27210343557     3.29
FR TR MI                 6.649070396424     3.29
VARIABLES OUT OF REGRESSION F-VALUES          R2 W/RESPONSE
FR CAR MI (NOT ENTERED) .2849203401501     6.43628083E-04
PIG BK LD (NOT ENTERED) 1.00869479109     2.17559756E-03
NTM/TR HR (NOT ENTERED) 2.62453156E-02     6.03081541E-05
AV FR CAR LD (NOT ENTERED) 1.5559683832     3.24504624E-03
AV FR TR LD (NOT ENTERED) .1146766763618     2.61969630E-04
CARS/AV TR (NOT ENTERED) .6546853062724     1.44398593E-03
XXXXXXXXXXXXXXXXXXXXXXXXXXXXXXXXXXXXXXXXXXXXXXXXXXXXXXXXXXXXXXXXXXXXXXXXXXXX
PERCENT VARIATION EXPLAINED          96
STD. DEV. OF RESIDUALS              378.48744738
XXXXXXXXXXXXXXXXXXXXXXXXXXXX EQUATION OF REGRESSION XXXXXXXXXXXXXXXXXXXXXXX
VARIABLE          SLOPE          STD DEVIATION          CONSTANTS

TM/FR CR DY      14.84721532354     2.0543568372     18806.22528956
AV CR MI/DY      -496.9352196424     127.1599503     -25557.37834621
FR TR MI         14.97799689633     5.8086240779     6346.851294835

RESPONSE VARIABLE          TOTAL CONSTANT
NO.DERAILED/YR           5103.80176182

```



TABLE VII-11

EXAMPLE 3  
TRAIN DERAILMENT TRENDS

YEAR	TON FRGHT CAR DAY	AVERAGE CAR MILES PER DAY	FREIGHT TRAIN MILES	ACTUAL DERAILMENTS	COMPUTED DERAILMENTS	PERCENT DEVIATION
1957	975	47.0	446.7	2684	2915	-8.64
1958	882	43.6	400.4	2579	2531	1.85
1959	950	45.9	414.1	2850	2603	8.66
1960	954	45.7	404.5	2918	2618	10.27
1961	966	45.5	386.4	2671	2624	1.73
1962	1041	47.6	393.3	2830	2797	1.13
1963	1113	49.2	399.9	3170	3170	-0.02
1964	1160	50.0	414.5	3399	3689	-8.55
1965	1251	51.7	420.9	3869	4291	-10.93
1966	1310	53.0	437.5	4447	4770	-7.27
1967	1271	51.5	420.4	4817	4680	2.82
1968	1350	53.5	429.3	5487	4993	9.00
1969	1416	54.9	433.4	5818	5338	8.23
1970	1418	54.6	427.1	5602	5423	3.19
1971	1373	53.3	429.5	5131	5437	-5.96
1972	1481	56.1	451.5	5509	5978	-8.52
1973	1621	57.7	469.1	7307	7525	-2.99
1974	1646	57.4	469.3	8513	8049	5.44
1975	1510	53.5	402.6	6328	6968	-10.12
1976	1645	56.9	424.5	8061	7611	5.57
	TIME ↓↓↓	TRENDS ↓↓↓	TIME ↓↓↓	TRENDS	TIME	TRENDS
1977	1744	↑	↑	↑	↑	↑
1978	1789	↑	↑	↑	↑	↑
1979	1834	↑	↑	↑	↑	↑
1980	1879	↑	↑	↑	↑	↑
1981	1924	↑	↑	↑	↑	↑

APPENDIX VII - REFERENCES

1. Draper, N. R., and Smith, H., "Applied Regression Analysis," John Wiley and Sons, Inc., N. Y., 1966.
2. Moroney, M. J., "Facts from Figures, Penguin Books, Inc., Baltimore, Md., 1954.
3. Arkin, H., and Colton, R.R., "Statistical Methods," 5th Edition, Barnes and Noble Books, N.Y., 1970.
4. Neter, J., and Wasserman, W., "Applied Linear Statistical Models," Richard D. Irwin, Inc., Ill., 1974.

APPENDIX VIII

REPORT OF INVENTIONS

The objective of the work was to identify sensors that were needed to reduce railcar-equipment-caused derailments. Although there were several innovations that were conceptually developed to provide derailment protection, no inventions resulted from this work.

Specifically, section 4 is concerned with a review of the cause-code groups that are important in causing railroad-equipment derailments.

Section 5 develops allowable cost-and-deployment data for potential new on-board inspection systems. These figures may be used to evaluate the cost/benefit ratio of the proposed systems. In addition, these cost numbers may be used in future studies to evaluate the effect on improved railcar design.

Six conceptual on-board protection systems are discussed in section 6. The methods discussed are presented in a functional manner. All designs will have to be detailed in future work.

Finally, the appendixes contain computer outputs of the accident data reviewed along with correlation-and-regression analyses concerned with the important aspects of the data.