

~~CLIFTON~~ B  
Ref

UMTA-73-2

REPORT NO. UMTA-MA-06-0027-74-1

NOISE AND VIBRATION OF A  
STEEL WHEEL/STEEL RAIL  
PERSONALIZED RAPID TRANSIT SYSTEM

Harold E. Gramse  
John H. Spence



JANUARY 1974  
INTERIM REPORT

DOCUMENT IS AVAILABLE TO THE PUBLIC  
THROUGH THE NATIONAL TECHNICAL  
INFORMATION SERVICE, SPRINGFIELD,  
VIRGINIA 22151.

Prepared for  
DEPARTMENT OF TRANSPORTATION  
URBAN MASS TRANSPORTATION ADMINISTRATION  
Office of Research, Development and Demonstrations  
Washington DC 20590

NOTICE

This document is disseminated under the sponsorship of the Department of Transportation in the interest of information exchange. The United States Government assumes no liability for its contents or use thereof.

Technical Report Documentation Page

1. Report No. UMTA-MA-06-0027-74-1		2. Government Accession No.		3. Recipient's Catalog No.	
4. Title and Subtitle NOISE AND VIBRATION OF A STEEL WHEEL/STEEL RAIL PERSONALIZED RAPID TRANSIT SYSTEM				5. Report Date January 1974	
				6. Performing Organization Code	
7. Author(s) Harold E. Gramse, John H. Spence				8. Performing Organization Report No. DOT-TSC-UMTA-73-2	
9. Performing Organization Name and Address PULLMAN-STANDARD 1414 Field Street Hammond IN 46320				10. Work Unit No. (TRAIS) UM406/R4703	
				11. Contract or Grant No. DOT-TSC-436	
12. Sponsoring Agency Name and Address Department of Transportation Urban Mass Transportation Administration Office of Research, Develop., and Demon. Washington DC 20590				13. Type of Report and Period Covered Interim Report FY 1973	
				14. Sponsoring Agency Code	
15. Supplementary Notes Under Contract to: Department of Transportation, Transportation Systems Center, Kendall Square, Cambridge MA 02142					
16. Abstract This report describes a test program which has been conducted to establish baseline noise levels and ride characteristics for a state-of-the-art steel wheel on steel rail personalized rapid transit vehicle. A full-scale test vehicle and an 840-foot track, including two 30-foot curves, have been built and used for 128 test runs under various conditions of operation. Permanent records have been made on magnetic tape and oscillograph paper for future analysis as needed.  The vehicle has been successfully demonstrated and has met speed and acceleration design goals. Noise levels of 82 to 85 dB(A) have substantially exceeded proposed criteria for both tangent track and curve track. The ride vibration has met current criteria on tangent track to the 30-mph test speed and to a 5-mph speed limit on the tight 30-foot curve track. There is some tendency to vehicle-hunting.					
17. Key Words Steel Wheel/Steel Rail Wheel-Screech Noise PRT Systems				18. Distribution Statement  DOCUMENT IS AVAILABLE TO THE PUBLIC THROUGH THE NATIONAL TECHNICAL INFORMATION SERVICE, SPRINGFIELD, VIRGINIA 22151.	
19. Security Classif. (of this report) Unclassified		20. Security Classif. (of this page) Unclassified		21. No. of Pages 84	22. Price



## PREFACE

This report describes an investigation, of base line steel wheel on steel rail interaction with emphasis on noise levels, performed for Transportation Systems Center in the context of an overall program to develop and demonstrate various personalized rapid transit systems. This program was sponsored by the Department of Transportation, Urban Mass Transportation Administration.

A state-of-the-art personalized rapid transit vehicle and test track were built to establish the base line information on noise and ride performance. The vehicle was operated under various conditions of speed, load, power and track, with instrumentation to provide recordings of the appropriate behavior measurements. This normal operation testing was supplemented by tests of non-operating situations and a dual-treaded vehicle. This report contains the procedures and general results of the project.



TABLE OF CONTENTS

	<u>Page</u>
SECTION 1. INTRODUCTION. . . . .	1
SECTION 2. SYSTEM DESCRIPTION. . . . .	2
2.1 General . . . . .	2
2.2 Prototype Vehicle . . . . .	2
2.3 Dual-Treaded Vehicle. . . . .	4
2.4 Test Track. . . . .	5
2.5 Test Instrumentation. . . . .	6
2.5.1 On Test Vehicle . . . . .	6
2.5.2 At Test Track . . . . .	6
SECTION 3. TEST PROCEDURE. . . . .	8
3.1 General . . . . .	8
3.2 Dual-Treaded Vehicle. . . . .	9
3.3 Jacked Position Vehicle Test. . . . .	9
SECTION 4. TEST RESULTS. . . . .	10
4.1 Noise . . . . .	10
4.2 Ride Vibration. . . . .	11
SECTION 5. DISCUSSION. . . . .	12
5.1 Noise Level . . . . .	12
5.2 Vehicle Ride Vibration. . . . .	14
5.2.1 General . . . . .	14
5.2.2 Tangent Track Ride. . . . .	14
5.2.3 Curved Track Ride . . . . .	15

TABLE OF CONTENTS (Cont'd.)

	<u>Page</u>
5.3 Power Requirement . . . . .	16
5.3.1 General . . . . .	16
5.3.2 Tangent Track . . . . .	17
5.3.3 Curved Track. . . . .	17
SECTION 6. CONCLUSIONS . . . . .	18
6.1 General . . . . .	18
6.2 Noise Levels. . . . .	18
6.3 Sound Recordings. . . . .	18
6.4 Vehicle Ride Vibration. . . . .	18
SECTION 7. RECOMMENDATIONS . . . . .	19
APPENDIX A - VEHICLE POWER AND PROPULSION. . . . .	A-1
A.1 Vehicle Electrical Power. . . . .	A-2
A.2 Vehicle Propulsion. . . . .	A-2
A.3 Wheel Tread . . . . .	A-2
APPENDIX B - TEST TRACK. . . . .	B-1
B.1 General . . . . .	B-2
B.2 Track Measurements. . . . .	B-2
APPENDIX C - INSTRUMENTS . . . . .	C-1
C.1 Accelerometers. . . . .	C-2
C.2 Vehicle Speed . . . . .	C-2
C.3 Vehicle Power . . . . .	C-2



LIST OF FIGURES

	<u>Page</u>
Figure 1. Vehicle Suspension System . . . . .	21
2. Umbilical Cord Arrangement for Power Off Mode Tests . .	22
3. Expansion Joint - Power Rail. . . . .	23
4. Vehicle's Power Collector and Magnetic Switch Holder. .	24
5. Instrumentation on Test Vehicle . . . . .	25
6. Instrumentation at Test Track . . . . .	26
7. Dual Treaded Vehicle. . . . .	27
8. Vehicle in Jacked Position. . . . .	28
9-13. Sound and Acceleration Test Data. . . . .	29-33
14-15. Wayside Sound Level - Special Tests . . . . .	34
16. Broad Band Analysis - Tangent Track . . . . .	35
17. Broad Band Analysis - Curved Track. . . . .	36
18-22. Maximum Acceleration at CG of Vehicle . . . . .	37-41
23. Sound Level - Power Vs. Coasting with Load. . . . .	42
24. Sound Level - Power Vs. Coasting Unloaded . . . . .	42
25. Sound Level - Welded Vs. Jointed Rail . . . . .	43
26. Sound Level - Tangent Vs. Curve . . . . .	43
27. Human Tolerance to Acceleration . . . . .	44
28. Oscillograph Traces on Tangent Track. . . . .	45
29. Lateral Acceleration at 12 mph for 30 Ft. Curve . . . .	46
30. Lateral Acceleration Actual Vs. Theoretical for 30 Ft. Curve. . . . .	47
31. Longitudinal Acceleration on 30 Ft. Curve . . . . .	48
32. Power Vs. Speed - Tangent Track . . . . .	49
33. Power Vs. Speed - Curve Track . . . . .	49

LIST OF FIGURES (Cont'd.)

	<u>Page</u>
Figure A-1. DOT Vehicle - Block Wiring Diagram . . . . .	A-3
A-2. DOT Vehicle - Block Hydraulic System . . . . .	A-4
A-3. DOT Vehicle - Wheel Profile. . . . .	A-5
A-4. Dual-Tread - Wheel Profile . . . . .	A-6
B-1. DOT Test Track . . . . .	B-4
B-2. DOT Test Track - Curve Zones . . . . .	B-5
B-3. Track Profile and Plan View. . . . .	B-6
B-4. Track Alignment - Zone 1 . . . . .	B-7
B-5. Track Alignment, Gage and Level Zone 1 . . . . .	B-8
B-6. Track Alignment - Zone 2 . . . . .	B-9
B-7. Track Alignment, Gage and Level Zone 2 . . . . .	B-10
B-8. Track Alignment - Zones 3, 4, and 5. . . . .	B-11
B-9. Track Alignment, Gage and Level Zones 3, 4, and 5. . . . .	B-12
C-1. Accelerometer Characteristics. . . . .	C-4
C-1A. Accelerometer Location . . . . .	C-5
C-2. Typical Accelerometer Mounting . . . . .	C-6

LIST OF ABBREVIATIONS AND SYMBOLS

A.C.	alternating current
ASCE	American Society of Civil Engineers
C.G.	center of gravity
DOT	Department of Transportation
dB(A)	Loudness rating on the "A" weighted scale, relative to $2 \times 10^{-5}$ Newtons/meter <sup>2</sup>
ft.	feet
g	acceleration equal to gravitational acceleration
H.P.	horsepower
Hyd.	hydraulic
hunting	resonant lateral motion of wheels
Hz.	Hertz (cycles/second)
in.	inches
jerk	rate of change of acceleration (ft/sec <sup>3</sup> or g/sec)
KW	kilowatt
KVA	kilovolt ampere
lb.	pound
Lat.	lateral
Long.	longitudinal
max.	maximum
mph	miles per hour
MV	milli volt
NR	No Record
∅	phase angle
PNC	preferred noise criterion
PRT	personalized rapid transit
QO	trade name for circuit breaker

LIST OF ABBREVIATIONS AND SYMBOLS (Cont'd.)

R	radius
rpm	revolutions per minute
sec.	seconds
UMTA	Urban Mass Transit Administration
v	velocity
V	volts
VAC	volts - alternating current
Vert.	vertical
yd.	yard

## 1. INTRODUCTION

In rapidly expanding urban areas, transportation of people is becoming a problem because of the inadequate service of present systems coupled with the adverse environmental effect of these systems. A people moving system is, therefore, needed to provide prompt, rapid, personalized service within urban areas, at a total system cost that our society can and will support.

A PRT system based on small steel wheeled vehicles running on conventional steel rail tracks is a possible solution. A steel wheel/steel rail system has the inherent advantage of low rolling resistance, vehicle guidance, smooth ride and safety; these can be obtained with maximum simplicity. Extensive experience and highly developed manufacturing and maintenance technologies of existing steel wheel/steel rail systems offer efficiency, safety, and economy to the future people mover systems.

A prime requirement for any people mover system is that it not degrade the environment. For the steel wheel/steel rail system, noise is a critical characteristic. Recognizing the coming need for more PRT systems, the Urban Mass Transportation Administration initiated a program to develop equipment designs, preliminary to ultimate development of complete PRT systems which will reduce or eliminate environmental impact when compared with present systems. The first step for a steel wheel/steel rail system is to identify and solve noise problems. The work described in this report is to define this problem and establish the base line for its solution.

The specific objectives were to obtain wayside noise levels, wayside noise recordings, ride vibration characteristics and power consumption for a vehicle and tracks representative of present concepts for a steel wheel/steel rail PRT system. The vehicle size and performance were based on previous DOT studies while the suspension, propulsion and running gear are simple state-of-the-art designs.

In preparing for this project, Pullman-Standard employed the consulting service of Bolt, Beranek and Newman, Inc. to review and critique the equipment and procedures as related to acoustical matters.

## 2. SYSTEM DESCRIPTION

### 2.1 General

To establish noise and vibration levels produced by a personalized rapid transit vehicle, it was necessary to design and build or lease the required hardware components to generate and record the characteristics associated with the interaction of a steel flanged wheel on a steel rail. This hardware component program consisted of the following four basic parts.

1. Prototype Vehicle
2. Dual-Treaded Vehicle
3. Test Track
4. Test Instrumentation

Each part is discussed in detail in the following paragraphs:

### 2.2 Prototype Vehicle

A full scale PRT vehicle was designed and fabricated for use as an engineering test vehicle for the measurement of wheel/rail interaction noise and vibration. This test vehicle's wheel base and platform area were selected to accommodate 8 passengers.

The dominant intent in this vehicle design was to provide a simple, accessible, state-of-the-art prototype compatible with the 8 passenger criteria. Thus, the wheel and track are standard, the suspension is typically simple and this design using independently rotating wheels is only a minor departure from normal in an effort to ease negotiation of tight curves. The hydraulic power was selected because of its compactness and its simplicity while facilitating independent wheel rotation with both power and braking.

This vehicle was designed with the following components and capabilities:

1. An independent wheel bolster suspension system, incorporating springs, hydraulic damping and torque stabilizers. (Figure 1 shows the suspension system of the test vehicle.)
2. Independent wheel traction - all four wheels are powered by individual hydraulic motors capable of power and brake modes.

3. Propulsion system capable of producing minimum vehicle acceleration of  $3.22 \text{ ft/sec}^2$  at a velocity of 44 ft/sec.
4. Manual speed control at all velocities up to 44 ft/sec.
5. Manually controlled brakes - dynamic braking supplied by the hydraulic propulsion system on vehicle.
6. A detachable third rail collector (power-pickup) which is manually operable with vehicle in motion. (Figure 4 shows collector in contact with power rail.)
7. Wheel tread profile - standard (Figure A-3 in Appendix A).
8. Roll-bar framework for operator safety and to simulate final contour dimensions of a PRT vehicle for 8 passengers.

The following items were applied to the vehicle framework for operation of the vehicle during the test program:

1. Control Panel - with electrical control switches for propulsion system and instrumentation.
2. Transformer - to supply 115V for on-board vehicle instruments from 480V third rail connector.
3. Recording Power Meter - for calibration of oscillograph power chart.
4. Recording Oscillograph - to record:
  - a. Vehicle speed.
  - b. Accelerometer measurements in the longitudinal, lateral and vertical directions.
  - c. Vehicle position in test zone.
  - d. Motive power.
5. An umbilical cord arrangement to permit instrumentation records for all power-off mode tests. Figure 2 shows the vehicle with this arrangement.
6. Weatherproof covering of operating and instrumentation areas of vehicle to permit testing of vehicle during inclement weather conditions and to reduce warm-up time of instrumentation.

The final assembled weights and dimensions for the personalized rapid transit test vehicle are:

Vehicle weight	6500 lbs.
Vehicle weight with instrumentation	7100 lbs.
Vehicle weight with 2 operators	7400 lbs.
Vehicle weight - simulated eight passenger load	8300 lbs.
Wheel base	8 ft.-0 in.
Width over side sills	4 ft.-6 in.
Length over end sills	12 ft.-0 in.
Extreme width over roll-bars	5 ft.-6 in.
Extreme length over roll-bars	12 ft.-6.5 in.
Height of the floor above rail	2 ft.-0.75 in.
Height of the floor above rail loaded	1 ft.-11.625 in.
Extreme height of vehicle loaded	7 ft.-1.125 in.

### 2.3 Dual-Treaded Vehicle

A second experimental vehicle was equipped with dual-treaded steel wheels, but no power and no brakes. It was loaded to a rail weight of 6,000 lbs. and coasted through various test zones.

The dual-treaded wheel is one element of a static switching concept for a PRT system. These special wheels could not be used on the prototype vehicle because of limited wheel space provided with available hardware. Therefore, a special Dual-Treaded Vehicle was built to obtain limited noise level data for these wheels in the non-switching mode.

The general dimensions for the dual-treaded steel wheel vehicle are:

Vehicle weight	2,000 lbs.
Vehicle weight - loaded	6,000 lbs.
Wheel base	8 ft.-0 in.
Width of vehicle	4 ft.-7 in.
Length of vehicle	9 ft.-4 in.
Height of vehicle above rail	1 ft.-9 in.



## 2.4 Test Track

The test track installed for operating the vehicle (Appendix B) was of conventional track construction utilizing timber ties of 4 in. x 6 in. x 6 ft., on ballast of crushed limestone of 1-1/2 in. and smaller, with steel tie plates, steel spikes and steel joint bars. The welded joint test zone had no joint bars and was hand ground at joints. New rail of type ASCE 60 lb./yd., in 33 foot lengths, was installed at a gage of 42 in. through the tangent zones and 42.5 in. through the curve zones with the change distributed over the spiral easement.

The 840 ft. of test track was made up of the following lengths to permit safe operation of the people mover vehicle at velocities of 44 ft./sec. (30 mph) in the tangent track zones and 17.6 ft./sec. (12 mph) in the curve track zones. The specific zone lengths are as follows:

1. Acceleration section - 270 ft. tangent track
2. 90 ft. tangent track - staggered joint - Zone 1
3. 90 ft. tangent track - welded joint - Zone 2
4. Deceleration section - 210 ft. tangent track ( to reduce vehicle speed to safely traverse the curve zones).
5. 30 ft. radius section - Zone 3, staggered joints with entrance and exit spirals (approximately 50 ft. in length).
6. Transition section - Zone 4, consisting of exit spiral of Zone 3, a 6.67 ft. length of tangent track, and the entrance spiral of Zone 5 (Zone 4 is approximately 35.5 ft. in length).
7. 30 ft. radius section - Zone 5, staggered joint with entrance and exit spirals (approximately 50 ft. in length).
8. Deceleration section sufficient to safely stop vehicle after leaving Zone 5 (approximately 80 ft.).

The power rail system used for energizing the vehicle was aluminum rail with a rated 500 ampere capacity. The power rail consisted of 3 conductors to provide a 3 phase A.C. power source. The running rails were used as a protective ground. The power rail (840 ft. in length) required one expansion joint, which was located in Test Zone 1, as shown in Figure 3.

A 125 KVA portable diesel generator (Caterpillar D-3336) supplied the 480 V/3-phase A.C. to the power rails for all tests.

All test track zone lengths and track measurements are shown on Figures B-1 and B-2 in Appendix B.

## 2.5 Test Instrumentation

- 2.5.1 On Test Vehicle - 6 accelerometers were provided to measure lateral, longitudinal and vertical accelerations of the passenger platform. The type and dimensional location of the accelerometers on the vehicle body structure are shown in Appendix C of this report.

The vehicle speed was measured by a dimagnetic pickup located in proximity to a gear which was mounted on the rotating axle of the vehicle. This speed indication is derived from a pulse generated each revolution for every tooth on the gear, which is converted through a frequency-to-voltage converter to provide speed indication. This signal operates a visual meter and is recorded on the oscillograph.

A magnetic switch holder, as shown in Figure 4, was located on the front wheel bolster of the vehicle to indicate vehicle position along each test zone of track. The magnetic switch passed in close proximity to bar magnets that were placed at the start, middle and end of the test zones, generating pulses which were recorded on the oscillograph paper for each test run. These pulses provide vehicle position for correlation with accelerometer, velocity and power measurements on the oscillograph print-out.

Vehicle power requirements during the acceleration and in test sections were recorded on the oscillograph. Motive power input to the vehicle from the 480-volt, 60-cycle, 3-phase power rail connection was recorded on the power recorder, an Esterline Angus 1 Milliamp Recorder. The instrumentation aboard the vehicle is shown in Figure 5.

- 2.5.2 At Test Track - Noise at each test section was detected by two microphones; one located on each side of the track normal to the midpoint of the zone at 5 feet above the rail plane and 25 feet from track centerline. This noise was recorded on analog magnetic tape using the microphones, power supplies and preamplifiers of the sound analyzers. The microphone on the east side of track recorded the noise on channel 2 and the microphone on the west side of track (3rd rail side) recorded on channel 4. Specification of this equipment is in Appendix C.

The sequence for recording the noise of a test run on tape was as follows; a calibration signal of known frequency and sound pressure level was first

recorded on each channel, then the background noise of the test zone was recorded on each channel, followed by the recording of noise produced by the test vehicle traversing a particular test zone.

Later, the output of this tape recording was played back through the octave band analyzer, which was set to the A-weighted scale, and this result recorded on chart paper using a graphic level recorder. Typical track sound measurement instrumentation is shown in Figure 6.

### 3. TEST PROCEDURE

#### 3.1 General

All testing was conducted between January 8 and February 6, 1973 between 9:00 a.m. and 4:30 p.m.

Each morning prior to testing, the vehicle was operated over the test zone to remove the rust and stabilize noise conditions. Then the sound level calibration signal and ambient or background noise were recorded on the magnetic tape. Weather conditions including temperature and wind at the site were voice recorded.

At the test zone, three locating bar magnets were placed and checked with the vehicle for proper position indication on the oscillograph.

All data collecting equipment on the vehicle was activated and an unrecorded, unlogged run made to verify that all was operating properly.

When the preliminary procedures were successful, the test runs were initiated. All tests were made by the vehicle passing through the test zone from south to north. The on-board recording oscillograph was operated continuously from vehicle start to stop on each test run. The wayside sound levels were recorded only while the vehicle was in the specific test zone. Non-test noise disturbances were noted on the test log sheets. All data recordings and log sheets are identified and integrated by event marker signals.

At the end of each test day, the sound calibration signal and the ambient sound level were again recorded.

Tests were made at each of the different zones in the following modes; power-on and power-off (no 3rd rail contact), while loaded and unloaded. The tests of this vehicle for the various load and mode conditions on tangent track, Zones 1 and 2, were made in 5 mph increments from 5 to 30 mph. The tests in curved track, Zones 3, 4 and 5, were made in 2 mph increments from 2 to 12 mph, except that for Zone 5 the maximum operable speed was reduced to 10 mph for safety. The sequence of control to restore power to the vehicle after completing a Zone 5 test involved a time delay in dynamic braking which was unsafe with the available track length at speeds over 10 mph.

The test crew included three people: (a) the vehicle operator was responsible for controlling the vehicle from start to stop of each test and for traversing the vehicle through the test zone at a constant speed; (b) the vehicle test recorder was responsible for keeping a log of all oscillograph and power recordings; for immediate inspection of all recordings and

for coordination of identification of all recorded data; (c) the sound recorder was responsible for operating all sound recording equipment (taping the calibration signals, background noise, noise input of test conditions and test numbers) and for notation of disturbances and sound records identification.

In addition to this test crew, supporting personnel were required for making test set-up changes, test vehicle movement to and from test track and other supporting functions such as maintenance of equipment and loading and unloading test car.

### 3.2 Dual-Treaded Vehicle

The test procedure used for the tests of the dual-treaded vehicle was different because the vehicle had no power. The powered PRT test vehicle pushed the dual-treaded vehicle at a designated velocity to a position about 15 ft. before the respective test zone. The powered PRT vehicle was then stopped and sound recording data taken as the dual-treaded vehicle coasted through the test zone. This procedure was used for the tests of the dual-treaded vehicle in test Zones 1, 2 and 3 only. Since this vehicle had no braking device, tests in Zones 4 and 5 could not be attempted because of insufficient track length for a friction stop. Figure 7 shows the dual-treaded vehicle in a Zone 3 test.

### 3.3 Jacked Position Vehicle Test

The PRT vehicle was jacked free of the tracks at mid-point of test Zone 1 and the noise generated by the vehicle propulsion system and rotating wheels recorded for speeds 5 to 30 mph in 5 mph increments. The vehicle position at track for this test is presented in Figure 8.

#### 4. TEST RESULTS

##### 4.1 Noise

Wayside sound levels for all moving PRT vehicle test runs are shown in tabular form on Figures 9 through 13 for test Zones 1 through 5 respectively. The maximum dB(A) value obtained from the all pass magnetic tape recording for each microphone is listed for each speed and mode of operation. The correlation of these sound levels with speed and accelerations at C.G. of vehicle for a typical tangent and curved track run are shown in Figures 16 and 17 respectively.

This sound data is a convenient condensation of the all pass recordings which are the primary result of the project. The dB(A) levels establish the baseline noise criteria and provide for comparisons. The various runs provide information on the influence of the following parameters:

- (1) Vehicle speed
- (2) Vehicle weight
- (3) Vehicle tractive effort
- (4) Jointed rail
- (5) Welded rail
- (6) Constant track curvature
- (7) Spiral easement curvature

In conjunction with the acceleration data, correlation of noise with body/wheel/rail force and motion is available. Referring to Figures 16 and 17, the sound level continuous plots are values at the zone boundaries. The maximum sound levels are those listed in the tabular sound level columns of Figures 9 and 11. Likewise, the maximum acceleration values on these plots are those shown on the acceleration columns of Figures 9 and 11.

Wayside sound levels for the dual-treaded vehicle are shown in Figure 14. The dual-treaded vehicle tests were performed to provide limited data for comparison with the conventional wheeled PRT vehicle. In addition to obvious differences in vehicle weight, size, and suspension, the dual tread wheels have greater mass and stiffness than the standard wheel.

Similar wayside sound levels for the PRT vehicle in the jacked position are shown in Figure 15. This test establishes the noise generated by the propelling systems of the vehicle and thus means to separate the wheel/rail noise in the moving test data. The low power level and absence of power pickup noise must be considered.

#### 4.2 Ride Vibration

The accelerations, measured at the PRT vehicle's center of gravity, are plotted on Figures 18 through 22 as a function of speed for the various operating modes. The maximum values, in g's, are shown in tabulation form for Zones 1 through 5 on Figures 9 through 13. This acceleration data provides the baseline for vehicle ride. It must be recognized that this applies to state-of-the-art track construction as well as vehicle design.

## 5. DISCUSSION

### 5.1 Noise Level

The basic objectives of this program were to provide a base line for evaluation in subsequent development and to demonstrate basic phenomena. Much of the useful information will be developed in future analysis of the all-band sound recordings as related both to understanding and reducing noise produced in wheel/rail interaction. The following discussion of Noise Level is preliminary to the sound recording analysis and is based on the A-weighted sound measurements and subjective observations.

The limiting wayside noise level for PRT systems have not been established but rather is evolving and is dependent upon many factors including public reaction, cost and weight penalties, government regulation and the fundamental desire for no disturbances. Even with a proposed level, the limits for noise generated cannot be simply stated because these depend upon location in the system and noise control measures. However, in a study of existing noise levels and criteria prepared for UMTA<sup>(1)</sup>, 57 dB(A) at 25 ft., equivalent to PNC 50,<sup>(2)</sup> was proposed as an acceptable basic level (subject to special conditions). This is roughly comparable to the sound level in a typical business office<sup>(3)</sup> or to an air conditioner condenser at 15 ft.<sup>(2)</sup>. The test noise levels are substantially higher as shown in Figures 9 through 13.

The sound pressure levels plotted in Figures 23 through 26 show comparatively the influence of basic operating conditions. For all conditions, the sound level increases with increasing vehicle speed, reaching maximums of 85 dB(A) at 30 mph on tangent track and 90 dB(A) at 10 mph on the 30 ft. curve track. In service, the operating conditions must be limited to those practical for service; i.e., the speed on a given curve must be limited by passenger comfort requirements. Figure 20 shows that for the maximum allowable lateral acceleration value of .08g, as shown in Figure 27, speed would be limited to 5 mph on the 30 ft. curve track. For this speed, Figure 26 indicates a dB(A) level of 82, which is less than that experienced at 30 mph on tangent track. Thus curve speed limits must be established to assess the magnitude of the curve noise problem.

- (1) Working paper 10194, "Rationale for Exterior and Interior Noise Criteria for Dual-Mode and Personal Rapid Transit Systems", by G. F. Swetnam of the Mitre Corporation, January 25, 1973.
- (2) "Noise and Vibration Control", edited by Leo L. Beranek, McGraw-Hill, 1971.
- (3) "Acoustic Noise Measurements", by Jens Trampe Broch, Bruel & Kjar, 1971.



Figures 23 and 24 show that for both empty and loaded vehicles, the coasting car produces less noise at low speed than the powered car. As speed increases, the difference decreases until at 20 mph and above, the difference is slight relative to data scatter. This is in agreement with the observation that at low speed, the propulsion system noise was dominant, while at higher speeds the wheel/rail rumble, common to both, was dominant.

It can also be seen by comparison of Figures 23 and 24 that there is little difference in noise level for empty and loaded cars, and this difference shows the loaded car noise greater only at top of speed range.

The noise level for the welded rail is higher than for the jointed rail, as indicated by the comparison of Figure 25. This shows that while the rail joint noise is noticeable and does appear on the all pass recording, it is insignificant compared to the dominant rumble. Since there were no other planned differences in the two track sections, it is evident that the noise level of the rumble is influenced by factors such as surface conditions, alignment, etc., at the wheel/rail interface - factors which are within tolerance of normal practice.

On Figure 26 is shown the comparison of sound level for tangent vs. 30 ft. curve track. It is obvious that there is a noise generating mechanism on the curve track not found on tangent track and that a major noise reduction is required if tight curves are to be included in the PRT system. Super-elevation of track reduces the lateral force in the track plane, and thus may reduce noise.

Based on observations during the test, there are three major sources of noise. First is the "rumbling" sound common to rolling of rigid wheels on relatively flat surfaces. This is dominant on tangent track at higher speeds in the immediate vicinity of the car. When the car was 100 to 200 feet from the point of observation along the track, the rumbling noise was hardly audible and the dominant sound became that of the sliding contact of the collectors on the power rail. This second sound source, characterized as "hissing", is much lower in sound level than the rumbling, but because of the extended time involved, might be considered objectionable. The third major noise source is the wheel/rail interaction by which the vehicle is guided around curves. This sound, termed "screeching," is a high pitched noise common to operation of conventional transit equipment on tight radius curves. This noise is dominant on tight curves and is by far the most objectionable to the observer. This interaction is not fully defined, so the precise mechanism for generating the sound is not fully known and may include combinations of several phenomena. Since there is no steering, the vehicle must be forced to follow the track curve by flange and/or flange radius contact with the outside railhead, resulting in a relative tangential motion or slip at the point of contact. Further, the wheel slides axially in response to the lateral or flange forces. In

each case the sliding may be preceded by elastic deflection which stores energy in the deflected element. When the driving force exceeds the friction force, slip occurs and the stored energy causes restoration of the deflected shape and the process is repeated. This intermittent motion, which occurs also at the inner rear wheel, with the associated deflections of the members, is the classic "stick-slip" vibration generator. This process in the wheel/rail interaction produces the fundamental vibration which produces the screech sounds.

The "stick-slip" process explanation is supported by the fact that conditions which are known to affect friction did affect the screech. For example, screech did not occur with wet rail. Further, each night a visible rust developed on the rail so that the first runs of the day over the curves produced no screech. Because vehicle operation over the rail removes rust, the screech would reappear intermittently after several runs and continuously after 5 or 6 runs. In order to control this variable, no data runs were made except on dry rail and only after sufficient preliminary runs had been made to stabilize the sound produced.

## 5.2 Vehicle Ride Vibration

5.2.1 General - From the standpoint of passenger comfort, as shown on Figure 27, this PRT test vehicle performed satisfactorily on tangent track; but the passenger comfort speed limit on the 30 ft. curve track would be 5 mph. Acceptable ride on tight curves might be obtained by changes in the track system, suspension system or speed reduction of vehicle.

5.2.2 Tangent Track Ride - Peak accelerations as plotted in Figures 18 to 22 show the PRT vehicle's ride performance to be good for tangent track. Note that jointed track gave the better vertical ride. The lateral and longitudinal values were mixed indicating a more complicated response to track conditions and operation, including the power variation made for speed control.

The maximum recorded vertical acceleration at the vehicle C.G. of .03 g's would be acceptable for a final suspension design. However, the .06 g's peak lateral acceleration should be improved for tangent track ride quality to a value of approximately .04 g's to be consistent with the vertical ride.

The oscillograph traces shown on Figure 28 give a clear indication of the cause of this mediocre lateral ride. This suspension arrangement showed a hunting tendency, which while not severe was substantial enough to adversely effect lateral ride. Notice that the oscillograph trace of lateral acceleration at the car C.G. shows a steady

2 Hz. disturbance, which is also reflected and amplified in the vertical acceleration at the side of the car. Since the vertical acceleration at the C.G. of the car shows little evidence of this 2 Hz. disturbance, it is concluded that the car body was responding in a roll-type oscillation. Also, in Figure 28, compare the longitudinal accelerometer traces at the C.G. of the car and at the side of the car. The difference of these two shapes indicates that the car oscillated in a yaw-type pattern at 2 Hz., which was slightly out of phase with respect to the lateral acceleration. The sustained, rhythmic undulation of lateral displacement and yawing shown on Figure 28 are indicative of vehicle hunting. This hunting was tolerable on the PRT vehicle, but could become severe at higher speeds. There are several low cost approaches to reducing the hunting tendency. First, wheel tread could be changed from the 1-20 conical tread used on the test vehicle to a cylindrical configuration. Cylindrical tread would not give the wheels an inherent centering tendency which initiates hunting. Second, lateral shock absorbers could be installed. The PRT vehicle had essentially vertical shock absorbers which were canted at  $15^{\circ}$  and were, therefore, ineffective in the lateral direction. The lateral shock absorber would provide damping to prevent amplitude build-up. Third, uncoupling of the roll and lateral oscillations might be achieved by changing the lateral to vertical spring constant ratio. These all represent empirical hardware approaches which could be successful.

- 5.2.3 Curved Track Ride - The ride on curved track did not meet the requirement for lateral or vertical acceleration, but this is not fundamentally a suspension deficiency. The lateral jerk rate was excessive and could indicate a suspension deficiency although it is highly sensitive to irregular rail curvature.

The highest lateral accelerations recorded during the tests occurred on the 30 ft. curve track at 12 mph; Figure 29 shows a typical lateral acceleration at the C.G. of the PRT vehicle. The oscillograph trace indicates that the greatest share of the .32 g's is attributable to the gross low frequency wave form resulting from centrifugal force. This would occur regardless of lateral suspension characteristics. The higher frequency disturbances, which are a function of lateral suspension, occur at amplitudes of  $\pm .03$  g's. The 0.3 g's centrifugal force is quite high compared to a .2 g which is considered the maximum for an emergency limit. To reduce lateral acceleration, the operating speed of vehicle could be reduced, curves could be superelevated or the minimum radius be increased. A compensating body tilt could also be used to reduce lateral motion felt by the passenger.

Also, Figure 29 shows a lateral jerk rate of .28 g/sec. (shaded area) for 12 mph which is beyond the normal tolerance level stated in Figure 27. This occurred as the PRT vehicle traveled through the transition track between the two 30 ft. curves. This value could be improved by having a longer transition section between the two 30 ft. curves, or by the means suggested to reduce lateral acceleration. At 8 mph, the lateral jerk rate was .06 g/sec. which is the limiting value indicated on Figure 27 for normal passenger comfort.

Figure 30 shows the lateral acceleration experienced on the 30 ft. curve track as a function of operation speed; also shown on this figure is the theoretical lateral acceleration resulting from  $v^2/R$  (velocity<sup>2</sup>/Curve Radius). Agreement is good.

The longitudinal acceleration comparison plot of Figure 31 shows that the left side accelerometer had some high frequency output in its trace; this probably signified a "stick-slip" friction interaction between wheel and rail. Each amplitude peak and subsequent decrease could represent the response of the spring supported car body to the force spectrum at the wheel/rail contact which excites the wheel bolsters and lateral dampers (shock absorbers) that transmit this torque to the car body.

### 5.3 Power Requirement

- 5.3.1 General - The power requirements for a wheeled vehicle depend upon acceleration, rolling resistance, propulsion system efficiency and air resistance. Of these, only rolling friction depends upon the wheel/guideway arrangement. The steel wheel/steel rail arrangement has extremely low resistance for pure rolling but since lateral flange contact causes energy loss, it must be investigated. Losses will increase on curves and on tangent track if hunting causes flange contact. Therefore, any technique which reduces flange contact, such as steering, will reduce power loss.

The most important aspect of power requirement is acceleration which does not depend upon the wheel arrangement.

Total power consumption in these tests has little significance because the off-the-shelf propulsion system was very inefficient and had some internal problems causing abnormally large losses. Further, determination of power consumption for given conditions was inexact because of inability of the manual control system to hold constant speed. The most useful power index is that which describes the rolling resistance, and this is best obtained from the unpowered runs. This is not exact rolling resistance power since the hydraulic drive motors on the axle are pumping against

a lubricating pressure and, therefore, is termed coast mode power loss.

Figures 32 and 33 show total power and coast mode power loss as a function of speed for various conditions. To obtain a power value for coast mode loss, the vehicle's kinetic energy change for an unpowered test run was converted to average power. To obtain total power, the electrical energy input is obtained from the electric power measurement, adjusted for kinetic energy change, and converted to average power. While efficiency of the propulsion system is not important for this test vehicle, comparison of the total power with a coast mode power loss indicates efficiency varies over a range of approximately 20 - 50%.

#### 5.3.2 Tangent Track

For tangent track, the coast mode power loss is essentially linear and slightly higher for loaded than empty car. The non-linear rise of total power indicates a decrease in efficiency.

#### 5.3.3 Curved Track

On the tight 30 ft. curve, both coast mode power loss and total power are linear with speed. The empty car values are significantly higher than for the loaded car, which could indicate a different behavior at the wheel/rail interface. Since speeds are restricted by the curvature, comparison of power values can be made only at the speed range overlap at 10 mph. This comparison indicates much more power is required on curves, but at the 5 mph ride comfort limit for this curve, coast mode power loss is only about equal to that at 10 mph on tangent track.

Curve coast mode power loss was of such magnitude that the vehicle could not coast through the curve test zone from starting speeds in the low end of the test speed range. Such adverse effects of curvature can best be controlled by use of steering or larger radius curvature.

## 6. CONCLUSIONS

### 6.1 General

The state-of-the-art PRT test vehicle was successfully demonstrated and did satisfy the criteria for acceleration ( $3.22 \text{ ft/sec}^2$ ), speed (44 ft/sec) and general operation. However, the noise levels were unacceptable on both tangent and curved track. The data obtained provides a satisfactory base line and the original recordings contain full information to be extracted for future needs.

### 6.2 Noise Levels

On tangent track, the dominant noise is a rumble which is related to track irregularities and speed. On curves, the dominant noise is a screech which also is related to speed. The noise levels are 82 to 85 dB(A) for both 30 mph speed on tangent track and 5 mph on the 30 ft. curve track, the latter being the maximum speed compatible with passenger comfort. The normal observer considers the high pitched screech noise to be more objectionable. The 82 to 85 dB(A) noise level range is comparable to that inside a transit motor bus. A desirable and proposed noise level is 57 dB(A), which is comparable to the sound level in a typical business office.

These tests demonstrate that on a practical vehicle, the screech mechanism is erratic and greatly influenced by water, rust, etc., at the wheel/rail contact. The mechanism must be better understood to facilitate noise control.

### 6.3 Sound Recordings

The sound recordings of the 128 tests, a prime objective of the project, make available base line noise data for future analysis and research.

### 6.4 Vehicle Ride Vibration

The acceleration limits for passenger comfort chosen for this study were .08g lateral and .07g vertical.

On tangent track, the ride was good with peak acceleration values of .06g for lateral and .03g for vertical.

On the tight 30 ft. curve track, speed must be restricted to 5 mph to comply with the lateral passenger comfort limit of .08g lateral acceleration. For this condition, the vertical acceleration is .01g. If increased speed and tight curves are necessary, the body must be tilted, either by the track or special suspension system. The lateral jerk rate in the reverse curve transition section was acceptable for speeds up to but not over 8 mph.

## 7. RECOMMENDATIONS

This investigation has provided better definition and separation of the critical problems in steel wheel/steel rail PRT concepts. It has also provided a general understanding of the relationship of the problems and a base line for evaluation. With this background, an orderly program can be established leading to an optimum PRT system.

There is now a recognition of the mechanisms involved in the problems, but in some cases inadequate fundamental understanding of the mechanism currently precludes problem solutions. It has also been demonstrated that the inter-relationship of some problems requires a systems approach to the family of problems. Alternate specific solutions must be developed and trade-off studies made as a guide to efficient development of the optimum system.

The major work areas are as follows:

### a. Screech and rumble

The most objectionable single phenomenon associated with steel wheel/steel rail vehicles is the screech noise, and this mechanism is not fully understood. Rumble also is not fully understood although it is less objectionable in the environment. Study is required to establish the details of both mechanisms to facilitate identification and comparison of solutions. Further effort with laboratory tests will be necessary to delineate the areas of practical design and provide a basis for evaluation.

### b. Ride and safety

Although the ride characteristics were generally good with the simple suspension of this PRT test vehicle, the hunting tendencies discerned compel further investigation. Good lateral ride performance is destroyed by hunting and, in severe cases, safety of operation is impaired. Hunting is highly dependent upon steering and other devices which may be considered for noise control. The hunting phenomena is well known in untracked as well as tracked vehicles, but has been largely ignored in past rail operations because it was not severe. Therefore, much effort is required in this area.

An additional safety related consideration is curve negotiation. Investigation must be made of the influence of noise control methods and means to increase curve speed, curve stability and ride quality, particularly lateral ride.

### c. Criteria

When alternate solutions for the problems are available, they must be evaluated against the system criteria in a trade-off study. Thus, the reference criteria for noise, ride, vibration,

vehicle operational performance, track curvature, curve speed, etc., must be established in a thorough analysis of representative PRT systems.

d. Evaluation techniques

Specific comparative rating techniques must be used in the trade-off studies. Background information, including cost data, must be collected and included in the evaluation equation. This technique must consider all the inter-related aspects of the system in evaluating separate elements, and provide comparative overall evaluations. On this basis, several arrangements can be selected for further consideration.

e. System demonstration

After the preceding work has been completed, system components can be assembled for refinement by test; and finally, the capabilities of a steel wheel/steel rail PRT system will be demonstrated.



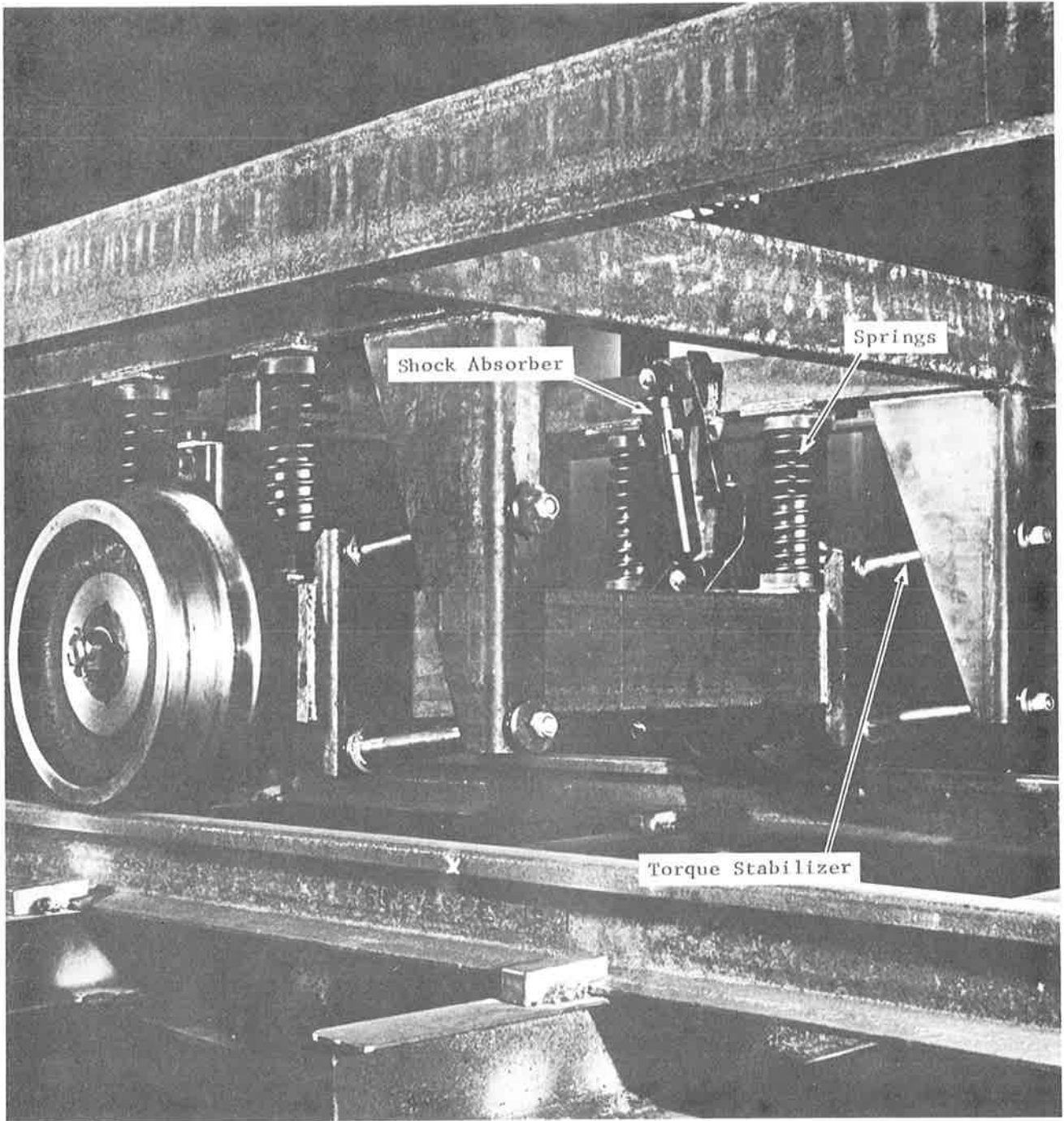

Vehicle Suspension System

Figure 1

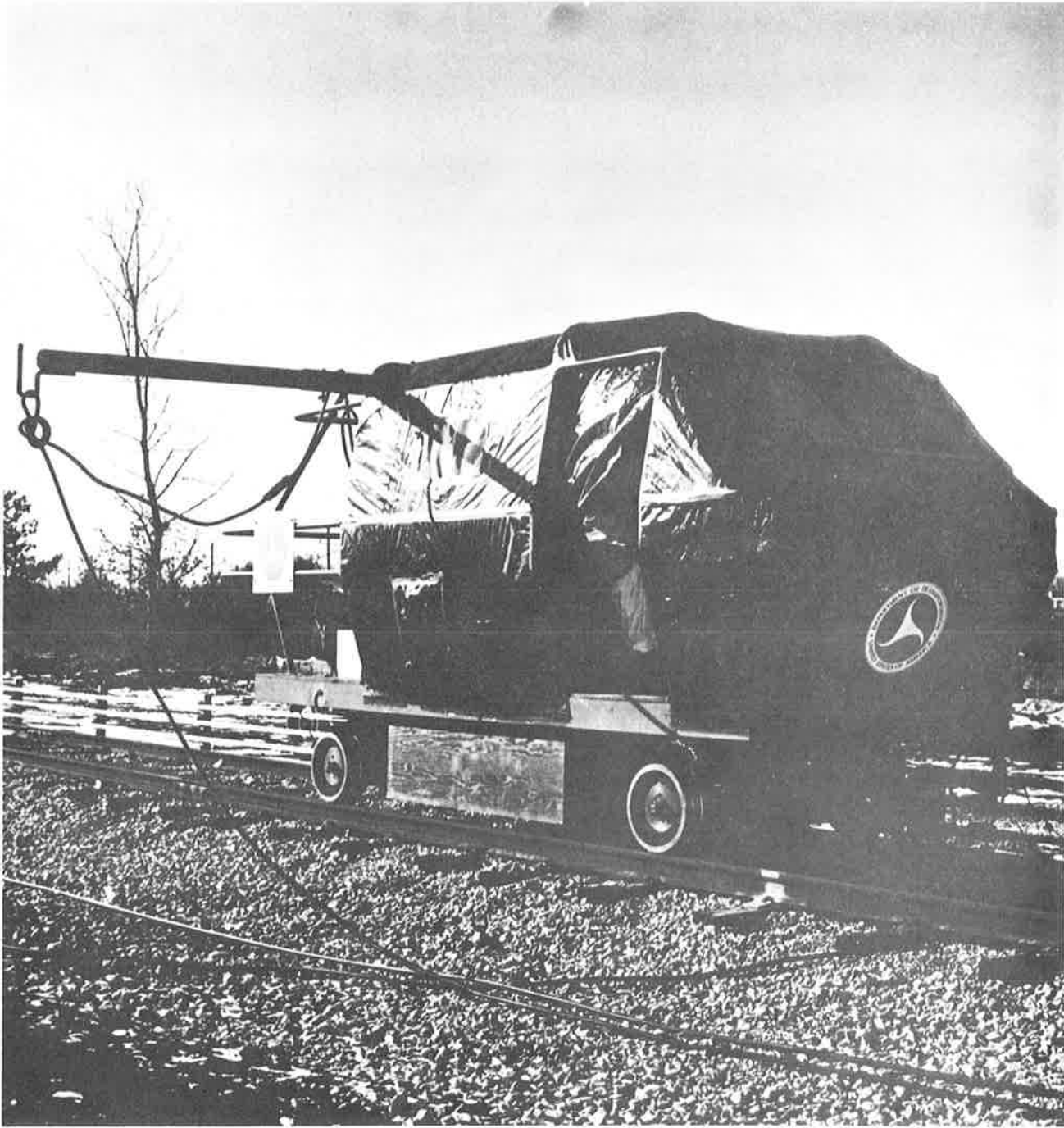

Umbilical Cord Arrangement for Power Off Mode Tests

Figure 2



Expansion Joint - Power Rail

Figure 3

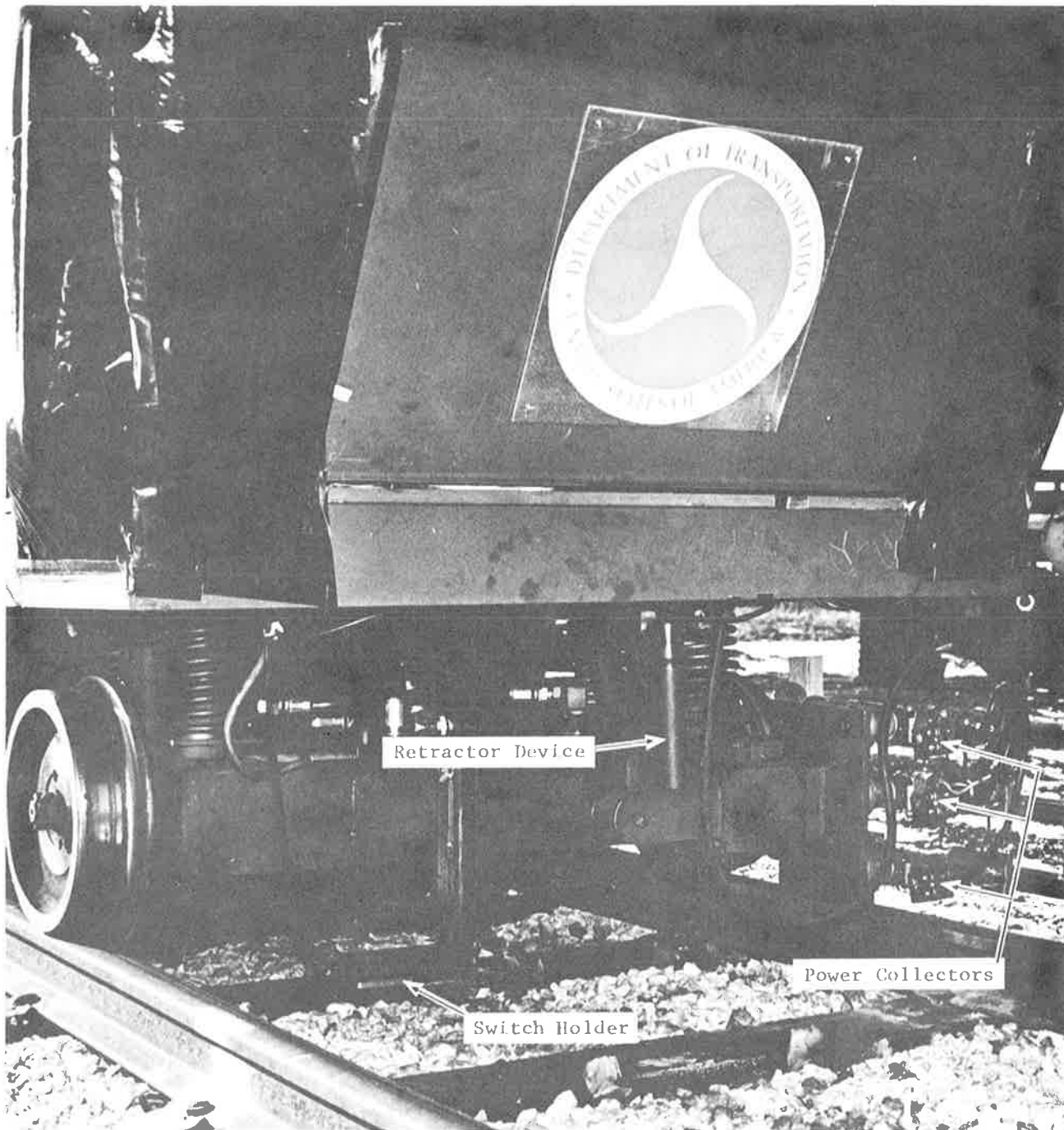

Vehicle's Power Collector and Magnetic Switch Holder

Figure 4

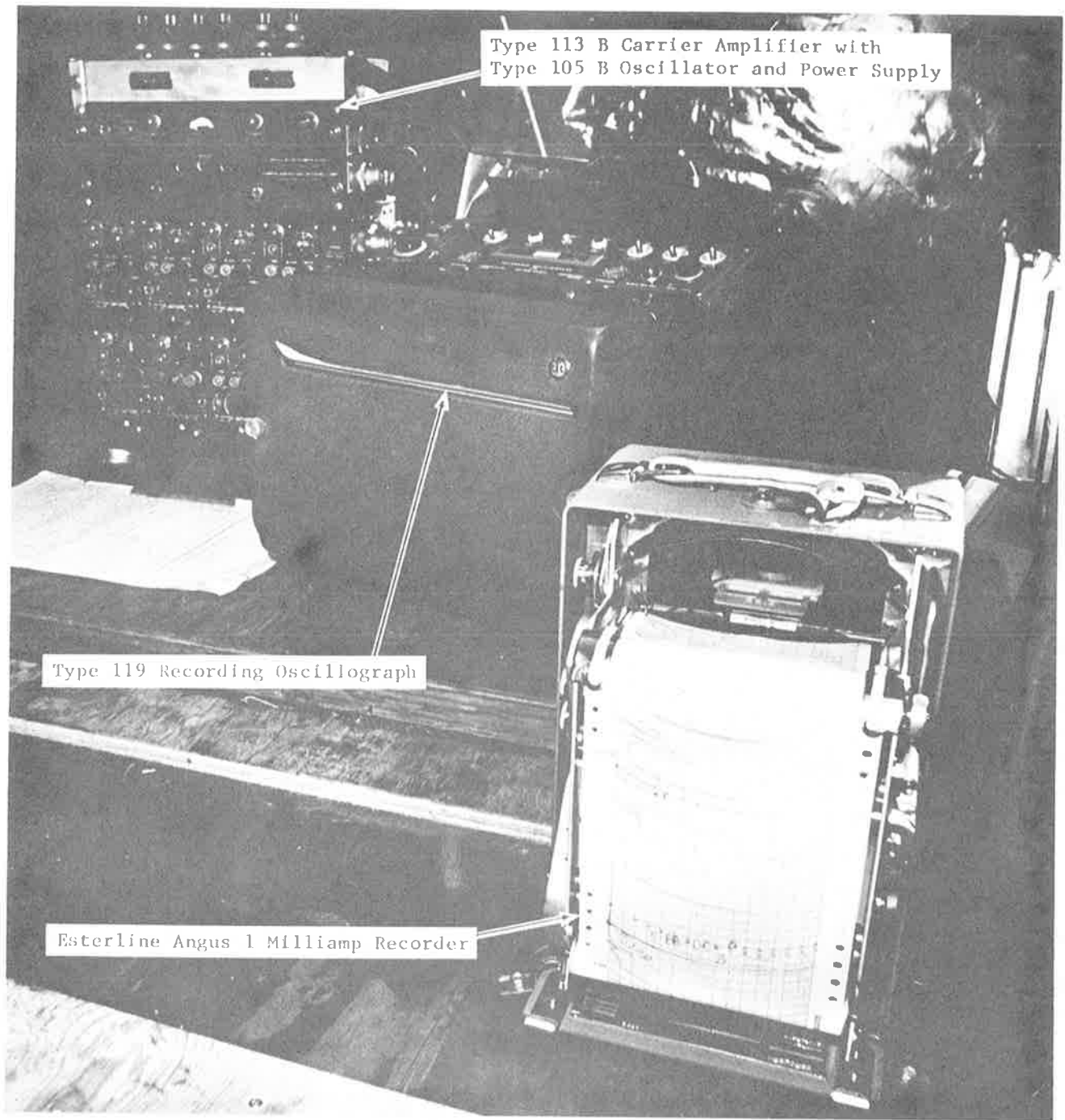

Instrumentation on Test Vehicle

Figure 5

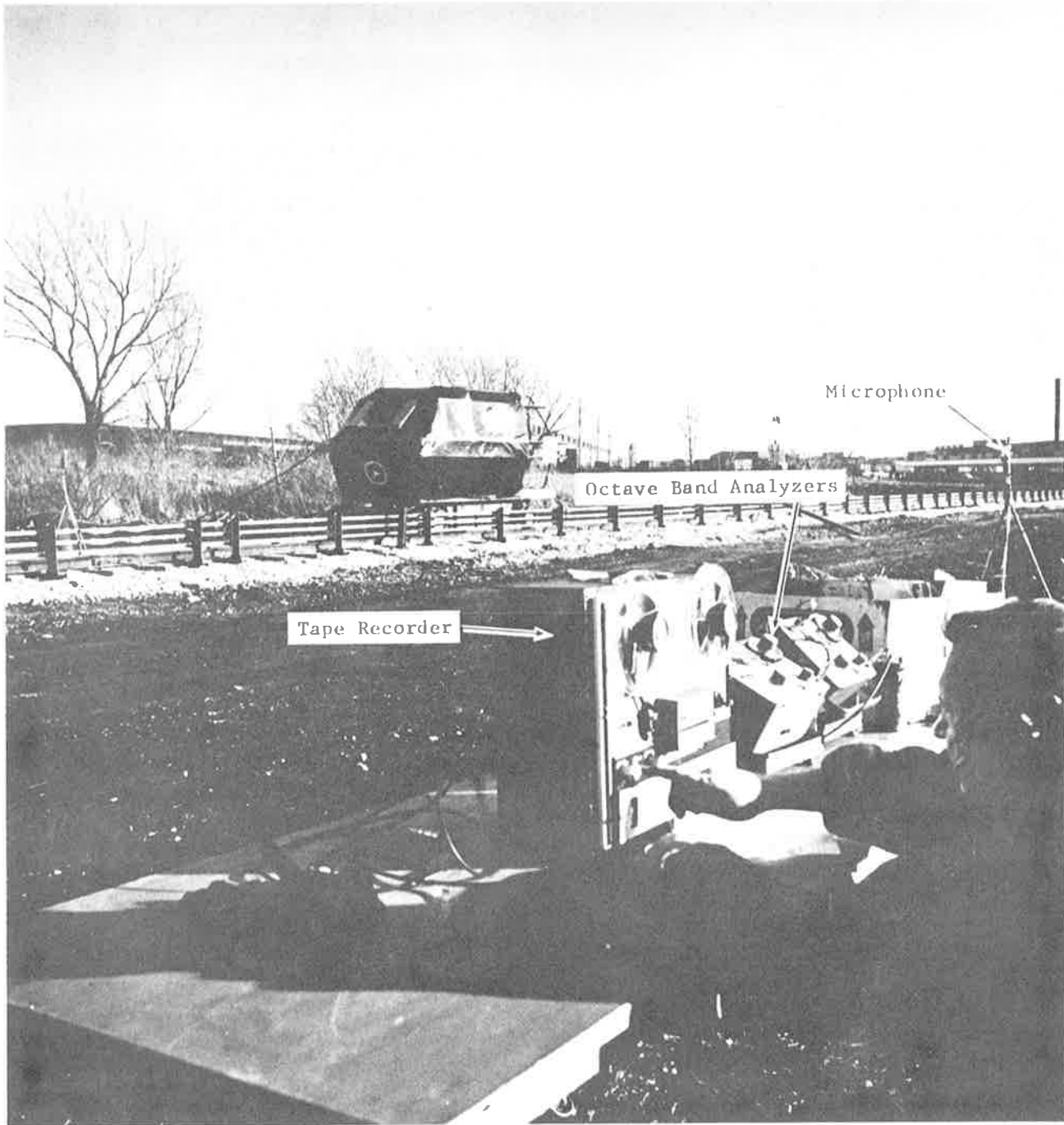

Instrumentation at Test Track

Figure 6

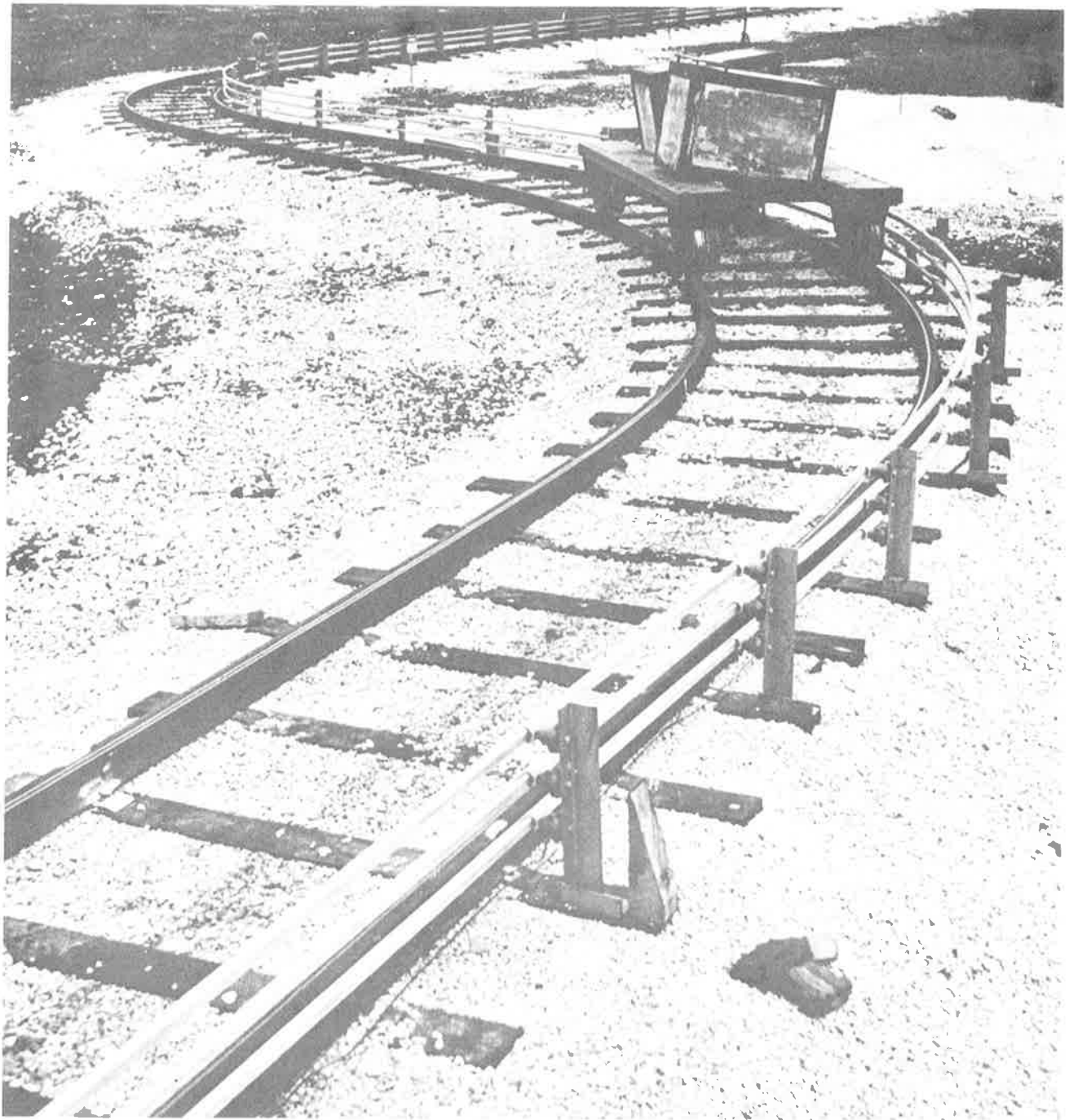

Dual Treaded Vehicle

Figure 7



Vehicle in Jacked Position

Figure 8



Run Number	Nominal Speed (mph)	Measured Speed (mph)	Max. Sound Level - dB(A)		Max. Accelerations At CG of Vehicle - g's		
			East Microphone	West Microphone	Long.	Lateral	Vertical
Unloaded Power On							
1	5	5.2	63	61	.000	.000	.000
2	10	9.4	73	62	.000	.000	.000
3	15	14.7	77	79	.000	.000	.000
111	20	19.0	75	79	.000	.006	.000
110	25	23.4	77	80	.036	.027	.003
109	30	29.4	78	83	.078	.042	.012
Unloaded Power Off							
101	5	5.5	NR	NR	.000	.000	.000
100	10	9.2	63	65	.000	.000	.000
99	15	11.9	73	75	.012	.012	.000
130	20	17.5	72	76	.015	.021	.000
131	25	23.4	77	77	.015	.025	.000
132	30	27.6	79	82	.020	.030	.000
Loaded Power On							
1L	5	4.9	63	NR	.000	.009	.000
2L	10	9.9	72	NR	.006	.015	.000
3L	15	15.4	76	NR	.012	.018	.000
114	20	20.5	82	81	.015	.021	.000
113	25	24.4	82	80	.021	.033	.000
112	30	28.9	84	70	.057	.036	.003
Loaded Power Off							
92	5	4.2	61	NR	.000	.000	.000
91	10	9.9	69	69	.006	.000	.000
90	15	13.8	74	74	.000	.012	.000
127	20	19.6	79	78	.015	.015	.003
128	25	25.2	81	81	.015	.033	.003
129	30	25.4	86	85	.015	.027	.003

Sound and Acceleration Test Data - Zone 1

Figure 9

Run Number	Nominal Speed (mph)	Measured Speed (mph)	Max. Sound Level - dB(A)		Max. Accelerations At CG of Vehicle - g's		
			East Microphone	West Microphone	Long-	Lateral	Vertical
Unloaded Power On							
1	5	4.9	66	63	.000	.000	.000
2	10	9.9	74	73	.000	.000	.000
3	15	14.5	79	83	.000	.000	.000
120	20	18.9	76	80	.000	.012	.000
119	25	23.5	77	79	.003	.015	.003
118	30	28.1	79	82	.015	.021	.004
Unloaded Power Off							
98	5	5.2	70	67	.007	.000	.000
97	10	10.3	68	65	.013	.007	.000
96	15	14.7	73	69	.013	.016	.000
121	20	17.8	75	80	.018	.018	.000
122	25	23.5	77	83	.018	.024	.003
123	30	28.2	78	83	.024	.028	.004
Loaded Power On							
1L	5	6.0	61	NR	.000	.000	.000
2L	10	10.8	72	NR	.006	.000	.000
3L	15	13.8	83	NR	.000	.011	.000
117	20	18.5	77	66	.007	.015	.000
116	25	22.4	78	72	.013	.013	.000
115	30	31.0	79	81	.023	.018	.007
Loaded Power Off							
95	5	5.2	65	61	.007	.006	.000
94	10	10.6	77	73	.012	.016	.000
93	15	13.6	82	78	.011	.004	.000
124	20	19.3	75	80	.018	.009	.009
125	25	23.7	77	82	.018	.036	.009
126	30	28.9	80	84	.027	.045	.000

Sound and Acceleration Test Data - Zone 2

Figure 10

Run Number	Nominal Speed (mph)	Measured Speed (mph)	Max. Sound Level - dB(A)		Max. Accelerations At CG of Vehicle - g's		
			East Microphone	West Microphone	Long.	Lateral	Vertical
Unloaded Power On							
37	2	3.0	67	67	.000	.000	.000
2	4	3.5	73	72	.000	.003	.000
4	6	6.0	67	71	.033	.090	.000
40	8	7.9	73	78	.027	.150	.000
41	10	9.9	82	88	.045	.225	.000
42	12	11.8	83	89	.000	.318	.000
Unloaded Power Off							
55	2	2.4	56	55	.000	.000	.000
56	4	2.8	64	65	.000	.000	.000
57	6	5.0	82	71	.048	.036	.000
58	8	6.9	86	86	.048	.087	.000
59	10	8.4	90	92	.051	.198	.000
60	12	10.5	86	86	.057	.261	.000
Loaded Power On							
43	2	2.4	63	69	.000	.000	.000
44	4	4.3	65	69	.003	.060	.000
45	6	6.1	69	66	.007	.105	.000
46	8	8.2	68	69	.012	.200	.000
47	10	9.7	75	NR	.024	.255	.000
48	12	11.6	80	79	.015	.345	.000
Loaded Power Off							
49	2	2.2	74	73	.000	.000	.000
50	4	2.3	76	78	.000	.000	.000
51	6	4.8	66	73	.015	.060	.000
52	8	7.0	70	78	.018	.120	.000
53	10	9.8	68	73	.027	.246	.015
54	12	11.8	74	82	.021	.375	.000

Sound and Acceleration Test Data - Zone 3

Figure 11

Run Number	Nominal Speed (mph)	Measured Speed (mph)	Max. Sound Level - dB(A)		Max. Accelerations At CG of Vehicle - g's		
			East Microphone	West Microphone	Long.	Lateral	Vertical
Unloaded Power On							
79	2	2.7	84	77	.015	.006	.000
80	4	3.2	84	74	.027	.063	.000
24	6	6.5	NR	NR	.024	.120	.000
25	8	9.0	NR	NR	.030	.150	.000
26	10	8.9	NR	NR	.030	.210	.000
135	12	10.2	NR	78	.036	.270	.000
Unloaded Power Off							
61	2	1.8	NR	NR	NR	NR	NR
62	4	5.2	89	80	.036	.120	.000
63	6	6.5	87	82	.060	.180	.000
64	8	8.4	89	NR	.057	.255	.000
65	10	10.1	82	NR	.057	.330	.018
66	12	10.9	82	87	.057	.393	.015
Loaded Power On							
73	2	3.6	80	78	.045	.015	.000
74	4	3.4	76	78	.015	.030	.000
75	6	4.6	72	76	.060	.078	.000
76	8	6.1	82	82	.060	.153	.000
77	10	8.1	79	81	.033	.210	.000
78	12	10.9	82	78	.060	.375	.015
Loaded Power Off							
67	2	5.5	80	78	.057	.030	.000
68	4	3.8	78	79	.060	.096	.000
69	6	6.6	83	85	.075	.180	.000
70	8	10.5	83	85	.072	.375	.030
71	10	10.4	82	82	.075	.390	.000
72	12	11.5	84	83	.084	.414	.030

Sound and Acceleration Test Data - Zone 4

Figure 12

Run Number	Nominal Speed (mph)	Measured Speed (mph)	Max. Sound Level - dB(A)		Max. Accelerations At CG of Vehicle - g's		
			East Microphone	West Microphone	Long.	Lateral	Vertical
Unloaded Power On							
136	2	3.2	65	71	.004	.016	.000
28	4	8.5	71	69	.013	.057	.000
29	6	6.5	86	90	.027	.117	.000
30	8	6.9	90	86	.030	.145	.007
31	10	8.2	90	86	.069	.183	.018
Unloaded Power Off							
81	2	7.2	69	71	NR	NR	NR
82	4	4.0	NR	NR	NR	NR	NR
83	6	6.5	70	64	.033	.101	.000
84	8	9.2	70	66	.051	.195	.000
85	10	7.7	67	71	.051	.212	.000
Loaded Power On							
32	2	2.6	60	NR	.006	.024	.000
33	4	4.5	73	68	.030	.051	.000
34	6	6.1	78	74	.029	.102	.000
35	8	7.2	80	74	.030	.146	.008
36	10	9.2	77	76	.075	.239	.023
Loaded Power Off							
86	2	8.7	64	68	.024	.216	.009
87	4	6.4	69	69	NR	NR	NR
85	NR	NR	NR	NR	NR	NR	NR
88	8	9.9	64	70	.051	.303	.016
89	10	9.1	76	82	.062	.273	.034

Sound and Acceleration Test Data - Zone 5

Figure 13

Test Zone	Run Number	Nominal Speed - mph	Max. Sound Level - dB(A)	
			East Microphone	West Microphone
1	139	5	60	63
1	140	10	69	71
1	141	15	72	77
2	137	5	59	62
2	138	10	71	74
3	133	5	66	73
3	134	10	75	80

Wayside Sound Level  
for Dual-Treaded Vehicle

Figure 14

Test Zone	Run Number	Nominal Speed - mph	Max. Sound Level - dB(A)	
			East Microphone	West Microphone
1	102	5	54	55
1	103	10	55	56
1	105	15	58	59
1	104	20	62	60
1	106	25	59	59
1	107	30	61	63

Wayside Sound Level for Vehicle  
in Jacked Position

Figure 15

Longitudinal  
Acceleration at  
C.G. of Vehicle  
g's

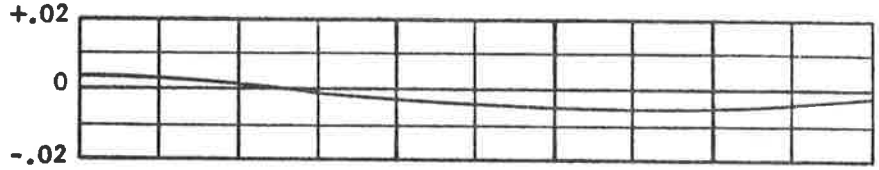

Lateral  
Acceleration at  
C.G. of Vehicle  
g's

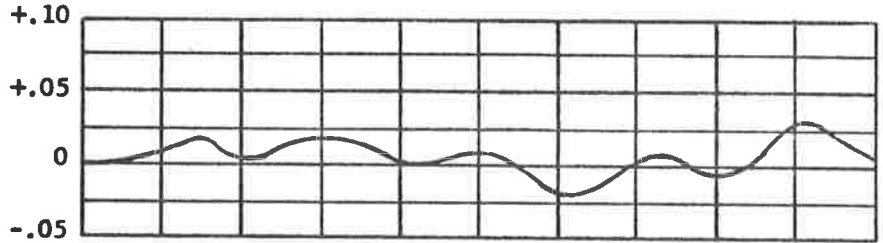

Vertical  
Acceleration at  
C.G. of Vehicle  
g's

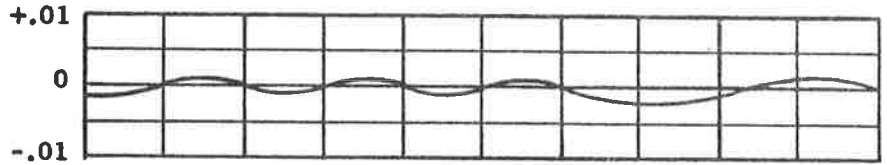

Sound Level - dB(A)  
re  $(2 \times 10^{-5} \text{ N/m}^2)$

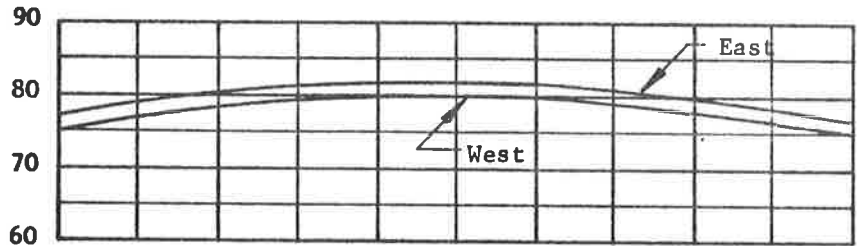

Speed - mph

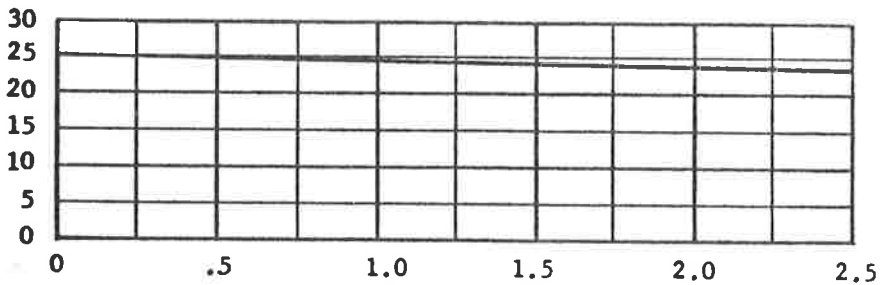

Time Seconds

Zone 1

25 mph

Loaded

Power On

Typical Broad Band Analysis  
Tangent Track - Loaded - Power On - Test Run No. 113

Figure 16

Longitudinal  
Acceleration at  
C.G. of Vehicle  
g's

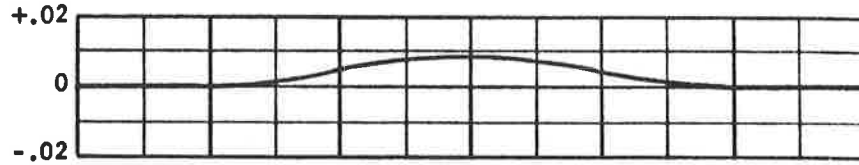

Lateral  
Acceleration at  
C.G. of Vehicle  
g's

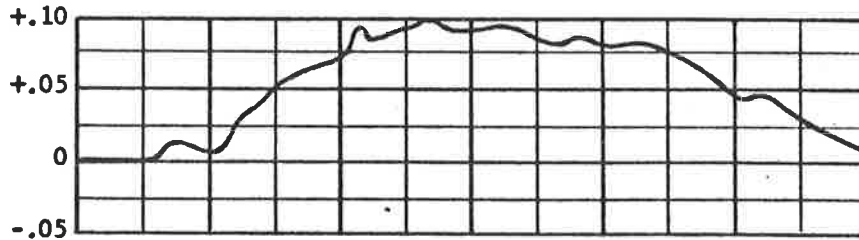

Vertical  
Acceleration at  
C.G. of Vehicle  
g's

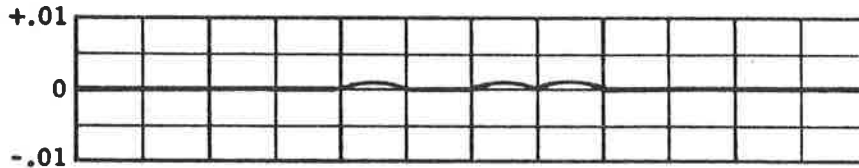

Sound Level - dB(A)  
re  $(2 \times 10^{-5} \text{ N/m}^2)$

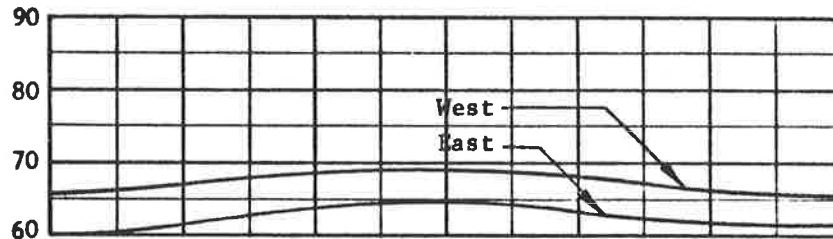

Speed - mph

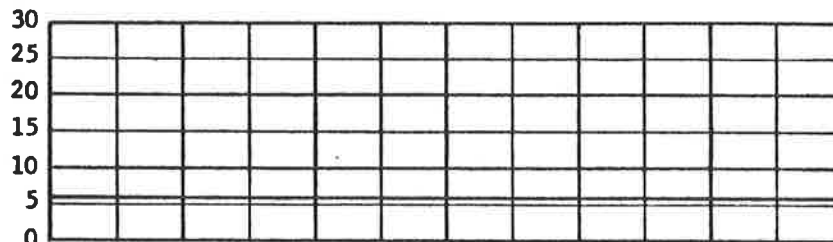

0 1 2 3 4 5 6

Time Seconds

Zone 3

6 mph

Loaded

Power On

Typical Broad Band Analysis  
Curved Track - Loaded - Power On - Test Run No. 45

Figure 17



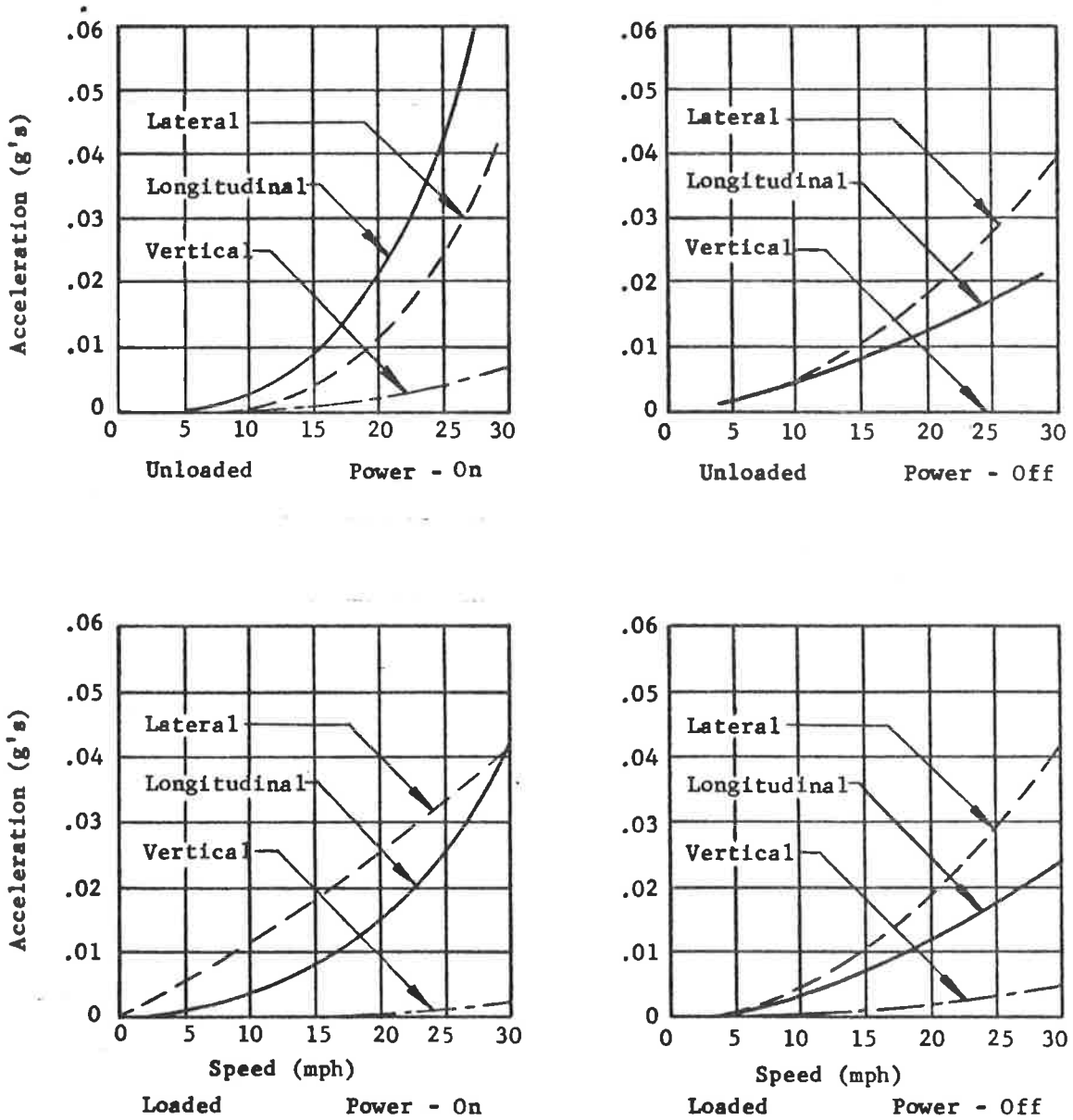

Maximum Accelerations at CG of Vehicle  
For Various Test Conditions - Zone 1

Figure 18

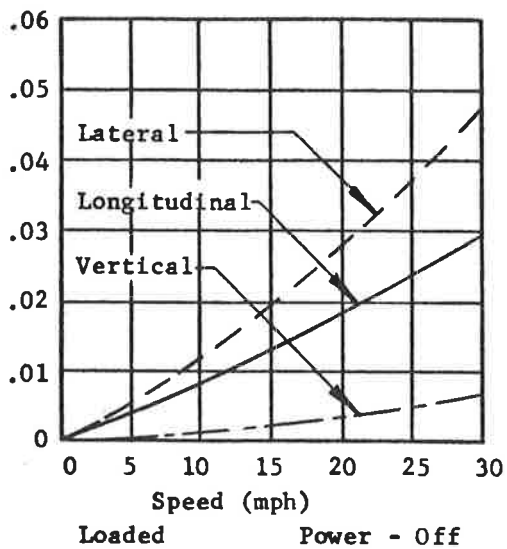
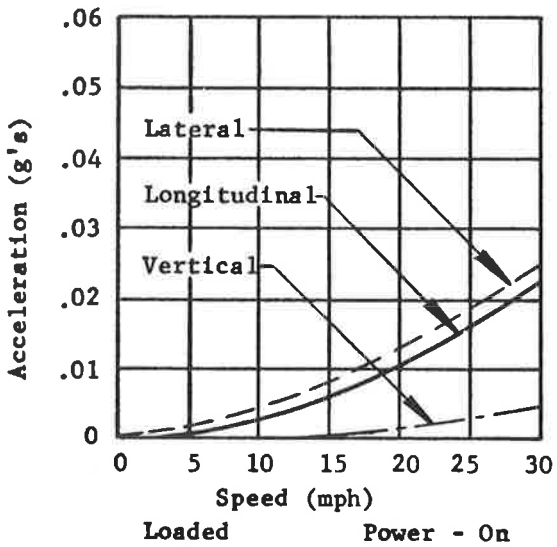
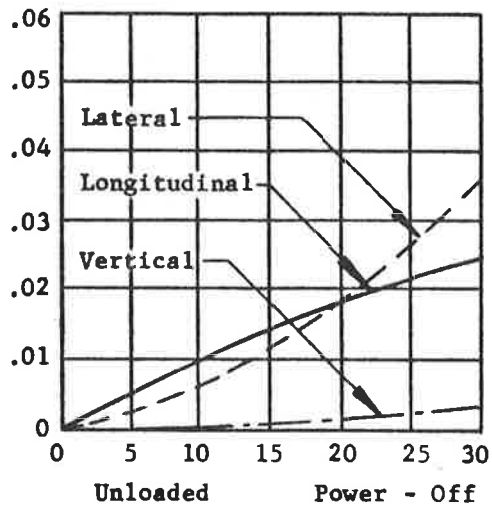
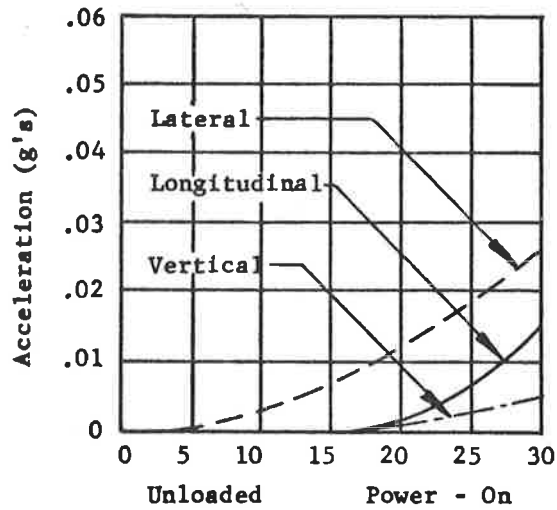

Maximum Accelerations at CG of Vehicle  
For Various Test Conditions - Zone 2

Figure 19

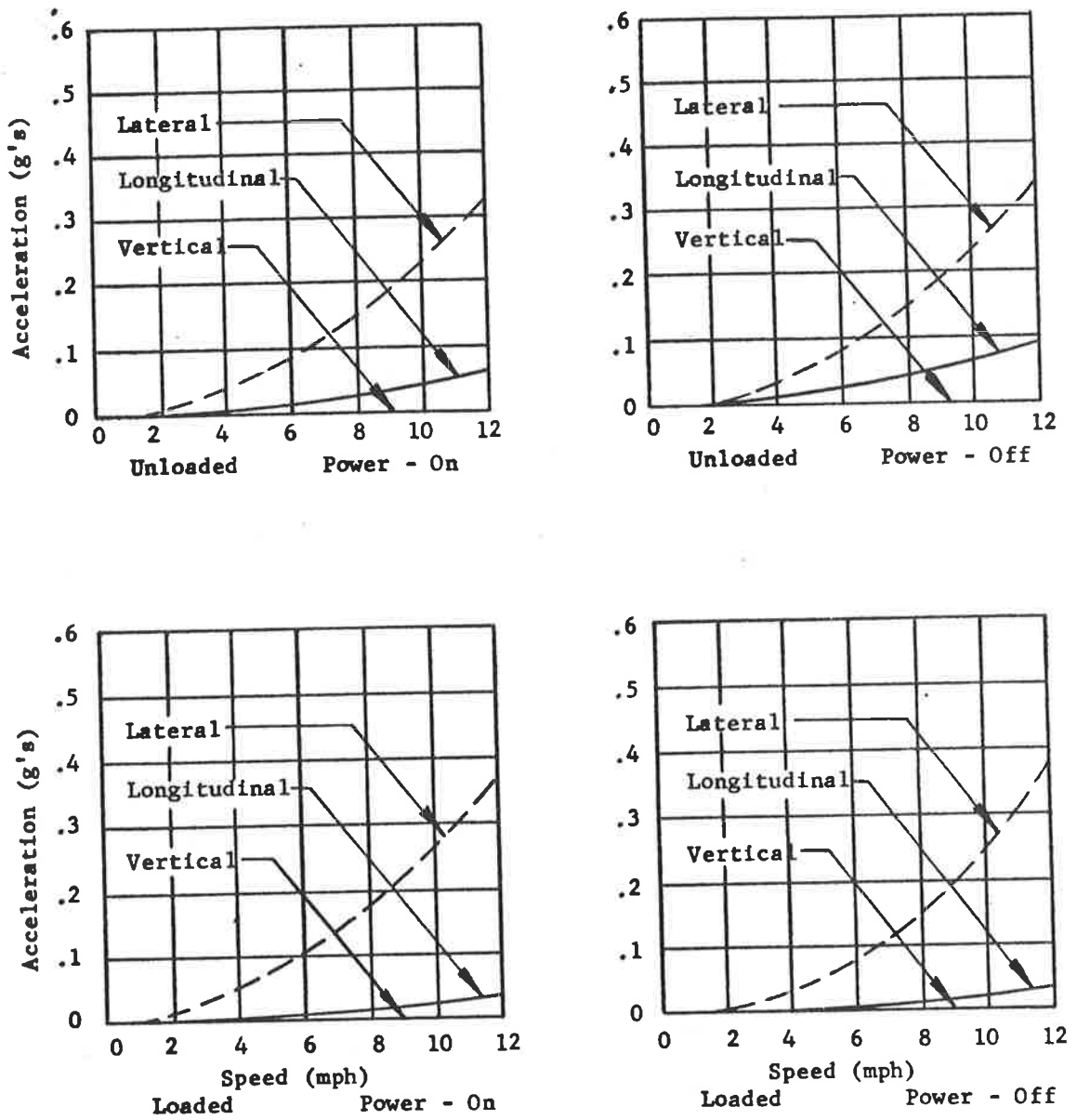

Maximum Accelerations at CG of Vehicle  
For Various Test Conditions - Zone 3

Figure 20

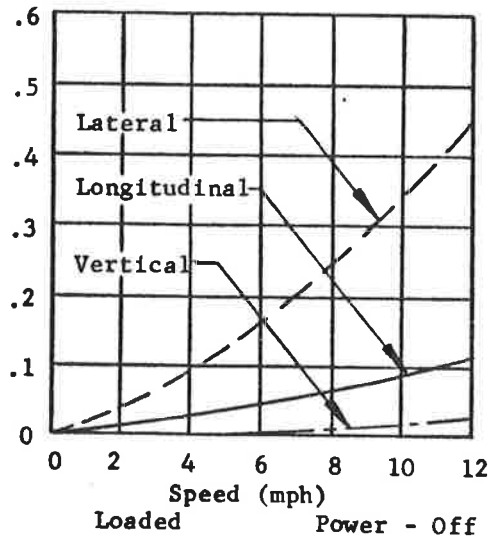
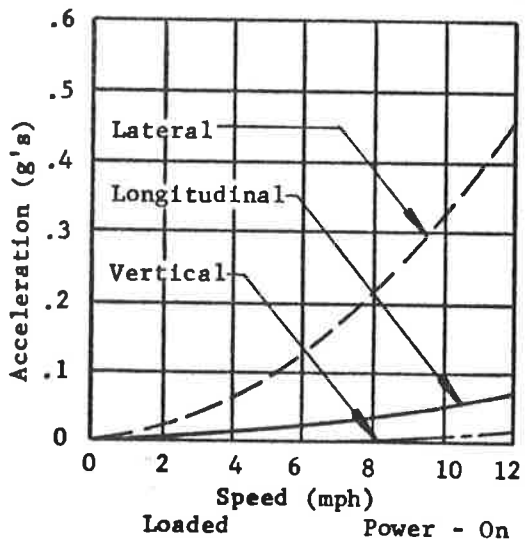
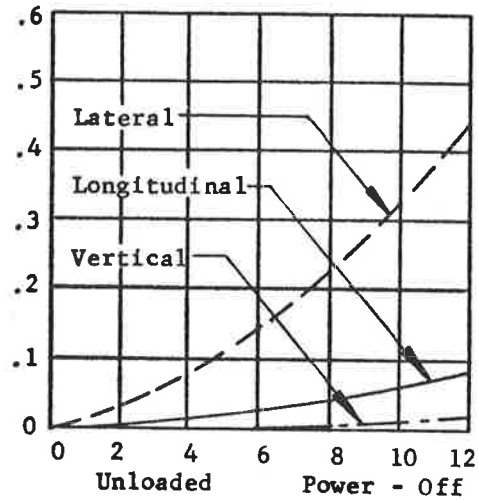
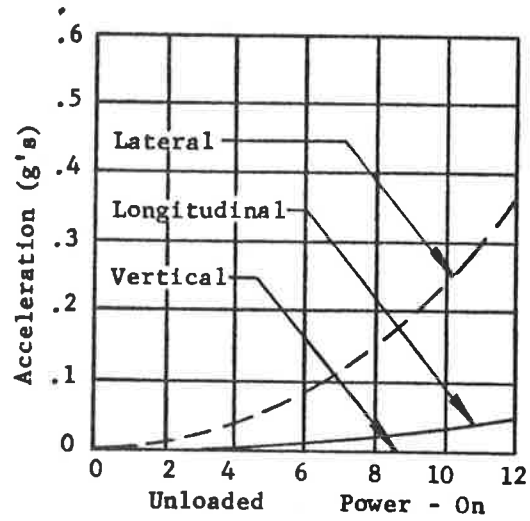

Maximum Accelerations at CG of Vehicle  
For Various Test Conditions - Zone 4

Figure 21

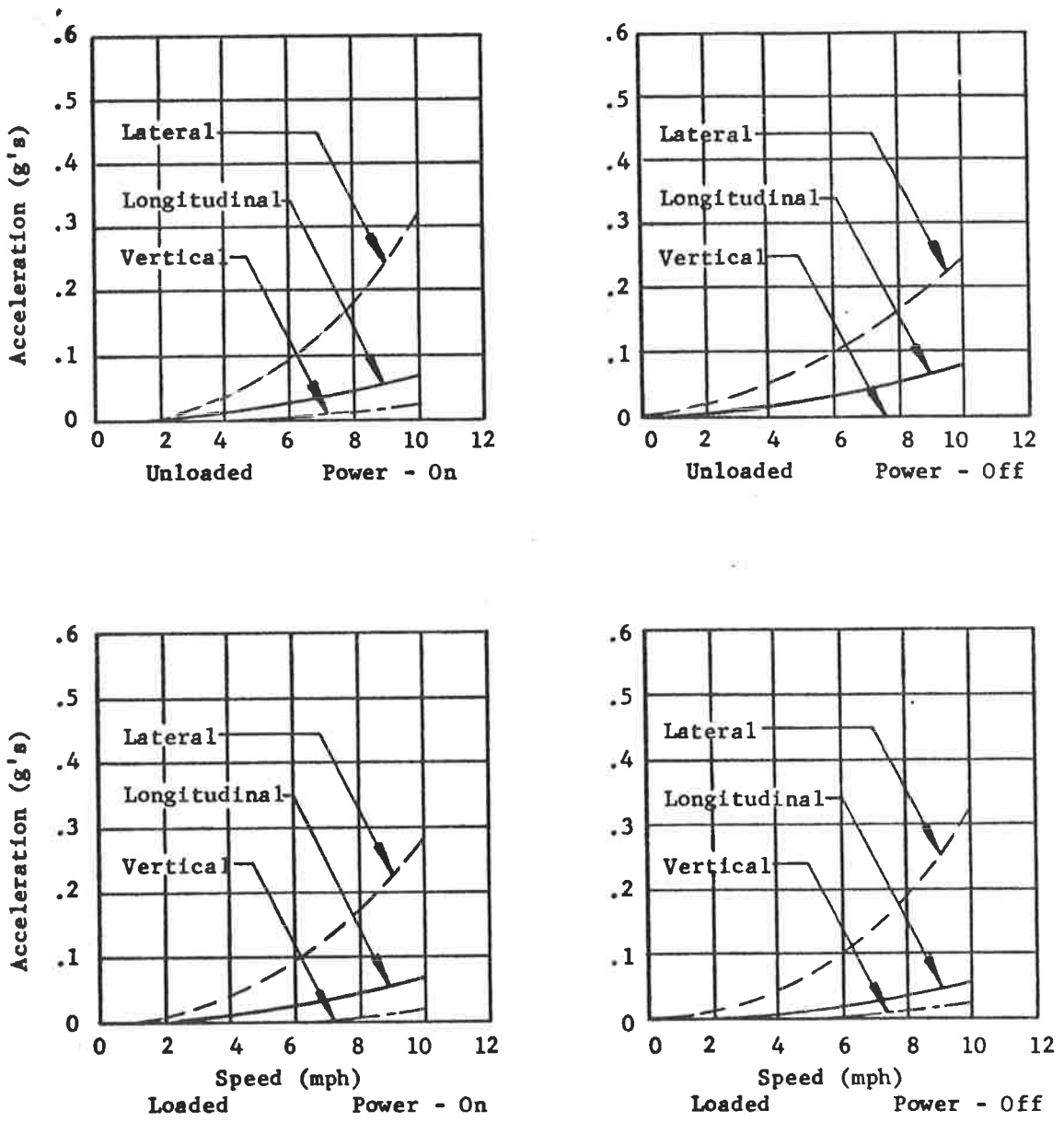

Maximum Accelerations at CG of Vehicle  
For Various Test Conditions - Zone 5

Figure 22

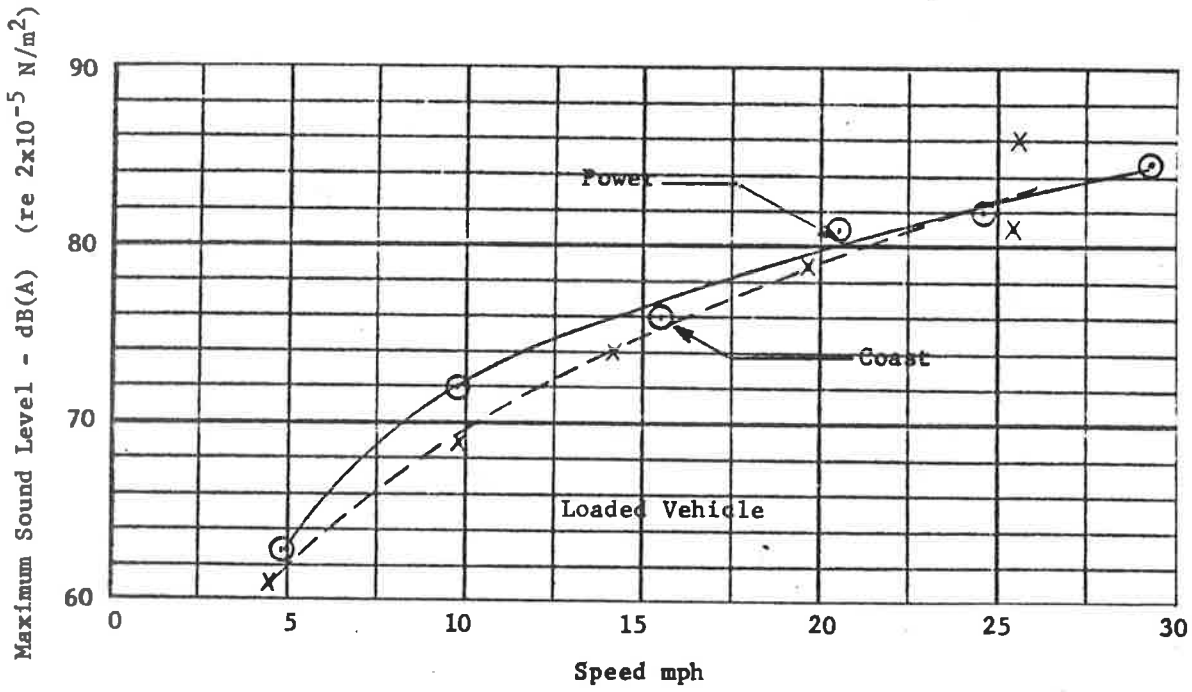

Sound Level for Power vs. Coasting - Loaded Vehicle - Zone 1

Figure 23

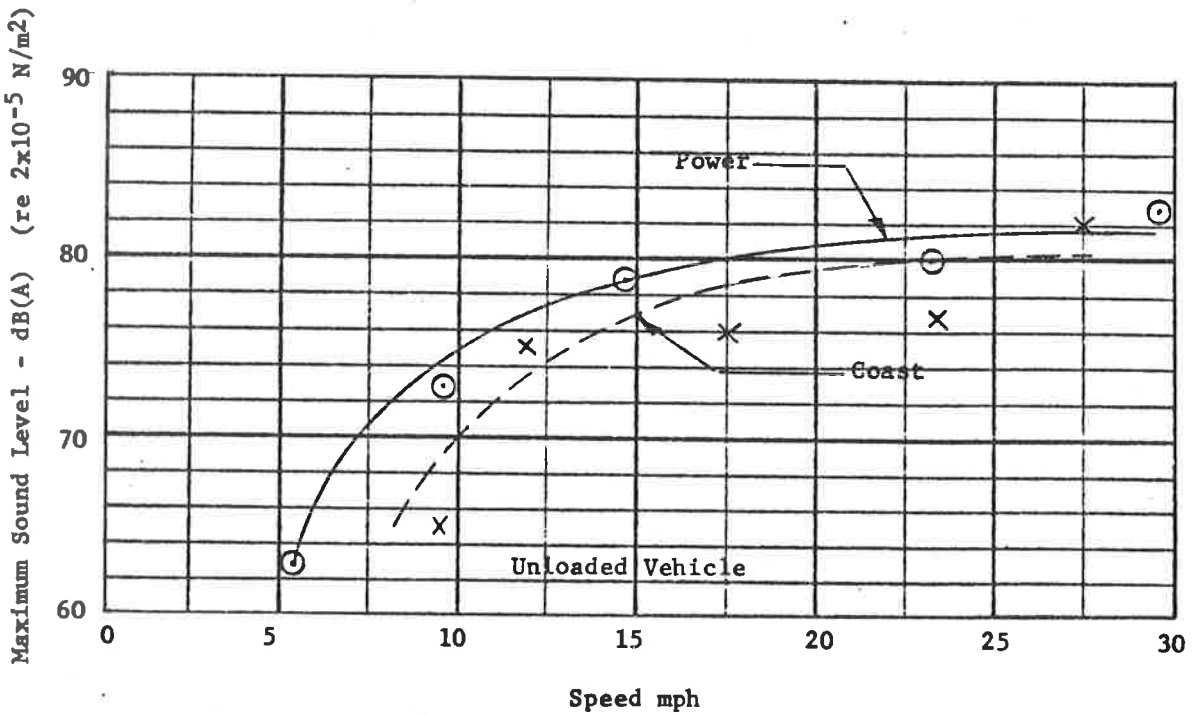

Sound Level for Power vs. Coasting - Unloaded Vehicle - Zone 1

Figure 24

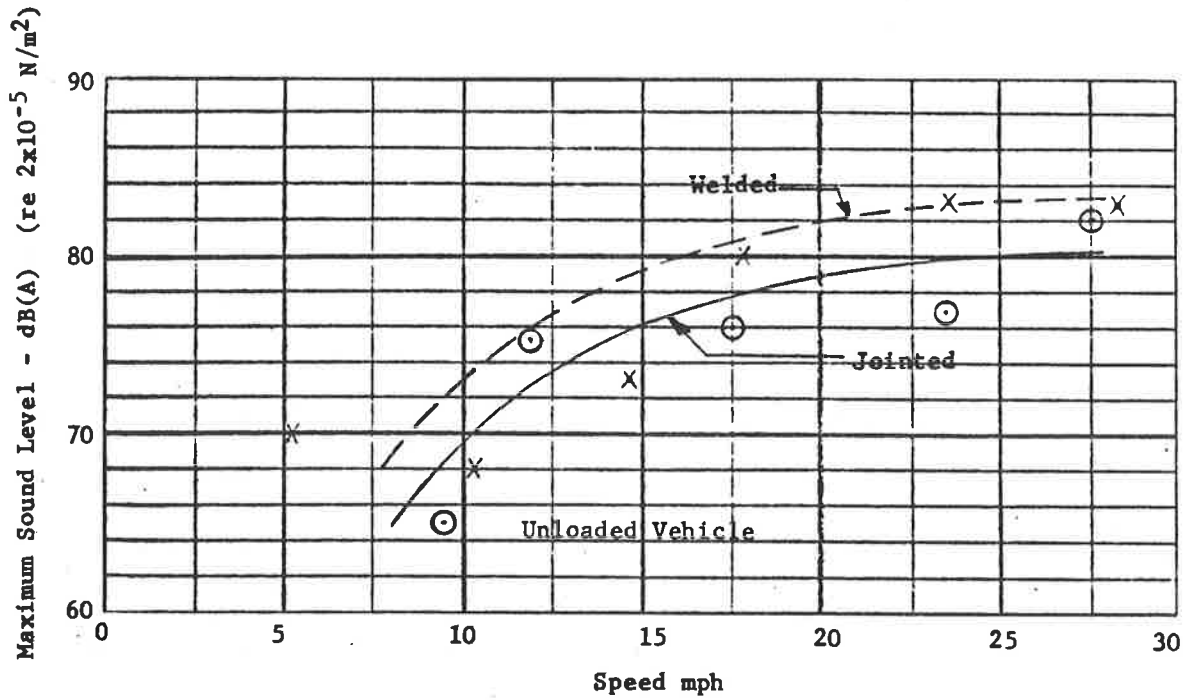

Sound Level for Welded vs. Jointed Rail - Unloaded Vehicle Coasting

Figure 25

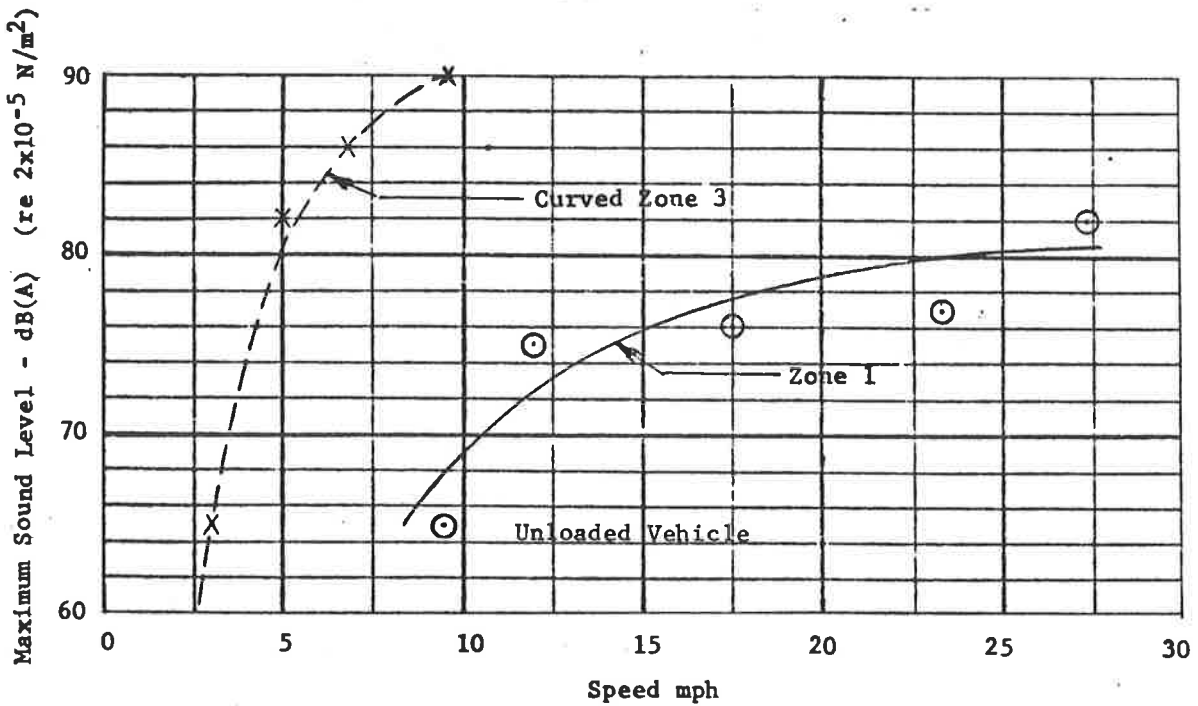

Sound Level for Tangent vs. 30 ft. Curve Track - Unloaded Vehicle Coasting

Figure 26

	<u>Normal</u>	<u>Emergency</u>
Backward longitudinal acceleration, g	0.07	0.30
Forward longitudinal acceleration, g	0.09	0.35
Lateral acceleration, g	0.08	0.20
Vertical acceleration, g	1.0 ± 0.07	1.0 ± 0.15
Backward longitudinal jerk, g/sec.	0.06	0.60
Forward longitudinal jerk, g/sec.	0.06	0.50
Lateral jerk, g/sec.	0.06	0.50
Vertical jerk, g/sec.	0.04	0.20

Human Tolerance to Acceleration<sup>(4)</sup>

Figure 27

<sup>(4)</sup> "Mass Transportation Report", Product Engineering, Morgan-Grampian, Inc., December, 1971, Pages 26-29.



Test Conditions: Loaded Power On

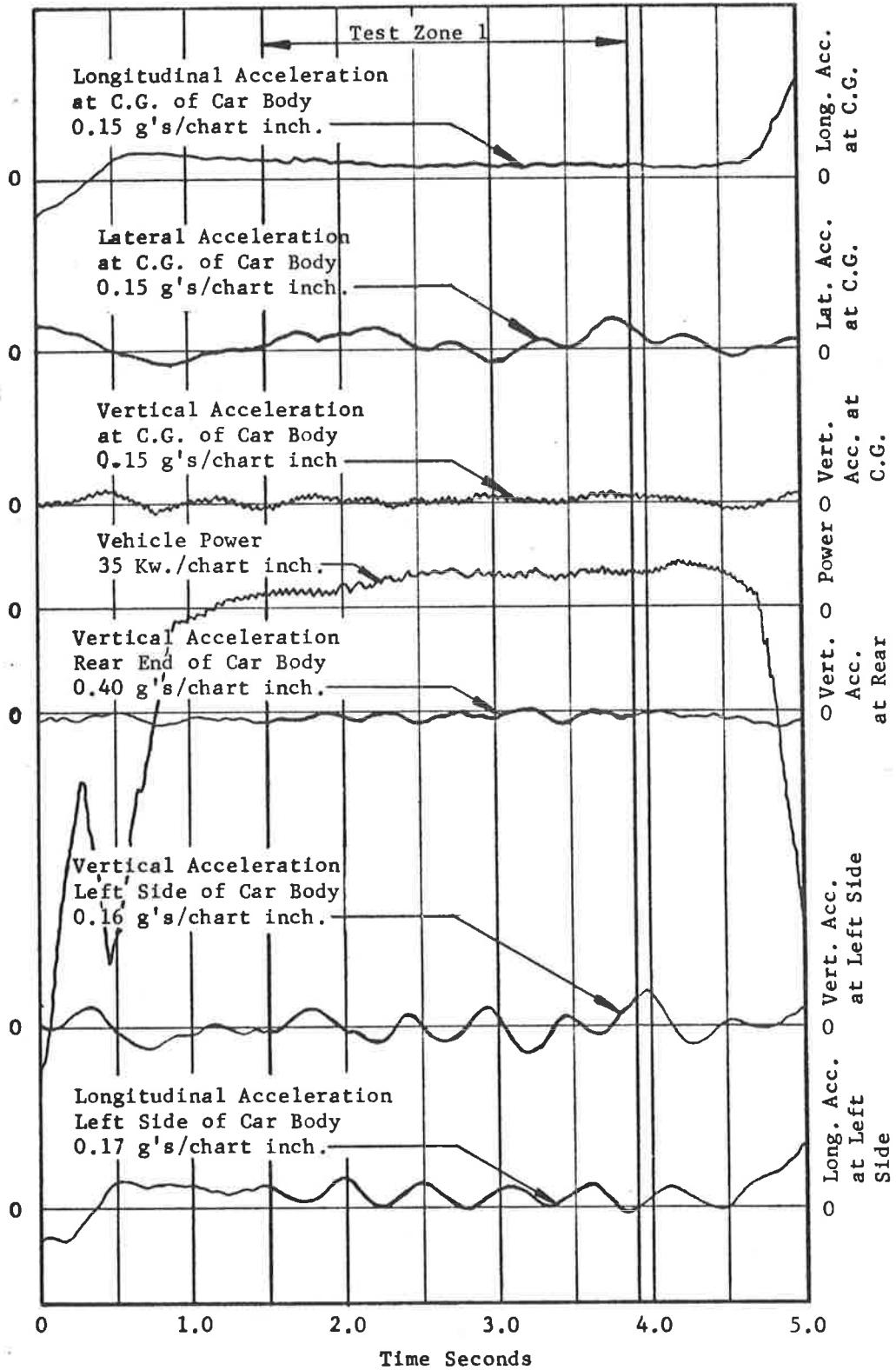

Typical oscillograph traces taken at 25 mph - Zone 1

Figure 28

Test Conditions: Unloaded - Power On

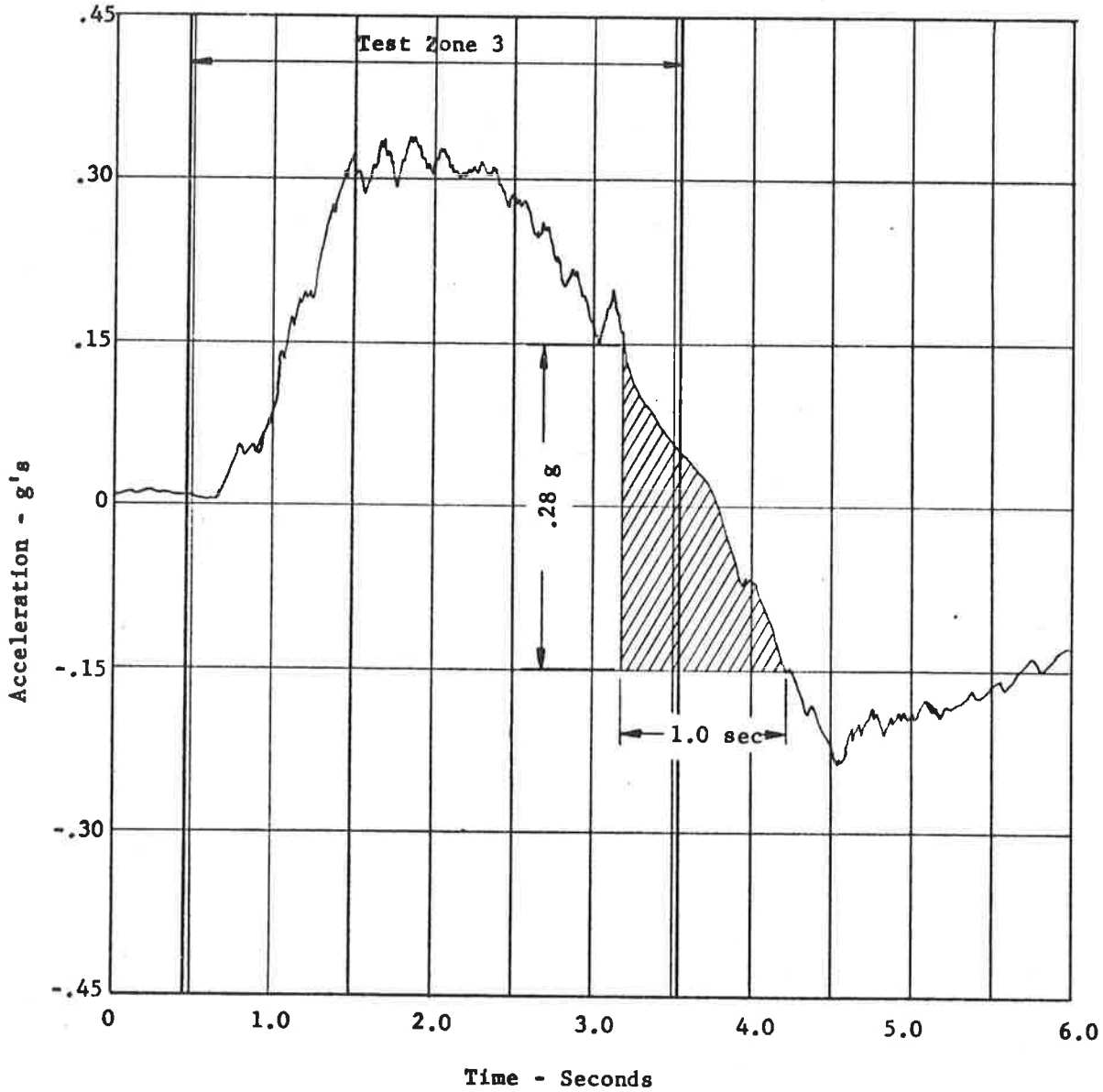

Lateral acceleration at C.G. of vehicle while negotiating a 30 ft. curve at 12 mph, Run No. 42

Figure 29

Test Conditions: Unloaded - Power On

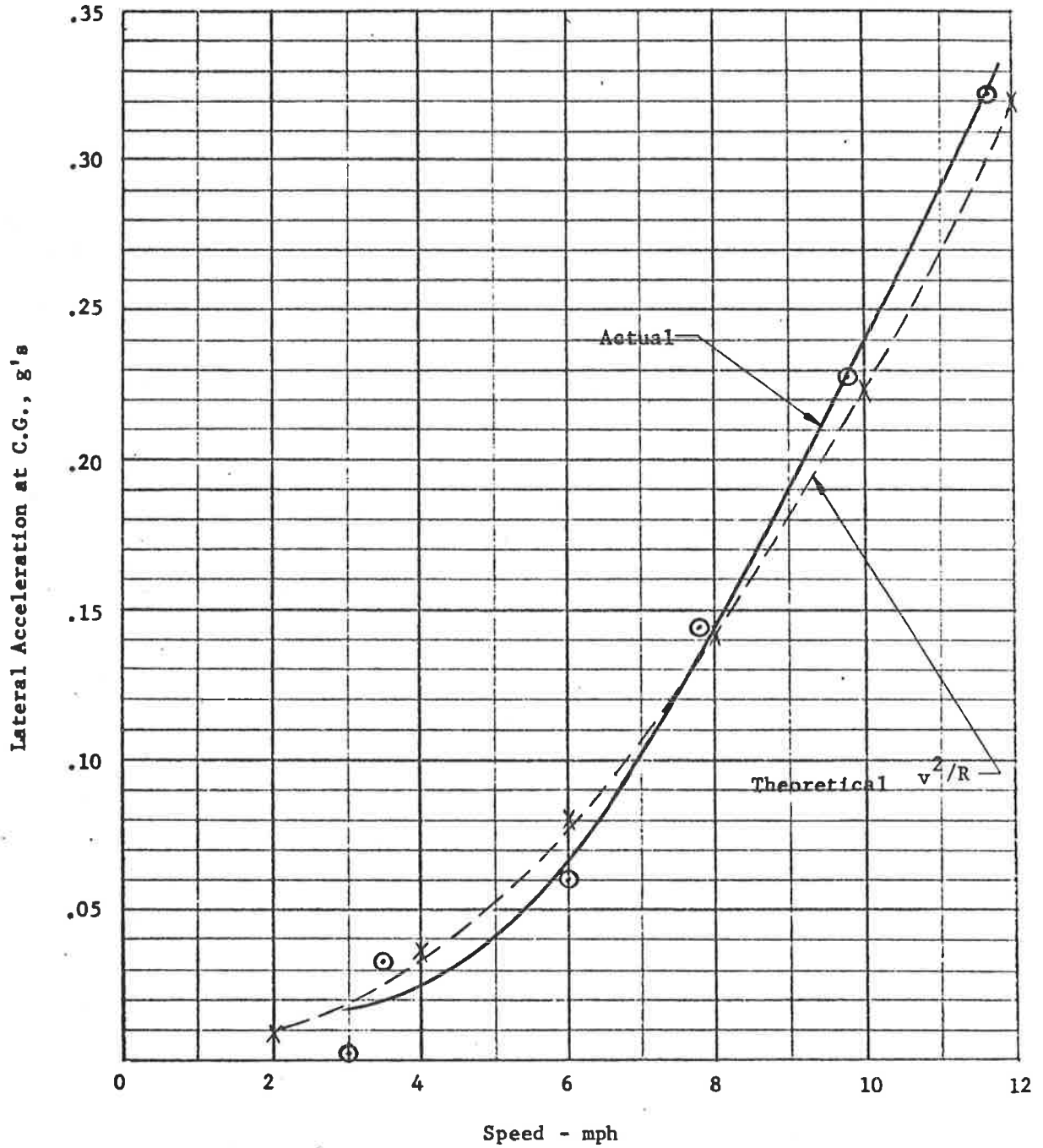

Peak lateral acceleration at C.G. of vehicle vs. speed for a 30 foot curve.

Figure 30

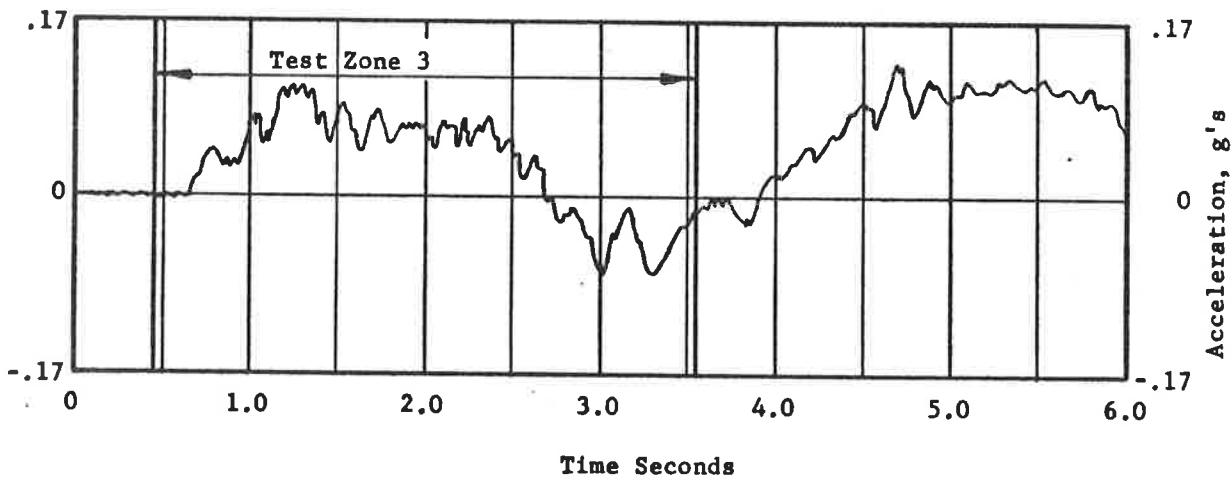
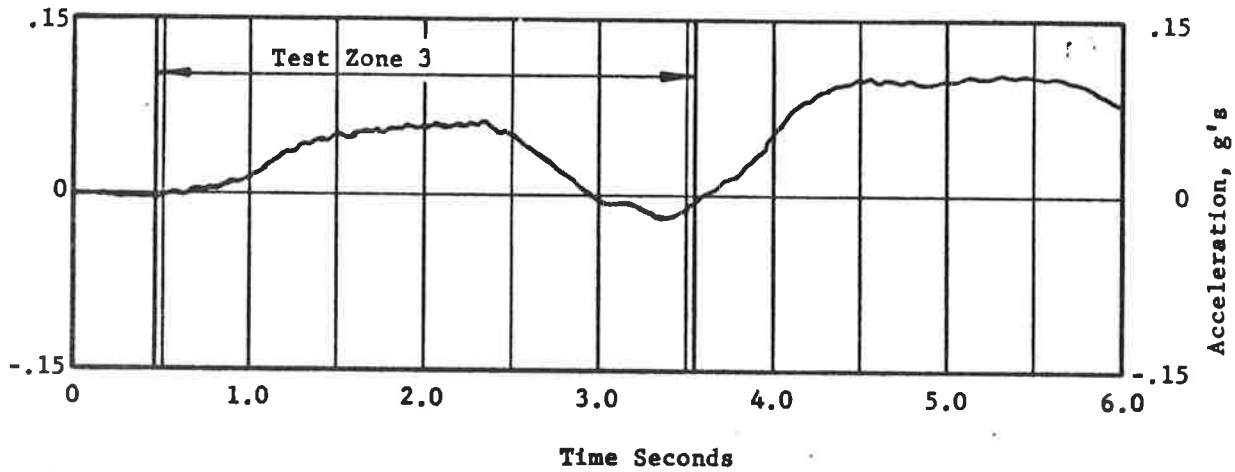

Test Conditions: Unloaded Power On

Longitudinal acceleration while negotiating a 30 foot curve at 12 mph; measured at C.G. of vehicle top and at left side of vehicle bottom.

Figure 31

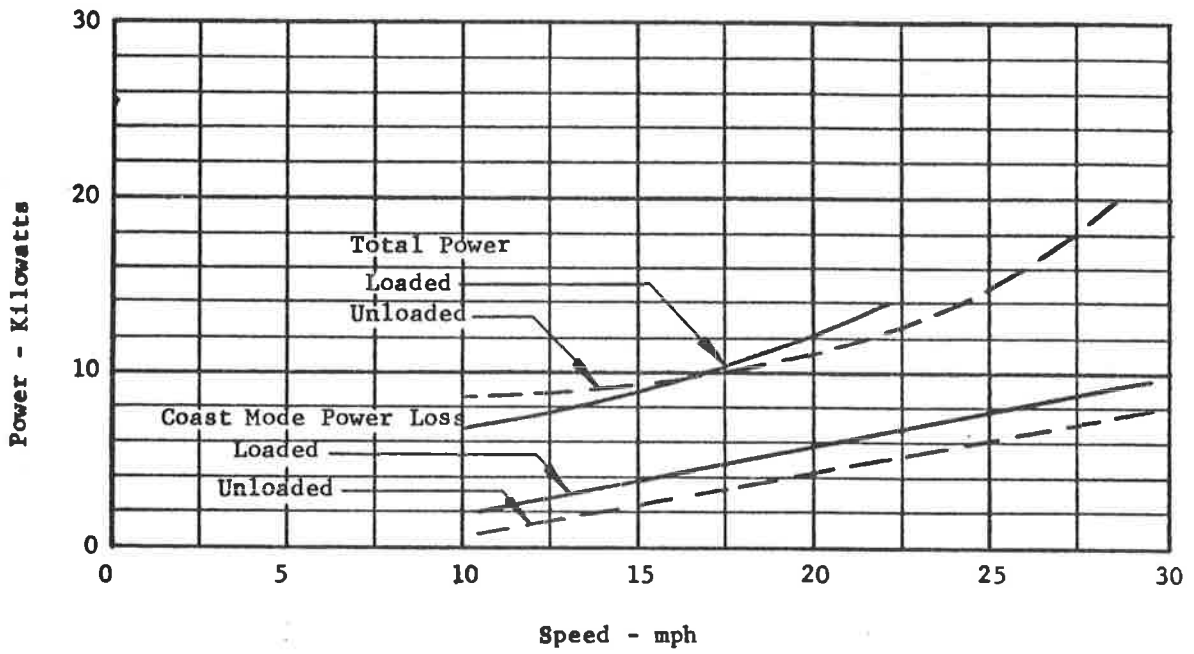

Power Vs. Speed for Tangent Track - Zone 2

Figure 32

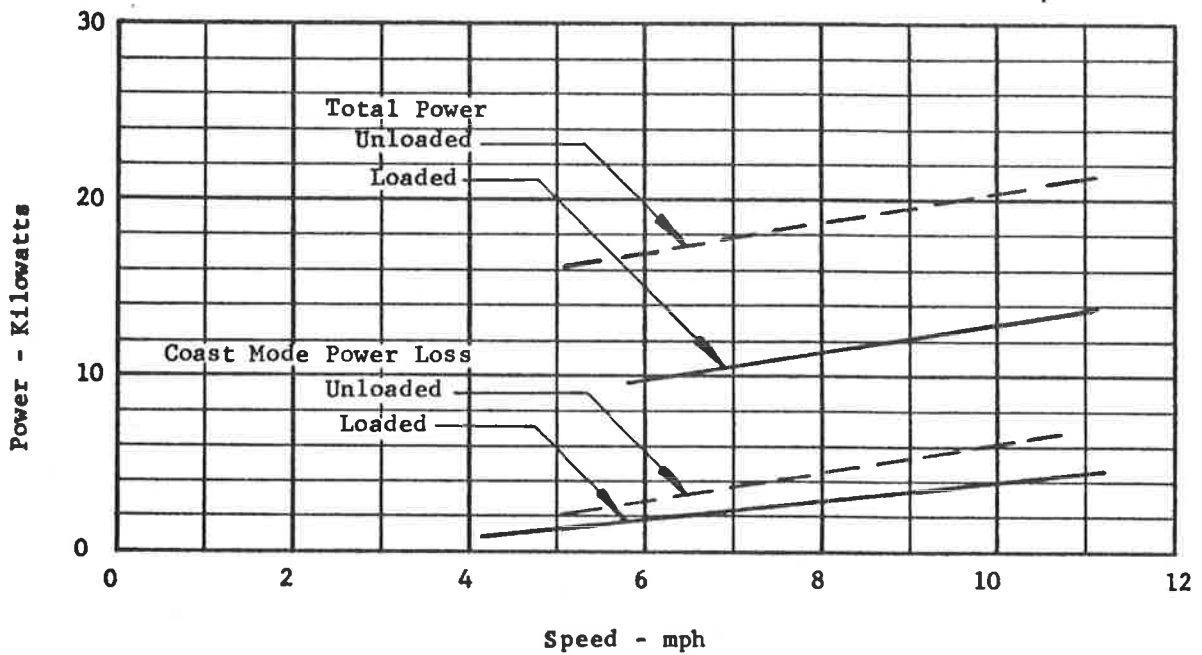

Power Vs. Speed for 30 Ft. Curve Track - Zone 3

Figure 33



APPENDIX A  
VEHICLE POWER AND PROPULSION

## A. VEHICLE POWER AND PROPULSION

### A.1 Vehicle Electrical Power

A 125 KVA portable diesel generator supplied the 480 V/3-phase A.C. to the power rails (3rd rail) system for all test runs. The vehicle's sliding collectors contacted the 3rd rail for pick-up of power to be distributed to the vehicle's motors and instruments. The major item of the vehicle electrical system is the 480 VAC single phase transformer, which accepted the power input from the 3rd rail conductors and reduced it to 220 VAC for power to the QO load center, for distribution of the electric power to the hydraulic replenishing pump and the test instruments of 110 VAC requirements. Figure A-1 shows the vehicle wiring in a simplified block diagram.

### A.2 Vehicle Propulsion

The 60 H.P. 480 VAC 3-phase motor of the electrical power system operated a hydraulic pump. The output from this variable displacement piston pump with a stem servo control, which was the vehicle operator's speed control, was distributed through a manifold system to the four (4) individual hydraulic wheel motors. A block diagram of the hydraulic system is shown in Figure A-2.

### A.3 Wheel Tread

Each individual wheel motor rotated a steel wheel, whose contact with the steel rail moved the vehicle. The steel wheel tread profile for the PRT prototype vehicle is shown in Figure A-3 and the wheel profile for the dual treaded vehicle is shown in Figure A-4.



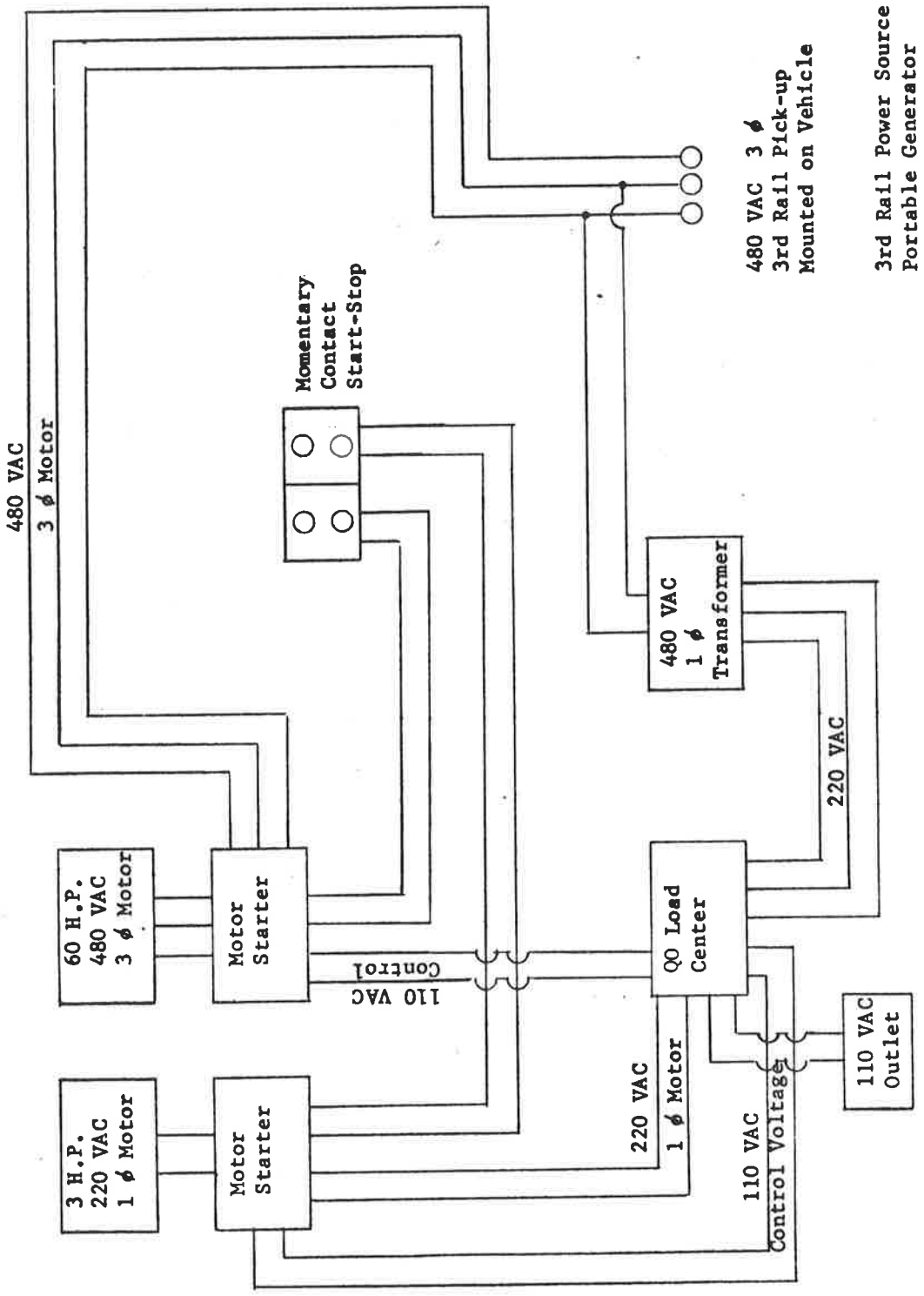

D.O.T. Vehicle - Block Wiring Diagram  
Figure A-1

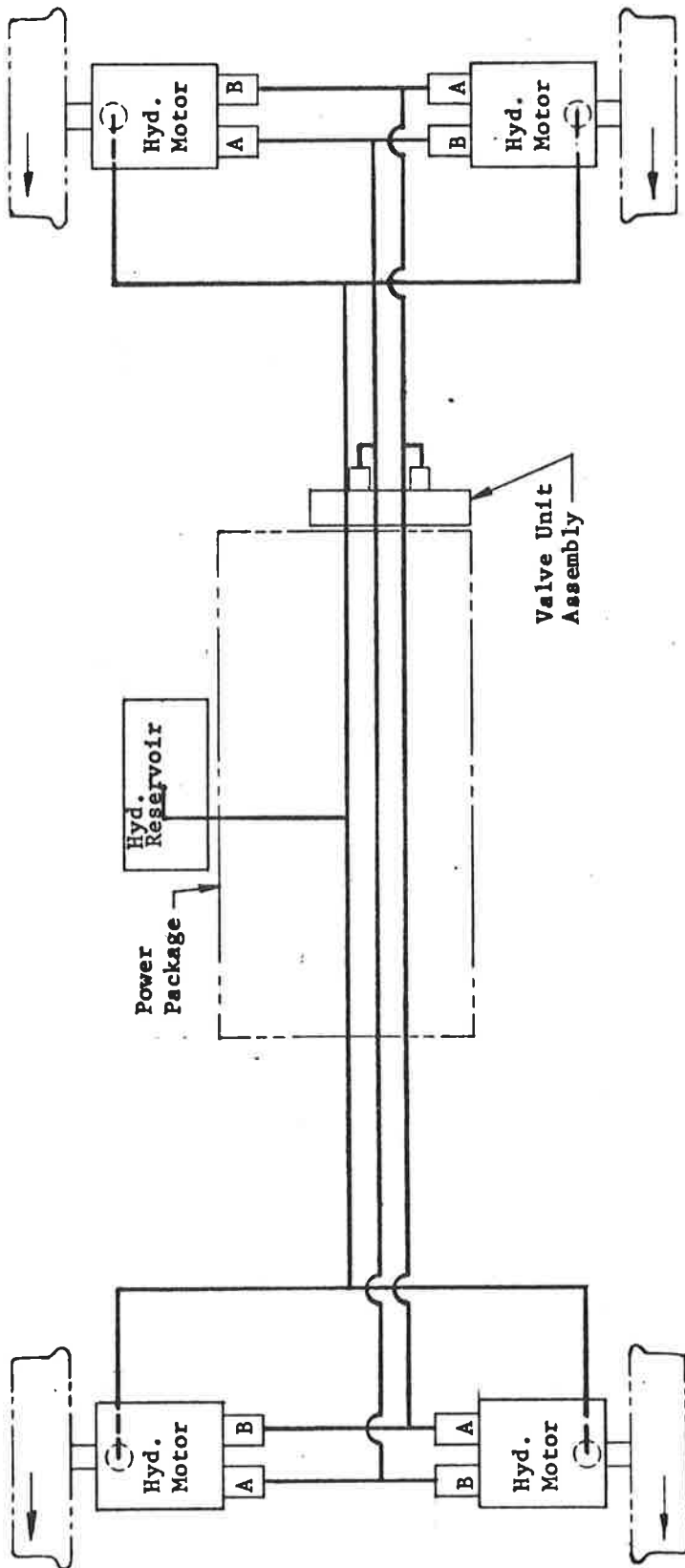

D.O.T. Vehicle - Block Hydraulic System

Figure A-2

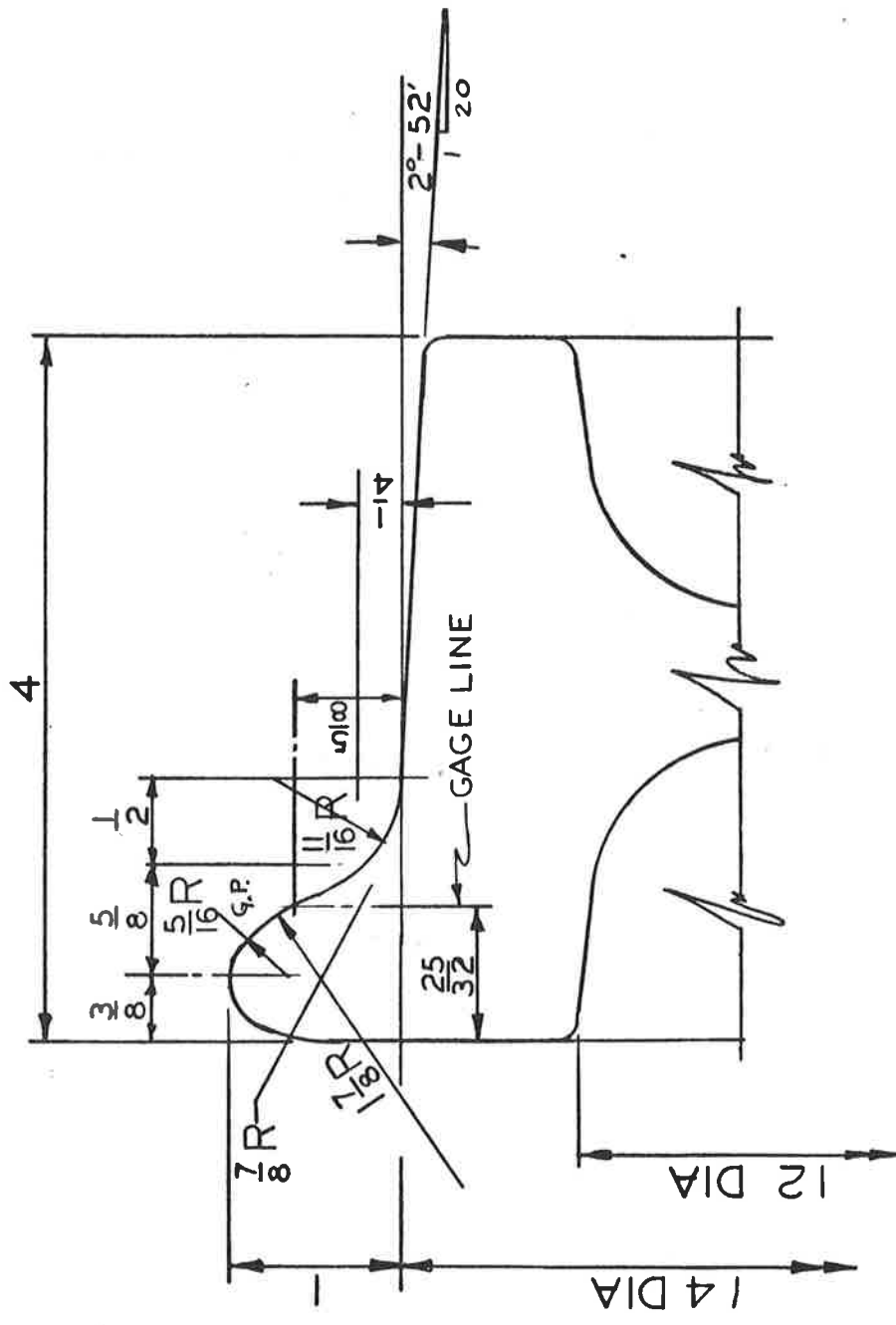

DOT Vehicle - Wheel Profile  
Figure A-3

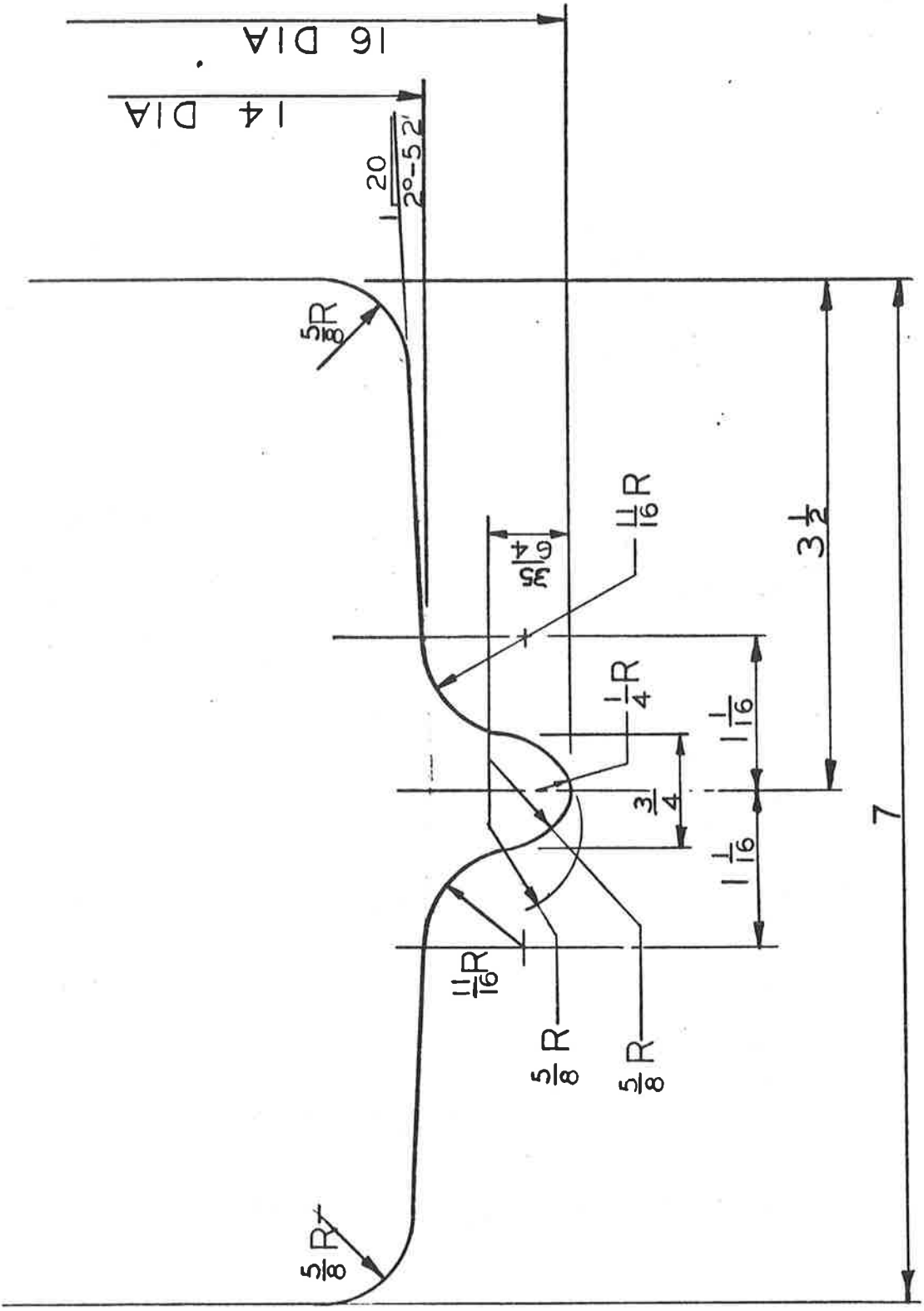

Dual-Tread - Wheel Profile  
Figure A-4

APPENDIX B  
TEST TRACK

## B. TEST TRACK

### B.1 General

The 840 ft. of 60 lb./yd. rail at a nominal gage of 42 in. was installed adjacent to the Champ Carry Technical Center of Pullman-Standard in Hammond, Indiana. The test track layout is shown in Figure B-1. The test track contained 5 test zones. The tangent track zones of staggered joint rail and welded rail were each 90 feet in length; the curve and transition zones were of the lengths as shown in detail in Figure B-2.

### B.2 Track Measurements

Track irregularity measurements including profile, alignment, gage and cross level were recorded for all test zones before any test runs and after all Phase I testing was completed.

The measurements for the track data were taken in .01 in. for profile and cross level and .001 in. for alignment and gage.

To obtain the data for Test Track measurements; it was necessary to use a level, a transit, a level rod, a scale rod with .01 in. measurement increments and an assembled gage fixture with .001 in. measurement increments.

The level, level rod and scale rod were used to establish the Datum Line and record the measurements for Columns "C", "D" and "C-D" of Tables B-1, B-2, and B-3. The level was used to establish the Datum Line which is a height measurement recorded by sighting on a Pullman-Standard "Bench Mark" and reading the level rod for that particular instrument position. The level rod was then placed on each rail at Station "0" and the measurements recorded; the scale rod measurements were also recorded at this time; this established the rail height measurements in .01 in. instead of .01 ft. which was the accuracy of the level rod. Then by addition or subtraction from Station "0" elevation all other rail elevations were recorded from the same instrument position. The after test readings were accomplished in the same manner except there was one additional addition or subtraction in level rod reading to reference all after readings to the same Datum Line.

A transit and a centerline fixture with 2 dial gages that recorded in .001 in. increment were used for obtaining the data in Columns "A", "B", and "Rail Gage" and "E" of Tables B-1, B-2, and B-3. The transit was positioned on one of the centerline spikes which were positioned at the ends of the 660 ft. of tangent track. With the transit in this position, the centerline fixture was positioned at 90° to a rail and the centerline (E) of the fixture was aligned with the vertical cross hair of the transit. When the alignment of the fixture was complete, the dial gages were read and that reading plus 20.500 in. was recorded in Columns "A" and "B" of Tables B-1, B-2, and B-3. "Rail Gage" was

then the total of "A" and "B" and Column "E" centerline deviation was one-half the difference of Column "A" and "B".

All track measurements for before and after the test runs are recorded in Tables B-1, B-2 and B-3; these measurements are plotted in Figures B-4, B-5 and B-6.

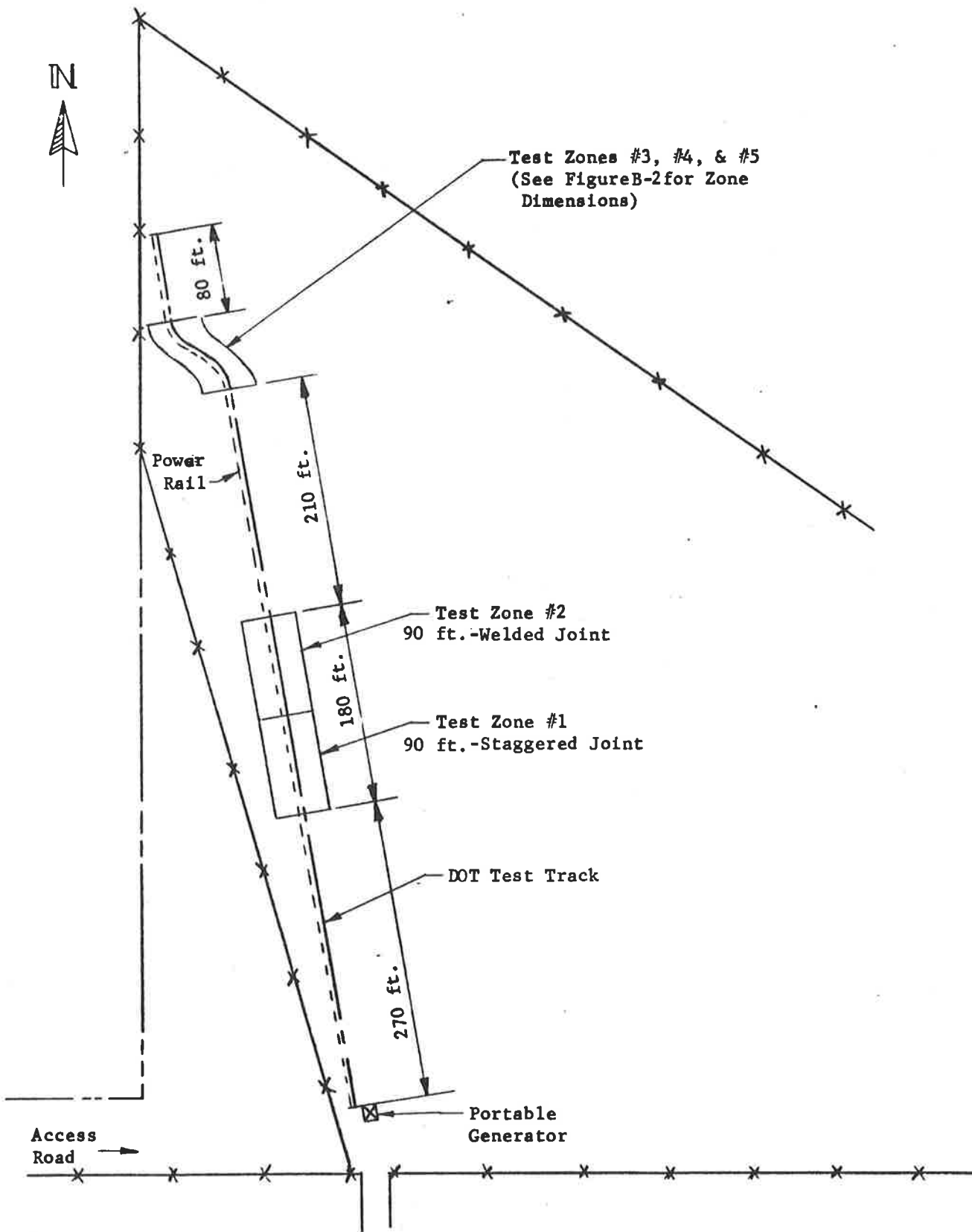

DOT Test Track

Figure B-1



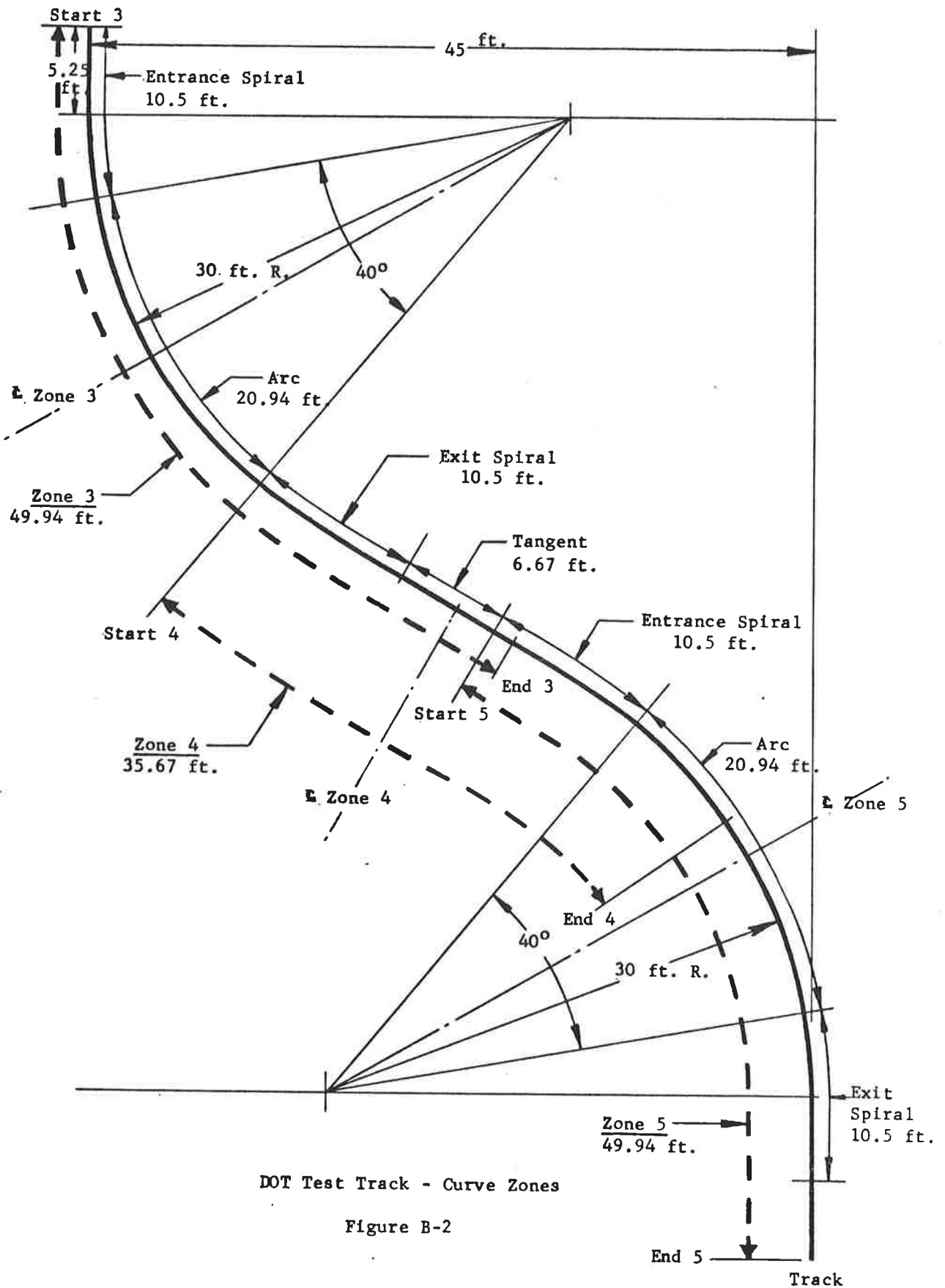

DOT Test Track - Curve Zones

Figure B-2

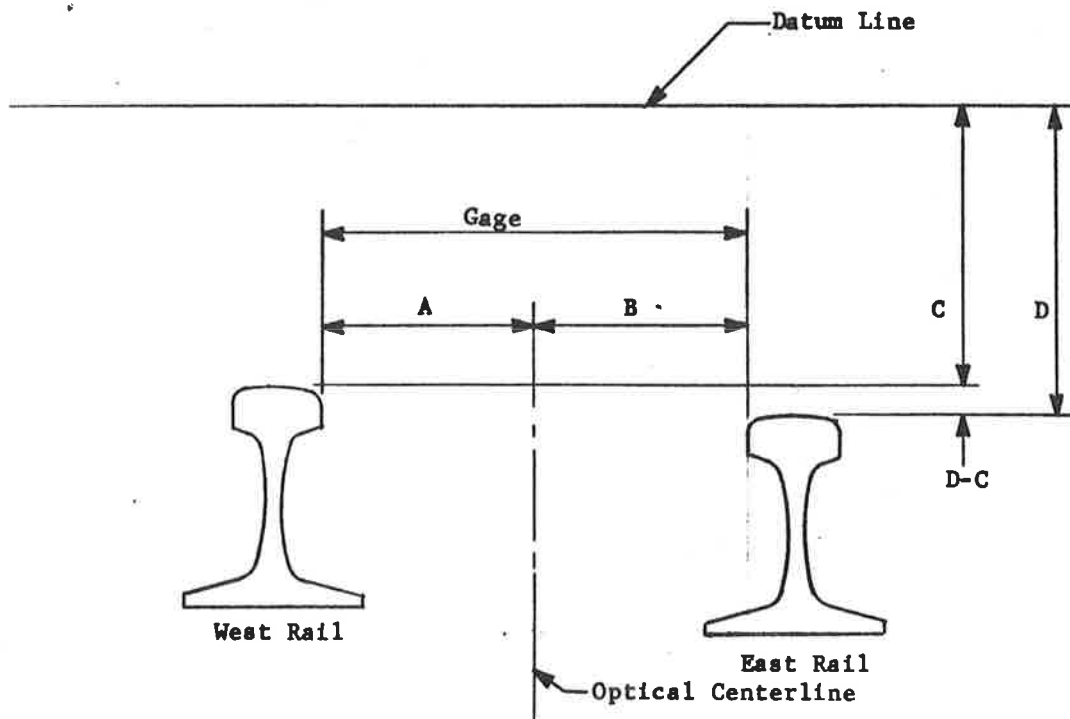

Key	A	Optical centerline to west rail
	B	Optical centerline to east rail
	C	Elevation west rail
	D	Elevation east rail
	D-C	Cross level difference
	E	Centerline deviation

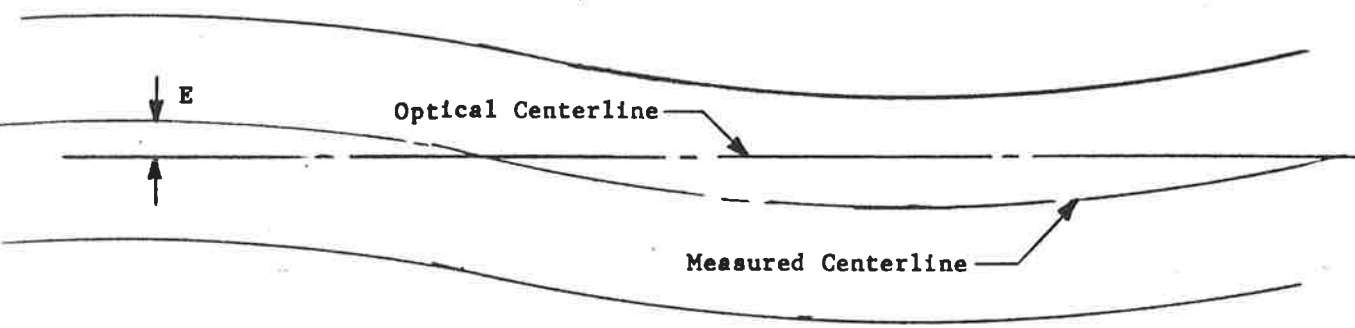

Track profile (top) and plan view (bottom).

Figure B-3

Distance from Start Feet	A	B	Rail Gage	C	D	D-C	E
Track Condition before start of test program							
0	20.708	21.126	41.834	5.71	6.13	.42	-.209
8	20.739	20.995	41.794	6.13	6.23	.10	-.098
16	20.968	20.838	41.806	6.31	6.30	-.01	.065
24	20.975	20.808	41.783	6.49	6.40	-.09	.084
32	20.964	20.897	41.861	6.38	6.39	.01	.034
40	20.796	21.131	41.927	6.32	6.38	.06	-.168
45	20.672	21.275	41.949	6.22	6.36	.04	-.300
48	20.799	21.135	41.934	6.17	6.40	.23	-.168
56	20.705	21.153	41.858	6.16	6.37	.21	-.224
64	21.004	20.885	41.889	6.04	6.22	.18	.060
72	20.927	20.864	41.791	5.80	6.03	.23	.032
80	20.766	21.068	41.834	5.74	5.85	.11	-.151
90	20.606	21.203	41.809	5.58	5.76	.18	-.299
Track Condition after completion of test program							
0	20.866	20.948	41.814	6.11	6.32	.21	-.043
8	21.053	20.682	41.735	6.28	6.14	-.14	.186
16	21.288	20.505	41.793	6.47	6.50	.03	.392
24	21.261	20.490	41.751	6.75	6.60	-.15	.386
32	20.918	20.937	41.845	6.60	6.60	.00	-.014
40	20.931	20.988	41.919	6.48	6.53	.05	-.028
45	20.807	21.136	41.943	6.64	6.59	-.05	-.164
48	20.758	21.159	41.917	6.48	6.59	.11	-.200
56	20.707	21.156	41.856	6.38	6.58	.20	-.228
64	20.971	20.917	41.888	6.30	6.47	.17	.027
72	20.952	20.832	41.784	6.06	6.30	.24	.060
80	20.844	20.986	41.830	5.97	6.14	.17	-.071
90	20.626	21.155	41.781	5.85	5.97	.13	-.026

TRACK ALIGNMENT - ZONE 1 (TANGENT TRACK)  
FIGURE B-4

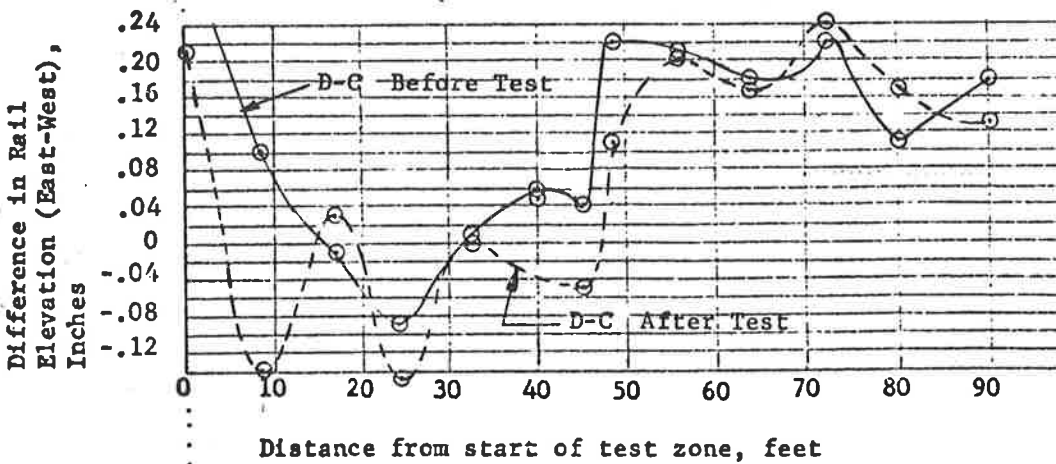
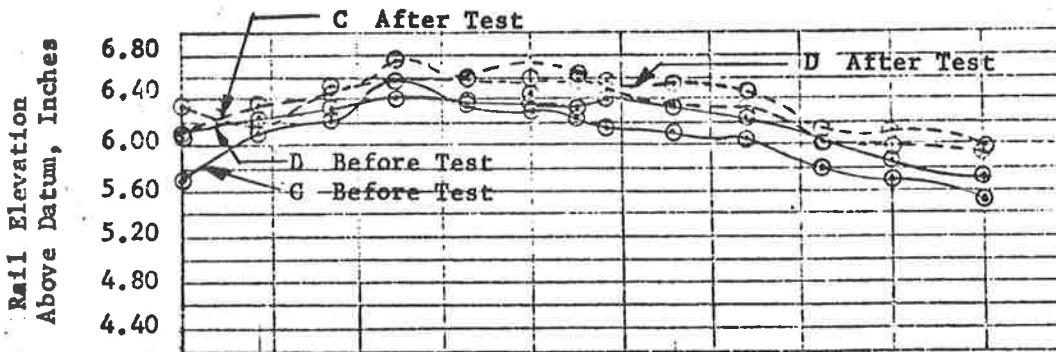
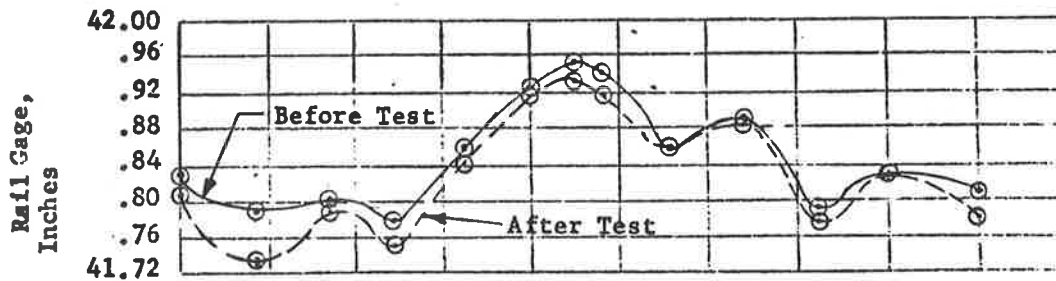
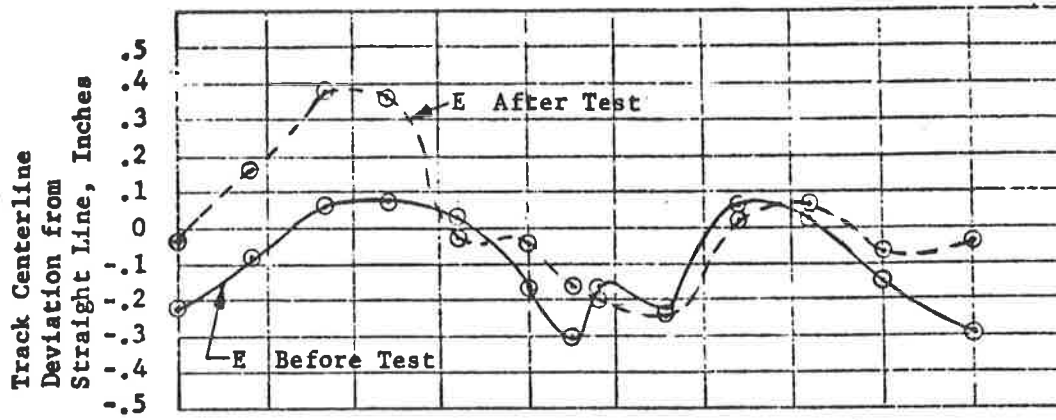

Track alignment, gage, level and cross elevation for test Zone 1 before and after testing

Figure B-5

Distance from Start Feet	A	B	Rail Gage	C	D	D-C	E
Track Condition before start of test program							
0	20.695	21.085	41.780	5.58	5.76	.18	-.195
6	20.665	21.162	41.827	5.67	5.80	.13	-.249
14	20.682	21.134	41.816	5.59	5.66	.07	-.226
22	20.882	20.992	41.874	5.35	5.44	.09	-.045
30	20.761	21.134	41.895	5.16	5.16	.00	-.187
38	20.843	20.990	41.833	5.07	5.03	-.04	-.074
44	20.763	21.019	41.782	5.03	5.04	.01	-.128
52	21.025	20.847	41.872	4.94	4.92	-.02	.089
60	20.895	21.000	41.895	4.75	4.92	.17	-.053
68	20.814	21.069	41.883	4.79	4.79	.00	-.128
76	20.886	21.082	41.968	4.71	4.66	-.05	-.098
84	20.722	21.151	41.873	4.67	4.64	-.03	-.215
90	20.750	21.098	41.848	4.50	4.56	.06	-.174
Track Condition after completion of test program							
0	20.626	21.155	41.781	5.85	5.97	.12	-.026
6	20.737	21.092	41.829	5.86	5.91	.05	-.178
14	20.739	21.068	41.807	5.74	5.80	.06	-.164
22	20.829	21.003	41.832	5.48	5.55	.07	-.087
30	21.080	20.819	41.889	5.20	5.26	.06	.125
38	21.072	20.752	41.824	5.31	5.31	.00	.160
44	20.716	21.061	41.877	5.31	5.39	.08	-.122
52	20.822	21.046	41.868	5.26	5.38	.12	-.112
60	20.906	20.980	41.886	5.20	5.28	.08	-.037
68	20.976	20.905	41.881	5.23	5.23	.00	.035
76	20.999	20.920	41.911	5.08	5.14	.06	.035
84	20.900	20.977	41.877	5.05	5.12	.07	-.038
90	20.873	20.965	41.838	5.11	5.21	.10	-.046

TRACK ALIGNMENT - ZONE 2 (TANGENT TRACK)

FIGURE B-6

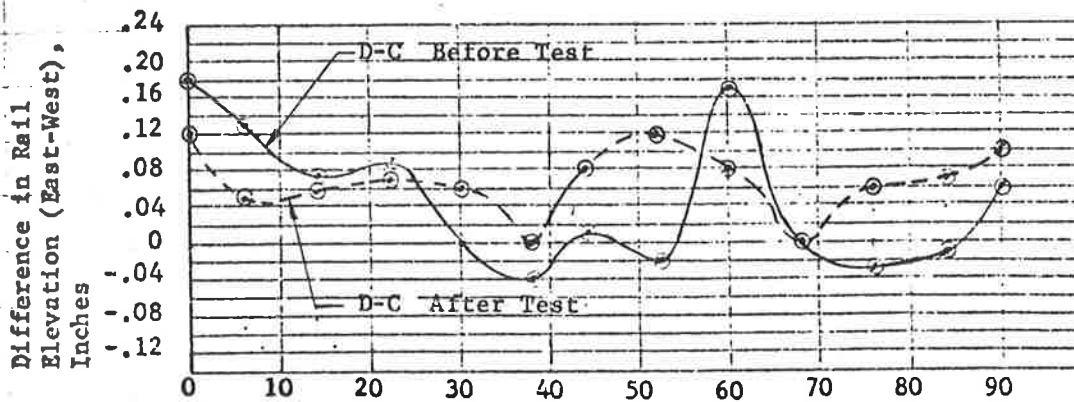
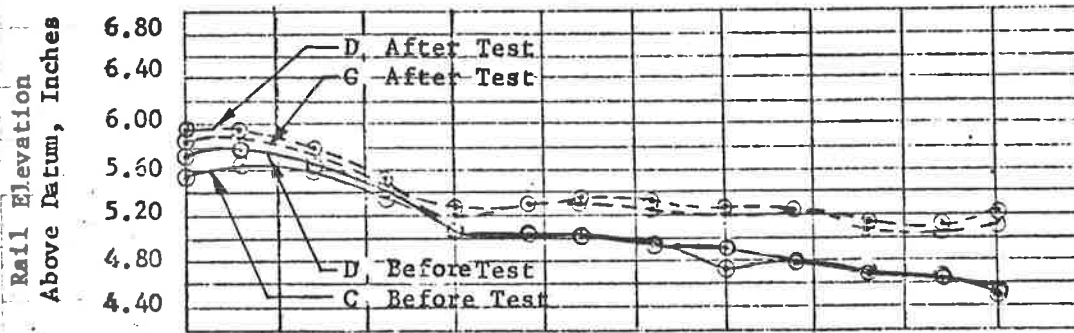
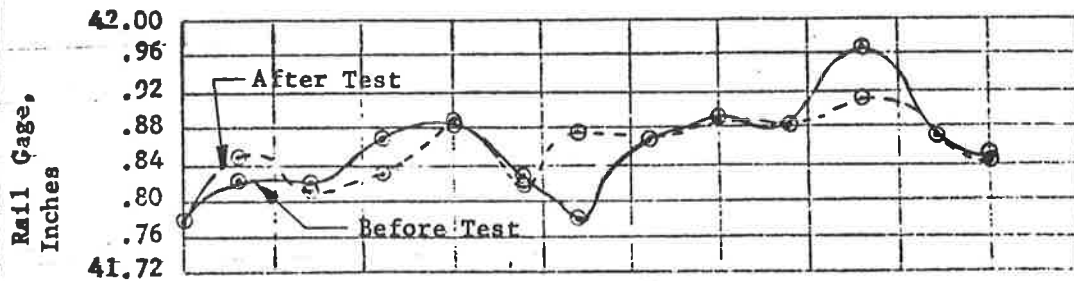
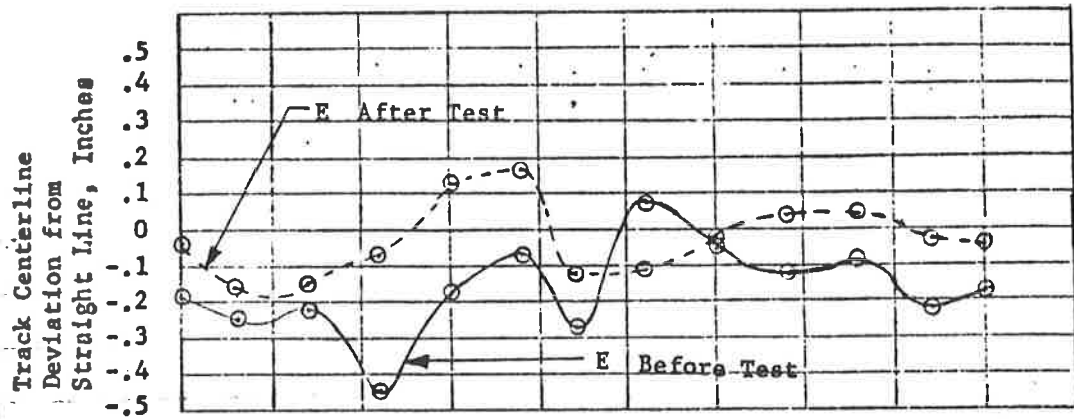

Distance from start of test zone, feet

Track alignment, gage, level and cross elevation for test Zone 2 before and after testing

Figure B-7

Distance from Start Feet Inches		A	B	Rail Gage	C	D	D-C	E
Track Condition before start of test program								
0	0	20.860	20.863	41.723	6.98	6.83	-.15	-.002
10	5.750	20.803	21.027	41.830	6.88	6.76	-.12	-.112
21	5.375	20.652	20.812	41.464	7.02	6.84	-.18	-.080
31	9.875	21.000	20.952	41.952	7.18	6.98	-.20	-.024
45	8.500	20.640	21.238	41.878	6.91	7.08	.17	-.299
60	8.250	20.890	20.882	41.772	7.08	7.08	.00	.004
70	5.875	20.862	20.672	41.534	7.14	7.05	-.09	.095
80	3.750	20.586	20.735	41.321	6.98	6.89	-.09	-.075
90	2.125	20.672	20.884	41.556	7.07	7.07	.00	-.106
Track Condition after completion of test program								
0	0	20.845	20.845	41.690	7.17	6.94	-.23	.000
10	5.750	20.882	20.953	41.835	7.17	6.94	-.23	-.036
21	5.375	20.690	20.759	41.449	7.16	6.97	-.19	-.035
31	9.875	20.831	21.111	41.942	7.40	7.17	-.23	-.140
45	8.5	20.820	21.360	42.180	7.33	7.48	.15	-.270
60	8.25	20.881	20.883	41.764	7.86	7.70	-.16	-.001
70	5.875	20.806	20.721	41.577	7.86	7.71	-.15	.043
80	3.75	20.422	20.826	41.248	7.84	7.68	-.18	-.202
90	2.125	20.766	20.785	41.551	7.71	7.77	.06	-.010

TRACK ALIGNMENT - ZONES 3, 4, AND 5 (CURVE TRACK)

FIGURE B-8

Track Centerline  
Deviation from  
Optical Centerline, Inches

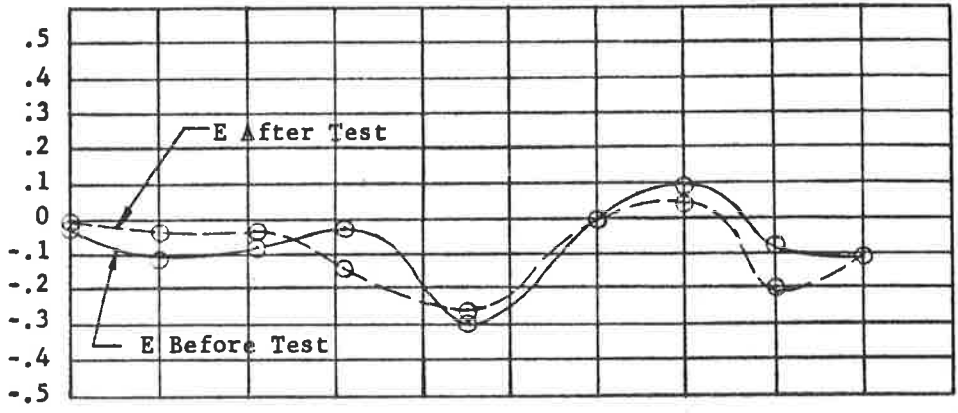

Rail Gage,  
Inches

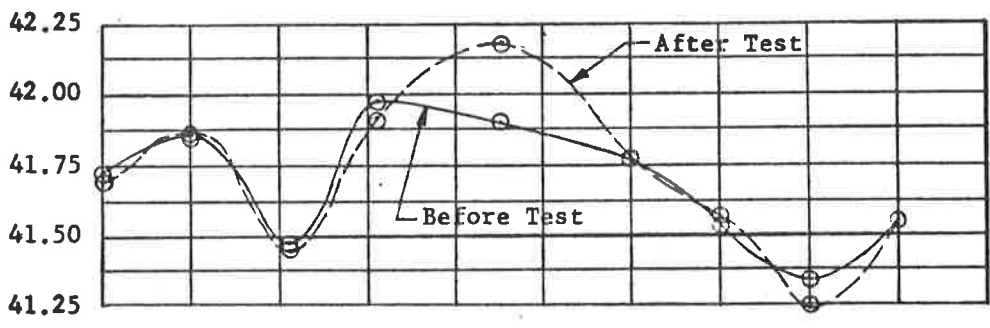

Rail Elevation  
Above Datum, Inches

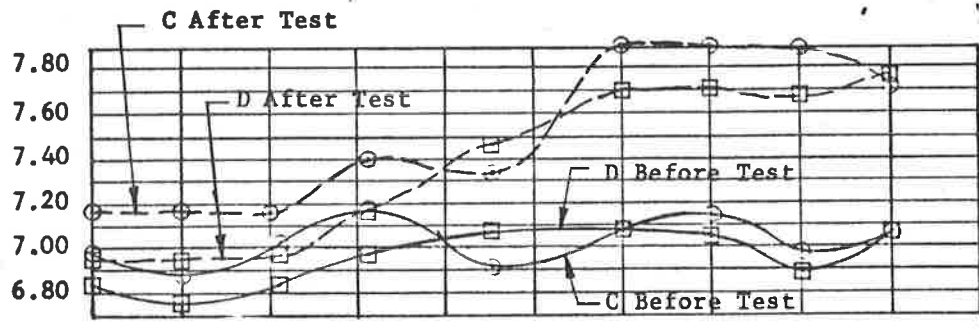

Difference in Rail  
Elevation (East-West)  
Inches

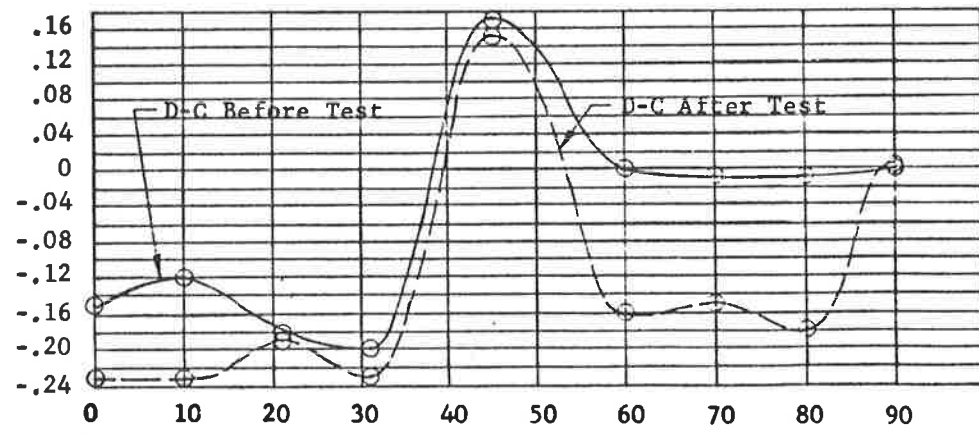

Distance from start of test zone - feet

Track alignment, gage, level and cross elevation for test Zones 3, 4, and 5 before and after testing

Figure B-9



APPENDIX C  
INSTRUMENTS

## C. INSTRUMENTS

### C.1 Accelerometers

Strain gage type accelerometers were used for recording all accelerations of the test vehicle. The location of these accelerometers on the test vehicle are shown in Figure C-1. Figure C-2 shows a typical accelerometer mounting used in this test program.

Table C-1 provides a listing of each accelerometer, its sensitivity range and scale factor as used for all tests.

Accelerometers were calibrated using the earth's gravitational field method. The earth's gravitational field provides a convenient means of applying small constant acceleration levels to a pick-up. A 2G change in acceleration is obtained by first orienting the accelerometer with the positive direction of its sensing axis up, and then rotating the accelerometer through  $180^\circ$  so that the positive direction is down. The output of the accelerometer is then fed through an amplifier to the recording oscillograph and the amplitude of the trace recorded and measured in inches. A calibration resistor is then inserted in the circuit to simulate a small acceleration. This output is recorded and is then used as a check.

To determine the acceleration; the amplitude of the trace on the recording oscillograph paper in inches is multiplied by the calibration factor calculated for that trace.

### C.2 Vehicle Speed

The visual speed indicator, which the vehicle operator used for determining vehicle velocity, was calibrated in the laboratory by rotating the gear at various speeds and measuring the output of the frequency to voltage converter with a series 500 digital voltmeter. Speed of the gear is then converted to vehicle speed and a plot made of vehicle speed (mph) vs. output voltage.

The voltage was also fed to a voltmeter which had been calibrated by inputing a variable voltage from a calibrated voltage source. A scale was then made and placed on the meter converting voltage to speed in mph for reference during test runs.

The output of the frequency to DC converter was also recorded on oscillograph paper and a plot made of speed (mph) vs. chart deflection in inches. The slope of the curve (mph/chart inch) is then the calibration factor assigned to the trace on the recording oscillograph paper which indicated vehicle speed.

### C.3 Vehicle Power

Power to the vehicle was measured by using a 3 element watt transducer whose output was measured with a calibrated Esterline Angus

1 milliamp recorder. The Esterline Angus 1 milliamp recorder was calibrated so that full scale deflection of meter indicated 90 KW.

The output of the 3 element watt transducer was also measured using the recording oscillograph. Inches of chart deflection were then plotted vs. power in KW. The slope of the line (KW/Chart Inch) is the calibration factor assigned to the trace on the recording oscillograpn identified as vehicle power.

Channel	Accelerometer Number & Type	Sensitivity	Amplitude Range	Frequency Range	Channel Scale Factor
3	A-5 CEC 4-205-0001, Strain Gage	40.36 MV/g/V	± 2.5g	0-50Hz	0.15g's/chart inch
6	A-6 CEC 4-205-0001, Strain Gage	39.04 MV/g/V	± 2.5g	0-50Hz	.15g's/chart inch
9	A-7 CEC 4-205-0001, Strain Gage	42.84 MV/g/V	± 2.5g	0-50Hz	.15g's/chart inch
15	A-16 CEC 4-202-0001, Strain Gage	41.28 MV/g/V	± 10g	0-135Hz	.40g's/chart inch
18	A-70 CEC 4-205-0001, Strain Gage	44.08 MV/g/V	± 5g	0-85Hz	.16g's/chart inch
21	A-71 CEC 4-205-0001, Strain Gage	42.70 MV/g/V	± 5g	0-85Hz	.17g's/chart inch

Accelerometer Characteristics

Figure C-1

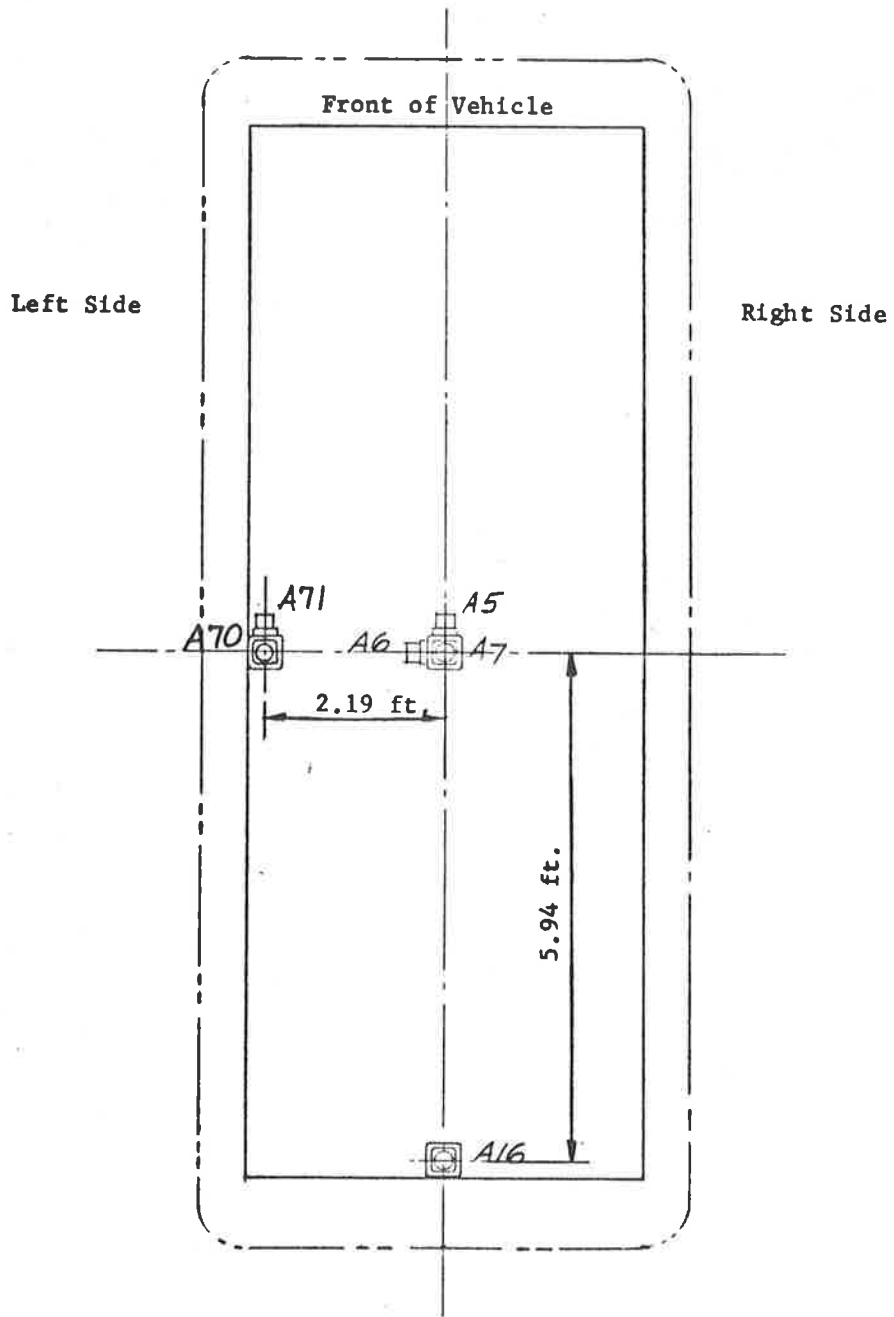

Accelerometer Location

Figure C-1A

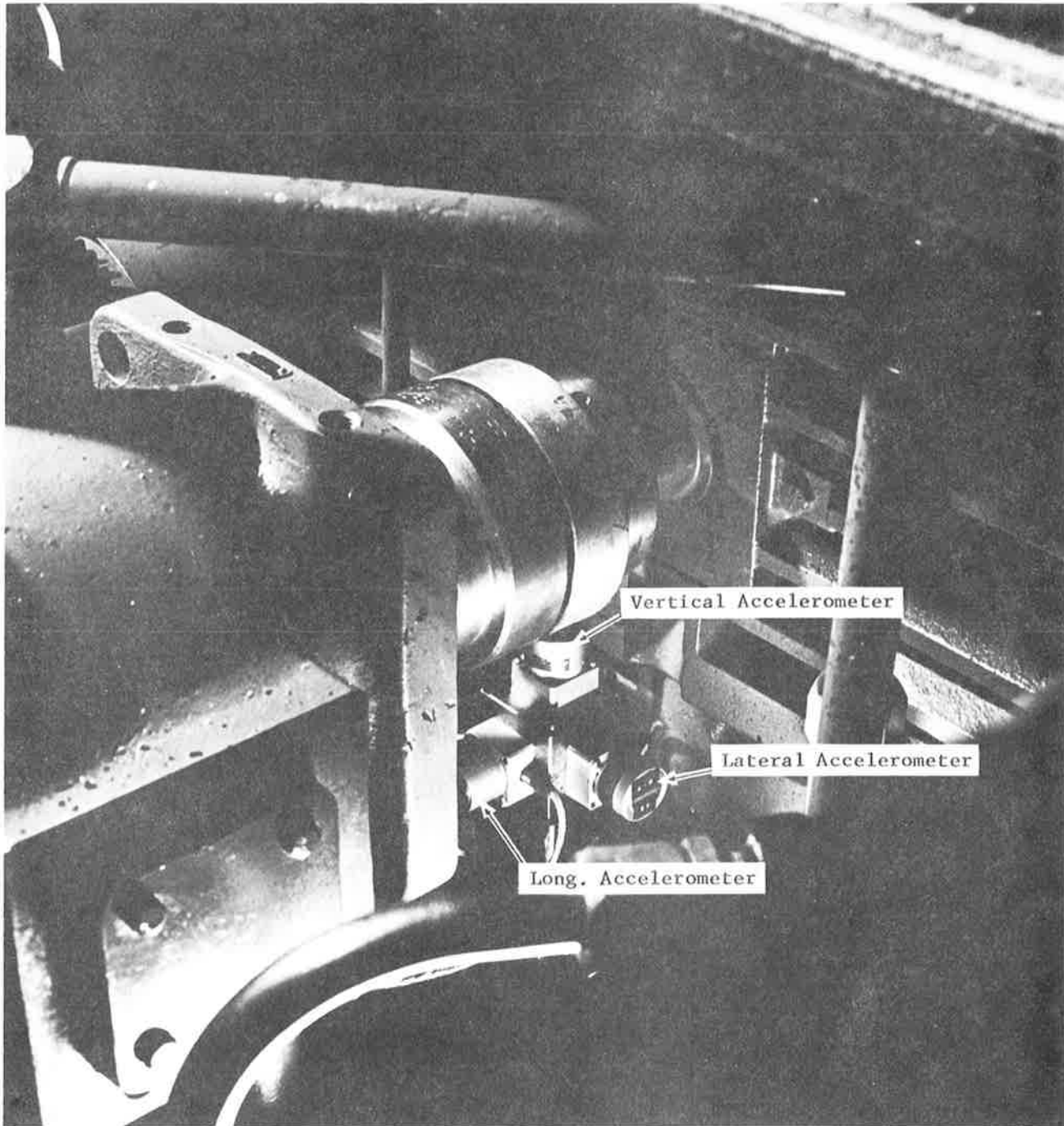

Typical Accelerometer Mounting at Vehicle's C.G.

Figure C-2



