

Dr.
RA-90-4



U.S. Department
of Transportation
**Federal Railroad
Administration**

Safety Relevant Observations on the X2000 Train as Developed for the Swedish National Railways

Office of Research and
Development
Washington, D.C. 20590

Robert M. Dorer
William T. Hathaway
Dr. Herbert Weinstock

U.S. Department of Transportation
Research and Special Programs Administration
John A. Volpe National Transportation Systems Center
Cambridge, MA 02142

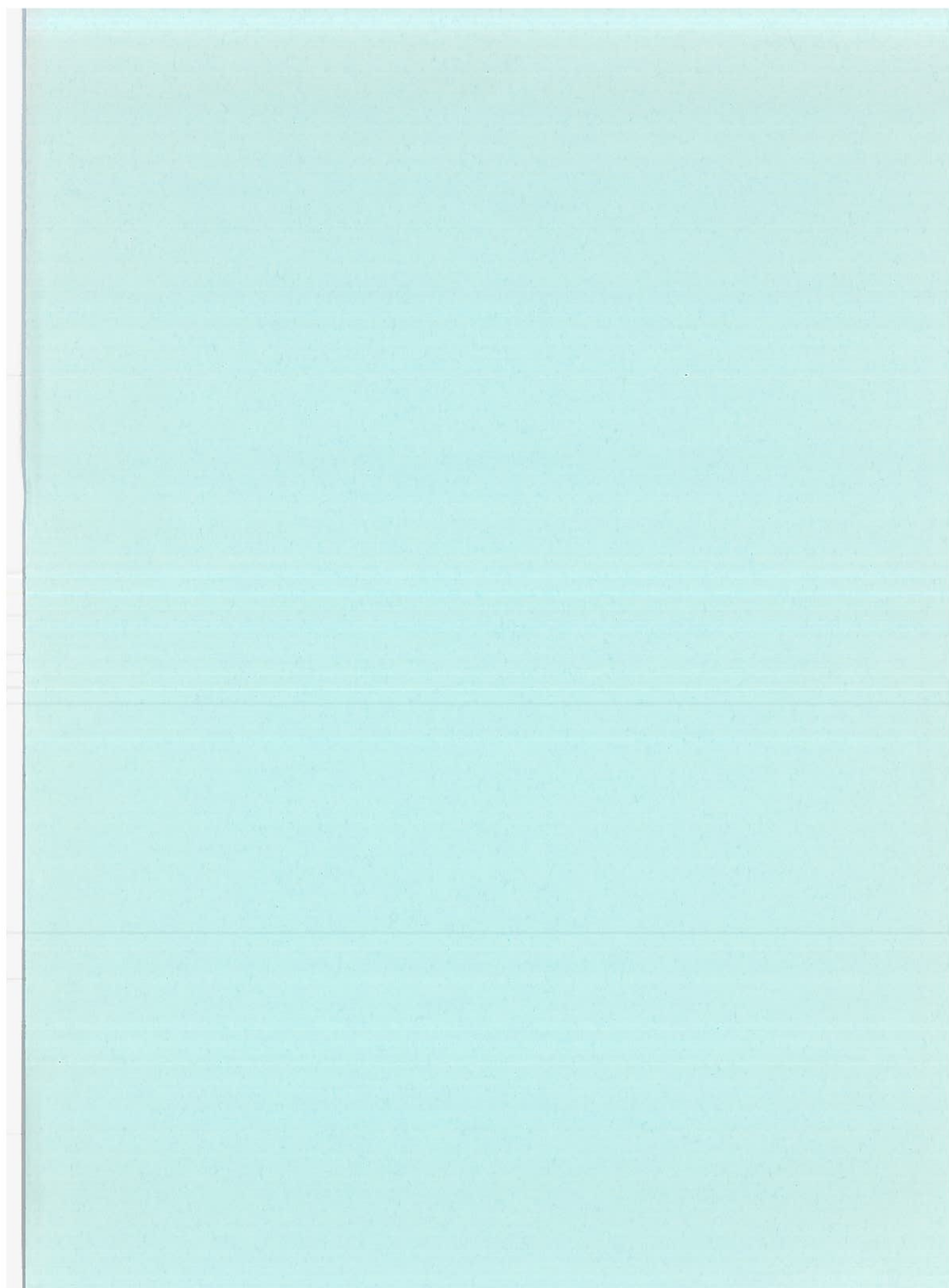

NOTICE

This document is disseminated under the sponsorship of the Departments of Transportation and Defense in the interest of information exchange. The United States Government assumes no liability for its contents or use thereof.

NOTICE

The United States Government does not endorse products or manufacturers. Trade or manufacturers' names appear herein solely because they are considered essential to the object of this report



1. Report No. DOT/FRA/ORD-90/14		2. Government Accession No.		3. Recipient's Catalog No.	
4. Title and Subtitle Safety Relevant Observations on the X2000 Train as Developed for the Swedish National Railways				5. Report Date December 1990	
				6. Performing Organization Code DTS-73	
				8. Performing Organization Report No. DOT-TSC-FRA-90-4	
7. Author(s) Robert M. Dorer, William T. Hathaway, Dr. Herbert Weinstock				10. Work Unit No. (TRAIS) RRI93/R1019	
9. Performing Organization Name and Address U.S. Department of Transportation Research and Special Programs Administration John A. Volpe National Transportation Systems Center Cambridge, MA 02142				11. Contract or Grant No.	
				13. Type of Report and Period Covered Final Report June 1990 - Nov. 1990	
12. Sponsoring Agency Name and Address U.S. Department of Transportation Federal Railroad Administration Office of Research and Development Washington, DC 20590				14. Sponsoring Agency Code RRD-3	
				15. Supplementary Notes	
16. Abstract The safety of high speed rail technology proposed for possible application in the United States is of concern to the Federal Railroad Administration. This report, one in a series of reports planned for high speed rail technologies presents an initial review of one such technology, the Swedish tilting train known as the X2000. This report utilizes material provided by the train developer, Asea Brown Boveri Traction AB (ABB), material gathered from independent sources, a site visit to the X2000 design and production facilities in June of 1990, and a ride on the equipment for over 400 km (250 miles) at speeds up to 200 km/hr (125 mph), also during June of 1990. This report describes the background leading up to the development of the X2000, the potential U.S. applications, and the technology in some detail and finally reviews FRA regulations that may be applicable to the design of this train relative to any potential U.S. application.					
17. Key Words High Speed Ground Transportation, High Speed Rail, Tilt Trains, Transportation Safety, Safety Regulations, Federal Railroad Administration, X2000, Swedish State Railways, SJ.			18. Distribution Statement DOCUMENT IS AVAILABLE TO THE PUBLIC THROUGH THE NATIONAL TECHNICAL INFORMATION SERVICE, SPRINGFIELD, VIRGINIA 22161		
19. Security Classif. (of this report) Unclassified		20. Security Classif. (of this page) Unclassified		21. No. of Pages 25	22. Price

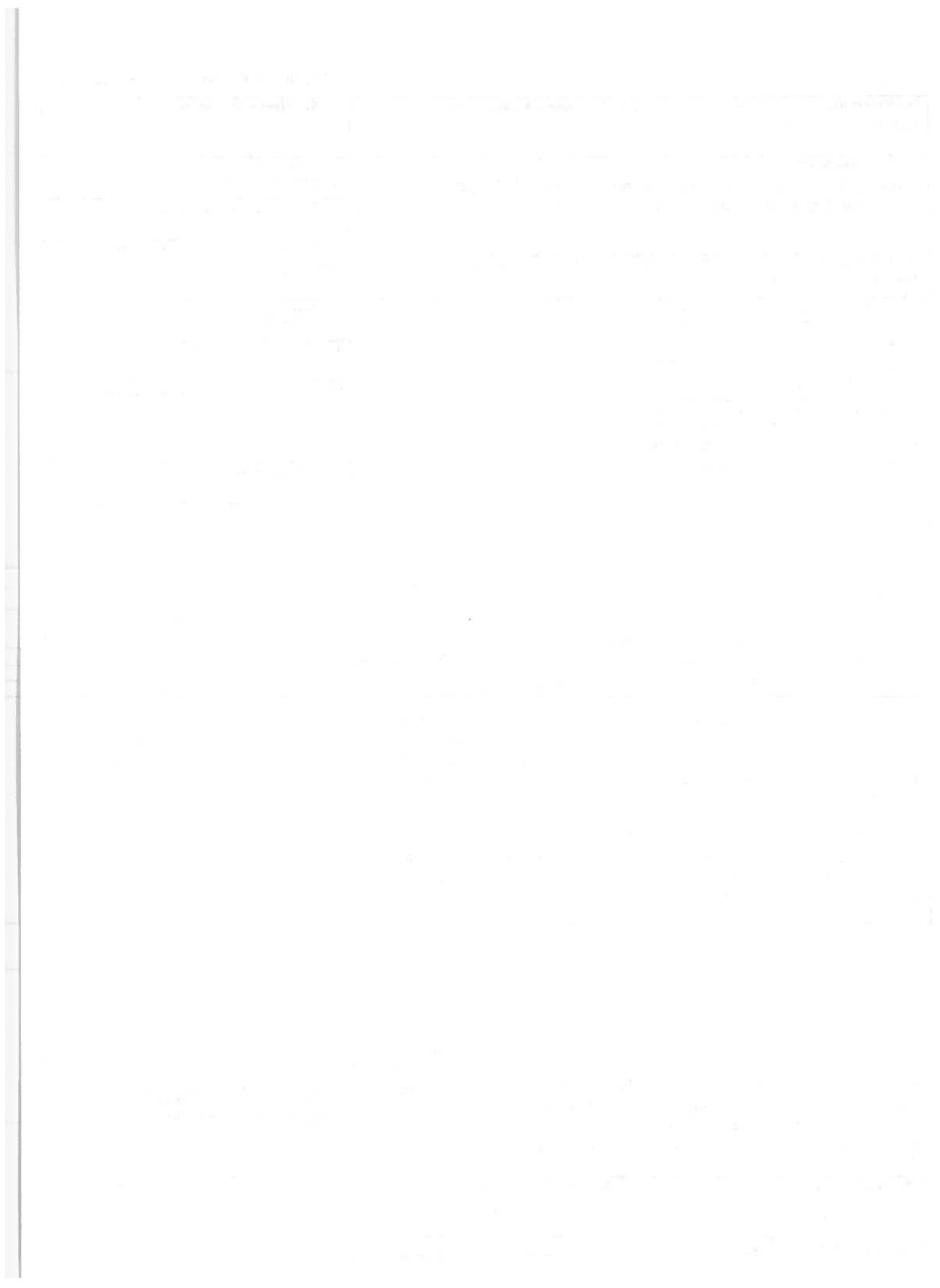

Preface

The use of various high speed rail technologies for high speed ground transportation in the United States may become a reality within the next few years. As a result of these developments there is a need to review the safety of those high speed rail systems that may utilize differing equipment and operating procedures from those currently employed in the United States. This review is the responsibility of the Federal Railroad Administration, United States Department of Transportation, which is charged with assuring the safety of rail systems in the United States under the Rail Safety Improvement Act of 1988.

This report, one in a series of reports planned for high speed rail technologies presents an initial review of one such technology, the Swedish tilting train known as the X2000.

SECRET

The following information was obtained from a review of the files of the [redacted] and is being furnished to you for your information. It is to be understood that this information is being furnished to you on a "need to know" basis and is not to be disseminated outside of your office.

The information is being furnished to you for your information and is not to be disseminated outside of your office.

METRIC / ENGLISH CONVERSION FACTORS

ENGLISH TO METRIC

LENGTH (APPROXIMATE)

1 inch (in) = 2.5 centimeters (cm)
 1 foot (ft) = 30 centimeters (cm)
 1 yard (yd) = 0.9 meter (m)
 1 mile (mi) = 1.6 kilometers (km)

AREA (APPROXIMATE)

1 square inch (sq in, in²) = 6.5 square centimeters (cm²)
 1 square foot (sq ft, ft²) = 0.09 square meter (m²)
 1 square yard (sq yd, yd²) = 0.8 square meter (m²)
 1 square mile (sq mi, mi²) = 2.6 square kilometers (km²)
 1 acre = 0.4 hectares (he) = 4,000 square meters (m²)

MASS - WEIGHT (APPROXIMATE)

1 ounce (oz) = 28 grams (gr)
 1 pound (lb) = .45 kilogram (kg)
 1 short ton = 2,000 pounds (lb) = 0.9 tonne (t)

VOLUME (APPROXIMATE)

1 teaspoon (tsp) = 5 milliliters (ml)
 1 tablespoon (tbsp) = 15 milliliters (ml)
 1 fluid ounce (fl oz) = 30 milliliters (ml)
 1 cup (c) = 0.24 liter (l)
 1 pint (pt) = 0.47 liter (l)
 1 quart (qt) = 0.96 liter (l)
 1 gallon (gal) = 3.8 liters (l)
 1 cubic foot (cu ft, ft³) = 0.03 cubic meter (m³)
 1 cubic yard (cu yd, yd³) = 0.76 cubic meter (m³)

TEMPERATURE (EXACT)

$$[(x - 32)(5/9)]^{\circ}\text{F} = y^{\circ}\text{C}$$

METRIC TO ENGLISH

LENGTH (APPROXIMATE)

1 millimeter (mm) = 0.04 inch (in)
 1 centimeter (cm) = 0.4 inch (in)
 1 meter (m) = 3.3 feet (ft)
 1 meter (m) = 1.1 yards (yd)
 1 kilometer (km) = 0.6 mile (mi)

AREA (APPROXIMATE)

1 square centimeter (cm²) = 0.16 square inch (sq in, in²)
 1 square meter (m²) = 1.2 square yards (sq yd, yd²)
 1 square kilometer (km²) = 0.4 square mile (sq mi, mi²)
 1 hectare (he) = 10,000 square meters (m²) = 2.5 acres

MASS - WEIGHT (APPROXIMATE)

1 gram (gr) = 0.036 ounce (oz)
 1 kilogram (kg) = 2.2 pounds (lb)
 1 tonne (t) = 1,000 kilograms (kg) = 1.1 short tons

VOLUME (APPROXIMATE)

1 milliliter (ml) = 0.03 fluid ounce (fl oz)
 1 liter (l) = 2.1 pints (pt)
 1 liter (l) = 1.06 quarts (qt)
 1 liter (l) = 0.26 gallon (gal)
 1 cubic meter (m³) = 36 cubic feet (cu ft, ft³)
 1 cubic meter (m³) = 1.3 cubic yards (cu yd, yd³)

TEMPERATURE (EXACT)

$$[(9/5)y + 32]^{\circ}\text{C} = x^{\circ}\text{F}$$

QUICK INCH-CENTIMETER LENGTH CONVERSION

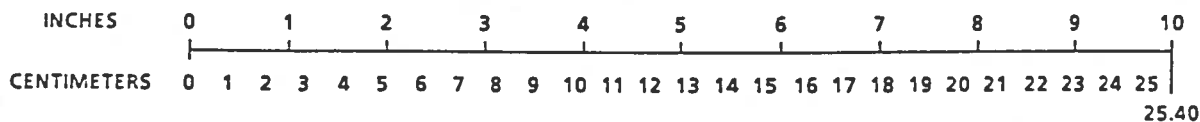

QUICK FAHRENHEIT-CELCIUS TEMPERATURE CONVERSION

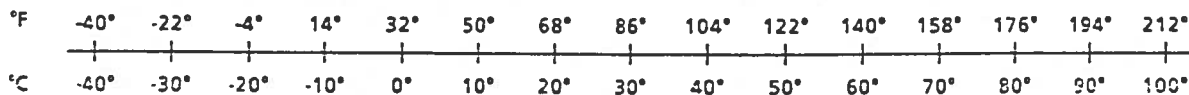

For more exact and/or other conversion factors, see NBS Miscellaneous Publication 286, Units of Weights and Measures. Price \$2.50. SD Catalog No. C13 10 286.

2000-01-01

100-1000

100-1000
100-1000
100-1000

100-1000
100-1000
100-1000

100-1000
100-1000
100-1000

100-1000
100-1000
100-1000

100-1000
100-1000
100-1000

100-1000
100-1000
100-1000

100-1000
100-1000
100-1000

100-1000
100-1000
100-1000

TABLE OF CONTENTS

Section	Page
1.0 Introduction	1
2.0 Background	1
2.1 Railroad Car Tilt Control	1
2.2 Development of the X2000	3
3.0 Proposed U.S. Applications	5
3.1 Florida High Speed Rail Act	5
3.2 Northeast Corridor Demonstration	5
4.0 System Description	5
4.1 Specifications	6
4.2 Coach Cars	7
4.3 Power and Driving Trailer Cars	8
4.4 Tilting System	9
4.5 Steerable Trucks	10
4.6 Braking System	10
4.7 Computer Control	11
4.8 Options Under Consideration by SJ	12
5.0 Compliance with Existing Regulations	12
5.1 FRA Regulations	12
5.2 FRA Guidelines	17
5.3 Americans with Disabilities Act	17
5.4 Potential Regulatory Issues	17
6.0 Summary	18

Mathematics

The first part of the document discusses the importance of mathematics in various fields. It highlights how mathematical concepts are applied in science, engineering, and economics. The text emphasizes the role of mathematics in problem-solving and decision-making. It also mentions the historical development of mathematics and its impact on modern society.

The second part of the document focuses on the practical applications of mathematics. It provides examples of how mathematical models are used to analyze real-world data. The text discusses the use of statistics and probability in various industries. It also touches upon the importance of mathematical literacy in a globalized world.

The final part of the document concludes with a call to action. It encourages students to continue their study of mathematics and to explore its many applications. The text also provides resources for further learning and research. It ends with a statement about the future of mathematics and its potential to shape a better world.

1.0 Introduction:

This report is a result of a request by the Federal Railroad Administration's (FRA) Office of Research and Development to the Research and Special Programs Administration's John A. Volpe National Transportation Systems Center (VNTSC) to conduct a preliminary safety assessment of the X2000, Swedish tilting train technology. This report utilizes material provided by the train developer, Asea Brown Boveri Traction AB (ABB), material gathered from independent sources, a site visit to the X2000 design and production facilities in June of 1990, and a ride on the equipment for over 400 km (250 miles) at speeds up to 200 km/h (125 mph), also during June of 1990.

This report describes the background leading up to the development of the X2000, the potential U.S. applications, and the technology in some detail and finally reviews FRA regulations that may be applicable to the design of this train relative to any potential U.S. application.

2.0 Background:

2.1 Railroad Car Tilt Control

The presence of a lateral acceleration as a rail car travels around a curve creates an unbalance effect on the rail car and passengers as shown in Figure 1a. To compensate for this effect, a track is superelevated around a curve. To increase the speed of a train around a curve beyond the limits compensated for by existing track superelevation without sacrificing passenger comfort, tilt mechanisms are sometimes employed.

Tilt control can be passive or active. A passive tilt mechanism is a design where the carbody produces a positive tilt in response to an applied lateral force acting on the car-body center of gravity. This compensation is accomplished by designing the car-body center of suspension above its center of gravity (Figure 1b).

A tilt mechanism that is actively controlled is a design where the car-body tilt is actuated in response to controller transmitted commands (Figure 1c). In this design, measurements are made of various system conditions such as the lateral acceleration, from which this information is then processed by the controller to activate the appropriate car-body tilt. Active tilt control systems have been designed using a variety of control strategies. The simplest of these strategies is "preview" control in which transducers at the lead axle of the train measure the unbalance associated with the track superelevation and the train speed. This effective unbalance is

The first part of the document discusses the importance of maintaining accurate records of all transactions. It emphasizes that every entry should be supported by a valid receipt or invoice. This ensures that the financial statements are reliable and can be audited without issue.

Furthermore, it is noted that the company's financial health is directly linked to the quality of its record-keeping. By keeping detailed accounts, management can identify trends, control costs, and make informed decisions about the future of the business.

The document also highlights the need for regular reconciliation of bank statements and internal ledgers. This practice helps to catch any discrepancies early on, preventing larger problems from developing. It is a key component of sound financial management.

In addition, the text stresses the importance of transparency in financial reporting. Stakeholders, including investors and creditors, rely on the company's financial statements to make their own assessments. Providing clear, honest, and timely information is essential for building trust and maintaining a strong reputation in the market.

The document also touches upon the legal requirements for record-keeping. Various regulations mandate that businesses must retain certain financial records for a specific period. Failure to comply with these regulations can result in penalties and legal complications.

Overall, the document serves as a comprehensive guide for businesses looking to improve their financial practices. It provides practical advice and highlights the long-term benefits of diligent record-keeping.

The final section of the document discusses the role of technology in modern financial management. While traditional methods have been used for centuries, the advent of computers and specialized software has revolutionized the way businesses handle their finances. Accounting software can automate many tasks, reduce the risk of human error, and provide real-time access to financial data.

However, it is important to note that technology is only a tool. The success of any financial system depends on the quality of the data entered and the expertise of the users. Proper training and oversight are still necessary to ensure that the technology is being used effectively.

The document concludes by reiterating the importance of a strong financial foundation for any business. By following the principles outlined here, businesses can ensure that they are well-prepared for whatever challenges the future may bring.

processed by a computational algorithm to control the tilt at each car at the appropriate point in time.

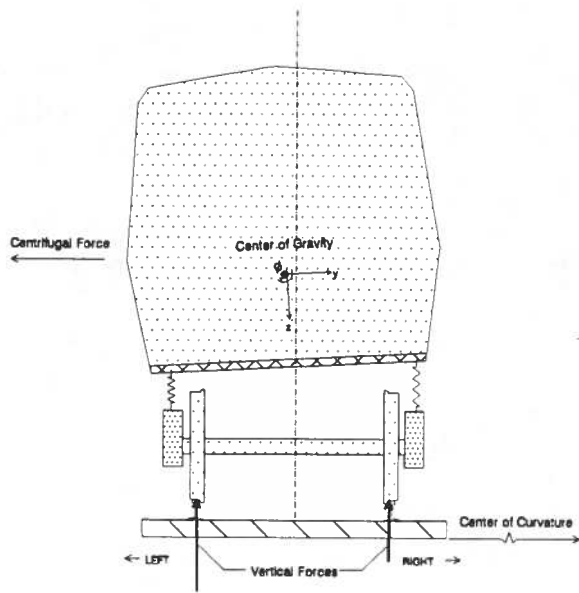

Figure 1a - Car on a Curve with no Tilt Control

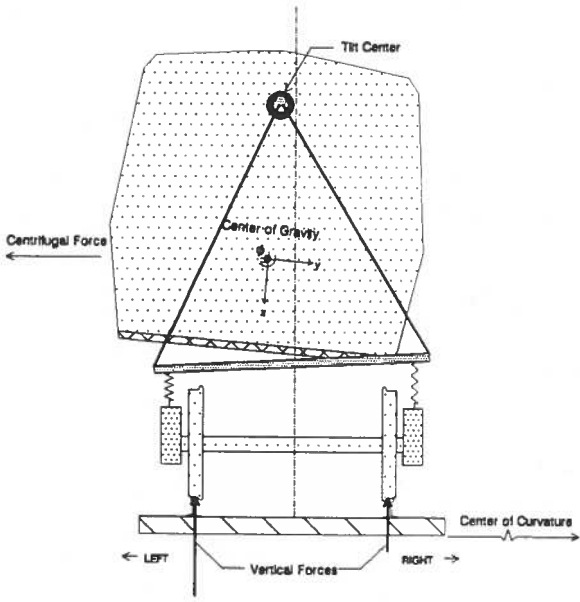

Figure 1b - Car on a Curve with Passive Tilt Control

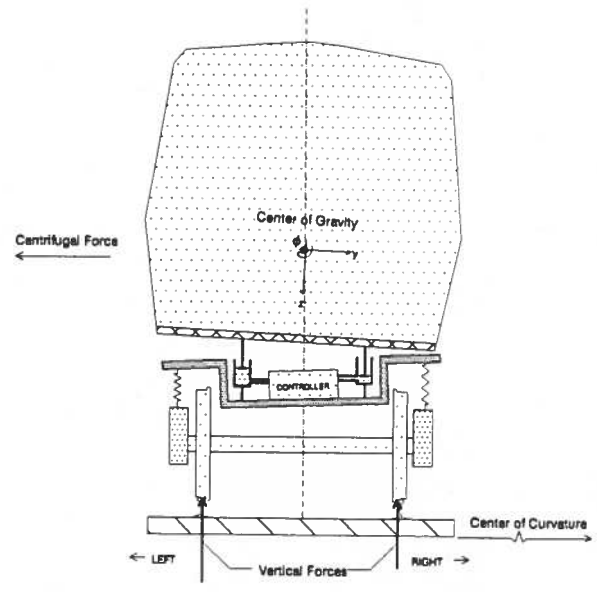

Figure 1c - Car on a Curve with Active Tilt Control

1. The first part of the document is a list of names and addresses of the members of the committee.

2. The second part of the document is a list of names and addresses of the members of the committee.

3. The third part of the document is a list of names and addresses of the members of the committee.

4. The fourth part of the document is a list of names and addresses of the members of the committee.

5. The fifth part of the document is a list of names and addresses of the members of the committee.

6. The sixth part of the document is a list of names and addresses of the members of the committee.

7. The seventh part of the document is a list of names and addresses of the members of the committee.

8. The eighth part of the document is a list of names and addresses of the members of the committee.

9. The ninth part of the document is a list of names and addresses of the members of the committee.

10. The tenth part of the document is a list of names and addresses of the members of the committee.

11. The eleventh part of the document is a list of names and addresses of the members of the committee.

There are positive and negative aspects to both the passive and active control techniques. There is an advantage of simplicity to the passive control tilt design since a positive tilt angle is produced whenever the carbody experiences a centripetal acceleration. However, a drawback to this design is that large vertical wheel unloading can occur on the inside wheel due to excessive lateral shift in the center of gravity of the carbody (Figure 1b).

In contrast to the passive tilt, the active control tilt has greater complexity. The advantage to the active control tilt is that the tilt configuration can be designed to limit the shift in the car-body center of gravity which would reduce wheel unloading (Figure 1c).

2.2 Development of the X2000

The X2000 is an ABB train design that employs active car-body tilt and steerable truck technology to traverse curves at higher speeds than would be achievable by conventional designs without compromising passenger comfort and safety.

Developed for the Swedish State Railways (SJ), the specification was designed to provide a train that would allow SJ to increase average speeds thus reducing trip times without the need for the building of a completely new track with a new route alignment.

The X2000 is the result of 20 years of effort researching effective means of instituting coach tilting and truck steering in curves. A wide variety of configurations and tests were conducted over the years utilizing a test car identified as X15.

In 1970, the program was initiated with theoretical research into tilt trains and radial trucks. Following this, an existing electric multiple-unit train, the X15, was fitted with a series of experimental trucks and tilt systems. Trials with this train were carried out between 1975 and 1982. These trials included extensive tests of passenger reaction to tilting, leading to the conclusion that the partial tilt, not fully compensating for cant deficiency, is preferable to full compensation.

By utilizing existing track with certain upgrades of the track structure and signaling system, SJ has chosen to trade off higher maximum speeds, 200 km/h vs. 300 km/h (125 mph vs. 186 mph), that would be attainable with other current high-speed train technology such as the French TGV developed by French National Railways, SNCF, and the German ICE developed by the German Federal Railway, DB, for lower track costs. Although both the TGV and ICE technologies can operate on existing non-high-speed rail lines, operation at their maximum revenue speeds requires a track structure that is more limited in its maximum curvature and that must be completely grade separated at all crossings with

1944
The following information was obtained from the records of the
Department of the Interior, Bureau of Land Management, on
the subject of the land in question.

The land in question is situated in the
County of [] State of [] and is
owned by []

The land is situated in the
Township of [] Range of []
Section of []

The land is situated in the
Quarter of []

The land is situated in the
Quarter of []

The land is situated in the
Quarter of []

The land is situated in the
Quarter of []

other modes. Thus more extensive rebuilding of existing track or, in some cases, completely new right-of-ways is required for the TGV and ICE to reach their full speed potentials.

In August of 1986, after review of various proposals to meet SJ's specifications, ABB was chosen to deliver 20 high-speed tilt-body consists. Each consist contains a power car, four trailing cars, and a driving trailer (see Figure 2). The order by SJ included responsibility for fulfillment of performance reliability and prescribed levels of operational and maintenance costs. These consists will initially serve the 456 km (284 mile) Stockholm to Gothenburg line in under 3 hours (after all signaling upgrades are completed). Service started in September of 1990 with one trainset. The second trainset is to be delivered to SJ from ABB in December 1990, with subsequent delivery of a trainset every other month. SJ plans to utilize the X2000 on other corridors if it proves as successful as current ridership projections indicate.

SJ feels the X2000 presents an option for improved rail service that is affordable. Pricing of the initial service will be somewhere between current rail and air fares. SJ is considering offering only first-class service on the initial trains and thus providing a level of comfort anticipated to be higher than the best air service. The one consist in operation has already had one second-class car replaced with a first-class car due to demand for this premium service.

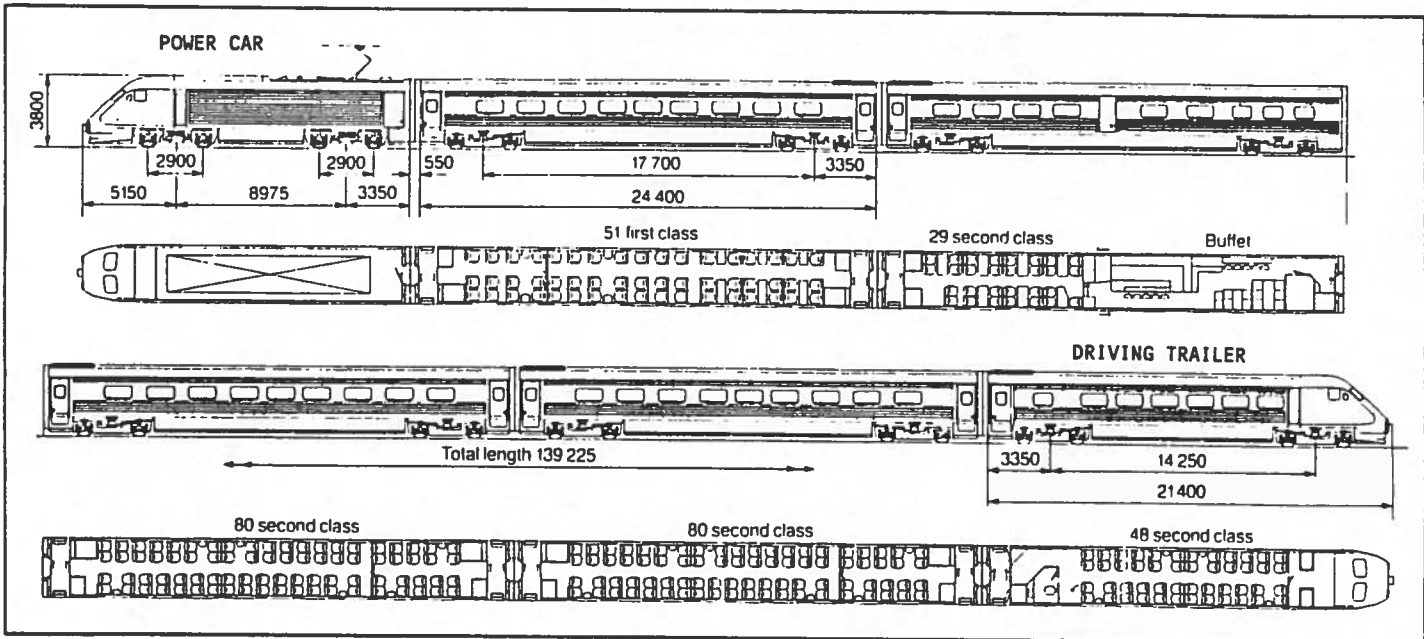

Figure 2 - Swedish State Railways - X2000 Train Consist

3.0 Proposed U.S. Applications:

X2000 based technology is currently being proposed for application in at least two areas of the United States.

3.1 Florida High Speed Rail Act

Although the X2000 operating speed is given as 200 km/h (125 mph), the Florida High Speed Rail Corporation (FHSRC) plans to utilize a variant of the X2000 (whether it will incorporate the tilting system has not yet been determined) to provide high-speed, 240 km/h (150 mph), rail service between Miami, Orlando and Tampa, Florida.

The FHSRC has stated it will meet all current applicable Federal Railroad Administration (FRA) regulations. It should be noted that some clarification may be needed on this subject. An example is whether the current buff strength requirement in 49 CFR 229.141, Body Structure, MU locomotives is considered applicable.

3.2 Northeast Corridor Demonstration

A planned proposal by ABB to the National Railroad Passenger Corporation, Amtrak, to place an X2000 consist in demonstration operation on the Northeast Corridor between Boston, Massachusetts and New York, New York may ultimately be submitted to the FRA for approval. This version of the X2000 would definitely employ the tilting mechanism. Speeds above 177 km/h (110 mph) are not proposed for this demonstration.

ABB proposes to undertake a program of testing to demonstrate that higher curving speeds do not introduce unacceptable risk. In addition to the data already collected from the SJ test program for the X2000, ABB proposes to utilize the SJ instrumented wheelset to demonstrate the safety and comfort of X2000 operation in a variety of speed ranges in the U.S. ABB also expects to show that the forces on the track resulting from X2000 operation at speeds up to 177 km/h (110 mph) will be the same as or less than those for conventional equipment operating at lower speeds. Data available from AEM-7 test runs with instrumented wheelsets will be utilized for this comparison.

4.0 System Description:

This description is based on briefings to FRA and VNTSC personnel at ABB Traction, Västerås, Sweden on June 25 and 26, 1990, observations obtained from riding the X2000 for over 400 km (250 miles) on June 27, 1990, and information contained in the April 1990 issue of International Railway Journal and Jane's World Railways 1988-89.

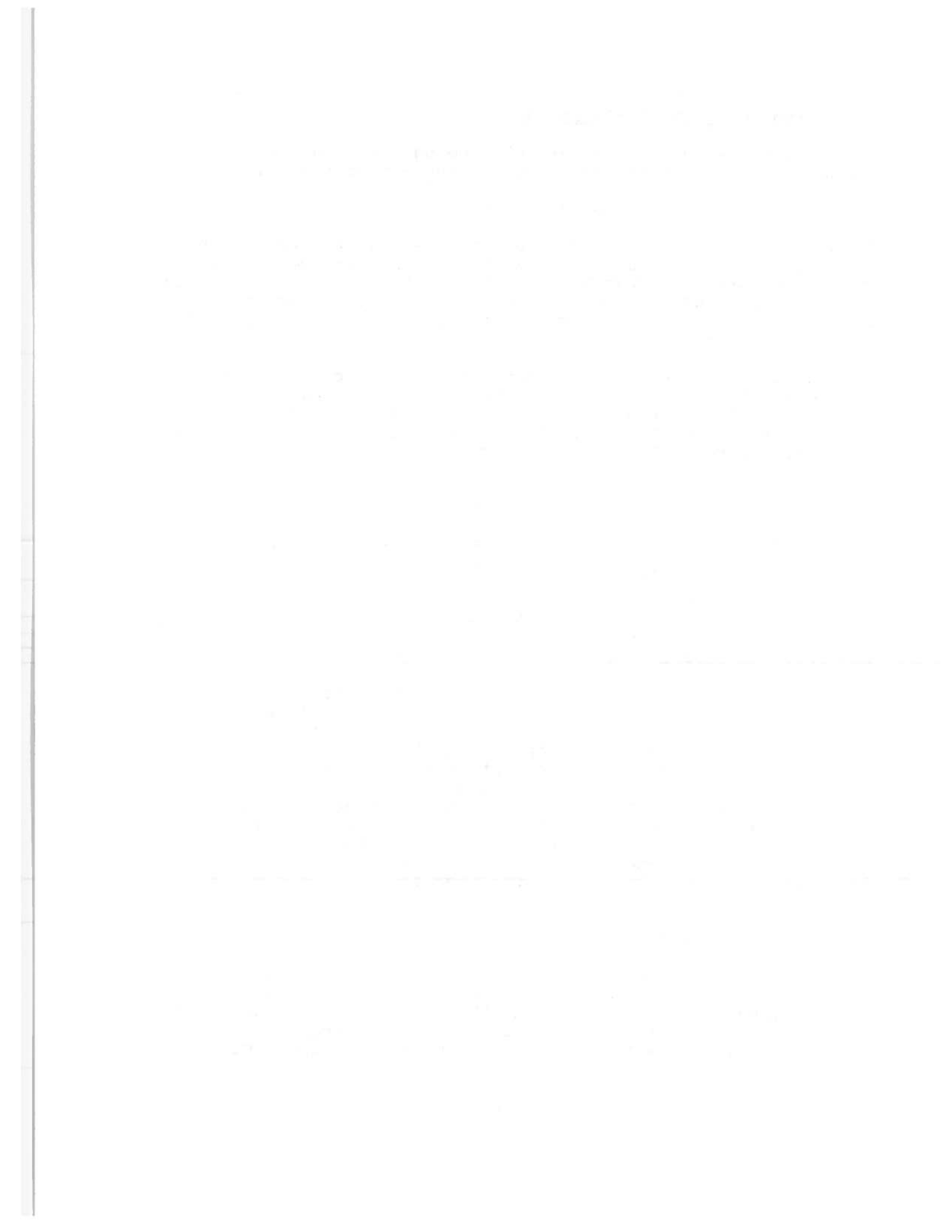

4.1 Specifications

Vehicle top speed - 210 km/h (130 mph)
 Vehicle maximum operating speed - 200 km/h (124 mph)

Tilt system, inactive under 70 km/h (43 mph)
 bogie bolster - bogie frame 8.0 degrees }
 coach body - bogie bolster -0.5 degrees } refer to
 bogie frame - track -1.5 degrees } Figure 3
 max. effective degree of tilt 6.5 degrees }
 effective compensation for lateral forces -0.68
 max. tilt rate - 4 degrees per second

Maximum axle load - 17.5 metric tons (19.3 short tons)
 Maximum tractive effort - 160 kN (36,000 pounds)
 Continuous power rating - 3,260 kW (4,372 horsepower)

Consist:

single power car length	17.4 meters (57 ft)
intermediate coach length	24.4 meters (80 ft)
driving trailer length	22.2 meters (73 ft)
total consist length	137.2 meters (450 ft)
total wt. (w/passengers)	340 metric tons (380 short tons) (760,000 lb)
truck wheelbase	2900 mm (114.2 inches)
vehicle height	3800 mm (149.6 inches)
max. width	3080 mm (121.2 inches)
power car wheel diameter	1100 mm (43.3 inches)
trailer wheel diameter	880 mm (34.6 inches)

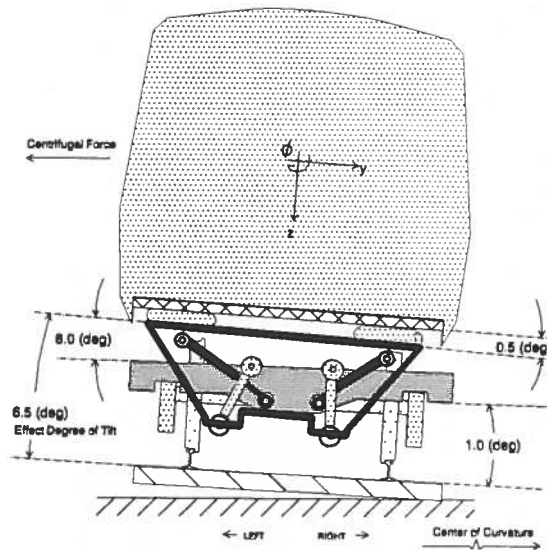
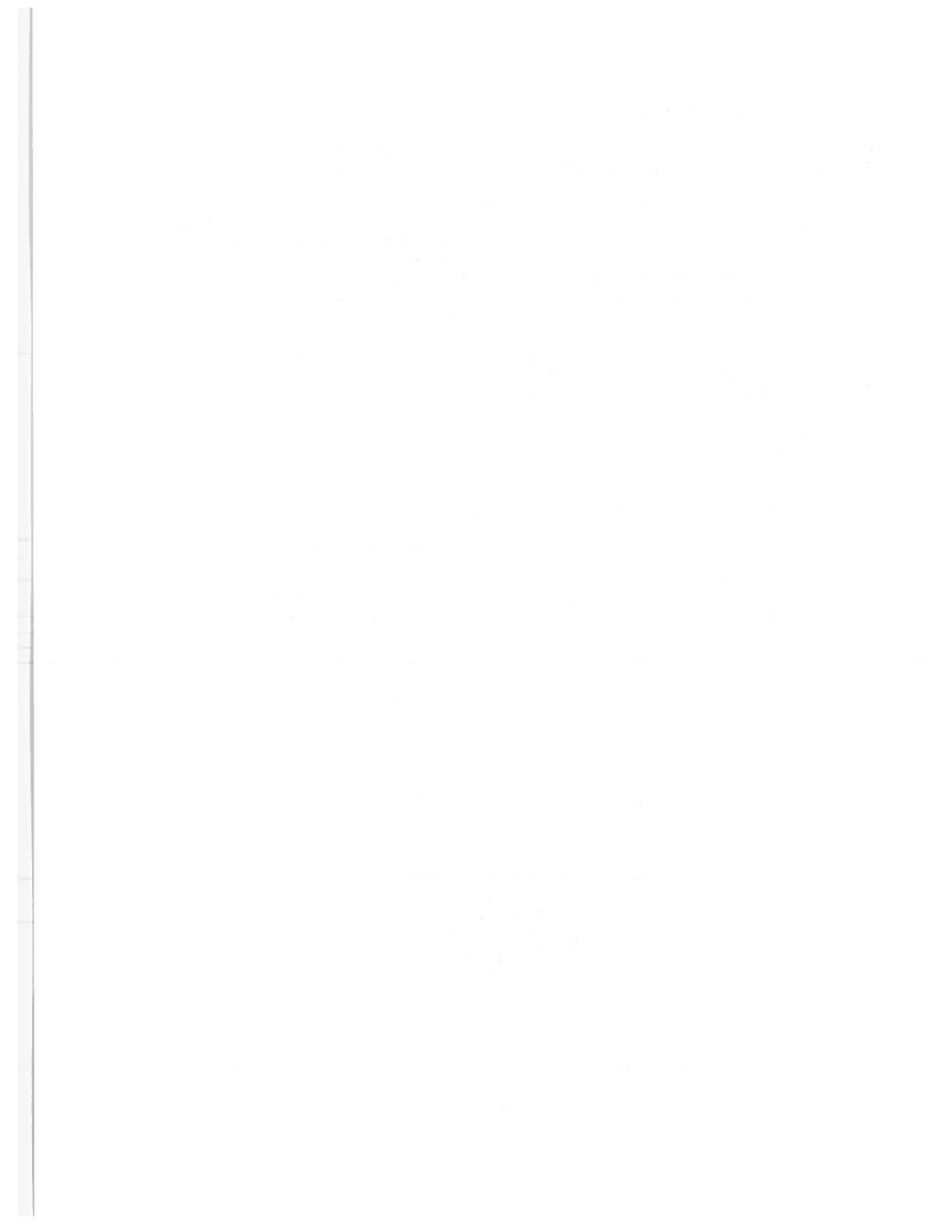

Figure 3 - X2000 Train with Coach Body Tilt System



The X2000 consist has been designed to meet all applicable SJ vehicle and track standards. However, SJ may add to these standards to incorporate issues relevant to the X2000 but not currently covered by existing standards.

4.2 Coach Cars:

In order to maintain passenger comfort while traveling in curves at speeds significantly higher than balance speed (speeds developing 228 mm (9 inches) of cant deficiency), the body of the X2000 coaches is tilted by hydraulic actuators relative to the trucks. The degree of tilt required is computed from measurements of lateral acceleration made on the lead truck of the train consist.

The coach body is made of a steel frame and is designed to meet the UIC 566 buff strength requirements of 203 metric tons (448,000 lb). It was noted by ABB representatives that any equipment built for operation in the United States could be made to conform to the Association of American Railroad's Manual of Standards and Recommended Practices requirement for passenger car buff strength. This standard, for trains over 272 metric tons (600,00 lb) light weight, requires that the passenger car structure be able to resist a minimum static end load of 363 metric tons (800,000 lb) applied on the centerline of draft without developing any permanent deformation in any member of the car structure. This standard also notes that vertical deflection should be kept to a minimum (1/2 to 3/4 inch).

The operator cabs (one at each end) have been designed to withstand impacts of 200 km/h (124 mph) from cylinders weighing 5 and 10 metric tons (5.5 and 11 short tons) (having widths of 2 and 4 meters (79 and 157 inches) respectively) located on the centerline of the track at a point 1.8 meters (71 inches) above top of rail. The current vehicle design intent is to prevent penetration of passenger areas and limit destruction to non-passenger areas. The train operator is expected to move behind a crash wall located at the rear of the operating cab prior to impact.

Modular construction is utilized via an open roof to drop in components. SJ has specified no pinch points or sharp corners on the interior or door areas. Overhead luggage racks with a lip of approximately 75 mm (3 inches) are provided for luggage storage. It appears this lip is designed to retain stored luggage within the rack area. The floor is wood and is isolated from the steel frame for noise reduction purposes. The wood floor is jacketed by steel sheets for fire barrier purposes.

Side windows are multilayer safety glass per IEC 529 and BSI 5490 standards. See 49 CFR 223 for U.S. standard (discussed on page 11). These windows are sealed and sized to reduce risk of injury

1. The first part of the document discusses the importance of maintaining accurate records of all transactions. It emphasizes that this is crucial for ensuring the integrity of the financial statements and for providing a clear audit trail.

2. The second part of the document outlines the various methods used to collect and analyze data. It includes a detailed description of the sampling process and the statistical techniques employed to interpret the results. The goal is to ensure that the data is representative and that the conclusions drawn are statistically sound.

3. The third part of the document provides a comprehensive overview of the findings. It details the key trends observed in the data and discusses the implications of these findings for the organization. The analysis shows that there are significant areas for improvement, particularly in the areas of cost control and operational efficiency.

4. The final part of the document offers recommendations for future action. It suggests specific measures that can be taken to address the identified issues and to improve the overall performance of the organization. These recommendations are based on the findings of the study and are designed to be practical and achievable.

5. In conclusion, the document highlights the value of a thorough and systematic approach to data analysis. It stresses that by following the outlined procedures, organizations can gain valuable insights into their operations and make informed decisions that lead to improved performance and profitability.

6. The document also includes a section on the limitations of the study. It acknowledges that there are certain constraints on the data and the analysis, and it discusses how these limitations might affect the results. This section is important for providing a balanced view of the findings and for setting realistic expectations for the future.

7. Finally, the document provides a list of references and a bibliography. These references include the key sources of information used in the study, as well as other relevant works in the field. This section is essential for ensuring the credibility and transparency of the research.

during a derailment. Currently small hatchets are located in each car for breaking windows if necessary for evacuation. These hatchets may be subject to pilferage or misuse. SJ may require emergency windows in the near future and is giving serious consideration to removing these hatchets. Wind tunnel tests to determine the effects of high-speed operation on such windows have already been completed.

Seat securement tests of the seats have been conducted at up to 9 g's. Actual g forces during operations should never exceed 3 g's but in collision and accident scenarios can approach 5.0 g's.

Heat and smoke sensors are located throughout all cars including areas such as battery compartments and hydraulic pump and reservoir locations. The battery fan also controls the battery charger thus eliminating the chance of explosive gases building up. Ventilation in the vehicles is automatically shut off if a fire is detected.

Trucks contain two disks per axle for service braking and two magnetic rail brake elements per truck that are utilized along with the disks to attain a higher deceleration rate for emergency braking purposes.

Two air lines run the length of the consist, the air brake and the main reservoir lines.

4.3 Power and Driving Trailer Cars

The power car has radial trucks but is not equipped with the tilting mechanism. It contains oil-cooled electronic elements and is equipped with an automatic CO² fire suppression system. A water-cooled version for cooling is under development. The base of the transformer is located below the floor to achieve a low center of gravity.

The driving trucks are designed to reduce the unsprung mass. Friction brake surfaces are located on the inside of the wheels; no magnetic rail brakes are located on the power car. The driving trailer is ballasted with 5 to 6 metric tons (5.5 to 6.6 short tons) to "keep the vehicle on the rail" during extreme weather conditions in the driving trailer ahead configuration. The trucks at each end of the consist are equipped with safety bars 120 mm (4.7 inches) above top of rail to keep any debris on the right-of-way away from the trucks or wheels.

Each powered truck has a traction bar connected to it for transferring tractive effort from the powered truck to the car body. According to ABB representatives these bars are located below the centerline of the truck to improve vehicle dynamics and

194- [Illegible text]

[Illegible text]

[Illegible text]

[Illegible text]

[Illegible text]

[Illegible text]

[Illegible text]

are safety hung to avoid the possibility of a bar contacting the right-of-way in the event of a primary securement failure.

4.4 Tilting System

Two identical accelerometers are mounted in the center of the lead truck of the consist to measure the lateral acceleration and degree of imbalance. The signals from the accelerometers are compared to each other to assure they are making accurate measurements. If the signals do not match, the tilting system is automatically turned off and the train speed is reduced.

Both the power car and driving trailer (operating cab with the passenger compartment immediately behind the cab) have this two accelerometer setup; but, only the signals from the leading end of the consist are utilized. They provide a signal proportional to the lateral acceleration of the truck; the signal is then sent through low pass filters to avoid reacting to discrete track irregularities. When the power car (the power car does not tilt) is leading, this method allows sufficient time for the first passenger occupied car (the second car in the consist) to tilt as the curve is entered, leading to a smooth transition for passenger comfort. The master computer (refer to Section 4.6 for details) directs slaves computers located in each car of the consist with tilt commands based on the accelerometer data as well as speed and distance calculations. In addition to a direct link to the master computer, each slave computer communicates with slave computers in adjacent cars. Thus, if communication with the master computer is lost by a specific car in the consist, the car will tilt based on information from adjacent cars as to what the master computer is commanding for tilt compensation. During tilt operation, tilt angles are monitored to assure correct operation of the system.

When the driving trailer leads, a delay is experienced between entering the curve and fully employed active tilt on the driving trailer. This delay in curving force compensation can cause instability to a passenger who happens to be walking in the aisle of the driving trailer at that moment. When sitting, the effect appears negligible.

To date the train has never tilted opposite the direction intended. However, this scenario has been evaluated by forcing a maximum tilt opposite the desired direction while operating through a curve at a speed requiring maximum compensation. Although details were not available, ABB representatives stated no unsafe conditions (other than rider discomfort) were detected during this test.

THE UNIVERSITY OF CHICAGO

PHYSICS DEPARTMENT

PHYSICS 350

LECTURE 1

MECHANICS

PROBLEM SET

DATE

4.5 Steerable Trucks

In order to maintain acceptable wheel-rail force levels and lateral-to-vertical force ratios in negotiating curves, the X2000 power car and coaches utilize soft primary longitudinal suspensions (elastomeric chevrons) in the fabricated truck design. The soft longitudinal suspension of the axle permits the wheel rail forces to generate a self-steering action which causes the axles of the truck to become more closely aligned with the curve radius of the track. This has the effect of reducing the wheel rail forces and the lateral/vertical ratios that would be critical to safety from those that would occur in a conventional truck. The truck design is similar to the X10 vehicle used by SJ for suburban service in Stockholm, Gothenburg and Malmö, except the primary elements of the X2000 are "softer."

4.6 Braking System

The braking system consists of air, dynamic regenerative, and magnetic rail brakes. The air brake system is electro-pneumatically controlled.

- power car: disc (pads contact rim of driving wheels), tread, and electric regenerative (dynamic braking) - three phase AC - no brake grids - if the power grids will not accept the power, dynamic braking is not used
- other cars: disc (pads contact axle mounted discs, two per axle), and magnetic track rail brakes (emergency only) these brakes do not affect the track circuits - they are dc field - current and pressure sensor output is provided to the train operator - SJ train operators have requested a separate button to activate the track rail brakes

The control cab has both an electronic emergency brake button which activates all available brakes and a backup manual air release emergency brake valve for activating all air operated brake systems. Three emergency brake valves are located in each car, one at each end and one at an interior partition.

For service brake applications, the train operator can choose between air or blended (air and dynamic). During blended operation, if dynamic braking is not available, automatic compensation is made by the brake system. Both braking options were noted as extremely smooth during the observed run of the X2000, no slack action was discernible.

The first part of the document discusses the importance of maintaining accurate records of all transactions. It emphasizes that every entry should be supported by a valid receipt or invoice. This ensures that the financial statements are reliable and can be audited without issue. The document also mentions that the records should be kept for a minimum of seven years, as required by law.

In addition, the document outlines the procedures for handling discrepancies. If there is a difference between the recorded amount and the actual amount, it is crucial to investigate the cause immediately. This could be due to a clerical error, a missing receipt, or a more serious issue like fraud. The document provides a step-by-step guide on how to identify and correct these errors, ensuring that the books are balanced and accurate.

The second part of the document focuses on the preparation of financial statements. It details the steps involved in calculating the net profit or loss for the period. This involves summing up all revenues and subtracting all expenses. The document also explains how to calculate the gross profit and the operating profit, providing formulas and examples for each. It stresses that these statements are essential for understanding the financial health of the business.

Finally, the document discusses the importance of regular reviews and audits. It suggests that the financial records should be reviewed at least once a month to catch any errors early on. An annual audit by a professional accountant is also recommended to ensure compliance with tax laws and to provide an independent opinion on the accuracy of the financial statements. The document concludes by stating that maintaining good financial records is a key to the success and longevity of any business.

Stopping Distances from 200 km/h (125 mph) to zero speed

Specification	1.75 km (5742 ft)
Service	1.45 km (4757 ft)
Emergency	1.1 km (3609 ft)

Stopping Distances from 160 km/h (100 mph) to zero speed

Specification	1.1 km (3609 ft)
Service	0.95 km (3117 ft)
Emergency	0.65 km (2133 ft)

Stopping Distances from 130 km/h (80 mph) to zero speed

Specification	0.7 km (2297 ft)
Service	0.6 km (1969 ft)
Emergency	0.5 km (1640 ft)

4.7 Computer Control

Many microprocessors are used to control various aspects of the X2000's operation. The master computer (superior computer) is located in the power car's machine room and controls various subordinate computers for the braking system, cab control, and converter control. All axles contain speed sensors for wheel slip control and other purposes. Other computers in the consist are:

- slave computers for tilt control - each coach (also used for skid control and door operation)
- single-board slave computer in train operator's compartment to transmit train operator commands
- single-board computer mounted in air brake rack of power car to received braking requests from the train operator or automatic train control system and control the automated portions of the braking system

The automatic train control system (ATC) will automatically stop the train if the train operator fails to keep the train within the proper speed range 10 km/h (6 mph) in excess of the speed is allowed, a warning sound and light comes on at 5 km/h (3 mph) in excess of the allowed speed. The ATC system will also stop the train if the train operator fails to activate the alerter at least once per minute. The ATC system will also automatically stop the train if gates at a grade crossing are not down in time or if presence of a vehicle on the crossing is detected by an automated induction loop vehicle detection system.

The ATC is an intermittent system that uses fixed position transmitters and receivers in the track to transfer data between wayside and train at specific locations. However, future plans are for the ATC to also utilize the train radio for data transfer

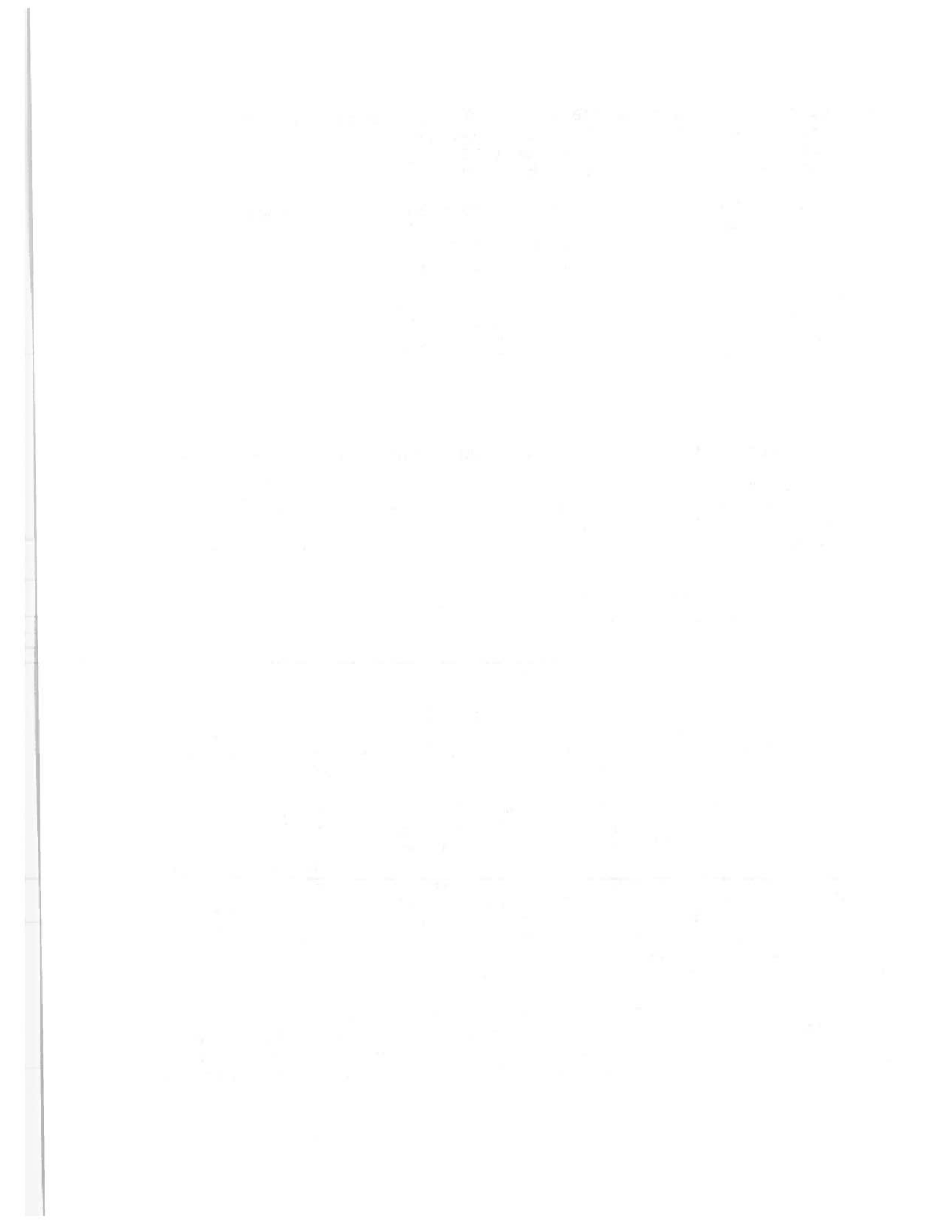

and thus avoid the data transfer delay disadvantage of an intermittent system.

4.8 Options Under Consideration by SJ

Additional intermediate car - The consist as designed is one power car and five coaches. One additional coach can be added without significant loss of acceleration capability and top speed capability is maintained. The specified auxiliary power load limits the train to six trailer cars.

Power car at each end - This configuration will allow for higher performance, or additional cars (up to 12 coaches) with no degradation in performance, as opposed to power car/driving trailer configuration. The high voltage line will be unnecessary for the length of train at the 12-car configuration as operation of pantographs at each end will be possible.

Coupled train consists - This option may be limited by the size of the coupled trainsets and the resulting higher localized amperage demand on portions of the catenary power transmission system. If catenary limitations exist, lower upper speed limits may be used to reduce trainset energy demands to acceptable levels until the catenary system is upgraded to the new requirements.

5.0 Compliance with Existing Regulations:

The X2000 is a high-speed rail train intended for operation on conventional track systems. Operation on conventional track, at 200 km/h (125 mph) is accomplished through the radial (self-steering) trucks and car-body tilting mechanism incorporated in each vehicle. With the exception of the radial (self-steering) trucks and car-body tilting mechanism, the X2000 is similar in design to conventional trains operating in the United States. This commonality with existing rail systems means the type of accidents that will occur with the X2000 will be similar to those of existing rail systems. The frequency or severity of the accidents may, however, differ from existing systems if the X2000 does not comply, where applicable, with the FRA regulations and guidelines.

5.1 FRA Regulations

FRA standards and guidelines that the X2000 design must comply with are summarized below. Regulations that can be applied uniformly, regardless of technology, such as radio operation, operating rules, and inspection and maintenance requirements and site-specific requirements are not covered in this report.

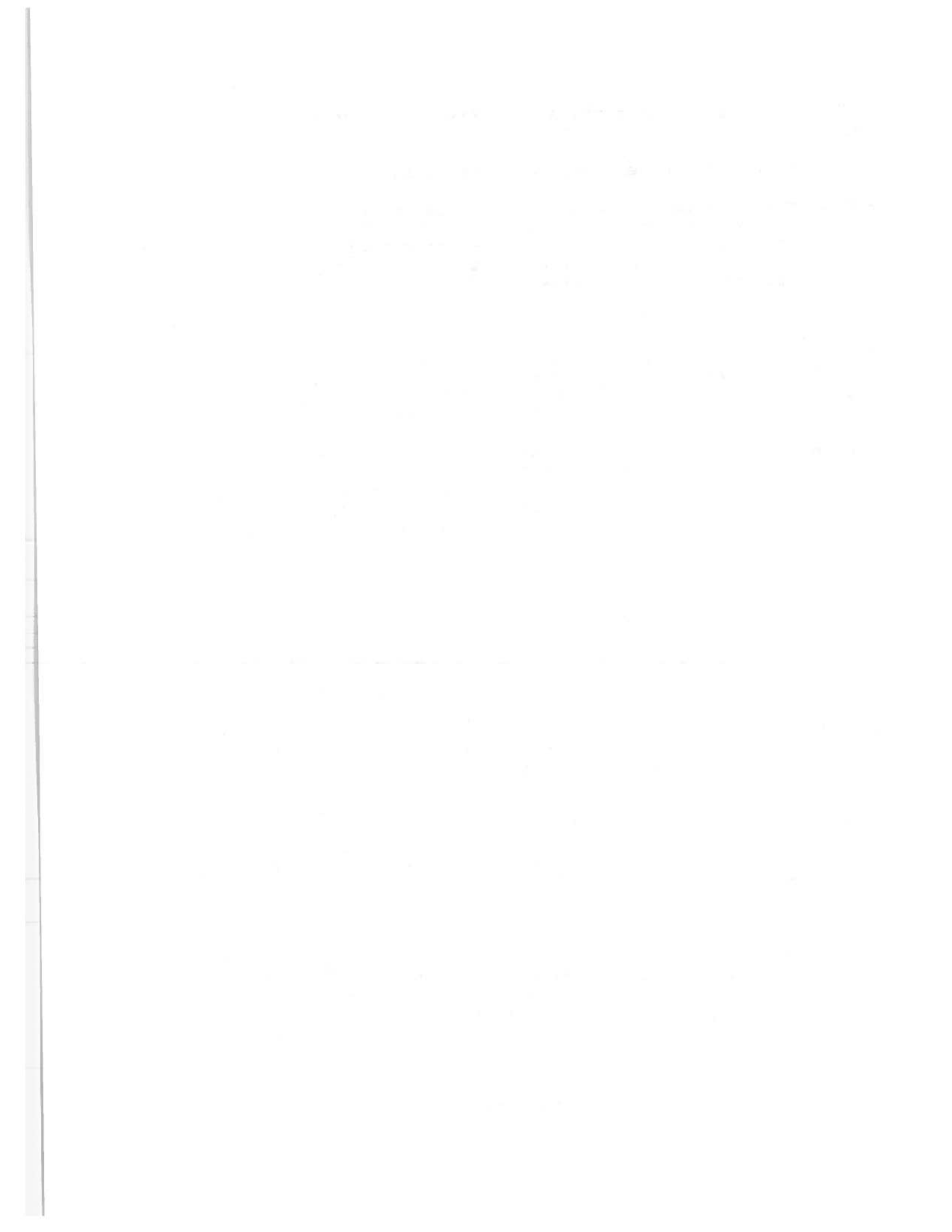

Part 210 Noise Emission Compliance Regulations

Information provided by SJ noted that the noise emitted by the train measured at 25 meters (82 ft) at 200 km/h (125 mph) was no greater than a conventional train at 130 km/h (80 mph). Actual noise data was not available. Due to the relatively streamlined profile of the consist and considering the similarity of the power car to the AEM 7 locomotive used by Amtrak, it is unlikely the X2000 consist will generate more exterior noise at 200 km/h (125 mph) than an AMTRAK train traveling at the same speed.

Part 213 Track Safety Standards

FRA track geometry standards are based on the 18.9 meter (62 ft) chord measurement, whereas SJ bases its track geometry measurements on a 10 meter (33 ft) chord.

The X2000 development in Sweden has included the measurements of wheel rail forces using SJ instrumented wheelsets over selected track segments to determine the impact of the higher speeds and cant deficiencies on the track structure. These measurements must be integrated with track geometry measurements to fully understand the results. It is possible for track geometry irregularities that are not readily detectable by the chord measurement systems to produce significant forces for particular truck designs. For example, the mid-chord offset from a 18.9 meter (62 ft) chord measurement attenuates misalignment variations at wavelengths larger than 18.9 meters (62 ft). ABB engineers were particularly concerned about misalignment variations at wavelengths of about 30 meters (98 ft) which have the effect of producing large lateral forces at the operating speed of the X2000 but are not readily observed in the normal SJ track geometry measurements.

Therefore, any demonstration of the X2000 in the U.S. should include use of instrumented wheelsets and detailed track geometry data to accurately characterize the wheel rail forces during operation on actual track segments.

Part 221 Rear End Marking Device

The actual "effective intensity" of the rear markers was unavailable. However rear markers are present on the train, are described as automatic and modification to the required intensity, if not adequate, should not be difficult.

The first part of the report deals with the ...

In the second part, we discuss the ...

The third part of the report is devoted to ...

Finally, we conclude with some ...

The results of the study are ...

In conclusion, the study shows ...

**Part 223 Safety Glazing Standards - Locomotives,
Passenger Cars and Cabooses**

Front windshields have been tested for an impact of 330 km/h (300 ft/sec) with a 900 grams (2 lb) object at 5 degrees C. Windshields have been designed to meet the American National Standards Safety Code for Safety Glazing Materials for Glazing Motor Vehicles (ANSI Z 26.1) and the Uniform provisions concerning the approval of safety glazing materials (ECE R 43).

FRA regulations require that the front windshield be able to withstand an impact by a 10.88 kg (24 lb) 20.3 cm (8 in) x 20.3 cm (8 in) object with a speed of 48.27 km/h (44 ft/sec) and a 22 caliber, 40 grams (1.4 oz), bullet at 1053 km/h (960 ft/sec) with no penetration.

Although the different requirements cannot be compared directly, it is of interest to note that the kinetic energy of a 900 grams (2 lb) 330 km/h (300 ft/sec) impact is greater than the kinetic energy of a 10.88 kg (24 lb) 48.27 km/h (44 ft/sec) impact.

The X2000 consist evaluated may not meet the FRA windshield requirements and does not meet the side window requirements. However, ABB personnel noted they intend to meet all safety glazing requirements required of the FRA for any U.S. application.

There is concern with the present design of the X2000 as to the lack of window exits and the multilayer safety glass that requires a small hatchet located in the passenger compartment. However, if the windows are brought into compliance with 49 CFR 223.9 four exits per car will be provided per car and the need for the hatchet should no longer exist.

Part 229 - Railroad Locomotive Safety Standards

Enough detailed information was not available to make a complete determination as to the compliance of the X2000 power car with the entirety of this part. Although specifics on seat securement were not available, the seat appeared well secured, the power car headlight appeared bright but actual candela output was not available, and the like. The air brake system represents the same basic concept as those in the U.S. that comply with this regulation and emergency brake valves were located in the cab. Thus, in general, it appears the X2000 power car will meet most, if not all, of the requirements of this regulation. Also, it appears that if some elements of the X2000 power car, such as side window glazing, do not comply with parts 223 and 229, bringing them into compliance should not be difficult for the manufacturer.

The following table shows the results of the experiments conducted on the reaction of hydrogen peroxide with various metal ions in the presence of a catalyst. The reaction was carried out at a constant temperature of 25°C and a constant concentration of hydrogen peroxide of 0.01 M. The rate of reaction was measured by the volume of oxygen gas evolved over a period of 10 minutes.

Metal Ion	Rate of Reaction (ml O ₂ /min)
Cu ²⁺	1.2
Fe ²⁺	0.8
Mn ²⁺	0.5
Ni ²⁺	0.3
Zn ²⁺	0.2
Co ²⁺	0.4
Pb ²⁺	0.1
Ag ⁺	0.05
Hg ²⁺	0.02

The results indicate that the rate of reaction increases with the concentration of the metal ion, and that the most active catalyst is Cu²⁺. The reaction is also catalyzed by Fe²⁺, Mn²⁺, Ni²⁺, Zn²⁺, Co²⁺, Pb²⁺, Ag⁺, and Hg²⁺, but the rate of reaction is much lower for these ions.

SJ information provided notes a noise level of 70 dB(A) in the train operators compartment. This level is well within FRA requirements under this part.

The control cab has the configuration of the new cab designs being adopted by Amtrak and some U.S. freight railroads. The cab design reflects an emphasis on train operator comfort. The seats can be adjusted for height and have a shock absorber type mounting, sunscreens are effective and easily deployed, controls are laid out in a straightforward manner and are all within reach of the seated train operator, and ventilation appears excellent. Visibility of the control panel and right-of-way compares favorably with U.S. locomotives. Mirrors for observation of passenger loading by the train operator are deployed at low speed and retract automatically when the train reaches 70 km/h (44 mph). They may be retracted manually at speeds below 70 km/h (44 mph).

For the SJ application, the train operator of the X2000 will be the "captain" of the train and will be in charge of all components including the tilt system.



X2000 Train Operator's Console

1. The first part of the document discusses the importance of maintaining accurate records of all transactions.

2. It is essential to ensure that all entries are supported by appropriate documentation and receipts.

3. Regular audits should be conducted to verify the accuracy of the records and to identify any discrepancies.

4. The second part of the document outlines the procedures for handling disputes and resolving conflicts.

5. It is important to establish clear communication channels and to resolve issues promptly and fairly.

6. The final part of the document provides a summary of the key points and offers recommendations for future actions.

7. It is hoped that these guidelines will help to improve the efficiency and effectiveness of the organization's operations.

8. The document is intended to serve as a reference for all staff members and to ensure consistency in the way business is conducted.

9. Please contact the relevant department if you have any questions or require further information.

10. Thank you for your attention and cooperation in implementing these guidelines.

11. The document is effective from the date of its issuance and will be reviewed periodically to ensure its relevance.

12. For more information, please refer to the attached documents or contact the relevant department.

13. The document is classified as internal and should be handled accordingly.

Clearance for the X2000 above top of rail is 120 mm (4.7 in), well above the FRA minimum limit of 63.5 mm (2.5 in) above top of rail.

It was also stated by ABB representatives that the consist, as presented for U.S. use, would be able to meet the design requirements of this part.

Part 231 Railroad Safety Appliance Standards

There are no handholds and emergency handbrakes on the X2000. The requirement to add handholds should not affect the profile clearance of the X2000 due to the tilting profile required. It is unclear what implication the requirement for handbrakes would have on the consist.

Part 232 Railroad Power Brakes and Drawbars

The height from top of rail to center line of the drawbar (with new wheels) is 1025 mm (40.34 in) for the X2000. Although this is not within the spread of 800 mm to 876 mm (31.5 in to 34.5 in) specified for freight cars by this part, this part does not specify any specific requirement for passenger cars.

Part 236 Rules, Standards, and Instructions Governing the Installation, Inspection, Maintenance, and Repair of Signal and Train Control Systems, Devices and Appliances

It is beyond the scope of this report to cover the broad topic of a completely new signal control system as may be applied in the Florida application of this technology.

However, it is apparent that the train control system currently on board the X2000 will be modified for any U.S. application. If the X2000 was placed in service on the Northeast Corridor, it would have to be adapted to meet the current Amtrak and FRA operating requirements for the Corridor and be compatible with Amtrak's train control systems.

If the Swedish concept of operation over at-grade highway crossings at 200 km/h (125 mph) is adopted, additions will be necessary to this part to reflect the requirements for additional crossing protection systems and the vital or critical interface with the signal control system. For example, the inductive loop vehicle presence detector cited earlier. Also, as most of these systems are microprocessor-based, regulations as to microprocessor safety verification (both software and hardware) are also needed.

1950

...

...

...

...

...

...

...

...

...

...

...

...

5.2 FRA Guidelines

FRA Docket No. RSPC-84-1, Notice 3 Guidelines for Selecting Materials to Improve Their Fire Safety Characteristics

The fire safety characteristics of the materials used in the construction of railroad vehicles are addressed in these FRA guidelines. These guidelines provide performance criteria for the flammability and smoke emission characteristics of the materials. The materials in the existing X2000 are not believed to meet these criteria (per an ABB representative). This is not a major problem as the vehicle to be constructed and deployed in the United States can be built to meet these guidelines.

Relative to fire/smoke detection and suppression, the FRA has no guidelines. However, smoke detectors (ion particle) and hand-held fire extinguishers are contained in the X2000 occupant compartment. Most rail vehicle fires are initiated under the vehicle. This situation will also be true with the X2000. The high voltage and other major ignition sources of the X2000 are under the vehicle floor. Fire detectors and alarms are provided in electrical cabinets and should be required at specific locations under the vehicle floor.

5.3 Americans with Disabilities Act

The X2000 will have to comply with this act and provide accessibility for elderly and disabled passengers.

5.4 Potential Regulatory Issues

Occupant Compartment Appointments

Issues that should be considered but are not specifically addressed in the existing FRA regulations relative to the interior vehicle appointments are methods of emergency egress from the vehicle, securement of packages in overhead racks (particularly important in view of the tilting) and signage.

Equipment Limitations

The use of radial self-steering trucks limits the maximum speed that could be achieved by the X2000 design on tangent track to about 240 km/h (150 mph) without developing self-excited lateral and yaw oscillations (hunting).

Current high-speed technology for speeds higher than 200 mph, such as the French TGV and the German ICE, uses truck designs which employ stiff primary suspensions to avoid hunting oscillations and permit very high speeds on tangent track. The stiff primary suspensions tend to generate large wheel rail forces and lateral to vertical force ratios in curves. These



1. The first part of the document discusses the importance of maintaining accurate records.

2. It then goes on to describe the various methods used to collect and analyze data. The results of these studies are presented in the following sections.

3. The data shows a clear trend towards increased efficiency in the process. This is due to the implementation of new technologies and procedures.

4. In conclusion, the findings of this study are significant and provide valuable insights into the current state of the industry.

high-speed trains would be acceptable for routes where there are a minimal number and degree of curves.

6.0 Summary:

Two major items differentiate the X2000 from passenger train designs currently operated in the United States, tilting and steerable trucks. The active tilting feature helps to maintain high passenger comfort levels, not safety, while the train negotiates curves at higher unbalance speeds. The use of steerable trucks is designed to allow for operation at higher unbalanced speeds through curves by maintaining wheel rail forces within safe limits.

Both tilting trains and higher cant deficiencies than allowed in the United States are currently utilized in several other countries.

Also, much data already exists as to the wheel rail forces that result from tilt train and higher than current limits of cant deficiency operation on portions of the Northeast Corridor between Boston and New York. Equipment tested in both the early and late 1980s has included the Canadian LRC active tilting train, Amfleet equipment, RTL and RTC turbo trains, and the Spanish Talgo passive tilting train.

The train operator's console exceeds U.S. industry practices in terms of ergonomics and cabin noise standards. Visibility for the train operator is good, seats are fully adjustable, and the overall cab design takes the train operator's comfort and job requirements into account. Mirrors for observation of passenger loading and unloading are deployed at low speed and retracted automatically at higher speeds.

The brake system operates smoothly and effectively. Stopping distances for emergency applications are well within U.S. accepted standards. The fully manual backup of the air brake portion of the brake system provides the same level of fail-safe design as current Amtrak trains.

Modification of the X2000 interior to meet various U.S. regulations, standards or guidelines for interior issues such as flammability standards, luggage retention, elderly and disabled access and emergency access and egress should not be difficult. To some degree, elderly and disabled access and facilities are provided on the train.

Several site-specific issues may be associated with the deployment and test of the X2000 in the United States. The present test operations on the Swedish State Railways track provide an insight into some of the physical aspects of the

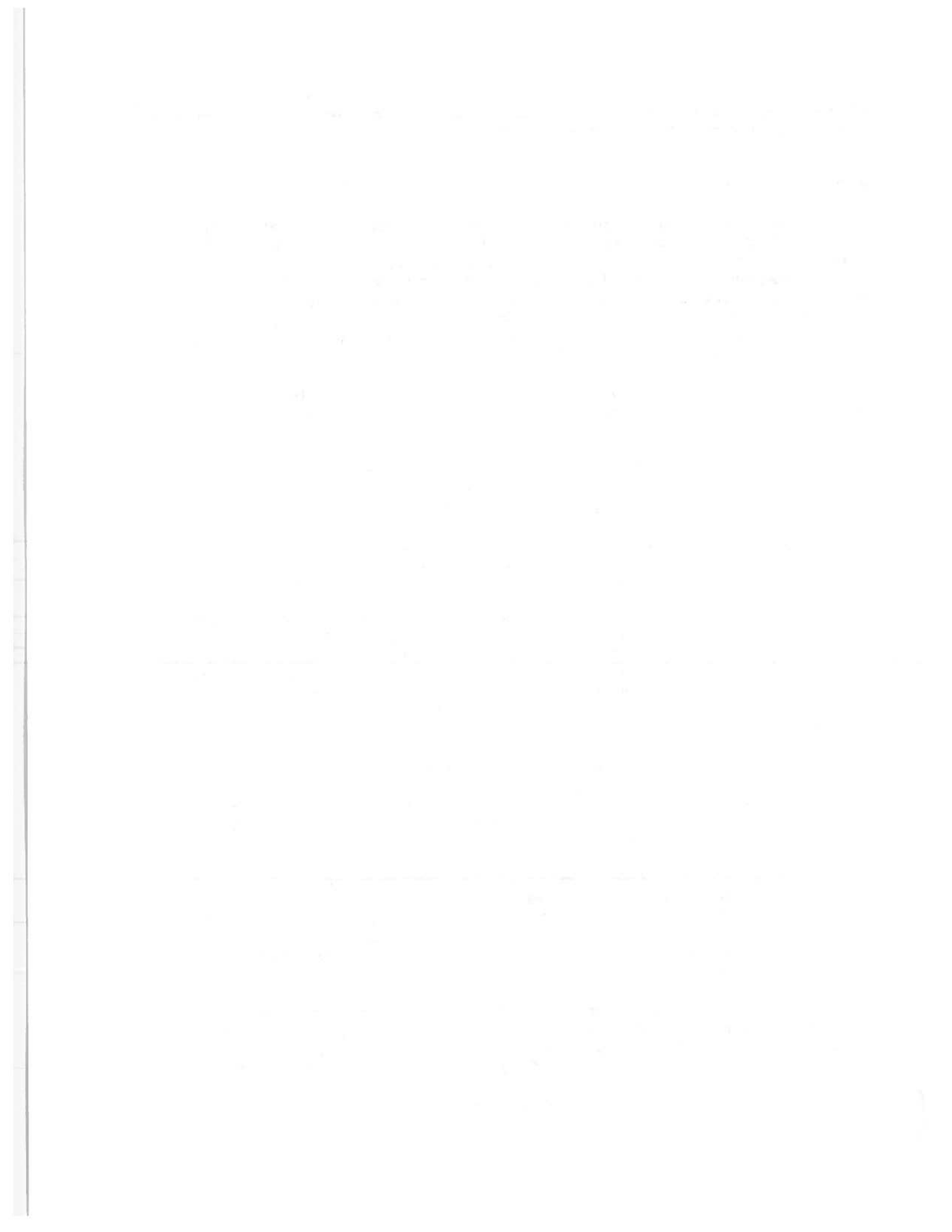

environmental issues. Operations in a physical environment containing grade crossings, track conditions, and snowy climate, flat topography, etc., are similar to those in Sweden. Social issues such as personnel, employee and equipment security, vandalism, arson, graffiti, etc., are more prevalent in the United States and should be considered. Finally, institutional issues such as the type of operation, private ownership, governmental, quasi-governmental and the safety oversight provided need to be addressed for site-specific requirements.

Faint, illegible text at the top of the page, possibly a header or title.

A faint horizontal line of text or a separator across the middle of the page.

Large block of very faint, illegible text at the bottom of the page.

Bibliography

An Assessment of High-Speed Rail Safety Issues and Research Needs, Federal Railroad Administration, Office of Research and Development, DOT/FRA/ORD-90/04, May 1990.

Manual of Standards and Recommended Practices, Section A, Part III, Passenger Car Requirements, Association of American Railroads, Operations and Maintenance Department, Mechanical Division, 1984.

Code of Federal Regulations, Title 49, Transportation, Parts 200 to 399, Office of the Federal Register, 1988.

Jane's World Railways, 1988-1989, 13th Edition, Geoffrey Freeman Allen, editor, Jane's Information Group Limited, Surrey, United Kingdom, 1989.

Safety of High Speed Magnetic Levitation Transportation Systems, Preliminary Safety Review of the Transrapid Maglev System, Federal Railroad Administration, Office of Research and Development, DOT/FRA/ORD-90/09, August 1990.

"Tilting Train Is SJ's Survival Tool," International Railway Journal, April 1990.

